



US006009469C1

(12) EX PARTE REEXAMINATION CERTIFICATE (8207th)

United States Patent
Mattaway et al.

(10) Number: US 6,009,469 C1
(45) Certificate Issued: May 10, 2011

- (54) GRAPHIC USER INTERFACE FOR INTERNET TELEPHONY APPLICATION
- (75) Inventors: Shane D. Mattaway, Boca Raton, FL (US); Glenn W. Hutton, Miami, FL (US); Craig B. Strickland, Tamarac, FL (US)

4,468,529 A 8/1984 Samuel et al.
 4,491,693 A 1/1985 Sano et al.
 4,528,659 A 7/1985 Jones, Jr.
 4,589,107 A 5/1986 Middleton et al.

(Continued)

FOREIGN PATENT DOCUMENTS

- (73) Assignee: Net2Phone, Inc., Newark, NJ (US)

AU 200059377 A1 11/2000
 AU 200059378 A1 11/2000
 AU 200059379 A1 11/2000
 EP 0455402 A2 11/1991
 EP 0497022 A1 5/1992

(Continued)

Reexamination Request:

No. 90/010,422, Feb. 26, 2009

Reexamination Certificate for:

Patent No.: 6,009,469
 Issued: Dec. 28, 1999
 Appl. No.: 08/721,316
 Filed: Sep. 25, 1996

OTHER PUBLICATIONS

The Open Group, Technical Standard, *Protocols for X/Open PC Interworking: SMB, Version 2*, 1992, pp. ii-xvi and pp. 1-516.

Zellweger, Polle T., et al., *Etherphone: Collected Papers 1987-1988*, Xerox Corporation, May 1989.

Vin, Herrick M., et al, *Multimedia Conferencing in the Etherphone Environment*, Oct. 1991, pp. 69-79.

Droms, R., *Dynamic Host Configuration Protocol, RFC 1531*, Bucknell University, Oct. 1993, pp. 1-39.

U.S. Patent No. 5533110 issued to Pinard, et al. ("the Pinard patent").

(Continued)

Primary Examiner—Alexander J Kosowski

Related U.S. Application Data

- (63) Continuation-in-part of application No. 08/533,115, filed on Sep. 25, 1995, now Pat. No. 6,108,704.
- (60) Provisional application No. 60/025,415, filed on Sep. 4, 1996, and provisional application No. 60/024,251, filed on Aug. 21, 1996.

- (51) Int. Cl.
 H04M 1/72 (2006.01)
 H04M 1/65 (2006.01)
 H04M 1/66 (2006.01)

- (52) U.S. Cl. 709/227
- (58) Field of Classification Search None
 See application file for complete search history.

References Cited

U.S. PATENT DOCUMENTS

4,313,035 A 1/1982 Jordan et al.
 4,332,982 A 6/1982 Thomas
 4,410,765 A 10/1983 Hestad et al.
 4,423,414 A 12/1983 Bryant et al.
 4,446,519 A 5/1984 Thomas
 4,450,554 A 5/1984 Steensma et al.

(57) ABSTRACT

A communication utility for establishing real-time, point-to-point communications between processes over a computer network includes apparatus for querying a server as to the network protocol address of another client process, and apparatus for directly establishing a communication link with the client process upon receipt of the network protocol address from the server. In one embodiment, the utility includes a sophisticated user interface having features similar to typical telephony hardware but implementing greater flexibility with software.

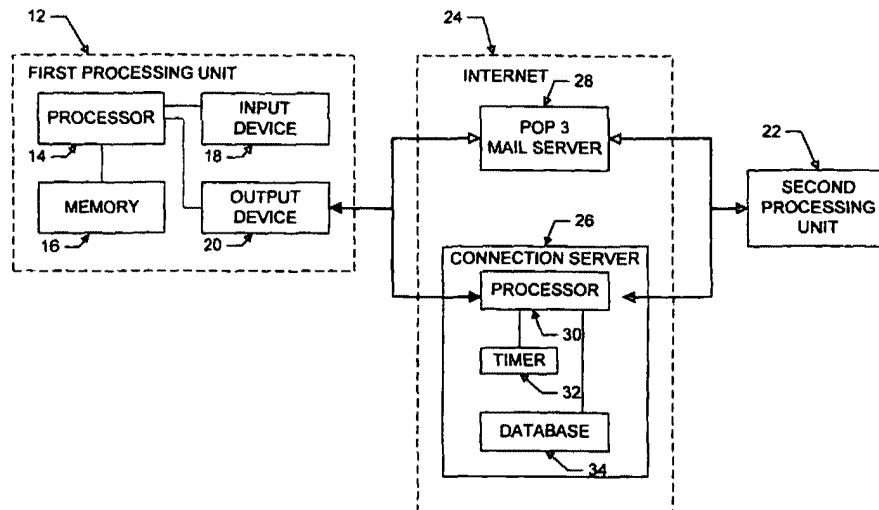

OTHER PUBLICATIONS

4,594,477 A	6/1986	Noirot	5,247,620 A	9/1993	Fukuzawa et al.
4,598,397 A	7/1986	Nelson et al.	5,249,290 A	9/1993	Heizer
4,602,132 A	7/1986	Nagatomi et al.	5,274,635 A	12/1993	Rahman et al.
4,630,262 A	12/1986	Callens et al.	5,282,197 A	1/1994	Kreitzer
4,652,703 A	3/1987	Lu et al.	5,283,819 A	2/1994	Glick et al.
4,653,090 A	3/1987	Hayden	5,287,103 A	2/1994	Kasprzyk et al.
4,654,483 A	3/1987	Imai et al.	5,301,324 A	4/1994	Dewey et al.
4,658,093 A	4/1987	Hellman	5,305,312 A	4/1994	Fomek et al.
4,694,492 A	9/1987	Wirstrom et al.	5,315,705 A	5/1994	Iwami et al.
4,706,274 A	11/1987	Baker et al.	5,319,705 A	6/1994	Halter et al.
4,740,963 A	4/1988	Eckley	5,325,524 A	6/1994	Black et al.
4,754,479 A	6/1988	Bicknell et al.	5,327,486 A	7/1994	Wolff et al.
4,755,985 A	7/1988	Jayapalan et al.	5,329,619 A	7/1994	Page et al.
4,756,020 A	7/1988	Fodale	5,335,276 A	8/1994	Thompson et al.
4,759,056 A	7/1988	Akiyama	5,341,374 A	8/1994	Lewen et al.
4,782,485 A	11/1988	Gollub	5,347,632 A	9/1994	Filepp et al.
4,799,153 A	1/1989	Hann et al.	5,377,260 A	12/1994	Long
4,800,488 A	1/1989	Agrawal et al.	5,388,213 A	2/1995	Oppenheimer et al.
4,809,271 A	2/1989	Kondo et al.	5,396,485 A	3/1995	Ohno et al.
4,813,040 A	3/1989	Futato	5,402,477 A	3/1995	McMahan et al.
4,819,228 A	4/1989	Baran et al.	5,402,528 A	3/1995	Christopher et al.
4,821,263 A	4/1989	Lundh	5,408,526 A	4/1995	McFarland et al.
4,823,374 A	4/1989	Verlohr	5,408,619 A	4/1995	Oran
4,827,411 A	5/1989	Arrowood	5,410,754 A	4/1995	Favreau et al.
4,829,554 A	5/1989	Barnes et al.	5,425,028 A	6/1995	Britton et al.
4,837,797 A	6/1989	Freeny, Jr.	5,428,608 A	6/1995	Freeman et al.
4,866,704 A	9/1989	Bergman	5,434,913 A	7/1995	Tung et al.
4,866,732 A	9/1989	Carey et al.	5,440,547 A	8/1995	Easki et al.
4,873,715 A	10/1989	Shibata	5,440,632 A	8/1995	Bacon et al.
4,887,265 A	12/1989	Felix	5,446,891 A	8/1995	Kaplan et al.
4,890,282 A	12/1989	Lambert et al.	5,446,919 A	8/1995	Wilkins
4,899,333 A	2/1990	Roediger	5,452,289 A	9/1995	Sharma et al.
4,899,373 A	2/1990	Lee et al.	5,459,864 A	10/1995	Brent et al.
4,912,705 A	3/1990	Paneth et al.	5,461,611 A	10/1995	Drake, Jr. et al.
4,914,571 A	4/1990	Baratz et al.	5,461,668 A	10/1995	Zdenek et al.
4,928,306 A	5/1990	Biswas et al.	5,467,388 A	11/1995	Redd et al.
4,932,022 A	6/1990	Keeney et al.	5,469,500 A	11/1995	Satter et al.
4,953,159 A	8/1990	Hayden	5,473,531 A	12/1995	Flora-Holmquist et al.
4,962,449 A	10/1990	Schlesinger	5,474,741 A	12/1995	Mikeska et al.
4,981,371 A	1/1991	Gurak et al.	5,474,819 A	12/1995	Chambers et al.
4,989,230 A	1/1991	Gillig et al.	5,475,819 A	12/1995	Miller et al.
4,995,074 A	2/1991	Goldman et al.	5,481,720 A	1/1996	Loucks et al.
5,031,089 A	7/1991	Liu et al.	5,483,524 A	1/1996	Lev et al.
5,036,513 A	7/1991	Greenblatt	5,487,100 A	1/1996	Kane
5,040,141 A	8/1991	Yazima et al.	5,491,800 A	2/1996	Goldsmith et al.
5,056,140 A	10/1991	Kimbell	5,499,295 A	3/1996	Cooper
5,065,425 A	11/1991	Lecomte et al.	5,500,890 A	3/1996	Rogge et al.
5,107,443 A	4/1992	Smith et al.	5,502,727 A	3/1996	Catanzaro et al.
5,109,403 A	4/1992	Sutphin	5,515,508 A	5/1996	Pettus et al.
5,113,499 A	5/1992	Ankney et al.	5,517,432 A	5/1996	Chandra et al.
5,121,385 A	6/1992	Tominaga et al.	5,528,671 A	6/1996	Ryu et al.
5,127,001 A	6/1992	Steagall et al.	5,533,102 A	7/1996	Robinson et al.
5,127,003 A	6/1992	Doll, Jr. et al.	5,533,110 A	7/1996	Pinard et al.
5,130,985 A	7/1992	Kondo et al.	5,544,164 A	8/1996	Baran
5,134,648 A	7/1992	Hochfield et al.	5,544,322 A	8/1996	Cheng et al.
5,136,716 A	8/1992	Harvey et al.	5,546,448 A	8/1996	Caswell et al.
5,150,410 A	9/1992	Bertrand	5,546,452 A	8/1996	Andrews et al.
5,153,908 A	10/1992	Kakizawa et al.	5,548,636 A	8/1996	Bannister et al.
5,155,726 A	10/1992	Spinney et al.	5,548,694 A	8/1996	Frissen Gibson
5,157,592 A	10/1992	Walters	5,555,290 A	9/1996	McLeod et al.
5,159,592 A	10/1992	Perkins	5,563,882 A	10/1996	Bruno et al.
5,164,988 A	11/1992	Matyas et al.	5,572,643 A	11/1996	Judson
5,185,860 A	2/1993	Wu	5,574,774 A	11/1996	Ahlberg et al.
5,187,591 A	2/1993	Guy et al.	5,574,934 A	11/1996	Mirashrafi et al.
5,195,086 A	3/1993	Baumgartner et al.	5,581,522 A	12/1996	Sibuya et al.
5,212,789 A	5/1993	Rago	5,581,702 A	12/1996	McArdle et al.
5,214,650 A	5/1993	Renner et al.	5,586,257 A	12/1996	Perlman
5,220,599 A	6/1993	Sasano et al.	5,586,260 A	12/1996	Hu
5,241,594 A	8/1993	Kung	5,604,737 A	2/1997	Iwami et al.
5,241,625 A	8/1993	Epard et al.	5,606,669 A	2/1997	Bertin et al.
			5,608,786 A	3/1997	Gordon

5,614,940 A	3/1997	Cobbley et al.	5,778,187 A	7/1998	Monteiro et al.
5,615,257 A	3/1997	Pezzullo et al.	5,784,564 A	7/1998	Camaisa et al.
5,619,557 A	4/1997	Van Berkum	5,784,619 A	7/1998	Evans et al.
5,621,789 A	4/1997	McCalmont et al.	5,787,253 A	7/1998	McCreery et al.
5,623,483 A	4/1997	Agrawal et al.	5,790,548 A	8/1998	Sistanizadeh et al.
5,623,490 A	4/1997	Richter et al.	5,790,792 A	8/1998	Dudgeon et al.
5,623,605 A	4/1997	Keshav et al.	5,790,793 A	8/1998	Higley
5,625,407 A	4/1997	Biggs et al.	5,790,803 A	8/1998	Kinoshita et al.
5,627,978 A	5/1997	Altom et al.	5,793,365 A	8/1998	Tang et al.
5,636,282 A	6/1997	Holmquist et al.	5,794,018 A	8/1998	Vrvilo et al.
5,636,346 A	6/1997	Saxe	5,794,257 A	8/1998	Liu et al.
5,642,156 A	6/1997	Saiki	5,796,394 A	8/1998	Wicks et al.
5,644,629 A	7/1997	Chow	5,799,063 A	8/1998	Krane
5,649,194 A	7/1997	Miller et al.	5,799,072 A	8/1998	Vulcan et al.
5,651,006 A	7/1997	Fujino et al.	5,799,150 A	8/1998	Hamilton et al.
5,652,759 A	7/1997	Stringfellow, Jr.	5,805,587 A	9/1998	Norris et al.
5,655,120 A	8/1997	Witte et al.	5,805,810 A	9/1998	Maxwell
5,659,542 A	8/1997	Bell et al.	5,805,822 A	9/1998	Long et al.
5,659,596 A	8/1997	Dunn	5,809,233 A	9/1998	Shur
5,668,862 A	9/1997	Bannister et al.	5,812,819 A	9/1998	Rodwin et al.
5,671,412 A	9/1997	Christiano	5,815,665 A	9/1998	Teper et al.
5,671,428 A	9/1997	Muranaga et al.	5,816,919 A	10/1998	Scagnelli et al.
5,675,507 A	10/1997	Bobo	5,818,510 A	10/1998	Cobbley et al.
5,680,392 A	10/1997	Semaan	5,818,836 A	10/1998	DuVal
5,684,800 A	11/1997	Dobbins et al.	5,819,084 A	10/1998	Shapiro et al.
5,684,951 A	11/1997	Goldman et al.	5,822,524 A	10/1998	Chen et al.
5,689,553 A	11/1997	Ahuja et al.	5,825,865 A	10/1998	Oberlander et al.
5,689,641 A	11/1997	Ludwig et al.	5,828,837 A	10/1998	Eikeland
5,692,180 A	11/1997	Lee	5,828,843 A	10/1998	Grimm et al.
5,692,192 A	11/1997	Sudo	5,828,846 A	10/1998	Kirby et al.
5,694,594 A	12/1997	Chang	5,832,119 A	11/1998	Rhoads
5,701,463 A	12/1997	Malcolm	5,832,240 A	11/1998	Larsen et al.
5,708,422 A	1/1998	Blonder et al.	5,835,720 A	11/1998	Nelson et al.
5,708,655 A	1/1998	Toth et al.	5,835,723 A	11/1998	Andrews et al.
5,710,884 A	1/1998	Dedrick	5,835,725 A	11/1998	Chiang et al.
5,717,923 A	2/1998	Dedrick	5,838,683 A	11/1998	Corley et al.
5,719,786 A	2/1998	Nelson et al.	5,838,970 A	11/1998	Thomas
5,721,827 A	2/1998	Logan et al.	5,841,769 A	11/1998	Okanoue et al.
5,724,092 A	3/1998	Davidsohn et al.	5,842,216 A	11/1998	Anderson et al.
5,724,412 A	3/1998	Srinivasan	5,844,978 A	12/1998	Reuss et al.
5,724,506 A	3/1998	Cleron et al.	5,848,143 A	12/1998	Andrews et al.
5,724,648 A	3/1998	Shaughnessy et al.	5,848,396 A	12/1998	Gerace
5,726,984 A	3/1998	Kubler et al.	5,854,901 A	12/1998	Cole et al.
5,729,748 A	3/1998	Robbins et al.	5,857,072 A	1/1999	Crowle
5,732,078 A	3/1998	Arango	5,864,684 A	1/1999	Nielsen
5,734,828 A	3/1998	Pendse et al.	5,867,156 A	2/1999	Beard et al.
5,736,968 A	4/1998	Tsakiris	5,867,654 A	2/1999	Ludwig et al.
5,742,668 A	4/1998	Pepe et al.	5,867,665 A	2/1999	Butman et al.
5,742,675 A	4/1998	Kilander et al.	5,872,850 A	2/1999	Klein et al.
5,742,762 A	4/1998	Scholl et al.	5,872,922 A	2/1999	Hogan et al.
5,742,905 A	4/1998	Pepe et al.	5,872,972 A	2/1999	Boland et al.
5,745,642 A	4/1998	Ahn	5,883,956 A	3/1999	Le et al.
5,745,702 A	4/1998	Morozumi	5,884,032 A	3/1999	Bateman et al.
5,745,711 A	4/1998	Kitahara et al.	5,884,035 A	3/1999	Butman et al.
5,751,712 A	5/1998	Farwell et al.	5,884,077 A	3/1999	Suzuki
5,751,961 A	5/1998	Smyk	5,890,162 A	3/1999	Huckins
5,754,636 A	5/1998	Bayless et al.	5,892,825 A	4/1999	Mages et al.
5,754,939 A	5/1998	Herz et al.	5,892,903 A	4/1999	Klaus
5,758,110 A	5/1998	Boss et al.	5,892,924 A	4/1999	Lyon et al.
5,758,257 A	5/1998	Herz et al.	5,903,721 A	5/1999	Sixtus
5,761,606 A	6/1998	Wolzien	5,903,723 A	5/1999	Beck et al.
5,764,736 A	6/1998	Shachar et al.	5,903,727 A	5/1999	Nielsen
5,764,741 A	6/1998	Barak	5,905,719 A	5/1999	Arnold et al.
5,764,756 A	6/1998	Onweller	5,905,736 A	5/1999	Ronen et al.
5,767,897 A	6/1998	Howell	5,905,865 A	5/1999	Palmer et al.
5,768,527 A	6/1998	Zhu et al.	5,905,872 A	5/1999	DeSimone et al.
5,771,355 A	6/1998	Kuzma	5,915,001 A	6/1999	Uppaluru
5,774,656 A	6/1998	Hattori et al.	5,923,736 A	7/1999	Shachar
5,774,660 A	6/1998	Brendel et al.	5,924,093 A	7/1999	Potter et al.
5,774,666 A	6/1998	Portuesi	5,925,103 A	7/1999	Magallanes et al.
5,778,181 A	7/1998	Hidary et al.	5,928,327 A	7/1999	Wang et al.

5,929,849 A	7/1999	Kikinis	6,347,085 B2	2/2002	Kelly
5,937,162 A	8/1999	Funk et al.	6,347,342 B1	2/2002	Marcos et al.
5,946,386 A	8/1999	Rogers et al.	6,360,266 B1	3/2002	Pettus
5,946,629 A	8/1999	Sawyer et al.	6,377,568 B1	4/2002	Kelly
5,950,123 A	9/1999	Schwelb et al.	6,385,583 B1	5/2002	Ladd et al.
5,950,172 A	9/1999	Klingman	6,393,455 B1	5/2002	Eilert et al.
5,953,350 A	9/1999	Higgins	6,427,064 B1	7/2002	Henderson
5,956,482 A	9/1999	Agraharam et al.	6,434,552 B1	8/2002	Leong
5,956,485 A	9/1999	Perlman	6,463,565 B1	10/2002	Kelly
5,961,584 A	10/1999	Wolf	6,477,586 B1	11/2002	Achenson et al.
5,964,872 A	10/1999	Turpin	6,513,066 B1	1/2003	Hutton et al.
5,969,967 A	10/1999	Aahlad et al.	6,594,254 B1	7/2003	Kelly
5,982,774 A	11/1999	Foladare et al.	6,687,738 B1	2/2004	Hutton
5,983,005 A	11/1999	Monteiro et al.	6,701,365 B1	3/2004	Hutton
5,999,965 A	12/1999	Kelly	6,704,802 B1	3/2004	Finch et al.
6,005,870 A	12/1999	Leung	6,728,784 B1	4/2004	Mattaway
6,006,257 A	12/1999	Slezak	6,772,335 B2	8/2004	Curtis et al.
6,009,469 A	12/1999	Mattaway et al.	6,829,645 B1	12/2004	Hutton
6,014,379 A	1/2000	White et al.	6,888,836 B1	5/2005	Cherkasova
6,014,710 A	1/2000	Talluri et al.	6,909,708 B1	6/2005	Krishnaswamy et al.
6,016,393 A	1/2000	White et al.	2003/0050075 A1	3/2003	Rangarajan et al.
6,018,768 A	1/2000	Ullman et al.	2004/0204146 A1	10/2004	Deeds
6,018,771 A	1/2000	Hayden	2005/0032435 A1	2/2005	Tischer et al.
6,021,126 A	2/2000	White et al.	2005/0130611 A1	6/2005	Lu et al.
6,026,086 A	2/2000	Lancelot et al.			
6,026,425 A	2/2000	Suguri et al.			
6,029,175 A	2/2000	Chow et al.			
6,031,836 A	2/2000	Haserodt			
6,032,192 A	2/2000	Wegner et al.			
6,041,345 A	3/2000	Levi et al.			
6,047,054 A	4/2000	Bayless et al.			
6,047,292 A	4/2000	Kelly et al.			
6,055,594 A	4/2000	Lo et al.			
6,061,716 A	5/2000	Moncreiff			
6,064,975 A	5/2000	Moon et al.			
6,065,048 A	5/2000	Higley			
6,067,350 A	5/2000	Gordon			
6,069,890 A	5/2000	White et al.			
6,085,217 A	7/2000	Ault et al.			
6,101,182 A	8/2000	Sistanizadeh et al.			
6,105,053 A	8/2000	Kimmel et al.			
6,108,704 A	8/2000	Hutton et al.			
6,122,255 A	9/2000	Bartholomew et al.			
6,125,113 A	9/2000	Farris et al.			
6,131,121 A	10/2000	Mattaway et al.			
6,137,877 A	10/2000	Robin et al.			
6,141,341 A	10/2000	Jones et al.			
6,151,643 A	11/2000	Cheng et al.			
6,154,445 A	11/2000	Farris et al.			
6,163,316 A	12/2000	Killian			
6,173,044 B1	1/2001	Hortensius et al.			
6,178,453 B1	1/2001	Mattaway et al.			
6,181,689 B1	1/2001	Choung et al.			
6,185,184 B1	2/2001	Mattaway et al.			
6,188,677 B1	2/2001	Oyama et al.			
6,195,357 B1	2/2001	Polcyn			
6,198,303 B1	3/2001	Rangasayee			
6,205,135 B1	3/2001	Chinni et al.			
6,212,625 B1	4/2001	Russell			
6,226,678 B1	5/2001	Mattaway et al.			
6,226,690 B1	5/2001	Banda et al.			
6,240,444 B1	5/2001	Fin et al.			
6,243,373 B1	6/2001	Turock			
6,266,539 B1	7/2001	Pardo			
6,275,490 B1	8/2001	Mattaway et al.			
6,282,272 B1	8/2001	Noonen et al.			
6,289,369 B1	9/2001	Sundaresan			
6,300,863 B1	10/2001	Cotichini et al.			
6,338,078 B1	1/2002	Chang et al.			
6,343,115 B1	1/2002	Foladare et al.			
6,343,220 B1	1/2002	Van Der Salm			

FOREIGN PATENT DOCUMENTS

EP	0518596	12/1992
EP	0556012 A2	8/1993
EP	0559047	9/1993
EP	0581722	2/1994
EP	0597691	5/1994
EP	0632672	1/1995
EP	0648038	4/1995
EP	1379039 A2	1/2004
EP	1379050 A2	1/2004
GB	2283645	5/1995
JP	5944140	3/1984
JP	63-131637	3/1988
JP	6-62020	3/1994
WO	WO-9003074	3/1990
WO	WO-9219054	10/1992
WO	WO-9422087	9/1994
WO	WO-9714234	4/1997
WO	WO-9811704	3/1998

OTHER PUBLICATIONS

VocalChat User's Guide Version 2.0, Vocaltec, 1994, pp. 1-77.

README, VocalChat Version 2.02 & VocalChat WAN Version 2.02, Vocaltec, Jun. 1994, pp. 1-3.

VocalChat 1.01 Network Information, Vocaltec, 1994, pp. 1-10.

VocalChat Information, Vocaltec, 1994, pp. 1-31.

VocalChat Troubleshooting, Vocaltec, 1994, pp. 1-101.

VocalChat GTI Information file, believed to be included with VocalChat GTI version 2.12 dated Sep. 1994.

VocalChat GTI README.TXT for Version 2.12 Beta, dated Sep. 1994.

VocalChat GTI Troubleshooting.Inf, believed to be included with VocalChat GTI version 2.12 dated Sep. 1994.

Translation of Japanese Kokai H07-129488 (published May 19, 1995).

David Strom, "Talking Telephony", Windows Sources, Ziff-Davis Publishing Company, Sep. 1996, vol. 4, No. 9, pp. 6, 7, 10, 150-152, 157, 158, 163, 167, 169, 171, 174, 181, 184, 186, 195, 203, 208.

- Emad Farag et al., "Structure and network control of a hierarchical mobile network architecture", IEEE Fourteenth Annual International Phoenix Conference on Computers and Communications, Mar. 1995, ISBN: 0-7803-2492-7, pp. 671-677.
- English translation of JP-06-62020 (dated Mar. 4, 1994).
- Huanxu Pan et al., "Analysis of a CCSS#7 Network supporting database services", IEEE International Conference on Information Engineering, Sep. 1993, ISBN: 0-7803-1445-X, pp. 193-197, vol. 1.
- John E. Goodwin, Project Gutenberg Alpha Edition of Email 101, <http://metalab.unc.edu/pub/docs/books/gutenberg/e1ext93/email025.txt>, Jul. 1993.
- Junichi Kimura, et al. "Voice/Data Multiplexing Transmission Methods", Kokai Japanese Patent, Kokai Sho 59-44140, pp. 205-215, with English Abstract, English Translation, pp. 1-24.
- Mark R. Brown et al. "Special Edition: Using Netscape 2", Que Publishing, 1995, ISBN 0-7897-0612-1, pp. 7-35, 37-56, 78, 83, 176, 301-320, 393, 395-467, 469-506.
- Preston Gralla, "How the Internet Works", Ziff-Davis Press, Emeryville, CA, c1997, pp. 34-37, 202-205, 214-215 and 272-275, ISBN 1-56276-552-3.
- After Downsizing: Overcoming Client-Server Chaos (May 21, 1994).
- Barrow Street Research report on New Paradigm Software Corp. (dated Sep. 20, 1995).
- Camelot Corps Shining Internet Dream/Draws Skeptics (Aug. 95).
- DigiPhone and Camelot Documents.
- DigiPhone Documents (including Q and A) (prior to Sep. 1995).
- DigiPhone Documents (prior to Sep. 1995).
- DigiPhone for Mac (1996).
- Electric Magic Beta Tester Agreement dated Jul. 21, 1995 (SKYPE-N2P01609523).
- Electric Magic Company Releases NetPhone 1.2 and Net-Pub Server (dated Jun. 8, 1995).
- Electric Magic Information (May 1995).
- Electric Magic Notebooks (prior to Sep. 1995).
- Electric Magic Notes (including references to Apr. 18, 1995) and patent pending.
- Electric Magic Notes (including references to DigiPhone) (prior to Sep. 1995).
- Electric Magic Press Release (dated Mar. 13, 1995).
- Google Groups comp.dcom.videoconf posting (dated Jul. 5, 1995).
- intern.tex (dated Aug. 30, 1994).
- Jabra—Corporate and Product Backgrounder (Apr. 19, 1995).
- Jabra Ear Phone Common Questions and Answers.
- Jabra Ear phone PC, 1995.
- Jabra Streamline Ear Phone, 1993.
- List of source modules in NetPhone (dated Oct. 10, 1995).
- MagicPhone Distribution Agreement (Aug. 1995).
- Maven README (including 1994 copyright notice).
- Net as Phone (Internet World Jul. 1995).
- Net phone ad (with Jabra fax line) (May 1995).
- NetPhone 1.1 User Manual (including date Jan. 9, 1995).
- NetPhone Advertisement (Aug. 1995).
- NetPhone Digital User Manual (dated Feb. 26, 1995).
- NetPhone gives your Mac voice over the Internet (Inside the Internet—Jun. 1995).
- NetPhone Tasks and Plans (dated Jan.-Feb. 1995).
- Open Systems Today, Feb. 20, 1995.
- Order for NetPhone version 1.2 labels (dated Jun. 6, 1995).
- Phoneless Phoning Apr. 2, 1995.
- PowWow Chunked Protocol Specification, Last edited Mar. 12, 1999.
- PowWow Native Protocols, last updated Dec. 8, 1998.
- Roadmap for the Internet (Mar. 1995).
- SlipMagic Ad for MacZone (dated Sep. 28, 1995) for selling product.
- The Mac Zone (Catalog) dated 1995.
- Two-way voice calls over the Internet (Nov. 21, 1994).
- Ubique documents relating to Virtual Places Products (dated 1995 and Mar. 1995).
- Ubique Ships Virtual Places Client and Server (dated Mar. 20, 1995).
- Ubique, Ltd. Fact Sheet (referencing NetPhone codecs and Vocaltec) (date unknown).
- Welcome to NetPhone Demo (includes copyright date 1994).
- "Circuit Switching", Ericsson, last published Jul. 5, 2001, found at <http://www.ericsson.com/multiservicenetworks/circuitswitching/axe/> printed on Aug. 1, 2001, 2 pages.
- "Data Communication Over the Telephone Network", International Telecommunication Union, CCITT The International Telegraph and Telephone Consultative Committee, Blue Book, vol. VIII—Fascicle VIII.1, IXth Plenary Assembly, Melbourne, Nov. 14-25, 1988, pp. 296-370.
- "Full Duplex Speakerphone", IBM Technical Disclosure Bulletin, vol. 29, No. 12, May 1987, pp. 5599-5602.
- "ICL OPD—One Per Desk", Issue Aug. 1, 1990, A Comprehensive Technical Information Document (24 pages).
- "Information Processing Techniques Program. vol. II. Wideband Integrated Voice/Data Technology" Semiannual Technical Summary Report, Massachusetts Institute of Technology Lexington, MA, Oct. 1, 1977-Mar. 31, 1978, Issued Aug. 31, 1978, pp. 1-25 and 27-31, ADA067014.
- "Integrated Voice/Data PABX Communications", IBM Technical Disclosure Bulletin, Sep. 1986, <http://patents.ibm.com>.
- "Level 1-5 of 65 Stories" 1990 Network World, Inc., Apr. 16, 1990, pp. 114-115.
- "Multi-Service Networks", Ericsson, last published Jun. 27, 2001, found at <http://www.ericsson.com/multiservicenetworks/circuitswitching/> printed on Aug. 1, 2001, 2 pages.
- "The History of TPC.INT", Jan. 15, 1999, 2 pages, found at <http://www.tpc.int/faq/history.html> printed on Aug. 8, 2002.
- A. A. Kapauan, et al. "Wideband Packet Access for Workstations: Integrated Voice/Data/Image Services on the UNIX+PC", IEEE Global Telecommunications Conference, Houston, Texas, Dec. 1-4, 1986, Conference Record vol. 3, pp. 1439-1441.
- Ahrens, Richard L., "Frequently-Asked Questions about Internet VoiceChat 1.1 FAQ Version: 1.0", 1994, 6 pages.
- Andy Hopper "Pandora—An Experimental System for Multimedia Applications", Operating Systems Review, Jan. 12, 1990, pp. 1-16.
- Bennett, Geoff, "Designing TCP/IP Internetworks", Chapter 11, pp. 290, 291 and 323, Van Nostrand Reinhold, 1995.
- Bernard Gold "Digital Speech Networks", Proceedings of the IEEE, vol. 65, No. 12, Dec. 1977, pp. 1636-1658.
- Bill Newman "An ISDN Data and Voice Terminal Based on a Personal Computer", Globecom'85, IEEE Global Telecommunications Conference, Conference Record vol. 3, New Orleans, Louisiana, Dec. 2-5, 1985, pp. 1048-1052.

- Borland, John, "Technology uses one number to find you on any device", May 17, 2001, 3 pages, found at <http://news.cnet.com/news/0-1004-201-5939191-0.html>.
- C. Malamud et al., "Principles of Operation for the TPC.INT Subdomain: General Principles and Policy", RFC 1530, Oct. 1993, pp. 1-7.
- C. Malamud et al., "Principles of Operation for the TPC.INT Subdomain: Remote Printing—Administrative Policies", RFC 1529, Oct. 1993, pp. 1-5.
- C. Malamud et al., "Principles of Operation for the TPC.INT Subdomain: Remote Printing—Technical Procedures", RFC 1528, Oct. 1993, pp. 1-12.
- C. Topolcic "Experimental Internet Stream Protocol, Version 2 (ST-II)", Request for Comments 1190, Oct. 1990, pp. 1-148.
- C. Yang, "INETPhone: Telephone Services and Servers on Internet", Request for Comments 1789, pp. 1-6, Apr. 1995.
- Carl A. Sunshine, et al. "Broad-Band Personal Computer LAN's", IEEE Journal on Selected Areas in Communications, vol. SAC-3, No. 3, May 1985, pp. 408-415.
- Cindy Mueller et al., "ATD Data Services", <http://www.iitra.ucar.edu/ws/dataworkshop/Abstract-ATD.html>, Jan. 5, 1995, 2 pages.
- Clifford J. Weinstein, et al. "Experience with Speech Communication in Packet Networks" IEEE Journal on Selected Areas in Communications, vol. SAC-1, No. 6, (ISSN 0733-8716), Dec. 1983, pp. 963-980.
- D. Adolphs, et al. "Adapters for the Public ISDN", pp. 72-80.
- D. Perkins "The Point-to-Point Protocol for the Transmission of Multi-Protocol Datagrams Over Point-to-Point Links", Request for Comments 1171, <ftp://ftp.isi.edu/in-notes/rfc1171.txt>, Jul. 1990, pp. 1-48.
- D.C. Swinehart et al., "Adding Voice to an Office Computer Network", IEEE Global Telecommunications Conference, Nov. 28-Dec. 1, 1983, Conference Record vol. 1 of 3, pp. 392-398.
- Dale Gulick et al., "Interface the ISDN to Your PC With a Voice/Data Board", Design Applications, 2328 Electronic Design, 35 (1987) Dec. 10, No. 29, Hashbrouck Heights, NJ, USA, pp. 85-88, XP 000004313.
- Daniel C. Swinehart "Telephone Management in the Etherphone System", IEEE/IEICE Global Telecommunications Conference '87, Conference Record vol. 2 of 3, Nov. 15-18, 1987, pp. 1176-1180.
- Danny Cohen "A Network Voice Protocol NVP-II", Apr. 1, 1981, pp. 1-68.
- Danny Cohen "Packet Communication of Online Speech", AFIPS Conference Proceedings, 1981 National Computer Conference, May 4-7, 1981, Chicago, Illinois, pp. 169-176.
- Danny Cohen "Specifications for the Network Voice Protocol (NVP)", Request for Comments 741, Jan. 29, 1976, pp. 1-30.
- Don H. Johnson, et al. "A Local Access Network for Packetized Digital Voice Communication", IEEE Transactions on Communications, vol. Com. 29, No. 5, May 1981, pp. 679-688.
- Douglas B. Terry and Daniel C. Swinehart, "Managing Stored Voice in the Etherphone System", 1987 ACM 089791-242-X/87/0011/0103, pp. 103-104.
- Douglas B. Terry And Daniel C. Swinehart, "Managing Stored Voice in the Etherphone System" ACM Transactions on Computer Systems, vol. 6, No. 1, Feb. 1988, pp. 3-27.
- Eve M. Schooler, et al. "A Packet-Switched Multimedia Conferencing System", SIGOIS Bulletin, pp. 12-22.
- Gary C. Kessler "ISDN Concepts, Facilities, and Services", McGraw-Hill, Inc., c1990, pp. 224-231, ISBN 0-07-034242-3.
- Giulio Barberis, et al. "Coded Speech in Packet-Switched Networks: Models and Experiments" IEEE Journal on Selected Areas in Communications, vol. SAC-1, No. 6, Dec. 1983, pp. 1028-1038.
- H. Jonathan Chao, et al. "A Packet Video System Using the Dynamic Time Division Multiplexing Technique", IEEE Global Telecommunications Conference, Houston, Texas, Dec. 1-4, 1988, Conference Record, vol. 3, pp. 0767-0772.
- H. Opperbeck "Throughput Degradations for Single Packet Messages", Request for Comments 632, <ftp://ftp.isi.edu/in-notes/rfc632.txt>, May 20, 1974, pp. 1-6.
- Henning Schulzrinne "Voice Communication Across the Internet: A Network Voice Terminal", Jul. 29, 1992, pp. 1-34.
- Hiroshi Kobayashi and Hideaki Haruyama, "Voice, Data and Video Integrated Broadband Metropolitan Area Network", Electronics and Communications in Japan, Part 1, vol. 73, No. 11, 1990, pp. 34-42.
- Hiroyuki Ichikawa et al. "High-Speed Packet Switching Systems for Multimedia Communications", IEEE Journal on Selected Areas in Communications, Oct. 1987, vol. SAC-5, No. 8 (ISSN 0733-8716), pp. 1336-1345.
- Ian H. Merritt "Providing Telephone Line Access to a Packet Voice Network", University of Southern California, Marina Del Rey. Information Sciences Inst., Feb. 1983, ADA126270.
- Implementation of Next-Generation Agent-Dedicated Communications, by Agatsuma et al., Tech Report of IEICE 94-216 (Mar. 1995).
- Israel Gitman, et al. "Economic Analysis of Integrated Voice and Data Networks: A Case Study" Proceedings of the IEEE, vol. 66, No. 11, Nov. 1978, pp. 1549-1570.
- J. Huelamo, et al. "End User Premises Equipment and Terminals for Broadband Applications", Electrical Communication, vol. 64, No. 2/3, 1990.
- J. K. Reynolds et al., Voice File Interchange Protocol (VFIP), Request for Comments 978, <ftp://ftp.isi.edu/innotes/rfc978.txt>, Feb. 1986, pp. 1-5.
- J. Romkey "A Nonstandard For Transmission of IP Datagrams Over Serial Lines: Slip", Request for Comments 1055, <ftp://ftp.isi.edu/in-notes/std/std47.txt>, Jun. 1988, pp. 1-6.
- James D. Mills, et al. "A data and voice system for the general service telephone network", Proceedings IECON '87, 1987 International Conference on IND. Electronics, Control, and Instrumentation, Cambridge, Massachusetts, Nov. 3-6, 1987.
- James W. Forgie "Speech Transmission in Packet-Switched Store-and-Forward Networks", AFIPS Conference Proceedings, 1975 National Computer Conference, May 19-22, 1975, Anaheim, California, pp. 137-142.
- James W. Forgie "Voice Conferencing in Packet Networks", ICC '80, Conference Record, International Conference on Communications, Seattle, WA, Jun. 8-12, 1980, vol. 1, 80CH1505-6 CSCB, pp. 21.3.1-21.3.4.
- Jane's Military Communications 1979-80, pp. 452 and 453.
- Jane's Military Communications 1985, pp. 585, 546, and 545.

- Jane's Military Communications 1989, Tenth Edition, Edited by John Williamson, ISBN 0710608772, pp. 443, 507, and 512.
- Jane's Military Communications 1990-91, Eleventh Edition, Edited by John Williamson, ISBN 0710609000, pp. [30], 264, 357, 398, 406, 450, 454, 456, 560, 572, 573, 814, 815, and 816.
- Jane's Military Communications 1992-93, Thirteenth Edition, Edited by John Williamson, ISBN 0710609809, pp. 375, 376, 384, and 704.
- Jim Stevens, "Much More Idle Chatter About Reference Models", http://www-mice.cs.ucl.ac.uk/multimedia/misc/tcp_ip/8709.mm.www/0041.html, Dec. 18, 1987, pp. 1-9.
- John Bellamy, "Digital Telephony", c1982 John Wiley & Sons, Inc., pp. 392-397 and 410-412.
- K. Sohraby, et al. "ISDN Primary Rate Interface Impact on Performance of Integrated Voice and Data on CSMA/CD Networks—A Measurement and Simulation Study", Globecom '90 IEEE Global Telecommunication Conference & Exhibition, San Diego, California, Dec. 2-5, 1990, vol. 2, pp. 0912-0919.
- Ken Sherman "Data Communications—A User's Guide", 3rd Edition, c1981 Prentice-Hall, Inc., pp. 296-307 and 404-407.
- Kevin Jeffay, et al. "Kernel Support for Live Digital Audio and Video", pp. 10-21, University of North Carolina at Chapel Hill, Department of Computer Science.
- Kyuta Saito, et al. "Voice Packet Communication System for Private Networks", Globecom '89, IEEE Global Telecommunications Conference & Exhibition, Dallas, Texas, Nov. 27-30, 1989, vol. 3, pp. 1874-1878.
- Lawrence G. Roberts "The Evolution of Packet Switching", Proceedings of the IEEE, vol. 66, No. 11, Nov. 1978, pp. 1307-1313.
- Lin, Hwa-Chun and C.S. Raghavendra, "A Dynamic Load-Balancing Policy With a Central Job Dispatcher (LBC)", IEEE Transactions on Software Engineering, vol. 18, No. 2, Feb. 1992, pp. 148-158.
- M. E. Ulug, et al. "Statistical Multiplexing of Data and Encoded Voice in a Transparent Intelligent Network", Fifth Data Communications Symposium, Sep. 27-29, 1977, Snowbird, Utah, pp. 6-14-6-20.
- M. Gopalakrishnan, et al. "Integrating Voice and Data SALAN: An Experimental Local Area Network", Computer Communications, vol. 9, No. 4, Aug. 1986, pp. 186-194 and p. 169.
- M.J. Ross "Alternatives for Integrating Voice and Data", 1981 International Switching Symposium, ISS' 81 CIC Montreal, Sep. 21-25, 1981.
- Natesa Janakiraman "An Overview of Recent Developments in the Designs and Applications of Customer Premises Switches", IEEE Communications Magazine, Oct. 1985, vol. 23, No. 10, pp. 32-45.
- P. Borgnis-Desbordes, et al. "Variable-Speed Data Transmission", IBM Technical Disclosure Bulletin, vol. 27, No. 4A, Sep. 1984, pp. 2269-2270.
- P. Venkat Rangan and Daniel C. Swinehart, "Software Architecture for Integration of Video Services in the Etherphone System", IEEE Journal on Selected Areas in Communication, vol. 9, No. 9, Dec. 1991, pp. 1395-1404.
- Paul Francis, "Comparison of Geographical and Provider-rooted Internet Addressing," Computer Networks and ISDN Systems 27(3)437-448, 1994 (selected paper from INET 94/JENC 5).
- Paul Gilster, "Internet Navigator", Maruzen Kabushiki-Kaisha (1st Ed.), pp. 473-476, Feb. 28, 1995 (with translation and SOR).
- Paul Tsuchiya, Tony Eng, "Extending the IP Internet Through Address Reuse," ACM SIGCOMM Computer Communications Review, 23(1):16-33, Jan. 1993.
- Philip H. Reagan, "Is it the PBX or is it the LAN?", Datamation, The Telecom Manager Emerges, Mar. 1984, vol. 30 No. 3, pp. 3-4, 147, 148, 150.
- Polle T. Zellweger et al., "An Overview of the Etherphone System and its Applications", 2nd IEEE Conference on Computer Workstations, Mar. 7-10, 1988, pp. 160-168.
- R. Braudes et al., "Requirements for Multicast Protocols", Request for Comments 1458, Network Working Group, May 1993, pp. 1-19.
- R. W. Meba, et al. "Experiments in Wideband Packet Technology", Digital Communications—New Directions in Switching and Networks, Proceedings of the International Seminar, Zurich, Switzerland, Mar. 11-13, 1986, pp. 135-139.
- R.P. McNamara, "Some Considerations of the Voice-Data Capabilities of Broadband Cable Networks", IEEE Digest of Papers Spring CompCon 82, Feb. 22-25, 1982, pp. 312-314.
- Randy Cole "Packet Voice: When It Makes Sense", Speech Technology, Sep./Oct. 1982, pp. 52-61.
- Scott Flinn, "Coordinating Heterogeneous Time-Based Media Between Independent Applications" ACM Multimedia 95—Electronic Proceedings Nov. 5-9, 1995, pp. 1-16.
- Shimmi Hattori et al., "Integrated Digital Switching System with Queuing Storage Facility", IEEE Transactions on Communications, vol. Com-30, No. 8, Aug. 1982, pp. 1900-1905, (ISSN 0090-6778).
- Steve Oltmanns, et al. "A Voice and Communications System for the IBM PC", Speech Technology, Mar./Apr. 1986, pp. 94-99.
- Stuart Cheshire et al., "Internet Mobility 4x4", www.acm.org, 1996, pp. 1-12.
- Susan Angebrannt et al., "Integrating Audio and Telephony in a Distributed Workstation Environment", Proceedings of the Summer 1991 USENIX Conference, Jun. 10-14, 1991, Nashville, Tennessee, pp. 419-435.
- T. Kamae "Visual Terminals and User Interfaces", FGCS North-Holland, pp. 257-278.
- T. Kamae "Voice/Data Integration in the INS Model System and Local Area Networks" IEEE Communications Magazine, Dec. 1986, vol. 24, No. 12, pp. 7-15.
- T7540 Digital Telephone Codec, AT&T Microelectronics, Jan. 1991, pp. 1-62 and Data Sheet Addendum, Jul. 1991, 4 pages.
- Takashi Yamada, et al. "New Technologies—Multimedia High-throughput X.25 Packet Switching System", NTT Review, vol. 1, No. 2, Jul. 1989, pp. 82-88.
- Tamohiro Kawai, Nikkei Communications, No. 202, pp. 29-30, Nikkei BP, Jul. 17, 1995 ("Communication software appears on the Internet") (w/ SOR).
- Theodore Bially, et al. "Voice Communication in Integrated Digital Voice and Data Networks", IEEE Transactions on Communications, vol. Com-28, No. 9, Sep. 1980, pp. 1478-1490.
- Toru Tsuda, et al. "An Approach to Multi-Service Subscriber Loop System Using Packetized Voice/Data Terminals" ISSLS '78, The International Symposium on Subscriber Loops and Services, Mar. 20-24, 1978, Atlanta, Georgia, Conference Record, pp. 161-165.

- V. Jacobson, et al. "TCP Extension for High-Speed Paths", Request for Comments 1185, ftp://ftp.isi.edu/in-notes/rfc1185.txt, Oct. 1990, pp. 1-21.
- V. Jacobson, et al. "TCP Extensions for High Performance", Request for Comments 1323, ftp://ftp.isi.edu/in-notes/rfc1323.txt, May 1992, pp. 1-37.
- Vinton G. Cerf, "Packet Satellite Technology Reference Sources", Request for Comments 829, Nov. 1982, http://www.cis.ohio-state.edu/htbin/rfc/rfc829.html, pp. 1-5.
- VocalTech Internet Phone (TM) Version 2.5 Readme, VocalTec Ltd., Feb. 1995, 5 pages.
- "A Low Cost Solution for: Using your WAN as a Voice Communication Tool" VocalTec White Paper (dated Jun. 3, 1994).
- "CyberPhone Announcement" Internet Posting in Newsgroups comp.speech, Jun. 8, 1995.
- "CyberPhone!" Internet Posting in Newsgroups comp.speech, Apr. 14, 1995.
- "Electric Magic Company Provides Internet Alternative to Long-Distance Calls", Electric Magic Company Press Release (Mar. 13, 1995).
- "Electric Magic Company Releases NetPhone 1.2 and Net-pub Serve", Electric Magic Company Press Release (Jun. 1995).
- "Frequently-Asked Questions about Tribal Voices PowWow" Version 0.34, Mar. 4, 1996.
- "Frequently-Asked Questions about Tribal Voices PowWow" Version 0.43, May 1, 1996.
- "Frequently-Asked Questions about Tribal Voices PowWow" Version 0.45, May 31, 1996.
- "Frequently-Asked Questions about Tribal Voices PowWow" Version 0.47, Jun. 12, 1996.
- "Frequently-Asked Questions about Tribal Voices PowWow" Version 0.48, Jun. 25, 1996.
- "Frequently-Asked Questions about Tribal Voices PowWow" Version 0.59, Oct. 30, 1996.
- "NetPhone Gets Internet Users Talking at Local Rates" MacUser UK, Mar. 3, 1995, p. 27.
- "NetPhone Gives Your Mac Voice Over the Internet" Inside the Internet Rocket Science for the Rest of Us. vol. 2 No. 3, Jun. 1995.
- "NetPhone" MacWorld, Jul. 1995.
- "NetPhone" West Coast Online, Ver. 3.02 (#26), Apr. 1995.
- "PowWow 1.3b Now Available!" Google Newsgroup comp.os.ms-windows.misc Discussion Posting (dated Apr. 22, 1995).
- 1996-1997 Buyer's Guide, CTI for Management.
- Abbe Cohen, Inessential Zephyr (Aug. 23, 1993).
- Adam Gaffin, VocalTec Ware Lets Users Make Voice Calls over 'Net, Network World (Feb. 13, 1995).
- Alexander Schill, ed., DCE—The OSF Distributed Computer Environment: Client/Server Model and Beyond, Lecture Notes in Computer Science 731, Karlsruhe University (1993).
- Analysis of DCE Security Draft (Sep. 18, 1996).
- Andrew D. Birrell, et al., Grapevine: An Exercise in Distributed Computing, Communications of the ACM (Apr. 1982).
- Andrew D. Birrell, et al., Grapevine: An Exercise in Distributed Computing, Communications of the ACM, vol. 25, No. 4, Apr. 1982.
- Andrew D. Birrell, et al., Implementing Remote Procedure Calls, ACM Transactions on Computer Systems (Feb. 1984).
- Andrew S. Tanenbaum, Computer Networks, 2d ed. (Prentice-Hall, 1988).
- Andy Patrizio, Telecom, Digital Limits Begin to Blur with 'Phone Calls' Across Internet, PC Week, vol. 12, No. 6 (Feb. 13, 1995).
- Antonio Ruiz, Voice and Telephony Applications for the Office Workstation, IEEE 1st International Conference on Computer Workstations, San Jose, California (Nov. 11-14, 1985).
- AVC-650: Technical Issues Concerning Real-Time Protocol in H.32Z Systems in ATM and Other Packet-Switched Computer Networks, Jul. 9, 1994.
- AVC-655: Communication Procedure for H.222.1, Jul. 1, 1994.
- AVC-666: H.32X Communication Modes, Terminal Types and Interworking Scenarios, Jul. 1994.
- AVC-683: Update Draft H.32Z Following Grimstad Meeting, Nov. 1994.
- AVC-696: An Example of Call Setup Procedure in a H.32Z Terminal, Nov. 1994.
- AVC-702: Terminal to Terminal Signaling in H.32X, Oct. 24, 1994.
- AVC-707R: Report of the Seventeenth Experts Group Meeting in Singapore (Jul. 1-11, 1994)—Part I and Part II, Nov. 11, 1994.
- AVC-716: Draft Recommendation H.32X, Jan. 1995.
- AVC-718: Draft H.32X, Jan. 1995.
- AVC-743R: Report of the Eighteenth Experts Group Meeting in Kamifukuoka (Jan. 24-27, 1995), Jan. 27, 1995.
- AVC-748: Update of Draft Recommendation H.322, May 1995.
- AVC-750: Report of the Study Group 15 Meeting Held During Feb. 6-17, 1995, Feb. 24, 1995.
- AVC-752: Open Issues Towards the Stockholm Meeting, Mar. 17, 1995.
- AVC-758: Draft Recommendation H.323 Visual Telephone Systems and Terminal Equipment for Local Area Networks Which Provide A Non-Guaranteed Quality of Service, Rev. May 12, 1995.
- AVC-767: Logical Channel Set-up Procedure, Apr. 28, 1995.
- AVC-799: Comments on Draft H.323 and H.22Z, May 11, 1995.
- AVC-800R: Report of the Nineteenth Experts Group Meeting in Haninge (May 15-18, 1995), May 18, 1995).
- AVC-813: Signaling Recommendation Within the Scope of H.323, Sep. 10, 1995.
- AVC-819: LAN Addressing Plan in H.323, Sep. 10, 1995.
- AVC-830: Connection Management Procedures for H.323, Oct. 24-27, 1995.
- AVC-842: Gateway, Gatekeeper and Terminal Procedures in H.323, Oct. 17, 1995.
- Avnish Aggarwal, et al., RFC 1002: Protocol Standard for a NetBIOS Service on a TCP/UDP Transport: Detailed Specifications (Mar. 1987).
- Barbara Darrow, Internet Phone Chat Software Prompts Spat: IRC Operators Rebuffed Use of Their Systems, Computer Reseller News (Mar. 20, 1995).
- Barry Michael Arons, The Audio-Graphical Interface to a Personal Integrated Telecommunications System, Masters Thesis, Massachusetts Institute of Technology (Jun. 1984).
- Barry Phillips, Casting the Net for New Media, OEM Magazine, No. 320 (1995).
- Belville, Sharon, "Zephyr on Athena", Athena Documentation, Sep. 10, 1991, Version 3.

- Ben Mesander, et al., The Client-To-Client Protocol (Aug. 12, 1994).
- Bill Welsh, H.245 Implementors' Guide (undated but references Apr. 1996).
- Bob Blakley's Email to sig-dce-security, DCE Delegation Proposal Review, Jul. 7, 1992.
- Brad Curtis Johnson, A Distributed Computing Environment Framework: An OSF Perspective (1991).
- Brent Nordin, et al., Remote Operation Across a Network of Small Computers (Association of Computing Machinery, 1986).
- Brian Fox, et al., GNU Finger program documentation, Free Software Foundation (1992).
- Bruce Brown, BugNet Bug/Fix List, Newsbytes (Dec. 13, 1995).
- Bruce Brown, BugNet Bug/Fix List, Newsbytes (Dec. 13, 1996).
- Butler W. Lampson, et al., A Distributed Systems Architecture for the 1990's (Dec. 17, 1989).
- Buy Memory Configured Expressly for Your Computer, San Jose Mercury News (Jul. 16, 1995).
- C. Anthony DellaFera, et al., Section E.4.1: Zephyr Notification Service, Athena Technical Plan (Jul. 29, 1988).
- C. Anthony DellaFera, et al., Section E.4.1: Zephyr Notification Service, Project Athena Technical Plan (Jun. 5, 1989).
- C. Anthony DellaFera, et al., The Athena Notification Service: Zephyr (1987).
- C. Anthony DellaFera, et al., The Athena Notification Service: Zephyr (Dec. 31, 1987).
- C. Anthony DellaFera, et al., The Zephyr Notification Service (undated).
- C. Anthony DellaFera, et al., The Zephyr Notification Service, Usenix Winter Conference, Feb. 9-12, 1988.
- C. Anthony DellaFera, The Zephyr Notification Service, MIT Project Athena, Winter Usenix Conference (Feb. 12, 1988).
- C. Malamud, et al., RFC 1528: Principles of Operation for the TPC.INT Subdomain: Technical Procedures (Oct. 1993).
- C. Malamud, et al., RFC1530: Principles of Operation for the TPC.INT Subdomain: General Principles and Policy (Oct. 1993).
- C. Sunshine, et al., IEN 135: Addressing Mobile Hosts in the ARPA Internet Environment (Oct. 1985).
- C. Yang, RFC 1789: INETPhone: Telephone Services and Servers on Internet (Apr. 1995).
- Calls Waiting on the Internet Although Telephone Software Makes 'Free' Long Distance Possible, it's a Long Way from Practical, Kansas City Star (Jul. 14, 1996).
- Carl Sunshine, IEN 178: Addressing Problems in Multi-Network Systems (Apr. 1981).
- Charles E. Perkins, et al., A Mobile Networking System Based on Internet Protocol, IEEE Personal Communications (First Quarter 1994).
- Charlie Kaufman's Email to dmackey re DCE 1.1 Delegation Proposal for Review, Jun. 22, 1992.
- Chii-Ren Tsai, et al., Distributed Audit with Secure Remote Procedure Calls (1991).
- Christopher Schmandt, et al., An Audio and Telephone Server for Multi-Media Workstations, IEEE (1988).
- Christopher Schmandt, et al., Phone Slave: A Graphical Telecommunications Interface, Society for Information Display, 1984 International Symposium Digest of Technical Papers (Jun. 1984).
- Chuck Kane, List of IRC servers as of Feb. 1, 1995, available at <http://ftp.funet.fi/pub/unix/irc/does/servers.950201>.
- Clinton Wilder, Pulling in the Net—InfoSeek, VocalTec Offer Search and Voice Options to Internet Users Online, Informationweek, No. 516 (1995).
- Common Desktop Environment 1.0—Advanced User's and System Administrator's Guide, Addison-Wesley Publishing Co. (1995).
- Common Desktop Environment 1.0—User's Guide, Addison-Wesley Publishing Co. (1995).
- Communications Connectivity Networking, Microsoft Systems Journal, vol. 10, No. 1 (Jan. 1995).
- Comp.Speech FAQ Archive; Comp.Speech FAQ Web Page, Comp.Speech Newsgroup. Jul. 17, 1995.
- Comp.Speech FAQ Weekly Reminder, Comp.Speech Newsgroup (Jun. 21, 1995).
- Contents, Preface, and Index to Open Software Foundation, X/Open Preliminary Specification—X/Open DCE: Authentication and Security Services (Mar. 1996).
- Conversation Excerpt from <ftp://svr-ftp.eng.cam.ac.uk/pub/comp.speech/archive/subject5xxx.txt> accessed on Nov. 28, 2007.
- Craig Crossman, Free Calls on Internet are CB-Style No Longer, Miami Herald (Jun. 26, 1995).
- Craig Crossman, Make Long Distance Calls Via the Internet, Record (Jul. 3, 1995).
- D. O'Mahoney, 1st Generation Internet Phones (1998).
- D. Reed, RFC 1324: A Discussion on Computer Network Conferencing (May 1992).
- D. Zimmerman, RFC 1288: The Finger User Information Protocol (Dec. 1991).
- Dale Skran, Draft ITU-T Recommendation H.225.0—Line Transmission of Non-Telephone Signals, Media Stream Packetization and Synchronization on Non-Guaranteed Quality of Service LANs (May 28, 1996).
- Dale Skran, ed. ASN.1 for H.225.0 (Jun. 18, 1996).
- Dan Cohen, IEN 31: On Name, Addresses and Routings (II) (Apr. 28, 1978).
- Dan Keating, Ring! It's Computer Calling Phone by Internet Has Gotten Better, Miami Herald (May 22, 1996).
- Daniel C. Swinehart, Telephone Management in the Ethernet System, IEEE (1987).
- Daniel H. Craft, Resource Management in a Decentralized System, Operating Systems Review, vol. 17, No. 5 (Association for Computing Machinery, Oct. 1983).
- Danny Cohen, IEN 23: On Name, Addresses and Routings (Jan. 23, 1978).
- Dave Lindbergh, H.323 Encryption, Document: CNC-96-22 (Apr. 15, 1996).
- David D. Clark, RFC 814: Name, Addresses, Ports, and Routes (Jul. 1982).
- David Gertler, Hardware and Software Tidbits CEBIT, Seybold Report on Desktop Publishing, vol. 9, No. 8 (Apr. 3, 1995).
- David Hafke, New on the Net—Talk It Up, Windows Magazine, No. 711 (1996).
- David Harvey, All the News That's Fit to Speak, Netguide, No. 301 (1996).
- David R. Cheriton, et al., A Decentralized Naming Facility (Stanford University, Feb. 1, 1986).
- David R. Cheriton, The V Distributed System, Communications of the ACM, vol. 31, No. 3 (Apr. 1988).

- David Rapp, I've Got to Get a Message to You, Instant Messaging Started as an MIT Computer-Science Department Project, *Technology Review* (2002).
- DCE 1.0 Security Technology, architectural overview documents, Walter Tuvell, Feb. 1997.
- DCE 1.1 Security Technology, architectural overview documents May 1994.
- DCE RPC Internals and Data Structures (Aug. 1993).
- Dean Adams, ed., *Security Survival: An indispensable guide to securing your business*, X/Open Co. (1996).
- Decided H.225.0 (Jun. 19, 1996).
- Derek C. Oppen, et al., *The Clearinghouse: A Decentralized Agent for Locating Named Objects in a Distributed Environment* (Association for Computing Machinery, 1983).
- Description of New Zephyr Protocol (undated).
- Digiphone Specifications, from Q1.11 of Section 1 of the comp.speech FAQ Home Page (dated Jan. 6, 1997).
- Douglas B. Terry, et al., *The Berkeley Internet Name Domain Server*, Usenix Association Software Tools Users Group, Summer Conference, Salt Lake City, Utah (Jun. 12-15, 1984).
- Douglas B. Terry, *Structure freeName Management for Evolving Distributed Environments*, IEEE 6th International Conference on Distributed Computing Systems, Cambridge, Massachusetts (May 19-23, 1986).
- Douglas Brian Terry, *Distributed Name Servers: Naming and Caching in Large Distributed Computing Environments*, Ph.D Thesis, University of California, Berkeley (Feb. 21, 1985).
- Douglas E. Comer, *Internetworking with TCP/IP: vol. 1: Principles, Protocols, and Architecture*, 1st ed. (Prentice-Hall, 1988).
- Douglas E. Comer, *Internetworking with TCP/IP: vol. 1: Principles, Protocols, and Architecture*, 3d ed. (Prentice-Hall, 1995).
- Douglas E. Comer, *Internetworking with TCP/IP: vol. 1: Principles, Protocols, and Architectures*, 2d ed. (Prentice-Hall, 1991).
- Douglas W. Johnson, *Internet-Connected Phone Calls Dial in to Lower Prices*, *Computerworld* (Feb. 19, 1996).
- Draft ITU-T Recommendation G.723—Dual Rate Speech Coder for Multimedia Communications Transmitting at 5.3 & 6.3 KBIT/S (Oct. 17, 1995).
- Draft ITU-T Recommendation H.323 Line Transmission of Non-Telephone Signals: Visual Telephone Systems and Equipment for Local Area Networks Which Provide a Non-Guaranteed Quality of Service, (May 28, 1996).
- Draft Recommendation H.323 Visual Telephone Systems and Terminal Equipment for Local Area Networks Which Provide A Non-Guaranteed Quality of Service, Sep. 8, 1995.
- Draft Recommendation H.323—Visual Telephone Systems and Equipment for Local Area Networks Which Provide A Non-Guaranteed Quality of Service (May 28, 1996).
- E.D. Sykas, et al., *Overview of the CCITT X500 Recommendations Series* (Butterworth-Heinemann, 1991).
- Electric Magic Company Sales Invoices, Feb. 23, 1995 thru Dec. 3, 1995.
- Electric Magic Company, *Beta Test License Agreement* (dated May 30, 1995).
- Elizabeth Feinler, et al., RFC 810: *DoD Internet Host Table Specification* (Mar. 1, 1982).
- Ellen Massmer, *PictureTel Brings Video to the Lan Network World* (Sep. 4, 1995).
- E-mail from Dale Skran to jtoga@ibeam.jf.intel.com, phone numbers for email list (Jan. 6, 1997).
- E-mail from Dale Skran to jtoga@ibeam.jf.intel.com, mailing list to enter (Jan. 6, 1997).
- E-mail from Ofer Shapiro to Bob Bell, et al., RE: Destination side gateway problem (Jul. 29, 1996).
- E-mail from Sakae Okubo to Experts of ITU-T SG16 Q.12/16, Q.13/16 and Q.14/16, Notice of the Q.12-14/16 Sunriver meeting (Jul. 17, 1997).
- Email from Sakae Okubo to yves.robin-champigneu@oissy.cnet.fr, et al., Working tools of SG16 experts groups (May 8, 1997).
- E-mail from Vineet Kumar to h323implementors@mailbag.jf.intel.com Receiver associating a logical channel with a RTP stream (Aug. 5, 1996).
- Erdos, Marlena and Pato, Joseph, "Extending the OSF DCE Authorization System to Support Practical Delegation," Feb. 11, 1993.
- Eric C. Rosen, IEN 183: Logical Addressing (May 1981).
- Eric C. Rosen, IEN 188: Issues in Internetting Part 3: Addressing (Jun. 1981).
- Etherphone: Collected Papers 1987-1988, Xerox PARC, CSL-89-2 (May 1989).
- Eve M. Schooler, *Case Study: Multimedia Conference Control in a Packet-Switched Teleconferencing System*, *Journal of Internetworking: Research and Experience*, vol. 4, No. 2 (Jun. 1993).
- Eve M. Schooler, et al., *An Architecture for Multimedia Connection Management*, Proceedings IEEE 4th Comsoc International Workshop on Multimedia Communications, MM '92, Monterey, California (Apr. 1992).
- Eve M. Schooler, *The Connection Control Protocol: Architecture Overview* (Jan. 28, 1992).
- Eve M. Schooler, *The Connection Control Protocol: Specification, Version 1.1* (Jan. 29, 1992).
- Eve M. Schooler, *The Impact of Scaling on Multimedia Connection Architecture*, *Multimedia Systems*, vol. 1 (Association for Computing Machinery, 1993).
- Exportability of DCE Multi-Crypto Feature by Walter Tuvell, Mar. 5, 1996.
- F. Anklesaria, et al., RFC 1436: *The Internet Gopher Protocol (A Distributed Document Search and Retrieval Protocol)* (Mar. 1993).
- FAQ: *How Can I Use the Internet as a Telephone*, Ver. 0.2 (Apr. 27, 1995).
- FAQ: *How Can I Use the Internet as a Telephone*, Ver. 0.4 (Feb. 23, 1996).
- Fax from Ryan Holmquist to Dale Skran (May 30, 1996).
- FLEXIm v3.0 Programmer's Guide, Globetrotter Software, Inc. (Aug. 1994).
- Full Duplex Internet Voice Comms Available, *Newsbytes* (Feb. 14, 1995).
- Gary A. Thom, H.323: *The Multimedia Communications Standard for Local Area Networks*, *IEEE Communications Magazine* (Dec. 2006).
- Gilbert Held, *The ABCs of IP Addressing*, CRC Press LLC (2002).
- Gligor, et al. "On Inter-realm Authentication in Large Distributed Systems" May 2, 1992.
- Google Groups "CyberPhone" Search Results, search conducted on Nov. 28, 2007.
- Goretsky, Aryeh "PowWow Quick Installation Guide", 1996.

- Green, Andrew, NetPhone Tasks and Plans, Email, 2 pages (printed Feb. 2, 1995).
- Greg Wood, Computer VAR Takes His First Computer Telephony Plunge, Computer Telephony (Sep. 1996).
- Gursharan S. Sidu, et al., Inside AppleTalk, 2d ed. (Addison-Wesley Publishing Co., 1990).
- H. Schulzrinne, et al., RFC 1889: RTP: A Transport Protocol for Real-Time Applications (Jan. 1996).
- Handwritten Notes, Electric Magic Company (dated Jul. 22, 1994 thru Aug. 30, 1995).
- Harrick M. Vin., et al., Multimedia Conferencing in the Etherphone Environment (IEEE, Oct. 1991).
- How Can I use the Internet as a telephone? from Q1.11 of Section 1 of the comp.speech FAQ Home Page (dated Mar. 19, 1996).
- Hussein M. Abdel-Wahab, XTV: A Framework for Sharing X Window Clients in Remote Synchronous Collaboration, IEEE Conference on Communications Software: Communications for Distributed Applications & Systems (Apr. 1991).
- I C. Weider, et al., RFC 1727: A Vision of an Integrated Information Service (Dec. 1994).
- Inder Gopal, et al., Directories for Networks with Casually Connected Users (IEEE, 1988).
- Information Technology—Database Language SQL (Proposed revised text of DIS 9075), Digital Equipment Corp. (Jul. 1992).
- InterFACE from Hijinx Specifications, from Q1.11 of Section 1 of the comp.speech FAQ Home Page (dated Mar. 19, 1996).
- Internet Phone from VocalTec Specifications, from Q1.11 of Section 1 of the comp.speech FAQ Home Page (dated Mar. 19, 1996).
- Internet Phone Release 4, Users Manual, VocalTech 1996.
- Internet Telephone Companies Racing to Market, Voice Technology & Service News, vol. 14 No. 20 (Oct. 3, 1995).
- Introduction to OSF DCE (Prentice-Hall, Inc., 1992).
- ITU-T Recommendation X.500—Information technology—Open Systems Interconnection—The Directory: Overview of concepts, models and services (Aug. 1997).
- ITU-T Recommendation X.501—Information technology—Open Systems Interconnection—The Directory: Models (Aug. 1997).
- J. Oikarinen, et al., RFC 1459: Internet Relay Chat Protocol (May 1993).
- J. Pato, Hierarchical Trust Relationships for Inter-Cell Authentication, Slides, (Jul. 7, 1992).
- J. Pato, RFC 7.0: Hierarchical Trust Relationships for Inter-Cell Authentication (Jul. 1992).
- J. Postel, et al., RFC 959: File Transfer Protocol (FTP) (Oct. 1985).
- J. Postel, RFC 765: File Transfer Protocol (Jun. 1980).
- J. Postel, RFC 925: Multi-LAN Address Resolution (Oct. 1984).
- J. Saltzer, RFC 1498: On the Naming and Binding of Network Destinations (Aug. 1993).
- Jack Rickard, Voice Over Internet—the Internet Phone, Boardwatch Magazine, vol. 9, No. 4 (Apr. 1995).
- James M. Bloom, et al., Experiences Implementing BIND, A Distributed Name Server for the DARPA Internet (Jun. 9–13, 1986).
- James Martin, et al., TCP/IP Networking: Architecture, Administration, and Programming (Prentice Hall, 1994).
- James Staten, NetPhone 1.2 Calls the Web, MacWeek, vol. 9 No. 27 (Jul. 10, 1995).
- Jennifer G. Steiner, et al., Kerberos: An Authentication Service for Open Network Systems, Usenix Winter Conference, Dallas, Texas (Feb. 9–12, 1988).
- Joe Maloney, DCE: Focus on Security, the Internet and the Future (printed Apr. 25, 2002, date unknown).
- Joe Pato, et al., Distributed Computing Environment (DCE) Design of the Security Services and Facilities (Aug. 10, 1992).
- Joe Pato, Extending the DCE Authorization Model to Support Practical Delegation—Extended Summary (Jul. 7, 1992).
- Joe Pato, RFC 3.0: Extending the DCE Authorization Model to Support Practical Delegation—Extended Summary (Jun. 1992).
- Joe Pato, RFC 6.0: A Generic Interface for Extended Registry Attributes (Jun. 1992).
- John A. Pershing, Jr., et al., IEN 162: Transport, Addressing, and Routing in the Wideband Net (Oct. 1980).
- John F. Shoch, IEN 19: Inter-Network Naming, Addressing, and Routing (Jan. 1978).
- John Ioannidis, et al., IP-based Protocols for Mobile Inter-networking, Columbia Univ., Dept. of Computer Science (1991).
- John R. Pickens, et al., RFC 756: The NIC Name Server—A Datagram Based Information Utility (Jul. 1979).
- John T. Kohl, The Zephyr Notification Service, First International Athena Technical Conference (Apr. 11, 1991).
- John Veizades, et al., Service Location Protocol, Internet Draft (May 2, 1995).
- Jon Hill, et al., Pow Wow, PC Magazine, vol. 15 No. 17 (Oct. 8, 1996).
- Jon Hill, TeleVox, PC Magazine, vol. 15 No. 17 (Oct. 8, 1996).
- Jon Livesey, Inter-process Communication and Naming in the Mininet System, Eighteenth Annual IEEE Computer Society International Conference, San Francisco, California (1979).
- Jon Postel, RFC 921: Domain Name System Implementation Schedule—Revised (Oct. 1984).
- José M. Bernabeu-Auban, et al., Optimizing a Generalized Polling Protocol for Resource Finding over a Multiple Access Channel, Computer Networks and ISDN Systems 27 (1995).
- Josina M. Arfman, et al., Project Athena: Supporting Distributed Computing at MIT, IBM Systems Journal (1992).
- K. Harrenstien, et al., RFC 811: Hostname Server (Oct. 1985).
- K. Harrenstien, et al., RFC 952: DoD Internet Host Table Specification (Oct. 1985).
- K. Harrenstien, RFC 742: Name/Finger (Dec. 30, 1977).
- Kahane, Opher et al., “Call Management Agent System Specification” Volp Forum Technical Committee Contribution (dated Aug. 15, 1996).
- Karl Auerbach, et al., RFC 1001: Protocol Standard for a NetBIOS Service on a TCP/UDP Transport: Concepts and Methods (Mar. 1987).
- Keith A. Lantz, et al., Towards a Universal Directory Service, 4th PODC Conference Proceedings (Association for Computing Machinery, 1985).
- Ken Harrenstien, et al., RFC 811: Hostnames Server (Mar. 1, 1982).
- Ken Harrenstien, RFC 811: Hostnames Server (Mar. 1, 1982).
- Ken Harrenstien, RFC 812: Ncname/Whois (Mar. 1, 1982).

- Kenneth Hart, Startups, industry mainstays add to Internet phone menu, *Communicationsweek Int'l* (Nov. 27, 1995).
- Klaus Zeuge, et al., The Client-to-Client Protocol (CTCP) (published no later than Aug. 12, 1994).
- Kohl, John T., "Zephyr Installation and Operation Guide", Draft—Nov. 20, 1989.
- Koster, Steven "The Phone Companies Worst Nightmare" *Hotwired*, Apr. 1995.
- L. Landweber, et al., Architecture of the CSNET Name Server (Association for Computing Machinery, 1983).
- L. Peter Deutsch, RFC 606: Host Names On-Line (Dec. 1973).
- Larry L. Peterson, A Yellow-Pages Service for a Local-Area Network (Association for Computing Machinery, 1988).
- Larry L. Peterson, The Profile Naming Service. *ACM Transactions on Computer Systems*, vol. 6, No. 4, (Nov. 1988).
- Lisa Zahn, et al., *Network Computing Architecture*, Prentice Hall (1990).
- List of Names from a DCE Meeting; attendees from DISA, OSF, DEC, Mitre, HP, Open Market and others (undated).
- Listery postings by Jon Postel, Dynamic Updated Proposal, dated Sep. 1 and 9, 1993.
- Listery postings by Susan Thomson, DNS Dynamic Updates, dated Jul. 14, 1994.
- Lon Wagner, New Software Lets Users Talk for Cheap, *Virginian-Pilot* (Mar. 26, 1995).
- M. Bever, et al., *Distributed Systems, OSF DCE, and Beyond* (1993).
- M.D. Kudlick, RFC 608: Host Names On-Line (Jan. 10, 1974).
- Making the Most of IP Telephony, *VocalTec Annual Report 1997*.
- Mark Crispin, RFC 752: A Universal Host Table (Jan. 2, 1979).
- Mark Reid, Ptell Call Control Procedure in H.323 (Jun. 16, 1995).
- Markus Sohlenkamp & Greg Chwelos, Integrating Communication, Cooperation, and Awareness: The DIVA Virtual Office Environment (1994).
- Mic Bowman, et al., *Unifers: An Attribute-based Name Server, Software Practice and Experience*, vol. 20(4) (Apr. 1990).
- Michael D. Schroeder, et al., Experience with Grapevine: The Growth of a Distributed System, *ACM Transactions on Computer Systems* (Feb. 1984).
- Michael D. Schroeder, et al., Experience with Grapevine: The Growth of a Distributed System, *ACM Transactions on Computer Systems*, vol. 2, No. 1 (Feb. 1984).
- Michael F. Schwartz, et al., A Comparison of Internet Resource Discovery Approaches, *Computing Systems* (Aug. 1992).
- Michael F. Schwartz, et al., A Name Service for Evolving, Heterogeneous Systems, *ACM* (1987).
- Michael J. Bibeau, A Formative Evaluation of CU-SeeMe, Masters Thesis, Virginia Polytechnic Institute and State University (Feb. 20, 1995) (including CU-SeeMe Users Manual by same author published Jan. 1995).
- Michelle Slatalla, Hold the Phone! You Can Call Long Distance on a Computer For Pennies, But it has its Drawbacks, *Newsday* (Mar. 14, 1995).
- Mike Kong, et al., *Network Computing System Reference Manual*, Prentice Hall (1990).
- Mike Kudlick, et al., RFC 627: ASCII Text File of Hostnames (Mar. 25, 1974).
- Mitch Wagner, Phone Home Cheaply Over the I-Way, *Open Systems Today* (Feb. 20, 1995).
- Mitre Fort Meade Site DCE Meeting Sign In Sheet Jan. 16, 1995.
- Mostafa H. Ammar, et al., Using Hint Tables to Locate Resources in Distributed Systems (IEEE, 1988).
- Motorola Micro TAC International 5000 Series Manual (undated).
- Motorola Micro TAC International 7000 Series (dated May 1994).
- Motorola Micro TAC International 7500 Series (undated).
- Motorola Micro TAC International 8000 Series (undated).
- Nate Zelnick, Chat on the Web: An Overview, *Interactive Content*, vol. 2, No. 17 (Sep. 1995).
- Nautilus: Secure Computer Telephony, from Q1.11 of Section 1 of the comp.speech FAQ Home Page (dated Aug. 7, 1996).
- NetPhone 1.0 User Manual, Electric Magic Company (document includes date Dec. 31, 1994).
- NetPhone 1.1 User Manual, Electric Magic Company (document includes date Feb. 16, 1995).
- NetPhone Demo Instructions, Electric Magic Company, 1994.
- NetPhone Development Plan (undated).
- NetPhone Development Plan v0.1 (undated).
- NetPhone Digital User Manual, Electric Magic Company, Feb. 26, 1995.
- NetPhone Digital User Manual, Electric Magic Company, Mar. 12, 1995.
- Netphone Information Manual, Electric Magic Company, May 30, 1995.
- NetPhone Testing Notes, Sep. 28, 1994.
- Netphone, Change Notes, Dec. 6.
- Nigel Hinds, et al., Name Space Models for Locating Services, IBM Canada Laboratory Technical Report 74.074 (1991).
- Norbert Leser, Towards a Worldwide Distributed File System: The OSF DCE File System as an example (Sep. 27, 1990).
- Open Group, Cambridge Information (Jun. 23, 1997).
- Open Software Foundation Security Sig (Mar. 19, 1996).
- Open Software Foundation, AES/Distributed Computing RPC Volume, PTR Prentice Hall (1994).
- Open Software Foundation, DCE Internals Course, Instructor Guide vol. 1 (1992).
- Open Software Foundation, DCE Internals Course, Instructor Guide vol. 2 (1992).
- Open Software Foundation, Industry Analysis of DCE (May 15, 1990).
- Open Software Foundation, Introduction to OSF DCE, Prentice Hall (1992).
- Open Software Foundation, Open Line Magazine (May/Jun. 1990).
- Open Software Foundation, OSF DCE Administration Guide Core Components, PTR Prentice Hall (1993).
- Open Software Foundation, OSF DCE Administration Guide—Extended Services, PTR Prentice Hall (1993).
- Open Software Foundation, OSF DCE Administration Guide—Introduction, PTR Prentice Hall (1993).
- Open Software Foundation, OSF DCE Administration Reference, PTR Prentice Hall (1993).
- Open Software Foundation, OSF DCE Application Development Guide, PTR Prentice Hall (1993).

- Open Software Foundation, OSF DCE Application Development Reference, PTR Prentice Hall (1993).
- Open Software Foundation, OSF DCE User's Guide and Reference, PTR Prentice Hall (1993).
- OSF DCE User's Guide and Reference (Prentice-Hall, Inc., 1993).
- P. Deutsch, et al., RFC 1835: Architecture of the Whois++ Service (Aug. 1995).
- P. Faltstrom, et al., RFC 1914: How to Interact with a Whois++ Mesh (Feb. 1996).
- P. Mockapetris, RFC 882: Domain Names—Concepts and Facilities (Nov. 1983).
- P. Mockapetris, RFC 883: Domain Names—Implementation and Specification (Nov. 1983).
- P. Venkat Rangan, et al., Software Architecture for Integration of Video Services in the Etherphone System, IEEE Journal on Selected Areas in Communications, vol. 9, No. 9 (Dec. 1991).
- P.M. Gopal, et al., Consistent Resource Registration, IBM Technical Disclosure Bulletin, vol. 37, No. 9 (Sep. 1994).
- Part 1 of Open Software Foundation, X/Open Preliminary Specification—X/Open DCE: Authentication and Security Services (Mar. 1996).
- Part 2 chapter 2 thru 5 of Open Software Foundation, X/Open Preliminary Specification—X/Open DCE: Authentication and Security Services (Mar. 1996).
- Part 2 chapter 6 thru 13 of Open Software Foundation, X/Open Preliminary Specification—X/Open DCE: Authentication and Security Services (Mar. 1996).
- Part 3 and Part 4 of Open Software Foundation, X/Open Preliminary Specification—X/Open DCE: Authentication and Security Services (Mar. 1996).
- Pato, Joseph N., A Generic Interface for Extended Registry Attributes, Jul. 7, 1992.
- Paul Albitz, et al., DNS and Bind in a Nutshell (O'Reilly & Associates, 1992).
- Paul Mockapetris, RFC 1034: Domain Name—Concepts and Facilities (Nov. 1987).
- Paul Mockapetris, RFC 1035: Domain Name—Implementation and Specification (Nov. 1987).
- Paul V. Mockapetris, et al., Development of the Domain Name Server, Computer Communication Review, vol. 18, No. 4 (Aug. 1988).
- Paul V. Mockapetris, et al., Development of the Domain Name System, Computer Communication Review (Aug. 1988).
- Phoning By Web, San Francisco Chronicle (Mar. 12, 1996).
- PictureTel Corp., 10-K405/A (filed Jan. 13, 1998).
- PictureTel LiveLan (printed Dec. 3, 2007).
- Ping Lin's Email to mackey, Comments on DCE 1.1 Delegation RFC, Jul. 2, 1992.
- Polle T. Zellweger, et al., An Overview of the Etherphone System and its Applications (IEEE, 1988).
- Postel, RFC 791: Internet Protocol: Darpa Internet Program Protocol Specification (Sep. 1981).
- Postel, RFC 793: Transmission Control Protocol: Darpa Internet Program Protocol Specification (Sep. 1981).
- PowWow For Microsoft Windows User's Guide, Version 1.4B, Documentation by Token White Man (dated 1995).
- PowWow For Microsoft Windows User's Guide, Version 1.5, Documentation by Aryeh Goretsky (dated 1995).
- PowWow For Microsoft Windows User's Guide, Version 1.6 beta 2, Documentation by Aryeh Goretsky (dated 1995).
- PowWow For Microsoft Windows User's Guide, Version 1.6 beta, Documentation by Aryeh Goretsky (dated 1995).
- PowWow For Microsoft Windows User's Guide, Version 1.7 beta 1, Documentation by Aryeh Goretsky (dated 1995).
- PowWow For Microsoft Windows User's Guide, Version 1.7 beta 2, Documentation by Aryeh Goretsky (dated 1995).
- PowWow For Microsoft Windows User's Guide, Version 1.7 beta 3, Documentation by Aryeh Goretsky (dated 1995).
- PowWow For Microsoft Windows User's Guide, Version 1.7 beta 4, Documentation by Aryeh Goretsky (dated 1995).
- PowWow For Microsoft Windows User's Guide, Version 2.0 beta 1, Documentation by Aryeh Goretsky (dated 1995, 1996).
- PowWow For Microsoft Windows User's Guide, Version 2.1, Documentation by Aryeh Goretsky (dated 1995, 1996).
- PowWow For Microsoft Windows User's Guide, Version 2.2 beta 1, Documentation by Aryeh Goretsky (dated 1995, 1996).
- PowWow For Microsoft Windows User's Guide, Version 2.2 beta 2, Documentation by Aryeh Goretsky (dated 1995, 1996).
- PowWow For Microsoft Windows User's Guide, Version 2.3, Documentation by Aryeh Goretsky (dated 1995, 1996).
- PowWow For Microsoft Windows User's Guide, Version 2.31, Documentation by Aryeh Goretsky (dated 1995, 1996).
- PowWow For Microsoft Windows User's Guide, Version 2.32, Documentation by Aryeh Goretsky (dated 1995, 1996).
- PowWow For Microsoft Windows User's Guide, Version 3.0 beta 3, Documentation by Aryeh Goretsky (dated 1995, 1996).
- PowWow User Local Server Version 1.0 beta 2 Release Notes (Dated Jun. 18, 1996).
- PowWow User Location Server for Microsoft Windows NT and 95 Version 1.0 beta 2 Installation Guide. by Goretsky, Aryeh (dated 1996).
- PowWow Version Release Notes (covering versions 1.4b to 2.32) (dated Jun. 26, 1996).
- PowWow32 Release Notes (PowWow Versions 3.0 beta 3 and 3.0 beta 2) (dated Nov. 21, 1996).
- Prospectus for VocalTech Ordinary Shares, Feb. 6, 1996.
- Questions and Comments: DCE RFC 6.0 "A Generic Interface for Extended Registry Attributes" Commentary by Bob Blakley, Jul. 6, 1992.
- R. Braden, RFC 1644 T/TCP—TCP Extensions for Transactions Functional Specifications (Jul. 1994).
- R. Droms, RFC 1531: Dynamic Host Configuration Protocol (Oct. 1993).
- R. Droms, RFC 1541: Dynamic Host Configuration Protocol (Oct. 1993).
- R.C. Summers, Local-Area Distributed Systems, IBM Systems Journal, vol. 28, No. 2 (1989).
- Raj Pandya, Emerging Mobile and Personal Communication Systems, IEEE Communications Magazine (Jun. 1995).
- RFC 1001: Protocol Standard for a NetBIOS Service on a TCP/UDP Transport: Concepts and Methods, Mar. 1987.
- RFC 1057: RPC Remote Procedure Call Protocol Specification Version 2, Jun. 1988.
- Richard Karpinski, Internet Phones Battle for the Market, Interactive Age, No. 212 (1995).
- Richard Karpinski, Upgrading Internet Phone—VocalTec Offers Full-Duplex Version, Eliminating Voice Delays, Interactive Age, No. 216 (1995).
- Richard T. Snodgrass, Developing Time-Oriented Database Applications in SQL, Morgan Kaufmann Publishers (2000).

- Rivka Tadjer, Internet Communications Solutions: How Well Do They Work?, Computer Shopper, vol. 15, No. 6 (Jun. 1995).
- Rivka Tadjer, Internet Phones to Upstage Videoconferencing Products? Talk is Cheaper with Local Worldwide Dialing, Computer Shopper, vol. 15, No. 5 (May 1995).
- Rob Walters, Computer Telephone Integration (Artech House, 1993).
- Robert E. Kahn, et al., Advances in Packet Radio Technology, Proceedings Of The IEEE (Nov. 1978).
- Robert Gurwitz, et al., IEN 212: IP—Local Area Network Addressing Issues (Sep. 1982).
- Robert J. Williams, User Location Service (Feb. 1996).
- Robert Joseph Fowler, Decentralized Object Finding Using Forwarding Addresses, Ph.D. Thesis, University of Washington (Dec. 1985).
- Robert Richardson, Internet Phone, LAN Magazine, vol. 10, No. 7 (Jul. 1995).
- Robert Richardson, Pow Wow, Anyone? A Web Chat That Works, LAN Magazine, vol. 10 No. 9 (Sep. 1995).
- Robert S. French, et al., The Zephyr Programmer's Manual, Rev. 2.1 (May 5, 1989).
- Rosen, Nick "Internet Opens Line on Cheap Global Phone Calls" The Guardian, Feb. 10, 1995, A1.
- S. Waldbusser, et al., RFC 1742: AppleTalk Management Information Base II (Jan. 1995).
- S.R. Ahuja, et al., The Rapport Multimedia Conferencing System, ACM (1988).
- Sakae Okubo, et al., Draft ITU-T Recommendation H.245—Line Transmission of Non-Telephone Signals: Control Protocol for Multimedia Communications (Nov. 14, 1995).
- Sakae Okubo, et al., ITU-T Recommendation H.245—Line Transmission of Non-Telephone Signals: Control Protocol for Multimedia Communication (May 20, 1996).
- Sakae Okubo, et al., Line Transmission of Non-Telephone Signals: Control Protocol for Multimedia Communication, Recommendation H245 (May 20, 1996).
- Sakae Okubo, et al., ITU-T Standardization of Audiovisual Communication Systems in ATM and LAN Environments (Apr. 17, 1996).
- Sape J. Mullender, et al., Distributed Match-Making for Processes in Computer Networks (Association for Computing Machinery, 1985).
- Sape Mullender, ed., Distributed Systems, ACM Press (1992).
- Sapwater, E. "Webbed", 2 pages (undated).
- Saruchi Mohan, Internet Phone Accepting Calls, Computerworld (Feb. 27, 1995).
- Savetz, Kevin "Net as Phone" Internet World, Jul. 1995.
- Schill, et al., ed., IFIP/IEEE International Conference on Distributed Platforms—Client/Server and Beyond: DCE, Corba, ODP & Advanced Distribution Applications, Technical University Bergakademie Freiberg (1996).
- Schulzrinne, Service Conference Invitation Protocol, Internet Draft (Feb. 22, 1996).
- Scott Kahn, Leave Your Message on My PC After the Beep, PC Week (Oct. 3, 1994).
- Sharon Fisher, Fruits of Athena—Academic Projects Like Athen Have Given the World Its First Inkling of What Computer Interoperability is All About, Communications Week (1992).
- Snell, Jason "Foiling Ma Bell" MacUser, Jul. 1995.
- Speak Freely, from Q1.11 of Section 1 of the comp.speech FAQ Home Page (dated Mar. 19, 1996).
- Staff Phone List (Jul. 1, 1997).
- Steinberg, Bob "Will Politics Interfere With The Global Internet?" Mashpee Enterprise, Apr. 28, 1995.
- Stephen A. Uhler, PhoneStation, Moving the Telephone onto the Virtual Desktop, 1993 Winter Usenix, San Diego, California (Jan. 25–29, 1993).
- Steve Hamm, The Merry Pranksters, PC Week, vol. 12 No. 34 (Aug. 28, 1995).
- Stuart Harris, The IRC Survival Guide: Talk to the World With Internet Relay Chat (Addison-Wesley, Feb. 1995).
- Sun Microsystems, Inc., RFC 1050: RPC: Remote Procedure Call Protocol Specification Version 2 (Jun. 1988).
- Surfers Can Drop Phones, Electronics Times (Feb. 16, 1995).
- Susan Thomson, et al., DNS Dynamic Updates, IETF DNSIND Working Group (Jul. 1994).
- T. Berners-Lee, et al., RFC 1738: Uniform Resource Locators (URL) (Dec. 1994).
- Tamila Baron, Hearing Voices on the Net, Communication Week (Feb. 20, 1995).
- Tamila Baron, VocalTec, Motorola Team Up for Internet Phone and Modem Bundle, Communications Week, No. 549 (1995).
- Ted Anderson's Email to dmackey re DCE 1.1 Delegation Proposal for Review, Jun. 23, 1992.
- Ted Anderson's Email to pato, Re: RFC 7.0 (really glp92), Jul. 21, 1992.
- The 4.BSD-Lite distribution announcement, Computer Systems Research Group (Mar. 1, 1994), and related news-group postings, dated Apr. 21–22, 1994.
- The Electric Magic Company, Business Plan, Version 0.1 draft, Apr. 17, 1995.
- The Open Group Organization Chart (Oct. 1997).
- The Open Group Organization Chart Oct. 1996 (Confidential).
- The OSF Distributed Computing Environment: Building on International Standards, OSF White Paper (Apr. 1992).
- The VocalChat User's Guide, Sep. 28, 1993.
- Thomas Maresca, The Internet Phone Company?, Consumer Information Appliance, No. 55 (Feb. 1995).
- TIMOP: DCE Time Operations Sample Application. (undated).
- Timothy J. O'Malley, Analysis of the Zephyr Communication Paradigm, Bachelor of Science in Computer Science and Engineering, Thesis, Massachusetts Institute of Technology (May 1993).
- Todd Copilevitz, Heard on the Internet, The Star-Ledger (Mar. 7, 1995).
- Tom Lyons, Network Computing System Tutorial, Prentice Hall (1991).
- Tony Pompili, VocalTec: The Internet Phone Number?, PC Magazine (May 16, 1995).
- Translation of Japanese Patent Application No. Sho 63[1988]-131637 (Original dated Jun. 3, 1988).
- Transparencies: Walter Tuvell, DCE 1.0 Security Technology—Detailed Architectural Overview (Feb. 1997).
- V. Jacobson, et al. RFC 1185: TCP Extension for High-Speed Paths (Oct. 1990).
- VocalChat 1.01 Network Information (undated).
- VocalChat Early Beta Release 1.02B Information (undated).
- VocalChat GTI 2.12 Beta Retrieval Instructions and Information (undated).
- LG v. Straight Path, IPR2015-00198
Straight Path - Ex. 2015 - Page 14

- VocalChat Version 1.0, README.TXT, Nov. 1993.
VocalChat Version 1.01, README.TXT, Mar. 1994.
VocalChat Version 2.01 and Wan 2.01, README.TXT. May 1994.
VocalTec Annual Report, 1996.
VocalTec Cross-Reference Sheet, Pursuant to Item 501 of Reg. S-K (dated Jan. 1996).
VocalTec Internet Phone Information Sheet, 2 pages. (dated Jun. 1995).
VocalTec Internet Phone Version 3.0 Build 17, README.TXT. Aug. 11, 1995.
VocalTec Internet Phone Version 3.2 Build 21, README.TXT, Mar. 25, 1996.
VocalTec SEC 20-F Filing, 1996.
VocalTec SEC F-1 Filing, Dec. 22, 1995.
VocalTec SEC F-1 Filing, Jan. 5, 1996.
Voice Over the Internet, Boardwatch Magazine, vol. IX, No. 1 (Jan. 1995).
W. David Albrecht, CPA Firms on the World Wide Web. Ohio CPA Journal (Jun. 1996).
W. Simpson, RFC 1661: The Point-to-Point Protocol (PPP) (Jul. 1994).
W. Yeong, et al., RFC 1777. Lightweight Directory Access Protocol (Mar. 1995).
Walt and mactcp's ip addresses and code (undated).
Walter Tuvell, DCE 1.0 Security Technology-Detailed Architectural Overview (Feb. 1997).
Walter Turvell, DCE 1.0, Security Technology Detailed Architectural Overview, Draft (Feb. 1997).
Walter Tuvell, DCE 1.0 Security Technology: Detailed Architectural Overview (Feb. 1997).
Walter Tuvell, DCE 1.0 Security Technology: Detailed Architectural Overview (May 1994).
Walter Tuvell, DCE Multi-Crypto Support-Proposal to NSA for Funding and Exportability of Multiple Cryptographic Mechanisms in OSF's Distributed Computing Environment (Sep. 12, 1995).
Walter Tuvell, Distribution & The Infobahn (1996).
Walter Tuvell, Exportability of DCE Multi-Crypto Feature (Mar. 5, 1996).
Walter Tuvell, RFC 98.0: Challenges Concerning Public-Key in DCE (Dec. 1996).
Walter Tuvell, System V/ONC Comparison to AIX/NCSS (Oct. 3, 1988).
Walter Tuvell, The DCE Dance: Application Development in 29 Easy Steps (Sep. 1991).
Walter Tuvell, The OSF Distributed Computing Environment (DE). (undated).
Web Phone, from Q1.11 of Section 1 of the comp.speech FAQ Home Page (dated Mar. 19, 1996).
WebSTAR Technical Reference (formerly MacHTTP), StarNine Technologies, 1995).
Wei Hu, DCE Security Programming, O'Reilly & Associates (Jul. 1995).
Welch, Nathalie "Vendors Ring in New Telephony Options" MacWeek, Apr. 10, 1995, p. 18.
Wendy Woods, Newsbytes Daily Summary, Newsbytes (Jun. 10, 1994).
William M. Bulkeley, On-line: Hello, world. Audible Chats on the Internet, Wall Street Journal (Feb. 10, 1995).
Winther, Mark. "The World Wide Web Phones Home: Internet Telephony Market Assessment, 1996-1999", International Data Corporation White Paper (dated 1996).
Xerox System Integration Standard Clearinghouse Protocol (Apr. 1984).
Yakov Rekhter, et al., Dynamic Updates in the Domain Name System (DNS):Architecture and Mechanism, Internet-Draft, DNSIND Working Group (Jul. 15, 1994).

1
EX PARTE
REEXAMINATION CERTIFICATE
ISSUED UNDER 35 U.S.C. 307

THE PATENT IS HEREBY AMENDED AS
INDICATED BELOW.

Matter enclosed in heavy brackets [] appeared in the patent, but has been deleted and is no longer a part of the patent; matter printed in italics indicates additions made to the patent.

AS A RESULT OF REEXAMINATION, IT HAS BEEN DETERMINED THAT:

The patentability of claims 5 and 6 is confirmed.

Claim 8 is cancelled.

Claims 1, 9, 14, 16 and 17 are determined to be patentable as amended.

Claims 2, 3, 15 and 18, dependent on an amended claim, are determined to be patentable.

Claims 4, 7 and 10-13 were not reexamined.

1. A computer program product for use with a computer system having a display, the computer system capable of executing a first process and connecting to other processes and a server process over a computer network, the computer program product comprising a computer usable medium having computer readable code means embodied in the medium comprising:

- a. program code for generating a user-interface enabling control of a first process executing on the computer system;
- b. program code for determining the currently assigned network protocol address of the first process upon connection to the computer network;
- c. program code responsive to the currently assigned network protocol address of the first process, for establishing a communication connection with the server process and for forwarding the assigned network protocol address of the first process and a unique identifier of the first process to the server process upon establishing a communication connection with the server process; and
- d. program code, responsive to user input commands, for establishing a point-to-point communications with another process over the computer network.

9. [The] *In a computer system having a display and capable of executing a process, a method for establishing a point-to-point communication from a caller process to a callee process over a computer network, the caller process capable of generating a user interface and being operatively connected to the callee process and a server process over the computer network, the method [of claim 8] comprising the steps of:*

- A. *generating a user-interface element representing a first communication line;*
- B. *generating a user interface element representing a first callee process;*

2

C. *querying the server process to determine if the first callee process is accessible; and*

D. *establishing a point-to-point communication link from the caller process to the first callee process, in response to a user associating the element representing the first callee process with the element representing the first communication line, wherein step C further comprises the steps of:*

C.1 *querying the server process as to the on-line status of the first callee process; and*

C.2 *receiving a network protocol address of the first callee process over the computer network from the server process.*

14. The method of claim [8] 9, further comprising the steps of:

E. *generating a user interface element representing a communication line having a temporarily disabled status; and*

F. *temporarily disabling the point-to-point communication between the caller process and the first callee process, in response to the user associating the element representing the first callee process with the element representing the communication line having a temporarily disabled status.*

16. [The] *In a computer system having a display and capable of executing a process, a method for establishing a point-to-point communication from a caller process to a callee process over a computer network, the caller process capable of generating a user interface and being operatively connected to the callee process and a server process over the computer network, the method [of claim 15] comprising the steps of:*

A. *generating a user-interface element representing a first communication line;*

B. *generating a user interface element representing a first callee process;*

C. *querying the server process to determine if the first callee process is accessible;*

D. *establishing a point-to-point communication link from the caller process to the first callee process, in response to a user associating the element representing the first callee process with the element representing the first communication line;*

E. *generating a user interface element representing a communication line having a temporarily disabled status; and*

F. *temporarily disabling the point-to-point communication between the caller process and the first callee process, in response to the user associating the element representing the first callee process with the element representing the communication line having a temporarily disabled status, wherein the element generated in step E represents a communication line on hold status, and wherein the element generated in step E represents a communication line on mute status.*

17. The method of claim [8] 9 wherein the display further comprises a visual display.

* * * * *



UNITED STATES PATENT AND TRADEMARK OFFICE

UNITED STATES DEPARTMENT OF COMMERCE
United States Patent and Trademark Office
Address: COMMISSIONER FOR PATENTS
P.O. Box 1450
Alexandria, Virginia 22313-1450
www.uspto.gov

APPLICATION NO.	FILING DATE	FIRST NAMED INVENTOR	ATTORNEY DOCKET NO.	CONFIRMATION NO.
90/010,422	02/26/2009	6,009,469	2655-0185	6565

42624 7590 12/03/2010

DAVIDSON BERQUIST JACKSON & GOWDEY LLP
4300 WILSON BLVD., 7TH FLOOR
ARLINGTON, VA 22203

EXAMINER

ART UNIT PAPER NUMBER

DATE MAILED: 12/03/2010

Please find below and/or attached an Office communication concerning this application or proceeding.



UNITED STATES PATENT AND TRADEMARK OFFICE

Commissioner for Patents
United States Patents and Trademark Office
P.O.Box 1450
Alexandria, VA 22313-1450
www.uspto.gov

THIRD PARTY REQUESTER'S CORRESPONDENCE ADDRESS

EWIN H. TAYLOR
BLAKELY, SOKOLOFF, TAYLOR & ZAFMAN, LLP
1279 OAKMEAD PARKWAY
SUNNYVALE, CA 94085-4040

Date:

MAILED

DEC 03 2010

CENTRAL REEXAMINATION UNIT

EX PARTE REEXAMINATION COMMUNICATION TRANSMITTAL FORM

REEXAMINATION CONTROL NO. : 90010422
PATENT NO. : 6009469
ART UNIT : 3992

Enclosed is a copy of the latest communication from the United States Patent and Trademark Office in the above identified ex parte reexamination proceeding (37 CFR 1.550(f)).

Where this copy is supplied after the reply by requester, 37 CFR 1.535, or the time for filing a reply has passed, no submission on behalf of the ex parte reexamination requester will be acknowledged or considered (37 CFR 1.550(g)).

Notice of Intent to Issue Ex Parte Reexamination Certificate	Control No. 90/010,422	Patent Under Reexamination 6,009,469	
	Examiner ALEXANDER J. KOSOWSKI	Art Unit 3992	

-- The MAILING DATE of this communication appears on the cover sheet with the correspondence address --

1. Prosecution on the merits is (or remains) closed in this *ex parte* reexamination proceeding. This proceeding is subject to reopening at the initiative of the Office or upon petition. Cf. 37 CFR 1.313(a). A Certificate will be issued in view of
 - (a) Patent owner's communication(s) filed: 10 November 2010.
 - (b) Patent owner's late response filed: _____
 - (c) Patent owner's failure to file an appropriate response to the Office action mailed: _____
 - (d) Patent owner's failure to timely file an Appeal Brief (37 CFR 41.31).
 - (e) Other: _____

Status of *Ex Parte* Reexamination:

 - (f) Change in the Specification: Yes No
 - (g) Change in the Drawing(s): Yes No
 - (h) Status of the Claim(s):
 - (1) Patent claim(s) confirmed: 2,3,5,6,15 and 18.
 - (2) Patent claim(s) amended (including dependent on amended claim(s)): 1,9,14,16 and 17
 - (3) Patent claim(s) canceled: 8.
 - (4) Newly presented claim(s) patentable: _____
 - (5) Newly presented canceled claims: _____
 - (6) Patent claim(s) previously currently disclaimed: _____
 - (7) Patent claim(s) not subject to reexamination: 4,7 and 10-13.

2. Note the attached statement of reasons for patentability and/or confirmation. Any comments considered necessary by patent owner regarding reasons for patentability and/or confirmation must be submitted promptly to avoid processing delays. Such submission(s) should be labeled: "Comments On Statement of Reasons for Patentability and/or Confirmation."

3. Note attached NOTICE OF REFERENCES CITED (PTO-892).

4. Note attached LIST OF REFERENCES CITED (PTO/SB/08 or PTO/SB/08 substitute).

5. The drawing correction request filed on _____ is: approved disapproved.

6. Acknowledgment is made of the priority claim under 35 U.S.C. § 119(a)-(d) or (f).
 - a) All b) Some* c) None of the certified copies have
 - been received.
 - not been received.
 - been filed in Application No. _____.
 - been filed in reexamination Control No. _____.
 - been received by the International Bureau in PCT Application No. _____.

* Certified copies not received: _____

7. Note attached Examiner's Amendment.

8. Note attached Interview Summary (PTO-474).

9. Other: _____

cc: Requester (if third party requester)
U.S. Patent and Trademark Office

DETAILED ACTION

1) This Office action addresses claims 1-3, 5-6, 9, 14-18 of United States Patent Number 6,009,469 (Mattaway et al), for which it has been determined in the Order Granting Ex Parte Reexamination (hereafter the "Order") mailed 3/13/09 that a substantial new question of patentability was raised in the Request for *Ex Parte* reexamination filed on 2/26/09 (hereafter the "Request"). Claims 4, 7, 10-13 are not subject to reexamination. This is a response to the second after final amendment filed 11/10/10. Claims 1-3, 5-6, 9 and 14-18 are allowable and/or confirmed below. Claim 8 has been canceled.

Examiner notes that the after final amendment filed 11/10/10 has re-written claim 9 in independent form, thereby incorporating the limitation from claim 9 into canceled claim 8. The limitation of claim 9 was confirmed in related reexamination 90/010416 in view of the same proposed prior art. In addition, previously confirmed claim 16 has been rewritten into independent form. Therefore, claims 9 and 16 are now allowable as amended.

STATEMENT OF REASONS FOR PATENTABILITY AND/OR CONFIRMATION

2) Claims 1-3, 5-6, 9 and 14-18 are allowable and/or confirmed.

The following is an examiner's statement of reasons for patentability and/or confirmation of the claims found patentable in this reexamination proceeding:

Referring to claim 1, the claim is allowable over the prior art that was explained in the request and determined to raise a substantial new question of patentability in the order granting reexamination and over the prior art that was applied and discussed by the examiner in the present reexamination proceeding because that prior art does not explicitly teach a computer

Art Unit: 3992

program product for use with a computer system comprising program code for determining the currently assigned network protocol address of the first process upon connection to the computer network, in combination with the remaining elements or features of the claimed invention.

Referring to claim 5, the claim is allowable over the prior art that was explained in the request and determined to raise a substantial new question of patentability in the order granting reexamination and over the prior art that was applied and discussed by the examiner in the present reexamination proceeding because that prior art does not explicitly teach a method for establishing point-to-point communications with other processes comprising determining the currently assigned network protocol address of the first process upon connection to the computer network, in combination with the remaining elements or features of the claimed invention.

Referring to claim 9, the claim is allowable over the prior art that was explained in the request and determined to raise a substantial new question of patentability in the order granting reexamination and over the prior art that was applied and discussed by the examiner in the present reexamination proceeding because that prior art does not explicitly teach a method for establishing a point-to-point communication including querying the server process as to the on-line status of the first callee process and receiving a network protocol address of the first callee process over the computer network from the server process, in combination with the remaining elements or features of the claimed invention.

Referring to claim 16, the claim is allowable over the prior art that was explained in the request and determined to raise a substantial new question of patentability in the order granting reexamination and over the prior art that was applied and discussed by the examiner in the present reexamination proceeding because that prior art does not explicitly teach a method for

Art Unit: 3992

establishing a point-to-point communication including wherein a generated element represents a communication line on mute status, in combination with the remaining elements or features of the claimed invention.

Claims 2-3, 6, 14-15, 17-18 depend on allowable claims, and are therefore also allowable.

Any comments considered necessary by PATENT OWNER regarding the above statement must be submitted promptly to avoid processing delays. Such submission by the patent owner should be labeled: "Comments on Statement of Reasons for Patentability and/or Confirmation" and will be placed in the reexamination file.

Conclusion

All correspondence relating to this ex parte reexamination proceeding should be directed as follows:

By U.S. Postal Service Mail to:

Mail Stop Ex Parte Reexam
ATTN: Central Reexamination Unit
Commissioner for Patents
P.O. Box 1450
Alexandria, VA 22313-1450

By FAX to:

(571) 273-9900
Central Reexamination Unit

By hand to:

Customer Service Window
Randolph Building
401 Dulany St.
Alexandria, VA 22314

Art Unit: 3992

By EFS-Web:

Registered users of EFS-Web may alternatively submit such correspondence via the electronic filing system EFS-Web, at



<https://sportal.uspto.gov/authenticate/authenticateuserlocalepf.html>

EFS-Web offers the benefit of quick submission to the particular area of the Office that needs to act on the correspondence. Also, EFS-Web submissions are "soft scanned" (i.e., electronically uploaded) directly into the official file for the reexamination proceeding, which offers parties the opportunity to review the content of their submissions after the "soft scanning" process is complete.

Any inquiry concerning this communication or earlier communications from the Reexamination Legal Advisor or Examiner, or as to the status of this proceeding, should be directed to the Central Reexamination Unit at telephone number (571) 272-7705.

/Alexander J Kosowski/

Primary Examiner, Art Unit 3992



JESSICA HARRISON
SUPERVISORY PATENT EXAMINER

OK to enter
ASX

IN THE CLAIMS

Please amend the claims in this re-examination as follows:

8. (Canceled)

9. (Amended) In a computer system having a display and capable of executing a process, a method for establishing a point-to-point communication from a caller process to a callee process over a computer network, the caller process capable of generating a user interface and being operatively connected to the callee process and a server process over the computer network, the [The] method [of claim 8] comprising the steps of:

A. generating a user-interface element representing a first communication line;

B. generating a user interface element representing a first callee process;

C. querying the server process to determine if the first callee process is accessible; and

D. establishing a point-to-point communication link from the caller process to the first callee process, in response to a user associating the element representing the first callee process with the element representing the first communication line, wherein step C further comprises the steps of:

C.1 querying the server process as to the on-line status of the first callee process; and

C.2 receiving a network protocol address of the first callee process over the computer network from the server process.

14. (Amended) The method of claim [8] 9, further comprising the steps of:

E. generating a user interface element representing a communication line having a temporarily disabled status; and

F. temporarily disabling the point-to-point communication between the caller process and the first callee process, in response to the user associating the element representing the first callee process with the element representing the communication line having a temporarily disabled status.

Search Notes 	Application/Control No. 90010422	Applicant(s)/Patent Under Reexamination 6,009,469
	Examiner ALEXANDER J KOSOWSKI	Art Unit 3992

SEARCHED			
Class	Subclass	Date	Examiner

SEARCH NOTES		
Search Notes	Date	Examiner
Reviewed proposed prior art and prosecution history	5/6/10	AJK
Reviewed proposed prior art	11/19/10	AJK

INTERFERENCE SEARCH			
Class	Subclass	Date	Examiner

--	--



UNITED STATES PATENT AND TRADEMARK OFFICE

UNITED STATES DEPARTMENT OF COMMERCE
 United States Patent and Trademark Office
 Address: COMMISSIONER FOR PATENTS
 P.O. Box 1450
 Alexandria, Virginia 22313-1450
 www.uspto.gov

BIB DATA SHEET

CONFIRMATION NO. 6565

SERIAL NUMBER 90/010,422	FILING or 371(c) DATE 02/26/2009 RULE	CLASS 709	GROUP ART UNIT 3992	ATTORNEY DOCKET NO. 2655-0185	
APPLICANTS 6,009,469, Residence Not Provided; NET2PHONE, INC. (OWNER), NEWARK, NJ; BLAKELY, SOKOLOFF, TAYLOR & ZAFMAN LLP (3RD.PTY.REQ.), SUNNYVALE, CA; EWIN H. TAYLOR, SUNNYVALE, CA;					
** CONTINUING DATA ***** This application is a REX of 08/721,316 09/25/1996 PAT 6,009,469 which is a CIP of 08/533,115 09/25/1995 PAT 6,108,704 and claims benefit of 60/025,415 09/04/1996 and claims benefit of 60/024,251 08/21/1996					
** FOREIGN APPLICATIONS *****					
** IF REQUIRED, FOREIGN FILING LICENSE GRANTED **					
Foreign Priority claimed <input type="checkbox"/> Yes <input checked="" type="checkbox"/> No 35 USC 119(a-d) conditions met <input type="checkbox"/> Yes <input checked="" type="checkbox"/> No Verified and Acknowledged <i>[Signature]</i> Examiner's Signature	<input type="checkbox"/> Met after Allowance Initials	STATE OR COUNTRY	SHEETS DRAWINGS	TOTAL CLAIMS 18	INDEPENDENT CLAIMS 4
ADDRESS DAVIDSON BERQUIST JACKSON & GOWDEY LLP 4300 WILSON BLVD., 7TH FLOOR ARLINGTON, VA 22203 UNITED STATES					
TITLE Graphic User Interface For Internet Telephony Application					
FILING FEE RECEIVED 2520	FEES: Authority has been given in Paper No. _____ to charge/credit DEPOSIT ACCOUNT No. _____ for following:			<input type="checkbox"/> All Fees <input type="checkbox"/> 1.16 Fees (Filing) <input type="checkbox"/> 1.17 Fees (Processing Ext. of time) <input type="checkbox"/> 1.18 Fees (Issue) <input type="checkbox"/> Other _____ <input type="checkbox"/> Credit	

Reexamination 	Application/Control No. 90010422	Applicant(s)/Patent Under Reexamination 6,009,469
	Certificate Date	Certificate Number C1

Requester Correspondence Address: Patent Owner Third Party

BLAKELY SOKOLOFF TAYLOR & ZAFMAN LLP
 1279 OAKMEAD PARKWAY
 SUNNYVALE, CA 94085-4040

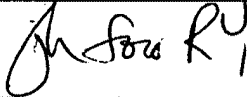
LITIGATION REVIEW <input checked="" type="checkbox"/>	AJK (examiner initials)	11/19/2010 (date)
Case Name		Director Initials
OPEN: 2:06cv2469 Net2phone v. Ebay		

COPENDING OFFICE PROCEEDINGS	
TYPE OF PROCEEDING	NUMBER
1. no copending proceedings	

--	--

INFORMATION DISCLOSURE STATEMENT BY APPLICANT FORM PTO-1449 (modified)	Reexam number	90/010,422
	First Named Inventor	Mattaway et al.
	Patent Under Re-Exam	6009469
	Issue Date	1999/12/28
	Group Art Unit	3992
	Examiner Name	KOSOWSKI, ALEXANDER J
	Attorney Docket No.	2655-0185
	Confirmation No.	6565

Sheet 1 of 1

NON-PATENT REFERENCES			
Examiner Initials*	Cite No.	Non-patent Reference bibliographic information, where available	Notes
	1-1	Second Supplemental Expert Report of Bruce M. Maggs dated October 8, 2008, 6 pgs.	
	1-2	Supplement to Responsive Expert Report of Kevin Jeffay, Ph.D. on Invalidity Issues, dated Sept. 8, 2008, 9 pgs.	
	1-3	Supplement to Responsive Expert Report of Kevin Jeffay on Invalidity Issues, dated October 8, 2008, 9 pages.	
/AK/	1-4	Translation of Japanese Kokai H07-129488 (published May 19, 1995)	
	1-5		
	1-6		
	1-7		

Examiner Signature	/Alexander Kosowski/	Date Considered	11/18/2010
--------------------	----------------------	-----------------	------------

*Examiner: Initial if reference was considered, whether or not citation is in conformance with MPEP 609. Draw a line through citation if not in conformance and not considered. Include a copy of this form with next communication to applicant. Notes: If identified, the following is provided: EA = English Abstract, T = Translation, PT = Partial Translation, SOR = Statement of Relevancy, PF = Patent Family.

IN THE UNITED STATES PATENT AND TRADEMARK OFFICE

In re PATENT APPLICATION OF:	Attorney Docket: 2655-0185
Net2Phone, Inc. (Patent No. 6,009,469)	Group Art Unit: 3992
Control No.: 90/010,422	Examiner: KOSOWSKI, Alexander
Issue Date: December 28, 1999	Confirmation No.: 6565
Title: GRAPHIC USER INTERFACE FOR INTERNET TELEPHONY APPLICATION	Date: November 10, 2010

SUPPLEMENTAL AMENDMENT AFTER FINAL UNDER 37 C.F.R. 1.116

Hon. Commissioner of Patents
P.O. Box 1450
Alexandria, VA 22313-1450

Sir:

In response to the Office Action dated May 10, 2010, and as a supplement to the Response filed on Monday, July 12, 2010, the Patent Owner hereby files a supplemental Amendment prior to the filing of its Appeal Brief, in which:

A listing of the amended claims in the re-examination are provided starting on page 2;
and
Remarks/Arguments are provided starting at page 4.

IN THE CLAIMS

Please amend the claims in this re-examination as follows:

8. (Canceled)

9. (Amended) In a computer system having a display and capable of executing a process, a method for establishing a point-to-point communication from a caller process to a callee process over a computer network, the caller process capable of generating a user interface and being operatively connected to the callee process and a server process over the computer network, the [The] method [of claim 8] comprising the steps of:

A. generating a user-interface element representing a first communication line;

B. generating a user interface element representing a first callee process;

C. querying the server process to determine if the first callee process is accessible; and

D. establishing a point-to-point communication link from the caller process to the first callee process, in response to a user associating the element representing the first callee process with the element representing the first communication line, wherein step C further comprises the steps of:

C.1 querying the server process as to the on-line status of the first callee process; and

C.2 receiving a network protocol address of the first callee process over the computer network from the server process.

14. (Amended) The method of claim [8] 9, further comprising the steps of:

E. generating a user interface element representing a communication line having a temporarily disabled status; and

F. temporarily disabling the point-to-point communication between the caller process and the first callee process, in response to the user associating the element representing the first callee process with the element representing the communication line having a temporarily disabled status.

16. (Amended) In a computer system having a display and capable of executing a process, a method for establishing a point-to-point communication from a caller process to a callee process over a computer network, the caller process capable of generating a user interface and being operatively connected to the callee process and a server process over the computer network, the [The] method [of claim 15] comprising the steps of:

A. generating a user-interface element representing a first communication line;
B. generating a user interface element representing a first callee process;
C. querying the server process to determine if the first callee process is accessible;
D. establishing a point-to-point communication link from the caller process to the first callee process, in response to a user associating the element representing the first callee process with the element representing the first communication line;

E. generating a user interface element representing a communication line having a temporarily disabled status; and

F. temporarily disabling the point-to-point communication between the caller process and the first callee process, in response to the user associating the element representing the first callee process with the element representing the communication line having a temporarily disabled status, wherein the element generated in step E represents a communication line on hold status, and wherein the element generated in step E represents a communication line on mute status.

17. (Amended) The method of claim [8] 9 wherein the display further comprises a visual display.

ARGUMENTS

The Rejection of Claims 9, 14, 15, 17 and 18 Over the Combination of the Etherphone Papers in view of Pinard

Status of the Claims and Support for the Changes

A statement of the status of all the claims in the proceeding is as follows:

Rejected: Claims 9 and 14, 15, 17 and 18;
allowed or confirmed: Claims 1-3, 5, 6 and 16;
withdrawn: none;
objected to: none;
canceled: 8; and
not subject to re-examination: Claims 4, 7 and 10-13.

The changes are supported by the originally filed specification and do not introduce any new matter. Claim 9 has been amended to include the limitations of claim 8. Claims 14 and 17 have been amended to update their dependencies in light of the cancellation of claim 8. Claim 16 has been rewritten in independent form in light of the confirmation of its patentability. Thus, the changes for each of the amended claims can be found, at least, in the claims which are being rewritten and the claims from which they depend.

These amendments should be entered as they are in compliance with 37 C.F.R. 41.33 which allows entry of Amendments filed after a notice of appeal but prior to the filing of an appeal brief if the amendments are in compliance with 37 C.F.R. 1.116. These amendments are in compliance with 37 C.F.R. 1.116 as they “present[] rejected claims in better form for consideration on appeal” by placing the case in condition for allowance/confirmation, as discussed in more detail below.

Summary of the Remaining Ground for Rejection

The remaining ground for rejection is a rejection of claims 9, 14, 15, 17 and 18 under 35 U.S.C. 103(a) based on the combination of the Etherphone papers in view of Pinard.¹

Response to Remaining Ground for Rejection

In an effort to accelerate prosecution, claim 8 has been canceled herewith (without prejudice to the validity of the claims which depend from claim 8 but which are not the subject of the re-examination), and claim 9 has been rewritten in independent form to have a claim structure similar to confirmed claim 11 of re-examined U.S. Patent No. 6,108,704 (Control No. 90/010,416) (hereinafter “the ‘416 re-examination”). As shown in the table below, amended claim 9 of this re-examination has the additional limitation of “querying the server process to determine if the first callee process is accessible” as compared to confirmed claim 11 of the ‘416 re-examination.

Amended Claim 9 of this Re-examination (without bracketing)	Amended Claim 11 of Re-examination Control No. 90/010,416 (without bracketing)
9. In a computer system having a display and capable of executing a process, a method for establishing a point-to-point communication from a caller process to a callee process over a computer network, the caller process capable of generating a user interface and being operatively connected to the callee process and a server process over the computer network, the method comprising the	11. In a computer system, a method for establishing a point-to-point communication link from a caller process to a callee process over a computer network, the caller process having a user interface and being operatively connectable to the callee process and a server over the computer network, the method comprising the steps of:

¹ The rejection under 35 U.S.C. 103(a) over NetBIOS and Pinard was withdrawn in the Advisory Action dated 7/20/2010, as was the rejection of claim 16 on all grounds.

steps of:	
A. generating a user-interface element representing a first communication line;	A. providing a user interface element representing a first communication line;
B. generating a user interface element representing a first callee process;	B. providing a user interface element representing a first callee process; and
C. querying the server process to determine if the first callee process is accessible;	
D. establishing a point-to-point communication link from the caller process to the first callee process, in response to a user associating the element representing the first callee process with the element representing the first communication line,	C. establishing a point-to-point communication link from the caller process to the first callee process, in response to a user associating the element representing the first callee process with the element representing the first communication line,
wherein step C further comprises the steps of: C.1 querying the server process as to the on-line status of the first callee process; and	wherein step C further comprises the steps of: c.1 querying the server as to the on-line status of the first callee process; and
C.2 receiving a network protocol address of the first callee process over the computer network from the server process.	c.2 receiving a network protocol address of the first callee process over the computer network from the server.

In the Statement of Reasons for Patentability and/or Confirmation in the ‘416 re-examination, the paragraph crossing pages 2 and 3 explains that amended claim 11 in the ‘416 re-examination was found to be patentable “because the prior art does not explicitly teach ... receiving a network protocol address of the first callee process over the computer network from the server.” It is respectfully submitted that the same rationale holds true for amended claim 9

Control No. 90/010,422
Re-examination of U.S. Patent No. 6,009,469

since the applied references do not teach the same claimed dynamic addressing limitation of amended claim 9 that they did not teach with respect to amended claim 11 of the '416 re-examination. In addition, the applied references also do not teach the claimed generating steps as set forth in the first response to the outstanding Office Action. Those arguments are incorporated herein by reference.

Consequently, in light of the above discussions, the outstanding grounds for rejection are believed to have been overcome and the patentability of the claims subject to re-examination should be indicated as confirmed. An early and favorable action to that effect is respectfully requested.

CHARGE STATEMENT: Deposit Account No. 501860, order no. 2655-0185 .
The Commissioner is hereby authorized to charge any fee specifically authorized hereafter, or any missing or insufficient fee(s) filed, or asserted to be filed, or which should have been filed herewith or concerning any paper filed hereafter, and which may be required under Rules 16-18 (<u>missing or insufficiencies only</u>) now or hereafter relative to this application and the resulting Official Document under Rule 20, or credit any overpayment, to our Accounting/ Order Nos. shown above, for which purpose a <u>duplicate</u> copy of this sheet is attached.
This CHARGE STATEMENT <u>does not authorize</u> charge of the <u>issue fee</u> until/unless an issue fee transmittal sheet is filed.

CUSTOMER NUMBER 42624	Respectfully submitted, By: / Michael R. Casey / _____ Michael R. Casey, Ph.D. Registration No.: 40,294
Davidson Berquist Jackson & Gowdey LLP 4300 Wilson Blvd., 7th Floor, Arlington, Virginia 22203 Main: (703) 894-6400 • FAX: (703) 894-6430	

IN THE UNITED STATES PATENT AND TRADEMARK OFFICE

In re PATENT APPLICATION OF:

Net2Phone, Inc.

Control No.: 90/010,422

Issue Date: December 28, 1999

Title: **GRAPHIC USER INTERFACE FOR
INTERNET TELEPHONY APPLICATION**

Attorney Docket: 2655-0185

Group Art Unit: 3992

Examiner: KOSOWSKI, Alexander
J.

Date: November 10, 2010

Confirmation No.: 6565

INFORMATION DISCLOSURE STATEMENT

Hon. Commissioner of Patents
P.O. Box 1450
Alexandria, VA 22313-1450

Sir:

Pursuant to 37 C.F.R. § 1.56, the attention of the Patent and Trademark Office is hereby directed to the reference(s) listed on the attached PTO-1449. One copy of each non-U.S. Patent reference is attached. It is respectfully requested that the information be expressly considered during the prosecution of this application, and that the reference(s) be made of record therein and appear among the "References Cited" on any patent to issue therefrom.

The submission of any document herewith, which is not a statutory bar, is not intended that any such document constitutes prior art against any of the claims of the present application or is considered to be material to patentability as defined in 37 C.F.R. § 1.56(b). Applicants do not waive any rights to take any action which would be appropriate to antedate or otherwise remove as a competent reference against the claims of the present application.

It has come to the attention of the undersigned that Exhibit D referenced on page 495 of the redacted Expert Report of Professor Bruce M. Maggs (as Supplemented September 8, 2008) was not included in the copy of the report filed in that IDS. That reference, however, was submitted as “Translation of Japanese Kokai H07-129488 (published May 19, 1995)” which was noted as considered by the Examiner.

CHARGE STATEMENT: Deposit Account No. 501860, order no. 2655-0185.

The Commissioner is hereby authorized to charge any fee specifically authorized hereafter, or any missing or insufficient fee(s) filed, or asserted to be filed, or which should have been filed herewith or concerning any paper filed hereafter, and which may be required under Rules 16-18 (missing or insufficiencies only) now or hereafter relative to this application and the resulting Official Document under Rule 20, or credit any overpayment, to our Accounting/Order Nos. shown above, for which purpose a duplicate copy of this sheet is attached

This CHARGE STATEMENT does not authorize charge of the issue fee until/unless an issue fee transmittal sheet is filed.

CUSTOMER NUMBER

42624

Davidson Berquist Jackson & Gowdey LLP
4300 Wilson Blvd., 7th Floor,
Arlington Virginia 22203
Main: (703) 894-6400 • FAX: (703) 894-6430

Respectfully submitted,

By: / Michael R. Casey /

Michael R. Casey, Ph.D.
Registration No.: 40,294

INFORMATION DISCLOSURE STATEMENT BY APPLICANT FORM PTO-1449 (modified)	Reexam number	90/010,422
	First Named Inventor	Mattaway et al.
	Patent Under Re-Exam	6009469
	Issue Date	1999/12/28
	Group Art Unit	3992
	Examiner Name	KOSOWSKI, ALEXANDER J
	Attorney Docket No.	2655-0185
	Confirmation No.	6565

Sheet 1 of 1

NON-PATENT REFERENCES			
Examiner Initials*	Cite No.	Non-patent Reference bibliographic information, where available	Notes
	1-1	Second Supplemental Expert Report of Bruce M. Maggs dated October 8, 2008, 6 pgs.	
	1-2	Supplement to Responsive Expert Report of Kevin Jeffay, Ph.D. on Invalidity Issues, dated Sept. 8, 2008, 9 pgs.	
	1-3	Supplement to Responsive Expert Report of Kevin Jeffay on Invalidity Issues, dated October 8, 2008, 9 pages.	
	1-4	Translation of Japanese Kokai H07-129488 (published May 19, 1995)	
	1-5		
	1-6		
	1-7		

Examiner Signature		Date Considered	
--------------------	--	-----------------	--

*Examiner: Initial if reference was considered, whether or not citation is in conformance with MPEP 609. Draw a line through citation if not in conformance and not considered. Include a copy of this form with next communication to applicant. Notes: If identified, the following is provided: EA = English Abstract, T = Translation, PT = Partial Translation, SOR = Statement of Relevancy, PF = Patent Family.

Control No. 90/010,422
Re-examination of U.S. Patent No. 6,009,469

CERTIFICATE OF SERVICE

The undersigned hereby certifies that, on November 10, 2010, the SUPPLEMENTAL AMENDMENT AFTER FINAL UNDER 37 C.F.R. 1.116 filed in Re-examination Control No. 90/010,422, and its corresponding Information Disclosure Statement (with 4 non-patent references) were served by U.S. First Class Mail, postage pre-paid, on Requestor as follows:

Blakely, Sokoloff, Taylor & Zafman LLP
1279 Oakmead Parkway
Sunnyvale, CA 94085-4040

/ Michael R. Casey /

Michael R. Casey, Ph.D.

Electronic Acknowledgement Receipt

EFS ID:	8808697
Application Number:	90010422
International Application Number:	
Confirmation Number:	6565
Title of Invention:	Graphic User Interface For Internet Telephony Application
First Named Inventor/Applicant Name:	6,009,469
Customer Number:	42624
Filer:	Michael R. Casey
Filer Authorized By:	
Attorney Docket Number:	2655-0185
Receipt Date:	10-NOV-2010
Filing Date:	26-FEB-2009
Time Stamp:	14:31:16
Application Type:	Reexam (Third Party)

Payment information:

Submitted with Payment	no
------------------------	----

File Listing:

Document Number	Document Description	File Name	File Size(Bytes)/ Message Digest	Multi Part /.zip	Pages (if appl.)
1	Supplemental Response or Supplemental Amendment	20101110_supplemental_after_final_01_cover.pdf	74214 <small>e100ffbbee3e8ce992c59093e51111d59725f0e</small>	no	1

Warnings:

Information:

2	Claims	20101110_supplemental_after_final_02_claims.pdf	61543 11b0fdc8d98abee56e552feedd5dedddcbe f66a6	no	2
Warnings:					
Information:					
3	Applicant Arguments/Remarks Made in an Amendment	20101110_supplemental_after_final_03_remarks.pdf	139533 fdb4c550cc91fc72311ea403372f0e45418 d7e	no	4
Warnings:					
Information:					
4	Transmittal Letter	20101110_IDS_transmittal.pdf	134763 62d80c799a257b5f9e00fd98f740c64a65bc 4254	no	2
Warnings:					
Information:					
5	Information Disclosure Statement (IDS) Filed (SB/08)	20101110_1449.pdf	51874 d6ceaf78376c9f5fc8994de68ece036f31118 b0e	no	1
Warnings:					
Information:					
This is not an USPTO supplied IDS fillable form					
6	NPL Documents	NP0000.pdf	460448 94816ae2b186fc3cfb6ec6b11f3c96a1ed5d 1190	no	6
Warnings:					
Information:					
7	NPL Documents	NP0001.pdf	169154 54f51f4f9fba5a0895016138eaa383458051 bc01	no	9
Warnings:					
Information:					
8	NPL Documents	NP0002.pdf	1105522 8bbf8a738631f4a9a78c1ff994df5cdbc9578 926	no	9
Warnings:					
Information:					
9	NPL Documents	NP0003.pdf	1380439 93da8abe7003f0a96bc5f683c173ddd234e 7f94a	no	7
Warnings:					
Information:					
10	Reexam Certificate of Service	20101110_supplemental_after_final_04_COS.pdf	58363 453e96876dc5c3edf6834ea068cc139093b 0b4c0	no	1

Warnings:	
Information:	
Total Files Size (in bytes):	3635853
<p>This Acknowledgement Receipt evidences receipt on the noted date by the USPTO of the indicated documents, characterized by the applicant, and including page counts, where applicable. It serves as evidence of receipt similar to a Post Card, as described in MPEP 503.</p> <p><u>New Applications Under 35 U.S.C. 111</u> If a new application is being filed and the application includes the necessary components for a filing date (see 37 CFR 1.53(b)-(d) and MPEP 506), a Filing Receipt (37 CFR 1.54) will be issued in due course and the date shown on this Acknowledgement Receipt will establish the filing date of the application.</p> <p><u>National Stage of an International Application under 35 U.S.C. 371</u> If a timely submission to enter the national stage of an international application is compliant with the conditions of 35 U.S.C. 371 and other applicable requirements a Form PCT/DO/EO/903 indicating acceptance of the application as a national stage submission under 35 U.S.C. 371 will be issued in addition to the Filing Receipt, in due course.</p> <p><u>New International Application Filed with the USPTO as a Receiving Office</u> If a new international application is being filed and the international application includes the necessary components for an international filing date (see PCT Article 11 and MPEP 1810), a Notification of the International Application Number and of the International Filing Date (Form PCT/RO/105) will be issued in due course, subject to prescriptions concerning national security, and the date shown on this Acknowledgement Receipt will establish the international filing date of the application.</p>	

IN THE UNITED STATES PATENT AND TRADEMARK OFFICE

In re PATENT APPLICATION OF:	Attorney Docket: 2655-0185
Net2Phone, Inc. (Patent No. 6,009,469)	Group Art Unit: 3992
Control No.: 90/010,422	Examiner: KOSOWSKI, Alexander
Issue Date: December 28, 1999	Confirmation No.: 6565
Title: GRAPHIC USER INTERFACE FOR INTERNET TELEPHONY APPLICATION	Date: November 10, 2010

APPEAL BRIEF

Hon. Commissioner of Patents
P.O. Box 1450
Alexandria, VA 22313-1450

Sir:

In response to the Office Action dated May 10, 2010, in support of its appeal, the Patentee respectfully submits this Appeal Brief in compliance with 37 C.F.R. 41.37 including sections set forth in the order specified in 37 C.F.R. 41.37(c)(1).

(i) Real Party in Interest

As evidenced by the assignment recorded at reel 017105/frame 0240, the real party in interest for this appeal is Net2Phone, Inc., having a principal place of business in Newark, NJ. Net2Phone, Inc. is a wholly-owned subsidiary of International Discount Telecommunications Corporation (IDT Corporation), a Delaware Corporation having a principal place of business at 520 Broad Street, Newark, New Jersey 07102. IDT Corporation is a publicly-traded corporation.

(ii) Related Appeals and Interferences

No prior and pending appeals, interferences or judicial proceedings are known to appellant, the appellant's legal representative, or assignee which may be related to, directly affect or be directly affected by or have a bearing on the Board's decision in the pending appeal. The

Control No. 90/010,422
Re-examination of U.S. Patent No. 6,009,469

patent under re-examination was the subject of a previous litigation (Net2Phone, Inc. v. eBay et al., U.S. District Court of New Jersey, Civil Action No. 06-2469 (KSH)), which has now settled.

(iii) Status of claims

If the Amendment filed on even-date herewith is entered, the status of the claims will be:

Rejected: Claims 9 and 14, 15, 17 and 18;

allowed or confirmed: Claims 1-3, 5, 6 and 16;

withdrawn: none;

objected to: none;

canceled: Claim 8; and

not subject to re-examination: Claims 4, 7 and 10-13.

Of those claims, claims 9 and 14, 15, 17 and 18 are being appealed.

If the Amendment filed on even-date herewith is not entered, the status of the claims will be:

Rejected: Claims 8, 9 and 14, 15, 17 and 18;

allowed or confirmed: Claims 1-3, 5, 6 and 16;

withdrawn: none;

objected to: none;

canceled: none; and

not subject to re-examination: Claims 4, 7 and 10-13.

Of those claims, claims 8, 9 and 14, 15, 17 and 18 are being appealed.

(iv) Status of amendments

The amendment filed on even-date herewith, but before the filing of the appeal brief, cancels claim 8 and contains amendments to claims 9, 14, 16 and 17. That amendment has not been entered as of the filing date of this appeal brief, but is believed to place the case in

condition for allowance as it incorporates the limitation of claim 8 into claim 9 and causes amended claim 9 to include limitations substantially similar to those of claim 11 of another, now-terminated reexamination (90/010,416) and contains an additional limitation as well.

(v) Summary of claimed subject matter

Claim 8

Claim 8 “relates ... to a method and apparatus for facilitating audio communications over computer networks.” U.S. Patent No. 6,009,469 (hereinafter “the ‘469 patent”), col. 1, lines 54-57. As described in the Background of the Invention “Permanent IP addresses of users and devices accessing the Internet readily support point-to-point communications of voice and video signals over the Internet. For example, real-time video teleconferencing has been implemented using dedicated IP addresses and mechanisms known as reflectors.” Col. 2, lines 31-36. However, many users are not associated with permanent IP addresses, as was often the case with dial-up users that connected to modems in modem “pools” where which modem a user connected with depended on which modem was not already in use at the time of the call. As described in the specification:

Devices such as a host computer or server of a company may include multiple modems for connection of users to the Internet, with a temporary IP address allocated to each user. For example, the host computer may have a general IP address “XXX.XXX.XXX,” and each user may be allocated a successive IP address of XXX.XXX.XXX.10, XXX.XXX.XXX.11, XXX.XXX.XXX.12, etc. Such temporary IP addresses may be reassigned or recycled to the users, for example, as each user is successively connected to an outside party. For example, a host computer of a company may support a maximum of 254 IP addresses which are pooled and shared between devices connected to the host computer.

Control No. 90/010,422
Re-examination of U.S. Patent No. 6,009,469

Col. 2, lines 18-30. This leads to the problem that “Due to the dynamic nature of temporary IP addresses of some devices accessing the Internet, point-to-point communications in real-time of voice and video have been generally difficult to attain.”

Col. 2, lines 36-39. Likewise, “The ability to locate users having temporary or dynamically assigned Internet Protocol address has been difficult without the user manually initiating the communication. Accordingly, spontaneous, real-time communications with such users over computer networks have been impractical.” Col. 2, lines 40-44.

As a result, a “need exists for a way to obtain the dynamically assigned Internet Protocol address of a user having on-line status with respect to a computer network, particularly the Internet.” Col. 2, lines 56-59. Also a “need exists for a method and apparatus by which to establish real-time, point-to-point communications over a computer network using a communication utility having an interface which combines the familiar aspects of current hardware communication utilities but which allows for the flexibility associated with graphic user interfaces.” Col. 2, lines 60-65.

In one embodiment, “The record entries of On-line table 1516B are used by connection server 1512 and information server 1514, as explained hereinafter, to provide a directory of those WebPhone client processes currently having on-line status with respect to the computer network.” Col. 20, lines 49-54. “Each WebPhone application, also referred to as a WebPhone client process, connects to global server 1500 upon start up to inform global server 1500 that the WebPhone client process is on-line and available to make and/or receive calls.” Col. 21, lines 57-61. Later, “Prior to transmission of the <ONLINE ACK> packet, connection server 1514 updates database 1516, specifically On-line table 1516B to indicate that WebPhone 1536 is on-line with respect to the computer network.” Col. 23, lines 28-32.

The preamble of claim 8 recites “a method for establishing a point-to-point communication from a caller process to a callee process over a computer network, the

caller process capable of generating a user interface and being operatively connected to the callee process and a server process over the computer network.” The method of claim 8 “provide[s] computer users with a powerful protocol in which to directly establish real-time, point-to-point communications over computer networks directly without server required linking. The ... directory server assists in furnishing the current dynamically assigned internet protocol address of other similarly equipped computer users or information about such users.” Col. 26, lines 31-38.

Claim 8 further recites “A. generating a user-interface element representing a first communication line.” “Referring again to FIG. 14, the WebPhone GUI 1400 consists of a main window which has the look of a modern cellular flip phone and a set of dialog boxes launched from window. Operation of the WebPhone is controlled by selecting objects, i.e., buttons, text and images, and dragging objects, i.e., lines, parties, messages, etc., as explained hereinafter.” Col. 26, lines 43-46. “WebPhone GUI 1400 comprises a plurality of visual objects, including ... line pad 1404” (col. 26, lines 47-49) which represents communication lines. “The line pad 1404 comprises four toggle buttons L1-L4, each of which has a letter, a number and an LED indicating the status of the line. When one or more parties are associated, i.e., dragged and dropped, with a line, the letter designating the appropriate line turns from an L to C indicating a conference call.” Paragraph crossing cols. 27 and 28.

Claim 8 further recites “B. generating a user interface element representing a first callee process.” “Operation of the WebPhone is controlled by selecting objects, i.e., buttons, text and images, and dragging objects, i.e., lines, parties, messages, etc., as explained hereinafter.” Col. 26, lines 43-46. The specification describes that “the user of WebPhone 1536 requests assistance from global server 1500 to obtain the current dynamically assigned Internet Protocol address of the prospective callee WebPhone.” Col. 23, lines 53-56. “The line pad 1404 comprises four toggle buttons L1-L4, each of which has a letter, a number and an LED indicating the status of the line. When one or

more parties are associated, i.e., dragged and dropped, with a line, the letter designating the appropriate line turns from an L to C indicating a conference call.” Paragraph crossing cols. 27 and 28.

Claim 8 further recites querying “the server process to determine if the first callee process is accessible.” The specification states “Connection server 1512 of global server 1500 utilizes the value of the E-mail address specified in the <CONNECT REQ> packet to perform a one-to-one mapping in the on-line table 1516B to determine the current Internet Protocol address of the indicated callee, as illustrated by the flowchart of FIG. 15A. Once this mapping is performed, the server 1500 transmits to WebPhone 1536 a <CONNECT ACK> packet, as indicated by message 7A of FIG. 17A. The <CONNECT ACK> packet has the format and content as illustrated in Table 6 and includes the IP address of the callee as well as information such as an error code to indicate that no WebPhone application is associated with that callee. Alternatively, if the selected callee is off line, global server 1500 transmits to WebPhone 1536 an <OFF LINE> packet to indicate that the desired party is not on-line, as illustrated by message 7B of FIG. 17A.” Paragraph crossing cols. 23 and 24.

Claim 8 further recites “D. establishing a point-to-point communication link from the caller process to the first callee process, in response to a user associating the element representing the first callee process with the element representing the first communication line.” “Operation of the WebPhone is controlled by selecting objects, i.e., buttons, text and images, and dragging objects, i.e., lines, parties, messages, etc., as explained hereinafter.” Col. 26, lines 43-46. “The line pad 1404 comprises four toggle buttons L1-L4, each of which has a letter, a number and an LED indicating the status of the line. When one or more parties are associated, i.e., dragged and dropped, with a line, the letter designating the appropriate line turns from an L to C indicating a conference call.” Paragraph crossing cols. 27 and 28. “WebPhone 1536 transmits to WebPhone 1538 a <CALL> packet as illustrated by message 8 of FIG. 16A. The <CALL> packet

has the format illustrated in Table 6 and may, optionally, include information identifying the compression/decompression (codec) used by the caller WebPhone.” Col. 24, lines 27-32. “Following transmission of <CALL ACK> packet by callee WebPhone 1538, the callee WebPhone further transmits an <ANSWER> packet to caller WebPhone 1536, as illustrated by message 10 of FIG. 17A. ... In addition, caller WebPhone 1536 opens a second socket to callee WebPhone 1538 over which the respective WebPhones may exchange <AUDIO> packets, as illustrated by messages 11A-B of FIG. 17A. ... The WebPhone application enables the parties to converse in real-time, telephone quality, encrypted audio communication over the Internet and other TCP/IP based networks.” Col. 25, lines 20-41.

Claim 9

Claim 9 further adds the limitation of “wherein step C further comprises the steps of: C.1 querying the server process as to the on-line status of the first callee process; and C.2 receiving a network protocol address of the first callee process over the computer network from the server process.” As described above with respect to claim 8, a “need exists for a way to obtain the dynamically assigned Internet Protocol address of a user having on-line status with respect to a computer network, particularly the Internet.” Col. 2, lines 56-59. In one embodiment, “The record entries of On-line table 1516B are used by connection server 1512 and information server 1514... to provide a directory of those WebPhone client processes currently having on-line status with respect to the computer network.” Col. 20, lines 49-54. “Each WebPhone application, also referred to as a WebPhone client process, connects to global server 1500 upon start up to inform global server 1500 that the WebPhone client process is on-line and available to make and/or receive calls.” Col. 21, lines 57-61. The system further “provide[s] computer users with a powerful protocol in which to directly establish real-time, point-to-point communications over computer networks directly without server required linking. The ...

directory server assists in furnishing the current dynamically assigned internet protocol address of other similarly equipped computer users or information about such users.” Col. 26, lines 31-38. Thus, the system can provide dynamically assigned addresses to clients wishing to perform point-to-point communication.

(vi) Grounds of rejection to be reviewed on appeal

The grounds for rejection to be reviewed on appeal are whether claims 8, 9, 14, 15, 17 and 18 are rendered obvious over the combination of the Etherphone papers in view of Pinard.¹ The patentability of claims 8 and 9 are argued separately herein.

(vii) Argument

The Rejection of Claims 8, 9, 14, 15, 17 and 18 Over the Combination of the Etherphone Papers in view of Pinard

Claim 8

Querying the Server Process

Claim 8 recites “a method for establishing a point-to-point communication from a caller process to a callee process over a computer network, the caller process capable of generating a user interface and being operatively connected to the callee process and a server process over the computer network.” Step C. of the method provides querying “the server process to determine if the first callee process is accessible.” The Office Action alleges that this limitation is taught by the Etherphone papers and cites “Swinehart, pg. 2, 4, Zellweger, pg. 5, whereby a query is transmitted to determine a location of a second Etherphone by contacting a server.” The Office Action does not identify any particular passages of those pages to guide an analysis, so those pages are discussed generally herein.²

¹ The rejection under 35 U.S.C. 103(a) over NetBIOS and Pinard was withdrawn in the Advisory Action dated 7/20/2010, as was the rejection of claim 16 on all grounds.

² Should an Examiner’s Answer be issued in response to this brief, it is respectfully requested that the portions relied upon by the Office Action be cited with greater specificity, e.g., by using paragraph numbers or section numbers.

The first paragraph of the left-hand column of page 2 of Swinehart states “Lee turns to his workstation and registers Karmen as a *visitor* (Figure 1). Immediately, Lee’s own telephone repeat’s the ring-duet. ... During Karmen’s meeting with Lee, two additional calls find her in a similar way, and Lee also answers one that rings with his own motif. An additional call to Karmen after she has returned to her office reminds lee to terminate the visiting arrangement.” Section 2.3 of Swinehart further states “Logging in tells the telephone system where Karmen is.”

Neither of those sections describes how the information is distributed among workstations, let alone querying the server process to determine if the first callee process is accessible. Instead, the workstations themselves could broadcast information about workstation associations and Etherphones such that the Etherphones initiating communication would have to receive the broadcast information in order to keep track of the associations. Alternatively, the workstations themselves could transmit information about workstation associations and Etherphones on a workstation-by-workstation basis such that the Etherphones initiating communication would have to receive a message from each workstation in order to keep track of its associations. Thus, page 2 of Swinehart does not inherently disclose the claimed querying limitation.

Page 4 of Swinehart also does not teach the claimed querying step. Section 3.1 of Swinehart states that the “telephone control server manages voice switching by sending to each Etherphone or service the network addresses of the other participants.” Section 3.2 of Swinehart also states that “The *telephone control server* ... uses dynamic information linking users to workstations in order to provide calls to individuals rather than fixed locations, and the registration of *visitors* in the offices of their colleagues.” However, both of those sections do not explicitly or inherently disclose querying the server process as claimed. As described above, the telephone control server could instead utilize broadcast messages (or messages to individual workstations) to inform the workstations and/or Etherphones about information that they may need in the future. In such a configuration, the caller process would not need to query the server

process for information that it already had. Thus, the Office Action has not shown that page 4 of Swinehart teaches the querying limitation either.

Page 5 of Zellweger is similarly deficient. The first full paragraph of the left-hand column of page 5 states:

If an Etherphone user logs in at a workstation, his calls can be automatically forwarded to the adjacent Etherphone. An additional feature, called visiting, allows him to register his presence with a second workstation or Etherphone, such as during a meeting. Each visit request cancels any earlier requests. The common problem of forgetting to cancel call forwarding is eased by ringing both Etherphones during visiting.

Like with Swinehart, Zellweger does not disclose the implementation details of how the call forwarding/visiting occurs. As it is not inherently implemented as claimed, Zellweger does not teach the claimed querying step.

Swinehart and Zellweger also disclose workstations that are separate from the Etherphones in the system. There is no disclosure in those references how the workstations know if the callee process that will engage in the point-to-point communication is accessible. The references do not disclose, for example, that the workstations periodically determine if the adjacent Etherphones are accessible. Instead, the Etherphones could be unplugged from power or the Ethernet (as they have their own Ethernet connections) such that they are not actually accessible. Thus, logging into a workstation will not actually enable one to know if the adjacent Etherphone is accessible. For this reason also, Swinehart and Zellweger do not disclose the querying limitation.

Since the querying step is not alleged to be taught by Pinard, the combination of references fails to teach the same limitation not taught by the references individually.

Establishing A Point-To-Point Communication Link

Claim 8 further includes the step of “establishing a point-to-point communication link from the caller process to the first callee process.” The Office Action asserts that Swinehart (page 2) and Zellweger (Figure 4) teach such a limitation in light of the disclosure that “voice datagrams are transmitted directly among participants.” As the Patentee argued in response to the first Office Action, it appears that the Office Action means that the Etherphones are the “participants.” If this is the case, there is no indication that the combination meets the limitation of “the caller process capable of generating a user interface” as the Office Action has not alleged that the Etherphone has such a capability. Declaration of Ketan Mayer-Patel Under 37 C.F.R. 1.132, dated November 25, 2009 (hereinafter the “First Mayer-Patel Declaration”), paragraph 43. Said differently, the Etherphones and workstations run on hardware in separate housings; thus, the process that is generating the user interface of the workstation (alleged by the Office Action to be the “caller process”) is not the process that engages in the point-to-point communication with the callee process.

In the second Office Action, in the section entitled Response to Arguments, the Office Action responded to such a point by stating:

Examiner notes that PO appears to be arguing that the Etherphones themselves are not capable of generating user interfaces by themselves. If this is the case, examiner points to Zellweger, page 2. Zellweger teaches that workstations work in combination with the Etherphones and provided the enhanced user interface functionality. The Etherphones are only used to separately split up voice voice-processing functionality due to hardware processing requirements. Therefore, the caller process is a function of the workstation in combination with the Etherphone.

Second Office Action, page 13.

In that argument, the Office Action admits that multiple hardware platforms are used to achieve the functionality alleged to be in the Etherphone papers. As shown below in Figures 1 and 11 of Zellweger and Swinehart, respectively, the workstations and Etherphones operate independently, are separate devices and, in fact, each have their own Ethernet connections.

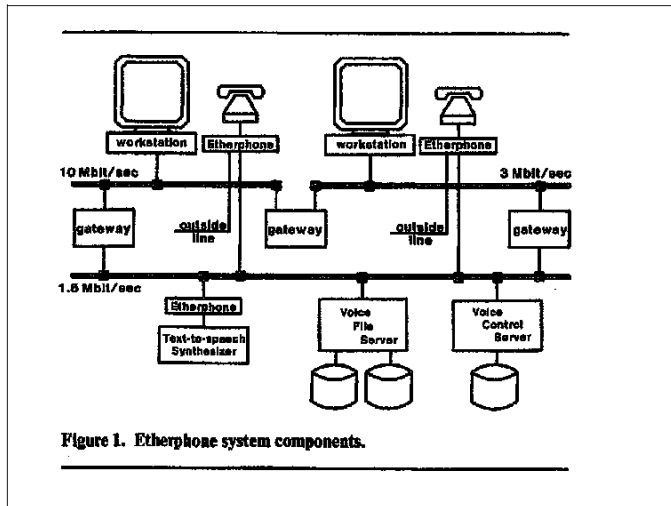

Page 2, Zellweger

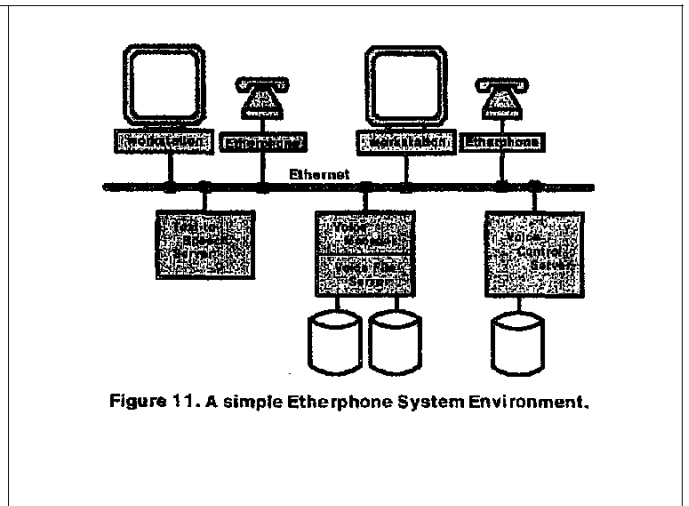

Page 4, Swinchart

Thus, there is no process as claimed that runs on a workstation or the Etherphone that both generates a user interface and participates in a point-to-point communication with a callee process. If the Office Action is proposing a modification to the teachings of the Etherphone papers in order to create a system where the user interface and point-to-point communication are implemented by the same process, then it is incumbent on the Office Action to show that one of ordinary skill in the art would have been motivated to make the proposed change.

The Office Action has also not alleged that the other references overcome this deficiency of the Etherphone references. Thus, claim 8 and its dependent claims are patentable over the applied combination of references for those reasons as well.

No Motivation To Combine The Applied References

With respect to the motivation to combine the references, the Office Action alleges that: it would have been obvious to one skilled in the art at the time the invention was made to utiliz[e] the user-interface elements and interactions taught by Pinard in

the invention taught by EtherPhone since Pinard teaches that the invention can be used in any system in which a personal computer in conjunction with a server operates..., and since examiner notes that both EtherPhone and Pinard relate to communications between at least two users implemented in a computerized environment.

The Office Action, however, provides no evidence to support this allegation. For example, the Office Action does not point to a problem identified in the art which was known to exist in one reference and for which the second references was the solution. Moreover, just because two references could be combined does not mean that one of ordinary skill in the art would have been motivated to do so absent the teachings in the patentee's specification.

Furthermore, the Etherphone papers and Pinard utilize different technologies for routing calls. Pinard places calls between conventional telephone equipment using a telephony server 5 connected to telephone interface circuits 8. Thus, Pinard does not disclose generating a user interface element representing a first callee process that is going to communicate with a caller process that generates a user interface because the phone application process in Pinard does not have another process with which to engage in point-to-point communications.

Accordingly, the patentability of claim 8 and its dependent claims should be confirmed.

Claim 9

Claim 9, in either its dependent or independent form, has an implicit or explicit claim structure similar to confirmed claim 11 of re-examined U.S. Patent No. 6,108,704 (Control No. 90/010,416) (hereinafter “the ‘416 re-examination”). As shown in the table below, amended claim 9 of this re-examination has the additional limitation of “querying the server process to determine if the first callee process is accessible” as compared to confirmed claim 11 of the ‘416 re-examination.

Amended Claim 9 of this Re-examination (without bracketing)	Amended Claim 11 of Re-examination Control No. 90/010,416 (without bracketing)
<p>9. In a computer system having a display and capable of executing a process, a method for establishing a point-to-point communication from a caller process to a callee process over a computer network, the caller process capable of generating a user interface and being operatively connected to the callee process and a server process over the computer network, the method comprising the steps of:</p>	<p>11. In a computer system, a method for establishing a point-to-point communication link from a caller process to a callee process over a computer network, the caller process having a user interface and being operatively connectable to the callee process and a server over the computer network, the method comprising the steps of:</p>
<p>A. generating a user-interface element representing a first communication line;</p>	<p>A. providing a user interface element representing a first communication line;</p>
<p>B. generating a user interface element representing a first callee process;</p>	<p>B. providing a user interface element representing a first callee process; and</p>
<p>C. querying the server process to determine if the first callee process is</p>	

Control No. 90/010,422
 Re-examination of U.S. Patent No. 6,009,469

Amended Claim 9 of this Re-examination (without bracketing)	Amended Claim 11 of Re-examination Control No. 90/010,416 (without bracketing)
accessible;	
D. establishing a point-to-point communication link from the caller process to the first callee process, in response to a user associating the element representing the first callee process with the element representing the first communication line,	C. establishing a point-to-point communication link from the caller process to the first callee process, in response to a user associating the element representing the first callee process with the element representing the first communication line,
wherein step C further comprises the steps of: C.1 querying the server process as to the on-line status of the first callee process; and	wherein step C further comprises the steps of: c.1 querying the server as to the on-line status of the first callee process; and
C.2 receiving a network protocol address of the first callee process over the computer network from the server process.	c.2 receiving a network protocol address of the first callee process over the computer network from the server.

In the Statement of Reasons for Patentability and/or Confirmation in the ‘416 re-examination, the paragraph crossing pages 2 and 3 explains that amended claim 11 in the ‘416 re-examination was found to be patentable “because the prior art does not explicitly teach ... receiving a network protocol address of the first callee process over the computer network from the server.” It is respectfully submitted that the same rationale holds true for amended claim 9 since the applied references do not teach the same claimed dynamic addressing limitation of amended claim 9 that they did not teach with respect to amended claim 11 of the ‘416 re-examination.

Control No. 90/010,422
Re-examination of U.S. Patent No. 6,009,469

Accordingly, the patentability of claim 9 and its dependent claims should be confirmed.

CUSTOMER NUMBER
42624

Davidson Berquist Jackson & Gowdey LLP
4300 Wilson Blvd., 7th Floor,
Arlington Virginia 22203
Main: (703) 894-6400 • FAX: (703) 894-6430

Respectfully submitted,

By: / Michael R. Casey /

Michael R. Casey, Ph.D.
Registration No.: 40,294

CHARGE STATEMENT: Deposit Account No. 501860, order no. 2655-0185.

The Commissioner is hereby authorized to charge any fee specifically authorized hereafter, or any missing or insufficient fee(s) filed, or asserted to be filed, or which should have been filed herewith or concerning any paper filed hereafter, and which may be required under Rules 16-18 (missing or insufficiencies only) now or hereafter relative to this application and the resulting Official Document under Rule 20, or credit any overpayment, to our Accounting/Order Nos. shown above.

This CHARGE STATEMENT does not authorize charge of the issue fee until/unless an issue fee transmittal sheet is filed.

(viii). CLAIMS APPENDIX

The unamended claims as pending prior to the filing of the amendment on even date are shown below:

1. (Confirmed) A computer program product for use with a computer system having a display and an audio transducer, the computer system capable of executing a first process and connecting to other processes and a server process over a computer network, the computer program product comprising a computer usable medium having computer readable code means embodied in the medium comprising:

a. program code for generating a user-interface enabling control of a first process executing on the computer system;

b. program code for determining the currently assigned network protocol address of the first process upon connection to the computer network;

c. program code responsive to the currently assigned network protocol address of the first process, for establishing a communication connection with the server process and for forwarding the assigned network protocol address of the first process and a unique identifier of the first process to the server process upon establishing a communication connection with the server process; and

d. program code means, responsive to user input commands, for establishing a point-to-point communications with another process over the computer network.

2. (Confirmed) The computer program product of claim 1 wherein the program code for establishing a point-to-point communication link further comprises:

d.1 program code, responsive to the network protocol address of a second process, for establishing a point-to-point communication link between the first process and the second process over the computer network.

3. (Confirmed) The computer program product of claim 2 wherein the program code for establishing a point-to-point communication link further comprise:

d.2 program code for transmitting, from the first process to the server process, a query as to whether the second process is connected to the computer network; and

d.3 program code means for receiving a network protocol address of the second process from the server process, when the second process is connected to the computer network.

4. (Not subject to re-examination) The computer program product of claim 2 wherein the program code for establishing a point-to-point communication link further comprises:

d.2 program code means for transmitting an E-mail message containing a network protocol address from the first process to the server process over the computer network;

d.3 program code means for receiving a second network protocol address from the second process over the computer network.

5. (Confirmed) In a computer system having a display and an audio transducer, the computer system capable of executing a first process and communicating with other processes and a server process over a computer network, a method for establishing point-to-point communications with other processes comprising:

A. determining the currently assigned network protocol address of the first process upon connection to the computer network;

B. establishing a communication connection with the server process once the assigned network protocol of the first process is known;

C. forwarding the assigned network protocol address of the first process to the server process upon establishing a communication connection with the server process; and

D. establishing a point-to-point communication with another process over the computer network.

6. (Confirmed) The method of claim 5 wherein the program step D comprises:

D.1 transmitting, from the first process to the server process, a query as to whether a second process is connected to the computer network; and

D.2 receiving a network protocol address of the second process from the server process, when the second process is connected to the computer network.

7. (Not subject to re-examination) The method of claim 5 wherein the program step D comprises:

D.1 transmitting an E-mail message containing a network protocol address from the first process to the server process over the computer network;

D.2 receiving a second network protocol address from a second process over the computer network.

8. (Appealed) In a computer system having a display and capable of executing a process, a method for establishing a point-to-point communication from a caller process to a callee process over a computer network, the caller process capable of generating a user interface and being operatively connected to the callee process and a server process over the computer network, the method comprising the steps of:

- A. generating a user-interface element representing a first communication line;
- B. generating a user interface element representing a first callee process;
- C. querying the server process to determine if the first callee process is accessible; and

D. establishing a point-to-point communication link from the caller process to the first callee process, in response to a user associating the element representing the first callee process with the element representing the first communication line.

9. (Appealed) The method of claim 8 wherein step C further comprises the steps of:

- C.1 querying the server process as to the on-line status of the first callee process; and
- C.2 receiving a network protocol address of the first callee process over the computer network from the server process.

10. (Not subject to re-examination) The method of claim 8 further comprising the step of:

E. generating a user-interface element representing a second communication line.

11. (Not subject to re-examination) The method of claim 8 further comprising the step of:

F. terminating the point-to-point communication from the caller process to the first callee process, in response to the user disassociating the element representing the first callee process from the element representing the first communication line; and

G. establishing a different point-to-point communication from the caller process to the first callee process, in response to the user associating the element representing the first callee process with the element representing the second communication line.

12. (Not subject to re-examination) The method of claim 8 further comprising the steps of:

E. generating a user interface element representing a second callee process; and

F. establishing a conference point-to-point communication between the caller process and the first and second callee processes, in response to the user associating the element representing the second callee process with the element representing the first communication line.

13. (Not subject to re-examination) The method of claim 8 further comprising the step of:

G. removing the second callee process from the conference point-to-point communication in response to the user disassociating the element representing the second callee process from the element representing the first communication line.

14. (Appealed) The method of claim 8 further comprising the steps of:

E. generating a user interface element representing a communication line having a temporarily disabled status; and

F. temporarily disabling the point-to-point communication between the caller process and the first callee process, in response to the user associating the element representing the first callee process with the element representing the communication line having a temporarily disabled status.

15. (Appealed) The method of claim 14 wherein the element generated in step E represents a communication line on hold status.

16. (Confirmed) The method of claim 15 wherein the element generated in step E represents a communication line on mute status.

17. (Appealed) The method of claim 8 wherein the display further comprises a visual display.

18. (Appealed) The method of claim 17 wherein the user interface is a graphic user interface and the user-interface elements generated in steps A and B are graphic elements.

The claims as they would be after entry of the amendment filed on even date are as follows:

1. (Confirmed) A computer program product for use with a computer system having a display and an audio transducer, the computer system capable of executing a first process and connecting to other processes and a server process over a computer network, the computer program product comprising a computer usable medium having computer readable code means embodied in the medium comprising:

a. program code for generating a user-interface enabling control of a first process executing on the computer system;

b. program code for determining the currently assigned network protocol address of the first process upon connection to the computer network;

c. program code responsive to the currently assigned network protocol address of the first process, for establishing a communication connection with the server process and for forwarding the assigned network protocol address of the first process and a unique identifier of the first process to the server process upon establishing a communication connection with the server process; and

d. program code means, responsive to user input commands, for establishing a point-to-point communications with another process over the computer network.

2. (Confirmed) The computer program product of claim 1 wherein the program code for establishing a point-to-point communication link further comprises:

d.1 program code, responsive to the network protocol address of a second process, for establishing a point-to-point communication link between the first process and the second process over the computer network.

3. (Confirmed) The computer program product of claim 2 wherein the program code for establishing a point-to-point communication link further comprise:

d.2 program code for transmitting, from the first process to the server process, a query as to whether the second process is connected to the computer network; and

d.3 program code means for receiving a network protocol address of the second process from the server process, when the second process is connected to the computer network.

4. (Not subject to re-examination) The computer program product of claim 2 wherein the program code for establishing a point-to-point communication link further comprises:

d.2 program code means for transmitting an E-mail message containing a network protocol address from the first process to the server process over the computer network;

d.3 program code means for receiving a second network protocol address from the second process over the computer network.

5. (Confirmed) In a computer system having a display and an audio transducer, the computer system capable of executing a first process and communicating with other processes and a server process over a computer network, a method for establishing point-to-point communications with other processes comprising:

A. determining the currently assigned network protocol address of the first process upon connection to the computer network;

B. establishing a communication connection with the server process once the assigned network protocol of the first process is known;

C. forwarding the assigned network protocol address of the first process to the server process upon establishing a communication connection with the server process; and

D. establishing a point-to-point communication with another process over the computer network.

6. (Confirmed) The method of claim 5 wherein the program step D comprises:

D.1 transmitting, from the first process to the server process, a query as to whether a second process is connected to the computer network; and

D.2 receiving a network protocol address of the second process from the server process, when the second process is connected to the computer network.

7. (Not subject to re-examination) The method of claim 5 wherein the program step D comprises:

D.1 transmitting an E-mail message containing a network protocol address from the first process to the server process over the computer network;

D.2 receiving a second network protocol address from a second process over the computer network.

8. (Canceled)

9. (Appealed) In a computer system having a display and capable of executing a process, a method for establishing a point-to-point communication from a caller process to a callee process over a computer network, the caller process capable of generating a user interface and being operatively connected to the callee process and a server process over the computer network, the [The] method [of claim 8] comprising the steps of:

A. generating a user-interface element representing a first communication line;
B. generating a user interface element representing a first callee process;
C. querying the server process to determine if the first callee process is accessible; and
D. establishing a point-to-point communication link from the caller process to the first callee process, in response to a user associating the element representing the first callee process with the element representing the first communication line, wherein step C further comprises the steps of:

C.1 querying the server process as to the on-line status of the first callee process; and
C.2 receiving a network protocol address of the first callee process over the computer network from the server process.

10. (Not subject to re-examination) The method of claim 8 further comprising the step of:
E. generating a user-interface element representing a second communication line.

11. (Not subject to re-examination) The method of claim 8 further comprising the step of:

F. terminating the point-to-point communication from the caller process to the first callee process, in response to the user disassociating the element representing the first callee process from the element representing the first communication line; and

G. establishing a different point-to-point communication from the caller process to the first callee process, in response to the user associating the element representing the first callee process with the element representing the second communication line.

12. (Not subject to re-examination) The method of claim 8 further comprising the steps of:

E. generating a user interface element representing a second callee process; and

F. establishing a conference point-to-point communication between the caller process and the first and second callee processes, in response to the user associating the element representing the second callee process with the element representing the first communication line.

13. (Not subject to re-examination) The method of claim 8 further comprising the step of:

G. removing the second callee process from the conference point-to-point communication in response to the user disassociating the element representing the second callee process from the element representing the first communication line.

14. (Appealed) The method of claim [8] 9 further comprising the steps of:

E. generating a user interface element representing a communication line having a temporarily disabled status; and

F. temporarily disabling the point-to-point communication between the caller process and the first callee process, in response to the user associating the element representing the first callee process with the element representing the communication line having a temporarily disabled status.

15. (Appealed) The method of claim 14 wherein the element generated in step E represents a communication line on hold status.

16. (Confirmed) In a computer system having a display and capable of executing a process, a method for establishing a point-to-point communication from a caller process to a callee process over a computer network, the caller process capable of generating a user interface and being operatively connected to the callee process and a server process over the computer network, the [The] method [of claim 15] comprising the steps of:

- A. generating a user-interface element representing a first communication line;
- B. generating a user interface element representing a first callee process;
- C. querying the server process to determine if the first callee process is accessible;
- D. establishing a point-to-point communication link from the caller process to the first callee process, in response to a user associating the element representing the first callee process with the element representing the first communication line;
- E. generating a user interface element representing a communication line having a temporarily disabled status; and
- F. temporarily disabling the point-to-point communication between the caller process and the first callee process, in response to the user associating the element representing the first callee process with the element representing the communication line having a temporarily disabled status, wherein the element generated in step E represents a communication line on hold status, and wherein the element generated in step E represents a communication line on mute status.

17. (Appealed) The method of claim [8] 9 wherein the display further comprises a visual display.

Control No. 90/010,422

Re-examination of U.S. Patent No. 6,009,469

18. (Appealed) The method of claim 17 wherein the user interface is a graphic user interface and the user-interface elements generated in steps A and B are graphic elements.

Control No. 90/010,422
Re-examination of U.S. Patent No. 6,009,469

(ix). EVIDENCE APPENDIX

The first and second Declarations of Dr. Ketan Mayer-Patel under 37 CFR 1.132 are being relied upon in this appeal and are attached hereto.

IN THE UNITED STATES PATENT AND TRADEMARK OFFICE

In re PATENT APPLICATION OF:	Attorney Docket: 2655-0185
Net2Phone, Inc. (Patent No. 6,009,469)	Group Art Unit: 3992
Control No.: 90/010,422	Examiner: KOSOWSKI, Alexander
Issue Date: December 28, 1999	Confirmation No.: 6565
Title: GRAPHIC USER INTERFACE FOR INTERNET TELEPHONY APPLICATION	

SECOND DECLARATION OF KETAN MAYER-PATEL UNDER 37 C.F.R. 1.132

Hon. Commissioner of Patents
P.O. Box 1450
Alexandria, VA 22313-1450

I. INTRODUCTION

1. I am the same Ketan Mayer-Patel that filed a Declaration in response to the first Office Action in the re-examination of U.S. Patent No. 6,009,469 (hereinafter "the '469 patent").
2. I have reviewed the outstanding Office Action dated May 10, 2010.
3. I understand that claims 8, 9, and 14-18 were alleged to be obvious over the combination of NetBIOS and Pinard (U.S. Patent No. 5,533,110), either alone or in combination with the VocalChat User's Guide, and claims 8, 9, and 14-18 were alleged to be obvious over the combination of the Etherphone papers in view of Pinard, either alone or in combination with the VocalChat User's Guide.
4. I understand that in response to evidence presented in my first Declaration the Office Action now alleges "under a broadest reasonable interpretation, this [accessible] limitation could simply mean that a user is registered with the system." As this argument was not presented in the first Office Action, I was not able to know that such a position needed to be addressed.
5. I do not believe that one of ordinary skill in the art at the time the invention was made would have believed that the definitions proposed by the Office Action are proper -- even under a "broadest reasonable interpretation" standard.

Re-Examination of Patent No. 6,009,469
Control No.: 90/010,422
Filed: February 24, 2009
Second Declaration of Ketan Mayer-Patel under 37 C.F.R. 1.132

6. The dictionary definitions of “accessible” and “registered” show that they are not synonymous with each other. See Exhibit 1 attached hereto. According to the definitions, a system such as NetBIOS would indicate whether a name is “registered” (e.g., recorded or listed), but it would not indicate that a callee process is accessible (e.g., easy to reach or use or easily approached or entered).

7. Accordingly, I do not agree that “under a broadest reasonable interpretation, this [accessible] limitation could simply mean that a user is registered with the system.”

8. In fact, NetBIOS explicitly provides for permanent registration of names. As described in Section 15.1.3.2 of RFC 1001, “Names held by an NBNS are given a lifetime during name registration.” The same section further states “The lifetime period is established through a simple negotiation mechanism during name registration: In the name registration request, the end-node proposes a lifetime value or *requests an infinite lifetime*. The NBNS places an actual lifetime value into the name registration response. The NBNS is always allowed to respond with an infinite actual period.” (Emphasis added.) Thus, in any number of cases, the NBNS may demand an infinite lifetime for names registered by nodes, with the effect that the NBNS would deliberately preserve the name and address information registered by a node permanently on the NBNS even weeks, months or years after the node had stopped using the name or had gone off-line altogether. Therefore, the correspondence between a name and an IP address is not indicative that a first callee process is accessible.

9. Moreover, the node requesting information on whether a name is registered does not receive an indication from the NBNS that the registered name corresponds to a name that has been given an infinite lifetime and could therefore be completely out-of-date. Section 4.2.13 of RFC 1002 describes the Positive Name Query Response (reproduced below) that is returned when a name has been registered, and there is no indication that the returned address is for a name associated with an identified lifetime, let alone an infinite lifetime.

4.2.13. POSITIVE NAME QUERY RESPONSE

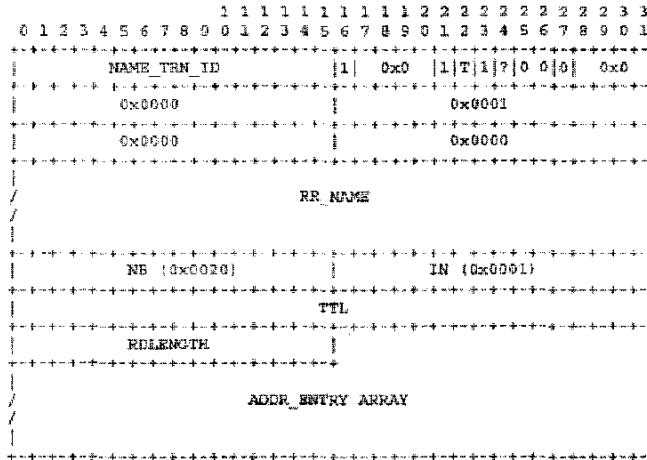

The ADDR_ENTRY ARRAY a sequence of zero or more ADDR_ENTRY records. Each ADDR_ENTRY record represents an owner of a name. For group names there may be multiple entries. However, the list may be incomplete due to packet size limitations. Bit 22, "T", will be set to indicate truncated data.

Each ADDR_ENTRY has the following format:

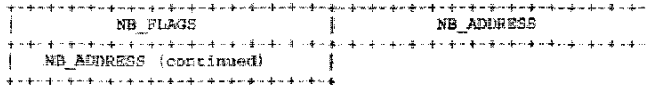

10. In addition, there is no indication in the Positive Name Query Response disclosed by NetBIOS that the returned address necessarily corresponds with a computer or process that was ever accessible as asserted by the pending office action. For example, a first user could manually enter a dummy address in the NB_Address field associated with a claimed name that he wanted to register and still be compliant with the NetBIOS protocol standard since queries by other users for that name are “not necessarily a prelude to NetBIOS session establishment or NetBIOS datagram transmission.” Section 15.3.1.

11. Furthermore, RFC 1002 further shows that a name registration is not an indication of whether a first callee process is accessible since a NBNS can refuse to release registered names for policy reasons. As described in Section 4.2.9, a node may request that a name be released using a Name Release Request (reproduced below).

Re-Examination of Patent No. 6,009,469
 Control No.: 90/010,422
 Filed: February 24, 2009
 Second Declaration of Ketan Mayer-Patel under 37 C.F.R. 1.132

4.2.9. NAME RELEASE REQUEST & DEMAND

```

          1 1 1 1 1 1 1 1 1 1 2 2 2 2 2 2 2 2 3 3
0 1 2 3 4 5 6 7 8 9 0 1 2 3 4 5 6 7 8 9 0 1 2 3 4 5 6 7 8 9 0 1
|-----|-----|-----|-----|-----|-----|-----|-----|
| NAME_TRN_ID | 0 | 0x6 | 0 | 0 | 0 | 0 | 0 | 0 | B | 0x0 |
|-----|-----|-----|-----|-----|-----|-----|-----|
| 0x0001 | | | | | | | | | | 0x0000 |
|-----|-----|-----|-----|-----|-----|-----|-----|
| 0x0000 | | | | | | | | | | 0x0001 |
|-----|-----|-----|-----|-----|-----|-----|-----|
|
| QUESTION_NAME
|
|-----|-----|-----|-----|-----|-----|-----|-----|
| NB (0x0020) | | | | | | | | | | IN (0x0001) |
|-----|-----|-----|-----|-----|-----|-----|-----|
|
| RR_NAME
|
|-----|-----|-----|-----|-----|-----|-----|-----|
| NB (0x0020) | | | | | | | | | | IN (0x0001) |
|-----|-----|-----|-----|-----|-----|-----|-----|
| 0x00000000 |
|-----|-----|-----|-----|-----|-----|-----|-----|
| 0x0006 | | | | | | | | | | NB_FLAGS |
|-----|-----|-----|-----|-----|-----|-----|-----|
| NB_ADDRESS
|-----|-----|-----|-----|-----|-----|-----|-----|

```

12. In response, as shown in Section 4.2.11, a server can generate a Negative Name Release Response, as shown below.

Re-Examination of Patent No. 6,009,469
 Control No.: 90/010,422
 Filed: February 24, 2009
 Second Declaration of Ketan Mayer-Patel under 37 C.F.R. 1.132

4.2.11. NEGATIVE NAME RELEASE RESPONSE

```

          1 1 1 1 1 1 1 1 1 1 2 2 2 2 2 2 2 2 3 3
0 1 2 3 4 5 6 7 8 9 0 1 2 3 4 5 6 7 8 9 0 1 2 3 4 5 6 7 8 9 0 1
+-----+-----+-----+-----+-----+-----+-----+-----+
|          NAME_TRN_ID          |1| 0x6 |1|0|0|0|0|0|0| RCODE |
+-----+-----+-----+-----+-----+-----+-----+-----+
|          0x0000          |          0x0001          |
+-----+-----+-----+-----+-----+-----+-----+-----+
|          0x0000          |          0x0000          |
+-----+-----+-----+-----+-----+-----+-----+-----+
|                               |
|                               | RR_NAME |
|                               |
+-----+-----+-----+-----+-----+-----+-----+-----+
|          NB (0x0020)          |          IN (0x0001)          |
+-----+-----+-----+-----+-----+-----+-----+-----+
|                               | TTL |
+-----+-----+-----+-----+-----+-----+-----+-----+
|          0x0006          |          NB_FLAGS          |
+-----+-----+-----+-----+-----+-----+-----+-----+
|                               | NB_ADDRESS |
+-----+-----+-----+-----+-----+-----+-----+-----+

```

The RCODE field indicates the response from the server. One such response is RFS_ERR which is described as follows:

```

RFS_ERR      0x5   Refused error.  For policy reasons server
                will not release this name from this host.

```

13. Thus, the registration of a name does not indicate that NetBIOS discloses that a “first callee process is accessible.”

Re-Examination of Patent No. 6,009,469
Control No.: 90/010,422
Filed: February 24, 2009
Second Declaration of Ketan Mayer-Patel under 37 C.F.R. 1.132

14. I hereby declare that all statements made herein of my own knowledge are true and that all statements made on information and belief are believed to be true; and further that these statements were made with the knowledge that willful false statements and the like so made are punishable by fine or imprisonment, or both, under Section 1001 of Title 18 of the United States Code and that such willful false statements may jeopardize the validity of the application or any patent issued thereon.

Dated: July 12, 2010



Ketan Mayer-Patel, Ph.D.

EXHIBIT 1

ac·ces·si·ble [ak-ses-uh-buhl]

–adjective

1. easy to approach, reach, ~~enter~~ speak with, or use.
2. that can be used, entered, reached, etc.: an accessible road; accessible ruins.
3. obtainable; attainable: accessible evidence.
4. open to the influence of (usually fol. by to): accessible to bribery.

Dictionary.com Unabridged

Based on the Random House Dictionary, © Random House, Inc. 2010.

ac·ces·si·ble (āk-sēs'ə-bəl)

adj.

1. Easily approached or entered.
2. Easily obtained: accessible money.
3. Easy to talk to or get along with: an accessible manager.
4. Easily swayed or influenced: accessible to flattery.

ac·ces'si·bil'i·ty, ac·ces'si·ble·ness n., ac·ces'si·bly adv.

The American Heritage® Dictionary of the English Language, Fourth Edition

Copyright © 2009 by Houghton Mifflin Company.

Published by Houghton Mifflin Company. All rights reserved.

reg·is·tered [rej-uh-sterd]

–adjective

1. recorded, as in a register or book; enrolled.
2. Commerce . officially listing the owner's name with the issuing corporation and suitably inscribing the certificate, as with bonds to evidence title. Abbreviation: r
3. officially or legally certified by a government officer or board: a registered patent.
4. denoting cattle, horses, dogs, etc., having pedigrees verified and filed by authorized associations of breeders.

dictionary.com

reg·is·tered (rĕj'ī-stərd)

adj.

1. Having the owner's name listed in a register: registered bonds.
2. Having the pedigree recorded and verified by an authorized association of breeders: a registered golden retriever.
3. Officially qualified or certified: a registered pharmacist.

The American Heritage® Dictionary of the English Language, Fourth Edition

Copyright © 2009 by Houghton Mifflin Company.

Published by Houghton Mifflin Company. All rights reserved.

Main Entry: registered

Part of Speech: adjective

Definition: recorded

Synonyms: cataloged, certified, enrolled

Main Entry: registered

Part of Speech: adjective

Definition: pedigreed

Synonyms: blooded, full-blooded, pure-blooded, purebred, thoroughbred

IN THE UNITED STATES PATENT AND TRADEMARK OFFICE

In re PATENT APPLICATION OF:	Attorney Docket: 2655-0185
Net2Phone, Inc. (Patent No. 6,009,469)	Group Art Unit: 3992
Control No.: 90/010,422	Examiner: KOSOWSKI, Alexander
Issue Date: December 28, 1999	Confirmation No.: 6565
Title: GRAPHIC USER INTERFACE FOR INTERNET TELEPHONY APPLICATION	

DECLARATION OF KETAN MAYER-PATEL UNDER 37 C.F.R. 1.132

Hon. Commissioner of Patents
P.O. Box 1450
Alexandria, VA 22313-1450

I. INTRODUCTION

1. I have been retained as an independent expert witness by Net2Phone, Inc., the assignee of the patent presently undergoing re-examination (i.e., U.S. Patent No. 6,009,469 (hereinafter “the ‘469 patent”)).
2. I am an expert in the field of networking protocols including networking protocols supporting multimedia streams including digital audio data. See Curriculum Vitae attached as Exhibit 1.
3. I received Bachelors of Arts degrees in Computer Science and Economics in 1992, a Masters of Science in 1997 from the Department of Electrical Engineering and Computer Science and a Ph.D. in 1999 from the Department of Electrical Engineering and Computer Science, all from the University of California, Berkeley.
4. I received the National Science Foundation CAREER Award in 2003 while an Assistant Professor at the University of North Carolina, Chapel Hill.
5. I have had extensive experience in both industry and academia as it relates to the technical fields relevant here. For example, I have been a programmer, a visiting researcher, and an Assistant and Associate professor.

Re-Examination of Patent No. 6,009,469
Control No.: 90/010,422
Filed: February 24, 2009
Declaration of Ketan Mayer-Patel under 37 C.F.R. 1.132

6. I am a co-author of numerous articles that have appeared in a number of refereed publications and proceedings.
7. Governmental agencies, such as the National Science Foundation and the Office of Naval Research, have provided funding for my research.

II. RETENTION AND COMPENSATION

8. I have been retained to offer an expert opinion on the prior art relevant to the '469 patent (and other patents currently under re-examination) and the validity of the claims undergoing re-examination.
9. My work on this case is being billed at a rate of \$400 per hour, with reimbursement for actual expenses. My compensation is not contingent upon the outcome of the case.

III. BASIS OF MY OPINION AND MATERIALS CONSIDERED

10. In preparation for this report, I have considered and relied on data or other documents identified in this report. For example, I have reviewed the Office Action dated August 25, 2009 as well as the Request for Re-examination that was filed for the '469 patent including the Exhibits to the Request for Re-examination. I have also reviewed the file history of the '469 patent.
11. I have familiarized myself with the state of the art at the time the '469 patent was filed by reviewing both patent and non-patent references from prior to the filing date of the application that became the '469 patent.
12. My opinions are also based upon my education, training, research, knowledge, and experience in this technical field.

IV. SUMMARY OF MY OPINIONS

13. Based on my prior experience in the field of computer systems and networking, including network communication protocols, and based on my review of the documents relating to the

Re-Examination of Patent No. 6,009,469
Control No.: 90/010,422
Filed: February 24, 2009
Declaration of Ketan Mayer-Patel under 37 C.F.R. 1.132

pending re-examination proceeding, I have developed an understanding of the '469 patent and the claimed inventions.

14. I have been asked to compare the claims of the '469 patent to the references applied in the outstanding Office Action. The results of my comparison are provided below.

15. In general, it is my opinion that all of the claims undergoing re-examination (i.e., claims 1-3, 5, 6, 8, 9 and 14-18) are patentable over the applied references for at least the reasons set forth below.

The rejection of claims 1-3, 5, 6, 8, 9, and 14-18 over NetBIOS, RFC 1531, Pinard and the VocalChat User's Guide

16. Claims 1-3, 5, 6, 8, 9, and 14-18 were rejected under 35 U.S.C. § 103(a) as being obvious in light of Protocols for X/Open PC Interworking SMB, Version 2, The Open Group (1992) (hereinafter "NetBIOS"), in view of RFC 1531, Pinard and the VocalChat User's Guide.

17. I understand that a rejection under 35 U.S.C. § 103(a) means that an examiner believes that although no single reference includes all of the claimed limitations, nonetheless the combination of references made by the examiner would have been obvious to one of ordinary skill in the art at the time the invention was made.

Claims 1-3

18. Claim 1 recites "a. program code for generating a user-interface enabling control of a first process executing on the computer system." With respect to the limitation of "program code for generating a user-interface enabling control of a first process executing on the computer system," the Office Action alleges that "computers executing NetBIOS *may contain* DOS operating systems or may operate on other operating systems, which examiner notes inherently contain at least text-based user interfaces." By stating that NetBIOS "may contain" DOS operating systems I believe the Examiner is indicating that NetBIOS need not actually contain or be running on a

Re-Examination of Patent No. 6,009,469
Control No.: 90/010,422
Filed: February 24, 2009
Declaration of Ketan Mayer-Patel under 37 C.F.R. 1.132

DOS operating system. Since that is true, NetBIOS (or the computer running NetBIOS) does not inherently include text-based user interfaces.

19. Furthermore, the recitation of “other operating systems” also does not inherently mean that “text-based user interfaces” are provided. For example, embedded systems need not have a display or a text interface even though they may have operating systems. The Office Action also has not asserted that this limitation is taught by RFC 1531. Thus, I do not believe that limitation (a) has been shown to be taught by either applied reference.

20. Claim 1 also recites “b. program code for determining the currently assigned network protocol address of the first process upon connection to the computer network.” The Office Action admits that NetBIOS does not teach this limitation. The Office Action alleges that such a limitation is taught by RFC 1531 because “RFC 1531 teaches dynamically assigning IP address on a TCP/IP network by an Internet access server.” By looking at limitations (a) and (b) together, however, it can be seen that the Office Action has not shown that the currently assigned network protocol address is that of the first process which the Office Action alleged was the “text-based user interface.” The Office Action also has not explained why the text-based interface would have to have its currently assigned network protocol address determined. Thus, I do not believe that limitation (b) is taught by either applied reference.

21. Claim 1 recites “c. program code responsive ... for forwarding the assigned network protocol address of the first process and a unique identifier of the first process to the server process upon establishing a communication connection with the server process.” The Office Action has not shown that the assigned network protocol address of the first process is determined, so the Office Action also has not shown that the assigned network protocol address of the first process would be forwarded to the server upon establishing a communication connection with the server process. Similarly, the Office Action has not shown that the text-based user interfaces would have a unique identifier to be forwarded to the server. The Office Action further has not shown that such a limitation is taught by RFC 1531. Accordingly, I do not believe that limitation (c) is taught by either applied reference.

Re-Examination of Patent No. 6,009,469
Control No.: 90/010,422
Filed: February 24, 2009
Declaration of Ketan Mayer-Patel under 37 C.F.R. 1.132

22. Claim 1 also recites “d. program code, responsive to user input commands, for establishing a point-to-point communications with another process over the computer network.” The Office Action cites NetBIOS, pgs. 397-400, as teaching that “point-to-point communication is established upon initiation between nodes once target names and addresses have been found.” However, the Office Action has not shown that the code is “responsive to user input commands” as no user input commands have been identified. Even assuming that text-based user interfaces were taught by NetBIOS, the Office Action still would not have shown that point-to-point communications are inherently established “responsive to user input commands.” The text-based user interfaces could have been used for non-communicating functions or even functions that use non-point-to-point communications. The Office Action further has not shown that such a limitation is taught by RFC 1531. Accordingly, I do not believe that limitation (d) is taught by either applied reference.

23. Since none of the limitations of claim 1 have been shown to be taught by the applied combination of references, I do not believe that claim 1 and dependent claims 2 and 3 are obvious in light of the proposed combination.

24. The Office Action states that “it would have been obvious ... to determine the currently assigned network address of the first process upon connection to the computer network in the invention taught by NetBIOS above since this allows for automatic reuse of an address ... and since examiner notes the use of dynamic IP address assignment ... are old and well known ... and are useful to eliminate the burdensome task of manually assigning IP addresses for all networked computers.” However, the Office Action does not acknowledge the problems that could arise in doing so or how those problems would be resolved by those of ordinary skill at the time the patent was filed.

25. In the context of point-to-point communication, widespread use of dynamically assigned addresses can create additional problems for a NetBIOS environment. For example, Section 15.1.7 of the NetBIOS reference (entitled “Consistency of the NBNS Data Base”) recognizes that the association between a node, a registered name and an IP address is tenuous, even in an

Re-Examination of Patent No. 6,009,469
Control No.: 90/010,422
Filed: February 24, 2009
Declaration of Ketan Mayer-Patel under 37 C.F.R. 1.132

environment that uses static IP addresses. “Even in a properly running NetBIOS scope the NBNS and its community of end-nodes may occasionally lose synchronization with respect to the true state of name registrations.” To minimize the impact of this problem, the reference states, “Various approaches have been incorporated into the NetBIOS-over-TCP protocols” which it then proceeds to describe.

26. However, by incorporating DHCP and adopting of dynamic address allocation (e.g., as used by Internet access providers), the synchronization problem would become more disruptive, not less. Dynamic addressing introduced a new uncertainty to the relationships among the NBNS and its community of end-nodes and a new set of obstacles to NetBIOS synchronization that *are not addressed by the NetBIOS reference*. Consider the case of a node that is turned-off and then subsequently turned back on, or the case of a node that has simply lost its Internet connection for some technical reason or whose DHCP lease has expired which then re-establishes a connection. In such a dynamic addressing environment, such a node would most likely obtain a new IP address when it was turned back on that was different than the one it had when it registered its name. This change could lead to any number of node-name-IP address synchronization problems for the disclosed NetBIOS protocols.

27. For example, because the NBNS does not know the node’s new address, the NBNS would be unable to send to the node a Name Release Request or a Name Conflict Demand or request that the node send it a Name Status Request. Because communication from the node would be originating at a new address that was not recognized by the NBNS, a node’s response to a Name Query Request (assuming it somehow knew that its name had been challenged, perhaps from before it lost network connectivity) would not be recognized. A node would also be unable to confirm its association with registered names by sending Name Refresh Request packets to the NBNS. If a session between two NetBIOS applications were cut-off, re-establishing the communication would be especially difficult where the ability of a called entity to obtain both its associated name and its associated IP address were in doubt. As a result, the Office Action has not demonstrated that a solution to the problems created by exposure of

Re-Examination of Patent No. 6,009,469
Control No.: 90/010,422
Filed: February 24, 2009
Declaration of Ketan Mayer-Patel under 37 C.F.R. 1.132

NetBIOS to DHCP and dynamic addressing has been addressed by any of the applied references.¹

28. The Office Action also has not identified anything in the cited art that suggests how a person of ordinary skill is to go about the redesign of NetBIOS and the solving of obstacles to NetBIOS operation that are created by Internet access; problems that were recognized and left as warnings unresolved in the NetBIOS reference.²

29. Thus, I believe claims 1-3 are patentable over the combination of NetBIOS and RFC 1531.

Claims 5 and 6

30. Claim 5 recites “determining the currently assigned network protocol address of the first process upon connection to the computer network.” The Office Action acknowledges that this limitation is not taught by NetBIOS but alleges that “RFC 1531 teaches dynamically assigning IP addresses on a TCP/IP network by an Internet access server.” The Office Action further alleges that “it would have been obvious ... to determine the currently assigned network address of the first process upon connection to the computer network in the invention taught by NetBIOS above since this allows for automatic reuse of an address ... and since examiner notes the use of dynamic IP address assignment ... are old and well known ... and are useful to eliminate the burdensome task of manually assigning IP addresses for all networked computers.” However, as described above with respect to claims 1-3, I do not believe that the Office Action has shown that in light of the problems that worsen by combining NetBIOS and RFC 1531, that a person of

¹ Besides dynamic addressing, Internet access would pose other challenges to a NetBIOS system. For example, because NetBIOS was designed for use on local area networks with small numbers of computers, trust among the network participants is assumed. That assumption cannot be transferred to a global Internet made up of unknown, and sometimes malevolent, entities. An implementation of NetBIOS on the public Internet would necessitate non-trivial adaptations to ensure that its services perform correctly and return accurate information. See Exhibit 2, from http://www.w3schools.com/Site/site_security.asp which instructs Microsoft Windows users whose computers access the Internet to disable NetBIOS over TCP/IP in order to solve their security problems.

² See Section 4.6 (“The proposed standard recognizes the need for NetBIOS operation across a set of networks interconnected by network (IP) level relays (gateways.) However, the standard assumes that this form of operation will be less frequent than on the local MAC bridged-LAN.”)

Re-Examination of Patent No. 6,009,469
Control No.: 90/010,422
Filed: February 24, 2009
Declaration of Ketan Mayer-Patel under 37 C.F.R. 1.132

ordinary skill in the art would have combined the two references as proposed. Thus, I believe that claims 5 and 6 are patentable over the applied NetBIOS and RFC 1531 references.

Claims 8, 9 and 14-18

31. Claim 8 recites “querying the server process to determine if the first callee process is accessible.” The Office Action asserts that this limitation is taught by NetBIOS and cites pages 377, 388, 389 and 446 as supporting the proposition that “a query is sent to the NBNS to determine if another node is logged in and discover[s] the node[']s IP address.” However, the Office Action has not shown how knowing that a name has been registered equates to “determin[ing] if the first callee process is accessible.” While NetBIOS uses name entries with “active” statuses as part of its name management process, an analysis of how that “active” status is used shows that “an active name” is not synonymous with determining if the first callee process is accessible. An active name simply refers to a name that has been registered and that has not yet been de-registered, independent of whether the associated computer is or is not accessible. As shown on page 447 (and reproduced below), the Node_Name entries stored with respect to a NetBIOS Name Server contain a series of fields including the “ACT” field.

Re-Examination of Patent No. 6,009,469
 Control No.: 90/010,422
 Filed: February 24, 2009
 Declaration of Ketan Mayer-Patel under 37 C.F.R. 1.132

The NAME_FLAGS field:



The NAME_FLAGS field is defined as:

Symbol	Bit(s)	Description:
RESERVED	7-15	Reserved for future use. Must be zero (0).
PRM	6	Permanent Name Flag. If one (1) then entry is for the permanent node name. Flag is zero (0) for all other names.
ACT	5	Active Name Flag. All entries have this flag set to one (1).
CNF	4	Conflict Flag. If one (1) then name on this node is in conflict.
DRG	3	Deregister Flag. If one (1) then this name is in the process of being deleted.
ONT	1,2	Owner Node Type: 00 = B node 01 = F node 10 = M node 11 = Reserved for future use
G	0	Group Name Flag. If one (1) then the name is a GROUP NetBIOS name. If zero (0) then it is a UNIQUE NetBIOS name.

32. The ACT field is a single bit field (in bit 5) that signifies an “Active Name Flag. *All entries have this flag set to one (1).*” (Emphasis added.) If all name entries have this flag set to one (1), then the NetBIOS name server cannot be using the Active Name Flag as a means of separately tracking whether the entity that owns the name is “active,” let alone what its “on-line” status might be.

33. The NetBIOS reference also does not teach that the active status of a name in the NetBIOS server is an indication of the active status of the owner of that name. To the contrary, when information about whether the owner of a name is “active” may be relevant, for example when a new entity seeks to register a name that has already been registered in the NetBIOS name server, the NetBIOS reference describes an elaborate set of interactions used to test whether the

Re-Examination of Patent No. 6,009,469
Control No.: 90/010,422
Filed: February 24, 2009
Declaration of Ketan Mayer-Patel under 37 C.F.R. 1.132

existing owner of the registered name is active or inactive. It does not rely on the fact that the name is active in the NetBIOS name server (See Section 15.2.2.2 and 15.2.2.3 entitled “Existing Name and Owner is Inactive”).

34. The NetBIOS reference also does not teach that an acquired IP address can be reasonably relied upon by a requesting end-node to confirm that an end-node associated with a sought name is, in fact, “accessible.” The NetBIOS reference describes at least two different scenarios where a second end-node sends a rejection response to the first end-node notwithstanding the fact that an end-node is connected to the computer network and active with respect to the sought name. See Section 16.1.1 (“There exists a NetBIOS LISTEN compatible with the incoming call, but there are inadequate resources to permit establishment of a session... The called name does, in fact, exist on the called node, but there is no pending NetBIOS LISTEN compatible with the incoming call.”). No distinction is made in the reference between the rejection response in these cases and the rejection response in cases where the called name does not exist on the called end-node. Section 16.1.1 also states “In all but the first case, a rejection response is sent back over the TCP connection to the caller.”

35. The Office Action also has not alleged that any of the remaining references teach this limitation missing from the NetBIOS reference. As such, claim 8 and its dependent claims (claims 9 and 14-18) are not rendered obvious by the cited combination of references.

The rejection of claims 1-3, 5, 6, 8, 9, and 14-18 over the combination of the Etherphone papers in view of Vin and further in view of RFC 1531, Pinard and the VocalChar User’s Guide

36. Claims 1-3 were rejected under 35 U.S.C. § 103(a) as obvious over Etherphone: Collected Papers 1987-1988 (May 1989) (hereinafter “Etherphone”) in view of Harrick M. Vin, et al. *Multimedia Conferencing in the Etherphone Environment*, IEEE Computer Society (October 1991) (hereinafter “Vin”) and further in view of RFC 1531, Pinard and VocalChat User’s Guide. The Etherphone Collected Papers include *An Overview of the Etherphone System and its Applications* (hereinafter “Zellweger”), *Telephone Management in the Etherphone*

Re-Examination of Patent No. 6,009,469
Control No.: 90/010,422
Filed: February 24, 2009
Declaration of Ketan Mayer-Patel under 37 C.F.R. 1.132

System (hereinafter "Swinehart"), and *Managing Stored Voice in the Etherphone System* (hereinafter "Terry").

37. Claim 1, as amended, recites "a. program code for generating a user-interface enabling control of a first process executing on the computer system" and "d. program code means, responsive to user input commands, for establishing a point-to-point communications with another process over the computer network." When read together, it can be seen that the Office Action has not shown that these limitations are taught by the applied combination of references.

38. With respect to the limitation "a. program code for generating a user-interface enabling control of a first process executing on the computer system," the Office Action cites Swinehart and Zellweger as teaching that "workstations include GUI's." Later, with respect to the limitation "d. program code means, responsive to user input commands, for establishing a point-to-point communications with another process over the computer network," the Office Action asserts that "after acquiring the network address of a callee, voice datagrams are transmitted directly among [sic; among] the participants, bypassing the control server." However, by "participants" it appears that the Office Action is referring to Etherphones participating in a telephone call. As such, the Office Action has not shown that the datagrams are transmitted as part of a point-to-point communication from the workstation (which was alleged as having the first process) to one of the Etherphones. In fact, with respect to limitation (c), the Office Action confirms that its interpretation is that the "workstation address [is] transmitted to the Voice Control Server when connected" -- not the Etherphone's network address.

39. Similarly, looking at it from the opposite perspective, if the voice datagrams are actually going from one Etherphone to another, then the Office Action has not shown how the "currently assigned network protocol address of the first process" is the address of the Etherphone and how the Etherphone has a display or "a user-interface enabling control a first process" on that Etherphone. The Office Action also has not alleged that RFC 1531 teaches this limitation missing from the Etherphone references. Thus, claims 1-3 are not rendered obvious by the proposed combination.

Re-Examination of Patent No. 6,009,469
Control No.: 90/010,422
Filed: February 24, 2009
Declaration of Ketan Mayer-Patel under 37 C.F.R. 1.132

Claims 5 and 6

40. Claim 5 recites “A. determining the currently assigned network protocol address of the first process upon connection to the computer network” and “D. establishing a point-to-point communication with another process over the computer network.” As described above with respect to claim 1, when these two limitations are examined together, it can be seen that the Office Action has not shown that these limitations are met.

41. With respect to the limitation “A. determining the currently assigned network protocol address of the first process upon connection to the computer network,” the Office Action again cites the GUI’s of the workstation as meeting this limitation. Then, with respect to the limitation “D. establishing a point-to-point communication with another process over the computer network,” the Office Action again states “voice datagrams are transmitted directly amont [sic; among] the participants, bypassing the control server.” Thus, as discussed above with respect to claim 1, the Office Action appears to have overlooked that the Etherphone, not the workstation with the GUI, is receiving the voice datagrams, so the Etherphone reference does not teach limitations (A) and (D). The Office Action also has not alleged that RFC 1531 teaches this limitation missing from the Etherphone references. Thus, claims 5 and 6 are not rendered obvious by the proposed combination.

Claims 8, 9 and 14-18

42. Claim 8 recites “a method for establishing a point-to-point communication from a caller process to a callee process over a computer network, the caller process capable of generating a user interface and being operatively connected to the callee process and a server process over the computer network.” That method includes “querying the server process to determine if the first callee process is accessible” and “establishing a point-to-point communication link from the caller process to the first callee process.”

Re-Examination of Patent No. 6,009,469
Control No.: 90/010,422
Filed: February 24, 2009
Declaration of Ketan Mayer-Patel under 37 C.F.R. 1.132

43. With respect to the limitation of “establishing a point-to-point communication link from the caller process to the first callee process,” the Office Action asserts that Swinehart and Zellweger teach “voice datagrams are transmitted directly among participants.” However, it appears that the Office Action means that the Etherphone are the “participants.” If this is the case, there is no indication that the combination meets the limitation of “the caller process capable of generating a user interface” as the Office Action has not alleged that the Etherphone has such a capability. The Office Action has also not alleged that the other references overcome this deficiency of the Etherphone references. Thus, claim 8 and its dependent claims are patentable over the applied combination of references.

The rejection of claims 1-3, 5, 6, 8, 9, and 14-18 over the combination of the VocalChat references in view of RFC 1531 and Pinard

44. Claims 1-3, 5, 6, 8, 9 and 14-18 were rejected under 35 U.S.C. § 103(a) as obvious over VocalChat User’s Guide in view of VocalChat Readme, VocalChat Networking, VocalChat Help File and VocalChat Troubleshooting Help file (collectively the “VocalChat References”) and further in view of RFC 1531 and Pinard.

Claims 1-3

45. Claim 1 recites “program code responsive to the currently assigned network protocol address of the first process, for establishing a communication connection with the server process and for forwarding the assigned network protocol address of the first process and a unique identifier of the first process to the server process upon establishing a communication connection with the server process.” The Office Action admits that this limitation is not disclosed by the VocalChat references. However, the Office Action attempts to overcome this deficiency by combining the VocalChat references with RFC 1531.

46. However, the Office Action does not acknowledge the problems that could arise in doing so or how those problems would be resolved by those of ordinary skill at the time the patent was

Re-Examination of Patent No. 6,009,469
Control No.: 90/010,422
Filed: February 24, 2009
Declaration of Ketan Mayer-Patel under 37 C.F.R. 1.132

filed. Thus, I do not believe that the Office Action has proven that one of ordinary skill at the time the patent was filed would have made the proposed combination.

47. Claim 1 also recites “forwarding the assigned network protocol address of the first process and a unique identifier of the first process to the server process upon establishing a communication connection with the server process.” The VocalChat Generic implementation does not disclose such a limitation. In the VocalChat Generic implementation, a local process reads a “USERS” file or a Connections file in its entirety and writes it back in its entirety rather than “forwarding the assigned network protocol address of the first process and a unique identifier of the first process to the server process upon establishing a communication connection with the server process.” This causes the VocalChat system to have to send an increasing amount of information as the number of users increases. Sending the whole file such that the new file replaces the old file also creates problems with consistency such that one user’s changes could overwrite the changes of another user -- especially as networks got larger which would have increased the problem of inconsistent files being written.

48. The Office Action also has not shown that one of ordinary skill in the art would have made the proposed combination. The Office Action proposes a modification to the VocalChat References by incorporating the teachings of RFC 1531 because it allegedly “would have been obvious to utilize dynamically assigned IP addresses from Internet access servers in the invention taught by VocalChat ... since this allows for automatic reuse of an address that is no longer needed by the host to which it is assigned.” Such an allegation ignores the development history of the VocalChat products themselves.

49. The Request cites a Generic version of the VocalChat client which, according to Mr. Cohen, was used on local area networks. See Cohen Declaration, paragraph 3. There apparently was a subsequent version of VocalChat that was also released by VocalTec to the public in 1994, at least in beta. This version, called VocalChat Gateway To Interent (or “VocalChat GTI”) was designed for use on the Internet, and I have been informed that Net2Phone believes that VocalChat GTI used static local address files into which static callee addresses were manually

Re-Examination of Patent No. 6,009,469
Control No.: 90/010,422
Filed: February 24, 2009
Declaration of Ketan Mayer-Patel under 37 C.F.R. 1.132

input. I have also been informed that Net2Phone believes that VocalChat GTI did not utilize a server at all.

50. Based on the above, I believe the use of manual inputting of static addresses and the absence of a server suggests that the VocalTec designers—presumably software developers of at least ordinary skill in the art—did not consider the alleged combination of their own VocalChat references with RFC 1531, or it suggests that they did consider it but were unable to overcome the non-trivial obstacles to doing so.

51. I have also been informed that Net2Phone believes that soon after the release of the VocalChat GTI version, VocalTec released another VocalChat version that used Internet Relay Chat (IRC) to help VocalChat clients with dynamically assigned IP addresses find one another. This change from VocalChat GTI to VocalChat IRC appears to be further objective evidence that even the VocalChat designers recognized that the “improvement” to the Generic VocalChat implementation was still deficient. If the designers of the VocalChat Generic implementation did not see fit to combine dynamic addressing with the Generic implementation disclosed in the VocalChat references, then I do not believe that one of ordinary skill in the art would not have done so either.

52. Accordingly, I do not believe that the Office Action has shown that claim 1 is rendered obvious by the combination of the VocalChat references and RFC 1531. Since claim 1 is not rendered obvious by the proposed combination, claims 2-3 are not rendered obvious as well.

53. With respect to claim 3, claim 3 further recites “program code for transmitting, from the first process to the server process, a query as to whether the second process is connected to the computer network.” As is discussed in greater detail below with respect to claim 8, the VocalChat references do not disclose querying whether processes are connected to the computer network. Thus, claim 3 is also separately patentable from claim 1.

Re-Examination of Patent No. 6,009,469
Control No.: 90/010,422
Filed: February 24, 2009
Declaration of Ketan Mayer-Patel under 37 C.F.R. 1.132

Claims 5 and 6

54. Claim 5 recites “A. determining the currently assigned network protocol address of the first process upon connection to the computer network” and “C. forwarding the assigned network protocol address of the first process to the server process upon establishing a communication connection with the server process.” As was discussed above with respect to claim 1, the combination of the VocalChat references and RFC 1531 does not disclose either of those elements. Thus, I believe claim 5 and its dependent claim 6 are not rendered obvious by the combination of the VocalChat references and RFC 1531.

Claims 8, 9 and 14-18

55. Claim 8 recites “C. querying the server process to determine if the first callee process is accessible.” The Office Action cites the Help file, pgs. 2 and 26, and Network information, page 10, and asserts that “a server can receive[] queries to determine status and information of users.” However, the Office Action has not identified what portion of those references teach the claimed “querying.” At best, the references teach that a local process reads a “USERS” file or a Connections file. As can be seen from page 4 of the VocalChat Network Information (reproduced below), when the VocalChat system uses the Generic mode, a USERS file is used.

Re-Examination of Patent No. 6,009,469
Control No.: 90/010,422
Filed: February 24, 2009
Declaration of Ketan Mayer-Patel under 37 C.F.R. 1.132

2.5. Network parameters in the VocalChat INI files

These are the network parameters in the VocalChat VOCLCHAT.INI and VCSETUP.INI files (under the NetWork section):

```
[NetWork]
NetWork-           / description of the selected network
NetWorkUsers=     / user services: NetWare / WinWorkgroups / Generic*
NetWorkProtocol=  / network protocol: IPX / NetBIOS
NetWorkType=      / name of the selected network, for future use
UsersFile=        / path name of users file (when Generic is set)
MyUserName=       / the name of the user (when Generic is set)**
```

* When Generic is set, a USERS file is used.

** This line appears only in the VOCALCHAT.INI file of each user.

The VOCLCHAT.INI files are in the windows directory of each user. The VCSETUP.INI file is in the VOCLCHAT directory, where VocalChat was installed, and is used only to supply default values for the different installations.

The USERS file configuration parameter includes a "UsersFile" entry that specifies the "path name of users file (when Generic is set)." However, it is also stated that "The VOCLCHAT.INI files are in the windows directory of each user." Thus, this "UsersFile" entry is a local configuration parameter such that the local VocalChat client reads and writes the USERS file on its own -- without performing the claimed query.

56. Similarly, page 8 of the VocalChat Help file states "If your network type is not NetWare or Windows for Workgroups, the Setup program creates a Connection List file which is used to identify and access users." The Connection List file and the USERS file apparently have the same function. Thus, the identification and access enabled by the Connection List is performed by the local client reading and writing the file itself -- without performing the claimed query. Accordingly, I do not believe that claims 8, 9 and 14-18 are obvious over the applied combination of references.

Re-Examination of Patent No. 6,009,469
Control No.: 90/010,422
Filed: February 24, 2009
Declaration of Ketan Mayer-Patel under 37 C.F.R. 1.132

57. I hereby declare that all statements made herein of my own knowledge are true and that all statements made on information and belief are believed to be true; and further that these statements were made with the knowledge that willful false statements and the like so made are punishable by fine or imprisonment, or both, under Section 1001 of Title 18 of the United States Code and that such willful false statements may jeopardize the validity of the application or any patent issued thereon.

Dated: November 25, 2009



Ketan Mayer-Patel, Ph.D.

EXHIBIT 1 TO MAYER-PATEL DECLARATION

Ketan Mayer-Patel

154 Fred Brooks Building
Department of Computer Science, CB #3175
University of North Carolina, Chapel Hill

kmp@cs.unc.edu
<http://www.cs.unc.edu/~kmp>

Education

- Ph.D. University of California, Berkeley, 1999
Parallel Software-only Video Effects Processing
- M.S. University of California, Berkeley, 1997
Design and Performance of the Berkeley Continuous Media Toolkit
- B.A. University of California, Berkeley, 1992
Majors: Computer Science and Economics

Professional Experience

- Associate Professor
University of North Carolina, Chapel Hill, NC (August 2005 – present)
- Assistant Professor
University of North Carolina, Chapel Hill, NC. (January 2000 – August 2005)
- Visiting Researcher
Microsoft Bay Area Research Center (BARC), San Francisco, CA. (June 2003 – December 2003)
- Graduate Student Researcher
University of California, Berkeley, CA. (June 1993 – November 1999)
- Graduate Student Instructor
University of California, Berkeley, CA. (August 1997 – December 1997)
- Programmer
University of California, Berkeley, CA. (June 1992 – June 1993)
- Programmer
United States Department of Agriculture, Albany, CA. (May 1991 – June 1992)

Honors and Notables

- National Science Foundation CAREER Award, 2003
- Computer Science Student Association Teaching Award, 2003
- Invited to three major meetings (one domestic and two international) of top multimedia researchers to discuss future directions for the field.
- In the sixteen-year history of the ACM SIGMultimedia Conference, considered to be the premier conference in the field of multimedia, I have published twelve papers in ten different years.

Publications

Refereed Journals

- K. Mayer-Patel and D. Gotz, "Scalable, Adaptive Streaming for Nonlinear Media," *IEEE Multimedia*, vol. 14, no. 3 (15 pages).

- D. Ott and K. Mayer-Patel, "An open architecture for transport-level protocol coordination for distributed multimedia applications," *ACM Transactions on Multimedia Computing, Communications, and Applications*, vol. 3, no. 3 (22 pages).
- D. Gotz and K. Mayer-Patel, "GAL: A middleware library for multidimensional adaptation," under review for *ACM Transactions on Multimedia Computing, Communications, and Applications* (21 pages).
- K. Mayer-Patel, B. Smith, and L.A. Rowe, "The Berkeley software MPEG-1 video decoder," to appear in *ACM Transactions on Multimedia Computing, Communications, and Applications*, vol. 1, no. 1 (23 pages).
- K. Mayer-Patel and S.-U. Kum, "Real-time multi depth stream compression," *ACM Transactions on Multimedia Computing, Communications, and Applications*, vol. 1, no. 2 (26 pages).
- D. Gotz and K. Mayer-Patel, "A Framework for Scalable Delivery of Digitized Spaces," *International Journal on Digital Libraries*, vol. 5, no. 3 (14 pages).
- J. Considine, K. Mayer-Patel, and J. Byers, "A case for testbed embedding services," *Computer Communication Review*, vol. 34, no. 1, January 2004, pp. 137-142.

Refereed Conferences and Workshops

- K. Mayer-Patel, "Systems challenges of media collectives: Supporting media collectives with adaptive MDC," *Proceedings of the 15th International ACM Conference on Multimedia*, Augsburg, Germany, 2007, pp. 625-630.
- S. Krishnan and K. Mayer-Patel, "A utility-driven framework for loss and encoding aware video adaptation," *Proceedings of the 15th International ACM Conference on Multimedia*, Augsburg, Germany, 2007, pp. 1026-1035.
- D. Gotz and K. Mayer-Patel, "A general framework for multidimensional adaptation," *Proceedings of the 12th International ACM Conference on Multimedia*, New York, 2004, pp 612-619.
- D. Ott and K. Mayer-Patel, "Coordinated multi-streaming for 3D tele-immersion," *Proceedings of the 12th International ACM Conference on Multimedia*, New York, NY, 2004, pp. 596-603.
- D. Ott and K. Mayer-Patel, "Aggregate congestion control for distributed multimedia applications," *Proceedings of IEEE Infocom '04*, Hong Kong, 7-11 March 2004, vol. 1, pp. 13-23.

- K. Mayer-Patel and W. Miaw, "Evaluating the effectiveness of automatic PVR management," *Proceedings of the SPIE Conference on Storage and Retrieval Methods and Applications for Multimedia*, San Jose, CA, January 2004, vol. 5307, pp. 360-365.
- S.-U. Kum, K. Mayer-Patel and H. Fuchs, "Real-time compression for dynamic 3D environments," *Proceedings of the 11th International ACM Conference on Multimedia*, Berkeley, CA, 2003, pp. 185-194.
- N. Kelshikar, X. Zabulis, J. Mulligan, K. Daniilidis, V. Sawant, S. Sinha, T. Sparks, S. Larsen, H. Towles, K. Mayer-Patel, H. Fuchs, J. Urbanic, K. Benninger, R. Reddy and G. Huntoon, "Real-time terascale implementation of tele-immersion," *Proceedings of the International Conference on Computation Science*, Melbourne, Australia, 2003, Springer-Verlag Lecture Notes in Computer Science vol. 2660, pp. 33-42.
- K. Mayer-Patel, L. Le and G. Carle, "An MPEG performance model and its application to adaptive forward error correction," *Proceedings of the 10th International ACM Conference on Multimedia*, Juan-les-Prins, France, 2002, pp. 1-10.
- D. Gotz and K. Mayer-Patel, "IRW: an incremental representation for image-based walkthroughs," *Proceedings of the 10th International ACM Conference on Multimedia*, Juan-les-Prins, France, 2002, pp. 67-76.
- D. Ott and K. Mayer-Patel, "A mechanism for TCP-friendly transport-level protocol coordination," *Proceedings of the USENIX Technical Conference*, Monterrey, CA, 2002 (14 pages).
- A. Wilson, K. Mayer-Patel and D. Manocha, "Spatially-encoded far-field representations for interactive walkthroughs," *Proceedings of the 9th International ACM Conference on Multimedia*, Ottawa, Canada, 2001, pp. 348-357.
- D. Ott and K. Mayer-Patel, "Transport-level protocol coordination in cluster-to-cluster applications," *Proceedings of the 8th International Workshop on Interactive Distributed Multimedia Systems (Lecture Notes in Computer Science)*, vol. 2158, Springer, 2001, pp. 10-22.
- D. Yu, D. Wu, K. Mayer-Patel and L.A. Rowe, "dc: a live webcast control system," *Proceedings of the SPIE Conference on Multimedia Computing and Networking*, vol. 4312, San Jose, CA, 2001, pp. 111-122.
- K. Mayer-Patel, "Incorporating application-level knowledge into the MPEG-2 coding model," *Proceedings of the Workshop on Network and Operating System Support for Digital Audio and Video (NOSSDAV)*, Chapel Hill, CA, 2000, (6 pages).
- K. Mayer-Patel and L.A. Rowe, "Exploiting spatial parallelism for software-only video effects processing," *Proceedings of the SPIE Conference on Multimedia Computing and Networking*, vol. 3654, San Jose, CA, 1999, pp. 252-263.

- K. Mayer-Patel and L.A. Rowe, "A multicast control scheme for parallel software-only video effects processing," *Proceedings of the 7th International ACM Conference on Multimedia*, Orlando, FL, 1999, pp. 409-418.
- K. Mayer-Patel and L.A. Rowe, "Exploiting temporal parallelism for software-only video effects processing," *Proceedings of the 6th International ACM Conference on Multimedia*, Bristol, England, 1998, pp. 161-169.
- T.H. Wong, K. Mayer-Patel and L.A. Rowe, "A software-only video production switcher for the Internet Mbone," *Proceedings of the SPIE conference on Multimedia Computing and Networking*, vol. 3310, San Jose, CA, 1998, pp. 28-41.
- K. Mayer-Patel and L.A. Rowe, "Design and performance of the Berkeley Continuous Media Toolkit," *Proceedings of the SPIE conference on Multimedia Computing and Networking*, vol. 3020, San Jose, CA, 1997, pp. 194-206.
- K. Mayer-Patel, D. Simpson, D. Wu, and L.A. Rowe, "Synchronized continuous media playback through the World Wide Web," *Proceedings of the 4th International ACM Conference on Multimedia*, Boston, MA, 1997, pp. 435-436.
- L.A. Rowe, K. Patel, and B. Smith, "MPEG video in software: representation, transmission, and playback," *Proceedings of the SPIE conference on High-Speed Networking and Multimedia Computing*, vol. 2188, San Jose, CA, 1994, pp. 134-144.
- K. Patel, B. Smith, and L.A. Rowe, "Performance of a software MPEG video decoder," *Proceedings of the 1st International ACM Conference on Multimedia*, Los Angeles, CA, 1993, pp. 75-82.

Software Artifacts

mpeg_play

The first publicly available MPEG-1 video decoder originally released in 1993. Over 1,000,000 copies of this program have been downloaded. It has been used as a code base for innumerable research and open source systems. Mayer-Patel was the architect of the original code that was later refactored and maintained by a number of other individuals.

The Berkeley Continuous Media Toolkit

The Berkeley CMT provided a framework within which to develop experimental multimedia tools and applications. Although primarily used by researchers at UC Berkeley, it was employed by a number of different research groups world-wide. Development of CMT ended in approximately 1998.

MPEG2Event

This recently released C# library allows researchers to rapidly develop MPEG-2 analysis tools that are interested in the details of bit-level coding elements. Although currently in use

by only a small number of researchers, it is freely available at <http://www.cs.unc.edu/~kmp/mpeg2event>. Further development of the library is on-going.

Teaching

COMP 416: Introduction to Web Programming

My goal with this course is to pique student interest for more detailed upper-division courses in operating systems, networking, databases, security, etc. while satisfying their practical interest in developing web programming skills.

COMP 426: Advanced Web Programming

A follow-on course to COMP 416, this course expands on client-server programming concepts and concentrates more attention to the design and use of databases and XML-related technologies.

COMP 249: Multimedia Computing and Networking

This course is an advanced graduate-level course that covers the fundamental concepts in multimedia computing and networking. Students are expected to complete an extensive final project, some of which have led to publications in refereed conferences and workshops.

COMP 249-080: Topics in Multimedia Systems

This seminar course provides students with an opportunity to read and present the most research literature in multimedia systems.

Research Areas

Coordinated Multistreaming

In this project, we are developing mechanisms to address the needs of distributed multimedia applications that employ many (i.e., 10's or 100's) of different media flows with complex inter-stream semantics and adaptation requirements. This project addresses fundamental problems in protocol coordination and aggregate congestion control.

Multidimensional Adaptation

We are developing a framework for compactly expressing and evaluating adaptation policies that must negotiate tradeoffs in real-time within very large multiresolutional datasets with high dimensionality.

StrandCast

StrandCast is an application-layer multicast protocol intended for latency-insensitive multimedia applications such as receiver-driven layered multicast and pyramid broadcasting. The design and implementation of StrandCast exploits the lax latency requirements of these applications to optimize for link stress, rapid joins and leaves, and robustness in the face of node failure.

Encoding and Transmission of 3D Scenes from Multiple Cameras

The project explores ways to efficiently transmit video data from a set of cameras viewing the same scene. This problem is at the heart of most tele-immersion applications. Our hypothesis is that it is possible to exploit depth information (even if imperfect) derived from stereo correlation between cameras to more efficiently encode the original color information.

Recoverable Video Adaptation

Existing video adaptation techniques generally lead to irreversibly loss of video quality. In this project, we are exploring adaptation techniques that can be used to recover high (or at least higher) quality video from a set of independently constructed lower quality representations.

Funding

CAREER: Enabling Futuristic Distributed Applications with Integrative Multistream Networking

PI's: K. Mayer-Patel
Agency: National Science Foundation (ANI-0238260)
Amount: \$404,387
Duration: 8/15/2003 – 8/14/2008

ITR: Protocol Coordination for Multi-Stream Applications

PI's: K. Mayer-Patel
Agency: National Science Foundation (ANI-0219780)
Amount: \$368,047
Duration: 10/1/2002 – 9/30/2005

RI: Tera-Pixels - Using High-Resolution Pervasive Displays to Transform Collaboration and Teaching

PI's: K. Jeffay, A. Lastra, F.D. Smith, K. Mayer-Patel and L. McMillan
Agency: National Science Foundation (EIA-0303590)
Amount: \$590,986
Duration: 8/15/2003 – 8/14/2008

3D Telepresence for Medical Consultation: Extending Medical Expertise Throughout, Between, and Beyond Hospitals

PI's: H. Fuchs, B. Cairns, K. Mayer-Patel, D. Sonnenwald, G. Welch
Agency: National Library of Medicine
Amount: \$2,549,980
Duration: 09/30/2003-09/29/2006

Video-Based Representation and Rendering of Large Real and Synthetic Environments

PI's: D. Manocha and K. Mayer-Patel
Agency: Office of Naval Research
Amount: \$112,384
Duration: 01/01/2001-12/31/2003

Video Quality Metric Oracle

PI's: K. Mayer-Patel
Agency: North Carolina Networking Initiative Fellowship Program
Amount: \$20,000
Duration: 08/15/2001 – 5/15/2002

SCOUT: An On-Line Network Path Measurement and Characterization Tool

PI's: K. Mayer-Patel
Agency: North Carolina Networking Initiative Fellowship Program
Amount: \$20,000
Duration: 08/15/2000 – 5/15/2001

Professional Activities

Editorships

- Associate Editor, ACM Transactions on Multimedia Communications, Computing, and Applications (TOMCCAP)
- Associate Editor, IEEE Multimedia Magazine

Executive Committees

- Co-Chair, International Workshop on Network and Operating System Support for Digital Audio and Video (NOSSDAV)

Organizing Committees

- Program Chair, ACM Multimedia Systems 2010
- General Co-Chair, Multimedia Networking and Computing 2009
- Program Co-Chair, Multimedia Modeling (MMM) 2009
- General Co-Chair, NOSSDAV 2005
- Program Co-Chair, ACM Multimedia, 2006
- Open Source Software Competition Chair, ACM Multimedia (2004, 2005)
- Tutorial Program Chair, ACM Multimedia (2003)
- Doctoral Symposium Chair, ACM Multimedia (2000, 2001)

Program Committees

- ACM Multimedia
- NOSSDAV
- Multimedia Computing and Networking (MMCN)
- Multimedia Interactive Protocols and Systems Workshop
- IFIP Networking Conference
- Multimedia Information Systems Conference
- International World Wide Web Conference
- SPIE Conference on Multimedia Computing and Networking
- IEEE International Conference on Distributed Computing Systems
- Interactive Distributed Multimedia Systems Workshop
- Global Internet Symposium

Other Professional Service

- Guest Editor, Special Issue of Multimedia Systems Journal featuring expanded papers from the SPIE Conference on Multimedia Computing and Networking, 2003.
- In 2004, participated in a by invitation-only meeting of leaders within ACM SIGMultimedia. A report of the meeting outlining important directions for multimedia research will appear in Transactions on Multimedia Computing, Communications, and Applications.
- Invited to an international meeting of leading multimedia researchers being organized for Spring 2005 in Dagstuhl, Germany to discuss the future of multimedia research.

Past Ph.D. Students

- David Gotz, *Supporting adaptive scalable access to multiresolutional multidimensional data*, May 2005.
- David Ott, *Coordination mechanisms for distributed multistream applications*, November 2005.
- Sang-Uok Kum, *Encoding and transmission of 3D depth streams*, November 2008.

University Service

University Committees

- Tar Heel Bus Tour Advisory Committee (Fall 2001).

Department Service

- Chair of Undergraduate Curriculum Committee (Fall 2009 – present).
- Chair of Graduate Admissions Committee (Spring 2005 – Fall 2009).
- Member of Graduate Admissions Committee (Spring 2001 – Spring 2005).

Other Service

- Project UPLIFT participant (recruitment of minority high school students)
- Co-coach of the UNC ACM Programming Competition team (Fall 2000 – present).

EXHIBIT 2 TO MAYER-PATEL DECLARATION



YOUR FREE WEBSITE

Free Flash Website
Free Website Builder
Free Web Design

Web Building

- Web HOME
- Web Building
- Web Design
- Web Users
- Web Standards
- Web Validation
- Web W3C
- Web Security
- Web Glossary
- Web Search

Web Building Security

[« Previous](#)

[Next Chapter »](#)

You are offering your IP address to the entire world at this very moment.

Make sure you are not offering access to your private data at the same time.

YOUR IP ADDRESS IS PUBLIC

Accessing the Internet is a security risk.

When you are connected to the Internet, an IP address is used to identify your computer. If you don't protect yourself, this IP address can be used to access your computer from the outside world.

A fixed IP address is a larger security risk.

If you're using a modem with a dial-up connection, you will get a new IP address every time you connect to Internet.

With an ADSL or cable connection users sometimes keep the same IP address for several months, this represents an increased security risk.

If you have a fixed IP address, you give Internet hackers all the time they need to search for entrances on your computer, and to store and share (with other hackers) information they find on your computer.

Your Network Shares

Personal computers are often connected to a shared network. Personal computers in large companies are connected to large corporate networks. Personal computers in small companies are connected to a small local network, and computers in private homes often share a network between family members.

Most often networks are used to share resources like printers, files and disk storage.

When you are connected to the Internet, your shared resources can be accessed by the rest of the world.

A Common Windows Security Problem

Unfortunately, many Microsoft Windows users are unaware of a common security leak in their network settings.

This is a common setup for network computers in Microsoft Windows:

- Client for Microsoft Networks
- File and Printer Sharing for Microsoft Networks
- NetBEUI Protocol
- Internet Protocol TCP/IP

If your setup allows NetBIOS over TCP/IP, you have a security problem:

- Your files can be shared all over the Internet
- Your logon-name, computer-name, and workgroup-name are visible to others

If your setup allows File and Printer Sharing over TCP/IP, you also have a problem:

- Your files can be shared all over the Internet

Computers that are not connected to any network can also have insecure network settings, because the settings were changed when Internet was installed.

Solving the Problem

For Windows 2000 users:

You can solve your security problem by **disabling NetBIOS over TCP/IP**:

- Open Windows Explorer
- Right-click on My Network Places
- Select: Properties
- Right-click on Local Area Network
- Select: Properties

WEB HOSTING

- Best Web Hosting
- PHP MySQL Hosting
- Top 10 Web Hosting
- UK Reseller Hosting
- Web Hosting
- FREE Web Hosting
- Top Web Hosting
- Windows Hosting

WEB BUILDING

- Download XML Editor
- FREE Flash Website
- FREE Web Templates
- Website Monetization

FLIGHT TICKETS

Find the cheapest flight to any destination now!

EDUCATION

- US Web Design Schools
- HTML Certification
- JavaScript Certification
- XML Certification
- PHP Certification
- ASP Certification

STATISTICS

- Browser Statistics
- Browser OS
- Browser Display

- Select: Internet Protocol TCP/IP
- Click on Properties
- Click on Advanced
- Select the WINS tab
- Select: Disable NetBIOS over TCP/IP
- Click OK

If you get the message: "This connection has an empty.....", ignore the message and click on YES to continue, and click OK to close the other setup windows.

You should restart your computer after the changes.

For Windows 95, 98, or ME users:

You can solve your security problem by **disabling NetBIOS over TCP/IP**:

- Open Windows Explorer
- Right-click on My Network Places
- Select: Properties
- Select: Internet Protocol TCP/IP
- Click on Properties
- Select the NetBIOS tab
- Uncheck: Enable NetBIOS over TCP/IP
- Click OK

You must also **disable the TCP/IP Bindings** to Client for Microsoft Networks and File and Printer Sharing:

- Open Windows Explorer
- Right-click on My Network Places
- Select: Properties
- Select: Internet Protocol TCP/IP
- Click on Properties
- Select the Bindings tab
- Uncheck: Client for Microsoft Networks
- Uncheck: File and Printer Sharing
- Click OK

If you get a message with something like: "You must select a driver.....", ignore the message and click on YES to continue, and click OK to close the other setup windows.

If you still want to **share your Files and Printer** over the network, you must use the NetBEUI protocol instead of the TCP/IP protocol. Make sure you have enabled it for your local network:

- Open Windows Explorer
- Right-click on My Network Places
- Select: Properties
- Select: NetBEUI
- Click on Properties
- Select the Bindings tab
- Check: Client for Microsoft Networks
- Check: File and Printer Sharing
- Click OK

You should restart your computer after the changes.

Protect Your Server

iisPROTECT provides a complete range of password protection, authentication and user management solutions:

iisPROTECTasp: Protect areas of your web site and require username and password. Grant/deny any users/groups on a per resource basis. Extensive Web Interface for user/group admin, use any DB backend, store custom data, set user start/end dates, email users, audit logins.

iisPROTECT: Protect all web site files including images, databases,html,ASP etc. Protect entire directories, users / groups independent from Windows accounts, complete web administration, does not require cookies or any programming. Complete turn key solution.

iisPROTECTquota: All of the features of iisPROTECT plus: prevent concurrent logins and password cracking attempts, set quotas on hits, logins, kb per user.

[Read more about iisPROTECT](#)

[« Previous](#)

[Next Chapter »](#)

Product Spotlight

[Web 2.0 Code Generation is Here!](#)

Generate data entry and reporting .NET Web apps in minutes. Quickly create visually stunning, feature-rich apps that are easy to customize and ready to deploy. [Download Now!](#)

1,050,724 Sites built with Wix. Make your own!

[Click here](#) to design a Stunning Flash Website for Free

Wix is a revolutionary web design tool that provides anyone with the possibility to create professional and beautiful websites for free.

With e-commerce features, search engine visibility and many more professional tools, Wix is the ultimate solution for creating a spectacular site while saving tons of money.

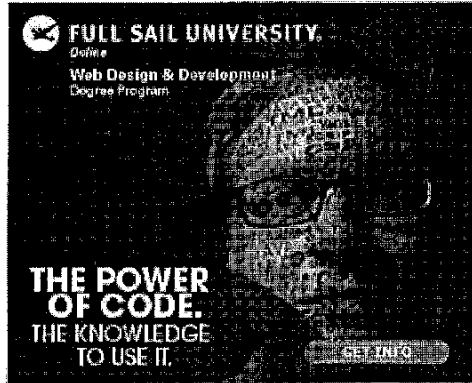

www.FullSail.edu

Art by Gonda

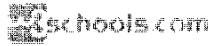

HOME | TOP | PRINT | FORUM | ABOUT

W3Schools is for training only. We do not warrant the correctness of its content. The risk from using it lies entirely with the user. While using this site, you agree to have read and accepted our terms of use and privacy policy. Copyright 1999-2009 by Refsnes Data. All Rights Reserved.

Control No. 90/010,422
Re-examination of U.S. Patent No. 6,009,469

(x). RELATED PROCEEDINGS APPENDIX

No related proceedings.

Electronic Patent Application Fee Transmittal

Application Number:	90010422
Filing Date:	26-Feb-2009
Title of Invention:	Graphic User Interface For Internet Telephony Application
First Named Inventor/Applicant Name:	6,009,469
Filer:	Michael R. Casey
Attorney Docket Number:	2655-0185

Filed as Large Entity

ex parte reexam Filing Fees

Description	Fee Code	Quantity	Amount	Sub-Total in USD(\$)
Basic Filing:				
Pages:				
Claims:				
Miscellaneous-Filing:				
Petition:				
Patent-Appeals-and-Interference:				
Filing a brief in support of an appeal	1402	1	540	540

Post-Allowance-and-Post-Issuance:

Extension-of-Time:

Description	Fee Code	Quantity	Amount	Sub-Total in USD(\$)
Miscellaneous:				
Total in USD (\$)				540

Electronic Acknowledgement Receipt

EFS ID:	8809507
Application Number:	90010422
International Application Number:	
Confirmation Number:	6565
Title of Invention:	Graphic User Interface For Internet Telephony Application
First Named Inventor/Applicant Name:	6,009,469
Customer Number:	42624
Filer:	Michael R. Casey
Filer Authorized By:	
Attorney Docket Number:	2655-0185
Receipt Date:	10-NOV-2010
Filing Date:	26-FEB-2009
Time Stamp:	15:07:14
Application Type:	Reexam (Third Party)

Payment information:

Submitted with Payment	yes
Payment Type	Deposit Account
Payment was successfully received in RAM	\$540
RAM confirmation Number	1409
Deposit Account	501860
Authorized User	

The Director of the USPTO is hereby authorized to charge indicated fees and credit any overpayment as follows:

Charge any Additional Fees required under 37 C.F.R. Section 1.16 (National application filing, search, and examination fees)

Charge any Additional Fees required under 37 C.F.R. Section 1.17 (Patent application and examination processing fees)

LG v. Straight Path, IP2015-00198

Charge any Additional Fees required under 37 C.F.R. Section 1.19 (Document supply fees)

Charge any Additional Fees required under 37 C.F.R. Section 1.20 (Post Issuance fees)

Charge any Additional Fees required under 37 C.F.R. Section 1.21 (Miscellaneous fees and charges)

File Listing:

Document Number	Document Description	File Name	File Size(Bytes)/ Message Digest	Multi Part /.zip	Pages (if appl.)
1	Reexam Certificate of Service	20101110_appeal_brief_COS.pdf	57211 7a5e80b833ca96bcd745d4b67cd54e64540d1e25	no	1

Warnings:

Information:

2	Appeal Brief Filed	20101110_appeal_brief.pdf	2180801 1dc1cd6a6cfecec42e073ce8f75bf9779d736f09	no	71
---	--------------------	---------------------------	---	----	----

Warnings:

Information:

3	Fee Worksheet (PTO-875)	fee-info.pdf	29450 a7aabb2cf9843744f39aa3766c5c93db007b482d	no	2
---	-------------------------	--------------	---	----	---

Warnings:

Information:

Total Files Size (in bytes):

2267462

This Acknowledgement Receipt evidences receipt on the noted date by the USPTO of the indicated documents, characterized by the applicant, and including page counts, where applicable. It serves as evidence of receipt similar to a Post Card, as described in MPEP 503.

New Applications Under 35 U.S.C. 111

If a new application is being filed and the application includes the necessary components for a filing date (see 37 CFR 1.53(b)-(d) and MPEP 506), a Filing Receipt (37 CFR 1.54) will be issued in due course and the date shown on this Acknowledgement Receipt will establish the filing date of the application.

National Stage of an International Application under 35 U.S.C. 371

If a timely submission to enter the national stage of an international application is compliant with the conditions of 35 U.S.C. 371 and other applicable requirements a Form PCT/DO/EO/903 indicating acceptance of the application as a national stage submission under 35 U.S.C. 371 will be issued in addition to the Filing Receipt, in due course.

New International Application Filed with the USPTO as a Receiving Office

If a new international application is being filed and the international application includes the necessary components for an international filing date (see PCT Article 11 and MPEP 1810), a Notification of the International Application Number and of the International Filing Date (Form PCT/RO/105) will be issued in due course, subject to prescriptions concerning national security, and the date shown on this Acknowledgement Receipt will establish the international filing date of the application.

CERTIFICATE OF SERVICE

The undersigned hereby certifies that, on November 10, 2010, the APPEAL BRIEF filed in Re-examination Control No. 90/010,422 was served by U.S. First Class Mail, postage pre-paid, on Requestor as follows:

Blakely, Sokoloff, Taylor & Zafman LLP
1279 Oakmead Parkway
Sunnyvale, CA 94085-4040

/ Michael R. Casey /

Michael R. Casey, Ph.D.

Under the Paperwork Reduction Act of 1995, no persons are required to respond to a collection of information unless it displays a valid OMB control number.

NOTICE OF APPEAL FROM THE EXAMINER TO THE BOARD OF PATENT APPEALS AND INTERFERENCES		Docket Number (Optional) 2655-0185	
I hereby certify that this correspondence is being facsimile transmitted to the USPTO or deposited with the United States Postal Service with sufficient postage as first class mail in an envelope addressed to "Commissioner for Patents, P.O. Box 1450, Alexandria, VA 22313-1450" [37 CFR 1.8(a)] on _____ Signature _____ Typed or printed name _____		In re Application of U.S. Patent No. 6,009,469	
		Application Number 90/010,422	Filed 02-26-2009
		For Art Unit 3992	

Applicant hereby **appeals** to the Board of Patent Appeals and Interferences from the last decision of the examiner.The fee for this Notice of Appeal is (37 CFR 41.20(b)(1)) \$ 540

- Applicant claims small entity status. See 37 CFR 1.27. Therefore, the fee shown above is reduced by half, and the resulting fee is: \$ _____
- A check in the amount of the fee is enclosed.
- Payment by credit card. Form PTO-2038 is attached.
- The Director has already been authorized to charge fees in this application to a Deposit Account.
- The Director is hereby authorized to charge any fees which may be required, or credit any overpayment to Deposit Account No. 501860.
- A petition for an extension of time under 37 CFR 1.136(a) (PTO/SB/22) is enclosed.

WARNING: Information on this form may become public. Credit card information should not be included on this form. Provide credit card information and authorization on PTO-2038.

I am the

- applicant/inventor. _____ / Michael R. Casey /
Signature
- assignee of record of the entire interest.
See 37 CFR 3.71. Statement under 37 CFR 3.73(b) is enclosed.
(Form PTO/SB/96) _____ Michael R. Casey
Typed or printed name
- attorney or agent of record. _____ 40,294 _____ 703-894-6406
Registration number Telephone number
- attorney or agent acting under 37 CFR 1.34.
Registration number if acting under 37 CFR 1.34. _____ 09/09/2010
Date

NOTE: Signatures of all the inventors or assignees of record of the entire interest or their representative(s) are required.
Submit multiple forms if more than one signature is required, see below*.

- *Total of _____ forms are submitted.

This collection of information is required by 37 CFR 41.31. The information is required to obtain or retain a benefit by the public which is to file (and by the USPTO to process) an application. Confidentiality is governed by 35 U.S.C. 122 and 37 CFR 1.11, 1.14 and 41.6. This collection is estimated to take 12 minutes to complete, including gathering, preparing, and submitting the completed application form to the USPTO. Time will vary depending upon the individual case. Any comments on the amount of time you require to complete this form and/or suggestions for reducing this burden, should be sent to the Chief Information Officer, U.S. Patent and Trademark Office, U.S. Department of Commerce, P.O. Box 1450, Alexandria, VA 22313-1450. DO NOT SEND FEES OR COMPLETED FORMS TO THIS ADDRESS. **SEND TO: Commissioner for Patents, P.O. Box 1450, Alexandria, VA 22313-1450.**

If you need assistance in completing the form, call 1-800-PTO-9199 and select option 2.

Privacy Act Statement

The **Privacy Act of 1974 (P.L. 93-579)** requires that you be given certain information in connection with your submission of the attached form related to a patent application or patent. Accordingly, pursuant to the requirements of the Act, please be advised that: (1) the general authority for the collection of this information is 35 U.S.C. 2(b)(2); (2) furnishing of the information solicited is voluntary; and (3) the principal purpose for which the information is used by the U.S. Patent and Trademark Office is to process and/or examine your submission related to a patent application or patent. If you do not furnish the requested information, the U.S. Patent and Trademark Office may not be able to process and/or examine your submission, which may result in termination of proceedings or abandonment of the application or expiration of the patent.

The information provided by you in this form will be subject to the following routine uses:

1. The information on this form will be treated confidentially to the extent allowed under the Freedom of Information Act (5 U.S.C. 552) and the Privacy Act (5 U.S.C. 552a). Records from this system of records may be disclosed to the Department of Justice to determine whether disclosure of these records is required by the Freedom of Information Act.
2. A record from this system of records may be disclosed, as a routine use, in the course of presenting evidence to a court, magistrate, or administrative tribunal, including disclosures to opposing counsel in the course of settlement negotiations.
3. A record in this system of records may be disclosed, as a routine use, to a Member of Congress submitting a request involving an individual, to whom the record pertains, when the individual has requested assistance from the Member with respect to the subject matter of the record.
4. A record in this system of records may be disclosed, as a routine use, to a contractor of the Agency having need for the information in order to perform a contract. Recipients of information shall be required to comply with the requirements of the Privacy Act of 1974, as amended, pursuant to 5 U.S.C. 552a(m).
5. A record related to an International Application filed under the Patent Cooperation Treaty in this system of records may be disclosed, as a routine use, to the International Bureau of the World Intellectual Property Organization, pursuant to the Patent Cooperation Treaty.
6. A record in this system of records may be disclosed, as a routine use, to another federal agency for purposes of National Security review (35 U.S.C. 181) and for review pursuant to the Atomic Energy Act (42 U.S.C. 218(c)).
7. A record from this system of records may be disclosed, as a routine use, to the Administrator, General Services, or his/her designee, during an inspection of records conducted by GSA as part of that agency's responsibility to recommend improvements in records management practices and programs, under authority of 44 U.S.C. 2904 and 2906. Such disclosure shall be made in accordance with the GSA regulations governing inspection of records for this purpose, and any other relevant (*i.e.*, GSA or Commerce) directive. Such disclosure shall not be used to make determinations about individuals.
8. A record from this system of records may be disclosed, as a routine use, to the public after either publication of the application pursuant to 35 U.S.C. 122(b) or issuance of a patent pursuant to 35 U.S.C. 151. Further, a record may be disclosed, subject to the limitations of 37 CFR 1.14, as a routine use, to the public if the record was filed in an application which became abandoned or in which the proceedings were terminated and which application is referenced by either a published application, an application open to public inspection or an issued patent.
9. A record from this system of records may be disclosed, as a routine use, to a Federal, State, or local law enforcement agency, if the USPTO becomes aware of a violation or potential violation of law or regulation.

CERTIFICATE OF SERVICE

The undersigned hereby certifies that, on September 10, 2010, the Notice of Appeal filed in Re-examination Control No. 90/010,422 was served by U.S. First Class Mail, postage pre-paid, on Requestor as follows:

Blakely, Sokoloff, Taylor & Zafman LLP
1279 Oakmead Parkway
Sunnyvale, CA 94085-4040

/ Michael R. Casey /

Michael R. Casey, Ph.D.

Electronic Patent Application Fee Transmittal

Application Number:	90010422
Filing Date:	26-Feb-2009
Title of Invention:	Graphic User Interface For Internet Telephony Application
First Named Inventor/Applicant Name:	6,009,469
Filer:	Michael R. Casey
Attorney Docket Number:	2655-0185

Filed as Large Entity

ex parte reexam Filing Fees

Description	Fee Code	Quantity	Amount	Sub-Total in USD(\$)
Basic Filing:				
Pages:				
Claims:				
Miscellaneous-Filing:				
Petition:				
Patent-Appeals-and-Interference:				
Notice of appeal	1401	1	540	540

Post-Allowance-and-Post-Issuance:

Extension-of-Time:

Description	Fee Code	Quantity	Amount	Sub-Total in USD(\$)
Miscellaneous:				
Total in USD (\$)				540

Electronic Acknowledgement Receipt

EFS ID:	8390486
Application Number:	90010422
International Application Number:	
Confirmation Number:	6565
Title of Invention:	Graphic User Interface For Internet Telephony Application
First Named Inventor/Applicant Name:	6,009,469
Customer Number:	42624
Filer:	Michael R. Casey
Filer Authorized By:	
Attorney Docket Number:	2655-0185
Receipt Date:	10-SEP-2010
Filing Date:	26-FEB-2009
Time Stamp:	11:01:03
Application Type:	Reexam (Third Party)

Payment information:

Submitted with Payment	yes
Payment Type	Deposit Account
Payment was successfully received in RAM	\$540
RAM confirmation Number	9694
Deposit Account	501860
Authorized User	

The Director of the USPTO is hereby authorized to charge indicated fees and credit any overpayment as follows:

Charge any Additional Fees required under 37 C.F.R. Section 1.16 (National application filing, search, and examination fees)

Charge any Additional Fees required under 37 C.F.R. Section 1.17 (Patent application and examination processing fees)

LG v. Straight Path, IP2015-00198

Charge any Additional Fees required under 37 C.F.R. Section 1.19 (Document supply fees)

Charge any Additional Fees required under 37 C.F.R. Section 1.21 (Miscellaneous fees and charges)

File Listing:

Document Number	Document Description	File Name	File Size(Bytes)/ Message Digest	Multi Part /.zip	Pages (if appl.)
1	Notice of Appeal Filed	NOA_90010422.pdf	243752	no	2
			11da765238c9aa4c3959c99a5e41177dca249191		
Warnings:					
Information:					
2	Reexam Certificate of Service	20100909_COS.pdf	56691	no	1
			98d048c1b967512ad0eb3c393d8a2d68e99bed9		
Warnings:					
Information:					
3	Fee Worksheet (PTO-875)	fee-info.pdf	29442	no	2
			ce067f002c78af4fa1b84a75939b6d1f1fae1c11		
Warnings:					
Information:					
Total Files Size (in bytes):			329885		

This Acknowledgement Receipt evidences receipt on the noted date by the USPTO of the indicated documents, characterized by the applicant, and including page counts, where applicable. It serves as evidence of receipt similar to a Post Card, as described in MPEP 503.

New Applications Under 35 U.S.C. 111

If a new application is being filed and the application includes the necessary components for a filing date (see 37 CFR 1.53(b)-(d) and MPEP 506), a Filing Receipt (37 CFR 1.54) will be issued in due course and the date shown on this Acknowledgement Receipt will establish the filing date of the application.

National Stage of an International Application under 35 U.S.C. 371

If a timely submission to enter the national stage of an international application is compliant with the conditions of 35 U.S.C. 371 and other applicable requirements a Form PCT/DO/EO/903 indicating acceptance of the application as a national stage submission under 35 U.S.C. 371 will be issued in addition to the Filing Receipt, in due course.

New International Application Filed with the USPTO as a Receiving Office

If a new international application is being filed and the international application includes the necessary components for an international filing date (see PCT Article 11 and MPEP 1810), a Notification of the International Application Number and of the International Filing Date (Form PCT/RO/105) will be issued in due course, subject to prescriptions concerning national security, and the date shown on this Acknowledgement Receipt will establish the international filing date of the application.



UNITED STATES PATENT AND TRADEMARK OFFICE

UNITED STATES DEPARTMENT OF COMMERCE
United States Patent and Trademark Office
Address: COMMISSIONER FOR PATENTS
P.O. Box 1450
Alexandria, Virginia 22313-1450
www.uspto.gov

APPLICATION NO.	FILING DATE	FIRST NAMED INVENTOR	ATTORNEY DOCKET NO.	CONFIRMATION NO.
90/010,422	02/26/2009	6,009,469	2655-0185	6565

42624 7590 07/20/2010

DAVIDSON BERQUIST JACKSON & GOWDEY LLP
4300 WILSON BLVD., 7TH FLOOR
ARLINGTON, VA 22203

EXAMINER

ART UNIT PAPER NUMBER

DATE MAILED: 07/20/2010

Please find below and/or attached an Office communication concerning this application or proceeding.



UNITED STATES PATENT AND TRADEMARK OFFICE

Commissioner for Patents
United States Patents and Trademark Office
P.O.Box 1450
Alexandria, VA 22313-1450
www.uspto.gov

THIRD PARTY REQUESTER'S CORRESPONDENCE ADDRESS

EWIN H. TAYLOR
BLAKELY, SOKOLOFF, TAYLOR & ZAFMAN, LLP
1279 OAKMEAD PARKWAY
SUNNYVALE, CA 94085-4040

Date: **MAILED**
JUL 20 2010

CENTRAL REEXAMINATION UNIT

EX PARTE REEXAMINATION COMMUNICATION TRANSMITTAL FORM

REEXAMINATION CONTROL NO. : 90010422
PATENT NO. : 6009469
ART UNIT : 3992

Enclosed is a copy of the latest communication from the United States Patent and Trademark Office in the above identified ex parte reexamination proceeding (37 CFR 1.550(f)).

Where this copy is supplied after the reply by requester, 37 CFR 1.535, or the time for filing a reply has passed, no submission on behalf of the ex parte reexamination requester will be acknowledged or considered (37 CFR 1.550(g)).

**Ex Parte Reexamination
Advisory Action
Before the Filing of an Appeal Brief**

Control No. 90/010,422	Patent Under Reexamination 6,009,469	
Examiner ALEXANDER J. KOSOWSKI	Art Unit 3992	

--The MAILING DATE of this communication appears on the cover sheet with the correspondence address--

THE PROPOSED RESPONSE FILED 12 July 2010 FAILS TO OVERCOME ALL OF THE REJECTIONS IN THE FINAL REJECTION MAILED 10 May 2010.

1. Unless a timely appeal is filed, or other appropriate action by the patent owner is taken to overcome all of the outstanding rejection(s), this prosecution of the present *ex parte* reexamination proceeding WILL BE TERMINATED and a Notice of Intent to Issue *Ex Parte* Reexamination Certificate will be mailed in due course. Any finally rejected claims, or claims objected to, will be CANCELLED.
THE PERIOD FOR RESPONSE IS EXTENDED TO RUN 4 MONTHS FROM THE MAILING DATE OF THE FINAL REJECTION. Extensions of time are governed by 37 CFR 1.550(c).

NOTICE OF APPEAL

2. An Appeal Brief is due two months from the date of the Notice of Appeal filed on ___ to a void dismissal of the appeal. See 37 CFR 41.37(a). Extensions of time are governed by 37 CFR 1.550(c). See 37 CFR 41.37(e).

AMENDMENTS

3. The proposed amendment(s) filed after a final action, but prior to the date of filing a brief, will not be entered because:
 (a) They raise new issues that would require further consideration and/or search (see NOTE below);
 (b) They raise the issue of new matter (see NOTE below);
 (c) They are not deemed to place the proceeding in better form for appeal by materially reducing or simplifying the issues for appeal; and/or
 (d) They present additional claims without canceling a corresponding number of finally rejected claims.
 NOTE: _____ (See 37 CFR 1.116 and 41.33(a)).

4. Patent owner's proposed response filed ___ has overcome the following rejection(s): _____
 5. The proposed new or amended claim(s) ___ would be allowable if submitted in a separate, timely filed amendment canceling the non-allowable claim(s).
 6. For purposes of appeal, the proposed amendment(s) a) will not be entered, or b) will be entered and an explanation of how the new or amended claim(s) would be rejected is provided below or appended.
 The status of the claim(s) is (or will be) as follows:
 Claim(s) patentable and/or confirmed: _____
 Claim(s) objected to: _____
 Claim(s) rejected: _____
 Claim(s) not subject to reexamination: _____

AFFIDAVIT OR OTHER EVIDENCE

7. The affidavit or other evidence filed after a final action, but before or on the date of filing a Notice of Appeal will not be entered because patent owner failed to provide a showing of good and sufficient reasons why the affidavit or other evidence is necessary and was not earlier presented. See 37 CFR 1.116(e).
 8. The affidavit or other evidence filed after the date of filing a Notice of Appeal, but prior to the date of filing a brief, will not be entered because the affidavit or other evidence fails to overcome all rejections under appeal and/or appellant failed to provide a showing of good and sufficient reasons why the affidavit or other evidence is necessary and was not earlier presented. See 37 CFR 41.33(d)(1).
 9. The affidavit or other evidence is entered. An explanation of the status of the claims after entry is below or attached.

REQUEST FOR RECONSIDERATION/OTHER

10. The request for reconsideration has been considered but does NOT place the application in condition for allowance because: See Continuation Sheet.
 11. Note the attached Information Disclosure Statement(s), PTO/SB/08, Paper No(s) _____
 12. Other: _____

/Alexander J Kosowski/ Primary Examiner, Art Unit 3992		
---	--	--

cc: Requester (if third party requester)
 U.S. Patent and Trademark Office
 PTOL-467 (Rev. 08-06) **Ex Parte Reexamination Advisory Action Before the Filing of an Appeal Brief** Part of Paper No. 20100719

Continuation of 10.

The request for reconsideration has been considered but does NOT place the application in condition for allowance because:

Examiner begins by noting the amendment and declaration filed 7/12/10 have been entered and considered.

- 1) Examiner notes that claim 16 was improperly rejected in the final office action. The rejection relied upon VocalChat as a secondary reference, however this reference has been removed from consideration. Therefore, examiner notes claim 16 is hereby confirmed.
- 2) Examiner notes that the amendment and declaration filed 7/12/10 are found persuasive with regard to the rejection of claims 8-9 and 14-18 under NetBIOS and Pinard. The NetBIOS name registration system does not mean that a "first callee process is accessible" as name registration is often permanent and the correspondence between name and IP address would not always be indicative of accessibility. Therefore, the rejection of claims 8-9 and 14-18 under the combination of NetBIOS and Pinard is hereby withdrawn.
- 3) The rejection of claims 8-9, 14-15 and 17-18 under the combination of the Etherphone Papers and Pinard is maintained. The rejection of claim 16 has been withdrawn due to utilization of the withdrawn VocalChat reference as noted above.

With regard to the rejection of claim 8 utilizing Etherphone and Pinard:

Patent Owner (PO) argues that Pinard does not "state that any of the icons are representative of a "callee process", and that the icon represents "a callee from a directory which does not inherently have a corresponding process". PO argues that Pinard is directed to using a conventional telephone number and not a process.

In Response, examiner notes that the callee process itself has been taught by Etherphone, and the graphical icon representing this is taught by Pinard. Pinard shows that a callee (for instance, an employee in a directory) can be graphically represented and manipulated visually through a graphical user interface on a computer associated with a telephony server. A user manipulating this callee icon to place a call can therefore, when considered in combination with Etherphone, be considered to be manipulating the callee process as this manipulation leads to placing the call. In addition, examiner notes that the term "callee process" does not appear to be defined anywhere in PO's specification. Therefore, no strict definition can be given to this term, and a graphical icon representing a callee which enables placement of a call utilizing a callee process taught by Etherphone can be considered a "user interface element representing a first callee process".

PO also argues that there is no motivation to combine the references, since Pinard does not have a general discussion of personal computers and since Pinard utilizes a conventional telephone.

In response, examiner notes that Pinard teaches the use of a telephony server in combination with a personal computer. The computer is utilized for its graphical user interface to control the calling process of the telephony server. Etherphone utilizes a personal computer and graphical user interface to place telephone calls over a network. Therefore, both pieces of prior art relate to communications between users in a computerized environment, and are therefore combinable.

Conclusion: Claims 8-9, 14-15 and 17-18 remain rejected under Etherphone and Pinard. Claim 16 is confirmed.

Reexamination 	Application/Control No. 90010422	Applicant(s)/Patent Under Reexamination 6,009,469
	Certificate Date	Certificate Number

Requester Correspondence Address: Patent Owner Third Party

BLAKELY SOKOLOFF TAYLOR & ZAFMAN LLP
1279 OAKMEAD PARKWAY
SUNNYVALE, CA 94085-4040

LITIGATION REVIEW <input checked="" type="checkbox"/>	AJK (examiner initials)	07/19/2010 (date)
Case Name	Director Initials	
OPEN: 2:06cv2469 Net2phone v. Ebay		

COPENDING OFFICE PROCEEDINGS	
TYPE OF PROCEEDING	NUMBER
1. no copending proceedings	

--	--

IN THE UNITED STATES PATENT AND TRADEMARK OFFICE

In re PATENT APPLICATION OF:

Net2Phone, Inc. (Patent No. 6,009,469)

Control No.: 90/010,422

Issue Date: December 28, 1999

Title: **GRAPHIC USER INTERFACE FOR
INTERNET TELEPHONY APPLICATION**

Attorney Docket: 2655-0185

Group Art Unit: 3992

Examiner: KOSOWSKI, Alexander

Date: July 12, 2010

Confirmation No.: 6565

RESPONSE TO FINAL REJECTION IN A RE-EXAMINATION

Hon. Commissioner of Patents
P.O. Box 1450
Alexandria, VA 22313-1450

*OK to Enter
ASU*

Sir:

In response to the Office Action dated May 10, 2010, the Assignee hereby requests the automatic one-month extension of time proscribed in MPEP 2265 for "a first timely response to an Office Action" after a final rejection in a re-examination and submits:

Remarks/Arguments beginning on page 2 of this paper.

IN THE UNITED STATES PATENT AND TRADEMARK OFFICE

In re PATENT APPLICATION OF:
Net2Phone, Inc. (Patent No. 6,009,469)
Control No.: 90/010,422
Issue Date: December 28, 1999
Title: **GRAPHIC USER INTERFACE FOR
INTERNET TELEPHONY APPLICATION**

Attorney Docket: 2655-0185
Group Art Unit: 3992
Examiner: KOSOWSKI, Alexander
Date: July 12, 2010
Confirmation No.: 6565

RESPONSE TO FINAL REJECTION IN A RE-EXAMINATION

Hon. Commissioner of Patents
P.O. Box 1450
Alexandria, VA 22313-1450

Sir:

In response to the Office Action dated May 10, 2010, the Assignee hereby requests the automatic one-month extension of time proscribed in MPEP 2265 for "a first timely response to an Office Action" after a final rejection in a re-examination and submits:

Remarks/Arguments beginning on page 2 of this paper.

Re-Examination of Patent No. 6,009,469
Control No.: 90/010,422
Filed: February 24, 2009
Reply to Office Action of May 10, 2010

REMARKS/ARGUMENTS

Favorable reconsideration, in light of the following discussion, is respectfully requested. In the outstanding Office Action, a number of previous grounds for rejection were withdrawn, the patentability of claims 1-3, 5 and 6 was confirmed, and claims 8, 9 and 14-18 were again rejected under 35 U.S.C 103(a) as follows:

1. Claims 8, 9, and 14-18 were alleged to be obvious over the combination of NetBIOS and Pinard (U.S. Patent No. 5,533,110), either alone or in combination with the VocalChat User's Guide; and
2. Claims 8, 9, and 14-18 were alleged to be obvious over the combination of the Etherphone papers in view of Pinard, either alone or in combination with the VocalChat User's Guide.

Each of those rejections is respectfully traversed for the reasons set forth below. Reference is made throughout this response to the Second Declaration Of Ketan Mayer-Patel Under 37 C.F.R. 1.132 (hereinafter the "Second Mayer-Patel Declaration") attached hereto as Exhibit 1. The Second Mayer-Patel Declaration is submitted herewith in response to the new argument in the final Office Action that "under a broadest reasonable interpretation, this [accessible] limitation could simply mean that a user is registered with the system." As this argument was not presented in the first Office Action, the Assignee was not able to know that such a position needed to be addressed. Accordingly, as the corresponding evidence could not have been presented earlier, it is respectfully requested that the Second Mayer-Patel Declaration be admitted into the record.

The Rejection of Claim 16 Over the Combination of the VocalChat User's Guide and Either (1) the Combination of NetBIOS and Pinard or (2) the Combination of the EtherPhone Papers and Pinard

With respect to claim 16 and the combination of NetBIOS, Pinard and the VocalChat User's Guide, the Office Action alleges, in section 5, that the "VocalChat User's Guide teaches

Re-Examination of Patent No. 6,009,469
Control No.: 90/010,422
Filed: February 24, 2009
Reply to Office Action of May 10, 2010

the use of a MUTE option on a phone so that a user can talk without being heard by the other user's system." Similarly, with respect to claim 16 and the combination of EtherPhone, Pinard and the VocalChat User's Guide, the Office Action alleges, in section 8, that the "VocalChat User's Guide teaches the use of a MUTE option on a phone so that a user can talk without being heard by the other user's system." However, as noted in section 9a of the Office Action, the use of this reference was withdrawn in light of the defect(s) in the Alon Cohen declaration. Specifically, the Office Action states "Examiner therefore withdraws all rejections utilizing the VocalChat references." Thus, the rejections of claim 16 are believed to be defective, and the rejections of claim 16 should be withdrawn.

The Rejection of Claims 8, 9, 14, 15, 17 and 18 Over the Combination of NetBIOS and Pinard

Claim 8

In addition to the reasons set forth in the previous response (which are incorporated herein by reference), the Assignee further submits the additional arguments set forth below for the patentability of claim 8 and its dependent claims.

With respect to the limitation of "determin[ing] if the first callee process is accessible," the Assignee previously argued that the Office Action had not shown that such a limitation was taught by NetBIOS. In section 9e, the Office Action now alleges that "under a broadest reasonable interpretation, this [accessible] limitation could simply mean that a user is registered with the system." However, users are not registered with a NetBIOS system, names are. Moreover, the registration of a name does not mean that a "first callee process is accessible."

As a preliminary matter, even the dictionary definitions of "accessible" and "registered" show that they are not synonymous with each other. See Exhibit 1 to the Second Mayer-Patel Declaration. According to the definitions, a system such as NetBIOS would indicate whether a name is "registered" (e.g., recorded or listed), but it would not indicate that a callee process is accessible (e.g., easy to reach or use or easily approached or entered). See Second Mayer-Patel Declaration, paragraphs 6 and 7.

Re-Examination of Patent No. 6,009,469
Control No.: 90/010,422
Filed: February 24, 2009
Reply to Office Action of May 10, 2010

NetBIOS explicitly provides for permanent registration of names. As described in Section 15.1.3.2 of RFC 1001, “Names held by an NBNS are given a lifetime during name registration.” The same section further states “The lifetime period is established through a simple negotiation mechanism during name registration: In the name registration request, the end-node proposes a lifetime value or *requests an infinite lifetime*. The NBNS places an actual lifetime value into the name registration response. The NBNS is *always allowed to respond with an infinite actual period*.” (Emphasis added.) Thus, in any number of cases, the NBNS may demand an infinite lifetime for names registered by nodes, with the effect that the NBNS would deliberately preserve the name and address information registered by a node permanently on the NBNS even though the node had stopped using the name or had gone off-line altogether years earlier. Therefore, the correspondence between a name and an IP address is not indicative of a first callee process being accessible. See Second Mayer-Patel Declaration, paragraph 8. This deliberate name preservation feature of NetBIOS teaches away from the limitation of a callee processing being accessible.

Moreover, the node requesting information on whether a name is registered does not receive an indication from the NBNS that the registered name corresponds to a name that has been given an infinite lifetime by the NBNS and could therefore be completely out-of-date. Section 4.2.13 of RFC 1002 describes the Positive Name Query Response (reproduced below) that is returned when a name has been registered, and there is no indication that the returned address is for a name associated with an identified lifetime, let alone an infinite lifetime:

Re-Examination of Patent No. 6,009,469
 Control No.: 90/010,422
 Filed: February 24, 2009
 Reply to Office Action of May 10, 2010

4.2.13. POSITIVE NAME QUERY RESPONSE

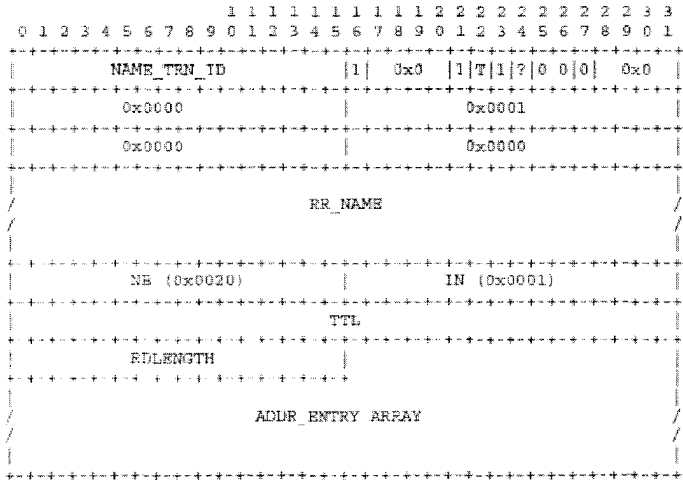

The ADDR_ENTRY ARRAY a sequence of zero or more ADDR_ENTRY records. Each ADDR_ENTRY record represents an owner of a name. For group names there may be multiple entries. However, the list may be incomplete due to packet size limitations. Bit 22, "T", will be set to indicate truncated data.

Each ADDR_ENTRY has the following format:



See Second Mayer-Patel Declaration, paragraph 9.

Also, there is no indication in the Positive Name Query Response disclosed by NetBIOS that the returned address necessarily corresponds with a computer or process that was ever accessible as asserted by the pending office action. For example, a first user could manually enter a dummy address in the NB_Address field associated with a claimed name that he wanted to register and still be compliant with the NetBIOS protocol standard since queries by other users for that name are "not necessarily a prelude to NetBIOS session establishment or NetBIOS datagram transmission." Section 15.3.1. See Second Mayer-Patel Declaration, paragraph 10.

RFC 1002 further shows that a name registration is not an indication of whether "a first callee process is accessible" given that a NetBIOS server may refuse to release registered names for policy reasons. As described in Section 4.2.9, a node may request that a name be released using a Name Release Request (reproduced below).

Re-Examination of Patent No. 6,009,469
 Control No.: 90/010,422
 Filed: February 24, 2009
 Reply to Office Action of May 10, 2010

4.2.9. NAME RELEASE REQUEST & DEMAND

```

                                1 1 1 1 1 1 1 1 1 1 2 2 2 2 2 2 2 2 2 2 3 3
    0 1 2 3 4 5 6 7 8 9 0 1 2 3 4 5 6 7 8 9 0 1 2 3 4 5 6 7 8 9 0 1
    +-----+-----+-----+-----+-----+-----+-----+-----+
    |          NAME_TRN_ID          |0| 0x6 |0|0|0|0|0|0|B| 0x0 |
    +-----+-----+-----+-----+-----+-----+-----+-----+
    |          0x0001          |          0x0000          |
    +-----+-----+-----+-----+-----+-----+-----+-----+
    |          0x0000          |          0x0001          |
    +-----+-----+-----+-----+-----+-----+-----+-----+
    |                               QUESTION_NAME                               |
    |                               /                                           |
    |                               /                                           |
    +-----+-----+-----+-----+-----+-----+-----+-----+
    |          NB (0x0020)          |          IN (0x0001)          |
    +-----+-----+-----+-----+-----+-----+-----+-----+
    |                               RR_NAME                               |
    |                               /                                           |
    |                               /                                           |
    +-----+-----+-----+-----+-----+-----+-----+-----+
    |          NB (0x0020)          |          IN (0x0001)          |
    +-----+-----+-----+-----+-----+-----+-----+-----+
    |                               0x00000000                               |
    +-----+-----+-----+-----+-----+-----+-----+-----+
    |          0x0006          |          NB_FLAGS          |
    +-----+-----+-----+-----+-----+-----+-----+-----+
    |                               NB_ADDRESS                               |
    +-----+-----+-----+-----+-----+-----+-----+-----+
  
```

See Second Mayer-Patel Declaration, paragraph 11.

In response, as shown in Section 4.2.11, a server can generate a Negative Name Release Response, as shown below.

Re-Examination of Patent No. 6,009,469
 Control No.: 90/010,422
 Filed: February 24, 2009
 Reply to Office Action of May 10, 2010

4.2.11. NEGATIVE NAME RELEASE RESPONSE

```

                                1 1 1 1 1 1 1 1 1 1 2 2 2 2 2 2 2 2 2 2 3 3
    0 1 2 3 4 5 6 7 8 9 0 1 2 3 4 5 6 7 8 9 0 1 2 3 4 5 6 7 8 9 0 1
    +-----+-----+-----+-----+-----+-----+-----+-----+
    |          NAME_TRN_ID          |1| 0x6 |1|0|0|0|0 0|0| RCODE |
    +-----+-----+-----+-----+-----+-----+-----+-----+
    |          0x0000          |          0x0001          |
    +-----+-----+-----+-----+-----+-----+-----+-----+
    |          0x0000          |          0x0000          |
    +-----+-----+-----+-----+-----+-----+-----+-----+
    |                               RR_NAME                               |
    |                               /                                     /
    +-----+-----+-----+-----+-----+-----+-----+-----+
    |          NB (0x0020)          |          IN (0x0001)          |
    +-----+-----+-----+-----+-----+-----+-----+-----+
    |                               TTL                               |
    +-----+-----+-----+-----+-----+-----+-----+-----+
    |          0x0006          |          NB_FLAGS          |
    +-----+-----+-----+-----+-----+-----+-----+-----+
    |                               NB_ADDRESS                               |
    +-----+-----+-----+-----+-----+-----+-----+-----+
  
```

The RCODE field indicates the response from the server. One such response is RFS_ERR which is described as follows:

```

RFS_ERR      0x5  Refused error.  For policy reasons server
                will not release this name from this host.
  
```

See Second Mayer-Patel Declaration, paragraph 12.

Thus, the registration of a name does not indicate that a corresponding process is accessible. Accordingly, the limitation of “determin[ing] if the first callee process is accessible” is not taught by NetBIOS. Since this limitation is not alleged to be taught by Pinard, the combination of references fails to teach this limitation that is not taught by the references individually. See Second Mayer-Patel Declaration, paragraph 13.

Re-Examination of Patent No. 6,009,469
Control No.: 90/010,422
Filed: February 24, 2009
Reply to Office Action of May 10, 2010

Claim 8 also recites “generating a user interface element representing a first callee process” and querying “the server process to determine if the first callee process is accessible.” The Office Action admits that NetBIOS “does not explicitly teach ... generating a user interface representing a first callee process.” In order to address this admitted deficiency, the Office Action alleges that “Pinard teaches a user interface element representing a first communication line and callee process (Pinard, Figure 6 and col. 5 lines 23-30), and also teaches clicking and dragging an icon representing a callee from a directory into a call setup icon to establish a call link.” However, both the portion of Pinard in col. 5 cited by the Office Action and the Office Action itself show that the Office Action’s assertion is incorrect.

Col. 5, lines 23-30 of Pinard states:

Now what the local user Debbie sees on the screen is a call in progress between her and Mary, by noting the Debbie and Mary icons 13 and 29 in the call icon 29. She also sees a ghost 13A of her icon (indicating inactive) in the same call icon as John 23, which indicates that John's line is on hold. If desired, the John icon can be made to flash or change colors at some frequency (which could increase, if desired, with increase in time).

Nowhere in that section does it state that any of the icons are representative of a “callee process.” Instead, as described in the Office Action, the icon represents “a callee from a directory” which does not inherently have a corresponding process. In fact, col. 4, lines 27-31, of Pinard states “The directory can be formed of alphanumeric characters, designating the names of persons listed in the directory (as shown), or the names and telephone numbers, or images of the faces of the persons listed in the directory, or combinations of the above.” Thus, Pinard is directed to using a conventional telephone number and not a process.

As further described in col. 4, lines 43-48:

The application software program then creates an icon 21 representing the party to be called (i.e. John) and places it with his name in the call setup icon. It looks up the directory number of John from directory (if it had not been typed in

Re-Examination of Patent No. 6,009,469
Control No.: 90/010,422
Filed: February 24, 2009
Reply to Office Action of May 10, 2010

by the local subscriber), and causes the server to dial John's telephone number. As soon as John answers the call, the application software program changes the call setup icon to a call icon designated as 23, and establishes a new call setup icon 24 spaced from the icon 23.

The fact that the server that dials John's telephone number is a "server [that] contains telephone interface circuits 8, conference digital signal processing circuits 9, dialing circuits, trunk circuits, etc." (Pinard, col. 3, last paragraph) is also indicative that Pinard is not describing "generating a user interface element representing a first callee process." Thus, neither Pinard nor NetBIOS nor their combination teach "generating a user interface element representing a first callee process." Accordingly, the patentability of claim 8 and its dependent claims should be confirmed.

No Motivation to Combine the References as in Claims 8, 9, 14, 15, 17 and 18

The Office Action alleges that:

it would have been obvious to one skilled in the art at the time the invention was made to utiliz[e] the user-interface elements and interactions taught by Pinard in the inventions taught by NetBIOS since Pinard teaches that the invention can be used in any system in which a personal computer in conjunction with a server operates..., since NetBIOS teaches that it can be implemented using different operating systems ..., and since examiner notes that both NetBIOS and Pinard relate to communications between at least two users implemented in a computerized environment.

The Office Action, however, provides no evidence to support this allegation. For example, the Office Action does not point to a problem identified in the art which was known to exist in one reference and for which the second references was the solution. Moreover, just because two

Re-Examination of Patent No. 6,009,469
Control No.: 90/010,422
Filed: February 24, 2009
Reply to Office Action of May 10, 2010

references could be combined does not mean that one of ordinary skill in the art would have been motivated to do so absent the teachings in the patentee's specification.

In addition, the fact that NetBIOS allegedly "teaches that it can be implemented using different operating systems" does not mean that NetBIOS should be combined with other, *different* systems. At best, it is an indication that the *same* unmodified services could be available under different operating systems.

Moreover, the use of a personal computer with "a server" is not a general discussion in col. 2 of Pinard, and the cited portion of col. 2 is taken out of context. That section states "Once the present invention is understood, it will be also understood that it is not restricted for use with those systems, but can be used with any system in which a telephony application on a personal computer or personal computer in conjunction with a server operates." Thus, it is the telephony application that can be used with a server, as is shown in, for example, figure 1 of Pinard. The cited section therefore is not an invitation to combine other services on other servers with Pinard but rather an indication that the telephony services can be implemented on a server instead of on the personal computer directly. Moreover, the server of Pinard is not a generic server but rather a "server [that] contains telephone interface circuits 8, conference digital signal processing circuits 9, dialing circuits, trunk circuits, etc." (Pinard, col. 3, last paragraph) which the Office Action has not shown to be relevant to a NetBIOS environment.

The last alleged motivation is that "both NetBIOS and Pinard relate to communications between at least two users implemented in a computerized environment"; however, this is incorrect (the callee in Pinard used a conventional telephone and need not have been implemented in a computerized environment), and it provides no evidence that the applied references are sufficiently related that one of ordinary skill in the art would have been motivated to combine them. The assertion is tantamount to a declaration that one of ordinary skill in the art would have been motivated to combine all computerized communication systems without regard for their use. Such a position has no support in the law. Accordingly, the patentability of claim 8 and its dependent claims should be confirmed.

Re-Examination of Patent No. 6,009,469
Control No.: 90/010,422
Filed: February 24, 2009
Reply to Office Action of May 10, 2010

The Rejection of Claims 8, 9, 14, 15, 17 and 18 Over the Combination of the Etherphone Papers
in view of Pinard

Claim 8

Claim 8 recites “generating a user interface element representing a first callee process” and querying “the server process to determine if the first callee process is accessible.” The Office Action admits that EtherPhone “does not explicitly teach ... generating a user interface representing a first callee process.” In order to address this admitted deficiency, the Office Action alleges that “Pinard teaches a user interface element representing a first communication line and callee process (Pinard, Figure 6 and col. 5 lines 23-30), and also teaches clicking and dragging an icon representing a callee from a directory into a call setup icon to establish a call link.” However, both the portion of Pinard in col. 5 cited by the Office Action and the Office Action itself show that the Office Action’s assertion is incorrect.

Col. 5, lines 23-30 of Pinard states:

Now what the local user Debbie sees on the screen is a call in progress between her and Mary, by noting the Debbie and Mary icons 13 and 29 in the call icon 29. She also sees a ghost 13A of her icon (indicating inactive) in the same call icon as John 23, which indicates that John's line is on hold. If desired, the John icon can be made to flash or change colors at some frequency (which could increase, if desired, with increase in time).

Nowhere in that section does it state that any of the icons are representative of a “callee process.” Instead, as described in the Office Action, the icon represents “a callee from a directory” which does not inherently have a corresponding process. In fact, col. 4, lines 27-31, of Pinard states “The directory can be formed of alphanumeric characters, designating the names of persons listed in the directory (as shown), or the names and telephone numbers, or images of the faces of

Re-Examination of Patent No. 6,009,469
Control No.: 90/010,422
Filed: February 24, 2009
Reply to Office Action of May 10, 2010

the persons listed in the directory, or combinations of the above.” Thus, Pinard is directed to using a conventional telephone number and not a process.

As further described in col. 4, lines 43-48:

The application software program then creates an icon 21 representing the party to be called (i.e. John) and places it with his name in the call setup icon. It looks up the directory number of John from directory (if it had not been typed in by the local subscriber), and causes the server to dial John's telephone number. As soon as John answers the call, the application software program changes the call setup icon to a call icon designated as 23, and establishes a new call setup icon 24 spaced from the icon 23.

The fact that the server that dials John's telephone number is a “server [that] contains telephone interface circuits 8, conference digital signal processing circuits 9, dialing circuits, trunk circuits, etc.” (Pinard, col. 3, last paragraph) is also indicative that Pinard is not describing “generating a user interface element representing a first callee process.” Thus, neither Pinard nor EtherPhone nor their combination teach “generating a user interface element representing a first callee process.” Accordingly, the patentability of claim 8 and its dependent claims should be confirmed.

No Motivation to Combine the References as in Claims 8, 9, 14, 15, 17 and 18

The Office Action alleges that:

it would have been obvious to one skilled in the art at the time the invention was made to utiliz[e] the user-interface elements and interactions taught by Pinard in the invention taught by EtherPhone since Pinard teaches that the invention can be used in any system in which a personal computer in conjunction with a server operates..., and since examiner notes that both EtherPhone and Pinard relate to communications between at least two users implemented in a computerized environment.

Re-Examination of Patent No. 6,009,469
Control No.: 90/010,422
Filed: February 24, 2009
Reply to Office Action of May 10, 2010

The Office Action, however, provides no evidence to support this allegation. For example, the Office Action does not point to a problem identified in the art which was known to exist in one reference and for which the second references was the solution. Moreover, just because two references could be combined does not mean that one of ordinary skill in the art would have been motivated to do so absent the teachings in the patentee's specification.

Moreover, the use of a personal computer with "a server" is not a general discussion in col. 2 of Pinard, and the cited portion of col. 2 is taken out of context. That section states "Once the present invention is understood, it will be also understood that it is not restricted for use with those systems, but can be used with any system in which a telephony application on a personal computer or personal computer in conjunction with a server operates." Thus, it is the telephony application that can be used with a server, as is shown in, for example, figure 1 of Pinard. The cited section therefore is not an invitation to combine other services on other servers with Pinard but rather an indication that the telephony services can be implemented on a server instead of on the personal computer directly.

The last alleged motivation is that "both EtherPhone and Pinard relate to communications between at least two users implemented in a computerized environment"; however, this is incorrect (the callee in Pinard used a conventional telephone and need not have been implemented in a computerized environment), and it provides no evidence that the applied references are sufficiently related that one of ordinary skill in the art would have been motivated to combine them. The assertion is tantamount to a declaration that one of ordinary skill in the art would have been motivated to combine all computerized communication systems without regard for their use. Such a position has no support in the law. Accordingly, the patentability of claim 8 and its dependent claims should be confirmed.

Re-Examination of Patent No. 6,009,469
Control No.: 90/010,422
Filed: February 24, 2009
Reply to Office Action of May 10, 2010

Consequently, in light of the above discussions, the outstanding grounds for rejection are believed to have been overcome and the patentability of the claims subject to re-examination should be indicated as confirmed. An early and favorable action to that effect is respectfully requested.

CHARGE STATEMENT: Deposit Account No. 501860, order no. **2655-0185**.

The Commissioner is hereby authorized to charge any fee specifically authorized hereafter, or any missing or insufficient fee(s) filed, or asserted to be filed, or which should have been filed herewith or concerning any paper filed hereafter, and which may be required under Rules 16-18 (missing or insufficiencies only) now or hereafter relative to this application and the resulting Official Document under Rule 20, or credit any overpayment, to our Accounting/ Order Nos. shown above, for which purpose a duplicate copy of this sheet is attached.

This CHARGE STATEMENT does not authorize charge of the issue fee until/unless an issue fee transmittal sheet is filed.

<p>CUSTOMER NUMBER 42624</p>	<p>Respectfully submitted,</p> <p>By: / Michael R. Casey /</p> <hr/> <p>Michael R. Casey, Ph.D. Registration No.: 40,294</p>
<p>Davidson Berquist Jackson & Gowdey LLP 4300 Wilson Blvd., 7th Floor, Arlington, Virginia 22203 Main: (703) 894-6400 • FAX: (703) 894-6430</p>	

Re-Examination of Patent No. 6,009,469
Control No.: 90/010,422
Filed: February 24, 2009
Reply to Office Action of May 10, 2010

CERTIFICATE OF SERVICE

The undersigned hereby certifies that, on July 12, 2010, the RESPONSE TO FINAL REJECTION IN A RE-EXAMINATION filed in Re-examination Control No. 90/010,422 was served by U.S. First Class Mail, postage pre-paid, on Requestor as follows:

Blakely, Sokoloff, Taylor & Zafman LLP
1279 Oakmead Parkway
Sunnyvale, CA 94085-4040

/ Michael R. Casey /

Michael R. Casey, Ph.D.

EXHIBIT 1

IN THE UNITED STATES PATENT AND TRADEMARK OFFICE

In re PATENT APPLICATION OF:
Net2Phone, Inc. (Patent No. 6,009,469)
Control No.: 90/010,422
Issue Date: December 28, 1999
Title: **GRAPHIC USER INTERFACE FOR
INTERNET TELEPHONY APPLICATION**

Attorney Docket: 2655-0185
Group Art Unit: 3992
Examiner: KOSOWSKI, Alexander
Confirmation No.: 6565

SECOND DECLARATION OF KETAN MAYER-PATEL UNDER 37 C.F.R. 1.132

Hon. Commissioner of Patents
P.O. Box 1450
Alexandria, VA 22313-1450

I. INTRODUCTION

1. I am the same Ketan Mayer-Patel that filed a Declaration in response to the first Office Action in the re-examination of U.S. Patent No. 6,009,469 (hereinafter “the ‘469 patent”).
2. I have reviewed the outstanding Office Action dated May 10, 2010.
3. I understand that claims 8, 9, and 14-18 were alleged to be obvious over the combination of NetBIOS and Pinard (U.S. Patent No. 5,533,110), either alone or in combination with the VocalChat User’s Guide, and claims 8, 9, and 14-18 were alleged to be obvious over the combination of the Etherphone papers in view of Pinard, either alone or in combination with the VocalChat User’s Guide.
4. I understand that in response to evidence presented in my first Declaration the Office Action now alleges “under a broadest reasonable interpretation, this [accessible] limitation could simply mean that a user is registered with the system.” As this argument was not presented in the first Office Action, I was not able to know that such a position needed to be addressed.
5. I do not believe that one of ordinary skill in the art at the time the invention was made would have believed that the definitions proposed by the Office Action are proper -- even under a “broadest reasonable interpretation” standard.

Re-Examination of Patent No. 6,009,469
Control No.: 90/010,422
Filed: February 24, 2009
Second Declaration of Ketan Mayer-Patel under 37 C.F.R. 1.132

6. The dictionary definitions of “accessible” and “registered” show that they are not synonymous with each other. See Exhibit 1 attached hereto. According to the definitions, a system such as NetBIOS would indicate whether a name is “registered” (e.g., recorded or listed), but it would not indicate that a callee process is accessible (e.g., easy to reach or use or easily approached or entered).

7. Accordingly, I do not agree that “under a broadest reasonable interpretation, this [accessible] limitation could simply mean that a user is registered with the system.”

8. In fact, NetBIOS explicitly provides for permanent registration of names. As described in Section 15.1.3.2 of RFC 1001, “Names held by an NBNS are given a lifetime during name registration.” The same section further states “The lifetime period is established through a simple negotiation mechanism during name registration: In the name registration request, the end-node proposes a lifetime value or *requests an infinite lifetime*. The NBNS places an actual lifetime value into the name registration response. The NBNS is always allowed to respond with an infinite actual period.” (Emphasis added.) Thus, in any number of cases, the NBNS may demand an infinite lifetime for names registered by nodes, with the effect that the NBNS would deliberately preserve the name and address information registered by a node permanently on the NBNS even weeks, months or years after the node had stopped using the name or had gone off-line altogether. Therefore, the correspondence between a name and an IP address is not indicative that a first callee process is accessible.

9. Moreover, the node requesting information on whether a name is registered does not receive an indication from the NBNS that the registered name corresponds to a name that has been given an infinite lifetime and could therefore be completely out-of-date. Section 4.2.13 of RFC 1002 describes the Positive Name Query Response (reproduced below) that is returned when a name has been registered, and there is no indication that the returned address is for a name associated with an identified lifetime, let alone an infinite lifetime.

Re-Examination of Patent No. 6,009,469
 Control No.: 90/010,422
 Filed: February 24, 2009
 Second Declaration of Ketan Mayer-Patel under 37 C.F.R. 1.132

4.2.13 POSITIVE NAME QUERY RESPONSE

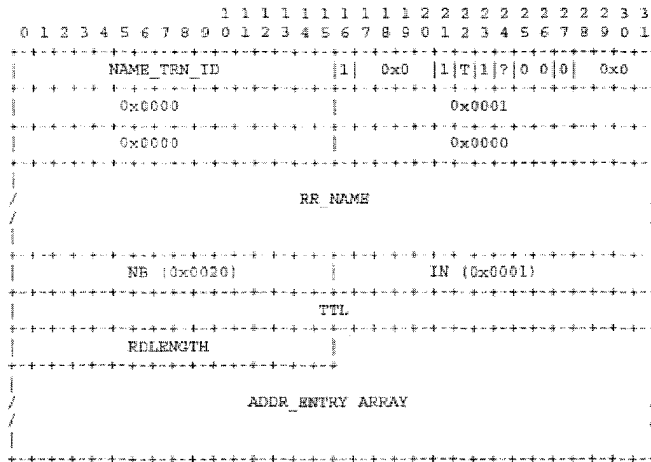

The ADDR_ENTRY_ARRAY a sequence of zero or more ADDR_ENTRY records. Each ADDR_ENTRY record represents an owner of a name. For group names there may be multiple entries. However, the list may be incomplete due to packet size limitations. Bit 22, "T", will be set to indicate truncated data.

Each ADDR_ENTRY has the following format:

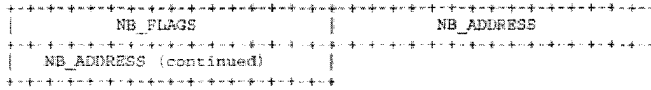

10. In addition, there is no indication in the Positive Name Query Response disclosed by NetBIOS that the returned address necessarily corresponds with a computer or process that was ever accessible as asserted by the pending office action. For example, a first user could manually enter a dummy address in the NB_Address field associated with a claimed name that he wanted to register and still be compliant with the NetBIOS protocol standard since queries by other users for that name are “not necessarily a prelude to NetBIOS session establishment or NetBIOS datagram transmission.” Section 15.3.1.

11. Furthermore, RFC 1002 further shows that a name registration is not an indication of whether a first callee process is accessible since a NBNS can refuse to release registered names for policy reasons. As described in Section 4.2.9, a node may request that a name be released using a Name Release Request (reproduced below).

Re-Examination of Patent No. 6,009,469
 Control No.: 90/010,422
 Filed: February 24, 2009
 Second Declaration of Ketan Mayer-Patel under 37 C.F.R. 1.132

4.2.9. NAME RELEASE REQUEST & DEMAND

```

                                1 1 1 1 1 1 1 1 1 1 2 2 2 2 2 2 2 2 3 3
0 1 2 3 4 5 6 7 8 9 0 1 2 3 4 5 6 7 8 9 0 1 2 3 4 5 6 7 8 9 0 1
|-----|-----|-----|-----|-----|-----|-----|-----|
| NAME_TRN_ID | 0 | 0x6 | 0 | 0 | 0 | 0 | 0 | 0 | B | 0x0 |
|-----|-----|-----|-----|-----|-----|-----|-----|
| 0x0001 | | | | | | | | | | 0x0000 |
|-----|-----|-----|-----|-----|-----|-----|-----|
| 0x0000 | | | | | | | | | | 0x0001 |
|-----|-----|-----|-----|-----|-----|-----|-----|
|                               QUESTION_NAME                               |
|-----|-----|-----|-----|-----|-----|-----|-----|
| NB (0x0020) | | | | | | | | | | IN (0x0001) |
|-----|-----|-----|-----|-----|-----|-----|-----|
|                               RR_NAME                               |
|-----|-----|-----|-----|-----|-----|-----|-----|
| NB (0x0020) | | | | | | | | | | IN (0x0001) |
|-----|-----|-----|-----|-----|-----|-----|-----|
|                               0x00000000                               |
|-----|-----|-----|-----|-----|-----|-----|-----|
| 0x0006 | | | | | | | | | | NB_FLAGS |
|-----|-----|-----|-----|-----|-----|-----|-----|
|                               NB_ADDRESS                               |
|-----|-----|-----|-----|-----|-----|-----|-----|

```

12. In response, as shown in Section 4.2.11, a server can generate a Negative Name Release Response, as shown below.

Re-Examination of Patent No. 6,009,469
 Control No.: 90/010,422
 Filed: February 24, 2009
 Second Declaration of Ketan Mayer-Patel under 37 C.F.R. 1.132

4.2.11. NEGATIVE NAME RELEASE RESPONSE

```

          1 1 1 1 1 1 1 1 1 1 2 2 2 2 2 2 2 2 2 2 3 3
0 1 2 3 4 5 6 7 8 9 0 1 2 3 4 5 6 7 8 9 0 1 2 3 4 5 6 7 8 9 0 1
+-----+-----+-----+-----+-----+-----+-----+-----+
|          NAME_TRM_ID          |1| 0x6 |1|0|0|0|0|0|0| RCODE |
+-----+-----+-----+-----+-----+-----+-----+-----+
|          0x0000          |          0x0001          |
+-----+-----+-----+-----+-----+-----+-----+-----+
|          0x0000          |          0x0000          |
+-----+-----+-----+-----+-----+-----+-----+-----+
|                               RR_NAME                               |
|                               /                                     /
|                               |                                     |
+-----+-----+-----+-----+-----+-----+-----+-----+
|          NB (0x0020)          |          IN (0x0001)          |
+-----+-----+-----+-----+-----+-----+-----+-----+
|                               TTL                               |
+-----+-----+-----+-----+-----+-----+-----+-----+
|          0x0006          |          NB_FLAGS          |
+-----+-----+-----+-----+-----+-----+-----+-----+
|                               NB_ADDRESS                               |
+-----+-----+-----+-----+-----+-----+-----+-----+

```

The RCODE field indicates the response from the server. One such response is RFS_ERR which is described as follows:

```

RFS_ERR      0x5   Refused error.  For policy reasons server
                will not release this name from this host.

```

13. Thus, the registration of a name does not indicate that NetBIOS discloses that a “first callee process is accessible.”

Re-Examination of Patent No. 6,009,469
Control No.: 90/010,422
Filed: February 24, 2009
Second Declaration of Ketan Mayer-Patel under 37 C.F.R. 1.132

14. I hereby declare that all statements made herein of my own knowledge are true and that all statements made on information and belief are believed to be true; and further that these statements were made with the knowledge that willful false statements and the like so made are punishable by fine or imprisonment, or both, under Section 1001 of Title 18 of the United States Code and that such willful false statements may jeopardize the validity of the application or any patent issued thereon.

Dated: July 12, 2010



Ketan Mayer-Patel, Ph.D.

EXHIBIT 1

ac·ces·si·ble [ak-ses-uh-buhl]

–adjective

1. easy to approach, reach, enter, speak with, or use.
2. that can be used, entered, reached, etc.: an accessible road; accessible ruins.
3. obtainable; attainable: accessible evidence.
4. open to the influence of (usually fol. by to): accessible to bribery.

Dictionary.com Unabridged

Based on the Random House Dictionary, © Random House, Inc. 2010.

ac·ces·si·ble (āk-sēs'ə-bəl)

adj.

1. Easily approached or entered.
2. Easily obtained: accessible money.
3. Easy to talk to or get along with: an accessible manager.
4. Easily swayed or influenced: accessible to flattery.

ac·ces'si·bil'i·ty, ac·ces'si·ble·ness n., ac·ces'si·bly adv.

The American Heritage® Dictionary of the English Language, Fourth Edition

Copyright © 2009 by Houghton Mifflin Company.

Published by Houghton Mifflin Company. All rights reserved.

reg·is·tered [rej-uh-sterd]

–adjective

1. recorded, as in a register or book; enrolled.
2. Commerce . officially listing the owner's name with the issuing corporation and suitably inscribing the certificate, as with bonds to evidence title. Abbreviation: r
3. officially or legally certified by a government officer or board: a registered patent.
4. denoting cattle, horses, dogs, etc., having pedigrees verified and filed by authorized associations of breeders.

dictionary.com

reg·is·tered (rĕj'ī-stərd)

adj.

1. Having the owner's name listed in a register: registered bonds.
2. Having the pedigree recorded and verified by an authorized association of breeders: a registered golden retriever.
3. Officially qualified or certified: a registered pharmacist.

The American Heritage® Dictionary of the English Language, Fourth Edition

Copyright © 2009 by Houghton Mifflin Company.

Published by Houghton Mifflin Company. All rights reserved.

Main Entry: registered

Part of Speech: adjective

Definition: recorded

Synonyms: cataloged, certified, enrolled

Main Entry: registered

Part of Speech: adjective

Definition: pedigreed

Synonyms: blooded, full-blooded, pure-blooded, purebred, thoroughbred

Electronic Acknowledgement Receipt

EFS ID:	7999155
Application Number:	90010422
International Application Number:	
Confirmation Number:	6565
Title of Invention:	Graphic User Interface For Internet Telephony Application
First Named Inventor/Applicant Name:	6,009,469
Customer Number:	42624
Filer:	Michael R. Casey
Filer Authorized By:	
Attorney Docket Number:	2655-0185
Receipt Date:	12-JUL-2010
Filing Date:	26-FEB-2009
Time Stamp:	19:14:31
Application Type:	Reexam (Third Party)

Payment information:

Submitted with Payment	no
------------------------	----

File Listing:

Document Number	Document Description	File Name	File Size(Bytes)/ Message Digest	Multi Part /.zip	Pages (if appl.)
1	Amendment After Final	20100712_469_cover.pdf	82954 <small>b1594ae7d97422e8750489bebbb5b8b8fa9f4998</small>	no	1

Warnings:

Information:

2	Applicant Arguments/Remarks Made in an Amendment	20100712_469_remarks.pdf	1857516 359478f4920be7b70a2934601f663e8e49a63bf7	no	13
Warnings:					
Information:					
3	Reexam Certificate of Service	20100712_469_COS.pdf	59425 433c977de471bf2376cc36d690568bed94e1c130	no	1
Warnings:					
Information:					
4	Rule 130, 131 or 132 Affidavits	20100712_469_exhibit_1.pdf	856300 db659bb04b3ca1263aaef1a4586e1b4d531e4fb3	no	10
Warnings:					
Information:					
Total Files Size (in bytes):			2856195		

This Acknowledgement Receipt evidences receipt on the noted date by the USPTO of the indicated documents, characterized by the applicant, and including page counts, where applicable. It serves as evidence of receipt similar to a Post Card, as described in MPEP 503.

New Applications Under 35 U.S.C. 111

If a new application is being filed and the application includes the necessary components for a filing date (see 37 CFR 1.53(b)-(d) and MPEP 506), a Filing Receipt (37 CFR 1.54) will be issued in due course and the date shown on this Acknowledgement Receipt will establish the filing date of the application.

National Stage of an International Application under 35 U.S.C. 371

If a timely submission to enter the national stage of an international application is compliant with the conditions of 35 U.S.C. 371 and other applicable requirements a Form PCT/DO/EO/903 indicating acceptance of the application as a national stage submission under 35 U.S.C. 371 will be issued in addition to the Filing Receipt, in due course.

New International Application Filed with the USPTO as a Receiving Office

If a new international application is being filed and the international application includes the necessary components for an international filing date (see PCT Article 11 and MPEP 1810), a Notification of the International Application Number and of the International Filing Date (Form PCT/RO/105) will be issued in due course, subject to prescriptions concerning national security, and the date shown on this Acknowledgement Receipt will establish the international filing date of the application.



UNITED STATES PATENT AND TRADEMARK OFFICE

UNITED STATES DEPARTMENT OF COMMERCE
United States Patent and Trademark Office
Address: COMMISSIONER FOR PATENTS
P.O. Box 1450
Alexandria, Virginia 22313-1450
www.uspto.gov

APPLICATION NO.	FILING DATE	FIRST NAMED INVENTOR	ATTORNEY DOCKET NO.	CONFIRMATION NO.
90/010,422	02/26/2009	6,009,469	2655-0185	6565

42624 7590 05/10/2010

DAVIDSON BERQUIST JACKSON & GOWDEY LLP
4300 WILSON BLVD., 7TH FLOOR
ARLINGTON, VA 22203

EXAMINER

ART UNIT PAPER NUMBER

DATE MAILED: 05/10/2010

Please find below and/or attached an Office communication concerning this application or proceeding.



DO NOT USE IN PALM PRINTER

(THIRD PARTY REQUESTER'S CORRESPONDENCE ADDRESS)

BLAKELY SOKOLOFF TAYLOR & ZAFMAN LLP

1279 OAKMEAD PARKWAY

SUNNYVALE, CA 94085-4040

MAILED

MAY 10 2010

CENTRAL REEXAMINATION UNIT

EX PARTE REEXAMINATION COMMUNICATION TRANSMITTAL FORM

REEXAMINATION CONTROL NO. 90/010,422.

PATENT NO. 6,009,469.

ART UNIT 3992.

Enclosed is a copy of the latest communication from the United States Patent and Trademark Office in the above identified *ex parte* reexamination proceeding (37 CFR 1.550(f)).

Where this copy is supplied after the reply by requester, 37 CFR 1.535, or the time for filing a reply has passed, no submission on behalf of the *ex parte* reexamination requester will be acknowledged or considered (37 CFR 1.550(g)).

Office Action in Ex Parte Reexamination	Control No. 90/010,422	Patent Under Reexamination 6,009,469	
	Examiner ALEXANDER J. KOSOWSKI	Art Unit 3992	

-- The MAILING DATE of this communication appears on the cover sheet with the correspondence address --

- a Responsive to the communication(s) filed on 25 November 2009. b This action is made FINAL.
c A statement under 37 CFR 1.530 has not been received from the patent owner.

A shortened statutory period for response to this action is set to expire 2 month(s) from the mailing date of this letter. Failure to respond within the period for response will result in termination of the proceeding and issuance of an *ex parte* reexamination certificate in accordance with this action. 37 CFR 1.550(d). **EXTENSIONS OF TIME ARE GOVERNED BY 37 CFR 1.550(c)**. If the period for response specified above is less than thirty (30) days, a response within the statutory minimum of thirty (30) days will be considered timely.

Part I THE FOLLOWING ATTACHMENT(S) ARE PART OF THIS ACTION:

- | | |
|---|---|
| 1. <input type="checkbox"/> Notice of References Cited by Examiner, PTO-892. | 3. <input type="checkbox"/> Interview Summary, PTO-474. |
| 2. <input checked="" type="checkbox"/> Information Disclosure Statement, PTO/SB/08. | 4. <input type="checkbox"/> _____ |

Part II SUMMARY OF ACTION

- 1a. Claims 1-3,5,6,8,9 and 14-18 are subject to reexamination.
1b. Claims 4,7 and 10-13 are not subject to reexamination.
2. Claims have been canceled in the present reexamination proceeding.
3. Claims 1-3,5 and 6 are patentable and/or confirmed.
4. Claims 8-9,14-18 are rejected.
5. Claims are objected to.
6. The drawings, filed on are acceptable.
7. The proposed drawing correction, filed on has been (7a) approved (7b) disapproved.
8. Acknowledgment is made of the priority claim under 35 U.S.C. § 119(a)-(d) or (f).
a) All b) Some* c) None of the certified copies have
1 been received.
2 not been received.
3 been filed in Application No.
4 been filed in reexamination Control No.
5 been received by the International Bureau in PCT application No.
* See the attached detailed Office action for a list of the certified copies not received.
9. Since the proceeding appears to be in condition for issuance of an *ex parte* reexamination certificate except for formal matters, prosecution as to the merits is closed in accordance with the practice under *Ex parte* Quayle, 1935 C.D. 11, 453 O.G. 213.
10. Other:

cc: Requester (if third party requester)

Art Unit: 3992

DETAILED ACTION

1) This Office action addresses claims 1-3, 5-6, 8-9, 14-18 of United States Patent Number 6,009,469 (Mattaway et al), for which it has been determined in the Order Granting Ex Parte Reexamination (hereafter the "Order") mailed 3/13/09 that a substantial new question of patentability was raised in the Request for *Ex Parte* reexamination filed on 2/26/09 (hereafter the "Request"). Claims 4, 7, 10-13 are not subject to reexamination. This is a final office action in response to the amendment filed 11/25/09. The rejection of claims 8, 9, 14-18 are maintained below. Amended claims 1-3 and 5-6 are allowable and/or confirmed below.

IDS

2) With regard to the IDS's filed 12/14/09, 12/16/09, 1/26/10, 2/24/10, 3/5/10, 5/6/10:

Where the IDS citations are submitted but not described, the examiner is only responsible for cursorily reviewing the references. The initials of the examiner on the PTO-1449 indicate only that degree of review unless the reference is either applied against the claims, or discussed by the examiner as pertinent art of interest, in a subsequent office action. See Guidelines for Reexamination of Cases in View of *In re Portola Packaging, Inc.*, 110 F.3d 786, 42 USPQ2d 1295 (Fed. Cir. 1997), 64 FR at 15347, 1223 Off. Gaz. Pat. Office at 125 (response to comment 6).

Consideration by the examiner of the information submitted in an IDS means that the examiner will consider the documents in the same manner as other documents in Office search files are considered by the examiner while conducting a search of the prior art in a proper field of search. The initials of the examiner placed adjacent to the citations on the PTO-1449 or PTO/SB/08A and 08B or its equivalent mean that the information has been considered by the examiner to the extent noted above.

Regarding IDS submissions MPEP 2256 recites the following: "Where patents, publications, and other such items of information are submitted by a party (patent owner or requester) in compliance with the requirements of the rules, the requisite degree of consideration to be given to such information will be normally limited by the degree to which the party filing the information citation has explained the content and relevance of the information."

Accordingly, the IDS submissions have been considered by the Examiner only with the scope required by MPEP 2256, unless otherwise noted.

In addition, that which are not either prior art patents or prior art printed publications have been crossed out so as not to appear reprinted on the front page of the patent.

Claim Rejection Paragraphs

3) *Claim Rejections - 35 USC § 103*

The following is a quotation of 35 U.S.C. 103(a) which forms the basis for all obviousness rejections set forth in this Office action:

(a) A patent may not be obtained though the invention is not identically disclosed or described as set forth in section 102 of this title, if the differences between the subject matter sought to be patented and the prior art are such that the subject matter as a whole would have been obvious at the time the invention was made to a person having ordinary skill in the art to which said subject matter pertains. Patentability shall not be negated by the manner in which the invention was made.

Issue 1

4) Claims 8-9, 14-15, and 17-18 are rejected under 35 U.S.C. 103(a) as being unpatentable by NetBIOS, further in view of Pinard.

Referring to **(Claim 8)**, NetBIOS teaches in a computer system having a display and capable of executing a process, a method for establishing a point-to-point communication from a caller process to a callee process over a computer network, the caller process capable of generating a user interface and being operatively connected to the callee process and a server process over the computer network (NetBIOS, pg. 356, 357, whereby the system is run on personal computers over TCP/IP networks, personal computers inherently containing a display), the method comprising the steps of: querying the server process to determine if the first callee process is accessible (NetBIOS, pg. 377, 388-389, 446, whereby a query is sent to the NBNS to determine if another node is logged in and discover the nodes IP address); and establishing a point-to-point communication link from the caller process to the first callee process (NetBIOS, pg. 397-400, whereby a point-point communication link is established between end nodes).

Art Unit: 3992

However, NetBIOS does not explicitly teach generating a user-interface element representing a first communication line, generating a user interface element representing a first callee process, and establishing the link in response to a user associating the element representing the first callee process with the element representing the first communication line

Pinard teaches a human machine interface for telephone feature invocation which is utilized on a personal computer and allows a user to make telephone calls by moving graphics around a screen. Pinard teaches a user interface element representing a first communication line and callee process (Pinard, Figure 6 and col. 5 lines 23-30), and also teaches clicking and dragging an icon representing a callee from a directory into a call setup icon to establish a call link (Pinard, Figure 3, col. 4 lines 38-51, Figure 6, col. 5 lines 36-37).

Therefore, it would have been obvious to one skilled in the art at the time the invention was made to utilizing the user-interface elements and interactions taught by Pinard in the invention taught by NetBIOS since Pinard teaches that the invention can be used with any system in which a personal computer in conjunction with a server operates (Pinard, col. 2 lines 43-46), since NetBIOS teaches that it can be implemented using different operating systems (NetBIOS, pg. 359), and since examiner notes that both NetBIOS and Pinard relate to communications between at least two users implemented in a computerized environment.

Referring to **(Claim 9)**, NetBIOS teaches the method of claim 8 wherein step C further comprises the steps of: querying the server process as to the on-line status of the first callee process (NetBIOS, pg. 377, 388-389, 446, 393-394, whereby name queries are used to discover if a node is connected and active); and receiving a network protocol address of the first callee

Art Unit: 3992

process over the computer network from the server process (NetBIOS, pg. 389, 440, 464-465, whereby the NBNS answers queries with a list of IP addresses of connected nodes).

Referring to **(Claims 14-15 and 17-18)**, NetBIOS teaches the above. However, NetBIOS does not explicitly teach generating a user interface element representing a communication line having a temporarily disabled status; and temporarily disabling the point-to-point communication between the caller process and the first callee process, in response to the user associating the element representing the first callee process with the element representing the communication line having a temporarily disabled status, wherein the element generated represents a communication line on hold status, wherein the display further comprises a visual display, and wherein the user interface is a graphic user interface and the user-interface elements generated in steps A and B are graphic elements.

Pinard teaches a “hard hold” icon to which caller/callees may be dragged to be put on hold status (Pinard, Figure 12, col. 6 lines 36-53), teaches a visual display (Pinard, col. 4 lines 10-11, Figure 2), and teaches a graphical user interface in which the elements are graphic elements (Pinard, Figures 2-16).

Therefore, it would have been obvious to one skilled in the art at the time the invention was made to utilizing the user-interface elements and interactions taught by Pinard in the invention taught by NetBIOS since Pinard teaches that the invention can be used with any system in which a personal computer in conjunction with a server operates (Pinard, col. 2 lines 43-46), since NetBIOS teaches that it can be implemented using different operating systems

Art Unit: 3992

(NetBIOS, pg. 359), and since examiner notes that both NetBIOS and Pinard relate to communications between at least two users implemented in a computerized environment.

5) Claim 16 is rejected under 35 U.S.C. 103(a) as being unpatentable by NetBIOS, further in view of Pinard, further in view of VocalChat User's Guide.

Referring to **(Claim 16)**, NetBIOS teaches the above. However, NetBIOS does not explicitly teach wherein the element generated represents a communication line on mute status.

VocalChat User's Guide teaches the use of a MUTE option on a phone so that a user can talk without being heard by the other user's system (VocalChat User's Guide, pg. 57).

Therefore, it would have been obvious to one skilled in the art at the time the invention was made to utilize an element representing a communication line on MUTE status in the invention taught by NetBIOS and Pinard above since all three references relate to the field of communications over a computer network, since VocalChat and Pinard utilize a computer system for telephony features specifically, and since examiner notes that the use of a MUTE feature in telephone conversations is old and well known in the art.

Issue 2

6) Examiner notes the following will represent the Etherphone references utilized for the rejection below (All considered a single reference as published together):

"Zellweger": An Overview of the Etherphone System and its Applications

"Swinehart": Telephone Management in the Etherphone System

"Terry": Managing Stored Voice in the Etherphone System

Art Unit: 3992

7) Claims 8-9, 14-15, and 17-18 are rejected under 35 U.S.C. 103(a) as being unpatentable by Etherphone, further in view of Pinard.

Referring to **(Claim 8)**, Etherphone teaches in a computer system having a display and capable of executing a process, a method for establishing a point-to-point communication from a caller process to a callee process over a computer network, the caller process capable of generating a user interface and being operatively connected to the callee process and a server process over the computer network (Zellweger, pg. 1, 3, Figure 1, Swinehart Figures 1-10), the method comprising the steps of: querying the server process to determine if the first callee process is accessible (Swinehart, pg. 2, 4, Zellweger, pg. 5, whereby a query is transmitted to determine the location of a second Etherphone by contacting a server); and establishing a point-to-point communication link from the caller process to the first callee process (Swinehart, pg. 2, Zellweger, Figure 4, whereby voice datagrams are transmitted directly among participants).

However, Etherphone does not explicitly teach generating a user-interface element representing a first communication line, generating a user interface element representing a first callee process, and establishing the link in response to a user associating the element representing the first callee process with the element representing the first communication line

Pinard teaches a human machine interface for telephone feature invocation which is utilized on a personal computer and allows a user to make telephone calls by moving graphics around a screen. Pinard teaches a user interface element representing a first communication line and callee process (Pinard, Figure 6 and col. 5 lines 23-30), and also teaches clicking and

Art Unit: 3992

dragging an icon representing a callee from a directory into a call setup icon to establish a call link (Pinard, Figure 3, col. 4 lines 38-51, Figure 6, col. 5 lines 36-37).

Therefore, it would have been obvious to one skilled in the art at the time the invention was made to utilizing the user-interface elements and interactions taught by Pinard in the invention taught by Etherphone since Pinard teaches that the invention can be used with any system in which a personal computer in conjunction with a server operates (Pinard, col. 2 lines 43-46), and since examiner notes that both Etherphone and Pinard relate to communications between at least two users implemented in a computerized environment.

Referring to **(Claim 9)**, Etherphone teaches the method of claim 8 wherein step C further comprises the steps of: querying the server process as to the on-line status of the first callee process (Swinehart, pg. 2, 4, Zellweger, pg. 5, whereby queries are transmitted to Voice Control Server); and receiving a network protocol address of the first callee process over the computer network from the server process (Swinehart, pg. 2, whereby the server sends the network protocol address of the logged in user to caller process on request).

Referring to **(Claims 14-15)**, Etherphone teaches the above. However, Etherphone does not explicitly teach generating a user interface element representing a communication line having a temporarily disabled status; and temporarily disabling the point-to-point communication between the caller process and the first callee process, in response to the user associating the element representing the first callee process with the element representing the communication

Art Unit: 3992

line having a temporarily disabled status, and wherein the element generated represents a communication line on hold status.

Pinard teaches a "hard hold" icon to which caller/callees may be dragged to be put on hold status (Pinard, Figure 12, col. 6 lines 36-53).

Therefore, it would have been obvious to one skilled in the art at the time the invention was made to utilizing the user-interface elements and interactions taught by Pinard in the invention taught by Etherphone since Pinard teaches that the invention can be used with any system in which a personal computer in conjunction with a server operates (Pinard, col. 2 lines 43-46), and since examiner notes that both Etherphone and Pinard relate to communications between at least two users implemented in a computerized environment.

Referring to **(Claims 17-18)**, Etherphone teaches wherein the display further comprises a visual display (Swinehart, Fig. 1-10, Zellweger, Fig. 3-4, whereby computer displays are considered visual displays), and wherein the user interface is a graphic user interface and the user-interface elements generated in steps A and B are graphic elements (Swinehart, Fig. 1-10, Zellweger, Fig. 3-4, whereby a GUI is used showing graphic elements of call display).

8) Claim 16 is rejected under 35 U.S.C. 103(a) as being unpatentable by Etherphone, further in view of Pinard, further in view of VocalChat User's Guide.

Referring to **(Claim 16)**, Etherphone teaches the above. However, Etherphone does not explicitly teach wherein the element generated represents a communication line on mute status.

Art Unit: 3992

VocalChat User's Guide teaches the use of a MUTE option on a phone so that a user can talk without being heard by the other user's system (VocalChat User's Guide, pg. 57).

Therefore, it would have been obvious to one skilled in the art at the time the invention was made to utilize an element representing a communication line on MUTE status in the invention taught by Etherphone and Pinard above since all three references relate to the field of communications over a computer network, since VocalChat and Pinard utilize a computer system for telephony features specifically, and since examiner notes that the use of a MUTE feature in telephone conversations is old and well known in the art.

Response to Arguments

9) In response to the amendment filed 11/25/09, some rejections are sustained as noted above, and others have been withdrawn. The following aspects of the current prosecution will be addressed as noted below:

- a) VocalChat are not printed publications.
 - b) The 1.132 Declaration
 - c) Objective evidence of non-obviousness
 - d) Withdrawn rejections
 - e) Maintained rejections
- a) The amendment submitted 11/25/09 includes arguments that the VocalChat references are not printed publications. The Patent Owner (PO) cites exhibit L of the Request (the declaration of Alon Cohen) as the only evidence provided by PO that the VocalChat references

Art Unit: 3992

are printed publications. Examiner notes that the Alon Cohen declaration fails to comply with 37 C.F.R. 1.68, including not setting forth in the body of the declaration that all statements made of the declarant's own knowledge are true and that all statements made on information and belief are believed to be true. Therefore, PO's arguments questioning the declaration as well as whether printed publication status has been established as set forth under statute are found persuasive. Examiner therefore withdraws all rejections utilizing the VocalChat references.

b) Examiner notes that all evidence presented has been considered in its entirety, including both PO's arguments, including secondary considerations, as well as the 1.132 Declaration submitted by expert Ketan Mayer-Patel.

c) Examiner notes that PO's arguments regarding objective evidence of non-obviousness, including commercial success and failure of others have been considered, however no nexus has been provided between the claimed invention and the submitted evidence as required by at least MPEP 716.03. Therefore, this evidence is not found persuasive.

d) In light of PO's arguments and amendments filed 11/25/09, as well as the declaration of expert Mayer-Patel, examiner withdraws the rejections of claims 1-3 and 5-6. Examiner finds the presented arguments to be persuasive.

With regard to the NetBios rejection, examiner agrees with declarant Mayer-Patel that bringing dynamic addressing into a NetBIOS type system would create a new set of obstacles that would need to be solved that are not obvious in view of the combination of references.

Art Unit: 3992

With regard to the rejection under Etherphone, examiner notes that a similar argument applies to Etherphone as to Netbios, namely that combining the system with dynamic addressing would create new, non obvious obstacles to overcome.

A reasons for confirmation for the claims discussed above will follow in a subsequent office action.

e) The rejection of claims 8, 9, 14-18 are maintained in view of NetBIOS and Etherphone.

With regard to the rejection of claim 8 under NetBIOS, maintained above:

Examiner first notes that claim 8 does not require any dynamic addressing limitations, unlike claims 1 and 5. Therefore, any arguments directed towards a combination with RFC 1531 do not apply to claim 8.

PO argues with regard to claim 8 that NetBIOS does not teach "determining if the first callee process is accessible". PO argues that having an "active name" is not synonymous with "determining if a first callee process is accessible", and that an "active name" simply refers to "a name that has been registered and that has not yet been de-registered". Examiner first notes that the term "accessible" is not specifically defined in PO's specification. Therefore, under a broadest reasonable interpretation, this limitation could simply mean that a user is registered with the system. In addition, examiner notes that PO's specification at col. 5 lines 39-44 teaches that the on-line status information may not always be current, and may be updated, for example, only every 24 hours based on operator configuration. Assuming a user being "accessible" is comparable to that user being "on-line", then the database of NetBIOS which contains active name information reads on claim 8, whether or not the user data is current.

Art Unit: 3992

PO also argues that NetBIOS does not teach “that the active status of a name in the NetBIOS server is an indication of the active status of the owner of that name”. However, examiner notes that claim 8 only requires connecting to a callee process, not necessarily to a particular name.

With regard to the rejection under Etherphone, maintained above:

PO argues with regard to claim 8 that if the Etherphone are “participants”, then “there is no indication that the combination meets the limitation of ‘the caller process capable of generating a user interface’”. Examiner notes that PO appears to be arguing that the Etherphones are not capable of generating user interfaces by themselves. If this is the case, examiner points to Zellweger, page 2. Zellweger teaches that workstations work in combination with the Etherphones and provided the enhanced user interface functionality. The Etherphones are only used separately to split up voice-processing functionality due to hardware processing requirements. Therefore, the caller process is a function of the workstation in combination with the Etherphone.

Therefore, the current arguments regarding claims 8-9 and 14-18 are not persuasive, and the rejections above are maintained.

Conclusion

THIS ACTION IS MADE FINAL.

Extensions of time under 37 CFR 1.136(a) do not apply in reexamination proceedings. The provisions of 37 CFR 1.136 apply only to "an applicant" and not to parties in a reexamination proceeding. Further, in 35 U.S.C. 305 and in 37 CFR 1.550(a), it is required that reexamination proceedings "will be conducted with special dispatch within the Office."

Extensions of time in reexamination proceedings are provided for in 37 CFR 1.550(c). A request for extension of time must be filed on or before the day on which a response to this action is due, and it must be accompanied by the petition fee set forth in 37 CFR 1.17(g). The mere filing of a request will not effect any extension of time. An extension of time will be granted only for sufficient cause, and for a reasonable time specified.

The filing of a timely first response to this final rejection will be construed as including a request to extend the shortened statutory period for an additional month, which will be granted even if previous extensions have been granted. In no event however, will the statutory period for response expire later than SIX MONTHS from the mailing date of the final action. See MPEP § 2265.

All correspondence relating to this ex parte reexamination proceeding should be directed as follows:

By U.S. Postal Service Mail to:

Mail Stop Ex Parte Reexam

Art Unit: 3992

ATTN: Central Reexamination Unit
Commissioner for Patents
P.O. Box 1450
Alexandria, VA 22313-1450

By FAX to:

(571) 273-9900
Central Reexamination Unit

By hand to:

Customer Service Window
Randolph Building
401 Dulany St.
Alexandria, VA 22314

By EFS-Web:

Registered users of EFS-Web may alternatively submit such correspondence via the electronic filing system EFS-Web, at

<https://sportal.uspto.gov/authenticate/authenticateuserlocalepf.html>

EFS-Web offers the benefit of quick submission to the particular area of the Office that needs to act on the correspondence. Also, EFS-Web submissions are "soft scanned" (i.e., electronically uploaded) directly into the official file for the reexamination proceeding, which offers parties the opportunity to review the content of their submissions after the "soft scanning" process is complete.

Any inquiry concerning this communication or earlier communications from the Reexamination Legal Advisor or Examiner, or as to the status of this proceeding, should be directed to the Central Reexamination Unit at telephone number (571) 272-7705.

/Alexander J Kosowski/

Primary Examiner, Art Unit 3992



ESK

INFORMATION DISCLOSURE STATEMENT BY APPLICANT FORM PTO-1449 (modified) Sheet 1 of 29	Reexam number	90/010,422
	First Named Inventor	Mattaway et al.
	Patent Under Re-Exam	6009469
	Issue Date	1999/12/28
	Group Art Unit	3992
	Examiner Name	KOSOWSKI, ALEXANDER J
	Attorney Docket No.	2655-0185
	Confirmation No.	6565

U.S. PATENT DOCUMENTS				
Examiner Initials*	Cite No.	Document No.	Publication/ Issue Date	Name of Patentee or Applicant of Cited Document
	1-1	US-2003/0050075	2003/13/03	Rangarajan et al.
	1-2	US-2004/0204146	2004/14/10	Deeds
	1-3	US-2005/0032435	2005/10/02	Tischer et al.
	1-4	US-2005/0130611	2005/16/06	Lu et al.
	1-5	US-4332982	1982/01/06	Thomas
	1-6	US-4410765	1983/18/10	Hestad et al.
	1-7	US-4446519	1984/01/05	Thomas
	1-8	US-4450554	1984/22/05	Steensma, et al.
	1-9	US-4468529	1984/28/08	Samuel et al.
	1-10	US-4528659	1985/09/07	Jones, Jr.
	1-11	US-4589107	1986/13/05	Middleton, et al.
	1-12	US-4594477	1986/10/06	Noirot
	1-13	US-4598397	1986/01/07	Nelson, et al.
	1-14	US-4630262	1986/16/12	Callens, et al.
	1-15	US-4652703	1987/24/03	Lu, et al.
	1-16	US-4654483	1987/03	Imai et al.
	1-17	US-4694492	1987/09	Wirstrom et al.
	1-18	US-4740963	1988/26/04	Eckley
	1-19	US-4782485	1988/01/11	Gollub
	1-20	US-4799153	1989/01	Hann et al.
	1-21	US-4809271	1989/28/02	Kondo, et al.
	1-22	US-4813040	1989/14/03	Futato
	1-23	US-4819228	1989/04/04	Baran, et al.
	1-24	US-4821263	1989/04	Lundh

Examiner Signature	/Alexander Kosowski/	Date Considered	05/06/2010
--------------------	----------------------	-----------------	------------

*Examiner: Initial if reference was considered, whether or not citation is in conformance with MPEP 609. Draw a line through citation if not in conformance and not considered. Include a copy of this form with next communication to applicant.

INFORMATION DISCLOSURE STATEMENT BY APPLICANT FORM PTO-1449 (modified) Sheet 2 of 29	Reexam number	90/010,422
	First Named Inventor	Mattaway et al.
	Patent Under Re-Exam	6009469
	Issue Date	1999/12/28
	Group Art Unit	3992
	Examiner Name	KOSOWSKI, ALEXANDER J
	Attorney Docket No.	2655-0185
	Confirmation No.	6565

U.S. PATENT DOCUMENTS				
Examiner Initials*	Cite No.	Document No.	Publication/ Issue Date	Name of Patentee or Applicant of Cited Document
	2-1	US-4829554	1989/09/05	Barnes et al.
	2-2	US-4837797	1989/06	Freeny, Jr., Charles C.
	2-3	US-4866704	1989/12/09	Bergman
	2-4	US-4866732	1989/12/09	Carey, et al.
	2-5	US-4873715	1989/10/10	Shibata
	2-6	US-4887265	1989/12/12	Felix
	2-7	US-4890282	1989/26/12	Lambert, et al.
	2-8	US-4912705	1990/27/03	Paneth, et al.
	2-9	US-4932022	1990/05/06	Keeney, et al.
	2-10	US-4981371	1991/01/01	Gurak, et al.
	2-11	US-4989230	1991/29/01	Gillig et al.
	2-12	US-4995074	1991/02	Goldman et al.
	2-13	US-5031089	1991/07	Liu et al.
	2-14	US-5036513	1991/30/07	Greenblatt
	2-15	US-5040141	1991/13/08	Yazima et al
	2-16	US-5056140	1991/10	Kimbell
	2-17	US-5065425	1991/12/11	Lecomte, et al.
	2-18	US-5107443	1992/04	Smith et al.
	2-19	US-5121385	1992/09/06	Tominaga, et al.
	2-20	US-5127003	1992/30/06	Dell Jr. et al
	2-21	US-5130985	1992/14/07	Kondo, et al.
	2-22	US-5150410	1992/22/09	Bertrand
	2-23	US-5155726	1992/13/10	Spinney, et al.
	2-24	US-5157592	1992/20/10	Walters

Examiner Signature		Date Considered	
--------------------	--	-----------------	--

*Examiner: Initial if reference was considered, whether or not citation is in conformance with MPEP 609. Draw a line through citation if not in conformance and not considered. Include a copy of this form with next communication to applicant.

ALL REFERENCES CONSIDERED EXCEPT WHERE LINED THROUGH. /AK/

INFORMATION DISCLOSURE STATEMENT BY APPLICANT FORM PTO-1449 (modified)	Reexam number	90/010,422
	First Named Inventor	Mattaway et al.
	Patent Under Re-Exam	6009469
	Issue Date	1999/12/28
	Group Art Unit	3992
	Examiner Name	KOSOWSKI, ALEXANDER J
	Attorney Docket No.	2655-0185
	Confirmation No.	6565

Sheet 3 of 29

U.S. PATENT DOCUMENTS				
Examiner Initials*	Cite No.	Document No.	Publication/ Issue Date	Name of Patentee or Applicant of Cited Document
	3-1	US-5187591	1993/16/02	Guy, et al.
	3-2	US-5212789	1993/18/05	Rago
	3-3	US-5214650	1993/25/05	Renner, et al.
	3-4	US-5220599	1993/06	Sasano et al
	3-5	US-5241594	1993/31/08	Kung
	3-6	US-5241625	1993/08	Epard et al.
	3-7	US-5247620	1993/09/21	Fukuzawa et al.
	3-8	US-5249290	1993/28/09	Heizer
	3-9	US-5274635	1993/12	Rahman et al.
	3-10	US-5282197	1994/25/01	Kreitzer
	3-11	US-5283819	1994/01/02	Glick, et al.
	3-12	US-5287103	1994/15/02	Kasprzyk Marlon Z et al
	3-13	US-5305312	1994/19/04	Fornek, et al.
	3-14	US-5327486	1994/07	Wolff et al.
	3-15	US-5335276	1994/02/08	Thompson et al.
	3-16	US-5341374	1994/23/08	Lewen et al.
	3-17	US-5347632	1994/09	Filepp et al.
	3-18	US-5377260	1994/12	Long
	3-19	US-5396485	1995/03	Ohno et al.
	3-20	US-5410754	1994/15/02	Favreau Keith et al
	3-21	US-5428608	1995/06	Freeman et al.
	3-22	US-5440547	1995/08/08	Esaki Hiroshi et al
	3-23	US-5446891	1995/29/08	Kaplan et al.
	3-24	US-5446919	1995/29/08	Wikins

Examiner Signature		Date Considered	
--------------------	--	-----------------	--

*Examiner: Initial if reference was considered, whether or not citation is in conformance with MPEP 609. Draw a line through citation if not in conformance and not considered. Include a copy of this form with next communication to applicant.

ALL REFERENCES CONSIDERED EXCEPT WHERE LINED THROUGH. /AK/

INFORMATION DISCLOSURE STATEMENT BY APPLICANT FORM PTO-1449 (modified) Sheet 4 of 29	Reexam number	90/010,422
	First Named Inventor	Mattaway et al.
	Patent Under Re-Exam	6009469
	Issue Date	1999/12/28
	Group Art Unit	3992
	Examiner Name	KOSOWSKI, ALEXANDER J
	Attorney Docket No.	2655-0185
	Confirmation No.	6565

U.S. PATENT DOCUMENTS

Examiner Initials*	Cite No.	Document No.	Publication/ Issue Date	Name of Patentee or Applicant of Cited Document
	4-1	US-5459864	1995/10	Brent et al.
	4-2	US-5461611	1995/10	Drake, Jr. et al.
	4-3	US-5467388	1995/11	Redd et al.
	4-4	US-5473531	1995/10	Flora-Holmquist et al.
	4-5	US-5474741	1995/12/12	Mikeska et al.
	4-6	US-5474819	1995/12/12	Chambers et al.
	4-7	US-5483524	1996/01	Lev et al.
	4-8	US-5487100	1996/01	Kane
	4-9	US-5491800	1996/13/02	Goldsmith et al.
	4-10	US-5500890	1996/03	Rogge et al.
	4-11	US-5517432	1996/05	Chandra et al.
	4-12	US-5528671	1996/18/06	Ryu et al.
	4-13	US-5533102	1996/02/07	Robinson et al.
	4-14	US-5544164	1996/08	Baran
	4-15	US-5544322	1996/06/08	Cheng et al.
	4-16	US-5546448	1996/08	Caswell et al.
	4-17	US-5546452	1996/13/08	Andrews et al.
	4-18	US-5548636	1996/08	Bannister et al.
	4-19	US-5548694	1996/08	Frissen Gibson
	4-20	US-5563882	1996/10	Bruno et al.
	4-21	US-5572643	1996/11	Judson, David H.
	4-22	US-5574774	1996/11	Ahlberg et al.
	4-23	US-5574934	1996/12/11	Mirashrafi et al.
	4-24	US-5581522	1996/12/03	Shibuya et al.

Examiner Signature		Date Considered	
--------------------	--	-----------------	--

*Examiner: Initial if reference was considered, whether or not citation is in conformance with MPEP 609. Draw a line through citation if not in conformance and not considered. Include a copy of this form with next communication to applicant.

INFORMATION DISCLOSURE STATEMENT BY APPLICANT FORM PTO-1449 (modified)	Reexam number	90/010,422
	First Named Inventor	Mattaway et al.
	Patent Under Re-Exam	6009469
	Issue Date	1999/12/28
	Group Art Unit	3992
	Examiner Name	KOSOWSKI, ALEXANDER J
	Attorney Docket No.	2655-0185
	Confirmation No.	6565
Sheet 5 of 29		

U.S. PATENT DOCUMENTS				
Examiner Initials*	Cite No.	Document No.	Publication/ Issue Date	Name of Patentee or Applicant of Cited Document
	5-1	US-5581702	1996/12	McArdle et al.
	5-2	US-5586257	1996/17/12	Perlman
	5-3	US-5586260	1996/17/12	Hu
	5-4	US-5591800	1996/02	Goldsmith et al.
	5-5	US-5604737	1997/02	Iwami et al.
	5-6	US-5606669	1997/25/02	Bertin et al.
	5-7	US-5614940	1997/25/03	Cobbley et al.
	5-8	US-5619557	1997/08/04	Van Berkum
	5-9	US-5623483	1997/22/04	Agrawal et al.
	5-10	US-5623490	1997/04	Richter et al.
	5-11	US-5623605	1997/22/04	Keshav et al.
	5-12	US-5625407	1997/29/04	Biggs et al.
	5-13	US-5636282	1997/06	Holmquist et al.
	5-14	US-5636346	1997/06	Saxe
	5-15	US-5642156	1997/24/06	Saiki
	5-16	US-5644629	1997/07	Chow
	5-17	US-5651006	1997/07	Fujino et al.
	5-18	US-5652759	1997/07	Stringfellow, Jr.
	5-19	US-5655120	1997/08	Witte et al.
	5-20	US-5659542	1997/08	Bell et al.
	5-21	US-5659596	1997/19/08	Dunn
	5-22	US-5668862	1997/09	Bannister et al.
	5-23	US-5671428	1997/23/09	Muranaga et al.
	5-24	US-5675507	1997/10	Bobo

Examiner Signature		Date Considered	
--------------------	--	-----------------	--

*Examiner: Initial if reference was considered, whether or not citation is in conformance with MPEP 609. Draw a line through citation if not in conformance and not considered. Include a copy of this form with next communication to applicant.

ALL REFERENCES CONSIDERED EXCEPT WHERE LINED THROUGH. /AK/

INFORMATION DISCLOSURE STATEMENT BY APPLICANT FORM PTO-1449 (modified)	Reexam number	90/010,422
	First Named Inventor	Mattaway et al.
	Patent Under Re-Exam	6009469
	Issue Date	1999/12/28
	Group Art Unit	3992
	Examiner Name	KOSOWSKI, ALEXANDER J
	Attorney Docket No.	2655-0185
Sheet 6 of 29	Confirmation No.	6565

U.S. PATENT DOCUMENTS				
Examiner Initials*	Cite No.	Document No.	Publication/ Issue Date	Name of Patentee or Applicant of Cited Document
	6-1	US-5680392	1997/10	Semaan
	6-2	US-5684800	1997/11	Dobbins et al.
	6-3	US-5689553	1997/18/11	Ahuja et al.
	6-4	US-5692192	1997/11	Sudo
	6-5	US-5694594	1997/02/12	Chang
	6-6	US-5701463	1997/23/12	Malcolm
	6-7	US-5708422	1998/13/01	Blonder et al.
	6-8	US-5708655	1998/01	Toth et al.
	6-9	US-5710884	1998/20/01	Dedrick
	6-10	US-5717923	1998/10/02	Dedrick
	6-11	US-5719786	1998/02	Nelson et al.
	6-12	US-5721827	1998/24/02	Logan et al.
	6-13	US-5724092	1998/03/03	Davidsohn et al.
	6-14	US-5724412	1998/03	Srinivasan
	6-15	US-5724506	1998/03/03	Cleron et al.
	6-16	US-5726984	1998/10/03	Kubler et al.
	6-17	US-5729748	1998/03	Robbins et al.
	6-18	US-5732078	1998/03	Arango
	6-19	US-5736968	1998/04	Tsakiris, Alexander L.
	6-20	US-5742668	1998/04	Pepe et al.
	6-21	US-5742675	1998/21/04	Kilander et al.
	6-22	US-5742762	1998/21/04	Scholl et al.
	6-23	US-5742905	1998/04	Pepe et al.
	6-24	US-5745642	1998/28/04	Ahn

Examiner Signature		Date Considered	
--------------------	--	-----------------	--

*Examiner: Initial if reference was considered, whether or not citation is in conformance with MPEP 609. Draw a line through citation if not in conformance and not considered. Include a copy of this form with next communication to applicant.

INFORMATION DISCLOSURE STATEMENT BY APPLICANT FORM PTO-1449 (modified)	Reexam number	90/010,422
	First Named Inventor	Mattaway et al.
	Patent Under Re-Exam	6009469
	Issue Date	1999/12/28
	Group Art Unit	3992
	Examiner Name	KOSOWSKI, ALEXANDER J
	Attorney Docket No.	2655-0185
Sheet 7 of 29	Confirmation No.	6565

U.S. PATENT DOCUMENTS				
Examiner Initials*	Cite No.	Document No.	Publication/ Issue Date	Name of Patentee or Applicant of Cited Document
	7-1	US-5745702	1998/04	Morozumi
	7-2	US-5745711	1998/04	Kitahara et al.
	7-3	US-5751712	1998/05	Farwell et al.
	7-4	US-5751961	1998/05	Smyk
	7-5	US-5754636	1998/05	Bayless et al.
	7-6	US-5754939	1998/19/05	Herz et al.
	7-7	US-5758110	1998/05	Boss et al.
	7-8	US-5758257	1998/26/03	Herz et al.
	7-9	US-5761606	1998/06	Wolzien
	7-10	US-5764736	1998/06	Shachar et al.
	7-11	US-5764741	1998/09/06	Barak
	7-12	US-5764756	1998/09/06	Onweller
	7-13	US-5767897	1998/16/06	Howell
	7-14	US-5768527	1998/06	Zhu et al.
	7-15	US-5771355	1998/23/06	Kuzma
	7-16	US-5774660	1998/30/06	Brendel et al.
	7-17	US-5774666	1998/30/06	Portuesi
	7-18	US-5778181	1998/07	Hidary et al.
	7-19	US-5778187	1998/07	Monteiro et al.
	7-20	US-5784564	1998/21/07	Camaisa et al.
	7-21	US-5784619	1998/21/07	Evans et al.
	7-22	US-5787253	1998/07	McCreery et al.
	7-23	US-5790548	1998/08	Sistanizadeh et al.
	7-24	US-5790792	1998/08	Dudgeon et al.

Examiner Signature		Date Considered	
--------------------	--	-----------------	--

*Examiner: Initial if reference was considered, whether or not citation is in conformance with MPEP 609. Draw a line through citation if not in conformance and not considered. Include a copy of this form with next communication to applicant.

ALL REFERENCES CONSIDERED EXCEPT WHERE LINED THROUGH. /AK/

INFORMATION DISCLOSURE STATEMENT BY APPLICANT FORM PTO-1449 (modified) Sheet 8 of 29	Reexam number	90/010,422
	First Named Inventor	Mattaway et al.
	Patent Under Re-Exam	6009469
	Issue Date	1999/12/28
	Group Art Unit	3992
	Examiner Name	KOSOWSKI, ALEXANDER J
	Attorney Docket No.	2655-0185
	Confirmation No.	6565

U.S. PATENT DOCUMENTS				
Examiner Initials*	Cite No.	Document No.	Publication/ Issue Date	Name of Patentee or Applicant of Cited Document
	8-1	US-5790793	1998/08	Higley
	8-2	US-5793365	1998/11/08	Tang et al.
	8-3	US-5794018	1998/08	Vrvilo et al.
	8-4	US-5794257	1998/08	Liu et al.
	8-5	US-5796394	1998/08	Wicks et al.
	8-6	US-5799063	1998/08	Krane
	8-7	US-5799072	1998/08	Vulcan et al.
	8-8	US-5799150	1998/08	Hamilton et al.
	8-9	US-5805587	1998/09	Norris et al.
	8-10	US-5805810	1998/09	Maxwell
	8-11	US-5805822	1998/08/09	Long et al.
	8-12	US-5809233	1998/15/09	Shur
	8-13	US-5812819	1998/22/08	Rodwin et al.
	8-14	US-5816919	1998/10	Scagnelli et al.
	8-15	US-5818510	1998/10	Cobbley et al.
	8-16	US-5818836	1998/10	DuVal
	8-17	US-5822524	1998/10	Chen et al.
	8-18	US-5828837	1998/10	Eikeland
	8-19	US-5828843	1998/27/10	Grimm et al.
	8-20	US-5828846	1998/10	Kirby et al.
	8-21	US-5832119	1998/11	Rhoads
	8-22	US-5832240	1998/11	Larsen et al.
	8-23	US-5835720	1998/10/11	Nelson et al.
	8-24	US-5835723	1998/11	Andrews et al.

Examiner Signature		Date Considered	
--------------------	--	-----------------	--

*Examiner: Initial if reference was considered, whether or not citation is in conformance with MPEP 609. Draw a line through citation if not in conformance and not considered. Include a copy of this form with next communication to applicant.

ALL REFERENCES CONSIDERED EXCEPT WHERE LINED THROUGH. /AK/

INFORMATION DISCLOSURE STATEMENT BY APPLICANT FORM PTO-1449 (modified)	Reexam number	90/010,422
	First Named Inventor	Mattaway et al.
	Patent Under Re-Exam	6009469
	Issue Date	1999/12/28
	Group Art Unit	3992
	Examiner Name	KOSOWSKI, ALEXANDER J
	Attorney Docket No.	2655-0185
	Confirmation No.	6565
Sheet 9 of 29		

U.S. PATENT DOCUMENTS				
Examiner Initials*	Cite No.	Document No.	Publication/ Issue Date	Name of Patentee or Applicant of Cited Document
	9-1	US-5835725	1998/10/11	Chiang et al.
	9-2	US-5838683	1998/11	Corley et al.
	9-3	US-5838970	1998/17/11	Thomas
	9-4	US-5841769	1998/11	Okanoue et al.
	9-5	US-5842216	1998/11	Anderson et al.
	9-6	US-5848143	1998/08/12	Andrews et al.
	9-7	US-5848396	1998/12	Gerace
	9-8	US-5854901	1998/12	Cole et al.
	9-9	US-5857072	1999/01	Crowle
	9-10	US-5864684	1999/26/01	Nielsen
	9-11	US-5867156	1999/02	Beard et al.
	9-12	US-5867654	1999/02/02	Ludwig et al.
	9-13	US-5867665	1999/02/02	Butman et al.
	9-14	US-5872850	1999/16/02	Klein et al.
	9-15	US-5872922	1999/02	Hogan et al.
	9-16	US-5872972	1999/02	Boland et al.
	9-17	US-5884032	1999/03	Bateman et al.
	9-18	US-5884035	1999/16/03	Butman et al.
	9-19	US-5884077	1999/03	Suzuki
	9-20	US-5890162	1999/03	Huckins
	9-21	US-5892825	1999/06/04	Mages et al.
	9-22	US-5892903	1999/06/04	Klaus
	9-23	US-5892924	1999/04	Lyon et al.
	9-24	US-5903721	1999/11/05	Sixtus

Examiner Signature		Date Considered	
--------------------	--	-----------------	--

*Examiner: Initial if reference was considered, whether or not citation is in conformance with MPEP 609. Draw a line through citation if not in conformance and not considered. Include a copy of this form with next communication to applicant.

ALL REFERENCES CONSIDERED EXCEPT WHERE LINED THROUGH. /AK/

INFORMATION DISCLOSURE STATEMENT BY APPLICANT FORM PTO-1449 (modified)	Reexam number	90/010,422
	First Named Inventor	Mattaway et al.
	Patent Under Re-Exam	6009469
	Issue Date	1999/12/28
	Group Art Unit	3992
	Examiner Name	KOSOWSKI, ALEXANDER J
	Attorney Docket No.	2655-0185
	Confirmation No.	6565
Sheet 10 of 29		

U.S. PATENT DOCUMENTS				
Examiner Initials*	Cite No.	Document No.	Publication/ Issue Date	Name of Patentee or Applicant of Cited Document
	10-1	US-5903723	1999/11/05	Beck et al.
	10-2	US-5903727	1999/11/05	Nielsen
	10-3	US-5905719	1999/05	Arnold et al.
	10-4	US-5905736	1999/18/05	Ronen et al.
	10-5	US-5905865	1999/05	Palmer et al.
	10-6	US-5905872	1999/05	DeSimone et al.
	10-7	US-5915001	1999/06	Uppaluru
	10-8	US-5923736	1999/07	Shachar, Yuval
	10-9	US-5924093	1999/07	Potter et al.
	10-10	US-5925103	1999/10/07	Magallanes et al.
	10-11	US-5928327	1999/07	Wang et al.
	10-12	US-5929849	1999/07	Kikinis
	10-13	US-5937162	1999/08	Funk et al.
	10-14	US-5946386	1999/08	Rogers et al.
	10-15	US-5946629	1999/08	Sawyer et al.
	10-16	US-5950123	1999/09	Schwelb et al.
	10-17	US-5950172	1999/09	Klingman
	10-18	US-5956482	1999/09	Agraharam et al.
	10-19	US-5961584	1999/10	Wolf
	10-20	US-5964872	1999/12/10	Turpin
	10-21	US-5969967	1999/10	Aahlad et al.
	10-22	US-5982774	1999/11	Foladare et al
	10-23	US-5983005	1999/11	Monteiro et al.
	10-24	US-5999965	1999/07/12	Kelly

Examiner Signature		Date Considered	
--------------------	--	-----------------	--

*Examiner: Initial if reference was considered, whether or not citation is in conformance with MPEP 609. Draw a line through citation if not in conformance and not considered. Include a copy of this form with next communication to applicant.

ALL REFERENCES CONSIDERED EXCEPT WHERE LINED THROUGH. /AK/

INFORMATION DISCLOSURE STATEMENT BY APPLICANT FORM PTO-1449 (modified)	Reexam number	90/010,422
	First Named Inventor	Mattaway et al.
	Patent Under Re-Exam	6009469
	Issue Date	1999/12/28
	Group Art Unit	3992
	Examiner Name	KOSOWSKI, ALEXANDER J
	Attorney Docket No.	2655-0185
Sheet 11 of 29	Confirmation No.	6565

U.S. PATENT DOCUMENTS				
Examiner Initials*	Cite No.	Document No.	Publication/ Issue Date	Name of Patentee or Applicant of Cited Document
	11-1	US-6005870	1999/21/12	Leung
	11-2	US-6006257	1999/12	Slezak
	11-3	US-6014379	2000/01	White et al.
	11-4	US-6014710	2000/01	Talluri et al.
	11-5	US-6016393	2000/18/01	White et al.
	11-6	US-6018768	2000/01	Ullman et al.
	11-7	US-6018771	2000/25/01	Hayden
	11-8	US-6021126	2000/02	White et al.
	11-9	US-6026086	2000/02	Lancelot et al.
	11-10	US-6026425	2000/02	Suguri et al.
	11-11	US-6029175	2000/22/02	Chow et al.
	11-12	US-6032192	2000/29/02	Wegner et al.
	11-13	US-6041345	2000/03	Levi et al.
	11-14	US-6047292	2000/04/04	Kelly et al.
	11-15	US-6055594	2000/04	Lo et al.
	11-16	US-6061716	2000/05	Moncreiff
	11-17	US-6064975	2000/05	Moon et al.
	11-18	US-6065048	2000/16/05	Highley
	11-19	US-6069890	2000/30/05	White et al.
	11-20	US-6085217	2000/07	Ault et al.
	11-21	US-6101182	2000/08	Sistanizadeh et al.
	11-22	US-6105053	2000/08	Kimmel et al.
	11-23	US-6122255	2000/09	Bartholomew et al.
	11-24	US-6125113	2000/09	Farris et al.

Examiner Signature		Date Considered	
--------------------	--	-----------------	--

*Examiner: Initial if reference was considered, whether or not citation is in conformance with MPEP 609. Draw a line through citation if not in conformance and not considered. Include a copy of this form with next communication to applicant.

ALL REFERENCES CONSIDERED EXCEPT WHERE LINED THROUGH. /AK/

INFORMATION DISCLOSURE STATEMENT BY APPLICANT FORM PTO-1449 (modified)	Reexam number	90/010,422
	First Named Inventor	Mattaway et al.
	Patent Under Re-Exam	6009469
	Issue Date	1999/12/28
	Group Art Unit	3992
	Examiner Name	KOSOWSKI, ALEXANDER J
	Attorney Docket No.	2655-0185
Sheet 12 of 29	Confirmation No.	6565

U.S. PATENT DOCUMENTS

Examiner Initials*	Cite No.	Document No.	Publication/ Issue Date	Name of Patentee or Applicant of Cited Document
	12-1	US-6137877	2000/24/10	Robin et al.
	12-2	US-6141341	2000/31/10	Jones et al.
	12-3	US-6151643	2000/11	Cheng et al.
	12-4	US-6154445	2000/11	Farris et al.
	12-5	US-6163316	2000/12	Killian
	12-6	US-6173044	2001/01	Hortensius et al.
	12-7	US-6178453	2001/23/01	Mattaway et al.
	12-8	US-6181689	2001/01	Choung et al.
	12-9	US-6185184	2001/06/02	Mattaway et al.
	12-10	US-6188677	2001/02	Oyama et al.
	12-11	US-6195357	2001/02	Polcyn
	12-12	US-6198303	2001/03	Rangasayee
	12-13	US-6205135	2001/20/03	Chinni et al.
	12-14	US-6212625	2001/04	Russell
	12-15	US-6226678	2001/05	Mattaway et al.
	12-16	US-6226690	2001/05	Banda et al.
	12-17	US-6240444	2001/05	Fin et al.
	12-18	US-6243373	2001/06	Turock
	12-19	US-6266539	2001/07	Pardo
	12-20	US-6275490	2001/14/08	Mattaway et al.
	12-21	US-6282272	2001/08	Noonen et al.
	12-22	US-6289369	2001/11/09	Sundaresan
	12-23	US-6300863	2001/10	Cotichini et al.
	12-24	US-6338078	2002/01	Chang et al.

Examiner Signature		Date Considered	
--------------------	--	-----------------	--

*Examiner: Initial if reference was considered, whether or not citation is in conformance with MPEP 609. Draw a line through citation if not in conformance and not considered. Include a copy of this form with next communication to applicant.

ALL REFERENCES CONSIDERED EXCEPT WHERE LINED THROUGH. /AK/

INFORMATION DISCLOSURE STATEMENT BY APPLICANT FORM PTO-1449 (modified)	Reexam number	90/010,422
	First Named Inventor	Mattaway et al.
	Patent Under Re-Exam	6009469
	Issue Date	1999/12/28
	Group Art Unit	3992
	Examiner Name	KOSOWSKI, ALEXANDER J
	Attorney Docket No.	2655-0185
	Confirmation No.	6565

Sheet 13 of 29

U.S. PATENT DOCUMENTS				
Examiner Initials*	Cite No.	Document No.	Publication/ Issue Date	Name of Patentee or Applicant of Cited Document
	13-1	US-6343115	2002/01	Foladare et al.
	13-2	US-6343220	2002/29/01	Van Der Salm
	13-3	US-6347085	2002/02	Kelly
	13-4	US-6347342	2002/02	Marcos et al.
	13-5	US-6377568	2002/04	Kelly
	13-6	US-6385583	2002/05	Ladd et al.
	13-7	US-6393455	2002/05	Eilert et al.
	13-8	US-6427064	2002/07	Henderson, Daniel
	13-9	US-6434552	2002/08	Leong, Jin Fye
	13-10	US-6463565	2002/08/10	Keith C. Kelly
	13-11	US-6477586	2002/11	Achenson et al.
	13-12	US-6594254	2003/15/07	Kelly
	13-13	US-6687738	2004/03/02	Glenn W. Hutton
	13-14	US-6704802	2004/03	Finch et al.
	13-15	US-6728784	2004/27/04	Mattaway
	13-16	US-6772335	2004/08	Curtis et al.
	13-17	US-6829645	2004/07/12	Glenn W. Hutton
	13-18	US-6888836	2005/03/05	Cherkasova
	13-19	US-6909708	2005/06	Krishnaswamy et al.
	13-20			
	13-21			
	13-22			
	13-23			
	13-24			

Examiner Signature		Date Considered	
--------------------	--	-----------------	--

*Examiner: Initial if reference was considered, whether or not citation is in conformance with MPEP 609. Draw a line through citation if not in conformance and not considered. Include a copy of this form with next communication to applicant.

ALL REFERENCES CONSIDERED EXCEPT WHERE LINED THROUGH. /AK/

INFORMATION DISCLOSURE STATEMENT BY APPLICANT FORM PTO-1449 (modified) Sheet 14 of 29	Reexam number	90/010,422
	First Named Inventor	Mattaway et al.
	Patent Under Re-Exam	6009469
	Issue Date	1999/12/28
	Group Art Unit	3992
	Examiner Name	KOSOWSKI, ALEXANDER J
	Attorney Docket No.	2655-0185
	Confirmation No.	6565

FOREIGN PATENT DOCUMENTS					
Examiner Initials*	Cite No.	Document No.	Publication Date	Name of Patentee or Applicant of Cited Document	Notes
	14-1	AU-200059377-A1	11-23-2000	Glenn W. Hutton et al.	
	14-2	AU-200059378-A1	11-30-2000	Glenn W. Hutton et al.	
	14-3	AU-200059379-A1	11-23-2000	Glenn W. Hutton et al.	
	14-4	EP-0518596	12/16/1992	Digital Equipment Corp	
	14-5	EP-0559047	09-1993	Iglehart	
	14-6	EP-0597691	05/18/1994	IBM	
	14-7	EP-0632672	01/04/1995	IBM	
	14-8	EP-0648038	04/12/1995	IBM	
	14-9	EP-1379039-A2	01-07-2004	Glenn W. Hutton	
	14-10	EP-1379050-A2	01-07-2004	Glenn W. Hutton	
	14-11	GB-2283645	05/10/1995	Digital Equipment Int.	
	14-12	JP 63-131637	3/6/1988	Y. Takehiko (w/ English abstract)	T
	14-13	JP 6-62020 (w/ SOR and EA)	1994/03/04	Masatoshi et al.	
	14-14	JP-5944140	03-12-1984	Junichi Kimura et al.	T
	14-15	WO-9422087	09/29/1994	3Com Corp	
	14-16	WO-9714234	04-17-1997	Glenn W. Hutton	
	14-17	WO-9811704	03/19/1998	Don Joon Lee et al.	
	14-18				
	14-19				
	14-20				
	14-21				
	14-22				
	14-23				
	14-24				

Examiner Signature		Date Considered	
--------------------	--	-----------------	--

*Examiner: Initial if reference was considered, whether or not citation is in conformance with MPEP 609. Draw a line through citation if not in conformance and not considered. Include a copy of this form with next communication to applicant. Notes: If identified, the following is provided: EA = English Abstract, T = Translation, PF = Patent Family.

ALL REFERENCES CONSIDERED EXCEPT WHERE LINED THROUGH. /AK/

INFORMATION DISCLOSURE STATEMENT BY APPLICANT FORM PTO-1449 (modified)	Reexam number	90/010,422
	First Named Inventor	Mattaway et al.
	Patent Under Re-Exam	6009469
	Issue Date	1999/12/28
	Group Art Unit	3992
	Examiner Name	KOSOWSKI, ALEXANDER J
	Attorney Docket No.	2655-0185
Sheet 15 of 29	Confirmation No.	6565

NON-PATENT REFERENCES			
Examiner Initials*	Cite No.	Non-patent Reference bibliographic information, where available	Notes
	15-1	"Circuit Switching", Ericsson, last published July 5, 2001, found at http://www.ericsson.com/multiservicenetworks/circuitswitching/axe/ printed on August 1, 2001, 2 pages.	
	15-2	"Data Communication Over the Telephone Network", International Telecommunication Union, CCITT The International Telegraph and Telephone Consultative Committee, Blue Book, Volume VIII - Fascicle VIII.1. IXth Plenary Assembly, Melbourne, November 14-25, 1988, pages 296-370	
	15-3	"Full Duplex Speakerphone", IBM Technical Disclosure Bulletin, Vol. 29, No. 12, May 1987, pages 5599-5602	
	15-4	"ICL OPD - One Per Desk", Issue 01 August 1990, A Comprehensive Technical Information Document (24 pages)	
	15-5	"Information Processing Techniques Program. Volume II. Wideband Integrated Voice/Data Technology" Semiannual Technical Summary Report, Massachusetts Institute of Technology Lexington, MA, 1 October 1977 - 31 March 1978. Issued 31 August 1978, pages 1-25 and 27-31, ADA067014	
	15-6	"Integrated Voice/Data PABX Communications", IBM Technical Disclosure Bulletin, September 1986, http://patents.ibm.com	
	15-7	"Level 1-5 of 65 Stories" 1990 Network World, Inc., April 16, 1990, pages 114-115	

Examiner Signature		Date Considered	
--------------------	--	-----------------	--

*Examiner: Initial if reference was considered, whether or not citation is in conformance with MPEP 609. Draw a line through citation if not in conformance and not considered. Include a copy of this form with next communication to applicant. Notes: If identified, the following is provided: EA = English Abstract, T = Translation, PF = Patent Family.

ALL REFERENCES CONSIDERED EXCEPT WHERE LINED THROUGH. /AK/

INFORMATION DISCLOSURE STATEMENT BY APPLICANT FORM PTO-1449 (modified)	Reexam number	90/010,422
	First Named Inventor	Mattaway et al.
	Patent Under Re-Exam	6009469
	Issue Date	1999/12/28
	Group Art Unit	3992
	Examiner Name	KOSOWSKI, ALEXANDER J
	Attorney Docket No.	2655-0185
	Confirmation No.	6565

Sheet 16 of 29

NON-PATENT REFERENCES			
Examiner Initials*	Cite No.	Non-patent Reference bibliographic information, where available	Notes
	16-1	"Multi-Service Networks", Ericsson, last published June 27, 2001, found at http://www.ericsson.com/multiservicenetworks/circuitswitching/ printed on August 1, 2001, 2 pages.	
	16-2	"The History of TPC.INT", January 15, 1999, 2 pages, found at http://www.tpc.int/faq/history.html printed on August 8, 2002.	
	16-3	A. A. Kapauan, et al. "Wideband Packet Access for Workstations: Integrated Voice/Data/Image Services on the UNIX+ PC", IEEE Global Telecommunications Conference, Houston, Texas, December 1-4, 1986, Conference Record Vol. 3, pages 1439-1441	
	16-4	AHRENS, Richard L., "Frequently-Asked Questions about Internet VoiceChat 1.1 FAQ Version: 1.0", 1994, 6 pages.	
	16-5	Andy Hopper "Pandora - An Experimental System for Multimedia Applications", Operating Systems Review, January 12, 1990, pages 1-16	
	16-6	BENNETT, Geoff, "Designing TCP/IP Internetworks", Chapter 11, pages 290, 291 and 323, Van Nostrand Reinhold, 1995.	
	16-7	Bernard Gold "Digital Speech Networks", Proceedings of the IEEE, Vol. 65, No. 12, December 1977, pages 1636-1658	

Examiner Signature		Date Considered	
--------------------	--	-----------------	--

*Examiner: Initial if reference was considered, whether or not citation is in conformance with MPEP 609. Draw a line through citation if not in conformance and not considered. Include a copy of this form with next communication to applicant. Notes: If identified, the following is provided: EA = English Abstract, T = Translation, PF = Patent Family.

ALL REFERENCES CONSIDERED EXCEPT WHERE LINED THROUGH. /AK/

INFORMATION DISCLOSURE STATEMENT BY APPLICANT FORM PTO-1449 (modified) Sheet 17 of 29	Reexam number	90/010,422
	First Named Inventor	Mattaway et al.
	Patent Under Re-Exam	6009469
	Issue Date	1999/12/28
	Group Art Unit	3992
	Examiner Name	KOSOWSKI, ALEXANDER J
	Attorney Docket No.	2655-0185
	Confirmation No.	6565

NON-PATENT REFERENCES			
Examiner Initials*	Cite No.	Non-patent Reference bibliographic information, where available	Notes
	17-1	Bill Newman "An ISDN Data and Voice Terminal Based on a Personal Computer", Globecom'85, IEEE Global Telecommunications Conference, Conference Record Volume 3, New Orleans, Louisiana, December 2-5, 1985, pages 1048-1052	
	17-2	BORLAND, John, "Technology uses one number to find you on any device", May 17, 2001, 3 pages, found at http://news.cnet.com/news/0-1004-201-5939191-0.html .	
	17-3	C. MALAMUD et al., "Principles of Operation for the TPC.INT Subdomain: General Principles and Policy", RFC 1530, October 1993, pages 1-7.	
	17-4	C. MALAMUD et al., "Principles of Operation for the TPC.INT Subdomain: Remote Printing -- Administrative Policies", RFC 1529, October 1993, pages 1-5.	
	17-5	C. MALAMUD et al., "Principles of Operation for the TPC.INT Subdomain: Remote Printing -- Technical Procedures", RFC 1528, October 1993, pages 1-12.	
	17-6	C. Topolcic "Experimental Internet Stream Protocol, Version 2 (ST-II)", Request for Comments 1190, October 1990, pages 1-148	
	17-7	C. YANG, "INETPhone: Telephone Services and Servers on Internet", Request for Comments 1789, pp. 1-6, April 1995.	

Examiner Signature		Date Considered	
--------------------	--	-----------------	--

*Examiner: Initial if reference was considered, whether or not citation is in conformance with MPEP 609. Draw a line through citation if not in conformance and not considered. Include a copy of this form with next communication to applicant. Notes: If identified, the following is provided: EA = English Abstract, T = Translation, PF = Patent Family.

ALL REFERENCES CONSIDERED EXCEPT WHERE LINED THROUGH. /AK/

INFORMATION DISCLOSURE STATEMENT BY APPLICANT FORM PTO-1449 (modified)	Reexam number	90/010,422
	First Named Inventor	Mattaway et al.
	Patent Under Re-Exam	6009469
	Issue Date	1999/12/28
	Group Art Unit	3992
	Examiner Name	KOSOWSKI, ALEXANDER J
	Attorney Docket No.	2655-0185
	Confirmation No.	6565

Sheet 18 of 29

NON-PATENT REFERENCES			
Examiner Initials*	Cite No.	Non-patent Reference bibliographic information, where available	Notes
	18-1	Carl A. Sunshine, et al. "Broad-Band Personal Computer LAN's", IEEE Journal on Selected Areas in Communications, Vol. SAC-3, No.3, May 1985, pages 408-415	
	18-2	Cindy MUELLER et al., "ATD Data Services", http://www.iita.ucar.edu/ws/datawkshop/Abstract-ATD.html , January 5, 1995, 2 pages.	
	18-3	Clifford J. Weinstein, et al. "Experience with Speech Communication in Packet Networks" IEEE Journal on Selected Areas in Communications, Vol. SAC-1, No. 6, (ISSN 0733-8716), December 1983, pages 963-980	
	18-4	D. Adolphs, et al. "Adapters for the Public ISDN", pages 72-80	
	18-5	D. Perkins "The Point-to-Point Protocol for the Transmission of Multi-Protocol Datagrams Over Point-to-Point Links", Request for Comments 1171, ftp://ftp.isi.edu/in-notes/rfc1171.txt , July 1990, pages 1-48	
	18-6	D.C. Swinehart et al., "Adding Voice to an Office Computer Network", IEEE Global Telecommunications Conference, Nov. 28-Dec 1, 1983, Conference Record Volume 1 of 3, pages 392-398	
	18-7	Dale Gulick et al., "Interface the ISDN to Your PC With a Voice/Data Board", Design Applications, 2328 Electronic Design, 35 (1987) Dec. 10, No. 29, Hashbrouck Heights, NJ, USA, pages 85-88, XP 000004313	

Examiner Signature		Date Considered	
--------------------	--	-----------------	--

*Examiner: Initial if reference was considered, whether or not citation is in conformance with MPEP 609. Draw a line through citation if not in conformance and not considered. Include a copy of this form with next communication to applicant. Notes: If identified, the following is provided: EA = English Abstract, T = Translation, PF = Patent Family.

ALL REFERENCES CONSIDERED EXCEPT WHERE LINED THROUGH. /AK/

INFORMATION DISCLOSURE STATEMENT BY APPLICANT FORM PTO-1449 (modified)	Reexam number	90/010,422
	First Named Inventor	Mattaway et al.
	Patent Under Re-Exam	6009469
	Issue Date	1999/12/28
	Group Art Unit	3992
	Examiner Name	KOSOWSKI, ALEXANDER J
	Attorney Docket No.	2655-0185
Sheet 19 of 29	Confirmation No.	6565

NON-PATENT REFERENCES			
Examiner Initials*	Cite No.	Non-patent Reference bibliographic information, where available	Notes
	19-1	Daniel C. Swinehart "Telephone Management in the Etherphone System", IEEE/IEICE Global Telecommunications Conference '87, Conference Record Volume 2 of 3, November 15-18, 1987, pages 1176-1180	
	19-2	Danny Cohen "A Network Voice Protocol NVP-II", April 1, 1981, pages 1-68	
	19-3	Danny Cohen "Packet Communication of Online Speech", AFIPS Conference Proceedings, 1981 National Computer Conference, May 4-7, 1981, Chicago, Illinois, pages 169-176	
	19-4	Danny Cohen "Specifications for the Network Voice Protocol (NVP)", Request for Comments 741, January 29, 1976, pages 1-30	
	19-5	Don H. Johnson, et al. "A Local Access Network for Packetized Digital Voice Communication", IEEE Transactions on Communications, Vol. Com. 29, No. 5, May 1981, pages 679-688	
	19-6	Douglas B. Terry and Daniel C. Swinehart, "Managing Stored Voice in the Etherphone System", 1987 ACM 089791-242-X/87/0011/0103, pages 103-104	
	19-7	Douglas B. Terry and Daniel C. Swinehart, "Managing Stored Voice in the Etherphone System", ACM Transactions on Computer Systems, Vol. 6, No. 1, February 1988, pages 3-27	

Examiner Signature		Date Considered	
--------------------	--	-----------------	--

*Examiner: Initial if reference was considered, whether or not citation is in conformance with MPEP 609. Draw a line through citation if not in conformance and not considered. Include a copy of this form with next communication to applicant. Notes: If identified, the following is provided: EA = English Abstract, T = Translation, PF = Patent Family.

ALL REFERENCES CONSIDERED EXCEPT WHERE LINED THROUGH. /AK/

INFORMATION DISCLOSURE STATEMENT BY APPLICANT FORM PTO-1449 (modified)	Reexam number	90/010,422
	First Named Inventor	Mattaway et al.
	Patent Under Re-Exam	6009469
	Issue Date	1999/12/28
	Group Art Unit	3992
	Examiner Name	KOSOWSKI, ALEXANDER J
	Attorney Docket No.	2655-0185
Sheet 20 of 29	Confirmation No.	6565

NON-PATENT REFERENCES			
Examiner Initials*	Cite No.	Non-patent Reference bibliographic information, where available	Notes
	20-1	Eve M. Schooler, et al. "A Packet-Switched Multimedia Conferencing System", SIGOIS Bulletin, pages 12-22	
	20-2	Gary C. Kessler "ISDN Concepts, Facilities, and Services", McGraw-Hill, Inc., c1990, pages 224-231, ISBN 0-07-034242-3	
	20-3	Giulio Barberis, et al. "Coded Speech in Packet-Switched Networks: Models and Experiments" IEEE Journal on Selected Areas in Communications, Vol. SAC-1, No. 6, December 1983, pages 1028-1038	
	20-4	H. Jonathan Chao, et al. "A Packet Video System Using the Dynamic Time Division Multiplexing Technique", IEEE Global Telecommunications Conference, Houston, Texas, December 1-4, 1988, Conference Record, Vol. 3, pages 0767-0772	
	20-5	H. Opderbeck "Throughput Degredations for Single Packet Messages", Request for Comments 632, ftp://ftp.isi.edu/in-notes/rfc632.txt, May 20, 1974, pages 1-6	
	20-6	Henning Schulzrinne "Voice Communication Across the Internet: A Network Voice Terminal", July 29, 1992, pages 1-34	
	20-7	Hiroshi Kobayashi and Hideaki Haruyama, "Voice, Data and Video Integrated Broadband Metropolitan Area Network", Electronics and Communications in Japan, Part 1, Vol. 73, No. 11, 1990, pages 34-42	

Examiner Signature		Date Considered	
--------------------	--	-----------------	--

*Examiner: Initial if reference was considered, whether or not citation is in conformance with MPEP 609. Draw a line through citation if not in conformance and not considered. Include a copy of this form with next communication to applicant. Notes: If identified, the following is provided: EA = English Abstract, T = Translation, PF = Patent Family.

ALL REFERENCES CONSIDERED EXCEPT WHERE LINED THROUGH. /AK/

INFORMATION DISCLOSURE STATEMENT BY APPLICANT FORM PTO-1449 (modified)	Reexam number	90/010,422
	First Named Inventor	Mattaway et al.
	Patent Under Re-Exam	6009469
	Issue Date	1999/12/28
	Group Art Unit	3992
	Examiner Name	KOSOWSKI, ALEXANDER J
	Attorney Docket No.	2655-0185
Sheet 21 of 29	Confirmation No.	6565

NON-PATENT REFERENCES			
Examiner Initials*	Cite No.	Non-patent Reference bibliographic information, where available	Notes
	21-1	Hiroyuki Ichikawa et al. "High-Speed Packet Switching Systems for Multimedia Communications", IEEE Journal on Selected Areas in Communications, October 1987, Volume SAC-5, Number 8 (ISSN 0733-8716), pages 1336-1345	
	21-2	Ian H. Merritt "Providing Telephone Line Access to a Packet Voice Network", University of Southern California, Marina Del Rey. Information Sciences Inst., February 1983, ADA126270	
	21-3	Implementation of Next-Generation Agent-Dedicated Communications, by Agatsuma et al., Tech Report of IEICE 94-216 (March 1995)	
	21-4	International Preliminary Examination Report (IPER) issued March 26, 1998 in corresponding International Application Serial No. PCT/US96/15504	
	21-5	International Search Report issued January 27, 1998 in corresponding International Application Serial No. PCT/US96/15504.	
	21-6	Israel GITMAN, et al. "Economic Analysis of Integrated Voice and Data Networks: A Case Study" Proceedings of the IEEE, Vol. 66, No. 11, November 1978, pages 1549-1570	
	21-7	J. Huelamo, et al. "End User Premises Equipment and Terminals for Broadband Applications", Electrical Communication, Volume 64, Number 2/3, 1990	

Examiner Signature		Date Considered	
--------------------	--	-----------------	--

*Examiner: Initial if reference was considered, whether or not citation is in conformance with MPEP 609. Draw a line through citation if not in conformance and not considered. Include a copy of this form with next communication to applicant. Notes: If identified, the following is provided: EA = English Abstract, T = Translation, PF = Patent Family.

ALL REFERENCES CONSIDERED EXCEPT WHERE LINED THROUGH. /AK/

INFORMATION DISCLOSURE STATEMENT BY APPLICANT FORM PTO-1449 (modified)	Reexam number	90/010,422
	First Named Inventor	Mattaway et al.
	Patent Under Re-Exam	6009469
	Issue Date	1999/12/28
	Group Art Unit	3992
	Examiner Name	KOSOWSKI, ALEXANDER J
	Attorney Docket No.	2655-0185
Sheet 22 of 29	Confirmation No.	6565

NON-PATENT REFERENCES			
Examiner Initials*	Cite No.	Non-patent Reference bibliographic information, where available	Notes
	22-1	J. K. Reynolds et al., "Voice File Interchange Protocol (VFIP), Request for Comments 978, ftp://ftp.isi.edu/innotes/rfc978.txt, February 1986, pages 1-5	
	22-2	J. Romkey "A Nonstandard For Transmission of IP Datagrams Over Serial Lines: Slip", Request for Comments 1055, ftp://ftp.isi.edu/in-notes/std/std47.txt, June 1988, pages 1-6	
	22-3	James D. Mills, et al. "A data and voice system for the general service telephone network", Proceedings IECON '87, 1987 International Conference on IND. Electronics, Control, and Instrumentation, Cambridge, Massachusetts, November 3-6, 1987	
	22-4	James W. Forgie "Speech Transmission in Packet-Switched Store-and-Forward Networks", AFIPS Conference Proceedings, 1975 National Computer Conference, May 19-22, 1975, Anaheim, California, pages 137-142	
	22-5	James W. Forgie "Voice Conferencing in Packet Networks", ICC '80, Conference Record, International Conference on Communications, Seattle, WA, June 8-12, 1980, Volume 1, 80CH1505-6 CSCB, pages 21.3.1-21.3.4	
	22-6	Jane's Military Communications 1979-80, pages 452 and 453	
	22-7	Jane's Military Communications 1985, pages 585, 546, and 545	

Examiner Signature		Date Considered	
--------------------	--	-----------------	--

*Examiner: Initial if reference was considered, whether or not citation is in conformance with MPEP 609. Draw a line through citation if not in conformance and not considered. Include a copy of this form with next communication to applicant. Notes: If identified, the following is provided: EA = English Abstract, T = Translation, PF = Patent Family.

ALL REFERENCES CONSIDERED EXCEPT WHERE LINED THROUGH. /AK/

INFORMATION DISCLOSURE STATEMENT BY APPLICANT FORM PTO-1449 (modified)	Reexam number	90/010,422
	First Named Inventor	Mattaway et al.
	Patent Under Re-Exam	6009469
	Issue Date	1999/12/28
	Group Art Unit	3992
	Examiner Name	KOSOWSKI, ALEXANDER J
	Attorney Docket No.	2655-0185
	Confirmation No.	6565
Sheet 23 of 29		

NON-PATENT REFERENCES			
Examiner Initials*	Cite No.	Non-patent Reference bibliographic information, where available	Notes
	23-1	Jane's Military Communications 1989, Tenth Edition, Edited by John Williamson, ISBN 0710608772, pages 443, 507, and 512	
	23-2	Jane's Military Communications 1990-91, Eleventh Edition, Edited by John Williamson, ISBN 0710609000, pages [30], 264, 357, 398, 406, 450, 454, 456, 560, 572, 573, 814, 815, and 816	
	23-3	Jane's Military Communications 1992-93, Thirteenth Edition, Edited by John Williamson, ISBN 0710609809, pages 375, 376, 384, and 704	
	23-4	Jim Stevens, "Much More Idle Chatter About Reference Models", http://www-mice.cs.ucl.ac.uk/multimedia/misc/tcp_ip/8709.mm.www/0041.html , December 18, 1987, pages 1-9	
	23-5	John Bellamy, "Digital Telephony", c1982 John Wiley & Sons, Inc., pages 392-397 and 410-412	
	23-6	JP Appln. No. 2008-163825 Office Action (Translation)	
	23-7	K. Sohraby, et al. "ISDN Primary Rate Interface Impact on Performance of Integrated Voice and Data on CSMA/CD Networks - A Measurement and Simulation Study", Globecom '90 IEEE Global Telecommunication Conference & Exhibition, San Diego, California, December 2-5, 1990, Volume 2, pages 0912-0919	

Examiner Signature		Date Considered	
--------------------	--	-----------------	--

*Examiner: Initial if reference was considered, whether or not citation is in conformance with MPEP 609. Draw a line through citation if not in conformance and not considered. Include a copy of this form with next communication to applicant. Notes: If identified, the following is provided: EA = English Abstract, T = Translation, PF = Patent Family.

ALL REFERENCES CONSIDERED EXCEPT WHERE LINED THROUGH. /AK/

INFORMATION DISCLOSURE STATEMENT BY APPLICANT FORM PTO-1449 (modified) Sheet 24 of 29	Reexam number	90/010,422
	First Named Inventor	Mattaway et al.
	Patent Under Re-Exam	6009469
	Issue Date	1999/12/28
	Group Art Unit	3992
	Examiner Name	KOSOWSKI, ALEXANDER J
	Attorney Docket No.	2655-0185
	Confirmation No.	6565

NON-PATENT REFERENCES			
Examiner Initials*	Cite No.	Non-patent Reference bibliographic information, where available	Notes
	24-1	Ken Sherman "Data Communications - A User's Guide", 3rd Edition, c1981 Prentice-Hall, Inc., pages 296-307 and 404-407	
	24-2	Kevin Jeffay, et al. "Kernel Support for Live Digital Audio and Video", pages 10-21, University of North Carolina at Chapel Hill, Department of Computer Science	
	24-3	Kyuta SAITO, et al. "Voice Packet Communication System for Private Networks", Globecom '89, IEEE Global Telecommunications Conference & Exhibition, Dallas, Texas, November 27-30, 1989, Volume 3, pages 1874-1878	
	24-4	Lawrence G. Roberts "The Evolution of Packet Switching", Proceedings of the IEEE, Vol. 66, No. 11, November 1978, pages 1307-1313	
	24-5	LIN, Hwa-Chun and C.S. Raghavendra, "A Dynamic Load-Balancing Policy With a Central Job Dispatcher (LBC)," IEEE Transactions on Software Engineering, Vol. 18, No. 2, February 1992, pages 148-158.	
	24-6	M. E. Ulug, et al. "Statistical Multiplexing of Data and Encoded Voice in a Transparent Intelligent Network", Fifth Data Communications Symposium, September 27-29, 1977, Snowbird, Utah, pages 6-14 - 6-20	
	24-7	M. Gopalakrishnan, et al. "Integrating Voice and Data SALAN: An Experimental Local Area Network", Computer Communications, Vol. 9, No. 4, August 1986, pages 186-194 and page 169	

Examiner Signature		Date Considered	
--------------------	--	-----------------	--

*Examiner: Initial if reference was considered, whether or not citation is in conformance with MPEP 609. Draw a line through citation if not in conformance and not considered. Include a copy of this form with next communication to applicant. Notes: If identified, the following is provided: EA = English Abstract, T = Translation, PF = Patent Family.

ALL REFERENCES CONSIDERED EXCEPT WHERE LINED THROUGH. /AK/

INFORMATION DISCLOSURE STATEMENT BY APPLICANT FORM PTO-1449 (modified)	Reexam number	90/010,422
	First Named Inventor	Mattaway et al.
	Patent Under Re-Exam	6009469
	Issue Date	1999/12/28
	Group Art Unit	3992
	Examiner Name	KOSOWSKI, ALEXANDER J
	Attorney Docket No.	2655-0185
Sheet 25 of 29	Confirmation No.	6565

NON-PATENT REFERENCES			
Examiner Initials*	Cite No.	Non-patent Reference bibliographic information, where available	Notes
	25-1	M.J. Ross "Alternatives for Integrating Voice and Data", 1981 International Switching Symposium, ISS' 81 CIC Montreal, September 21-25, 1981	
	25-2	Natesa Janakiraman "An Overview of Recent Developments in the Designs and Applications of Customer Premises Switches", IEEE Communications Magazine, October 1985, Vol. 23, No. 10, pages 32-45	
	25-3	P. Borgnis-Desbordes, et al. "Variable-Speed Data Transmission". IBM Technical Disclosure Bulletin, Vol. 27, No. 4A, September 1984, pages 2269-2270	
	25-4	P. Venkat Rangan and Daniel C. Swinehart, "Software Architecture for Integration of Video Services in the Etherphone System", IEEE Journal on Selected Areas in Communication, Vol. 9, No. 9, December 1991, pages 1395-1404	
	25-5	Paul Francis, "Comparison of Geographical and Provider-rooted Internet Addressing," Computer Networks and ISDN Systems 27(3)437-448, 1994 (selected paper from INET 94/JENC 5)	
	25-6	Paul Gilster, "Internet Navigator", Maruzen Kabushiki-Kaisha (1st Ed.), pgs. 473-476, Feb. 28, 1995 (with translation and SOR)	
	25-7	Paul Tsuchiya, Tony Eng, "Extending the IP Internet Through Address Reuse," ACM SIGCOMM Computer Communications Review, 23(1):16-33, Jan. 1993	

Examiner Signature		Date Considered	
--------------------	--	-----------------	--

*Examiner: Initial if reference was considered, whether or not citation is in conformance with MPEP 609. Draw a line through citation if not in conformance and not considered. Include a copy of this form with next communication to applicant. Notes: If identified, the following is provided: EA = English Abstract, T = Translation, PF = Patent Family.

ALL REFERENCES CONSIDERED EXCEPT WHERE LINED THROUGH. /AK/

INFORMATION DISCLOSURE STATEMENT BY APPLICANT FORM PTO-1449 (modified)	Reexam number	90/010,422
	First Named Inventor	Mattaway et al.
	Patent Under Re-Exam	6009469
	Issue Date	1999/12/28
	Group Art Unit	3992
	Examiner Name	KOSOWSKI, ALEXANDER J
	Attorney Docket No.	2655-0185
Sheet 26 of 29	Confirmation No.	6565

NON-PATENT REFERENCES			
Examiner Initials*	Cite No.	Non-patent Reference bibliographic information, where available	Notes
	26-1	Philip H. Reagan, "Is it the PBX or is it the LAN?", Datamation, The Telecom Manager Emerges, 03/1984, Volume 30 Number 3, pages 3-4, 147, 148, 150	
	26-2	Polle T. Zellweger et al., "An Overview of the Etherphone System and its Applications", 2nd IEEE Conference on Computer Workstations, March 7-10, 1988, pages 160-168	
	26-3	R. BRAUDES et al., "Requirements for Multicast Protocols", Request for Comments 1458, Network Working Group, May 1993, pp. 1-19.	
	26-4	R. W. Meba, et al. "Experiments in Wideband Packet Technology", Digital Communications - New Directions in Switching and Networks, Proceedings of the International Seminar, Zurich, Switzerland, March 11-13, 1986, pages 135-139	
	26-5	R.P. McNamara, "Some Considerations of the Voice-Data Capabilities of Broadband Cable Networks", IEEE Digest of Papers Spring CompCon 82, February 22-25, 1982, pages 312-314	
	26-6	Randy Cole "Packet Voice: When It Makes Sense", Speech Technology, September/October 1982, pages 52-61.	
	26-7	Scott FLINN, "Coordinating Heterogeneous Time-Based Media Between Independent Applications" ACM Multimedia 95 - Electronic Proceedings November 5-9, 1995, pages 1-16.	

Examiner Signature		Date Considered	
--------------------	--	-----------------	--

*Examiner: Initial if reference was considered, whether or not citation is in conformance with MPEP 609. Draw a line through citation if not in conformance and not considered. Include a copy of this form with next communication to applicant. Notes: If identified, the following is provided: EA = English Abstract, T = Translation, PF = Patent Family.

ALL REFERENCES CONSIDERED EXCEPT WHERE LINED THROUGH. /AK/

INFORMATION DISCLOSURE STATEMENT BY APPLICANT FORM PTO-1449 (modified)	Reexam number	90/010,422
	First Named Inventor	Mattaway et al.
	Patent Under Re-Exam	6009469
	Issue Date	1999/12/28
	Group Art Unit	3992
	Examiner Name	KOSOWSKI, ALEXANDER J
	Attorney Docket No.	2655-0185
Sheet 27 of 29	Confirmation No.	6565

NON-PATENT REFERENCES			
Examiner Initials*	Cite No.	Non-patent Reference bibliographic information, where available	Notes
	27-1	Shimmi Hattori et al., "Integrated Digital Switching System with Queueing Storage Facility", IEEE Transactions on Communications, Vol. Com-30, No. 8, August 1982, pages 1900-1905, (ISSN 0090-6778)	
	27-2	Steve Oltmanns, et al. "A Voice and Communications System for the IBM PC", Speech Technology, March/April 1986, pages 94-99	
	27-3	Stuart CHESHIRE et al., "Internet Mobility 4x4", www.acm.org, 1996, pages 1-12.	
	27-4	Susan Angebrannt et al., "Integrating Audio and Telephony in a Distributed Workstation Environment", Proceedings of the Summer 1991 USENIX Conference, June 10-14, 1991, Nashville, Tennessee, pages 419-435	
	27-5	T. Kamae "Visual Terminals and User Interfaces", FGCS North-Holland, pages 257-278	
	27-6	T. Kamae "Voice/Data Integration in the INS Model System and Local Area Networks" IEEE Communications Magazine, December 1986, Vol. 24, No. 12, pages 7-15	
	27-7	T7540 Digital Telephone Codec, AT&T Microelectronics, January 1991, pages 1-62 and Data Sheet Addendum, July 1991, 4 pages	

Examiner Signature		Date Considered	
--------------------	--	-----------------	--

*Examiner: Initial if reference was considered, whether or not citation is in conformance with MPEP 609. Draw a line through citation if not in conformance and not considered. Include a copy of this form with next communication to applicant. Notes: If identified, the following is provided: EA = English Abstract, T = Translation, PF = Patent Family.

ALL REFERENCES CONSIDERED EXCEPT WHERE LINED THROUGH. /AK/

INFORMATION DISCLOSURE STATEMENT BY APPLICANT FORM PTO-1449 (modified) Sheet 28 of 29	Reexam number	90/010,422
	First Named Inventor	Mattaway et al.
	Patent Under Re-Exam	6009469
	Issue Date	1999/12/28
	Group Art Unit	3992
	Examiner Name	KOSOWSKI, ALEXANDER J
	Attorney Docket No.	2655-0185
	Confirmation No.	6565

NON-PATENT REFERENCES			
Examiner Initials*	Cite No.	Non-patent Reference bibliographic information, where available	Notes
	28-1	Takashi Yamada, et al. "New Technologies - Multimedia High-throughput X.25 Packet Switching System", NTT Review, Vol. 1, No. 2, July 1989, pages 82-88	
	28-2	talk (software) description from WikiPedia	
	28-3	Tamohiro Kawai, Nikkei Communications, No. 202, pgs 29-30, Nikkei BP, July 17, 1995 ("Communication software appears on the Internet") (w/ SOR)	
	28-4	Theodore Bially, et al. "Voice Communication in Integrated Digital Voice and Data Networks", IEEE Transactions on Communications, Vol. Com-28, No. 9, September 1980, pages 1478-1490	
	28-5	Toru Tsuda, et al. "An Approach to Multi-Service Subscriber Loop System Using Packetized Voice/Data Terminals" ISSLS '78, The International Symposium on Subscriber Loops and Services, March 20-24, 1978, Atlanta, Georgia, Conference Record, pages 161-165	
	28-6	Translation of Japanese Kokai H07-129488 (published May 19, 1995)	
	28-7	U.S. Reexam Control No. 90/010,416 - 2009-08-27 PTO Office Action	

Examiner Signature		Date Considered	
--------------------	--	-----------------	--

*Examiner: Initial if reference was considered, whether or not citation is in conformance with MPEP 609. Draw a line through citation if not in conformance and not considered. Include a copy of this form with next communication to applicant. Notes: If identified, the following is provided: EA = English Abstract, T = Translation, PF = Patent Family.

ALL REFERENCES CONSIDERED EXCEPT WHERE LINED THROUGH. /AK/

INFORMATION DISCLOSURE STATEMENT BY APPLICANT FORM PTO-1449 (modified) Sheet 29 of 29	Reexam number	90/010,422
	First Named Inventor	Mattaway et al.
	Patent Under Re-Exam	6009469
	Issue Date	1999/12/28
	Group Art Unit	3992
	Examiner Name	KOSOWSKI, ALEXANDER J
	Attorney Docket No.	2655-0185
	Confirmation No.	6565

NON-PATENT REFERENCES			
Examiner Initials*	Cite No.	Non-patent Reference bibliographic information, where available	Notes
	29-1	U.S. Reexam Control No. 90/010,421 - 2009-08-14 PTO Office Action	
	29-2	U.S. Reexam Control No. 90/010,424 - 2009-08-25 PTO Office Action	
	29-3	V. Jacobson, et al. "TCP Extension for High-Speed Paths", Request for Comments 1185, ftp://ftp.isi.edu/in-notes/rfc1185.txt, October 1990, pages 1-21	
	29-4	V. Jacobson, et al. "TCP Extensions for High Performance", Request for Comments 1323, ftp://ftp.isi.edu/in-notes/rfc1323.txt, May 1992, pages 1-37	
	29-5	Vinton G. Cerf, "Packet Satellite Technology Reference Sources", Request for Comments 829, November 1982, http://www.cis.ohio-state.edu/htbin/rfc/rfc829.html, pages 1-5	
	29-6	VocalTec Internet Phone (TM) Version 2.5 Readme, VocalTec Ltd., 02/1995, 5 pages.	
	29-7	Written Opinion issued February 12, 1998 in corresponding International Application Serial No. PCT/US96/15504.	

Examiner Signature		Date Considered	
--------------------	--	-----------------	--

*Examiner: Initial if reference was considered, whether or not citation is in conformance with MPEP 609. Draw a line through citation if not in conformance and not considered. Include a copy of this form with next communication to applicant. Notes: If identified, the following is provided: EA = English Abstract, T = Translation, PF = Patent Family.

ALL REFERENCES CONSIDERED EXCEPT WHERE LINED THROUGH. /AK/

INFORMATION DISCLOSURE STATEMENT BY APPLICANT FORM PTO-1449 (modified)	Reexam number	90/010,422
	First Named Inventor	Mattaway et al.
	Patent Under Re-Exam	6009469
	Issue Date	1999/12/28
	Group Art Unit	3992
	Examiner Name	KOSOWSKI, ALEXANDER J
	Attorney Docket No.	2655-0185
	Confirmation No.	6565

Sheet 1 of 10

FOREIGN PATENT DOCUMENTS					
Examiner Initials*	Cite No.	Document No.	Publication Date	Name of Patentee or Applicant of Cited Document	Notes
	1-1	WO-9003074	03-22-1990	LE CLERCQ, Patrick	
	1-2				
	1-3				
	1-4				
	1-5				
	1-6				
	1-7				
	1-8				
	1-9				
	1-10				
	1-11				
	1-12				
	1-13				
	1-14				
	1-15				
	1-16				
	1-17				
	1-18				
	1-19				
	1-20				
	1-21				
	1-22				
	1-23				
	1-24				

Examiner Signature	/Alexander Kosowski/	Date Considered	05/06/2010
--------------------	----------------------	-----------------	------------

*Examiner: Initial if reference was considered, whether or not citation is in conformance with MPEP 609. Draw a line through citation if not in conformance and not considered. Include a copy of this form with next communication to applicant. Notes: If identified, the following is provided: EA = English Abstract, T = Translation, PF = Patent Family.

ALL REFERENCES CONSIDERED EXCEPT WHERE LINED THROUGH. /AK/

INFORMATION DISCLOSURE STATEMENT BY APPLICANT FORM PTO-1449 (modified) Sheet 2 of 10	Reexam number	90/010,422
	First Named Inventor	Mattaway et al.
	Patent Under Re-Exam	6009469
	Issue Date	1999/12/28
	Group Art Unit	3992
	Examiner Name	KOSOWSKI, ALEXANDER J
	Attorney Docket No.	2655-0185
	Confirmation No.	6565

NON-PATENT REFERENCES			
Examiner Initials*	Cite No.	Non-patent Reference bibliographic information, where available	Notes
	2-1	About NetPhone (undated)	
	2-2	After Downsizing: Overcoming Client-Server Chaos (May 21, 1994)	
	2-3	Barrow Street Research report on New Paradigm Software Corp. (dated sep. 20, 1995)	
	2-4	Camelot 10-Q for quarter ending January 31, 1995	
	2-5	Camelot Corporation 10-K, 1994	
	2-6	Camelot Corps Shining Internet Dream Draws Skeptics (Aug. 95)	
	2-7	Completed Beta Tester Agreements (May 1995)	

Examiner Signature		Date Considered	
--------------------	--	-----------------	--

*Examiner: Initial if reference was considered, whether or not citation is in conformance with MPEP 609. Draw a line through citation if not in conformance and not considered. Include a copy of this form with next communication to applicant. Notes: If identified, the following is provided EA = English Abstract, T = Translation, PF = Patent Family.

ALL REFERENCES CONSIDERED EXCEPT WHERE LINED THROUGH. /AK/

INFORMATION DISCLOSURE STATEMENT BY APPLICANT FORM PTO-1449 (modified)	Reexam number	90/010,422
	First Named Inventor	Mattaway et al.
	Patent Under Re-Exam	6009469
	Issue Date	1999/12/28
	Group Art Unit	3992
	Examiner Name	KOSOWSKI, ALEXANDER J
	Attorney Docket No.	2655-0185
	Confirmation No.	6565
Sheet 3 of 10		

NON-PATENT REFERENCES			
Examiner Initials*	Cite No.	Non-patent Reference bibliographic information, where available	Notes
	3-1	Correspondence with MacZone (Aug.-Sept. 1995).	
	3-2	DigiPhone and Camelot Documents	
	3-3	DigiPhone Documents (including Q and A) (prior to Sept. 1995)	
	3-4	DigiPhone Documents (prior to Sept. 1995)	
	3-5	DigiPhone for Mac (1996)	
	3-6	Electric Magic and Jabra Correspondence relating to new products (prior to 9/1995)	
	3-7	Electric Magic and PSINet License Negotiation Documentation (prior to Sept. 1995)	

Examiner Signature		Date Considered	
--------------------	--	-----------------	--

*Examiner: Initial if reference was considered, whether or not citation is in conformance with MPEP 609. Draw a line through citation if not in conformance and not considered. Include a copy of this form with next communication to applicant. Notes: If identified, the following is provided: EA = English Abstract, T = Translation, PF = Patent Family.

ALL REFERENCES CONSIDERED EXCEPT WHERE LINED THROUGH. /AK/

INFORMATION DISCLOSURE STATEMENT BY APPLICANT FORM PTO-1449 (modified) Sheet 4 of 10	Reexam number	90/010,422
	First Named Inventor	Mattaway et al.
	Patent Under Re-Exam	6009469
	Issue Date	1999/12/28
	Group Art Unit	3992
	Examiner Name	KOSOWSKI, ALEXANDER J
	Attorney Docket No.	2655-0185
	Confirmation No.	6565

NON-PATENT REFERENCES			
Examiner Initials*	Cite No.	Non-patent Reference bibliographic information, where available	Notes
	4-1	Electric Magic Beta Tester Agreement dated July 21, 1995 (SKYPE-N2P01609523)	
	4-2	Electric Magic Company Releases NetPhone 1.2 and NetPub Server (dated June 8, 1995)	
	4-3	Electric Magic Information (May 1995)	
	4-4	Electric Magic Notebooks (prior to Sept. 1995)	
	4-5	Electric Magic Notes (including references to 4/18/95) and patent pending	
	4-6	Electric Magic Notes (including references to DigiPhone) (prior to Sept. 1995)	
	4-7	Electric Magic Notes (undated)	

Examiner Signature		Date Considered	
--------------------	--	-----------------	--

*Examiner: Initial if reference was considered, whether or not citation is in conformance with MPEP 609. Draw a line through citation if not in conformance and not considered. Include a copy of this form with next communication to applicant. Notes: If identified, the following is provided: EA = English Abstract, T = Translation, PF = Patent Family.

ALL REFERENCES CONSIDERED EXCEPT WHERE LINED THROUGH. /AK/

INFORMATION DISCLOSURE STATEMENT BY APPLICANT FORM PTO-1449 (modified) Sheet 5 of 10	Reexam number	90/010,422
	First Named Inventor	Mattaway et al.
	Patent Under Re-Exam	6009469
	Issue Date	1999/12/28
	Group Art Unit	3992
	Examiner Name	KOSOWSKI, ALEXANDER J
	Attorney Docket No.	2655-0185
	Confirmation No.	6565

NON-PATENT REFERENCES			
Examiner Initials*	Cite No.	Non-patent Reference bibliographic information, where available	Notes
	5-1	Electric Magic Press Release (dated Mar. 13, 1995)	
	5-2	ElectricMagic and WebKat Licensing Documents (Sept. 1995 and prior)	
	5-3	E-mail dated May 9, 1995 re NetPhone Development with Jabra R/D	
	5-4	Fax dated 5/31/95 to IVP including press releases	
	5-5	Google Groups comp.dcom.videoconf posting (dated Jul. 5, 1995)	
	5-6	intern.tex (dated Aug. 30, 1994)	
	5-7	Jabra - Corporate and Product Backgrounder (April 19, 1995)	

Examiner Signature		Date Considered	
--------------------	--	-----------------	--

*Examiner: Initial if reference was considered, whether or not citation is in conformance with MPEP 609. Draw a line through citation if not in conformance and not considered. Include a copy of this form with next communication to applicant. Notes: If identified, the following is provided: EA = English Abstract, T = Translation, PF = Patent Family.

ALL REFERENCES CONSIDERED EXCEPT WHERE LINED THROUGH. /AK/

INFORMATION DISCLOSURE STATEMENT BY APPLICANT FORM PTO-1449 (modified) Sheet 6 of 10	Reexam number	90/010,422
	First Named Inventor	Mattaway et al.
	Patent Under Re-Exam	6009469
	Issue Date	1999/12/28
	Group Art Unit	3992
	Examiner Name	KOSOWSKI, ALEXANDER J
	Attorney Docket No.	2655-0185
	Confirmation No.	6565

NON-PATENT REFERENCES

Examiner Initials*	Cite No.	Non-patent Reference bibliographic information, where available	Notes
	6-1	Jabra Ear Phone Common Questions and Answers	
	6-2	Jabra Ear phone PC, 1995	
	6-3	Jabra Streamline Ear Phone, 1993	
	6-4	Letter of Intent including target dates (dated 19 Sept 95) (7 pgs)	
	6-5	List of source modules in NetPhone (dated Oct. 10, 1995)	
	6-6	MagicPhone Distribution Agreement (Aug. 1995)	
	6-7	Maven README (including 1994 copyright notice)	

Examiner Signature		Date Considered	
--------------------	--	-----------------	--

*Examiner: Initial if reference was considered, whether or not citation is in conformance with MPEP 609. Draw a line through citation if not in conformance and not considered. Include a copy of this form with next communication to applicant. Notes: If identified, the following is provided: EA = English Abstract, T = Translation, PF = Patent Family.

ALL REFERENCES CONSIDERED EXCEPT WHERE LINED THROUGH. /AK/

INFORMATION DISCLOSURE STATEMENT BY APPLICANT FORM PTO-1449 (modified) Sheet 7 of 10	Reexam number	90/010,422
	First Named Inventor	Mattaway et al.
	Patent Under Re-Exam	6009469
	Issue Date	1999/12/28
	Group Art Unit	3992
	Examiner Name	KOSOWSKI, ALEXANDER J
	Attorney Docket No.	2655-0185
	Confirmation No.	6565

NON-PATENT REFERENCES			
Examiner Initials*	Cite No.	Non-patent Reference bibliographic information, where available	Notes
	7-1	Net as Phone (Internet World July 1995)	
	7-2	NET phone ad (with Jabra fax line) (May 95)	
	7-3	NetPhone 1.1 User Manual (including date 95-01-09)	
	7-4	NetPhone Advertisement (Aug. 1995)	
	7-5	NetPhone Correspondence (Jun.-July 1995)	
	7-6	NetPhone Development Plan (SKYPE-N2P01610487)	
	7-7	NetPhone Development Plan with time charts (including reference to 5/9/1995)	

Examiner Signature		Date Considered	
--------------------	--	-----------------	--

*Examiner: Initial if reference was considered, whether or not citation is in conformance with MPEP 609. Draw a line through citation if not in conformance and not considered. Include a copy of this form with next communication to applicant. Notes: If identified, the following is provided: EA = English Abstract, T = Translation, PF = Patent Family.

ALL REFERENCES CONSIDERED EXCEPT WHERE LINED THROUGH. /AK/

INFORMATION DISCLOSURE STATEMENT BY APPLICANT FORM PTO-1449 (modified) Sheet 8 of 10	Reexam number	90/010,422
	First Named Inventor	Mattaway et al.
	Patent Under Re-Exam	6009469
	Issue Date	1999/12/28
	Group Art Unit	3992
	Examiner Name	KOSOWSKI, ALEXANDER J
	Attorney Docket No.	2655-0185
	Confirmation No.	6565

NON-PATENT REFERENCES			
Examiner Initials*	Cite No.	Non-patent Reference bibliographic information, where available	Notes
	8-1	NetPhone Digital User Manual (dated 95-02-26)	
	8-2	NetPhone gives your Mac voice over the Internet (Inside the Internet - June 1995)	
	8-3	Netphone invoices (including invoices prior to 9/1995)	
	8-4	NetPhone Make Free Calls over the Internet (undated)	
	8-5	NetPhone Screenshots (undated)	
	8-6	NetPhone Tasks and Plans (dated Jan.-Feb. 1995)	
	8-7	New Paradigm Software Agreement (dated Oct. 9, 1995) referencing existing software as of that date	

Examiner Signature		Date Considered	
--------------------	--	-----------------	--

*Examiner: Initial if reference was considered, whether or not citation is in conformance with MPEP 609. Draw a line through citation if not in conformance and not considered. Include a copy of this form with next communication to applicant. Notes: If identified, the following is provided: EA = English Abstract, T = Translation, PF = Patent Family.

ALL REFERENCES CONSIDERED EXCEPT WHERE LINED THROUGH. /AK/

INFORMATION DISCLOSURE STATEMENT BY APPLICANT FORM PTO-1449 (modified) Sheet 9 of 10	Reexam number	90/010,422
	First Named Inventor	Mattaway et al.
	Patent Under Re-Exam	6009469
	Issue Date	1999/12/28
	Group Art Unit	3992
	Examiner Name	KOSOWSKI, ALEXANDER J
	Attorney Docket No.	2655-0185
	Confirmation No.	6565

NON-PATENT REFERENCES			
Examiner Initials*	Cite No.	Non-patent Reference bibliographic information, where available	Notes
	9-1	Open Systems Today, Feb. 20, 1995	
	9-2	Order for NetPhone version 1.2 labels (dated 6 June 95)	
	9-3	Phoneless Phoning April 2, 1995	
	9-4	PowWow Chunked Protocol Specification, Last edited 3/12/1999	
	9-5	PowWow Native Protocols, last updated Dec. 8, 1998	
	9-6	Roadmap for the Internet (March 1995)	
	9-7	SlipMagic Ad for MacZone (dated 9/28/1995) for selling product	

Examiner Signature		Date Considered	
--------------------	--	-----------------	--

*Examiner: Initial if reference was considered, whether or not citation is in conformance with MPEP 609. Draw a line through citation if not in conformance and not considered. Include a copy of this form with next communication to applicant. Notes: If identified, the following is provided: EA = English Abstract, T = Translation, PF = Patent Family.

ALL REFERENCES CONSIDERED EXCEPT WHERE LINED THROUGH. /AK/ :

INFORMATION DISCLOSURE STATEMENT BY APPLICANT FORM PTO-1449 (modified)	Reexam number	90/010,422
	First Named Inventor	Mattaway et al.
	Patent Under Re-Exam	6009469
	Issue Date	1999/12/28
	Group Art Unit	3992
	Examiner Name	KOSOWSKI, ALEXANDER J
	Attorney Docket No.	2655-0185
	Confirmation No.	6565
Sheet 10 of 10		

NON-PATENT REFERENCES			
Examiner Initials*	Cite No.	Non-patent Reference bibliographic information, where available	Notes
	10-1	The Mac Zone (Catalog) dated 1995	
	10-2	Two-way voice calls over the Internet (11/21/94)	
	10-3	Ubique documents relating to Virtual Places Products (dated 1995 and March, 1995)	
	10-4	Ubique Ships Virtual Places Client and Server (dated March 20, 1995)	
	10-5	Ubique, Ltd. Fact Sheet (referencing NetPhone codecs and Vocaltec) (date unknown)	
	10-6	Undated Technical document	
	10-7	Welcome to NetPhone Demo (includes copyright date 1994)	

Examiner Signature	/Alexander Kosowski/	Date Considered	05/06/2010
--------------------	----------------------	-----------------	------------

*Examiner: Initial if reference was considered, whether or not citation is in conformance with MPEP 609. Draw a line through citation if not in conformance and not considered. Include a copy of this form with next communication to applicant. Notes: If identified, the following is provided: EA = English Abstract, T = Translation, PF = Patent Family.

ALL REFERENCES CONSIDERED EXCEPT WHERE LINED THROUGH. /AK/

INFORMATION DISCLOSURE STATEMENT BY APPLICANT FORM PTO-1449 (modified) Sheet 1 of 4	Reexam number	90/010,422
	First Named Inventor	Mattaway et al.
	Patent Under Re-Exam	6009469
	Issue Date	1999/12/28
	Group Art Unit	3992
	Examiner Name	KOSOWSKI, ALEXANDER J
	Attorney Docket No.	2655-0185
Confirmation No.	6565	

NON-PATENT REFERENCES			
Examiner Initials*	Cite No.	Non-patent Reference bibliographic information, where available	Notes
	1-1	David STROM, "Talking Telephony", Windows Sources, Ziff-Davis Publishing Company, September 1996, Vol. 4, No. 9, pages 6, 7, 10, 150-152, 157, 158, 163, 167, 169, 171, 174, 181, 184, 186, 195, 203, 208.	
	1-2	Deposition transcript of Andrew Green (dated Aug. December 30, 2008) in Net2Phone v. Skype et al. (Civil Action No. 06-2469-KSH-PS) in DCNJ	
	1-3	Deposition transcript of Daniel Mayer (dated Aug. 26, 2008) in Net2Phone v. Skype et al. (Civil Action No. 06-2469-KSH-PS) in DCNJ	
	1-4	Deposition transcript of Daniel Zwanziger (dated July 9, 2008) in Net2Phone v. Skype et al. (Civil Action No. 06-2469-KSH-PS) in DCNJ	
	1-5	Deposition transcript of expert Bruce Maggs (dated May 30, 2008) in Net2Phone v. Skype et al. (Civil Action No. 06-2469-KSH-PS) in DCNJ	
	1-6	Deposition transcript of expert Kevin Jeffay (dated May 20, 2008) in Net2Phone v. Skype et al. (Civil Action No. 06-2469-KSH-PS) in DCNJ	
	1-7	Deposition transcript of expert Stephen Kunin (dated June 3, 2008) in Net2Phone v. Skype et al. (Civil Action No. 06-2469-KSH-PS) in DCNJ	

Examiner Signature		Date Considered	
--------------------	--	-----------------	--

*Examiner: Initial if reference was considered, whether or not citation is in conformance with MPEP 609. Draw a line through citation if not in conformance and not considered. Include a copy of this form with next communication to applicant. Notes: If identified, the following is provided: EA = English Abstract, T = Translation, PT = Partial Translation, SOR = Statement of Relevancy, PF = Patent Family.

ALL REFERENCES CONSIDERED EXCEPT WHERE LINED THROUGH. /AK/

INFORMATION DISCLOSURE STATEMENT BY APPLICANT FORM PTO-1449 (modified) Sheet 2 of 4	Reexam number	90/010,422
	First Named Inventor	Mattaway et al.
	Patent Under Re-Exam	6009469
	Issue Date	1999/12/28
	Group Art Unit	3992
	Examiner Name	KOSOWSKI, ALEXANDER J
	Attorney Docket No.	2655-0185
	Confirmation No.	6565

NON-PATENT REFERENCES			
Examiner Initials*	Cite No	Non-patent Reference bibliographic information, where available	Notes
	2-1	Deposition transcript of former Tribal Voice employee and PowWow designer Paul Peterson (dated Apr. 9, 2008) in Net2Phone v. Skype et al. (Civil Action No. 06-2469-KSH-PS) in DCNJ	
	2-2	Deposition transcript of former VocalTec employee Alon Cohen (dated Mar. 11, 2008) in Net2Phone v. Skype et al. (Civil Action No. 06-2469-KSH-PS) in DCNJ	
	2-3	Deposition transcript of former VocalTec employee Lior Haramaty (dated Mar. 6, 2008) in Net2Phone v. Skype et al. (Civil Action No. 06-2469-KSH-PS) in DCNJ	
	2-4	Deposition transcript of inventor Craig Strickland (dated Sep. 19, 2007) in Net2Phone v. Skype et al. (Civil Action No. 06-2469-KSH-PS) in DCNJ	
	2-5	Deposition transcript of inventor Glenn Hutton (dated Aug. 24, 2007) (vol. 1) in Net2Phone v. Skype et al. (Civil Action No. 06-2469-KSH-PS) in DCNJ	
	2-6	Deposition transcript of inventor Glenn Hutton (dated Aug. 24, 2007) (vol. 2) in Net2Phone v. Skype et al. (Civil Action No. 06-2469-KSH-PS) in DCNJ	
	2-7	Deposition transcript of inventor Shane Mattaway (dated Sep. 10, 2007) (vol. 1) in Net2Phone v. Skype et al. (Civil Action No. 06-2469-KSH-PS) in DCNJ	

Examiner Signature		Date Considered	
--------------------	--	-----------------	--

*Examiner: Initial if reference was considered, whether or not citation is in conformance with MPEP 609. Draw a line through citation if not in conformance and not considered. Include a copy of this form with next communication to applicant. Notes: If identified, the following is provided: EA = English Abstract, T = Translation, PT = Partial Translation, SOR = Statement of Relevancy, PF = Patent Family.

ALL REFERENCES CONSIDERED EXCEPT WHERE LINED THROUGH. /AK/

INFORMATION DISCLOSURE STATEMENT BY APPLICANT FORM PTO-1449 (modified) Sheet 3 of 4	Reexam number	90/010,422
	First Named Inventor	Mattaway et al.
	Patent Under Re-Exam	6009469
	Issue Date	1999/12/28
	Group Art Unit	3992
	Examiner Name	KOSOWSKI, ALEXANDER J
	Attorney Docket No.	2655-0185
	Confirmation No.	6565

NON-PATENT REFERENCES			
Examiner Initials*	Cite No.	Non-patent Reference bibliographic information, where available	Notes
	3-1	Deposition transcript of inventor Shane Mattaway (dated Sep. 10, 2007) (vol. 2) in <i>Net2Phone v. Skype et al.</i> (Civil Action No. 06-2469-KSH-PS) in DCNJ	
	3-2	Deposition transcript of prosecuting attorney Bruce Jobse (dated Jan. 1, 2008) in <i>Net2Phone v. Skype et al.</i> (Civil Action No. 06-2469-KSH-PS) in DCNJ	
	3-3	Deposition transcript of Sheldon Glashow (dated July 16, 2008) in <i>Net2Phone v. Skype et al.</i> (Civil Action No. 06-2469-KSH-PS) in DCNJ	
	3-4	Emad FARAG et al., "Structure and network control of a hierarchical mobile network architecture", IEEE Fourteenth Annual International Phoenix Conference on Computers and Communications, 03/1995, ISBN: 0-7803-2492-7, pp. 671-677.	
	3-5	English translation of JP-06-62020 (dated 1994-03-04)	
	3-6	Huanxu PAN et al., "Analysis of a CCSS#7 Network supporting database services", IEEE International Conference on Information Engineering, 09/1993, ISBN: 0-7803-1445-X, pp. 193-197, vol. 1.	
	3-7	John E. GOODWIN, Project Gutenberg Alpha Edition of EMAIL 101, http://metalab.unc.edu/pub/docs/books/gutenberg/etext93/email025.txt , July 1993.	

Examiner Signature		Date Considered	
--------------------	--	-----------------	--

*Examiner: Initial if reference was considered, whether or not citation is in conformance with MPEP 609. Draw a line through citation if not in conformance and not considered. Include a copy of this form with next communication to applicant. Notes: If identified, the following is provided: EA = English Abstract, T = Translation, PT = Partial Translation, SOR = Statement of Relevancy, PF = Patent Family.

ALL REFERENCES CONSIDERED EXCEPT WHERE LINED THROUGH. /AK/

INFORMATION DISCLOSURE STATEMENT BY APPLICANT FORM PTO-1449 (modified)	Reexam number	90/010,422
	First Named Inventor	Mattaway et al.
	Patent Under Re-Exam	6009469
	Issue Date	1999/12/28
	Group Art Unit	3992
	Examiner Name	KOSOWSKI, ALEXANDER J
	Attorney Docket No.	2655-0185
	Confirmation No.	6565

Sheet 4 of 4

NON-PATENT REFERENCES			
Examiner Initials*	Cite No.	Non-patent Reference bibliographic information, where available	Notes
	4-1	Junichi Kimura, et al. "Voice/Data Multiplexing Transmission Methods", Kokai Japanese Patent, Kokai Sho 59-44140, pages 205-215, with English Abstract, English Translation, pages 1-24	
	4-2	Mark R. BROWN et al. "Special Edition: Using Netscape 2", Que Publishing, 1995, ISBN 0-7897-0612-1, pages 7-35, 37-56, 78, 83, 176, 301-320, 393, 395-467, 469-506.	
	4-3	Preston GRALLA, "How the Internet Works", Ziff-Davis Press, Emeryville, CA, c1997, pp. 34-37, 202-205, 214-215 and 272-275, ISBN 1-56276-552-3.	
	4-4		
	4-5		
	4-6		
	4-7		

Examiner Signature		Date Considered	
--------------------	--	-----------------	--

*Examiner: Initial if reference was considered, whether or not citation is in conformance with MPEP 609. Draw a line through citation if not in conformance and not considered. Include a copy of this form with next communication to applicant. Notes: If identified, the following is provided: EA = English Abstract, T = Translation, PT = Partial Translation, SOR = Statement of Relevancy, PF = Patent Family.

ALL REFERENCES CONSIDERED EXCEPT WHERE LINED THROUGH. /AK/

INFORMATION DISCLOSURE STATEMENT BY APPLICANT FORM PTO-1449 (modified) Sheet 1 of 1	Reexam number	90/010,422
	First Named Inventor	Mattaway et al.
	Patent Under Re-Exam	6009469
	Issue Date	1999/12/28
	Group Art Unit	3992
	Examiner Name	KOSOWSKI, ALEXANDER J
	Attorney Docket No.	2655-0185
	Confirmation No.	6565

NON-PATENT REFERENCES			
Examiner Initials*	Cite No.	Non-patent Reference bibliographic information, where available	Notes
	1-1	(Redacted) Expert Report of Professor Bruce M. Maggs (as Supplemented Sept. 9, 2008) in Net2Phone v. Skype et al. (Civil Action No. 06-2469-KSH-PS) in DCNJ	
	1-2	(Redacted) Responsive Expert Report of Kevin Jeffay, Ph.D. in Net2Phone v. Skype et al. (Civil Action No. 06-2469-KSH-PS) in DCNJ, Aug. 7, 2008	
	1-3	VocalChat GTI Information file, believed to be included with VocalChat GTI version 2.12 dated September, 1994	
	1-4	VocalChat GTI README.TXT for Version 2.12 Beta, dated September, 1994	
	1-5	VocalChat GTI Troubleshooting.Inf, believed to be included with VocalChat GTI version 2.12 dated September, 1994	
	1-6		
	1-7		

Examiner Signature	/Alexander Kosowski/	Date Considered	05/06/2010
--------------------	----------------------	-----------------	------------

*Examiner: Initial if reference was considered, whether or not citation is in conformance with MPEP 609. Draw a line through citation if not in conformance and not considered. Include a copy of this form with next communication to applicant. Notes: If identified, the following is provided: EA = English Abstract, T = Translation, PF = Patent Family.

RECEIVED

MAR 05 2010

<p>CENTRAL REEXAMINATION UNIT</p> <p>INFORMATION DISCLOSURE STATEMENT BY APPLICANT</p> <p>FORM PTO-1449 (modified)</p> <p>Sheet 1 of 1</p>	Reexam number	90/010,422
	First Named Inventor	Mattaway et al.
	Patent Under Re-Exam	6009469
	Issue Date	1999/12/28
	Group Art Unit	3992
	Examiner Name	KOSOWSKI, ALEXANDER J
	Attorney Docket No.	2655-0185
	Confirmation No.	6565

NON-PATENT REFERENCES			
Examiner Initials*	Cite No.	Non-patent Reference bibliographic information, where available	Notes
	1-1	CD-ROM including VocalChat GTI Version 2.12 Software (including .hlp files and README.TXT file), alleged to be dated September, 1994	
	1-2		
	1-3		
	1-4		
	1-5		
	1-6		
	1-7		

Examiner Signature	/Alexander Kosowski/	Date Considered	05/06/2010
--------------------	----------------------	-----------------	------------

*Examiner: Initial if reference was considered, whether or not citation is in conformance with MPEP 609. Draw a line through citation if not in conformance and not considered. Include a copy of this form with next communication to applicant. Notes: If identified, the following is provided: EA = English Abstract, T = Translation, PT = Partial Translation, SOR = Statement of Relevancy, PF = Patent Family.

INFORMATION DISCLOSURE STATEMENT BY APPLICANT FORM PTO-1449 (modified) Sheet 1 of 1	Reexam number	90/010,422
	First Named Inventor	Mattaway et al.
	Patent Under Re-Exam	6009469
	Issue Date	1999/12/28
	Group Art Unit	3992
	Examiner Name	KOSOWSKI, ALEXANDER J
	Attorney Docket No.	2655-0185
	Confirmation No.	6565

NON-PATENT REFERENCES

Examiner Initials*	Cite No.	Non-patent Reference bibliographic information, where available	Notes
	1-1	Notice Of Motion To Transfer Venue To The Western District of Arkasas, Civ. Action No. 06-2469	
	1-2	Reply Brief In Further Support Of Net2Phone's Motion To Transfer Venue To The vwestern District Of Arkansas, Civ. Action No. 06-2469	
	1-3		
	1-4		
	1-5		
	1-6		
	1-7		

Examiner Signature	/Alexander Kosowski/	Date Considered	05/07/2010
--------------------	----------------------	-----------------	------------

*Examiner: Initial if reference was considered, whether or not citation is in conformance with MPEP 609. Draw a line through citation if not in conformance and not considered. Include a copy of this form with next communication to applicant. Notes: If identified, the following is provided: EA = English Abstract, T = Translation, PT = Partial Translation, SOR = Statement of Relevancy, PF = Patent Family.

**This Page is Inserted by IFW Indexing and Scanning
Operations and is not part of the Official Record**

BEST AVAILABLE IMAGES

Defective images within this document are accurate representations of the original documents submitted by the applicant.

Defects in the images include but are not limited to the items checked:

- BLACK BORDERS**
- IMAGE CUT OFF AT TOP, BOTTOM OR SIDES**
- FADED TEXT OR DRAWING**
- BLURRED OR ILLEGIBLE TEXT OR DRAWING**
- SKEWED/SLANTED IMAGES**
- COLOR OR BLACK AND WHITE PHOTOGRAPHS**
- GRAY SCALE DOCUMENTS**
- LINES OR MARKS ON ORIGINAL DOCUMENT**
- REFERENCE(S) OR EXHIBIT(S) SUBMITTED ARE POOR QUALITY**
- OTHER:**

IMAGES ARE BEST AVAILABLE COPY.

As rescanning these documents will not correct the image problems checked, please do not report these problems to the IFW Image Problem Mailbox.

Reexamination 	Application/Control No. 90010422	Applicant(s)/Patent Under Reexamination 6,009,469
	Certificate Date	Certificate Number

Requester Correspondence Address: **Patent Owner** **Third Party**

BLAKELY SOKOLOFF TAYLOR & ZAFMAN LLP
 1279 OAKMEAD PARKWAY
 SUNNYVALE, CA 94085-4040

LITIGATION REVIEW <input checked="" type="checkbox"/>	AJK (examiner initials)	05/06/2010 (date)
Case Name		Director Initials
OPEN: 2:06cv2469 Net2phone v. Ebay		<i>See Serial to OA</i>

COPENDING OFFICE PROCEEDINGS	
TYPE OF PROCEEDING	NUMBER
1. no copending proceedings	

--	--

Search Notes 	Application/Control No. 90010422	Applicant(s)/Patent Under Reexamination 6,009,469
	Examiner ALEXANDER J KOSOWSKI	Art Unit 3992

SEARCHED			
Class	Subclass	Date	Examiner

SEARCH NOTES		
Search Notes	Date	Examiner
Reviewed proposed prior art and prosecution history	5/6/10	AJK

INTERFERENCE SEARCH			
Class	Subclass	Date	Examiner

--	--

**INFORMATION DISCLOSURE
STATEMENT BY APPLICANT**
FORM PTO-1449 (modified)

Sheet 1 of 1

Reexam number	90/010,422
First Named Inventor	Mattaway et al.
Patent Under Re-Exam	6009469
Issue Date	1999/12/28
Group Art Unit	3992
Examiner Name	KOSOWSKI, ALEXANDER J
Attorney Docket No.	2655-0185
Confirmation No.	6565

NON-PATENT REFERENCES

Examiner Initials*	Cite No.	Non-patent Reference bibliographic information, where available	Notes
	1-1	Notice Of Motion To Transfer Venue To The Western District of Arkasas, Civ. Action No. 06-2469	
	1-2	Reply Brief In Further Support Of Net2Phone's Motion To Transfer Venue To The Western District Of Arkansas, Civ. Action No. 06-2469	
	1-3		
	1-4		
	1-5		
	1-6		
	1-7		

Examiner Signature		Date Considered	
--------------------	--	-----------------	--

*Examiner: Initial if reference was considered, whether or not citation is in conformance with MPEP 609. Draw a line through citation if not in conformance and not considered. Include a copy of this form with next communication to applicant. Notes: If identified, the following is provided: EA = English Abstract, T = Translation, PT = Partial Translation, SOR = Statement of Relevancy, PF = Patent Family.

Electronic Acknowledgement Receipt

EFS ID:	7566967
Application Number:	90010422
International Application Number:	
Confirmation Number:	6565
Title of Invention:	Graphic User Interface For Internet Telephony Application
First Named Inventor/Applicant Name:	6,009,469
Customer Number:	42624
Filer:	Michael R. Casey
Filer Authorized By:	
Attorney Docket Number:	2655-0185
Receipt Date:	06-MAY-2010
Filing Date:	26-FEB-2009
Time Stamp:	18:07:27
Application Type:	Reexam (Third Party)

Payment information:

Submitted with Payment	no
------------------------	----

File Listing:

Document Number	Document Description	File Name	File Size(Bytes)/ Message Digest	Multi Part /.zip	Pages (if appl.)
1	Transmittal Letter	20100506_0185_IDS.pdf	133986 <small>188c8ed2a8219e138cb5350bbe8db181764957dd</small>	no	2

Warnings:

Information:

2	Information Disclosure Statement (IDS) Filed (SB/08)	20100506_0185_1449.pdf	127222 3604aa0efc189e11e5cde3598fff8430ad76e35c	no	1
Warnings:					
Information:					
This is not an USPTO supplied IDS fillable form					
3	NPL Documents	NP0000.pdf	102125 a7d17c07971330af903f13907088be7b3d2b1e0d	no	19
Warnings:					
Information:					
4	NPL Documents	NP0001.pdf	545041 63514a7badf524502040085964c36bbfa03fe99	no	78
Warnings:					
Information:					
5	NPL Documents	20100506_0185_COS.pdf	57284 a263ccc398fd0f5d6112b5a4c1a2ceb925e17c0	no	1
Warnings:					
Information:					
Total Files Size (in bytes):				965658	
<p>This Acknowledgement Receipt evidences receipt on the noted date by the USPTO of the indicated documents, characterized by the applicant, and including page counts, where applicable. It serves as evidence of receipt similar to a Post Card, as described in MPEP 503.</p> <p><u>New Applications Under 35 U.S.C. 111</u> If a new application is being filed and the application includes the necessary components for a filing date (see 37 CFR 1.53(b)-(d) and MPEP 506), a Filing Receipt (37 CFR 1.54) will be issued in due course and the date shown on this Acknowledgement Receipt will establish the filing date of the application.</p> <p><u>National Stage of an International Application under 35 U.S.C. 371</u> If a timely submission to enter the national stage of an international application is compliant with the conditions of 35 U.S.C. 371 and other applicable requirements a Form PCT/DO/EO/903 indicating acceptance of the application as a national stage submission under 35 U.S.C. 371 will be issued in addition to the Filing Receipt, in due course.</p> <p><u>New International Application Filed with the USPTO as a Receiving Office</u> If a new international application is being filed and the international application includes the necessary components for an international filing date (see PCT Article 11 and MPEP 1810), a Notification of the International Application Number and of the International Filing Date (Form PCT/RO/105) will be issued in due course, subject to prescriptions concerning national security, and the date shown on this Acknowledgement Receipt will establish the international filing date of the application.</p>					

IN THE UNITED STATES PATENT AND TRADEMARK OFFICE

In re PATENT APPLICATION OF:
Net2Phone, Inc. (Patent No. 6,009,469)
Control No.: 90/010,422
Issue Date: December 28, 1999
Title: **GRAPHIC USER INTERFACE FOR
INTERNET TELEPHONY APPLICATION**

Attorney Docket: 2655-0185
Group Art Unit: 3992
Examiner: KOSOWSKI, Alexander
Date: May 6, 2010
Confirmation No.: 6565

INFORMATION DISCLOSURE STATEMENT

Hon. Commissioner of Patents
P.O. Box 1450
Alexandria, VA 22313-1450

Sir:

Pursuant to 37 C.F.R. § 1.56, the attention of the Patent and Trademark Office is hereby directed to the reference(s) listed on the attached PTO-1449. One copy of each non-U.S. Patent reference is attached. It is respectfully requested that the information be expressly considered during the prosecution of this application, and that the reference(s) be made of record therein and appear among the "References Cited" on any patent to issue therefrom.

The submission of any document herewith, which is not a statutory bar, is not intended that any such document constitutes prior art against any of the claims of the present application or is considered to be material to patentability as defined in 37 C.F.R. § 1.56(b). Applicants do not waive any rights to take any action which would be appropriate to antedate or otherwise remove as a competent reference against the claims of the present application.

The Opposition to the enclosed Motion will be filed under separate cover.

CHARGE STATEMENT: Deposit Account No. 501860, order no. 2655-0185.

The Commissioner is hereby authorized to charge any fee specifically authorized hereafter, or any missing or insufficient fee(s) filed, or asserted to be filed, or which should have been filed herewith or concerning any paper filed hereafter, and which may be required under Rules 16-18 (missing or insufficiencies only) now or hereafter relative to this application and the resulting Official Document under Rule 20, or credit any overpayment, to our Accounting/Order Nos. shown above, for which purpose a duplicate copy of this sheet is attached

This CHARGE STATEMENT does not authorize charge of the issue fee until/unless an issue fee transmittal sheet is filed.

CUSTOMER NUMBER

42624

Davidson Berquist Jackson & Gowdey LLP
4300 Wilson Blvd., 7th Floor,
Arlington Virginia 22203
Main: (703) 894-6400 • FAX: (703) 894-6430

Respectfully submitted,

By: / Michael R. Casey /

Michael R. Casey, Ph.D. (Reg. No.: 40,294)



RECEIVED

MAR 05 2010

Reexam

CENTRAL REEXAMINATION UNIT
IN THE UNITED STATES PATENT AND TRADEMARK OFFICE

In re PATENT APPLICATION OF:

Net2Phone, Inc. (Patent No. 6,009,469)

Control No.: 90/010,422

Issue Date: December 28, 1999

Title: **GRAPHIC USER INTERFACE FOR
INTERNET TELEPHONY APPLICATION**

Attorney Docket: 2655-0185

Group Art Unit: 3992

Examiner: KOSOWSKI, Alexander

Date: March 5, 2010

Confirmation No.: 6565

INFORMATION DISCLOSURE STATEMENT

Hon. Commissioner of Patents
P.O. Box 1450
Alexandria, VA 22313-1450

Sir:

Pursuant to 37 C.F.R. § 1.56, the attention of the Patent and Trademark Office is hereby directed to the reference(s) listed on the attached PTO-1449. One copy of each non-U.S. Patent reference is attached. It is respectfully requested that the information be expressly considered during the prosecution of this application, and that the reference(s) be made of record therein and appear among the "References Cited" on any patent to issue therefrom.

The submission of any document herewith, which is not a statutory bar, is not intended that any such document constitutes prior art against any of the claims of the present application or is considered to be material to patentability as defined in 37 C.F.R. § 1.56(b). Applicants do not waive any rights to take any action which would be appropriate to antedate or otherwise remove as a competent reference against the claims of the present application.

The enclosed CD-ROM includes electronic copies of the help files (.hlp files) filed in the IDS submitted February 24, 2010 (as References 1-3 and 1-5)

which were inadvertently referred to as “.inf” files in that IDS. The enclosed CD-ROM further includes a copy of the VocalChat GTI installation program (setup.exe) and its corresponding data file (vocchat.001). As described in the Redacted expert reports (References 1-1 and 1-2 of the IDS dated February 24, 2010), the VocalChat GTI software (including the .hlp files and the README.TXT file) is alleged to have been distributed more than one year prior to the effective filing date of this application.

CHARGE STATEMENT: Deposit Account No. 501860, order no. 2655-0185.

The Commissioner is hereby authorized to charge any fee specifically authorized hereafter, or any missing or insufficient fee(s) filed, or asserted to be filed, or which should have been filed herewith or concerning any paper filed hereafter, and which may be required under Rules 16-18 (missing or insufficiencies only) now or hereafter relative to this application and the resulting Official Document under Rule 20, or credit any overpayment, to our Accounting/Order Nos. shown above, for which purpose a duplicate copy of this sheet is attached

This CHARGE STATEMENT does not authorize charge of the issue fee until/unless an issue fee transmittal sheet is filed.

CUSTOMER NUMBER

42624

Davidson Berquist Jackson & Gowdey LLP
4300 Wilson Blvd., 7th Floor,
Arlington Virginia 22203
Main: (703) 894-6400 • FAX: (703) 894-6430

Respectfully submitted,

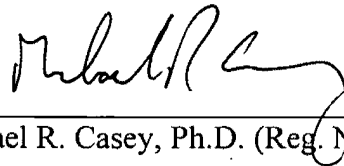
By: 

Michael R. Casey, Ph.D. (Reg. No.: 40,294)

RECEIVED

MAR 05 2010

CENTRAL REEXAMINATION UNIT INFORMATION DISCLOSURE STATEMENT BY APPLICANT FORM PTO-1449 (modified) Sheet 1 of 1	Reexam number	90/010,422
	First Named Inventor	Mattaway et al.
	Patent Under Re-Exam	6009469
	Issue Date	1999/12/28
	Group Art Unit	3992
	Examiner Name	KOSOWSKI, ALEXANDER J
	Attorney Docket No.	2655-0185
	Confirmation No.	6565

NON-PATENT REFERENCES			
Examiner Initials*	Cite No.	Non-patent Reference bibliographic information, where available	Notes
	1-1	CD-ROM including VocalChat GTI Version 2.12 Software (including .hlp files and README.TXT file), alleged to be dated September, 1994	
	1-2		
	1-3		
	1-4		
	1-5		
	1-6		
	1-7		

Examiner Signature		Date Considered	
--------------------	--	-----------------	--

*Examiner: Initial if reference was considered, whether or not citation is in conformance with MPEP 609. Draw a line through citation if not in conformance and not considered. Include a copy of this form with next communication to applicant. Notes: If identified, the following is provided: EA = English Abstract, T = Translation, PT = Partial Translation, SOR = Statement of Relevancy, PF = Patent Family.

In re PATENT APPLICATION OF:
Net2Phone, Inc. (Patent No. 6,009,469)
Control No.: 90/010,422
Issue Date: December 28, 1999
Title: **GRAPHIC USER INTERFACE FOR
INTERNET TELEPHONY APPLICATION**

Attorney Docket: 2655-0185
Group Art Unit: 3992
Examiner: KOSOWSKI, Alexander
Date: March 5, 2010
Confirmation No.: 6565

TRANSMITTAL LETTER

This compact disc is in the IBM-PC format and compatible with MS-Windows-based systems. The files contained on the compact disc are:

File Date	File Time	File Size (bytes)	File Name
03/05/2010	02:47 PM	574	files.txt
02/02/2010	11:28 AM	23,886	info.hlp
03/05/2010	01:55 PM	1,517	README.TXT
03/05/2010	01:55 PM	233,282	setup.exe
02/02/2010	11:28 AM	125,066	trouble.hlp
03/05/2010	01:55 PM	885,233	VOCLCHAT.001

The text of this file is contained in the file: files.txt.

CUSTOMER NUMBER
42624

Davidson Berquist Jackson & Gowdey LLP
4300 Wilson Blvd., 7th Floor,
Arlington Virginia 22203
Main: (703) 894-6400 • FAX: (703) 894-6430

Respectfully submitted,

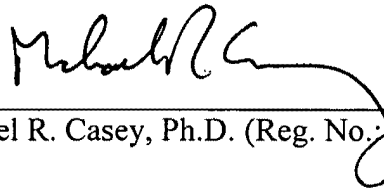
By: 
Michael R. Casey, Ph.D. (Reg. No. 40,294)

ARTIFACT SHEET

Enter artifact number below. Artifact number is application number + artifact type code (see list below) + sequential letter (A, B, C ...). The first artifact folder for an artifact type receives the letter A, the second B, etc.. Examples: 59123456PA, 59123456PB, 59123456ZA, 59123456ZB

901010422 PA

Indicate quantity of a single type of artifact received but not scanned. Create individual artifact folder/box and artifact number for each Artifact Type.

CD(s) containing:

computer program listing

Doc Code: Computer

pages of specification

and/or sequence listing

and/or table

Doc Code: Artifact

content unspecified or combined

Doc Code: Artifact

Artifact Type Code: P

Artifact Type Code: S

Artifact Type Code: U

Stapled Set(s) Color Documents or B/W Photographs

Doc Code: Artifact Artifact Type Code: C

Microfilm(s)

Doc Code: Artifact Artifact Type Code: F

Video tape(s)

Doc Code: Artifact Artifact Type Code: V

Model(s)

Doc Code: Artifact Artifact Type Code: M

Bound Document(s)

Doc Code: Artifact Artifact Type Code: B

Confidential Information Disclosure Statement or Other Documents marked Proprietary, Trade Secrets, Subject to Protective Order, Material Submitted under MPEP 724.02, etc.

Doc Code: Artifact Artifact Type Code X

Other, description: _____

Doc Code: Artifact Artifact Type Code: Z

March 8, 2004

INFORMATION DISCLOSURE STATEMENT BY APPLICANT FORM PTO-1449 (modified)	Reexam number	90/010,422
	First Named Inventor	Mattaway et al.
	Patent Under Re-Exam	6009469
	Issue Date	1999/12/28
	Group Art Unit	3992
	Examiner Name	KOSOWSKI, ALEXANDER J
	Attorney Docket No.	2655-0185
	Confirmation No.	6565

Sheet 1 of 1

NON-PATENT REFERENCES			
Examiner Initials*	Cite No.	Non-patent Reference bibliographic information, where available	Notes
	1-1	(Redacted) Expert Report of Professor Bruce M. Maggs (as Supplemented Sept. 9, 2008) in Net2Phone v. Skype et al. (Civil Action No. 06-2469-KSH-PS) in DCNJ	
	1-2	(Redacted) Responsive Expert Report of Kevin Jeffay, Ph.D. in Net2Phone v. Skype et al. (Civil Action No. 06-2469-KSH-PS) in DCNJ, Aug. 7, 2008	
	1-3	VocalChat GTI Information file, believed to be included with VocalChat GTI version 2.12 dated September, 1994	
	1-4	VocalChat GTI README.TXT for Version 2.12 Beta, dated September, 1994	
	1-5	VocalChat GTI Troubleshooting.Inf, believed to be included with VocalChat GTI version 2.12 dated September, 1994	
	1-6		
	1-7		

Examiner Signature		Date Considered	
--------------------	--	-----------------	--

*Examiner: Initial if reference was considered, whether or not citation is in conformance with MPEP 609. Draw a line through citation if not in conformance and not considered. Include a copy of this form with next communication to applicant. Notes: If identified, the following is provided: EA = English Abstract, T = Translation, PF = Patent Family.

Electronic Acknowledgement Receipt

EFS ID:	7079480
Application Number:	90010422
International Application Number:	
Confirmation Number:	6565
Title of Invention:	Graphic User Interface For Internet Telephony Application
First Named Inventor/Applicant Name:	6,009,469
Customer Number:	42624
Filer:	Michael R. Casey
Filer Authorized By:	
Attorney Docket Number:	2655-0185
Receipt Date:	24-FEB-2010
Filing Date:	26-FEB-2009
Time Stamp:	16:07:55
Application Type:	Reexam (Third Party)

Payment information:

Submitted with Payment	no
------------------------	----

File Listing:

Document Number	Document Description	File Name	File Size(Bytes)/ Message Digest	Multi Part /.zip	Pages (if appl.)
1	Transmittal Letter	20100224_IDS_0185.pdf	122391 <small>49f6490e571483d99ecd4f5f721a5d11923c3c2c</small>	no	2

Warnings:

Information:

2	Information Disclosure Statement (IDS) Filed (SB/08)	20100224_1449_0185.pdf	145960 c7f2d9a7f4d5763d818505b3f3af0cb41cf6326f	no	1
Warnings:					
Information:					
This is not an USPTO supplied IDS fillable form					
3	NPL Documents	NP0000.pdf	1979901 a449a91e441753b8d66cd6c68a2596713f56a7e8	no	555
Warnings:					
Information:					
4	NPL Documents	NP0001.pdf	19102486 44dba22520e559a2aa39babaa6d2d99f77c3acb9	no	379
Warnings:					
Information:					
5	NPL Documents	NP0002.pdf	459371 1487bd49cf03d60e47137272cc06b82f35bf425	no	14
Warnings:					
Information:					
6	NPL Documents	NP0003.pdf	31729 3c3fa76b6f608e01672697686901d4f92bba4cc47	no	2
Warnings:					
Information:					
7	NPL Documents	NP0004.pdf	1920797 31dd0b006cf48147ce4ed2f5ce4a54e94b15e2bb	no	33
Warnings:					
Information:					
8	Reexam Certificate of Service	20100224_COS_0185.pdf	52165 2dbd8f8e94af00bf601d60f1748bc133e9d34413	no	1
Warnings:					
Information:					
Total Files Size (in bytes):				23814800	

This Acknowledgement Receipt evidences receipt on the noted date by the USPTO of the indicated documents, characterized by the applicant, and including page counts, where applicable. It serves as evidence of receipt similar to a Post Card, as described in MPEP 503.

New Applications Under 35 U.S.C. 111

If a new application is being filed and the application includes the necessary components for a filing date (see 37 CFR 1.53(b)-(d) and MPEP 506), a Filing Receipt (37 CFR 1.54) will be issued in due course and the date shown on this Acknowledgement Receipt will establish the filing date of the application.

National Stage of an International Application under 35 U.S.C. 371

If a timely submission to enter the national stage of an international application is compliant with the conditions of 35 U.S.C. 371 and other applicable requirements a Form PCT/DO/EO/903 indicating acceptance of the application as a national stage submission under 35 U.S.C. 371 will be issued in addition to the Filing Receipt, in due course.

New International Application Filed with the USPTO as a Receiving Office

If a new international application is being filed and the international application includes the necessary components for an international filing date (see PCT Article 11 and MPEP 1810), a Notification of the International Application Number and of the International Filing Date (Form PCT/RO/105) will be issued in due course, subject to prescriptions concerning national security, and the date shown on this Acknowledgement Receipt will establish the international filing date of the application.

IN THE UNITED STATES PATENT AND TRADEMARK OFFICE

In re PATENT APPLICATION OF:
Net2Phone, Inc. (Patent No. 6,009,469)
Control No.: 90/010,422
Issue Date: December 28, 1999
Title: **GRAPHIC USER INTERFACE FOR
INTERNET TELEPHONY APPLICATION**

Attorney Docket: 2655-0185
Group Art Unit: 3992
Examiner: KOSOWSKI, Alexander
Date: February 24, 2010
Confirmation No.: 6565

INFORMATION DISCLOSURE STATEMENT

Hon. Commissioner of Patents
P.O. Box 1450
Alexandria, VA 22313-1450

Sir:

Pursuant to 37 C.F.R. § 1.56, the attention of the Patent and Trademark Office is hereby directed to the reference(s) listed on the attached PTO-1449. One copy of each non-U.S. Patent reference is attached. It is respectfully requested that the information be expressly considered during the prosecution of this application, and that the reference(s) be made of record therein and appear among the "References Cited" on any patent to issue therefrom.

The submission of any document herewith, which is not a statutory bar, is not intended that any such document constitutes prior art against any of the claims of the present application or is considered to be material to patentability as defined in 37 C.F.R. § 1.56(b). Applicants do not waive any rights to take any action which would be appropriate to antedate or otherwise remove as a competent reference against the claims of the present application.

It is noted that References 1-1 and 1-2 are Redacted expert reports. Those reports have been redacted to protect third party confidential information.

References 1-3 and 1-5 are printed copies of “.inf” files that are alleged to have been distributed with the VocalChat GTI version 2.12 Beta which is referenced in Reference 1-4.

<p>CHARGE STATEMENT: Deposit Account No. 501860, order no. 2655-0185.</p> <p>The Commissioner is hereby authorized to charge any fee specifically authorized hereafter, or any missing or insufficient fee(s) filed, or asserted to be filed, or which should have been filed herewith or concerning any paper filed hereafter, and which may be required under Rules 16-18 (<u>missing or insufficiencies only</u>) now or hereafter relative to this application and the resulting Official Document under Rule 20, or credit any overpayment, to our Accounting/Order Nos. shown above, for which purpose a <u>duplicate</u> copy of this sheet is attached</p> <p>This CHARGE STATEMENT <u>does not authorize</u> charge of the <u>issue fee</u> until/unless an issue fee transmittal sheet is filed.</p>

<p>CUSTOMER NUMBER</p> <p>42624</p>
--

Respectfully submitted,

Davidson Berquist Jackson & Gowdey LLP
4300 Wilson Blvd., 7th Floor,
Arlington Virginia 22203
Main: (703) 894-6400 • FAX: (703) 894-6430

By: /Michael R. Casey /

Michael R. Casey, Ph.D. (Reg. No.: 40,294)

INFORMATION DISCLOSURE STATEMENT BY APPLICANT FORM PTO-1449 (modified)	Reexam number	90/010,422
	First Named Inventor	Mattaway et al.
	Patent Under Re-Exam	6009469
	Issue Date	1999/12/28
	Group Art Unit	3992
	Examiner Name	KOSOWSKI, ALEXANDER J
	Attorney Docket No.	2655-0185
	Confirmation No.	6565

Sheet 1 of 4

NON-PATENT REFERENCES			
Examiner Initials*	Cite No.	Non-patent Reference bibliographic information, where available	Notes
	1-1	David STROM, "Talking Telephony", Windows Sources, Ziff-Davis Publishing Company, September 1996, Vol. 4, No. 9, pages 6, 7, 10, 150-152, 157, 158, 163, 167, 169, 171, 174, 181, 184, 186, 195, 203, 208.	
	1-2	Deposition transcript of Andrew Green (dated Aug. December 30, 2008) in Net2Phone v. Skype et al. (Civil Action No. 06-2469-KSH-PS) in DCNJ	
	1-3	Deposition transcript of Daniel Mayer (dated Aug. 26, 2008) in Net2Phone v. Skype et al. (Civil Action No. 06-2469-KSH-PS) in DCNJ	
	1-4	Deposition transcript of Daniel Zwanziger (dated July 9, 2008) in Net2Phone v. Skype et al. (Civil Action No. 06-2469-KSH-PS) in DCNJ	
	1-5	Deposition transcript of expert Bruce Maggs (dated May 30, 2008) in Net2Phone v. Skype et al. (Civil Action No. 06-2469-KSH-PS) in DCNJ	
	1-6	Deposition transcript of expert Kevin Jeffay (dated May 20, 2008) in Net2Phone v. Skype et al. (Civil Action No. 06-2469-KSH-PS) in DCNJ	
	1-7	Deposition transcript of expert Stephen Kunin (dated June 3, 2008) in Net2Phone v. Skype et al. (Civil Action No. 06-2469-KSH-PS) in DCNJ	

Examiner Signature		Date Considered	
--------------------	--	-----------------	--

*Examiner: Initial if reference was considered, whether or not citation is in conformance with MPEP 609. Draw a line through citation if not in conformance and not considered. Include a copy of this form with next communication to applicant. Notes: If identified, the following is provided: EA = English Abstract, T = Translation, PT = Partial Translation, SOR = Statement of Relevancy, PF = Patent Family.

INFORMATION DISCLOSURE STATEMENT BY APPLICANT FORM PTO-1449 (modified)	Reexam number	90/010,422
	First Named Inventor	Mattaway et al.
	Patent Under Re-Exam	6009469
	Issue Date	1999/12/28
	Group Art Unit	3992
	Examiner Name	KOSOWSKI, ALEXANDER J
	Attorney Docket No.	2655-0185
	Confirmation No.	6565
Sheet 2 of 4		

NON-PATENT REFERENCES			
Examiner Initials*	Cite No.	Non-patent Reference bibliographic information, where available	Notes
	2-1	Deposition transcript of former Tribal Voice employee and PowWow designer Paul Peterson (dated Apr. 9, 2008) in Net2Phone v. Skype et al. (Civil Action No. 06-2469-KSH-PS) in DCNJ	
	2-2	Deposition transcript of former VocalTec employee Alon Cohen (dated Mar. 11, 2008) in Net2Phone v. Skype et al. (Civil Action No. 06-2469-KSH-PS) in DCNJ	
	2-3	Deposition transcript of former VocalTec employee Lior Haramaty (dated Mar. 6, 2008) in Net2Phone v. Skype et al. (Civil Action No. 06-2469-KSH-PS) in DCNJ	
	2-4	Deposition transcript of inventor Craig Strickland (dated Sep. 19, 2007) in Net2Phone v. Skype et al. (Civil Action No. 06-2469-KSH-PS) in DCNJ	
	2-5	Deposition transcript of inventor Glenn Hutton (dated Aug. 24, 2007) (vol. 1) in Net2Phone v. Skype et al. (Civil Action No. 06-2469-KSH-PS) in DCNJ	
	2-6	Deposition transcript of inventor Glenn Hutton (dated Aug. 24, 2007) (vol. 2) in Net2Phone v. Skype et al. (Civil Action No. 06-2469-KSH-PS) in DCNJ	
	2-7	Deposition transcript of inventor Shane Mattaway (dated Sep. 10, 2007) (vol. 1) in Net2Phone v. Skype et al. (Civil Action No. 06-2469-KSH-PS) in DCNJ	

Examiner Signature		Date Considered	
--------------------	--	-----------------	--

*Examiner: Initial if reference was considered, whether or not citation is in conformance with MPEP 609. Draw a line through citation if not in conformance and not considered. Include a copy of this form with next communication to applicant. Notes: If identified, the following is provided: EA = English Abstract, T = Translation, PT = Partial Translation, SOR = Statement of Relevancy, PF = Patent Family.

**INFORMATION DISCLOSURE
STATEMENT BY APPLICANT**
FORM PTO-1449 (modified)

Sheet 3 of 4

Reexam number	90/010,422
First Named Inventor	Mattaway et al.
Patent Under Re-Exam	6009469
Issue Date	1999/12/28
Group Art Unit	3992
Examiner Name	KOSOWSKI, ALEXANDER J
Attorney Docket No.	2655-0185
Confirmation No.	6565

NON-PATENT REFERENCES

Examiner Initials*	Cite No.	Non-patent Reference bibliographic information, where available	Notes
	3-1	Deposition transcript of inventor Shane Mattaway (dated Sep. 10, 2007) (vol. 2) in Net2Phone v. Skype et al. (Civil Action No. 06-2469-KSH-PS) in DCNJ	
	3-2	Deposition transcript of prosecuting attorney Bruce Jobse (dated Jan. 1, 2008) in Net2Phone v. Skype et al. (Civil Action No. 06-2469-KSH-PS) in DCNJ	
	3-3	Deposition transcript of Sheldon Glashow (dated July 16, 2008) in Net2Phone v. Skype et al. (Civil Action No. 06-2469-KSH-PS) in DCNJ	
	3-4	Emad FARAG et al., "Structure and network control of a hierarchical mobile network architecture", IEEE Fourteenth Annual International Phoenix Conference on Computers and Communications, 03/1995, ISBN: 0-7803-2492-7, pp. 671-677.	
	3-5	English translation of JP-06-62020 (dated 1994-03-04)	
	3-6	Huanxu PAN et al., "Analysis of a CCSS#7 Network supporting database services", IEEE International Conference on Information Engineering, 09/1993, ISBN: 0-7803-1445-X, pp. 193-197, vol. 1.	
	3-7	John E. GOODWIN, Project Gutenberg Alpha Edition of EMAIL 101, http://metalab.unc.edu/pub/docs/books/gutenberg/etext93/email025.txt , July 1993.	

Examiner Signature		Date Considered	
--------------------	--	-----------------	--

*Examiner: Initial if reference was considered, whether or not citation is in conformance with MPEP 609. Draw a line through citation if not in conformance and not considered. Include a copy of this form with next communication to applicant. Notes: If identified, the following is provided: EA = English Abstract, T = Translation, PT = Partial Translation, SOR = Statement of Relevancy, PF = Patent Family.

**INFORMATION DISCLOSURE
STATEMENT BY APPLICANT**
FORM PTO-1449 (modified)

Sheet 4 of 4

Reexam number	90/010,422
First Named Inventor	Mattaway et al.
Patent Under Re-Exam	6009469
Issue Date	1999/12/28
Group Art Unit	3992
Examiner Name	KOSOWSKI, ALEXANDER J
Attorney Docket No.	2655-0185
Confirmation No.	6565

NON-PATENT REFERENCES

Examiner Initials*	Cite No.	Non-patent Reference bibliographic information, where available	Notes
	4-1	Junichi Kimura, et al. "Voice/Data Multiplexing Transmission Methods", Kokai Japanese Patent, Kokai Sho 59-44140, pages 205-215, with English Abstract, English Translation, pages 1-24	
	4-2	Mark R. BROWN et al. "Special Edition: Using Netscape 2", Que Publishing, 1995, ISBN 0-7897-0612-1, pages 7-35, 37-56, 78, 83, 176, 301-320, 393, 395-467, 469-506.	
	4-3	Preston GRALLA, "How the Internet Works", Ziff-Davis Press, Emeryville, CA, c1997, pp. 34-37, 202-205, 214-215 and 272-275, ISBN 1-56276-552-3.	
	4-4		
	4-5		
	4-6		
	4-7		

Examiner Signature		Date Considered	
--------------------	--	-----------------	--

*Examiner: Initial if reference was considered, whether or not citation is in conformance with MPEP 609. Draw a line through citation if not in conformance and not considered. Include a copy of this form with next communication to applicant. Notes: If identified, the following is provided: EA = English Abstract, T = Translation, PT = Partial Translation, SOR = Statement of Relevancy, PF = Patent Family.

IN THE UNITED STATES PATENT AND TRADEMARK OFFICE

In re PATENT APPLICATION OF:
Net2Phone, Inc. (Patent No. 6,009,469)
Control No.: 90/010,422
Issue Date: December 28, 1999
Title: **GRAPHIC USER INTERFACE FOR
INTERNET TELEPHONY APPLICATION**

Attorney Docket: 2655-0185
Group Art Unit: 3992
Examiner: KOSOWSKI, Alexander
Date: January 26, 2010
Confirmation No.: 6565

INFORMATION DISCLOSURE STATEMENT

Hon. Commissioner of Patents
P.O. Box 1450
Alexandria, VA 22313-1450

Sir:

Pursuant to 37 C.F.R. § 1.56, the attention of the Patent and Trademark Office is hereby directed to the reference(s) listed on the attached PTO-1449. One copy of each non-U.S. Patent reference is attached. It is respectfully requested that the information be expressly considered during the prosecution of this application, and that the reference(s) be made of record therein and appear among the "References Cited" on any patent to issue therefrom.

The submission of any document herewith, which is not a statutory bar, is not intended that any such document constitutes prior art against any of the claims of the present application or is considered to be material to patentability as defined in 37 C.F.R. § 1.56(b). Applicants do not waive any rights to take any action which would be appropriate to antedate or otherwise remove as a competent reference against the claims of the present application.

In re Application of: Net2Phone, Inc.
Control No.: 90/010,422
Information Disclosure Statement dated January 26, 2010
Page 2 of 2

CHARGE STATEMENT: Deposit Account No. 501860, order no. **2655-0185.**

The Commissioner is hereby authorized to charge any fee specifically authorized hereafter, or any missing or insufficient fee(s) filed, or asserted to be filed, or which should have been filed herewith or concerning any paper filed hereafter, and which may be required under Rules 16-18 (missing or insufficiencies only) now or hereafter relative to this application and the resulting Official Document under Rule 20, or credit any overpayment, to our Accounting/Order Nos. shown above, for which purpose a duplicate copy of this sheet is attached

This CHARGE STATEMENT does not authorize charge of the issue fee until/unless an issue fee transmittal sheet is filed.

CUSTOMER NUMBER

42624

Davidson Berquist Jackson & Gowdey LLP
4300 Wilson Blvd., 7th Floor,
Arlington Virginia 22203
Main: (703) 894-6400 • FAX: (703) 894-6430

Respectfully submitted,

By: /Michael R. Casey /

Michael R. Casey, Ph.D. (Reg. No.: 40,294)

Electronic Acknowledgement Receipt

EFS ID:	6885471
Application Number:	90010422
International Application Number:	
Confirmation Number:	6565
Title of Invention:	Graphic User Interface For Internet Telephony Application
First Named Inventor/Applicant Name:	6,009,469
Customer Number:	42624
Filer:	Michael R. Casey
Filer Authorized By:	
Attorney Docket Number:	2655-0185
Receipt Date:	26-JAN-2010
Filing Date:	26-FEB-2009
Time Stamp:	17:35:47
Application Type:	Reexam (Third Party)

Payment information:

Submitted with Payment	no
------------------------	----

File Listing:

Document Number	Document Description	File Name	File Size(Bytes)/ Message Digest	Multi Part /.zip	Pages (if appl.)
1	Information Disclosure Statement (IDS) Filed (SB/08)	20100126_1449_0185.pdf	668401 <small>52f6d48c011ffa9f4abab202e113e9d0d2666507</small>	no	4

Warnings:

Information:

This is not an USPTO supplied IDS fillable form					
2	Reexam Certificate of Service	20100126_COS_0185.pdf	51646	no	1
			f6c1b8a67b9288bbd10f298f26ade744b9c ba193		
Warnings:					
Information:					
3	Transmittal Letter	20100126_IDS_0185.pdf	119510	no	2
			b0a2874f2d50adff1750a119ac5a156c4e55 500e		
Warnings:					
Information:					
4	NPL Documents	NP0000.pdf	2849230	no	21
			f6c70ebc7a75070c48a44ce952700a97947 0617		
Warnings:					
Information:					
5	NPL Documents	NP0001.pdf	324894	no	165
			0d4e7d18798d0547ab9f7217bf438d32d4a ca151		
Warnings:					
Information:					
6	NPL Documents	NP0002.pdf	158137	no	76
			9d019ba52ea92885a4de182f30a26e83407 97d17		
Warnings:					
Information:					
7	NPL Documents	NP0003.pdf	197976	no	97
			e77951235711e2e7a11a53c2103667cbcc8 7ee4b		
Warnings:					
Information:					
8	NPL Documents	NP0004.pdf	536699	no	296
			a5f42c11f6a61da6ed373eb9beefc8b1cdb e410		
Warnings:					
Information:					
9	NPL Documents	NP0005.pdf	538883	no	310
			775254c12e40277ca609e2e4917ac30603d df7e1		
Warnings:					
Information:					
10	NPL Documents	NP0006.pdf	143967	no	30
			8dd5cd21d27fba7687f0157d2f1e035809b 8f680		

Warnings:					
Information:					
11	NPL Documents	NP0007.pdf	234922 c54976a90b5f782a7b5261f39abf45e67de30392	no	123
Warnings:					
Information:					
12	NPL Documents	NP0008.pdf	243217 de51ab6bd3717584d8f259603d52b1b9fc1b5a20	no	120
Warnings:					
Information:					
13	NPL Documents	NP0009.pdf	191407 64f22007d6f00c2d952572a5ee4bf8103cd9ed69	no	89
Warnings:					
Information:					
14	NPL Documents	NP0010.pdf	406575 d5366a0e76b1b131f88398023425bc0005285cc3	no	216
Warnings:					
Information:					
15	NPL Documents	NP0011.pdf	293003 11de56d0b56cef5be91de574e37335118ecc03bc	no	153
Warnings:					
Information:					
16	NPL Documents	NP0012.pdf	356895 f67059d2ddaef30cb87335cdcb8f819a30f55fbb3	no	194
Warnings:					
Information:					
17	NPL Documents	NP0013.pdf	341088 ddb8b7e2ed765fd5b656445edd36b9b3e3cb689	no	177
Warnings:					
Information:					
18	NPL Documents	NP0014.pdf	237011 e6bc987db2c3e70586f860117cb5267e9ed47a0	no	116
Warnings:					
Information:					
19	NPL Documents	NP0015.pdf	390203 24ba2cc419e3723b4778921466940109	no	225

Warnings:					
Information:					
20	NPL Documents	NP0016.pdf	246519 7d1bb73e5f0bbdfa6ca112d1b438a981bd59187d9	no	122
Warnings:					
Information:					
21	NPL Documents	NP0017.pdf	557280 bd59240ef179ad7b550b46e2e3e6987533ede89c	no	8
Warnings:					
Information:					
22	NPL Documents	NP0018.pdf	488130 b78dc26c39396504962862c2554d073552db1348	no	28
Warnings:					
Information:					
23	NPL Documents	NP0019.pdf	381732 bf2b1d0ed5f2043102da896eb14363c17bb22de6	no	5
Warnings:					
Information:					
24	NPL Documents	NP0020.pdf	2436121 78a7093d4c5233498055bdfdf13ec7fa32915ed7	no	44
Warnings:					
Information:					
25	NPL Documents	NP0021.pdf	1315455 0599b13abf1c7fc807f2612c5d47eaf88cf78d6	no	36
Warnings:					
Information:					
26	NPL Documents	NP0022.pdf	12867743 1b175ba39ec382d8eb4a37187275a4eff099eec8	no	187
Warnings:					
Information:					
27	NPL Documents	NP0023.pdf	710975 182d26e9f78b2d565d519aadcf049bdd3a98a89f	no	5
Warnings:					
Information:					
Total Files Size (in bytes):			27287619		

This Acknowledgement Receipt evidences receipt on the noted date by the USPTO of the indicated documents, characterized by the applicant, and including page counts, where applicable. It serves as evidence of receipt similar to a Post Card, as described in MPEP 503.

New Applications Under 35 U.S.C. 111

If a new application is being filed and the application includes the necessary components for a filing date (see 37 CFR 1.53(b)-(d) and MPEP 506), a Filing Receipt (37 CFR 1.54) will be issued in due course and the date shown on this Acknowledgement Receipt will establish the filing date of the application.

National Stage of an International Application under 35 U.S.C. 371

If a timely submission to enter the national stage of an international application is compliant with the conditions of 35 U.S.C. 371 and other applicable requirements a Form PCT/DO/EO/903 indicating acceptance of the application as a national stage submission under 35 U.S.C. 371 will be issued in addition to the Filing Receipt, in due course.

New International Application Filed with the USPTO as a Receiving Office

If a new international application is being filed and the international application includes the necessary components for an international filing date (see PCT Article 11 and MPEP 1810), a Notification of the International Application Number and of the International Filing Date (Form PCT/RO/105) will be issued in due course, subject to prescriptions concerning national security, and the date shown on this Acknowledgement Receipt will establish the international filing date of the application.

**INFORMATION DISCLOSURE
STATEMENT BY APPLICANT**

FORM PTO-1449 (modified)

Sheet 1 of 10

Reexam number	90/010,422
First Named Inventor	Mattaway et al.
Patent Under Re-Exam	6009469
Issue Date	1999/12/28
Group Art Unit	3992
Examiner Name	KOSOWSKI, ALEXANDER J
Attorney Docket No.	2655-0185
Confirmation No.	6565

FOREIGN PATENT DOCUMENTS

Examiner Initials*	Cite No.	Document No.	Publication Date	Name of Patentee or Applicant of Cited Document	Notes
	1-1	WO-9003074	03-22-1990	LE CLERCQ, Patrick	
	1-2				
	1-3				
	1-4				
	1-5				
	1-6				
	1-7				
	1-8				
	1-9				
	1-10				
	1-11				
	1-12				
	1-13				
	1-14				
	1-15				
	1-16				
	1-17				
	1-18				
	1-19				
	1-20				
	1-21				
	1-22				
	1-23				
	1-24				

Examiner Signature		Date Considered	
--------------------	--	-----------------	--

*Examiner: Initial if reference was considered, whether or not citation is in conformance with MPEP 609. Draw a line through citation if not in conformance and not considered. Include a copy of this form with next communication to applicant. Notes: If identified, the following is provided: EA = English Abstract, T = Translation, PF = Patent Family.

**INFORMATION DISCLOSURE
STATEMENT BY APPLICANT**
FORM PTO-1449 (modified)

Sheet 2 of 10

Reexam number	90/010,422
First Named Inventor	Mattaway et al.
Patent Under Re-Exam	6009469
Issue Date	1999/12/28
Group Art Unit	3992
Examiner Name	KOSOWSKI, ALEXANDER J
Attorney Docket No.	2655-0185
Confirmation No.	6565

NON-PATENT REFERENCES

Examiner Initials*	Cite No.	Non-patent Reference bibliographic information, where available	Notes
	2-1	About NetPhone (undated)	
	2-2	After Downsizing: Overcoming Client-Server Chaos (May 21, 1994)	
	2-3	Barrow Street Research report on New Paradigm Software Corp. (dated sep. 20, 1995)	
	2-4	Camelot 10-Q for quarter ending January 31, 1995	
	2-5	Camelot Corporation 10-K, 1994	
	2-6	Camelot Corps Shining Internet Dream Draws Skeptics (Aug. 95)	
	2-7	Completed Beta Tester Agreements (May 1995)	

Examiner Signature		Date Considered	
--------------------	--	-----------------	--

*Examiner: Initial if reference was considered, whether or not citation is in conformance with MPEP 609. Draw a line through citation if not in conformance and not considered. Include a copy of this form with next communication to applicant. Notes: If identified, the following is provided: EA = English Abstract, T = Translation, PF = Patent Family.

**INFORMATION DISCLOSURE
STATEMENT BY APPLICANT**
FORM PTO-1449 (modified)

Sheet 3 of 10

Reexam number	90/010,422
First Named Inventor	Mattaway et al.
Patent Under Re-Exam	6009469
Issue Date	1999/12/28
Group Art Unit	3992
Examiner Name	KOSOWSKI, ALEXANDER J
Attorney Docket No.	2655-0185
Confirmation No.	6565

NON-PATENT REFERENCES

Examiner Initials*	Cite No.	Non-patent Reference bibliographic information, where available	Notes
	3-1	Correspondence with MacZone (Aug.-Sept. 1995)	
	3-2	DigiPhone and Camelot Documents	
	3-3	DigiPhone Documents (including Q and A) (prior to Sept. 1995)	
	3-4	DigiPhone Documents (prior to Sept. 1995)	
	3-5	DigiPhone for Mac (1996)	
	3-6	Electric Magic and Jabra Correspondence relating to new products (prior to 9/1995)	
	3-7	Electric Magic and PSINet License Negotiation Documentation (prior to Sept. 1995)	

Examiner Signature		Date Considered	
--------------------	--	-----------------	--

*Examiner: Initial if reference was considered, whether or not citation is in conformance with MPEP 609. Draw a line through citation if not in conformance and not considered. Include a copy of this form with next communication to applicant. Notes: If identified, the following is provided: EA = English Abstract, T = Translation, PF = Patent Family.

**INFORMATION DISCLOSURE
STATEMENT BY APPLICANT**
FORM PTO-1449 (modified)

Sheet 4 of 10

Reexam number	90/010,422
First Named Inventor	Mattaway et al.
Patent Under Re-Exam	6009469
Issue Date	1999/12/28
Group Art Unit	3992
Examiner Name	KOSOWSKI, ALEXANDER J
Attorney Docket No.	2655-0185
Confirmation No.	6565

NON-PATENT REFERENCES

Examiner Initials*	Cite No.	Non-patent Reference bibliographic information, where available	Notes
	4-1	Electric Magic Beta Tester Agreement dated July 21, 1995 (SKYPE-N2P01609523)	
	4-2	Electric Magic Company Releases NetPhone 1.2 and NetPub Server (dated June 8, 1995)	
	4-3	Electric Magic Information (May 1995)	
	4-4	Electric Magic Notebooks (prior to Sept. 1995)	
	4-5	Electric Magic Notes (including references to 4/18/95) and patent pending	
	4-6	Electric Magic Notes (including references to DigiPhone) (prior to Sept. 1995)	
	4-7	Electric Magic Notes (undated)	

Examiner Signature		Date Considered	
--------------------	--	-----------------	--

*Examiner: Initial if reference was considered, whether or not citation is in conformance with MPEP 609. Draw a line through citation if not in conformance and not considered. Include a copy of this form with next communication to applicant. Notes: If identified, the following is provided: EA = English Abstract, T = Translation, PF = Patent Family.

**INFORMATION DISCLOSURE
STATEMENT BY APPLICANT**
FORM PTO-1449 (modified)

Sheet 5 of 10

Reexam number	90/010,422
First Named Inventor	Mattaway et al.
Patent Under Re-Exam	6009469
Issue Date	1999/12/28
Group Art Unit	3992
Examiner Name	KOSOWSKI, ALEXANDER J
Attorney Docket No.	2655-0185
Confirmation No.	6565

NON-PATENT REFERENCES

Examiner Initials*	Cite No.	Non-patent Reference bibliographic information, where available	Notes
	5-1	Electric Magic Press Release (dated Mar. 13, 1995)	
	5-2	ElectricMagic and WebKat Licensing Documents (Sept. 1995 and prior)	
	5-3	E-mail dated May 9, 1995 re NetPhone Development with Jabra R/D	
	5-4	Fax dated 5/31/95 to IVP including press releases	
	5-5	Google Groups comp.dcom.videoconf posting (dated Jul. 5, 1995)	
	5-6	intern.tex (dated Aug. 30, 1994)	
	5-7	Jabra - Corporate and Product Backgrounder (April 19, 1995)	

Examiner Signature		Date Considered	
--------------------	--	-----------------	--

*Examiner: Initial if reference was considered, whether or not citation is in conformance with MPEP 609. Draw a line through citation if not in conformance and not considered. Include a copy of this form with next communication to applicant. Notes: If identified, the following is provided: EA = English Abstract, T = Translation, PF = Patent Family.

**INFORMATION DISCLOSURE
STATEMENT BY APPLICANT**
FORM PTO-1449 (modified)

Sheet 6 of 10

Reexam number	90/010,422
First Named Inventor	Mattaway et al.
Patent Under Re-Exam	6009469
Issue Date	1999/12/28
Group Art Unit	3992
Examiner Name	KOSOWSKI, ALEXANDER J
Attorney Docket No.	2655-0185
Confirmation No.	6565

NON-PATENT REFERENCES

Examiner Initials*	Cite No.	Non-patent Reference bibliographic information, where available	Notes
	6-1	Jabra Ear Phone Common Questions and Answers	
	6-2	Jabra Ear phone PC, 1995	
	6-3	Jabra Streamline Ear Phone, 1993	
	6-4	Letter of Intent including target dates (dated 19 Sept 95) (7 pgs)	
	6-5	List of source modules in NetPhone (dated Oct. 10, 1995)	
	6-6	MagicPhone Distribution Agreement (Aug. 1995)	
	6-7	Maven README (including 1994 copyright notice)	

Examiner Signature		Date Considered	
--------------------	--	-----------------	--

*Examiner: Initial if reference was considered, whether or not citation is in conformance with MPEP 609. Draw a line through citation if not in conformance and not considered. Include a copy of this form with next communication to applicant. Notes: If identified, the following is provided: EA = English Abstract, T = Translation, PF = Patent Family.

**INFORMATION DISCLOSURE
STATEMENT BY APPLICANT**
FORM PTO-1449 (modified)

Sheet 7 of 10

Reexam number	90/010,422
First Named Inventor	Mattaway et al.
Patent Under Re-Exam	6009469
Issue Date	1999/12/28
Group Art Unit	3992
Examiner Name	KOSOWSKI, ALEXANDER J
Attorney Docket No.	2655-0185
Confirmation No.	6565

NON-PATENT REFERENCES

Examiner Initials*	Cite No.	Non-patent Reference bibliographic information, where available	Notes
	7-1	Net as Phone (Internet World July 1995)	
	7-2	NET phone ad (with Jabra fax line) (May 95)	
	7-3	NetPhone 1.1 User Manual (including date 95-01-09)	
	7-4	NetPhone Advertisement (Aug. 1995)	
	7-5	NetPhone Correspondence (Jun.-July 1995)	
	7-6	NetPhone Development Plan (SKYPE-N2P01610487)	
	7-7	NetPhone Development Plan with time charts (including reference to 5/9/1995)	

Examiner Signature		Date Considered	
--------------------	--	-----------------	--

*Examiner: Initial if reference was considered, whether or not citation is in conformance with MPEP 609. Draw a line through citation if not in conformance and not considered. Include a copy of this form with next communication to applicant. Notes: If identified, the following is provided: EA = English Abstract, T = Translation, PF = Patent Family.

**INFORMATION DISCLOSURE
STATEMENT BY APPLICANT**
FORM PTO-1449 (modified)

Sheet 8 of 10

Reexam number	90/010,422
First Named Inventor	Mattaway et al.
Patent Under Re-Exam	6009469
Issue Date	1999/12/28
Group Art Unit	3992
Examiner Name	KOSOWSKI, ALEXANDER J
Attorney Docket No.	2655-0185
Confirmation No.	6565

NON-PATENT REFERENCES

Examiner Initials*	Cite No.	Non-patent Reference bibliographic information, where available	Notes
	8-1	NetPhone Digital User Manual (dated 95-02-26)	
	8-2	NetPhone gives your Mac voice over the Internet (Inside the Internet - June 1995)	
	8-3	Netphone invoices (including invoices prior to 9/1995)	
	8-4	NetPhone Make Free Calls over the Internet (undated)	
	8-5	NetPhone Screenshots (undated)	
	8-6	NetPhone Tasks and Plans (dated Jan.-Feb. 1995)	
	8-7	New Paradigm Software Agreement (dated Oct. 9, 1995) referencing existing software as of that date	

Examiner Signature		Date Considered	
--------------------	--	-----------------	--

*Examiner: Initial if reference was considered, whether or not citation is in conformance with MPEP 609. Draw a line through citation if not in conformance and not considered. Include a copy of this form with next communication to applicant. Notes: If identified, the following is provided: EA = English Abstract, T = Translation, PF = Patent Family.

**INFORMATION DISCLOSURE
STATEMENT BY APPLICANT**
FORM PTO-1449 (modified)

Sheet 9 of 10

Reexam number	90/010,422
First Named Inventor	Mattaway et al.
Patent Under Re-Exam	6009469
Issue Date	1999/12/28
Group Art Unit	3992
Examiner Name	KOSOWSKI, ALEXANDER J
Attorney Docket No.	2655-0185
Confirmation No.	6565

NON-PATENT REFERENCES

Examiner Initials*	Cite No.	Non-patent Reference bibliographic information, where available	Notes
	9-1	Open Systems Today, Feb. 20, 1995	
	9-2	Order for NetPhone version 1.2 labels (dated 6 June 95)	
	9-3	Phoneless Phoning April 2, 1995	
	9-4	PowWow Chunked Protocol Specification, Last edited 3/12/1999	
	9-5	PowWow Native Protocols, last updated Dec. 8, 1998	
	9-6	Roadmap for the Internet (March 1995)	
	9-7	SlipMagic Ad for MacZone (dated 9/28/1995) for selling product	

Examiner Signature		Date Considered	
--------------------	--	-----------------	--

*Examiner: Initial if reference was considered, whether or not citation is in conformance with MPEP 609. Draw a line through citation if not in conformance and not considered. Include a copy of this form with next communication to applicant. Notes: If identified, the following is provided: EA = English Abstract, T = Translation, PF = Patent Family.

**INFORMATION DISCLOSURE
STATEMENT BY APPLICANT**
FORM PTO-1449 (modified)

Sheet 10 of 10

Reexam number	90/010,422
First Named Inventor	Mattaway et al.
Patent Under Re-Exam	6009469
Issue Date	1999/12/28
Group Art Unit	3992
Examiner Name	KOSOWSKI, ALEXANDER J
Attorney Docket No.	2655-0185
Confirmation No.	6565

NON-PATENT REFERENCES

Examiner Initials*	Cite No.	Non-patent Reference bibliographic information, where available	Notes
	10-1	The Mac Zone (Catalog) dated 1995	
	10-2	Two-way voice calls over the Internet (11/21/94)	
	10-3	Ubique documents relating to Virtual Places Products (dated 1995 and March, 1995)	
	10-4	Ubique Ships Virtual Places Client and Server (dated March 20, 1995)	
	10-5	Ubique, Ltd. Fact Sheet (referencing NetPhone codecs and Vocaltec) (date unknown)	
	10-6	Undated Technical document	
	10-7	Welcome to NetPhone Demo (includes copyright date 1994)	

Examiner Signature		Date Considered	
--------------------	--	-----------------	--

*Examiner: Initial if reference was considered, whether or not citation is in conformance with MPEP 609. Draw a line through citation if not in conformance and not considered. Include a copy of this form with next communication to applicant. Notes: If identified, the following is provided: EA = English Abstract, T = Translation, PF = Patent Family.



DEMANDE INTERNATIONALE PUBLIÉE EN VERTU DU TRAITE DE COOPÉRATION EN MATIÈRE DE BREVETS (PCT)

<p>(51) Classification internationale des brevets⁴ : H04L 11/20, H04M 11/08</p>	<p>A1</p>	<p>(11) Numéro de publication internationale: WO 90/03074 (43) Date de publication internationale: 22 mars 1990 (22.03.90)</p>
<p>(21) Numéro de la demande internationale: PCT/EP88/00814 (22) Date de dépôt international: 6 septembre 1988 (06.09.88) (71) Déposant (pour tous les Etats désignés sauf US): CAPRICOM S.A. [LU/LU]; 40, boulevard Joseph II, L-1840 Luxembourg (LU). (72) Inventeur; et (75) Inventeur/Déposant (US seulement): LE CLERCQ, Patrick [BE/BE]; 381, avenue de la Forêt-de-Soignes, B-1640 Rhode-Saint-Genèse (BE). (74) Mandataires: VANDERPERRE, Robert etc.; Bureau Vander Haeghen, 63, avenue de la Toison d'Or, B-1060 Bruxelles (BE).</p>		<p>(81) Etats désignés: AT (brevet européen), BE (brevet européen), CH (brevet européen), DE (brevet européen), FR (brevet européen), GB (brevet européen), IT (brevet européen), JP, LU (brevet européen), NL (brevet européen), SE (brevet européen), US. Publiée <i>Avec rapport de recherche internationale.</i></p>
<p>(54) Title: SYSTEM FOR THE AUTOMATIC NOTIFICATION OF MESSAGE RECEPTION IN AN ELECTRONIC MESSAGING SYSTEM</p>		
<p>(54) Titre: SYSTEME D'AVERTISSEMENT AUTOMATIQUE DE LA RECEPTION DE MESSAGES DANS UN SYSTEME DE MESSAGERIE ELECTRONIQUE</p>		
<p>(57) Abstract</p> <p>A microprocessor (12) is connected to the electronic messaging system for receiving the information identifying the messages in stand-by. A random access memory (16) is organized so as to constitute a file (FIL) containing codes ($u_1, u_2 \dots u_n$) identifying the addressees of predetermined messages and information ($n_1, n_2 \dots n_n$) representing the telephone numbers of said addressees. A modem (17) connected to a telephone line (6) is organized for extracting from said file (FIL) the information relating to telephone numbers and for automatically dialling the telephone numbers of the addressees in order to transmit call signals to them over the telephone line. The microprocessor (12) is organized for reading the queue of messages received in the electronic messaging system, for detecting therein the presence of identification codes ($u_1, u_2 \dots u_n$) contained in the file (FIL), for extracting from the file the telephone number information corresponding with each identification code detected, and for instructing the modem (7) to automatically dial the corresponding telephone numbers in order to emit a call signal over the telephone line (6) for a predetermined time interval.</p>		
<p>(57) Abrégé</p> <p>Un microprocesseur (12) est relié au système de messagerie électronique pour recevoir les informations qui identifient les messages en attente et une mémoire vive (16) est organisée pour constituer un fichier (FIL) contenant des codes ($u_1, u_2 \dots u_n$) qui identifient des destinataires de messages prédéterminés et des informations ($n_1, n_2 \dots n_n$) représentant les numéros de téléphone de ces destinataires. Un modem (17) connecté à une ligne téléphonique (6) est organisé pour extraire les informations de numéros de téléphone dudit fichier (FIL) et composer automatiquement les numéros de téléphone des destinataires afin de leur transmettre des signaux d'appel sur la ligne téléphonique. Le microprocesseur (12) est organisé pour lire la file d'attente des messages reçus dans le système de messagerie électronique, pour y détecter la présence des codes d'identification ($u_1, u_2 \dots u_n$) résidant dans le fichier (FIL), pour extraire du fichier l'information de numéro de téléphone correspondant à chaque code d'identification détecté, et pour donner ordre au modem (17) de composer automatiquement les numéros d'appel correspondants afin de lancer un signal d'appel sur la ligne téléphonique (6) pendant un intervalle de temps prédéterminé.</p>		

UNIQUEMENT A TITRE D'INFORMATION

Codes utilisés pour identifier les Etats parties au PCT, sur les pages de couverture des brochures publiant des demandes internationales en vertu du PCT.

AT	Autriche	ES	Espagne	MG	Madagascar
AU	Australie	FI	Finlande	ML	Mali
BB	Barbade	FR	France	MR	Mauritanie
BE	Belgique	GA	Gabon	MW	Malawi
BF	Burkina Faso	GB	Royaume-Uni	NL	Pays-Bas
BG	Bulgarie	HU	Hongrie	NO	Norvège
BJ	Bénin	IT	Italie	RO	Roumanie
BR	Bresil	JP	Japon	SD	Soudan
CA	Canada	KP	République populaire démocratique de Corée	SE	Suède
CF	République Centrafricaine	KR	République de Corée	SN	Sénégal
CG	Congo	LI	Liechtenstein	SU	Union soviétique
CH	Suisse	LK	Sri Lanka	TD	Tchad
CM	Cameroon	LU	Luxembourg	TG	Togo
DE	Allemagne, République fédérale d'	MC	Monaco	US	Etats-Unis d'Amérique
DK	Danemark				

**Système d'avertissement automatique de la réception
de messages dans un système de messagerie électronique**

DESCRIPTION

Description de l'art antérieur

Un système de messagerie électronique tel que le système DISOSS (Distributed Office Support System) de
5 marque IBM assure l'archivage et la distribution automatiques de messages et de documents au sein d'une
entreprise ou d'une organisation. Un tel système comprend un ordinateur central sur lequel tourne un
logiciel de messagerie électronique, un contrôleur
10 d'écran connecté à l'ordinateur et plusieurs terminaux connectés au contrôleur d'écran. L'arrivée de messages
ou documents dans l'ordinateur central est signalée par l'apparition d'une information dans une liste de
messages et documents reçus (file d'attente). La file
15 d'attente se trouve transmise en permanence vers les divers terminaux et sur l'écran de ceux-ci, les usagers
peuvent consulter la file d'attente et demander la réception d'un message ou consulter un document
identifié. Un système de messagerie électronique de ce
20 genre rend de grands services en ce sens qu'il permet notamment d'améliorer l'efficacité du travail administratif,
d'améliorer la communication entre décideurs et de réduire l'espace nécessaire pour les archives.
Cependant, un tel système ne permet pas d'avertir les

destinataires de messages ou de documents de l'arrivée de ces messages et de ces documents. Il s'agit là d'un désavantage universellement reconnu. La présentation d'un message ou d'un document, en effet, nécessite la consultation régulière sinon permanente de la file d'attente des messages reçus, ce qui peut entraîner des délais dans la réception des messages ou la communication des documents et requiert une surveillance quasi-constante des utilisateurs.

10

Résumé de l'invention

L'invention a pour objet un système électronique automatique qui remédie au désavantage évoqué plus haut et assure que les destinataires de messages ou de documents soient avertis automatiquement de l'arrivée de ces messages ou documents. Les particularités caractéristiques du système selon l'invention sont définies dans les revendications ci-annexées.

20

Un microprocesseur est relié au système de messagerie électronique pour recevoir les informations qui identifient les messages en attente et une mémoire vive est organisée pour constituer un fichier contenant des codes qui identifient des destinataires de messages prédéterminés et des informations représentant les numéros de téléphone de ces destinataires. Un modem connecté à une ligne téléphonique est organisé pour extraire les informations de numéros de téléphone dudit fichier et composer automatiquement les numéros de téléphone des destinataires afin de leur transmettre des signaux d'appel sur la ligne téléphonique. Le microprocesseur est organisé pour lire la file d'attente des messages reçus dans le système de messa-

35

gerie électronique, pour y détecter la présence des codes d'identification résidant dans le fichier, pour extraire du fichier l'information de numéro de téléphone correspondant à chaque code d'identification détecté, et pour donner ordre au modem de composer automatiquement les numéros d'appel correspondants afin de lancer un signal d'appel sur la ligne téléphonique pendant un intervalle de temps prédéterminé.

5

10 Le système selon l'invention a pour avantages que les destinataires de messages ou de documents reçus sont avertis immédiatement par téléphone de la réception d'un message ou document qui leur est destiné et que les messages et documents peuvent être réceptionnés plus rapidement par leurs destinataires et cela sans nécessiter de surveillance particulière. De plus, les destinataires peuvent être prévenus non seulement localement par l'intermédiaire d'un réseau téléphonique intérieur mais également à longue distance par l'intermédiaire d'un réseau téléphonique extérieur. Ce système selon l'invention peut également remplacer avec avantage l'utilisation telex en cas d'urgence au sein d'un groupe utilisant un système de messagerie électronique. Enfin, le système selon l'invention est d'un faible coût en matériel et en logiciel.

15

20

25

Description des dessins

30 La Fig. 1 représente schématiquement un système de messagerie électronique auquel est intégré un système d'avertissement automatique selon l'invention.

La Fig. 2 représente schématiquement l'architecture générale du système d'avertissement automatique selon l'invention.

35

La Fig. 3 est un organigramme du processus d'avertissement téléphonique mis en oeuvre dans le système selon l'invention.

5

Description d'un mode de réalisation exemplaire

Dans la figure 1 est représenté schématiquement un système de messagerie électronique tel que le système DISOSS. Un système de ce genre comprend un processeur central ou processeur-hôte 1, un contrôleur d'écran 2 et un ensemble de terminaux dont un terminal 4 est représenté. Le processeur-hôte gère la réception et la distribution des messages et documents. La réception d'un message ou document est signalée par l'insertion d'une information dans une liste ou file d'attente (QUEUE). Cette liste d'attente peut être transmise sur la ligne 3 et visualisée sur l'écran de chaque terminal 4 à la demande de l'utilisateur. Un exemple de liste d'attente est reproduit au tableau 1 ci-après.

Tableau 1

1	2	3	4	5	6	7	8	9
QUEUE	IDENTIF	TYPE			DATE	WT	DATE	WT
					(M/D)	(H:M)	(M/D)	(H:M)
BXLDIS32	BXLAR5IN	RECP	4	0	08/03	332:19	08/03	332:19
BXLDIS32	BXLPC2EX	RECP	2	0	08/05	284:13	08/05	284:13
BXLDIS32	EPSPC1GS	RECP	1	0	08/16	24:46	08/16	24:46

25

30

Dans cet exemple, chaque rubrique de la liste d'attente contient la référence de la liste (colonne 1), le code d'identification d'un destinataire (colonne 2), le type de liste d'attente (colonne 3), le nombre de messages entrés pour le destinataire (colonne 4), le nombre de tentatives de réception des messages (colonne 5), la date et le temps d'attente du premier message entré (colonnes 6 et 7), la date et le temps d'attente du message le plus ancien (colonnes 8 et 9).
Lorsqu'un message ou document a été réceptionné par son destinataire, la rubrique correspondante se trouve mise à jour ou effacée selon qu'il reste encore un message à réceptionner par le destinataire en question ou que le dernier message ou document en attente a été réceptionné. Dans ce système connu, chaque usager doit consulter la file d'attente et pour cela manipuler le clavier de son terminal pour savoir si un message ou document lui est destiné.

Suivant l'invention, le système décrit ci-dessus est avantageusement complété par un système d'avertissement automatique 10 destiné à avertir automatiquement le destinataire d'un message ou d'un document par téléphone sitôt qu'un tel message ou document est reçu. Le système d'avertissement automatique selon l'invention est connecté d'une part au contrôleur d'écran 2 au moyen d'un câble coaxial 5 et il est connecté d'autre part à une ligne téléphonique 6 qui peut être reliée à un central téléphonique privé ou à un réseau téléphonique public représenté par le bloc 7.

L'architecture générale du système d'avertissement automatique 10 est représentée schématiquement par blocs à la figure 2. Le câble coaxial 5 est connecté à un circuit de connexion 11 qui sert d'interface avec

le bus 20 reliant entre elles les différentes unités organiques du système. Ces unités sont essentiellement un microprocesseur 12, un écran de contrôle 13 avec son interface 14, une mémoire ROM de grande capacité 5 15 pour stocker les programmes de commande, une mémoire vive 16 pour constituer un fichier comme on le verra plus loin, et un circuit modem 17 dont la fonction sera décrite ultérieurement.

10 Le microprocesseur 12 est un dispositif bien connu en soi, qui peut être réalisé dans divers modes d'exécution relevant de la compétence normale de l'homme de l'art pour exécuter différentes connexions et tâches fonctionnelles sous la direction de signaux de commande 15 prévus dans un programme d'opération enregistré dans la mémoire morte 15. Celle-ci a par exemple une capacité d'au moins 10 MB (mégabytes ou méga-octets).

Suivant l'invention, on attribue un code particulier à 20 chaque destinataire pour lequel un avertissement automatique est demandé et dans la mémoire vive 16 est constitué un fichier d'avertissement FIL. Les codes de destinataires sont appelés dans la suite codes $u_1, u_2 \dots u_n$. Dans le fichier FIL sont enregistrés les codes 25 $u_1, u_2 \dots u_n$ identifiant les destinataires et pour chaque code, des données numériques $n_1, n_2 \dots n_n$ représentant le numéro de téléphone du destinataire ainsi que des données $t_1, t_2 \dots t_n$ représentant des paramètres de transmission pour chaque appel téléphonique 30 ainsi qu'on le verra plus loin. Les numéros de téléphone peuvent être des numéros d'extension dans un réseau intérieur d'un groupe, des numéros d'appel d'une zone téléphonique locale ou des numéros d'appel interzonal ou à longue distance. Le modem 17 est un 35 dispositif connu en soi, organisé pour composer auto-

matiquement des numéros de téléphone à partir de données numériques et produire des signaux propres à la transmission sur la ligne téléphonique 6.

5 Le système d'avertissement automatique selon l'invention fonctionne sous la direction du microprocesseur 12 animé ou organisé par un système de commande résidant dans la mémoire 15. Le fonctionnement du système selon l'invention est illustré par l'organigramme de
10 la figure 3.

Après démarrage du système (étape 100), la première étape du fonctionnement (étape 101) consiste à établir la liaison avec le processeur-hôte 1 du système de
15 messagerie électronique par l'intermédiaire du câble 3. Le microprocesseur 12 commande ensuite l'envoi au processeur-hôte 1 d'un signal de requête REQ demandant la présentation des codes d'identification des messages en attente (étape 102). En réponse au signal de
20 requête REQ, le processeur-hôte 1 envoie les codes d'identification de destinataires figurant dans la liste d'attente QUEUE et le microprocesseur 12 en commande l'affichage sur l'écran de contrôle 14.

25 Le microprocesseur 12 commande alors la lecture du contenu du fichier FIL résidant dans la mémoire 16 et la comparaison de chaque code d'identification $u_1, u_2 \dots u_n$ du fichier FIL avec les codes d'identification de la liste d'attente QUEUE (étape 103). Lorsque
30 celle-ci contient un code correspondant à un des codes $u_1, u_2 \dots u_n$ du fichier FIL, le microprocesseur 12 commande la production d'un signal d'adresse ADR pour adresser la mémoire 16 et extraire du fichier FIL les informations n_i représentant le numéro d'appel du
35 destinataire identifié et les données paramétriques t_i

précédemment mentionnées. Ces données servent à fixer les modalités ou conditions de transmission des signaux d'appel sur la ligne téléphonique 6. On peut par exemple fixer la durée de l'appel téléphonique, la tranche horaire durant laquelle l'appel doit être effectué, les jours pendant lesquels un appel peut être effectué, ou d'autres indications éventuelles. Le microprocesseur 12 commande l'affichage de ces informations sur l'écran de contrôle 14 en regard de chaque code d'identification. Sur l'écran de contrôle 14 apparaît par exemple une table du type montré au tableau 2 ci-après.

15

Tableau 2

u_i	N	DATE	t_i	n_i
BXLPC1DI	4	28/04	2:56	3280
BXLPC1RE	2	28/04	2:56	9145
EPSPC1OA	2	27/04	0:25	4302

20

Dans cette table exemplaire, chaque rubrique contient le code u_i d'un destinataire, le nombre N de messages ou documents reçus pour ce destinataire, la date de réception, la durée t_i (minutes et secondes) fixée pour chaque appel téléphonique, le numéro de téléphone n_i du destinataire. Les informations u_i , t_i et n_i , ainsi qu'il a été dit plus haut, sont extraites du fichier FIL selon l'invention.

25

30

Le microprocesseur 12 commande ensuite le transfert des informations numériques $n_1, n_2 \dots n_n$ au modem 17 (étape 104) et le modem répond en composant automatiquement le numéro de téléphone et produisant les im-

35

pulsions propres à la transmission sur la ligne téléphonique 6 (étape 105), suivant un processus bien connu dans le domaine de l'art.

5 Après un laps de temps correspondant aux informations paramétriques t_1 extraites du fichier FIL, le micro-
processeur 12 envoie au modem 17 un ordre d'interrup-
tion en réponse auquel le modem interrompt la trans-
mission des impulsions sur la ligne téléphonique 6. Le
10 même processus se déroule pour chacun des codes
d'identification $u_1, u_2 \dots u_n$ du fichier FIL. Lorsque
tous les codes ont été scrutés (étape 106), le proces-
sus de commande se poursuit (ligne 107) en répétant
les opérations à partir de l'étape 102 et ce, jusqu'à
15 ce qu'un ordre de fin soit reçu (étape 108). L'affi-
chage sur l'écran de contrôle 14 est mis à jour auto-
matiquement à intervalles réguliers ajustables.

20 Grâce au système selon l'invention, les destinataires
de messages ou documents reçus dans un système de mes-
sagerie électronique se trouvent avertis immédiatement
par téléphone de la réception des messages et docu-
ments qui leur sont destinés. Ces messages et docu-
ments peuvent ainsi être réceptionnés très rapidement
25 par leurs destinataires, ce qui accroît avec avantage
et optimise l'efficacité du système de messagerie
électronique. Il est à remarquer que les destinataires
de messages et documents peuvent être prévenus aussi
bien localement par l'intermédiaire d'un réseau télé-
30 phonique intérieur que par communication téléphonique
à longue distance.

35 Dans un mode de réalisation exemplaire, le système
d'avertissement électronique 10 est constitué à partir
d'un appareil disponible sur le marché sous l'appella-

tion d'ordinateur personnel, par exemple un appareil
PC 3270 de marque IBM. Pour pouvoir communiquer, selon
l'invention, avec le contrôleur d'écran 2 du système
de messagerie électronique, l'ordinateur personnel
5 doit être équipé d'une carte de connexion coaxiale,
par exemple la carte d'interface 3270 Adapter de mar-
que IBM. De plus, pour pouvoir convertir les données
numériques extraites de la mémoire 16 en signaux pro-
pres à être transmis sur la ligne téléphonique 6,
10 l'ordinateur personnel doit être équipé d'une carte
modem, par exemple une carte modem de la firme
Devlonics Terminals N.V. compatible avec les protoco-
les de transmission Hayes et CCITT V25bis bien connus
de l'homme de l'art.

15

La mémoire vive de l'ordinateur personnel est utilisée
pour contenir le fichier FIL précité et la mémoire
morte de l'appareil est utilisée pour mémoriser le
système de commande destiné à diriger le processus
20 d'avertissement téléphonique automatique décrit dans
ce qui précède. Il suffit de recopier sur disque dur,
par exemple, le système de commande d'application en-
registré préalablement sur une disquette.

25

Dans ce mode d'exécution exemplaire, dans lequel il
est fait usage d'un ordinateur personnel pour réaliser
le système selon l'invention, le système d'avertisse-
ment entre en liaison opérationnelle avec l'équipe-
ment de l'ordinateur personnel par l'intermédiaire de
30 logiciels d'interfaçage, par exemple : le logiciel
d'interfaçage DOS 3.30 pour la gestion d'un fichier et
le logiciel API pour l'interfaçage avec le logiciel
d'application (processus d'avertissement téléphonique)
dans le cas d'un ordinateur personnel PC 3270. La
35 liaison entre celui-ci et le système de messagerie

électronique peut s'effectuer au moyen d'un logiciel
d'opération Workstation Program 1.00. Tous ces logi-
ciels d'interfaçage, ainsi qu'il est clair pour l'hom-
me de l'art, sont démarrés avant le démarrage du
5 processus d'avertissement téléphonique selon l'inven-
tion.

L'homme de l'art reconnaîtra que l'invention n'est
nullement limitée au mode d'exécution exemplaire
10 décrit à titre illustratif. Toute variante, modifica-
tion ou tout agencement équivalent doit être consi-
déré comme compris dans le cadre de l'invention.

REVENDICATIONS

1. Système d'avertissement automatique de la réception d'un message dans un système de messagerie électronique, comprenant un microprocesseur (12) relié pour recevoir du système de messagerie électronique, les informations identifiant les messages en attente, une
5 mémoire vive (16) organisée pour constituer un fichier (FIL) contenant les codes d'identification ($u_1, u_2 \dots u_n$) de destinataires de messages prédéterminés et leurs numéros d'appel téléphonique ($n_1, n_2 \dots n_n$), et
10 un circuit modem (17) connecté à une ligne téléphonique (6), ce circuit modem étant agencé et organisé pour convertir les informations d'appel numériques ($n_1, n_2 \dots n_n$) résidant dans ledit fichier (FIL) en signaux analogiques propres à la transmission sur la
15 ligne téléphonique (6), le microprocesseur (12) étant organisé pour lire la file d'attente des messages (Queue) dans le système de messagerie électronique, pour y détecter la présence de codes d'identification ($u_1, u_2 \dots u_n$), pour extraire du fichier (FIL) l'in-
20 formation d'appel numérique correspondant à chaque code d'identification ($u_1, u_2 \dots u_n$) détecté, et pour donner ordre au circuit modem (17) de composer automatiquement les numéros d'appel correspondants pour leur transmission sur la ligne téléphonique (6).

25

2. Système selon la revendication 1, caractérisé en ce que le fichier (FIL) constitué dans la mémoire vive (16) contient en outre pour chaque numéro d'appel enregistré, des données fixant la durée de transmis-
30 sion de chaque appel téléphonique et/ou d'autres données de transmission.

3. Système selon la revendication 1 ou 2, caractérisé en ce qu'il est organisé pour afficher les données résidant dans le fichier (FIL) sur un écran de contrôle.
- 5 4. Système selon l'une quelconque des revendications précédentes, caractérisé en ce que la ligne téléphonique (6) est connectée à un central téléphonique privé.
- 10 5. Système selon l'une quelconque des revendications précédentes, caractérisé en ce que la ligne téléphonique (6) est connectée à un central téléphonique public.
- 15 6. Système selon l'une quelconque des revendications précédentes, caractérisé en ce qu'il est réalisé à partir d'un ordinateur personnel équipé d'une carte de connexion pour la connexion avec la ligne (5) allant vers le contrôleur d'écran (2), et d'une carte modem (17) pour la connexion avec la ligne téléphonique (6),
- 20 la mémoire vive de l'ordinateur personnel étant utilisée pour contenir le fichier (FIL) précité et la mémoire morte étant utilisée pour mémoriser le système de commande d'avertissement automatique.

FIG. 1

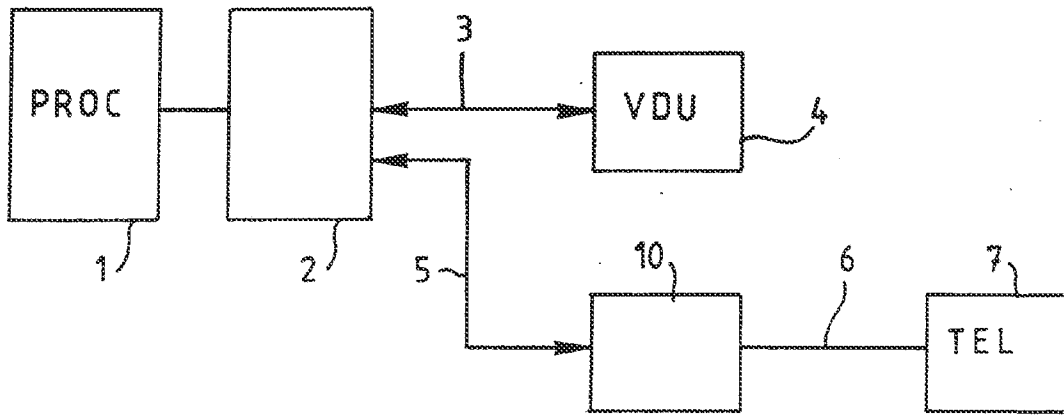

FIG. 2

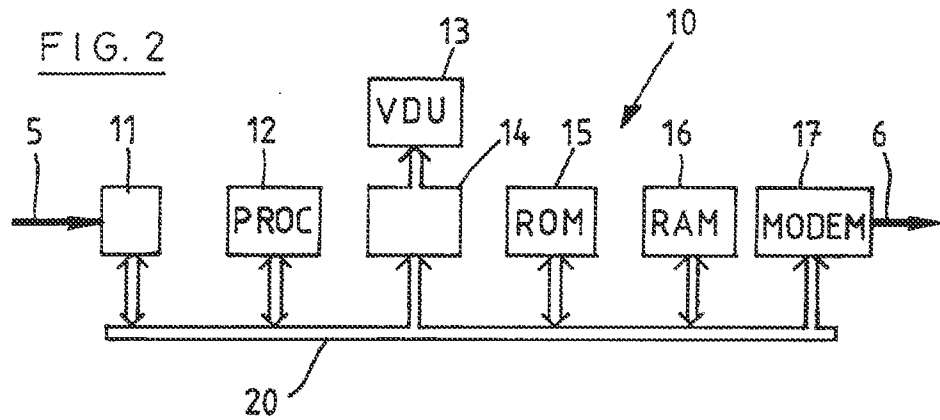
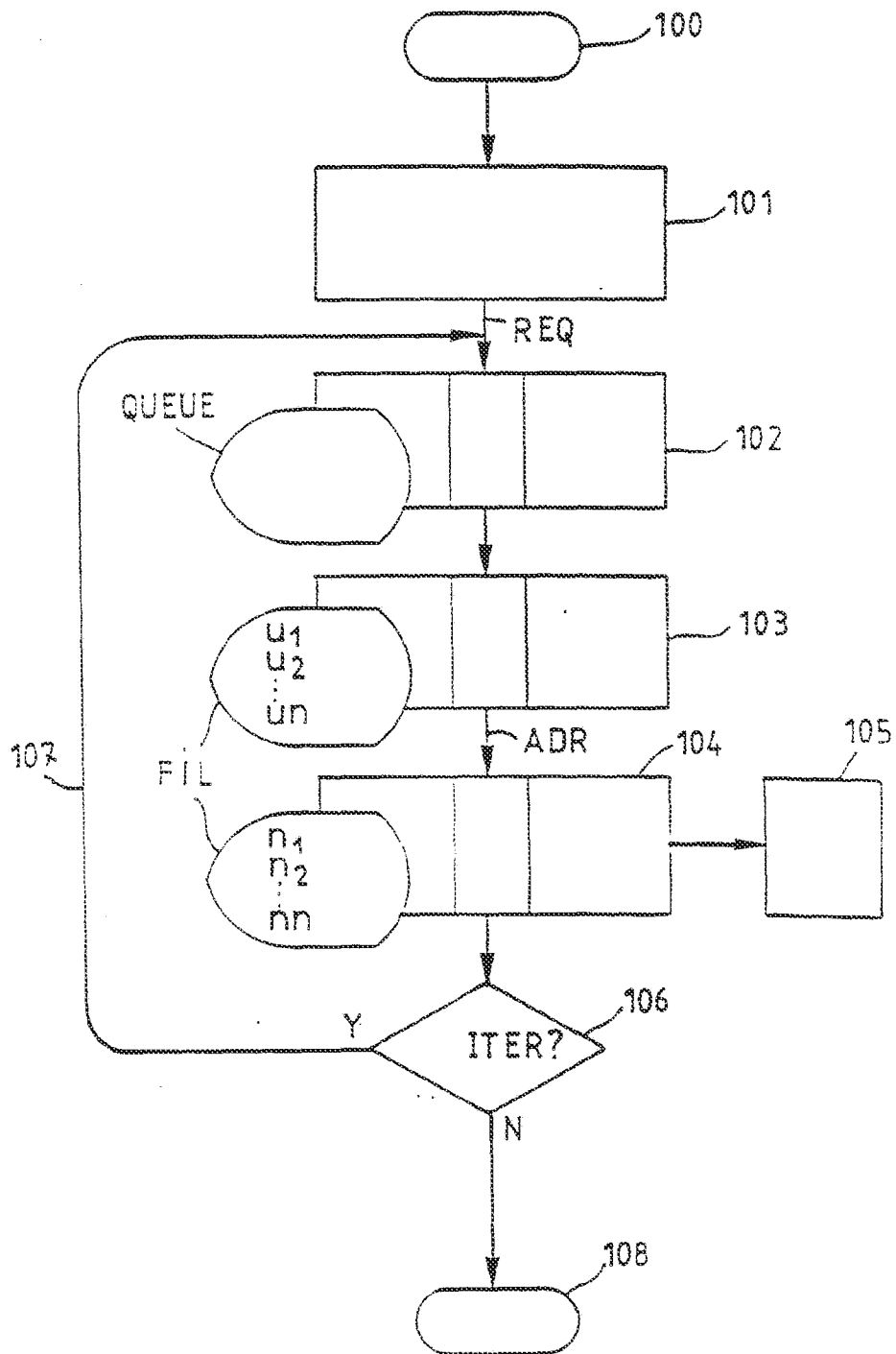

FIG. 3



INTERNATIONAL SEARCH REPORT

International Application No PCT/EP88/00814

I. CLASSIFICATION OF SUBJECT MATTER (if several classification symbols apply, indicate all) ¹		
According to International Patent Classification (IPC) or to both National Classification and IPC		
Int.Cl.4	H04L 11/20 ; H04M 11/08	
II. FIELDS SEARCHED		
Minimum Documentation Searched ²		
Classification System	Classification Symbols	
Int.Cl.4	H04L ; H04M	
Documentation Searched other than Minimum Documentation to the Extent that such Documents are Included in the Fields Searched ³		
III. DOCUMENTS CONSIDERED TO BE RELEVANT ⁴		
Category ⁵	Citation of Document, ¹¹ with indication, where appropriate, of the relevant passages ¹²	Relevant to Claim No. ¹³
Y	US,A, 4506111 (TAKENOUCHI) 19 March 1985 see column 1, lines 30-45; column 2, lines 47-51; column 4, lines 61-65; column 5, lines 9-17, column 5, line 64- column 6, line 8; column 8, lines 23-28; column 9, lines 4-12; column 10, lines 31-36; column 12, lines 42-45; figures 1, 5A	1
A	----	2, 3, 5
Y	IBM Technical Disclosure Bulletin, Vol. 27, Nr. 11, April 1985, (New York, US), "Beeper-electronic mail and reminder paging system" , page 6367 see the whole document	1
X	EP,A, 0087849 (VMX INC) 7 September 1983 see page 7, lines 13-28; page 9, lines 5-19 ; page 45, lines 19-33; page 54, lines 16-35; page 66, lines 27-31	1-3
.../...		
<p>¹⁰ Special categories of cited documents:</p> <p>"A" document defining the general state of the art which is not considered to be of particular relevance</p> <p>"E" earlier document but published on or after the international filing date</p> <p>"L" document which may throw doubts on priority claim(s) or which is cited to establish the publication date of another citation or other special reason (as specified)</p> <p>"O" document referring to an oral disclosure, use, exhibition or other means</p> <p>"P" document published prior to the international filing date but later than the priority date claimed</p> <p>"T" later document published after the international filing date or priority date and not in conflict with the application but cited to understand the principle or theory underlying the invention</p> <p>"X" document of particular relevance: the claimed invention cannot be considered novel or cannot be considered to involve an inventive step</p> <p>"Y" document of particular relevance: the claimed invention cannot be considered to involve an inventive step when the document is combined with one or more other such documents, such combination being obvious to a person skilled in the art.</p> <p>"Z" document member of the same patent family</p>		
IV. CERTIFICATION		
Date of the Actual Completion of the International Search:	Date of Mailing of this International Search Report:	
2 May 1989 (02.05.89)	5 June 1989 (05.06.89)	
International Searching Authority:	Signature of Authorized Officer:	
European Patent Office		

Form PCT/ISA/210 (second sheet) (January 1985)

III. DOCUMENTS CONSIDERED TO BE RELEVANT (CONTINUED FROM THE SECOND SHEET)		
Category *	Citation of Document, with indication, where appropriate, of the relevant passages	Relevant to Claim No
A		4-6

A	Patent Abstracts of Japan, Vol. 9, Nr. 325 (E-368) (2048), 20 December 1985, & JP,A, 60157363 (FUJITSU K.K.) 17 August 1985 see the whole document	1

A	Patent Abstracts of Japan, Vol. 4, Nr 181 (E-37) (663), 13 December 1980; & JP,A, 55123268 (FUJITSU K.K.) 22 September 1980 see the whole document	1-4

**ANNEX TO THE INTERNATIONAL SEARCH REPORT
ON INTERNATIONAL PATENT APPLICATION NO.**

EP 8800814

SA 24136

This annex lists the patent family members relating to the patent documents cited in the above-mentioned international search report. The members are as contained in the European Patent Office EDP file on 26/05/89. The European Patent Office is in no way liable for these particulars which are merely given for the purpose of information.

Patent document cited in search report	Publication date	Patent family member(s)	Publication date
US-A- 4506111	19-03-85	JP-A- 58040965	10-03-83
EP-A- 0087849	07-09-83	US-A- 4371752	01-02-83
		CA-A- 1157551	22-11-83
		EP-A, B 0029938	10-06-81
		US-A- 4581486	08-04-86
		US-A- 4602129	22-07-86
		US-A- 4640991	03-02-87
		US-A- 4585906	29-04-86
		US-A- 4580012	01-04-86
		US-A- 4652700	24-03-87

EPO FORM 883 (08/79)

For more details about this annex : see Official Journal of the European Patent Office, No. 12/82

RAPPORT DE RECHERCHE INTERNATIONALE

Demande internationale N°

PCT/EP 88/00814

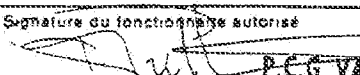
I. CLASSEMENT DE L'INVENTION (si plusieurs symboles de classification sont applicables, les indiquer tous) ⁷		
Selon la classification internationale des brevets (CIB) ou à la fois selon la classification nationale et la CIB		
CIB ⁴ : H 04 L 11/20; H 04 M 11/08		
II. DOMAINES SUR LESQUELS LA RECHERCHE A PORTE		
Documentation minimale consultée ⁸		
Système de classification	Symboles de classification	
CIB ⁴	H 04 L; H 04 M	
Documentation consultée autre que la documentation minimale dans la mesure ou de tels documents font partie des domaines sur lesquels la recherche a porté ⁹		
III. DOCUMENTS CONSIDÉRÉS COMME PERTINENTS ¹⁰		
Catégorie ⁶	Identification des documents cités, ¹¹ avec indication, si nécessaire, des passages pertinents ¹²	N° des revendications visées ¹³
Y	US, A, 4506111 (TAKENOUCHI) 19 mars 1985 voir colonne 1, lignes 30-45; colonne 2, lignes 47-51; colonne 4, lignes 61-65; colonne 5, lignes 9-17, colonne 5, ligne 64 - colonne 6, ligne 8; colonne 8, lignes 23-28; colonne 9, lignes 4-12; colonne 10, lignes 31-36; colonne 12, lignes 42-45; figures 1,5A	1
A	---	2,3,5
Y	IBM Technical Disclosure Bulletin, volume 27, no. 11, avril 1985, (New York, US), "Beeper - electronic mail and reminder paging system", page 6367 voir le document en entier	1
X	EP, A, 0087849 (VMX INC.) 7 septembre 1983 voir page 7, lignes 13-28; page 9, lignes 5-19; page 45, lignes 19-33;	1-3.
<p>⁶ Catégories spéciales de documents cités: ¹³</p> <p>« A » document définissant l'état général de la technique, non considéré comme particulièrement pertinent</p> <p>« E » document antérieur, mais publié à la date de dépôt international ou après cette date</p> <p>« L » document pouvant jeter un doute sur une revendication de priorité ou cité pour déterminer la date de publication d'une autre citation ou pour une raison spéciale (telle qu'indiquée)</p> <p>« O » document se référant à une divulgation orale, à un usage, à une exposition ou tous autres moyens</p> <p>« P » document publié avant la date de dépôt international, mais postérieurement à la date de priorité revendiquée</p> <p>« T » document ultérieur publié postérieurement à la date de dépôt international ou à la date de priorité et n'appartenant pas à l'état de la technique pertinent, mais cité pour comprendre le principe ou la théorie constituant la base de l'invention</p> <p>« X » document particulièrement pertinent: l'invention revendiquée ne peut être considérée comme nouvelle ou comme impliquant une activité inventive</p> <p>« Y » document particulièrement pertinent: l'invention revendiquée ne peut être considérée comme impliquant une activité inventive lorsque le document est associé à un ou plusieurs autres documents de même nature, cette combinaison étant évidente pour une personne du métier.</p> <p>« & » document qui fait partie de la même famille de brevets</p>		
IV. CERTIFICATION		
Date à laquelle la recherche internationale a été effectivement achevée	Date d'expédition du présent rapport de recherche internationale	
2 mai 1989	05.05.89	
Administration chargée de la recherche internationale OFFICE EUROPEEN DES BREVETS	Signature du fonctionnaire autorisé  P.C.G. VAN DER PUTTEN	

III. DOCUMENTS CONSIDÉRÉS COMME PERTINENTS		
(SUITE DES RENSEIGNEMENTS INDIGUÉS SUR LA DEUXIÈME FEUILLE)		
Catégorie *	Identification des documents cités, avec indication, si nécessaire, des passages pertinents	N° des revendications visées
	page 54, lignes 16-35; page 66, lignes 27-31	
A	--	4-6
A	Patent Abstracts of Japan, volume 9, no. 325 (E-368)(2048), 20 décembre 1985, & JP, A, 60157363 (FUJITSU K.K.) 17 août 1985 voir le document en entier	1
A	--	
A	Patent Abstracts of Japan, volume 4, no. 181 (E-37)(663), 13 décembre 1980, & JP, A, 55123268 (FUJITSU K.K.) 22 septembre 1980 voir le document en entier	1,4

ANNEXE AU RAPPORT DE RECHERCHE INTERNATIONALE
RELATIF A LA DEMANDE INTERNATIONALE NO.

EP 8800814
SA 24136

La présente annexe indique les membres de la famille de brevets relatifs aux documents brevets cités dans le rapport de recherche internationale visé ci-dessus.
Lesdits membres sont contenus au fichier informatique de l'Office européen des brevets à la date du 26/05/89
Les renseignements fournis sont donnés à titre indicatif et n'engagent pas la responsabilité de l'Office européen des brevets.

Document brevet cité au rapport de recherche	Date de publication	Membre(s) de la famille de brevet(s)	Date de publication
US-A- 4506111	19-03-85	JP-A- 58040965	10-03-83
EP-A- 0087849	07-09-83	US-A- 4371752	01-02-83
		CA-A- 1157551	22-11-83
		EP-A, B 0029938	10-06-81
		US-A- 4581486	08-04-86
		US-A- 4602129	22-07-86
		US-A- 4640991	03-02-87
		US-A- 4585906	29-04-86
		US-A- 4580012	01-04-86
		US-A- 4652700	24-03-87

EPCE F43R06 P0472

Pour tout renseignement concernant cette annexe : voir Journal Officiel de l'Office européen des brevets, No.12/82

Electronic Acknowledgement Receipt

EFS ID:	6653367
Application Number:	90010422
International Application Number:	
Confirmation Number:	6565
Title of Invention:	Graphic User Interface For Internet Telephony Application
First Named Inventor/Applicant Name:	6,009,469
Customer Number:	42624
Filer:	Michael R. Casey
Filer Authorized By:	
Attorney Docket Number:	2655-0185
Receipt Date:	16-DEC-2009
Filing Date:	26-FEB-2009
Time Stamp:	23:36:02
Application Type:	Reexam (Third Party)

Payment information:

Submitted with Payment	no
------------------------	----

File Listing:

Document Number	Document Description	File Name	File Size(Bytes)/ Message Digest	Multi Part /.zip	Pages (if appl.)
1	Transmittal Letter	20091216_IDS_0185.pdf	119502 <small>20f58eb64ebafd84d90087f9e0d139a898948c2d</small>	no	2

Warnings:

Information:

2	Information Disclosure Statement (IDS) Filed (SB/08)	20091216_1449_0185.pdf	1358525 a890cfc16800709db1d7ca4f01c5d386c421abe1	no	10
Warnings:					
Information:					
This is not an USPTO supplied IDS fillable form					
3	Foreign Reference	F0000.pdf	5776244 5db55d4eda8a0d2fd0196df6f864d30cd613945d	no	23
Warnings:					
Information:					
4	NPL Documents	NP0000.pdf	838513 66a00754dc0d285ad4ae2a16eb29ca5535a7e23e	no	12
Warnings:					
Information:					
5	NPL Documents	NP0001.pdf	1241879 818dbd15befd8fb9a18d81893660208beb586e2	no	10
Warnings:					
Information:					
6	NPL Documents	NP0002.pdf	3422190 688985dfa25e78fd99fe3116cd6b41ac1b9a3c	no	10
Warnings:					
Information:					
7	NPL Documents	NP0003.pdf	526182 6f29622e18272de514a8b523c8c558d727e22251	no	13
Warnings:					
Information:					
8	NPL Documents	NP0004.pdf	4227094 d64e00a142a7bd72a370ba0d27aa633753af920	no	79
Warnings:					
Information:					
9	NPL Documents	NP0005.pdf	208083 31eca1a7e09cc7b2cc282768acb8614ede89ac93	no	4
Warnings:					
Information:					
10	NPL Documents	NP0006.pdf	425889 6ae5def5036f84cae5ffbb37fb62bac0205075b	no	8

Warnings:					
Information:					
11	NPL Documents	NP0007.pdf	302525 f3bc0d9816e9f047696df85bb96a215257264f6a	no	5
Warnings:					
Information:					
12	NPL Documents	NP0008.pdf	1330198 2bdf74423abf934b7ca1331c58fd96c8f45560c	no	6
Warnings:					
Information:					
13	NPL Documents	NP0009.pdf	833351 19ff45b96990ce8af408921cca37030759a5c19b	no	17
Warnings:					
Information:					
14	NPL Documents	NP0010.pdf	2368381 9fa3e3672017796e58e337584fd708dab333c69f	no	16
Warnings:					
Information:					
15	NPL Documents	NP0011.pdf	46655 097bb5fe01f7fd3f9596a67fcb1f4eae95ed2cea	no	1
Warnings:					
Information:					
16	NPL Documents	NP0012.pdf	3918575 42e0839f8342ede5ab6eef591af94e229f5820c9	no	63
Warnings:					
Information:					
17	NPL Documents	NP0013.pdf	1730069 ab452329d457eda50aea323e0e225d0ea2cfff95d	no	38
Warnings:					
Information:					
18	NPL Documents	NP0014.pdf	159215 439d8fd36ca8c8d9945937caa2e886b48e46ff67	no	4
Warnings:					
Information:					
19	NPL Documents	NP0015.pdf	112236 d06d92044b4d10ff4c015876c3748	no	2

Warnings:					
Information:					
20	NPL Documents	NP0016.pdf	746742 ee6d3da204e570c757b7a86be06d667d0c d85a89	no	13
Warnings:					
Information:					
21	NPL Documents	NP0017.pdf	10192099 8bb5837e3483404a7764d5d6129a613537 c04cd6	no	137
Warnings:					
Information:					
22	NPL Documents	NP0018.pdf	1252953 e46b8e3413a412002c26043b8382cc75ff2d 3ff5	no	2
Warnings:					
Information:					
23	NPL Documents	NP0019.pdf	355718 89ec17b41322acbb71f1318f061e0c7b7305 28ce	no	6
Warnings:					
Information:					
24	NPL Documents	NP0020.pdf	2283804 86055346dfaed7d63f86617a14c5ae674498 2192	no	3
Warnings:					
Information:					
25	NPL Documents	NP0021.pdf	99080 fe8c39ed19be2d96019e636e215676703b7 9914a	no	2
Warnings:					
Information:					
26	NPL Documents	NP0022.pdf	1260193 20aafd94b1c44010bd829d2b76133ca794f 4673	no	21
Warnings:					
Information:					
27	NPL Documents	NP0023.pdf	232340 2854ffc648d5a38810d8be922f9c18299cf9a 1e2	no	3
Warnings:					
Information:					
28	NPL Documents	NP0024.pdf	1118134 b7c37c04e9907124b26441668f 24b1	no	13

Warnings:					
Information:					
38	NPL Documents	NP0034.pdf	622455 5aac29f9118eae3b35dc4e22539675a85771dccc0	no	6
Warnings:					
Information:					
39	NPL Documents	NP0035.pdf	328173 0b3488e7ceb550715aee21189ae20323db906ab6	no	3
Warnings:					
Information:					
40	NPL Documents	NP0036.pdf	82042 68eace526727b55011a0d49ba2f44c23d974ed13	no	1
Warnings:					
Information:					
41	NPL Documents	NP0037.pdf	794823 0aea74a46b1b248ff8949464e562d047a43e2953	no	15
Warnings:					
Information:					
42	NPL Documents	NP0038.pdf	188253 7efb6563a32913ab5f1381e2382a825bd2cd9954	no	4
Warnings:					
Information:					
43	NPL Documents	NP0039.pdf	1341931 a5f927ccfec575f2babac8eb0642029cf227bd98	no	7
Warnings:					
Information:					
44	NPL Documents	NP0040.pdf	270279 0b1197f973354dd7c09150aae4b4ef89a8b6db30	no	4
Warnings:					
Information:					
45	NPL Documents	NP0041.pdf	515282 992f0ab173da4e34fe9e929239dfe14ca8a4730b	no	8
Warnings:					
Information:					
46	NPL Documents	NP0042.pdf	1374917 04ab0780471761144c0c0551104110	no	9

Warnings:					
Information:					
47	NPL Documents	NP0043.pdf	129364 25894fdd723151278a66d67669a5ce13f1418da9	no	2
Warnings:					
Information:					
48	NPL Documents	NP0044.pdf	4559066 556cac20bfc5237c7450cbcd0c1da914e34b0330	no	60
Warnings:					
Information:					
49	NPL Documents	NP0045.pdf	1125310 1d3a599b89f8fedb3d13523b9636e1bf53580783	no	2
Warnings:					
Information:					
50	NPL Documents	NP0046.pdf	129444 bf86ec075e0838ac77053709645285863d22f668	no	1
Warnings:					
Information:					
Total Files Size (in bytes):			61189399		

This Acknowledgement Receipt evidences receipt on the noted date by the USPTO of the indicated documents, characterized by the applicant, and including page counts, where applicable. It serves as evidence of receipt similar to a Post Card, as described in MPEP 503.

New Applications Under 35 U.S.C. 111

If a new application is being filed and the application includes the necessary components for a filing date (see 37 CFR 1.53(b)-(d) and MPEP 506), a Filing Receipt (37 CFR 1.54) will be issued in due course and the date shown on this Acknowledgement Receipt will establish the filing date of the application.

National Stage of an International Application under 35 U.S.C. 371

If a timely submission to enter the national stage of an international application is compliant with the conditions of 35 U.S.C. 371 and other applicable requirements a Form PCT/DO/EO/903 indicating acceptance of the application as a national stage submission under 35 U.S.C. 371 will be issued in addition to the Filing Receipt, in due course.

New International Application Filed with the USPTO as a Receiving Office

If a new international application is being filed and the international application includes the necessary components for an international filing date (see PCT Article 11 and MPEP 1810), a Notification of the International Application Number and of the International Filing Date (Form PCT/RO/105) will be issued in due course, subject to prescriptions concerning national security, and the date shown on this Acknowledgement Receipt will establish the international filing date of the application.

IN THE UNITED STATES PATENT AND TRADEMARK OFFICE

In re PATENT APPLICATION OF:
Net2Phone, Inc. (Patent No. 6,009,469)
Control No.: 90/010,422
Issue Date: December 28, 1999
Title: **GRAPHIC USER INTERFACE FOR
INTERNET TELEPHONY APPLICATION**

Attorney Docket: 2655-0185
Group Art Unit: 3992
Examiner: KOSOWSKI, Alexander
Date: December 16, 2009
Confirmation No.: 6565

INFORMATION DISCLOSURE STATEMENT

Hon. Commissioner of Patents
P.O. Box 1450
Alexandria, VA 22313-1450

Sir:

Pursuant to 37 C.F.R. § 1.56, the attention of the Patent and Trademark Office is hereby directed to the reference(s) listed on the attached PTO-1449. One copy of each non-U.S. Patent reference is attached. It is respectfully requested that the information be expressly considered during the prosecution of this application, and that the reference(s) be made of record therein and appear among the "References Cited" on any patent to issue therefrom.

The submission of any document herewith, which is not a statutory bar, is not intended that any such document constitutes prior art against any of the claims of the present application or is considered to be material to patentability as defined in 37 C.F.R. § 1.56(b). Applicants do not waive any rights to take any action which would be appropriate to antedate or otherwise remove as a competent reference against the claims of the present application.

In re Application of: Net2Phone, Inc.
Control No.: 90/010,422
Information Disclosure Statement dated December 16, 2009
Page 2 of 2

CHARGE STATEMENT: Deposit Account No. 501860, order no. **2655-0185.**

The Commissioner is hereby authorized to charge any fee specifically authorized hereafter, or any missing or insufficient fee(s) filed, or asserted to be filed, or which should have been filed herewith or concerning any paper filed hereafter, and which may be required under Rules 16-18 (missing or insufficiencies only) now or hereafter relative to this application and the resulting Official Document under Rule 20, or credit any overpayment, to our Accounting/Order Nos. shown above, for which purpose a duplicate copy of this sheet is attached

This CHARGE STATEMENT does not authorize charge of the issue fee until/unless an issue fee transmittal sheet is filed.

CUSTOMER NUMBER

42624

Davidson Berquist Jackson & Gowdey LLP
4300 Wilson Blvd., 7th Floor,
Arlington Virginia 22203
Main: (703) 894-6400 • FAX: (703) 894-6430

Respectfully submitted,

By: /Michael R. Casey /

Michael R. Casey, Ph.D. (Reg. No.: 40,294)

Electronic Acknowledgement Receipt

EFS ID:	6653381
Application Number:	90010422
International Application Number:	
Confirmation Number:	6565
Title of Invention:	Graphic User Interface For Internet Telephony Application
First Named Inventor/Applicant Name:	6,009,469
Customer Number:	42624
Filer:	Michael R. Casey
Filer Authorized By:	
Attorney Docket Number:	2655-0185
Receipt Date:	16-DEC-2009
Filing Date:	26-FEB-2009
Time Stamp:	23:44:40
Application Type:	Reexam (Third Party)

Payment information:

Submitted with Payment	no
------------------------	----

File Listing:

Document Number	Document Description	File Name	File Size(Bytes)/ Message Digest	Multi Part /.zip	Pages (if appl.)
1	NPL Documents	NP0047.pdf	372034 <small>04829c731f16636e5bc5b0353ce0fbee080a4fd4</small>	no	6

Warnings:

Information:

2	NPL Documents	NP0048.pdf	1632756	no	40
			c039f09efedcc08f0922b5349b1f9eb53b8fcf88		
Warnings:					
Information:					
3	NPL Documents	NP0049.pdf	106160	no	1
			811171af7c20d05a7ab94ff31f00955da7f07a10		
Warnings:					
Information:					
4	NPL Documents	NP0050.pdf	84902	no	2
			53e340b1c19c6f28b25adf24422de815645cd5da8		
Warnings:					
Information:					
5	NPL Documents	NP0051.pdf	34224	no	1
			42189422f4f7a9915e0889f1e57621050f3acd74a		
Warnings:					
Information:					
6	NPL Documents	NP0052.pdf	449807	no	14
			84918706614b66bfff75d5ca17574df2a6d57da5a		
Warnings:					
Information:					
7	NPL Documents	NP0053.pdf	2382021	no	76
			54973552c2d219244652826c3b0a1338c806d6f6		
Warnings:					
Information:					
8	NPL Documents	NP0054.pdf	332973	no	3
			9df5ea65e334ad7aceef41bfd937a511d7a53b58		
Warnings:					
Information:					
9	NPL Documents	NP0055.pdf	245043	no	2
			167884b4176f7a116e0ac7d9d647da9028132eb4		
Warnings:					
Information:					
10	NPL Documents	NP0056.pdf	20293336	no	120
			f8a2b73d6f4ed0a13f19c778f4462f02d3eaa7ca7		
Warnings:					
Information:					

11	NPL Documents	NP0057.pdf	198007	no	2
			7c6dac2f326fa5d9b2e26d9bdcbcf9ae64a24f		
Warnings:					
Information:					
12	NPL Documents	NP0058.pdf	152156	no	4
			9a4f73e8c0868a24856b98ce159a37f83c1e553d		
Warnings:					
Information:					
13	NPL Documents	NP0059.pdf	714939	no	11
			4237ad09b674a5185893aeef43389bad416ca699		
Warnings:					
Information:					
14	NPL Documents	NP0060.pdf	319167	no	8
			43e0bbb0eeeadc80560b1c62432d523dbc1b1a8		
Warnings:					
Information:					
15	NPL Documents	NP0061.pdf	1432267	no	21
			425b51cc4725a08491d4a2c62becad16186ac3d2		
Warnings:					
Information:					
16	NPL Documents	NP0062.pdf	1044072	no	9
			ebe3c41605b1878ac51b4d7d0bc9a04bd5f7544f		
Warnings:					
Information:					
17	Reexam Certificate of Service	20091216_COS_0185.pdf	58729	no	1
			29c57a48690546cc3e211d3a3848ab75377544f8		
Warnings:					
Information:					
Total Files Size (in bytes):			29852593		

This Acknowledgement Receipt evidences receipt on the noted date by the USPTO of the indicated documents, characterized by the applicant, and including page counts, where applicable. It serves as evidence of receipt similar to a Post Card, as described in MPEP 503.

New Applications Under 35 U.S.C. 111

If a new application is being filed and the application includes the necessary components for a filing date (see 37 CFR 1.53(b)-(d) and MPEP 506), a Filing Receipt (37 CFR 1.54) will be issued in due course and the date shown on this Acknowledgement Receipt will establish the filing date of the application.

National Stage of an International Application under 35 U.S.C. 371

If a timely submission to enter the national stage of an international application is compliant with the conditions of 35 U.S.C. 371 and other applicable requirements a Form PCT/DO/EO/903 indicating acceptance of the application as a national stage submission under 35 U.S.C. 371 will be issued in addition to the Filing Receipt, in due course.

New International Application Filed with the USPTO as a Receiving Office

If a new international application is being filed and the international application includes the necessary components for an international filing date (see PCT Article 11 and MPEP 1810), a Notification of the International Application Number and of the International Filing Date (Form PCT/RO/105) will be issued in due course, subject to prescriptions concerning national security, and the date shown on this Acknowledgement Receipt will establish the international filing date of the application.

**INFORMATION DISCLOSURE
STATEMENT BY APPLICANT**
FORM PTO-1449 (modified)

Sheet 1 of 29

Reexam number	90/010,422
First Named Inventor	Mattaway et al.
Patent Under Re-Exam	6009469
Issue Date	1999/12/28
Group Art Unit	3992
Examiner Name	KOSOWSKI, ALEXANDER J
Attorney Docket No.	2655-0185
Confirmation No.	6565

U.S. PATENT DOCUMENTS

Examiner Initials*	Cite No.	Document No.	Publication/ Issue Date	Name of Patentee or Applicant of Cited Document
	1-1	US-2003/0050075	2003/13/03	Rangarajan et al.
	1-2	US-2004/0204146	2004/14/10	Deeds
	1-3	US-2005/0032435	2005/10/02	Tischer et al.
	1-4	US-2005/0130611	2005/16/06	Lu et al.
	1-5	US-4332982	1982/01/06	Thomas
	1-6	US-4410765	1983/18/10	Hestad et al.
	1-7	US-4446519	1984/01/05	Thomas
	1-8	US-4450554	1984/22/05	Steensma, et al.
	1-9	US-4468529	1984/28/08	Samuel et al.
	1-10	US-4528659	1985/09/07	Jones, Jr.
	1-11	US-4589107	1986/13/05	Middleton, et al.
	1-12	US-4594477	1986/10/06	Noirot
	1-13	US-4598397	1986/01/07	Nelson, et al.
	1-14	US-4630262	1986/16/12	Callens, et al.
	1-15	US-4652703	1987/24/03	Lu, et al.
	1-16	US-4654483	1987/03	Imai et al.
	1-17	US-4694492	1987/09	Wirstrom et al.
	1-18	US-4740963	1988/26/04	Eckley
	1-19	US-4782485	1988/01/11	Gollub
	1-20	US-4799153	1989/01	Hann et al.
	1-21	US-4809271	1989/28/02	Kondo, et al.
	1-22	US-4813040	1989/14/03	Futato
	1-23	US-4819228	1989/04/04	Baran, et al.
	1-24	US-4821263	1989/04	Lundh

Examiner Signature		Date Considered	
--------------------	--	-----------------	--

*Examiner: Initial if reference was considered, whether or not citation is in conformance with MPEP 609. Draw a line through citation if not in conformance and not considered. Include a copy of this form with next communication to applicant.

**INFORMATION DISCLOSURE
STATEMENT BY APPLICANT**
FORM PTO-1449 (modified)

Sheet 2 of 29

Reexam number	90/010,422
First Named Inventor	Mattaway et al.
Patent Under Re-Exam	6009469
Issue Date	1999/12/28
Group Art Unit	3992
Examiner Name	KOSOWSKI, ALEXANDER J
Attorney Docket No.	2655-0185
Confirmation No.	6565

U.S. PATENT DOCUMENTS

Examiner Initials*	Cite No.	Document No.	Publication/ Issue Date	Name of Patentee or Applicant of Cited Document
	2-1	US-4829554	1989/09/05	Barnes et al.
	2-2	US-4837797	1989/06	Freeny, Jr., Charles C.
	2-3	US-4866704	1989/12/09	Bergman
	2-4	US-4866732	1989/12/09	Carey, et al.
	2-5	US-4873715	1989/10/10	Shibata
	2-6	US-4887265	1989/12/12	Felix
	2-7	US-4890282	1989/26/12	Lambert, et al.
	2-8	US-4912705	1990/27/03	Paneth, et al.
	2-9	US-4932022	1990/05/06	Keeney, et al.
	2-10	US-4981371	1991/01/01	Gurak, et al.
	2-11	US-4989230	1991/29/01	Gillig et al.
	2-12	US-4995074	1991/02	Goldman et al.
	2-13	US-5031089	1991/07	Liu et al.
	2-14	US-5036513	1991/30/07	Greenblatt
	2-15	US-5040141	1991/13/08	Yazima et al
	2-16	US-5056140	1991/10	Kimbell
	2-17	US-5065425	1991/12/11	Lecomte, et al.
	2-18	US-5107443	1992/04	Smith et al.
	2-19	US-5121385	1992/09/06	Tominaga, et al.
	2-20	US-5127003	1992/30/06	Dell Jr. et al
	2-21	US-5130985	1992/14/07	Kondo, et al.
	2-22	US-5150410	1992/22/09	Bertrand
	2-23	US-5155726	1992/13/10	Spinney, et al.
	2-24	US-5157592	1992/20/10	Walters

Examiner Signature		Date Considered	
--------------------	--	-----------------	--

*Examiner: Initial if reference was considered, whether or not citation is in conformance with MPEP 609. Draw a line through citation if not in conformance and not considered. Include a copy of this form with next communication to applicant.

**INFORMATION DISCLOSURE
STATEMENT BY APPLICANT**
FORM PTO-1449 (modified)

Sheet 3 of 29

Reexam number	90/010,422
First Named Inventor	Mattaway et al.
Patent Under Re-Exam	6009469
Issue Date	1999/12/28
Group Art Unit	3992
Examiner Name	KOSOWSKI, ALEXANDER J
Attorney Docket No.	2655-0185
Confirmation No.	6565

U.S. PATENT DOCUMENTS

Examiner Initials*	Cite No.	Document No.	Publication/ Issue Date	Name of Patentee or Applicant of Cited Document
	3-1	US-5187591	1993/16/02	Guy, et al.
	3-2	US-5212789	1993/18/05	Rago
	3-3	US-5214650	1993/25/05	Renner, et al.
	3-4	US-5220599	1993/06	Sasano et al
	3-5	US-5241594	1993/31/08	Kung
	3-6	US-5241625	1993/08	Epard et al.
	3-7	US-5247620	1993/09/21	Fukuzawa et al.
	3-8	US-5249290	1993/28/09	Heizer
	3-9	US-5274635	1993/12	Rahman et al.
	3-10	US-5282197	1994/25/01	Kreitzer
	3-11	US-5283819	1994/01/02	Glick, et al.
	3-12	US-5287103	1994/15/02	Kasprzyk Marlon Z et al
	3-13	US-5305312	1994/19/04	Fornek, et al.
	3-14	US-5327486	1994/07	Wolff et al.
	3-15	US-5335276	1994/02/08	Thompson et al.
	3-16	US-5341374	1994/23/08	Lewen et al.
	3-17	US-5347632	1994/09	Filepp et al.
	3-18	US-5377260	1994/12	Long
	3-19	US-5396485	1995/03	Ohno et al.
	3-20	US-5410754	1994/15/02	Favreau Keith et al
	3-21	US-5428608	1995/06	Freeman et al.
	3-22	US-5440547	1995/08/08	Esaki Hiroshi et al
	3-23	US-5446891	1995/29/08	Kaplan et al.
	3-24	US-5446919	1995/29/08	Wilkins

Examiner Signature		Date Considered	
--------------------	--	-----------------	--

*Examiner: Initial if reference was considered, whether or not citation is in conformance with MPEP 609. Draw a line through citation if not in conformance and not considered. Include a copy of this form with next communication to applicant.

**INFORMATION DISCLOSURE
STATEMENT BY APPLICANT**
FORM PTO-1449 (modified)

Sheet 4 of 29

Reexam number	90/010,422
First Named Inventor	Mattaway et al.
Patent Under Re-Exam	6009469
Issue Date	1999/12/28
Group Art Unit	3992
Examiner Name	KOSOWSKI, ALEXANDER J
Attorney Docket No.	2655-0185
Confirmation No.	6565

U.S. PATENT DOCUMENTS

Examiner Initials*	Cite No.	Document No.	Publication/ Issue Date	Name of Patentee or Applicant of Cited Document
	4-1	US-5459864	1995/10	Brent et al.
	4-2	US-5461611	1995/10	Drake, Jr. et al.
	4-3	US-5467388	1995/11	Redd et al.
	4-4	US-5473531	1995/10	Flora-Holmquist et al.
	4-5	US-5474741	1995/12/12	Mikeska et al.
	4-6	US-5474819	1995/12/12	Chambers et al.
	4-7	US-5483524	1996/01	Lev et al.
	4-8	US-5487100	1996/01	Kane
	4-9	US-5491800	1996/13/02	Goldsmith et al.
	4-10	US-5500890	1996/03	Rogge et al.
	4-11	US-5517432	1996/05	Chandra et al.
	4-12	US-5528671	1996/18/06	Ryu et al.
	4-13	US-5533102	1996/02/07	Robinson et al.
	4-14	US-5544164	1996/08	Baran
	4-15	US-5544322	1996/06/08	Cheng et al.
	4-16	US-5546448	1996/08	Caswell et al.
	4-17	US-5546452	1996/13/08	Andrews et al.
	4-18	US-5548636	1996/08	Bannister et al.
	4-19	US-5548694	1996/08	Frisken Gibson
	4-20	US-5563882	1996/10	Bruno et al.
	4-21	US-5572643	1996/11	Judson, David H.
	4-22	US-5574774	1996/11	Ahlberg et al.
	4-23	US-5574934	1996/12/11	Mirashrafi et al.
	4-24	US-5581522	1996/12/03	Shibuya et al.

Examiner Signature		Date Considered	
--------------------	--	-----------------	--

*Examiner: Initial if reference was considered, whether or not citation is in conformance with MPEP 609. Draw a line through citation if not in conformance and not considered. Include a copy of this form with next communication to applicant.

**INFORMATION DISCLOSURE
STATEMENT BY APPLICANT**
FORM PTO-1449 (modified)

Sheet 5 of 29

Reexam number	90/010,422
First Named Inventor	Mattaway et al.
Patent Under Re-Exam	6009469
Issue Date	1999/12/28
Group Art Unit	3992
Examiner Name	KOSOWSKI, ALEXANDER J
Attorney Docket No.	2655-0185
Confirmation No.	6565

U.S. PATENT DOCUMENTS

Examiner Initials*	Cite No.	Document No.	Publication/ Issue Date	Name of Patentee or Applicant of Cited Document
	5-1	US-5581702	1996/12	McArdle et al.
	5-2	US-5586257	1996/17/12	Perlman
	5-3	US-5586260	1996/17/12	Hu
	5-4	US-5591800	1996/02	Goldsmith et al.
	5-5	US-5604737	1997/02	Iwami et al.
	5-6	US-5606669	1997/25/02	Bertin et al.
	5-7	US-5614940	1997/25/03	Cobbley et al.
	5-8	US-5619557	1997/08/04	Van Berkum
	5-9	US-5623483	1997/22/04	Agrawal et al.
	5-10	US-5623490	1997/04	Richter et al.
	5-11	US-5623605	1997/22/04	Keshav et al.
	5-12	US-5625407	1997/29/04	Biggs et al.
	5-13	US-5636282	1997/06	Holmquist et al.
	5-14	US-5636346	1997/06	Saxe
	5-15	US-5642156	1997/24/06	Saiki
	5-16	US-5644629	1997/07	Chow
	5-17	US-5651006	1997/07	Fujino et al.
	5-18	US-5652759	1997/07	Stringfellow, Jr.
	5-19	US-5655120	1997/08	Witte et al.
	5-20	US-5659542	1997/08	Bell et al.
	5-21	US-5659596	1997/19/08	Dunn
	5-22	US-5668862	1997/09	Bannister et al.
	5-23	US-5671428	1997/23/09	Muranaga et al.
	5-24	US-5675507	1997/10	Bobo

Examiner Signature		Date Considered	
--------------------	--	-----------------	--

*Examiner: Initial if reference was considered, whether or not citation is in conformance with MPEP 609. Draw a line through citation if not in conformance and not considered. Include a copy of this form with next communication to applicant.

**INFORMATION DISCLOSURE
STATEMENT BY APPLICANT**
FORM PTO-1449 (modified)

Sheet 6 of 29

Reexam number	90/010,422
First Named Inventor	Mattaway et al.
Patent Under Re-Exam	6009469
Issue Date	1999/12/28
Group Art Unit	3992
Examiner Name	KOSOWSKI, ALEXANDER J
Attorney Docket No.	2655-0185
Confirmation No.	6565

U.S. PATENT DOCUMENTS

Examiner Initials*	Cite No.	Document No.	Publication/ Issue Date	Name of Patentee or Applicant of Cited Document
	6-1	US-5680392	1997/10	Semaan
	6-2	US-5684800	1997/11	Dobbins et al.
	6-3	US-5689553	1997/18/11	Ahuja et al.
	6-4	US-5692192	1997/11	Sudo
	6-5	US-5694594	1997/02/12	Chang
	6-6	US-5701463	1997/23/12	Malcolm
	6-7	US-5708422	1998/13/01	Blonder et al.
	6-8	US-5708655	1998/01	Toth et al.
	6-9	US-5710884	1998/20/01	Dedrick
	6-10	US-5717923	1998/10/02	Dedrick
	6-11	US-5719786	1998/02	Nelson et al.
	6-12	US-5721827	1998/24/02	Logan et al.
	6-13	US-5724092	1998/03/03	Davidsohn et al.
	6-14	US-5724412	1998/03	Srinivasan
	6-15	US-5724506	1998/03/03	Cleron et al.
	6-16	US-5726984	1998/10/03	Kubler et al.
	6-17	US-5729748	1998/03	Robbins et al.
	6-18	US-5732078	1998/03	Arango
	6-19	US-5736968	1998/04	Tsakiris, Alexander L.
	6-20	US-5742668	1998/04	Pepe et al.
	6-21	US-5742675	1998/21/04	Kilander et al.
	6-22	US-5742762	1998/21/04	Scholl et al.
	6-23	US-5742905	1998/04	Pepe et al.
	6-24	US-5745642	1998/28/04	Ahn

Examiner Signature		Date Considered	
--------------------	--	-----------------	--

*Examiner: Initial if reference was considered, whether or not citation is in conformance with MPEP 609. Draw a line through citation if not in conformance and not considered. Include a copy of this form with next communication to applicant.

**INFORMATION DISCLOSURE
STATEMENT BY APPLICANT**
FORM PTO-1449 (modified)

Sheet 7 of 29

Reexam number	90/010,422
First Named Inventor	Mattaway et al.
Patent Under Re-Exam	6009469
Issue Date	1999/12/28
Group Art Unit	3992
Examiner Name	KOSOWSKI, ALEXANDER J
Attorney Docket No.	2655-0185
Confirmation No.	6565

U.S. PATENT DOCUMENTS

Examiner Initials*	Cite No.	Document No.	Publication/ Issue Date	Name of Patentee or Applicant of Cited Document
	7-1	US-5745702	1998/04	Morozumi
	7-2	US-5745711	1998/04	Kitahara et al.
	7-3	US-5751712	1998/05	Farwell et al.
	7-4	US-5751961	1998/05	Smyk
	7-5	US-5754636	1998/05	Bayless et al.
	7-6	US-5754939	1998/19/05	Herz et al.
	7-7	US-5758110	1998/05	Boss et al.
	7-8	US-5758257	1998/26/03	Herz et al.
	7-9	US-5761606	1998/06	Wolzien
	7-10	US-5764736	1998/06	Shachar et al.
	7-11	US-5764741	1998/09/06	Barak
	7-12	US-5764756	1998/09/06	Onweller
	7-13	US-5767897	1998/16/06	Howell
	7-14	US-5768527	1998/06	Zhu et al.
	7-15	US-5771355	1998/23/06	Kuzma
	7-16	US-5774660	1998/30/06	Brendel et al.
	7-17	US-5774666	1998/30/06	Portuesi
	7-18	US-5778181	1998/07	Hidary et al.
	7-19	US-5778187	1998/07	Monteiro et al.
	7-20	US-5784564	1998/21/07	Camaisa et al.
	7-21	US-5784619	1998/21/07	Evans et al.
	7-22	US-5787253	1998/07	McCreery et al.
	7-23	US-5790548	1998/08	Sistanizadeh et al.
	7-24	US-5790792	1998/08	Dudgeon et al.

Examiner Signature		Date Considered	
--------------------	--	-----------------	--

*Examiner: Initial if reference was considered, whether or not citation is in conformance with MPEP 609. Draw a line through citation if not in conformance and not considered. Include a copy of this form with next communication to applicant.

**INFORMATION DISCLOSURE
STATEMENT BY APPLICANT**
FORM PTO-1449 (modified)

Sheet 8 of 29

Reexam number	90/010,422
First Named Inventor	Mattaway et al.
Patent Under Re-Exam	6009469
Issue Date	1999/12/28
Group Art Unit	3992
Examiner Name	KOSOWSKI, ALEXANDER J
Attorney Docket No.	2655-0185
Confirmation No.	6565

U.S. PATENT DOCUMENTS

Examiner Initials*	Cite No.	Document No.	Publication/ Issue Date	Name of Patentee or Applicant of Cited Document
	8-1	US-5790793	1998/08	Higley
	8-2	US-5793365	1998/11/08	Tang et al.
	8-3	US-5794018	1998/08	Vrvilo et al.
	8-4	US-5794257	1998/08	Liu et al.
	8-5	US-5796394	1998/08	Wicks et al.
	8-6	US-5799063	1998/08	Krane
	8-7	US-5799072	1998/08	Vulcan et al.
	8-8	US-5799150	1998/08	Hamilton et al.
	8-9	US-5805587	1998/09	Norris et al.
	8-10	US-5805810	1998/09	Maxwell
	8-11	US-5805822	1998/08/09	Long et al.
	8-12	US-5809233	1998/15/09	Shur
	8-13	US-5812819	1998/22/08	Rodwin et al.
	8-14	US-5816919	1998/10	Scagnelli et al.
	8-15	US-5818510	1998/10	Cobbley et al.
	8-16	US-5818836	1998/10	DuVal
	8-17	US-5822524	1998/10	Chen et al.
	8-18	US-5828837	1998/10	Eikeland
	8-19	US-5828843	1998/27/10	Grimm et al.
	8-20	US-5828846	1998/10	Kirby et al.
	8-21	US-5832119	1998/11	Rhoads
	8-22	US-5832240	1998/11	Larsen et al.
	8-23	US-5835720	1998/10/11	Nelson et al.
	8-24	US-5835723	1998/11	Andrews et al.

Examiner Signature		Date Considered	
--------------------	--	-----------------	--

*Examiner: Initial if reference was considered, whether or not citation is in conformance with MPEP 609. Draw a line through citation if not in conformance and not considered. Include a copy of this form with next communication to applicant.

**INFORMATION DISCLOSURE
STATEMENT BY APPLICANT**
FORM PTO-1449 (modified)

Sheet 9 of 29

Reexam number	90/010,422
First Named Inventor	Mattaway et al.
Patent Under Re-Exam	6009469
Issue Date	1999/12/28
Group Art Unit	3992
Examiner Name	KOSOWSKI, ALEXANDER J
Attorney Docket No.	2655-0185
Confirmation No.	6565

U.S. PATENT DOCUMENTS

Examiner Initials*	Cite No.	Document No.	Publication/ Issue Date	Name of Patentee or Applicant of Cited Document
	9-1	US-5835725	1998/10/11	Chiang et al.
	9-2	US-5838683	1998/11	Corley et al.
	9-3	US-5838970	1998/17/11	Thomas
	9-4	US-5841769	1998/11	Okanoue et al.
	9-5	US-5842216	1998/11	Anderson et al.
	9-6	US-5848143	1998/08/12	Andrews et al.
	9-7	US-5848396	1998/12	Gerace
	9-8	US-5854901	1998/12	Cole et al.
	9-9	US-5857072	1999/01	Crowle
	9-10	US-5864684	1999/26/01	Nielsen
	9-11	US-5867156	1999/02	Beard et al.
	9-12	US-5867654	1999/02/02	Ludwig et al.
	9-13	US-5867665	1999/02/02	Butman et al.
	9-14	US-5872850	1999/16/02	Klein et al.
	9-15	US-5872922	1999/02	Hogan et al.
	9-16	US-5872972	1999/02	Boland et al.
	9-17	US-5884032	1999/03	Bateman et al.
	9-18	US-5884035	1999/16/03	Butman et al.
	9-19	US-5884077	1999/03	Suzuki
	9-20	US-5890162	1999/03	Huckins
	9-21	US-5892825	1999/06/04	Mages et al.
	9-22	US-5892903	1999/06/04	Klaus
	9-23	US-5892924	1999/04	Lyon et al.
	9-24	US-5903721	1999/11/05	Sixtus

Examiner Signature		Date Considered	
--------------------	--	-----------------	--

*Examiner: Initial if reference was considered, whether or not citation is in conformance with MPEP 609. Draw a line through citation if not in conformance and not considered. Include a copy of this form with next communication to applicant.

INFORMATION DISCLOSURE STATEMENT BY APPLICANT FORM PTO-1449 (modified)	Reexam number	90/010,422
	First Named Inventor	Mattaway et al.
	Patent Under Re-Exam	6009469
	Issue Date	1999/12/28
	Group Art Unit	3992
	Examiner Name	KOSOWSKI, ALEXANDER J
	Attorney Docket No.	2655-0185
	Confirmation No.	6565

Sheet 10 of 29

U.S. PATENT DOCUMENTS				
Examiner Initials*	Cite No.	Document No.	Publication/ Issue Date	Name of Patentee or Applicant of Cited Document
	10-1	US-5903723	1999/11/05	Beck et al.
	10-2	US-5903727	1999/11/05	Nielsen
	10-3	US-5905719	1999/05	Arnold et al.
	10-4	US-5905736	1999/18/05	Ronen et al.
	10-5	US-5905865	1999/05	Palmer et al.
	10-6	US-5905872	1999/05	DeSimone et al.
	10-7	US-5915001	1999/06	Uppaluru
	10-8	US-5923736	1999/07	Shachar, Yuval
	10-9	US-5924093	1999/07	Potter et al.
	10-10	US-5925103	1999/10/07	Magallanes et al.
	10-11	US-5928327	1999/07	Wang et al.
	10-12	US-5929849	1999/07	Kikinis
	10-13	US-5937162	1999/08	Funk et al.
	10-14	US-5946386	1999/08	Rogers et al.
	10-15	US-5946629	1999/08	Sawyer et al.
	10-16	US-5950123	1999/09	Schwelb et al.
	10-17	US-5950172	1999/09	Klingman
	10-18	US-5956482	1999/09	Agraharam et al.
	10-19	US-5961584	1999/10	Wolf
	10-20	US-5964872	1999/12/10	Turpin
	10-21	US-5969967	1999/10	Aahlad et al.
	10-22	US-5982774	1999/11	Foladare et al
	10-23	US-5983005	1999/11	Monteiro et al.
	10-24	US-5999965	1999/07/12	Kelly

Examiner Signature		Date Considered	
--------------------	--	-----------------	--

*Examiner: Initial if reference was considered, whether or not citation is in conformance with MPEP 609. Draw a line through citation if not in conformance and not considered. Include a copy of this form with next communication to applicant.

INFORMATION DISCLOSURE STATEMENT BY APPLICANT FORM PTO-1449 (modified)	Reexam number	90/010,422
	First Named Inventor	Mattaway et al.
	Patent Under Re-Exam	6009469
	Issue Date	1999/12/28
	Group Art Unit	3992
	Examiner Name	KOSOWSKI, ALEXANDER J
	Attorney Docket No.	2655-0185
	Confirmation No.	6565
Sheet 11 of 29		

U.S. PATENT DOCUMENTS				
Examiner Initials*	Cite No.	Document No.	Publication/ Issue Date	Name of Patentee or Applicant of Cited Document
	11-1	US-6005870	1999/21/12	Leung
	11-2	US-6006257	1999/12	Slezak
	11-3	US-6014379	2000/01	White et al.
	11-4	US-6014710	2000/01	Talluri et al.
	11-5	US-6016393	2000/18/01	White et al.
	11-6	US-6018768	2000/01	Ullman et al.
	11-7	US-6018771	2000/25/01	Hayden
	11-8	US-6021126	2000/02	White et al.
	11-9	US-6026086	2000/02	Lancelot et al.
	11-10	US-6026425	2000/02	Suguri et al.
	11-11	US-6029175	2000/22/02	Chow et al.
	11-12	US-6032192	2000/29/02	Wegner et al.
	11-13	US-6041345	2000/03	Levi et al.
	11-14	US-6047292	2000/04/04	Kelly et al.
	11-15	US-6055594	2000/04	Lo et al.
	11-16	US-6061716	2000/05	Moncreiff
	11-17	US-6064975	2000/05	Moon et al.
	11-18	US-6065048	2000/16/05	Highley
	11-19	US-6069890	2000/30/05	White et al.
	11-20	US-6085217	2000/07	Ault et al.
	11-21	US-6101182	2000/08	Sistanizadeh et al.
	11-22	US-6105053	2000/08	Kimmel et al.
	11-23	US-6122255	2000/09	Bartholomew et al.
	11-24	US-6125113	2000/09	Farris et al.

Examiner Signature		Date Considered	
--------------------	--	-----------------	--

*Examiner: Initial if reference was considered, whether or not citation is in conformance with MPEP 609. Draw a line through citation if not in conformance and not considered. Include a copy of this form with next communication to applicant.

**INFORMATION DISCLOSURE
STATEMENT BY APPLICANT**
FORM PTO-1449 (modified)

Sheet 12 of 29

Reexam number	90/010,422
First Named Inventor	Mattaway et al.
Patent Under Re-Exam	6009469
Issue Date	1999/12/28
Group Art Unit	3992
Examiner Name	KOSOWSKI, ALEXANDER J
Attorney Docket No.	2655-0185
Confirmation No.	6565

U.S. PATENT DOCUMENTS

Examiner Initials*	Cite No.	Document No.	Publication/ Issue Date	Name of Patentee or Applicant of Cited Document
	12-1	US-6137877	2000/24/10	Robin et al.
	12-2	US-6141341	2000/31/10	Jones et al.
	12-3	US-6151643	2000/11	Cheng et al.
	12-4	US-6154445	2000/11	Farris et al.
	12-5	US-6163316	2000/12	Killian
	12-6	US-6173044	2001/01	Hortensius et al.
	12-7	US-6178453	2001/23/01	Mattaway et al.
	12-8	US-6181689	2001/01	Choung et al.
	12-9	US-6185184	2001/06/02	Mattaway et al.
	12-10	US-6188677	2001/02	Oyama et al.
	12-11	US-6195357	2001/02	Polcyn
	12-12	US-6198303	2001/03	Rangasayee
	12-13	US-6205135	2001/20/03	Chinni et al.
	12-14	US-6212625	2001/04	Russell
	12-15	US-6226678	2001/05	Mattaway et al.
	12-16	US-6226690	2001/05	Banda et al.
	12-17	US-6240444	2001/05	Fin et al.
	12-18	US-6243373	2001/06	Turock
	12-19	US-6266539	2001/07	Pardo
	12-20	US-6275490	2001/14/08	Mattaway et al.
	12-21	US-6282272	2001/08	Noonen et al.
	12-22	US-6289369	2001/11/09	Sundaresan
	12-23	US-6300863	2001/10	Cotichini et al.
	12-24	US-6338078	2002/01	Chang et al.

Examiner Signature		Date Considered	
--------------------	--	-----------------	--

*Examiner: Initial if reference was considered, whether or not citation is in conformance with MPEP 609. Draw a line through citation if not in conformance and not considered. Include a copy of this form with next communication to applicant.

**INFORMATION DISCLOSURE
STATEMENT BY APPLICANT**
FORM PTO-1449 (modified)

Sheet 13 of 29

Reexam number	90/010,422
First Named Inventor	Mattaway et al.
Patent Under Re-Exam	6009469
Issue Date	1999/12/28
Group Art Unit	3992
Examiner Name	KOSOWSKI, ALEXANDER J
Attorney Docket No.	2655-0185
Confirmation No.	6565

U.S. PATENT DOCUMENTS

Examiner Initials*	Cite No.	Document No.	Publication/ Issue Date	Name of Patentee or Applicant of Cited Document
	13-1	US-6343115	2002/01	Foladare et al.
	13-2	US-6343220	2002/29/01	Van Der Salm
	13-3	US-6347085	2002/02	Kelly
	13-4	US-6347342	2002/02	Marcos et al.
	13-5	US-6377568	2002/04	Kelly
	13-6	US-6385583	2002/05	Ladd et al.
	13-7	US-6393455	2002/05	Eilert et al.
	13-8	US-6427064	2002/07	Henderson, Daniel
	13-9	US-6434552	2002/08	Leong, Jin Fye
	13-10	US-6463565	2002/08/10	Keith C. Kelly
	13-11	US-6477586	2002/11	Achenson et al.
	13-12	US-6594254	2003/15/07	Kelly
	13-13	US-6687738	2004/03/02	Glenn W. Hutton
	13-14	US-6704802	2004/03	Finch et al.
	13-15	US-6728784	2004/27/04	Mattaway
	13-16	US-6772335	2004/08	Curtis et al.
	13-17	US-6829645	2004/07/12	Glenn W. Hutton
	13-18	US-6888836	2005/03/05	Cherkasova
	13-19	US-6909708	2005/06	Krishnaswamy et al.
	13-20			
	13-21			
	13-22			
	13-23			
	13-24			

Examiner Signature		Date Considered	
--------------------	--	-----------------	--

*Examiner: Initial if reference was considered, whether or not citation is in conformance with MPEP 609. Draw a line through citation if not in conformance and not considered. Include a copy of this form with next communication to applicant.

**INFORMATION DISCLOSURE
STATEMENT BY APPLICANT**
FORM PTO-1449 (modified)

Sheet 14 of 29

Reexam number	90/010,422
First Named Inventor	Mattaway et al.
Patent Under Re-Exam	6009469
Issue Date	1999/12/28
Group Art Unit	3992
Examiner Name	KOSOWSKI, ALEXANDER J
Attorney Docket No.	2655-0185
Confirmation No.	6565

FOREIGN PATENT DOCUMENTS

Examiner Initials*	Cite No.	Document No.	Publication Date	Name of Patentee or Applicant of Cited Document	Notes
	14-1	AU-200059377-A1	11-23-2000	Glenn W. Hutton et al.	
	14-2	AU-200059378-A1	11-30-2000	Glenn W. Hutton et al.	
	14-3	AU-200059379-A1	11-23-2000	Glenn W. Hutton et al.	
	14-4	EP-0518596	12/16/1992	Digital Equipment Corp	
	14-5	EP-0559047	09-1993	Iglehart	
	14-6	EP-0597691	05/18/1994	IBM	
	14-7	EP-0632672	01/04/1995	IBM	
	14-8	EP-0648038	04/12/1995	IBM	
	14-9	EP-1379039-A2	01-07-2004	Glenn W. Hutton	
	14-10	EP-1379050-A2	01-07-2004	Glenn W. Hutton	
	14-11	GB-2283645	05/10/1995	Digital Equipment Int.	
	14-12	JP 63-131637	3/6/1988	Y. Takehiko (w/ English abstract)	T
	14-13	JP 6-62020 (w/ SOR and EA)	1994/03/04	Masatoshi et al.	
	14-14	JP-5944140	03-12-1984	Junichi Kimura et al.	T
	14-15	WO-9422087	09/29/1994	3Com Corp	
	14-16	WO-9714234	04-17-1997	Glenn W. Hutton	
	14-17	WO-9811704	03/19/1998	Don Joon Lee et al.	
	14-18				
	14-19				
	14-20				
	14-21				
	14-22				
	14-23				
	14-24				

Examiner Signature		Date Considered	
--------------------	--	-----------------	--

*Examiner: Initial if reference was considered, whether or not citation is in conformance with MPEP 609. Draw a line through citation if not in conformance and not considered. Include a copy of this form with next communication to applicant. Notes: If identified, the following is provided: EA = English Abstract, T = Translation, PF = Patent Family.

INFORMATION DISCLOSURE STATEMENT BY APPLICANT FORM PTO-1449 (modified) Sheet 15 of 29	Reexam number	90/010,422
	First Named Inventor	Mattaway et al.
	Patent Under Re-Exam	6009469
	Issue Date	1999/12/28
	Group Art Unit	3992
	Examiner Name	KOSOWSKI, ALEXANDER J
	Attorney Docket No.	2655-0185
	Confirmation No.	6565

NON-PATENT REFERENCES			
Examiner Initials*	Cite No.	Non-patent Reference bibliographic information, where available	Notes
	15-1	"Circuit Switching", Ericsson, last published July 5, 2001, found at http://www.ericsson.com/multiservicenetWORKS/circuitswitching/axe/ printed on August 1, 2001, 2 pages.	
	15-2	"Data Communication Over the Telephone Network", International Telecommunication Union, CCITT The International Telegraph and Telephone Consultative Committee, Blue Book, Volume VIII - Fascicle VIII.1, IXth Plenary Assembly, Melbourne, November 14-25, 1988, pages 296-370	
	15-3	"Full Duplex Speakerphone", IBM Technical Disclosure Bulletin, Vol. 29, No. 12, May 1987, pages 5599-5602	
	15-4	"ICL OPD - One Per Desk", Issue 01 August 1990, A Comprehensive Technical Information Document (24 pages)	
	15-5	"Information Processing Techniques Program. Volume II. Wideband Integrated Voice/Data Technology" Semiannual Technical Summary Report, Massachusetts Institute of Technology Lexington, MA, 1 October 1977 - 31 March 1978, Issued 31 August 1978, pages 1-25 and 27-31, ADA067014	
	15-6	"Integrated Voice/Data PABX Communications", IBM Technical Disclosure Bulletin, September 1986, http://patents.ibm.com	
	15-7	"Level 1-5 of 65 Stories" 1990 Network World, Inc., April 16, 1990, pages 114-115	

Examiner Signature		Date Considered	
--------------------	--	-----------------	--

*Examiner: Initial if reference was considered, whether or not citation is in conformance with MPEP 609. Draw a line through citation if not in conformance and not considered. Include a copy of this form with next communication to applicant. Notes: If identified, the following is provided: EA = English Abstract, T = Translation, PF = Patent Family.

INFORMATION DISCLOSURE STATEMENT BY APPLICANT FORM PTO-1449 (modified)	Reexam number	90/010,422
	First Named Inventor	Mattaway et al.
	Patent Under Re-Exam	6009469
	Issue Date	1999/12/28
	Group Art Unit	3992
	Examiner Name	KOSOWSKI, ALEXANDER J
	Attorney Docket No.	2655-0185
Confirmation No.	6565	
Sheet 16 of 29		

NON-PATENT REFERENCES			
Examiner Initials*	Cite No.	Non-patent Reference bibliographic information, where available	Notes
	16-1	"Multi-Service Networks", Ericsson, last published June 27, 2001, found at http://www.ericsson.com/multiservicenetworks/circuitswitching/ printed on August 1, 2001, 2 pages.	
	16-2	"The History of TPC.INT", January 15, 1999, 2 pages, found at http://www.tpc.int/faq/history.html printed on August 8, 2002.	
	16-3	A. A. Kapauan, et al. "Wideband Packet Access for Workstations: Integrated Voice/Data/Image Services on the UNIX+ PC", IEEE Global Telecommunications Conference, Houston, Texas, December 1-4, 1986, Conference Record Vol. 3, pages 1439-1441	
	16-4	AHRENS, Richard L., "Frequently-Asked Questions about Internet VoiceChat 1.1 FAQ Version: 1.0", 1994, 6 pages.	
	16-5	Andy Hopper "Pandora - An Experimental System for Multimedia Applications", Operating Systems Review, January 12, 1990, pages 1-16	
	16-6	BENNETT, Geoff, "Designing TCP/IP Internetworks", Chapter 11, pages 290, 291 and 323, Van Nostrand Reinhold, 1995.	
	16-7	Bernard Gold "Digital Speech Networks", Proceedings of the IEEE, Vol. 65, No. 12, December 1977, pages 1636-1658	

Examiner Signature		Date Considered	
--------------------	--	-----------------	--

*Examiner: Initial if reference was considered, whether or not citation is in conformance with MPEP 609. Draw a line through citation if not in conformance and not considered. Include a copy of this form with next communication to applicant. Notes: If identified, the following is provided: EA = English Abstract, T = Translation, PF = Patent Family.

INFORMATION DISCLOSURE STATEMENT BY APPLICANT FORM PTO-1449 (modified)	Reexam number	90/010,422
	First Named Inventor	Mattaway et al.
	Patent Under Re-Exam	6009469
	Issue Date	1999/12/28
	Group Art Unit	3992
	Examiner Name	KOSOWSKI, ALEXANDER J
	Attorney Docket No.	2655-0185
	Confirmation No.	6565
Sheet 17 of 29		

NON-PATENT REFERENCES			
Examiner Initials*	Cite No.	Non-patent Reference bibliographic information, where available	Notes
	17-1	Bill Newman "An ISDN Data and Voice Terminal Based on a Personal Computer", Globecom'85, IEEE Global Telecommunications Conference, Conference Record Volume 3, New Orleans, Louisiana, December 2-5, 1985, pages 1048-1052	
	17-2	BORLAND, John, "Technology uses one number to find you on any device", May 17, 2001, 3 pages, found at http://news.cnet.com/news/0-1004-201-5939191-0.html .	
	17-3	C. MALAMUD et al., "Principles of Operation for the TPC.INT Subdomain: General Principles and Policy", RFC 1530, October 1993, pages 1-7.	
	17-4	C. MALAMUD et al., "Principles of Operation for the TPC.INT Subdomain: Remote Printing -- Administrative Policies", RFC 1529, October 1993, pages 1-5.	
	17-5	C. MALAMUD et al., "Principles of Operation for the TPC.INT Subdomain: Remote Printing -- Technical Procedures", RFC 1528, October 1993, pages 1-12.	
	17-6	C. Topolcic "Experimental Internet Stream Protocol, Version 2 (ST-II)", Request for Comments 1190, October 1990, pages 1-148	
	17-7	C. YANG, "INETPhone: Telephone Services and Servers on Internet", Request for Comments 1789, pp. 1-6, April 1995.	

Examiner Signature		Date Considered	
--------------------	--	-----------------	--

*Examiner: Initial if reference was considered, whether or not citation is in conformance with MPEP 609. Draw a line through citation if not in conformance and not considered. Include a copy of this form with next communication to applicant. Notes: If identified, the following is provided: EA = English Abstract, T = Translation, PF = Patent Family.

INFORMATION DISCLOSURE STATEMENT BY APPLICANT FORM PTO-1449 (modified)	Reexam number	90/010,422
	First Named Inventor	Mattaway et al.
	Patent Under Re-Exam	6009469
	Issue Date	1999/12/28
	Group Art Unit	3992
	Examiner Name	KOSOWSKI, ALEXANDER J
	Attorney Docket No.	2655-0185
Confirmation No.	6565	
Sheet 18 of 29		

NON-PATENT REFERENCES			
Examiner Initials*	Cite No.	Non-patent Reference bibliographic information, where available	Notes
	18-1	Carl A. Sunshine, et al. "Broad-Band Personal Computer LAN's", IEEE Journal on Selected Areas in Communications, Vol. SAC-3, No.3, May 1985, pages 408-415	
	18-2	Cindy MUELLER et al., "ATD Data Services", http://www.iita.ucar.edu/ws/dataworkshop/Abstract-ATD.html , January 5, 1995, 2 pages.	
	18-3	Clifford J. Weinstein, et al. "Experience with Speech Communication in Packet Networks" IEEE Journal on Selected Areas in Communications, Vol. SAC-1, No. 6, (ISSN 0733-8716), December 1983, pages 963-980	
	18-4	D. Adolphs, et al. "Adapters for the Public ISDN", pages 72-80	
	18-5	D. Perkins "The Point-to-Point Protocol for the Transmission of Multi-Protocol Datagrams Over Point-to-Point Links", Request for Comments 1171, ftp://ftp.isi.edu/in-notes/rfc1171.txt , July 1990, pages 1-48	
	18-6	D.C. Swinehart et al., "Adding Voice to an Office Computer Network", IEEE Global Telecommunications Conference, Nov. 28-Dec 1, 1983, Conference Record Volume 1 of 3, pages 392-398	
	18-7	Dale Gulick et al., "Interface the ISDN to Your PC With a Voice/Data Board", Design Applications, 2328 Electronic Design, 35 (1987) Dec. 10, No. 29, Hashbrouck Heights, NJ, USA, pages 85-88, XP 000004313	

Examiner Signature		Date Considered	
--------------------	--	-----------------	--

*Examiner: Initial if reference was considered, whether or not citation is in conformance with MPEP 609. Draw a line through citation if not in conformance and not considered. Include a copy of this form with next communication to applicant. Notes: If identified, the following is provided: EA = English Abstract, T = Translation, PF = Patent Family.

INFORMATION DISCLOSURE STATEMENT BY APPLICANT FORM PTO-1449 (modified) Sheet 19 of 29	Reexam number	90/010,422
	First Named Inventor	Mattaway et al.
	Patent Under Re-Exam	6009469
	Issue Date	1999/12/28
	Group Art Unit	3992
	Examiner Name	KOSOWSKI, ALEXANDER J
	Attorney Docket No.	2655-0185
	Confirmation No.	6565

NON-PATENT REFERENCES			
Examiner Initials*	Cite No.	Non-patent Reference bibliographic information, where available	Notes
	19-1	Daniel C. Swinehart "Telephone Management in the Etherphone System", IEEE/IEICE Global Telecommunications Conference '87, Conference Record Volume 2 of 3, November 15-18, 1987, pages 1176-1180	
	19-2	Danny Cohen "A Network Voice Protocol NVP-II", April 1, 1981, pages 1-68	
	19-3	Danny Cohen "Packet Communication of Online Speech", AFIPS Conference Proceedings, 1981 National Computer Conference, May 4-7, 1981, Chicago, Illinois, pages 169-176	
	19-4	Danny Cohen "Specifications for the Network Voice Protocol (NVP)", Request for Comments 741, January 29, 1976, pages 1-30	
	19-5	Don H. Johnson, et al. "A Local Access Network for Packetized Digital Voice Communication", IEEE Transactions on Communications, Vol. Com. 29, No. 5, May 1981, pages 679-688	
	19-6	Douglas B. Terry and Daniel C. Swinehart, "Managing Stored Voice in the Etherphone System", 1987 ACM 089791-242-X/87/0011/0103, pages 103-104	
	19-7	Douglas B. Terry and Daniel C. Swinehart, "Managing Stored Voice in the Etherphone System", ACM Transactions on Computer Systems, Vol. 6, No. 1, February 1988, pages 3-27	

Examiner Signature		Date Considered	
--------------------	--	-----------------	--

*Examiner: Initial if reference was considered, whether or not citation is in conformance with MPEP 609. Draw a line through citation if not in conformance and not considered. Include a copy of this form with next communication to applicant. Notes: If identified, the following is provided: EA = English Abstract, T = Translation, PF = Patent Family.

INFORMATION DISCLOSURE STATEMENT BY APPLICANT FORM PTO-1449 (modified) Sheet 20 of 29	Reexam number	90/010,422
	First Named Inventor	Mattaway et al.
	Patent Under Re-Exam	6009469
	Issue Date	1999/12/28
	Group Art Unit	3992
	Examiner Name	KOSOWSKI, ALEXANDER J
	Attorney Docket No.	2655-0185
	Confirmation No.	6565

NON-PATENT REFERENCES			
Examiner Initials*	Cite No.	Non-patent Reference bibliographic information, where available	Notes
	20-1	Eve M. Schooler, et al. "A Packet-Switched Multimedia Conferencing System", SIGOIS Bulletin, pages 12-22	
	20-2	Gary C. Kessler "ISDN Concepts, Facilities, and Services", McGraw-Hill, Inc., c1990, pages 224-231, ISBN 0-07-034242-3	
	20-3	Giulio Barberis, et al. "Coded Speech in Packet-Switched Networks: Models and Experiments" IEEE Journal on Selected Areas in Communications, Vol. SAC-1, No. 6, December 1983, pages 1028-1038	
	20-4	H. Jonathan Chao, et al. "A Packet Video System Using the Dynamic Time Division Multiplexing Technique", IEEE Global Telecommunications Conference, Houston, Texas, December 1-4, 1988, Conference Record, Vol. 3, pages 0767-0772	
	20-5	H. Opderbeck "Throughput Degredations for Single Packet Messages", Request for Comments 632, ftp://ftp.isi.edu/in-notes/rfc632.txt, May 20, 1974, pages 1-6	
	20-6	Henning Schulzrinne "Voice Communication Across the Internet: A Network Voice Terminal", July 29, 1992, pages 1-34	
	20-7	Hiroshi Kobayashi and Hideaki Haruyama, "Voice, Data and Video Integrated Broadband Metropolitan Area Network", Electronics and Communications in Japan, Part 1, Vol. 73, No. 11, 1990, pages 34-42	

Examiner Signature		Date Considered	
--------------------	--	-----------------	--

*Examiner: Initial if reference was considered, whether or not citation is in conformance with MPEP 609. Draw a line through citation if not in conformance and not considered. Include a copy of this form with next communication to applicant. Notes: If identified, the following is provided: EA = English Abstract, T = Translation, PF = Patent Family.

INFORMATION DISCLOSURE STATEMENT BY APPLICANT FORM PTO-1449 (modified) Sheet 21 of 29	Reexam number	90/010,422
	First Named Inventor	Mattaway et al.
	Patent Under Re-Exam	6009469
	Issue Date	1999/12/28
	Group Art Unit	3992
	Examiner Name	KOSOWSKI, ALEXANDER J
	Attorney Docket No.	2655-0185
	Confirmation No.	6565

NON-PATENT REFERENCES			
Examiner Initials*	Cite No.	Non-patent Reference bibliographic information, where available	Notes
	21-1	Hiroyuki Ichikawa et al. "High-Speed Packet Switching Systems for Multimedia Communications", IEEE Journal on Selected Areas in Communications, October 1987, Volume SAC-5, Number 8 (ISSN 0733-8716), pages 1336-1345	
	21-2	Ian H. Merritt "Providing Telephone Line Access to a Packet Voice Network", University of Southern California, Marina Del Rey. Information Sciences Inst., February 1983, ADA126270	
	21-3	Implementation of Next-Generation Agent-Dedicated Communications, by Agatsuma et al., Tech Report of IEICE 94-216 (March 1995)	
	21-4	International Preliminary Examination Report (IPER) issued March 26, 1998 in corresponding International Application Serial No. PCT/US96/15504.	
	21-5	International Search Report issued January 27, 1998 in corresponding International Application Serial No. PCT/US96/15504.	
	21-6	Israel GITMAN, et al. "Economic Analysis of Integrated Voice and Data Networks: A Case Study" Proceedings of the IEEE, Vol. 66, No. 11, November 1978, pages 1549-1570	
	21-7	J. Huelamo, et al. "End User Premises Equipment and Terminals for Broadband Applications", Electrical Communication, Volume 64, Number 2/3, 1990	

Examiner Signature		Date Considered	
--------------------	--	-----------------	--

*Examiner: Initial if reference was considered, whether or not citation is in conformance with MPEP 609. Draw a line through citation if not in conformance and not considered. Include a copy of this form with next communication to applicant. Notes: If identified, the following is provided: EA = English Abstract, T = Translation, PF = Patent Family.

INFORMATION DISCLOSURE STATEMENT BY APPLICANT FORM PTO-1449 (modified) Sheet 22 of 29	Reexam number	90/010,422
	First Named Inventor	Mattaway et al.
	Patent Under Re-Exam	6009469
	Issue Date	1999/12/28
	Group Art Unit	3992
	Examiner Name	KOSOWSKI, ALEXANDER J
	Attorney Docket No.	2655-0185
	Confirmation No.	6565

NON-PATENT REFERENCES			
Examiner Initials*	Cite No.	Non-patent Reference bibliographic information, where available	Notes
	22-1	J. K. Reynolds et al., "Voice File Interchange Protocol (VFIP), Request for Comments 978, ftp://ftp.isi.edu/innotes/rfc978.txt, February 1986, pages 1-5	
	22-2	J. Romkey "A Nonstandard For Transmission of IP Datagrams Over Serial Lines: Slip", Request for Comments 1055, ftp://ftp.isi.edu/in-notes/std/std47.txt, June 1988, pages 1-6	
	22-3	James D. Mills, et al. "A data and voice system for the general service telephone network", Proceedings IECON '87, 1987 International Conference on IND. Electronics, Control, and Instrumentation, Cambridge, Massachusetts, November 3-6, 1987	
	22-4	James W. Forgie "Speech Transmission in Packet-Switched Store-and-Forward Networks", AFIPS Conference Proceedings, 1975 National Computer Conference, May 19-22, 1975, Anaheim, California, pages 137-142	
	22-5	James W. Forgie "Voice Conferencing in Packet Networks", ICC '80, Conference Record, International Conference on Communications, Seattle, WA, June 8-12, 1980, Volume 1, 80CH1505-6 CSCB, pages 21.3.1-21.3.4	
	22-6	Jane's Military Communications 1979-80, pages 452 and 453	
	22-7	Jane's Military Communications 1985, pages 585, 546, and 545	

Examiner Signature		Date Considered	
--------------------	--	-----------------	--

*Examiner: Initial if reference was considered, whether or not citation is in conformance with MPEP 609. Draw a line through citation if not in conformance and not considered. Include a copy of this form with next communication to applicant. Notes: If identified, the following is provided: EA = English Abstract, T = Translation, PF = Patent Family.

INFORMATION DISCLOSURE STATEMENT BY APPLICANT FORM PTO-1449 (modified) Sheet 23 of 29	Reexam number	90/010,422
	First Named Inventor	Mattaway et al.
	Patent Under Re-Exam	6009469
	Issue Date	1999/12/28
	Group Art Unit	3992
	Examiner Name	KOSOWSKI, ALEXANDER J
	Attorney Docket No.	2655-0185
	Confirmation No.	6565

NON-PATENT REFERENCES			
Examiner Initials*	Cite No.	Non-patent Reference bibliographic information, where available	Notes
	23-1	Jane's Military Communications 1989, Tenth Edition, Edited by John Williamson, ISBN 0710608772, pages 443, 507, and 512	
	23-2	Jane's Military Communications 1990-91, Eleventh Edition, Edited by John Williamson, ISBN 0710609000, pages [30], 264, 357, 398, 406, 450, 454, 456, 560, 572, 573, 814, 815, and 816	
	23-3	Jane's Military Communications 1992-93, Thirteenth Edition, Edited by John Williamson, ISBN 0710609809, pages 375, 376, 384, and 704	
	23-4	Jim Stevens, "Much More Idle Chatter About Reference Models", http://www-mice.cs.ucl.ac.uk/multimedia/misc/tcp_ip/8709.mm.www/0041.html , December 18, 1987, pages 1-9	
	23-5	John Bellamy, "Digital Telephony", c1982 John Wiley & Sons, Inc., pages 392-397 and 410-412	
	23-6	JP Appln. No. 2008-163825 Office Action (Translation)	
	23-7	K. Sohraby, et al. "ISDN Primary Rate Interface Impact on Performance of Integrated Voice and Data on CSMA/CD Networks -- A Measurement and Simulation Study", Globecom '90 IEEE Global Telecommunication Conference & Exhibition, San Diego, California, December 2-5, 1990, Volume 2, pages 0912-0919	

Examiner Signature		Date Considered	
--------------------	--	-----------------	--

*Examiner: Initial if reference was considered, whether or not citation is in conformance with MPEP 609. Draw a line through citation if not in conformance and not considered. Include a copy of this form with next communication to applicant. Notes: If identified, the following is provided: EA = English Abstract, T = Translation, PF = Patent Family.

INFORMATION DISCLOSURE STATEMENT BY APPLICANT FORM PTO-1449 (modified) Sheet 24 of 29	Reexam number	90/010,422
	First Named Inventor	Mattaway et al.
	Patent Under Re-Exam	6009469
	Issue Date	1999/12/28
	Group Art Unit	3992
	Examiner Name	KOSOWSKI, ALEXANDER J
	Attorney Docket No.	2655-0185
	Confirmation No.	6565

NON-PATENT REFERENCES			
Examiner Initials*	Cite No.	Non-patent Reference bibliographic information, where available	Notes
	24-1	Ken Sherman "Data Communications - A User's Guide", 3rd Edition, c1981 Prentice-Hall, Inc., pages 296-307 and 404-407	
	24-2	Kevin Jeffay, et al. "Kernel Support for Live Digital Audio and Video", pages 10-21, University of North Carolina at Chapel Hill, Department of Computer Science	
	24-3	Kyuta SAITO, et al. "Voice Packet Communication System for Private Networks", Globecom '89, IEEE Global Telecommunications Conference & Exhibition, Dallas, Texas, November 27-30, 1989, Volume 3, pages 1874-1878	
	24-4	Lawrence G. Roberts "The Evolution of Packet Switching", Proceedings of the IEEE, Vol. 66, No. 11, November 1978, pages 1307-1313	
	24-5	LIN, Hwa-Chun and C.S. Raghavendra, "A Dynamic Load-Balancing Policy With a Central Job Dispatcher (LBC)," IEEE Transactions on Software Engineering, Vol. 18, No. 2, February 1992, pages 148-158.	
	24-6	M. E. Ulug, et al. "Statistical Multiplexing of Data and Encoded Voice in a Transparent Intelligent Network", Fifth Data Communications Symposium, September 27-29, 1977, Snowbird, Utah, pages 6-14 - 6-20	
	24-7	M. Gopalakrishnan, et al. "Integrating Voice and Data SALAN: An Experimental Local Area Network", Computer Communications, Vol. 9, No. 4, August 1986, pages 186-194 and page 169	

Examiner Signature		Date Considered	
--------------------	--	-----------------	--

*Examiner: Initial if reference was considered, whether or not citation is in conformance with MPEP 609. Draw a line through citation if not in conformance and not considered. Include a copy of this form with next communication to applicant. Notes: If identified, the following is provided: EA = English Abstract, T = Translation, PF = Patent Family.

INFORMATION DISCLOSURE STATEMENT BY APPLICANT FORM PTO-1449 (modified) Sheet 25 of 29	Reexam number	90/010,422
	First Named Inventor	Mattaway et al.
	Patent Under Re-Exam	6009469
	Issue Date	1999/12/28
	Group Art Unit	3992
	Examiner Name	KOSOWSKI, ALEXANDER J
	Attorney Docket No.	2655-0185
	Confirmation No.	6565

NON-PATENT REFERENCES			
Examiner Initials*	Cite No.	Non-patent Reference bibliographic information, where available	Notes
	25-1	M.J. Ross "Alternatives for Integrating Voice and Data", 1981 International Switching Symposium, ISS' 81 CIC Montreal, September 21-25, 1981	
	25-2	Natesa Janakiraman "An Overview of Recent Developments in the Designs and Applications of Customer Premises Switches", IEEE Communications Magazine, October 1985, Vol. 23, No. 10, pages 32-45	
	25-3	P. Borgnis-Desbordes, et al. "Variable-Speed Data Transmission", IBM Technical Disclosure Bulletin, Vol. 27, No. 4A, September 1984, pages 2269-2270	
	25-4	P. Venkat Rangan and Daniel C. Swinehart, "Software Architecture for Integration of Video Services in the Etherphone System", IEEE Journal on Selected Areas in Communication, Vol. 9, No. 9, December 1991, pages 1395-1404	
	25-5	Paul Francis, "Comparison of Geographical and Provider-rooted Internet Addressing," Computer Networks and ISDN Systems 27(3)437-448, 1994 (selected paper from INET 94/JENC 5)	
	25-6	Paul Gilster, "Internet Navigator", Maruzen Kabushiki-Kaisha (1st Ed.), pgs. 473-476, Feb. 28, 1995 (with translation and SOR)	
	25-7	Paul Tsuchiya, Tony Eng, "Extending the IP Internet Through Address Reuse," ACM SIGCOMM Computer Communications Review, 23(1):16-33, Jan. 1993	

Examiner Signature		Date Considered	
--------------------	--	-----------------	--

*Examiner: Initial if reference was considered, whether or not citation is in conformance with MPEP 609. Draw a line through citation if not in conformance and not considered. Include a copy of this form with next communication to applicant. Notes: If identified, the following is provided: EA = English Abstract, T = Translation, PF = Patent Family.

INFORMATION DISCLOSURE STATEMENT BY APPLICANT FORM PTO-1449 (modified)	Reexam number	90/010,422
	First Named Inventor	Mattaway et al.
	Patent Under Re-Exam	6009469
	Issue Date	1999/12/28
	Group Art Unit	3992
	Examiner Name	KOSOWSKI, ALEXANDER J
	Attorney Docket No.	2655-0185
	Confirmation No.	6565
Sheet 26 of 29		

NON-PATENT REFERENCES			
Examiner Initials*	Cite No.	Non-patent Reference bibliographic information, where available	Notes
	26-1	Philip H. Reagan, "Is it the PBX or is it the LAN?", Datamation, The Telecom Manager Emerges, 03/1984, Volume 30 Number 3, pages 3-4, 147, 148, 150	
	26-2	Polle T. Zellweger et al., "An Overview of the Etherphone System and its Applications", 2nd IEEE Conference on Computer Workstations, March 7-10, 1988, pages 160-168	
	26-3	R. BRAUDES et al., "Requirements for Multicast Protocols", Request for Comments 1458, Network Working Group, May 1993, pp. 1-19.	
	26-4	R. W. Meba, et al. "Experiments in Wideband Packet Technology", Digital Communications - New Directions in Switching and Networks, Proceedings of the International Seminar, Zurich, Switzerland, March 11-13, 1986, pages 135-139	
	26-5	R.P. McNamara, "Some Considerations of the Voice-Data Capabilities of Broadband Cable Networks", IEEE Digest of Papers Spring CompCon 82, February 22-25, 1982, pages 312-314	
	26-6	Randy Cole "Packet Voice: When It Makes Sense", Speech Technology, September/October 1982, pages 52-61.	
	26-7	Scott FLINN, "Coordinating Heterogeneous Time-Based Media Between Independent Applications" ACM Multimedia 95 - Electronic Proceedings November 5-9, 1995, pages 1-16.	

Examiner Signature		Date Considered	
--------------------	--	-----------------	--

*Examiner: Initial if reference was considered, whether or not citation is in conformance with MPEP 609. Draw a line through citation if not in conformance and not considered. Include a copy of this form with next communication to applicant. Notes: If identified, the following is provided: EA = English Abstract, T = Translation, PF = Patent Family.

INFORMATION DISCLOSURE STATEMENT BY APPLICANT FORM PTO-1449 (modified) Sheet 27 of 29	Reexam number	90/010,422
	First Named Inventor	Mattaway et al.
	Patent Under Re-Exam	6009469
	Issue Date	1999/12/28
	Group Art Unit	3992
	Examiner Name	KOSOWSKI, ALEXANDER J
	Attorney Docket No.	2655-0185
	Confirmation No.	6565

NON-PATENT REFERENCES			
Examiner Initials*	Cite No.	Non-patent Reference bibliographic information, where available	Notes
	27-1	Shimmi Hattori et al., "Integrated Digital Switching System with Queueing Storage Facility", IEEE Transactions on Communications, Vol. Com-30, No. 8, August 1982, pages 1900-1905, (ISSN 0090-6778)	
	27-2	Steve Oltmanns, et al. "A Voice and Communications System for the IBM PC", Speech Technology, March/April 1986, pages 94-99	
	27-3	Stuart CHESHIRE et al., "Internet Mobility 4x4", www.acm.org, 1996, pages 1-12.	
	27-4	Susan Angebrannt et al., "Integrating Audio and Telephony in a Distributed Workstation Environment", Proceedings of the Summer 1991 USENIX Conference, June 10-14, 1991, Nashville, Tennessee, pages 419-435	
	27-5	T. Kamae "Visual Terminals and User Interfaces", FGCS North-Holland, pages 257-278	
	27-6	T. Kamae "Voice/Data Integration in the INS Model System and Local Area Networks" IEEE Communications Magazine, December 1986, Vol. 24, No. 12, pages 7-15	
	27-7	T7540 Digital Telephone Codec, AT&T Microelectronics, January 1991, pages 1-62 and Data Sheet Addendum, July 1991, 4 pages	

Examiner Signature		Date Considered	
--------------------	--	-----------------	--

*Examiner: Initial if reference was considered, whether or not citation is in conformance with MPEP 609. Draw a line through citation if not in conformance and not considered. Include a copy of this form with next communication to applicant. Notes: If identified, the following is provided: EA = English Abstract, T = Translation, PF = Patent Family.

**INFORMATION DISCLOSURE
STATEMENT BY APPLICANT**
FORM PTO-1449 (modified)

Sheet 28 of 29

Reexam number	90/010,422
First Named Inventor	Mattaway et al.
Patent Under Re-Exam	6009469
Issue Date	1999/12/28
Group Art Unit	3992
Examiner Name	KOSOWSKI, ALEXANDER J
Attorney Docket No.	2655-0185
Confirmation No.	6565

NON-PATENT REFERENCES

Examiner Initials*	Cite No.	Non-patent Reference bibliographic information, where available	Notes
	28-1	Takashi Yamada, et al. "New Technologies - Multimedia High-throughput X.25 Packet Switching System", NTT Review, Vol. 1, No. 2, July 1989, pages 82-88	
	28-2	talk (software) description from WikiPedia	
	28-3	Tamohiro Kawai, Nikkei Communications, No. 202, pgs 29-30, Nikkei BP, July 17, 1995 ("Communication software appears on the Internet") (w/ SOR)	
	28-4	Theodore Bially, et al. "Voice Communication in Integrated Digital Voice and Data Networks", IEEE Transactions on Communications, Vol. Com-28, No. 9, September 1980, pages 1478-1490	
	28-5	Toru Tsuda, et al. "An Approach to Multi-Service Subscriber Loop System Using Packetized Voice/Data Terminals" ISSLS '78, The International Symposium on Subscriber Loops and Services, March 20-24, 1978, Atlanta, Georgia, Conference Record, pages 161-165	
	28-6	Translation of Japanese Kokai H07-129488 (published May 19, 1995)	
	28-7	U.S. Reexam Control No. 90/010,416 - 2009-08-27 PTO Office Action	

Examiner Signature		Date Considered	
--------------------	--	-----------------	--

*Examiner: Initial if reference was considered, whether or not citation is in conformance with MPEP 609. Draw a line through citation if not in conformance and not considered. Include a copy of this form with next communication to applicant. Notes: If identified, the following is provided: EA = English Abstract, T = Translation, PF = Patent Family.

INFORMATION DISCLOSURE STATEMENT BY APPLICANT FORM PTO-1449 (modified) Sheet 29 of 29	Reexam number	90/010,422
	First Named Inventor	Mattaway et al.
	Patent Under Re-Exam	6009469
	Issue Date	1999/12/28
	Group Art Unit	3992
	Examiner Name	KOSOWSKI, ALEXANDER J
	Attorney Docket No.	2655-0185
	Confirmation No.	6565

NON-PATENT REFERENCES			
Examiner Initials*	Cite No.	Non-patent Reference bibliographic information, where available	Notes
	29-1	U.S. Reexam Control No. 90/010,421 - 2009-08-14 PTO Office Action	
	29-2	U.S. Reexam Control No. 90/010,424 - 2009-08-25 PTO Office Action	
	29-3	V. Jacobson, et al. "TCP Extension for High-Speed Paths", Request for Comments 1185, ftp://ftp.isi.edu/in-notes/rfc1185.txt, October 1990, pages 1-21	
	29-4	V. Jacobson, et al. "TCP Extensions for High Performance", Request for Comments 1323, ftp://ftp.isi.edu/in-notes/rfc1323.txt, May 1992, pages 1-37	
	29-5	Vinton G. Cerf, "Packet Satellite Technology Reference Sources", Request for Comments 829, November 1982, http://www.cis.ohio-state.edu/htbin/rfc/rfc829.html, pages 1-5	
	29-6	VocalTec Internet Phone (TM) Version 2.5 Readme, VocalTec Ltd., 02/1995, 5 pages.	
	29-7	Written Opinion issued February 12, 1998 in corresponding International Application Serial No. PCT/US96/15504.	

Examiner Signature		Date Considered	
--------------------	--	-----------------	--

*Examiner: Initial if reference was considered, whether or not citation is in conformance with MPEP 609. Draw a line through citation if not in conformance and not considered. Include a copy of this form with next communication to applicant. Notes: If identified, the following is provided: EA = English Abstract, T = Translation, PF = Patent Family.

(12) PATENT APPLICATION
(19) AUSTRALIAN PATENT OFFICE

(11) Application No. AU 200059377 A1

(54) Title
Point-to-point Internet protocol

(51)⁷ International Patent Classification(s)
H04L 029/00

(21) Application No: 200059377

(22) Application Date: 2000.09.13

(43) Publication Date : 2000.11.23

(43) Publication Journal Date : 2000.11.23

(62) Divisional of:
199672476

(71) Applicant(s)
NetSpeak Corporation

(72) Inventor(s)
Glenn W Hutton; Shane D Mattaway; Craig B Strickland

(74) Agent/Attorney
DAVIES COLLISON CAVE, 1 Little Collins Street, MELBOURNE VIC 3000

Abstract

An apparatus for establishing a point-to-point communication link, the apparatus operating in a computer system operatively coupled to another computer system and a server over a computer network, the apparatus comprising
5 means for transmitting an E-mail signal containing a network protocol address from a first process to a second process over the computer network, means for receiving a second network protocol address from the second process over the computer network, and means, responsive to the second network protocol
10 address, for establishing a point-to-point communication link between the first process and the second process over the computer network.



13 00 00 59377

1/6

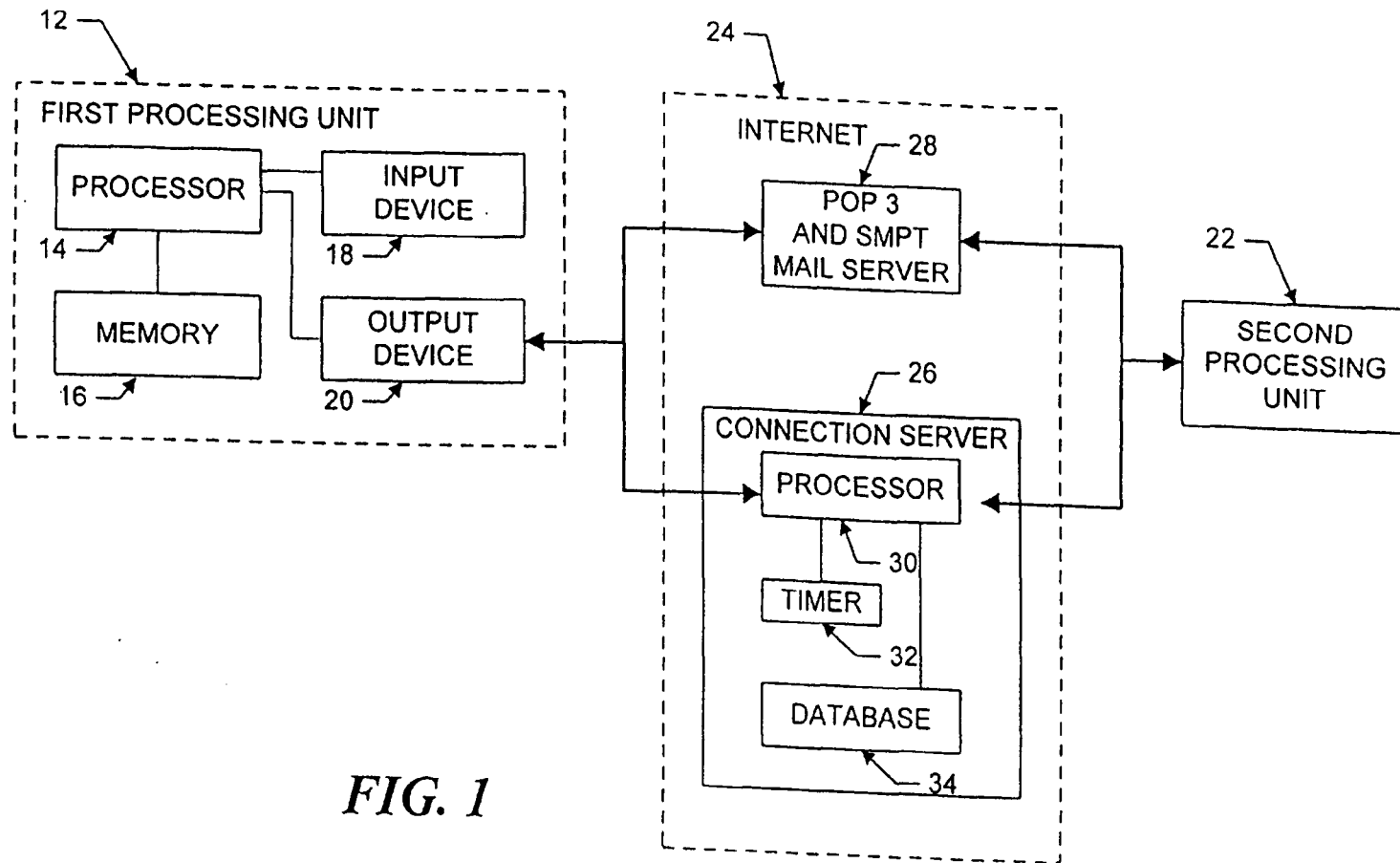
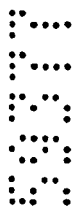

FIG. 1

A U S T R A L I A
Patents Act 1990
COMPLETE SPECIFICATION
STANDARD PATENT
(ORIGINAL)



Name of Applicant: **NetSpeak Corporation**, of 902 Clint Moore Road, Suite 104, Boca Raton, Florida 33487, United States of America.

Actual Inventors: **HUTTON, Glenn W**
MATTAWAY, Shane D
STRICKLAND, Craig B

Address for Service: **DAVIES COLLISON CAVE**, Patent Attorneys, of 1 Little Collins Street, Melbourne, Victoria 3000, Australia.

Invention Title: **"Point-to-Point Internet Protocol"**

The following statement is a full description of this invention, including the best method of performing it known to us:

POINT-TO-POINT INTERNET PROTOCOL

The present invention relates, in general, to data processing systems, and more specifically, to a method and apparatus for facilitating audio communications over computer networks.

5

The increased popularity of on-line services such as AMERICA ONLINE™, COMPUSERVE®, and other services such as Internet gateways have spurred applications to provide multimedia, including video and voice clips, to online users. An example of an online voice clip application is VOICE E-MAIL FOR WINCIM and VOICE E-MAIL FOR AMERICA ONLINE™, available from Bonzi Software, as described in "Simple Utilities Send Voice E-Mail Online", MULTIMEDIA WORLD, VOL. 2, NO. 9, August 1995, p. 52. Using such Voice E-Mail software, a user may create an audio message to be sent to a predetermined E-mail address specified by the user.

Generally, devices interfacing to the Internet and other online services may communicate with each other upon establishing respective device addresses. One type of device address is the Internet Protocol (IP) address, which acts as a pointer to the device associated with the IP address. A typical device may have a Serial Line Internet Protocol or Point-to-Point Protocol (SLIP/PPP) account with a permanent IP address for receiving E-mail, voicemail, and the like over the Internet. E-mail and voicemail is generally intended to convey text, audio, etc., with any routing information such as an IP address and routing headers generally

being considered an artifact of the communication, or even gibberish to the recipient.

Devices such as a host computer or server of a company may include multiple modems for connection of users to the Internet, with a temporary IP address allocated to each user. For example, the host computer may have a general IP address "XXX.XXX.XXX," and each user may be allocated a successive IP address of XXX.XXX.XXX.10, XXX.XXX.XXX.11, XXX.XXX.XXX.12, etc. Such temporary IP addresses may be reassigned or recycled to the users, for example, as each user is successively connected to an outside party. For example, a host computer of a company may support a maximum of 254 IP addresses which are pooled and shared between devices connected to the host computer.

Permanent IP addresses of users and devices accessing the Internet readily support point-to-point communications of voice and video signals over the Internet. For example, realtime video teleconferencing has been implemented using dedicated IP addresses and mechanisms known as reflectors.

A technique for matching domain names to Internet Protocol addresses is described in the text entitled "Internetworking With TCP/IP", 2nd Edition, by Douglas E. Comer, November 1992, Prentice Hall, Englewood Cliffs, New Jersey, U.S.A. Comer describes a domain name system and cooperative systems of name servers for matching domain names to network addresses. Each name server is a server program that supplies mapping of domain names to IP addresses. The system described in Comer, however, is not designed for use with network nodes whose network names or name to address bindings change frequently.

International Publication WO 92/19054 discloses a network

monitoring system including an address tracking module which uses passive monitoring of all packet communications over a local area network to maintain a name table of IP address mappings. The disclosed address tracking module is capable of monitoring only a small number of nodes on a local area network and is
5 not suitable for use with a multitude of nodes over a wide area network.

None of the above-described systems are suitable for use with processes which have dynamically assigned network protocol addresses and which are communicating over wide area or global networks.

Due to the dynamic nature of temporary IP addresses of some devices
10 accessing the Internet, point-to-point communications in realtime of voice and video have been generally difficult to attain.

In accordance with the present invention, there is provided an apparatus for establishing a point-to-point communication link, said apparatus operating in a computer system operatively coupled to another computer system and a server
15 over a computer network, said apparatus comprising:

- a. means for transmitting an E-mail signal containing a network protocol address from a first process to a second process over the computer network;
- b. means for receiving a second network protocol address from the second process over the computer network; and
- 20 c. means, responsive to the second network protocol address, for establishing a point-to-point communication link between the first process and the second process over the computer network.

The present invention also provides a method of establishing a point-to-point communication between a first process and a second process, said method
25 for use in a first computer process operatively coupled over a computer network to a second process and a mail server process, said method comprising:

- a. transmitting an E-mail signal to the mail server process over the computer network, the E-mail signal containing a first network protocol address assigned to the first process upon connection to the computer network;

b. receiving a second network protocol address from the second process over the computer network, the second network protocol address assigned to the second process upon connection to the computer network; and

c. establishing a point-to-point communication link between the first
5 process and the second process over the computer network, in response to receiving the second network protocol address.

The present invention also provides an apparatus for establishing a point-to-point communication link, said apparatus operating in a computer system operatively connectable to other processes and a server process over a computer
10 network, said apparatus comprising:

a. program logic configured to transmit an E-mail signal containing a network protocol address from a first process to a second process over the computer network;

b. program logic configured to receive a second network protocol
15 address from the second process over the computer network; and

c. program logic, responsive to the second network protocol address, and configured to establish a point-to-point communication link between the first process and the second process over the computer network.

The present invention also provides a computer program product for use
20 with a computer system, the computer system capable of executing a first process and operatively connectable to a second process and a server over a computer network, the computer program product comprising a computer useable medium having program code embodied in the medium, the program code further comprising:

25 program code for transmitting an E-mail signal comprising a network protocol address of the first process to the second processor over the computer network;

program code for receiving a second network protocol address from the second process over the computer network; and

30 program code, responsive to the second network protocol address, for establishing a point-to-point communication link between the first process and the

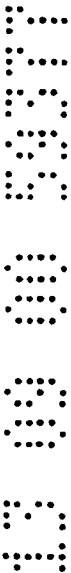

second process over the computer network.

The present invention also provides a method of establishing a point-to-point communication between a first process and second process, said method for use in a first computer process operatively coupled over a computer network to a second process and an E-mail server, said method comprising the steps of:

- A. transmitting to the second process over the computer network an E-mail signal comprising a network protocol address of the first process;
- B. receiving from the second process over the computer network a second network protocol address; and
- 10 C. in response to the second network protocol address, establishing a point-to-point communication link between the first process and the second process over the computer network.

Preferred embodiments of the present invention are hereinafter described, by way of example only, with reference to the following drawings, wherein:

FIG 1 illustrates, in block diagram format, a system for the disclosed point-to-point Internet protocol:

FIG 2 illustrates, in block diagram format, the system using a secondary point-to-point Internet protocol;

20 FIG 3 illustrates, in block diagram format; the system of FIGS 1-2 with the point-to-point Internet protocol established;

FIG 4 is another block diagram of the system of FIGS 1-2 with audio communications being conducted;

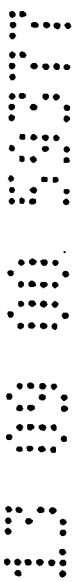

FIG. 5 illustrates a display screen for a processing unit;

FIG. 6 illustrates another display screen for a processing unit;

FIG. 7 illustrates a flowchart of the initiation of the point-to-point Internet protocols;

5 FIG. 8 illustrates a flowchart of the performance of the primary point-to-point Internet protocols; and

 FIG. 9 illustrates a flowchart of the performance of the secondary point-to-point Internet protocol.

5
6
7
8
9
10
11
12
13
14

Referring now in specific detail to the drawings, with like reference numerals identifying similar or identical elements, as shown in FIG. 1, the present disclosure describes a point-to-point network protocol and system
 5 10 for using such a protocol.

In an exemplary embodiment, the system 10 includes a first processing unit 12 for sending at least a voice signal from a first user to a second user. The first processing unit 12 includes a processor 14, a memory 16, an input device 18, and an output device 20. The output device 20 includes at least one modem capable of, for example, 14.4 kbaud communications and operatively connected via wired and/or wireless communication connections to the Internet or other computer networks such as an Intranet, i.e., a private computer network. One skilled in the art would understand that the input device 18 may be implemented at least in part by the modem of the output device 20 to allow input signals from the communication connections to be received. The second processing unit 22 may have a processor, memory, and input and output devices, including at least one modem and associated communication connections, as described above for the first processing unit 12. In an exemplary embodiment, each of the processing units 12, 22 may execute the WEBPHONE™ Internet telephony application available from NetSpeak Corporation, Boca Raton, FL, which is capable of performing the disclosed point-to-point Internet protocol and system 10, as described herein.

25 The first processing unit 12 and the second processing unit 22 are operatively connected to the Internet 24 by communication devices and software known in the art, such as an Internet Service Provider (ISP) or an Internet gateway. The processing units 12, 22 may be operatively interconnected through the Internet 24 to a connection server 26, and

may also be operatively connected to a mail server 28 associated with the Internet 24.

The connection server 26 includes a processor 30, a timer 32 for generating time stamps, and a memory such as a database 34 for storing, for example, E-mail and Internet Protocol (IP) addresses of logged-in units. In an exemplary embodiment, the connection server 26 may be a SPARC 5 server or a SPARC 20 server, available from SUN MICROSYSTEMS, INC., Mountain View, CA, having a central processing unit (CPU) as processor 30, an operating system (OS) such as UNIX, for providing timing operations such as maintaining the timer 32, a hard drive or fixed drive, as well as dynamic random access memory (DRAM) for storing the database 34, and a keyboard and display and/or other input and output devices (not shown in FIG. 1). The database 34 may be an SQL database available from ORACLE or INFORMIX.

In an exemplary embodiment, the mail server 28 may be a Post Office Protocol (POP) Version 3 mail server including a processor, memory, and stored programs operating in a UNIX environment, or, alternatively, another OS, to process E-mail capabilities between processing units and devices over the Internet 24.

The first processing unit 12 may operate the disclosed point-to-point Internet protocol by a computer program described hereinbelow in conjunction with FIG. 6, which may be implemented from compiled and/or interpreted source code in the C++ programming language and which may be downloaded to the first processing unit 12 from an external computer. The operating computer program may be stored in the memory 16, which may include about 8 MB RAM and/or a hard or fixed drive having about 8 MB. Alternatively, the source code may be implemented in the first processing unit 12 as firmware, as an erasable read only memory (EPROM), etc. It is understood that one skilled in the

art would be able to use programming languages other than C++ to implement the disclosed point-to-point network protocol and system 10.

The processor 14 receives input commands and data from a first user associated with the first processing unit 12 through the input device 18, which may be an input port connected by a wired, optical, or a wireless connection for electromagnetic transmissions, or alternatively may be transferable storage media, such as floppy disks, magnetic tapes, compact disks, or other storage media including the input data from the first user.

The input device 18 may include a user interface (not shown) having, for example, at least one button actuated by the user to input commands to select from a plurality of operating modes to operate the first processing unit 12. In alternative embodiments, the input device 18 may include a keyboard, a mouse, a touch screen, and/or a data reading device such as a disk drive for receiving the input data from input data files stored in storage media such as a floppy disk or, for example, an 8 mm storage tape. The input device 18 may alternatively include connections to other computer systems to receive the input commands and data therefrom.

The first processing unit 12 may include a visual interface for use in conjunction with the input device 18 and output device 20 similar to those screens illustrated in FIGS. 5-6, discussed below. It is also understood that alternative devices may be used to receive commands and data from the user, such as keyboards, mouse devices, and graphical user interfaces (GUI) such as WINDOWS™ 3.1 available from MICROSOFT Corporation, Redmond, WA., and other operating systems and GUIs, such as OS/2 and OS/2 WARP, available from IBM CORPORATION, Boca Raton, FL. Processing unit 12 may also include microphones and/or telephone handsets for receiving audio voice data

and commands, speech or voice recognition devices, dual tone multi-frequency (DTMF) based devices, and/or software known in the art to accept voice data and commands and to operate the first processing unit 12.

5 In addition, either of the first processing unit 12 and the second processing unit 22 may be implemented in a personal digital assistant (PDA) providing modem and E-mail capabilities and Internet access, with the PDA providing the input/output screens for mouse interactions or for touchscreen activation as shown, for example, in FIGS. 5-6, as a
10 combination of the input device 18 and output device 20.

For clarity of explanation, the illustrative embodiment of the disclosed point-to-point Internet protocol and system 10 is presented as having individual functional blocks, which may include functional blocks labeled as "processor" and "processing unit". The functions represented by these blocks may be provided through the use of either shared or dedicated hardware, including, but not limited to, hardware capable of executing software. For example, the functions of each of the processors and processing units presented herein may be provided by a shared processor or by a plurality of individual processors. Moreover, the use of the functional blocks with accompanying labels herein is not to be construed to refer exclusively to hardware capable of executing software. Illustrative embodiments may include digital signal processor (DSP) hardware, such as the AT&T DSP16 or DSP32C, read-only memory (ROM) for storing software performing the operations discussed below, and random access memory (RAM) for storing DSP results. Very large scale integration (VLSI) hardware embodiments, as well as custom VLSI circuitry in combination with a general purpose DSP circuit, may also be provided. Any and all of these embodiments may be deemed to fail within the meaning of the labels for the functional blocks as used herein.

15
20
25

The processing units 12, 22 are capable of placing calls and connecting to other processing units connected to the Internet 24, for example, via dialup SLIP/PPP lines. In an exemplary embodiment, each processing unit assigns an unsigned long session number, for example, a 32-bit long sequence in a *.ini file for each call. Each call may be assigned a successive session number in sequence, which may be used by the respective processing unit to associate the call with one of the SLIP/PPP lines, to associate a <ConnectOK> response signal with a <Connect Request> signal, and to allow for multiplexing and demultiplexing of inbound and outbound conversations on conference lines, as explained hereinafter.

For callee (or called) processing units with fixed IP addresses, the caller (or calling) processing unit may open a "socket", i.e. a file handle or address indicating where data is to be sent, and transmit a <Call> command to establish communication with the callee utilizing, for example, datagram services such as Internet Standard network layering as well as transport layering, which may include a Transport Control Protocol (TCP) or a User Datagram Protocol (UDP) on top of the IP. Typically, a processing unit having a fixed IP address may maintain at least one open socket and a called processing unit waits for a <Call> command to assign the open socket to the incoming signal. If all lines are in use, the callee processing unit sends a BUSY signal or message to the callee processing unit. As shown in FIG. 1, the disclosed point-to-point Internet protocol and system 10 operate when a callee processing unit does not have a fixed or predetermined IP address. In the exemplary embodiment and without loss of generality, the first processing unit 12 is the caller processing unit and the second processing unit 22 is the called processing unit. When either of processing units 12, 22 logs on to the Internet via a dial-up connection, the respective unit is provided a

dynamically allocated IP address by the a connection service provider.

Upon the first user initiating the point-to-point Internet protocol when the first user is logged on to the Internet 24, the first processing unit 12 automatically transmits its associated E-mail address and its dynamically allocated IP address to the connection server 26. The connection server 26 then stores these addresses in the database 34 and time stamps the stored addresses using timer 32. The first user operating the first processing unit 12 is thus established in the database 34 as an active on-line party available for communication using the disclosed point-to-point Internet protocol. Similarly, a second user operating the second processing unit 22, upon connection to the Internet 24 through the a connection service provider, is processed by the connection server 26 to be established in the database 34 as an active on-line party.

The connection server 26 may use the time stamps to update the status of each processing unit; for example, after 2 hours, so that the on-line status information stored in the database 34 is relatively current. Other predetermined time periods, such as a default value of 24 hours, may be configured by a systems operator.

The first user with the first processing unit 12 initiates a call using, for example, a Send command and/or a command to speeddial an NTH stored number, which may be labeled [SND] and [SPD] [N], respectively, by the input device 18 and/or the output device 20, such as shown in FIGS. 5-6. In response to either the Send or speeddial commands, the first processing unit 12 retrieves from memory 16 a stored E-mail address of the callee corresponding to the NTH stored number. Alternatively, the first user may directly enter the E-mail address of the callee.

The first processing unit 12 then sends a query, including the E-mail address of the callee, to the connection server 26. The connection

server 26 then searches the database 34 to determine whether the callee is logged-in by finding any stored information corresponding to the callee's E-mail address indicating that the callee is active and on-line. If the callee is active and on-line, the connection server 26 then performs the primary point-to-point Internet protocol; i.e. the IP address of the callee is retrieved from the database 34 and sent to the first processing unit 12. The first processing unit 12 may then directly establish the point-to-point Internet communications with the callee using the IP address of the callee.

10 If the callee is not on-line when the connection server 26 determines the callee's status, the connection server 26 sends an OFF-LINE signal or message to the first processing unit 12. The first processing unit 12 may also display a message such as "Called Party Off-Line" to the first user.

15 When a user logs off or goes off-line from the Internet 24, the connection server 26 updates the status of the user in the database 34; for example, by removing the user's information, or by flagging the user as being off-line. The connection server 26 may be instructed to update the user's information in the database 34 by an off-line message, such as a data packet, sent automatically from the processing unit of the user prior to being disconnected from the connection server 26. Accordingly, an off-line user is effectively disabled from making and/or receiving point-to-point Internet communications.

20 As shown in FIGS. 2-4, the disclosed secondary point-to-point Internet protocol may be used as an alternative to the primary point-to-point Internet protocol described above, for example, if the connection server 26 is non-responsive, inoperative, and/or unable to perform the primary point-to-point Internet protocol, as a non-responsive condition. Alternatively, the disclosed secondary point-to-point Internet protocol may

be used independent of the primary point-to-point Internet protocol. In the disclosed secondary point-to-point Internet protocol, the first processing unit 12 sends a <ConnectRequest> message via E-mail over the Internet 24 to the mail server 28. The E-mail including the

5 <ConnectRequest> message may have, for example, the subject

[*wp#XXXXXXXXX#nnn.nnn.nnn.#emailAddr]

where nnn.nnn.nnn.nnn. is the current (i.e. temporary or permanent) IP address of the first user, and XXXXXXXX is a session number, which may be unique and associated with the request of the first user to initiate

10 point-to-point communication with the second user.

As described above, the first processing unit 12 may send the <ConnectRequest> message in response to an unsuccessful attempt to perform the primary point-to-point Internet protocol. Alternatively, the first processing unit 12 may send the <ConnectRequest> message in response to the first user initiating a SEND command or the like.

After the <ConnectRequest> message via E-mail is sent, the first processing unit 12 opens a socket and waits to detect a response from the second processing unit 22. A timeout timer, such as timer 32, may be set by the first processing unit 12, in a manner known in the art, to wait for a predetermined duration to receive a <ConnectOK> signal. The processor 14 of the first processing unit 12 may cause the output device 20 to output a Ring signal to the user, such as an audible ringing sound, about every 3 seconds. For example, the processor 14 may output a *.wav file, which may be labeled RING.WAV, which is processed by the output device 20 to output an audible ringing sound.

The mail server 28 then polls the second processing unit 22, for example, every 3-5 seconds, to deliver the E-mail. Generally, the second processing unit 22 checks the incoming lines, for example, at regular intervals to wait for and to detect incoming E-mail from the mail server 28

through the Internet 24.

Typically, for sending E-mail to users having associated processing units operatively connected to a host computer or server operating an Internet gateway, E-mail for a specific user may be sent over the Internet 24 and directed to the permanent IP address or the SLIP/PPP account designation of the host computer, which then assigns a temporary IP address to the processing unit of the specified user for properly routing the E-mail. The E-mail signal may include a name or other designation such as a user name which identifies the specific user regardless of the processing unit assigned to the user; that is, the host computer may track and store the specific device where a specific user is assigned or logged on, independent of the IP address system, and so the host computer may switch the E-mail signal to the device of the specific user. At that time, a temporary IP address may be generated or assigned to the specific user and device.

Upon detecting and/or receiving the incoming E-mail signal from the first processing unit 12, the second processing unit 22 may assign or may be assigned a temporary IP address. Therefore, the delivery of the E-mail through the Internet 24 provides the second processing unit 22 with a session number as well as IP addresses of both the first processing unit 12 and the second processing unit 22.

Point-to-point communication may then be established by the processing unit 22 processing the E-mail signal to extract the <ConnectRequest> message, including the IP address of the first processing unit 12 and the session number. The second processing unit 22 may then open a socket and generate a <ConnectOK> response signal, which includes the temporary IP address of the second processing unit 22 as well as the session number of the first processing unit.

The second processing unit 22 sends the <ConnectOK> signal

directly over the Internet 24 to the IP address of the first processing unit 12 without processing by the mail server 28, and a timeout timer of the second processing unit 22 may be set to wait and detect a <Call> signal expected from the first processing unit 12.

5 Realtime point-to-point communication of audio signals over the Internet 24, as well as video and voicemail, may thus be established and supported without requiring permanent IP addresses to be assigned to either of the users or processing units 12, 22. For the duration of the realtime point-to-point link, the relative permanence of the current IP
10 addresses of the processing units 12, 22 is sufficient, whether the current IP addresses were permanent (i.e. predetermined or preassigned) or temporary (i.e. assigned upon initiation of the point-to-point communication).

In the exemplary embodiment, a first user operating the first
15 processing unit 12 is not required to be notified by the first processing unit 12 that an E-mail is being generated and sent to establish the point-to-point link with the second user at the second processing unit 22.

Similarly, the second user is not required to be notified by the second
processing unit 22 that an E-mail has been received and/or a temporary

20 IP address is associated with the second processing unit 22. The processing units 12, 22 may perform the disclosed point-to-point Internet protocol automatically upon initiation of the point-to-point communication command by the first user without displaying the E-mail interactions to either user. Accordingly, the disclosed point-to-point Internet protocol
25 may be transparent to the users. Alternatively, either of the first and second users may receive, for example, a brief message of "CONNECTION IN PROGRESS" or the like on a display of the respective output device of the processing units 12, 22.

After the initiation of either the primary or the secondary point-to-

point Internet protocols described above in conjunction with FIGS. 1-2, the point-to-point communication link over the Internet 24 may be established as shown in FIGS. 3-4 in a manner known in the art. For example, referring to FIG. 3, upon receiving the <ConnectorOK> signal from the second processing unit 22, the first processing unit 12 extracts the IP address of the second processing unit 22 and the session number, and the session number sent from the second processing unit 22 is then checked with the session number originally sent from the first processing unit 12 in the <ConnectRequest> message as E-mail. If the session numbers sent and received by the processing unit 12 match, then the first processing unit 12 sends a <Call> signal directly over the Internet 24 to the second processing unit 22; i.e. using the IP address of the second processing unit 22 provided to the first processing unit 12 in the <ConnectOK> signal.

Upon receiving the <Call> signal, the second processing unit 22 may then begin a ring sequence, for example, by indicating or annunciating to the second user that an incoming call is being received. For example, the word "CALL" may be displayed on the output device of the second processing unit 22. The second user may then activate the second processing unit 22 to receive the incoming call.

Referring to FIG. 4, after the second processing unit 22 receives the incoming call, realtime audio and/or video conversations may be conducted in a manner known in the art between the first and second users through the Internet 24, for example, by compressed digital audio signals. Each of the processing units 12, 22 also display to each respective user the words "IN USE" to indicate that the point-to-point communication link is established and audio or video signals are being transmitted.

In addition, either user may terminate the point-to-point

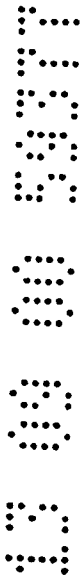

communication link by, for example, activating a termination command, such as by activating an [END] button or icon on a respective processing unit, causing the respective processing unit to send an <End> signal which causes both processing units to terminate the respective sockets, as well as to perform other cleanup commands and functions known in the art.

FIGS. 5-6 illustrate examples of display screens 36 which may be output by a respective output device of each processing unit 12, 22 of FIGS. 1-4 for providing the disclosed point-to-point Internet protocol and system 10. Such display screens may be displayed on a display of a personal computer (PC) or a PDA in a manner known in the art.

As shown in FIG. 5, a first display screen 36 includes a status area 38 for indicating, for example, a called user by name and/or by IP address or telephone number; a current function such as C2; a current time; a current operating status such as "IN USE", and other control icons such as a down arrow icon 40 for scrolling down a list of parties on a current conference line. The operating status may include such annunciators as "IN USE," "IDLE," "BUSY," "NO ANSWER," "OFFLINE," "CALL," "DIALING," "MESSAGES," and "SPEEDDIAL."

Other areas of the display screen 36 may include activation areas or icons for actuating commands or entering data. For example, the display screen 36 may include a set of icons 42 arranged in columns and rows including digits 0-9 and commands such as END, SND, HLD, etc. For example, the END and SND commands may be initiated as described above, and the HLD icon 44 may be actuated to place a current line on hold. Such icons may also be configured to substantially simulate a telephone handset or a cellular telephone interface to facilitate ease of use, as well as to simulate function keys of a keyboard. For example, icons labeled L1-L4 may be mapped to function keys F1-F4 on standard

PC keyboards, and icons C1-C3 may be mapped to perform as combinations of function keys, such as CTRL-F1, CTRL-F2, and CTRL-F3, respectively. In addition, the icons labeled L1-L4 and C1-C3 may include circular regions which may simulate light emitting diodes (LEDs) which indicate that the function or element represented by the respective icon is active or being performed.

Icons L1-L4 may represent each of 4 lines available to the caller, and icons C1-C3 may represent conference calls using at least one line to connect, for example, two or more parties in a conference call. The icons L1-L4 and C1-C3 may indicate the activity of each respective line or conference line. For example, as illustrated in FIG. 5, icons L1-L2 may have lightly shaded or colored circles, such as a green circle, indicating that each of lines 1 and 2 are in use, while icons L3-L4 may have darkly shaded or color circles, such as a red or black circle, indicating that each of lines 3 and 4 are not in use. Similarly, the lightly shaded circle of the icon labeled C2 indicates that the function corresponding to C2 is active, as additionally indicated in the status area 38, while darkly shaded circles of icons labeled C1 and C3 indicate that such corresponding functions are not active.

The icons 42 are used in conjunction with the status area 38. For example, using a mouse for input, a line that is in use, as indicated by the lightly colored circle of the icon, may be activated to indicate a party's name by clicking a right mouse button for 5 seconds until another mouse click is actuated or the [ESC] key or icon is actuated. Thus, the user may switch between multiple calls in progress on respective lines.

Using the icons as well as an input device such as a mouse, a user may enter the name or alias or IP address, if known, of a party to be called by either manually entering the name, by using the speedial feature, or by double clicking on an entry in a directory stored in the

memory, such as the memory 16 of the first processing unit 12, where the directory entries may be scrolled using the status area 38 and the down arrow icon 40.

5 Once a called party is listed in the status area 38 as being active on a line, the user may transfer the called party to another line or a conference line by clicking and dragging the status area 38, which is represented by a reduced icon 46. Dragging the reduced icon 46 to any one of line icons L1-L4 transfers the called party in use to the selected line, and dragging the reduced icon 46 to any one of conference line icons C1-C3 adds the called party to the selected conference call.

10 Other features may be supported, such as icons 48-52, where icon 48 corresponds to, for example, an ALT-X command to exit the communication facility of a processing unit, and icon 50 corresponds to, for example, an ALT-M command to minimize or maximize the display screen 36 by the output device of the processing unit. Icon 52 corresponds to an OPEN command, which may, for example, correspond to pressing the O key on a keyboard, to expand or contract the display screen 36 to represent the opening and closing of a cellular telephone. An "opened" configuration is shown in FIG. 5, and a "closed" configuration is shown in FIG. 6. In the "opened" configuration, additional features such as output volume (VOL) controls, input microphone (MIC) controls, waveform (WAV) sound controls, etc.

15 The use of display screens such as those shown in FIGS. 5-6 provided flexibility in implementing various features available to the user. It is to be understood that additional features such as those known in the art may be supported by the processing units 12, 22.

25 Alternatively, it is to be understood that one skilled in the art may implement the processing units 12, 22 to have the features of the display screens in FIGS. 5-6 in hardware; i.e. a wired telephone or wireless

cellular telephone may include various keys, LEDs, liquid crystal displays (LCDs), and touchscreen actuators corresponding to the icons and features shown in FIGS. 5-6. In addition, a PC may have the keys of a keyboard and mouse mapped to the icons and features shown in FIGS. 5-6.

5

Referring to FIG. 7, the disclosed point-to-point Internet protocol and system 10 is illustrated. First processing unit 12 initiates the point-to-point Internet protocol in step 56 by sending a query from the first processing unit 12 to the connection server 26. If connection server 26 is operative to perform the point-to-point Internet protocol, in step 58, first processing unit 12 receives an on-line status signal from the connection server 26, such signal may include the IP address of the callee or a "Callee Off-Line" message. Next, first processing unit 12 performs the primary point-to-point Internet protocol in step 60, which may include receiving, at the first processing unit 12, the IP address of the callee if the callee is active and on-line. Alternatively, processing unit 60 may initiate and perform the secondary point-to-point Internet protocol in step 62, if the called party is not active and/or on-line.

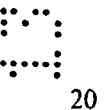
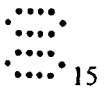
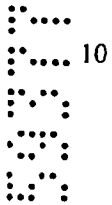

20

Referring to FIG. 8, in conjunction with FIGS. 1 and 3-4, the disclosed point-to-point Internet protocol and system 10 is illustrated. Connection server 26 starts the point-to-point Internet protocol, in step 64, and timestamps and stores E-mail and IP addresses of logged-in users and processing units in the database 34 in step 66. Connection server 26 receives a query from a first processing unit 12 in step 68 to determine whether a second user or second processing unit 22 is logged-in to the Internet 24, with the second user being specified, for example, by an E-mail address. Connection server 26 retrieves the IP address of the specified user from the database 34 in step 70, if the specified user is logged-in to the Internet, and sends the retrieved IP address to the first

25

processing unit 12 in step 72 to enable first processing unit 12 to establish point-to-point communications with the specified second user.

The disclosed secondary point-to-point Internet protocol operates as shown in FIG. 9. First processing unit 12 generates an E-mail signal, including a session number and a first IP address corresponding to a first processing unit in step 76. First processing unit 12 transmits the E-mail signal as a <ConnectRequest> signal to the Internet 24 in step 78. The E-mail signal is delivered through the Internet 24 using a mail server 28 to the second processing unit 22 in step 80. Second processing unit 22 extracts the session number and the first IP address from the E-mail signal in step 82 and transmits or sends the session number and a second IP address corresponding to the second processing unit 22, back to the first processing unit 12 through the Internet 24, in step 84. First processing unit 12 verifies the session number received from the second processing unit 22 in step 86, and establishes a point-to-point Internet communication link between the first processing unit 12 and second processing unit 22 using the first and second IP addresses in step 88.

While the disclosed point-to-point Internet protocols and system have been particularly shown and described with reference to the preferred embodiments, it is understood by those skilled in the art that various modifications in form and detail may be made therein without departing from the scope and spirit of the invention. Accordingly, modifications such as those suggested above, but not limited thereto, are to be considered within the scope of the invention.

Throughout this specification and the claims which follow, unless the context requires otherwise, the word "comprise", and variations such as "comprises" and "comprising", will be understood to imply the inclusion of a stated integer or step or group of integers or steps but not the exclusion of any other
5 integer or step or group of integers or steps.

The reference to any prior art in this specification is not, and should not be taken as, an acknowledgment or any form of suggestion that that prior art forms part of the common general knowledge in Australia.

5
6
7
8
9

10
11
12

13
14
15

16
17
18

THE CLAIMS DEFINING THE INVENTION ARE AS FOLLOWS:

1. Apparatus for establishing a point-to-point communication link, said apparatus operating in a computer system operatively coupled to another
5 computer system and a server over a computer network, said apparatus comprising:

a. means for transmitting an E-mail signal containing a network protocol address from a first process to a second process over the computer network;

b. means for receiving a second network protocol address from the
10 second process over the computer network; and

c. means, responsive to the second network protocol address, for establishing a point-to-point communication link between the first process and the second process over the computer network.

15 2. A method of establishing a point-to-point communication between a first process and a second process, said method for use in a first computer process operatively coupled over a computer network to a second process and a mail server process, said method comprising:

a. transmitting an E-mail signal to the mail server process over the
20 computer network, the E-mail signal containing a first network protocol address assigned to the first process upon connection to the computer network;

b. receiving a second network protocol address from the second process over the computer network, the second network protocol address assigned to the second process upon connection to the computer network; and

25 c. establishing a point-to-point communication link between the first process and the second process over the computer network, in response to receiving the second network protocol address.

3. Apparatus for establishing a point-to-point communication link, said
30 apparatus operating in a computer system operatively connectable to other

processes and a server process over a computer network, said apparatus comprising:

- a. program logic configured to transmit an E-mail signal containing a network protocol address from a first process to a second process over the computer network;
- b. program logic configured to receive a second network protocol address from the second process over the computer network; and
- c. program logic, responsive to the second network protocol address, and configured to establish a point-to-point communication link between the first process and the second process over the computer network.

4. A computer program product for use with a computer system, the computer system capable of executing a first process and operatively connectable to a second process and a server over a computer network, the computer program product comprising a computer useable medium having program code embodied in the medium, the program code further comprising:

- program code for transmitting an E-mail signal comprising a network protocol address of the first process to the second processor over the computer network;
- program code for receiving a second network protocol address from the second process over the computer network; and
- program code, responsive to the second network protocol address, for establishing a point-to-point communication link between the first process and the second process over the computer network.

5. A method of establishing a point-to-point communication between a first process and second process, said method for use in a first computer process operatively coupled over a computer network to a second process and an E-mail server, said method comprising the steps of:

- A. transmitting to the second process over the computer network an E-mail signal comprising a network protocol address of the first process;

B. receiving from the second process over the computer network a second network protocol address; and

C. in response to the second network protocol address, establishing a point-to-point communication link between the first process and the second process over the computer network.

6. Apparatus substantially as hereinbefore described with reference to the accompanying drawings.

10 7. A method substantially as hereinbefore described with reference to the accompanying drawings.

8. A computer program product substantially as hereinbefore described with reference to the accompanying drawings.

15

DATED this 8th day of September 2000

NetSpeak Corporation

By its Patent Attorneys

DAVIES COLLISON CAVE

20

13 09 00 59377

1/6

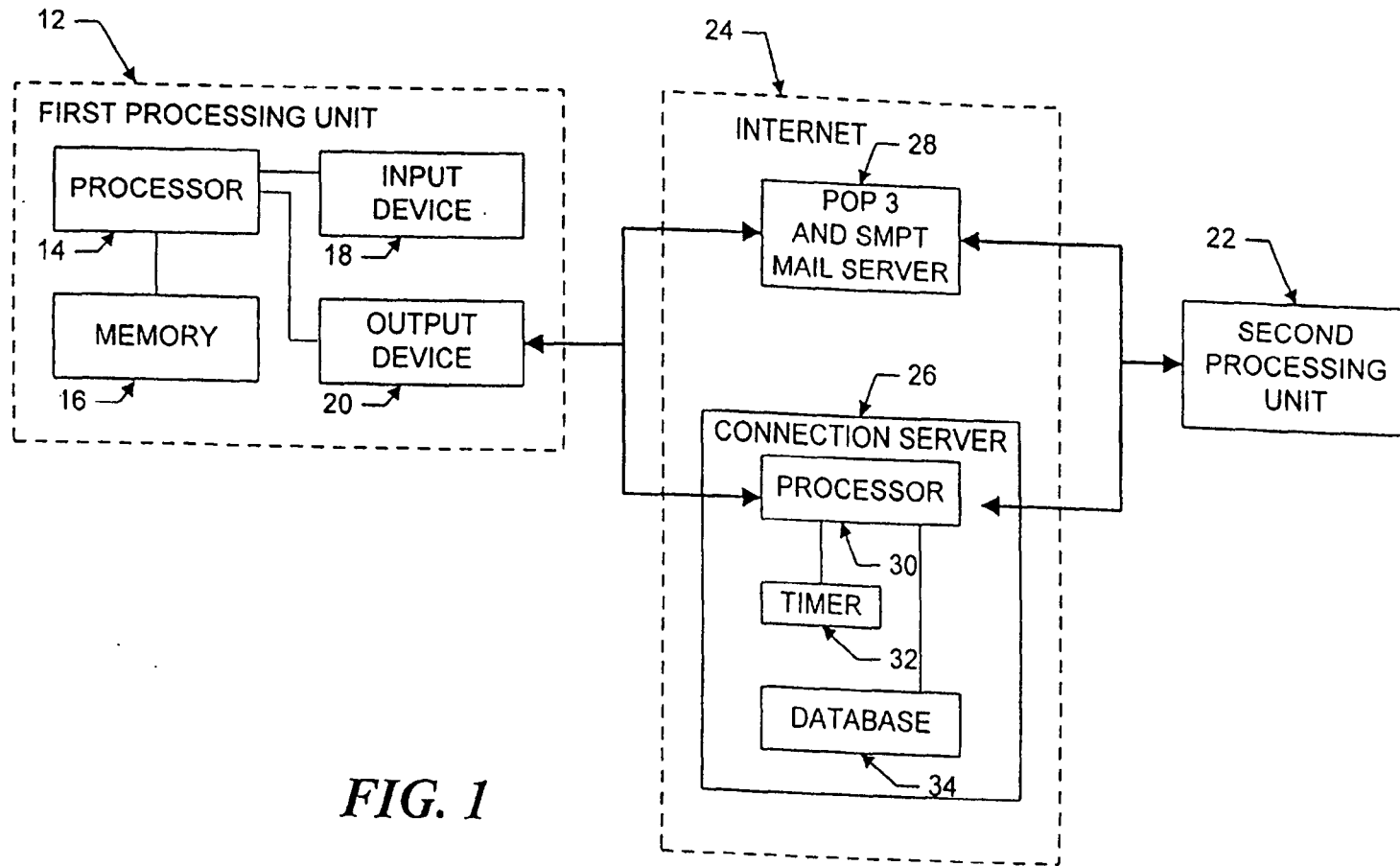

FIG. 1

13 09 00 59377

2/6

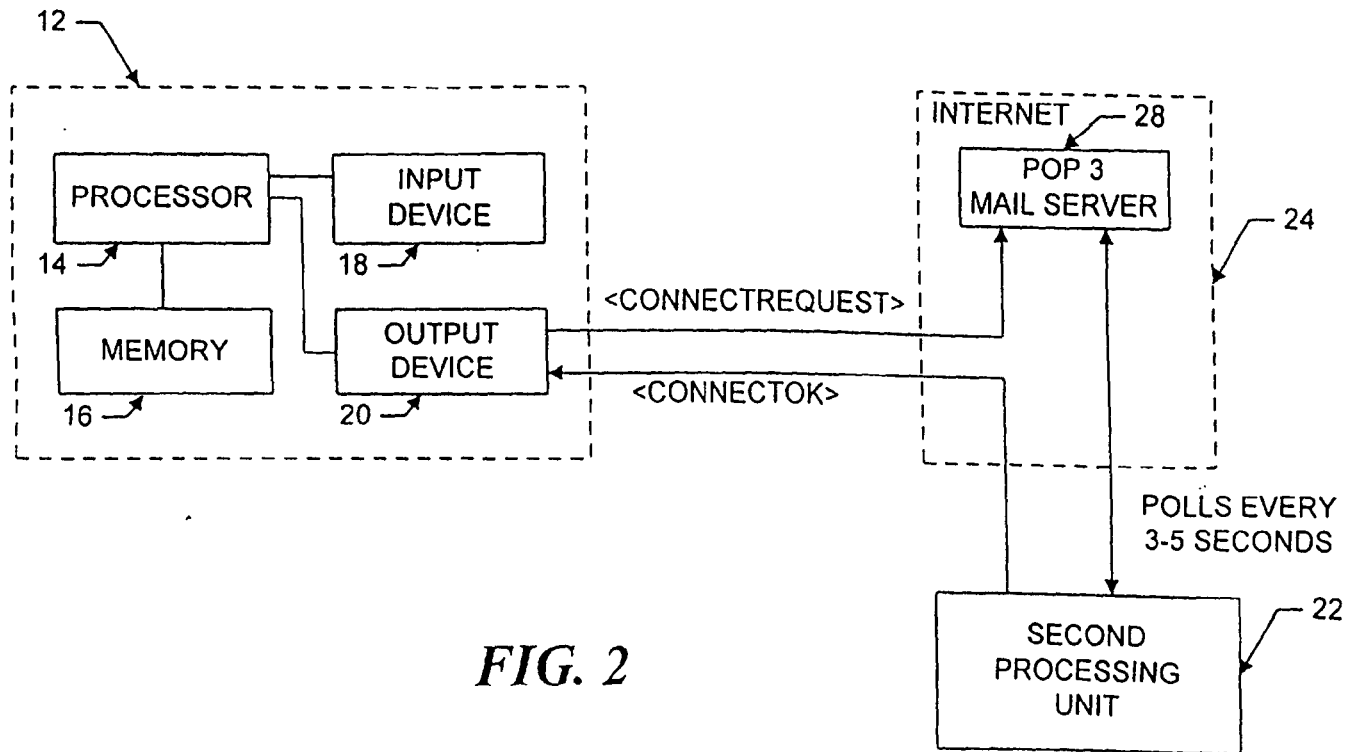

FIG. 2

13 09 00 59377

3/6

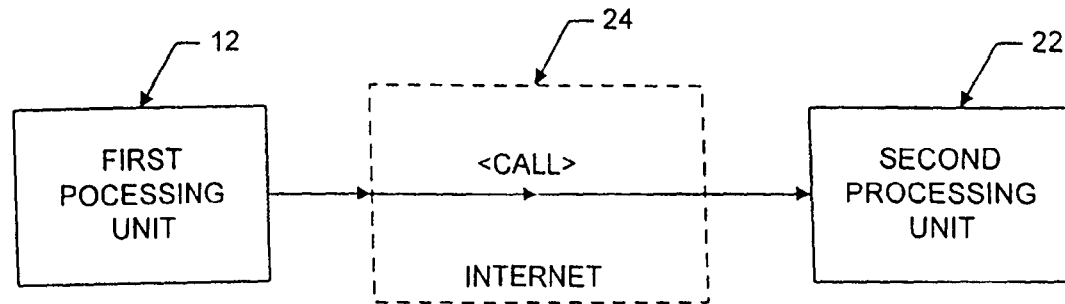

FIG. 3

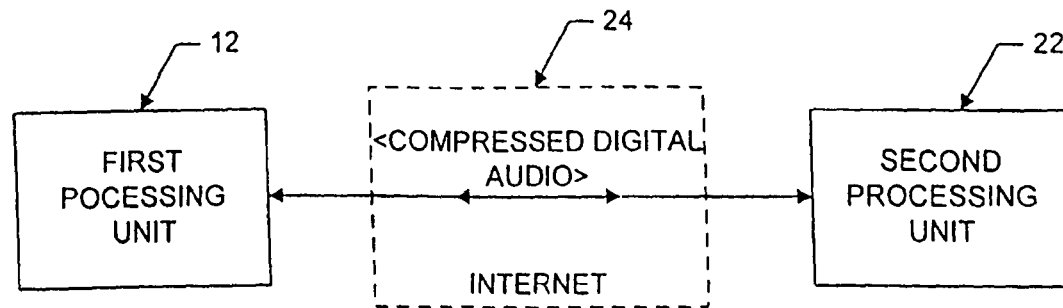

FIG. 4

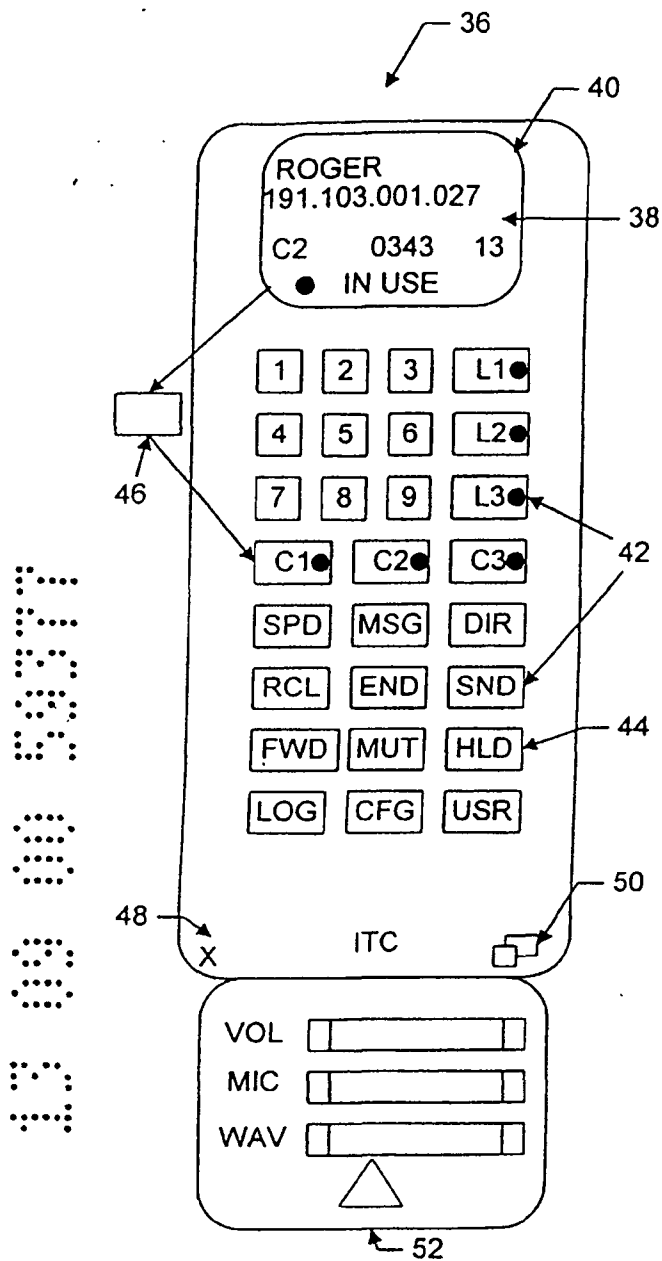

FIG. 5

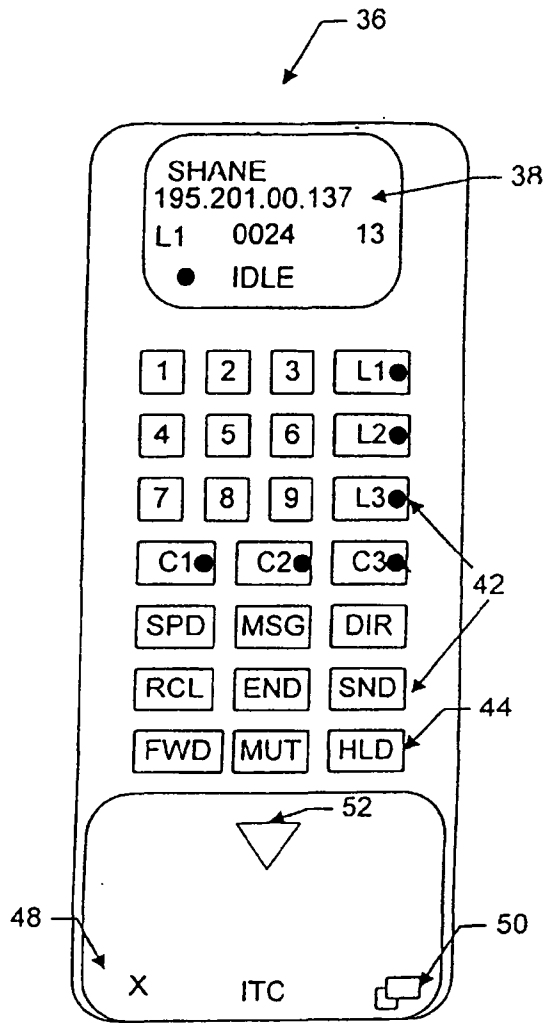

FIG. 6

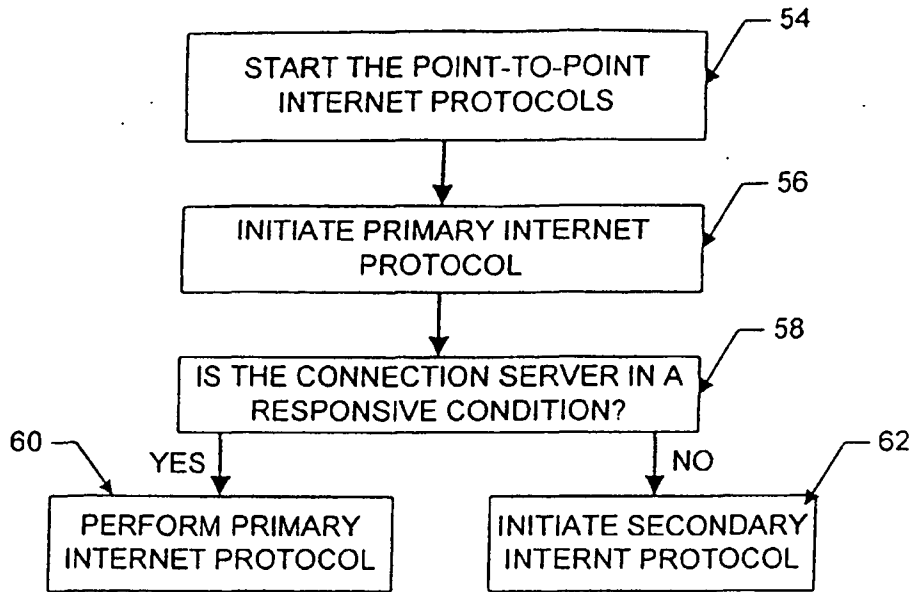

FIG. 7

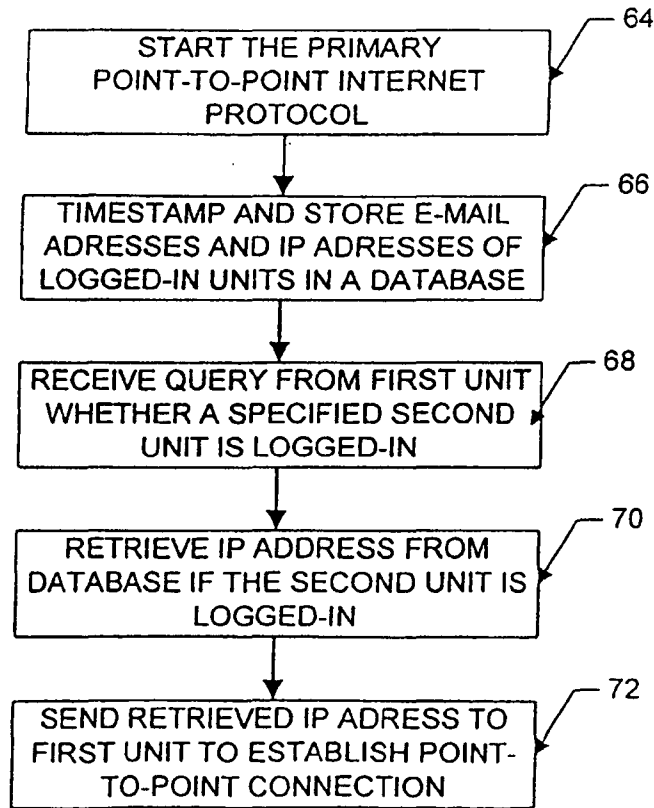

FIG. 8

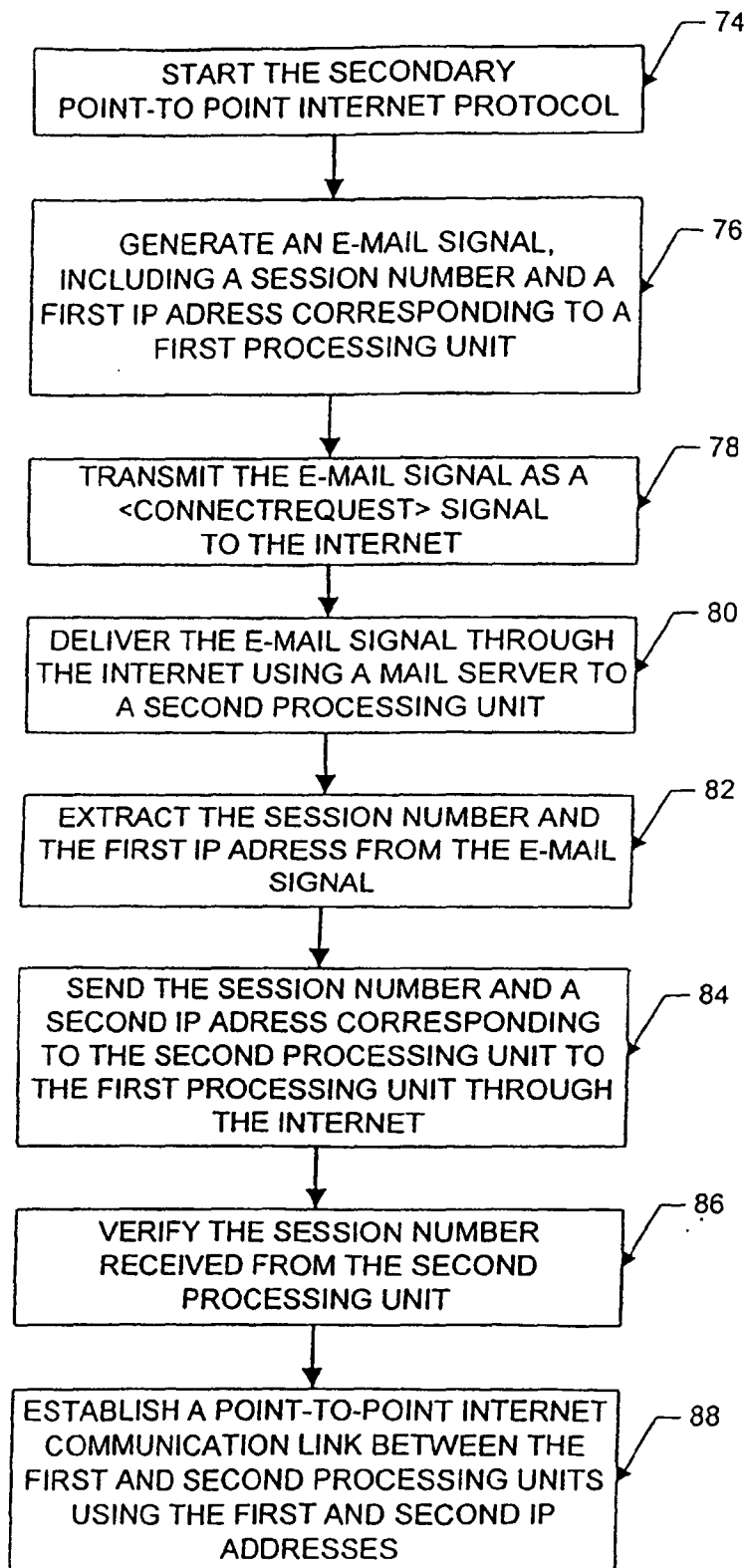

FIG. 9

(12) PATENT APPLICATION
(19) AUSTRALIAN PATENT OFFICE

(11) Application No. AU 200059378 A1

(54) Title
Point-to-point internet protocol

(51)⁷ International Patent Classification(s)
H04L 029/00

(21) Application No: **200059378**

(22) Application Date: **2000.09.13**

(43) Publication Date : **2000.11.30**

(43) Publication Journal Date : **2000.11.30**

(62) Divisional of:
199672476

(71) Applicant(s)
NetSpeak Corporation

(72) Inventor(s)
Glenn W Hutton; Shane D Mattaway; Craig B Strickland

(74) Agent/Attorney
DAVIES COLLISON CAVE, 1 Little Collins Street, MELBOURNE VIC 3000

Abstract

A method for establishing a point-to-point communication link from a caller process to a callee process over a computer network, the caller process having a user interface and being operatively connectable to the callee process and a server over the computer network, said method for use in a computer system, the method comprising, providing a user interface element representing a first communication line, providing a user interface element representing a first callee process, and establishing a point-to-point communication link from the caller process to the first callee process, in response to a user associating the element representing the first callee process with the element representing the first communication line.

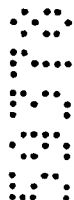

9. The method of claim 7 wherein the element provided in step D represents a communication line on mute status.

10. The method of claim 1 wherein the caller process further comprises a visual display and the user interface comprises a graphic user interface.

11. The method of claim 10 wherein the steps of establishing a point-to-point link as described in step C is performed in response to manipulation of the graphic elements on the graphic user interface.

10

12. A computer program product for use with a computer system comprising:
a computer useable medium having program code embodied in the medium for establishing a point-to-point communication link from a caller process to a callee process over a computer network, the caller process having a user interface and being operatively connectable to the callee process and a server over the computer network, the medium further comprising:

program code for generating an element representing a first communication line;

program code for generating an element representing a first callee process;

program code, responsive to a user associating the element representing the first callee process with the element representing the first communication line, for establishing a point-to-point communication link from the caller process to the first callee process.

13. The computer program product of claim 12 wherein the program code for establishing a point-to-point communication link further comprises:

program code for querying the server as to the on-line status of the first callee process; and

program code for receiving a network protocol address of the first callee process over the computer network from the server.

13 09 00 5078

1/6

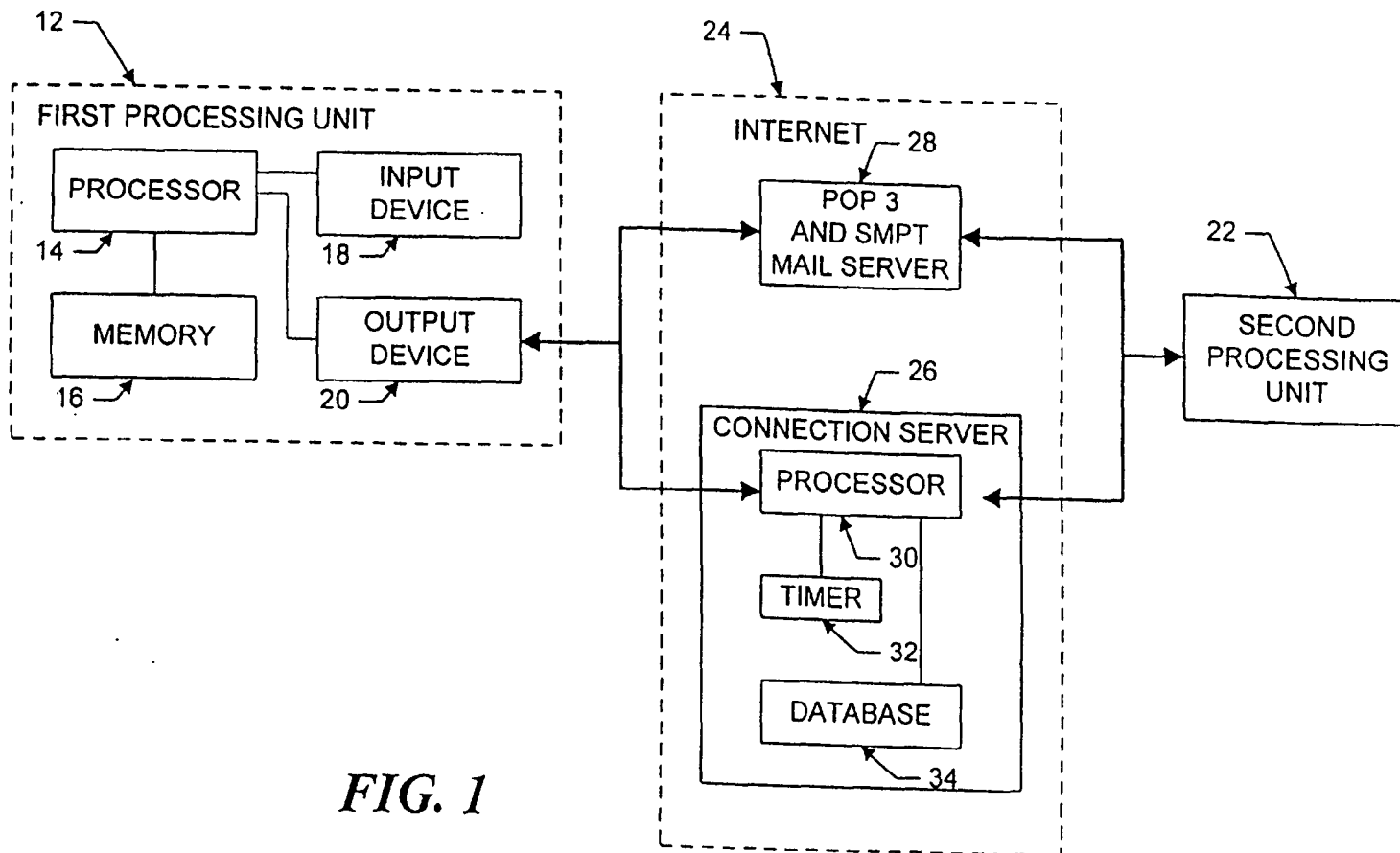

FIG. 1

A U S T R A L I A
Patents Act 1990
COMPLETE SPECIFICATION
STANDARD PATENT
(ORIGINAL)



Name of Applicant: **NetSpeak Corporation**, of 902 Clint Moore Road, Suite 104, Boca Raton, Florida 33487, United States of America.

Actual Inventors: **HUTTON, Glenn W**
MATTAWAY, Shane D
STRICKLAND, Craig B

Address for Service: **DAVIES COLLISON CAVE**, Patent Attorneys, of 1 Little Collins Street, Melbourne, Victoria 3000, Australia.

Invention Title: **"Point-to-Point Internet Protocol"**

The following statement is a full description of this invention, including the best method of performing it known to us:

POINT-TO-POINT INTERNET PROTOCOL

The present invention relates, in general, to data processing systems, and more specifically, to a method and apparatus for facilitating audio communications over computer networks.

5

The increased popularity of on-line services such as AMERICA ONLINE™, COMPUSERVE®, and other services such as Internet gateways have spurred applications to provide multimedia, including video and voice clips, to online users. An example of an online voice clip application is VOICE E-MAIL FOR WINCIM and VOICE E-MAIL FOR AMERICA ONLINE™, available from Bonzi Software, as described in "Simple Utilities Send Voice E-Mail Online", MULTIMEDIA WORLD, VOL. 2, NO. 9, August 1995, p. 52. Using such Voice E-Mail software, a user may create an audio message to be sent to a predetermined E-mail address specified by the user.

Generally, devices interfacing to the Internet and other online services may communicate with each other upon establishing respective device addresses. One type of device address is the Internet Protocol (IP) address, which acts as a pointer to the device associated with the IP address. A typical device may have a Serial Line Internet Protocol or Point-to-Point Protocol (SLIP/PPP) account with a permanent IP address for receiving E-mail, voicemail, and the like over the Internet. E-mail and voicemail is generally intended to convey text, audio, etc., with any routing information such as an IP address and routing headers generally

being considered an artifact of the communication, or even gibberish to the recipient.

Devices such as a host computer or server of a company may include multiple modems for connection of users to the Internet, with a temporary IP address allocated to each user. For example, the host computer may have a general IP address "XXX.XXX.XXX," and each user may be allocated a successive IP address of XXX.XXX.XXX.10, XXX.XXX.XXX.11, XXX.XXX.XXX.12, etc. Such temporary IP addresses may be reassigned or recycled to the users, for example, as each user is successively connected to an outside party. For example, a host computer of a company may support a maximum of 254 IP addresses which are pooled and shared between devices connected to the host computer.

Permanent IP addresses of users and devices accessing the Internet readily support point-to-point communications of voice and video signals over the Internet. For example, realtime video teleconferencing has been implemented using dedicated IP addresses and mechanisms known as reflectors.

A technique for matching domain names to Internet Protocol addresses is described in the text entitled "Internetworking With TCP/IP", 2nd Edition, by Douglas E. Comer, November 1992, Prentice Hall, Englewood Cliffs, New Jersey, U.S.A. Comer describes a domain name system and cooperative systems of name servers for matching domain names to network addresses. Each name server is a server program that supplies mapping of domain names to IP addresses. The system described in Comer, however, is not designed for use with network nodes whose network names or name to address bindings change frequently.

International Publication WO 92/19054 discloses a network

- 2A -

monitoring system including an address tracking module which uses passive monitoring of all packet communications over a local area network to maintain a name table of IP address mappings. The disclosed address tracking module is capable of monitoring only a small number of nodes on a local area network and is
5 not suitable for use with a multitude of nodes over a wide area network.

None of the above-described systems are suitable for use with processes which have dynamically assigned network protocol addresses and which are communicating over wide area or global networks.

Due to the dynamic nature of temporary IP addresses of some devices
10 accessing the Internet, point-to-point communications in realtime of voice and video have been generally difficult to attain.

In accordance with the present invention, there is provided a method for establishing a point-to-point communication link from a caller process to a callee process over a computer network, the caller process having a user interface and
15 being operatively connectable to the callee process and a server over the computer network, said method for use in a computer system, said method comprising:

A. providing a user interface element representing a first communication line;

20 B. providing a user interface element representing a first callee process; and

C. establishing a point-to-point communication link from the caller process to the first callee process, in response to a user associating the element representing the first callee process with the element representing the first
25 communication line.

The present invention also provides a computer program product for use with a computer system comprising:

a computer useable medium having program code embodied in the medium for establishing a point-to-point communication link from a caller process to a
30 callee process over a computer network, the caller process having a user interface

and being operatively connectable to the callee process and a server over the computer network, the medium further comprising:

program code for generating an element representing a first communication line;

5 program code for generating an element representing a first callee process; program code, responsive to a user associating the element representing the first callee process with the element representing the first communication line, for establishing a point-to-point communication link from the caller process to the first callee process.

10 The present invention also provides a computer data signal embodied in a carrier wave comprising:

program code for generating a element representing a first communication line;

program code for generating an element representing a first callee process;

15 program code, responsive to association of the element representing the first callee process with the element representing the first communication line, for establishing a point-to-point communication link from the caller process to the first callee process over a computer network.

20 Preferred embodiments of the present invention are hereinafter described, by way of example only, with reference to the following drawings, wherein:

FIG 1 illustrates, in block diagram format, a system for the disclosed point-to-point Internet protocol:

25 FIG 2 illustrates, in block diagram format, the system using a secondary point-to-point Internet protocol;

FIG 3 illustrates, in block diagram format; the system of FIGS 1-2 with the point-to-point Internet protocol established;

FIG 4 is another block diagram of the system of FIGS 1-2 with audio communications being conducted;

FIG. 5 illustrates a display screen for a processing unit;

FIG. 6 illustrates another display screen for a processing unit;

FIG. 7 illustrates a flowchart of the initiation of the point-to-point Internet protocols;

5 FIG. 8 illustrates a flowchart of the performance of the primary point-to-point Internet protocols; and

FIG. 9 illustrates a flowchart of the performance of the secondary point-to-point Internet protocol.

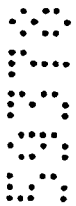

Referring now in specific detail to the drawings, with like reference numerals identifying similar or identical elements, as shown in FIG. 1, the present disclosure describes a point-to-point network protocol and system 10 for using such a protocol.

In an exemplary embodiment, the system 10 includes a first processing unit 12 for sending at least a voice signal from a first user to a second user. The first processing unit 12 includes a processor 14, a memory 16, an input device 18, and an output device 20. The output device 20 includes at least one modem capable of, for example, 14.4 kbaud communications and operatively connected via wired and/or wireless communication connections to the Internet or other computer networks such as an Intranet, i.e., a private computer network. One skilled in the art would understand that the input device 18 may be implemented at least in part by the modem of the output device 20 to allow input signals from the communication connections to be received. The second processing unit 22 may have a processor, memory, and input and output devices, including at least one modem and associated communication connections, as described above for the first processing unit 12. In an exemplary embodiment, each of the processing units 12, 22 may execute the WEBPHONE™ Internet telephony application available from NetSpeak Corporation, Boca Raton, FL, which is capable of performing the disclosed point-to-point Internet protocol and system 10, as described herein.

The first processing unit 12 and the second processing unit 22 are operatively connected to the Internet 24 by communication devices and software known in the art, such as an Internet Service Provider (ISP) or an Internet gateway. The processing units 12, 22 may be operatively interconnected through the Internet 24 to a connection server 26, and

may also be operatively connected to a mail server 28 associated with the Internet 24.

5 The connection server 26 includes a processor 30, a timer 32 for generating time stamps, and a memory such as a database 34 for storing, for example, E-mail and Internet Protocol (IP) addresses of logged-in units. In an exemplary embodiment, the connection server 26 may be a SPARC 5 server or a SPARC 20 server, available from SUN MICROSYSTEMS, INC., Mountain View, CA, having a central processing unit (CPU) as processor 30, an operating system (OS) such as UNIX, for providing timing operations such as maintaining the timer 32, a hard drive or fixed drive, as well as dynamic random access memory (DRAM) for storing the database 34, and a keyboard and display and/or other input and output devices (not shown in FIG. 1). The database 34 may be an SQL database available from ORACLE or INFORMIX.

10
15 In an exemplary embodiment, the mail server 28 may be a Post Office Protocol (POP) Version 3 mail server including a processor, memory, and stored programs operating in a UNIX environment, or, alternatively, another OS, to process E-mail capabilities between processing units and devices over the Internet 24.

20
25 The first processing unit 12 may operate the disclosed point-to-point Internet protocol by a computer program described hereinbelow in conjunction with FIG. 6, which may be implemented from compiled and/or interpreted source code in the C++ programming language and which may be downloaded to the first processing unit 12 from an external computer. The operating computer program may be stored in the memory 16, which may include about 8 MB RAM and/or a hard or fixed drive having about 8 MB. Alternatively, the source code may be implemented in the first processing unit 12 as firmware, as an erasable read only memory (EPROM), etc. It is understood that one skilled in the

art would be able to use programming languages other than C++ to implement the disclosed point-to-point network protocol and system 10.

The processor 14 receives input commands and data from a first user associated with the first processing unit 12 through the input device 18, which may be an input port connected by a wired, optical, or a wireless connection for electromagnetic transmissions, or alternatively may be transferable storage media, such as floppy disks, magnetic tapes, compact disks, or other storage media including the input data from the first user.

The input device 18 may include a user interface (not shown) having, for example, at least one button actuated by the user to input commands to select from a plurality of operating modes to operate the first processing unit 12. In alternative embodiments, the input device 18 may include a keyboard, a mouse, a touch screen, and/or a data reading device such as a disk drive for receiving the input data from input data files stored in storage media such as a floppy disk or, for example, an 8 mm storage tape. The input device 18 may alternatively include connections to other computer systems to receive the input commands and data therefrom.

The first processing unit 12 may include a visual interface for use in conjunction with the input device 18 and output device 20 similar to those screens illustrated in FIGS. 5-6, discussed below. It is also understood that alternative devices may be used to receive commands and data from the user, such as keyboards, mouse devices, and graphical user interfaces (GUI) such as WINDOWS™ 3.1 available from MICROSOFT Corporation, Redmond, WA., and other operating systems and GUIs, such as OS/2 and OS/2 WARP, available from IBM CORPORATION, Boca Raton, FL. Processing unit 12 may also include microphones and/or telephone handsets for receiving audio voice data

and commands, speech or voice recognition devices, dual tone multi-frequency (DTMF) based devices, and/or software known in the art to accept voice data and commands and to operate the first processing unit 12.

5 In addition, either of the first processing unit 12 and the second processing unit 22 may be implemented in a personal digital assistant (PDA) providing modem and E-mail capabilities and Internet access, with the PDA providing the input/output screens for mouse interactions or for touchscreen activation as shown, for example, in FIGS. 5-6, as a
10 combination of the input device 18 and output device 20.

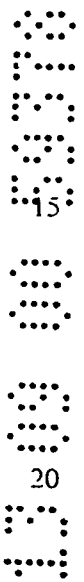

For clarity of explanation, the illustrative embodiment of the disclosed point-to-point Internet protocol and system 10 is presented as having individual functional blocks, which may include functional blocks labeled as "processor" and "processing unit". The functions represented by these blocks may be provided through the use of either shared or dedicated hardware, including, but not limited to, hardware capable of executing software. For example, the functions of each of the processors and processing units presented herein may be provided by a shared processor or by a plurality of individual processors. Moreover, the use of the functional blocks with accompanying labels herein is not to be construed to refer exclusively to hardware capable of executing software. Illustrative embodiments may include digital signal processor (DSP) hardware, such as the AT&T DSP16 or DSP32C, read-only memory (ROM) for storing software performing the operations discussed below, and random access memory (RAM) for storing DSP results. Very large scale integration (VLSI) hardware embodiments, as well as custom VLSI circuitry in combination with a general purpose DSP circuit, may also be provided. Any and all of these embodiments may be deemed to fail within the meaning of the labels for the functional blocks as used herein.

The processing units 12, 22 are capable of placing calls and connecting to other processing units connected to the Internet 24, for example, via dialup SLIP/PPP lines. In an exemplary embodiment, each processing unit assigns an unsigned long session number, for example, a 32-bit long sequence in a *.ini file for each call. Each call may be assigned a successive session number in sequence, which may be used by the respective processing unit to associate the call with one of the SLIP/PPP lines, to associate a <ConnectOK> response signal with a <Connect Request> signal, and to allow for multiplexing and demultiplexing of inbound and outbound conversations on conference lines, as explained hereinafter.

For callee (or called) processing units with fixed IP addresses, the caller (or calling) processing unit may open a "socket", i.e. a file handle or address indicating where data is to be sent, and transmit a <Call> command to establish communication with the callee utilizing, for example, datagram services such as Internet Standard network layering as well as transport layering, which may include a Transport Control Protocol (TCP) or a User Datagram Protocol (UDP) on top of the IP. Typically, a processing unit having a fixed IP address may maintain at least one open socket and a called processing unit waits for a <Call> command to assign the open socket to the incoming signal. If all lines are in use, the callee processing unit sends a BUSY signal or message to the callee processing unit. As shown in FIG. 1, the disclosed point-to-point Internet protocol and system 10 operate when a callee processing unit does not have a fixed or predetermined IP address. In the exemplary embodiment and without loss of generality, the first processing unit 12 is the caller processing unit and the second processing unit 22 is the called processing unit. When either of processing units 12, 22 logs on to the Internet via a dial-up connection, the respective unit is provided a

dynamically allocated IP address by the a connection service provider.

Upon the first user initiating the point-to-point Internet protocol when the first user is logged on to the Internet 24, the first processing unit 12 automatically transmits its associated E-mail address and its dynamically allocated IP address to the connection server 26. The connection server 26 then stores these addresses in the database 34 and time stamps the stored addresses using timer 32. The first user operating the first processing unit 12 is thus established in the database 34 as an active on-line party available for communication using the disclosed point-to-point Internet protocol. Similarly, a second user operating the second processing unit 22, upon connection to the Internet 24 through the a connection service provider, is processed by the connection server 26 to be established in the database 34 as an active on-line party.

The connection server 26 may use the time stamps to update the status of each processing unit; for example, after 2 hours, so that the on-line status information stored in the database 34 is relatively current. Other predetermined time periods, such as a default value of 24 hours, may be configured by a systems operator.

The first user with the first processing unit 12 initiates a call using, for example, a Send command and/or a command to speeddial an NTH stored number, which may be labeled [SND] and [SPD] [N], respectively, by the input device 18 and/or the output device 20, such as shown in FIGS. 5-6. In response to either the Send or speeddial commands, the first processing unit 12 retrieves from memory 16 a stored E-mail address of the callee corresponding to the NTH stored number. Alternatively, the first user may directly enter the E-mail address of the callee.

The first processing unit 12 then sends a query, including the E-mail address of the callee, to the connection server 26. The connection

server 26 then searches the database 34 to determine whether the callee is logged-in by finding any stored information corresponding to the callee's E-mail address indicating that the callee is active and on-line. If the callee is active and on-line, the connection server 26 then performs the primary point-to-point Internet protocol; i.e. the IP address of the callee is retrieved from the database 34 and sent to the first processing unit 12. The first processing unit 12 may then directly establish the point-to-point Internet communications with the callee using the IP address of the callee.

If the callee is not on-line when the connection server 26 determines the callee's status, the connection server 26 sends an OFF-LINE signal or message to the first processing unit 12. The first processing unit 12 may also display a message such as "Called Party Off-Line" to the first user.

When a user logs off or goes off-line from the Internet 24, the connection server 26 updates the status of the user in the database 34; for example, by removing the user's information, or by flagging the user as being off-line. The connection server 26 may be instructed to update the user's information in the database 34 by an off-line message, such as a data packet, sent automatically from the processing unit of the user prior to being disconnected from the connection server 26. Accordingly, an off-line user is effectively disabled from making and/or receiving point-to-point Internet communications.

As shown in FIGS. 2-4, the disclosed secondary point-to-point Internet protocol may be used as an alternative to the primary point-to-point Internet protocol described above, for example, if the connection server 26 is non-responsive, inoperative, and/or unable to perform the primary point-to-point Internet protocol, as a non-responsive condition. Alternatively, the disclosed secondary point-to-point Internet protocol may

be used independent of the primary point-to-point Internet protocol. In the disclosed secondary point-to-point Internet protocol, the first processing unit 12 sends a <ConnectRequest> message via E-mail over the Internet 24 to the mail server 28. The E-mail including the

5 <ConnectRequest> message may have, for example, the subject

[*wp#XXXXXXXXX#nnn.nnn.nnn.#emailAddr]

where nnn.nnn.nnn.nnn. is the current (i.e. temporary or permanent) IP address of the first user, and XXXXXXXX is a session number, which may be unique and associated with the request of the first user to initiate

10 point-to-point communication with the second user.

As described above, the first processing unit 12 may send the <ConnectRequest> message in response to an unsuccessful attempt to perform the primary point-to-point Internet protocol. Alternatively, the first processing unit 12 may send the <ConnectRequest> message in response to the first user initiating a SEND command or the like.

After the <ConnectRequest> message via E-mail is sent, the first processing unit 12 opens a socket and waits to detect a response from the second processing unit 22. A timeout timer, such as timer 32, may be set by the first processing unit 12, in a manner known in the art, to wait for a predetermined duration to receive a <ConnectOK> signal. The processor 14 of the first processing unit 12 may cause the output device

20 to output a Ring signal to the user, such as an audible ringing sound, about every 3 seconds . For example, the processor 14 may output a *.wav file, which may be labeled RING.WAV, which is processed by the

25 output device 20 to output an audible ringing sound.

The mail server 28 then polls the second processing unit 22, for example, every 3-5 seconds, to deliver the E-mail. Generally, the second processing unit 22 checks the incoming lines, for example, at regular intervals to wait for and to detect incoming E-mail from the mail server 28

through the Internet 24.

Typically, for sending E-mail to users having associated processing units operatively connected to a host computer or server operating an Internet gateway, E-mail for a specific user may be sent
 5 over the Internet 24 and directed to the permanent IP address or the SLIP/PPP account designation of the host computer, which then assigns a temporary IP address to the processing unit of the specified user for properly routing the E-mail. The E-mail signal may include a name or other designation such as a user name which identifies the specific user
 10 regardless of the processing unit assigned to the user; that is, the host computer may track and store the specific device where a specific user is assigned or logged on, independent of the IP address system, and so the host computer may switch the E-mail signal to the device of the specific user. At that time, a temporary IP address may be generated or assigned to the specific user and device.

Upon detecting and/or receiving the incoming E-mail signal from the first processing unit 12, the second processing unit 22 may assign or
 may be assigned a temporary IP address. Therefore, the delivery of the E-mail through the Internet 24 provides the second processing unit 22
 with a session number as well as IP addresses of both the first
 processing unit 12 and the second processing unit 22.

Point-to-point communication may then be established by the processing unit 22 processing the E-mail signal to extract the
 <ConnectRequest> message, including the IP address of the first
 25 processing unit 12 and the session number. The second processing unit 22 may then open a socket and generate a <ConnectOK> response signal, which includes the temporary IP address of the second processing unit 22 as well as the session number of the first processing unit.

The second processing unit 22 sends the <ConnectOK> signal

directly over the Internet 24 to the IP address of the first processing unit 12 without processing by the mail server 28, and a timeout timer of the second processing unit 22 may be set to wait and detect a <Call> signal expected from the first processing unit 12.

5 Realtime point-to-point communication of audio signals over the Internet 24, as well as video and voicemail, may thus be established and supported without requiring permanent IP addresses to be assigned to either of the users or processing units 12, 22. For the duration of the realtime point-to-point link, the relative permanence of the current IP
10 addresses of the processing units 12, 22 is sufficient, whether the current IP addresses were permanent (i.e. predetermined or preassigned) or temporary (i.e. assigned upon initiation of the point-to-point communication).

15 In the exemplary embodiment, a first user operating the first processing unit 12 is not required to be notified by the first processing unit 12 that an E-mail is being generated and sent to establish the point-to-point link with the second user at the second processing unit 22.

20 Similarly, the second user is not required to be notified by the second processing unit 22 that an E-mail has been received and/or a temporary IP address is associated with the second processing unit 22. The processing units 12, 22 may perform the disclosed point-to-point Internet protocol automatically upon initiation of the point-to-point communication command by the first user without displaying the E-mail interactions to
25 either user. Accordingly, the disclosed point-to-point Internet protocol may be transparent to the users. Alternatively, either of the first and second users may receive, for example, a brief message of "CONNECTION IN PROGRESS" or the like on a display of the respective output device of the processing units 12, 22.

After the initiation of either the primary or the secondary point-to-

point Internet protocols described above in conjunction with FIGS. 1-2, the point-to-point communication link over the Internet 24 may be established as shown in FIGS. 3-4 in a manner known in the art. For example, referring to FIG. 3, upon receiving the <ConnectorOK> signal from the second processing unit 22, the first processing unit 12 extracts the IP address of the second processing unit 22 and the session number, and the session number sent from the second processing unit 22 is then checked with the session number originally sent from the first processing unit 12 in the <ConnectRequest> message as E-mail. If the session numbers sent and received by the processing unit 12 match, then the first processing unit 12 sends a <Call> signal directly over the Internet 24 to the second processing unit 22; i.e. using the IP address of the second processing unit 22 provided to the first processing unit 12 in the <ConnectOK> signal.

Upon receiving the <Call> signal, the second processing unit 22 may then begin a ring sequence, for example, by indicating or annunciating to the second user that an incoming call is being received. For example, the word "CALL" may be displayed on the output device of the second processing unit 22. The second user may then activate the second processing unit 22 to receive the incoming call.

Referring to FIG. 4, after the second processing unit 22 receives the incoming call, realtime audio and/or video conversations may be conducted in a manner known in the art between the first and second users through the Internet 24, for example, by compressed digital audio signals. Each of the processing units 12, 22 also display to each respective user the words "IN USE" to indicate that the point-to-point communication link is established and audio or video signals are being transmitted.

In addition, either user may terminate the point-to-point

communication link by, for example, activating a termination command, such as by activating an [END] button or icon on a respective processing unit, causing the respective processing unit to send an <End> signal which causes both processing units to terminate the respective sockets, as well as to perform other cleanup commands and functions known in the art.

5

10

FIGS. 5-6 illustrate examples of display screens 36 which may be output by a respective output device of each processing unit 12, 22 of FIGS. 1-4 for providing the disclosed point-to-point Internet protocol and system 10. Such display screens may be displayed on a display of a personal computer (PC) or a PDA in a manner known in the art.

15

As shown in FIG. 5, a first display screen 36 includes a status area 38 for indicating, for example, a called user by name and/or by IP address or telephone number; a current function such as C2; a current time; a current operating status such as "IN USE", and other control icons such as a down arrow icon 40 for scrolling down a list of parties on a current conference line. The operating status may include such annunciators as "IN USE," "IDLE," "BUSY," "NO ANSWER," "OFFLINE," "CALL," "DIALING," "MESSAGES," and "SPEEDDIAL."

20

Other areas of the display screen 36 may include activation areas or icons for actuating commands or entering data. For example, the display screen 36 may include a set of icons 42 arranged in columns and rows including digits 0-9 and commands such as END, SND, HLD, etc. For example, the END and SND commands may be initiated as described above, and the HLD icon 44 may be actuated to place a current line on hold. Such icons may also be configured to substantially simulate a telephone handset or a cellular telephone interface to facilitate ease of use, as well as to simulate function keys of a keyboard. For example, icons labeled L1-L4 may be mapped to function keys F1-F4 on standard

25

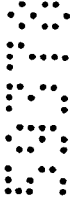

PC keyboards, and icons C1-C3 may be mapped to perform as combinations of function keys, such as CTRL-F1, CTRL-F2, and CTRL-F3, respectively. In addition, the icons labeled L1-L4 and C1-C3 may include circular regions which may simulate light emitting diodes (LEDs) which indicate that the function or element represented by the respective icon is active or being performed.

5

Icons L1-L4 may represent each of 4 lines available to the caller, and icons C1-C3 may represent conference calls using at least one line to connect, for example, two or more parties in a conference call. The icons L1-L4 and C1-C3 may indicate the activity of each respective line or conference line. For example, as illustrated in FIG. 5, icons L1-L2 may have lightly shaded or colored circles, such as a green circle, indicating that each of lines 1 and 2 are in use, while icons L3-L4 may have darkly shaded or color circles, such as a red or black circle, indicating that each of lines 3 and 4 are not in use. Similarly, the lightly shaded circle of the icon labeled C2 indicates that the function corresponding to C2 is active, as additionally indicated in the status area 38, while darkly shaded circles of icons labeled C1 and C3 indicate that such corresponding functions are not active.

10

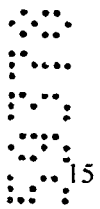

15

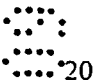

20



25

The icons 42 are used in conjunction with the status area 38. For example, using a mouse for input, a line that is in use, as indicated by the lightly colored circle of the icon, may be activated to indicate a party's name by clicking a right mouse button for 5 seconds until another mouse click is actuated or the [ESC] key or icon is actuated. Thus, the user may switch between multiple calls in progress on respective lines.

Using the icons as well as an input device such as a mouse, a user may enter the name or alias or IP address, if known, of a party to be called by either manually entering the name, by using the speedial feature, or by double clicking on an entry in a directory stored in the

memory, such as the memory 16 of the first processing unit 12, where the directory entries may be scrolled using the status area 38 and the down arrow icon 40.

Once a called party is listed in the status area 38 as being active on a line, the user may transfer the called party to another line or a conference line by clicking and dragging the status area 38, which is represented by a reduced icon 46. Dragging the reduced icon 46 to any one of line icons L1-L4 transfers the called party in use to the selected line, and dragging the reduced icon 46 to any one of conference line icons C1-C3 adds the called party to the selected conference call.

Other features may be supported, such as icons 48-52, where icon 48 corresponds to, for example, an ALT-X command to exit the communication facility of a processing unit, and icon 50 corresponds to, for example, an ALT-M command to minimize or maximize the display screen 36 by the output device of the processing unit. Icon 52 corresponds to an OPEN command, which may, for example, correspond to pressing the O key on a keyboard, to expand or contract the display screen 36 to represent the opening and closing of a cellular telephone. An "opened" configuration is shown in FIG. 5, and a "closed" configuration is shown in FIG. 6. In the "opened" configuration, additional features such as output volume (VOL) controls, input microphone (MIC) controls, waveform (WAV) sound controls, etc.

The use of display screens such as those shown in FIGS. 5-6 provided flexibility in implementing various features available to the user. It is to be understood that additional features such as those known in the art may be supported by the processing units 12, 22.

Alternatively, it is to be understood that one skilled in the art may implement the processing units 12, 22 to have the features of the display screens in FIGS. 5-6 in hardware; i.e. a wired telephone or wireless

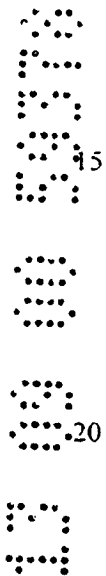

cellular telephone may include various keys, LEDs, liquid crystal displays (LCDs), and touchscreen actuators corresponding to the icons and features shown in FIGS. 5-6. In addition, a PC may have the keys of a keyboard and mouse mapped to the icons and features shown in FIGS. 5-6.

5

Referring to FIG. 7, the disclosed point-to-point Internet protocol and system 10 is illustrated. First processing unit 12 initiates the point-to-point Internet protocol in step 56 by sending a query from the first processing unit 12 to the connection server 26. If connection server 26 is operative to perform the point-to-point Internet protocol, in step 58, first processing unit 12 receives an on-line status signal from the connection server 26, such signal may include the IP address of the callee or a "Callee Off-Line" message. Next, first processing unit 12 performs the primary point-to-point Internet protocol in step 60, which may include receiving, at the first processing unit 12, the IP address of the callee if the callee is active and on-line. Alternatively, processing unit 60 may initiate and perform the secondary point-to-point Internet protocol in step 62, if the called party is not active and/or on-line.

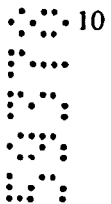

10

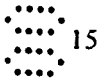

15

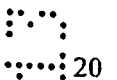

20

Referring to FIG. 8, in conjunction with FIGS. 1 and 3-4, the disclosed point-to-point Internet protocol and system 10 is illustrated. Connection server 26 starts the point-to-point Internet protocol, in step 64, and timestamps and stores E-mail and IP addresses of logged-in users and processing units in the database 34 in step 66. Connection server 26 receives a query from a first processing unit 12 in step 68 to determine whether a second user or second processing unit 22 is logged-in to the Internet 24, with the second user being specified, for example, by an E-mail address. Connection server 26 retrieves the IP address of the specified user from the database 34 in step 70, if the specified user is logged-in to the Internet, and sends the retrieved IP address to the first

25

processing unit 12 in step 72 to enable first processing unit 12 to establish point-to-point communications with the specified second user.

5 The disclosed secondary point-to-point Internet protocol operates as shown in FIG. 9. First processing unit 12 generates an E-mail signal, including a session number and a first IP address corresponding to a first processing unit in step 76. First processing unit 12 transmits the E-mail signal as a <ConnectRequest> signal to the Internet 24 in step 78. The E-mail signal is delivered through the Internet 24 using a mail server 28 to the second processing unit 22 in step 80. Second processing unit 22 extracts the session number and the first IP address from the E-mail signal in step 82 and transmits or sends the session number and a second IP address corresponding to the second processing unit 22, back to the first processing unit 12 through the Internet 24, in step 84. First processing unit 12 verifies the session number received from the second processing unit 22 in step 86, and establishes a point-to-point Internet communication link between the first processing unit 12 and second processing unit 22 using the first and second IP addresses in step 88.

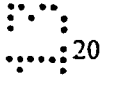
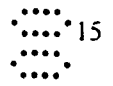
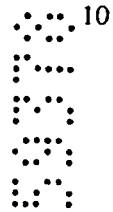

10
15
20 While the disclosed point-to-point Internet protocols and system have been particularly shown and described with reference to the preferred embodiments, it is understood by those skilled in the art that various modifications in form and detail may be made therein without departing from the scope and spirit of the invention. Accordingly, modifications such as those suggested above, but not limited thereto, are to be considered within the scope of the invention.

Throughout this specification and the claims which follow, unless the context requires otherwise, the word "comprise", and variations such as "comprises" and "comprising", will be understood to imply the inclusion of a stated integer or step or group of integers or steps but not the exclusion of any other
5 integer or step or group of integers or steps.

The reference to any prior art in this specification is not, and should not be taken as, an acknowledgment or any form of suggestion that that prior art forms part of the common general knowledge in Australia.



THE CLAIMS DEFINING THE INVENTION ARE AS FOLLOWS:

1. A method for establishing a point-to-point communication link from a caller process to a callee process over a computer network, the caller process having a user interface and being operatively connectable to the callee process and a server over the computer network, said method for use in a computer system, said method comprising:

A. providing a user interface element representing a first communication line;

10 B. providing a user interface element representing a first callee process; and

C. establishing a point-to-point communication link from the caller process to the first callee process, in response to a user associating the element representing the first callee process with the element representing the first communication line.

2. The method of claim 1 wherein step C further comprises the steps of:

c.1 querying the server as to the on-line status of the first callee process and

20 c.2 receiving a network protocol address of the first callee process over the computer network from the server.

3. The method of claim 1 further comprising the step of:

D. providing an element representing a second communication line.

4. The method of claim 3 further comprising the step of:

E. terminating the point-to-point communication link from the caller process to the first callee process, in response to the user disassociating the element representing the first callee process from the element representing the first communication line; and

F. establishing a different point-to-point communication link from the caller process to the first callee process, in response to the user associating the element representing the first callee process with the element representing the second communication line.

5

5. The method of claim 1 further comprising the steps of:

D. providing a user interface element representing a second callee process; and

E. establishing a conference point-to-point communication link between the caller process and the first and second callee process, in response to the user associating the element representing the second callee process with the element representing the first communication line.

10

6. The method of claim 5 further comprising the step of:

F. removing the second callee process from the conference point-to-point communication link in response to the user disassociating the element representing the second callee process from the element representing the first communication line.

15

7. The method of claim 1 further comprising the steps of:

D. providing a user interface element representing a communication line having a temporarily disabled status; and

E. temporarily disabling a point-to-point communication link between the caller process and the first callee process, in response to the user associating the element representing the first callee process with the element representing the communication line having a temporarily disabled status.

25

8. The method of claim 7 wherein the element provided in step D represents a communication line on hold status.

30

9. The method of claim 7 wherein the element provided in step D represents a communication line on mute status.

10. The method of claim 1 wherein the caller process further comprises a visual display and the user interface comprises a graphic user interface.

11. The method of claim 10 wherein the steps of establishing a point-to-point link as described in step C is performed in response to manipulation of the graphic elements on the graphic user interface.



10

12. A computer program product for use with a computer system comprising:
a computer useable medium having program code embodied in the medium for establishing a point-to-point communication link from a caller process to a callee process over a computer network, the caller process having a user interface and being operatively connectable to the callee process and a server over the computer network, the medium further comprising:



15

program code for generating an element representing a first communication line;
program code for generating an element representing a first callee process;
program code, responsive to a user associating the element representing the first callee process with the element representing the first communication line, for establishing a point-to-point communication link from the caller process to the first callee process.



20



13. The computer program product of claim 12 wherein the program code for establishing a point-to-point communication link further comprises:

program code for querying the server as to the on-line status of the first callee process; and

program code for receiving a network protocol address of the first callee process over the computer network from the server.

30

14. A computer program product of claim 12 further comprising:
program code for generating an element representing a second communication line.

5 15. The computer program product of claim 14 further comprising:
program code, responsive to the user disassociating the element representing the first callee process from the element representing the first communication line, for terminating the point-to-point communication link from the caller process to the first callee process; and



10 program code, responsive to the user associating the element representing the first callee process with the element presenting the second communication line, for establishing a different point-to-point communication link from the caller process to the first callee process.



15 16. The computer program product of claim 12 further comprising:
program code for generating an element representing a second callee process; and



20 program code means, responsive to the user associating the element representing the second callee process with the element representing the first communication line, for establishing a conference communication link between the caller process and the first and second callee process.



17. The computer program product of claim 16 further comprising:
program code, responsive to the user disassociating the element representing the second callee process from the element representing the first communication line, for removing the second callee process from the conference communication link.

18. The computer program product of claim 12 further comprising:
30 program code for generating an element representing a communication line having a temporarily disabled status; and

program code, responsive to the association of the element representing the first callee process with the element representing the communication line having a temporarily disabled status, for temporarily disabling the point-to-point communication link between the caller process and the first callee process.

5

19. The computer program product of claim 18 wherein the communication line having a temporarily disabled status comprises a communication line on hold status.

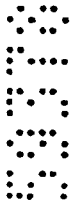

10 20. The computer program product of claim 18 wherein the communication line having a temporarily disabled status comprises a communication line on mute status.



15 21. A computer program product of claim 12 wherein the computer system further comprises a visual display and the user interface comprises a graphic user interface.



20 22. The computer program product of claim 21 wherein the element representing the first communication line and the element representing the first callee process are graphic elements and wherein the program code for establishing a point-to-point communication link from the caller process to the first callee process further comprises:



25 program code, responsive to manipulation of the graphic elements on the graphic user interface, for establishing the point-to-point communication link from the caller process to the first callee process.

23. A computer data signal embodied in a carrier wave comprising:
program code for generating a element representing a first communication line;
30 program code for generating an element representing a first callee process;

program code, responsive to association of the element representing the first callee process with the element representing the first communication line, for establishing a point-to-point communication link from the caller process to the first callee process over a computer network.

5

24. A method substantially as hereinbefore described with reference to the accompanying drawings.

25. A computer program product substantially as hereinbefore described with
10 reference to the accompanying drawings.

26. A computer data signal substantially as hereinbefore described with
reference to the accompanying drawings.

15

DATED this 8th day of September 2000

NetSpeak Corporation
By its Patent Attorneys
DAVIES COLLISON CAVE

20

13 09 00 9978

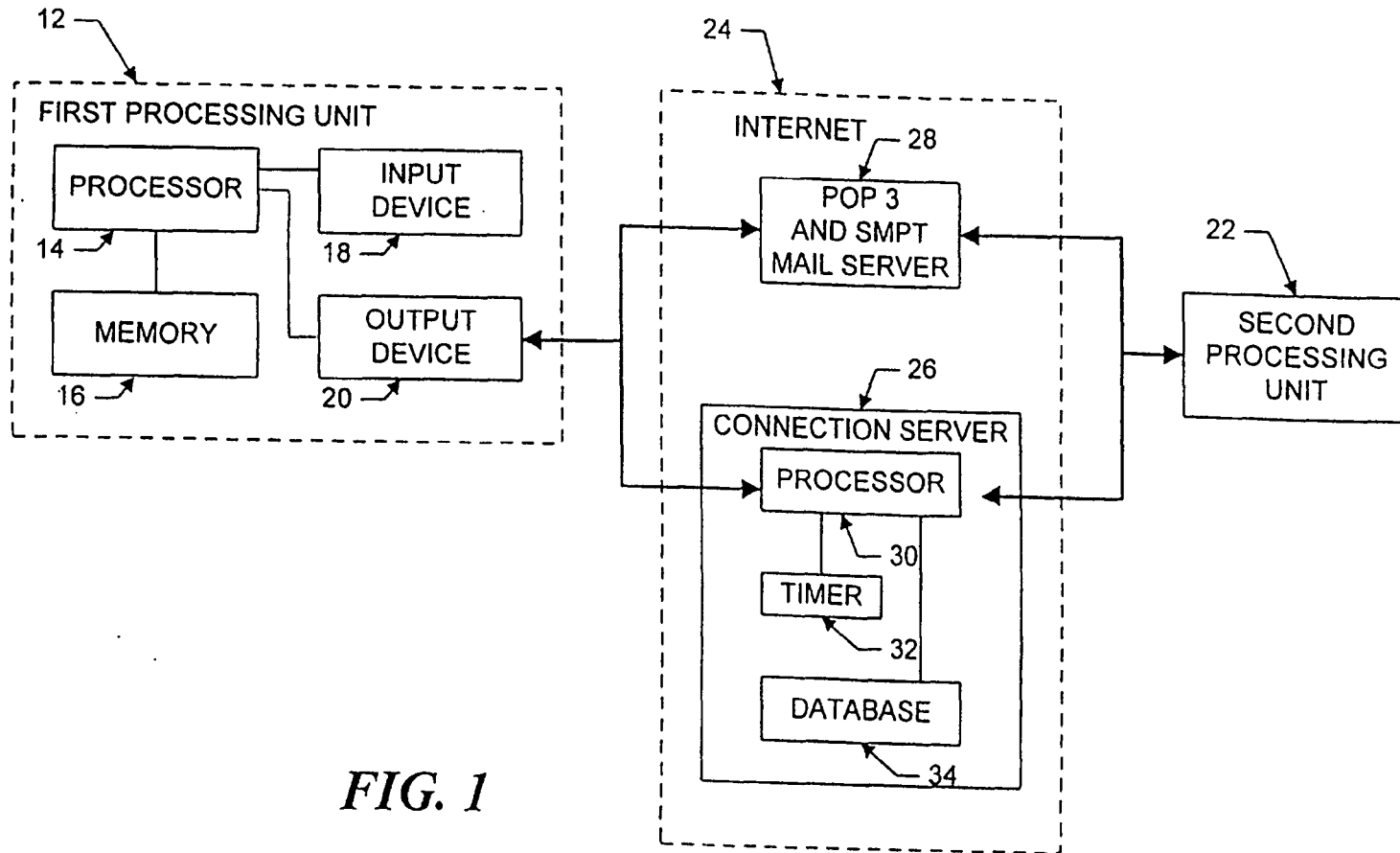

FIG. 1

13 09 00 50378

2/6

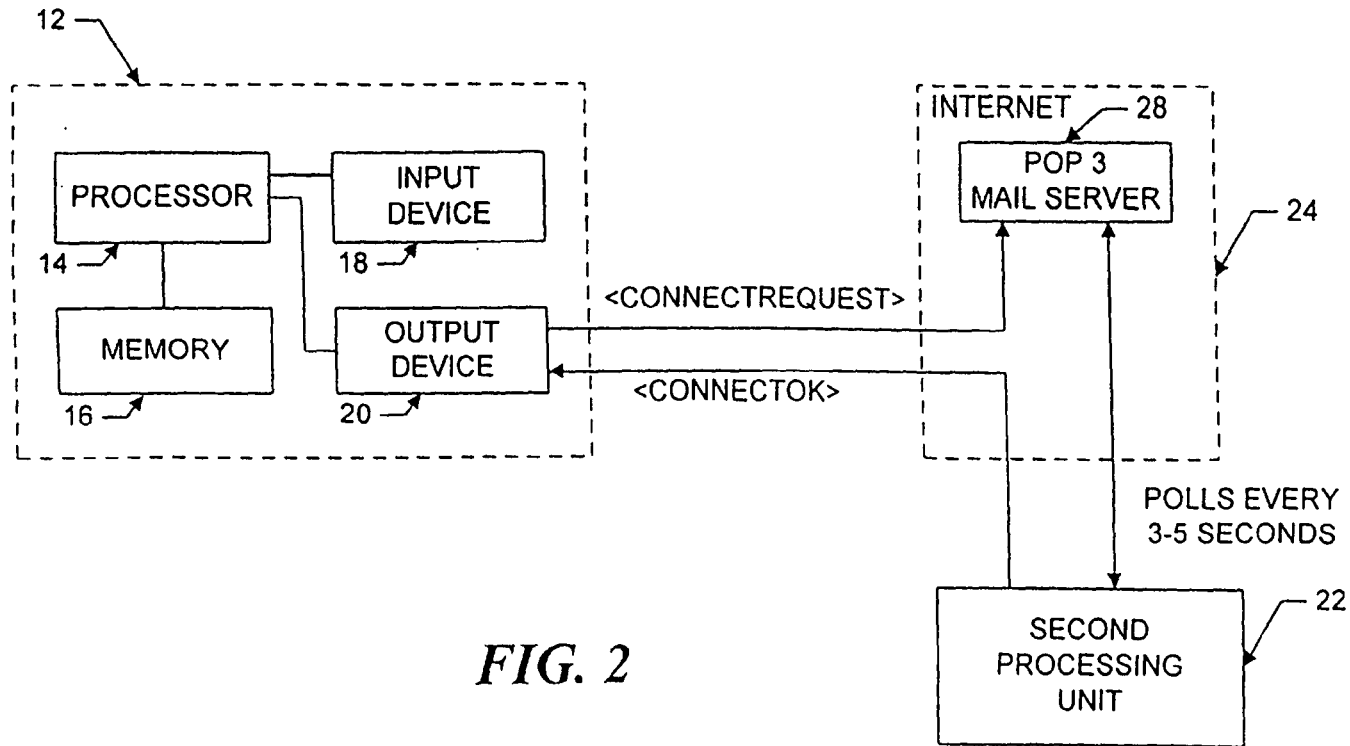

FIG. 2

13 09 00 59370

3/6

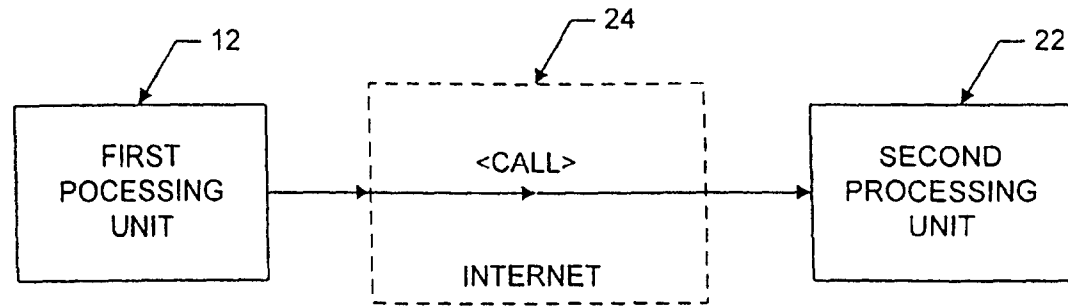

FIG. 3

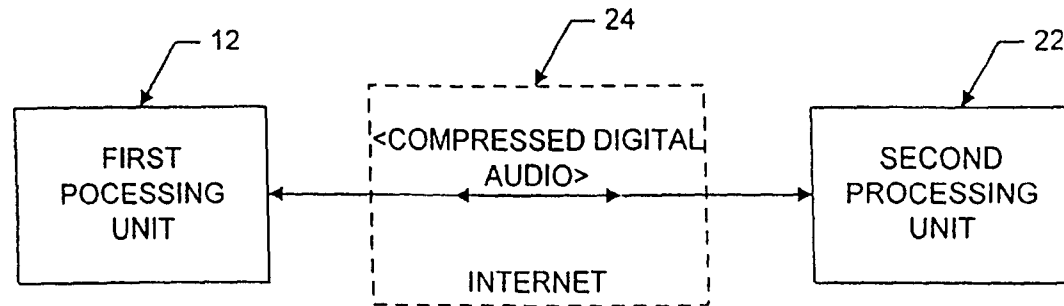

FIG. 4

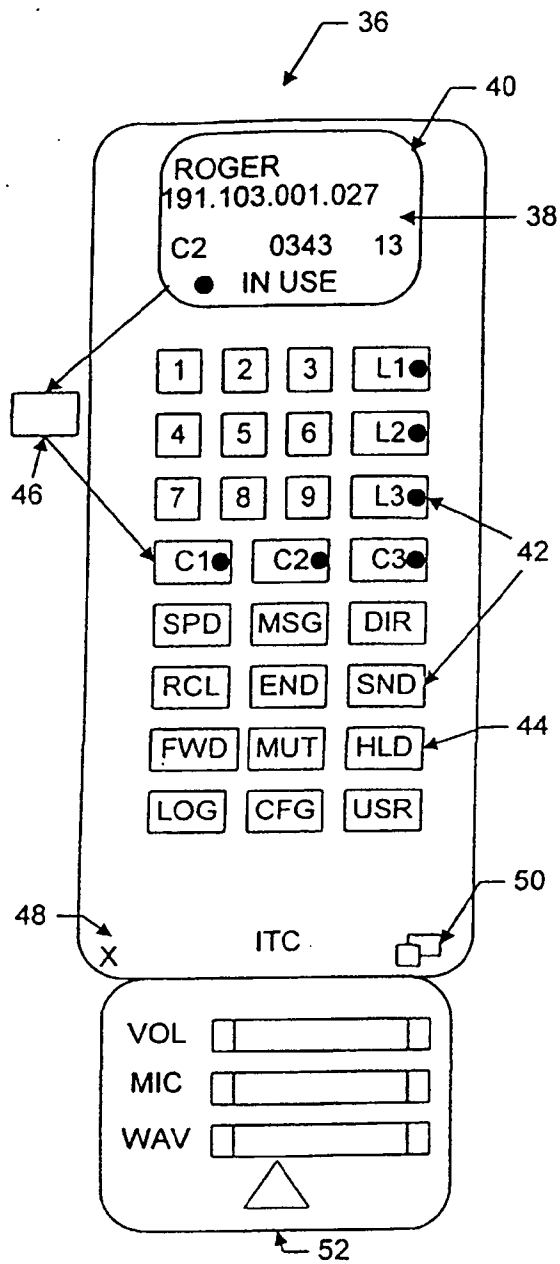

FIG. 5

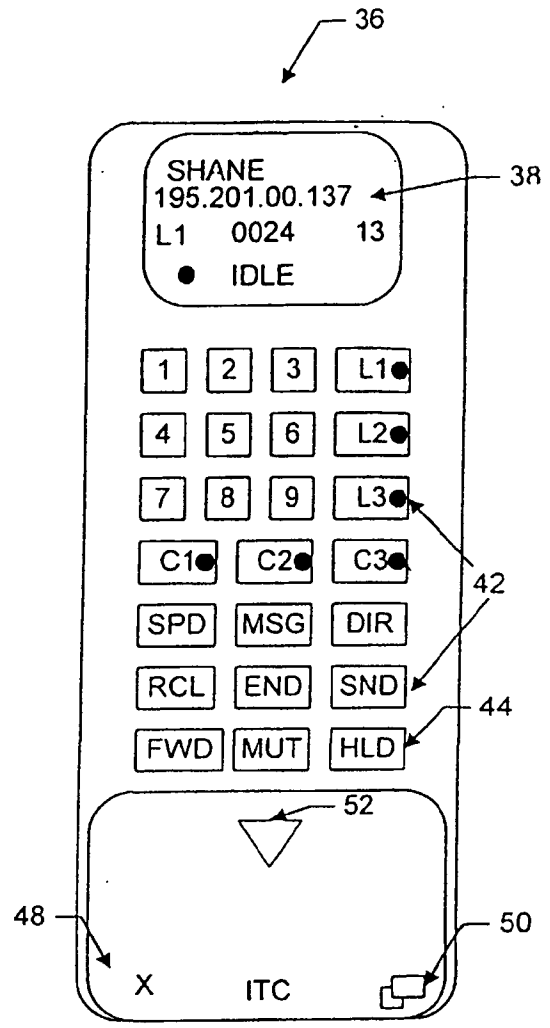

FIG. 6

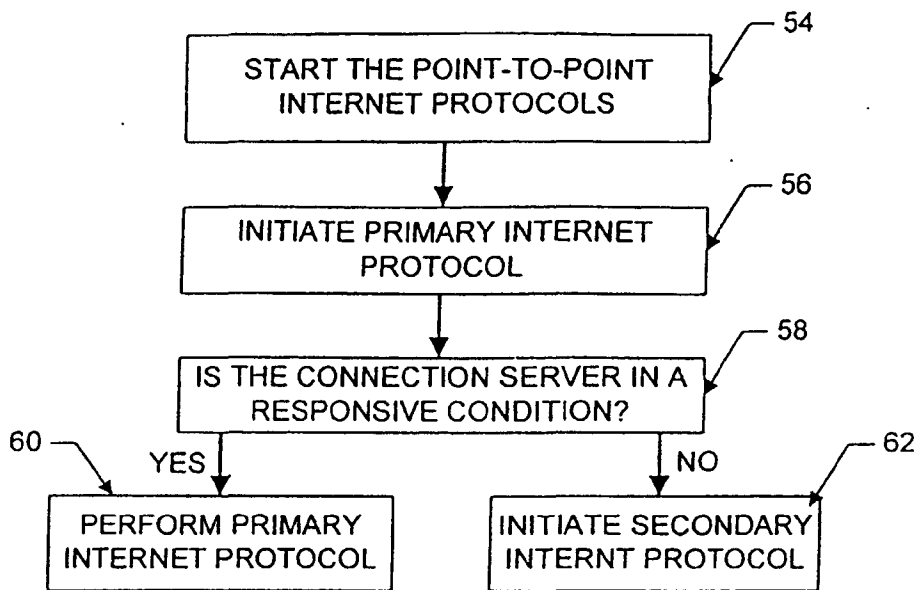

FIG. 7

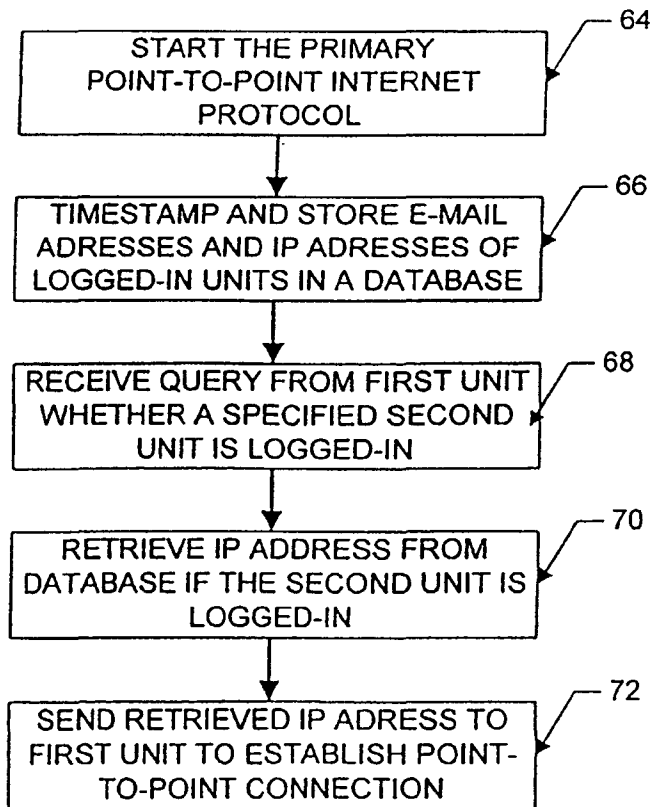

FIG. 8

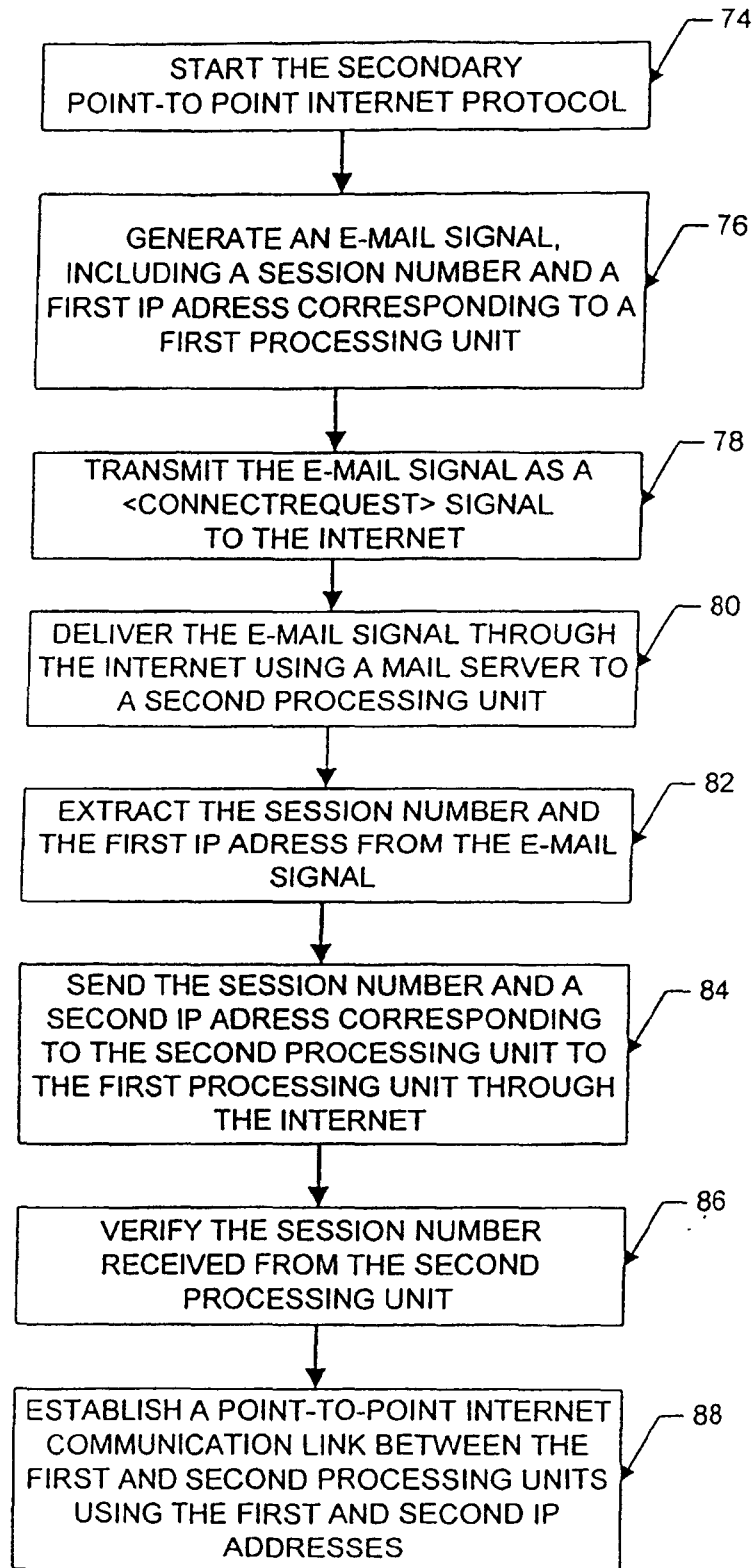

FIG. 9

(12) PATENT APPLICATION
(19) AUSTRALIAN PATENT OFFICE

(11) Application No. AU 200059379 A1

(54) Title
Point-to-point internet protocol

(51)⁷ International Patent Classification(s)
H04L 029/00 G06F 019/00

(21) Application No: 200059379

(22) Application Date: 2000.09.13

(43) Publication Date : 2000.11.23

(43) Publication Journal Date : 2000.11.23

(62) Divisional of:
199672476

(71) Applicant(s)
NetSpeak Corporation

(72) Inventor(s)
Glenn W Hutton; Shane D Mattaway; Craig B Strickland

(74) Agent/Attorney
DAVIES COLLISON CAVE,1 Little Collins Street,MELBOURNE VIC 3000

Abstract

An apparatus for establishing a point-to-point communication link said apparatus operating in a computer system operatively coupled to other computers
5 and a server over a computer network, the apparatus comprising means for transmitting, from the first process to a server a query as to whether a second process is connected to the computer network, means for receiving a network protocol address of the second process from the server when the second process
10 is connected to the computer network, and means, responsive to the network protocol address of the second process, for establishing a point-to-point communication link between the first process and the second process over the computer network.

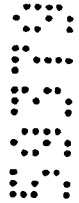

13 09 00 59379

1/6

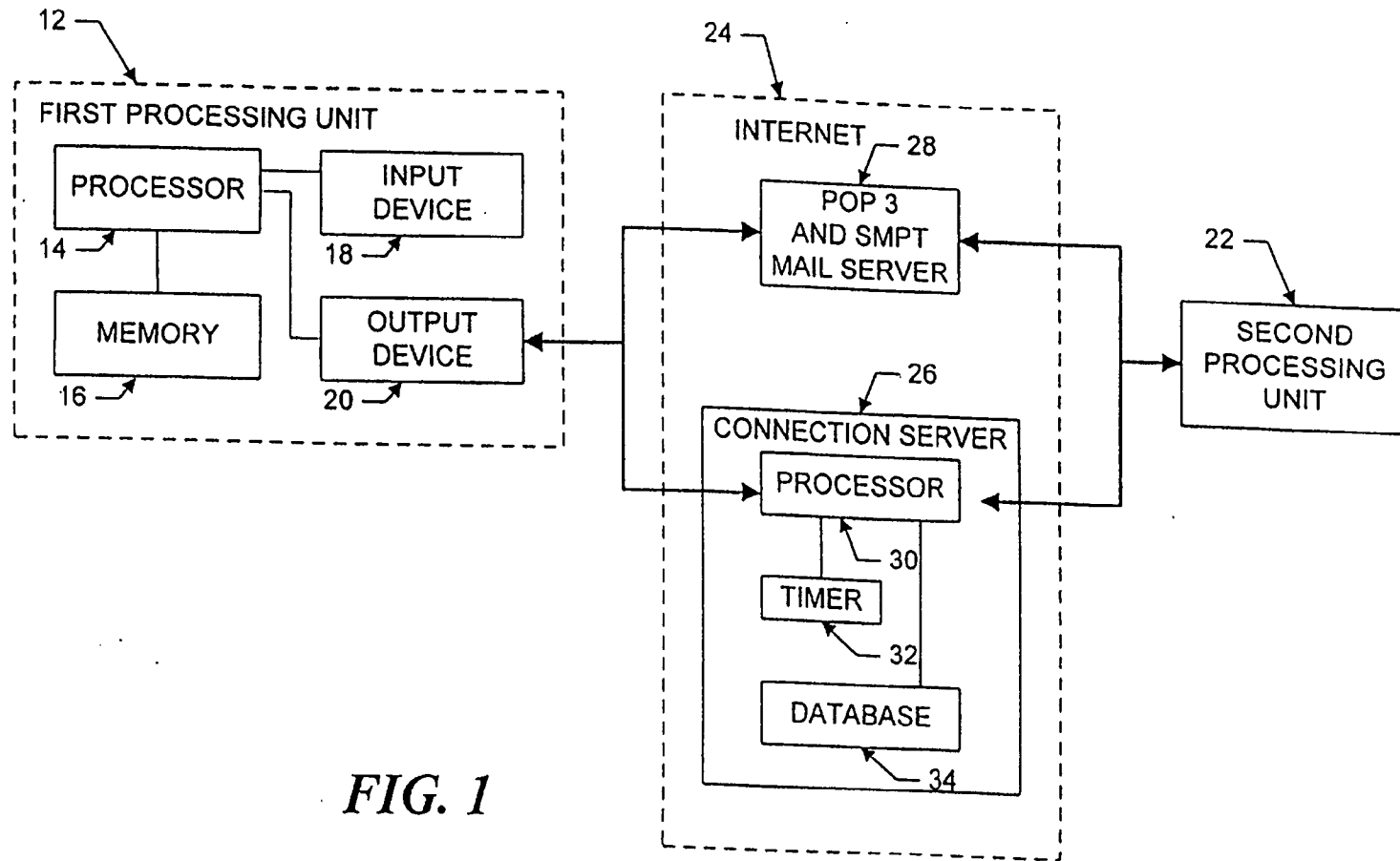

FIG. 1

A U S T R A L I A
Patents Act 1990
COMPLETE SPECIFICATION
STANDARD PATENT
(ORIGINAL)



Name of Applicant: **NetSpeak Corporation**, of 902 Clint Moore Road, Suite 104, Boca Raton, Florida 33487, United States of America.



Actual Inventors: **HUTTON, Glenn W**
MATTAWAY, Shane D
STRICKLAND, Craig B



Address for Service: **DAVIES COLLISON CAVE**, Patent Attorneys, of 1 Little Collins Street, Melbourne, Victoria 3000, Australia.

Invention Title: **"Point-to-Point Internet Protocol"**

The following statement is a full description of this invention, including the best method of performing it known to us:

POINT-TO-POINT INTERNET PROTOCOL

The present invention relates, in general, to data processing systems, and more specifically, to a method and apparatus for facilitating audio communications over computer networks.

5

The increased popularity of on-line services such as AMERICA ONLINE™, COMPUSERVE®, and other services such as Internet gateways have spurred applications to provide multimedia, including video and voice clips, to online users. An example of an online voice clip application is VOICE E-MAIL FOR WINCIM and VOICE E-MAIL FOR AMERICA ONLINE™, available from Bonzi Software, as described in "Simple Utilities Send Voice E-Mail Online", MULTIMEDIA WORLD, VOL. 2, NO. 9, August 1995, p. 52. Using such Voice E-Mail software, a user may create an audio message to be sent to a predetermined E-mail address specified by the user.

Generally, devices interfacing to the Internet and other online services may communicate with each other upon establishing respective device addresses. One type of device address is the Internet Protocol (IP) address, which acts as a pointer to the device associated with the IP address. A typical device may have a Serial Line Internet Protocol or Point-to-Point Protocol (SLIP/PPP) account with a permanent IP address for receiving E-mail, voicemail, and the like over the Internet. E-mail and voicemail is generally intended to convey text, audio, etc., with any routing information such as an IP address and routing headers generally

15

being considered an artifact of the communication, or even gibberish to the recipient.

5 Devices such as a host computer or server of a company may include multiple modems for connection of users to the Internet, with a temporary IP address allocated to each user. For example, the host computer may have a general IP address "XXX.XXX.XXX," and each user may be allocated a successive IP address of XXX.XXX.XXX.10, XXX.XXX.XXX.11, XXX.XXX.XXX.12, etc. Such temporary IP addresses
10 may be reassigned or recycled to the users, for example, as each user is successively connected to an outside party. For example, a host computer of a company may support a maximum of 254 IP addresses which are pooled and shared between devices connected to the host computer.

15 Permanent IP addresses of users and devices accessing the Internet readily support point-to-point communications of voice and video signals over the Internet. For example, realtime video teleconferencing has been implemented using dedicated IP addresses and mechanisms known as reflectors.

20 A technique for matching domain names to Internet Protocol addresses is described in the text entitled "Internetworking With TCP/IP", 2nd Edition, by Douglas E. Comer, November 1992, Prentice Hall, Englewood Cliffs, New Jersey, U.S.A. Comer describes a domain name system and cooperative systems of name servers for matching domain
25 names to network addresses. Each name server is a server program that supplies mapping of domain names to IP addresses. The system described in Comer, however, is not designed for use with network nodes whose network names or name to address bindings change frequently.

International Publication WO 92/19054 discloses a network

30

monitoring system including an address tracking module which uses passive monitoring of all packet communications over a local area network to maintain a name table of IP address mappings. The disclosed address tracking module is capable of monitoring only a small number of nodes on a local area network and is
5 not suitable for use with a multitude of nodes over a wide area network.

None of the above-described systems are suitable for use with processes which have dynamically assigned network protocol addresses and which are communicating over wide area or global networks.

Due to the dynamic nature of temporary IP addresses of some devices
10 accessing the Internet, point-to-point communications in realtime of voice and video have been generally difficult to attain.

In accordance with the present invention, there is provided an apparatus for establishing a point-to-point communication link said apparatus operating in a computer system operatively coupled to other computers and a server over a
15 computer network, said apparatus comprising:

a. means for transmitting, from the first process to a server a query as to whether a second process is connected to the computer network;

b. means for receiving a network protocol address of the second process from the server when the second process is connected to the
20 computer network; and

c. means, responsive to the network protocol address of the second process, for establishing a point-to-point communication link between the first process and the second process over the computer network.

The present invention also provides an apparatus for use with a computer
25 system capable of executing a first process and communicating with other processes, a directory server process and a mail server process over a computer network, the apparatus comprising:

A. program logic configured to determine the currently assigned network protocol address of the first process upon connection to the
30 computer network;

B. program logic configured to establish a communication connection

with the directory server process once the assigned network protocol of the first process is known;

C. program logic configured to forward the assigned network protocol address of the first process to the directory server process upon establishing a communication connection with the directory server process; and

D. program logic configured to establish a point-to-point communication with another process over the computer network.

The present invention also provides an apparatus for use with a computer system, the computer system capable of executing a first process connectable over a computer network to a second process and a directory database server process, the apparatus comprising:

a. program logic configured to access a directory database, the database having a network protocol address for a selected plurality of processes having on-line status with respect to the computer network, the network protocol address of each respective process forwarded to the database following connection to the computer network; and

b. program logic responsive to one of the network protocol addresses and configured to establish a point-to-point communication link from the first process to the second process over the computer network.

The present invention also provides a computer program product for use with a computer system, the computer system executing a first process operatively connectable over a computer network to a second process and a server process, the computer program product comprising a computer useable medium having computer readable program code embodied therein, the program code comprising:

a. program code configured to access a directory database, the database having a network protocol address for a selected plurality of processes having on-line status with respect to the computer network, the network protocol address of each respective process forwarded to the database following connection to the computer network; and

b. program code responsive to one of the network protocol addresses and configured to establish a point-to-point communication link from the first

process to the second process over the computer network.

The present invention also provides a method of establishing a point-to-point communication between a first process and a second process, said method for use in a first computer process operatively coupled over a computer network to
5 a second process and an address server, said method comprising:

A. following connection of the first process to the computer network forwarding to the address server a network protocol address at which the first process is connected to the computer network;

B. querying the address server as to whether the second process is
10 connected to the computer network;

C. receiving a network protocol address of the second process from the address server, when the second process is connected to the computer network; and

D. in response to the network protocol address of the second process,
15 establishing a point-to-point communication link with the second process over the computer network.

9 The present invention also provides a method for establishing point-to-point communications with other processes, said method for use in a computer system capable of executing a first process and communicating with other processes and
20 a server process over a computer network, said method comprising:

A. determining the currently assigned network protocol address of the first process upon connection to the computer network;

B. establishing a communication connection with the server process once the assigned network protocol of the first process is known;

C. forwarding the assigned network protocol address of the first process
25 to the server process upon establishing a communication connection with the server process; and

D. establishing a point-to-point communication with another process over the computer network.

30

The present invention also provides A method of establishing a point-to-point communication between a first process and a second process, said method for use in a first computer process operatively coupled over a computer network to a second process and an address server, said method comprising:

- 5 a. accessing a directory database, the database having a network protocol address for a selected plurality of processes having on-line status with respect to the computer network, the network protocol address of each respective process forwarded to the database following connection to the computer network; and
- 10 b. in response to one of the network protocol addresses, establishing a point-to-point communication link from the first process to the second process over the computer network.

The present invention also provides a method of establishing a point-to-point communication between a first process and a second process, said method for use in a first computer process operatively coupled over a computer network to a second process and an address server, said method comprising:

- 15 a. transmitting to the server a network protocol address received by the first process following connection to the computer network;
- b. transmitting, to the server, a query as to whether the second process
- 20 is connected to the computer network;
- c. receiving a network protocol address of the second process from the server, when the second process is connected to the computer network; and
- d. in response to the network protocol address of the second process, establishing a point-to-point communication link between the first process and the
- 25 second process over the computer network.

The present invention also provides an apparatus capable of executing a first process and connecting to other processes and a server process over a computer network, the apparatus comprising:

- a. program logic configured to generate a user-interface enabling
- 30 control of a first process executing on the computer system;

- 2E -

b. program logic configured to determine the currently assigned network protocol address of the first process upon connection to the computer network;

c. program logic, responsive to the currently assigned network protocol address of the first process, and configured to establish a communication connection with the server process and to forward the assigned network protocol address of the first process to the server process upon establishing a communication connection with the server process; and

d. program logic, responsive to user input commands, and configured to establish a point-to-point communications with another process over the computer network.

The present invention also provides an apparatus for use with a computer system, the computer system executing a first process operatively coupled over a computer network to a second process and a directory database server process, the apparatus comprising:

A. program logic configured to, following connection of the first process to the computer network, forward to the address server a network protocol address at which the first process is connected to the computer network;

B. program logic configured to query the address server as to whether the second process is connected to the computer network;

C. program logic configured to receive a network protocol address of the second process from the address server, when the second process is connected to the computer network; and

D. program logic configured to, in response to the network protocol address of the second process, establish a point-to-point communication link with the second process over the computer network.

The present invention also provides Apparatus for establishing a point-to-point communication link, said apparatus operating in a computer system capable of executing a first process and operatively connectable to other processes and a server over a computer network, said apparatus comprising:

a. means for transmitting, from the first process to the server, a query as to whether a second process is connected to the computer network;

b. means for receiving a network protocol address of the second process from the server when the second process is connected to the computer
5 network; and

c. means, responsive to the network protocol address of the second process, for establishing a point-to-point communication link between the first process and the second process over the computer network.

The present invention also provides a computer data signal embodied in a
10 carrier wave comprising:

program code for transmitting to a server a network protocol address received by a first process following connection to a computer network;

program code for transmitting, to the server, a query as to whether a second process is connected to the computer network;

15 program code for receiving a network protocol address of the second process from the server, when the second process is connected to the computer network; and

program code, responsive to the network protocol address of the second process, for establishing a point-to-point communication link between the first
20 process and the second process over the computer network.

The present invention also provides a computer program product for use with a computer system, the computer system executing a first process and operatively connectable to a second process and a server over a computer network, the computer program product comprising a computer useable medium
25 having program code embodied in the medium, the program code comprising:

program code for transmitting to the server a network protocol address received by the first process following connection to the computer network;

program code for transmitting, to the server, a query as to whether the second process is connected to the computer network;

program code for receiving a network protocol address of the second process from the server, when the second process is connected to the computer network; and

- 5 program code, responsive to the network protocol address of the second process; for establishing a point-to-point communication link between the first process and the second process over the computer network.

Preferred embodiments of the present invention are hereinafter described, 10 by way of example only, with reference to the following drawings, wherein:

FIG 1 illustrates, in block diagram format, a system for the disclosed point-to-point Internet protocol:

FIG 2 illustrates, in block diagram format, the system using a secondary point-to-point Internet protocol;

- 15 FIG 3 illustrates, in block diagram format; the system of FIGS 1-2 with the point-to-point Internet protocol established;

FIG 4 is another block diagram of the system of FIGS 1-2 with audio communications being conducted;

20

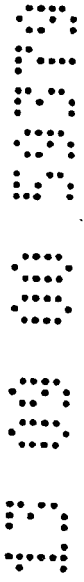

FIG. 5 illustrates a display screen for a processing unit;

FIG. 6 illustrates another display screen for a processing unit;

FIG. 7 illustrates a flowchart of the initiation of the point-to-point Internet protocols;

5 FIG. 8 illustrates a flowchart of the performance of the primary point-to-point Internet protocols; and

 FIG. 9 illustrates a flowchart of the performance of the secondary point-to-point Internet protocol.

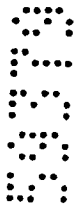

Referring now in specific detail to the drawings, with like reference numerals identifying similar or identical elements, as shown in FIG. 1, the present disclosure describes a point-to-point network protocol and system 10 for using such a protocol.

In an exemplary embodiment, the system 10 includes a first processing unit 12 for sending at least a voice signal from a first user to a second user. The first processing unit 12 includes a processor 14, a memory 16, an input device 18, and an output device 20. The output device 20 includes at least one modem capable of, for example, 14.4 kbaud communications and operatively connected via wired and/or wireless communication connections to the Internet or other computer networks such as an Intranet, i.e., a private computer network. One skilled in the art would understand that the input device 18 may be implemented at least in part by the modem of the output device 20 to allow input signals from the communication connections to be received. The second processing unit 22 may have a processor, memory, and input and output devices, including at least one modem and associated communication connections, as described above for the first processing unit 12. In an exemplary embodiment, each of the processing units 12, 22 may execute the WEBPHONE™ Internet telephony application available from NetSpeak Corporation, Boca Raton, FL, which is capable of performing the disclosed point-to-point Internet protocol and system 10, as described herein.

The first processing unit 12 and the second processing unit 22 are operatively connected to the Internet 24 by communication devices and software known in the art, such as an Internet Service Provider (ISP) or an Internet gateway. The processing units 12, 22 may be operatively interconnected through the Internet 24 to a connection server 26, and

may also be operatively connected to a mail server 28 associated with the Internet 24.

The connection server 26 includes a processor 30, a timer 32 for generating time stamps, and a memory such as a database 34 for storing, for example, E-mail and Internet Protocol (IP) addresses of logged-in units. In an exemplary embodiment, the connection server 26 may be a SPARC 5 server or a SPARC 20 server, available from SUN MICROSYSTEMS, INC., Mountain View, CA, having a central processing unit (CPU) as processor 30, an operating system (OS) such as UNIX, for providing timing operations such as maintaining the timer 32, a hard drive or fixed drive, as well as dynamic random access memory (DRAM) for storing the database 34, and a keyboard and display and/or other input and output devices (not shown in FIG. 1). The database 34 may be an SQL database available from ORACLE or INFORMIX.

In an exemplary embodiment, the mail server 28 may be a Post Office Protocol (POP) Version 3 mail server including a processor, memory, and stored programs operating in a UNIX environment, or, alternatively, another OS, to process E-mail capabilities between processing units and devices over the Internet 24.

The first processing unit 12 may operate the disclosed point-to-point Internet protocol by a computer program described hereinbelow in conjunction with FIG. 6, which may be implemented from compiled and /or interpreted source code in the C++ programming language and which may be downloaded to the first processing unit 12 from an external computer. The operating computer program may be stored in the memory 16, which may include about 8 MB RAM and/or a hard or fixed drive having about 8 MB. Alternatively, the source code may be implemented in the first processing unit 12 as firmware, as an erasable read only memory (EPROM), etc. It is understood that one skilled in the

art would be able to use programming languages other than C++ to implement the disclosed point-to-point network protocol and system 10.

The processor 14 receives input commands and data from a first user associated with the first processing unit 12 through the input device 18, which may be an input port connected by a wired, optical, or a wireless connection for electromagnetic transmissions, or alternatively may be transferable storage media, such as floppy disks, magnetic tapes, compact disks, or other storage media including the input data from the first user.

10 The input device 18 may include a user interface (not shown) having, for example, at least one button actuated by the user to input commands to select from a plurality of operating modes to operate the first processing unit 12. In alternative embodiments, the input device 18 may include a keyboard, a mouse, a touch screen, and/or a data reading device such as a disk drive for receiving the input data from input data files stored in storage media such as a floppy disk or, for example, an 8 mm storage tape. The input device 18 may alternatively include connections to other computer systems to receive the input commands and data therefrom.

20 The first processing unit 12 may include a visual interface for use in conjunction with the input device 18 and output device 20 similar to those screens illustrated in FIGS. 5-6, discussed below. It is also understood that alternative devices may be used to receive commands and data from the user, such as keyboards, mouse devices, and graphical user interfaces (GUI) such as WINDOWS™ 3.1 available from MICROSOFT Corporation, Redmond, WA., and other operating systems and GUIs, such as OS/2 and OS/2 WARP, available from IBM CORPORATION, Boca Raton, FL. Processing unit 12 may also include microphones and/or telephone handsets for receiving audio voice data

and commands, speech or voice recognition devices, dual tone multi-frequency (DTMF) based devices, and/or software known in the art to accept voice data and commands and to operate the first processing unit 12.

5 In addition, either of the first processing unit 12 and the second processing unit 22 may be implemented in a personal digital assistant (PDA) providing modem and E-mail capabilities and Internet access, with the PDA providing the input/output screens for mouse interactions or for touchscreen activation as shown, for example, in FIGS. 5-6, as a
10 combination of the input device 18 and output device 20.

For clarity of explanation, the illustrative embodiment of the disclosed point-to-point Internet protocol and system 10 is presented as having individual functional blocks, which may include functional blocks labeled as "processor" and "processing unit". The functions represented by these blocks may be provided through the use of either shared or
15 dedicated hardware, including, but not limited to, hardware capable of executing software. For example, the functions of each of the processors and processing units presented herein may be provided by a shared processor or by a plurality of individual processors. Moreover, the use of the functional blocks with accompanying labels herein is not to be
20 construed to refer exclusively to hardware capable of executing software. Illustrative embodiments may include digital signal processor (DSP) hardware, such as the AT&T DSP16 or DSP32C, read-only memory (ROM) for storing software performing the operations discussed below, and random access memory (RAM) for storing DSP results. Very large
25 scale integration (VLSI) hardware embodiments, as well as custom VLSI circuitry in combination with a general purpose DSP circuit, may also be provided. Any and all of these embodiments may be deemed to fail within the meaning of the labels for the functional blocks as used herein.

The processing units 12, 22 are capable of placing calls and connecting to other processing units connected to the Internet 24, for example, via dialup SLIP/PPP lines. In an exemplary embodiment, each processing unit assigns an unsigned long session number, for example, a 32-bit long sequence in a *.ini file for each call. Each call may be assigned a successive session number in sequence, which may be used by the respective processing unit to associate the call with one of the SLIP/PPP lines, to associate a <ConnectOK> response signal with a <Connect Request> signal, and to allow for multiplexing and demultiplexing of inbound and outbound conversations on conference lines, as explained hereinafter.

For callee (or called) processing units with fixed IP addresses, the caller (or calling) processing unit may open a "socket", i.e. a file handle or address indicating where data is to be sent, and transmit a <Call> command to establish communication with the callee utilizing, for example, datagram services such as Internet Standard network layering as well as transport layering, which may include a Transport Control Protocol (TCP) or a User Datagram Protocol (UDP) on top of the IP. Typically, a processing unit having a fixed IP address may maintain at least one open socket and a called processing unit waits for a <Call> command to assign the open socket to the incoming signal. If all lines are in use, the callee processing unit sends a BUSY signal or message to the callee processing unit. As shown in FIG. 1, the disclosed point-to-point Internet protocol and system 10 operate when a callee processing unit does not have a fixed or predetermined IP address. In the exemplary embodiment and without loss of generality, the first processing unit 12 is the caller processing unit and the second processing unit 22 is the called processing unit. When either of processing units 12, 22 logs on to the Internet via a dial-up connection, the respective unit is provided a

dynamically allocated IP address by the a connection service provider.

Upon the first user initiating the point-to-point Internet protocol when the first user is logged on to the Internet 24, the first processing unit 12 automatically transmits its associated E-mail address and its dynamically allocated IP address to the connection server 26. The connection server 26 then stores these addresses in the database 34 and time stamps the stored addresses using timer 32. The first user operating the first processing unit 12 is thus established in the database 34 as an active on-line party available for communication using the disclosed point-to-point Internet protocol. Similarly, a second user operating the second processing unit 22, upon connection to the Internet 24 through the a connection service provider, is processed by the connection server 26 to be established in the database 34 as an active on-line party.

The connection server 26 may use the time stamps to update the status of each processing unit; for example, after 2 hours, so that the on-line status information stored in the database 34 is relatively current.

Other predetermined time periods, such as a default value of 24 hours, may be configured by a systems operator.

The first user with the first processing unit 12 initiates a call using, for example, a Send command and/or a command to speeddial an NTH stored number, which may be labeled [SND] and [SPD] [N], respectively, by the input device 18 and/or the output device 20, such as shown in FIGS. 5-6. In response to either the Send or speeddial commands, the first processing unit 12 retrieves from memory 16 a stored E-mail address of the callee corresponding to the NTH stored number. Alternatively, the first user may directly enter the E-mail address of the callee.

The first processing unit 12 then sends a query, including the E-mail address of the callee, to the connection server 26. The connection

server 26 then searches the database 34 to determine whether the callee is logged-in by finding any stored information corresponding to the callee's E-mail address indicating that the callee is active and on-line. If the callee is active and on-line, the connection server 26 then performs the primary point-to-point Internet protocol; i.e. the IP address of the callee is retrieved from the database 34 and sent to the first processing unit 12. The first processing unit 12 may then directly establish the point-to-point Internet communications with the callee using the IP address of the callee.

If the callee is not on-line when the connection server 26 determines the callee's status, the connection server 26 sends an OFF-LINE signal or message to the first processing unit 12. The first processing unit 12 may also display a message such as "Called Party Off-Line" to the first user.

When a user logs off or goes off-line from the Internet 24, the connection server 26 updates the status of the user in the database 34; for example, by removing the user's information, or by flagging the user as being off-line. The connection server 26 may be instructed to update the user's information in the database 34 by an off-line message, such as a data packet, sent automatically from the processing unit of the user prior to being disconnected from the connection server 26. Accordingly, an off-line user is effectively disabled from making and/or receiving point-to-point Internet communications.

As shown in FIGS. 2-4, the disclosed secondary point-to-point Internet protocol may be used as an alternative to the primary point-to-point Internet protocol described above, for example, if the connection server 26 is non-responsive, inoperative, and/or unable to perform the primary point-to-point Internet protocol, as a non-responsive condition. Alternatively, the disclosed secondary point-to-point Internet protocol may

be used independent of the primary point-to-point Internet protocol. In the disclosed secondary point-to-point Internet protocol, the first processing unit 12 sends a <ConnectRequest> message via E-mail over the Internet 24 to the mail server 28. The E-mail including the

5 <ConnectRequest> message may have, for example, the subject

[*wp#XXXXXXXXX#nnn.nnn.nnn.#emailAddr]

where nnn.nnn.nnn.nnn. is the current (i.e. temporary or permanent) IP address of the first user, and XXXXXXXX is a session number, which may be unique and associated with the request of the first user to initiate

10 point-to-point communication with the second user.

As described above, the first processing unit 12 may send the <ConnectRequest> message in response to an unsuccessful attempt to perform the primary point-to-point Internet protocol. Alternatively, the first processing unit 12 may send the <ConnectRequest> message in response to the first user initiating a SEND command or the like.

After the <ConnectRequest> message via E-mail is sent, the first processing unit 12 opens a socket and waits to detect a response from the second processing unit 22. A timeout timer, such as timer 32, may be set by the first processing unit 12, in a manner known in the art, to wait for a predetermined duration to receive a <ConnectOK> signal. The processor 14 of the first processing unit 12 may cause the output device 20 to output a Ring signal to the user, such as an audible ringing sound, about every 3 seconds. For example, the processor 14 may output a *.wav file, which may be labeled RING.WAV, which is processed by the

25 output device 20 to output an audible ringing sound.

The mail server 28 then polls the second processing unit 22, for example, every 3-5 seconds, to deliver the E-mail. Generally, the second processing unit 22 checks the incoming lines, for example, at regular intervals to wait for and to detect incoming E-mail from the mail server 28

through the Internet 24.

Typically, for sending E-mail to users having associated processing units operatively connected to a host computer or server operating an Internet gateway, E-mail for a specific user may be sent over the Internet 24 and directed to the permanent IP address or the SLIP/PPP account designation of the host computer, which then assigns a temporary IP address to the processing unit of the specified user for properly routing the E-mail. The E-mail signal may include a name or other designation such as a user name which identifies the specific user regardless of the processing unit assigned to the user; that is, the host computer may track and store the specific device where a specific user is assigned or logged on, independent of the IP address system, and so the host computer may switch the E-mail signal to the device of the specific user. At that time, a temporary IP address may be generated or assigned to the specific user and device.

Upon detecting and/or receiving the incoming E-mail signal from the first processing unit 12, the second processing unit 22 may assign or may be assigned a temporary IP address. Therefore, the delivery of the E-mail through the Internet 24 provides the second processing unit 22 with a session number as well as IP addresses of both the first processing unit 12 and the second processing unit 22.

Point-to-point communication may then be established by the processing unit 22 processing the E-mail signal to extract the <ConnectRequest> message, including the IP address of the first processing unit 12 and the session number. The second processing unit 22 may then open a socket and generate a <ConnectOK> response signal, which includes the temporary IP address of the second processing unit 22 as well as the session number of the first processing unit.

The second processing unit 22 sends the <ConnectOK> signal

directly over the Internet 24 to the IP address of the first processing unit 12 without processing by the mail server 28, and a timeout timer of the second processing unit 22 may be set to wait and detect a <Call> signal expected from the first processing unit 12.

5 Realtime point-to-point communication of audio signals over the Internet 24, as well as video and voicemail, may thus be established and supported without requiring permanent IP addresses to be assigned to either of the users or processing units 12, 22. For the duration of the realtime point-to-point link, the relative permanence of the current IP
10 addresses of the processing units 12, 22 is sufficient, whether the current IP addresses were permanent (i.e. predetermined or preassigned) or temporary (i.e. assigned upon initiation of the point-to-point communication).

15 In the exemplary embodiment, a first user operating the first processing unit 12 is not required to be notified by the first processing unit 12 that an E-mail is being generated and sent to establish the point-to-point link with the second user at the second processing unit 22. Similarly, the second user is not required to be notified by the second processing unit 22 that an E-mail has been received and/or a temporary
20 IP address is associated with the second processing unit 22. The processing units 12, 22 may perform the disclosed point-to-point Internet protocol automatically upon initiation of the point-to-point communication command by the first user without displaying the E-mail interactions to either user. Accordingly, the disclosed point-to-point Internet protocol
25 may be transparent to the users. Alternatively, either of the first and second users may receive, for example, a brief message of "CONNECTION IN PROGRESS" or the like on a display of the respective output device of the processing units 12, 22.

After the initiation of either the primary or the secondary point-to-

point Internet protocols described above in conjunction with FIGS. 1-2, the point-to-point communication link over the Internet 24 may be established as shown in FIGS. 3-4 in a manner known in the art. For example, referring to FIG. 3, upon receiving the <ConnectorOK> signal from the second processing unit 22, the first processing unit 12 extracts the IP address of the second processing unit 22 and the session number, and the session number sent from the second processing unit 22 is then checked with the session number originally sent from the first processing unit 12 in the <ConnectRequest> message as E-mail. If the session numbers sent and received by the processing unit 12 match, then the first processing unit 12 sends a <Call> signal directly over the Internet 24 to the second processing unit 22; i.e. using the IP address of the second processing unit 22 provided to the first processing unit 12 in the <ConnectOK> signal.

Upon receiving the <Call> signal, the second processing unit 22 may then begin a ring sequence, for example, by indicating or annunciating to the second user that an incoming call is being received. For example, the word "CALL" may be displayed on the output device of the second processing unit 22. The second user may then activate the second processing unit 22 to receive the incoming call.

Referring to FIG. 4, after the second processing unit 22 receives the incoming call, realtime audio and/or video conversations may be conducted in a manner known in the art between the first and second users through the Internet 24, for example, by compressed digital audio signals. Each of the processing units 12, 22 also display to each respective user the words "IN USE" to indicate that the point-to-point communication link is established and audio or video signals are being transmitted.

In addition, either user may terminate the point-to-point

communication link by, for example, activating a termination command, such as by activating an [END] button or icon on a respective processing unit, causing the respective processing unit to send an <End> signal which causes both processing units to terminate the respective sockets, as well as to perform other cleanup commands and functions known in the art.

FIGS. 5-6 illustrate examples of display screens 36 which may be output by a respective output device of each processing unit 12, 22 of FIGS. 1-4 for providing the disclosed point-to-point Internet protocol and system 10. Such display screens may be displayed on a display of a personal computer (PC) or a PDA in a manner known in the art.

As shown in FIG. 5, a first display screen 36 includes a status area 38 for indicating, for example, a called user by name and/or by IP address or telephone number; a current function such as C2; a current time; a current operating status such as "IN USE", and other control icons such as a down arrow icon 40 for scrolling down a list of parties on a current conference line. The operating status may include such annunciators as "IN USE," "IDLE," "BUSY," "NO ANSWER," "OFFLINE," "CALL," "DIALING," "MESSAGES," and "SPEEDDIAL."

Other areas of the display screen 36 may include activation areas or icons for actuating commands or entering data. For example, the display screen 36 may include a set of icons 42 arranged in columns and rows including digits 0-9 and commands such as END, SND, HLD, etc. For example, the END and SND commands may be initiated as described above, and the HLD icon 44 may be actuated to place a current line on hold. Such icons may also be configured to substantially simulate a telephone handset or a cellular telephone interface to facilitate ease of use, as well as to simulate function keys of a keyboard. For example, icons labeled L1-L4 may be mapped to function keys F1-F4 on standard

PC keyboards, and icons C1-C3 may be mapped to perform as combinations of function keys, such as CTRL-F1, CTRL-F2, and CTRL-F3, respectively. In addition, the icons labeled L1-L4 and C1-C3 may include circular regions which may simulate light emitting diodes (LEDs) which indicate that the function or element represented by the respective icon is active or being performed.

Icons L1-L4 may represent each of 4 lines available to the caller, and icons C1-C3 may represent conference calls using at least one line to connect, for example, two or more parties in a conference call. The icons L1-L4 and C1-C3 may indicate the activity of each respective line or conference line. For example, as illustrated in FIG. 5, icons L1-L2 may have lightly shaded or colored circles, such as a green circle, indicating that each of lines 1 and 2 are in use, while icons L3-L4 may have darkly shaded or color circles, such as a red or black circle, indicating that each of lines 3 and 4 are not in use. Similarly, the lightly shaded circle of the icon labeled C2 indicates that the function corresponding to C2 is active, as additionally indicated in the status area 38, while darkly shaded circles of icons labeled C1 and C3 indicate that such corresponding functions are not active.

The icons 42 are used in conjunction with the status area 38. For example, using a mouse for input, a line that is in use, as indicated by the lightly colored circle of the icon, may be activated to indicate a party's name by clicking a right mouse button for 5 seconds until another mouse click is actuated or the [ESC] key or icon is actuated. Thus, the user may switch between multiple calls in progress on respective lines.

Using the icons as well as an input device such as a mouse, a user may enter the name or alias or IP address, if known, of a party to be called by either manually entering the name, by using the speedial feature, or by double clicking on an entry in a directory stored in the

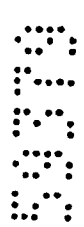

memory, such as the memory 16 of the first processing unit 12, where the directory entries may be scrolled using the status area 38 and the down arrow icon 40.

Once a called party is listed in the status area 38 as being active on a line, the user may transfer the called party to another line or a conference line by clicking and dragging the status area 38, which is represented by a reduced icon 46. Dragging the reduced icon 46 to any one of line icons L1-L4 transfers the called party in use to the selected line, and dragging the reduced icon 46 to any one of conference line icons C1-C3 adds the called party to the selected conference call.

Other features may be supported, such as icons 48-52, where icon 48 corresponds to, for example, an ALT-X command to exit the communication facility of a processing unit, and icon 50 corresponds to, for example, an ALT-M command to minimize or maximize the display screen 36 by the output device of the processing unit. Icon 52 corresponds to an OPEN command, which may, for example, correspond to pressing the O key on a keyboard, to expand or contract the display screen 36 to represent the opening and closing of a cellular telephone. An "opened" configuration is shown in FIG. 5, and a "closed" configuration is shown in FIG. 6. In the "opened" configuration, additional features such as output volume (VOL) controls, input microphone (MIC) controls, waveform (WAV) sound controls, etc.

The use of display screens such as those shown in FIGS. 5-6 provided flexibility in implementing various features available to the user. It is to be understood that additional features such as those known in the art may be supported by the processing units 12, 22.

Alternatively, it is to be understood that one skilled in the art may implement the processing units 12, 22 to have the features of the display screens in FIGS. 5-6 in hardware; i.e. a wired telephone or wireless

cellular telephone may include various keys, LEDs, liquid crystal displays (LCDs), and touchscreen actuators corresponding to the icons and features shown in FIGS. 5-6. In addition, a PC may have the keys of a keyboard and mouse mapped to the icons and features shown in FIGS. 5-6.

5

Referring to FIG. 7, the disclosed point-to-point Internet protocol and system 10 is illustrated. First processing unit 12 initiates the point-to-point Internet protocol in step 56 by sending a query from the first processing unit 12 to the connection server 26. If connection server 26 is operative to perform the point-to-point Internet protocol, in step 58, first processing unit 12 receives an on-line status signal from the connection server 26, such signal may include the IP address of the callee or a "Callee Off-Line" message. Next, first processing unit 12 performs the primary point-to-point Internet protocol in step 60, which may include receiving, at the first processing unit 12, the IP address of the callee if the callee is active and on-line. Alternatively, processing unit 60 may initiate and perform the secondary point-to-point Internet protocol in step 62, if the called party is not active and/or on-line.

10



15



20



25

Referring to FIG. 8, in conjunction with FIGS. 1 and 3-4, the disclosed point-to-point Internet protocol and system 10 is illustrated. Connection server 26 starts the point-to-point Internet protocol, in step 64, and timestamps and stores E-mail and IP addresses of logged-in users and processing units in the database 34 in step 66. Connection server 26 receives a query from a first processing unit 12 in step 68 to determine whether a second user or second processing unit 22 is logged-in to the Internet 24, with the second user being specified, for example, by an E-mail address. Connection server 26 retrieves the IP address of the specified user from the database 34 in step 70, if the specified user is logged-in to the Internet, and sends the retrieved IP address to the first

processing unit 12 in step 72 to enable first processing unit 12 to establish point-to-point communications with the specified second user.

The disclosed secondary point-to-point Internet protocol operates as shown in FIG. 9. First processing unit 12 generates an E-mail signal, including a session number and a first IP address corresponding to a first processing unit in step 76. First processing unit 12 transmits the E-mail signal as a <ConnectRequest> signal to the Internet 24 in step 78. The E-mail signal is delivered through the Internet 24 using a mail server 28 to the second processing unit 22 in step 80. Second processing unit 22 extracts the session number and the first IP address from the E-mail signal in step 82 and transmits or sends the session number and a second IP address corresponding to the second processing unit 22, back to the first processing unit 12 through the Internet 24, in step 84. First processing unit 12 verifies the session number received from the second processing unit 22 in step 86, and establishes a point-to-point Internet communication link between the first processing unit 12 and second processing unit 22 using the first and second IP addresses in step 88.

While the disclosed point-to-point Internet protocols and system have been particularly shown and described with reference to the preferred embodiments, it is understood by those skilled in the art that various modifications in form and detail may be made therein without departing from the scope and spirit of the invention. Accordingly, modifications such as those suggested above, but not limited thereto, are to be considered within the scope of the invention.

Throughout this specification and the claims which follow, unless the context requires otherwise, the word "comprise", and variations such as "comprises" and "comprising", will be understood to imply the inclusion of a stated integer or step or group of integers or steps but not the exclusion of any other integer or step or group of integers or steps.

The reference to any prior art in this specification is not, and should not be taken as, an acknowledgment or any form of suggestion that that prior art forms part of the common general knowledge in Australia.

10



THE CLAIMS DEFINING THE INVENTION ARE AS FOLLOWS:

1. Apparatus for establishing a point-to-point communication link said apparatus operating in a computer system operatively coupled to other computers
5 and a server over a computer network, said apparatus comprising:

a. means for transmitting, from the first process to a server a query as to whether a second process is connected to the computer network;

b. means for receiving a network protocol address of the
10 second process from the server when the second process is connected to the computer network; and

c. means, responsive to the network protocol address of the second process, for establishing a point-to-point communication link between the first process and the second process over the computer network.

15 2. The computer apparatus of claim 1 further comprising:

d. means for receiving audio data and transmitting the audio data to the second processor over the established point-to-point communication link.

20 3. An apparatus for use with a computer system capable of executing a first process and communicating with other processes, a directory server process and a mail server process over a computer network, the apparatus comprising:

A. program logic configured to determine the currently assigned network protocol address of the first process upon connection to the
25 computer network;

B. program logic configured to establish a communication connection with the directory server process once the assigned network protocol of the first process is known;

C. program logic configured to forward the assigned network protocol address of the first process to the directory server process upon establishing a communication connection with the directory server process; and

5 D. program logic configured to establish a point-to-point communication with another process over the computer network.

4. The apparatus of claim 3 wherein the program logic D further comprises:

8
9
10 D.1 program logic configured to transmit, from the first process to the directory server process, a query as to whether a second process is connected to the computer network; and

11
12
13 D.2 program logic configured to receive a network protocol address of the second process from the directory server process, when the second process is connected to the computer network.

15 5. The apparatus of claim 3 wherein the program logic D further comprises:

16
17
18 D.1 program logic configured to transmit an E-mail message containing a network protocol address from the first process to the mail server process over the computer network;

19
20 D.2 program logic configured to receive a second network protocol address from a second process over the computer network.

21
22
23
24 6. An apparatus for use with a computer system, the computer system capable of executing a first process connectable over a computer network to a second process and a directory database server process, the apparatus comprising:

25
26
27
28
29
30 a. program logic configured to access a directory database, the database having a network protocol address for a selected plurality of processes having on-line status with respect to the computer network, the network protocol address of each respective process forwarded to the database following connection to the computer network; and

b. program logic responsive to one of the network protocol addresses and configured to establish a point-to-point communication link from the first process to the second process over the computer network.

5 7. A computer program product for use with a computer system, the computer system executing a first process operatively connectable over a computer network to a second process and a server process, the computer program product comprising a computer useable medium having computer readable program code embodied therein, the program code comprising:

10 a. program code configured to access a directory database, the database having a network protocol address for a selected plurality of processes having on-line status with respect to the computer network, the network protocol address of each respective process forwarded to the database following connection to the computer network; and

15 b. program code responsive to one of the network protocol addresses and configured to establish a point-to-point communication link from the first process to the second process over the computer network.

20 8. A method of establishing a point-to-point communication between a first process and a second process, said method for use in a first computer process operatively coupled over a computer network to a second process and an address server, said method comprising:

A. following connection of the first process to the computer network forwarding to the address server a network protocol address at which the first
25 process is connected to the computer network;

B. querying the address server as to whether the second process is connected to the computer network;

C. receiving a network protocol address of the second process from the address server, when the second process is connected to the computer network;
30 and

D. in response to the network protocol address of the second process, establishing a point-to-point communication link with the second process over the computer network.

5 9. A method for establishing point-to-point communications with other processes, said method for use in a computer system capable of executing a first process and communicating with other processes and a server process over a computer network, said method comprising:

- 10 A. determining the currently assigned network protocol address of the first process upon connection to the computer network;
- B. establishing a communication connection with the server process once the assigned network protocol of the first process is known;
- 15 C. forwarding the assigned network protocol address of the first process to the server process upon establishing a communication connection with the server process; and
- D. establishing a point-to-point communication with another process over the computer network.

10. The method of claim 9 wherein the program step D comprises:

- 20 D.1 transmitting, from the first process to the server process, a query as to whether a second process is connected to the computer network; and
- D.2 receiving a network protocol address of the second process from the server process, when the second process is connected to the computer network.

25 11. A method of establishing a point-to-point communication between a first process and a second process, said method for use in a first computer process operatively coupled over a computer network to a second process and an address server, said method comprising:

a. accessing a directory database, the database having a network protocol address for a selected plurality of processes having on-line status with respect to the computer network, the network protocol address of each respective process forwarded to the database following connection to the computer network;
5 and

b. in response to one of the network protocol addresses, establishing a point-to-point communication link from the first process to the second process over the computer network.
10

12. A method of establishing a point-to-point communication between a first process and a second process, said method for use in a first computer process operatively coupled over a computer network to a second process and an address server, said method comprising:

15 a. transmitting to the server a network protocol address received by the first process following connection to the computer network;

b. transmitting, to the server, a query as to whether the second process is connected to the computer network;

c. receiving a network protocol address of the second process from the
20 server, when the second process is connected to the computer network; and

d. in response to the network protocol address of the second process, establishing a point-to-point communication link between the first process and the second process over the computer network.

25 13. An apparatus capable of executing a first process and connecting to other processes and a server process over a computer network, the apparatus comprising:

a. program logic configured to generate a user-interface enabling control of a first process executing on the computer system;

30

b. program logic configured to determine the currently assigned network protocol address of the first process upon connection to the computer network;

5 c. program logic, responsive to the currently assigned network protocol address of the first process, and configured to establish a communication connection with the server process and to forward the assigned network protocol address of the first process to the server process upon establishing a communication connection with the server process; and

10 d. program logic, responsive to user input commands, and configured to establish a point-to-point communications with another process over the computer network.

14. The apparatus of claim 13 wherein the program logic configured to establish a point-to-point communication link further comprises:

15 d.1 program logic, responsive to the network protocol address of a second process, and configured to establish a point-to-point communication link between the first process and the second process over the computer network.

15. The apparatus of claim 14 wherein the program logic configured to establish a point-to-point communication link further comprise:

d.2 program logic configured to transmit, from the first process to the server process, a query as to whether the second process is connected to the computer network; and

25 d.3 program logic configured to receive a network protocol address of the second process from the server process, when the second process is connected to the computer network.

16. An apparatus for use with a computer system, the computer system executing a first process operatively coupled over a computer network to a second process and a directory database server process, the apparatus comprising:

A. program logic configured to, following connection of the first process to the computer network, forward to the address server a network protocol address at which the first process is connected to the computer network;

5 B. program logic configured to query the address server as to whether the second process is connected to the computer network;

C. program logic configured to receive a network protocol address of the second process from the address server, when the second process is connected to the computer network; and

10 D. program logic configured to, in response to the network protocol address of the second process, establish a point-to-point communication link with the second process over the computer network.

17. Apparatus for establishing a point-to-point communication link, said apparatus operating in a computer system capable of executing a first process and
15 operatively connectable to other processes and a server over a computer network, said apparatus comprising:

a. means for transmitting, from the first process to the server, a query as to whether a second process is connected to the computer network;

20 b. means for receiving a network protocol address of the second process from the server when the second process is connected to the computer network; and

c. means, responsive to the network protocol address of the second process, for establishing a point-to-point communication link between the first process and the second process over the computer network.

25

18. A computer data signal embodied in a carrier wave comprising:

program code for transmitting to a server a network protocol address received by a first process following connection to a computer network;

30 program code for transmitting, to the server, a query as to whether a second process is connected to the computer network;

program code for receiving a network protocol address of the second process from the server, when the second process is connected to the computer network; and

5 program code, responsive to the network protocol address of the second process, for establishing a point-to-point communication link between the first process and the second process over the computer network.

19. A computer program product for use with a computer system, the computer system executing a first process and operatively connectable to a second process
10 and a server over a computer network, the computer program product comprising a computer useable medium having program code embodied in the medium, the program code comprising:

program code for transmitting to the server a network protocol address received by the first process following connection to the computer network;

15 program code for transmitting, to the server, a query as to whether the second process is connected to the computer network;

program code for receiving a network protocol address of the second process from the server, when the second process is connected to the computer network; and

20 program code, responsive to the network protocol address of the second process, for establishing a point-to-point communication link between the first process and the second process over the computer network.

20. Apparatus substantially as hereinbefore described with reference to the
25 accompanying drawings.

21. A computer program product substantially as hereinbefore described with reference to the accompanying drawings.

30 22. A method substantially as hereinbefore described with reference to the accompanying drawings.

23. A computer data signal substantially as hereinbefore described with reference to the accompanying drawings.

5

DATED this 8th day of September 2000

NetSpeak Corporation
By its Patent Attorneys
DAVIES COLLISON CAVE

10

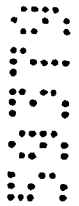

13 00 00 5079

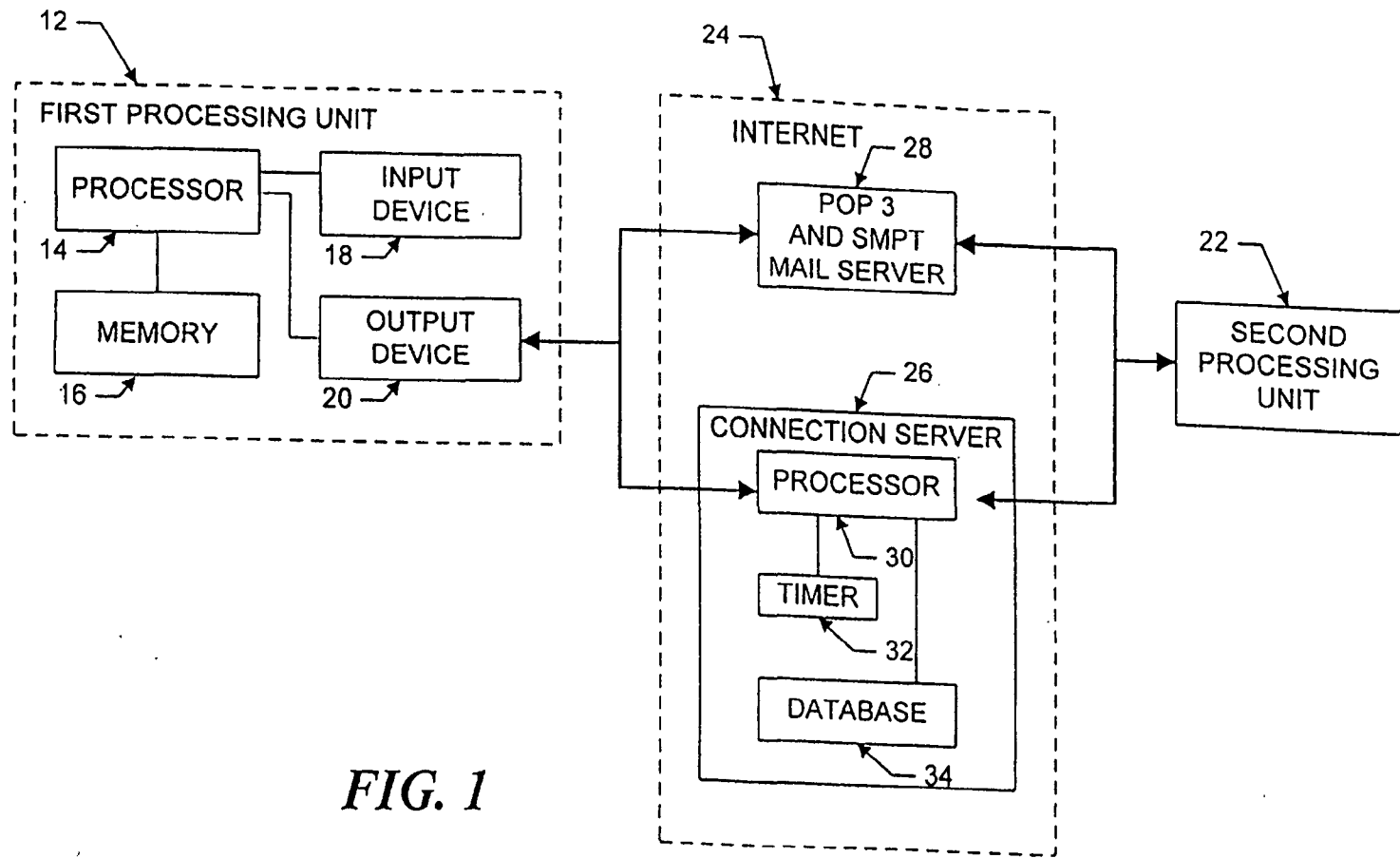

FIG. 1

13 09 00 59379

2/6

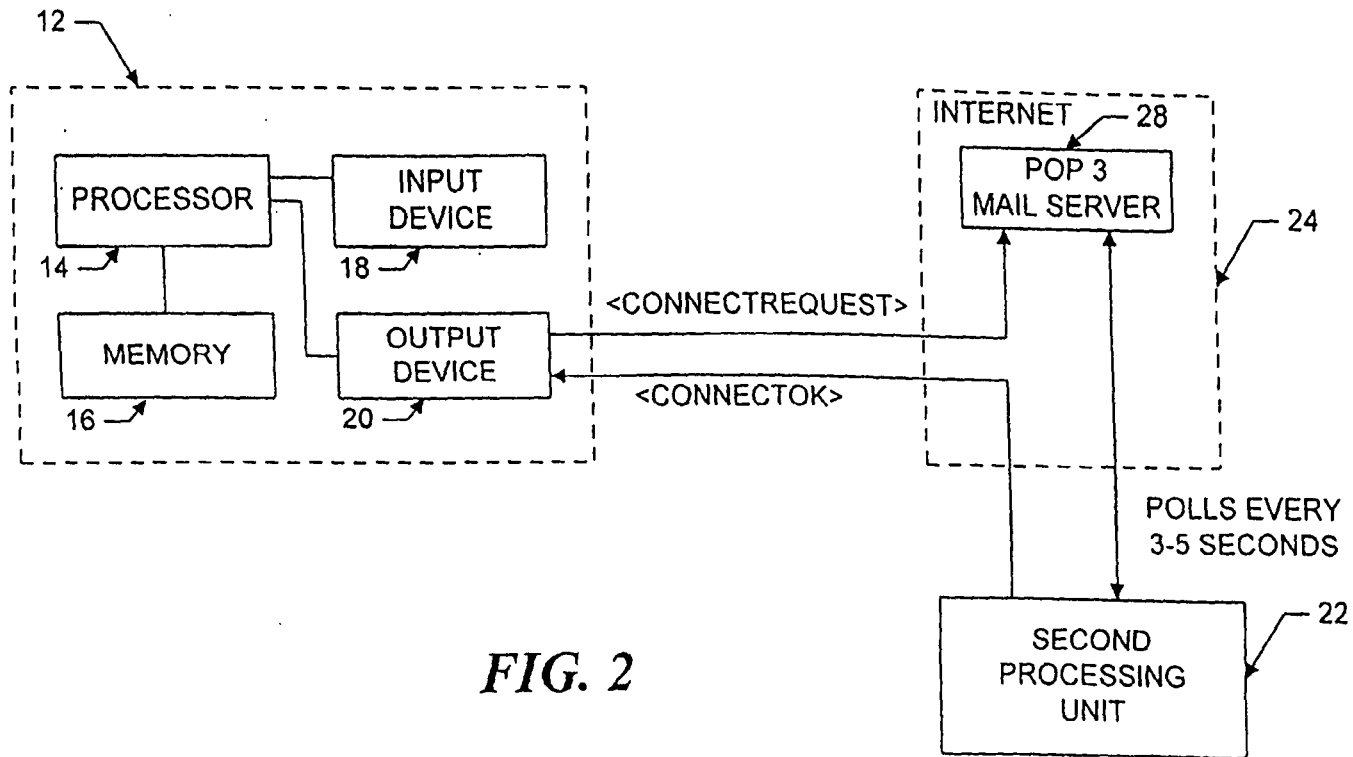

FIG. 2

13 00 00 50379

3/6

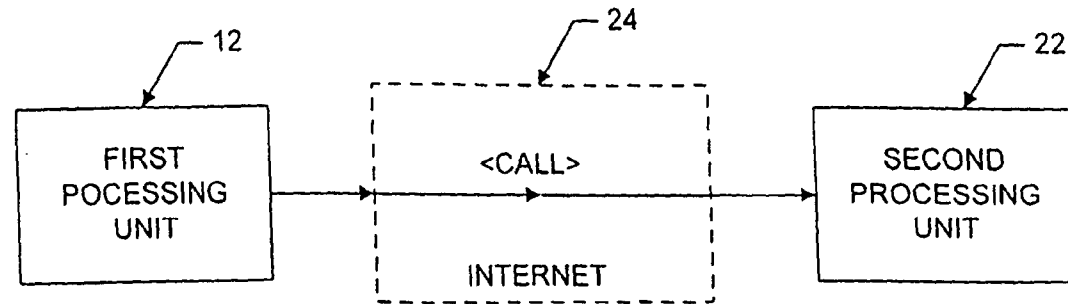

FIG. 3

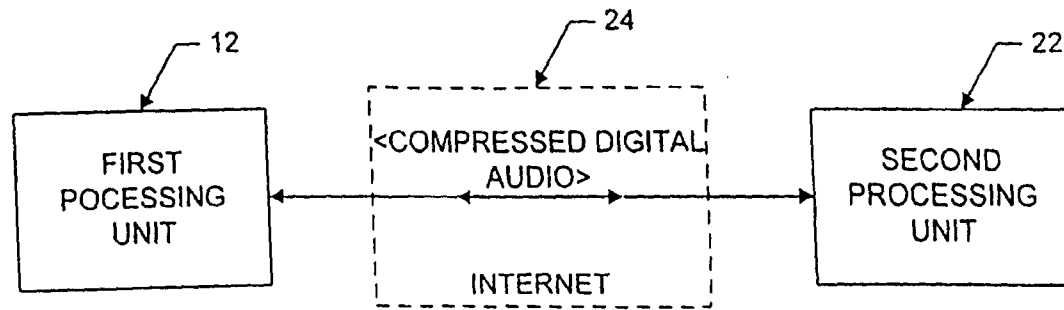

FIG. 4

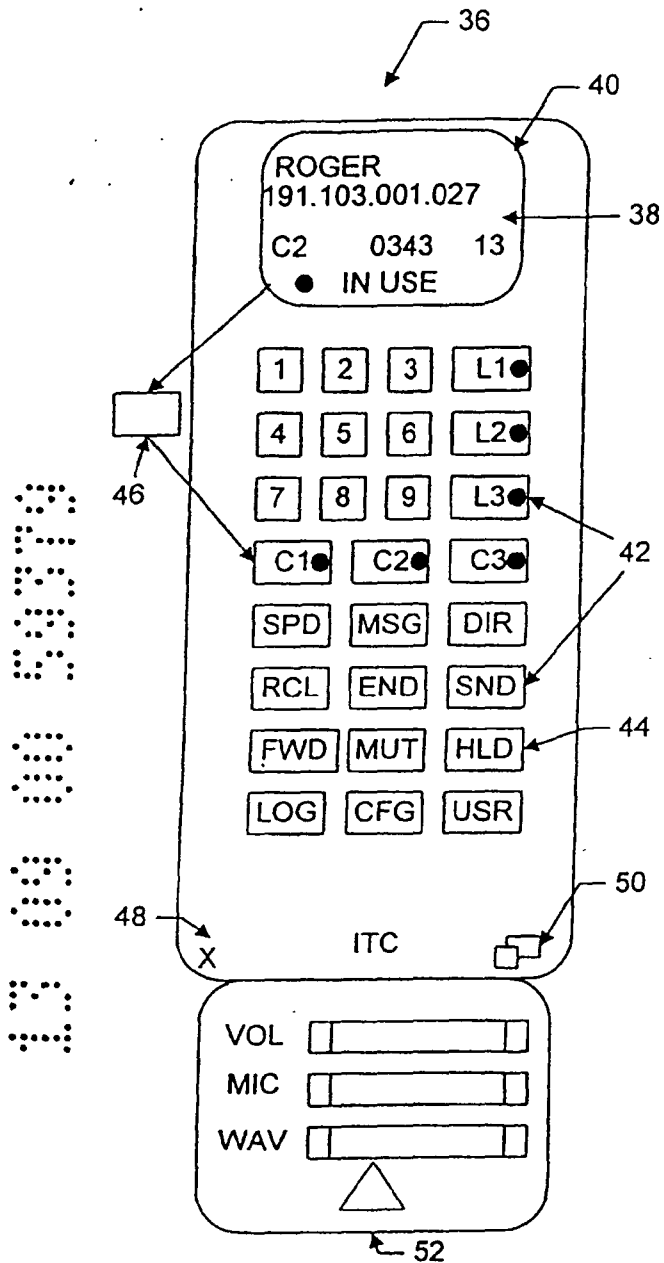

FIG. 5

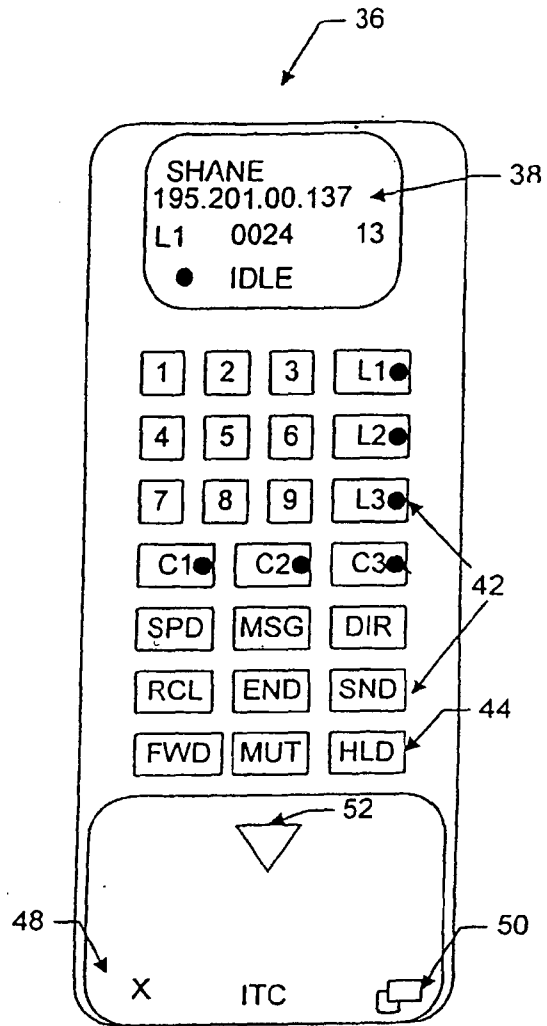

FIG. 6

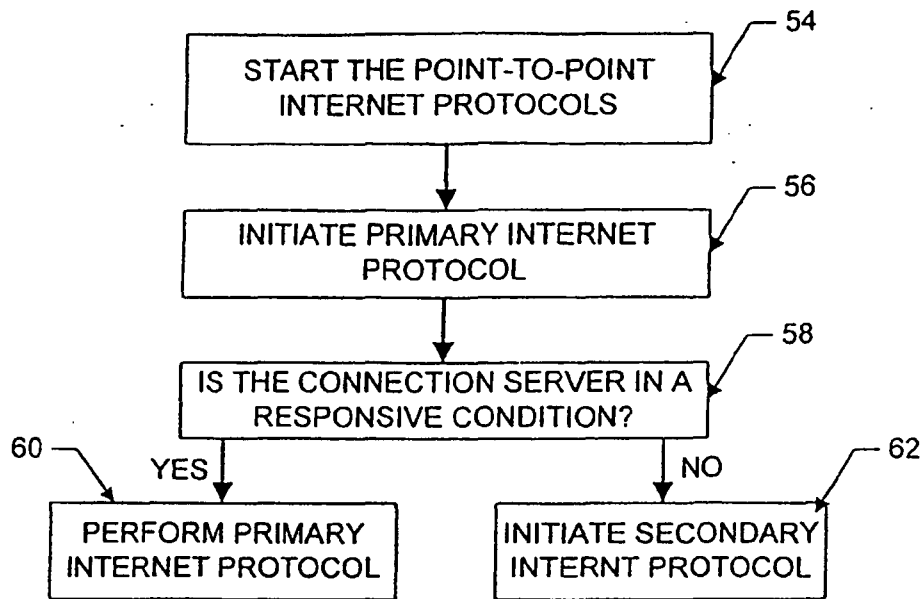

FIG. 7

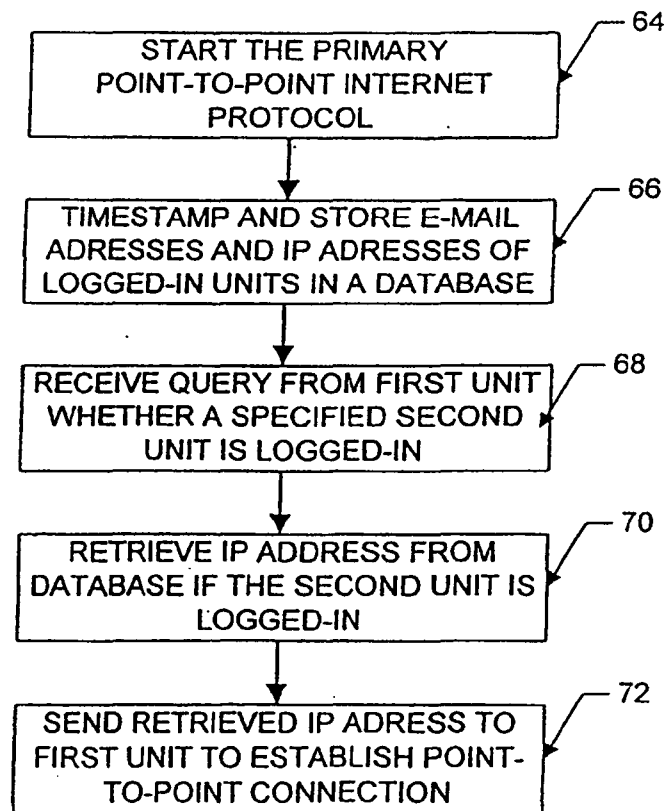

FIG. 8

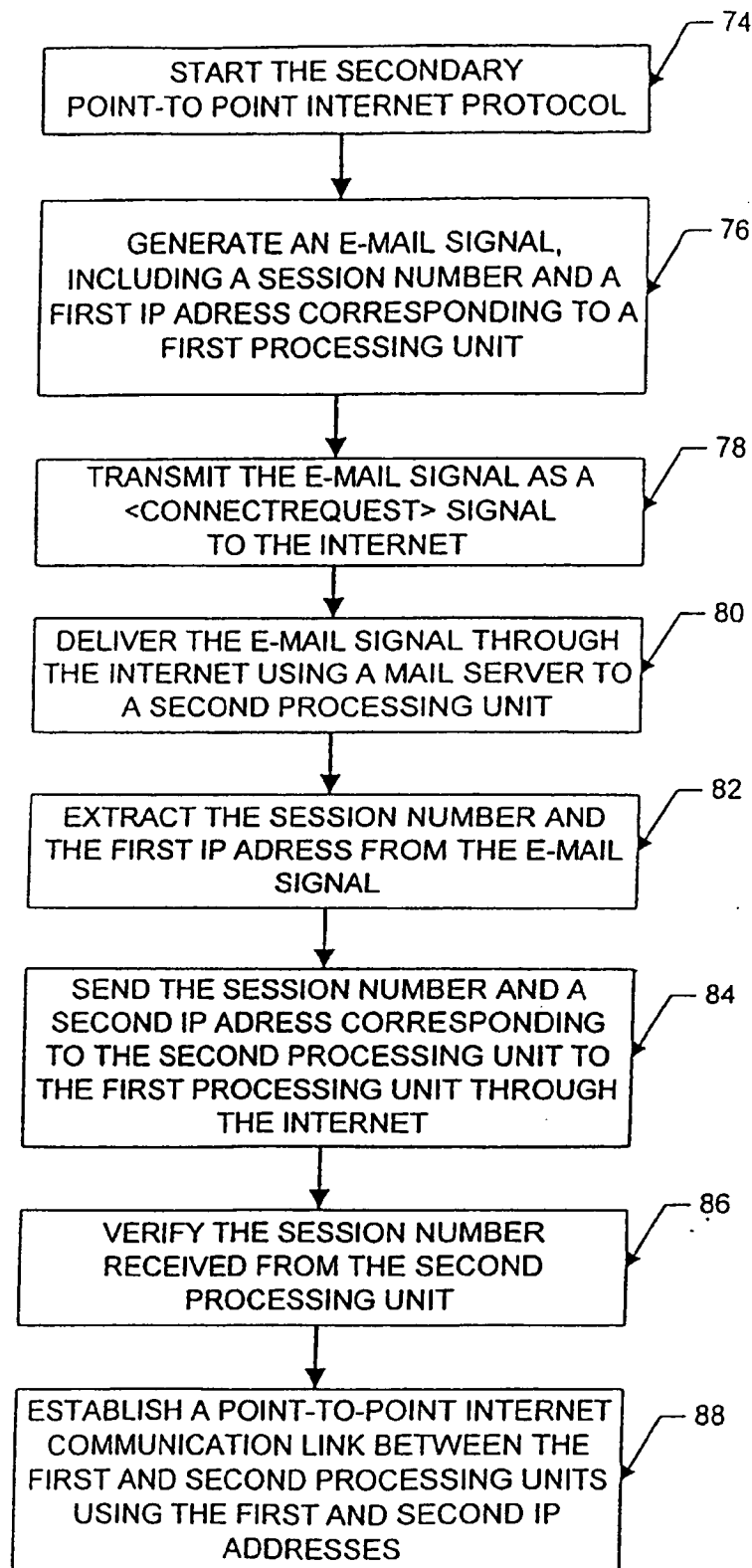

FIG. 9



EUROPEAN PATENT APPLICATION

Application number : **92305234.4**

Int. Cl.⁵ : **H04L 12/46**

Date of filing : **08.06.92**

Priority : **14.06.91 US 716041**

Inventor : **Perlman, Radia J.**
10 Huckleberry Lane
Acton, Massachusetts 01720 (US)

Date of publication of application :
16.12.92 Bulletin 92/51

Designated Contracting States :
DE FR GB IT

Representative : **Goodman, Christopher et al**
Eric Potter & Clarkson St. Mary's Court St.
Mary's Gate
Nottingham NG1 1LE (GB)

Applicant : **DIGITAL EQUIPMENT CORPORATION**
146 Main Street
Maynard, Massachusetts 01745 (US)

Router using remote address resolution to enable bridge like data forwarding.

(57) A communications system has a first communications link (110) and a second communications link (112), at least one end station (111,113) capable of communicating on each of the communications links, an apparatus (100) for forwarding a packet from the first link to the second link, the apparatus capable of detecting a network layer header on a data packet, the network layer header having a destination address. There is assigned, to the apparatus, an apparatus mask having a forwarding mask length for distinguishing the destination address into a subnet address part and into a host address part. Also there is assigned, to an end station, an end station mask having an end station mask length for distinguishing the destination address into a subnet address part and into a host address part. And there is assigned a greater length to the forwarding mask length than to the end station mask length, to enable the end station in using the end station mask to identify all end stations on the first link and the second link as being on a single link, and to enable the apparatus in using the forwarding mask to distinguish which of the first link or the second link an end station addressed by the network layer address is located.

A selected end station transmits an Address Request Protocol (hereinafter ARP) message onto the first communications link, the ARP message requesting a data link address from a receiving end station, and the apparatus sends the ARP message to a second forwarding apparatus connected to the second link having the receiving end station connected thereto. The apparatus receives an ARP response message containing the data link address of the receiving end station from the second forwarding apparatus. And finally, the apparatus forwards the ARP response message to the selected end

station. The forwarding apparatus forwards a data packet as a bridge in the event that a data link address in a message packet is not a data link address of the apparatus. The forwarding apparatus forwards a data packet as a router in the event that a data link address in the message packet is a data link address of the apparatus.

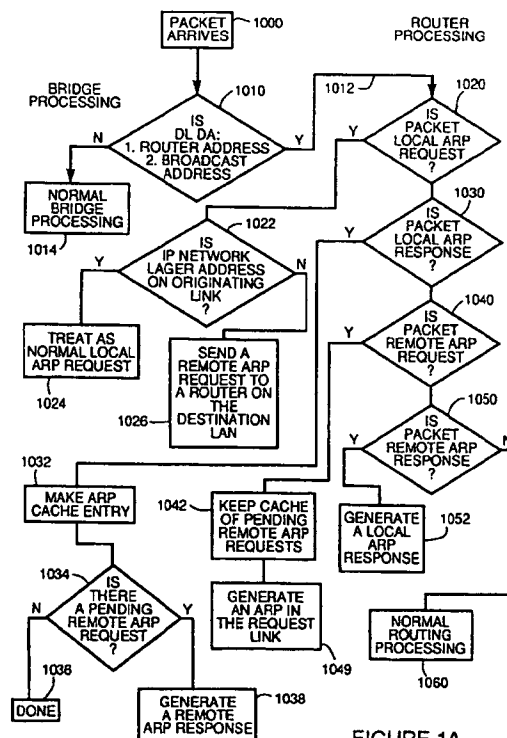

FIGURE 1A

EP 0 518 596 A1

FIELD OF THE INVENTION

This invention relates to forwarding messages from a first link to another link, and more particularly relates to reducing the time required to forward data packets.

BACKGROUND OF THE INVENTION

Communications systems between computers are presently capable of connecting tens of thousands of computers. Typically, a computer will originate a message directed to another computer, and will transmit the message as a sequence of data packets onto the communications system. Because of the large number of computers connected to the system, and the large number of data packets transferred between the computers, throughput of packets transferred by the system is an important issue.

Communications systems are often divided into a number of links. Typically, a link may be a local area network, where each local area network is capable of supporting a few hundred computers. A local area network will hereinafter be referred to as a LAN. The LANs are connected together by a number of different standard devices which forward packets. With the increasingly large size of modern communications systems, the time required to forward a data packet between LANs becomes an important parameter of system design.

Other types of links in a communications system may be, for example, a wide area network formed by joining other links such as LANs, a point to point connection between computers, etc. Maintaining high throughput of system packet traffic is also an important problem in all link to link connections.

Also, all types of links may be connected together by standard devices.

Before discussing standard devices used to connect links together, data packets and the headers of data packets added by different layers of the communications protocol must be discussed. A data packet is typically formed in a higher level of the communications protocol, and finally is transferred down to the Transport Layer which passes the packet into the Network layer. The Network layer attaches a header, the Network Layer Header, to the data packet, and then passes the packet into the Data Link Layer. The Data Link Layer then attaches a header, the Data Link Layer Header, to the data packet. The packet is then transmitted onto the communications system by the physical layer.

A packet, once transmitted onto the communications system, is then forwarded from link to link until it reaches its destination end station.

A first type of device connecting links of the communications system is a bridge. A bridge operates in the Data Link level of the communications protocol,

which is the level immediately above the physical level. A bridge receives data packets from one link, typically a LAN, and then parses the Data Link Header. The bridge then makes a decision on what to do with the data packet, where the decision is based upon the contents found in the Data Link Header.

A second type of device linking LANs is a router. A router operates in the network layer, a layer above the data link layer. A router operates by parsing both the Data Link Header and the Network Layer Header, and making decisions based on the contents of both headers.

In some designs a bridge may be on the order of 200 times faster than a router in forwarding a data packet from a first link to a second link.

Even though a router is slower in forwarding packets from one link, such as a LAN, to another link, it is necessary to use routers rather than bridges at certain locations between multiple numbers of links. The router performs functions beyond those of a bridge, such as: forwarding along better routes than a bridge; incrementing a "hop count" field of a forwarded packet to show the number of passes of the packet through a router in order to prevent indefinite looping of the packet; preventing certain management traffic such as "hello" messages from end stations on one link from being forwarded to the other link; maintaining "network layer addresses" of stations on the links that it connects; fragmentation and reassembly of packets because of different protocols employed by different links; performing explicit handshaking protocols with end stations connected to links connected to the router; participating in routing algorithms, and other functions.

However, a difficulty in operation of large computer communications networks is that the time required for a router to forward messages may result in lower throughput.

SUMMARY OF THE INVENTION

The invention resides in an apparatus for forwarding packets, and solves the difficulty of a router requiring too much time for forwarding a packet, along with the difficulty of a bridge increasing address request protocol (ARP) traffic by forwarding ARP messages.

A communications system has a first communications link and a second communications link, at least one end station capable of communicating on each of the communications links, an apparatus for forwarding a packet from the first link to the second link, the apparatus capable of detecting a network layer header on a data packet, the network layer header having a destination address. There is assigned, to the apparatus, an apparatus mask having a forwarding mask length for distinguishing the destination address into a subnet address part and into a host address part. Also there is assigned, to an end station, an end sta-

tion mask having an end station mask length for distinguishing the destination address into a subnet address part and into a host address part. And there is assigned a greater length to the forwarding mask length than to the end station mask length, to enable the end station in using the end station mask to identify all end stations on the first link and the second link as being on a single link, and to enable the apparatus in using the forwarding mask to distinguish which of the first link or the second link an end station addressed by the network layer address is located.

Also there is a first means for a selected end station to transmit a local Address Request Protocol (hereinafter ARP) request message onto the first communications link, the local ARP request message requesting a data link address of a receiving end station. Further, there is a second means, in response to the local ARP request message, for the apparatus to create a remote ARP request message and to send the remote ARP request message to a second forwarding apparatus connected to the second link having the receiving end station connected thereto. There is also a third means for the apparatus to receive a remote ARP response message containing the data link address of the receiving end station from the second forwarding apparatus. And there is a fourth means, responsive to the remote ARP request message, for the apparatus to create a local ARP response message and to send the local ARP response message to the selected end station.

The forwarding apparatus forwards a data packet as a bridge in the event that a data link address in a message packet is not a data link address of the apparatus.

The forwarding apparatus forwards a data packet as a router in the event that a data link address in the message packet is a data link address of the apparatus.

BRIEF DESCRIPTION OF THE DRAWINGS

A more detailed understanding of the invention may be had from the following description of preferred exemplary embodiments to be understood in conjunction with the accompanying drawing wherein:

Fig. 1 is a logic diagram of two LANs connected by a router in accordance with a preferred embodiment of the invention.

Fig. 1A is a flow chart of a brox in accordance with the invention.

Fig. 2 is a field diagram of a data packet in accordance with a preferred embodiment of the invention.

Fig. 3A is field diagram of an address field.

Fig. 3B is a field diagram of a mask for an address field.

Fig. 3C is a field diagram of a mask for an address field.

Fig. 4 is a block diagram of a communications

system having multiple links, in accordance with the invention.

Fig. 5 is a field diagram of an address in accordance with the invention.

Fig. 6A is a field diagram of an address in accordance with a preferred embodiment of the invention.

Fig. 6B is a field diagram of a bridge router box (brox) mask in accordance with a preferred embodiment of the invention.

Fig. 7A is a field diagram of an address in accordance with a preferred embodiment of the invention.

Fig. 7B is a field diagram of an end station mask in accordance with a preferred embodiment of the invention.

Fig. 8 is a block diagram of a communications system in accordance with the invention.

DETAILED DESCRIPTION

FIRST EXEMPLARY EMBODIMENT

Capitalization will be used in this document to highlight names of fields of a packet, in order to improve readability of the document.

Referring now to Fig. 1, there is shown a communications link connection apparatus 100, a "brox", in accordance with the invention. The term "brox" is coined herein, and is defined as a box for connecting communications links in accordance with the present invention. A brox forwards as a router under certain conditions, but under other conditions forwards as a bridge. The word "brox" is an acronym (created from the capitalized letters Bridge Router bOX) for a box that behaves as a bridge or as a router. Also a brox may have behavior modes that are neither those of a standard bridge nor those of a standard router.

For a multiple hop data packet transmission, operation of the invention can be described in simple terms for a network using a Transmission Control Protocol-Internet Protocol (TCP-IP) type protocol as follows. TCP-IP is a well known protocol suite which has been developed in the United States. The present invention works particularly well with the TCP-IP protocol, but will also work with similar protocols.

But first, a TCP-IP type of protocol will be briefly described. In a TCP-IP type protocol, a destination address in the Network Layer Header of a packet is resolved into a subnet address and a host address by applying a mask to the total address. A mask is assigned to a link. A station is configured with a network layer address and a mask for each link to which the station is attached. The mask has as many bit positions as the address in the packet.

The mask has some bits set equal to "1", and some bits set equal to "0". The bits of the mask that equal "1" correspond to bits of the address that identify the link. The bits of the mask that equal "0" correspond to bits of the address that identify the host, or

end station, on that link.

For example: in the event that the network layer address is 32 bits (or 4 octets), then the mask is also 32 bits; in the further event that the mask has 16 bits set =1, and 16 bits set =0, then the station interprets the bits in the address corresponding to the bits =1 of the mask as identifying the link. The bits in the address corresponding to "0s" in the mask identify the host, or end station, on that link.

As further example, if the first two octets of the mask contain 8 bits =1 each, and the second two octets of the mask contain all bits =0, then the address of the link is contained in the two octets of the address corresponding to the bits =1 of the mask. Also, the host, or station, address on that link is contained in the address bits corresponding to the bits =0 of the mask.

Terminology used in the art of computer communications will now be addressed. The terms "link" and "subnet" are substantially synonyms. Also, the terms "host" and "end station" are substantially synonyms. The terms "link" and "end station" are frequently used in discussions of OSI standard type computer communications systems. The terms "subnet" and "host" are frequently used in discussions of TCP-IP type computer communications systems. A link or a subnet may be a local area network, or may be another type of system for computer communications. A host or end station is the computer attached to the link or the subnet.

A further standard feature of a TCP-IP type protocol is that when an initiating station initiates a transmission to an intended receiving station, the initiating station "knows" only the Network Layer address of the intended receiving station. In order to "learn" the Data Link Layer address of the intended receiving station, the initiating station transmits an Address Request Protocol (ARP) message. A bridge forwards the ARP message, but a router ignores the ARP message. In the event that the intended receiving station receives the ARP message, either by being on the same link as the station or by having the ARP request bridged to the link containing the intended receiving station, then the intended receiving station sends to the initiating station an ARP response containing the Data Link Layer address of the intended receiving station. Upon receipt of the ARP response, the initiating station sends data packets to the intended receiving station by placing the Data Link Layer address learned from the ARP response into the Data Link Header of the data packets.

Also, as a standard practice in a TCP-IP type protocol, an initiating station first tests the Network Layer address of the intended receiving station against its own Network Layer address. Each station on the communications link of the initiating station has the same subnet address, and so the initiating station tests the subnet address of the intended receiving station against the subnet address its own subnet address.

In the event that the two subnet addresses are equal, the initiating station transmits an ARP message.

In the event that the two subnet addresses are different, then the initiating station transmits a data packet to a router connected to the communications link of the initiating station. The router maintains a forwarding table, and so "knows" the communications link containing the intended receiving station. The router then forwards the data packet to the proper link, where a further router places the Data Link Layer address of the intended receiving station into the Data Link Layer Header of the data packet, and forwards the data packet onto the proper link for receipt by the intended receiving station. The originating station does not learn the data link address of the receiving station.

Turning now to a simple discussion of the invention, both the router and the bridge are replaced with the "brox" of the invention. Also, in the invention, the network layer addresses of the end stations on the various links are carefully chosen so that all end stations on all links connected by the invention have in their network layer address: firstly, a sequence of bits that are identical for all end stations attached to any of the links connected by broxs; secondly, a sequence of bits that are identical for stations on a single link, but different for stations on other links; and, thirdly, a sequence of bits that are unique among stations on any one link.

The forwarding apparatus of the invention is the brox. A brox has assigned a mask that exposes both the sequence of identical bits and the sequence of unique bits. In contrast, the end stations have a shorter mask that exposes only the sequence of identical bits.

All end stations linked by the invention have the same sequence of identical bits. Accordingly, when an initiating station tests the network layer address of the intended receiving station against its own network layer address in order to determine if the initiating station has permission to send a local ARP message, then permission to send a local ARP message will be granted for an intended end station linked by the invention, whether the intended end station is on the same link as the initiating station or whether it is on a different link.

Also in the invention it is important to distinguish four (4) different types of ARP messages. These four different types of ARP messages are:

1. a local ARP request. A local ARP request is transmitted by an end station onto a link connected to the end station. A local AR request asks for a data link address of an intended destination station. A local ARP request is identical to the standard TCP-IP compatible ARP request discussed hereinabove.
2. a local ARP response. A local ARP response

is received by an end station, and the local ARP response delivers a data link address to the end station. A local ARP response is identical to the standard TCP-IP ARP response discussed hereinabove.

3. a remote ARP request. A remote ARP request is created by a brox on the link of an originating end station, and is created by the brox in response to receipt by the brox of a local ARP request. The remote ARP request is transmitted to a remote brox on the link of a remote intended destination station.

4. a remote ARP response. A remote ARP response is created by a remote brox on the link of a remote intended destination station, and is created in response to the remote brox receiving a local ARP response. The remote ARP response is transmitted to a brox on the link of the originating end station, and in response to receiving the remote ARP request, the brox creates and transmits a local ARP response to the originating end station.

By carefully choosing the addresses of all end stations linked by the invention, by using broxs for forwarding between the various links, and by using short masks for stations and long masks for broxs, useful results flow from the invention. The first useful result is that data packets are forwarded at bridge speed between end stations linked by the invention. A second useful result is that local ARP traffic on one link is confined to that link and is not forwarded as it would be if the links were joined by a conventional bridge. A third useful result is that all links joined by the invention may be reached by remote ARP messages generated in response to any end station on any of the links, without flooding every link with unnecessary local ARP messages.

Forwarding rules followed by a brox may be summarized as follows:

1. in the event that the brox recognizes the address found by parsing the Data Link Destination Address field of a packet as an address used by that brox, then the brox receives the packet and functions as a router.
2. in the event that the brox does not recognize the destination address found by parsing the Data Link header as an address of the brox, then the brox bridges the packet.
3. in the event that the brox recognizes the packet as a local ARP request, and the intended destination end station is on a remote link as determined by the brox using its long mask, then the brox creates a remote ARP request and sends it to a brox on the link of the intended destination end station.
4. later the brox receives a remote ARP response from a brox attached to the link of the intended destination end station. The brox then creates a

local ARP response in response to the original local ARP request. The local ARP response contains the data link layer address of the intended receiving end station. The brox then transmits the local ARP response onto the link having the originating end station. The local ARP response is received by the originating end station, and so the originating end station learns the data link address of the intended destination station.

A significant benefit of the invention is that, once the originating end station learns the data link address of the intended destination end station, forwarding of later sent data packets is at bridge speed, rather than router speed. The forwarding delay at each brox, in some designs, may be as much as 200 times less when the brox functions as a bridge rather than as a router. Accordingly, the invention greatly speeds forwarding of data packets.

Referring now to Fig. 2, there is shown a typical field structure for a data packet used by an end station of LAN 110, 112 shown in Fig. 1. Data packet 120 is shown having a Data Link Header 122 and a Network Layer Header 124. When data packet 120 is created and transmitted onto a LAN, the network layer attaches Network Header 124 to the packet, and then the packet is handed down to the data link layer. The data link layer then attaches the Data Link Header 122 to the packet. Upon transmission, data packet 120 may have additional fields preceding the Data Link Header 122 such as, for example, preamble fields, and the precise structure of such preamble fields will depend upon the standard to which LAN 110 is designed. Such preamble fields are not shown in Fig. 2, as Fig. 2 focuses on those fields used by the invention.

Data Link Header 122 contains Data Link Destination Address field 126, and Data Link Source Address field 128. Other Data Link Header fields 130 are also shown in Fig. 2, but are not further described herein in that the invention focuses on the Data Link Destination Address field 126 and the Data Link Source Address field 128 of the Data Link Header 122. Data Link Destination Address field 126 is abbreviated DL D. Data Link Source Address field 128 is abbreviated DL S.

Network Layer Header 124, as shown in Fig. 2, has: Network Layer Destination address field 140, NL D field 140; Network Layer Source address field 142 NL S; and other fields 144. Also, data fields 146 follows the Network Layer Header 124. The Network Layer Destination Address field 140 is abbreviated NL D. The Network Layer Source address field 142 is abbreviated NL S.

In exemplary network designs, the Network Layer Destination address field 140 and the Network Source Layer field 142 may each be assigned a fixed length. The length is often expressed in terms of octets. An octet is a data structure that is ordinarily 8 bits long. For example, in a TCP-IP compatible network both

the Network Layer Destination Address field 140 and the Network Layer Source Address field 142 are assigned a length of 32 bits, or 4 octets each.

Turning now to Fig. 1A, there is shown a flow chart of the logic of an exemplary brox 100. At block 1000 the packet arrives at the brox. Control passes to decision block 1010 where the packet data link destination address contained in the Data Link Destination Address field 126 of the packet is determined. Then, the packet data link destination address is tested in order to determine if it is either a router address or a broadcast address used by a router. In the event that decision block 1010 answers "yes", the packet data link destination address is either a router address or a broadcast address, then control passes to line 1012 for router type processing.

In the event that decision block 1010 answers "no", then control passes to block 1014 where the packet is further processed by normal bridge forwarding.

Router processing proceeds along line 1012 to a series of decision blocks, block 1020, block 1030, block 1040, and block 1050. At these decision blocks the type of packet is determined.

At block 1020 the packet is tested in order to determine if it is a local ARP request, and in the event that it is, decision block 1020 answers "yes", and control passes to decision block 1022 for handling as a local ARP request. In the event that decision block 1020 answers "no", then control passes to decision block 1030.

At decision block 1030 the packet is tested in order to determine if it is a local ARP response, and if it is decision block 1030 answers "yes", then control passes to block 1032 for further processing as a local ARP response. In the event that decision block 1030 answers "no", then control passes to decision block 1040.

At decision block 1040 the packet is tested in order to determine if it is a remote ARP request, and if it is decision block 1040 answers "yes", then control passes to block 1042 for processing as a remote ARP request. In the event that decision block 1040 answers "no", then control passes to decision block 1050.

At decision block 1050 the packet is tested in order to determine if it is a remote ARP response, and if it is decision block 1050 answers "yes", then control passes to block 1052 for further processing as a remote ARP response. In the event that decision block 1050 answers "no", then control passes to block 1060.

At block 1060 the packet is forwarded to the proper link in accordance with normal routing processing.

We return to discuss the processing in the event that the packet tested with a "yes" at decision blocks 1020, 1030, 1040, and 1050.

First we discuss processing in the event that de-

cision block 1020 answers "yes", the packet is a local ARP request, and control passes to decision block 1022. A branch to decision block 1022 means that a host on a link connected to the brox issued a local ARP request. At decision block 1022 the packet is tested in order to determine if the network layer address of the intended destination host is on the originating link, and if it is decision block 1022 answers "yes", then processing branches to block 1024. At block 1024 the packet is treated as a normal local ARP request.

In the event that decision block 1022 answers "no", the packet network layer destination address is not on the originating link, then control passes to block 1026. At block 1026 the brox sends a remote ARP request to a brox or router on the destination LAN.

Next we discuss processing in the event that the packet is a remote ARP request as determined by a "yes" response at decision block 1040, where control passed to block 1042. At block 1042 a cache entry is made to record that a pending remote ARP request has been received. Control then passes to block 1044 where a local ARP request is generated on the relevant link, where the link is connected to a port of the brox. Processing in blocks 1042 and 1044 means that the brox is the remote brox in a remote ARP request.

Next we discuss processing in the event that the packet is a local ARP response, that is that decision block 1030 answered "yes", and processing passed to block 1032. At block 1032 an entry is made into the cache of pending remote ARP requests, and control passes to decision block 1034. At decision block 1034 the question, "Is there a pending remote ARP request that matches this local ARP response?" is asked, and in the event that the answer is "no", then control passes to block 1036 where processing of this packet stops because processing is done.

In the event that decision block 1034 answers "yes", there is a matching pending remote ARP request, then control passes to block 1038. At block 1038 the brox generates a remote ARP response message and sends the response to the originating brox.

Next we discuss processing in the event that decision block 1050 answered "yes", the packet is a remote ARP response, and control passes to block 1052. At block 1052 the brox generates a local ARP response and transmits it onto the relevant link connected to the brox. Processing at block 1052 means that the brox originally generated a remote ARP request, now the remote ARP response has arrived, and the remote ARP response is used to create a local ARP response directed to the originating host.

Normal operation of a bridge and normal operation of a router will now be described.

Bridges

The Data Link Header 122 contains a number of fields, and the fields principally used by the bridge are: the Data Link Destination Address field 126; and, the Data Link Source Address field 128 (Fig. 2).

The bridge compares the address found in the Data Link Destination Address field with a forwarding table maintained in a database contained in the bridge, and also compares the contents of the Data Link Source Address field of the packet with a list of source addresses maintained for each link connected to the bridge. The bridge then, typically makes forwarding decisions based upon the contents of these fields.

Typical design rules for operation of a bridge are as follows, and include both rules for receipt of a packet and rules for forwarding a packet.

For receipt of a packet, a bridge tests the contents of the Data Link Destination Address field of the packet against internally maintained forwarding tables.

For forwarding, the bridge decides what to do with the packet, for example, as follows. Typically, for a bridge that uses the flooding and backward learning algorithm, the bridge makes the following decisions, based upon the contents of the Data Link Destination Address field of the packet: if the packet Data Link Destination Address is in the forwarding table of a link attached to the bridge, then forward the packet to the proper link, except, if the packet destination is on the link from which the packet originated, then disregard the packet; and, if the destination address is not in the forwarding table, then flood the packet to all of the links connected to the bridge, but not the link from which the packet originated. Also, typically, a bridge forwards packets having certain multicast or broadcast addresses in their Data Link Destination Address field, such as end station hello messages. A bridge attempts to make the links that it joins together operate as an extended LAN.

Also, if the content of the Data Link Source Address field of the packet is absent from the bridge forwarding tables, then the bridge adds to its appropriate forwarding table a correlation between the address contained in the Data Link Source Address field of the packet and the link from which the packet arrived. Any subsequent packets addressed to that address are then forwarded onto the correlated link. By updating its forwarding table using the arrival link of unknown packets, a bridge learns the correlation between arrival links and the source address of end stations either on those links or connected to those links from other links, and thereby builds up entries into its forwarding tables. Further, for example, there are many other ways that entries in a bridge forwarding table may be compiled.

Routers

A router receives a packet in the event that the Data Link Destination Address field DL D 126 of the packet contains the data link address of the router or a special multicast address used by routers, otherwise the router ignores the packet.

In the event that a router receives a packet, the router uses its mask to analyze the network layer destination address carried in the Network Layer Destination Address field NL D 140 of the packet. By using its mask, the router breaks the packet network layer destination address into a subnet, or link, part and into a host address part.

The router "knows" a route to the destination link as a result of a forwarding table maintained by the router. The forwarding table is built up by the router participating in router protocol algorithms. The router forwards the packet by placing an appropriate data link destination address in the Data Link Destination Address field DL D of the packet, and by transmitting the packet onto the proper link.

Routers perform other functions not directly related to the present invention, such as: running routing protocols in order to decide on routes to maintain between links when there are choices of multiple routes, that is, participating in routing algorithms; isolating links, by, for example, preventing certain management traffic such as end station hello messages on one link from being forwarded to another link; fragmentation and reassembly of packets because of different protocols employed by different links; performing explicit handshaking protocols with end stations connected to links connected to the router; and other functions.

Referring now to Fig. 3A, there is shown the structure of a Network Layer Address. Fig. 3A may refer to the address of a station on a link. Alternatively, Fig. 3A may refer to a Network Layer Destination Address field of a message packet. As a further alternative, Fig. 3A may refer to a Network Layer Source Address field of a message packet. For convenience, the field structure of Fig. 3A may be referred to as the structure of a Network Layer Destination (often abbreviated as NL D) address field of a message packet, although, as will be apparent to those skilled in the art, the discussion could equally well apply to the Network Layer Source Address field (often abbreviated as NL S address field) 142 of a message packet. Also, Fig. 3A will be used to describe a Network Layer Address assigned to a station.

As shown in Fig. 3A, NL D address field 140 contains 4 bytes, byte 150, byte 152, byte 154, and byte 156. Each byte 150 152 154 156 is an octet, and thereby contains 8 bits.

Referring now to Fig. 3B, there is shown mask 158. Mask 158 has 4 bytes, byte 160, byte 162, byte 164, and byte 166. A mask is assigned to a station,

for example the mask is assigned to end station A 111A, or, for example, B 111B, or, for example, end station C 113C, or to brox 100. In the event that a station detects a message packet, the station applies mask 158 to NL D address field 140 in order to determine the address represented by the NL D address field 140. For example, in the example shown in Fig. 3A and Fig. 3B, the mask 158 is shown having all ones in byte 160, byte 162, and byte 164. In contrast, byte 166 contains all zeros. Accordingly, the corresponding bytes of NL D address field 140, that is byte 150 corresponding to byte 160 of the mask, byte 152 corresponding to byte 162 of the mask, and byte 154 corresponding to the mask byte 164 represent the subnet address. The term "subnet" is synonymous with "link", and may accordingly stand for a local area network LAN, or any other type of link. Byte 156 of NL D address field 140 corresponds to the zeros of mask byte 166, and accordingly represents the address of a "host". The term "host" is synonymous with "station", and so may stand for an "end station", a "brox", or any other type of station. Mask 158 indicates, by the zeros in byte 166, that the host address represented by NL D address field 140 is contained in byte 156.

Accordingly, mask 158 interprets NL D address field 140 so that bytes 150, 152, 154 represent a subnet address. And also mask 158 indicates that byte 156 represents a host address.

As shown in Fig. 3B, mask 158 has byte 160 indicated as byte B1. Byte 162 is indicated as byte B2. Byte 164 is indicated by byte as B3. Byte 166 is indicated as byte B4. The labels B1, B2, B3, and B4 indicate the position of the byte within mask 158.

SECOND EXEMPLARY EMBODIMENT

Operation of communications system 101, as shown in Fig. 1, will now be discussed. In the event that end station A 111A decides to send a message packet to end station C 113, then the following events occur:

1. End station A 111A first attempts to learn the data link layer address of end station C 113. In the first step to learn the data link layer address of end station C 113, end station A 111A tests its network layer address against the network layer address of end station C 113 in order to determine if the two end stations are on the same link. And if the two end stations are on the same link, then end station A 111A has permission to transmit an Address Request Protocol message (a local ARP request message). An local ARP request message transmitted by an end station will be hereinafter referred to as a local ARP request.

End station A 111A uses a short mask, as shown in Fig. 3C, in making the determination as to whether or not end station C 113 is on the same link as end station A 111A, and because of the

careful choice of end station network layer addresses, concludes that end station C 113 is on the same link as end station A 111A. As shown in Fig. 3C, the short mask used by end station A 111A has byte 161 and byte 163 both contain eight ones, and byte 165 and byte 167 both contain eight zeros. Accordingly, end station A 111A "sees" only byte 150 and byte 152 of the address fields shown in Fig. 3A, as the subnet address of itself and of end station C 113. By careful choice of the end station addresses, both end station A 111A and end station C 113 have the same value of bytes 150 152 in their network layer addresses. Accordingly, end station A 111A concludes that it and end station C 113 are on the same link.

Physically, as is shown in Fig. 1, end station A 111A is on link 110 and end station C 113 is on link 112. However, because of the careful choice of end station network layer addresses, and by end station A 111A using a short mask, end station A 111A concludes that it and end station C 113 are on the same link.

2. In response to its conclusion that end station C 113 is on the same link, end station A 111A transmits a local ARP Request onto link 110.

3. The local ARP Request is detected by brox 100. Logic unit 115 detects that the packet is a local ARP request. In response to receiving the local ARP request, brox 100 creates a new local ARP request. Brox 100 sends the new local ARP request onto link 112 with the data link layer address of end station C 113 in the data link destination address field 126. By using the long mask of Fig. 3B, where byte 164 contains eight ones, brox 100 can determine the link to which end station C 113 is connected. And by using the portion of the mask containing "0s", brox 100 can determine the network layer address of intended destination end station C 113.

4. End station C 113 receives the second local ARP Request message from LAN 112, and responds by creating a local ARP response message, and then transmitting the local ARP Response message onto link 112. The local ARP Response message contains the data link layer address of end station C 113.

5. Brox 100 detects the local ARP response message and processes it by logic 117. Brox 100 then determines that this local ARP response is in completion of a pending ARP request. Brox 100 then creates a second local ARP response message, and transmits the second local ARP response message onto link 110.

6. End station A 111A receives the second local ARP response message on LAN 110, and extracts from it the data link layer address of end station C 113.

7. End station A 111A transmits a message pack-

et to end station C 113 by placing the data link layer address of end station C 113 into the Data Link Destination Address field 126 of the message packet.

8. Brox 100 detects the message packet addressed to end station C 113, concludes that the data link destination address field 126 of the packet does not contain a data link destination address of brox 100, and therefor forwards the message packet as a bridge, and the message packet is thereby forwarded onto link 112. This bridge type forwarding operation is fast, as brox 100 made the decision by parsing only the Data Link Header field 122 of the message packet.

9. End station C 113 then detects the message packet by recognizing its data link destination address in the data link destination address field 126 of the message packet, and receives the message packet.

10. End station A 111A then may transmit a sequence of message packets to end station C 113 by: inserting the data link address of end station C 113 into the data link destination address field 126 of the message packet; and then brox 100 forwards the message packets as a bridge.

Advantages of the invention may be seen as follows. Brox 100 blocked the local ARP request message transmitted by end station 111A from being forwarded onto link 112, and in that respect functioned as a router. Brox 100 forwards the message packets transmitted by end station A 111A onto link 110, where the message packet contains the data link layer address of end station C 113 in the data link destination address field 126. Brox 100 thus rapidly forwards message packets, and also isolates local ARP traffic onto a single link.

A benefit of the invention is that local ARP request and local ARP response messages on one link, for example link 110, are blocked from the other link, in this example link 112, by brox 100. A further benefit of the invention is that in the event that an end station on one link, say link 112, sends a sequence of data packets to an end station on the other link, then all packets after the first packet are forwarded at bridge speed.

THIRD EXEMPLARY EMBODIMENT

A multiple hop embodiment of the invention will now be discussed. Referring now to Fig. 4, there is shown a more complex communications system 170. Communications system 170 has link 172, link 174, link 176, and link 178. Link 172 has end stations 172A, 172B, and 172C. Additionally, link 172 may have a further plurality of end stations, and may, for example, support up to several hundred end stations.

Link 174 has end stations 174A, 174B, 174C, and 174D. Also, Link 174 may support a further plurality of end stations.

Link 176 has end station 176A, end station 176B, and end stations 176C. Further, Link 178 has end station 178A, end station 178B, and end station 178C. Also, Link 176 and 178 may each support a further plurality of end stations.

Although links 172 174 176 178 are shown in Fig. 4 as straight lines, each link may, for example, be a token ring communications system such as an IEEE 802.5 token ring or an ANSI/IEEE FDDI token ring.

Brox 180 has a connection 182 to link 172, and also has a connection 184 to link 174. Brox 190 has connection 192 to link 174, and also has a connection 194 to link 176. Additionally, brox 190 has a connection 196 to link 178. Brox 200 has a connection 202 to link 174, and a connection 204 to a wide area network through a communications link, as indicated by jagged arrows 206.

The addresses of stations on links 172 174 176 178 are given by the address field of Fig. 3A. Bytes 150 and byte 152 of the addresses are the same for all stations on all links 172 174 176 178. Bytes 154 and byte 156 are different for the various links and stations as described hereinbelow.

Referring to Fig. 4, address 210 shows fields 154 and 156 of the address fields of Fig. 3A as assigned to stations on link 172. Field 154 contains; 11111000. Byte 156 may contain any combination of ones and zeros. The value of byte 156 is assigned to give a unique value for each end station 172A, 172B, 172C, and so forth. Only one byte 156 is reserved for the host address for end stations connected to link 172, and so the number of stations that may be individually addressed are 2^{*8} , or 256 stations.

Address 212 show bytes 154 and 156 of addresses of Fig. 3A as assigned to stations on link 174. Byte 154 contains: 11110000. Byte 156 contains any value, and a unique value of byte 156 is assigned to each station connected to link 174. For example, end stations 174A, 174B, 174C, 174D, and connection 184 to brox 180, and connection 192 to brox 190 are each assigned a unique value of byte 156. Again, byte 156 may refer to as many as 256 stations.

Address 214 shows bytes 154 and 156 of addresses of Fig. 3A as assigned to stations on link 176. Byte 154 of address 214 contains: 11100000. Byte 156 contains any value, and a unique value of byte 156 is assigned to each station on link 176. For example, end station 176A, 176B, 176C, and connection 194 to brox 190, each have assigned a unique value of byte 156.

Address 216 shows bytes 154 and 156 of addresses of Fig. 3A as assigned to stations on link 178. Byte 154 of address of 216 contains; 11000000. Byte 156 has assigned any value, and has a unique value assigned for each station connected to link 178, for example, end stations 178A, 178B, 178C, and connection 196 to brox 190.

Each end station in communications system 170

uses mask 221 as shown in Fig. 7B. Mask 221 has all ones in byte B1 160, all ones in byte in B2 162, all zeros in byte B3 164, and all zeros in byte B4 166. Accordingly, whenever any end station in system 170 applies mask 221 to an address of an intended receiving station lying within system 170, the intended receiving station will appear to the transmitting end station to lie on the same link as the transmitting end station. This result arises from the following application of mask 221 to the address of any end station on system 170:

AND (A_my, mask)

AND (A_receive, mask),

where A_my is the network layer address of the end station,

and where A_receive is the network layer address of the intended receiving end station.

The AND operations are followed by a test of the equality of the two AND operations.

In the event that the two AND operations are equal, then the transmitting end station concludes that it is on the same link as the intended receiving end station. Accordingly, in the event that the two AND operations are equal, the transmitting end station has permission to transmit a local ARP request message in order to inquire: "What is the data link address of the intended receiving end station?"

Referring now to Fig. 6A and Fig. 6B, there is shown an address in Fig. 6A. Part of the address of Fig. 6A is a subnet address, and part of the address is a host address, as determined by the appropriate mask.

There is shown a mask for a brox in Fig. 6B. The mask of Fig. 6B is assigned to broxs 180 190 200. Byte B1 160, and byte B2 162, both contain 8 ones, as shown in Fig. 6B. Byte B3 164 contains: 11111000. Byte B4 166 contains all zeros. When mask 220, Fig. 6B, is applied to the address 210 of link 172, or to address 212 of link 174, or to address 214 of link 176, or to address 216 of link 178, then the arrangement of ones in byte 164 of mask 220 allows the various links to be distinguished. That is, the longest address in byte 154 is in address 210 of link 172, and consists of five (5) ones. These five ones are masked for incorporation in the subnet address by the arrangement of five ones in byte 164 of mask 220, as shown in Fig. 6B. Accordingly, by making use of mask 220 assigned to brox 180, 190, or 200, a determination may be made as to which link a particular station address is located.

By making use of the 0s in mask 220 of Fig. 6B, an identification may be made of the host address 224 as shown in Fig. 6B. The host address, as shown in Fig. 6B, will comprise the last three bits of byte 154 and all eight bits of byte 156. Accordingly, byte 156 of address 210 will uniquely identify any of the stations connected to link 172. Alternatively, address 212, at

byte 156, will identify any station connected to link 174, through a masking of the 0s of the mask 220 of Fig. 6b. Additionally, the end stations of link 176 and link 178 may likewise be identified by the 0s of mask 220 taken with the address 214 for link 176, and address 216 taken for link 178.

Since the host address of brox mask 220 of Fig. 6B uses eleven (11) bits, each link may have as many as 2^{11} or two thousand forty eight (2,048) unique station addresses.

Referring now to Fig. 7A and Fig. 7B there is shown in Fig. 7B an end station mask 221. End station mask 221 has byte B1 160 contain: eight ones, byte B2 162 also contains eight ones. However, bytes B3 164 and byte B4 166 contain all zeros. Accordingly, an end station using mask 221, when applied to any address shown as address 210, 212, 214, 216 will determine that the addresses is given by bytes 150 and byte 152. Bytes 150 and 152 were chosen to be the same for all stations in communications system 170. Accordingly, by use of mask 221, all end stations of communications systems 170 will determine the same subnet address 222. A consequence of all end stations on communications system 170 determining the same subnet address through use of end station mask 221 is that, in accordance with the ordinary rules of operation for a TCP-IP communications type system, the end stations will have permission to transmit a local ARP request message.

Turning now to Fig. 5, there is shown the full address for addresses 210, 212, 214 and 216. As shown in Fig. 5, bytes 150 and 152 contain the same value for each of addresses 210, 212, 214 and 216. The addresses 210, 212, 214, and 216 differ only in the different values contained in byte 154 and byte 156.

Operation of the Multiple Hop System

In the event that end station 172A desires to transmit a data message to end station 178C, the following events occur:

1. End station 172A does an AND operation between its address and the address of end station 178C. End station 172A uses the end station mask 221 of Fig. 7B. End station 172A then concludes that the subnet address 222 of itself and the subnet address 222 of end station 172A are equal, and so concludes that it may transmit a local ARP request message to end station 178C in order to learn the data link address of end station 178C.

2. Brox 180 parses the data link address of the local ARP request message, concludes that the local ARP request message is not addressed to brox 180, and accordingly receives the local ARP request message. Brox 180 recognizes the data packet as a local ARP request message, recognizes that the network layer address contained in

the local ARP request message is the network layer address of end station 178C, and then creates a remote ARP request message and sends the remote ARP request message to brox 190. Brox 180 knows to send the remote ARP request message to brox 190 because brox 180 maintains a forwarding table showing the end stations attached to various broxs. This forwarding table is built up by inter-brox traffic, analogous to the inter-router traffic used by routers to build up forwarding tables.

3. Brox 190 receives the remote ARP request message, and transmits on connection 196 to link 178 a standard local ARP request message containing the data link address of end station 178C.

4. End station 178C responds to the local ARP request message by transmitting a local ARP response message containing the data link layer address of end station 178C onto link 178.

5. Brox 190 receives the local ARP response message from end station 178C, and brox 190 creates a remote ARP response message, and sends it to brox 180.

6. Brox 180 then creates a standard local ARP response message and transmits it through connection 182 to link 172, with the data link layer address of end station 172A in the Data Link Destination Address field 126 of the local ARP response message.

7. End station 172A then interprets the local ARP response message and extracts from it the data link layer address of end station 178C.

8. End station 172A then transmits a message packet directed to end station 178C, where the message packet contains the data link layer address of end station 178C in the Data Link Destination Address field 126.

9. Brox 180 parses the data link header 122 of the message packet, discovers the Data Link Destination address field 126 does not contain the address of connection 182, and therefore forwards the message packet as a bridge.

10. The message packet is forwarded through connection 184 to link 174 where brox 190 detects the message packet at connection 192.

11. Brox 190 parses the data link header 122 of the message packet, concludes that the data link destination address field 126 does not contain the data link address of connection 192, and accordingly forwards the message packet as a bridge. Brox 190 bridges the message packet through connection 196 onto link 178 on the basis of a forwarding table maintained within brox 190.

12. The message packet is detected by end station 178C detecting its own data link address address in the Data Link Destination Address field 126 of the message packet. Accordingly, the intended receiving station 178C receives the mes-

sage packet.

Each station in communication system 170 as shown in Fig. 4 uses end station mask 221 as shown in Fig. 7B, that is: on link 172 end stations 172A, 172B, 172C; on link 174 end stations 174A, 174B, 174C 174D; on link 176 end stations 176A, 176B, 176C; and on link 178 end stations 178A, 178B, 178C. The short mask 221 of Fig. 7B, when used by the end stations of communication system 170, causes all of the end stations of communication system 170 to conclude that they are on the same link. By coming to this conclusion, the end stations are permitted to transmit a local ARP request message for the data link address of an intended receiving station.

Each of the broxs, 180, 200, 190 use the longer brox mask 220, as shown in Fig. 6b. This longer brox mask 220 has ones in the first five (5) positions of byte 164, and these ones permit the broxs to distinguish the subnet addresses of links 172, 174, 176, 178.

In the event that an end station on communication system 170 prepares to transmit a message packet to an end station connected to communication system 170 through brox 200 by wide area network communication link 204, then the address in bytes 150 and 152 of the proposed Network Layer Destination Address field 140 of the message packet will differ from bytes 150, 152 of an address of links 172, 174, 176, 178. Accordingly, a brox receiving a local ARP request message for such a distant end station will forward, in performing as a router, and forward the message packet to brox 200 which then sends it on the wide area network link 204 to an appropriate brox having a link to the intended receiving end station.

As can be seen from Fig. 6B and Fig. 7B, a brox sees a longer subnet address then does an end station. As shown at byte 164 in Fig. 6B, the subnet address seen by a brox is 5 bits longer than a subnet address seen by an end station using mask 221 from Fig. 7B. The shorter end station mask causes end station to see all of the end stations on communications network 170 as being on the same link. The longer brox mask 220, as shown in Fig. 6B, permits a brox to distinguish the intended receiving end station and also the link to which the intended receiving end station is attached to.

Further, the assignment of the addresses of the end station is carefully done in order for the end stations to be distinguishable in accordance with the above discussion of the brox mask and the end station mask as shown in Fig. 6B and Fig. 7B. That is, each end station on communications system 170 was assigned a value of byte 154 as follows: link 172 was assigned a value of byte 154 of 11111000; link 174 was assigned a value of byte 154 of 11110000; link 176 was assigned a value of byte 154 of 11100000; link 178 was assigned a value of byte 154 of 11000000. This careful selection of addresses is the key to distinguishing end stations on different links by use of a

short end station mask 221 and long brox mask 220.

FOURTH EXEMPLARY EMBODIMENT

Referring now to Fig. 8, communications system 300 is shown. Network layer addresses for the end stations of communications system 300 will now be discussed. The network layer address are used in the Network Layer Destination Address field 140 of Fig. 2. The network layer address may, for example, have 4 bytes, 150, 152, 154, 156 as set out in address field 140 in Fig. 3A. The value of byte 150 may be represented by the numeral N1. The value of byte 152 may be represented as numeral N2. The value of byte 154 may be represented as numeral N3. The value of byte of 156 may be represented as numeral N4. The four byte address may then he represented as follows:

N1.N2.N3.N4

In the above symbolic representation of the network layer address, the numbers N1, N2, N3, N4, refer to the bytes of address 140, that is bytes 150, 152, 154, 156, respectively.

Careful selection of the values of the bytes N1, N2, N3, N4 permit the invention to utilize a short end station mask for an end station to gain permission to send a local ARP request, and a long brox mask to enable a brox to distinguish end stations on different links.

As a further example of representation of a network layer address, a mask may be, for example 12 bits long, that is the mask boundaries may not coincide with octet boundaries. For example, the mask shown in Fig. 6B uses 5 bits from octet 164. Still, a symbolic representation of the network layer address may be given as:

A1.A2.A3

where A1, A2, and A3 are numbers used to refer to parts of the network layer address. For example, A1 may represent a group of related LANs, A2 may represent a particular LAN of the group, and A3 may represent the host address.

An exemplary assignment of end station address follows.

Referring now to communications system 300 as shown in Fig. 8, LAN 302 is connected by brox BR4 304 to LAN 306. LAN 308 is connected brox BR6 310 to LAN 306. LAN 306 is connected by brox BR3 312 to LAN 314. LAN 314 is connected by brox BR1 316 to LAN 320. LAN 320 is connected by brox 322 to LAN 324. LAN 320 is connected by brox BR5 326 to LAN 328.

Each LAN, 302, 306, 308, 314, 320, 324, 328 has connected in communications connection, a plurality of end stations. For simplicity, only particular end stations will be directly discussed. LAN 302 is shown with end station A 340. LAN 328 is shown with end station B 342.

Addresses are assigned to the end stations on

each LAN in accordance with the present invention. For example, addresses may be assigned to the LANs as follows. Each LAN is assigned an address 140 comprising 4 bytes, bytes 150, 152, 154, 156. As a simplification, only three of the bytes will be discussed herein, bytes 152, 154, 156. The highest byte 150 may be assigned an arbitrary number, however each link has the same value of byte 150.

For example, in communication system 300 byte 152 is assigned the value "19". Accordingly, all stations on LAN 302 are assigned the address 19.3.*. The "*" means any unique number to distinguish the stations. All stations connected to LAN 306 are assigned the address 19.4.*. All stations connected to LAN 308 are assigned the address 19.8.*. All stations connected to LAN 314 are assigned the address 19.5.*. All stations attached to LAN 320 are assigned the address 19.5.*. All stations connected to LAN 324 are assigned the address 19.6.*. All stations attached to LAN 328 are assigned the address 19.7.*. The stations on each link include the plurality of end stations, as well as the connections to the respective broxs.

We now consider the event wherein end station A 340 on LAN 302, having a network layer address of 19.3.8 decides to send a message packet to end station B on LAN 328, having a network layer address of 19.7.5. The following events occur:

1. End station A 340 tests the network layer address of the intended receiving station B 342 in order to determine if end station 340 has permission to transmit a local ARP request message in order to learn the data link layer address of end station B 342. Addresses other than a TCP-IP 32 bit address may be used with the invention. For example, in the event thai a three octet address is used, the end station A 340 may use a mask having the values:

11111111.00000000.00000000

and each brox in communication system 300 utilizes a mask having the values:

11111111.11111111.11111111

in making forwarding decisions. Accordingly, end station A 340 utilizes its end station mask and concludes that the link where end station B 342 resides is "19.*.*", the same as the link where end station A 340 resides. Accordingly, end station A transmits a local ARP request message on LAN 302.

2. Brox BR4 304 detects the local ARP request message, interprets the local ARP request message, and creates a remote ARP request message directed to brox BR5 326. Brox BR4 304 knows to send the remote ARP request message to brox BR5 326 as a result of the broxs participating in a routing algorithms, as is well known in those skilled in the art of computer communications. Accordingly, brox BR4 304 transmits the remote ARP request message to brox BR5 326.

Brox BR5 326 receives the remote ARP request message, and in response thereto transmits a standard local ARP request message onto LAN 328.

3. End station B 342 receives the local ARP request transmitted onto LAN 328, and generates a local ARP response message containing the data link address of end station B 342, where the data link address corresponds to the station having network layer address 19.7.5.

4. Brox BR5 326 detects the local ARP response message transmitted by end station B 342, recognizes it as a completion of a pending remote ARP request message, and creates a remote ARP response message. Brox BR5 326 then sends the remote ARP response message to brox BR4 304. Brox BR4 304 receives the remote ARP response message, and in response thereto creates a local ARP response message. Brox BR4 304 then transmits the local ARP response message onto LAN 302.

5. End station A 340 receives the local ARP response message from LAN 302, and interprets the local ARP response message, and stores the data link layer address of end station B 342.

6. End station A 340 then constructs a data packet containing the data link layer address of end station B 342 in Data Link Destination Address field 126 of a message packet 120.

7. Brox BR4 304 detects the data packet, parses the Data Link Header 122 and finds that the contents of the Data Link Destination Address field 126 are not an address used by brox BR4 304, and so concludes to forward the message packet as a bridge.

The data packet transmitted by end station A 340 is forward by all of the intermediate broxs behaving as bridges, brox BR4 304, brox BR3 312, brox BR1 316, and brox BR5 326. The data packet is thus forwarded at each hop, in some designs, in less than 1/200th of the time that would be required if a brox operated as a router.

The local ARP Request transmitted by end station A 340 onto LAN 302 is blocked by brox BR4 304. That is, the local ARP Request is not forwarded to LAN 306 as it would be if brox BR4 304 acted as a standard bridge. That is, brox BR4 304 acts as a standard router and isolates LAN 302 from LAN 306, in that it does not forward ARP messages between the LANs. Likewise, all local ARP requests and local ARP responses are isolated to the LAN on which they were created by the broxs functioning as routers.

Accordingly, data traffic may be forwarded between any end station on any link in communications network 300 by each of the broxs forwarding rapidly as a bridge. Also, the local ARP traffic generated on each LAN is isolated from each of the other links by each brox functioning as a router.

The invention, in all embodiments, has the beneficial effect that it speeds forwarding of data packets and so improves throughput in the data communications system.

A further benefit of the invention is that, in the event that an intermediate forwarding station is an old style router that does not change into a bridge in accordance with the Rules of the invention hereinabove, the invention will work perfectly well with all of the intermediate broxs functioning in accordance with the invention. Any intermediate "old style" routers already installed in an old system will not interfere with the improvements gained from new broxs added to the system.

Accordingly, the invention greatly improves the speed at which a message is forwarded over multiple links of a complex communications system.

Claims

1. In a communications system having a first communications link and a second communications link, at least one end station capable of communicating on each said communications link, an apparatus for forwarding a packet from said first link to said second link, said apparatus being capable of detecting a network layer header on a data packet, said network layer header having a destination address, said apparatus comprising:

means for assigning an apparatus mask having a forwarding mask length to said apparatus for distinguishing said destination address into a subnet address part and into a host address part;

means for assigning an end station mask having an end station mask length to said at least one end station for distinguishing said destination address into a subnet address part and into a host address part;

means for assigning a greater length to said forwarding mask length than to said end station mask length, to enable said end station in using said end station mask to identify all end stations on said first link and said second link as being on a single link, and to enable said apparatus in using said forwarding mask to distinguish on which of said first link or said second link an end station addressed by said network layer address is located.

2. The apparatus as in claim 1 further comprising:
means for a selected end station to transmit a local Address Request Protocol (hereinafter ARP) request message onto said first communications link, said local ARP request message requesting a data link address of a receiving end station;

means, in response to said local ARP request message, for said apparatus to create a remote ARP request message and to send said remote ARP request message to a second forwarding apparatus connected to said second link having said receiving end station connected thereto;

means for said apparatus to receive a remote ARP response message containing said data link address of said receiving end station from said second forwarding apparatus;

means, responsive to said remote ARP request message, for said apparatus to create a local ARP response message and to send said local ARP response message to said selected end station.

3. The apparatus as in claim 1 further comprising:

means associated with said forwarding apparatus to forward a data packet as a bridge in the event that a data link address in a message packet is not a data link address of said apparatus.

4. The apparatus as in claim 1 further comprising:

means associated with said apparatus to forward a message packet as a router in the event that a data link address in said message packet is a data link address of said apparatus.

5. A communications system having a plurality of communications links, a forwarding apparatus for forwarding a message packet from a first link to a second link, said first link and said second link selected from said plurality of links, said apparatus being capable of detecting a network layer header on a data packet, said network layer header having a destination address, said system comprising:

means for assigning an apparatus mask having a forwarding mask length to said apparatus for distinguishing said destination address into a subnet address part and into a host address part;

means for assigning an end station mask having an end station mask length to said said at least one end station for distinguishing said destination address into a subnet address part and into a host address part;

means for assigning a greater length to said forwarding mask length than to said end station mask length, to enable said end station in using said end station mask to identify all end stations on said plurality of links as being on a single link, and to enable said apparatus in using said forwarding mask to distinguish which of said plurality of links an end station addressed by said network layer address is located;

means, responsive to said greater length of said forwarding mask than said end station

mask, for a selected end station to transmit a local ARP request message onto an attached link, said local ARP request message requesting a data link address of a receiving end station, said receiving end station connected to a second link that is not said attached link;

means, responsive to said local ARP request message, for said apparatus to send a remote ARP request message to a second forwarding apparatus attached to said second link;

means, responsive to said remote ARP request message, for said second forwarding apparatus to send a second local ARP request message to said intended receiving end station;

means, responsive to said second local ARP request message, for said intended end station to send a local ARP response message to said second forwarding apparatus, said second local ARP response message containing said data link address of said intended end station;

means, responsive to said local ARP response message, for said second forwarding apparatus to send a remote ARP response message to said apparatus;

means, responsive to said remote ARP response message, for said apparatus to send a second local ARP response message to said selected end station;

means, responsive to said second local ARP response message, for said selected end station to receive a data link address of said intended receiving end station, and for said selected end station to transmit a message packet containing said data link address of said selected receiving end station, and for said apparatus to forward said message packet as a bridge in response to said data link address of said intended receiving end station being contained in said message packet.

6. A communications system having a plurality of communications links, a forwarding apparatus for forwarding a message packet from a first link to a second link, said first link and said second link selected from said plurality of links, said apparatus being capable of detecting a network layer header on a data packet, said network layer header having a destination address, comprising:

means for assigning an apparatus mask having a forwarding mask length to said apparatus for distinguishing said destination address into a subnet address part and into a host address part;

means for assigning an end station mask having an end station mask length to said said at least one end station for distinguishing said destination address into a subnet address part and into a host address part;

means for assigning a greater length to said forwarding mask length than to said end station mask length, to enable said end station in using said end station mask to identify all end stations on said plurality of links as being on a single link, and to enable said apparatus in using said forwarding mask to distinguish which of said plurality of links an end station addressed by said network layer address is located.

5

10

15

20

25

30

35

40

45

50

55

15

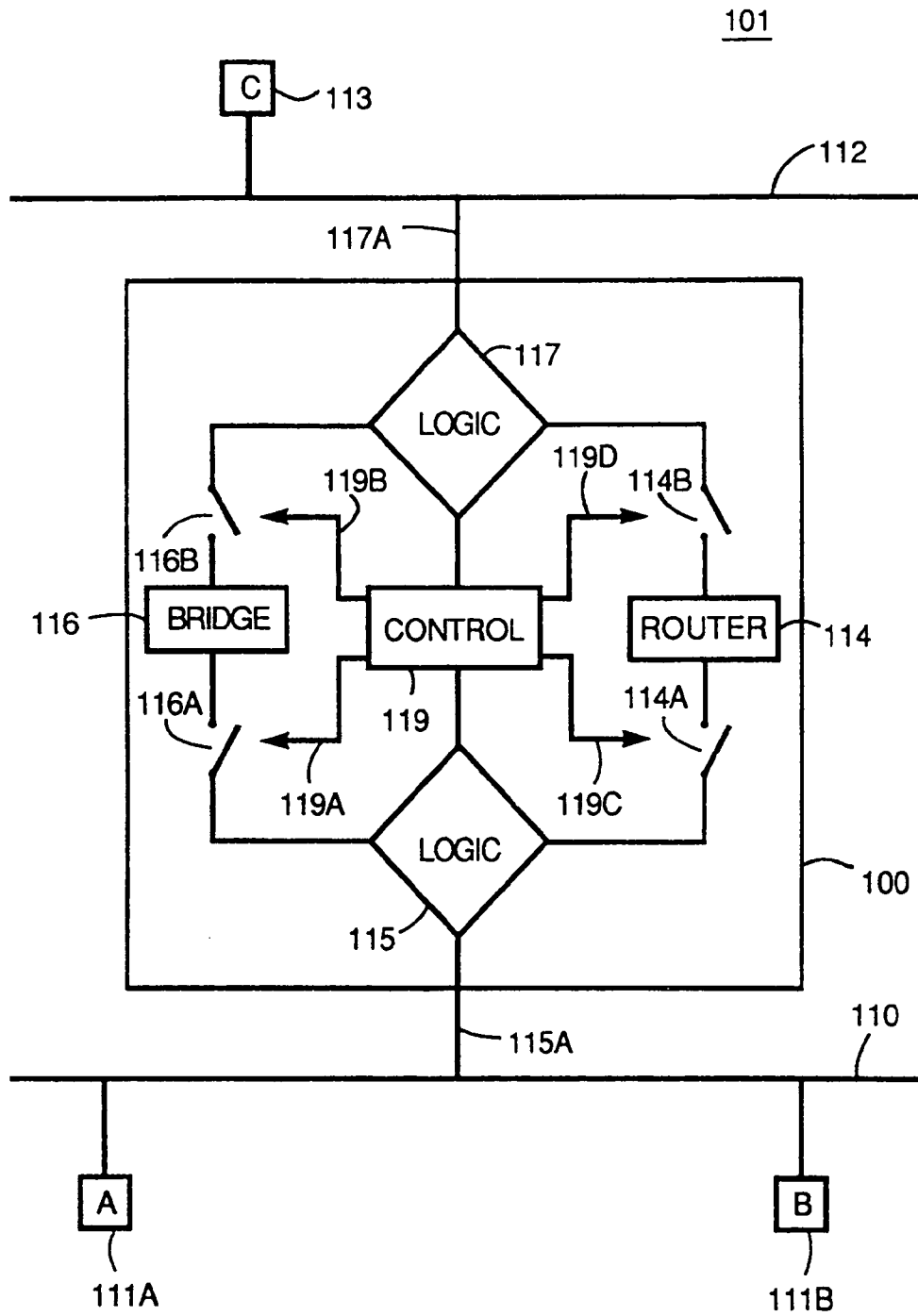

FIGURE 1

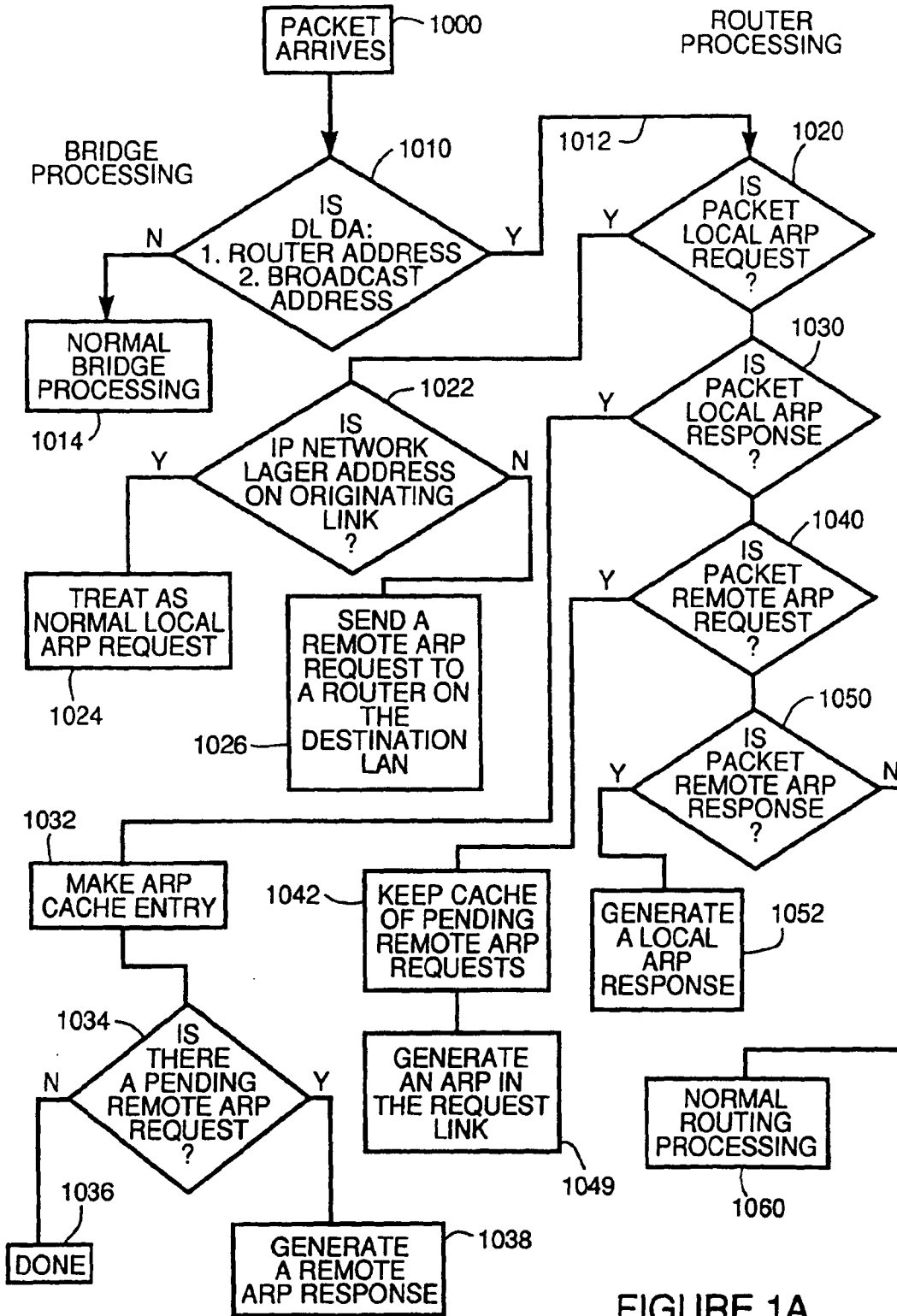

FIGURE 1A

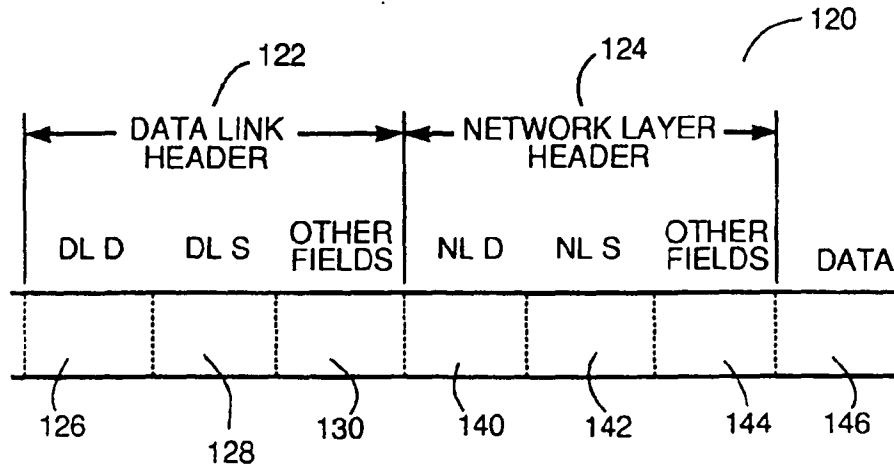

FIGURE 2

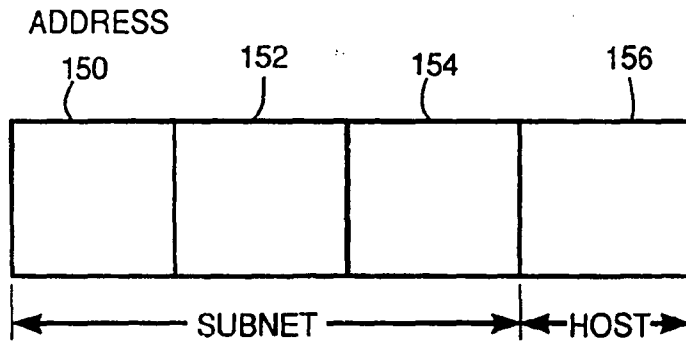

FIGURE 3A

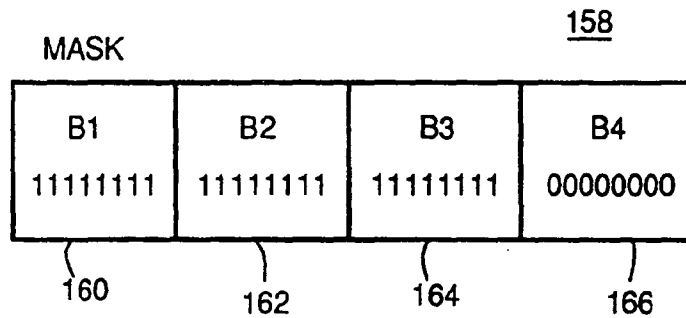

FIGURE 3B

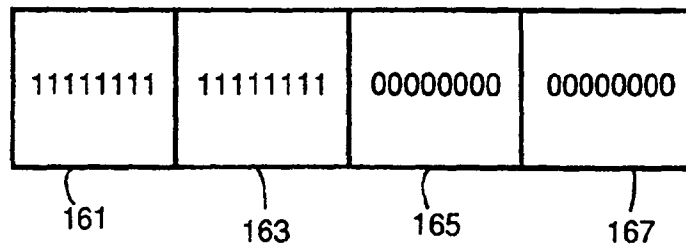

FIGURE 3C

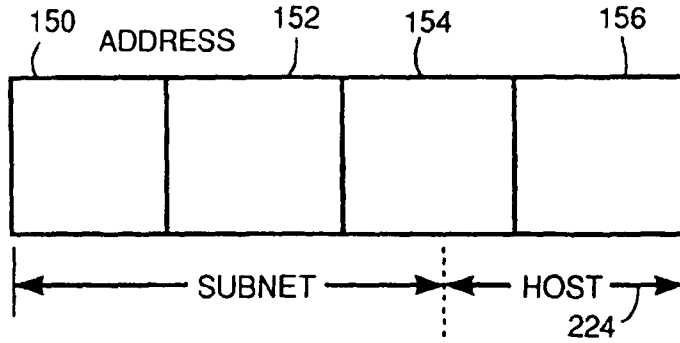

FIGURE 6A

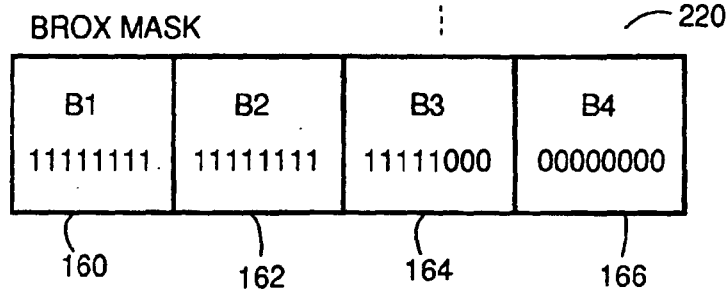

FIGURE 6B

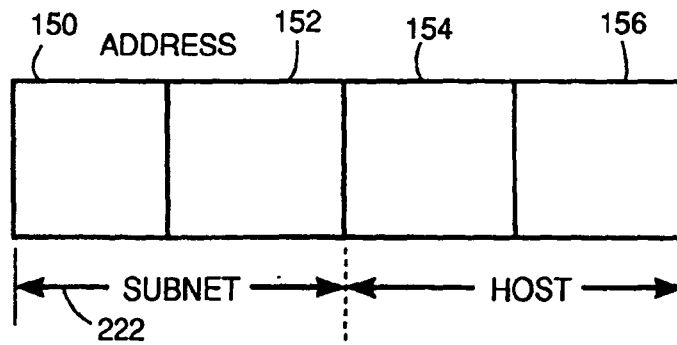

FIGURE 7A

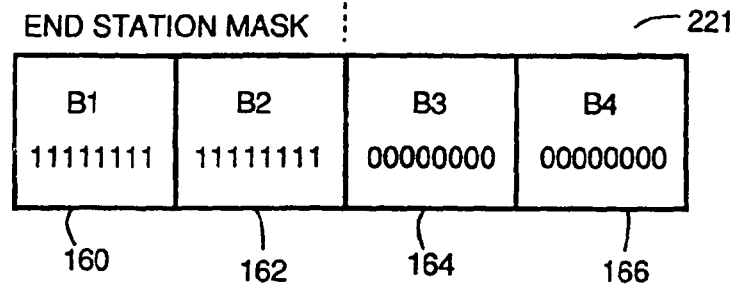

FIGURE 7B

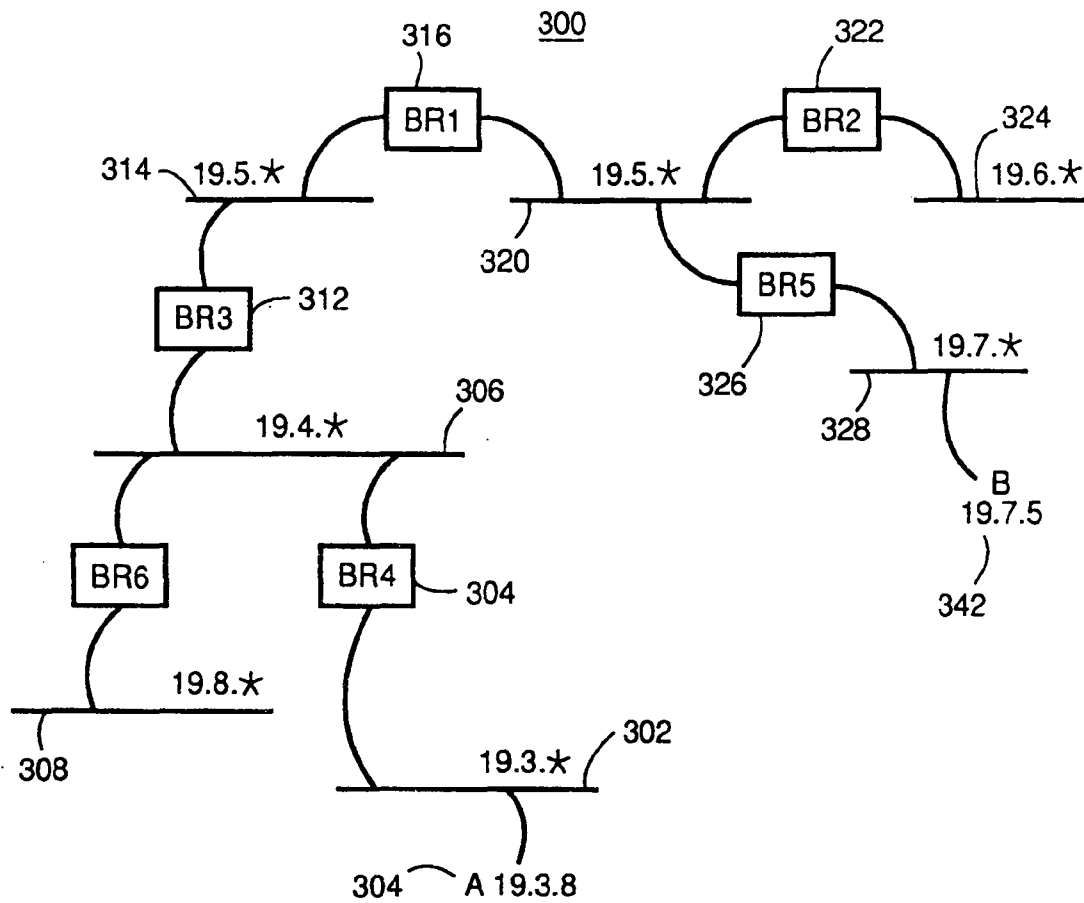

FIGURE 8

European Patent
Office

EUROPEAN SEARCH REPORT

Application Number

EP 92 30 5234

DOCUMENTS CONSIDERED TO BE RELEVANT			
Category	Citation of document with indication, where appropriate, of relevant passages	Relevant to claim	CLASSIFICATION OF THE APPLICATION (Int. Cl.5)
A	EP-A-0 357 136 (PHILIPS) * column 2, line 15 - column 3, line 32 * ---	1,5,6	H04L12/46
A	EP-A-0 255 767 (AT&T) * column 2, line 34 - column 3, line 50 * ---	1,5,6	
A	IEEE NETWORK: THE MAGAZINE OF COMPUTER COMMUNICATIONS vol. 2, no. 1, January 1988, NEW YORK US pages 49 - 56 L. BOSACK ET AL. 'Bridges and Routers, Observations Comparisons and Choosing. Problems in Large LANs' * page 52, left column, line 10 - line 25 * * page 52, right column, line 7 - line 41 * ---	2-4	
P,A	EP-A-0 465 201 (DEC) * the whole document * -----	2	
			TECHNICAL FIELDS SEARCHED (Int. Cl.5)
			H04L
The present search report has been drawn up for all claims			
Place of search THE HAGUE		Date of completion of the search 22 SEPTEMBER 1992	Examiner MESSELKEN M.
CATEGORY OF CITED DOCUMENTS		T : theory or principle underlying the invention E : earlier patent document, but published on, or after the filing date D : document cited in the application L : document cited for other reasons ----- & : member of the same patent family, corresponding document	
X : particularly relevant if taken alone Y : particularly relevant if combined with another document of the same category A : technological background O : non-written disclosure P : intermediate document			

EPO FORM LS03 03.82 (P0401)



(12) **EUROPEAN PATENT APPLICATION**

(21) Application number: 93102782.5

(51) Int. Cl.⁵: **H04M 1/66**

(22) Date of filing: 23.02.93

(30) Priority: 02.03.92 US 844268

(71) Applicant: **ROLM COMPANY**
 4900 Old Ironside Drive P.O. Box 58075
 Santa Clara, CA 95052(US)

(43) Date of publication of application:
 08.09.93 Bulletin 93/36

(72) Inventor: **Iglehart, David**
 2006 Westridge Drive
 Austin, TX 78704(US)
 Inventor: **Ford, Gordon**
 1004 Lime Rock Drive
 Round Rock, TX 78681(US)

(64) Designated Contracting States:
AT BE DE ES FR GB IT NL PT

(74) Representative: **Fuchs, Franz-Josef, Dr.-Ing.**
 Postfach 22 13 17
 D-80503 München (DE)

(54) **Future blocking of incoming telephone calls.**

(57) Method and apparatus for screening telephone calls for use in conjunction with a telephone set as, opposed to a switch, which provides a capability of storing a telephone number for use in blocking calls from the telephone number, without the need for re-entering the telephone number.

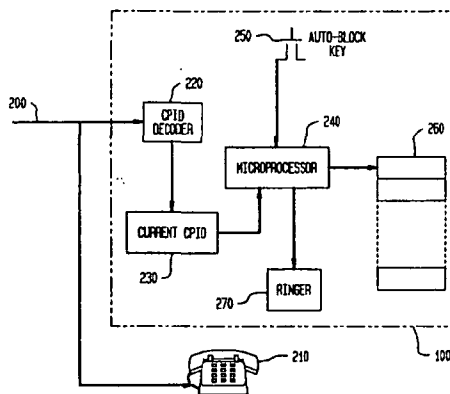

EP 0 559 047 A1

Technical Field of the Invention

The present invention pertains to method and apparatus for screening telephone calls for use in conjunction with a telephone set, as opposed to a switch, which provides a capability of storing a telephone number for use in blocking calls from the telephone number, without the need for re-entering the telephone number.

Background of the Invention

Several methods exist in the prior art for providing screening of incoming telephone calls. In a first prior method, a called party utilizes a display telephone to visually identify a caller's telephone number and then chooses whether or not to answer. In a second prior art method, a secretary manually screens calls and chooses whether or not to transfer the caller to the called party. In a third prior art method, the called party blocks all incoming calls by placing his/her telephone off hook or by activating a Do Not Disturb feature. In a fourth prior art method, the called party can screen incoming calls utilizing an audio-monitoring capability which is associated with most answering machines. In a fifth prior art method, the called party can order a service from a telephone company that enables him/her to key in an access code after receiving an incoming telephone call to cause the telephone company to block future calls from the telephone number. In a sixth prior art method, the called party may enter a telephone number into a data base of telephone numbers to be blocked by centralized switching equipment.

In general, the above-described prior methods suffer from several disadvantages. Namely, they: (a) do not provide immediate control to the called party; (b) do not permit him/her to identify the telephone number of the incoming call; (c) do not automate the process of identifying and listing telephone numbers to be blocked; and (d) can only be used to block calls from telephone numbers that are known in advance.

In particular, the first prior method has the disadvantages that: (a) not all telephones have displays; (b) the called party may not know the telephone numbers of callers he/she wishes to block; and (c) the called party has to utilize a more complicated, manual method to identify and list the telephone number he/she wishes to block.

In particular, the second prior art method has the disadvantages that it is complicated and does not provide called party control. Specifically, the called party has to rely on a secretary who knows in advance which callers should be blocked. If a called party determines during a call that he/she does not wish to receive further calls from the

caller, he/she would have to communicate with the secretary to block future calls from that caller.

In particular, the third prior art method has the disadvantages that it is impractical and unspecific. The called party can block all calls or no calls, with no ability to identify and list telephone numbers.

In particular, the fourth prior art method has the disadvantages that it requires the called party has to listen to part of an incoming call to determine if he/she wants to receive it. Moreover, it requires him/her to be rude to callers he/she does not want to receive, making them talk into his/her answering machine before he/she answers. Also, some callers that he/she does not want to speak to may simply hang up rather than leave a message.

In particular, the fifth prior art method has the disadvantages that it relies on a capability of a central switching unit and that the user would have to pay a monthly service fee for blocking.

In particular, the sixth prior art method has the disadvantages that the called party would have to know in advance the telephone numbers he/she wishes to block and the called party lacks an automatic way to identify and list, during a call, the caller's telephone number, so that it can be blocked in the future. Furthermore, such a method relies on a central switching data base to store the list of numbers to be blocked, to which not all users have access.

As a result, there is a need in the art for a method and apparatus for screening telephone calls for use in conjunction with a telephone set, as opposed to a switch, which provides a capability of storing a telephone number for use in blocking calls from the telephone number, without the need for re-entering the telephone number.

Summary of the Invention

Embodiments of the present invention advantageously satisfy the above-described need in the prior art by providing method and apparatus for screening telephone calls for use in conjunction with a telephone set, as opposed to a switch, which provides a capability of storing a telephone number for use in blocking calls from the telephone number, without the need for re-entering the telephone number.

In particular, embodiments of the present invention provide method and apparatus which enable a called party to specify, preferably with a single key stroke, during a call, that further calls from the caller's telephone number be blocked, i.e., will not ring the called party's telephone. It is important to note that method and apparatus is provided by the capabilities of the telephone and not by those of a central switching unit. Further, the inventive apparatus can either be contained in the

telephone or be arranged separate from the telephone. As those of ordinary skill in the art will readily appreciate, in utilizing embodiments of the present invention, the called party does not have to rely on support by others, does not have to have a display, can have the caller's telephone number identified and listed immediately, can store a large number of extensions for blocking, and does not have to have central switching support or pay a monthly fee for a blocking service.

Specifically, an embodiment of the present invention comprises: (a) means for determining the telephone number of an incoming call; (b) indication means for receiving an indication that future calls from the telephone number of the incoming call are to be blocked; (c) means, responsive to the indication means, for storing the telephone number in a data base; and (d) means, responsive to the incoming call, for determining whether the telephone number is stored in the data base and, if so, blocking the incoming call.

As an example of the advantageous use of the present invention, consider the following scenario. John, a hard-working businessman, sits down with his wife and family for dinner. As on most nights, the telephone starts ringing promptly at six from sales calls, and John finds himself listening to a computer trying to sell him smoked cheese. A smile crosses John's face as he presses an "Auto-block" key on his telephone and hangs up, secure in the knowledge that he will never be bothered by calls from that telephone number again.

The invention will be better understood from the following more detailed description taken with the accompanying drawings and claims.

Brief Description of the Drawings

FIG. 1 shows a block diagram of an embodiment of the present invention for use in blocking incoming telephone calls.

Corresponding elements in each of the drawings have the same reference numbers.

Detailed Description

FIG. 1 shows a block diagram of apparatus 100 which is an embodiment the present invention for use in blocking incoming telephone calls. As shown in FIG. 1, telephone line 200 supplies input to apparatus 100 and to telephone 210. In the embodiment shown in FIG. 1, the ringer in telephone 210 is turned off.

Telephone line 200 provides calling party identification (CPID), commonly referred to as Automatic Number Identification (ANI), which is available with telephone services such as Integrated Services Digital Network (ISDN) or Customized Lo-

cal Area Signalling Services (CLASS), all of which is well known to those of ordinary skill in the art.

As shown in FIG. 1, output from telephone line 200 is applied as input to CPID decoder 220. CPID decoder 220 is apparatus which is well known to those of ordinary skill in the art for decoding the telephone number of incoming a call on telephone line 200 into a static digital format which can be utilized by other elements in apparatus 100. Output from CPID decoder 220 is applied as input to current CPID 230. Current CPID 230 is memory storage means which is well known to those of ordinary skill in the art such as solid state random access memory which stores information produced by CPID decoder.

Output from current CPID 230 is applied as input to microprocessor 240. Microprocessor 240 is any appropriate general purpose microprocessor of a type which is well known to those of ordinary skill in the art which is capable of monitoring a number of stimuli and making decisions on the basis of those stimuli to provide predetermined responses.

Auto-block key 250 is means of providing stimuli which is well known to those of ordinary skill in the art to microprocessor 240 for use in indicating that a called party has decided to block future calls from the telephone number contained in current CPID 230. Thus, whenever the called party depresses auto-block key 250, microprocessor 240 retrieves the telephone number stored in current CPID 230 and transfers it to data base 260.

Data base 260 is means of memory storage which is well known to those of ordinary skill in the art such as, for example, random access memory, for retaining a list of telephone numbers to be blocked. Finally, ringer 270 is a device which is well known to those of ordinary skill in the art for alerting a called party that an incoming call is being received. As will be explained below, ringer 270 will not be activated for blocked calls.

The following describes the operation of apparatus 100 shown in FIG. 1. When an incoming call is being received by apparatus 100, CPID decoder decodes the CPID and stores it in current CPID 230. Microprocessor 240 retrieves the CPID stored in current CPID 230 and compares it with the telephone numbers stored in data base 260. The comparison of the CPID of the incoming calls with the telephone numbers in the data base may be performed in any one a multiplicity of methods which are well known to those of ordinary skill in the art. If there is a match, i.e., the incoming call is to be blocked, ringer 270 is not activated and the called party does not answer the call and, advantageously, is not even made aware of its existence. However, if there is a match, microprocessor 240 causes ringer 270 to be activated to alert the called party of the incoming call.

Later, at any time during the call, or at any time while the telephone number is stored in current CPID 230, if the called party desires to block future calls from the telephone number he/she depresses auto-block key 250. In response, by generation of a signal or by polling, microprocessor 240 retrieves the telephone number from current CPID 230 and stores it in data base 260.

As those of ordinary skill in the art readily appreciate, embodiments of the present invention may either be contained in telephone 210 or may be separate from telephone 210. Further, if apparatus 100 or telephone set 210 has a display, the number to be blocked may be displayed thereby. Still further, apparatus 100 may further comprise a keypad for use in interacting with microprocessor 240 or the keypad of telephone 210 may be used to interact with microprocessor 240 for use in deleting telephone numbers from the data base. Lastly, although embodiments of the present invention have been described which utilize an auto-block key, it should be understood that this is not a limitation on the scope of the present invention. Specifically, in an embodiment which utilizes a keypad or the keypad of telephone 210, the notification of the desire to block future calls from a telephone number may be indicated by a predetermined one or more keypad presses.

It is to be appreciated and understood that the specific embodiments of the invention described hereinbefore are merely illustrative of the general principles of the invention. Various modifications may be made by those skilled in the art consistent with the principles set forth hereinbefore.

Claims

1. Apparatus for use in conjunction with a telephone set for blocking future incoming telephone calls which comprises:
 - means for determining the telephone number of an incoming call;
 - indication means for receiving an indication that future calls from the telephone number of the incoming call are to be blocked;
 - means, responsive to the indication means, for storing the telephone number in a data base; and
 - means, responsive to the incoming call, for determining whether the telephone number is stored in the data base and, if so, blocking the incoming call.
2. The apparatus of claim 1 further comprising means for generating the indication.
3. The apparatus of claim 2 wherein said means for generating the indication comprises a key.

4. A telephone set for blocking future incoming telephone calls which comprises:
 - means for determining the telephone number of an incoming call;
 - indication means for receiving an indication that future calls from the telephone number of the incoming call are to be blocked;
 - means, responsive to the indication means, for storing the telephone number in a data base; and
 - means, responsive to the incoming call, for determining whether the telephone number is stored in the data base and, if so, blocking the incoming call.
5. The telephone set of claim 4 further comprising means for generating the indication.
6. The apparatus of claim 5 wherein said means for generating the indication comprises a key on the telephone set.
7. The telephone set of claim 4 wherein the indication is provided by a predetermined sequence of one or more keys on the telephone set.

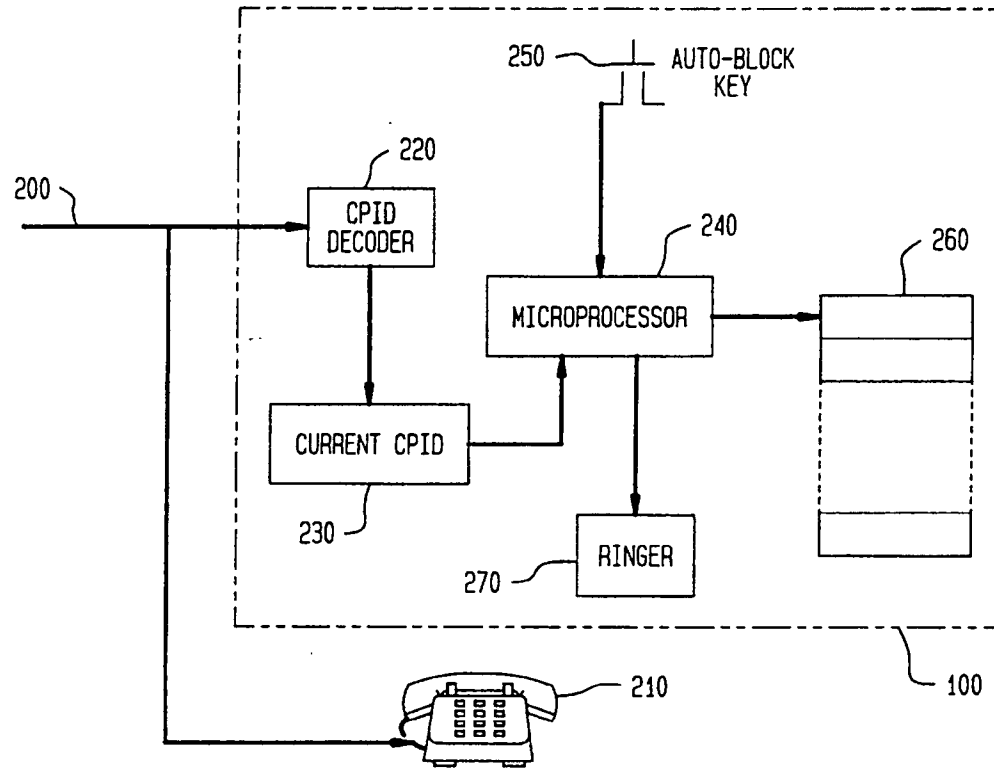



DOCUMENTS CONSIDERED TO BE RELEVANT			
Category	Citation of document with indication, where appropriate, of relevant passages	Relevant to claim	CLASSIFICATION OF THE APPLICATION (Int. Cl.5)
X	DE-A-3 234 093 (SIEMENS A.G.) * page 6, line 32 - page 12, line 23; figures 1,2 *	1,2	H04M1/66
X	--- PATENT ABSTRACTS OF JAPAN vol. 14, no. 371 (E-963)10 August 1990 & JP-A-21 34 950 (NEC) * abstract *	1-7	
X	--- PATENT ABSTRACTS OF JAPAN vol. 14, no. 187 (E-917)16 April 1990 & JP-A-20 36 657 (CANON) * abstract *	1-7	
X	--- PATENT ABSTRACTS OF JAPAN vol. 14, no. 328 (E-952)13 July 1990 & JP-A-21 11 146 (OMRON TATEISI ELECTRON) * abstract *	1-7	
X,P	--- PATENT ABSTRACTS OF JAPAN vol. 16, no. 150 (E-1189)14 April 1992 & JP-A-40 04 647 (MITSUBISHI ELECTRIC CORP.) * abstract *	1-7	
The present search report has been drawn up for all claims			TECHNICAL FIELDS SEARCHED (Int. Cl.5)
			H04M
Place of search THE HAGUE		Date of completion of the search 02 APRIL 1993	Examiner DELANGUE P.C.J.
CATEGORY OF CITED DOCUMENTS		T : theory or principle underlying the invention E : earlier patent document, but published on, or after the filing date D : document cited in the application L : document cited for other reasons ----- & : member of the same patent family, corresponding document	
X : particularly relevant if taken alone Y : particularly relevant if combined with another document of the same category A : technological background O : non-written disclosure P : intermediate document			

EPO FORM 1503 (01.92) (P/0401)



 **EUROPEAN PATENT APPLICATION**

 Application number : **93308975.7**

 Int. Cl.⁵ : **G06F 13/12**

 Date of filing : **10.11.93**

 Priority : **12.11.92 US 975037**

 Date of publication of application :
18.05.94 Bulletin 94/20

 Designated Contracting States :
DE FR GB

 Applicant : **International Business Machines Corporation**
Old Orchard Road
Armonk, N.Y. 10504 (US)

 Inventor : **Chamberlain, Paul Clement**
10402-A Golden Meadow
Austin, Texas 78758 (US)
 Inventor : **Smith, Brian Rutledge**
2303 Falcon Drive
Round Rock, Texas 78681 (US)

 Representative : **Bailey, Geoffrey Alan**
IBM United Kingdom Limited Intellectual
Property Department Hursley Park
Winchester Hampshire SO21 2JN (GB)

 **Queuing system and method of operation.**

 A queuing system and method of operation are provided that reduces latency and increases efficiency in a general purpose queuing system. The technique of the present invention is applied in an intermediate node that receives an entity, such as information, from a first node, and transfers that entity to a second node. The technique comprises the steps of (a) receiving at the intermediate node (B) a first block of the entity sent by the first node (A); (b) upon receipt of the block, initiating the sending of a subsequent block of the entity to the intermediate node; (c) concurrently with step (b), transferring the first block of the entity to the second node (C); (d) upon receipt of an acknowledgement from the second node (C), causing the intermediate node to transfer a portion of the entity to the second node (C), the portion transferred being all of the entity that has at the time of the transferral been received by the intermediate node (B) from the first node (A) since the previous transfer was made; and (e) repeating steps (b) and (d) until all of the entity has been transferred.

The above technique is adaptive to many environments and will optimize throughput for systems that need to transfer entities such as information. This system and method can handle mismatched flow problems from diverse environments and provides optimal flow for solutions that require guaranteed transfers. This algorithm can change and adapt to varying circumstances. It can be altered in real-time for communication systems. If the block size changes the modification does not alter the smooth flow of the algorithm.

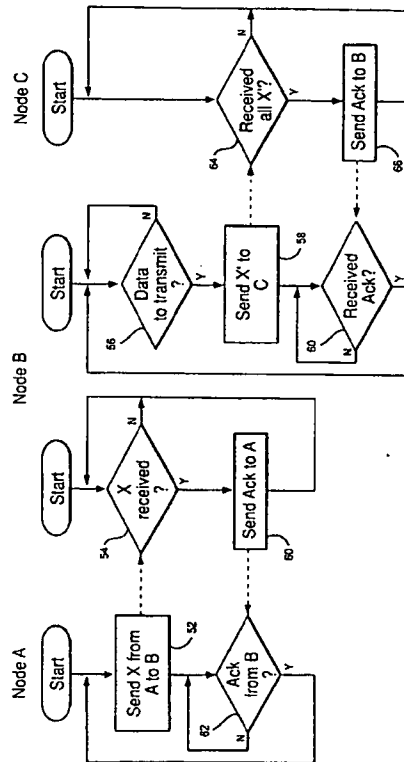

FIG. 4

EP 0 597 691 A1

This invention relates to queuing systems and more particularly to transporting of entities, such as items or information, from one location to another using an intermediate queue.

As computer manufacturers develop faster and more efficient computer communication networks, increasingly there are cases of mismatched bus and communication media speeds. One example is the IBM Microchannel and an IBM Fiber Channel (FCS) Microchannel adapter. The IBM Microchannel is capable of sustaining approximately 50 megabytes/sec, whereas the IBM FCS adapter can support either 25 megabytes/sec or 100 megabytes/sec. This mismatch also occurs with the Microchannel and an IBM Token Ring adapter. Because of these mismatches, data transfers can often be very inefficient with respect to the given communication media speed. They can also be very efficient, but have a long delay in starting transmission. This delay is often referred to as latency. These two problems, latency and efficiency, are classic in the field of communications.

There are numerous applications which require optimization of either latency or throughput. There are also those that require optimization of both. Customers are increasingly interested in low latency and very efficient use of the communication media. The present state of the art fails to provide an adaptive yet simple throughput mechanism between systems when trying to minimize latency and maximize efficiency.

It is therefore an object of the present invention to provide an improved queuing technique for an entity being transferred from a first node to a second node via an intermediate node.

Accordingly the present invention provides a method of operating an intermediate node to receive an entity from a first node and to transfer the entity to a second node, the first and second nodes being connected to the intermediate node by transmission links, the method comprising the steps of:

- (a) receiving at the intermediate node a first block of the entity sent by the first node;
- (b) upon receipt of the block, initiating the sending of a subsequent block of the entity to the intermediate node;
- (c) concurrently with step (b), transferring the first block of the entity to the second node;
- (d) upon receipt of an acknowledgement from the second node, causing the intermediate node to transfer a portion of the entity to the second node, the portion transferred being all of the entity that has at the time of the transferral been received by the intermediate node from the first node since the previous transfer was made; and
- (e) repeating steps (b) and (d) until all of the entity has been transferred.

Viewed from a second aspect the present invention provides a queuing system in an intermediate node for receiving an entity from a first node and transferring the entity to a second node, the first and second nodes being connected to the intermediate node by transmission links, the system comprising: reception means in the intermediate node for receiving a first block of the entity sent by the first node; initiation means, responsive to the reception means indicating receipt of the block, for initiating the sending of a subsequent block of the entity to the intermediate node; a transfer means, operating concurrently with the initiation means, to transfer the first block of the entity to the second node; the transfer means further, upon receipt by the intermediate node of an acknowledgement from the second node, transferring a portion of the entity to the second node, the portion transferred being all of the entity that has at the time of the transferral been received by the intermediate node from the first node since the previous transfer was made; the initiation means and transfer means repeating their functions until all of the entity has been transferred.

The present invention reduces latency and increases efficiency in a general purpose queuing system. The present invention is adaptive to many environments and will optimize throughput for systems that need to transfer information or other types of entities from point A to point C through intermediate point B. Example environments for utilizing the invention described herein include transfer of data via a communication channel, movement of people/equipment/goods via a transportation system, mail delivery scheduling, telephonic switching, etc.

An intermediate node of a multi-node system controls information flowing through it by queuing received information and transferring the received information to a subsequent node independent of the block size of the information being transferred. Subsequent blocks of information are transferred upon completion of a previous transferred block, rather than upon completion of an incoming block being received.

This procedure can handle mismatched flow problems from diverse environments and provides optimal flow for solutions that require guaranteed transfers. Better performing algorithms exist, but they cannot guarantee that the element being transferred will get from system A to C.

This procedure can change and adapt to varying circumstances. It can be altered in real-time for communication systems. If the block size changes the modification does not alter the smooth flow of the algorithmic procedure. The block size could be changed by a customer desiring to have real-time control over latency and throughput. In the case of IBM's FCS adapter, it may be desirable to expedite certain services and not others. It provides fine-tuned control over the data flowing through the system. When the setup time is very small,

one could use a standard communication meter and small block size to get good results. However, if the setup time were sizable, the incurred overhead with a small block size would be very high. The invention disclosed herein is better in both cases, especially the latter.

It can be seen that the present invention provides an adaptive flow control system. In preferred embodiments the technique provides an efficient yet adaptive communication system, being able to match dissimilar path speeds used for transporting information.

The present invention will be described further, by way of example only, with reference to an embodiment thereof as illustrated in the accompanying drawings, in which:

Figure 1 is a block diagram of a system in accordance with the preferred embodiment of the invention, including a sending, intermediate, and receiving node;

Figure 2 is a flow diagram of a simple algorithm used to transfer information between nodes;

Figure 3 is a flow diagram of a standard algorithm used to transfer information between nodes;

Figure 4 is a flow diagram of an adaptive flow algorithm used to transfer information between nodes in accordance with the preferred embodiment of the invention;

Figure 5 is a block diagram of a multi-node environment, such as used in a switched telecommunication system;

Figure 6 is a typical data processing system, which can provide the functionality of a sending and intermediate node; and

Figure 7 is a block diagram of a communications adapter.

Referring initially to Figure 1, there are several parameters that should be defined before describing the preferred system and method.

- Systems A (10) and B (20) communicate over link AB (12) with link speed M.
- Block moves between A and B are of size $\leq x$.
- Systems B (20) and C (30) communicate over link BC (14) with link speed N.
- Block moves between B and C are of any size. Blocks can be any quantity of items/people/information being conveyed or transferred between points.
- There exists a setup time for transfers between B and C of T_s .
- M and N are not necessarily equal.
- Y is the size of data transferred.
- T_{total} is the total time required in the transfer.

Simple Algorithm

Referring to Figure 2, the simplest technique for transferring data from A (10) to C (30) is to:

- Transfer x from A to B (at 22)
- When x arrives at B (24), transfer x to C (at 26) and send acknowledgement to A (at 28)
- If done (32), exit (34); else go to the beginning (22)

The equation for $T_{total} = Y/M + Y/N + Y \cdot T_s/x$

Standard Algorithm

Referring to Figure 3, a technique at the next level of complexity would be:

- Transfer x from A to B (at 36)
- Dual transfer
 - When x arrives at B (38), send acknowledgement to A (40); when link BC clear (42), transfer x to C (44)
 - and, when acknowledgement received from B (46), transfer another x from A to B (36)
- If done(48), exit; else go to the dual transfer (36)

The equation for $T_{total} = x/M + Y/N + Y \cdot T_s/x$

Adaptive Flow Algorithm

The adaptive algorithm employed in the preferred embodiment of the present invention uses the ratio of M to N, and a value p, where $p = \text{ceil}(\log(Y/x)/\log(M/N)) - 1$ and $\text{ceil}()$ is the ceiling function. $\sigma_i(n)$ is the sum from $j=0$ to $j=i$ of n raised to the jth power.

$p + 2$ is the total number of transfers for the adaptive algorithm. Referring to Figure 4, the adaptive algorithm flows as follows:

- Transfer x from A to B (52)

- First dual transfer
 - When x arrives at B (56); transfer x to C (58)
 - When x at B (54), send acknowledgement to A (60) to initiate (62) another transfer of x from A to B (52)
- 5 - Second through (p + 2)th dual transfer
 - Upon receipt of an acknowledgment from C (60), whatever is at B (designated by x' as determined at 56; where x' is larger or smaller than x, due to differing link speeds M and N), transfer that to C (58).
 - When x at B (54), send acknowledgement to A (60) to initiate (62) another transfer of x from A to B (52)
 - 10 - If done, exit; else go do the lth transfer
 - Node C, upon receipt of block x' (64), sends an acknowledgment to B (66). The determination as to whether the block x' has been received is made using any conventional technique known in the communication art for conveying a length of data being sent within the data packet, such as in a packet header file.

The equation for Ttotal using the adaptive algorithm is:

$$T_{total} = x/M + Y/N + \text{ceil}(\log(Y/x)/\log(M/N) + 1) * T_s$$

Formula Derivation

$$\begin{aligned}
 T_{total} &= x/M + T_s + x/N && \text{1st transfer} \\
 &+ (M/N) * x/N + T_s && \text{2nd transfer} \\
 &+ \dots \\
 &+ (M/N)^i * x/N + T_s && \text{ith transfer} \\
 &+ \dots \\
 &+ (M/N)^p * x/N + T_s && \text{p+1st transfer} \\
 &+ (Y - x * \text{sigma-p}(H/N))/N + T_s && \text{p+2nd transfer}
 \end{aligned}$$

Solving for Ttotal:

- 35 When M/N != 1:
 - $T_{total} = x/M + (p+2)*T_s + Y/N$ and
 - $p = \text{ceil}(\log(Y/x)/\log(M/N)) - 1$
- When M/N = 1:

The adaptive flow algorithm reduces to the standard algorithm.

40 Tables 1-4 demonstrate transfer times for various communication channel scenarios using the above described algorithms. Table 1 shows Ttotal for a 1 Megabyte file transferred using 1K blocks, where the channel speed between A and B is 50 Megabytes/second and the channel speed between B and C is 25 Megabytes/second. This table also shows two set-up time (Ts) examples (10 and 100 microseconds). Not only is the total transfer time less using the adaptive algorithm, but overhead is minimized. The overhead % $\underline{\Delta} (1 - (T_{total} / \min(M,N) / Y)) * 100$, where Y is the file size. The overhead ratio $\underline{\Delta} (\text{overhead \%})/(\text{adaptive overhead \%})$.

50

55

Table 1. Comparison of Algorithms: 1k blocks, 1M file, M=50MB/s, N=25MB/s

Algorithm	Ts, us	Total time,s	Overhead, %	Overhead Ratio
Simple	10	0.07	75%	230.8
Standard	10	0.05002	25%	77.1
Adaptive	10	0.04013	0.33%	1
Simple	100	0.16	300%	107.1
Standard	100	0.1401	250%	89.4
Adaptive	100	0.04112	2.8%	1

Table 2. Comparison of Algorithms: 4k blocks, 1M file, M=50MB/s, N=25MB/s

Algorithm	Ts, us	Total time,s	Overhead, %	Overhead Ratio
Simple	10	0.0625	60%	132.4
Standard	10	0.04258	6.5%	15.2
Adaptive	10	0.04017	0.425%	1
Simple	100	0.085	112.5%	45.9
Standard	100	0.0654	63.5%	25.9
Adaptive	100	0.04098	2.45%	1

Table 3. Comparison of Algorithms: 1k blocks, 100M file, M=50MB/s, N=25MB/s

Algorithm	Ts, us	Total time,s	Overhead, %	Overhead Ratio
Simple	10	7.0	75%	15000
Standard	10	5.00002	25%	5000
Adaptive	10	4.0002	0.005%	1
Simple	100	16	400%	6593
Standard	100	14.0001	250%	5495
Adaptive	100	4.00182	0.045%	1

Table 4. Comparison of Algorithms: 4k blocks, 100M file, M=50MB/s, N=25MB/s

Algorithm	Ts, us	Total time,s	Overhead, %	Overhead Ratio
Simple	10	6.25	60%	8654
Standard	10	4.25008	6.25%	962
Adaptive	10	4.00026	0.0065%	1
Simple	100	8.5	112.5%	2394
Standard	100	6.5004	62.5%	1330
Adaptive	100	4.00188	0.047%	1

Tables 2-4 similarly show various results when using the above described algorithms, for various file and block sizes.

The adaptive algorithm can be implemented using standard programming techniques as follows. One need only count the amount of data that has come from A to B (keep total at system/node B) while the transfer from B to C is occurring. Once the B to C transfer is complete, send the total accounted for data at B (the portion

received and counted) on to C. Thus, only node B is concerned with the possibly dissimilar data rates of link AB and link BC. Further, the block size can be dynamically changed at A without disrupting the adaptive algorithm, as the actual block size being used in the transfer of information is not used by B when determining whether to send information to C. This greatly simplifies system design by consolidating the transfer decision at a single node independent of the actual block size being used. The block could be changed to allow greater control over the latency and throughput of a particular flow of information, or to expedite a particular item through the system. The block size would be changed at the sending node, either manually by a user or automatically by the sending node's controller or computer. As the other system node(s) queue and transfer information irrespective of the block size, this size can be dynamically changed by the sender.

As shown in Figure 5, the technique of the preferred embodiment of this invention could similarly be extended to a system having multiple intermediate nodes 80, such as in a switched point-to-point communication system, with the adaptive algorithm running in each intermediate node (a node other than the originating 78 or final 82 node). Thus, each intermediate node handles the data flow mismatch for its respective sending and receiving nodes.

Figure 6 shows the preferred embodiment data processing system 84, which comprises a CPU 90, read only memory 96, random access memory 94, I/O adapter 98, user interface adapter 102, communication adapter 114, and display adapter 116 all interconnected via a common data path, or bus, 92. Each of the above components accesses the common bus using conventional techniques known to those of ordinary skill in the art, and include such methods as dedicating particular address ranges to each component in the system, with the CPU being the bus master. Other conventional techniques known to those of ordinary skill in the art include direct memory access, or DMA, used to transfer data at high speed from external devices such as DASD 100 or network 110 to the data processing system's random access memory (RAM) at 94. As is further shown in Figure 6, these external devices 100 and 110 interface to the common bus 92 through respective adapters 98 and 114. Other external devices such as the display 118 similarly use an adapter 116 to provide data flow between the bus 92 and the display 118. User interface means are provided by adapter 102, which has attached thereto such items as a joystick 112, mouse 106, keyboard 104, and speaker 108. Each of these units is well known as such and so will not be described in detail herein.

Figure 6 corresponds to the logical functions of Figure 1 in the following manner. Link 12 between system A 10 and system B 20 corresponds to bus 92 of Figure 6. System A of Figure 1 is the sender of data, and could be any of CPU 90, RAM 94, or I/O adapter 98 of Figure 6. In the preferred embodiment, data is provided to the communications adapter 114 from RAM 94 using conventional DMA techniques across bus 92. Link 14 of Figure 1 corresponds to network 110 of Figure 6. System C 30 of Figure 1 corresponds to a similar communications adapter 114 in a similar data processing system 84 also residing on network 110. Other embodiments of this invention could similarly use entire data processing systems 84 at each of System A, B, and C of Figure 1, and interconnected using traditional communication techniques.

Figure 7 shows in greater detail the communication adapter 114, which enables the essential features of System B (Figure 1) in the preferred embodiment. The adapter 114 is comprised of a microcontroller 122 coupled to a buffer 124, a transceiver 120 and a transceiver 126. Microcontrollers are commonly known in the art, and comprise a CPU 121, read only memory 123 and random access memory 125. Transceivers are used to interface to bus or network protocols by inserting/extracting the actual data to be transferred, as well as handling status signalling, within the particular bus or network protocol, as is commonly known in the art. The transceiver 120 receives data at 12 from the bus 92 of Figure 6. The transceiver 126 is an optical transceiver, and link 14 is an optical fiber, although it is apparent that the system of the invention could employ any type of transport mechanism. When data arrives at transceiver 120, it is buffered at 124, and the CPU is notified at 128. The CPU 122 maintains a count of the number of bytes received across link 12. The CPU 122, upon receipt of an acknowledgment at 130 which arrived across link 14 from System C (Figure 1), can initiate at 132 a transmittal of buffered information 124 across link 14 using transceiver 126.

The adaptive flow algorithm can be generalized to solve problems outside of the communications environment. It can handle parts inventory/shipping problems, military troop movement, mail delivery scheduling, and many other real world mismatched flow problems. In each case, the user defines the given parameter x to yield an acceptable latency at the beginning, and then follows the algorithm to determine total flow time. The simple and standard algorithms each are $O(n)$ overhead algorithms, whereas the adaptive flow algorithm is $O(\log(n))$. Therefore, as n grows, the adaptive flow algorithm overhead time will grow as $\log(n)$ and the others will grow as n . For large n , the first two algorithms require considerable processing and overhead compared to the adaptive flow algorithm.

Claims

1. A method of operating an intermediate node (B) to receive an entity from a first node (A) and to transfer the entity to a second node (C), the first and second nodes being connected to the intermediate node by transmission links, the method comprising the steps of:
- 5 (a) receiving at the intermediate node (B) a first block of the entity sent by the first node (A);
 (b) upon receipt of the block, initiating the sending of a subsequent block of the entity to the intermediate node;
 (c) concurrently with step (b), transferring the first block of the entity to the second node (C);
 10 (d) upon receipt of an acknowledgement from the second node (C), causing the intermediate node to transfer a portion of the entity to the second node (C), the portion transferred being all of the entity that has at the time of the transferral been received by the intermediate node (B) from the first node (A) since the previous transfer was made; and
 (e) repeating steps (b) and (d) until all of the entity has been transferred.
- 15 2. A method as claimed in Claim 1, wherein the entity is information.
3. A method as claimed in Claim 2 wherein said information is of total length Y and comprises a plurality of blocks having a block length "x".
- 20 4. A method as claimed in Claim 3 wherein the block length "x" comprises a plurality of data bytes, and a count of the data bytes received at the intermediate node (B) is maintained in order to determine the length of the portion to be transferred at step (d).
- 25 5. A method as claimed in any preceding claim wherein the transmission link between the first (A) and intermediate (B) nodes operates at a different data rate to the transmission link between the intermediate (B) and second (C) nodes.
6. A method as claimed in Claim 5, wherein the portion transferred at step (d) has a length different to the block length of the blocks sent by the first node (A).
- 30 7. A method as claimed in any preceding claims wherein the initiating step (b) is carried out by sending an acknowledgement of receipt of each block to the first node (A).
- 35 8. A queuing system in an intermediate node (B) for receiving an entity from a first node (A) and transferring the entity to a second node (C), the first and second nodes being connected to the intermediate node by transmission links, the system comprising:
 reception means in the intermediate node (B) for receiving a first block of the entity sent by the first node (A);
 40 initiation means, responsive to the reception means indicating receipt of the block, for initiating the sending of a subsequent block of the entity to the intermediate node;
 a transfer means, operating concurrently with the initiation means, to transfer the first block of the entity to the second node (C);
 the transfer means further, upon receipt by the intermediate node (B) of an acknowledgement from the second node (C), transferring a portion of the entity to the second node (C), the portion transferred being
 45 all of the entity that has at the time of the transferral been received by the intermediate node (B) from the first node (A) since the previous transfer was made;
 the initiation means and transfer means repeating their functions until all of the entity has been transferred.
- 50 9. A system as claimed in Claim 8, wherein the entity is information.
10. A system as claimed in Claim 9 wherein said information is of total length Y and comprises a plurality of blocks having a block length "x".
- 55 11. A system as claimed in Claim 10 wherein the block length "x" comprises a plurality of data bytes, and a count of the data bytes received at the intermediate node (B) is maintained in order to determine the length of the portion to be transferred by the transfer means.

12. A system as claimed in any of claims 8 to 11, wherein the transmission link between the first (A) and intermediate (B) nodes operates at a different data rate to the transmission link between the intermediate (B) and second (C) nodes, and the portion transferred by the transfer means has a length different to the block length of the blocks sent by the first node (A).

5

13. A system as claimed in any of claims 8 to 12, wherein the initiation means initiates the sending of the subsequent block by sending an acknowledgement of receipt of each block to the first node (A).

10

15

20

25

30

35

40

45

50

55

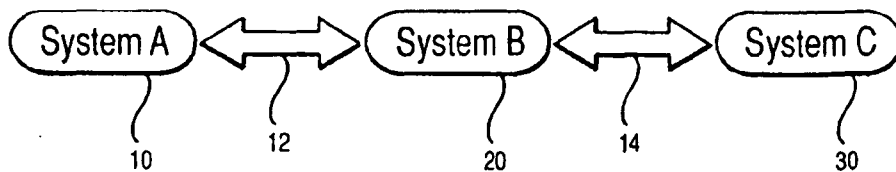

FIG. 1

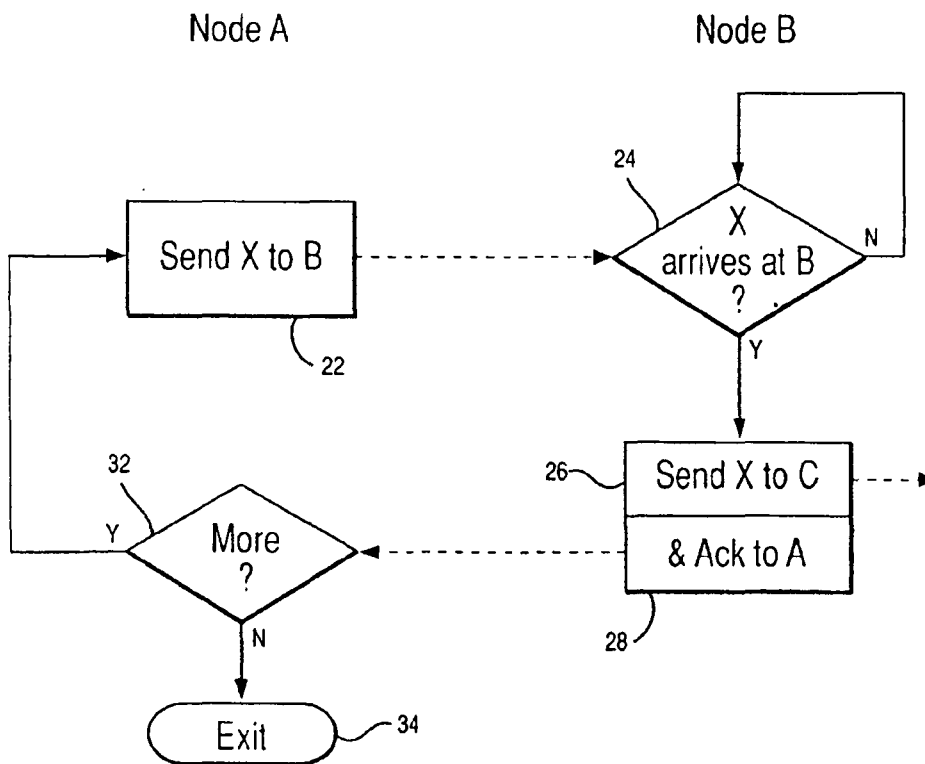

FIG. 2

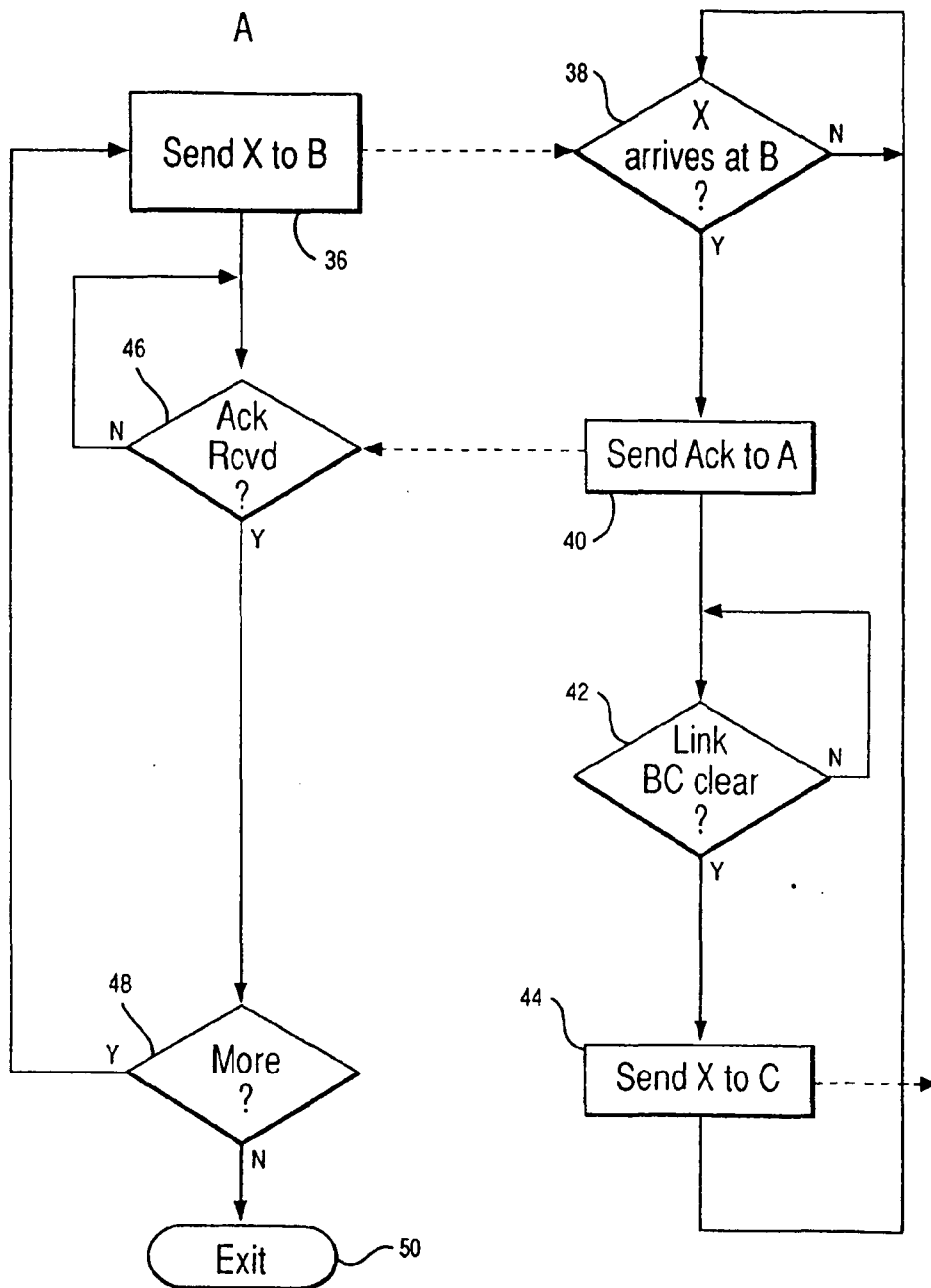

FIG. 3

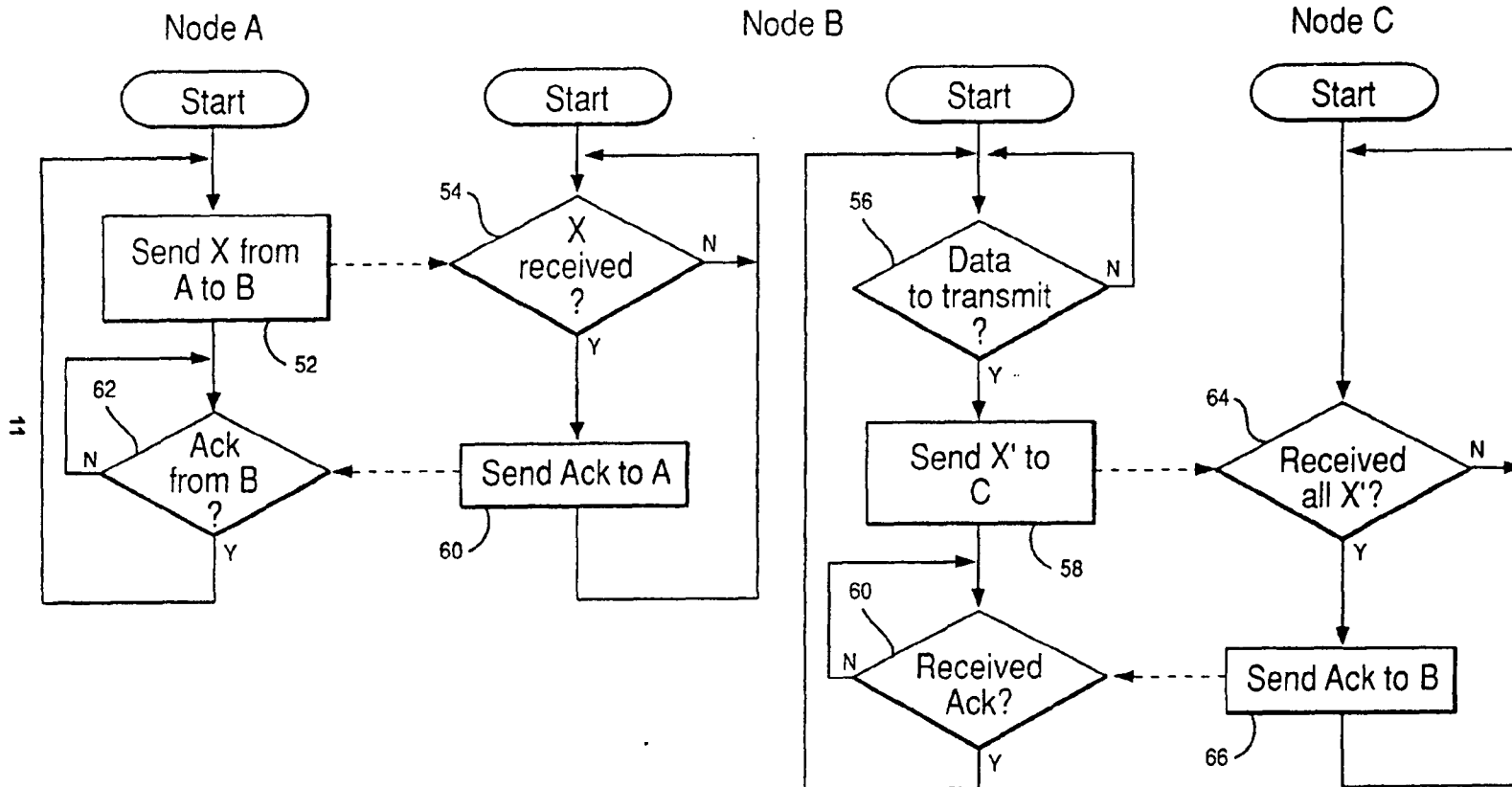

FIG. 4

EP 0 597 691 A1

FIG. 5

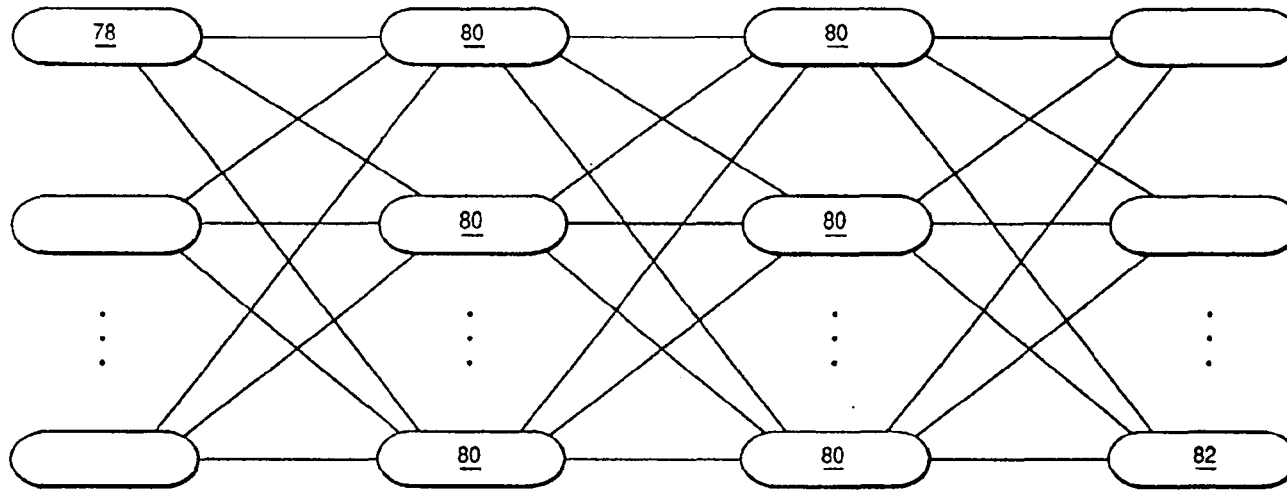
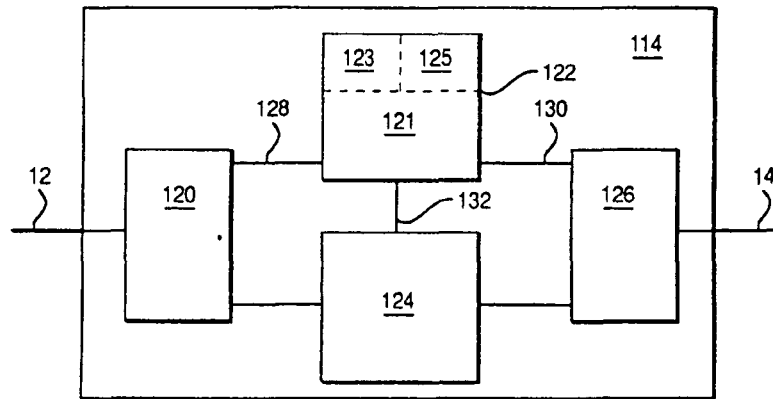
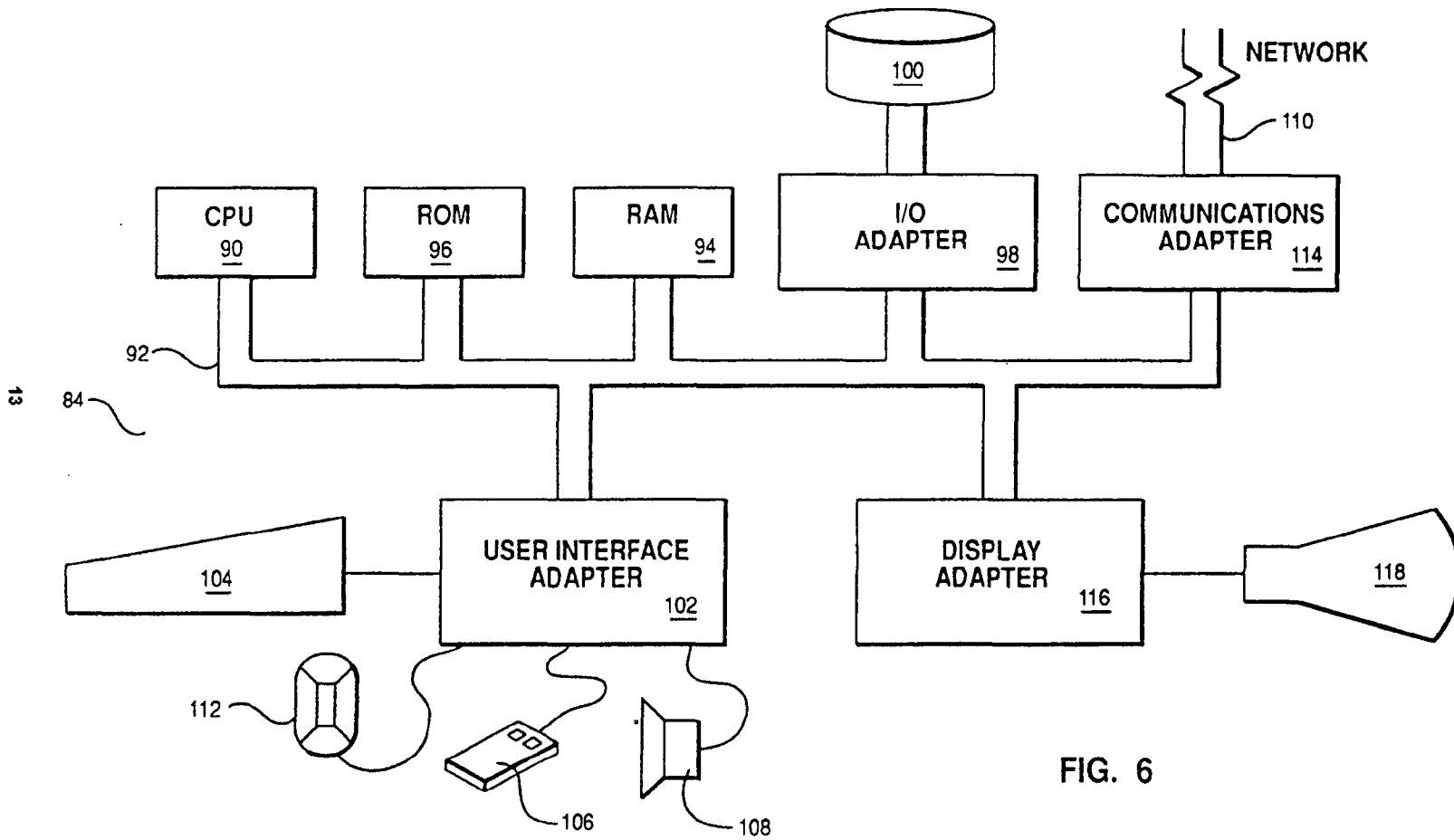

FIG. 7





EP 0 597 691 A1



European Patent
Office

EUROPEAN SEARCH REPORT

Application Number
EP 93 30 8975

DOCUMENTS CONSIDERED TO BE RELEVANT			
Category	Citation of document with indication, where appropriate, of relevant passages	Relevant to claim	CLASSIFICATION OF THE APPLICATION (Int.Cl.5)
A	WO-A-84 03192 (AMERICAN TELEPHONE AND TELEGRAPH COMPANY) * page 32, line 8 - page 43, line 14 * * figures 1,6 *	1,2,8,9	G06F13/12
A	COMPUTER COMMUNICATIONS REVIEW, vol.21, no.4, September 1991, NEW YORK US pages 307 - 315 B. S. DAVIE 'A host-network interface architecture for ATM' * the whole document *	1,2,8,9	
			TECHNICAL FIELDS SEARCHED (Int.Cl.5)
			G06F H04L
The present search report has been drawn up for all claims			
Place of search BERLIN		Date of completion of the search 3 March 1994	Examiner Masche, C
CATEGORY OF CITED DOCUMENTS		I : theory or principle underlying the invention E : earlier patent document, but published on, or after the filing date D : document cited in the application L : document cited for other reasons ----- A : member of the same patent family, corresponding document	
X : particularly relevant if taken alone Y : particularly relevant if combined with another document of the same category A : technological background O : non-written disclosure P : intermediate document			

EPO FORM LISA CLASS (P0401)



⑫ **EUROPEAN PATENT APPLICATION**

⑲ Application number : **94304718.3**

⑤① Int. Cl.⁸ : **H04Q 11/04**

⑳ Date of filing : **28.06.94**

③① Priority : **29.06.93 US 85264**

④③ Date of publication of application :
04.01.95 Bulletin 95/01

⑧④ Designated Contracting States :
DE FR GB

⑦① Applicant : **International Business Machines Corporation**
Old Orchard Road
Armonk, N.Y. 10504 (US)

⑦② Inventor : **Baugher, Mark John**
4613 Ramsey Avenue
Austin, Texas 78756 (US)
Inventor : **Van Horn, Isabel Berdeen**
12701 Marimba Trail
Austin, Texas 78729 (US)

⑦④ Representative : **Moss, Robert Douglas**
IBM United Kingdom Limited
Intellectual Property Department
Hursley Park
Winchester Hampshire SO21 2JN (GB)

⑤④ **System and method for bandwidth reservation for different traffic classes.**

⑤⑦ A system and method ensure transmission of data elements between computers at a preselected quality of service. A computer in a layered reference model communication network requests a preselected quality of service for selected transmissions. An existing session is employed whereby transmissions having a variety of preselected of service guarantees are multiplexed onto the existing session. Data elements having the preselected qualities of service are transferred from service channels of another such layer. In one embodiment a system and method are provided for use between layer N+1 and layer N, wherein elements from two or more service channels from N+1 are transferred to one or more service channels in layer N such that a preselected quality of service is provided for the elements being transferred. Elements from a service channel having a higher priority, deadline, or period are transferred from the layer N=1 service channel to the layer N service channel before elements from a service channel having a lower priority, deadline, or period. In yet another embodiment, the number of elements are constrained whereby no more than a fixed number of such elements will receive service in a layer N service channel at a given point in time.

EP 0 632 672 A2

Technical Field

The present invention relates to data processing systems and, more particularly, to such systems providing for multimedia connections or sessions.

Background of the Invention

It has long been known to provide computer workstations interconnected by digital communication networks whereby users of the individual workstations may communicate with one another over the network, previously common, for example, by means of a typed note, data or program file transmitted to another user. More recently, users have increasingly requested desktop conferencing, remote presentations, and other multimedia applications between network users. However, such multimedia applications, having associated therewith data-intensive sound, voice, and video flows. This requires concomitant high bandwidth communication links between distributed computing systems with minimal communication delay, maximum throughput, and instantaneous burst communication capability. The requirements of such multimedia applications accordingly make scheduling appropriate resources to provide for necessary quality of service very difficult.

Prior art has recognized that certain data in a network, such as that associated with multimedia, may require priority handling. Thus, for example, a "quality of service" (QOS) has been defined in the literature, hereinafter described in more detail. This seeks to describe various parameters which may be specified in an attempt to define certain minimum requirements which must be met for transmission of given data types over the network. See, for example, quality of service standards set forth in the Open System Interconnect Standard X.214 of the International Standards Organization interface and the quality of service standards defined in CCITTQ.931 (ISDN), Q.933 (frame relay), and Q.93B (B-ISDN ATM) drafts.

As yet another example there is an architected priority mechanism in the IEEE 802.5 Token Ring. A station on the ring with a high priority frame to send may indicate this in an access control field of a passing frame. When a station sending the frame releases the token, it releases the token at the priority of the AC field, and eventually sets it back to its original priority as specified in an IEEE 802.5 medium access control protocol. The IEEE standard and implementations thereof merely specify a protocol for increasing and decreasing priority, but each station is unconstrained in its use of priority beyond this protocol.

This in turn gives rise to a serious problem associated with the prior art. In seeking to accommodate situations in which a high priority channel is required to guarantee real time service for multimedia traffic, one approach, since each station is unconstrained,

has been for users to indiscriminately increase the priority of their flows. Such increases often result in no guarantees for multimedia quality of service in that no discrimination is provided, e.g. all users simply increase their priorities.

As yet another example of this, unconstrained use of priorities has resulted in bridges and routers loading so much high priority data as to flood the token rings and the like with this priority traffic such that multimedia traffic obtains no guaranteed priority. Again, this results from no discrimination between differing connections, sessions, and transmit operations.

Clearly other instances in the communication art have recognized the notion of a need for differing priority of data types, whether in the form of multiple channels with different priorities (such as the IBM LAN Streamer Token Ring Adapter Card with two transmit channels, and the 100 Mbps Ethernet System with priority channels) and the synchronous/asynchronous approach of, for example, the FDDI standards, a representative example of which is the FDDI SMT 7.X.

Moreover, it is clear in the literature that the notion of scheduling data in differing priorities is well known. See for example Liu and Layland, Scheduling Algorithms For Multiprogramming in a Hard-Real-Time Environment, Journal of the Association for Computing Machinery, Vol. 20, #1, January, 1973, where "rate-monotonic priority assignment" is discussed, page 50. Also see, for example, Dominico Ferrari, A Scheme for Real Time Channel Establishment in Wide Area Networks, IEEE Journal of Selected Areas in Communications, Vol. 8, #3, April, 1990, page 368. In this reference modification of an earliest due date (EDD) policy is presented which governs differing levels of priority assigned to tasks.

Similarly, the notion of specifying performance requirements in real time communication services is further addressed in another reference to Dominico Ferrari, Client Requirements for Real-Time Communication Services, IEEE Communications Magazine, Nov. 1990, page 65, wherein it is noted that a client and server will negotiate a specification for their respective requirements for services including delay bounds, throughput bounds, and the like.

From the foregoing it is clear that notions in the art have developed of varying degrees of priority service (based upon deadlines variously computer as burst/throughput or as a specified delay bound) being required in communication networks. However, several problems have remained in implementing a successful system which addresses the needs for guaranteeing real time service for multimedia traffic. First there is the aforementioned problem of lack of discrimination amongst the traffic whereupon users indiscriminately simply designate all their traffic to a higher priority, thereby "congesting" the network.

Yet another problem not effectively addressed by the prior art relates to the emergence of heterogeneous networks from differing vendor implementations of multimedia sessions. Their equipment has differing capabilities e.g. speed and capacity, and make quality of service guarantees problematic since over-reservation (or overcommitment) of resources can result in long-term throughput or short-term delays to violate pre-specified QOS. To be practical, this requires that in providing for reserved bandwidth connections, a solution must be provided which minimizes changes to application program interfaces and underlying client implementations. Yet another problem relates to failure to provide for multiple priority queues or channels extending through multiple layers since end-to-end delivery among digital computing devices requires services of multiple layers of the OSI model. The link layer guarantees service between two ends of a digital communication link and network over multiple links. Transport services at the endpoint must all provide QOS guarantees using priority service to meet deadlines.

Thus, particularly with the proliferation of multimedia data content, the industry was in need of a communication system providing for multimedia flows with quality of service guarantees at the transport and network layers utilizing reserved bandwidth networks whereby the session might be controlled to ensure that traffic from the session remains within traffic descriptors.

Summary of the Invention

According to the present invention there is provided a system and method for effecting multimedia quality of service sessions in a communication network.

Accordingly, there is provided a method for transmitting data elements between computers of a multilayered computer communication network at least at one predetermined assured quality of service, comprising:

generating a request at one of said computers for transmission of data elements; and

responsive to said request including specification of a predetermined quality of service for transmission, either refusing said quality of service if resources to provide said quality of service are not available or transmitting said data elements according to said quality of service wherein the transmission of said data elements includes transferring said data elements having said quality of service requirements through at least one service channel of a first layer of said network to at least one service channel of a second lower layer of said network which provides said predetermined quality of service.

In a second aspect of the invention there is provided apparatus for use in transmitting data elements

between computers of a multilayered computer communication network at least at one predetermined assured quality of service, comprising:

means for generating a request at one of said computers for transmission of data elements; and

means responsive to said request including specification of a predetermined quality of service for transmission, for transmitting said data elements according to said quality of service wherein the means for transmitting said data elements includes means for transferring said data elements having said quality of service requirement through at least one service channel of a first layer of said network to at least one service channel of a second lower layer of said network which provides said predetermined quality of service.

The invention is embodied in computerized system components implementable in hardware or software or in combination. In a preferred embodiment the components regulate access to priority queues or transmission channels which are attached to the shared medium local area network or any point-to-point digital communications link over copper, fibre, radio or satellite transponders.

In one embodiment, a system and method are provided for use in an OSI layered reference model computer communication network for ensuring that transmissions of data elements between computers obtain a preselected quality of service. A computer in the network requests from another such digital service a preselected quality of service for selected transmissions. A determination is made if resource is available within the computers and network to meet the preselected quality of service. An existing session or connection between the computers is then employed such that transmissions having a variety of preselected quality of service guarantees, even commingled with such transmissions having no quality of service guarantees, are multiplexed onto the existing session or connection. In one implementation of the invention, the quality of service is altered in the session or connected by means of a session-modify command.

The priority, deadline, or period of each particular transmission on the session or connection is identified prior to transferring data elements having the preselected qualities of service on the session or connection. In one embodiment, the priority, deadline, or period is a computed function of a ratio of the burst and throughput quality of service parameters, and the session or connection transmission is effected by a reserved-send command. The data elements having the preselected qualities of service are thence transferred from service channels at one layer of the OSI layered reference model to one or more service channels of another such layer. The lower layer service channels are selected from a group comprising priority token ring service channels, B-ISDN ATM service

channels (corresponding to services in the ASM adaptation layers), 100 Mbps Ethernet high and low priority channels, and synchronous/asynchronous FDDI service channels.

In another embodiment of the invention, wherein a pre-established session has been transferring data elements without a quality of service requirement, upon occurrence of the need for a quality of service guarantee, a new session or connection is established, in one form employing a call-modify command. Data elements belonging to this next session or connection having the preselected quality of service requirement are thence transferred from one or more service channels at one layer of the OSI layered reference model to one or more service channels of another such layer.

In both embodiments, a system and method are provided for use between a layer N+1 and layer N in an OSI layered reference model implementation, wherein elements from two or more service channels from layer N+1 are transferred to one or more service channels in layer N, such that a preselected quality of service is provided for the elements being transferred. A reserved-send-with-specified-priority operation is provided in which the reserved-send is augmented with a parameter that describes the urgency, deadline or period of the transmission, e.g. throughput/burst.

More particularly, elements from a service channel having a higher priority, deadline, or period are transferred from the layer N+1 service channel to the layer N service channel before elements from a service channel having a lower priority, deadline, or period.

In yet another embodiment, the number of elements from a service channel having a layer priority, deadline, or period transferred from the layer N+1 service channel to a layer N service channel are constrained whereby no more than a fixed number of such elements will receive service in a layer N service channel at a given point in time.

Brief Description of the Drawings

Fig. 1 is a block diagram showing the configuration of a typical workstation in accordance with the subject invention;

Fig. 2 is an illustration of a data processing system including three workstations interconnected by a network in accordance with the subject invention;

Fig. 3 is a representation of a layered open systems interconnection model showing the relationship of components of the subject invention to the layers;

Fig. 4 is a simplified illustration of a workstation network interconnection in one embodiment of the invention providing for separate sessions

having differing priorities;

Fig. 5 is another simplified illustration of a workstation network interconnection in another embodiment of the invention providing for multiplexed multimedia flows on a single session having differing priorities;

Fig. 6 is a simplified illustration of a portion of the open system interconnection layered reference model for Fig. 3 depicting the abstraction of multiple layers with corresponding service access points.

Fig. 7 is a simplified illustration of a layered service channel model portion of the open system interconnection model of Fig. 3.

Fig. 8 is a flowchart detailing the program logic in accordance with one embodiment of the invention;

Figs. 9A and 9B is a flowchart detailing the program logic of another embodiment of the subject invention;

Detailed Description of the Preferred Embodiment

Referring now to Fig. 1, there is illustrated a typical hardware configuration of a workstation with a central processing unit 10, and a number of other units interconnected via a system bus 12. The workstation shown in Fig. 1 includes a random access memory (RAM) 14, read only memory (ROM) 16, and I/O adapter 18 for connecting peripheral devices such as disk units 20 to the bus, a user interface adapter 22 for connecting a keyboard 24, mouse 26, loudspeaker 28, microphone 32, and/or other user interface devices to the bus, a communication adapter 34, for connecting the workstation to a data processing network, and a display adapter 36 for connecting the bus to a display device 38.

Fig. 1 depicts a typical "intelligent" workstation, however, the workstation may in fact be a "dumb" terminal with only a limited processing capability under control of a host processor. Alternatively, the workstation may be a simple digital device for presenting audio or video streams. This is made clear in connection with Fig. 2.

Fig. 2 illustrates a data processing system comprising a number of workstations (here, three workstations 200, 220, and 230) interconnected by a pair of data networks 210 and 240, so as to permit communication between the workstations. It is assumed that the data processing system shown in Fig. 2 is of a type which permits concurrent real-time communication between the users. The network operates according to a conventional network protocol, such as the token ring protocol described in Token Ring Network Architecture reference, SC30-3374, IBM, 1989.

Fig. 2 depicts only one possible hardware configuration for a data processing network. Other configurations are possible. For example, the data process-

ing system could be based upon a star network, or a host processor connected to a plurality of dumb terminals, or could further be based upon a plurality of remote processors connected by a communication network. The networks could also be based upon a telephone network, an ISDN network, or any other "dial up" networks. Moreover, the workstations could be located within the single workspace or within a local area, or could be remote from one another. A source for detailing technical planning information for configuring a network of workstations in accordance with the invention, is the IBM Extended Services for OS/2 Example Scenarios Manual, 1991.

Multimedia computing is the processing of various media, such as video, waveform audio, musical instrument digital interface (MIDI) streams, animation, graphics, and text. Such processing includes the capture, authoring (editing) and playback of media streams as well as other data processing applications. Multimedia documents which are stored on some non-volatile medium, such as a disk, are referred to as recorded multimedia applications. There are also live multimedia applications in which two or more people communicate with each other at the same time using a computer. Live multimedia applications are normally conducted across space and time indicating that live multimedia is inherently distributed. Even recorded multimedia applications require distributed file system services to share large volumes of stored media, such as video disk, audio information, or computer-generated images. Thus, it is critical that a prioritizing scheme in accordance with the invention for multimedia applications includes support for a distributed environment.

To reduce design complexity, most networks are organized as a series of layers, each one built upon its predecessor as described in Computer Networks, Tannenbaum, Andrew S., Prentice Hall (1988) and OSI, A Model for Computer Communications Standards, Black, Ulyess, Prentice Hall, 1991. The number of layers, the name of each layer, contents, and function of each layer differ from network to network. However, in each network, the purpose of the layers is to offer certain services to the higher layers, shielding those layers from the details of how the offered services are actually implemented. The purpose, function, and details of each of the layers and their interaction is set forth in the previously noted references and is familiar to communication programmers ordinarily skilled in the art.

The transport layer accepts data from the session layer, splits it up into smaller units and passes the units to the network layer to ensure that the pieces all arrive at the other end. Details of the transport layer and how it fits into the OSI architecture are shown in Fig. 18 of the Tannenbaum book and described in the related pages. A representative of network architecture that provide technical standards docu-

ments for the networking framework are ISO/IEC JTC 1/SC 21 Information Retrieval, Transfer and Management for OSI Secretariat: USA (ANSI) (3294) Basic Reference Model Management Framework (7498-4), and Management Information Model (3324) ISO, 1989.

One way of looking at the transport layer is to regard its primary function as enhancing the Quality of Service (QOS) provided by the network layer. QOS can be characterized by a number of specific parameters. The OSI transport service allows a user to specify preferred, acceptable, and unacceptable values for these parameters when a connection is made. Some of these parameters also apply to connectionless transports. The transport layer examines the parameters, and depending upon the kind of network services available to it, determines whether the transport layer can provide the necessary service. Representative QOS parameters are:

Connection Delay, which is the amount of elapsed time between a transport connection being requested and confirmation being received by the user, which, as with all parameters dealing with delay, the shorter the delay the better;

Connection Establishment Failure Probability is the probability of a connection not being established within the maximum establishment delay time. Network congestion, lack of table space, and other internal problems affect this value;

Throughput measures the number of bytes of user data transferred per second as measured over a recent time interval, and is measured separately for each direction;

Transit Delay measures the time between a message being sent by the transport user on the source machine and its being received by the transport user on the destination machine;

Residual Error Rate measures the number of lost or garbled messages as a fraction of the total sent in the sampling period. In theory, the residual error rate should be equal to zero since it is the job of the transport layer to hide all network layer errors.

Yet additional QOS parameters includes;

Transfer Failure Probability which measures how well the transport service is living up to its assigned tasks. When a transport connection is established, a given level of throughput, transit delay, and residual error are agreed upon. The transfer failure probability gives the fraction of times that these agreed upon goals were not met during some time period;

Connection Release Delay is the amount of time elapsing between a transport user initiating a release of a connection and the actual release occurring at the end;

Connection Release Failure Probability (CRFP) is the fraction of a connection release attempts which did not complete within the agreed-upon connection release delay interval;

Protection provides a way for the transport user to specify interest in having the transport layer provide protection against unauthorized third parties reading or changing reading or changing transmitted information;

Resilience yields the probability of the transport layer spontaneously terminating a connection due to internal problems or congestion.

The hereinbefore-noted QOS parameters are specified by a transport application when a connection is requested. Both the desired, minimum, and maximum acceptable values are given. In some cases, the transport layer immediately recognizes that the values are not achievable. When this occurs, the communication attempt fails, and an appropriate exception is noted. In other cases the transport layer knows that it cannot achieve the desired goal, but can achieve a lower, but still acceptable rate. The lower rate, minimum acceptable rate, and maximum acceptable rate are sent to the remote machine requesting the established of a connection. If the remote machine cannot handle the proposed value, but can handle a value above the minimum or below the maximum, then it may lower the parameter to its value. If it cannot handle any value above a minimum, then it rejects the connection attempt. Then, the originating transport application is informed of whether the connection was established or rejected.

This process is called open negotiation. Once the options have been negotiated, they remain that way through the life of the connection. The OSI Transport Service Definition, (ISO 8072) does not specify the QOS parameters. These are normally agreed upon by a carrier and customer. A T-connect request is employed to initialize communication, and the QOS is specified as part of this transactions. Details on the transport primitives are found in the aforementioned reference. Below the transport and network layers are the link or MAC layers in the OSI and IEEE 802 reference models to be hereinafter described. Some MAC protocols, such as synchronous FDDI, provide guarantees for throughput, delay, and delay variation to applications. Other MACs such as the Token Ring and Token Bus have architected priority mechanisms which can support quality of service guarantees (throughput, delay, etc.) when the subject invention is employed.

Priority assurance is an important factor in ensuring QOS, and is enabled by operation of a component which may be implemented in hardware logic or software. The component regulates access to the priority queues or transmit channels that are attached to the shared medium local area network section. Access to the priority queue or transmit channels will pass through this component, thus subjecting all communication transactions to rejection or tracking by the component. A more detailed discussion of this component and the related station's bandwidth manager

component are described in Network Priority Management, U.S. Patent Application, (AT9-92-089) S/N 07/930,587, filed August 17, 1992.

Turning now to Fig. 3, depicted there is a schematic representation of several forms of a multi-layered computer communication network model based upon the OSI layered reference model. Further detail of this OSI and related IEEE models may be found in OSI, A Model for Computer Communications Standards, infra. The first five layers of the OSI model are shown in Fig. 3 as reference numerals 40-56. The lowest layer is the physical layer OSI 1, 56, which is responsible for implementing a physical circuit between data terminal equipment and data circuit terminating equipment.

The data link or second layer, OSI 2, 54, is responsible for transfer of data across the link. The third or network layer, OSI 3, 52, specifies the interface of the user into a network and also defines network switching/routing and communications between networks. The fourth or transport layer, OSI 4, 50, provides an interface between the data communications network and the upper three layers. This layer is of particular interest inasmuch as it provides the user options in obtaining certain levels of quality, and is designed to keep the user isolated from some of the physical and functional aspects of the network.

The fifth or session layer, OSI 5, 48, serves as a user interface into the transport layer below, providing a means for exchange of data between users such as simultaneous transmission, alternate transmission, checkpoint procedures and the like. The remaining two layers, the presentation layer and application layer (not depicted), ensure that user applications can communicate with each other and further concern the support of the end-user application process.

It will be noted from Fig. 3 that there are other implementations in the art of such an OSI reference model bearing varying degrees of similarity thereto, a portion of one being depicted in the left part of Fig. 3 as the IEEE model. A physical layer 46 may be seen corresponding to the first layer 56 of the OSI model. The IEEE recognized the need to divide the data link layer OSI 2, 54, into two sublayers in order to handle different link configurations and thus a medium access control (MAC), 44, and logical link control (LLC), 42, were provided for. The IEEE model is specialized to links which are shared media, e.g. having more than two connected stations. The MAC sublayer is protocol-specific (such as to a LAN such as Ethernet) whereas the LLC, 42, serves as an interface to an upper layer protocol, typically the network layer (and isolates the network layer from the specific actions of the MAC sublayer). One purpose of depicting varying forms of a multilayered computer communication network in Fig. 3 is to illustrate that the invention admits to implementations in any number of such multi-layered models, and is thereby not intended to be lim-

ited to application to the OSI reference model emphasized in the description herein.

Still referring to Fig. 3, a more practical implementation of the invention is shown in the righthand portion thereof as it relates to the theoretical reference models just described. More particularly, there is first shown an adapter card 62, implementing the physical layer and part of the MAC of the reference model. In a preferred form, this adapter card will provide for a plurality of priority channels, services or queues, as illustrated by the P0 and P5 channels. The figure is further intended to indicate that the adapter card 62 will be for at least two channels through which data elements may flow, each such channel having a differing priority. Although a P0 and P5 have been shown, the invention admits to implementations with more priority channels as required (with, conventionally, the right or higher numbered channels such as P5 indicating higher priority whereby data elements transferred through this channel will be transmitted in preference over those at a lower priority. A media access control software driver 60 is also shown implementing the MAC sublayer 44 in the IEEE model, for example, and finally a netbios or functionally equivalent form of LAN software, 58, is shown implementing the session layer 5 of the OSI reference model.

It is important to note that the invention contemplates implementation of multiple service channels in the lower layers of the architecture in a number of forms and is not intended to be limited to any particular such implementation. Thus the channels depicted with associated priorities P0 and P5 may be implemented as priority token ring service channels, B-ISDN ATM service channels, 100 Mbps Ethernet high and low priority channels, and even as lower layer service channels in the synchronous and asynchronous FDDI form of priority channels or queues.

Still referring to Fig. 3, as will be described hereinafter in greater detail, yet an additional feature of the invention is shown depicted therein. In a preferred embodiment, once a session has been established, shown at reference numeral 64, data elements having a preselected QOS belonging to the session or connection from one or more such just described service channels at one layer of the OSI layered reference model (such as the netbios layer 58), will be transferred to one or more service channels of yet another layer such as that of the MAC driver 60 or physical layer 62. This is schematically depicted by the line 64 splitting into two parallel downward arrows culminating in the two channels P0 and P5 having differing priorities, shown as arrows 66 and 68.

In another form of the invention, a pre-existing session shown as arrow 70 may have been established which may not have required a quality of service. Such a session may have been established by a call command. When a determination is made by the sys-

tem that a multimedia transmission requiring a guaranteed quality of service is required, a new session may be established by a call modify, shown by the arrow 72 extending downwards through the various reference model layers and terminating in the P5 channel. This is intended to indicate that when such multimedia data transmissions are required, in implementations allowing for only one session per file or connection, this form of the invention will provide for a next session operating at higher priority to effect the desired quality of service guarantee at, for example, the higher P5 priority.

This latter form of the invention may be seen more clearly depicted in Fig. 4. In this embodiment there may be various forms of data in need of transfer shown generically as file 1, 84, and a second device 2, 86, each form of data having associated therewith either no quality of service requirement or some form of quality of service guarantee dependent upon the data type. For example, device 2 might be a real time video capture card having a relatively high throughput requirement of perhaps 150 KBS, whereas the data associated with file 1 may be digitized audio requiring a lesser QOS or perhaps even a binary executable file or text file with no particular required QOS.

As previously described, a first session 88 may have previously been established between two computers 80 and 82 on the network for transmission of non-QOS data such as that from file 1. Upon determination of the capability of the network to transfer QOS data, in one embodiment, a next session (shown schematically at reference numeral 90) may thereafter be established between the computers 80-82 wherein a QOS is bound to this next session 90 to carry the multimedia data associated with device 2, 86, at a guaranteed QOS.

Turning now to Fig. 5, this figure is intended to more practically represent the multiplexed flows of data at varying qualities of service at a single session, as briefly hereinbefore with reference to the rightmost portion of Fig. 3. In this implementation, again data having differing quality of service requirements (or none) may be seen graphically illustrated as file 1, 104, and device 2, 106. In this preferred embodiment, however, a session may have been established between computers 100 and 102 shown by line 108. It is contemplated that data elements corresponding to differing QOS needs may nevertheless be transmitted or multiplexed on the same single session 108. In this manner, the aforementioned real-time video captured by device 2, 106, may be given a high priority and transmitted on the session 108 in preference to but nevertheless multiplexed with lower priority data associated with file 1, 104.

Turning now to Figs. 6 and 7, it is an important feature of the invention that data elements belonging to sessions or connections having a preselected quality of service from one or more service channels at

one layer of a layered reference model may be transferred to one or more service channels of another layer.

Thus, turning now to Figs. 6 and 7, they are intended to represent a more generalized case than that of Fig. 3, and represent the notion that multiple channels or priority queues may be provided at a plurality of layers providing quality of service guarantees.

Fig. 6 is an OSI depiction of a service access point (SAP) which is an addressable unit by which layer N provides service access to a layer N+1 user. The invention extends or replaces this abstraction by which a layer N service offers a multiplicity of service priorities that correspond to the deadline, period or quality of service to be provided to a layer N+1 user.

Turning now to Fig. 8, a flow diagram is provided which may be implemented in software for use by the network system in effecting one embodiment of the invention. First, a request for a quality of service transfer 130, is placed on the network 210 or 240 by one of the workstations 220 which may be a client or an application program. The QOS request is received, 132, by the host or server 220 or communications transport product, which then determines whether sufficient QOS resources are available in the network to service the request 134. If not, as indicated as block 136, the QOS session or connection is refused. If, on the other hand, sufficient resource is available, the QOS connection is established, 138, and transfer of data commences utilizing the aforementioned plurality of QOS service channels extending through the multiple layers of the reference model 140, in accordance with the invention.

Turning now to Figs. 9A and 9B, a more detailed flow diagram for an alternate embodiment of the invention is provided wherein elements from a service channel having a higher priority, deadline or period are transferred from a layer N+1 service channel to layer N service channel before elements from a service channel having a lower priority, deadline, or period are transferred. First, as in the case of the prior embodiment, one of the network computers may generate a QOS request 142, which is then received by the host or server 144. Again, the server or host determines whether QOS resources are available, 146, to service the request. If this is not the case, QOS guarantees are not provided. Upon a subsequent data transfer request 150, the server or host determines whether QOS service channels are empty, 152, and if not, a polling procedure is entered looping back on the block 152 for the channel to empty so that lower priority data may be transferred. Upon the QOS service channel's emptying, data is then transferred over non-QOS service channels 160.

If a QOS request has been received, 144, and QOS resources are available, 146, one or more priority channels will be reserved such that a QOS guarantee may be made, 154. Upon a subsequent data

transfer request 156, the server or host will determine whether QOS data is involved, 158. If not, the hereinbefore described process relative to blocks 152 and 160 will be repeated. If, on the other hand, QOS data is involved in the data transfer request 158, the host or server will thereafter identify the period, priority, or deadline associated with the desired QOS transfer and thereafter will identify an appropriate service channel 164. The host or server thereafter will determine whether service channel constraints exist, 166. If so, the system next determines whether the service channel is at the predetermined limit 168, in which case again a polling loop is entered, looping back on the block 168 determination. When the service channel is detected as not being at a limit, the system then detects whether higher priority QOS service channels are empty, 170. If not, again a polling routine is entered looping back on the block 170 determination until higher priority traffic is handled whereupon flow exits to the right of block 170 and data is transferred in the desired manner on the service channels 172.

Referring back to block 166, if there were no service channel constraints 166, the logic flow exits from the right of block 166 to the subsequent determination of whether a higher QOS service channel or channels are empty, 170, and the process thence continues in the manner previously described.

From the foregoing relative to Figs. 9A and 9B, it is apparent that no attempt is made to put lower priority traffic in a higher priority channel. Rather, when two channels from layer N+1 to a single channel at layer N exist, in a preferred embodiment the number of lower priority requests will be constrained which go into the layer N channel from the layer N+1 lower priority service channel. In this manner, the system may determine how long a higher priority service channel request will have to wait, at maximum, to obtain access to the layer N service channel. The system moreover avoids putting lower priority requests into the service channel when there are higher priority requests waiting to go to the same channel.

While the invention has been shown and described with reference to particular embodiments thereof, it will be understood by those skilled in the art that the foregoing and other changes in form and detail may be made therein without departing from the spirit and scope of the invention.

Claims

1. A method for transmitting data elements between computers of a multilayered computer communication network at least at one predetermined assured quality of service, comprising:
 - generating a request at one of said computers for transmission of data elements; and
 - responsive to said request including spec-

- ification of a predetermined quality of service for transmission, either refusing said quality of service if resources to provide said quality of service are not available or transmitting said data elements according to said quality of service wherein the transmission of said data elements includes transferring said data elements having said quality of service requirements through at least one service channel of a first layer of said network to at least one service channel of a second lower layer of said network which provides said predetermined quality of service.
2. A method according to claim 1 including, responsive to said specified quality of service being provided by pre-existing data transmission session, multiplexing said data transmission at said quality of service on said pre-existing session.
 3. A method according to claim 2, wherein said data transmission is multiplexed with other data transmissions which either also have quality of service guarantees supported by said service channel of said second layer or have no predetermined quality of service.
 4. A method according to claim 2 or claim 3, wherein said pre-existing session includes a preselected quality of service transmission, and wherein said method includes the further step of altering said quality of service for a next transmission within the session.
 5. A method according to any one of the preceding claims, including establishing a data transmission session providing said at least one quality of service when said specified quality of service is not provided by any pre-existing data transmission sessions.
 6. A method according to any one of the preceding claims, wherein said at least one service channel of said second layer is comprised of synchronous and asynchronous channels.
 7. A method according to any one of the preceding claims, wherein said at least one channel of said first and second layers comprises multiple priority channels.
 8. A method according to claim 7, wherein said step of transferring said data elements includes transferring said data elements through a plurality of service channels each having a different priority associated therewith and receiving a plurality of subgroups of said data elements having corresponding different qualities of service and priorities associated therewith through corresponding
- ones of said channels.
9. A method according to any one of the preceding claims wherein said at least one service channel of said second layer is taken from the group comprising:
 - priority token-ring channels, B-ISDN ATM channels, Ethernet high and low priority channels, and synchronous/asynchronous FDDI channels.
 10. A method according to any one of the preceding claims, wherein a quality of service associated with each data transmission of a particular group of data elements is identified by identifying a priority, deadline, or period associated with said particular group of data elements, or by determining burst and throughput quality of service parameters.
 11. A method according to any one of the preceding claims, wherein the multilayer network includes at least an N+1 layer and an N layer for assured transmission of data elements, including the steps of:
 - establishing two or more service channels in said N+1 layer;
 - establishing one or more service channels in said N layer; and transferring said data elements from said two or more channels in said N+1 layer to said one or more channels in said N layer at said predetermined quality of service.
 12. A method according to claim 11, wherein selected groups of said data elements from said two or more channels have a higher and a lower priority, deadline, or period respectively; and
 - wherein said selected groups having said higher priority are transferred from said N+1 layer through said two or more channels to said one or more channels of said N layer before said selected groups having said lower priority are transferred.
 13. A method according to claim 12 including:
 - preselecting a fixed number of data elements to be received in said one or more channels at said lower priority in said transfer from said N+1 layer to said N layer;
 - servicing up to said fixed number of data elements in said one or more service channels in said N layer at said lower priority; and
 - discontinuing said transfer of said data elements at said lower priority when said fixed number of data elements per unit of time is reached.
 14. Apparatus for use in transmitting data elements

between computers of a multilayered computer communication network at least at one predetermined assured quality of service, comprising:

means for generating a request at one of said computers for transmission of data elements; and 5

means responsive to said request including specification of a predetermined quality of service for transmission, for transmitting said data elements according to said quality of service wherein the means for transmitting said data elements includes means for transferring said data elements having said quality of service requirement through at least one service channel of a first layer of said network to at least one service channel of a second lower layer of said network which provides said predetermined quality of service. 10 15

15. Apparatus according to claim 14, wherein said multilayered network is an open systems interconnection network. 20

25

30

35

40

45

50

55

10

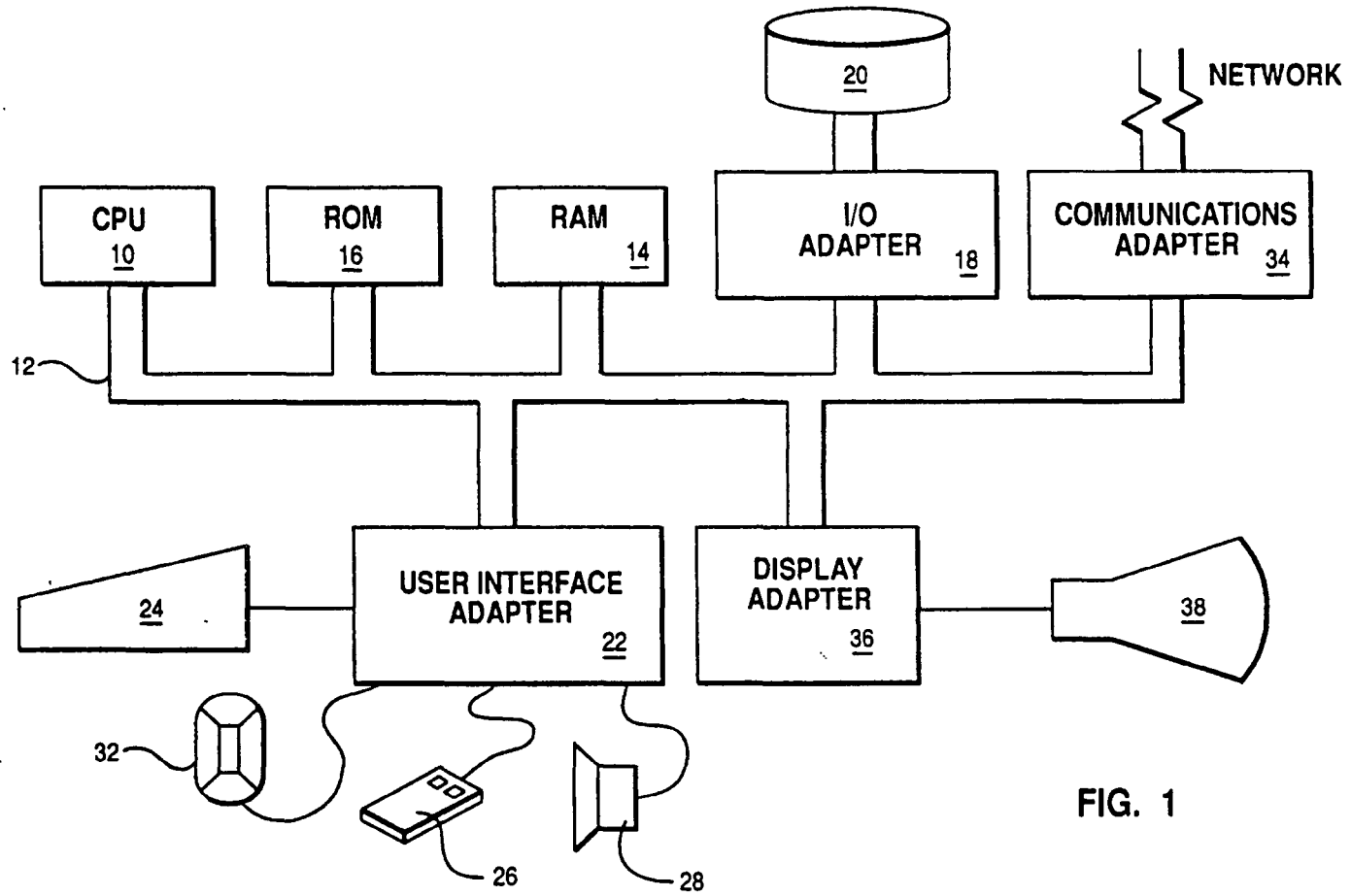

FIG. 1

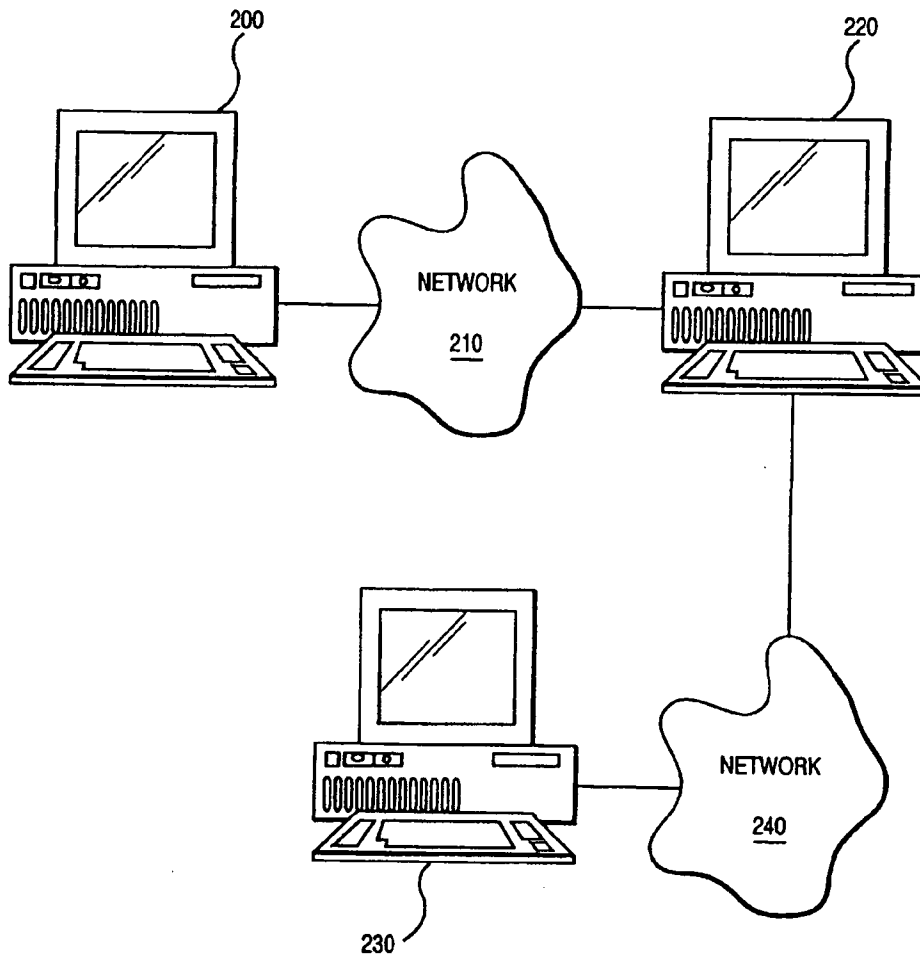

FIG. 2

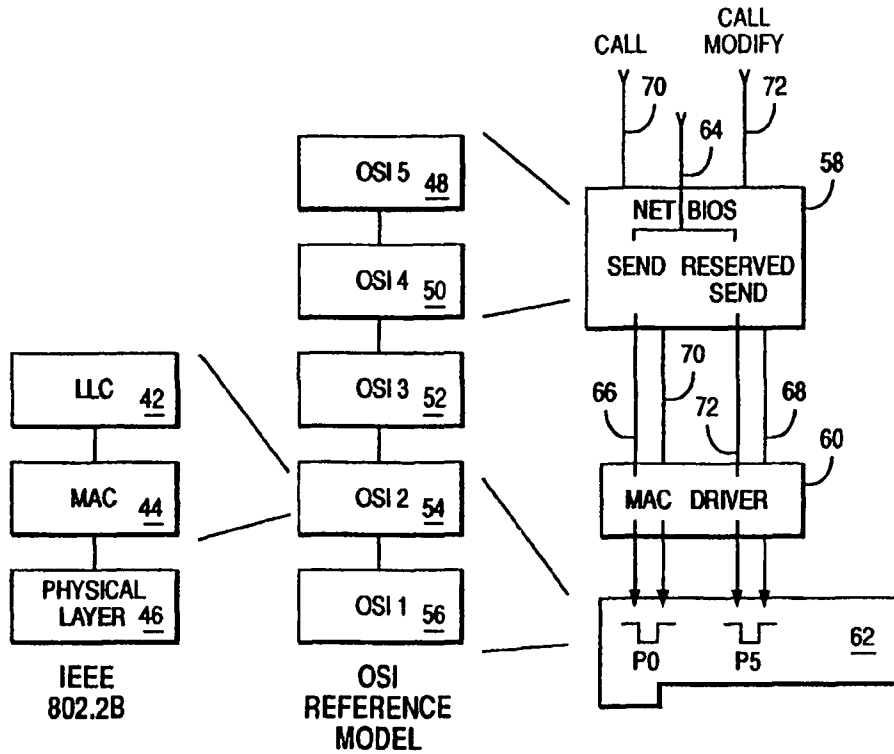
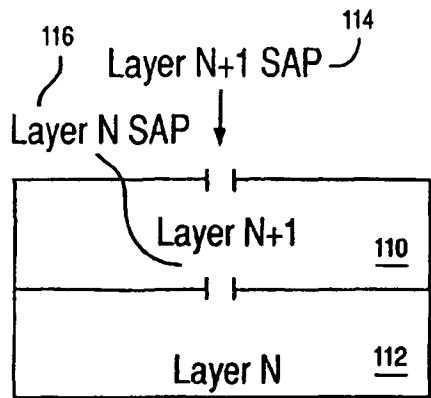
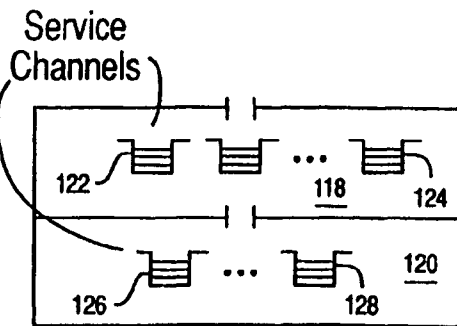

FIG. 3



OSI LAYERED REFERENCE MODEL

FIG. 6



LAYERED SERVICE CHANNEL MODEL

FIG. 7

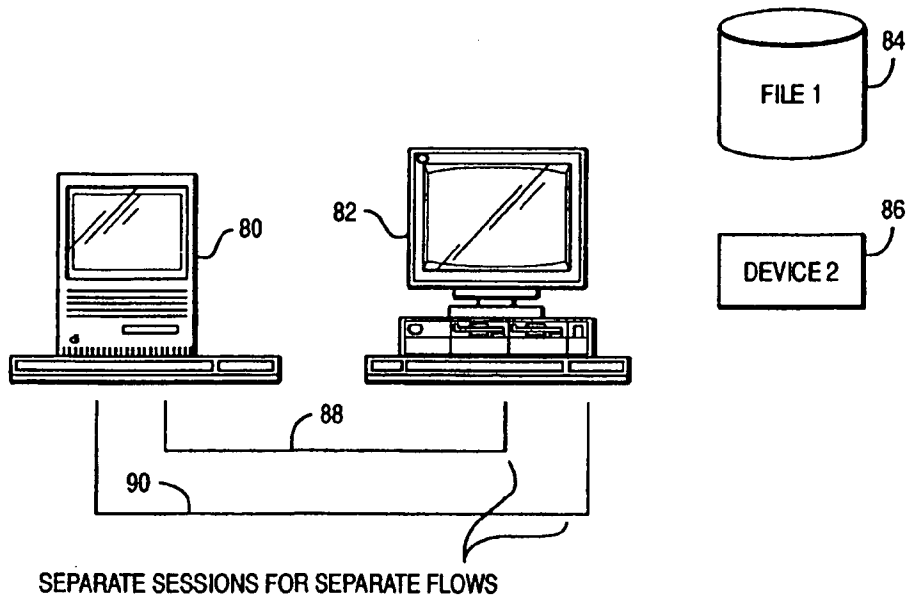

FIG. 4

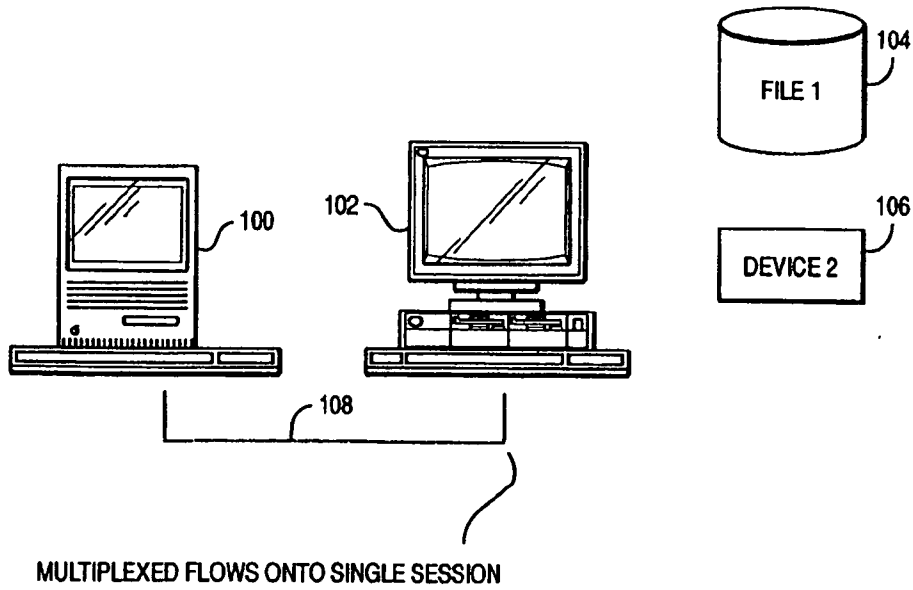

FIG. 5

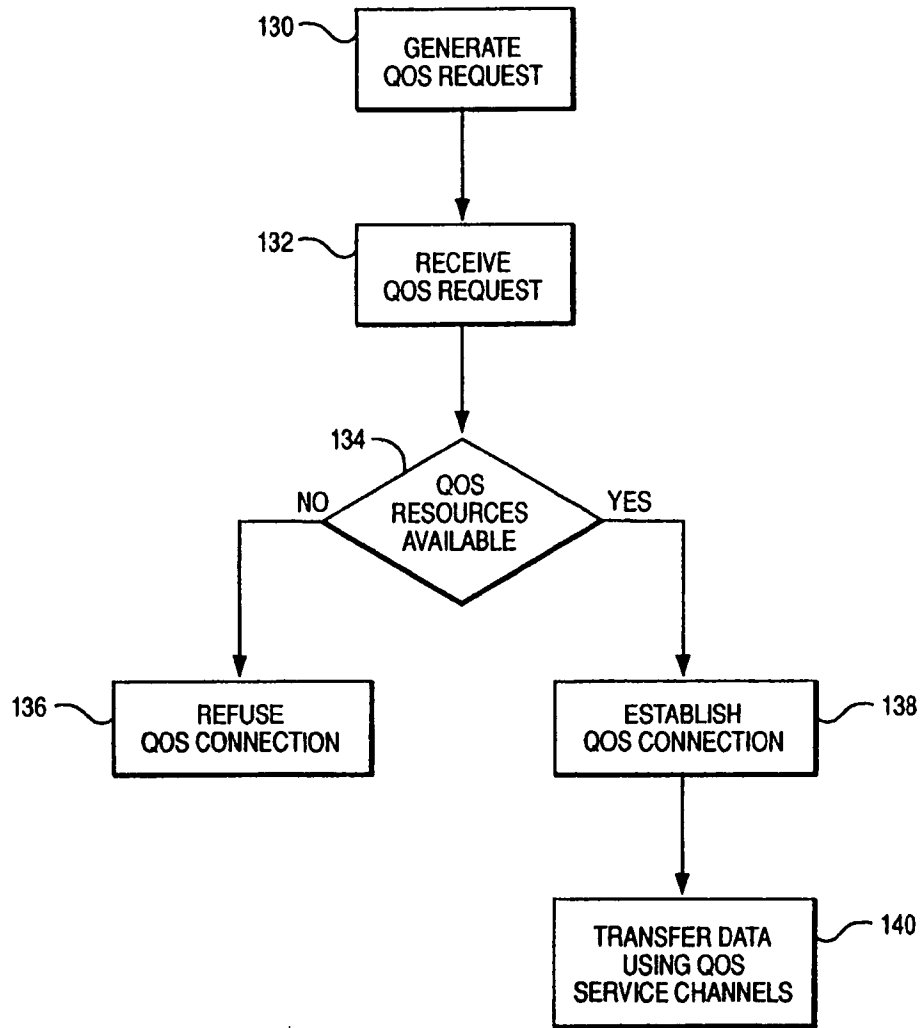

FIG. 8

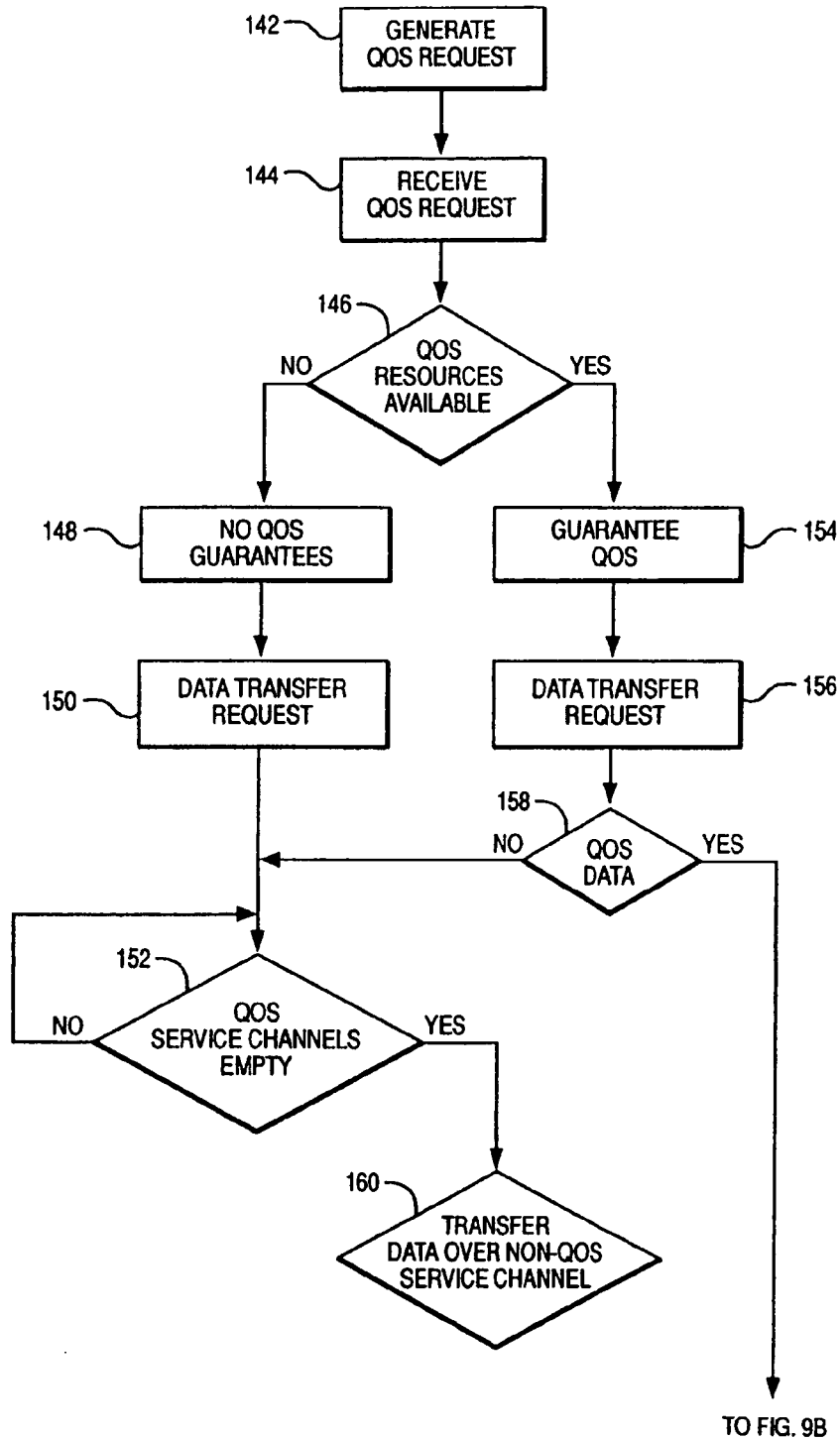

FIG. 9A

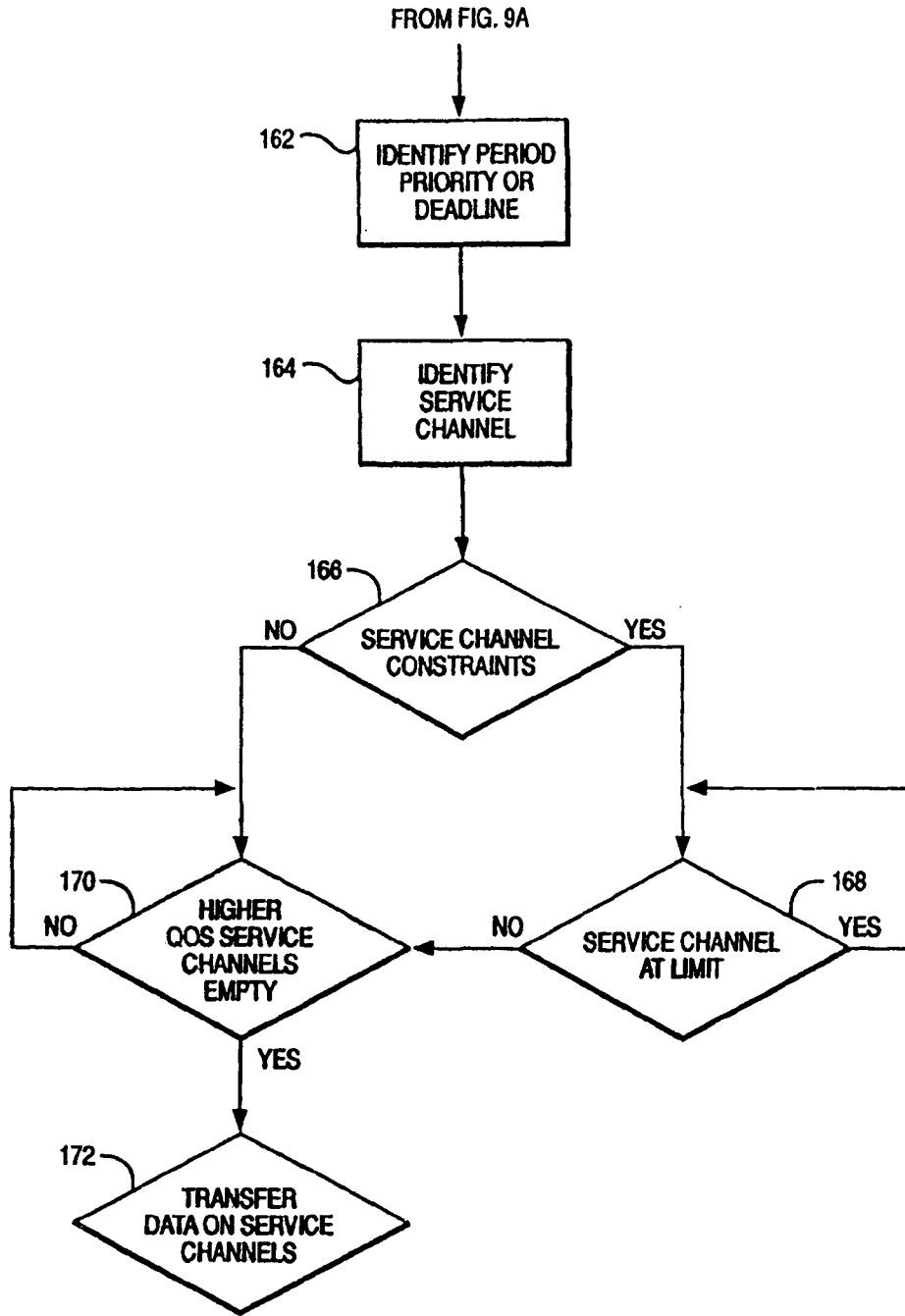

FIG. 9B



(12) **EUROPEAN PATENT APPLICATION**

(21) Application number : **94306326.3**

(51) Int. Cl.⁸ : **H04L 29/06**

(22) Date of filing : **26.08.94**

(30) Priority : **11.09.93 GB 9318877**

(43) Date of publication of application :
12.04.95 Bulletin 95/15

(84) Designated Contracting States :
DE FR GB

(71) Applicant : **International Business Machines Corporation**
Old Orchard Road
Armonk, N.Y. 10504 (US)

(72) Inventor : **Wallis, Graham Derek**
75 Raley Road
Locks Heath, Hampshire, SO3 6PB (GB)

Inventor : Taylor, Michael George
St Elmo,
Duncan Road,
Park Gate
Southampton, Hampshire, SO3 7BD (GB)
Inventor : Platt, Michael
Avoca, Chidden Holt,
Hambledon
Hampshire, PO7 6TG (GB)
Inventor : Stanford-Clark, Andrew James
68 Allbrook Knoll,
Allbrook
Eastleigh, Hampshire, SO3 4RY (GB)

(74) Representative : **Burt, Roger James, Dr.**
IBM United Kingdom Limited
Intellectual Property Department
Hursley Park
Winchester Hampshire SO21 2JN (GB)

(54) **A data processing system for providing user load levelling in a network.**

(57) The present invention provides a data processing system, and method of operating such a system, for facilitating a connection of a program on a client computer to a server, the server consisting of a plurality of server computers with shared resources. The data processing system, the client computer, and the server computers all reside in a logical network. The data processing system has an input means for receiving a request from the client computer for a machine address of a server computer identified by a server computer name sent with the request, such a machine address enabling a connection to be made from the client computer to that server computer via the network. A storage device is provided by the system for storing a list identifying server computer names with machine addresses of the server computers. A conversion means in the system uses the list to convert the server computer name received by the input means into the machine address of the server computer, and then an output means sends the machine address from the conversion means to the client computer. The system is characterised by decision logic for studying the server computers at predetermined intervals having regard to a predetermined test criteria, in order to select one of the server computers; and writing means for updating the list by associating the machine address for the server computer selected by the decision logic with a particular server computer name contained as a generic server computer

name in the list. Using this technique, when a client computer specifies the generic server computer name, it receives the machine address of the server computer identified by the decision logic.

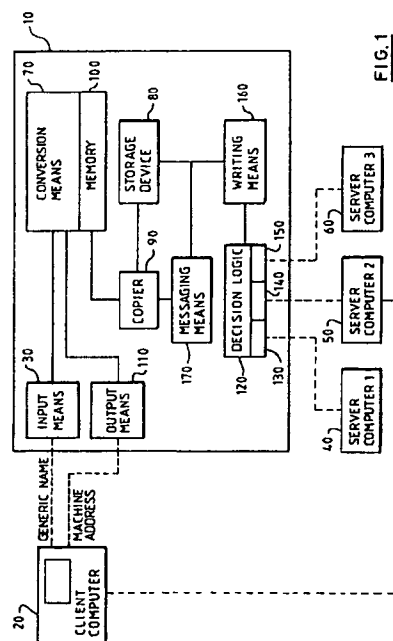

EP 0 648 038 A2

The present invention relates to a data processing system for facilitating the connection of a program on a client computer to a server, the server consisting of a plurality of server computers with shared resources.

The data processing system, the client computer, and the server computers are all resident on a network. This network need not be one physical network such as a Local Area Network (LAN); for instance it may consist of a number of LANS or WANS (wide area networks) connected together (eg. via 'bridges') to form a single logical network. However the same network protocol will be employed throughout the network, a typical example of such a protocol being TCP/IP which will be familiar to those skilled in the art.

In many environments it is increasingly found that a number of server computers are connected together using some form of network, eg. a LAN. It is often the case that several users of client computers will be connected to one such server computer, whilst other server computers stand idle. An example of this is when such computers are situated in workers' offices, connected by, for example, a token ring LAN using the standard TCP/IP network protocol. When workers are away from their offices, their computers will usually stand idle.

In such situations it is commonly the case that a few of the computers in the network are heavily loaded, whilst other computers in the network are very lightly loaded, giving poor response and performance for the client computers using the heavily loaded server computers. Hence there is a problem of how to enable the client user load to be spread more evenly across the available computing resources of the server in a manner which is transparent to the client computer and its programs. If transparency is to be achieved, standard protocols need to be observed in order that client computers can use a variety of connection methods without modification of any programs being required.

A prior art technique which has been developed to provide some sort of load spreading is called "Static load levelling". With this technique each application on each client computer has a designated server to which it always connects. Hence, for example, if there are 200 potential clients of a server having five server computers, a pre-specified group of, say, 40 of the clients will be told (or configured) to always connect to machine 1, etc. On average it may be argued that this will give a reasonably even load across all of the server computers. However in practice it is often the case that, using this technique, a large number of users of client computers are connected to one server computer, while an adjacent server computer stands completely idle (eg. given the above example there could easily be 40 users on one server computer whilst the other 4 server computers stand idle). Hence in situations where the user loading changes

from time to time, the prior art static load levelling technique is not particularly satisfactory. What is required in such instances is a more 'dynamic' technique which can respond to changing user loads, and thus direct new users to the most suitable (eg. least heavily loaded) server computers in the server.

Other prior art techniques can be found in other environments, such as those where job allocation is an issue. For instance in "batch processing", a client computer submits an encapsulated task to a central server, which determines which one of several possible servers is quiet enough to be able to handle the task. The task is sent to that server, is processed, and the results are then sent back to the client (e.g. as a results file, or by electronic mail). With a batch processing system, there is a brief connection to the central server while the job is transferred from the client to the server allocated by the central server. After this brief connection the client disconnects, and has no more interaction with the submitted task until it has been completed, and the results have been passed back to the client by some means.

However in the situation with which we are currently concerned, the dynamic load levelling technique that is required must be able to deal with "interactive" sessions. Rather like a phone conversation, the connection between the program on the client computer and a particular server computer will persist for the duration of the "conversation" session. Hence the batch processing concept is inappropriate in the present situation.

It is possible to write some specific code within a program on a client computer which contains internal message-passing systems to route work from that client program to a corresponding server program. Such systems are dedicated only to that particular client program, and the connection and load-levelling methods are not accessible to other client-server applications. Often, such systems operate by the client connecting to a specific "host" server computer, and from there the work will be sent to another server for processing. Clearly this technique can result in large bottlenecks arising at the "host" server computer.

Hence such a technique is not suitable in the present situation since it only supports one very specific type of client-server connection, whereas we need a technique that will allow any client-server connection method using the network protocol to be connected to a quiet server in a way that is completely transparent to the client program. Further the above technique relies on an initial connection to the 'central' host server computer, which then passes the request on to another server computer; as described above this can potentially create a serious bottleneck.

It is an object of the present invention to provide a technique which facilitates a connection between a client program and a server computer on a server in

a way that takes into account the current status of the server computers forming the server. This technique must observe standard network protocols and should operate in a manner which is transparent to the client program requesting access.

Accordingly the present invention provides a data processing system for facilitating a connection of a program on a client computer to a server, the server consisting of a plurality of server computers with shared resources, the data processing system, the client computer, and the server computers residing in a network, the system comprising: input means for receiving a request from the client computer for a machine address of a server computer identified by a server computer name sent with the request, such a machine address enabling a connection to be made from the client computer to that server computer via the network; a storage device for storing a list identifying server computer names with machine addresses of the server computers; conversion means for using the list to convert the server computer name received by the input means into the machine address of the server computer; output means for sending the machine address from the conversion means to the client computer; the system being characterised by: decision logic for studying the server computers at predetermined intervals having regard to predetermined test criteria, in order to select one of the server computers; and writing means for updating the list by associating the machine address for the server computer selected by the decision logic with a particular server computer name contained as a generic server computer name in the list; whereby when a client computer specifies the generic server computer name, it receives the machine address of the server computer identified by the decision logic.

Typically the conversion means will access the list from a local piece of storage, the data processing system having a copier to copy the list from the storage device to that piece of memory. In preferred embodiments the data processing system further comprises a messaging means, responsive to the updating of the list by the writing means, for sending a message to the copier requesting the copier to copy the updated list into the piece of local memory.

Any manner of predetermined test criteria can be used in the data processing system of the invention, for example the amount of idle processor time, the number of processes running, the amount of free memory, the "load average", etc. However in preferred embodiments the predetermined test criteria are such that the decision logic identifies the server computer having the least number of client programs logged on to it

In preferred embodiments the predetermined intervals are variable and will either be set by a user of the system, eg. the system administrator, or will be adjusted dynamically. The user will also set the pre-

determined test criteria to be used by the decision logic.

Further in preferred embodiments the user can limit the number of server computers which the decision logic studies. This may be useful if, for instance, some of the server computers have not got access to all of the resources that other server computers have access to, and so would not be suitable as server computers to be associated with the generic server computer name.

In some embodiments it may be advantageous to use a plurality of generic names. Each server name would then have a number of server computers whose machine addresses are associated with that generic name, the decision logic employing different sets of predetermined test criteria for each generic name. In such embodiments one or more of the server computers can be associated with a plurality of the generic names.

Viewed from a second aspect the present invention provides a method of operating a data processing system to facilitate a connection of a program on a client computer to a server, the server consisting of a plurality of server computers with shared resources, the data processing system, the client computer, and the server computers residing in a network, the method comprising the steps of: (a) receiving a request from the client computer for a machine address of a server computer identified by a server computer name sent with the request, such a machine address enabling a connection to be made from the client computer to that server computer via the network; (b) storing a list identifying server computer names with machine addresses of the server computers in a storage device; (c) converting, with reference to the list, the server computer name received at step (a) into the machine address of the server computer; (d) sending the machine address identified at step (c) to the client computer; the method being characterised by the steps of: (e) employing decision logic to study the server computers at predetermined intervals having regard to predetermined test criteria, in order to select one of the server computers; and (f) updating the list by associating the machine address for the server computer selected by the decision logic with a particular server computer name contained as a generic server computer name in the list; whereby when a client computer specifies the generic server computer name at step (a), it receives the machine address of the server computer identified by the decision logic.

The present invention will be described further, by way of example only, with reference to an embodiment thereof as illustrated in the accompanying drawings, in which:

Figure 1 is a block diagram illustrating the data processing system of the preferred embodiment; Figure 2 is a flow diagram illustrating how the de-

cision logic in the data processing system of the preferred embodiment operates; and

Figure 3 illustrates a particular embodiment where two generic computer names are used.

In the preferred embodiment we will consider the situation where the server in question is a high performance database server which has its data distributed across a network of server computers, this server network hereafter being referred to as a cluster. Database applications being run by users on client computers are required to connect to one of the server computers in the cluster to enable them to access the data in the database server. By the nature of the database system, it does not matter which server computer the client connects to - all of the data is accessible from any server computer in the cluster. In the preferred embodiment the server computers and the client computers are all interconnected using TCP/IP on a token ring Local Area Network.

For a large number of users, it is highly desirable to have a number of users on each of the server computers in the server cluster, rather than all users connecting to (and hence overloading) just one or a few of the server computers. With a widely varying user workload profile for the database server, this problem can only be solved by providing some form of "load levelling" process, which will allocate new client application instances to server computers in the cluster that are most suitable for the client connection (eg. because they are more lightly loaded than other server computers). Clearly this process must be dynamic, able to respond to changing load conditions over time. Since the database applications on the client computers are typically complex and often are supplied only in object code form, it would be very difficult (or impossible) for the system administrator to alter them, and so it is essential that this allocation is done in a manner which is entirely transparent to the client application.

The manner in which the data processing system of the preferred embodiment solves the above problems will now be described with reference to Figure 1.

Each client computer in a network using the TCP/IP protocol (there will typically be many such client computers) will have been informed by the network administrator that it is to communicate with a particular computer when it wishes to convert a computer name of another computer in the network into a machine address. When utilising the present invention that computer will be the data processing system of the preferred embodiment.

Hence when a program running on a client computer 20 (for clarity, only one client computer is illustrated) wishes to obtain access to a server computer (40, 50, 60) in the cluster it will communicate with the data processing system 10 in order to obtain a full Internet machine address for the desired server (Internet addressing is part of the TCP/IP protocol). With

the prior art technique the client computer would specify a server computer name in this communication that was specific to one particular server computer in the cluster. The input means 30 of the data processing system 10 would receive this server computer name and pass it to the conversion means 70.

In a storage device 80 of the data processing system a list is maintained which identifies server computer names with particular Internet addresses. When the conversion means is initiated the copier 90 copies this list from the storage device 80 into a piece of local memory 100 accessible by the conversion means 70. Hence the conversion means will access the list in memory 100 to find the Internet address of the computer associated with the server computer name passed to it by the input means 30. This Internet address will then be provided by the conversion means to the output means 110 for transmission back to the client computer 20.

Once the client computer has the Internet address it can then make direct contact with the server computer residing at the Internet address provided; in Figure 1 this is server computer 2. Since the TCP/IP protocol is used any of the access methods that use this protocol can be used to access the server computer.

When using the data processing system of the preferred embodiment the program running on the client computer 20 will not use the server computer name that it previously used. Instead a generic server computer name will be used. This generic server name will either have been placed in the program's configuration file, or alternatively the user of the program will specify the generic name when running the program.

Within the data processing system, decision logic 120 is provided which periodically studies the server computers in the cluster having regard to some predetermined test criteria, hereafter called the metric string. In the preferred embodiment the metric string is a list of questions which when answered by the various server computers will enable the decision logic to decide which server computer is most suitable for a client connection (the most suitable perhaps being the least heavily loaded server computer). The metric string can be altered as the system administrator deems appropriate, depending on what criteria the administrator wishes to be used to select a server computer.

In the preferred embodiment the decision logic actually sets up a number of child processes, each one being responsible for sending the metric string to a particular server computer and receiving the response from the server computer.

Once the responses have been received the decision logic will collate the responses, decide which server computer is most suitable, and then request the writing means 160 to pass the Internet address of

that server computer to the storage device for association with the generic server computer name. If however the most suitable server computer is the same server computer as that identified in the last iteration of the process then there is no need to update the storage device and the writing means will not be activated.

Once any necessary update to the storage device 80 has been made the messaging means 170 will notify the copier 90 so that the copier updates the local memory 100 with the new list as stored in the storage device 80.

Hence when the client computer requests a machine address for the generic server computer name the conversion means 70 accesses the list in memory 100 and identifies a machine address just as it would if any other server computer name had been given. However in this instance the machine address actually relates to the server computer in the cluster which has been identified by the decision logic as the most suitable (eg. least heavily loaded). When this machine address is passed back to the client computer 20 via the output means 110, the client computer will proceed to automatically access the server which is most suitable.

By this approach it will be seen that a dynamic load levelling facility is provided which is completely transparent to the client program. As far as the program is concerned it is requesting a machine address as normal and is using one of the normal TCP/IP access methods to gain access to the server computer allocated to it.

In many of today's computing environments (eg Unix, AIX (Unix is a Trade Mark of Unix Systems Laboratories Inc)) an application is provided to perform the standard name resolution service (ie receipt of a computer name and conversion of that computer name into a full Internet address). This application is commonly known as a "nameserver" application, and is installed on one or more computers in the logical network. Every other computer in the network is told to communicate with a specified one of these 'nameserver' computers when it wishes to determine an Internet address for any other computer in the network. Hence a nameserver computer provides a resolution service to client computers by receiving from them a convenient name given to a particular computer (eg. abc.def.ghi.com), and converting it into a full Internet address (eg. 29.1.19.66). This Internet address is then used by the routing subsystem (TCP/IP) to allow a client user or application access to the physical computer (eg "abc" in this example).

In the above example of a computer name, "abc" is the physical machine, "def" is typically the site location, "ghi" the organisation, and "com" one of the Internet classes (three such classes are (com)mercial, (edu)cation, (mil)itary). Domains and sub-domains can also be added as part of this computer name. Ba-

sically the name takes a hierarchical form, with the finest resolution at the beginning and the coarsest resolution at the end; this type of naming structure will of course be well known to those skilled in the art.

All TCP/IP-based applications, including remote-login, remote-shell, telnet, ftp, and also client-server applications (such as database applications), are aware of the nameserver facility, and will automatically go to the designated nameserver computer to ask for resolution of a computer name into an Internet address before attempting to make a connection to another computer in the network.

If we consider Figure 1 again, the standard nameserver facility will include the following elements: the input means 30, the conversion means 70 with associated memory 100, the output means 110, the list stored in the storage device 80, and the copier 90.

The nameserver application is a "daemon" (background) process which runs on the data processing system; this data processing system may (but need not) be one of the server computers forming part of the cluster over which users are to be distributed. In Unix-type operating systems (eg. AIX by IBM Corporation, Ultrix by Digital Equipment Corporation, OSF/1 by the Open Software Foundation, and HP-UX by Hewlett Packard, etc) this daemon process is called "named" (name-daemon), and when it is initialised, it reads a special database file (named.data) stored on the storage device 80 to obtain details of the computer names about which it is expected to know (over which it has "authority"), and the corresponding Internet addresses ("dotted decimal", e.g. 29.1.19.66) for each computer name. Whilst the name daemon is operating, it can be forced to re-read the information from the named.data database file by the sending of an inter-process signal to the name daemon process telling it to update its internal tables 100 from the database file (named.data).

In the preferred embodiment of the present invention we provide a further facility which runs on the same computer as the nameserver application ("named"), and interfaces with it. A 'generic' computer name is introduced into the database file (named.data), which refers not to one specific computer, but to any one of a number of computers offering equivalent functionality. For example, the generic name might be "server.cluster.def.ghi.com"; a client program requesting a connection to 'server.cluster' is requesting connection to any one of the computers in the server cluster.

The further facility provided by the preferred embodiment will be referred to hereafter as the "User Load Leveller" (ULL) application. This application is responsible for deciding which server computer in the cluster is currently the least heavily loaded, according to some appropriate metric, and for conveying this information to the nameserver application. Then subsequent requests for resolution of the generic server

computer name to an Internet address result in the nameserver application sending back to the client computer the Internet address of the server computer which has been deemed to be the most appropriate server computer for connection at that point in time.

The ULL application consists of the following elements from figure 1: the decision logic 120 with child processes 130, 140, 150; the writing means 160; and the messaging means 170. As described earlier with reference to Figure 1 the ULL application periodically (at a frequency which can varied (eg. tuned by a system administrator or dynamically adjusted)) polls the server computers in the cluster to determine how "busy" in some sense they are. The metric used may vary, depending on the type of work which is being handled by the cluster, but may for example include the number of login sessions, number of application instances running, number of idle cpu cycles since the last poll, etc. The metric can be altered to ensure that it is appropriate to a specific situation.

Based on the results of this polling, and taking into account the situation where a server computer in the cluster is too busy to respond to the status request within a certain number of seconds, the ULL application decides which machine is currently the least heavily loaded. The ULL application then modifies the database file (named.data) to associate the generic cluster machine name with the Internet address of this least heavily loaded machine, and sends the special inter-process signal via the messaging means 170 which tells the nameserver application to re-read its database file. The nameserver application will then, in response to a name resolution request from a client program, resolve the generic server computer name into the Internet address of the most appropriate server computer in the cluster for the client program to connect to.

The process carried out by the decision logic 120 of the preferred embodiment will now be described in more detail with reference to Figure 2. At step 200 the ULL application is initialised. A number of steps are carried out at initialisation. For example the application: checks for multiple copies of the ULL application in memory; cleans up from a previous run of the application (by freeing up system resources such as memory, locks and semaphores still held in the name of the previous instance of the ULL application); and locates the nameserver application (named) and its data file (named.data). The ULL application then parses its configuration file to read information defined by the system administrator, such as the metric strings, poll periods, identities of server computers in the cluster, etc. Further the ULL application generates a number of "child" processes - one per server computer - which are each responsible for polling the activity of one designated server.

Once the initialisation has been completed the process enters a main loop which executes until the

ULL application is terminated. At steps 210, 220, 230 and 240 the child processes send a metric string (as defined by the system administrator) to each server computer in the cluster, await responses from those computers, and then wait for a trigger signal from the main ULL application.

Once the trigger signal has been sent by the main application the responses are sent by the child processes to the main application. The main application then collates the activity results received from the child processes (step 250), and based on predetermined test criteria identifies the most appropriate server computer (the "least busy" server computer) at step 260. At step 270 it is determined whether the server computer identified at step 260 differs from the current nominated server computer. If it does then the process advances to step 290, at which point the nameserver's data file (named.data) is modified. Further at step 300 a notification signal is sent to the nameserver application (named) to tell it to update its internal information from the data file.

The process then proceeds to step 280. If at step 270 it is determined that the server computer identified at step 260 is the same as the current nominated server computer then the process moves straight to step 280 without steps 290 and 300 being carried out. Writing to and reading from the data file are time consuming activities and so steps 290 and 300 should only be performed when necessary (ie when the "least busy" server computer changes).

At step 280 the process waits until the end of the "poll period". This period is the predetermined interval (as defined by the system administrator) between successive studies of the server computers by the ULL application. Once the poll period has expired the process loops back to steps 210-240 and the main loop is repeated.

Having discussed the preferred embodiment a few possible alterations will now be discussed. Firstly more than one generic server computer name can be added to the list in storage device 80 (the named.data file). Each generic name could be associated with a particular group of server computers, these groups being either completely separate or having a few server computers common to a plurality of the groups. Indeed one group may be a subset of another group. As an example consider Figure 3. A server cluster 410 comprises eight server computers 400. All eight server computers have access to a main body of data, but only four of them have access to some further (possibly more confidential) data.

In this situation two generic names could be generated, eg. "general.cluster" and "specific.cluster". Any one of the eight computers (enclosed by ring 430) can be associated with the former generic name, but only the four enclosed by ring 420 can be associated with the latter generic name, since only those four have access to the further (confidential) data.

The system administrator can then set up the metric string to be used when studying all eight server computers, or when studying only the four in ring 420; the metric string could be the same in both instances but need not be. If a client application needs access to the confidential information then it would request access to "specific.cluster", but if an application only needed access to the general information then it would request access to "general.cluster".

By this approach an application which only needs access to the general information will always be connected to the least busy server computer, whilst an application which needs access to the further (confidential) information will be given the machine address of the least busy server computer that can actually provide the necessary service; this may or may not be the least busy server computer in the network.

In preferred embodiments a further feature is provided to enable the decision logic to temporarily implement a "round-robin" metric instead of the above described 'studying' process. The round-robin principle will be familiar to those skilled in the art; basically when a client application requests access to a server computer it is assigned a particular server computer, and when the next request is received then that application is assigned the next server computer in the cluster, and so on. In this way the server computers are rotated so that each successive server access is made on a different server computer to the previous server access. Alternatively the server computers can be rotated at fixed time intervals rather than after each access request.

Although the round-robin technique does not have regard to the loading on any of the server computers, and so there is no determination of the least busy server computer, there are certain situations (eg. where there are lots of client applications which only take a short amount of database connection time) where a round-robin approach is acceptable. To implement the round robin approach the decision logic 120 would ask the writing means 160 to update the storage device 80 after each access request has been handled (or at fixed time intervals if the alternative approach is used), so that the generic name is always associated with successive server computers in the cluster in turn.

From the above description it will be clear that the system of the preferred embodiment has a number of advantages. Firstly the technique dynamically allocates new client users and applications to the server computer which is least heavily loaded at the time they make the connection, thus ensuring an even distribution of users and applications across all of the available server computers. The client computer only briefly contacts the data processing system of the preferred embodiment to resolve the generic computer name into a machine address. Completely standard access methods (eg. as provided by TCP/IP) are

then used to make the connection, thus avoiding any proprietary protocols or any need to modify access methods or applications, and so providing fully transparent user load levelling.

Secondly the technique of the preferred embodiment does not involve any modification to the nameserver code - the User Load Leveller application interfaces with the standard code (eg. "named" as shipped with the unix/AIX operating system). It would be possible to provide similar functionality to that described here by producing a modified version of the nameserver code. However, avoiding this brings major advantages from both marketing and maintenance points of view.

Further the technique can be operated without requiring any modification to the server computers. They are accessed in a standard way after the generic server computer name has been used to provide the client computer with a machine address.

Another advantage is that the key parameters, such as the time interval between polls of the server computers in the cluster and the metric used to determine which server computer is least heavily loaded, can be altered and tuned by a local system administrator, allowing the system to be optimised for a particular situation.

The above described ULL application could be supplied as a separate tool to enhance the useability of parallel and distributed systems, or could be shipped with the nameserver application.

Claims

1. A data processing system for facilitating a connection of a program on a client computer to a server, the server consisting of a plurality of server computers with shared resources, the data processing system, the client computer, and the server computers residing in a network, the system comprising:
 - input means for receiving a request from the client computer for a machine address of a server computer identified by a server computer name sent with the request, such a machine address enabling a connection to be made from the client computer to that server computer via the network;
 - a storage device for storing a list identifying server computer names with machine addresses of the server computers;
 - conversion means for using the list to convert the server computer name received by the input means into the machine address of the server computer;
 - output means for sending the machine address from the conversion means to the client computer;

- the system being characterised by:
 decision logic for studying the server computers at predetermined intervals having regard to predetermined test criteria, in order to select one of the server computers; and
 writing means for updating the list by associating the machine address for the server computer selected by the decision logic with a particular server computer name contained as a generic server computer name in the list;
 whereby when a client computer specifies the generic server computer name, it receives the machine address of the server computer identified by the decision logic.
2. A system as claimed in Claim 1 further comprising:
 - a copier to copy the list from the storage device to a piece of memory accessible by the conversion means;
 - a messaging means, responsive to the updating of the list by the writing means, for sending a message to the copier requesting the copier to copy the updated list into the piece of local memory.
 3. A system as claimed in Claim 1 or Claim 2, wherein the predetermined test criteria are such that the decision logic identifies the server computer having the least number of client programs logged on to it.
 4. A system as claimed in any of claims 1 to 3, wherein the predetermined intervals are variable.
 5. A system as claimed in any preceding claim, wherein the predetermined test criteria are set by a user of the system.
 6. A system as claimed in any preceding claim, wherein the user can limit the number of server computers which the decision logic studies.
 7. A system as claimed in any preceding claim wherein a plurality of generic names are used, each one having a number of server computers whose machine addresses are associated with that generic name, the decision logic employing different sets of predetermined test criteria for each generic name.
 8. A system as claimed in Claim 7, wherein one or more of the server computers are associated with a plurality of the generic names.
 9. A method of operating a data processing system to facilitate a connection of a program on a client computer to a server, the server consisting of a

plurality of server computers with shared resources, the data processing system, the client computer, and the server computers residing in a network, the method comprising the steps of:

- (a) receiving a request from the client computer for a machine address of a server computer identified by a server computer name sent with the request, such a machine address enabling a connection to be made from the client computer to that server computer via the network;
 - (b) storing a list identifying server computer names with machine addresses of the server computers in a storage device;
 - (c) converting, with reference to the list, the server computer name received at step (a) into the machine address of the server computer;
 - (d) sending the machine address identified at step (c) to the client computer;
- the method being characterised by the steps of:
- (e) employing decision logic to study the server computers at predetermined intervals having regard to predetermined test criteria, in order to select one of the server computers; and
 - (f) updating the list by associating the machine address for the server computer selected by the decision logic with a particular server computer name contained as a generic server computer name in the list;
- whereby when a client computer specifies the generic server computer name at step (a), it receives the machine address of the server computer identified by the decision logic.
10. A method as claimed in Claim 9 further comprising the steps of:
 - copying the list from the storage device to a piece of memory accessible at the conversion step (c);
 - repeating, in response to the updating of the list at step (f), the copying step to ensure that the updated list is copied into the piece of local memory.
 11. A method as as claimed in claim 9 or claim 10, wherein the predetermined intervals are set by a user of the system.
 12. A method as claimed in any of claims 9 to 11, wherein the predetermined test criteria are set by a user of the system.
 13. A method as claimed in any of claims 9 to 12, wherein the user can limit the number of server computers which the decision logic studies.

- 14. A method as claimed in any of claims 9 to 13, wherein a plurality of generic names are used, each one having a number of server computers whose machine addresses are associated with that generic name, the decision logic employing different sets of predetermined test criteria for each generic name. 5
- 15. A method as claimed in Claim 14, wherein one or more of the server computers are associated with a plurality of the generic names. 10

15

20

25

30

35

40

45

50

55

9

10

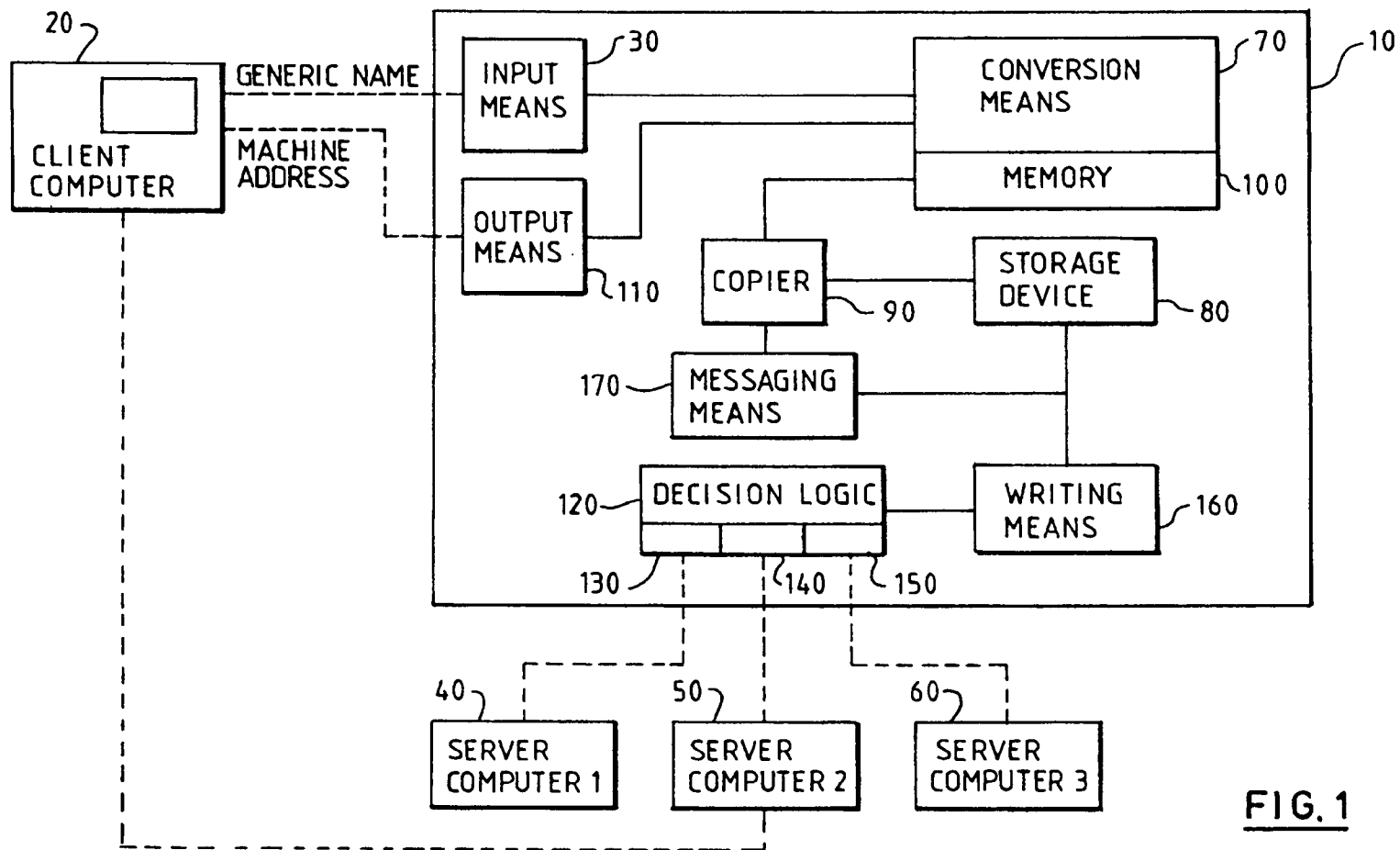

EP 0 648 038 A2

FIG. 1

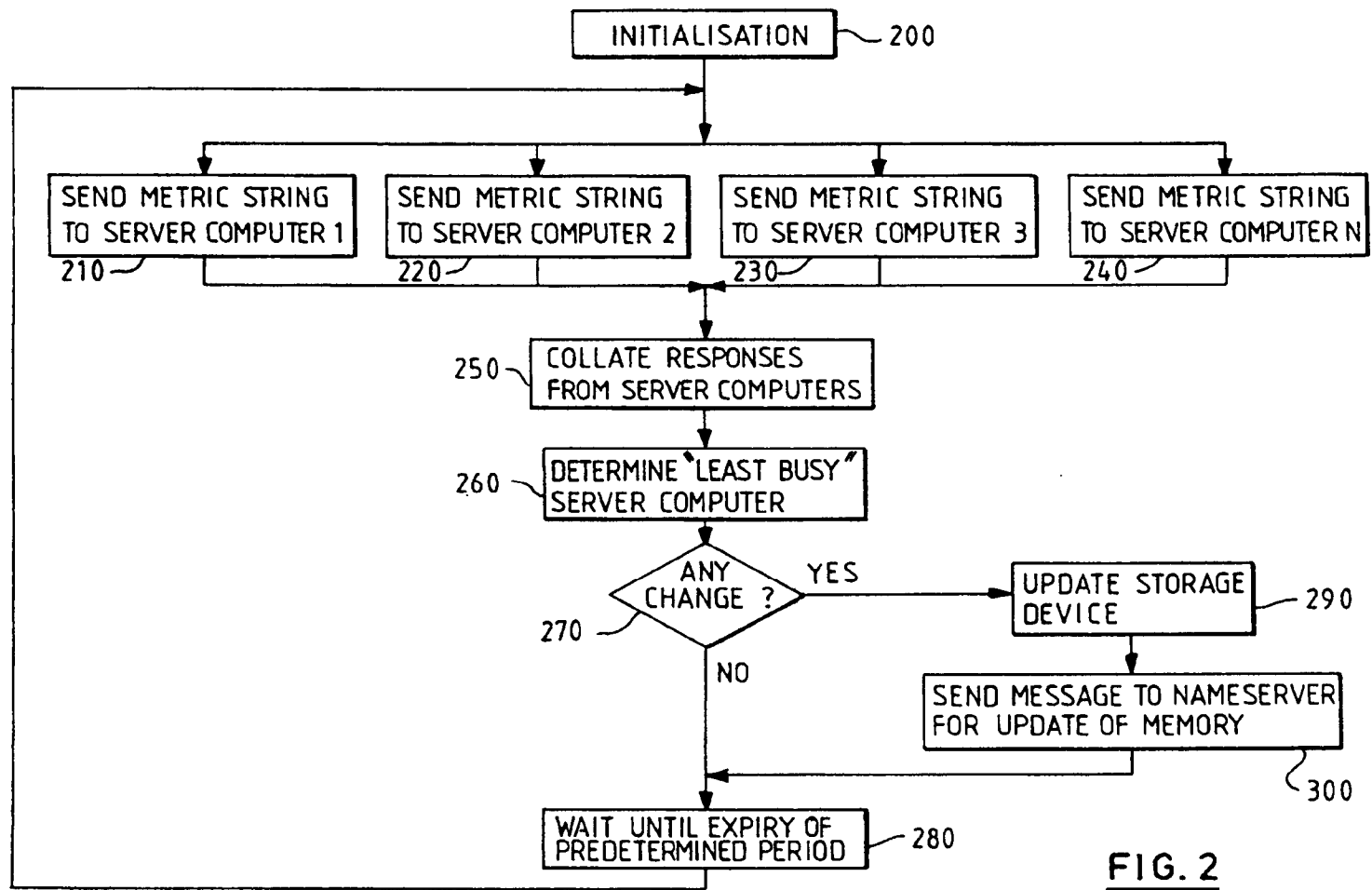

FIG. 2

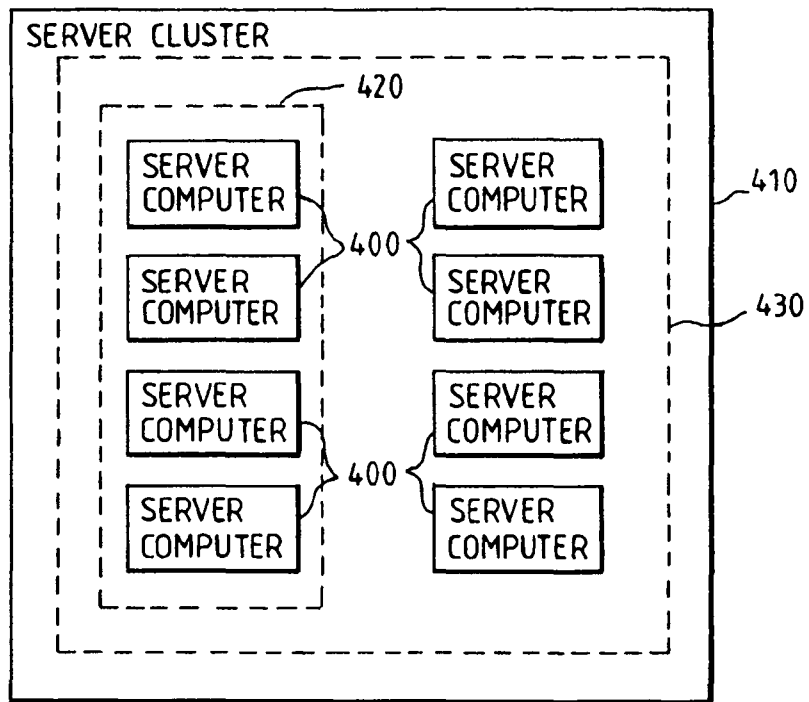

FIG. 3



(12) **EUROPEAN PATENT APPLICATION**

(43) Date of publication:
07.01.2004 Bulletin 2004/02

(51) Int Cl.7: **H04L 12/58, H04L 29/06**

(21) Application number: **03022287.1**

(22) Date of filing: **25.09.1996**

(84) Designated Contracting States:
CH DE ES FI FR GB IE IT LI NL SE

(72) Inventor: **Hutton, Glenn W.**
Miami, FL 33196 (US)

(30) Priority: **25.09.1995 US 533115**

(74) Representative: **Kindermann, Manfred**
Patentanwalt,
Sperberweg 29
71032 Böblingen (DE)

(62) Document number(s) of the earlier application(s) in
accordance with Art. 76 EPC:
96933928.2 / 0 852 868

(71) Applicant: **Netspeak Corporation**
Boca Raton, FL 33487 (US)

Remarks:

This application was filed on 02 - 10 - 2003 as a
divisional application to the application mentioned
under INID code 62.

(54) **Point-to-point communication using e-mail to establish dynamic network addresses**

(57) In a computer system having an audio transducer and a display device and being operatively coupled to other computers over a computer network (24), such as the Internet, means are included for establishing a point-to-point communication link between processes. The means provide for transmitting from a first processing unit (12) to the Internet an E-mail signal, in-

cluding a first IP address assigned to the first processing unit, and for processing the E-mail signal through the Internet to deliver the E-mail signal to a second processing unit (22). Further means are provided for transmitting a second IP address to the first processing unit for establishing a point-to-point communication link between the first and second processing units through the Internet.

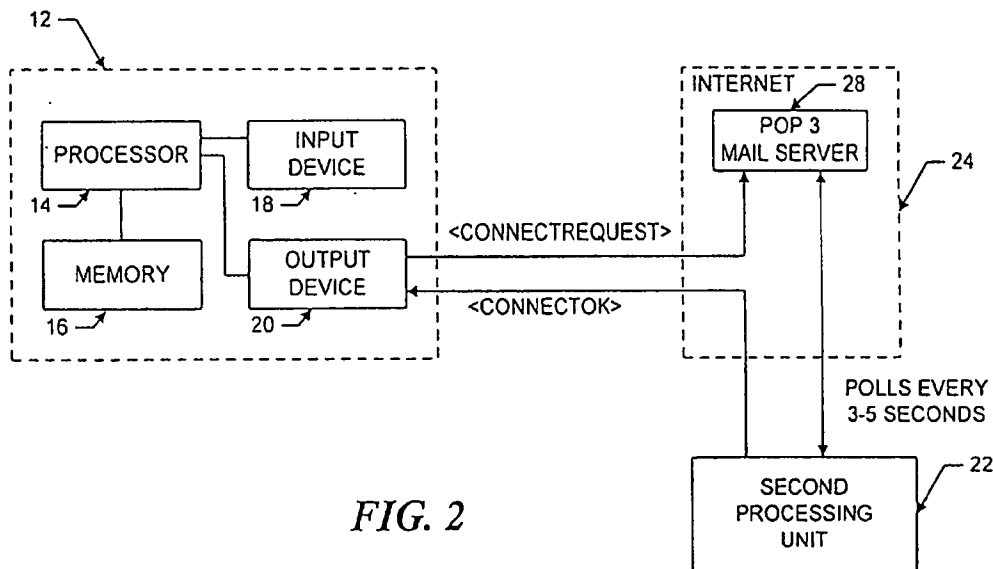

FIG. 2

Description**FIELD OF THE INVENTION**

[0001] The present invention relates in general to data processing systems, and more specifically, to an apparatus, a method and a computer program product for facilitating audio communications over computer networks.

BACKGROUND OF THE INVENTION

[0002] The increased popularity of on-line services such as AMERICA ONLINE (TM), COMPUSERVE (R), and other services such as Internet gateways have spurred applications to provide multimedia contents, including video and voice clips, to online users. An example of an online voice clip application is VOICE E-MAIL FOR WINCIM and VOICE E-MAIL FOR AMERICA ONLINE (TM), available from Bonzi Software, as described in "Simple Utilities Send Voice E-Mail Online", MULTIMEDIA WORLD, VOL. 2, NO. 9, August 1995, p. 52. Using such Voice E-Mail software, a user may create an audio message to be sent to a predetermined E-mail address specified by the user.

[0003] Generally, devices interfacing with the Internet and other online services may communicate with each other upon establishing respective device addresses. One type of device address is the Internet Protocol (IP) address, which acts as a pointer to the device associated with the IP address. A typical device may have a Serial Line Internet Protocol or Point-to-Point Protocol (SLIP/PPP) account with a permanent IP address for receiving E-mail, voicemail, and the like over the Internet. E-mail and voicemail is generally intended to convey text, audio, etc., with any routing information such as an IP address and routing headers generally being considered an artifact of the communication, or even gibberish to the recipient.

[0004] Devices such as a host computer or server of a company may include multiple modems for connection of users to the Internet, with a temporary IP address allocated to each user. For example, the host computer may have a general IP address "XXX.XXX.XXX", and each user may be allocated a successive IP address of XXX.XXX.XXX.10, XXX.XXX.XXX.11, XXX.XXX.XXX.12, etc. Such temporary IP addresses may be re-assigned or recycled to the users, for example, as each user is successively connected to an outside party. For example, a host computer of a company may support a maximum of 254 IP addresses which are pooled and shared between devices connected to the host computer.

[0005] Permanent IP addresses of users and devices accessing the Internet readily support point-to-point communications of voice and video signals over the Internet. For example, global real-time video conferencing has been implemented using dedicated IP addresses

and mechanisms known as reflectors.

[0006] A technique for matching domain names to Internet Protocol addresses is described in the text entitled "Internetworking With TCP/IP", 2nd Edition, by Douglas E. Comer, November 1992, Prentice Hall, Englewood Cliffs, New Jersey, U.S.A. Comer describes a domain name system and cooperative systems of name servers for matching domain names to network addresses. Each name server is a server program that supplies mapping of domain names to IP addresses. The system described in Comer, however, is not designed for use with network nodes whose network names or name to address bindings change frequently.

[0007] International Publication WO 92/19054 discloses a network monitoring system including an address tracking module which uses passive monitoring of all packet communications over a local area network to maintain a name table of IP address mappings. The disclosed address tracking module is capable of monitoring only a small number of nodes on a local area network and is not suitable for use with a multitude of nodes over a wide area network.

[0008] Due to the dynamic nature of temporary IP addresses of some devices accessing the Internet, point-to-point communications in real-time of voice and video have been generally difficult to attain.

SUMMARY OF THE INVENTION

[0009] In a system for enabling point-to-point communications between a plurality of processing units over the Internet, means are provided for establishing a point-to-point communication link between a first processing unit and a second processing unit. The invention, as defined in the claims, comprises (a) means for transmitting from a first processing unit to the Internet an E-mail signal, including a first IP address assigned to the first processing unit, (b) means for processing the E-mail signal through the Internet to deliver the E-mail signal to a second processing unit and (c) means for transmitting a second IP address to the first processing unit for establishing a point-to-point communication link between the first and second processing units through the Internet.

[0010] The invention is in particular suitable for being used in connection with computer networks, such as the Internet, wherein the processing unit does not have a fixed or predetermined network protocol address. The invention thus provides for a protocol wherein a calling processing unit transmits by E-mail its dynamically assigned network protocol address, or IP address, directly to the called processing unit. The called processing unit then transmits its dynamically assigned IP address to the calling processing unit also via E-mail message.

BRIEF DESCRIPTION OF THE DRAWINGS

[0011] The features of the invention will become more

readily apparent and may be better understood by referring to the following detailed description of an illustrative embodiment of the present invention, taken in conjunction with the accompanying drawings, in which:

FIG. 1 illustrates, in block diagram format, a system for the disclosed point-to-point Internet protocol;
 FIG. 2 illustrates, in block diagram format, the system using a secondary point-to-point Internet protocol;
 FIG. 3 illustrates, in block diagram format, the system of FIGS. 1-2 with the point-to-point Internet protocol established;
 FIG. 4 is another block diagram of the system of FIGS. 1-2 with audio communications being conducted;
 FIG. 5 illustrates a display screen for a processing unit;
 FIG. 6 illustrates another display screen for a processing unit;
 FIG. 7 illustrates a flowchart of the initiation of the point-to-point Internet protocols;
 FIG. 8 illustrates a flowchart of the performance of the primary point-to-point Internet protocols; and
 FIG. 9 illustrates a flowchart of the performance of the secondary point-to-point Internet protocol.

DETAILED DESCRIPTION

[0012] Referring now in specific detail to the drawings, with like reference numerals identifying similar or identical elements, as shown in FIG. 1, the present disclosure describes a point-to-point network protocol and system 10 for using such a protocol.

[0013] In an exemplary embodiment, the system 10 includes a first processing unit 12 for sending at least a voice signal from a first user to a second user. The first processing unit 12 includes a processor 14, a memory 16, an input device 18, and an output device 20. The output device 20 includes at least one modem capable of, for example, 14.4 kbaud communications and operatively connected via wired and/or wireless communication connections to the Internet or other computer networks such as an Intranet, i.e., a private computer network. One skilled in the art would understand that the input device 18 may be implemented at least in part by the modem of the output device 20 to allow input signals from the communication connections to be received. The second processing unit 22 may have a processor, memory, and input and output devices, including at least one modem and associated communication connections, as described above for the first processing unit 12. In an exemplary embodiment, each of the processing units 12, 22 may execute the WEBPHONE™ Internet telephony application available from NetSpeak Corporation, Boca Raton, FL, which is capable of performing the disclosed point-to-point Internet protocol and system 10, as described herein.

[0014] The first processing unit 12 and the second processing unit 22 are operatively connected to the Internet 24 by communication devices and software known in the art, such as an Internet Service Provider (ISP) or an Internet gateway. The processing units 12, 22 may be operatively interconnected through the Internet 24 to a connection server 26, and may also be operatively connected to a mail server 28 associated with the Internet 24.

[0015] The connection server 26 includes a processor 30, a timer 32 for generating time stamps, and a memory such as a database 34 for storing, for example, E-mail and Internet Protocol (IP) addresses of logged-in units. In an exemplary embodiment, the connection server 26 may be a SPARC 5 server or a SPARC 20 server, available from SUN MICROSYSTEMS, INC., Mountain View, CA, having a central processing unit (CPU) as processor 30, an operating system (OS) such as UNIX, for providing timing operations such as maintaining the timer 32, a hard drive or fixed drive, as well as dynamic random access memory (DRAM) for storing the database 34, and a keyboard and display and/or other input and output devices (not shown in FIG. 1). The database 34 may be an SQL database available from ORACLE or INFORMIX.

[0016] In an exemplary embodiment, the mail server 28 may be a Post Office Protocol (POP) Version 3 mail server including a processor, memory, and stored programs operating in a UNIX environment, or, alternatively, another OS, to process E-mail capabilities between processing units and devices over the Internet 24.

[0017] The first processing unit 12 may operate the disclosed point-to-point Internet protocol by a computer program described hereinbelow in conjunction with FIG. 6, which may be implemented from compiled and/or interpreted source code in the C++ programming language and which may be downloaded to the first processing unit 12 from an external computer. The operating computer program may be stored in the memory 16, which may include about 8 MB RAM and/or a hard or fixed drive having about 8 MB. Alternatively, the source code may be implemented in the first processing unit 12 as firmware, as an erasable read only memory (EPROM), etc. It is understood that one skilled in the art would be able to use programming languages other than C++ to implement the disclosed point-to-point network protocol and system 10.

[0018] The processor 14 receives input commands and data from a first user associated with the first processing unit 12 though the input device 18, which may be an input port connected by a wired, optical, or a wireless connection for electromagnetic transmissions, or alternatively may be transferable storage media, such as floppy disks, magnetic tapes, compact disks, or other storage media including the input data from the first user.

[0019] The input device 18 may include a user interface (not shown) having, for example, at least one but-

ton actuated by the user to input commands to select from a plurality of operating modes to operate the first processing unit 12. In alternative embodiments, the input device 18 may include a keyboard, a mouse, a touch screen, and/or a data reading device such as a disk drive for receiving the input data from input data files stored in storage media such as a floppy disk or, for example, an 8 mm storage tape. The input device 18 may alternatively include connections to other computer systems to receive the input commands and data therefrom.

[0020] The first processing unit 12 may include a visual interface for use in conjunction with the input device 18 and output device 20 similar to those screens illustrated in FIGS. 5-6, discussed below. It is also understood that alternative devices may be used to receive commands and data from the user, such as keyboards, mouse devices, and graphical user interfaces (GUI) such as WINDOWSTM 3.1 available from MICROSOFT Corporation, Redmond, WA., and other operating systems and GUIs, such as OS/2 and OS/2 WARP, available from IBM CORPORATION, Boca Raton, FL. Processing unit 12 may also include microphones and/or telephone handsets for receiving audio voice data and commands, speech or voice recognition devices, dual tone multifrequency (DTMF) based devices, and/or software known in the art to accept voice data and commands and to operate the first processing unit 12.

[0021] In addition, either of the first processing unit 12 and the second processing unit 22 may be implemented in a personal digital assistant (PDA) providing modem and E-mail capabilities and Internet access, with the PDA providing the input/output screens for mouse interactions or for touchscreen activation as shown, for example, in FIGS. 5-6, as a combination of the input device 18 and output device 20.

[0022] For clarity of explanation, the illustrative embodiment of the disclosed point-to-point Internet protocol and system 10 is presented as having individual functional blocks, which may include functional blocks labeled as "processor" and "processing unit". The functions represented by these blocks may be provided through the use of either shared or dedicated hardware, including, but not limited to, hardware capable of executing software. For example, the functions of each of the processors and processing units presented herein may be provided by a shared processor or by a plurality of individual processors. Moreover, the use of the functional blocks with accompanying labels herein is not to be construed to refer exclusively to hardware capable of executing software. Illustrative embodiments may include digital signal processor (DSP) hardware, such as the AT&T DSP16 or DSP32C, read-only memory (ROM) for storing software performing the operations discussed below, and random access memory (RAM) for storing DSP results. Very large scale integration (VLSI) hardware embodiments, as well as custom VLSI circuitry in combination with a general purpose DSP circuit,

may also be provided. Any and all of these embodiments may be deemed to fall within the meaning of the labels for the functional blocks as used herein.

[0023] The processing units 12, 22 are capable of placing calls and connecting to other processing units connected to the Internet 24, for example, via dialup SLIP/PPP lines. In an exemplary embodiment, each processing unit assigns an unsigned long session number, for example, a 32-bit long sequence in a *.ini file for each call. Each call may be assigned a successive session number in sequence, which may be used by the respective processing unit to associate the call with one of the SLIP/PPP lines, to associate a <ConnectOK> response signal with a <Connect Request> signal, and to allow for multiplexing and demultiplexing of inbound and outbound conversations on conference lines, as explained hereinafter.

[0024] For callee (or called) processing units with fixed IP addresses, the caller (or calling) processing unit may open a "socket", i.e. a file handle or address indicating where data is to be sent, and transmit a <Call> command to establish communication with the callee utilizing, for example, datagram services such as Internet Standard network layering as well as transport layering, which may include a Transport Control Protocol (TCP) or a User Datagram Protocol (UDP) on top of the IP. Typically, a processing unit having a fixed IP address may maintain at least one open socket and a called processing unit waits for a <Call> command to assign the open socket to the incoming signal. If all lines are in use, the callee processing unit sends a BUSY signal or message to the callee processing unit. As shown in FIG. 1, the disclosed point-to-point Internet protocol and system 10 operate when a callee processing unit does not have a fixed or predetermined IP address. In the exemplary embodiment and without loss of generality, the first processing unit 12 is the caller processing unit and the second processing unit 22 is the called processing unit. When either of processing units 12, 22 logs on to the Internet via a dial-up connection, the respective unit is provided a dynamically allocated IP address by the a connection service provider.

[0025] Upon the first user initiating the point-to-point Internet protocol when the first user is logged on to the Internet 24, the first processing unit 12 automatically transmits its associated E-mail address and its dynamically allocated IP address to the connection server 26. The connection server 26 then stores these addresses in the database 34 and time stamps the stored addresses using timer 32. The first user operating the first processing unit 12 is thus established in the database 34 as an active on-line party available for communication using the disclosed point-to-point Internet protocol. Similarly, a second user operating the second processing unit 22, upon connection to the Internet 24 through the a connection service provider, is processed by the connection server 26 to be established in the database 34 as an active on-line party.

[0026] The connection server 26 may use the time stamps to update the status of each processing unit; for example, after 2 hours, so that the on-line status information stored in the database 34 is relatively current. Other predetermined time periods, such as a default value of 24 hours, may be configured by a systems operator.

[0027] The first user with the first processing unit 12 initiates a call using, for example, a Send command and/or a command to speedial an NTH stored number, which may be labeled [SND] and [SPD][N], respectively, by the input device 18 and/or the output device 20, such as shown in FIGS. 5-6. In response to either the Send or speedial commands, the first processing unit 12 retrieves from memory 16 a stored E-mail address of the callee corresponding to the NTH stored number. Alternatively, the first user may directly enter the E-mail address of the callee.

[0028] The first processing unit 12 then sends a query, including the E-mail address of the callee, to the connection server 26. The connection server 26 then searches the database 34 to determine whether the callee is logged-in by finding any stored information corresponding to the callee's E-mail address indicating that the callee is active and on-line. If the callee is active and on-line, the connection server 26 then performs the primary point-to-point Internet protocol; i.e. the IP address of the callee is retrieved from the database 34 and sent to the first processing unit 12. The first processing unit 12 may then directly establish the point-to-point Internet communications with the callee using the IP address of the callee.

[0029] If the callee is not on-line when the connection server 26 determines the callee's status, the connection server 26 sends an OFFLINE signal or message to the first processing unit 12. The first processing unit 12 may also display a message such as "Called Party Off-Line" to the first user.

[0030] When a user logs off or goes off-line from the Internet 24, the connection server 26 updates the status of the user in the database 34; for example, by removing the user's information, or by flagging the user as being off-line. The connection server 26 may be instructed to update the user's information in the database 34 by an off-line message, such as a data packet, sent automatically from the processing unit of the user prior to being disconnected from the connection server 26. Accordingly, an off-line user is effectively disabled from making and/or receiving point-to-point Internet communications.

[0031] As shown in FIGS. 2-4, the disclosed secondary point-to-point Internet protocol may be used as an alternative to the primary point-to-point Internet protocol described above, for example, if the connection server 26 is non-responsive, inoperative, and/or unable to perform the primary point-to-point Internet protocol, as a non-responsive condition. Alternatively, the disclosed secondary point-to-point Internet protocol may be used

independent of the primary point-to-point Internet protocol. In the disclosed secondary point-to-point Internet protocol, the first processing unit 12 sends a <ConnectRequest> message via E-mail over the Internet 24 to the mail server 28. The E-mail including the <ConnectRequest> message may have, for example, the subject

[*wp#XXXXXXXX#nnn.nnn.nnn.#emailAddr]

where nnn.nnn.nnn.nnn. is the current (i.e. temporary or permanent) IP address of the first user, and XXXXXXXX is a session number, which may be unique and associated with the request of the first user to initiate point-to-point communication with the second user.

[0032] As described above, the first processing unit 12 may send the <ConnectRequest> message in response to an unsuccessful attempt to perform the primary point-to-point Internet protocol. Alternatively, the first processing unit 12 may send the <ConnectRequest> message in response to the first user initiating a SEND command or the like.

[0033] After the <ConnectRequest> message via E-mail is sent, the first processing unit 12 opens a socket and waits to detect a response from the second processing unit 22. A timeout timer, such as timer 32, may be set by the first processing unit 12, in a manner known in the art, to wait for a predetermined duration to receive a <ConnectOK> signal. The processor 14 of the first processing unit 12 may cause the output device 20 to output a Ring signal to the user, such as an audible ringing sound, about every 3 seconds. For example, the processor 14 may output a *.wav file, which may be labeled RING.WAV, which is processed by the output device 20 to output an audible ringing sound.

[0034] The mail server 28 then polls the second processing unit 22, for example, every 3-5 seconds, to deliver the E-mail. Generally, the second processing unit 22 checks the incoming lines, for example, at regular intervals to wait for and to detect incoming E-mail from the mail server 28 through the Internet 24.

[0035] Typically, for sending E-mail to users having associated processing units operatively connected to a host computer or server operating an Internet gateway, E-mail for a specific user may be sent over the Internet 24 and directed to the permanent IP address or the SLIP/PPP account designation of the host computer, which then assigns a temporary IP address to the processing unit of the specified user for properly routing the E-mail. The E-mail signal may include a name or other designation such as a user name which identifies the specific user regardless of the processing unit assigned to the user; that is, the host computer may track and store the specific device where a specific user is assigned or logged on, independent of the IP address system, and so the host computer may switch the E-mail signal to the device of the specific user. At that time, a temporary IP address may be generated or assigned to the specific user and device.

[0036] Upon detecting and/or receiving the incoming E-mail signal from the first processing unit 12, the sec-

ond processing unit 22 may assign or may be assigned a temporary IP address. Therefore, the delivery of the E-mail through the Internet 24 provides the second processing unit 22 with a session number as well as IP addresses of both the first processing unit 12 and the second processing unit 22.

[0037] Point-to-point communication may then be established by the processing unit 22 processing the E-mail signal to extract the <ConnectRequest> message, including the IP address of the first processing unit 12 and the session number. The second processing unit 22 may then open a socket and generate a <ConnectOK> response signal, which includes the temporary IP address of the second processing unit 22 as well as the session number of the first processing unit.

[0038] The second processing unit 22 sends the <ConnectOK> signal directly over the Internet 24 to the IP address of the first processing unit 12 without processing by the mail server 28, and a timeout timer of the second processing unit 22 may be set to wait and detect a <Call> signal expected from the first processing unit 12.

[0039] Realtime point-to-point communication of audio signals over the Internet 24, as well as video and voicemail, may thus be established and supported without requiring permanent IP addresses to be assigned to either of the users or processing units 12, 22. For the duration of the realtime point-to-point link, the relative permanence of the current IP addresses of the processing units 12, 22 is sufficient, whether the current IP addresses were permanent (i.e. predetermined or pre-assigned) or temporary (i.e. assigned upon initiation of the point-to-point communication).

[0040] In the exemplary embodiment, a first user operating the first processing unit 12 is not required to be notified by the first processing unit 12 that an E-mail is being generated and sent to establish the point-to-point link with the second user at the second processing unit 22. Similarly, the second user is not required to be notified by the second processing unit 22 that an E-mail has been received and/or a temporary IP address is associated with the second processing unit 22. The processing units 12, 22 may perform the disclosed point-to-point Internet protocol automatically upon initiation of the point-to-point communication command by the first user without displaying the E-mail interactions to either user. Accordingly, the disclosed point-to-point Internet protocol may be transparent to the users. Alternatively, either of the first and second users may receive, for example, a brief message of "CONNECTION IN PROGRESS" or the like on a display of the respective output device of the processing units 12, 22.

[0041] After the initiation of either the primary or the secondary point-to-point Internet protocols described above in conjunction with FIGS. 1-2, the point-to-point communication link over the Internet 24 may be established as shown in FIGS. 3-4 in a manner known in the art. For example, referring to FIG. 3, upon receiving the

<ConnectorOK> signal from the second processing unit 22, the first processing unit 12 extracts the IP address of the second processing unit 22 and the session number, and the session number sent from the second processing unit 22 is then checked with the session number originally sent from the first processing unit 12 in the <ConnectRequest> message as E-mail. If the session numbers sent and received by the processing unit 12 match, then the first processing unit 12 sends a <Call> signal directly over the Internet 24 to the second processing unit 22; i.e. using the IP address of the second processing unit 22 provided to the first processing unit 12 in the <ConnectOK> signal.

[0042] Upon receiving the <Call> signal, the second processing unit 22 may then begin a ring sequence, for example, by indicating or annunciating to the second user that an incoming call is being received. For example, the word "CALL" may be displayed on the output device of the second processing unit 22. The second user may then activate the second processing unit 22 to receive the incoming call.

[0043] Referring to FIG. 4, after the second processing unit 22 receives the incoming call, realtime audio and/or video conversations may be conducted in a manner known in the art between the first and second users through the Internet 24, for example, by compressed digital audio signals. Each of the processing units 12, 22 also display to each respective user the words "IN USE" to indicate that the point-to-point communication link is established and audio or video signals are being transmitted.

[0044] In addition, either user may terminate the point-to-point communication link by, for example, activating a termination command, such as by activating an [END] button or icon on a respective processing unit, causing the respective processing unit to send an <End> signal which causes both processing units to terminate the respective sockets, as well as to perform other cleanup commands and functions known in the art.

[0045] FIGS. 5-6 illustrate examples of display screens 36 which may be output by a respective output device of each processing unit 12, 22 of FIGS. 1-4 for providing the disclosed point-to-point Internet protocol and system 10. Such display screens may be displayed on a display of a personal computer (PC) or a PDA in a manner known in the art.

[0046] As shown in FIG. 5, a first display screen 36 includes a status area 38 for indicating, for example, a called user by name and/or by IP address or telephone number; a current function such as C2; a current time; a current operating status such as "IN USE", and other control icons such as a down arrow icon 40 for scrolling down a list of parties on a current conference line. The operating status may include such annunciators as "IN USE," "IDLE," "BUSY," "NO ANSWER," "OFFLINE," "CALL," "DIALING," "MESSAGES," and "SPEEDDIAL."

[0047] Other areas of the display screen 36 may include activation areas or icons for actuating commands

or entering data. For example, the display screen 36 may include a set of icons 42 arranged in columns and rows including digits 0-9 and commands such as END, SND, HLD, etc. For example, the END and SND commands may be initiated as described above, and the HLD icon 44 may be actuated to place a current line on hold. Such icons may also be configured to substantially simulate a telephone handset or a cellular telephone interface to facilitate ease of use, as well as to simulate function keys of a keyboard. For example, icons labeled L1-L4 may be mapped to function keys F1-F4 on standard PC keyboards, and icons C1-C3 may be mapped to perform as combinations of function keys, such as CTRL-F1, CTRL-F2, and CTRL-F3, respectively. In addition, the icons labeled L1-L4 and C1-C3 may include circular regions which may simulate light emitting diodes (LEDs) which indicate that the function or element represented by the respective icon is active or being performed.

[0048] Icons L1-L4 may represent each of 4 lines available to the caller, and icons C1-C3 may represent conference calls using at least one line to connect, for example, two or more parties in a conference call. The icons L1-L4 and C1-C3 may indicate the activity of each respective line or conference line. For example, as illustrated in FIG. 5, icons L1-L2 may have lightly shaded or colored circles, such as a green circle, indicating that each of lines 1 and 2 are in use, while icons L3-L4 may have darkly shaded or color circles, such as a red or black circle, indicating that each of lines 3 and 4 are not in use. Similarly, the lightly shaded circle of the icon labeled C2 indicates that the function corresponding to C2 is active, as additionally indicated in the status area 38, while darkly shaded circles of icons labeled C1 and C3 indicate that such corresponding functions are not active.

[0049] The icons 42 are used in conjunction with the status area 38. For example, using a mouse for input, a line that is in use, as indicated by the lightly colored circle of the icon, may be activated to indicate a party's name by clicking a right mouse button for 5 seconds until another mouse click is actuated or the [ESC] key or icon is actuated. Thus, the user may switch between multiple calls in progress on respective lines.

[0050] Using the icons as well as an input device such as a mouse, a user may enter the name or alias or IP address, if known, of a party to be called by either manually entering the name, by using the speeddial feature, or by double clicking on an entry in a directory stored in the memory, such as the memory 16 of the first processing unit 12, where the directory entries may be scrolled using the status area 38 and the down arrow icon 40.

[0051] Once a called party is listed in the status area 38 as being active on a line, the user may transfer the called party to another line or a conference line by clicking and dragging the status area 38, which is represented by a reduced icon 46. Dragging the reduced icon 46 to any one of line icons L1-L4 transfers the called party

in use to the selected line, and dragging the reduced icon 46 to any one of conference line icons C1-C3 adds the called party to the selected conference call.

[0052] Other features may be supported, such as icons 48-52, where icon 48 corresponds to, for example, an ALT-X command to exit the communication facility of a processing unit, and icon 50 corresponds to, for example, an ALT-M command to minimize or maximize the display screen 36 by the output device of the processing unit. Icon 52 corresponds to an OPEN command, which may, for example, correspond to pressing the O key on a keyboard, to expand or contract the display screen 36 to represent the opening and closing of a cellular telephone. An "opened" configuration is shown in FIG. 5, and a "closed" configuration is shown in FIG. 6. In the "opened" configuration, additional features such as output volume (VOL) controls, input microphone (MIC) controls, waveform (WAV) sound controls, etc.

[0053] The use of display screens such as those shown in FIGS. 5-6 provided flexibility in implementing various features available to the user. It is to be understood that additional features such as those known in the art may be supported by the processing units 12, 22.

[0054] Alternatively, it is to be understood that one skilled in the art may implement the processing units 12, 22 to have the features of the display screens in FIGS. 5-6 in hardware; i.e. a wired telephone or wireless cellular telephone may include various keys, LEDs, liquid crystal displays (LCDs), and touchscreen actuators corresponding to the icons and features shown in FIGS. 5-6. In addition, a PC may have the keys of a keyboard and mouse mapped to the icons and features shown in FIGS. 5-6.

[0055] Referring to FIG. 7, the disclosed point-to-point Internet protocol and system 10 is illustrated. First processing unit 12 initiates the point-to-point Internet protocol in step 56 by sending a query from the first processing unit 12 to the connection server 26. If connection server 26 is operative to perform the point-to-point Internet protocol, in step 58, first processing unit 12 receives an on-line status signal from the connection server 26, such signal may include the IP address of the callee or a "Callee Off-Line" message. Next, first processing unit 12 performs the primary point-to-point Internet protocol in step 60, which may include receiving, at the first processing unit 12, the IP address of the callee if the callee is active and on-line. Alternatively, processing unit 60 may initiate and perform the secondary point-to-point Internet protocol in step 62, if the called party is not active and/or on-line.

[0056] Referring to FIG. 8, in conjunction with FIGS. 1 and 3-4, the disclosed point-to-point Internet protocol and system 10 is illustrated. Connection server 26 starts the point-to-point Internet protocol, in step 64, and timestamps and stores E-mail and IP addresses of logged-in users and processing units in the database 34 in step 66. Connection server 26 receives a query from a first processing unit 12 in step 68 to determine whether

a second user or second processing unit 22 is logged-in to the Internet 24, with the second user being specified, for example, by an E-mail address. Connection server 26 retrieves the IP address of the specified user from the database 34 in step 70, if the specified user is logged-in to the Internet, and sends the retrieved IP address to the first processing unit 12 in step 72 to enable first processing unit 12 to establish point-to-point communications with the specified second user.

[0057] The disclosed secondary point-to-point Internet protocol operates as shown in FIG. 9. First processing unit 12 generates an E-mail signal, including a session number and a first IP address corresponding to a first processing unit in step 76. First processing unit 12 transmits the E-mail signal as a <ConnectRequest> signal to the Internet 24 in step 78. The E-mail signal is delivered through the Internet 24 using a mail server 28 to the second processing unit 22 in step 80. Second processing unit 22 extracts the session number and the first IP address from the E-mail signal in step 82 and transmits or sends the session number and a second IP address corresponding to the second processing unit 22, back to the first processing unit 12 through the Internet 24, in step 84. First processing unit 12 verifies the session number received from the second processing unit 22 in step 86, and establishes a point-to-point Internet communication link between the first processing unit 12 and second processing unit 22 using the first and second IP addresses in step 88.

[0058] While the disclosed point-to-point Internet protocols and system have been particularly shown and described with reference to the preferred embodiments, it is understood by those skilled in the art that various modifications in form and detail may be made therein without departing from the scope and spirit of the invention. Accordingly, modifications such as those suggested above, but not limited thereto, are to be considered within the scope of the invention.

Claims

1. A method for establishing point-to-point Internet communication between a plurality of processing units **characterized by** the steps:

- a) transmitting an E-mail signal, including a first IP address assigned to a first processing unit (12);
- b) processing the E-mail signal through the Internet to deliver the E-mail signal to a second processing unit (22); and
- c) transmitting a second IP address to the first processing unit for establishing a point-to-point communication link between the first and second processing units through the Internet.

2. The method of claim 1, further **characterized by**:

a1) generating the E-mail signal from the first IP address corresponding to the first processing unit before the step (a) of transmitting the E-mail signal.

3. The method of claim 1, further **characterized by**:

a1) generating the E-mail signal from a session number before the step (a) of transmitting the E-mail signal.

4. The method of claim 1, **characterized in that** the step of processing the E-mail signal further comprises the step of:

b1) processing the E-mail signal using a mail server operatively connected to the second processing unit.

5. The method of claim 1, further **characterized by**:

b1) generating a connection signal (CONNECTOK) including the second IP address at the second processing unit before the step (c) of transmitting the second IP address to the first processing unit, and

wherein the step (c) of transmitting the second IP address includes the step of transmitting the connection signal from the second processing unit to the first processing unit.

6. A system for enabling point-to-point communications between a first and a second processing unit over the Internet, **characterized by**:

- a) means for transmitting from the first processing unit (12) to the Internet an E-mail signal, including a first IP address assigned to the first processing unit;
- b) means (28) for processing the E-mail signal through the Internet to deliver the E-mail signal to the second processing (22) unit; and
- c) means for transmitting a second IP address to the first processing unit for establishing a point-to-point communication link between the first and second processing units through the Internet.

7. The system of claim 6 comprising a server which is **characterized by**:

- a processor;
- a memory operatively coupled to the processor;
- a network interface logic operatively coupled to the processor and the memory and configured to connect the server to a computer network;
- and

mail processing logic responsive to an E-mail signal from the first processing unit and configured to provide the E-mail signal to the second processing unit, the E-mail signal comprising the network protocol address of the first processing unit.

8. The system of claim 6, further **characterized by**:

b1) means for generating a connection signal (CONNECTOK) including the second IP address in the second processing unit, and for transmitting the connection signal from the second processing unit to the first processing unit.

9. The system of claim 6, wherein the first processing unit comprises a processor for executing the point-to-point Internet protocol, **characterized by** means for generating an E-mail signal, including a first IP address, and by means for transmitting the E-mail signal through the Internet to the second processing unit for establishing a point-to-point communication link to the first processing unit.

10. The system of claim 9, **characterized in that** the processor is adapted to generate the E-mail signal from the first IP address corresponding to the first processing unit.

11. The apparatus of claim 9, **characterized in that** the processor is adapted to wait to detect a response from the second processing unit.

12. The system according to one of the claims 6-11, **characterized in that** the first IP address is dynamically assigned to the first processing unit.

13. The system according to one of the claims 6-12, comprising a mail server (28) for processing the E-mail signal through the Internet to deliver the E-mail to the second processing unit (22) for establishing a point-to-point communication link between the first and second processing unit through the Internet.

14. The system of claim 13, wherein the second processing unit comprises a processor adapted for receiving the E-mail signal from the mail server and for generating a connection signal (CONNECTOK) including a second IP address and for transmitting the connection signal to the first processing unit for establishing the point-to-point communication link to the first processing unit.

15. A computer program product for establishing point-to-point Internet communication between a plurality of processing units, the computer program product having a computer usable medium containing com-

puter readable program code, comprising:

- a) program code for transmitting an E-mail signal including a first IP address assigned to a first processing unit (12);
- b) program code for processing the E-mail signal through the Internet to deliver the E-mail signal to a second processing unit (22);
- c) program code for transmitting a second IP address to the first processing unit; and
- d) program code for establishing in response to receiving the second IP address in the first processing unit a point-to-point communication link between the first and second processing units through the Internet.

16. The computer program product of claim 15, further **characterized by**:

- b1) program code for generating a connection signal (CONNECTOK) including the second IP address at the second processing unit; and
- c1) program code for transmitting the connection signal from the second processing unit to the first processing unit.

17. The computer program product of claim 15, further comprising in a memory (16) of the first processing unit:

program code for performing a point-to-point Internet protocol;
 program code for generating an E-mail signal, including a first IP address; and
 program code for use of a mail server (28) for processing the E-mail signal through the Internet to deliver the E-mail to the second processing unit for establishing a point-to-point communication link between the first and second processing unit.

18. The computer program product of claim 15, further comprising in a memory of the second processing unit:

second program code for performing a point-to-point Internet protocol; program code for receiving the E-mail signal from a mail server; and program code for generating a connection signal including a second IP address for establishing the point-to-point communication link to the first processing unit.

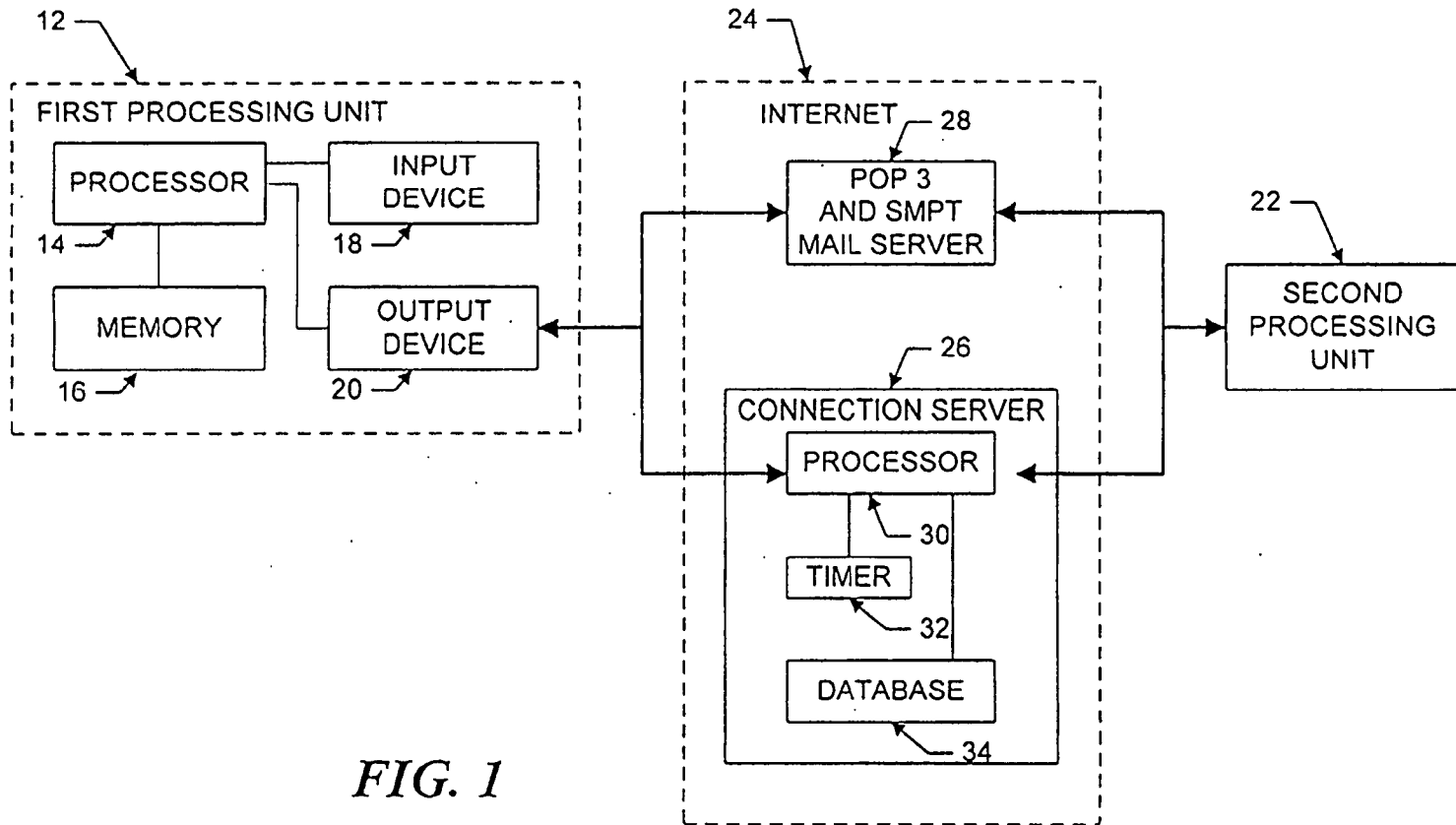

FIG. 1

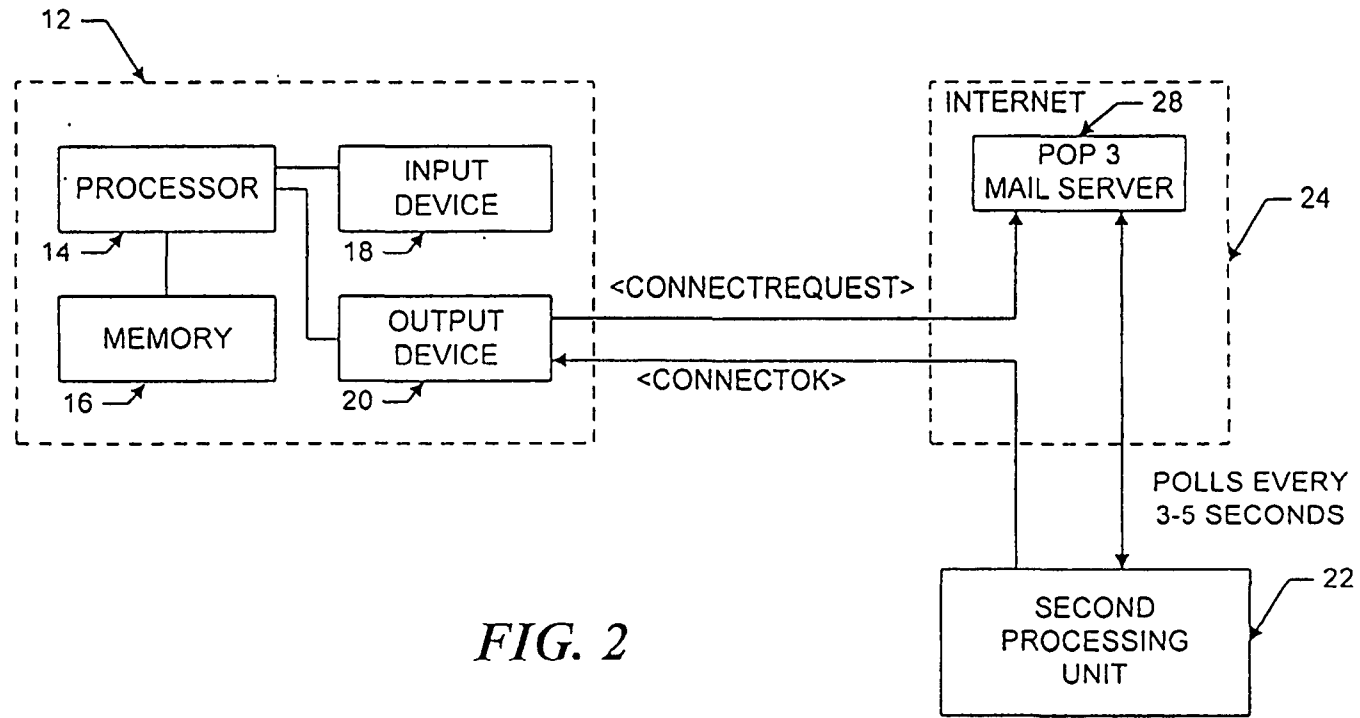

FIG. 2

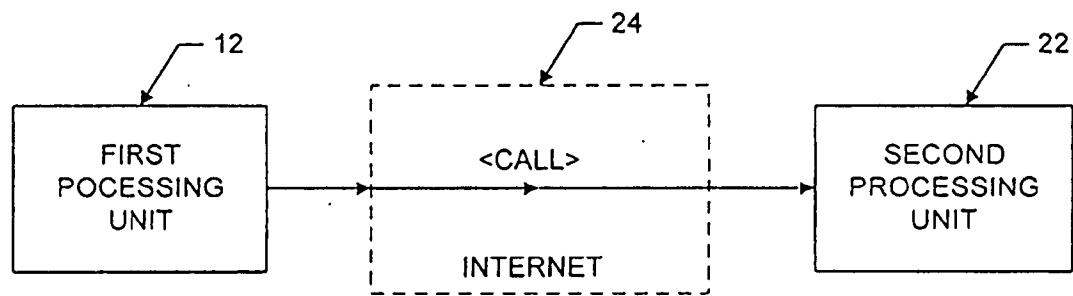

FIG. 3

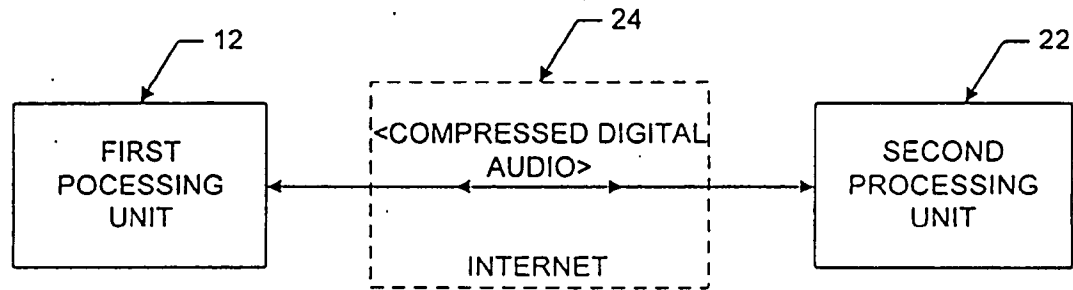

FIG. 4

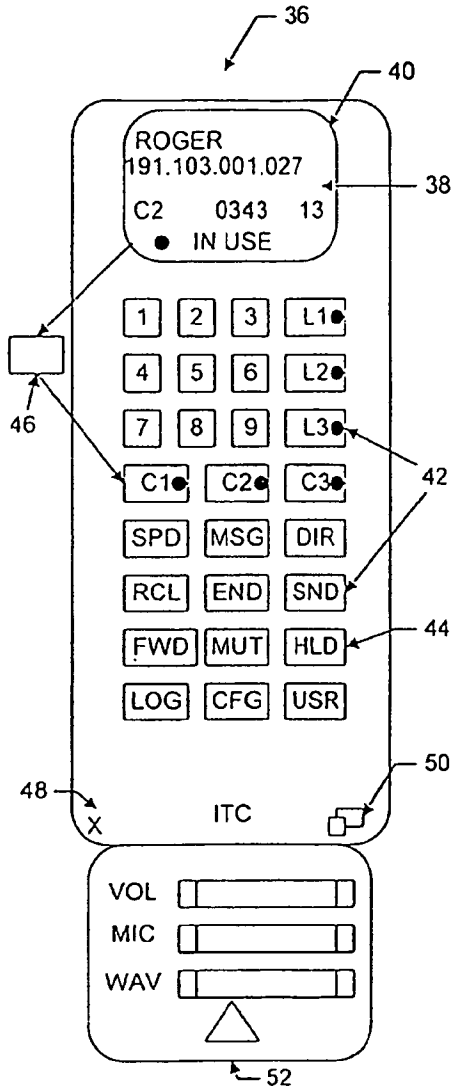

FIG. 5

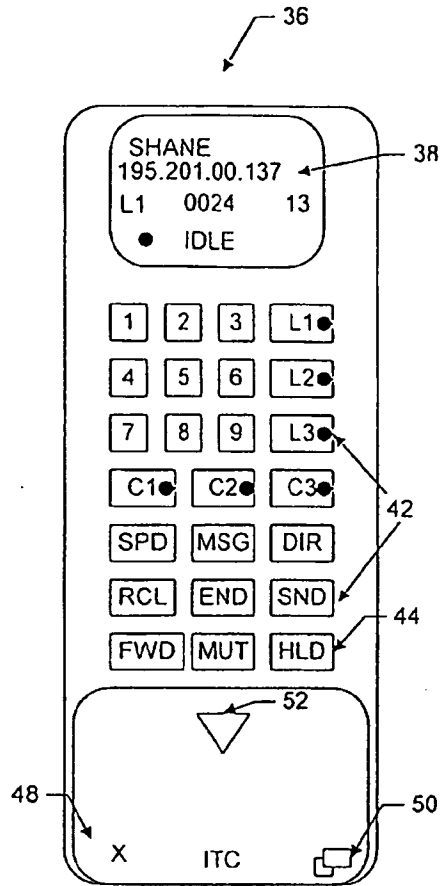

FIG. 6

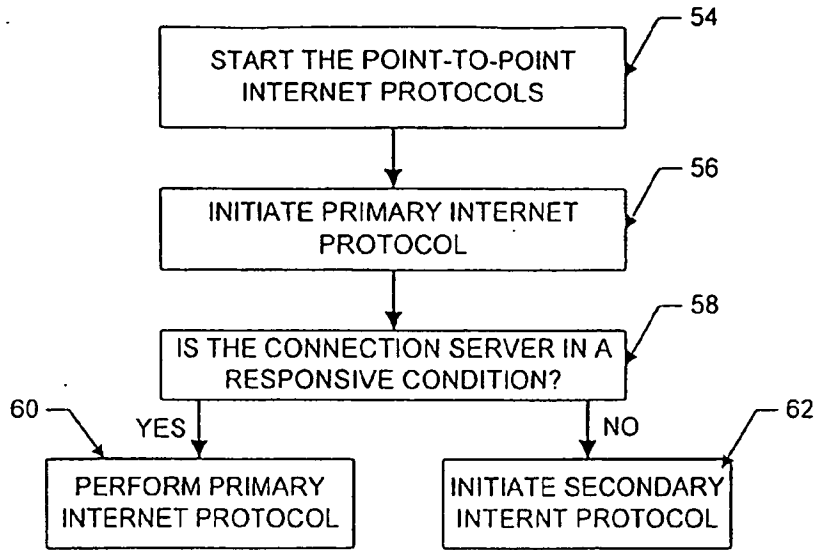

FIG. 7

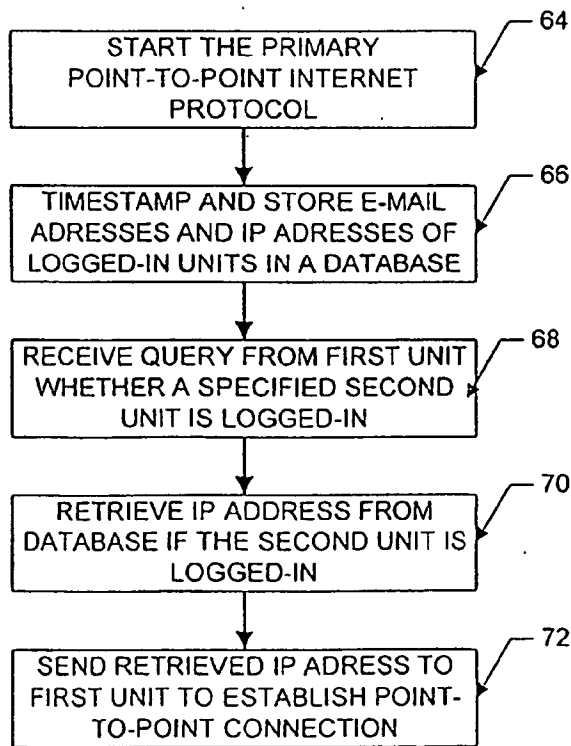

FIG. 8

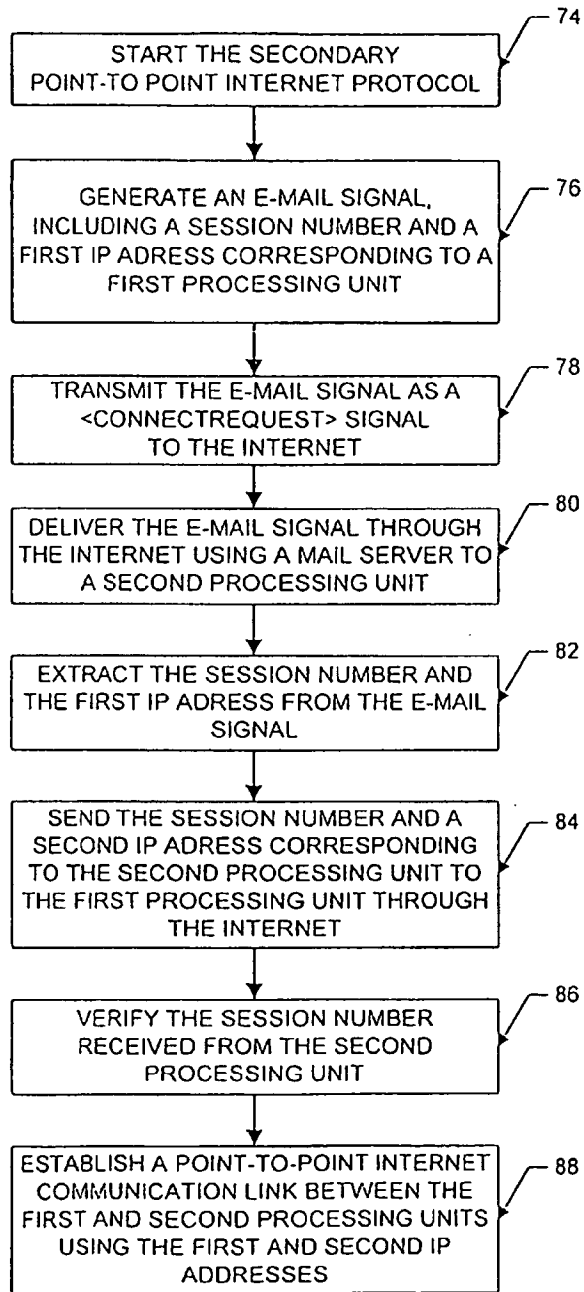

FIG. 9



(12) **EUROPEAN PATENT APPLICATION**

(88) Date of publication A3:
 10.03.2004 Bulletin 2004/11

(51) Int Cl.7: **H04L 12/58**, H04L 29/06,
 H04L 29/12

(43) Date of publication A2:
 07.01.2004 Bulletin 2004/02

(21) Application number: **03022287.1**

(22) Date of filing: **25.09.1996**

(84) Designated Contracting States:
CH DE ES FI FR GB IE IT LI NL SE

(30) Priority: **25.09.1995 US 533115**

(62) Document number(s) of the earlier application(s) in
 accordance with Art. 76 EPC:
96933928.2 / 0 852 868

(71) Applicant: **Netspeak Corporation**
Boca Raton, FL 33487 (US)

(72) Inventor: **Hutton, Glenn W.**
Miami, FL 33196 (US)

(74) Representative: **Kindermann, Manfred**
Patentanwalt,
Sperberweg 29
71032 Böblingen (DE)

(54) **Point-to-point communication using e-mail to establish dynamic network addresses**

(57) In a computer system having an audio transducer and a display device and being operatively coupled to other computers over a computer network (24), such as the Internet, means are included for establishing a point-to-point communication link between processes. The means provide for transmitting from a first processing unit (12) to the Internet an E-mail signal, in-

cluding a first IP address assigned to the first processing unit, and for processing the E-mail signal through the Internet to deliver the E-mail signal to a second processing unit (22). Further means are provided for transmitting a second IP address to the first processing unit for establishing a point-to-point communication link between the first and second processing units through the Internet.

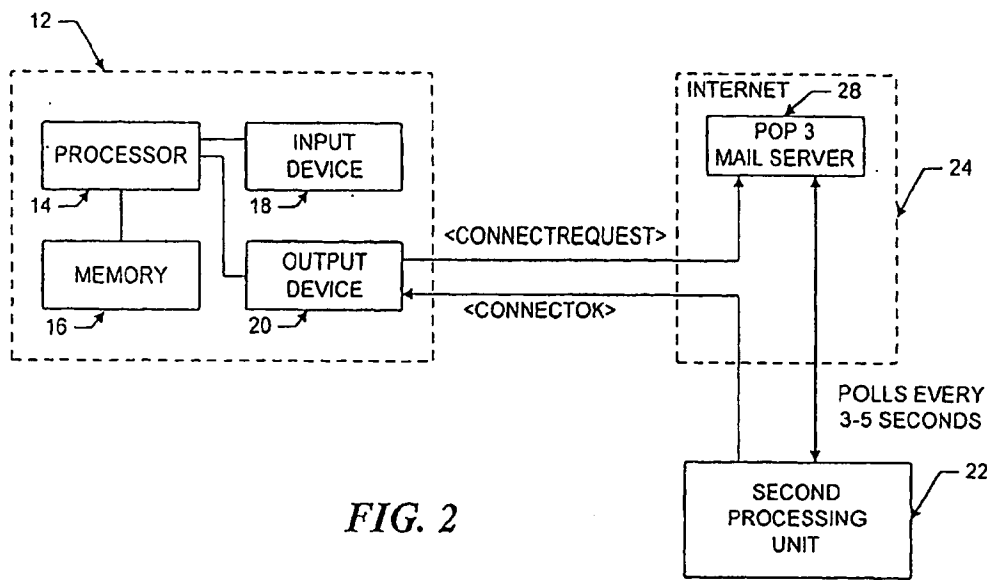

FIG. 2

EP 1 379 039 A3



European Patent Office

EUROPEAN SEARCH REPORT

Application Number
EP 03 02 2287

DOCUMENTS CONSIDERED TO BE RELEVANT			
Category	Citation of document with indication, where appropriate, of relevant passages	Relevant to claim	CLASSIFICATION OF THE APPLICATION (Int.Cl.7)
X	EP 0 581 722 A (YEDA RES & DEV) 2 February 1994 (1994-02-02) * page 2, line 3 - page 3, line 58 * * page 5, line 33 - page 6, line 13 * * page 7, line 10 - line 17 * * page 8, line 19 - line 24 * ---	1-18	H04L12/58 H04L29/06 H04L29/12
A	US 5 440 547 A (ESAKI HIROSHI ET AL) 8 August 1995 (1995-08-08) * column 1, line 9 - column 4, line 48 * * column 15, line 67 - column 17, line 6 * ---	1-18	
A	GB 2 283 645 A (DIGITAL EQUIPMENT INT) 10 May 1995 (1995-05-10) * page 1, line 3 - page 3, line 22 * * page 5, line 22 - line 26 * * page 6, line 4 - page 7, line 28 * * page 11, line 17 - page 12, line 21 * ---	1,6,15	
A	US 5 287 103 A (KASPRZYK MARLON Z ET AL) 15 February 1994 (1994-02-15) * the whole document * ---	1,6,15	TECHNICAL FIELDS SEARCHED (Int.Cl.7)
A	US 5 410 754 A (FAVREAU KEITH ET AL) 25 April 1995 (1995-04-25) * column 1, line 6 - column 3, line 41 * * column 15, line 13 - line 16 * -----	1,6,15	H04L
The present search report has been drawn up for all claims			
Place of search THE HAGUE		Date of completion of the search 12 January 2004	Examiner Vaskimo, K
CATEGORY OF CITED DOCUMENTS X : particularly relevant if taken alone Y : particularly relevant if combined with another document of the same category A : technological background O : non-written disclosure P : intermediate document		T : theory or principle underlying the invention E : earlier patent document, but published on, or after the filing date D : document cited in the application L : document cited for other reasons ----- & : member of the same patent family, corresponding document	

EPO FORM 1503 (03.02.02) (P04G01)

**ANNEX TO THE EUROPEAN SEARCH REPORT
ON EUROPEAN PATENT APPLICATION NO.**

EP 03 02 2287

This annex lists the patent family members relating to the patent documents cited in the above-mentioned European search report. The members are as contained in the European Patent Office EDP file on
The European Patent Office is in no way liable for these particulars which are merely given for the purpose of information.

12-01-2004

Patent document cited in search report	Publication date	Patent family member(s)	Publication date
EP 0581722 A	02-02-1994	EP 0581722 A1 JP 6216937 A	02-02-1994 05-08-1994
US 5440547 A	08-08-1995	JP 6318951 A JP 6261094 A	15-11-1994 16-09-1994
GB 2283645 A	10-05-1995	NONE	
US 5287103 A	15-02-1994	NONE	
US 5410754 A	25-04-1995	US 5796742 A	18-08-1998

EPO FORM P10159

For more details about this annex : see Official Journal of the European Patent Office, No. 12/82



(12) **EUROPEAN PATENT APPLICATION**

(43) Date of publication:
07.01.2004 Bulletin 2004/02

(51) Int Cl.7: **H04L 29/06, H04L 12/58**

(21) Application number: **03022288.9**

(22) Date of filing: **25.09.1996**

(84) Designated Contracting States:
CH DE ES FI FR GB IE IT LI NL SE

(72) Inventor: **Hutton, Glenn W.**
Miami, FL 33196 (US)

(30) Priority: **25.09.1995 US 533115**

(74) Representative: **Kindermann, Manfred**
Patentanwalt,
Sperberweg 29
71032 Böblingen (DE)

(62) Document number(s) of the earlier application(s) in
accordance with Art. 76 EPC:
96933928.2 / 0 852 868

(71) Applicant: **Netspeak Corporation**
Boca Raton, FL 33487 (US)

Remarks:

This application was filed on 02 - 10 - 2003 as a
divisional application to the application mentioned
under INID code 62.

(54) **Server mediated point-to-point communication over a computer network**

(57) In a computer system (12) having an audio transducer and a display device and being operatively coupled to other computers (22) and a server (26) over a computer network (24), means are described for establishing a point-to-point communication link between computer systems. The means provide for transmitting from a first process to the server a query as to whether

a second process is connected to the computer network and for receiving a network protocol address of the second process from the server when the second process is connected to the computer network. In response to the received network protocol of the second process a point-to-point communication link is established between the first process and the second process over the computer network.

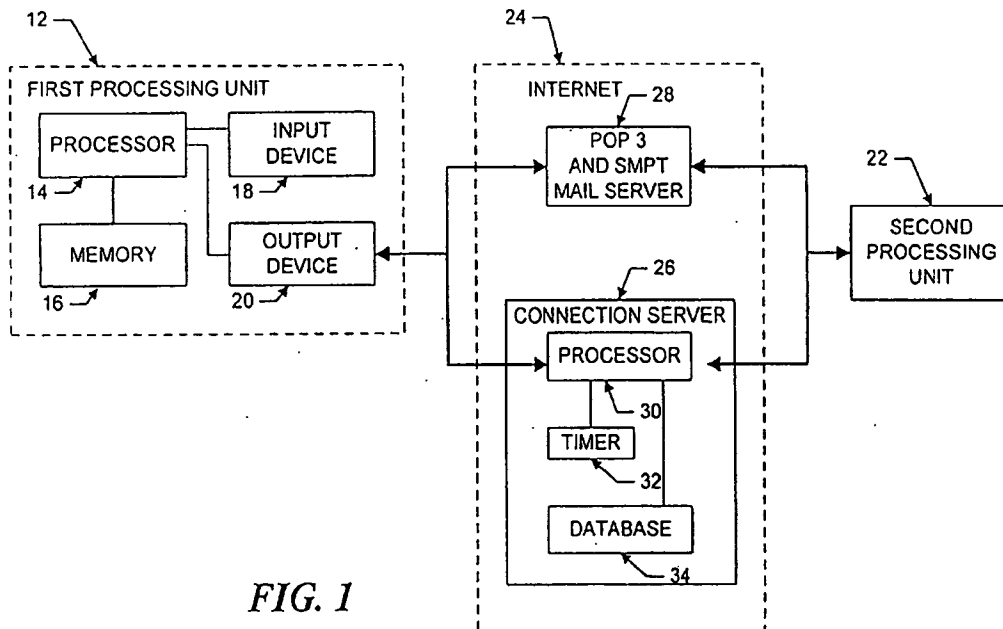

FIG. 1

Description**FIELD OF THE INVENTION**

[0001] The present invention relates in general to data processing systems, and more specifically, to an apparatus, a method and a computer program product for facilitating audio communications over computer networks.

BACKGROUND OF THE INVENTION

[0002] The increased popularity of on-line services such as AMERICA ONLINE (TM), COMPUSERVE (R), and other services such as Internet gateways have spurred applications to provide multimedia contents, including video and voice clips, to online users. An example of an online voice clip application is VOICE E-MAIL FOR WINCIM and VOICE E-MAIL FOR AMERICA ONLINE (TM), available from Bonzi Software, as described in "Simple Utilities Send Voice E-Mail Online", MULTIMEDIA WORLD, VOL. 2, NO. 9, August 1995, p. 52. Using such Voice E-Mail software, a user may create an audio message to be sent to a predetermined E-mail address specified by the user.

[0003] Generally, devices interfacing with the Internet and other online services may communicate with each other upon establishing respective device addresses. One type of device address is the Internet Protocol (IP) address, which acts as a pointer to the device associated with the IP address. A typical device may have a Serial Line Internet Protocol or Point-to-Point Protocol (SLIP/PPP) account with a permanent IP address for receiving E-mail, voicemail, and the like over the Internet. E-mail and voicemail is generally intended to convey text, audio, etc., with any routing information such as an IP address and routing headers generally being considered an artifact of the communication, or even gibberish to the recipient.

[0004] Devices such as a host computer or server of a company may include multiple modems for connection of users to the Internet, with a temporary IP address allocated to each user. For example, the host computer may have a general IP address "XXX.XXX.XXX", and each user may be allocated a successive IP address of XXX.XXX.XXX.10, XXX.XXX.XXX.11, XXX.XXX.XXX.12, etc. Such temporary IP addresses may be reassigned or recycled to the users, for example, as each user is successively connected to an outside party. For example, a host computer of a company may support a maximum of 254 IP addresses which are pooled and shared between devices connected to the host computer.

[0005] Permanent IP addresses of users and devices accessing the Internet readily support point-to-point communications of voice and video signals over the Internet. For example, global real-time video conferencing has been implemented using dedicated IP addresses

and mechanisms known as reflectors.

[0006] A technique for matching domain names to Internet Protocol addresses is described in the text entitled "Internetworking With TCP/IP", 2nd Edition, by Douglas E. Comer, November 1992, Prentice Hall, Englewood Cliffs, New Jersey, U.S.A. Comer describes a domain name system and cooperative systems of name servers for matching domain names to network addresses. Each name server is a server program that supplies mapping of domain names to IP addresses. The system described in Comer, however, is not designed for use with network nodes whose network names or name to address bindings change frequently.

[0007] International Publication WO 92/19054 discloses a network monitoring system including an address tracking module which uses passive monitoring of all packet communications over a local area network to maintain a name table of IP address mappings. The disclosed address tracking module is capable of monitoring only a small number of nodes on a local area network and is not suitable for use with a multitude of nodes over a wide area network.

[0008] Due to the dynamic nature of temporary IP addresses of some devices accessing the Internet, point-to-point communications in realtime of voice and video have been generally difficult to attain.

SUMMARY OF THE INVENTION

[0009] In a computer system having an audio transducer and a display device and being operatively coupled to other computers and a server over a computer network, means are provided for establishing a point-to-point communication link between the computer system and a second computer system over the computer network. The invention, as defined in the claims, comprises (a) means for transmitting from the first process to a server a query as to whether a second process is connected to the computer network; (b) means for receiving a network protocol address of the second process from the server when the second process is connected to the computer network, and (c) means, responsive to the network protocol of the second process, for establishing a point-to-point communication link between the first process and the second process over the computer network.

[0010] The invention is in particular suitable for being used in connection with computer networks, such as the Internet, wherein the processing unit does not have a fixed or predetermined network protocol address. The invention thus provides for a protocol by which the processing units report their dynamically assigned network protocol address to a server once they are logging on the computer network. The server maintains and retrieves such information upon request from a calling processing unit.

BRIEF DESCRIPTION OF THE DRAWINGS

[0011] The features of the invention will become more readily apparent and may be better understood by referring to the following detailed description of an illustrative embodiment of the present invention, taken in conjunction with the accompanying drawings, in which:

FIG. 1 illustrates, in block diagram format, a system for the disclosed point-to-point Internet protocol;

FIG. 2 illustrates, in block diagram format, the system using a secondary point-to-point Internet protocol;

FIG. 3 illustrates, in block diagram format, the system of FIGS. 1-2 with the point-to-point Internet protocol established;

FIG. 4 is another block diagram of the system of FIGS 1-2 with audio communications being conducted;

FIG. 5 illustrates a display screen for a processing unit;

FIG. 6 illustrates another display screen for a processing unit;

FIG. 7 illustrates a flowchart of the initiation of the point-to-point Internet protocols;

FIG. 8 illustrates a flowchart of the performance of the primary point-to-point Internet protocols; and

FIG. 9 illustrates a flowchart of the performance of the secondary point-to-point Internet protocol.

DETAILED DESCRIPTION

[0012] Referring now in specific detail to the drawings, with like reference numerals identifying similar or identical elements, as shown in FIG. 1, the present disclosure describes a point-to-point network protocol and system 10 for using such a protocol.

[0013] In an exemplary embodiment, the system 10 includes a first processing unit 12 for sending at least a voice signal from a first user to a second user. The first processing unit 12 includes a processor 14, a memory 16, an input device 18, and an output device 20. The output device 20 includes at least one modem capable of, for example, 14.4 kbaud communications and operatively connected via wired and/or wireless communication connections to the Internet or other computer networks such as an Intranet, i.e., a private computer network. One skilled in the art would understand that the input device 18 may be implemented at least in part by the modem of the output device 20 to allow input signals from the communication connections to be received. The second processing unit 22 may have a processor, memory, and input and output devices, including at least one modem and associated communication connections, as described above for the first processing unit 12. In an exemplary embodiment, each of the processing units 12, 22 may execute the WEBPHONE™ Internet telephony application available from NetSpeak Cor-

poration, Boca Raton, FL, which is capable of performing the disclosed point-to-point Internet protocol and system 10, as described herein.

[0014] The first processing unit 12 and the second processing unit 22 are operatively connected to the Internet 24 by communication devices and software known in the art, such as an Internet Service Provider (ISP) or an Internet gateway. The processing units 12, 22 may be operatively interconnected through the Internet 24 to a connection server 26, and may also be operatively connected to a mail server 28 associated with the Internet 24.

[0015] The connection server 26 includes a processor 30, a timer 32 for generating time stamps, and a memory such as a database 34 for storing, for example, E-mail and Internet Protocol (IP) addresses of logged-in units. In an exemplary embodiment, the connection server 26 may be a SPARC 5 server or a SPARC 20 server, available from SUNMICROSYSTEMS, INC., Mountain View, CA, having a central processing unit (CPU) as processor 30, an operating system (OS) such as UNIX, for providing timing operations such as maintaining the timer 32, a hard drive or fixed drive, as well as dynamic random access memory (DRAM) for storing the database 34, and a keyboard and display and/or other input and output devices (not shown in FIG. 1). The database 34 may be an SQL database available from ORACLE or INFORMIX.

[0016] In an exemplary embodiment, the mail server 28 may be a Post Office Protocol (POP) Version 3 mail server including a processor, memory, and stored programs operating in a UNIX environment, or, alternatively, another OS, to process E-mail capabilities between processing units and devices over the Internet 24.

[0017] The first processing unit 12 may operate the disclosed point-to-point Internet protocol by a computer program described hereinbelow in conjunction with FIG. 6, which may be implemented from compiled and/or interpreted source code in the C++ programming language and which may be downloaded to the first processing unit 12 from an external computer. The operating computer program may be stored in the memory 16, which may include about 8 MB RAM and/or a hard or fixed drive having about 8 MB. Alternatively, the source code may be implemented in the first processing unit 12 as firmware, as an erasable read only memory (EPROM), etc. It is understood that one skilled in the art would be able to use programming languages other than C++ to implement the disclosed point-to-point network protocol and system 10.

[0018] The processor 14 receives input commands and data from a first user associated with the first processing unit 12 through the input device 18, which may be an input port connected by a wired, optical, or a wireless connection for electromagnetic transmissions, or alternatively may be transferable storage media, such as floppy disks, magnetic tapes, compact disks, or other storage disks including the input data

from the first user.

[0019] The input device 18 may include a user interface (not shown) having, for example, at least one button actuated by the user to input commands to select from a plurality of operating modes to operate the first processing unit 12. In alternative embodiments, the input device 18 may include a keyboard, a mouse, a touch screen, and/or a data reading device such as a disk drive for receiving the input data from input data files stored in storage media such as a floppy disk or, for example, an 8 mm storage tape. The input device 18 may alternatively include connections to other computer systems to receive the input commands and data therefrom.

[0020] The first processing unit 12 may include a visual interface for use in conjunction with the input device 18 and output device 20 similar to those screens illustrated in FIGS. 5-6, discussed below. It is also understood that alternative devices may be used to receive commands and data from the user, such as keyboards, mouse devices, and graphical user interfaces (GUI) such as WINDOWS™ 3.1 available from MICROSOFT Corporation, Redmond, WA., and other operating systems and GUIs, such as OS/2 and OS/2 WARP, available from IBM CORPORATION, Boca Raton, FL. Processing unit 12 may also include microphones and/or telephone handsets for receiving audio voice data and commands, speech or voice recognition devices, dual tone multifrequency (DTMF) based devices, and/or software known in the art to accept voice data and commands and to operate the first processing unit 12.

[0021] In addition, either of the first processing unit 12 and the second processing unit 22 may be implemented in a personal digital assistant (PDA) providing modem and E-mail capabilities and Internet access, with the PDA providing the input/output screens for mouse interactions or for touchscreen activation as shown, for example, in FIGS. 5-6, as a combination of the input device 18 and output device 20.

[0022] For clarity of explanation, the illustrative embodiment of the disclosed point-to-point Internet protocol and system 10 is presented as having individual functional blocks, which may include functional blocks labeled as "processor" and "processing unit". The functions represented by these blocks may be provided through the use of either shared or dedicated hardware, including, but not limited to, hardware capable of executing software. For example, the functions of each of the processors and processing units presented herein may be provided by a shared processor or by a plurality of individual processors. Moreover, the use of the functional blocks with accompanying labels herein is not to be construed to refer exclusively to hardware capable of executing software. Illustrative embodiments may include digital signal processor (DSP) hardware, such as the AT&T DSP16 or DSP32C, read-only memory (ROM) for storing software performing the operations discussed below, and random access memory (RAM) for

storing DSP results. Very large scale integration (VLSI) hardware embodiments, as well as custom VLSI circuitry in combination with a general purpose DSP circuit, may also be provided. Any and all of these embodiments may be deemed to fall within the meaning of the labels for the functional blocks as used herein.

[0023] The processing units 12, 22 are capable of placing calls and connecting to other processing units connected to the Internet 24, for example, via dialup SLIP/PPP lines. In an exemplary embodiment, each processing unit assigns an unsigned long session number, for example, a 32-bit long sequence in a *.ini file for each call. Each call may be assigned a successive session number in sequence, which may be used by the respective processing unit to associate the call with one of the SLIP/PPP lines, to associate a <ConnectOK> response signal with a <Connect Request> signal, and to allow for multiplexing and demultiplexing of inbound and outbound conversations on conference lines, as explained hereinafter.

[0024] For callee (or called) processing units with fixed IP addresses, the caller (or calling) processing unit may open a "socket", i.e. a file handle or address indicating where data is to be sent, and transmit a <Call> command to establish communication with the callee utilizing, for example, datagram services such as Internet Standard network layering as well as transport layering, which may include a Transport Control Protocol (TCP) or a User Datagram Protocol (UDP) on top of the IP. Typically, a processing unit having a fixed IP address may maintain at least one open socket and a called processing unit waits for a <Call> command to assign the open socket to the incoming signal. If all lines are in use, the callee processing unit sends a BUSY signal or message to the callee processing unit. As shown in FIG. 1, the disclosed point-to-point Internet protocol and system 10 operate when a callee processing unit does not have a fixed or predetermined IP address. In the exemplary embodiment and without loss of generality, the first processing unit 12 is the caller processing unit and the second processing unit 22 is the called processing unit. When either of processing units 12, 22 logs on to the Internet via a dial-up connection, the respective unit is provided a dynamically allocated IP address by the a connection service provider.

[0025] Upon the first user initiating the point-to-point Internet protocol when the first user is logged on to the Internet 24, the first processing unit 12 automatically transmits its associated E-mail address and its dynamically allocated IP address to the connection server 26. The connection server 26 then stores these addresses in the database 34 and time stamps the stored addresses using timer 32. The first user operating the first processing unit 12 is thus established in the database 34 as an active on-line party available for communication using the disclosed point-to-point Internet protocol. Similarly, a second user operating the second processing unit 22, upon connection to the Internet 24 through

the a connection service provider, is processed by the connection server 26 to be established in the database 34 as an active on-line party.

[0026] The connection server 26 may use the time stamps to update the status of each processing unit; for example, after 2 hours. so that the on-line status information stored in the database 34 is relatively current. Other predetermined time periods, such as a default value of 24 hours, may be configured by a systems operator.

[0027] The first user with the first processing unit 12 initiates a call using, for example, a Send command and/or a command to speedial an NTH stored number, which may be labeled [SND] and [SPD][N], respectively, by the input device 18 and/or the output device 20, such as shown in FIGS. 5-6. In response to either the Send or speedial commands, the first processing unit 12 retrieves from memory 16 a stored E-mail address of the callee corresponding to the NTH stored number. Alternatively, the first user may directly enter the E-mail address of the callee.

[0028] The first processing unit 12 then sends a query, including the E-mail address of the callee, to the connection server 26. The connection server 26 then searches the database 34 to determine whether the callee is logged-in by finding any stored information corresponding to the callee's E-mail address indicating that the callee is active and on-line. If the callee is active and on-line, the connection server 26 then performs the primary point-to-point Internet protocol; i.e. the IP address of the callee is retrieved from the database 34 and sent to the first processing unit 12. The first processing unit 12 may then directly establish the point-to-point Internet communications with the callee using the IP address of the callee.

[0029] If the callee is not on-line when the connection server 26 determines the callee's status, the connection server 26 sends an OFFLINE signal or message to the first processing unit 12. The first processing unit 12 may also display a message such as "Called Party Off-Line" to the first user.

[0030] When a user logs off or goes off-line from the Internet 24, the connection server 26 updates the status of the user in the database 34; for example, by removing the user's information, or by flagging the user as being off-line. The connection server 26 may be instructed to update the user's information in the database 34 by an off-line message, such as a data packet, sent automatically from the processing unit of the user prior to being disconnected from the connection server 26. Accordingly, an off-line user is effectively disabled from making and/or receiving point-to-point Internet communications.

[0031] As shown in FIGS. 2-4, the disclosed secondary point-to-point Internet protocol may be used as an alternative to the primary point-to-point Internet protocol described above, for example, if the connection server 26 is non-responsive, inoperative, and/or unable to per-

form the primary point-to-point Internet protocol, as a non-responsive condition. Alternatively, the disclosed secondary point-to-point Internet protocol may be used independent of the primary point-to-point Internet protocol. In the disclosed secondary point-to-point Internet protocol, the first processing unit 12 sends a <ConnectRequest> message via E-mail over the Internet 24 to the mail server 28. The E-mail including the <ConnectRequest> message may have, for example, the subject

10 [*wp#XXXXXXXX#nnn.nnn.nnn.#emailAddr]
where nnn.nnn.nnn.nnn. is the current (i.e. temporary or permanent) IP address of the first user, and XXXXXXXX is a session number, which may be unique and associated with the request of the first user to initiate point-to-point communication with the second user.

[0032] As described above, the first processing unit 12 may send the <ConnectRequest> message in response to an unsuccessful attempt to perform the primary point-to-point Internet protocol. Alternatively, the first processing unit 12 may send the <ConnectRequest> message in response to the first user initiating a SEND command or the like.

[0033] After the <ConnectRequest> message via E-mail is sent, the first processing unit 12 opens a socket and waits to detect a response from the second processing unit 22. A timeout timer, such as timer 32, may be set by the first processing unit 12, in a manner known in the art, to wait for a predetermined duration to receive a <ConnectOK> signal. The processor 14 of the first processing unit 12 may cause the output device 20 to output a Ring signal to the user, such as an audible ringing sound, about every 3 seconds. For example, the processor 14 may output a *.wav file, which may be labeled RING.WAV, which is processed by the output device 20 to output an audible ringing sound.

[0034] The mail server 28 then polls the second processing unit 22, for example, every 3-5 seconds, to deliver the E-mail. Generally, the second processing unit 22 checks the incoming lines, for example, at regular intervals to wait for and to detect incoming E-mail from the mail server 28 through the Internet 24.

[0035] Typically, for sending E-mail to users having associated processing units operatively connected to a host computer or server operating an Internet gateway, E-mail for a specific user may be sent over the Internet 24 and directed to the permanent IP address or the SLIP/PPP account designation of the host computer, which then assigns a temporary IP address to the processing unit of the specified user for properly routing the E-mail. The E-mail signal may include a name or other designation such as a user name which identifies the specific user regardless of the processing unit assigned to the user; that is, the host computer may track and store the specific device where a specific user is assigned or logged on, independent of the IP address system, and so the host computer may switch the E-mail signal to the device of the specific user. At that time, a temporary IP address may be generated or assigned to

the specific user and device.

[0036] Upon detecting and/or receiving the incoming E-mail signal from the first processing unit 12, the second processing unit 22 may assign or may be assigned a temporary IP address. Therefore, the delivery of the E-mail through the Internet 24 provides the second processing unit 22 with a session number as well as IP addresses of both the first processing unit 12 and the second processing unit 22.

[0037] Point-to-point communication may then be established by the processing unit 22 processing the E-mail signal to extract the <ConnectRequest> message, including the IP address of the first processing unit 12 and the session number. The second processing unit 22 may then open a socket and generate a <ConnectOK> response signal, which includes the temporary IP address of the second processing unit 22 as well as the session number of the first processing unit.

[0038] The second processing unit 22 sends the <ConnectOK> signal directly over the Internet 24 to the IP address of the first processing unit 12 without processing by the mail server 28, and a timeout timer of the second processing unit 22 may be set to wait and detect a <Call> signal expected from the first processing unit 12.

[0039] Realtime point-to-point communication of audio signals over the Internet 24, as well as video and voicemail, may thus be established and supported without requiring permanent IP addresses to be assigned to either of the users or processing units 12, 22. For the duration of the realtime point-to-point link, the relative permanence of the current IP addresses of the processing units 12, 22 is sufficient, whether the current IP addresses were permanent (i.e. predetermined or pre-assigned) or temporary (i.e. assigned upon initiation of the point-to-point communication).

[0040] In the exemplary embodiment, a first user operating the first processing unit 12 is not required to be notified by the first processing unit 12 that an E-mail is being generated and sent to establish the point-to-point link with the second user at the second processing unit 22. Similarly, the second user is not required to be notified by the second processing unit 22 that an E-mail has been received and/or a temporary IP address is associated with the second processing unit 22. The processing units 12, 22 may perform the disclosed point-to-point Internet protocol automatically upon initiation of the point-to-point communication command by the first user without displaying the E-mail interactions to either user. Accordingly, the disclosed point-to-point Internet protocol may be transparent to the users. Alternatively, either of the first and second users may receive, for example, a brief message of "CONNECTION IN PROGRESS" or the like on a display of the respective output device of the processing units 12, 22.

[0041] After the initiation of either the primary or the secondary point-to-point Internet protocols described above in conjunction with FIGS. 1-2, the point-to-point

communication link over the Internet 24 may be established as shown in FIGS. 3-4 in a manner known in the art. For example, referring to FIG. 3, upon receiving the <ConnectorOK> signal from the second processing unit 22, the first processing unit 12 extracts the IP address of the second processing unit 22 and the session number, and the session number sent from the second processing unit 22 is then checked with the session number originally sent from the first processing unit 12 in the <ConnectRequest> message as E-mail. If the session numbers sent and received by the processing unit 12 match, then the first processing unit 12 sends a <Call> signal directly over the Internet 24 to the second processing unit 22; i.e. using the IP address of the second processing unit 22 provided to the first processing unit 12 in the <ConnectOK> signal.

[0042] Upon receiving the <Call> signal, the second processing unit 22 may then begin a ring sequence, for example, by indicating or annunciating to the second user that an incoming call is being received. For example, the word "CALL" may be displayed on the output device of the second processing unit 22. The second user may then activate the second processing unit 22 to receive the incoming call.

[0043] Referring to FIG. 4, after the second processing unit 22 receives the incoming call, realtime audio and/or video conversations may be conducted in a manner known in the art between the first and second users through the Internet 24, for example, by compressed digital audio signals. Each of the processing units 12, 22 also display to each respective user the words "IN USE" to indicate that the point-to-point communication link is established and audio or video signals are being transmitted.

[0044] In addition, either user may terminate the point-to-point communication link by, for example, activating a termination command, such as by activating an [END] button or icon on a respective processing unit, causing the respective processing unit to send an <End> signal which causes both processing units to terminate the respective sockets, as well as to perform other cleanup commands and functions known in the art.

[0045] FIGS. 5-6 illustrate examples of display screens 36 which may be output by a respective output device of each processing unit 12, 22 of FIGS. 1-4 for providing the disclosed point-to-point Internet protocol and system 10. Such display screens may be displayed on a display of a personal computer (PC) or a PDA in a manner known in the art.

[0046] As shown in FIG. 5, a first display screen 36 includes a status area 38 for indicating, for example, a called user by name and/or by IP address or telephone number; a current function such as C2; a current time; a current operating status such as "IN USE", and other control icons such as a down arrow icon 40 for scrolling down a list of parties on a current conference line. The operating status may include such annunciators as "IN USE," "IDLE," "BUSY," "NO ANSWER," "OFFLINE,"

"CALL," "DIALING," "MESSAGES," and "SPEEDDIAL."

[0047] Other areas of the display screen 36 may include activation areas or icons for actuating commands or entering data. For example, the display screen 36 may include a set of icons 42 arranged in columns and rows including digits 0-9 and commands such as END, SND, HLD, etc. For example, the END and SND commands may be initiated as described above, and the HLD icon 44 may be actuated to place a current line on hold. Such icons may also be configured to substantially simulate a telephone handset or a cellular telephone interface to facilitate ease of use, as well as to simulate function keys of a keyboard. For example, icons labeled L1-L4 may be mapped to function keys F1-F4 on standard PC keyboards, and icons C1-C3 may be mapped to perform as combinations of function keys, such as CTRL-F1, CTRL-F2, and CTRL-F3, respectively. In addition, the icons labeled L1-L4 and C1-C3 may include circular regions which may simulate light emitting diodes (LEDs) which indicate that the function or element represented by the respective icon is active or being performed.

[0048] Icons L1-L4 may represent each of 4 lines available to the caller, and icons C1-C3 may represent conference calls using at least one line to connect, for example, two or more parties in a conference call. The icons L1-L4 and C1-C3 may indicate the activity of each respective line or conference line. For example, as illustrated in FIG. 5, icons L1-L2 may have lightly shaded or colored circles, such as a green circle, indicating that each of lines 1 and 2 are in use, while icons L3-L4 may have darkly shaded or color circles, such as a red or black circle, indicating that each of lines 3 and 4 are not in use. Similarly, the lightly shaded circle of the icon labeled C2 indicates that the function corresponding to C2 is active, as additionally indicated in the status area 38, while darkly shaded circles of icons labeled C1 and C3 indicate that such corresponding functions are not active.

[0049] The icons 42 are used in conjunction with the status area 38. For example, using a mouse for input, a line that is in use, as indicated by the lightly colored circle of the icon, may be activated to indicate a party's name by clicking a right mouse button for 5 seconds until another mouse click is actuated or the [ESC] key or icon is actuated. Thus, the user may switch between multiple calls in progress on respective lines.

[0050] Using the icons as well as an input device such as a mouse, a user may enter the name or alias or IP address, if known, of a party to be called by either manually entering the name, by using the speeddial feature, or by double clicking on an entry in a directory stored in the memory, such as the memory 16 of the first processing unit 12, where the directory entries may be scrolled using the status area 38 and the down arrow icon 40.

[0051] Once a called party is listed in the status area 38 as being active on a line, the user may transfer the called party to another line or a conference line by click-

ing and dragging the status area 38, which is represented by a reduced icon 46. Dragging the reduced icon 46 to any one of line icons L1-L4 transfers the called party in use to the selected line, and dragging the reduced icon 46 to any one of conference line icons C1-C3 adds the called party to the selected conference call.

[0052] Other features may be supported, such as icons 48-52, where icon 48 corresponds to, for example, an ALT-X command to exit the communication facility of a processing unit, and icon 50 corresponds to, for example, an ALT-M command to minimize or maximize the display screen 36 by the output device of the processing unit. Icon 52 corresponds to an OPEN command, which may, for example, correspond to pressing the O key on a keyboard, to expand or contract the display screen 36 to represent the opening and closing of a cellular telephone. An "opened" configuration is shown in FIG. 5, and a "closed" configuration is shown in FIG. 6. In the "opened" configuration, additional features such as output volume (VOL) controls, input microphone (MIC) controls, waveform (WAV) sound controls, etc.

[0053] The use of display screens such as those shown in FIGS. 5-6 provided flexibility in implementing various features available to the user. It is to be understood that additional features such as those known in the art may be supported by the processing units 12, 22.

[0054] Alternatively, it is to be understood that one skilled in the art may implement the processing units 12, 22 to have the features of the display screens in FIGS. 5-6 in hardware; i.e. a wired telephone or wireless cellular telephone may include various keys, LEDs, liquid crystal displays (LCDs), and touchscreen actuators corresponding to the icons and features shown in FIGS. 5-6. In addition, a PC may have the keys of a keyboard and mouse mapped to the icons and features shown in FIGS. 5-6.

[0055] Referring to FIG. 7, the disclosed point-to-point Internet protocol and system 10 is illustrated. First processing unit 12 initiates the point-to-point Internet protocol in step 56 by sending a query from the first processing unit 12 to the connection server 26. If connection server 26 is operative to perform the point-to-point Internet protocol, in step 58, first processing unit 12 receives an on-line status signal from the connection server 26, such signal may include the IP address of the callee or a "Callee Off-Line" message. Next, first processing unit 12 performs the primary point-to-point Internet protocol in step 60, which may include receiving, at the first processing unit 12, the IP address of the callee if the callee is active and on-line. Alternatively, processing unit 60 may initiate and perform the secondary point-to-point Internet protocol in step 62, if the called party is not active and/or on-line.

[0056] Referring to FIG. 8, in conjunction with FIGS. 1 and 3-4, the disclosed point-to-point Internet protocol and system 10 is illustrated. Connection server 26 starts the point-to-point Internet protocol, in step 64, and timestamps and stores E-mail and IP addresses of

logged-in users and processing units in the database 34 in step 66. Connection server 26 receives a query from a first processing unit 12 in step 68 to determine whether a second user or second processing unit 22 is logged-in to the Internet 24, with the second user being specified, for example, by an E-mail address. Connection server 26 retrieves the IP address of the specified user from the database 34 in step 70, if the specified user is logged-in to the Internet, and sends the retrieved IP address to the first processing unit 12 in step 72 to enable first processing unit 12 to establish point-to-point communications with the specified second user.

[0057] The disclosed secondary point-to-point Internet protocol operates as shown in FIG. 9. First processing unit 12 generates an E-mail signal, including a session number and a first IP address corresponding to a first processing unit in step 76. First processing unit 12 transmits the E-mail signal as a <ConnectRequest> signal to the Internet 24 in step 78. The E-mail signal is delivered through the Internet 24 using a mail server 28 to the second processing unit 22 in step 80. Second processing unit 22 extracts the session number and the first IP address from the E-mail signal in step 82 and transmits or sends the session number and a second IP address corresponding to the second processing unit 22, back to the first processing unit 12 through the Internet 24, in step 84. First processing unit 12 verifies the session number received from the second processing unit 22 in step 86, and establishes a point-to-point Internet communication link between the first processing unit 12 and second processing unit 22 using the first and second IP addresses in step 88.

[0058] While the disclosed point-to-point Internet protocols and system have been particularly shown and described with reference to the preferred embodiments, it is understood by those skilled in the art that various modifications in form and detail may be made therein without departing from the scope and spirit of the invention. Accordingly, modifications such as those suggested above, but not limited thereto, are to be considered within the scope of the invention.

Claims

1. In a computer system (12) having a display (36) and audio transducer, the computer system coupled to other computer systems and a server (26) over a computer network (24), an apparatus for establishing a point-to-point communication link comprising:

- a. means for transmitting, from the computer system (12) to the server (26) a query as to whether a second computer system (22) is connected to the computer network (24);
- b. means for receiving a network protocol address of the of the second computer from the server when the second computer system is

connected to the computer network; and
c. means, responsive to the network protocol address of the second computer system, for establishing a point-to-point communication link between the first computer system and the second computer system over the computer network.

2. The apparatus of claim 1 further comprising:

d. means for receiving audio data and transmitting the audio data to the second computer over the established point-to-point communication link.

3. The apparatus claim 1, wherein the network protocol addresses comprise Internet Protocol Addresses (IP addresses).

4. The apparatus claim 1 wherein the query transmitted to the server includes an E-mail address of the second computer system (22).

5. The apparatus claim 1, further comprising:

f. means for transmitting an E-mail signal containing a network protocol address from the computer system (12) to a second computer system over the computer network (24) when the server (26) indicates that the second computer system is not connected to the computer network;

g. means for receiving a second network protocol address from the second computer system over the computer network; and

h. means, responsive to the second network protocol address, for establishing a point-to-point communication link between the first computer system (12) and the second computer system (22) over the computer network.

6. A method of operating a processing unit (12) for establishing a point-to-point communication between the processing unit (12) and a second one of a plurality of other processing units (22) over a computer network (24) including a server (26), each of said processing units having a display and an audio transducer, the method comprising the steps of:

a. transmitting from the processing unit (12) to the server a query as to whether the second processing (22) unit is connected to the computer network (24);

b. receiving a network protocol address of the second processing unit from the server when the second processing unit is connected to the computer network; and

c. establishing in response to the network pro-

tocol address of the second processing unit a point-to-point communication link between the first processing unit and the second processing unit over the computer network.

7. The method of claim 6 further comprising the step:

d. receiving audio data and transmitting the audio data to the second processing unit over the established point-to-point communication link.

8. The method of claim 6, wherein the network protocol addresses comprise Internet Protocol Addresses (IP addresses).

9. The method of claim 6 wherein the query transmitted to the server includes the E-mail address of the second computer system (22).

10. The method of claim 4, further comprising the steps of:

e. transmitting an E-mail signal containing a network protocol address from the first processing unit to the second processing unit over the computer network when the server indicates that the second computer system is not connected to the computer network;

f. receiving a second network protocol address from the second processing unit over the computer network; and

g. establishing in response to the second network protocol address a point-to-point communication link between the first processing unit and the second processing unit over the computer network.

11. A computer program product for use in a processing unit (12) having a memory (16), a display (36) and an audio transducer, to establish a point-to-point communication between the processing unit (12) and a second one of a plurality of other processing units (22) over a computer network (24) including a server (26), the computer program product having a computer usable medium containing computer readable program code, comprising:

a. program code for transmitting from the processing unit to the server a query as to whether the second processing unit is connected to the computer network;

b. program code for receiving a network protocol address of the second processing unit from the server when the second processing unit is connected to the computer network; and

c. program code for establishing in response to the network protocol address of the second processing unit a point-to-point communication

link between the first processing unit and the second processing unit over the computer network.

12. The program product of claim 11 further comprising:

d. program code for receiving audio data and transmitting the audio data to the second processing unit over the established point-to-point communication link.

13. The program product of claim 11, wherein the network protocol addresses comprise Internet Protocol Addresses (IP addresses).

14. The program product of claim 11, wherein the query transmitted to the server includes the E-mail address of the second processing unit (22).

15. The program product of claim 11, further comprising:

e. program code for transmitting an E-mail signal containing a network protocol address from the first processing unit to the second processing unit over the computer network when the server indicates that the second computer system is not connected to the computer network;

f. program code for receiving a second network protocol address from the second processing unit over the computer network; and

g. program code for establishing in response to the second network protocol address a point-to-point communication link between the first processing unit and the second processing unit over the computer network.

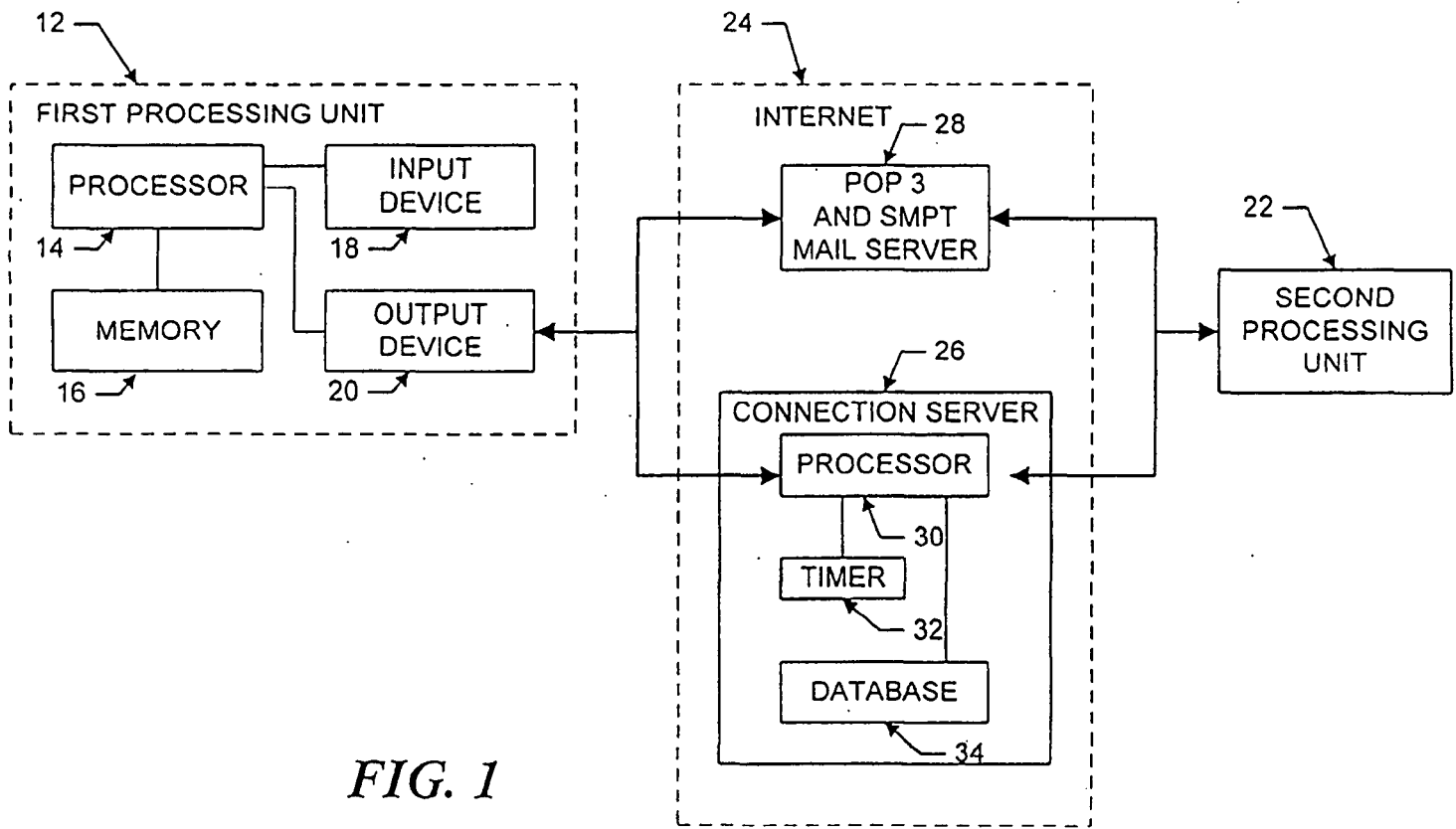

FIG. 1

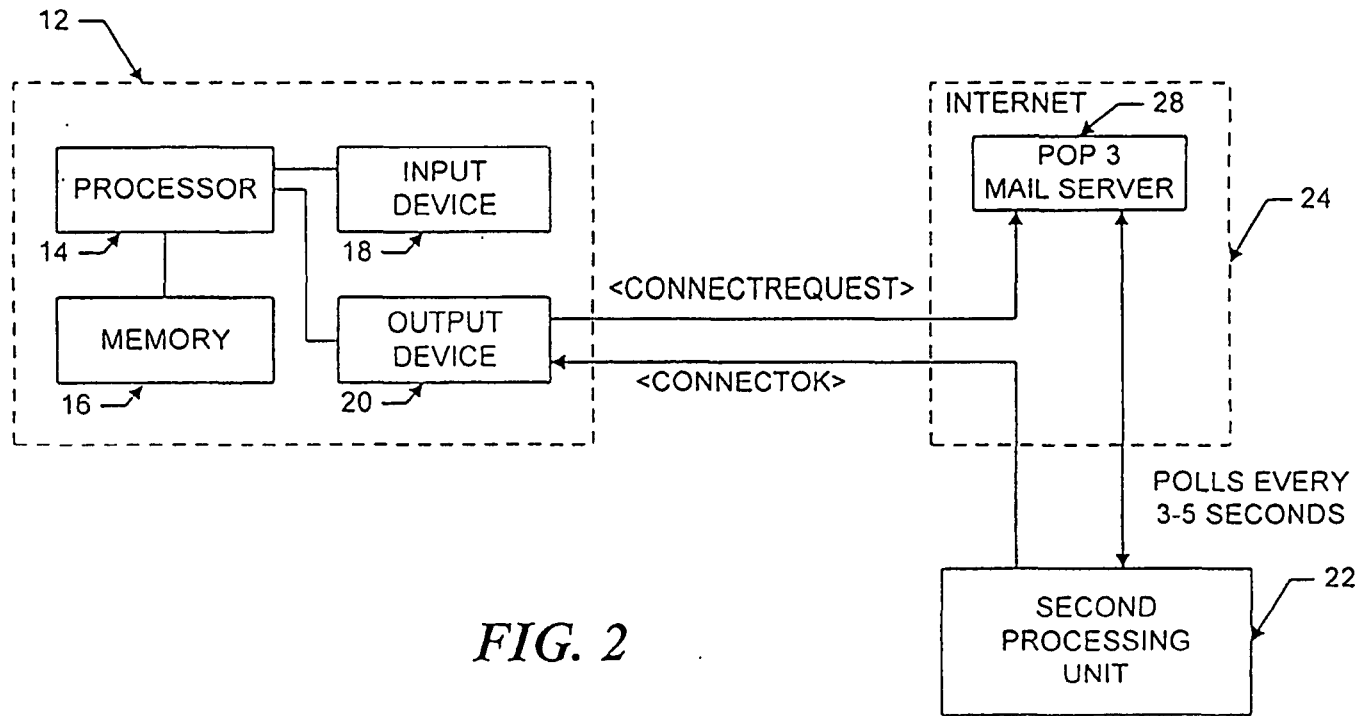

FIG. 2

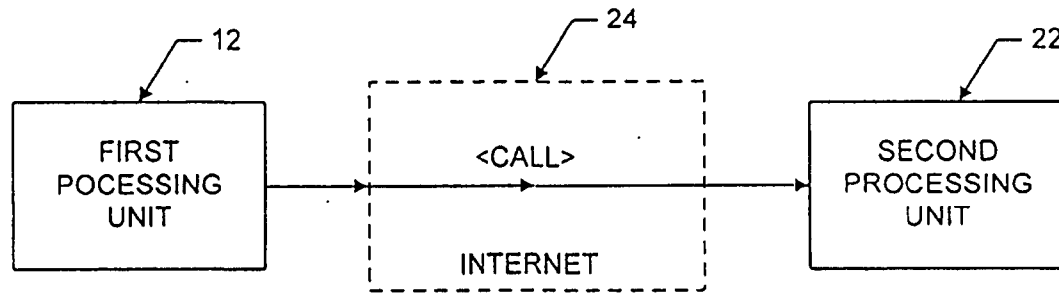

FIG. 3

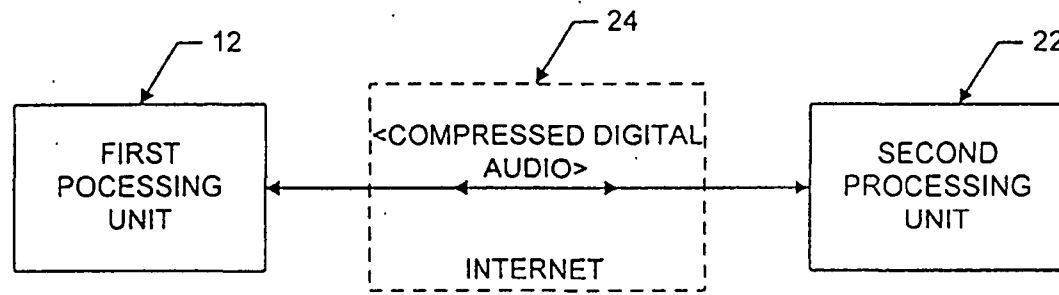

FIG. 4

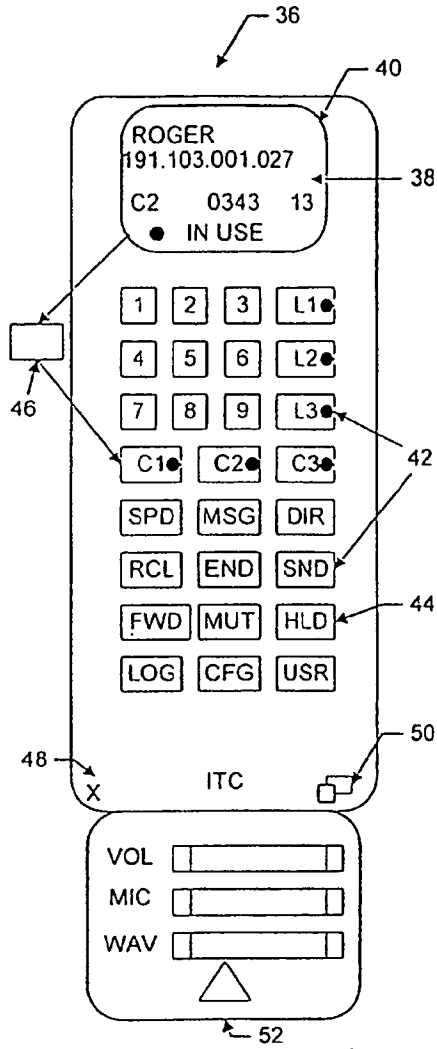

FIG. 5

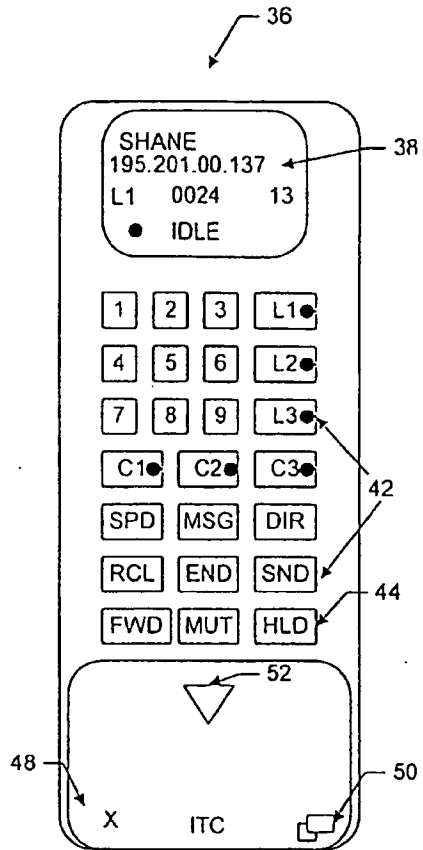

FIG. 6

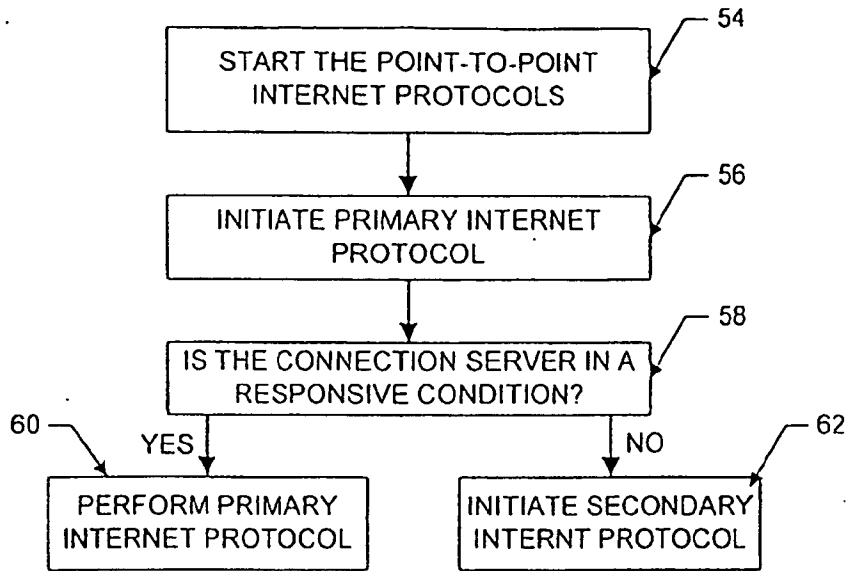

FIG. 7

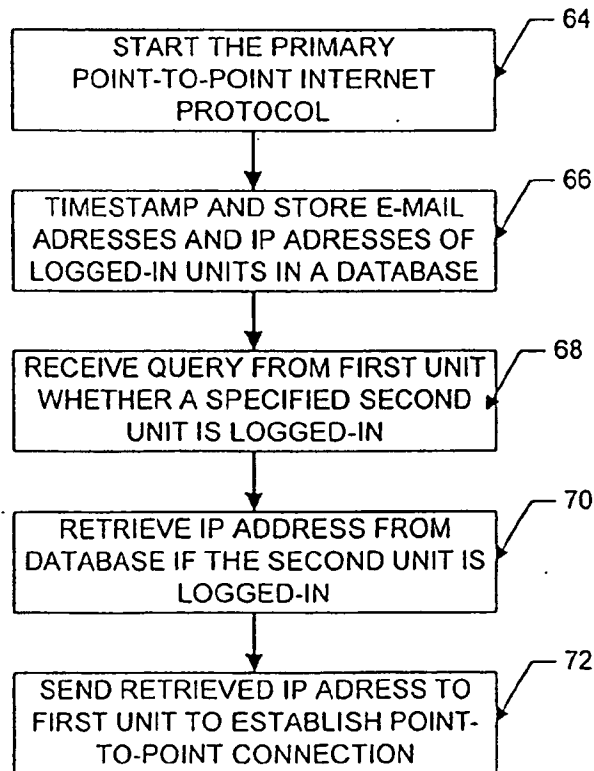

FIG. 8

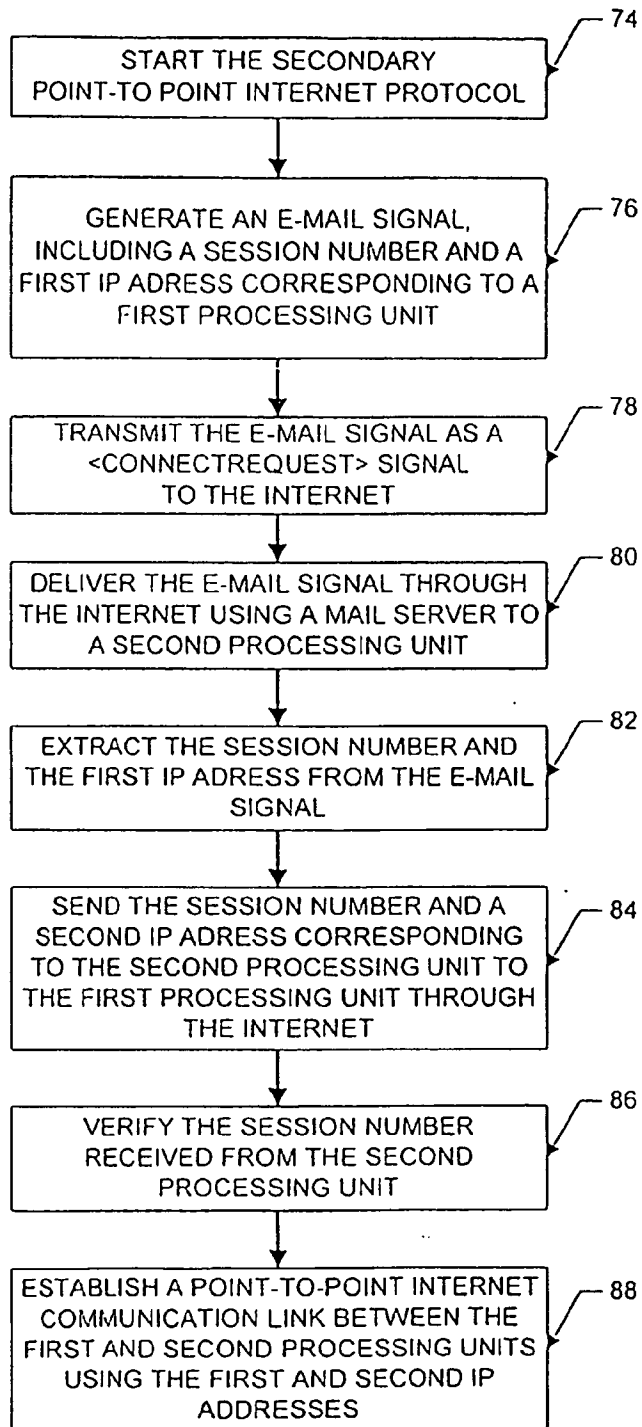

FIG. 9



(12) **EUROPEAN PATENT APPLICATION**

(88) Date of publication A3:
10.03.2004 Bulletin 2004/11

(51) Int Cl.7: **H04L 29/06, H04L 12/58**

(43) Date of publication A2:
07.01.2004 Bulletin 2004/02

(21) Application number: **03022288.9**

(22) Date of filing: **25.09.1996**

(84) Designated Contracting States:
CH DE ES FI FR GB IE IT LI NL SE

(71) Applicant: **Netspeak Corporation**
Boca Raton, FL 33487 (US)

(30) Priority: **25.09.1995 US 533115**

(72) Inventor: **Hutton, Glenn W.**
Miami, FL 33196 (US)

(62) Document number(s) of the earlier application(s) in
accordance with Art. 76 EPC:
96933928.2 / 0 852 868

(74) Representative: **Kindermann, Manfred**
Patentanwalt,
Sperberweg 29
71032 Böblingen (DE)

(54) **Server mediated point-to-point communication over a computer network**

(57) In a computer system (12) having an audio transducer and a display device and being operatively coupled to other computers (22) and a server (26) over a computer network (24), means are described for establishing a point-to-point communication link between computer systems. The means provide for transmitting from a first process to the server a query as to whether

a second process is connected to the computer network and for receiving a network protocol address of the second process from the server when the second process is connected to the computer network. In response to the received network protocol of the second process a point-to-point communication link is established between the first process and the second process over the computer network.

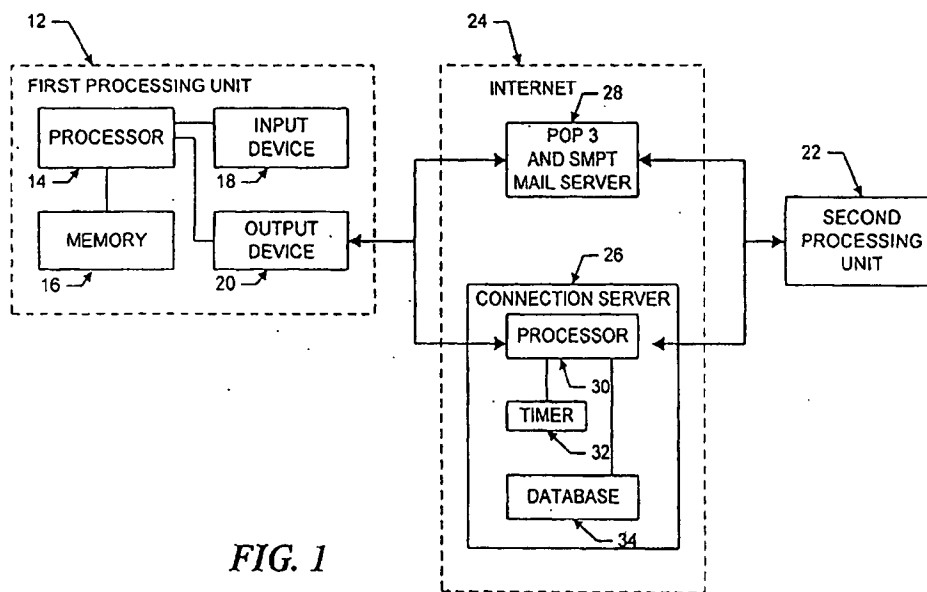

FIG. 1

EP 1 379 050 A3



European Patent Office

EUROPEAN SEARCH REPORT

Application Number
EP 03 02 2288

DOCUMENTS CONSIDERED TO BE RELEVANT			
Category	Citation of document with indication, where appropriate, of relevant passages	Relevant to claim	CLASSIFICATION OF THE APPLICATION (Int.Cl.7)
X	US 5 440 547 A (ESAKI HIROSHI ET AL) 8 August 1995 (1995-08-08) * column 1, line 9 - column 4, line 43 * * column 16, line 9 - column 17, line 6 * ---	1-15	H04L29/06 H04L12/58
Y	GB 2 283 645 A (DIGITAL EQUIPMENT INT) 10 May 1995 (1995-05-10) * page 2, line 26 - page 3, line 2 * * page 11, line 17 - line 23 * ---	1-15	
Y	WO 94 22087 A (3COM CORP) 29 September 1994 (1994-09-29) * page 1, line 2 - page 6, line 8 * * page 12, line 17 - page 13, line 30 * * page 14, line 6 - line 10 * * page 15, line 12 - page 16, line 7 * * page 17, line 17 - line 22 * ---	1-15	
A	US 5 315 705 A (IWAMI NAOKO ET AL) 24 May 1994 (1994-05-24) * abstract * * column 1, line 44 - line 62 * ---	1,6,11	TECHNICAL FIELDS SEARCHED (Int.Cl.7)
A	US 5 287 103 A (KASPRZYK MARLON Z ET AL) 15 February 1994 (1994-02-15) * column 4, line 18 - column 6, line 60 * ---	1,6,11	H04L
A	EP 0 648 038 A (IBM) 12 April 1995 (1995-04-12) * column 7, line 33 - line 52 * ---	1,6,11	
A	EP 0 518 596 A (DIGITAL EQUIPMENT CORP) 16 December 1992 (1992-12-16) * column 1, line 31 - line 36 * * column 3, line 12 - line 30 * --- -/--	1,6,11	
The present search report has been drawn up for all claims			
Place of search THE HAGUE		Date of completion of the search 20 January 2004	Examiner Vaskimo, K
CATEGORY OF CITED DOCUMENTS X : particularly relevant if taken alone Y : particularly relevant if combined with another document of the same category A : technological background O : non-written disclosure P : intermediata document		T : theory or principle underlying the invention E : earlier patent document, but published on, or after the filing date D : document cited in the application L : document cited for other reasons @ : member of the same patent family, corresponding document	

EPO FORM 1503 (01.02) (P04001)



European Patent Office

EUROPEAN SEARCH REPORT

Application Number
EP 03 02 2288

DOCUMENTS CONSIDERED TO BE RELEVANT			
Category	Citation of document with indication, where appropriate, of relevant passages	Relevant to claim	CLASSIFICATION OF THE APPLICATION (Int.Cl.7)
A	EP 0 597 691 A (IBM) 18 May 1994 (1994-05-18) * page 6, line 10 - line 27 * ---		
A	EP 0 632 672 A (IBM) 4 January 1995 (1995-01-04) * column 4, line 17 - line 24 * * column 6, line 24 - line 37 * * figure 1 * -----		
			TECHNICAL FIELDS SEARCHED (Int.Cl.7)
The present search report has been drawn up for all claims			
Place of search THE HAGUE		Date of completion of the search 20 January 2004	Examiner Vaskimo, K
CATEGORY OF CITED DOCUMENTS X : particularly relevant if taken alone Y : particularly relevant if combined with another document of the same category A : technological background O : non-written disclosure P : intermediate document		T : theory or principle underlying the invention E : earlier patent document, but published on, or after the filing date D : document cited in the application L : document cited for other reasons & : member of the same patent family, corresponding document	

EPO FORM 1503 01.82 (P04/O01)

ANNEX TO THE EUROPEAN SEARCH REPORT
ON EUROPEAN PATENT APPLICATION NO.

EP 03 02 2288

This annex lists the patent family members relating to the patent documents cited in the above-mentioned European search report. The members are as contained in the European Patent Office EDP file on The European Patent Office is in no way liable for these particulars which are merely given for the purpose of information.

20-01-2004

Patent document cited in search report	Publication date	Patent family member(s)	Publication date
US 5440547	A	08-08-1995	JP 6318951 A 15-11-1994
			JP 6261094 A 16-09-1994
GB 2283645	A	10-05-1995	NONE
WO 9422087	A	29-09-1994	US 5526489 A 11-06-1996
			AU 672097 B2 19-09-1996
			AU 6017894 A 11-10-1994
			CA 2157193 A1 29-09-1994
			EP 0689696 A1 03-01-1996
			JP 8507911 T 20-08-1996
			WO 9422087 A1 29-09-1994
US 5315705	A	24-05-1994	JP 4269049 A 25-09-1992
US 5287103	A	15-02-1994	NONE
EP 0648038	A	12-04-1995	GB 2281793 A 15-03-1995
			EP 0648038 A2 12-04-1995
			JP 2505116 B2 05-06-1996
			JP 7093238 A 07-04-1995
			US 6282569 B1 28-08-2001
EP 0518596	A	16-12-1992	US 5420862 A 30-05-1995
			DE 69216915 D1 06-03-1997
			DE 69216915 T2 11-09-1997
			EP 0518596 A1 16-12-1992
			JP 5207022 A 13-08-1993
EP 0597691	A	18-05-1994	CA 2103766 A1 13-05-1994
			EP 0597691 A1 18-05-1994
			JP 2566730 B2 25-12-1996
			JP 7212363 A 11-08-1995
EP 0632672	A	04-01-1995	US 5694548 A 02-12-1997
			EP 0632672 A2 04-01-1995
			JP 2868178 B2 10-03-1999
			JP 7058809 A 03-03-1995

EPO FORM P0458

For more details about this annex : see Official Journal of the European Patent Office, No. 12/82

(12) **UK Patent Application** (19) **GB** (11) **2 283 645** (13) **A**

(43) Date of A Publication 10.05.1995

(21) Application No 9322910.2

(22) Date of Filing 06.11.1993

(71) Applicant(s)
Digital Equipment International Limited
 (Incorporated in Switzerland)
 1 Grand Places, 1700 Fribourg, Switzerland

(72) Inventor(s)
Stewart F Bryant
Ian Michael Charles Shand

(74) Agent and/or Address for Service
Eric Potter Clarkson
 St Mary's Court, St Mary's Gate, NOTTINGHAM,
 NG1 1LE, United Kingdom

(51) INT CL⁶
 H04L 12/46 12/66

(52) UK CL (Edition N)
 H4P PPA

(56) Documents Cited
 GB 2267418 A

(58) Field of Search
 UK CL (Edition M) H4P PPA PPG
 INT CL⁵ H04L 12/46 12/66
 Online databases:WPI,INSPEC

(54) Digital communication systems

(57) A digital communication system comprising a network of routers R1-R3 linked together by links LK12-LK23 and having LANs LAN1-LAN7 coupled to them, and using IP (Internet Protocol), under which each LAN has a subnet address, and each host on a LAN has the subnet address as the high-order part of its own address. In IP, each router contains a set of interface/LAN tables each listing the low-order address portions of the addresses of the hosts attached to the LAN plus the MAC (medium access control) identifiers of those hosts, and a set of link tables listing the subnet addresses of the LANs reachable through those links. In the present system, both the interface tables and the link tables contain the full host addresses of all hosts reachable through those interfaces and links, and the routers also contain means for polling the interfaces for unknown hosts. Each router also contain an ARP (address resolution protocol) unit (30, Fig. 2) for detecting ARP requests from a source for a destination having the same subnet address as the source but not on the same interface, and returning a proxy ARP response giving the router's identification. A host can thereby be moved to a LAN whose address does not match that of the host.

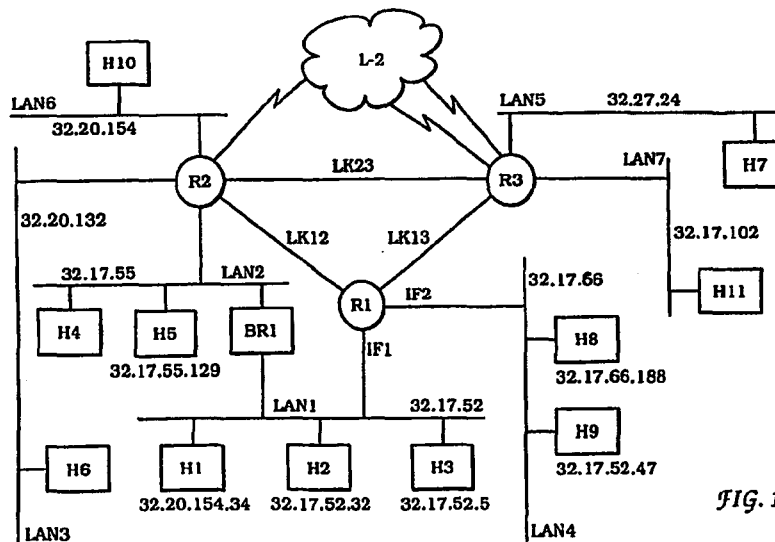
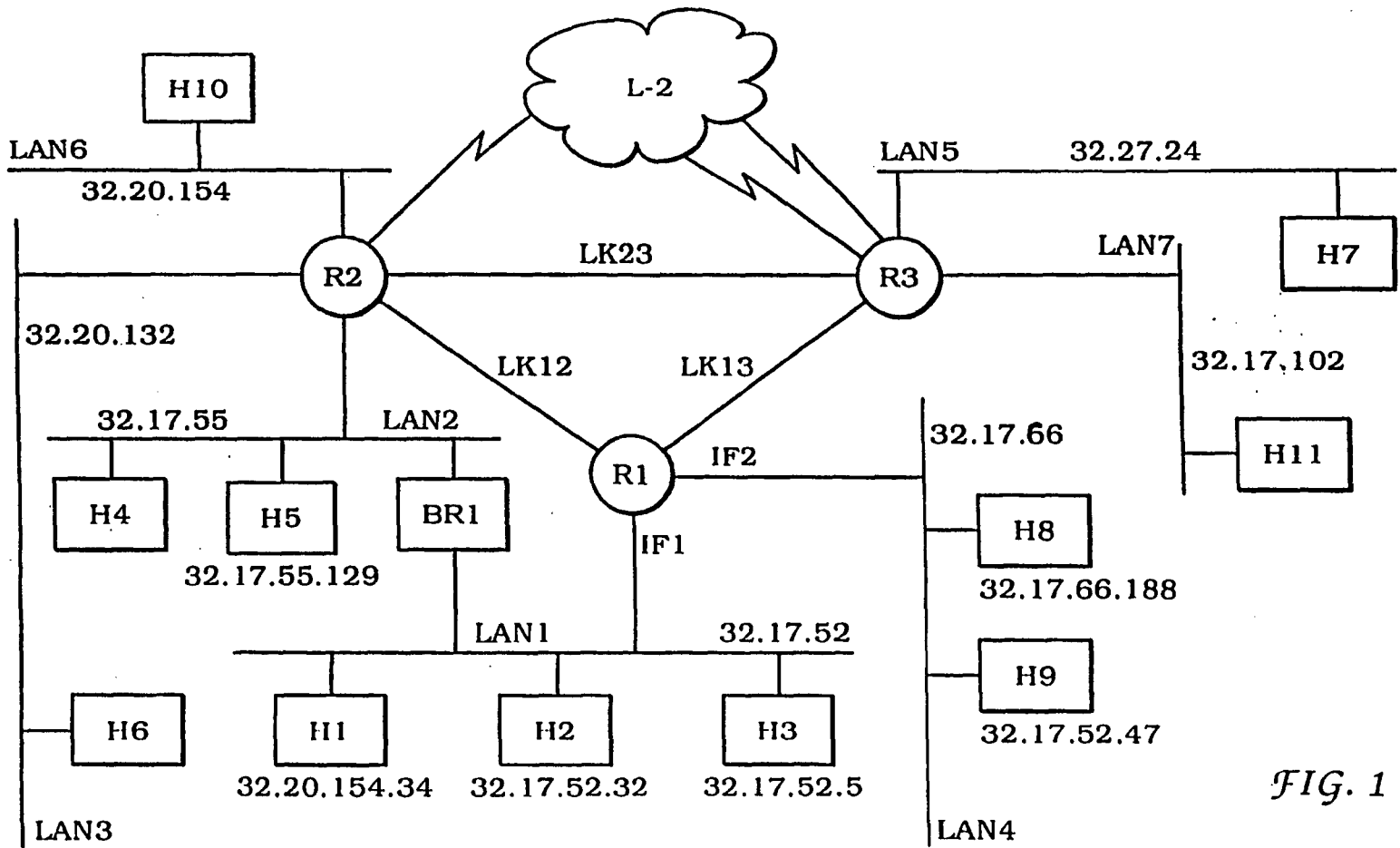

FIG. 1

GB 2 283 645 A

At least one drawing originally filed was informal and the print reproduced here is taken from a later filed formal copy.



1/2

⋮
⋮
⋮
⋮
⋮

FIG. 1

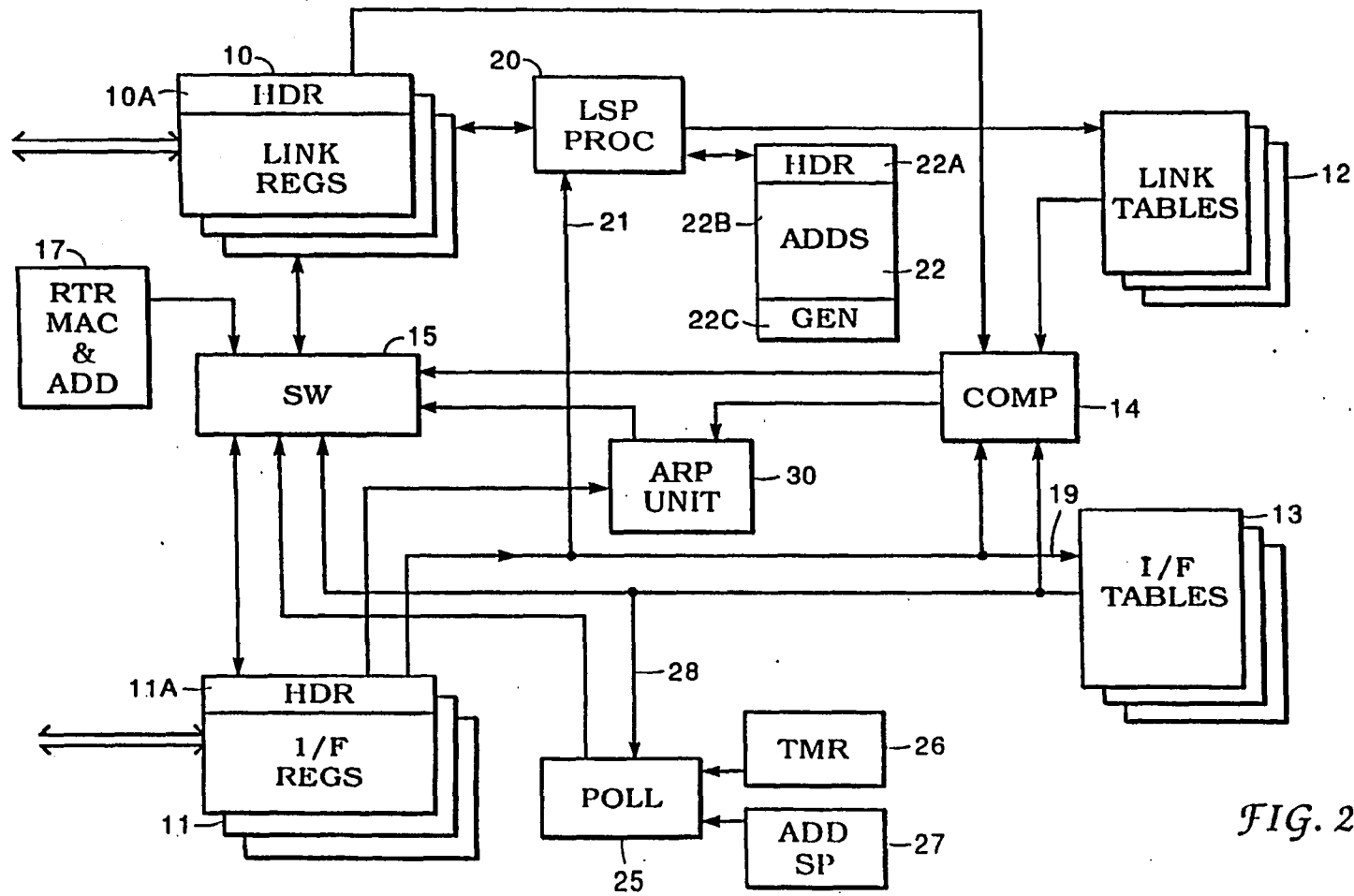

FIG. 2

2/2

Digital Communication Systems

The present invention relates to digital communication systems, and more particularly to the addressing of units therein.

5

Digital communication systems: general

There is a considerable variety of digital communication systems. We are primarily concerned here with systems which interconnect a considerable number of essentially independent units (typically devices such as personal computers and work-stations), and are typically geographically extensive. Depending on the particular type of system, the units which it interconnects are termed end units, end-systems, or hosts.

As a very general matter, there are two extreme forms of system: a pure switching system and a pure broadcast-type system. In a pure switching system, the connections between the hosts are all individual, passing through a network of switching nodes. In a pure broadcast-type system, all end-units are connected to all other end-units by means of a common message medium.

It is clear that both these extreme types of system have major disadvantages. A pure switching system requires a highly complicated network of switching nodes, while there are obvious capacity limits on a pure broadcast-type system. A hybrid style of system has therefore become well established, in which there are local broadcast-type subsystems which are connected to each other by means of a switching system. (In a sense, this constitutes a hierarchy, but the term "hierarchy", and the associated term "levels", are normally used to describe the organization of the more complicated and elaborate forms of switching network.)

A simple and common form of local broadcast-type subsystem is the LAN (local area network). A LAN consists essentially of a common message medium to which a number of hosts are connected. When a host wants to send a message, it monitors the LAN to determine whether any other host is currently using the LAN. If not, then the host sends its message. Every host permanently monitors the LAN, watching to see whether any of the messages on the LAN are directed to itself. (There are various mechanisms for dealing with collisions, where two hosts try to transmit substantially simultaneously.)

10 There are various specific forms and various modifications of LANs, and there are other similar broadcast (common medium) systems. We shall use the term LAN loosely to cover all such systems, regardless of the details of the manufacturer or protocol.

15 As noted above, a number of LANs may be coupled together or interconnected by means of a switching network. The switching network in general consists of a number of nodes or switching devices, which we shall term "routers". (Alternative terms are "intermediate systems" and "gateways".) The connection from a router to a LAN is termed an interface; the connection
20 from a router to another router is termed a link.

Obviously, there must be a suitable addressing system. Each host must have an address, and the communication system must somehow deliver messages from any host to any other host.

25

IP systems

We will consider primarily the types of system known as IP (Internet Protocol) systems from now on, because that is the main type of system for which the present invention is applicable. However, the principles of the

present invention are not limited to IP systems, but are also applicable to other systems having similar characteristics, such as Appletalk.

Identifiers and addresses

5 Hosts generally have unique identifiers which are physically defined by their manufacturers, eg. by hard-wiring or burning in, often termed MAC (medium access control) identifiers. A MAC identifier is normally globally unique; it will typically include a portion distinguishing the manufacturer from all other manufacturers and a serial number distinguishing it from all other
10 machines made by that manufacturer.

 It is however preferred to assign each machine a logical address, which can be chosen to facilitate the finding of connection paths in the system. (If desired, a single physical machine can be given more than one logical address,
15 in which case it will behave as more than one logical host.) The MAC identifier is more usually termed a MAC address, but we will use the term "identifier" for MAC addresses to avoid confusion with logical addresses.

 In the IP system, the logical address (IP address) is a 32-bit number,
20 which is conventionally divided into 4 bytes or octets which are then written in decimal form (eg. 1.5.21.178). These logical addresses are normally assigned manually.

 A major feature of the IP system is that all hosts attached to a LAN have
25 a common high-order part (which is typically the top 3 bytes) of their addresses; this high-order part thus forms the address of the LAN. Thus the host with address 1.5.21.178 will be attached to a LAN with address 1.5.21, and all the other devices attached to that LAN will have addresses with the same high-order part, eg. 1.5.21.17, 1.5.21.8, etc. Each LAN forms a subnet;
30 the address of the LAN is normally termed a subnet address.

If only part of an address is significant, then the significant part is indicated by a mask associated with the address (and of the same length as the address). Thus for the above LAN, the mask will be 255.255.255.0, because only the top 3 bytes of the address are significant. (In theory, the mask can be used to define non-contiguous bits, but in practice this rarely happens.)

The IP system as so far described therefore consists of a network of routers with LANs attached to the routers. A host on a LAN can send messages to other hosts on the same LAN directly over the LAN. To send a message to a host on a different LAN, the host must send the message to the router attached to the LAN. The network of routers then has the responsibility for passing the message to the router attached to the destination LAN. That router then puts the message on that LAN, and the destination host receives it.

15 System elaborations

There are certain elaborations of this basic system which are worth noting.

First, there is a special address used for broadcasting. In effect, every device has two addresses; its own normal address and the special broadcast address. A message with the broadcast address is received and accepted by every device. Messages with the broadcast address are normally confined to a single LAN; the routers do not attempt to pass such messages through the router network. (There are in fact various special addresses, to allow multicasting (to a group, but not all, of the hosts), and a second broadcast address, but this is not relevant for present purposes.)

Second, a LAN can be connected to more than one router. This may be the most convenient way to connect two parts of the system, with the LAN forming the only connection between the two routers. More often, however,

the two routers are both in the same router network, so that they provide two alternative paths to the LAN (from some other LAN). This redundancy allows the system to maintain communication with the LAN even if one of the routers connected to the LAN fails; also, it may allow the message flow rate to or from the LAN to be increased above the limit attainable with one router.

Third, two LANs can be coupled together by means of a bridge in known manner. A bridge is, in effect, a relay device which repeats any message on either of the LANs onto the other LAN. Thus LANs can be connected together into an extended LAN network in manner well known in the art. (We shall use the simple term "LAN" to include extended LANs.)

Fourth, a LAN (which may be a single or extended LAN) can have more than one logical address; the router to which it is attached will treat the single physical port or interface to which that LAN is attached as two separate logical interfaces. Any message put onto such a LAN at any point is physically transmitted to all hosts on it. (In fact, a bridge may have some form of filtering built into it, but this is not relevant for present purposes.) Logically, however, the LAN consists of two or more distinct subnets with different subnet addresses.

IP message flow protocol on LANs

In the IP system, message routing through the router network is determined by the IP addresses, but message routing over LANs is determined by the MAC identifiers. Mechanisms are therefore required to convert IP addresses to MAC identifiers when messages pass over LANs.

There are three main cases to consider for a source host sending a message to a destination host: the destination host may be on the same subnet

as the source host, it may be on a different LAN, or it may be on the same LAN but a different subnet.

5 In the first case, the source sends out an ARP (address resolution protocol) request message with the logical (IP) address of the destination. That ARP request is received by the destination, which sends back an ARP response message to the source. (The ARP request is a broadcast message which is received by all the hosts on the subnet, but only the destination host responds; all the other hosts recognize that the destination address in the ARP request
10 does not match their own address, and they therefore discard the message.) The destination host includes its MAC identifier in its ARP response. The source then sends the actual data message to the destination using the destination's MAC identifier.

15 This involves a large message overhead, since the passing of each data message is preceded by an ARP request and ARP response. The various units of the system therefore store tables of IP (logical) addresses and MAC identifiers, so that most data messages can be sent out with the MAC identifiers without having to be preceded by ARP requests and responses.

20 In the second case, the message has to be passed through the router network. In general, each host knows of the existence of at least one router on its LAN. (This may be achieved by routers advertising their presence to their hosts by means of broadcast messages.) The source therefore sends the
25 message to a router (using the router's MAC identifier). The router network forwards the message to a router attached to the LAN including the destination host. That router then sends an ARP request to the destination host, which returns an ARP response. The router then sends the data message to the destination host, using the host's MAC identifier. (If the router does not get

an ARP response, the packet is discarded or sent back to the source with an error status.)

The third case is where the source and destination hosts are on the same LAN but different subnets. The first message is passed in the same way as for the second case; the router accepts the message and then transmits it again on the same LAN. The router also returns a redirect message to the source, informing the source of the MAC address of the destination. The source stores this information, and can then send any further messages direct to the destination over the LAN common to the source and destination.

More specifically, each host maintains a connection table which lists the IP addresses and corresponding MAC identifiers of other hosts with which it has recently been in communication (without passing through a router - ie. in the first and third cases above). If a host wants to send a message, the destination is initially identified by its IP address. The host checks its table for the IP address, and if it is in the table, it extracts the associated MAC identifier from the table and sends the data message directly to that MAC identifier. If the IP address is not in the table, then the host has to send an ARP request to obtain a MAC identifier for the data message to be sent to. It enters the MAC identifier and associated IP address in the table for future use.

Similarly, each router has a set of interface tables, one for each interface. Each table lists the logical subnet addresses for that interface and, for each subnet address, lists the hosts with that subnet address, by logical address and MAC identifier. Obviously, the router will only know of the hosts which have sent out ARP requests. Each table in the router also has the identifier of its physical interface associated with it.

The various tables normally incorporates a time-out mechanism, so that entries which have not been used for some considerable time are deleted. This minimizes the chance of a unit trying to send a message to a unit which has disappeared from the system.

5

Router network organization

As noted above, if a message has to pass through the router network, that network has the responsibility for passing the message to the router attached to the destination LAN. This means that the routers have to pass routing (addressing) information between themselves so that when a router on
10 a LAN receives a message (from a host on that LAN) for another LAN, it will know how to forward the message through the router network (and similarly, the router to which the message is forwarded will in turn know which router to forward the message to, and so on throughout the router network). This
15 routing information is passed between the routers by means of routing control messages.

We are assuming here that a subnet address consists of the top 3 bytes of a 32-bit IP address (as determined by the associated mask), and that all hosts
20 on that subnet have the subnet address as the high-order part of their own addresses. (The routing control messages will also generally contain other information, eg. about the cost and capacity of the paths between routers.) The routers therefore only have to deal with subnet addresses.

25 We are primarily concerned with the type of network in which every router is in communication, directly or indirectly, with all other routers on essentially the same basis. This is a single-level (level 1) system, and the number of routers will generally be fairly modest for such a system. Various types of routing control mechanisms are known for achieving this; for
30 convenience, we shall assume that the routing control messages are link state

packets (LSPs), and that the router network passes the LSPs around so that each router maintains a set of link tables, one for each link to other routers, with each subnet address being held in the table for a link which points to a router which is in some sense nearer to the actual location of that subnet.

5

Further details of the mechanisms which the router network uses to pass messages (either data messages passing between hosts, or router network control messages) through itself are not relevant for present purposes.

10 Router network elaborations

This basic mechanism for establishing and maintaining the topology of the router network is subject to possible elaborations.

15 As noted above, some of the links in the router network may pass through LANs. This does not affect the operation of the system, though of course any messages in the router network which pass through such links have to be encapsulated by the LAN messaging mechanism for their passage over those links.

20 The routers can operate algorithms for combining (condensing) subnet addresses. Thus if a router has several LANs attached to it with the same top 2 bytes in their addresses (eg. subnet addresses 1.5.21, 1.5.34, 1.5.26, etc), and these LANs are the only ones in the system with these top 2 bytes, that router can identify all those LANs by the single address of just the top 2 bytes
25 (1.5). (As noted above, a mask will define the address as consisting of only 2 bytes.)

This mechanism allows the router network to be hierarchical. In each local (level 1) region of the network, the routers will have full information
30 about all the LANs attached to that region, but will have only summary

(condensed) information about the subnet addresses of other local regions. The mechanisms used for passing messages between different level 1 regions of the router network form a second level, level 2, of the network.

5 The condition for combining subnet addresses in a router in a level 1 area can in fact be relaxed slightly. If there is a odd subnet with say 1.5.102 as its address attached to some other router, the router to which all other subnets with 1.5 as the top 2 bytes in their addresses are connected can advertise itself as the router for address 1.5, provided that it forwards any
10 messages it receives for subnet 1.5.102 on to the other router having the 1.5.102 subnet attached to it.

The problem

15 In the IP system, the address of a host includes the address of its LAN (as a subnet address). A host is therefore "tied" to its LAN. It can be moved to a physically different place on its LAN; all physical locations on a LAN are logically identical. However, it cannot be moved to another LAN. If it is so moved, it will be inaccessible; although it will be physically attached to the new
20 LAN, no other host will be able to reach it.

 In some situations, this restriction on moving hosts is not significant; in others, it provides a useful security feature.

25 However, in a large company or other organization, there may be a number of different LANs which are connected in an IP system, and for a variety of reasons, such as changes of organization, it may be desirable or even necessary to physically move a host in such a way that it has to be removed from its LAN and attached to another LAN.

This causes a problem. To move a host from one LAN to another, the host's address has to be changed to match the address of the new LAN. Since addresses are manually assigned, it is possible to make this change. Making the change may not in itself be particularly difficult. However, that will in effect turn the host into a new host. None of the other hosts which have been in communication with it will know its new address, and communication will have to be re-established from scratch with all these other hosts. This can be highly inconvenient.

One potential solution to this difficulty is to couple the different LANs together to form an extended LAN, as discussed above. However, this increases the complexity of system management, and involves difficulties arising from the complexity and proprietary nature of multipath bridging. The message density on the extended LAN is also increased, eg. by the increased multicast traffic, and this may limit the extent to which this solution is feasible.

Another potential solution utilizes a directory service. IP systems often have a directory service, which is essentially a table correlating host "names" with their IP addresses. This allows a source host to identify a destination host by means of the destination host's name; but before a source host can actually communicate with a destination host, the source has to obtain the destination's IP address from the directory service by sending the destination's name to the directory service, which returns the associated IP address.

If a host is moved, it can be given a new IP address consistent with its new location, and the directory service can be updated to associate the new IP address with the host's name (which is unchanged). If a source host wants to communicate with the host which has moved, the source host will find that messages directed to the old destination IP address will fail to reach their destination. It can then use the directory service to obtain the destination's IP

address, as if it were trying to establish communication with the destination for the first time, and will thereby acquire the destination's new IP address.

5 This solution requires manual updating of the directory service, which is likely to involve considerable time delays during which the migrated host is inaccessible. It also requires the organization to have a management structure capable of dealing with the changes involved in an acceptably simple and effective manner.

10 A third potential solution is to provide re-addressing. This involves giving the migrated host a new IP address, consistent with its new LAN, and recording its old and new addresses in the router for its original LAN. A message sent to the host using its old address will reach its old router; that router will replace the old address by the new address and forward the message
15 to the new router. However, this has various disadvantages. For example, message paths through the router network are considerably extended; also, the number of host addresses used in the system is increased each time a host migrates, and the need for the migrating host to be given an address consistent with its new LAN may be inconvenient. Also, the return path for messages
20 between the two hosts is different to the outward path, which can cause difficulties.

The broad object of the present invention is therefore to provide an improved technique whereby a host in an IP or similar system can be moved
25 from one subnet to another without having to have its address changed.

There are some important constraints implied in this formulation of the problem. Any solution must be compatible with existing IP systems; any modifications to only some of the routers and/or hosts in an existing IP system
30 to provide the required technique must not interfere with the operation of the

remaining routers and/or hosts. Further, IP-type systems are of course very well established, and include huge numbers of existing hosts. It is therefore desirable, if possible, for the solution to involve modifications to only routers, so that existing hosts can be moved without having to be modified.

5

As just noted, IP-type systems are very well established, and many such systems are extremely large, both in the numbers of hosts and geographically. The ideal solution in an abstract sense would permit a host to be moved from any location on the system to any other location. However, a solution which
10 allowed only a limited degree of mobility of hosts around the system would be of great practical value, even though it would theoretically be only a partial solution.

The solution

15 The present invention provides a solution which comprises a combination of several features, all involving modifications of the details of the manner in which the routers operate.

According to the present invention there is provided a digital
20 communication system comprising a network of routers linked together by links and having interfaces with local area networks (LANs) coupled to them, and operating under a protocol under which each LAN has a subnet address, and each host on a LAN has the subnet address as the high-order part of its own address, each router containing a set of interface/LAN tables listing the low-
25 order address portions of the addresses of the hosts attached to the LAN plus the MAC (medium access control) identifiers of those hosts, and a set of link tables listing the subnet addresses of the LANs reachable through those links, wherein: both the interface tables and the link tables in the routers contain the full addresses of all hosts reachable through those interfaces and links; the
30 routers contain means for detecting ARP (address resolution protocol) requests

from a source host for a destination host having the same subnet address as the source host but not on the same interface, and returning a proxy ARP response giving the router's identification; and the routers contain polling means for polling the interfaces for unknown hosts.

5

Since the present system does not require any changes to the hosts, the address space of the system is unchanged. However, the present system in effect decouples the host addresses from the subnet addresses and hence from the geographical LAN locations. This allows considerably greater freedom in assigning addresses to hosts within the system address space.

10

In the standard system as described above, we have taken the top 3 bytes of the 32-bit address space as being used for subnet addresses, and the bottom byte as being used for different host addresses on the subnet. In fact, the division between the subnet address and the host addresses on the subnet can be defined more flexibly, by the use of suitable masks. However, the number of possible host addresses on a subnet must obviously be a power of 2, and the actual number of hosts on the subnet is likely to fall well short of the maximum.

15
20

Thus in the standard system, there are likely to be many spare addresses, which cannot be used (or can only be used by hosts added to the subnet with which those unused addresses are associated). In the present system, these spare addresses can be used much more freely, since they can be assigned to hosts regardless of which subnets (and hence LANs) those hosts are to be attached to.

25

Router network organization

A major feature of router operation is that the present modified routers use full host addresses for level 1 routing.

30

In the standard IP system, the routers use abbreviated addresses - the subnet addresses of the LANs - for level 1 routing; in effect, the routers operate an address compression algorithm which compresses the addresses of all the hosts on a subnet into a single subnet address. In the present system, the router operation is modified so that this address compression is no longer performed.

The result is that in a router network using the present modified routers, each router will hold effectively the same routing information as before, albeit in an expanded form. The operation of the router network is therefore effectively unchanged in principle (as far as the routing of messages through the router network is concerned). However, the amount of LSP traffic is increased, the amount of processing required for routing is increased, and the routers have to have a greater storage capacity.

15

If the level 1 network forms part of a larger system coupled to other level 1 networks through a level 2 organization, the level 2 organization is unaffected. Compressed or summary addresses are used unchanged for level 2 routing. The migration of hosts is restricted to within their own level 1 systems; it is not possible for a host to migrate from one level 1 system to another. As mentioned above, this restriction is rarely significant.

The present routers are largely compatible with standard routers, so that a network can consist of a mixture of standard and compatible routers. For present purposes, it is convenient to regard the resulting network as a network of modified routers to which standard routers have been added.

In a standard router network, the routing information consists of subnet addresses, which are distributed by the LSPs and stored by the routers. A subnet address has the form of a full address plus a mask, with the mask

30

defining which part of the full address forms the subnet address; the rest of the address is ignored. The ignored part of the address is in fact, of course, a host address (on the subnet defined by the mask).

5 In a mixed system, the modified routers will send LSPs with full addresses in the same format, ie. address plus mask pairs, and any standard router receiving such an LSP will automatically store this address in the usual way. As far as such a standard router is concerned, there is no difference between subnet and full (host) addresses; the distinction arises solely from the
10 contents of the masks associated with the various addresses. In a mixed system, therefore, the presence of standard routers will not affect the performance of the subsystem of modified routers (provided, of course, that the standard routers have sufficient storage capacity). The migration of hosts in such a mixed system is of course limited to the subsystem of modified routers.

15

As noted above, in the present system the amount of address information which has to be propagated through the router system is considerably increased. It may therefore be desirable to introduce a new LSP option type or format, to reduce the size and/or number of LSPs.

20

In the standard system, routing information is exchanged between the routers in the form of information units termed "options", of which there can be various formats or types. To reduce the number of LSP messages, a number of options are typically assembled into a single LSP. The standard
25 option type can be taken as consisting of a header, an address section, and a general information section. The header contains an identifier which defines the LSP option type and length; the address section will consist of the address plus mask pair; and the general information section will contain associated routing information such as cost and distance.

30

The new LSP option type has the same general format, but the address section contains a set of host addresses without masks. Thus a considerable number of addresses can be sent as a single option of the new type, instead of needing a separate option (of the old type) in the LSP for each address. The length of this new LSP option will be considerably less than the total length of the separate LSP options of the old type, because there will be only one header and general information section, and each address will consist of a pure address with no accompanying mask.

The number of addresses in the new LSP option type may be included explicitly in the header, or may be calculated from the total length of the option by subtracting the header and general information lengths and dividing by the address length. Different addresses cannot, of course, have different associated routing information, because the addresses all share the common general information in the final section of the option. The routers will normally assemble the addresses of hosts on a common LAN when constructing an LSP option of the new type; those addresses will then all have the same characteristics and can share the same general information.

The new LSP option type can be used in a mixed system, as standard routers forward all LSP options (including those of the new type); the full host address information will thus be maintained throughout the subsystem of modified routers. However, the standard routers will not update themselves with the contents of LSP options of the new type. The modified routers must therefore also send out LSP options of the old type, so that the routing information in the standard routers is maintained. Also, if the standard routers split the subsystem of modified routers into disconnected parts, hosts cannot migrate between those parts because the standard routers connecting those parts will maintain only subnet addresses, not full host addresses.

30

LAN addressing by routers

For the router network to be able to route messages correctly, each router must know the whereabouts of all the hosts. This knowledge is distributed amongst the different routers using LSPs. However, before the
5 router can distribute information about the location of a host, it must become aware of the existence of the host.

In the standard system, each router is aware of the subnets attached to it (this knowledge may, for example, be entered manually). A router need not
10 be explicitly aware of the existence of the hosts attached to the LAN. If a message for a host on the LAN is received, the router can send out an ARP request, and the ARP response confirms the existence of the host on the LAN. (If there is no ARP response, then it is assumed that the host does not exist.)

As discussed above, in the standard system the router in fact maintains
15 an interface table for the various hosts on the LAN, so that it can forward future messages to them without having to obtain their MAC identifiers by ARP requests. The interface table is built up partly from ARP requests sent out by the router, and partly by ARP requests sent out from the hosts.

20 A standard router preferably maintains this table actively, by polling the hosts at suitable intervals. The poll message is simply an ARP request to the host. An ARP response confirms the existence of the host; if there is no ARP response, the host no longer exists.

25 In the present system, the modified router maintains its interface tables in broadly the same way as do standard routers. The present router, however, necessarily constructs its interface tables entirely automatically, whereas in a standard router the subnet addresses may be entered manually.

30

The present routers listen promiscuously for ARP requests from hosts (for a reason discussed later), and may listen similarly to other messages. This listening helps the routers to maintain their interface tables. The routers will therefore automatically learn of the existence of hosts which are involved in message transmission. However, it is possible that when a host is moved from one router to another, some other host may want to send a message to it before it has itself tried to send any messages. (In the standard IP system, hosts do not advertise themselves; the identity between the subnet address and the top part of the host address means that the location of a host is inherent in the system.)

Another way in which the routers can automatically discover the existence of hosts is for the hosts to announce their existence when they are first turned on, with the routers listening for such messages. However, this requires the hosts to issue suitable identification messages when first turned on; this may require modification of some hosts, and some types of host may not be modifiable.

Some mechanism must therefore be provided for the router network to discover the existence of silent hosts. Since changes cannot be imposed on the hosts themselves, the standard routers must therefore be modified, in the present system, so that they can discover the existence of such silent hosts. There are two ways in which this can be done, which may be termed active and passive. (It may be noted that in standard routers, the subnet addresses may be passed round automatically but will normally be set manually. In the present system, the subnet addresses are not of such importance, and the modified routers must determine all host addresses automatically.)

With the active technique, the routers actively search for hosts. Each router has to be modified to perform polling. For this, the routers in the level