

Draft **EN 301 349** V6.1.0 (1998-08)

*European Standard (Telecommunications series)*

**Digital cellular telecommunications system (Phase 2+);  
General Packet Radio Service (GPRS);  
Mobile Station (MS) - Base Station System (BSS) interface;  
Radio Link Control / Medium Access Control (RLC/MAC)  
protocol  
(GSM 04.60 version 6.1.0 Release 1997)**



**Microsoft Corporation**  
Exhibit 1005.06-00001

Reference

---

DEN/SMG-020460Q6 (cho030c0.PDF)

Keywords

---

Digital cellular telecommunications system,  
Global System for Mobile communications  
(GSM), General Packet Radio Service (GPRS)

**ETSI**

Postal address

---

F-06921 Sophia Antipolis Cedex - FRANCE

Office address

---

650 Route des Lucioles - Sophia Antipolis  
Valbonne - FRANCE  
Tel.: +33 4 92 94 42 00 Fax: +33 4 93 65 47 16  
Siret N° 348 623 562 00017 - NAF 742 C  
Association à but non lucratif enregistrée à la  
Sous-Préfecture de Grasse (06) N° 7803/88

Internet

---

secretariat@etsi.fr  
<http://www.etsi.fr>  
<http://www.etsi.org>

---

**Copyright Notification**

---

No part may be reproduced except as authorized by written permission.  
The copyright and the foregoing restriction extend to reproduction in all media.

© European Telecommunications Standards Institute 1998.  
All rights reserved.

**ETSI**

**Microsoft Corporation**  
**Exhibit 1005.06-00002**

# Contents

Intellectual Property Rights.....	8
Foreword .....	8
1 Scope.....	9
2 Normative references .....	10
3 Definitions and abbreviations .....	11
3.1 Vocabulary.....	11
4 Layered overview of radio interface .....	12
4.1 Layer services .....	13
4.2 Layer functions .....	13
4.3 Service primitives .....	14
4.4 Services required from lower layers.....	14
5 Introduction to the Medium Access Control (MAC) procedures .....	14
5.1 General.....	14
5.2 Multiplexing principles.....	14
5.2.1 Temporary Block Flow .....	14
5.2.2 Temporary Flow Identity.....	15
5.2.3 Uplink State Flag.....	15
5.2.4 Medium Access modes.....	15
5.3 Packet idle mode.....	16
5.4 Packet transfer mode.....	17
5.5 Procedures in packet idle mode .....	17
5.5.1 Mobile station side.....	17
5.5.1.1 Selection and reselection of CCCH or PCCCH.....	17
5.5.1.2 System information on PBCCCH.....	17
5.5.1.3 System information on BCCH.....	18
5.5.1.4 Discontinuous reception (DRX) .....	18
5.5.1.5 Page mode procedures on PCCCH.....	19
5.5.2 Network side .....	19
5.5.2.1 System Information broadcasting .....	19
5.6 Measurement reporting .....	20
5.6.1 Ready state measurement reporting.....	20
5.6.2 Idle mode measurement report.....	21
6 Paging procedures .....	21
6.1 Paging procedure for RR connection establishment .....	21
6.1.1 Paging initiation using paging subchannel on CCCH.....	22
6.1.2 Paging initiation using paging subchannel on PCCCH .....	22
6.1.3 Paging initiation using PACCH.....	22
6.1.4 Paging response.....	22
6.2 Paging procedure for downlink packet transfer .....	22
6.2.1 Paging procedure using paging subchannel on CCCH.....	22
6.2.2 Paging using paging subchannel on PCCCH.....	22
6.2.3 Paging response.....	23
7 Medium Access Control (MAC) procedures on PCCCH.....	23
7.1 TBF establishment initiated by the mobile station on PCCCH.....	23
7.1.1 Permission to access the network .....	23
7.1.2 TBF establishment using one phase packet access .....	24
7.1.2.1 Initiation of the packet access procedure.....	24
7.1.2.1.1 Access persistence control on PRACH, the network steered method .....	24
7.1.2.1.2 Access persistence control on PRACH, the mobile station steered method.....	25
7.1.2.2 Packet immediate assignment procedure .....	25
7.1.2.2.1 On receipt of a PACKET CHANNEL REQUEST message .....	25

7.1.2.2.2	Packet access queuing notification procedure.....	26
7.1.2.2.3	Packet polling procedure.....	26
7.1.2.2.4	Packet access reject procedure.....	27
7.1.2.3	Contention resolution at one phase access.....	27
7.1.2.4	One phase packet access completion.....	28
7.1.3	TBF establishment using two phase access.....	28
7.1.3.1	Initiation of the Packet resource request procedure.....	28
7.1.3.2	Packet resource assignment for uplink procedure.....	28
7.1.3.2.1	On receipt of a PACKET RESOURCE REQUEST message.....	28
7.1.3.3	Contention resolution at two phase access.....	29
7.1.3.4	Two phase packet access completion.....	29
7.1.4	Abnormal cases.....	29
7.2	TBF establishment initiated by the network on PCCCH.....	29
7.2.1	Entering the packet transfer mode.....	30
7.2.1.1	Packet downlink assignment procedure.....	30
7.2.1.2	Packet downlink assignment procedure completion.....	31
7.2.1.3	Packet polling procedure.....	31
7.2.2	Abnormal cases.....	31
7.3	Procedure for measurement report in packet idle mode.....	31
7.3.1	On receipt of a PACKET CHANNEL REQUEST message.....	31
7.3.1.1	Packet access reject procedure.....	32
7.3.1.2	Abnormal cases.....	32
8	Medium Access Control (MAC) Procedures in Packet Transfer Mode.....	32
8.1	Transfer of RLC data blocks.....	32
8.1.1	Uplink RLC data block transfer.....	32
8.1.1.1	Dynamic allocation uplink RLC data block transfer.....	33
8.1.1.1.1	PACCH operation.....	33
8.1.1.1.2	Resource Reallocation for Uplink.....	33
8.1.1.1.2.1	Abnormal cases.....	34
8.1.1.1.3	Establishment of Downlink TBF.....	34
8.1.1.1.3.1	Abnormal cases.....	35
8.1.1.2	Extended Dynamic Allocation uplink RLC data block transfer.....	35
8.1.1.2.1	Uplink PDCH Allocation.....	35
8.1.1.2.2	PACCH operation.....	36
8.1.1.2.3	Neighbour cell power measurements.....	36
8.1.1.3	Fixed Allocation uplink RLC data block transfer.....	36
8.1.1.3.1	Transfer of RLC/MAC blocks.....	36
8.1.1.3.2	Reallocation.....	37
8.1.1.3.2.1	Abnormal Cases.....	38
8.1.1.3.3	Neighbour cell power measurements.....	39
8.1.1.3.4	PACCH operation.....	39
8.1.1.3.5	Establishment of Downlink TBF.....	39
8.1.1.3.5.1	Abnormal cases.....	40
8.1.1.4	Network initiated release of uplink TBF.....	41
8.1.1.5	Abnormal cases.....	41
8.1.2	Downlink RLC data block transfer.....	41
8.1.2.1	Downlink RLC data block transfer.....	42
8.1.2.2	Polling for Packet Downlink Ack/Nack.....	42
8.1.2.3	Suspending the downlink TBF.....	42
8.1.2.4	Resource Reassignment for Downlink.....	43
8.1.2.5	Establishment of uplink TBF.....	43
8.1.2.5.1	Abnormal cases.....	44
8.1.2.6	Downlink Measurement Report.....	45
8.1.2.7	Extended dynamic allocation neighbour cell power measurements.....	45
8.1.2.8	Fixed allocation neighbour cell power measurements.....	45
8.1.2.9	Mobile station initiated downlink TBF release.....	45
8.1.3	Concurrent TBF procedures.....	45
8.1.3.1	Dynamic allocation and extended dynamic allocation procedures.....	45
8.1.3.2	Fixed allocation procedures.....	46
8.1.3.2.1	Suspending downlink TBF and initiating uplink TBF.....	46



8.1.3.2.2	Suspending downlink TBF and activating uplink TBF .....	46
8.1.3.2.3	Ending downlink TBF and activating uplink TBF .....	46
8.1.3.2.4	Suspending uplink TBF and initiating downlink TBF .....	46
8.1.3.2.5	Suspending uplink TBF and activating downlink TBF .....	46
8.1.3.2.6	Ending uplink TBF and activating downlink TBF .....	47
8.2	Packet PDCH Release.....	47
8.3	Network Change Order procedure .....	48
8.4	Cell Change Order procedure .....	48
8.4.1	Network controlled cell reselection completion.....	48
8.4.2	Abnormal cases .....	48
8.5	PACKET CONTROL ACKNOWLEDGEMENT .....	49
8.6	Abnormal cases.....	49
8.6.1	Abnormal Release with Return to CCCH or PCCCH.....	49
8.6.2	Abnormal Release with Random Access.....	49
8.6.3	Abnormal Release with System Information .....	49
9	Radio Link Control (RLC) procedures in packet transfer mode.....	49
9.1	Procedures and parameters for peer-to-peer operation .....	49
9.1.1	Send state variable V(S).....	50
9.1.2	Acknowledge state variable V(A) .....	50
9.1.3	Acknowledge state array V(B).....	50
9.1.4	Block sequence number BSN.....	51
9.1.5	Receive state variable V(R).....	51
9.1.6	Receive window state variable V(Q).....	51
9.1.7	Receive state array V(N) .....	51
9.1.8	Starting sequence number (SSN) and received block bitmap (RBB) .....	51
9.1.9	Window Size .....	52
9.1.10	Segmentation of LLC PDUs into RLC data blocks .....	52
9.1.11	Re-assembly of LLC PDUs from RLC data blocks .....	52
9.1.12	Priority of LLC frames .....	52
9.2	Operation during RLC/MAC control message transfer.....	53
9.3	Operation during packet transfer.....	53
9.3.1	Countdown procedure .....	53
9.3.2	Acknowledged mode operation.....	54
9.3.2.1	Establishment of Temporary Block Flow .....	54
9.3.2.2	Operation of uplink Temporary Block Flow.....	54
9.3.2.3	Release of uplink Temporary Block Flow .....	54
9.3.2.4	Operation of downlink Temporary Block Flow .....	55
9.3.2.5	Release of downlink Temporary Block Flow .....	55
9.3.3	Unacknowledged mode operation .....	55
9.3.3.1	Establishment of Temporary Block Flow .....	56
9.3.3.2	Operation of uplink Temporary Block Flow.....	56
9.3.3.3	Release of uplink Temporary Block Flow .....	56
9.3.3.4	Operation of downlink Temporary Block Flow .....	56
9.3.3.5	Release of downlink Temporary Block Flow .....	56
9.4	Abnormal release cases.....	57
9.4.1	Abnormal release with random access .....	57
10	RLC/MAC block structure.....	57
10.1	Spare bits .....	57
10.2	RLC data blocks.....	57
10.2.1	Downlink RLC data block.....	58
10.2.2	Uplink RLC data block .....	58
10.3	RLC/MAC control blocks.....	59
10.3.1	Downlink RLC/MAC control block .....	59
10.3.2	Uplink RLC/MAC control block.....	59
10.4	MAC header and RLC data block header fields .....	60
10.4.1	Uplink state flag (USF) field .....	60
10.4.2	Retry (R) bit .....	60
10.4.3	Stall indicator (SI) bit.....	60
10.4.4	Supplementary/Polling (S/P) Bit .....	60

10.4.5	Relative Reserved Block Period (RRBP) field .....	60
10.4.6	Countdown Value (CV) field .....	61
10.4.7	Payload Type field .....	61
10.4.8	Final block indicator (FBI) bit .....	61
10.4.9	TLLI Indicator (TI) bit .....	61
10.4.10	Temporary Flow Identifier (TFI) field .....	62
10.4.11	Extension (E) Bit .....	62
10.4.12	Block Sequence Number (BSN) field .....	62
10.4.13	More (M) bit .....	62
10.4.14	Length Indicator (LI) field .....	62
10.4.15	TLLI field .....	63
10.4.16	RLC data field .....	63
10.4.17	Control message contents field .....	63
11	Message functional definitions and contents .....	63
11.1	Handling of erroneous protocol data .....	64
11.2	RLC/MAC control messages .....	64
11.2.1	Packet Access Reject .....	65
11.2.2	Packet Control Acknowledgement .....	66
11.2.3	Packet Cell Change Failure .....	67
11.2.4	Packet Cell Change Order .....	68
11.2.5	Packet Channel Request .....	69
11.2.6	Packet Downlink Ack/Nack .....	71
11.2.7	Packet Downlink Assignment .....	73
11.2.8	Packet Dummy Control Block .....	76
11.2.9	Packet Measurement Report .....	76
11.2.10	Packet Paging Request .....	78
11.2.11	Packet PDCH Release .....	81
11.2.12	Packet Polling Request .....	81
11.2.13	Packet Power/Timing Update .....	82
11.2.14	Packet PRACH Parameters .....	82
11.2.15	Packet Queueing Notification .....	83
11.2.16	Packet Resource Request .....	83
11.2.17	Spare .....	86
11.2.18	Packet System Information Type 1 .....	86
11.2.19	Packet System Information Type 2 .....	90
11.2.19.1	PSI2 message set .....	92
11.2.19.2	Reference frequency list .....	93
11.2.19.3	Mobile Allocation .....	93
11.2.19.4	PCCCH description .....	93
11.2.20	Packet System Information Type 3 .....	94
11.2.21	Packet System Information Type 3 bis .....	98
11.2.22	Packet System Information Type 4 .....	99
11.2.23	Packet System Information Type 5 .....	101
11.2.24	Packet System Information Type 5 bis .....	104
11.2.25	Packet System Information Type 6 .....	104
11.2.25.1	Attributes .....	105
11.2.26	Packet TBF Release .....	106
11.2.27	Packet TBF Status .....	106
11.2.28	Packet Uplink Ack/Nack .....	107
11.2.29	Packet Uplink Assignment .....	109
11.2.30	Packet Uplink Assignment bis .....	114
11.2.31	Packet Timeslot Reconfigure .....	115
12	Information element coding .....	120
12.1	Overview .....	120
12.2	Message Type .....	120
12.3	Ack/Nack Description .....	121
12.4	ALLOCATION_BITMAP .....	123
12.5	ALLOCATION_REFERENCE .....	124
12.6	CHANNEL_CODING_REQUESTED .....	124

12.7	Channel Request Description.....	124
12.8	Frequency Parameters.....	126
12.9	Global Power Control Parameters.....	126
12.10	Global TFI .....	128
12.11	Packet Request Reference.....	128
12.12	Packet Timing Advance .....	128
12.13	Power Control Parameters .....	129
12.14	PRACH Control Parameters .....	130
12.15	Temporary Flow Identifier (TFI) .....	132
12.16	Temporary Logical Link Identity (TLLI).....	133
12.17	Temporary Queuing Identifier (TQI) .....	133
12.18	TIMESLOT_ALLOCATION .....	133
12.19	TS_OVERRIDE .....	133
13	Timers and counters.....	134
13.1	Timers on the Mobile Station side .....	134
13.2	Timers on the network side .....	137
13.3	Counters on the Mobile Station side.....	137
13.4	Counters on the Network side .....	138
<b>Annex A (informative):</b>	<b>Bibliography.....</b>	<b>139</b>
<b>Annex B (informative):</b>	<b>RLC data block encoding.....</b>	<b>140</b>
B.1	Example 1.....	140
B.2	Example 2.....	141
<b>Annex C (informative):</b>	<b>Message Sequence Diagrams .....</b>	<b>142</b>
<b>Annex D (informative):</b>	<b>Examples of Fixed Allocation Timeslot Assignment.....</b>	<b>143</b>
<b>Annex E (informative):</b>	<b>Repeated Fixed Allocations .....</b>	<b>149</b>
<b>Annex F (informative):</b>	<b>Document change History.....</b>	<b>151</b>
History	.....	152

---

## Intellectual Property Rights

IPRs essential or potentially essential to the present document may have been declared to ETSI. The information pertaining to these essential IPRs, if any, is publicly available for **ETSI members and non-members**, and can be found in SR 000 314: "*Intellectual Property Rights (IPRs); Essential, or potentially Essential, IPRs notified to ETSI in respect of ETSI standards*", which is available **free of charge** from the ETSI Secretariat. Latest updates are available on the ETSI Web server (<http://www.etsi.fr/ipr> or <http://www.etsi.org/ipr>).

Pursuant to the ETSI IPR Policy, no investigation, including IPR searches, has been carried out by ETSI. No guarantee can be given as to the existence of other IPRs not referenced in SR 000 314 (or the updates on the ETSI Web server) which are, or may be, or may become, essential to the present document.

---

## Foreword

This European Standard (Telecommunications series) has been produced by ETSI Special Mobile Group (SMG), and is now submitted for the Public Enquiry phase of the ETSI standards Two-step Approval Procedure.

This EN specifies the procedures used at the radio interface (Reference Point Um, see GSM 04.02) for the General Packet Radio Service (GPRS) Medium Access Control /Radio Link Control (MAC/RLC) layer within the digital cellular telecommunications system (Phase 2+).

The contents of this EN are subject to continuing work within SMG and may change following formal SMG approval. Should SMG modify the contents of this EN it will then be re-submitted for OAP with an identifying change of release date and an increase in version number as follows:

Version 6.x.y

where:

- 6 indicates GSM Release 1997 of Phase 2+
- x the second digit is incremented for all other types of changes, i.e. technical enhancements, corrections, updates, etc.
- y the third digit is incremented when editorial only changes have been incorporated in the specification.

<b>Proposed national transposition dates</b>	
Date of latest announcement of this EN (doa):	3 months after ETSI publication
Date of latest publication of new National Standard or endorsement of this EN (dop/e):	6 months after doa
Date of withdrawal of any conflicting National Standard (dow):	6 months after doa

---

# 1 Scope

This European Telecommunication Standard (EN) specifies the procedures used at the radio interface (Reference Point Um, see GSM 04.02) for the General Packet Radio Service (GPRS) Medium Access Control /Radio Link Control (MAC/RLC) layer.

When the notations for “further study” or “FS” or “FFS” are present in this ETS they mean that the indicated text is not a normative portion of this standard.

This specification is applicable to the following GPRS Um functional layers:

- Radio Link Control functions,
- Medium Access Control functions, and
- Physical Link Control functions.

The procedures described in this EN are for the RLC/MAC functions of the GPRS radio interface (Um) when operating on a Packet Data Channel (PDCH).

GSM 03.64 contains an overview of the GPRS radio interface (Um).

GSM 04.03 and GSM 04.04 contains the definition of the control channels used in this ETS.

GSM 04.07 contains a description in general terms of the structured functions and procedures of this protocol and the relationship of this protocol with other layers and entities.

GSM 04.08 contains the definition of GPRS RLC/MAC procedures when operating on the Common Control Channel (CCCH).

GSM 04.64 contains functional procedures for the Logical Link Control (LLC) layer.

## **Application to interface structure**

The RLC/MAC procedures apply to the interface structures defined in GSM 04.03. They use the functions and services provided by layer 1 defined in GSM 04.04. GSM 04.07 gives the general description of layer 3 including procedures, messages format and error handling.

## **Test procedures**

Test procedures of the GSM radio interface signalling are described in GSM 11.10 and GSM 11.2x series.

## **Use of logical control channels**

The logical control channels are defined in GSM 05.02. Two similar sets of logical channels are defined. The first set consists of the logical channels:

- Broadcast Control Channel (BCCH): downlink only, used to broadcast Cell specific information;
- Paging Channel (PCH): downlink only, used to send page requests to Mobile Stations (MSs);
- Random Access Channel (RACH): uplink only, used to request GPRS resources or a Dedicated Control Channel;
- Access Grant Channel (AGCH): downlink only, used to allocate GPRS resources or a Dedicated Control Channel;
- The second set consists of the logical channels:
  - Packet Broadcast Control Channel (PBCCH): downlink only, used to broadcast Cell specific information;
  - Packet Paging Channel (PPCH): downlink only, used to send page requests to Mobile Stations (MSs);
  - Packet Random Access Channel (PRACH): uplink only, used to request GPRS resources;

- Packet Access Grant Channel (PAGCH): downlink only, used to allocate GPRS resources;
- Packet Associated Control Channel (PACCH): bi-directional, associated with a Temporary Block Flow (TBF);
- Packet Timing advance control channel uplink (PTCCH/U): used to transmit random access bursts to allow estimation of the timing advance for one MS in transfer state;
- Packet Timing advance control channel downlink (PTCCH/D): used to transmit timing advance updates for several MS. One PTCCH/D is paired with several PTCCH/U's.

#### Applicability of implementations

For GPRS, the following possible mobile station implementations exist (see GSM 02.60):

- GPRS MS class A;
- GPRS MS class B; and
- GPRS MS class C.

Throughout this technical specification, it is explicitly mentioned if a certain procedure is applicable only to a subset of GPRS MS classes and, if necessary, how a mobile station not belonging to such a subset shall behave.

---

## 2 Normative references

References may be made to:

- a) specific versions of publications (identified by date of publication, edition number, version number, etc.), in which case, subsequent revisions to the referenced document do not apply; or
- b) all versions up to and including the identified version (identified by "up to and including" before the version identity); or
- c) all versions subsequent to and including the identified version (identified by "onwards" following the version identity); or
- d) publications without mention of a specific version, in which case the latest version applies.

A non-specific reference to an ETS shall also be taken to refer to later versions published as an EN with the same number.

- [1] GSM 01.04: "Digital cellular telecommunications system (Phase 2+); Abbreviations and acronyms".
- [2] GSM 02.60: "Digital cellular telecommunications system (Phase 2+); Stage 1 Service Description of the General Packet Radio Service (GPRS)".
- [3] GSM 03.03: "Digital cellular telecommunications system (Phase 2+); Numbering, addressing and identification".
- [4] GSM 03.13: "Digital cellular telecommunications system (Phase 2+); Discontinuous Reception (DRX) in the GSM system".
- [5] GSM 03.64: "Digital cellular telecommunications system (Phase 2+); General Packet Radio Service (GPRS); Overall description of GPRS radio Interface; Stage 2".
- [6] GSM 04.02: "Digital cellular telecommunications system (Phase 2+); GSM Public Land Mobile Network (PLMN) access reference configuration".
- [7] GSM 04.03: "Digital cellular telecommunications system (Phase 2+); Mobile Station - Base Station System (MS - BSS) interface Channel structures and access capabilities".
- [8] GSM 04.04: "Digital cellular telecommunications system (Phase 2+); Layer 1 General requirements".

*ETSI*

- [9] GSM 04.05: "Digital cellular telecommunications system (Phase 2+); Data Link (DL) layer General aspects".
- [10] GSM 04.07: "Digital cellular telecommunications system (Phase 2+); Mobile radio interface signalling layer 3 General aspects".
- [11] GSM 04.08: "Digital cellular telecommunications system (Phase 2+); Mobile radio interface layer 3 specification".
- [12] GSM 04.64: "Digital cellular telecommunications system (Phase 2+); General Packet Radio Service (GPRS); Logical Link Control (LLC)".
- [13] GSM 05.02: "Digital cellular telecommunications system (Phase 2+); Multiplexing and multiple access on the radio path".
- [14] GSM 05.03: "Digital cellular telecommunications system (Phase 2+); Channel coding".
- [15] GSM 05.08: "Digital cellular telecommunications system (Phase 2+); Radio subsystem link control".
- [16] GSM 05.10: "Digital cellular telecommunications system (Phase 2+); Radio subsystem synchronisation".
- [17] GSM 11.10: "Digital cellular telecommunications system (Phase 2+); Mobile Station (MS) conformity specification".
- [18] GSM 11.21: "Digital cellular telecommunications system (Phase 2); The GSM Base Station System (BSS) equipment specification".

---

## 3 Abbreviations

Abbreviations used in this specification are listed in GSM 01.04 and GSM 02.60.

### 3.1 Vocabulary

The following terms are used in this Technical Specification:

**Block period:** A block period is the sequence of four timeslots on a PDCH used to convey one radio block.

**Packet idle mode:** (only applicable for mobile stations supporting GPRS of class A, B or C): In this mode, the mobile station is prepared to transfer LLC PDUs on packet data physical channels, see clause 5. The mobile station is not allocated any radio resource on a packet data physical channel; it listens to the PBCCH and PCCCH or, if those are not provided by the network, to the BCCH and the CCCH;

**Packet transfer mode:** (only applicable for mobile stations supporting GPRS of class A, B or C): In this mode, the mobile station is prepared to transfer LLC PDUs on packet data physical channels, see clause 5. The mobile station is allocated radio resource on one or more packet data physical channels for the transfer of LLC PDUs.

**Radio block:** A radio block is the sequence of four normal bursts carrying one RLC/MAC protocol data unit. (The one exception is a radio block occasionally used on PACCH consisting of a sequence of four access bursts, each carrying a repetition of one short RLC/MAC block.)

**RLC/MAC block:** A RLC/MAC block is the protocol data unit exchanged between RLC/MAC entities, see clause 10.

**RLC/MAC control block:** A RLC/MAC control block is the part of a RLC/MAC block carrying a control message between RLC/MAC entities.

**RLC data block:** A RLC data block is the part of a RLC/MAC block carrying user data or upper layers' signalling data.

**Temporary Block Flow (TBF):** A Temporary Block Flow (TBF) is a physical connection used by the two RR peer entities to support the unidirectional transfer of LLC PDUs on packet data physical channels, see clause 5.

**Uplink State Flag (USF):** The Uplink State Flag (USF) is used on PDCH channel(s) to allow multiplexing of uplink Radio blocks from different mobile stations, see clause 10 and GSM 05.02.

#### **GPRS MS class**

The term *GPRS MS class* refers to the different mobile station implementations and the different modes of operation possible for GPRS, see GSM 02.60. In this ETS, the expression that a mobile station *belongs to* a certain GPRS MS class (A, B or C) is used to denote the case that a mobile station is currently operating according to the RR procedures specified for the particular GPRS MS class.

The GPRS MS class, to which a mobile station belongs, depends on the GSM services to which the mobile station is currently attached, i.e., GSM GPRS services, GSM circuit switched services including SMS, or both, and to the extent a simultaneous invocation of these services is possible. The GPRS MS class a mobile station belongs to may shift in time.

#### **GPRS multislot class**

The term GPRS multislot class refers to the different mobile station capabilities to transmit and receive on different combinations of multiple PDCHs. The multislot classes are defined in GSM 05.02. Note that the mobile station may indicate different multislot classes for circuit mode services and for GPRS (see GSM 04.08). Different multislot class mobile stations are capable of supporting different medium access modes (see subclause 5.2.4).

#### **Random values**

In a number of places in this Technical Specification, it is mentioned that some value must take a “random” value, in a given range, or more generally with some statistical distribution. For such random values refer to GSM 04.08.

---

## 4 Layered overview of radio interface

The Radio Resource sublayer provides the functions necessary for

- Radio Resource (RR) management of packet data physical channels (PDCHs); and
- Radio Link Control and Medium Access Control (RLC/MAC) on packet data physical channels.

As shown in Figure 1, the RR sublayer provides services to the MM and LLC sublayers. The RR sublayer utilises the services of the Data Link layer (signalling layer 2) and the Physical Link layer. The packet logical channels PBCCH, PCCCH (including PPCH, PAGCH and PRACH), PACCH and PDTCH, are multiplexed onto the packet data physical channels on a per radio block basis.



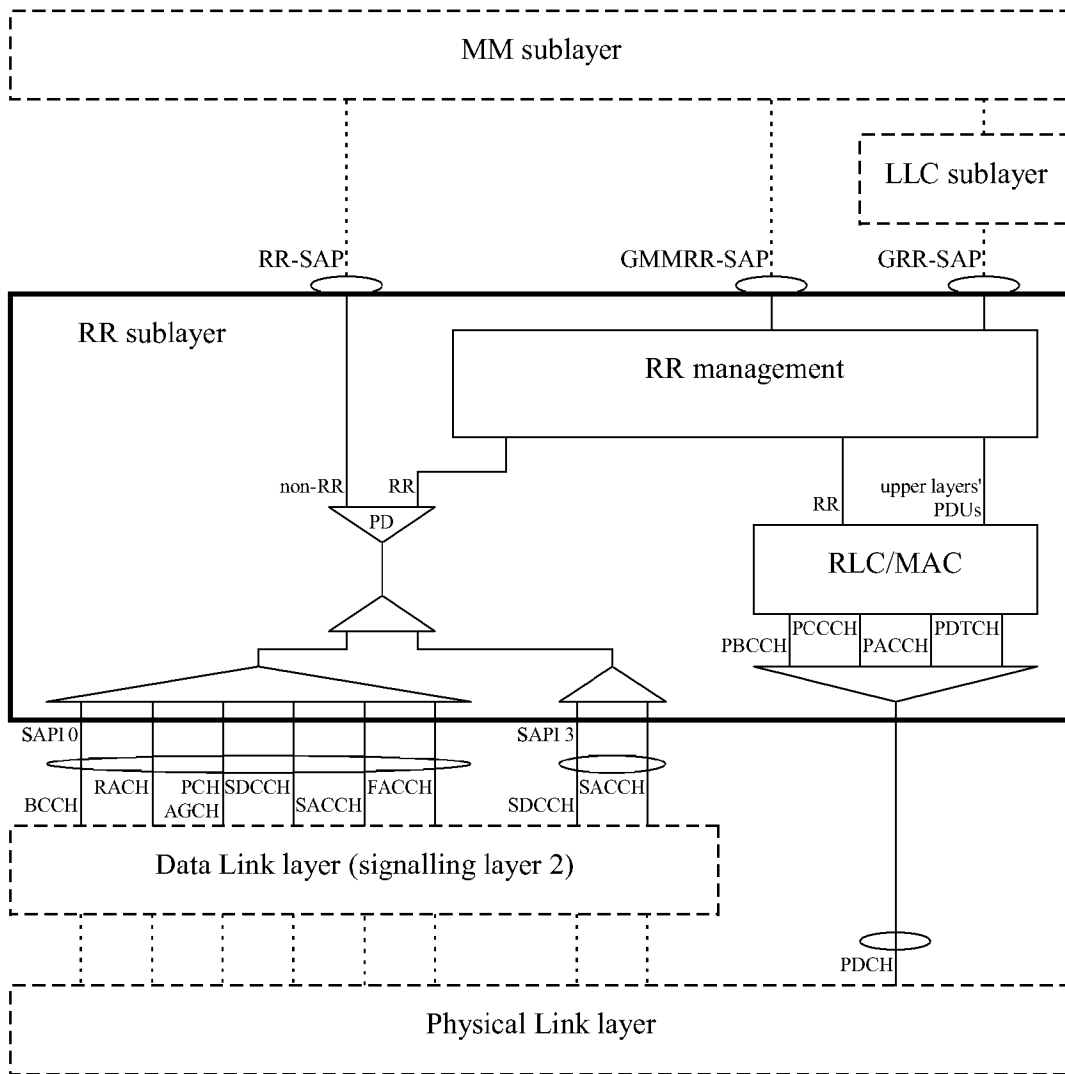

Figure 1: Protocol architecture of Radio Resource (RR) sublayer and RLC/MAC function

## 4.1 Layer services

The RR sublayer provides services for the transfer of upper layer PDUs using a shared medium between multiple mobile stations and the network. Direct communication is only possible between the network and one or more mobile stations.

The RLC/MAC function supports two modes of operation:

- unacknowledged operation; and
- acknowledged operation.

The RR sublayer further provides services for the paging of mobile stations.

## 4.2 Layer functions

The RLC function defines the procedures for segmentation and reassemble of LLC PDUs into RLC/MAC blocks and, in RLC acknowledged mode of operation, for the Backward Error Correction (BEC) procedures enabling the selective

retransmission of unsuccessfully delivered RLC/MAC blocks. In RLC acknowledged mode of operation, the RLC function preserves the order of higher layer PDUs provided to it.

The MAC function defines the procedures that enable multiple mobile stations to share a common transmission medium, which may consist of several physical channels. The function may allow a mobile station to use several physical channels in parallel, i.e. use several timeslots within the TDMA frame.

For the mobile station originating access, the MAC function provides the procedures, including the contention resolution procedures, for the arbitration between multiple mobile stations simultaneously attempting to access the shared transmission medium.

For the mobile station terminating access, the MAC function provides the procedures for queuing and scheduling of access attempts.

## 4.3 Service primitives

Information flow between layers is performed by the use of Service Primitives. Service Access Points (SAP) and their corresponding Service Primitives for the RR sublayer are defined in GSM 04.07.

## 4.4 Services required from lower layers

The RLC/MAC function uses the services provided by the physical link layer as defined in GSM 04.04.

The RR sublayer may use the services provided by the data link layer as defined in GSM 04.05. Moreover, the RR sublayer directly uses services provided by the physical layer such as BCCH searching, as defined in GSM 04.04.

---

# 5 Introduction to the Medium Access Control (MAC) procedures

## 5.1 General

The Medium Access Control procedures include the functions related to the management of the common transmission resources, e.g. the packet data physical channels and the radio link connections on packet data physical channels.

The Medium Access Control procedures support the provision of Temporary Block Flows (TBFs) that allow the point-to-point transfer of signalling and user data within a cell between the network and a mobile station.

Moreover, the Medium Access Control procedures include the procedures for reception of PBCCH and PCCCH, which permits automatic cell reselection (see GSM 05.08).

## 5.2 Multiplexing principles

### 5.2.1 Temporary Block Flow

A Temporary Block Flow (TBF) is a physical connection used by the two RR entities to support the unidirectional transfer of LLC PDUs on packet data physical channels. The TBF is allocated radio resource on one or more PDCHs and comprises a number of RLC/MAC blocks carrying one or more LLC PDUs. A TBF is temporary and is maintained only for the duration of the data transfer (i.e. until there are no more RLC/MAC blocks to be transmitted and, in RLC acknowledged mode, all of the transmitted RLC/MAC blocks have been successfully acknowledged by the receiving entity).

## 5.2.2 Temporary Flow Identity

Each TBF is assigned a Temporary Flow Identity (TFI) by the network. The mobile station shall assume that the TFI value is unique among concurrent TBFs in each direction (uplink or downlink). The same TFI value may be used concurrently for TBFs in opposite directions.

An RLC/MAC block associated with a certain TBF shall comprise a TFI. The TBF is identified by the TFI together with, in case of a RLC data block, the direction (uplink or downlink) in which the RLC data block is sent; and in case of a RLC/MAC control message, the direction in which the RLC/MAC control message is sent and the message type.

## 5.2.3 Uplink State Flag

An Uplink State Flag (USF) is included in the header of each RLC/MAC block on a downlink PDCH, as specified in clause 10. It may be used by the network to control the multiplexing of different mobile stations on uplink PDCH. The use of USF is further specified in GSM 05.02.

## 5.2.4 Medium Access modes

Three medium access modes are supported:

- Dynamic Allocation (characterised by USF);
- Extended Dynamic Allocation; and
- Fixed Allocation.

The Dynamic Allocation medium access mode or Fixed Allocation medium access mode shall be supported by all networks that support GPRS. The support of Extended Dynamic Allocation is optional.

The Dynamic Allocation and Fixed Allocation modes shall be supported in all mobile stations. Table 1 indicates which MS multislot classes are applicable for the Extended Dynamic medium access mode (see GSM 05.02) and the default medium access mode for each MS multislot class. During single phase access, if the network supports the default medium access mode for the multislot class indicated by the mobile station in the `PACKET_CHANNEL_ACCESS`, the network should, when appropriate, use that medium access mode.

**Table 1: Medium Access modes allowed per multislot class**

Multislot class	Extended Dynamic Allocation	Default MAC mode
1		Dynamic or Fixed
2		Dynamic or Fixed
3	X	Dynamic or Fixed
4	X	Dynamic or Fixed
5	X	Dynamic or Fixed
6	X	Dynamic or Fixed
7	X	Dynamic or Fixed
8		Dynamic or Fixed
9	X	Dynamic or Fixed
10	X	Dynamic or Fixed
11	X	Dynamic or Fixed
12	X	Dynamic or Fixed
13		Dynamic or Fixed
14		Dynamic or Fixed
15		Dynamic or Fixed
16		Dynamic or Fixed
17		Dynamic or Fixed
18		Dynamic or Fixed
19	X	Fixed
20	X	Fixed
21	X	Fixed
22	X	Extended Dynamic
23	X	Fixed
24	X	Extended Dynamic
25	X	Extended Dynamic
26	X	Fixed
27	X	Extended Dynamic
28	X	Fixed
29	X	Fixed

### 5.3 Packet idle mode

In packet idle mode no temporary block flow exists.

In packet idle mode, the mobile station monitors the relevant paging subchannels on PCCCH, if such is present in the cell. If a PCCCH is not present in the cell, the mobile station monitors the relevant paging subchannels on CCCH.

Cell reselection in packet idle mode is specified in GSM 05.08. The RR sublayer (on the mobile station side) shall indicate to the upper layers the availability of a cell and of the cell change when decided by the RR sublayer. Upper layers are advised of system information broadcast in the cell when a new cell has been selected, and when a relevant part of this information changes.

In packet idle mode, upper layer may require the transfer of a LLC PDU, which implicitly triggers the establishment of a TBF and the transition to packet transfer mode.

While operating in packet idle mode, a mobile station belonging to GPRS MS class A may simultaneously enter the different RR service modes defined in GSM 04.08. A mobile station belonging to either of GPRS MS class B or C leaves both packet idle mode and packet transfer modes before entering dedicated mode, group receive mode or group transmit mode.

## 5.4 Packet transfer mode

In packet transfer mode, a TBF provides a physical point-to-point connection on one or more packet data physical channels for the unidirectional transfer of LLC PDUs between the network and the mobile station. Continuous transfer of one or more LLC PDUs is possible. Concurrent TBFs may be established in opposite directions. The following RR services are provided:

- transfer of LLC PDUs in RLC acknowledged mode;
- transfer of LLC PDUs in RLC unacknowledged mode.

Cell reselection in packet transfer mode is specified in GSM 05.08. When a new cell has been selected, the mobile station leave the packet transfer mode, enters the packet idle mode where it switches to the new cell, reads the system information, and may then resume to packet transfer mode in the new cell.

While operating in packet transfer mode, a mobile station belonging to GPRS MS class A may simultaneously enter the different RR service modes defined in GSM 04.08. A mobile station belonging to either of GPRS MS class B or C leaves both packet idle mode and packet transfer modes before entering dedicated mode, group receive mode or group transmit mode.

## 5.5 Procedures in packet idle mode

### 5.5.1 Mobile station side

The mobile station in packet idle mode shall monitor the system information broadcast in the cell. Moreover, the mobile station shall monitor the radio blocks on PCCCH corresponding to the PCCCH\_GROUP the mobile station belongs to and where paging may appear, see GSM 05.02. If PCCCH is not present in the cell, the mobile station shall monitor the radio blocks on CCCH corresponding to the PCCCH\_GROUP the mobile station belongs to and where paging may appear. The paging sub-channels on CCCH or PCCCH shall be monitored according to the current DRX mode and the values of the PAGING\_GROUP parameter defined for the mobile station, see subclause 0, and possible page mode information received on CCCH or PCCCH, as defined in subclause 0 and in GSM 04.08.

The determination of the PCCCH\_GROUP and the values of the PAGING\_GROUP parameter defined for a mobile station is defined in GSM 05.02.

#### 5.5.1.1 Selection and reselection of CCCH or PCCCH

When the mobile station switches to a new cell, or switches to a new CCCH or PCCCH in a cell, the mobile station shall read system information on BCCH as defined in GSM 04.08. The system information on BCCH indicates whether the cell supports GPRS and, in such case, whether a PCCCH is provided in the cell.

If the cell supports GPRS, the mobile station may camp on the cell and may perform packet access in the cell. If the cell does not support GPRS, the mobile station may camp on the cell but is not allowed to do packet access in the cell.

If a PCCCH is active in the cell, the mobile station shall stop reading system information on BCCH and start reading system information on PCCCH.

A mobile station that receives an indication that a PCCCH is being deactivated shall reread the system information starting with the system information on BCCH and then calculate a new value of CCCH\_GROUP or PCCCH\_GROUP.

If the mobile station is unable to read system information on PCCCH according to the requirements defined in subclause 5.5.1.2 and in GSM 05.08, it shall assume that the PCCCH has been released by the network, start reading system information on BCCH and perform a reselection of CCCH or PCCCH.

#### 5.5.1.2 System information on PCCCH

If a PCCCH is provided in the cell, the mobile station shall read system information on PCCCH. When a new cell has been selected, or a reselection of PCCCH has been performed, the mobile station shall read PACKET SYSTEM INFORMATION TYPE 1 (PSI1) message, a consistent set of TYPE 2 (PSI2) messages and a consistent set of TYPE 3

and optional TYPE 3 bis (PSI3 and PSI3 bis) messages, optional consistent set of TYPE 4 (PSI4) messages, and optional consistent set of TYPE 5 and 5 bis (PSI5 and PSI5 bis) messages.

The mobile station shall keep the value of the PBCCH\_INF\_CHANGED parameter received in a PSI1 message from the last refresh of system information on PBCCH. The mobile station shall also keep the values of the different PSI CHANGE MARK parameters identifying the respective consistent sets of PSI2, PSI3 and 3 bis, PSI4 and PSI5 and 5 bis messages last received on PBCCH. The mobile station shall read each of the different PSI CHANGE MARK parameters at least once after having obtained the value of the PBCCH\_INF\_CHANGED parameter.

If the mobile station receives a value of a PSI\_CHANGE\_MARK parameter which does not match the value identifying the currently corresponding consistent set of PSI messages, the mobile station shall read system information on PBCCH and obtain a new such consistent set of PSI messages. The mobile station shall read the PSI1 message and obtain the value of the PBCCH\_INF\_CHANGED parameter, and further verify the validity of all other consistent sets of PSI messages. For each PSI\_CHANGE\_MARK parameter received, which does not match the value identifying the currently corresponding consistent set of PSI messages, this procedure is repeated.

The mobile station shall refresh the information broadcast in the PSI1 message repeatedly. The time requirement for this is specified in GSM 05.08.

If the mobile station receives a value of the PBCCH\_INF\_CHANGED parameter which does not match the currently kept value, the mobile station shall verify the validity of each consistent set of PSI messages and initiate the refresh procedure as required.

If the mobile station is unable to read PSI1 messages as required, it shall assume that the value of the PBCCH\_INF\_CHANGED parameter has changed.

### 5.5.1.3 System information on BCCH

If a PCCCH is not provided in the cell, the mobile station shall read system information on BCCH using the procedures specified in GSM 04.08.

### 5.5.1.4 Discontinuous reception (DRX)

A mobile station in packet idle mode shall listen to the radio blocks on CCCH or PCCCH as defined in GSM 05.02. In the *GPRS attach procedure*, defined in GSM 04.08, the mobile station may negotiate values for the different DRX parameters to be applied on CCCH or PCCCH. These parameters controls:

- the recurrence of paging blocks on CCCH or PCCCH belonging to the mobile station (SPLIT PG CYCLE parameter, see GSM 05.02) when DRX is applied; and
- the duration of the non-DRX mode (timer T3194) requested by the mobile station to be applied when the mobile station leaves the packet transfer mode and enters packet idle mode.

The network may broadcast an upper limit for timer T3194 to be applied in each cell. The upper limit for timer T3194 is specified by the parameter DRX TIMER MAX which is broadcast in the system information on BCCH or PBCCH.

The mobile station shall enter the non-DRX mode when it leaves the packet transfer mode and enters the packet idle mode. In the non-DRX mode, the mobile station shall listen to the full PDCH corresponding to the PCCCH GROUP it belongs to. The mobile station starts timer T3194. The value to be applied for timer T3194 in each cell is the minimum of the value negotiated in the *GPRS attach procedure* and the value defined by the parameter DRX TIMER MAX broadcast in each cell.

On the expiry of timer T3194, the mobile station leaves the non-DRX mode and starts to apply DRX on CCCH or PCCCH for the remaining duration of the packet idle mode.

If timer T3194 is still running when the mobile station enters the packet transfer mode, the mobile station stops timer T3194.

During the MM procedures for *GPRS attach* and *routing area update* defined in GSM 04.08, the mobile station shall remain in the non-DRX mode for the entire duration of the packet idle mode. The mobile station may resume the normal DRX handling after the receipt of a *GPRS attach accept* or a *routing area update accept*.

### 5.5.1.5 Page mode procedures on PCCCH

The network may send page mode information in PACKET PAGING REQUEST, PACKET UPLINK ASSIGNMENT, PACKET QUEUING NOTIFICATION, PACKET ACCESS REJECT and PACKET DOWNLINK ASSIGNMENT messages on PCCCH. The page mode information controls possible additional requirements on a mobile station receiving the message.

The mobile station shall take into account the page mode information received in any message received in a radio block on PCCCH corresponding to one of the paging groups defined by the different PAGING\_GROUP values for the mobile station. The mobile station shall not take into account possible page mode information in a message that is received in any other radio block on PCCCH than those corresponding to the paging groups defined for the mobile station.

The requirements yielded by the page mode information are as follows:

- *normal paging*: no additional requirements;
- *extended paging*: the mobile station is required in addition to receive and analyse the possible message in the next but one block period on PCCCH which may be used for PCCCH;
- *paging reorganization*: The mobile station shall receive all messages on the PCCCH regardless of the BS\_PAG\_BLK\_RES setting. It is required to receive all PCCCH messages. When the mobile station receives the next message to a (possibly new) PAGING\_GROUP defined for the mobile station, subsequent action is defined by the possible page mode information received in that message.

Note that a mobile station takes into account the page mode information only in messages received in a radio block corresponding to a paging group defined for the mobile station, whatever the currently applied requirements (a, b, or c).

When the mobile station selects a new set of PAGING\_GROUP values, the initial page mode in the mobile station shall be set to paging reorganization. If a message in a paging sub-channel does not contain page mode information, or if it is not received correctly, the default page mode information is *normal paging*.

## 5.5.2 Network side

### 5.5.2.1 System Information broadcasting

In cells supporting GPRS, GPRS specific system information is broadcast. If a PCCCH is established in a cell, the required GPRS system information is broadcast on PCCCH. In that case the system information broadcast on BCCH indicates that a PCCCH is allocated and its location. GPRS specific System information sent on BCCH is further specified in GSM 04.08.

PACKET SYSTEM INFORMATION TYPE 1 to 3 messages, and optionally 3 bis, 4, 5, 5 bis and 6 and further types are regularly broadcast by the network on the PCCCH. Based on this information the mobile station is able to decide whether and how it may gain access to the system via the current cell.

The PACKET SYSTEM INFORMATION TYPE 1 message contains common parameters and control channel information for GPRS. In the TYPE 1 message it is also indicated with an 'Information Changed'-flag when relevant information has been changed in other system information messages on either BCCH or PCCCH which requires that the mobile station updates this information. Consequently when a mobile station has read all the GPRS System Information messages once, only the TYPE 1 message needs to be read until a 'Information Changed' is indicated. The BCCH information supervised through the BCCH\_INF\_CHANGED flag is:

- The RACH parameters CELL\_BAR\_ACCESS, CALL\_REESTABLISHMENT\_ALLOWED and EMERGENCY\_CALL\_ALLOWED;
- The CCCH Control Channel description parameters ATTACH/DETACH\_ALLOWED and the T3212 Timer for Periodic Updating.

The PACKET SYSTEM INFORMATION TYPE 2 contains a list of PCCCHs and a list of mobile allocations. Multiple instances of the TYPE 2 message shall be sent if the list of PCCCHs and list of mobile allocations takes up too much room to fit into one TYPE 2 message. The number of instances of the TYPE 2 message is indicated in each TYPE 2 message.

The SYSTEM INFORMATION TYPE 3 and the TYPE 3 bis messages contain BA-lists and cell reselection parameters. The existence and number of TYPE 3 bis messages are indicated in the TYPE 3 message.

The PACKET SYSTEM INFORMATION TYPE 4 message contains channel lists for power control interference measurements. The message is optional and its existence is indicated in the TYPE 1 message. Multiple instances of the TYPE 4 message may be sent if the channel list does not fit into one TYPE 4 message. . The number of instances of the TYPE 4 message is indicated in each TYPE 4 message.

The PACKET SYSTEM INFORMATION TYPE 5 message contains parameters for network controlled cell reselection that apply when the mobile station is in MM ready state, and optionally, lists of channels to be measured to be measured and reported while the mobile station is in packet idle mode. The message is optional and shall be sent if and only if indicated in the TYPE 1 message. If the information does not fit into the TYPE 5 message, it may be continued in the TYPE 5 bis message.

The network may send to the mobile station PBCCH scheduling information in the PACKET SYSTEM INFORMATION TYPE 6 message. If the PACKET SYSTEM INFORMATION TYPE 6 is not present, the allowed scheduling of PACKET SYSTEM INFORMATION messages on the PBCCH are specified in GSM 05.02 .

## 5.6 Measurement reporting

The network may order the mobile station to perform measurements while in MM ready state, while in packet idle mode, or both. If the mobile station is ordered to perform both MM ready state measurements and packet idle mode measurements, when the mobile station is in MM ready state and packet idle mode at the same time the mobile station shall perform both sets of measurements and send measurements reports for both sets of measurements to the network. The mobile station may be required to send multiple PACKET MEASUREMENT REPORT messages to convey both sets of measurements (see subclause 7.3).

### 5.6.1 Ready state measurement reporting

The network may order the mobile station in MM ready state (see GSM 04.08) to:

- send measurement reports (NC1); or
- send measurement reports, suspend normal cell re-selection, and accept network controlled cell re-selection (NC2).

The behaviour of the mobile station is controlled by the parameter NETWORK\_CONTROL\_ORDER broadcast in a PSI5 message on PBCCH. Alternatively, the network may address the PSI5 message to a particular mobile station when sending the message on PCCCH or PACCH. The parameter NETWORK\_CONTROL\_ORDER may have the following values, see GSM 05.08:

- NC0 'Normal MS control'; the mobile station does not send measurement reports and makes autonomous cell reselection.
- NC1 'MS control with measurement reports'; the mobile station sends measurement reports but makes autonomous cell reselection.
- NC2 'Network control'; the mobile station sends measurement reports, suspend normal cell reselection and accept network controlled cell re-selection

The parameter NETWORK\_CONTROL\_ORDER applies only when the mobile station is in MM ready state. When the mobile station enters MM stand-by state, the mode of operation shall be set to NC0. Also, in the case of a downlink signalling failure, see GSM 05.08, the mobile station shall autonomously set the mode of operation to NC0.

The network may send to the mobile station one or more lists of frequencies upon which to perform measurements, where each list has different reporting criteria (see GSM 05.08)

If the mobile station receives a PSI5 message addressed to itself, the mobile station shall act upon the parameters in the PSI5 message addressed to itself and shall ignore all PSI5 and PSI5 bis messages not addressed to itself until its mode of operation is set to NC0 or until the mobile station exits MM ready state.



The procedure for measurement reporting is specified in subclause 7.3 for packet idle mode, and in subclause 8.3 for packet transfer mode.

The network may send a PACKET CELL CHANGE ORDER message to the mobile station on PCCCH or PACCH. The PACKET CELL CHANGE ORDER message includes the description of a target cell and a NETWORK\_CONTROL\_ORDER command to be applied in the new cell.

If the mobile station is not involved in an RR connection, upon receiving the PACKET CELL CHANGE ORDER message, the mobile station shall abort any ongoing TBFs in the current cell, re-select to the target cell, read system information and resume packet transactions in the target cell. If the mobile station is involved in an RR connection, the mobile station shall ignore the PACKET CELL CHANGE ORDER message.

A mobile station involved in a simultaneous RR connection (GPRS MS class A) or performing *anonymous access*, see GSM 04.08, shall indicate so in the measurement reports sent to the network, if the mode of operation is set to NC1 or NC2. On receipt of such an indication, the network may change the mode of operation by sending PSI5 message to the mobile station.

## 5.6.2 Idle mode measurement report

The network may order the mobile station in packet idle mode to send measurement reports. The behaviour of the mobile station is controlled by the parameter IDLE\_MEASUREMENT\_ORDER broadcast in PSI5 or PSI5 bis message on PBCCH. Alternatively, the network may address the PSI5 or PSI5 bis message to a particular mobile station when sending the message on PCCCH or PACCH. The PSI5 and PSI5 bis messages may include:

- the parameter IDLE\_MEASUREMENT\_ORDER;
- a reporting period; and
- one or more frequency lists.

If these parameters are not provided by the network, the default behaviour of the mobile station is to not send packet idle mode measurement reports.

If the indicated mode of operation in the cell is to send packet idle mode measurement reports, the mobile station shall perform the measurements as defined in GSM 05.08 at regular intervals, applying the indicated reporting period, and send the results to the network using the procedure defined in subclause 7.3.

The mobile station shall continue to let the packet idle mode measurement report interval timer run while in packet transfer mode. If the mobile station is in packet transfer mode when a measurement shall take place, it shall not perform that measurement and shall not send the corresponding report.

If the mode of operation is to send packet idle mode measurement reports, the reporting timer is running with a value  $T$  when the mobile station reselects to a new cell, and the indicated reporting period in the new cell is  $T_0$ , then the mobile station shall restart the reporting timer at a value equal to  $(T \text{ modulo } T_0)$  in the new cell.

---

# 6 Paging procedures

For a mobile station in packet idle mode or packet transfer mode, the network may initiate the establishment of an RR connection, see subclause 6.1, or a downlink packet transfer, see subclause 6.2, by the paging procedures. The paging procedure can only be initiated by the network on a paging subchannel either on CCCH or on PCCCH. A number of mobile stations can be paged for either downlink packet transfer or RR connection establishment in the same paging message.

## 6.1 Paging procedure for RR connection establishment

The network may initiate the establishment of an RR connection by the paging procedure for RR connection establishment.

The network initiates the paging procedure to trigger an RR connection establishment by broadcasting a paging request message on the appropriate paging subchannel on CCCH or PCCCH. The paging subchannels on CCCH and PCCCH

are specified in GSM 05.02 and GSM 03.13. The mobile station is paged on the PCCCH if available, otherwise on the CCCH.

The network may also send paging related information on PACCH to a mobile station supporting GPRS MS class A or B when such mobile station is in packet transfer mode.

### 6.1.1 Paging initiation using paging subchannel on CCCH

The paging initiation procedure and the paging request messages used on CCCH are specified in GSM 04.08.

### 6.1.2 Paging initiation using paging subchannel on PCCCH

Paging initiation using the paging subchannel on PCCCH applies when sending paging information to a mobile station supporting GPRS MS class A or B, when such mobile station is not in packet transfer mode and when the network operates according to mode I (see GSM 03.60).

For each mobile station, that is paged to trigger RR connection establishment, a channel needed field is included in the PACKET PAGING REQUEST message, see subclause 11.2.22. The channel needed field defines how mobile stations of different capabilities shall code the establishment cause field in the CHANNEL REQUEST message, as specified in GSM 04.08.

A PACKET PAGING REQUEST message on PCCCH may include more than one mobile station identification.

### 6.1.3 Paging initiation using PACCH

Paging initiation using PACCH applies to a mobile station supporting GPRS MS class A or B when such mobile station is in packet transfer mode and when the network operates according to mode I (see GSM 0.60). In this case, the network shall send the PACKET PAGING REQUEST message to the mobile station on the appropriate PACCH. The message includes the mobile station identification and the channel needed field which defines how mobiles of different capabilities shall code the establishment cause field in the CHANNEL REQUEST message, as specified in GSM 04.08.

### 6.1.4 Paging response

Upon receipt of a PACKET PAGING REQUEST message, which purpose was to trigger the establishment of an RR connection, the paging response procedures as specified in GSM 04.08 shall be followed.

## 6.2 Paging procedure for downlink packet transfer

The network may initiate the packet paging procedure in order to obtain the mobile station cell location required for downlink packet transfer. The packet paging procedure can only be initiated by the network. The procedure is initiated by broadcasting PACKET PAGING REQUEST message on the appropriate paging subchannel on CCCH or PCCCH. The paging subchannels on CCCH and PCCCH are specified in GSM 05.02 and GSM 03.13.

Packet paging using the paging subchannel on PCCCH applies when sending a paging request message to a mobile station supporting GPRS MS class A, B or C, when such a mobile station is not in packet transfer mode. Packet paging using the paging subchannel on CCCH applies to mobile stations supporting GPRS MS class A, B and C when such a mobile station is not in packet transfer mode and when a PCCCH is not provided in the cell.

### 6.2.1 Paging procedure using paging subchannel on CCCH

The packet paging procedure and the paging request messages used on CCCH are specified in GSM 04.08.

### 6.2.2 Paging using paging subchannel on PCCCH

The packet paging procedure is initiated by the network. It is triggered by a page request from the MM sublayer, see GSM 04.07 and GSM 04.08

The network initiates the paging procedure by broadcasting a PACKET PAGING REQUEST message on an appropriate paging subchannel on PPCH, considering the DRX parameters valid for each targeted mobile station.

A PACKET PAGING REQUEST message may include more than one mobile station identification.

On receipt of a PACKET PAGING REQUEST message, the addressed mobile station shall forward an indication of the received paging information to the MM sublayer in the mobile station (see GSM 04.07 and GSM 04.08).

### 6.2.3 Paging response

Whenever the MM sublayer in the mobile station indicates an LLC frame in response to a PACKET PAGING REQUEST, the mobile station shall initiate the uplink TBF using a PACKET CHANNEL REQUEST with cause value of 'Page Response'.

NOTE: The mobile station initiates an implicit packet paging response by sending an LLC PDU to the network as defined in GSM 04.64 and GSM 04.08.

---

## 7 Medium Access Control (MAC) procedures on PCCCH

The establishment of a Temporary Block Flow (TBF) can be initiated by either the mobile station or the network.

The request for establishment of a TBF on PCCCH, if allocated in the cell, is described in this clause. If no PCCCH is allocated in the cell, the establishment of a TBF occurs on CCCH as described in GSM 04.08.

For mobile stations in packet idle mode on PCCCH, measurement reports messages are sent on temporary fixed allocations without the establishment of an uplink TBF. (see subclause 7.3)

### 7.1 TBF establishment initiated by the mobile station on PCCCH

The purpose of the packet access procedure is to establish a TBF to support the transfer of LLC PDUs in the direction from the mobile station to the network. Packet access shall be done on PCCCH, as defined in this clause, if a PCCCH exists. Otherwise, packet access shall be done on CCCH, as defined in GSM 04.08. The packet access can be done in either one phase (subclause 7.1.3) or in two phases (subclause 7.1.4). If the requested RLC mode is *unacknowledged mode*, the mobile station shall perform a two phase packet access.

TBF establishment can also be done on PACCH if a TBF for transfer of LLC PDUs in the direction from the network to the mobile station is already established (see subclause 8.1.1.1.3 and subclause 8.1.1.3.5).

The packet access procedure is initiated by the mobile station. Initiation is triggered by a request from upper layers to transfer a LLC PDU. The request from upper layers specifies a priority level to be associated with the packet transfer. Upon such a request,

- if access to the network is allowed (subclause 7.1.1), the mobile station shall initiate the packet access procedure as defined in subclause 7.1.3.1;
- otherwise, the RR sublayer in the mobile station shall reject the request.

#### 7.1.1 Permission to access the network

The network broadcasts the list of authorised access classes and authorised special access classes in the ACC\_CONTR\_CLASS parameter on PBCCH.

The network broadcasts a threshold specifying the Priority classes allowed for packet access in the cell in the PRIORITY\_ACCESS\_THR parameter on PBCCH.

Access to the network is allowed:

- if the mobile station is a member of at least one authorised access class or special access class as defined in GSM 04.08, and
- if packet access is allowed in the cell for the priority class required for the packet transfer, as indicated by the PRIORITY\_ACCESS\_THR parameter. The mobile station is not allowed to transmit an LLC PDU belonging to a lower priority class than the priority class granted by the network in response to a PACKET CHANNEL REQUEST or PACKET RESOURCE REQUEST message.

## 7.1.2 TBF establishment using one phase packet access

### 7.1.2.1 Initiation of the packet access procedure

The mobile station shall initiate the packet access procedure by scheduling the sending of PACKET CHANNEL REQUEST messages on PRACH and simultaneously leaving the packet idle mode and entering packet transfer mode. The mobile station shall continue to monitor PBCCH and PCCCH. A mobile station supporting GPRS MS class A or B shall respond to a PACKET PAGING REQUEST messages indicating an RR connection establishment. A mobile station supporting GPRS MS class B may abort the packet access procedure at the receipt of a PACKET PAGING REQUEST message indicating an establishment of an RR connection. PACKET PAGING REQUEST messages indicating a non-RR connection shall be ignored.

Mobile stations supporting GPRS MS class C shall ignore all PACKET PAGING REQUEST messages during the packet access procedure.

The PACKET CHANNEL REQUEST messages are sent on PRACH and contain an indication of the type of access and parameters required to indicate the mobile station's demand of radio resource.

There are two formats of the PACKET CHANNEL REQUEST message containing either 8 bit or 11 bit of information. The format to be applied on PRACH is controlled by the parameter ACC\_BURST\_TYPE which is broadcast on PBCCH.

The mobile station shall indicate Short Access as access type if the amount of data can fit in 8 or less than 8 RLC/MAC blocks. The number of blocks shall be calculated assuming channel coding scheme CS-1. If the amount of data to send takes more than 8 RLC/MAC blocks, the mobile station shall request either one phase access or two phase access.

There are two possible algorithms to be used for PRACH access persistence: the network steered and the mobile station steered method. If the values of RO\_PRI and K\_IJ are broadcast on PBCCH, the mobile station shall use the network steered method for access persistence control (as described in subclause 7.1.2.1.1). Otherwise the mobile station steered method, shall be used (subclause 7.1.2.1.2).

#### 7.1.2.1.1 Access persistence control on PRACH, the network steered method

The PERSISTENCE\_LEVEL parameters shall be broadcast on PBCCH or PAGCH. They consist of the PERSISTENCE\_LEVEL P(i) for each priority class i (i = 1, 2, 3, 4); where  $P(i) \in \{0, 1, \dots, 14, 16\}$ .

The mobile station shall monitor the PERSISTENCE\_LEVEL parameters on the PBCCH and PAGCH.

For each TDMA frame containing PRACH on PDCH matching the mobile station's PCCCH\_GROUP (see GSM 05.02), the mobile station shall draw a random value R with uniform probability distribution in the set  $\{0, 1, \dots, 15\}$ . The mobile station is allowed to transmit a PACKET CHANNEL REQUEST message if P(i), where i is the priority level of the TBF being established, is less or equal to R.

At sending of the first PACKET CHANNEL REQUEST message, timer T3160 shall be started.

After sending the PACKET CHANNEL REQUEST message, the mobile station shall listen to the PBCCH; it shall also listen to the PAGCH that corresponds to the PRACH (i.e. same PDCH).

At expiry of T3160 no more PACKET CHANNEL REQUEST messages shall be sent. The mobile station shall start timer T3170. At expiry of timer T3170, the packet access procedure shall be aborted and a failure shall be indicated to the upper layer.

### 7.1.2.1.2 Access persistence control on PRACH, the mobile station steered method

The mobile station shall make maximally  $M + 1$  attempts to send a PACKET CHANNEL REQUEST message in a way such that:

- the number of timeslots belonging to the PRACH between the initiation of the packet access procedure and the first attempt to send a PACKET CHANNEL REQUEST message, excluding the timeslot potentially containing the message itself, is a random value drawn for each new initial assignment initiation with uniform probability distribution in the set  $\{0, 1, \dots, \max(T,8) - 1\}$ ;
- the number of slots belonging to the PRACH on the PDCH defined by the PCCCH group for the mobile station between two successive attempts to send a PACKET CHANNEL REQUEST message excluding the timeslots potentially containing the messages themselves is a random value drawn for each transmission with uniform probability distribution in the set  $\{S, S + 1, \dots, S + T - 1\}$ ;

Here,  $M$  is the value of the parameter MAX\_RETRANS, broadcast on PBCCH and belonging to the priority class of the access;

$T$  is the value of the parameter TX\_INT broadcast on PBCCH;

$S$  is the value of the parameter S broadcast on PBCCH.

After sending the PACKET CHANNEL REQUEST message, the mobile station shall listen to the PBCCH; it shall also listen to the PAGCH that corresponds to the PRACH.

Having made  $M + 1$  attempts to send a PACKET CHANNEL REQUEST, the mobile station shall start timer T3170. At expiry of timer T3170, the packet access procedure shall be aborted and a failure shall be indicated to the upper layer.

### 7.1.2.2 Packet immediate assignment procedure

#### 7.1.2.2.1 On receipt of a PACKET CHANNEL REQUEST message

On receipt of a PACKET CHANNEL REQUEST message, the network may assign a radio resource on one or more PDCHs to be used by the mobile station for the TBF.

The allocated PDTCH and PACCH resource is assigned to the mobile station in a PACKET UPLINK ASSIGNMENT message, sent on the same PCCCH on which the network has received the PACKET CHANNEL REQUEST message. There is no further restriction on what part of the downlink PCCCH a PACKET UPLINK ASSIGNMENT message may be sent.

The Packet Request Reference information element shall be used to address the mobile station and frequency parameters shall be included.

If the dynamic allocation medium access mode is used, the network shall include the USF values allocated for PDCHs in the PACKET UPLINK ASSIGNMENT message.

If the mobile station multislot class indicates that fixed allocation is supported, the network may assign fixed resources to the mobile station. In that case, the PACKET UPLINK ASSIGNMENT message shall include an ALLOCATION\_REFERENCE and an ALLOCATION\_BITMAP. The network may include gaps in the ALLOCATION\_BITMAP where the mobile station shall monitor the PACCH and perform neighbour cell power measurements.

If the RESPONSE\_INDICATOR parameter in the PACKET UPLINK ASSIGNMENT message denotes one phase packet access, the mobile station shall proceed with the one phase packet access procedure. Otherwise, the mobile station shall perform a two phase packet access.

Initial timing advance may be provided in the PACKET UPLINK ASSIGNMENT in the TIMING\_ADVANCE\_VALUE field.

Thereafter either the timing advance is updated with a PACKET TIMING ADVANCE/POWER CONTROL message or a continuous timing advance procedure is used. If a Timing Advance Index is included in the assignment message, the mobile station shall use the continuous update timing advance mechanism, using its allocation on PTCCH (see GSM 05.10). Otherwise, the continuous update timing advance mechanism shall not be used. For the case where a

TIMING\_ADVANCE\_VALUE field is not provided in the assignment message, the mobile station is not allowed to send normal bursts on the uplink until it receives a valid timing advance either through the continuous timing advance procedure or in a PACKET TIMING ADVANCE/POWER CONTROL message.

The mobile station shall use information received on the PBCCH to decode the channel descriptions contained in the assignment.

If the mobile station receives a PACKET SYSTEM INFORMATION TYPE 2 or a PACKET UPLINK ASSIGNMENT bis message containing a Packet Request Reference information element corresponding to one of the mobile station's three last PACKET CHANNEL REQUEST messages, the mobile station shall store the PACKET SYSTEM INFORMATION TYPE 2 or PACKET UPLINK ASSIGNMENT bis message. If the mobile station receives a subsequent PACKET SYSTEM INFORMATION TYPE 2 or a PACKET UPLINK ASSIGNMENT bis message containing a Packet Request Reference information element corresponding to one of the mobile station's three last PACKET CHANNEL REQUEST messages, the mobile station shall replace the stored message with the more recently received message.

On receipt of a PACKET UPLINK ASSIGNMENT message corresponding to one of its 3 last PACKET CHANNEL REQUEST messages, if the field 2\_MESSAGE\_UPLINK\_ASSIGNMENT indicates the PACKET UPLINK ASSIGNMENT message is self contained, the mobile station shall stop timer T3160 and T3170 if running, stop sending PACKET CHANNEL REQUEST messages, and switch to the assigned PDCHs. If the field 2\_MESSAGE\_UPLINK\_ASSIGNMENT indicates that the PACKET UPLINK ASSIGNMENT message is not self contained, the mobile station shall wait for the second message of the 2 message assignment. When the mobile station receives the second message of the 2 message assignment, or if it has already received the second message of the 2 message assignment, the mobile station shall stop timer T3160 and T3170 if running, stop sending PACKET CHANNEL REQUEST messages, and switch to the assigned PDCHs.

A PACKET UPLINK ASSIGNMENT message may indicate an assignment starting time in the TBF Starting Time parameter. The mobile station shall monitor PCCCH until the point in time denoted by the TBF Starting Time. Thereafter it shall switch to the assigned PDCHs. If the mobile station receives more than one PACKET UPLINK ASSIGNMENT message, it shall act upon the most recently received message.

#### 7.1.2.2.2 Packet access queuing notification procedure

The network may send to the mobile station a PACKET QUEUING NOTIFICATION message. The PACKET QUEUING NOTIFICATION message shall be sent on the same PCCCH on which the network has received the PACKET CHANNEL REQUEST message. It contains a Temporary Queuing Identity which is later used to identify the mobile station (either when polling or sending an assignment).

On receipt of a PACKET QUEUING NOTIFICATION message corresponding to one of its 3 last PACKET CHANNEL REQUEST messages, the mobile station shall stop timer T3160 and T3170 if running, start timer T3162, and stop sending PACKET CHANNEL REQUEST messages. It shall continue to listen to the PBCCH and the PCCCH. If the mobile station receives a PACKET QUEUING NOTIFICATION message while waiting for the TBF Starting Time of a valid PACKET UPLINK ASSIGNMENT message, the mobile station shall ignore the PACKET QUEUING NOTIFICATION.

The network may send to the mobile station a PACKET UPLINK ASSIGNMENT message following a PACKET QUEUING NOTIFICATION message. In this case, the reference address to the mobile station shall be the Temporary Queuing Identity received in the PACKET QUEUING NOTIFICATION message.

On receipt of a PACKET UPLINK ASSIGNMENT message following a PACKET QUEUING NOTIFICATION message, the mobile station shall stop timer T3162, start timer T3164, and switch to the assigned PDCHs, as further defined in subclause 7.1.3.2.1.

On expiry of timer T3162, the packet access procedure shall be aborted and a packet access failure is indicated to the upper layer.

#### 7.1.2.2.3 Packet polling procedure

The network may send to the mobile station a PACKET POLLING message, after having sent a PACKET QUEUING NOTIFICATION message. The PACKET POLLING message shall be sent on the same PDCH on which the network has received the PACKET CHANNEL REQUEST message. The mobile station shall be addressed by the Temporary Queuing Identity.

On receipt of a PACKET POLLING message, the mobile station shall restart the timer T3162 and respond to the network with the PACKET CONTROL ACKNOWLEDGEMENT message in the allocated uplink radio block.

#### 7.1.2.2.4 Packet access reject procedure

The network may send to the mobile station a PACKET ACCESS REJECT message on the same PCCCH on which the channel request message was received. There is no further restriction on what part of the downlink PCCCH a PACKET ACCESS REJECT message can be sent. This message contains the request reference with time of reception of the PACKET CHANNEL REQUEST message, and a packet access reject cause.

On receipt of a PACKET ACCESS REJECT message with Reject Cause of Wait, where the message corresponds to one of its 3 last PACKET CHANNEL REQUEST messages,

the mobile station shall stop sending PACKET CHANNEL REQUEST messages, start timer T3172 with the indicated value, (Wait Indication), start timer T3162 if it has not already been started, stop timer T3160 if running, and listen to the downlink PCCCH until timer T3162 expires. During this time, the mobile station shall ignore additional PACKET ACCESS REJECT messages, but on reception of any PACKET UPLINK ASSIGNMENT message corresponding to any other of its 3 last PACKET CHANNEL REQUEST messages the mobile station shall stop timers T3162 and T3172, and follow the same procedure as for receiving a PACKET UPLINK ASSIGNMENT message following a PACKET QUEUING NOTIFICATION message, described in subclause 7.1.3.2.2.

If no PACKET UPLINK ASSIGNMENT message is received before expiration of timer T3162, the mobile station shall return to packet idle mode (listening to its paging channel). As an option the mobile station may stop timer T3162 and return to packet idle mode as soon as it has received responses from the network on all, or in case more than 3 were sent, the last 3 of its PACKET CHANNEL REQUEST messages.

The mobile station is not allowed to make a new attempt for packet access in the same cell until timer T3172 expires, but may attempt packet access in an other cell after successful cell reselection. A mobile station supporting GPRS MS class A or B may attempt to enter the dedicated mode in the same cell before timer T3172 has expired. During the time T3172 is running, the mobile station shall ignore all received PACKET PAGING REQUEST messages.

The value of the Wait Indication (i.e. timer T3172) relates to the cell from which it was received.

On receipt of a PACKET ACCESS REJECT message with Reject Cause "Read System Information", the mobile station shall stop timers T3160 and T3162 if running and return to packet idle mode. Before initiating a new packet access procedure the mobile station shall decode the PRACH Control Parameters if they are broadcast.

#### 7.1.2.3 Contention resolution at one phase access

In order to uniquely identify the mobile station when sending on uplink, the RLC Header for the first three RLC data block on uplink is extended to include the TLLI of the mobile station. At sending of the first RLC data block, the mobile station shall stop timer T3164, set counter N3104 to 1, and start timer T3166.

The counter N3104 shall be stepped each time the mobile station sends an RLC data block.

The network shall respond by including the TLLI in the PACKET UPLINK ACK/NACK message after the first correctly received RLC data block that comprises the TLLI.

The contention resolution is completed on the network side when the network receives a TLLI value identifying the mobile station, as part of the contention resolution procedure on the TBF.

The contention resolution is completed on the mobile station side when the mobile station receives a PACKET UPLINK ACK/NACK message with the same TLLI as the mobile station has included in the RLC header of the first RLC data blocks. The mobile shall then stop timer T3166 and counter N3104.

The contention resolution has failed on the mobile station side when the counter N3104 has reached its maximum value, or on expiry of timer T3166, or if the mobile station receives a PACKET UPLINK ACK/NACK message with the right TFI but with another TLLI than the mobile station has included in the RLC header of the first RLC data blocks. The mobile station shall then reset the counter N3104, stop timer T3166 if not expired, immediately stop transmitting on this

TBF and reinitiate the packet access procedure unless it has already been repeated 4 times. In that case, TBF failure has occurred.

#### 7.1.2.4 One phase packet access completion

The one phase packet access procedure is completed upon a successful contention resolution. The mobile station has entered the packet transfer mode.

### 7.1.3 TBF establishment using two phase access

#### 7.1.3.1 Initiation of the Packet resource request procedure

In the first phase of a two phase access the same procedures as for one phase access are used until the network sends a PACKET UPLINK ASSIGNMENT message with Response Indicator denoting two phase access to the mobile station. In that message, the network reserves a limited resource on one PDCH to the mobile station where the mobile station transmits a PACKET RESOURCE REQUEST message.

A two phase access can be initiated:

- by the network by ordering the mobile station to send a PACKET RESOURCE REQUEST message. The order is sent in the PACKET UPLINK ASSIGNMENT message in the parameter Response Indicator;
- by a mobile station, by requiring a two phase access in the PACKET CHANNEL REQUEST message. In this case, the network may order the mobile station to send a PACKET RESOURCE REQUEST message. The order is sent in the PACKET UPLINK ASSIGNMENT message in the parameter Response Indicator. If the network does not set the Response Indicator, the mobile station shall continue with a one phase access procedure.

At sending of the PACKET RESOURCE REQUEST message, the mobile station shall start timer T3168.

- The PACKET RESOURCE REQUEST message is sent by the mobile station to the network. In a message from a mobile station requesting Fixed Allocation, ALLOCATION\_REFERENCE and the MS Measurement Capability shall be included.

The mobile station shall indicate in the RLC\_OCTET\_COUNT the number of octets of user data that it has to be transferred in the TBF. If the dynamic allocation or extended dynamic allocation medium access method is used, the maximum value of RLC\_OCTET\_COUNT shall be interpreted as a request for an open ended TBF by the mobile station. If the fixed allocation medium access method is used, the maximum value of RLC\_OCTET\_COUNT shall be interpreted as a request for the maximum number of octets.

#### 7.1.3.2 Packet resource assignment for uplink procedure

##### 7.1.3.2.1 On receipt of a PACKET RESOURCE REQUEST message

On receipt of a PACKET RESOURCE REQUEST message, the network shall respond by sending a PACKET UPLINK ASSIGNMENT (radio resources assignment on one or more PDCHs to be used by the mobile station for the TBF) or a PACKET ACCESS REJECT message to the mobile station on PAGCH on the same PDCH on which the network has received the PACKET RESOURCE REQUEST message.

If the mobile station receives a PACKET SYSTEM INFORMATION TYPE 2 or a PACKET UPLINK ASSIGNMENT bis message addressed to the mobile station's TLLI, the mobile station shall store the PACKET SYSTEM INFORMATION TYPE 2 or PACKET UPLINK ASSIGNMENT bis message. If the mobile station receives a subsequent PACKET SYSTEM INFORMATION TYPE 2 or a PACKET UPLINK ASSIGNMENT bis message addressed to the mobile station's TLLI, the mobile station shall replace the stored message with the more recently received message.

On receipt of a PACKET UPLINK ASSIGNMENT message, if the field 2\_MESSAGE\_UPLINK\_ASSIGNMENT indicates the PACKET UPLINK ASSIGNMENT message is self contained, the mobile station shall switch to the assigned PDCHs. If the field 2\_MESSAGE\_UPLINK\_ASSIGNMENT indicates that the PACKET UPLINK ASSIGNMENT message is not self contained, the mobile station shall wait for the second message of the 2 message



assignment. When the mobile station receives the second message of the 2 message assignment, or if it has already received the second message of the 2 message assignment, the mobile station shall switch to the assigned PDCHs.

On receipt of a PACKET ACCESS REJECT message with Reject Cause of Wait, the mobile station shall stop timer T3168 and start timer T3172 with the indicated value (Wait Indication). The mobile station is not allowed to make a new attempt for packet access in the same cell until timer T3172 expires, but may attempt packet access in an other cell after successful cell reselection. When timer T3172 expires, the mobile station may initiate the establishment on an uplink TBF on CCCH or PCCCH.

On receipt of a PACKET ACCESS REJECT message with Reject Cause "Read System Information", the mobile station shall stop timer T3168 and shall decode the PACKET SYSTEM INFORMATION messages, if broadcast, or the SYSTEM INFORMATION messages before re-attempting the uplink TBF establishment.

On expiry of timer T3168, contention resolution has failed on the mobile station side. The mobile station shall then reinitiate the packet access procedure unless it has already been repeated 4 times. In that case, TBF failure has occurred.

### 7.1.3.3 Contention resolution at two phase access

The contention resolution is completed on the network side when the network receives a TLLI value identifying the mobile station, as part of the contention resolution procedure on the TBF.

The contention resolution is completed on the mobile station side when the mobile station receives a PACKET UPLINK ASSIGNMENT message with the same TLLI as the mobile station has included in the PACKET RESOURCE REQUEST message. The mobile shall then stop timer T3168.

The contention resolution has failed on the mobile station side when the mobile station receives a PACKET UPLINK ASSIGNMENT message with the same TFI but with another TLLI than the one the mobile station has included in the PACKET RESOURCE REQUEST message. The mobile station shall then reinitiate the packet access procedure unless it has already been repeated 4 times. In that case, TBF failure has occurred.

### 7.1.3.4 Two phase packet access completion

The two phase packet access procedure is completed upon a successful contention resolution. The mobile station has entered the packet transfer mode.

## 7.1.4 Abnormal cases

If a failure occurs on the mobile station side of the new TBF before mobile station has successfully entered the packet transfer mode, the newly reserved resources are released; the subsequent behaviour of the mobile station depends on the type of failure and previous actions.

- If the failure is due to a TLLI mismatch in the contention resolution procedure, and repetition as described in subclause 7.1.3.3 or subclause 7.1.4.3 has been performed, the mobile station shall remain in packet idle mode, notify higher layer (TBF establishment failure), transactions in progress shall be aborted and cell reselection continued.
- If the mobile station has been assigned more PDCHs than it supports according to its MS multislot class, the mobile station shall reinitiate the packet access procedure unless it has already been repeated 4 times. In that case, TBF failure has occurred.
- On expiry of timer T3164, a new packet access procedure may be initiated.
- If the failure is due to any other reason, the mobile station shall return to packet idle mode, notify higher layer (TBF establishment failure), transactions in progress shall be aborted and cell reselection continues.

## 7.2 TBF establishment initiated by the network on PCCCH

The purpose of network initiated TBF establishment is to establish a TBF to support the transfer of LLC PDUs in the direction from the network to the mobile station. The procedure may be entered when the mobile station is in packet idle mode. Network initiated TBF establishment can also be done on PACCH if a TBF for transfer of LLC PDUs in the direction from the mobile station to the network is already established (subclause 8.1.2.5).

## 7.2.1 Entering the packet transfer mode

The procedure is triggered by a request from upper layers on the network side to transfer a LLC PDU to a mobile station in packet idle mode. The request from upper layers specifies a priority level, DRX parameters, multislot class and mobile classmark to be associated with the packet transfer. The request is implicit when receiving a LLC PDU to a mobile station not already having any assigned radio resources. Upon such a request, the network shall initiate a packet downlink assignment procedure as defined in subclause 7.2.1.1.

### 7.2.1.1 Packet downlink assignment procedure

The network may assign a radio resource on one or more PDCHs to be used for the TBF. The amount of radio resource to be reserved is a network dependent choice.

The allocated radio resource is assigned to the mobile station in a PACKET DOWNLINK ASSIGNMENT message to the mobile station. The PACKET DOWNLINK ASSIGNMENT message is transmitted on PAGCH which is mapped on the proper block that is currently monitored by mobile station (see GSM 05.02). The multislot capabilities of the mobile station must be considered.

Initial timing advance can be provided in the PACKET DOWNLINK ASSIGNMENT as Timing Advance Value field. In case valid timing advance for the mobile station is not available and the CONTROL\_ACK\_TYPE parameter in the System Information indicates acknowledgement is access bursts, the network may set the poll bit in the PACKET DOWNLINK ASSIGNMENT message. The mobile station shall then send the PACKET CONTROL ACKNOWLEDGEMENT as four access bursts, which is used to derive the timing advance

Thereafter, either the timing advance in the mobile station is updated with a PACKET TIMING ADVANCE/POWER CONTROL message or a continuous timing advance procedure is used. If a Timing Advance Index is included in the assignment message, the mobile station shall use the continuous update timing advance mechanism, using its allocation on PTCCH (see GSM 05.10). Otherwise the continuous update timing advance mechanism shall not be used. For the case where Timing Advance Value is not provided in the assignment message, the mobile station is not allowed to send normal bursts (e.g. PACKET UPLINK ACK/NACK) on the uplink until it receives a valid timing advance either through the continuous timing advance procedure or in a PACKET TIMING ADVANCE/POWER CONTROL message.

A PACKET DOWNLINK ASSIGNMENT message may indicate an assignment starting time in the TBF Starting Time parameter. The mobile station shall monitor PCCCH until the point in time denoted by the TBF Starting Time. Thereafter it shall switch to the assigned PDCHs.

In the assignment using Fixed Allocation access method, the network may use the Measurement Starting time, Interval and Bitmap parameters to define when the mobile station shall monitor the PACCH and perform adjacent channel measurements.

The mobile station shall use information received on the PBCCH to decode the channel descriptions contained in the assignment. If frequency hopping is applied, the mobile station shall use the last CA received on PBCCH to decode the Mobile Allocation. Alternatively, the network provide a Mobile Allocation and CA in a PACKET SYSTEM INFORMATION TYPE 2 message addressed to the mobile station.

If the mobile station receives a PACKET SYSTEM INFORMATION TYPE 2 message addressed to the mobile station's TLLI, the mobile station shall store the PACKET SYSTEM INFORMATION TYPE 2 message. If the mobile station receives a subsequent PACKET SYSTEM INFORMATION TYPE 2 addressed to the mobile station's TLLI, the mobile station shall replace the stored message with the more recently received message.

The radio resource is assigned to the mobile station in a PACKET DOWNLINK ASSIGNMENT message. On receipt of a PACKET DOWNLINK ASSIGNMENT message, if the field 2\_MESSAGE\_DOWNLINK\_ASSIGNMENT indicates the PACKET DOWNLINK ASSIGNMENT message is self contained, the mobile station shall switch to the assigned PDCHs. If the field 2\_MESSAGE\_DOWNLINK\_ASSIGNMENT indicates that the PACKET DOWNLINK ASSIGNMENT message is not self contained, the mobile station shall wait for the second message of the 2 message assignment. When the mobile station receives the second message of the 2 message assignment, or if it has already received the second message of the 2 message assignment, the mobile station shall switch to the assigned PDCHs.

When receiving the PACKET DOWNLINK ASSIGNMENT message and after waiting the TBF Starting Time when applicable, the mobile station starts timer T3190. The timer is reset when receiving the first valid RLC/MAC block.

On expiry of timer T3190, the mobile station shall abort the procedure and return to packet idle mode.

The network shall wait at least one block period after sending the PACKET DOWNLINK ASSIGNMENT message before starting to send the first RLC/MAC block if no PACKET CONTROL ACKNOWLEDGEMENT is requested. Otherwise, the network shall wait at least one block period after receiving the PACKET CONTROL ACKNOWLEDGEMENT before sending the first RLC/MAC block to the mobile station.

#### 7.2.1.2 Packet downlink assignment procedure completion

The Packet downlink assignment procedure is completed when the mobile station receives a valid RLC/MAC block. The mobile station has entered the packet transfer mode.

#### 7.2.1.3 Packet polling procedure

The network may send to the mobile station a PACKET POLLING message. The PACKET POLLING message shall be sent on PAGCH. The mobile station shall be addressed by its TLLI.

On receipt of a PACKET POLLING message, the mobile station shall respond to the network with the PACKET CONTROL ACKNOWLEDGEMENT message in the allocated block period.

### 7.2.2 Abnormal cases

If a failure occurs on the mobile station side of the new TBF before mobile station has successfully entered the packet transfer mode, the newly reserved resources are released; the subsequent behaviour of the mobile station depends on the type of failure and previous actions.

- If the mobile station has been assigned more PDCHs than it supports according to its MS multislot class, the mobile station shall return to packet idle mode.
- On expiry of timer T3190, the mobile station shall return to packet idle mode.
- If the failure is due to any other reason, the mobile station shall return to packet idle mode and cell reselection continues.

## 7.3 Procedure for measurement report in packet idle mode

The procedure for measurement report sending on is initiated by the mobile station on PCCCH. Initiation is triggered by expiry of a MM ready state measurement report interval timer or a packet idle mode measurement report interval timer. The mobile station shall initiate the packet access procedure as defined in subclause 7.1.3.1 but with access type 'Measurement Report'. The mobile station may ignore PACKET POLLING messages.

The procedure for measurement report initiation on CCCH is defined in GSM 04.08.

### 7.3.1 On receipt of a PACKET CHANNEL REQUEST message

On receipt of a PACKET CHANNEL REQUEST message with access type indicating measurement report, the network may allocate one radio block on an uplink PDCH.

Whether or not a radio resource is reserved is a network dependent choice.

The radio resource is assigned to the mobile station in a PACKET UPLINK ASSIGNMENT message, sent on the same PCCCH on which the network has received the PACKET CHANNEL REQUEST message. There is no further restriction on what part of the downlink PCCCH the PACKET UPLINK ASSIGNMENT message may be sent.

The mobile station may ignore the RESPONSE\_INDICATOR parameter and the CHANNEL\_CODING\_COMMAND in the PACKET UPLINK ASSIGNMENT message.

The mobile station shall use information received on the PBCCH to decode the channel descriptions contained in the assignment. If the MA\_CHANGE\_MARK received in the PACKET UPLINK ASSIGNMENT message does not match

the mobile station's stored MA\_CHANGE\_MARK, the mobile station shall abort the procedure, read all of the PACKET SYSTEM INFORMATION TYPE 2 messages on the PBCCH, and then re-initiate this procedure.

On receipt of a PACKET UPLINK ASSIGNMENT message corresponding to one of its 3 last PACKET CHANNEL REQUEST messages, the mobile station shall stop timer T3160 (if running), stop sending PACKET CHANNEL REQUEST messages, and switch to the assigned PDCH.

The mobile station then sends PACKET MEASUREMENT REPORT in the allocated radio block on the assigned PDCH and immediately switches back to the PCCCH. No TBF is established and the network shall not acknowledge the reception of the PACKET MEASUREMENT REPORT.

#### 7.3.1.1 Packet access reject procedure

The network may send to the mobile station a PACKET ACCESS REJECT message.

The mobile station shall react to this as described in subclause 7.1.3.2.4.

#### 7.3.1.2 Abnormal cases

If a failure occurs on the mobile station side, before the procedure for measurement report is successfully performed, the mobile station shall abort the procedure and return to packet idle mode.

---

## 8 Medium Access Control (MAC) Procedures in Packet Transfer Mode

### 8.1 Transfer of RLC data blocks

The transfer of RLC data blocks is governed by different principles on both uplink and downlink for each of the defined medium access modes: dynamic allocation, extended dynamic allocation, and fixed allocation. The medium access mode the mobile station is to use is signalled in the MAC\_MODE parameter of the PACKET UPLINK ASSIGNMENT and PACKET DOWNLINK ASSIGNMENT messages.

#### 8.1.1 Uplink RLC data block transfer

Prior to the initiation of RLC data block transfer on the uplink, the network assigns the following parameters to the downlink TBF in the PACKET UPLINK ASSIGNMENT message:

- a unique Temporary Flow Identity (TFI). The mobile station shall set the TFI field of each uplink RLC data block to the TFI value assigned to the mobile station in the PACKET UPLINK ASSIGNMENT message.
- a set of PDCHs to be used for the uplink transfer;
- optionally, a TBF Starting Time indication.

The first three RLC data blocks of an uplink TBF shall each contain a TLLI field in the RLC data block header. No other RLC data blocks shall contain a TLLI field. The TLLI\_BLOCK\_CHANNEL\_CODING parameter in the PACKET UPLINK ASSIGNMENT message indicates whether a RLC data block containing a TLLI field in the RLC data block header shall be encoded using CS-1 or using the channel coding scheme commanded. (see GSM 05.03). The mobile station shall send all other RLC data blocks using the channel coding scheme commanded.

The mobile station shall transmit RLC/MAC blocks with the following priority:

- RLC control blocks, except Packet Dummy Control Blocks
- RLC data blocks
- RLC control blocks containing Packet Dummy Control Blocks

If the mobile station has received a PACKET CHANGE ORDER message commanding the mobile station to send measurement reports while in packet transfer mode, the mobile station shall send the PACKET MEASUREMENT REPORT on the uplink PACCH at the repetition rate specified

Whenever a mobile station needs to monitor the BCCH or PBCCH on the serving cell or other cells, the mobile station may temporarily ignore the uplink medium access command to transmit (i.e., USF bits or Allocation Bitmap). The mobile station shall omit no more than 8 allocated block periods in a 12 block period interval. The mobile station shall omit no more than 75 allocated block periods in every 15 second interval..

#### 8.1.1.1 Dynamic allocation uplink RLC data block transfer

When the mobile station receives a complete uplink assignment, the mobile station shall immediately begin monitoring the assigned PDCHs for the assigned USF value for each assigned PDCH. If a TBF starting time information element is present and no uplink TBF is in progress, the mobile station may wait until the starting time expires before beginning to monitor for the USFs. While waiting for the starting time to expire, the mobile station shall monitor the PDCH carrying its assigned PACCH. If an uplink TBF is already in progress, the mobile station shall continue to use the assigned parameters of the uplink TBF until the TDMA framenummer indicated by the TBF starting time occurs, at which time the mobile station shall immediately begin to use the newly assigned uplink TBF parameters.

If the PACKET UPLINK ASSIGNMENT message contains the RLC\_DATA\_BLOCKS\_GRANTED information element, the mobile station shall transmit only the specified number of RLC data blocks within the TBF. Retransmissions of RLC data blocks and RLC control blocks do not count toward the limit. When the mobile station nears the end of the fixed length TBF, it shall begin the count down procedure so that it sends the last RLC data block when CV = 0 (see subclause 9.3.1). The mobile station and network shall then follow the appropriate procedure for release of TBF defined in subclause 9.3.2.3 or subclause 9.3.3.3.

Whenever the mobile station detects an assigned USF value on an assigned PDCH, the mobile station shall transmit one or four RLC/MAC blocks on the same PDCH in the next block period(s) (see GSM 05.02). The choice is steered by the value in the USF\_GRANULARITY field received in the PACKET UPLINK ASSIGNMENT message.

When the mobile station transmits an RLC/MAC block to the network, it shall start timer T3180. When the mobile station detects an assigned USF value on an assigned PDCH, the mobile station shall reset timer T3180. If timer T3180 expires, the mobile station shall perform the abnormal release with random access procedure (see subclause 8.6.2).

Whenever the network receives a valid RLC/MAC block from the mobile station, it shall reset counter N3101. The network shall increment counter N3101 for each radio block, allocated to that mobile station, for which no data is received. If  $N3101 = N3101_{max}$ , the network shall abort the uplink TBF internally and start timer T3169. When T3169 expires, the network may reuse the USF and TFI.

##### 8.1.1.1.1 PACCH operation

The mobile station shall attempt to decode every downlink RLC/MAC block on all assigned PDCHs. Whenever the mobile station receives an RLC/MAC block containing an RLC control block, the mobile station shall attempt to interpret the message contained therein. If the message addresses the mobile station, the mobile station shall act on the message.

Whenever the mobile station detects an assigned USF value on any assigned PDCH, the mobile station may transmit a PACCH block on the same PDCH in the next block period (see GSM 05.02). The mobile station shall not transmit an RLC data block in any uplink radio block allocated via the polling mechanism (see subclause 10.4.4).

##### 8.1.1.1.2 Resource Reallocation for Uplink

During an uplink packet transfer, upper layers may request to transfer another LLC PDU with a different priority level, a different throughput class or a different RLC mode than the one which is in transfer.

If the upper layers request to transfer a new LLC PDU with the same RLC mode as before, and when the mobile station starts sending a new LLC PDU with a different priority level or a different throughput class than before, the mobile station shall then request a resource reallocation for uplink according to the new priority level and new throughput class by sending a PACKET RESOURCE REQUEST message on the PACCH and starting timer T3168.

As an exception to this rule, in RLC acknowledged mode, and if the new LLC PDU has either a lower priority level or a lower throughput class than the one which is in transfer, the mobile station may first complete the sending of the LLC

PDU in transfer, including acknowledgement from the network. When the sending of LLC PDUs at the higher priority level or the higher throughput class stops, the mobile station shall then perform the request of a resource reallocation for uplink for any remaining LLC PDU(s) by sending a PACKET RESOURCE REQUEST message on the PACCH and start timer T3168.

On receipt of the PACKET RESOURCE REQUEST the network shall respond by sending a PACKET UPLINK ASSIGNMENT, and optionally a PACKET SYSTEM INFORMATION TYPE 2 message addressed to the mobile station, or a PACKET ACCESS REJECT message to the mobile station on the downlink PACCH.

If the mobile station receives a PACKET SYSTEM INFORMATION TYPE 2 addressed to the mobile station, the mobile station shall store the PACKET SYSTEM INFORMATION TYPE 2 message. If the mobile station receives a subsequent PACKET SYSTEM INFORMATION TYPE 2 message addressed to the mobile station, the mobile station shall replace the stored message with the more recently received message.

On receipt of a PACKET UPLINK ASSIGNMENT message, if the field 2\_MESSAGE\_UPLINK\_ASSIGNMENT indicates the PACKET UPLINK ASSIGNMENT message is self contained, the mobile station shall stop timer T3168 and switch to the assigned PDCHs. If the field 2\_MESSAGE\_UPLINK\_ASSIGNMENT indicates that the PACKET UPLINK ASSIGNMENT message is not self contained, the mobile station shall wait for the second message of the 2 message assignment. When the mobile station receives the second message of the 2 message assignment, or if it has already received the second message of the 2 message assignment, the mobile station shall stop timer T3168 and switch to the assigned PDCHs.

The mobile station is then not allowed to send new PACKET RESOURCE REQUEST messages until either a new packet transfer request is received from the upper layers or when resuming an interrupted sending of LLC PDU(s) at a lower priority level.

On expiry of timer T3168 the mobile station shall retransmit the PACKET RESOURCE REQUEST message.

The network may at any time initiate a change of resources by sending an unsolicited PACKET UPLINK ASSIGNMENT to the mobile station.

On receipt of a PACKET ACCESS REJECT message, the mobile station shall stop timer T3168, release the uplink TBF, and then, if it has additional RLC data blocks to transfer, initiate a new TBF establishment procedure.

The mobile station and the network are not allowed to change the RLC mode of an already established TBF during resource reallocation. Change of RLC mode shall be achieved through termination of on-going TBF and establishment of a new TBF with the newly requested RLC mode.

#### 8.1.1.1.2.1 Abnormal cases

The following abnormal cases apply:

- if the mobile station receives a PACKET UPLINK ASSIGNMENT message with an MA\_CHANGE\_MARK field whose value does not match the MA\_CHANGE\_MARK value stored in the mobile station, the mobile station shall perform an abnormal release with random access.
- if the mobile station receives a PACKET UPLINK message with a MA\_NUMBER information element specifying frequencies that are not all in one band then the mobile station shall perform an abnormal release with random access.

NOTE: A PACKET UPLINK ASSIGNMENT message received by a multi-band mobile station shall not be considered invalid if it indicates new frequencies that are all in a different frequency band to that of the ARFCN of the serving cell.

#### 8.1.1.1.3 Establishment of Downlink TBF

During uplink transfer, the network may initiate a downlink TBF by sending a PACKET DOWNLINK ASSIGNMENT message, or a PACKET TIMESLOT RECONFIGURE, and optionally a PACKET SYSTEM INFORMATION TYPE 2, to the mobile station on the PACCH. If a PACKET TIMESLOT RECONFIGURE message is sent, then the GLOBAL\_TFI\_ASSIGNMENT field shall assign a downlink TFI. The multislot restrictions of the mobile station shall be observed.

If the mobile station receives a PACKET SYSTEM INFORMATION TYPE 2 message addressed to the mobile station, the mobile station shall store the PACKET SYSTEM INFORMATION TYPE 2 message. If the mobile station receives a subsequent PACKET SYSTEM INFORMATION TYPE 2 addressed to the mobile station, the mobile station shall replace the stored message with the more recently received message.

The downlink radio resource is assigned to the mobile station in a PACKET DOWNLINK ASSIGNMENT message. On receipt of a PACKET DOWNLINK ASSIGNMENT message, if the field 2\_MESSAGE\_DOWNLINK\_ASSIGNMENT indicates the PACKET DOWNLINK ASSIGNMENT message is self contained, the mobile station shall switch to the assigned PDCHs. If the field 2\_MESSAGE\_DOWNLINK\_ASSIGNMENT indicates that the PACKET DOWNLINK ASSIGNMENT message is not self contained, the mobile station shall wait for the second message of the 2 message assignment. When the mobile station receives the second message of the 2 message assignment, or if it has already received the second message of the 2 message assignment, the mobile station shall switch to the assigned PDCHs.

The operation of the downlink TBF follows the procedures in subclause 8.1.2 with the following additions:

- the mobile station shall prioritize transmission of RLC control blocks associated with the downlink TBF over RLC control blocks associated with the uplink TBF;
- if a timer or counter expiry causes the uplink TBF to be aborted in the mobile station, the mobile station shall also abort the downlink TBF and perform the abnormal release with random access procedure (see subclause 8.6.2).

#### 8.1.1.1.3.1 Abnormal cases

If a failure occurs on the mobile station side before the new TBF has been successfully established, the newly reserved resources are released. The subsequent behaviour of the mobile station depends on the type of failure and previous actions:

- If the information available in the mobile station, after the reception of a PACKET DOWNLINK ASSIGNMENT message does not satisfactorily define a PDCH, the mobile station shall ignore the PACKET DOWNLINK ASSIGNMENT message.
- If the information in the PACKET TIMESLOT RECONFIGURE does not properly specify an uplink and downlink PDCH or violates the mobile station's multislot capabilities, the mobile station shall perform an abnormal release with random access.
- If the PACKET TIMESLOT RECONFIGURE does not include a downlink TFI in the GLOBAL\_TFI\_ASSIGNMENT field, then the mobile station shall perform an abnormal release with random access.
- If a failure in the PACKET TIMESLOT RECONFIGURE is due to any other reason, the mobile station shall abort the procedure and perform an abnormal release with random access.
- If a failure in the PACKET DOWNLINK ASSIGNMENT is due to any other reason, the mobile station shall abort the procedure and continue the normal operation of the uplink TBF.

#### 8.1.1.2 Extended Dynamic Allocation uplink RLC data block transfer

The Extended Dynamic Allocation medium access method extends the Dynamic Allocation medium access method to allow higher uplink throughput when used with multislot class type 3 (classes 19-29) MSs.

This subclause defines the extensions to the Dynamic Allocation medium access method. All procedures defined in subclause 8.1.1.1 apply, except where this subclause defines a new procedure. In cases where this subclause conflicts with subclause 8.1.1.1, this subclause takes precedence.

##### 8.1.1.2.1 Uplink PDCH Allocation

The PACKET UPLINK ASSIGNMENT message allocates to the mobile station a subset of 1 to N consecutive PDCHs, where N depends on the MSs multislot class.

The mobile station shall monitor its assigned PDCHs starting with the lowest numbered PDCH, then next highest numbered PDCH, then the next highest number PDCH, etc. Whenever the mobile station detects an assigned USF value on an assigned PDCH, the mobile station shall transmit an RLC/MAC block on the same PDCH in the next block period. The mobile station shall then transmit an RLC/MAC in each higher number assigned PDCH in the same block period, without monitoring the higher numbered PDCHs.

If the network reduces the number of PDCHs allocated to the mobile station per block period, the network shall not allocate any resources during one block period following the block period with the higher number of PDCHs allocated and the block period with the lower number of PDCHs allocated.

#### 8.1.1.2.2 PACCH operation

The mobile station shall attempt to decode every downlink RLC/MAC block on all monitored PDCHs. Whenever the mobile station receives an RLC/MAC block containing an RLC control block, the mobile station shall attempt to interpret the message contained therein. If the message addresses the mobile station, the mobile station shall act on the message.

The network shall transmit all PACCH messages on the first PDCH in the allocation.

Whenever the mobile station detects an assigned USF value on any assigned PDCH, the mobile station may transmit a PACCH block on the same PDCH in the next block period (see GSM 05.02). The mobile station shall not transmit an RLC data block in any uplink radio block allocated via the polling mechanism (see subclause 10.4.4).

#### 8.1.1.2.3 Neighbour cell power measurements

The mobile station shall perform neighbour cell measurements during any unused PDCH or group of unused PDCHs where the MS's Measurement Capabilities indicate that the mobile station is capable of making a neighbour cell measurement.

The network shall ensure that there are sufficient gaps as to allow the necessary number of measurements based upon the MS's Measurement Capabilities.

#### 8.1.1.3 Fixed Allocation uplink RLC data block transfer

At initiation of an uplink TBF using two phase access, the mobile station shall signal the number of ready RLC data octets in the RLC\_OCTET\_COUNT parameter of the PACKET RESOURCE REQUEST.

In a one phase access, the RLC\_OCTET\_COUNT shall default to 2400.

In a one phase access, the ALLOCATION\_REFERENCE shall default to a value of '00'.

##### 8.1.1.3.1 Transfer of RLC/MAC blocks

The PACKET UPLINK ASSIGNMENT message shall contain the following information when signalling a Fixed Allocation:

- a TIMESLOT\_ALLOCATION indicating which PDCHs are assigned to the fixed allocation;
- an ALLOCATION\_BITMAP indicating radio blocks assigned to the fixed allocation;
- a TBF starting time indicating the TDMA framenummer where the ALLOCATION\_BITMAP begins;
- an optional BLOCKS\_OR\_BLOCK\_PERIODS indication;
- an optional ALLOCATION\_BITMAP\_LENGTH.

The TIMESLOT\_BITMAP shall assign from 1 to 8 PDCHs to the fixed allocation. The multislot restrictions of the mobile station shall be observed.

If the BLOCKS\_OR\_BLOCK\_PERIODS field indicates blocks, then the bits in the ALLOCATION\_BITMAP correspond to radio blocks. Bits are included in the bitmap only for radio blocks on assigned PDCHs. Each bit in the bitmap indicates whether the corresponding radio block is assigned to the fixed allocation. The mobile station shall transmit an RLC/MAC block in each radio block assigned by the ALLOCATION\_BITMAP.



If the BLOCKS\_OR\_BLOCK\_PERIODS field indicates block periods, then the bits in the bitmap indicate which block periods are assigned to the allocation. The mobile station shall transmit an RLC/MAC block on each timeslot assigned in the TIMESLOT\_ALLOCATION field in each block period assigned to the allocation.

The ALLOCATION\_BITMAP\_LENGTH field, if present, indicates the length of the ALLOCATION\_BITMAP field. If not present, the ALLOCATION\_BITMAP continues until the end of the message.

The network shall acknowledge packet transfers by sending PACKET UPLINK ACK/NACK messages on the PACCH during gaps in the uplink allocation. The network shall maintain a count of the number of erroneous blocks received from the mobile and allocate additional resources for the retransmissions with a PACKET UPLINK ACK/NACK or an unsolicited PACKET UPLINK ASSIGNMENT message. The mobile station shall not request resources or adjust its RLC\_OCTET\_COUNT for retransmissions requested in the PACKET UPLINK ACK/NACK (see subclause 8.1.1.4.2). The mobile station may retransmit erroneous blocks in any allocated uplink block.

#### 8.1.1.3.2 Reallocation

During transfer of RLC/MAC blocks, a mobile station may request to continue the TBF by transmitting a PACKET RESOURCE REQUEST message on the uplink PACCH. The mobile station shall include as the ALLOCATION\_REFERENCE value  $n = [\text{previous ALLOCATION\_REFERENCE value} + 1] \text{ modulo } 4$ . The mobile station shall start timer  $T3186_n$ , where  $n$  indicates one of four instances of timer T3186.

The mobile station shall signal the number of ready RLC data octets in the RLC\_OCTET\_COUNT parameter of the PACKET RESOURCE REQUEST. The mobile shall always indicate the current state of its transmit buffer at the time the PACKET RESOURCE REQUEST message is sent. In RLC acknowledged mode, previously transmitted but currently unacknowledged octets shall not be included in the RLC\_OCTET\_COUNT.

The mobile station and the network are not allowed to change the RLC mode of an already established TBF during resource reallocation. Change of RLC mode shall be achieved through termination of on-going TBF and establishment of a new TBF with the newly requested RLC mode.

In response to the PACKET RESOURCE REQUEST with ALLOCATION\_REFERENCE value  $n$  during an uplink fixed allocation TBF, the network shall send a PACKET UPLINK ASSIGNMENT message with ALLOCATION\_REFERENCE value  $n$  or a PACKET UPLINK ACK/NACK with ALLOCATION\_REFERENCE value  $n$  and containing an ALLOCATION\_BITMAP. Or the network may indicate that the resource request has been queued by sending a PACKET UPLINK ACK/NACK to the mobile station with ALLOCATION\_REFERENCE value  $n$  but without an ALLOCATION\_BITMAP. Or the network may deny the resource request by sending the mobile station a PACKET ACCESS REJECT message with ALLOCATION\_REFERENCE value  $n$ .

Whenever the mobile station receives a PACKET UPLINK ASSIGNMENT or PACKET UPLINK ACK/NACK with an ALLOCATION\_BITMAP or REPEAT\_ALLOCATION, with ALLOCATION\_REFERENCE value  $n$ , in response to a PACKET RESOURCE REQUEST with ALLOCATION\_REFERENCE value  $n$ , the mobile station shall stop timer  $T3186_n$ . If there is a conflict between a previous allocation and the new allocation, the new allocation shall take precedence.

If the timer  $T3186_n$  expires before the mobile station receives a PACKET UPLINK ASSIGNMENT or REPEAT\_ALLOCATION, or PACKET UPLINK ACK/NACK message containing a ALLOCATION\_BITMAP, and with ALLOCATION\_REFERENCE value of  $n$ , the mobile station shall retransmit the PACKET RESOURCE REQUEST message using the same ALLOCATION\_REFERENCE value  $n$ . If timer  $T3186_n$  expires three times consecutively without reception of PACKET UPLINK ASSIGNMENT or PACKET UPLINK ACK/NACK containing a ALLOCATION\_BITMAP with the same ALLOCATION\_REFERENCE value  $n$ , the mobile station shall perform the Abnormal Release with Random Access procedure (see 8.6.2).

If the mobile station receives a PACKET UPLINK ACK/NACK message with ALLOCATION\_REFERENCE value  $n$  but without an ALLOCATION\_BITMAP, the mobile station shall stop timer  $T3186_n$ .

Whenever the mobile station receives a PACKET ACCESS REJECT message with ALLOCATION\_REFERENCE value  $n$ , the mobile station shall stop all instances of timer T3186, finish transmitting on any previously allocated resources, terminate the TBF normally, and then, if it has additional RLC data blocks to transfer, initiate a new establishment procedure on the RACH or PRACH.

When a mobile station initiates a fixed allocation TBF, it shall set counter N3100 to the value 0. When the mobile station receives a PACKET UPLINK ACK/NACK containing an ALLOCATION\_REFERENCE value  $n$  equal to the

ALLOCATION\_REFERENCE value  $n$  in the most recent PACKET RESOURCE REQUEST sent by the mobile station, it shall increment counter N3100. Each time the mobile station receives a PACKET UPLINK ASSIGNMENT message, it shall decrement N3100. N3100 shall not be decremented below the value 0. Whenever N3100 is equal to or greater than 2, the mobile station shall not send any PACKET RESOURCE REQUEST messages.

Whenever the mobile station receives a PACKET UPLINK ACK/NACK containing an ALLOCATION\_BITMAP, it shall begin transmitting on the new resources at the indicated TBF Starting Time. If there is a conflict between a previous allocation and the new allocation, the new allocation shall take precedence.

If the mobile receives a PACKET UPLINK ACK/NACK with a REPEAT\_ALLOCATION, the mobile shall start a new allocation when the current allocation ends. This new allocation shall begin immediately after the current allocation ends and shall use the most recently received ALLOCATION\_BITMAP. If the mobile station receives multiple PACKET UPLINK ACK/NACK messages with REPEAT\_ALLOCATION during an allocation, the mobile shall repeat the ALLOCATION\_BITMAP only once. If the mobile receives a PACKET UPLINK ACK/NACK without the REPEAT\_ALLOCATION indication, the mobile station shall transmit to the end of its current allocation without repeating the allocation, regardless of any previous REPEAT\_ALLOCATION indications that may have been received.

The network may also specify a TS\_OVERRIDE indication in the PACKET UPLINK ACK/NACK. The TS\_OVERRIDE applies to the next allocation after the current allocation expires. The TS\_OVERRIDE field is a bitmap with a bit corresponding to each timeslot. For each bit set in the TS\_OVERRIDE, the mobile shall disregard the ALLOCATION\_BITMAP for that timeslot and shall transmit on all uplink radio blocks for that timeslot for the duration of the next allocation. If a bit is not set in the TS\_OVERRIDE field, then the ALLOCATION\_BITMAP shall apply to that timeslot.

Whenever the mobile station exhausts its assigned fixed allocation and has more RLC data blocks to transmit, it shall start timer T3188. If the mobile station receives a PACKET UPLINK ASSIGNMENT message, the mobile station shall stop timer T3188 and use the new allocation.

If the mobile station receives a PACKET UPLINK ACK/NACK with an ALLOCATION\_BITMAP or REPEAT\_ALLOCATION, it shall stop timer T3188 and use the new allocation.

If the mobile station receives a PACKET UPLINK ACK/NACK with a REPEAT\_ALLOCATION after its current allocation has been exhausted, it shall wait until the next repeated allocation boundary and then begin transmitting using the repeated ALLOCATION\_BITMAP. The mobile shall stop timer T3188 and compute the number of blocks remaining in the repeated ALLOCATION\_BITMAP and use the remainder of the new allocation.

If timer T3188 expires, the mobile station shall abort the TBF and perform the Abnormal Release with Random Access procedure (see 8.6.2).

If the mobile station receives a PACKET SYSTEM INFORMATION TYPE 2 or a PACKET UPLINK ASSIGNMENT bis message addressed to the mobile station, the mobile station shall store the PACKET SYSTEM INFORMATION TYPE 2 or PACKET UPLINK ASSIGNMENT bis message. If the mobile station receives a subsequent PACKET SYSTEM INFORMATION TYPE 2 or a PACKET UPLINK ASSIGNMENT bis message addressed to the mobile station, the mobile station shall replace the stored message with the more recently received message.

On receipt of a PACKET UPLINK ASSIGNMENT message, if the field 2\_MESSAGE\_UPLINK\_ASSIGNMENT indicates the PACKET UPLINK ASSIGNMENT message is self contained, the mobile station shall switch to the assigned PDCHs. If the field 2\_MESSAGE\_UPLINK\_ASSIGNMENT indicates that the PACKET UPLINK ASSIGNMENT message is not self contained, the mobile station shall wait for the second message of the 2 message assignment. When the mobile station receives the second message of the 2 message assignment, or if it has already received the second message of the 2 message assignment, the mobile station shall switch to the assigned PDCHs.

#### 8.1.1.3.2.1 Abnormal Cases

If the mobile station receives a REPEAT\_ALLOCATION and the number of bits in the most recently received ALLOCATION\_BITMAP is not an integer multiple of the number of bits set in the most recently received TIMESLOT\_ALLOCATION, it shall perform the Abnormal Release with Random Access procedure (see subclause 8.5.2).

### 8.1.1.3.3 Neighbour cell power measurements

The mobile station shall signal its measurement capabilities in the PACKET RESOURCE REQUEST message.

If the multislot capabilities and timeslot assignment would prevent the mobile station from making a neighbour cell power measurement during 25 of every 26 TDMA frames, the network shall signal in the PACKET UPLINK ASSIGNMENT message the length and number of inactivity periods in the Measurement Mapping parameters during which the mobile station shall make neighbour cell power measurements.

If the mobile does not receive the Measurement Mapping parameters, the mobile station shall make neighbour cell power measurements according to its Measurement Capabilities during a gap of one or more radio blocks if:

- the gap does not meet the criteria for the downlink PACCH (see subclause 8.1.1.3.4); and
- the uplink is not allocated during the radio block(s) comprising the gap; and
- the gap is at least  $T_{ra}$  (see GSM 05.02) timeslot(s) in length.

### 8.1.1.3.4 PACCH operation

A multislot class type 1 mobile station shall monitor a radio block on an assigned PDCH for downlink a PACCH block, according to its multislot capabilities:

- if the radio block is not assigned as part of a measurement gap; and
- the uplink is not allocated during the radio block; and
- the uplink of the  $T_{tb}$  (see GSM 05.02) timeslot(s) immediately before the radio block is not allocated or is in the idle frame; and
- if the mobile is multislot class 1 through 12, the uplink of the  $T_{ra}$  (see GSM 05.02) timeslot(s) immediately after the radio block is not allocated or is in the idle frame.
- if the mobile is multislot class 19 through 29, the uplink of the  $T_{rb}$  (see GSM 05.02) timeslot(s) immediately after the radio block is not allocated or is in the idle frame.

The network shall leave such sets of gaps in the uplink fixed allocation for the purpose of transmission of the downlink PACCH.

A multislot class type 2 shall monitor all assigned PDCHs for PACCH, unless the mobile station also has current downlink TBF, in which case PDCH assigned for the downlink TBF shall take precedence.

After the fixed allocation is exhausted, the mobile station shall continue to monitor all assigned PDCH(s) that it is able to monitor according to its multislot class.

In the case of simultaneous uplink and downlink TBFs, the mobile station shall monitor all assigned downlink PDCHs and any uplink PDCHs it is able to monitor.

The mobile station may transmit a PACCH block on any uplink radio block allocated via the ALLOCATION\_BITMAP.

In the case of simultaneous uplink and downlink TBFs, the mobile station shall not transmit an RLC data block in any uplink radio block allocated via the polling mechanism (see subclause 10.4.4).

### 8.1.1.3.5 Establishment of Downlink TBF

During an uplink fixed allocation TBF, the network may initiate a downlink TBF by sending the PACKET DOWNLINK ASSIGNMENT or PACKET TIMESLOT RECONFIGURE message on the PACCH.

If the mobile station receives a PACKET SYSTEM INFORMATION TYPE 2 message addressed to the mobile station, the mobile station shall store the PACKET SYSTEM INFORMATION TYPE 2 message. If the mobile station receives a subsequent PACKET SYSTEM INFORMATION TYPE 2 addressed to the mobile station, the mobile station shall replace the stored message with the more recently received message.

The downlink radio resource is assigned to the mobile station in a PACKET DOWNLINK ASSIGNMENT message. On receipt of a PACKET DOWNLINK ASSIGNMENT message, if the field 2\_MESSAGE\_DOWNLINK\_ASSIGNMENT indicates the PACKET DOWNLINK ASSIGNMENT message is self contained, the mobile station shall follow the procedure below. If the field 2\_MESSAGE\_DOWNLINK\_ASSIGNMENT indicates that the PACKET DOWNLINK ASSIGNMENT message is not self contained, the mobile station shall wait for the second message of the 2 message assignment. When the mobile station receives the second message of the 2 message assignment, or if it has already received the second message of the 2 message assignment, the mobile station shall switch follow the procedure below.

Text modified by CR A016r1:

(If the mobile station's multislot class and timeslot configuration does not allow semi-duplex or full duplex operation, the network shall wait for the mobile station to finish its current uplink resource allocation before sending RLC data blocks on the downlink. The uplink TBF, if not finished, shall remain suspended until the network allocates uplink resources again. )

(Text removed by CR A020r1:

The network shall then wait for the mobile station to finish its current uplink resource allocation before sending RLC data blocks on the downlink. The uplink TBF, if not finished, shall remain suspended until the network allocates uplink resources again.)

Text modified by CR A016r1:

(Whenever a mobile station operating on an uplink TBF receives a PACKET DOWNLINK ASSIGNMENT on the PACCH and mobile station's multislot class and assigned timeslot configuration does not allow semi-duplex or full duplex operation, the MS shall immediately suspend the uplink TBF.)

(Text removed by CR A020r1:

Whenever a mobile station operating on an uplink TBF receives a PACKET DOWNLINK ASSIGNMENT on the PACCH, the mobile station shall immediately suspend the uplink TBF.)

If a mobile station's multislot capability and the assigned PDCH(s) allow semi-duplex or full duplex operation, then the network may send a PACKET TIMESLOT RECONFIGURE message, If a PACKET TIMESLOT RECONFIGURE message is sent, then the GLOBAL\_TFI\_ASSIGNMENT shall assign a downlink TFI.

If the mobile station's multislot capabilities or assigned PDCH(s) do not allow semi-duplex or full duplex operation, the network shall wait for the mobile station to finish its current uplink resource allocation before sending RLC data blocks on the downlink. The uplink TBF, if not finished, shall remain suspended until the network allocates uplink resources again.

Suspending an uplink TBF consists of the following:

- the mobile station shall continue to transmit until all of its current granted uplink fixed allocations are exhausted; and;
- the mobile state shall then suspend the following timers, saving the state and value of each timer but not allowing the value of the timer to change:

T3182 - Wait for Acknowledgement

T3184 - No Ack/Nack Received

All instances of T3186 - Wait for Allocation Response

T3188 - Allocation Exhausted

After the mobile station has suspended it uplink TBF, the mobile station shall then act upon the PACKET DOWNLINK ASSIGNMENT or PACKET TIMESLOT RECONFIGURE message.

#### 8.1.1.3.5.1 Abnormal cases

If a failure occurs on the mobile station side before the new TBF has been successfully established, the newly reserved resources are released. The subsequent behaviour of the mobile station depends on the type of failure and previous actions:

*ETSI*

- If the information available in the mobile station, after the reception of a PACKET DOWNLINK ASSIGNMENT message does not satisfactorily define a PDCH, the mobile station shall ignore the PACKET DOWNLINK ASSIGNMENT message.
- If a failure in the PACKET DOWNLINK ASSIGNMENT is due to any other reason, then the mobile station shall ignore the PACKET DOWNLINK ASSIGNMENT.
- If the information in the PACKET TIMESLOT RECONFIGURE does not properly specify an uplink and downlink PDCH or violates the mobile station's multislot capabilities, the mobile station shall perform an abnormal release with random access.- If the failure is due to any other reason, the mobile station shall abort the procedure and continue the normal operation of the uplink TBF.
- If the PACKET TIMESLOT RECONFIGURE does not include an uplink TFI in the GLOBAL\_TFI\_ASSIGNMENT field, then the mobile station shall perform an abnormal release with random access.
- If a failure in the PACKET TIMESLOT RECONFIGURE is due to any other reason, then the mobile station shall perform an abnormal release with random access.

#### 8.1.1.4 Network initiated release of uplink TBF

The network may initiate release of an uplink TBF by transmitting a PACKET TBF RELEASE message to the mobile station on the PACCH. A cause value indicates the reason for release.

If the cause value is "Normal release" the mobile station shall continue to the next LLC frame boundary, starting the count down procedure (see subclause 9.3.1) at whatever value of CV is appropriate to count down to zero at the LLC frame boundary, and then follow the procedure defined in subclause 9.3.1 and subclause 9.3.2.3 or 9.3.3.3, whichever is appropriate.

If the cause value is "Invalid Priority" the mobile station shall immediately stop transmitting and follow the Abnormal Release with Random Access procedure (see 8.6.2).

#### 8.1.1.5 Abnormal cases

The following abnormal cases apply:

- if the mobile station receives a PACKET UPLINK ASSIGNMENT, PACKET UPLINK ACK/NACK with an ALLOCATION\_BITMAP, or a PACKET DOWNLINK ASSIGNMENT message with an MA\_CHANGE\_MARK field whose value does not match the MA\_CHANGE\_MARK value stored in the mobile station, the mobile station shall perform an abnormal release with system information (see 8.6.3).
- if the mobile station receives a PACKET UPLINK ASSIGNMENT, PACKET UPLINK ACK/NACK with an ALLOCATION\_BITMAP, or a PACKET DOWNLINK ASSIGNMENT message with a MA\_NUMBER information element specifying frequencies that are not all in one band then the mobile shall perform an abnormal release with random access (see 8.6.2).
- if the mobile station receives a PACKET UPLINK ASSIGNMENT or a PACKET UPLINK ACK/NACK with an ALLOCATION\_BITMAP whose TBF starting time has elapsed, the mobile station shall use whatever portion of the fixed allocation remains. If none of the fixed allocation remains, the mobile station shall ignore the message after having stopped the instance of timer T3186<sub>n</sub>, where n is the value of ALLOCATION\_REFERENCE..

NOTE: A PACKET UPLINK ASSIGNMENT, PACKET UPLINK ACK/NACK with an ALLOCATION\_BITMAP, or a PACKET DOWNLINK ASSIGNMENT message sent to a multi-band mobile station shall not be considered invalid if it indicates new frequencies that are all in a different frequency band to that of the ARFCN of the serving cell.

#### 8.1.2 Downlink RLC data block transfer

Prior to the initiation of RLC data block transfer on the downlink, the network assigns the following parameters to the downlink TBF in the PACKET DOWNLINK ASSIGNMENT message:

ETSI

- a unique Temporary Flow Identity (TFI). The TFI applies to all radio blocks transferred in regards to the downlink Temporary Block Flow (TBF).
- a set of PDCHs to be used for the downlink transfer;
- optionally, a TBF starting time indication.

### 8.1.2.1 Downlink RLC data block transfer

Upon reception of a complete downlink assignment the mobile station shall start timer T3190 and then shall attempt to decode every downlink block on its assigned PDCHs. If the PACKET DOWNLINK ASSIGNMENT message contains a TBF starting time information element and there is no downlink TBF in progress, the mobile station shall remain on the PCCCH until the TDMA framenumber indicated by the TBF starting time, at which time the mobile station shall immediately begin decoding the assigned downlink PDCH(s). If the PACKET DOWNLINK ASSIGNMENT message contains a TBF starting time and there is a downlink TBF already in progress, the mobile station shall continue to use the parameters of the downlink TBF in progress until the TDMA framenumber indicated in the TBF starting time occurs, at which time the mobile station shall immediately begin to use the new assigned downlink TBF parameters.

If the mobile station receives a valid RLC data block addressed to itself and without the FBI bit set to '1', the mobile station shall reset and restart timer T3190. If the mobile station receives a valid RLC data block addressed to itself and with the FBI set to 1, the mobile station shall stop timer T3190. If timer T3190 expires, the mobile station shall terminate the TBF with abnormal release return to CCCH or PCCCH procedure (see subclause 8.10.1).

### 8.1.2.2 Polling for Packet Downlink Ack/Nack

Whenever the mobile station receives an RLC data block addressed to itself and with a valid RRBp field in the RLC data block header (i.e., is polled), the mobile station shall transmit a PACKET DOWNLINK ACK/NACK message in the uplink radio block specified by the RRBp field, unless another RLC/MAC control message is waiting to be transmitted, in which case the other RLC/MAC control message shall be sent. However, the mobile station shall transmit an RLC/MAC control other than PACKET DOWNLINK ACK/NACK at most every fourth time it is polled.

If the mobile station is multislot class type 1, the mobile station need not decode the  $T_{tb}$  (see GSM 05.02) timeslot(s) immediately before, the timeslot during, the uplink radio block allocated to the mobile station via the RRBp.

If the mobile station is multislot class 1 through 12 or the mobile station is multislot class 19 through 29 and has not received the Measurement Mapping parameters, the mobile station need not decode the  $T_{tb}$  (see GSM 05.02) timeslot(s) following the uplink radio block allocated to the mobile station via the RRBp.

If the mobile station is multislot class 19 through 29 and the mobile station has received the Measurement Mapping parameters, the mobile station need not decode the  $T_{tb}$  (see GSM 05.02) timeslot(s) following the uplink radio block allocated to the mobile station via the RRBp.

In the case of simultaneous uplink and downlink TBFs, the transmission of the polling response takes precedence over the transmission of allocated uplink radio blocks. If transmission of the poll response would result in more than the maximum Tx timeslots per TDMA frame allowed by the multislot class, transmission of the highest numbered PDCH(s) shall be omitted.

### 8.1.2.3 Suspending the downlink TBF

The mobile station may request a temporary suspension in the downlink data flow. The mobile station shall signal this by sending a Suspend Request in the PACKET DOWNLINK ACK/NACK message indicating the desired duration and starting time of the suspension. If an uplink TBF is active, the Suspend Request also requests a temporary suspension in the uplink data flow.

The mobile station shall include an I LEVEL measurement on every assigned downlink timeslot in at least every other PACKET DOWNLINK ACK/NACK message. The mobile station may append as many Suspend Requests as will fit into the PACKET DOWNLINK ACK/NACK message. If the mobile station is unable to fit the desired Suspend Requests into the PACKET DOWNLINK ACK/NACK message, the mobile station may stop monitoring the downlink PDCHs during the desired suspension period(s) as though the Suspend Request(s) had been sent to the network.

The mobile station shall omit no more than 75 block periods in every 15 second interval.

The mobile station shall continue to operate normally until the starting time, at which time the mobile station need not monitor any downlink PDCHs for the duration of the suspension. Once the suspension has elapsed, the mobile station shall resume normal operation.

Text modified by CR A006r2z:

(If timer T3196 expires, the mobile station shall retransmit the suspension request in the next available PACKET DOWNLINK ACK/NACK message up to 2 times. On the third expiry of T3196, the mobile station shall perform an abnormal release with return to CCCH or PCCCH (see 8.6.1).)

(Text removed by CR A022r1:

If timer T3196 expires, the mobile station shall retransmit the suspension request in the next available PACKET DOWNLINK ACK/NACK message.)

#### 8.1.2.4 Resource Reassignment for Downlink

The network initiates resource reassignment by sending a PACKET DOWNLINK ASSIGNMENT message on the downlink PACCH. This message indicates a change in resources in the same TBF.

The network is not allowed to change the RLC mode of an already established TBF during resource reallocation. Change of RLC mode shall be achieved through termination of on-going TBF and establishment of a new TBF with the newly requested RLC mode.

If the mobile station receives a PACKET SYSTEM INFORMATION TYPE 2 message addressed to the mobile station, the mobile station shall store the PACKET SYSTEM INFORMATION TYPE 2 message. If the mobile station receives a subsequent PACKET SYSTEM INFORMATION TYPE 2 addressed to the mobile station, the mobile station shall replace the stored message with the more recently received message.

On receipt of a PACKET DOWNLINK ASSIGNMENT message, if the field 2\_MESSAGE\_DOWNLINK\_ASSIGNMENT indicates the PACKET DOWNLINK ASSIGNMENT message is self contained, the mobile station shall switch to the assigned PDCHs. If the field 2\_MESSAGE\_DOWNLINK\_ASSIGNMENT indicates that the PACKET DOWNLINK ASSIGNMENT message is not self contained, the mobile station shall wait for the second message of the 2 message assignment. When the mobile station receives the second message of the 2 message assignment, or if it has already received the second message of the 2 message assignment, the mobile station shall switch to the assigned PDCHs.

On receipt of the complete downlink assignment, the mobile station shall start timer T3190.

When the mobile station receives an RLC/MAC block addressed to itself on any of the new assigned resources, not including any resources common to both the previous assignment and the new assignment, it shall stop timer T3190. If timer T3190 expires, the mobile station shall perform the abnormal release with return to CCCH or PCCCH procedure (see subclause 8.6.1).

#### 8.1.2.5 Establishment of uplink TBF

The mobile station may request establishment of an uplink transfer during a downlink TBF by including a Channel Request Description information element in the PACKET DOWNLINK ACK/NACK message. The Channel Request Description must indicate the same MAC mode as the downlink TBF in operation. Initiation is triggered by a request from upper layers to transfer a LLC PDU. The request from upper layers specifies a priority level to be associated with the packet transfer. Upon such a request,

- if access to the network is allowed, according to the latest values for authorized special access classes and Access Priority Threshold parameter that the mobile station has received (see subclause 7.1.1.1), the mobile station shall initiate the packet access procedure.
- otherwise, the RR sublayer in the mobile station shall reject the request.

The mobile station initiates the packet access procedure by sending the Channel Request Description information element in the PACKET DOWNLINK ACK/NACK message on the PACCH and starting timer T3168.

On receipt of a Channel Request Description information element in the PACKET DOWNLINK ACK/NACK message, the network may assign radio resources to the mobile station on one or more PDCHs by transmitting a PACKET UPLINK ASSIGNMENT or PACKET TIMESLOT RECONFIGURE message on the PACCH, or may reject the

request by sending a PACKET ACCESS REJECT message on the PACCH. If the PACKET TIMESLOT RECONFIGURE message is sent, then the GLOBAL\_TFI\_ASSIGNMENT field shall specify an uplink TFI

If the mobile station receives a PACKET SYSTEM INFORMATION TYPE 2 or PACKET UPLINK ASSIGNMENT bis message addressed to the mobile station, the mobile station shall store the PACKET SYSTEM INFORMATION TYPE 2 or PACKET UPLINK ASSIGNMENT bis message. If the mobile station receives a subsequent PACKET SYSTEM INFORMATION TYPE 2 or PACKET UPLINK ASSIGNMENT bis addressed to the mobile station, the mobile station shall replace the stored message with the more recently received message.

On receipt of a PACKET UPLINK ASSIGNMENT message, if the field 2\_MESSAGE\_UPLINK\_ASSIGNMENT indicates the PACKET UPLINK ASSIGNMENT message is self contained, the mobile station shall follow the procedure below. If the field 2\_MESSAGE\_DOWNLINK\_ASSIGNMENT indicates that the PACKET DOWNLINK ASSIGNMENT message is not self contained, the mobile station shall wait for the second message of the 2 message assignment. When the mobile station receives the second message of the 2 message assignment, or if it has already received the second message of the 2 message assignment, the mobile station shall follow the procedure below.

On reception of a complete uplink assignment, and optional PACKET UPLINK ASSIGNMENT bis or PACKET SYSTEM INFORMATION TYPE 2,, the mobile station shall stop timer T3168. If the mobile station's multislot capabilities cannot simultaneously support both the downlink TBF allocation and the uplink TBF allocation, the mobile station shall immediately stop the downlink TBF and save the RLC state variables associated with the downlink TBF.

The mobile station shall then switch to the assigned uplink PDCHs and begin to send RLC data blocks on the assigned PDCH(s). The TLLI shall not be included in any of the uplink RLC data blocks in that case.

On receipt of a PACKET ACCESS REJECT message with Reject Cause of Wait, the mobile station shall stop timer T3168 and start timer T3172 with the indicated value (Wait Indication). The mobile station is not allowed to make a new attempt for packet access in the same cell until timer T3172 expires, but may attempt packet access in an other cell after successful cell reselection. When timer T3172 expires, if the downlink TBF is still active the mobile station may initiate the establishment of an uplink TBF using the procedure in this subclause. Of no TBF is active, the mobile station may initiate the establishment of an uplink TBF on CCCH or PCCCH.

On receipt of a PACKET ACCESS REJECT message with Reject Cause "Read System Information", the mobile station shall stop timer T3168 and shall decode the PACKET SYSTEM INFORMATION messages, if broadcast, or the SYSTEM INFORMATION messages before re-attempting the uplink TBF establishment.

If timer T3168 expires, the mobile station retransmit the Channel Request Description information element in the next PACKET DOWNLINK ACK/NACK message.

The uplink TBF establishment is completed when the mobile station has successfully received a PACKET UPLINK ASSIGNMENT or PACKET TIMESLOT RECONFIGURE message. The mobile station shall then following the procedures for uplink RLC data block transfer (see subclause 8.1.1) and the procedure for concurrent TBFs (see subclause 8.1.3).

#### 8.1.2.5.1 Abnormal cases

If a failure occurs on the mobile station side before the new TBF has been successfully established, the newly reserved resources are released. The subsequent behaviour of the mobile station depends on the type of failure and previous actions.

- If the mobile station has been assigned more PDCHs than it supports according to its mobile station multislot class, the mobile station shall reinitiate the access unless it has already been attempted 4 times, in which case, the mobile station shall perform the release with return to CCCH or PCCCH.
- If a failure in the PACKET UPLINK ASSIGNMENT is due to any other reason, the mobile station shall abort the procedure and continue the reception of downlink PDUs.
- If the information in the PACKET TIMESLOT RECONFIGURE does not properly specify a set of uplink and downlink PDCH(s) or violates the mobile station's multislot capabilities, the mobile station shall perform an abnormal release with return to CCCH or PCCCH.
- If the PACKET TIMESLOT RECONFIGURE does not include a correct GLOBAL\_TFI\_ASSIGNMENT field, then the mobile station shall perform an abnormal release with return to CCCH or PCCCH.

ETSI



- If a failure in the PACKET TIMESLOT RECONFIGURE is due to any other reason, the mobile station shall perform an abnormal release with return to CCCH of PCCCH.

### 8.1.2.6 Downlink Measurement Report

If the mobile station has received a PACKET SYSTEM INFORMATION TYPE 5 message commanding the mobile station to send measurement reports while in packet transfer mode, the mobile station shall send the PACKET MEASUREMENT REPORT on the uplink PACCH at the repetition rate specified.

### 8.1.2.7 Extended dynamic allocation neighbour cell power measurements

A mobile station operating in extended dynamic allocation mode shall perform a neighbour cell power measurement immediately prior to each uplink PACCH transmission.

The mobile station shall also perform a neighbour cell power measurement in any unallocated timeslots or group of timeslots in which the mobile station is capable of making a measurement. If the mobile station is capable of making more than one measurement in an unallocated timeslot or group of timeslots, the mobile station shall make as many measurements as it is capable.

### 8.1.2.8 Fixed allocation neighbour cell power measurements

A mobile station operating in fixed allocation mode may be directed by the network to perform neighbour cell power measurements in predefined gaps via the Measurement Mapping parameters. The location in time and the size of the gaps are signalled by the following parameters:

- the starting time of the first TDMA frame of the first gap;
- a bitmap indicating the timeslots that are part of the gap; and
- the number of RLC/MAC block periods between gaps.

If the mobile has received the Measurement Mapping parameters, the mobile station need not decode the radio blocks(s) comprising the gap during each occurrence of the gap.

If the mobile station has not received the Measurement Mapping parameters, the mobile station shall perform a neighbour cell power measurement in 25 of 26 TDMA frames. If the mobile station's multislot class and the assigned timeslot configuration prevent the mobile station from making these measurements, the downlink TBF assignment shall be considered invalid and the procedures of subclause 8.1.1.1.3.1 apply.

### 8.1.2.9 Mobile station initiated downlink TBF release

The mobile station can initiate release of a downlink TBF by setting the TBF\_RELEASE bit in the PACKET DOWNLINK ACK/NACK to the value '1'. The mobile station shall then set the TBF\_RELEASE bit the value '1' in all subsequent PACKET DOWNLINK ACK/NACK messages until the TBF is released.

Upon receipt of a PACKET DOWNLINK ACK/NACK message with the TBF\_RELEASE bit set to '1', the network shall initiate termination of the downlink TBF. The network may initiate termination of the downlink TBF immediately or may wait until the next LLC frame boundary. The network shall then follow the procedure in subclause 9.3.2.5 or subclause 9.3.3.5.

## 8.1.3 Concurrent TBF procedures

### 8.1.3.1 Dynamic allocation and extended dynamic allocation procedures

A mobile station operating in dynamic allocation or extended dynamic allocation mode is able to transmit on the uplink and the downlink in each TDMA frame. The mobile station is able to transfer data in both directions simultaneously after the establishment of both an uplink and downlink TBF.

The mobile station uses the TBF establishment procedure defined in subclause 8.1.1.1.3 and the network uses the TBF establishment procedure defined in subclause 8.1.2.5.

If uplink and downlink TBFs are already established, then the network may send a PACKET TIMESLOT RECONFIGURE message with no GLOBAL\_TFI\_ASSIGNMENT. The mobile station shall interpret this as a reassignment of the timeslot allocations of the concurrent uplink and downlink TBFs.

### 8.1.3.2 Fixed allocation procedures

For multislot class 1 through 18, the procedures of subclause 8.1.3.1 are followed.

For multislot class 19 through 29 (see GSM 05.02), if the mobile station's multislot class and the assigned PDCH(s) allow the mobile station to transmit on the assigned uplink PDCH(s) and the assigned downlink PDCH(s) in each TDMA frame, the procedures of subclause 8.1.1.3.5 and 8.1.2.5 are followed. If uplink and downlink TBFs are already established, the network may send a PACKET TIMESLOT RECONFIGURE message with no GLOBAL\_TFI\_ASSIGNMENT. The mobile station shall interpret this as a reassignment of the timeslot allocations of the concurrent uplink and downlink TBFs.

For multislot class 19 through 29 (see GSM 05.02), if the mobile station's multislot class and assigned PDCH(s) do not allow the mobile station to transmit on the uplink and the downlink in each TDMA frame, the procedures defined in this subclause shall be followed.

Procedures are defined to:

- allow one TBF to be suspended while data is transferred in the TBF; and
- allow the mobile station and network to signal to each other that the current TBF shall be suspended in order to allow data to be transferred by the other TBF.

#### 8.1.3.2.1 Suspending downlink TBF and initiating uplink TBF

A mobile station operating using the fixed allocation medium access mode may initiate an uplink TBF during a downlink TBF using the procedure defined in subclause 8.1.2.5.

#### 8.1.3.2.2 Suspending downlink TBF and activating uplink TBF

A mobile station may indicate that it wishes to transfer RLC data on a suspended uplink TBF by initiating the procedure defined in subclause 8.1.2.5.

#### 8.1.3.2.3 Ending downlink TBF and activating uplink TBF

If the network sends an RLC data block with the FBI field set to indicate the last RLC data block of the TBF and an associated uplink TBF for the mobile station exists, the network shall also transmit a PACKET UPLINK ASSIGNMENT message, and optionally a PACKET SYSTEM INFORMATION TYPE 2 or PACKET UPLINK ASSIGNMENT bis message on the downlink PACCH to the mobile station.

If a mobile station receives an RLC data block with the FBI set to indicate the last RLC data block of the TBF and an associated uplink TBF for the mobile station exists, the mobile station shall follow the downlink TBF termination procedures defined in subclause 9.3.2.5 or subclause 9.3.3.5. If the mobile station receives an uplink assignment during the termination procedure the mobile station shall obey the downlink TBF procedures, if a conflict exists between the downlink and uplink allocations, and then the mobile station shall act upon the uplink assignment.

#### 8.1.3.2.4 Suspending uplink TBF and initiating downlink TBF

The network may initiate a downlink TBF during an uplink TBF to a mobile station operating using the fixed allocation medium access mode by using the procedure defined in subclause 8.1.1.3.5.

#### 8.1.3.2.5 Suspending uplink TBF and activating downlink TBF

The mobile station sending RLC data on an uplink TBF and with a suspended downlink TBF may indicate to the network that it has temporarily run out of RLC data to transmit on the uplink TBF by transmitting a PACKET TBF STATUS message with TBF\_STATUS\_CAUSE = "Ready Block Count is below threshold" on the uplink TBF.

When the network receives a PACKET TBF STATUS message with TBF\_STATUS\_CAUSE = "Ready Block Count is below threshold" from a mobile station operating on an uplink TBF and with a suspended downlink TBF, the network may suspend the uplink TBF and resume the suspended downlink TBF (Removed text by CR A004r2: by sending a PACKET DOWNLINK ASSIGNMENT message to the mobile station.) (Inserted text by CR A004r2: following the procedure defined in subclause 8.1.1.3.5) (Inserted text by CR A016r1:, and optionally a PACKET SYSTEM INFORMATION TYPE 2 or PACKET UPLINK ASSIGNMENT bis message.)

Removed by CR A004r2: (Whenever a mobile station using the fixed allocation medium access method and operating on an uplink TBF receives a PACKET DOWNLINK ASSIGNMENT on the PACCH, the MS shall immediately suspend the uplink TBF)

Modified by CR A016r1: (Whenever a mobile station using the fixed allocation medium access method and operating on an uplink TBF receives a PACKET DOWNLINK ASSIGNMENT, and if indicated, an associated PACKET SYSTEM INFORMATION TYPE 2 or PACKET UPLINK ASSIGNMENT bis message, on the PACCH, and the assigned uplink and downlink TBFs exceed the mobile station's multislot class capability, the MS shall immediately suspend the uplink TBF.) (Removed text by CR A004r2:

After the mobile station has exhausted all of its uplink fixed allocation, the mobile shall then act upon the PACKET DOWNLINK ASSIGNMENT message by switching to the assigned uplink PDCHs and beginning to send RLC data blocks on the assigned PDCH(s). The TLLI shall be included in the first three RLC data blocks and the first three data shall be encoded according to the TLLI\_BLOCK\_CHANNEL\_CODING parameter in the PACKET UPLINK ASSIGNMENT.

If the mobile station receives a PACKET UPLINK ASSIGNMENT message containing an uplink assignment exceeding its multislot capability, the mobile station shall use the PDCHs according to its multislot capability.

The uplink TBF establishment is completed when the mobile station has successfully received a PACKET UPLINK ASSIGNMENT message. The mobile station shall then following the procedures for uplink RLC data block transfer (see subclause 8.1.1) and the procedure for concurrent TBFs (see subclause 8.1.3). )

(Modified text by CR A016r1:

After the mobile station has suspended the uplink TBF, it shall start timer T3190 and then act upon the downlink assignment by beginning to monitor the assigned PDCHs.

The downlink TBF establishment is completed when the mobile station has successfully received a downlink RLC data block. The mobile station shall then stop timer T3190 and following the procedures for downlink RLC data block transfer (see subclause 8.1.2) and the procedure for concurrent TBFs (see subclause 8.1.3).

If timer T3190 expires, the mobile station shall perform an abnormal release with random access (see subclause 8.6.2).

#### 8.1.3.2.6 Ending uplink TBF and activating downlink TBF

Whenever a mobile station operating in the fixed allocation medium access mode terminates its uplink TBF by following the procedures in subclause 9.3.2.3 or subclause 9.3.3.5 and a downlink TBF exists, the mobile station shall immediately begin to monitor the downlink PDCH(s) allocated in its downlink TBF.

## 8.2 Packet PDCH Release

The network may broadcast the PACKET PDCH RELEASE message to indicate one or more timeslots is no longer available for packet data service.

When a mobile station receives a PACKET PDCH RELEASE message without a TIMESLOT\_BITMAP, it shall immediately stop transmitting on the PDCH on which the PACKET PDCH RELEASE message was received, and shall remove that PDCH from its list of assigned PDCHs.

When a mobile station receives a PACKET PDCH RELEASE message containing a TIMESLOT\_BITMAP, it shall immediately stop transmitting on all assigned PDCHs which are indicated as not present in the TIMESLOT\_BITMAP, and shall remove those PDCHs from its list of assigned PDCHs.

If all of the mobile station's assigned PDCHs are removed from its list of assigned PDCH, and, if an uplink TBF was in progress, the mobile station shall perform an abnormal release with random access. If no uplink TBF was in progress, the mobile station shall perform an abnormal release with return to CCCH or PCCCH.

## 8.3 Network Change Order procedure

The network may send to the mobile station a PACKET SYSTEM INFORMATION TYPE 4, TYPE 5, or TYPE 5 bis message while the mobile station is in packet transfer state.

Upon receiving a PACKET SYSTEM INFORMATION TYPE 4 message while in the packet transfer state, the mobile station shall act upon the message as defined in subclause 5.6 once the mobile station has entered the packet idle mode.

Upon receiving a PACKET SYSTEM INFORMATION TYPE 5 or TYPE 5 bis message with NETWORK CHANGE ORDER value of NC1 or NC2 and containing a Ready Frequency Lists parameter, the mobile station shall immediately begin to perform the specified measurements. The mobile station shall transfer a PACKET MEASUREMENT REPORT containing a Ready State Measurement Result at the specified interval on the uplink PACCH.

Upon receiving a PACKET SYSTEM INFORMATION TYPE 5 or TYPE 5 bis message containing an Idle Frequency Lists parameter, the mobile station shall wait until entering packet idle mode before beginning to perform the specified measurements (see subclause 5.6.2).

## 8.4 Cell Change Order procedure

The network initiates the cell change order procedure by sending a PACKET CELL CHANGE ORDER message to the mobile station on the PACCH.

Upon receipt of the PACKET CELL CHANGE ORDER message, the mobile aborts any TBFs in progress by immediately ceasing to decode the downlink, ceasing to transmit on the uplink, stopping all RLC/MAC timers. The mobile station shall start timer T3174. The mobile station shall then switch to the identified specified new cell and obeys the relevant RLC/MAC procedures on this new cell. The mobile station starts timers T3174.

The PACKET CELL CHANGE ORDER message contains:

- The characteristics of the new cell that are necessary to identify it (i.e. BSIC + BCCH frequency);
- optionally, the network change order value to be applied in the new cell.

### 8.4.1 Network controlled cell reselection completion

The network regards the procedure as successfully completed when it knows that communication has been established with that mobile station via the new cell (e.g., the network has received a message containing the mobile's identity).

The mobile station regards the procedure as completed when it has received a successful response to its CHANNEL REQUEST or PACKET CHANNEL message on the new cell. It shall then stop timers T3174.

### 8.4.2 Abnormal cases

If the PACKET CELL CHANGE ORDER message instructs the mobile station to use a frequency that it is not capable of using, then the mobile station shall return a PACKET CELL CHANGE FAILURE message with cause "frequency not implemented" on the PACCH, and the mobile station shall remain on the current PDCH(s).

On the mobile station side, if timer T3174 expires before a response to the CHANNEL REQUEST or PACKET CHANNEL REQUEST message has been received on the new cell, or, if an IMMEDIATE ASSIGNMENT REJECT or PACKET ACCESS REJECT message is received from the new cell, or, if the contention resolution procedure fails on the new cell, then the mobile station shall start timer T3176 and return to the old cell. On the old cell, the mobile station shall initiate a random access, requesting a single uplink radio block, and then transmit the PACKET CELL CHANGE FAILURE message on the single block. If T3176 expires and the mobile station was previous active in an uplink TBF on the old cell, the mobile station shall perform the abnormal release with RACH or PRACH. If the mobile station was previous active in a downlink TBF on the old cell the mobile station shall perform an abnormal release with return to CCCH or PCCCH.

On the network side, lower layer failures occurring on the old channels after the sending of the PACKET CELL CHANGE ORDER message are ignored.

## 8.5 PACKET CONTROL ACKNOWLEDGEMENT

The transmission of the PACKET CONTROL ACKNOWLEDGEMENT takes precedence over the transmission of allocated uplink radio blocks or the reception of PCCCH or assigned PDTCH radio blocks. If transmission of the PACKET CONTROL ACKNOWLEDGEMENT would result in more than the maximum Tx timeslots per TDMA frame allowed by the multislot class, transmission of the highest numbered PDCH(s) shall be omitted.

## 8.6 Abnormal cases

The following abnormal cases apply:

- If a mobile station receives a PACKET DOWNLINK ASSIGNMENT assigning a different MAC mode than the MAC mode of an already operating uplink TBF, the PACKET DOWNLINK ASSIGNMENT message shall be ignored.
- If a mobile station receives a PACKET UPLINK ASSIGNMENT assigning a different MAC mode than the MAC mode of an already operating downlink TBF, the PACKET UPLINK ASSIGNMENT message shall be ignored.

### 8.6.1 Abnormal Release with Return to CCCH or PCCCH

The mobile station shall immediately return to the CCCH or PCCCH and wait for a new PACKET DOWNLINK ASSIGNMENT.

### 8.6.2 Abnormal Release with Random Access

The mobile station shall return to the CCCH or PCCCH and initiate establishment of an uplink TBF as defined in subclause 7.1.

### 8.6.3 Abnormal Release with System Information

The mobile station shall immediately return to the BCCH and reread all relevant BCCH and PBCCH information.

---

## 9 Radio Link Control (RLC) procedures in packet transfer mode

The RLC function is responsible for:

- Interface primitives allowing the transfer of Logical Link Control layer PDUs (LLC PDU) between the LLC layer and the MAC function.
- Segmentation of LLC PDUs into RLC data blocks and re-assembly of RLC data blocks into LLC PDU.
- Backward Error Correction (BEC) procedures enabling the selective retransmission of RLC data blocks.

In this clause Packet Ack/Nack refers to any of the following messages:

PACKET DOWNLINK ACK/NACK

PACKET UPLINK ACK/NACK

### 9.1 Procedures and parameters for peer-to-peer operation

An RLC connection is comprised of two peer entities. Each RLC endpoint has a receiver that receives RLC data blocks. Each RLC endpoint also has a transmitter that transmits RLC data blocks.

Each endpoint's receiver has a receive window. In RLC acknowledged mode, the receive window is defined by the receive state variable  $V(R)$  in the following inequality:  $[V(Q) \leq BSN < V(R)] \text{ modulo } 128$ , where  $[V(R) - V(Q)] \text{ modulo } 128 \leq \text{window size } k$ . All BSNs which meet that criteria are valid within the receive window. In RLC unacknowledged mode, all values of BSN are within the receive window.

Each endpoint's transmitter has a transmit window. In RLC acknowledged mode, the transmit window is defined by the send state variable  $V(S)$  in the following inequality:  $[V(A) \leq BSN < V(S)] \text{ modulo } 128$ , where  $[V(S) - V(A)] \text{ modulo } 128 \leq \text{window size } k$ . All BSNs which meet that criteria are valid within the transmit window. In RLC unacknowledged mode, all values of BSN are within the transmit window.

### 9.1.1 Send state variable $V(S)$

Each RLC endpoint transmitter shall have an associated send state variable  $V(S)$ .  $V(S)$  denotes the sequence number of the next in-sequence RLC data block to be transmitted.  $V(S)$  can take on the value 0 through 127.  $V(S)$  shall be set to the value 0 at the beginning of each TBF in which the RLC endpoint is the transmitter. The value of  $V(S)$  shall be incremented by 1 after transmission of the RLC data block with  $BSN = V(S)$ . In RLC acknowledged mode,  $V(S)$  shall not exceed  $V(A) \text{ modulo } 128$  by more than the maximum allowed number of outstanding RLC data blocks  $k$  (window size  $k$  is defined in subclause 9.1.9).

### 9.1.2 Acknowledge state variable $V(A)$

In RLC acknowledged mode, each RLC endpoint transmitter shall have an associated acknowledge state variable  $V(A)$ .  $V(A)$  contains the BSN value of the oldest RLC data block that has not been positively acknowledged by its peer.  $V(A)$  can take on the values 0 through 127.  $V(A)$  shall be set to the value 0 at the beginning of each TBF in which the RLC endpoint is the transmitter. The value of  $V(A)$  shall be updated from the values received from its peer in the received block bitmap (RBB) of the Packet Ack/Nack message (see subclause 9.1.8)

Furthermore,  $[V(S) - V(A)] \text{ modulo } 128 \leq \text{window size } k$ .

### 9.1.3 Acknowledge state array $V(B)$

In RLC acknowledged mode, each RLC endpoint transmitter shall have an associated acknowledge state array ( $V(B)$ ).  $V(B)$  is an array of 128 elements indicating the acknowledgement status of  $k$  ( $k = \text{window size}$ ) previous RLC data blocks. The array is indexed relative to the acknowledge state variable  $V(A) \text{ modulo } 128$  or relative to the starting sequence number (SSN). The values of  $V(B)$  shall be updated from the values received from its peer in the received block bitmap (RBB) of the Packet Ack/Nack message. (see subclause 9.1.8)

The transmitter shall transmit the oldest RLC data block whose corresponding element in  $V(B)$  indexed relative to  $V(A)$  has the value NACKED. As each RLC data block is transmitted the corresponding element in  $V(B)$  is set to the value PENDING\_ACK.

If  $[V(S) < V(A) + k] \text{ modulo } 128$  and no RLC data blocks have a corresponding element in  $V(B)$  with the value NACKED, the RLC data block with  $BSN = V(S)$  shall be transmitted and the corresponding element in  $V(B)$  shall be set to the value PENDING\_ACK.

If  $V(S) = V(A) + k \text{ modulo } 128$  (i.e., the transmit window is stalled), the sending side shall transmit the oldest RLC data block whose corresponding element in  $V(B)$  has the value PENDING\_ACK, then the next oldest RLC data block whose corresponding element in  $V(B)$  has the value PENDING\_ACK, etc. If all RLC data blocks whose corresponding element in  $V(B)$  has the value PENDING\_ACK has been transmitted once, the process shall be repeated beginning with the oldest RLC data block. This process of transmitting the oldest RLC data blocks whose value in  $V(B)$  has the value PENDING\_ACK shall continue indefinitely.

When an element in  $V(B)$  falls outside of the active transmit window (i.e.,  $[V(S) - 64 \leq BSN < V(S)] \text{ modulo } 128$ ) the element shall be set to the value INVALID.

If the mobile station is the transmitter, it shall set an instance of timer T3198 for each RLC data block sent. The timer T3198 shall have the expiry value set to BS\_CV\_MAX block periods.

### 9.1.4 Block sequence number BSN

Each RLC data block contains a block sequence number (BSN) field that is 7 bits in length. At the time that an in-sequence RLC data block is designated for transmission, the value of BSN is set equal to the value of the send state variable V(S).

### 9.1.5 Receive state variable V(R)

In RLC acknowledged mode, each RLC endpoint receiver shall have an associated receive state variable V(R). The receive state variable denotes the BSN of the next in-sequence RLC data block expected to be received. V(R) shall be set to the value '0' at the beginning of each TBF in which the RLC endpoint is the receiver. V(R) can take on the value 0 through 127.

The value of the receive state variable shall be set to the greatest BSN value received in the current receive window, provided the RLC data block was error free and the BSN does not exceed  $[V(Q) + 64] \text{ modulo } 128$ .

### 9.1.6 Receive window state variable V(Q)

In RLC acknowledged mode, each RLC endpoint receiver shall have an associated receive window state variable V(Q). The receive window state variable denotes the BSN of the oldest RLC data block within the receive window that has not been received. V(Q) shall be set to the value 0 at the beginning of each TBF in which the RLC endpoint is the receiver. The receive window state variable can take on the value 0 through 127.

The value of V(Q) shall be updated when the RLC receiver receives the RLC data block whose BSN is equal to V(Q). The value of V(Q) shall then be set to the value of the oldest BSN in the receive window that has not been received, or it shall be set to V(R) if all RLC data blocks in the receive window have been received properly.

### 9.1.7 Receive state array V(N)

In RLC acknowledged mode, each RLC endpoint receiver shall have an associated receive state array V(N). V(N) is an array of 128 elements indicating the receive status of k (k = window size) previous RLC data blocks. The array is indexed relative to the receive state variable V(R) modulo 128. When an RLC data block is received with BSN such that  $[V(Q) \leq \text{BSN} < V(R)] \text{ modulo } 128$ , the corresponding element in V(N) is set to the value RECEIVED.

When an element in V(N) falls outside of the active window (i.e.,  $[\text{BSN} < V(R) - k] \text{ modulo } 128$ ) the element is set to the value INVALID.

### 9.1.8 Starting sequence number (SSN) and received block bitmap (RBB)

The Packet Ack/Nack message contains a starting sequence number (SSN) and a received block bitmap (RBB). The Packet Ack/Nack message is sent by the RLC receiver and is received by the RLC transmitter. The SSN and RBB do not have meaning in RLC unacknowledged mode and shall be ignored by the RLC receiver.

In RLC acknowledged mode, the BSN values specified in the RBB are interpreted by subtracting the bit position in the bitmap from the starting sequence number (SSN) modulo 128.

A valid BSN value in the RBB is one that is in the range  $[V(A) \leq \text{BSN} < V(S)] \text{ modulo } 128$ .

These inequalities shall be interpreted in the following way:

BSN is valid if, and only if,  $[\text{BSN} - V(A)] \text{ modulo } 128 < [V(S) - V(A)] \text{ modulo } 128$ .

At the RLC transmitter:

For each bit in the RBB whose corresponding BSN value is within the transmit window, if the bit contains the value '1', the corresponding element in V(B) indexed relative to SSN shall be set to the value ACKED. If the bit contains the value '0', and the instance of timer T3198 corresponding to BSN is expired, the element in V(B) shall be set to the value NACKED. If the bit contains the value '0' and the instance of timer T3198 is not expired (i.e., the RLC data block was recently (re)transmitted and thus can not be validly negatively acknowledged in this particular Packet Ack/Nack message), the element in V(B) shall not be modified.

A bit within the RBB whose corresponding BSN is not within the transmit window, shall be ignored.

At the RLC receiver:

The starting sequence number (SSN) is assigned the value of the receive state variable  $V(R)$ . The received block bitmap (RBB) is assigned the 64 elements whose indices in the receive state array  $V(N)$  at the receiver range from  $[V(R) - 1]$  modulo 128 to  $[V(R) - 64]$  modulo 128. For each bit in the bitmap, the bit is assigned the value '1' if the corresponding element in  $V(N)$  indexed relative to SSN has the value RECEIVED. The bit is assigned the value '0' if the element in  $V(N)$  has the value INVALID.

### 9.1.9 Window Size

The window size ( $k$ ) shall be 64.

### 9.1.10 Segmentation of LLC PDUs into RLC data blocks

Each received LLC PDU shall be segmented into RLC data blocks. If the contents of an LLC PDU do not fill an integer number of RLC data blocks, the beginning of the next LLC PDU shall be placed within the final RLC data block of the first LLC PDU with no padding or spacing between the end of the first LLC PDU and the beginning of the next. If the final LLC PDU in the TBF does not fill an integer number of RLC data blocks, filler octets shall be used to fill the remainder of the RLC data block.

Once a RLC data block has been transmitted over the physical link, should it be necessary to re-transmit the RLC data block, it shall be re-transmitted using the same channel coding scheme, BSN, and CV.

### 9.1.11 Re-assembly of LLC PDUs from RLC data blocks

RLC data blocks shall be collected at the receiver until all RLC data blocks comprising an LLC PDU have been received. The RLC headers shall be removed from each RLC data block at this time and the re-assembled LLC PDU shall be passed to the higher layer.

During RLC acknowledged mode operation, received LLC PDUs shall be delivered to the higher layer in the order in which they were originally transmitted.

During RLC unacknowledged mode operation, received LLC PDUs shall be delivered to the higher layer in the order in which they are received. Fill bits having the value '0' shall be substituted for RLC data blocks not received. The number of fill bits substituted shall be determined using Table 2. In the uplink direction the channel coding scheme shall be the commanded channel coding scheme. In the downlink direction the channel coding scheme shall be the channel coding scheme of the last correctly received RLC data block. If no RLC data blocks have been correctly received, by the mobile station the requested channel coding scheme shall be used. If no requested channel coding scheme has been sent to the network, the mobile station shall use the number of fill bits for CS-1.

**Table 2: RLC unacknowledged mode fill bits**

Channel Coding Scheme	Number of fill bits
CS-1	160
CS-2	240
CS-3	288
CS-4	400

### 9.1.12 Priority of LLC frames

The mobile station shall not transmit LLC frames during a TBF that have a lower priority than the priority that was used at initial access or the priority sent in the last PACKET RESOURCE REQUEST. The mobile station may change the priority of an uplink TBF by sending a PACKET RESOURCE REQUEST message to the network (see subclause 8.1.1.1.2 and subclause 8.1.1.3.2).



## 9.2 Operation during RLC/MAC control message transfer

RLC/MAC control blocks shall be used to transport RLC control messages. Only one RLC/MAC control message shall be transported per RLC control block.

RLC/MAC control blocks shall be sent at a higher priority than RLC data blocks.

The receiving side shall determine the length of the RLC/MAC control message contents by interpreting the RLC/MAC control message contents.

No general acknowledgement shall be made as part of the transfer of RLC/MAC control blocks. The receiver shall not acknowledge an RLC/MAC control message except when a valid RRBP field is present in the RLC/MAC control block header or when the RLC/MAC procedures explicitly specify an acknowledgement.

## 9.3 Operation during packet transfer

The RLC ARQ functions support two modes of operation: RLC acknowledged mode, and RLC unacknowledged mode. RLC acknowledged mode operation uses retransmission of RLC data blocks to achieve high reliability. RLC unacknowledged mode operation does not utilize retransmission of RLC data blocks. A TBF may operate in either RLC acknowledged mode or RLC unacknowledged mode.

The mobile station sets the RLC mode of the uplink TBF by setting the RLC\_MODE bit to either RLC acknowledged mode or RLC unacknowledged mode in the PACKET RESOURCE REQUEST or the PACKET DOWNLINK ACK/NACK message. In a one phase access, the RLC mode defaults to RLC acknowledged mode.

The network sets the RLC mode of the downlink TBF by setting the RLC\_MODE bit in the PACKET DOWNLINK ASSIGNMENT message.

### 9.3.1 Countdown procedure

The mobile station shall send the Countdown Value (CV) in each uplink RLC data block to indicate to the network the absolute BSN (BSN') of the last RLC data block that will be sent in the uplink TBF. The CV shall be calculated as follows.

Let integer  $x = \text{round} \left( \frac{\text{TBC} - \text{BSN}' - 1}{\text{NTS}} \right)$ .

Then,  $\text{CV} = \begin{cases} x, & \text{if } x \leq \text{BS\_CV\_MAX} \\ 15, & \text{otherwise} \end{cases}$ ,

where:

TBC = total number of RLC data blocks that will be transmitted in the TBF,

BSN' = absolute block sequence number of the RLC data block, with range from 0 to (TBC - 1),

NTS = number of timeslots assigned to the uplink TBF, with range 1 to 8,

the function round() rounds upwards to the nearest integer,

BS\_CV\_MAX is a parameter broadcast in the system information,

the division operation is non-integer and results in zero only for (TBC - BSN' - 1) = 0.

The final RLC data block transmitted in the TBF (i.e., the RLC data block with BSN' = TBC - 1) shall have CV set to the value '0'.

Once the mobile station transmits a value of CV other than 15, the mobile station shall not enqueue any new RLC data blocks and the total number of RLC data blocks to transmit value used to compute the CV shall not be altered. Any data which arrives after the commencement of the countdown process shall be sent within a future TBF.

If an RLC data block is retransmitted, the same CV shall be used as during the previous transmission of the RLC data block.

If the mobile station receives a change in the Channel Coding Command in a PACKET UPLINK ACK/NACK message during the countdown procedure, the mobile station shall act upon the new Channel Coding Command. The mobile station shall then recalculate the CV values for any un-transmitted RLC data blocks using the new RLC data block size.

### 9.3.2 Acknowledged mode operation

The transfer of RLC data blocks in the RLC acknowledged mode uses retransmissions of RLC data blocks. The transmitting side numbers the RLC data blocks via the block sequence number (BSN) for retransmission and for reassembly. The receiving side sends PACKET UPLINK ACK/NACK or PACKET DOWNLINK ACK/NACK messages in order to request retransmission of RLC data blocks.

#### 9.3.2.1 Establishment of Temporary Block Flow

The establishment of a TBF occurs as described in clause 7. RLC functions related to the ARQ function shall not operate until RLC data block transfer has been initiated.

If the last uplink TBF ended with an incompletely transmitted LLC frame, the mobile station shall begin transmission on the new TBF with the last unacknowledged LLC frame.

#### 9.3.2.2 Operation of uplink Temporary Block Flow

The mobile station shall transmit an RLC data block on each assigned uplink data block. RLC control blocks shall preempt the transmission of RLC data blocks, (i.e., temporarily replacing the PDTCH with PACCH).

The network shall send PACKET UPLINK ACK/NACK messages when needed.

The mobile station shall indicate a transmit window stall condition when  $V(S) = V(A) + k$ . Upon detecting a transmit window stall condition, the mobile station shall set the Stall indicator (SI) bit in all subsequent uplink RLC data block until the stall condition ceases to exist.

Upon detecting the stall condition the mobile station shall also start timer T3182. Timer T3182 shall be stopped upon reception of a PACKET UPLINK ACK/NACK message. If timer T3182 expires, the mobile station shall break the RLC connection, decrement counter N3102 by PAN\_DEC, and perform an abnormal release with random access (see subclause 9.4.1).

Whenever the mobile station receives a PACKET UPLINK ACK/NACK that allows the advancement of  $V(Q)$  or  $V(R)$ , the mobile station shall increment N3102 by PAN\_INC, however N3102 shall never exceed the value PAN\_MAX. Upon cell reselection the mobile station shall set counter N3102 to the value PAN\_MAX. When  $N3102 \leq 0$  is reached, the mobile station shall perform an abnormal release with cell re-selection. If PAN\_DEC, PAN\_INC, or PAN\_MAX are set to the value 0, counter N3102 shall be disabled.

A mobile station operating with a fixed allocation shall start or restart timer T3184 upon reception of a PACKET UPLINK ACK/NACK message. If timer T3184 expires, the mobile station shall break the RLC connection and perform an abnormal release with random access (see subclause 9.4.1).

#### 9.3.2.3 Release of uplink Temporary Block Flow

The mobile station initiates release of the uplink TBF by beginning the countdown process (see subclause 9.3.1). When the mobile station has sent the RLC data block with  $CV = 0$  and there are no elements in the  $V(B)$  array set to the value Nacked, it shall start timer T3182. Upon reception of a PACKET UPLINK ACK/NACK message the mobile station shall stop timer T3182.

If the PACKET UPLINK ACK/NACK message requests retransmission of RLC data blocks, the mobile station shall wait for allocation of uplink resources and then retransmit the RLC data blocks requested. The mobile station shall then start timer T3182 and wait for a PACKET UPLINK ACK/NACK as above.

If the PACKET UPLINK ACK/NACK has the Final Ack Indicator bit set to '1', the mobile station shall consider the TBF to be released. If the mobile station has negotiated a non-zero value for T3194 during the attach procedure, the

mobile station shall start timer T3194 and then begin to monitor the AGCH and PCH of the CCCH indicated by the mobile station's CCCH\_GROUP or the PAGCH and PPCH of the PDCH indicated by the mobile station's PCCCH\_GROUP. When timer T3194 expires the mobile station shall begin to monitor its assigned paging channel only. If the mobile station has not negotiated a non-zero value for T3194, it shall begin to monitor its assigned paging channel.

If timer T3182 expires the mobile station shall break the RLC connection and perform an abnormal release with random access (see subclause 9.4.1).

If the network has not received all of the RLC data blocks when it detects the end of the TBF, it shall send a PACKET UPLINK ACK/NACK message to the mobile station and allocate sufficient uplink resources for the mobile station to retransmit the required RLC data blocks.

If the network has received all RLC data blocks when it detects the end of the TBF, it shall set the Final Ack Indicator bit in the PACKET UPLINK ACK/NACK and include a valid RRBP field in the RLC/MAC control block header. If the network does not receive the PACKET CONTROL ACKNOWLEDGEMENT in the radio block indicated by the RRBP field, it shall clear and then increment counter N3103 and retransmit the PACKET UPLINK ACK/NACK message. If counter N3103 exceeds its limit, the network shall start timer T3169. When timer T3169 expires the network may reuse the TFI and USF resources.

#### 9.3.2.4 Operation of downlink Temporary Block Flow

The mobile station shall transmit a PACKET DOWNLINK ACK/NACK on all uplink PACCH blocks unless another RLC control message is waiting to be transmitted, in which case the other RLC control block shall be transmitted in the uplink PACCH block.

#### 9.3.2.5 Release of downlink Temporary Block Flow

The network initiates release of a downlink TBF by sending an RLC data block with the Final Bit Indicator (FBI) set to the value '1' and with a valid RRBP field. The RLC data block sent must have the highest BSN' (see clause 9.3.1) of the downlink TBF. The network shall start timer T3191.

If the mobile station receives an RLC data block with the FBI bit set the value '1' and with a valid RRBP field, the mobile station shall transmit a PACKET DOWNLINK ACK/NACK message in the uplink radio block specified.

If the network receives a PACKET DOWNLINK ACK/NACK message is received before timer T3191 expires, then the network shall start transmitting data to the mobile station, if retransmissions are required, according to the ARQ protocol. If no retransmission are required, the TBF is considered properly terminated. If timer T3191 expires, then the network shall terminate the TBF.

If the mobile station requested retransmissions in the PACKET DOWNLINK ACK/NACK message, the mobile station shall continue to monitor all assigned PDCHs.

If the mobile station has received all previous RLC data blocks, the mobile station shall set the Final Ack indicator bit to '1' in the PACKET UPLINK ACK/NACK message, start timer T3192, and continue to monitor all assigned downlink PDCHs. If the mobile station then receives a subsequent RLC data block with a valid RRBP and the FBI set to '1', the mobile station shall retransmit the PACKET DOWNLINK ACK/NACK.

When timer T3192 expires the mobile station shall stop monitoring its assigned downlink PDCHs. If the mobile station has negotiated a non-zero value for T3194 during the attach procedure, the mobile station shall then start timer T3194 and then begin to monitor the AGCH and PCH of the CCCH indicated by the mobile station's CCCH\_GROUP or the PAGCH and PPCH of the PDCH indicated by the mobile station's PCCCH\_GROUP. When timer T3194 expires the mobile station shall begin to monitor its assigned paging channel only. If the mobile station has not negotiated a non-zero value for T3194, it shall begin to monitor its assigned paging channel.

### 9.3.3 Unacknowledged mode operation

The transfer of RLC data blocks in the RLC unacknowledged mode does not include any retransmissions. The block sequence number (BSN) in the RLC data block header is used to number the RLC data blocks for reassembly. The receiving side sends Packet Ack/Nack messages in order to convey the necessary other control signalling (e.g.

monitoring of channel quality for downlink transfer or timing advance correction for uplink transfers) while the fields for requesting retransmission of RLC data blocks are not used.

### 9.3.3.1 Establishment of Temporary Block Flow

If the last uplink TBF ended with an incompletely transmitted LLC frame, the mobile station shall begin transmission on the new TBF with the last incompletely transmitted LLC frame.

### 9.3.3.2 Operation of uplink Temporary Block Flow

The network shall send PACKET UPLINK ACK/NACK messages when needed.

The mobile station shall set the Stall indicator (SI) bit to '0' in all RLC data blocks.

If the mobile station transmits  $k$  ( $k =$  window size) RLC data blocks without receiving a Packet Ack/Nack message the mobile station shall start timer T3182. Timer T3182 shall be stopped upon reception of a PACKET UPLINK ACK/NACK message. If timer T3182 expires, the mobile station shall break the RLC connection, decrement counter N3102 by PAN\_DEC, and perform an abnormal release with random access (see subclause 9.4.1).

Whenever the mobile station receives a PACKET UPLINK ACK/NACK message, the mobile station shall increment N3102 by PAN\_INC, however N3102 shall never exceed the value Z. Upon cell reselection the mobile station shall set counter N3102 to the value PAN\_MAX. When  $N3102 \leq 0$  is reached, the mobile station shall perform an abnormal release with cell re-selection.

A mobile station operating with a fixed allocation shall start or restart timer T3184 upon reception of a PACKET UPLINK ACK/NACK message. If timer T3184 expires the mobile station shall break the RLC connection and perform an abnormal release with random access (see subclause 9.4.1).

### 9.3.3.3 Release of uplink Temporary Block Flow

The mobile station initiates release of the uplink TBF by beginning the countdown process (see subclause 9.3.1). When the mobile station sends its final RLC data block (with CV set to the value "0") it shall end the TBF.

If the mobile station has negotiated a non-zero value for T3194 during the attach procedure, the mobile station shall begin to monitor the AGCH and PCH of the CCCH indicated by the mobile station's CCCH\_GROUP or the PAGCH and PPCH of the PDCH indicated by the mobile station's PCCCH\_GROUP. When timer T3194 expires the mobile station shall begin to monitor its assigned paging channel only.

If the mobile station has not negotiated a non-zero value for T3194, it shall begin to monitor its assigned paging channel.

When the network detects the end of the TBF it shall start timer T3169. When timer T3169 expires the network may reuse the TFI and USF resources.

### 9.3.3.4 Operation of downlink Temporary Block Flow

The mobile station shall transmit a PACKET DOWNLINK ACK/NACK on all uplink PACCH blocks unless another RLC control message is waiting to be transmitted, in which case the other RLC control block shall be transmitted in the uplink PACCH block.

### 9.3.3.5 Release of downlink Temporary Block Flow

The network initiates release of a downlink TBF by sending an RLC data block with the Final Bit Indicator (FBI) set to the value '1' and with a valid RRBP field. The network shall start timer T3191.

If the mobile station receives an RLC data block with the FBI bit set the value '1' and with a valid RRBP field, the mobile station shall transmit the PACKET CONTROL ACKNOWLEDGE message in the uplink block by the RRBP. The mobile station shall then start timer T3192 and continue to monitor all assigned downlink PDCHs. If the mobile station then receives a subsequent RLC data block with a valid RRBP and the FBI set to '1', the mobile station shall retransmit the PACKET DOWNLINK ACK/NACK.

If the network receives the PACKET CONTROL ACKNOWLEDGEMENT before timer T3191 expires, the network shall consider the TBF properly terminated. If timer T3191 expires, the network shall terminate the TBF and release the resources.

When timer T3192 expires the mobile station shall stop monitoring its assigned downlink PDCHs. If the mobile station has negotiated a non-zero value for T3194 during the attach procedure, the mobile station shall then start timer T3194 and then begin to monitor the AGCH and PCH of the CCCH indicated by the mobile station's CCCH\_GROUP or the PAGCH and PPCH of the PDCH indicated by the mobile station's PCCCH\_GROUP. When timer T3194 expires the mobile station shall begin to monitor its assigned paging channel only. If the mobile station has not negotiated a non-zero value for T3194, it shall begin to monitor its assigned paging channel.

## 9.4 Abnormal release cases

When an abnormal release occurs, the sending side shall reorganize its sending buffer and establish a new RLC connection with a new TFI. The first LLC frame transmitted during the new TBF shall be the LLC frame whose RLC data blocks were not all acknowledged by the RLC/MAC layer during the abnormally released TBF.

### 9.4.1 Abnormal release with random access

The mobile station shall release the TBF and the resources associated with the TBF (e.g., USF, TFI) and shall immediately go to the CCCH or PCCCH and perform the channel access to start a new uplink TBF.

---

## 10 RLC/MAC block structure

A RLC/MAC block consists of a MAC Header and a RLC data block or RLC/MAC control block. The RLC/MAC block structure is shown in Figure 2.

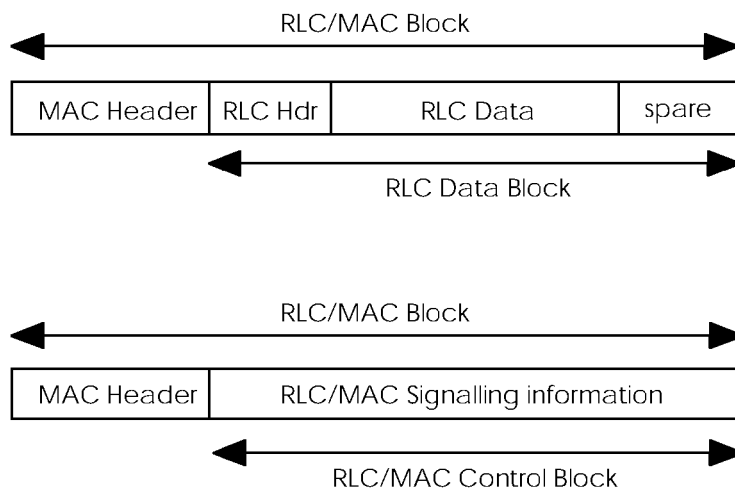

Figure 2: RLC/MAC block structure

### 10.1 Spare bits

Where the description of RLC/MAC blocks in this Technical Specification contains bits defined to be "spare bits", these bits shall be set to the value 0 by the sending side, and their value shall be ignored by the receiving side.

### 10.2 RLC data blocks

The RLC data block consists of an RLC Header, an RLC Data field, and spare bits. Each RLC data block may be encoded using any of the available channel coding schemes CS-1, CS-2, CS-3, or CS-4 (see GSM 05.03). RLC data

blocks encoded using CS-1 do not contain spare bits. The size of the RLC data block for each of the channel coding schemes is shown in Table 3.

**Table 3: RLC data block size**

Channel Coding Scheme	RLC data block size without spare bits (octets)	Number of spare bits	RLC data block size (octets)
CS-1	22	0	22
CS-2	32	7	32 7/8
CS-3	38	3	38 3/8
CS-4	52	7	52 7/8

### 10.2.1 Downlink RLC data block

The Downlink RLC data block is formatted as shown in Figure 3.

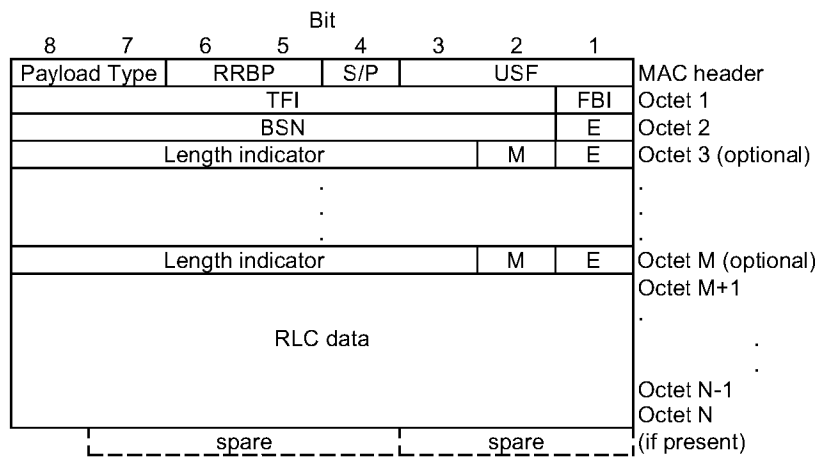

**Figure 3: Downlink RLC data block with polling**

### 10.2.2 Uplink RLC data block

The Uplink RLC data block is formatted as shown in Figure 4.



## 10.4 MAC header and RLC data block header fields

### 10.4.1 Uplink state flag (USF) field

The USF field is sent in all downlink RLC/MAC blocks and indicates the owner or use of the next uplink Radio block on the same timeslot (see GSM 05.02). The USF field is three bits in length and eight different USF values can be assigned, except on PCCCH, where the value '111' indicates the corresponding uplink Radio block contains PRACH.

### 10.4.2 Retry (R) bit

The Retry (R) bit shall indicate whether the mobile station transmitted the CHANNEL REQUEST (see GSM 04.08) or PACKET CHANNEL REQUEST message one time or more than one time during its most recent channel access. The mobile station shall send the same value for the R bit in each uplink RLC/MAC block of the TBF.

**Table 4: Retry (R) bit**

bit	
1	Retry (R) bit
0	MS sent channel request message once
1	MS sent channel request message more than once

### 10.4.3 Stall indicator (SI) bit

The Stall indicator (SI) bit indicates whether the mobile's RLC transmit window can advance (i.e., is not stalled) or can not advance (i.e., is stalled). The mobile station shall set the SI bit in all uplink RLC data blocks.

**Table 5: Stall indicator bit**

bit	
1	Stall indicator
0	MS RLC transmit window is not stalled
1	MS RLC transmit window is stalled

### 10.4.4 Supplementary/Polling (S/P) Bit

The S/P bit is used to indicate whether the RRBP field is valid or not valid.

**Table 6: Supplementary/Polling (S/P) bit**

bit	
1	S/P
0	RRBP field is not valid
1	RRBP field is valid

### 10.4.5 Relative Reserved Block Period (RRBP) field

The RRBP value specifies a single uplink block in which the mobile station shall transmit either a PACKET CONTROL ACKNOWLEDGEMENT or a PACCH block to the network. If the RRBP field is received as part of a RLC/MAC block containing an RLC/MAC control block containing any message except Packet Paging Request, Packet Access Reject, and Packet Queueing Notification, the mobile station shall transmit a PACKET CONTROL ACKNOWLEDGEMENT in the uplink radio block specified. If the mobile station receives two or more RLC/MAC control messages with different RRBP values such that they specify the same uplink radio block, the mobile station shall transmit a PACKET CONTROL ACKNOWLEDGEMENT in the specified uplink radioblock.

If the RRBP field is received as part of a RLC/MAC block containing an RLC data block, the mobile station shall transmit a PACCH block in the specified uplink radio block. If the mobile station receives two or more RLC data blocks with different RRBP values such they specify the same uplink radio block, the mobile station shall transmit one PACCH block in the specified uplink radio block.



If the mobile station receives an RLC data block and an RLC/MAC control block with different RRBP values such that they specify the same uplink radio block, the mobile station shall transmit an PACKET CONTROL ACKNOWLEDGEMENT in the specified uplink radio block.

The mobile station need not monitor the USF bits in the downlink RLC/MAC block before the uplink block it shall transmit.

Table 7 indicates the number of TDMA frames the mobile station shall wait before transmitting. The delay is relative to the first TDMA frame (N) of the downlink block containing the RRBP value.

**Table 7: Relative Reserved Block Period (RRBP) field**

bits	
2 1	Relative Reserved Block Period (RRBP)
0 0	uplink block with TDMA framenumber = N+8 or N+9
0 1	uplink block with TDMA framenumber = N+13
1 0	uplink block with TDMA framenumber = N+17 or N+18
1 1	uplink block with TDMA framenumber = N+21 or N+22

#### 10.4.6 Countdown Value (CV) field

The Countdown Value (CV) field is sent by the mobile station to allow the network to calculate the number of RLC data blocks remaining for the current uplink TBF. The CV value shall be calculated according to the process described in subclause 84.1.1.1. The CV field is 4 bits in length and is encoded as a binary number with range 0 to 15.

#### 10.4.7 Payload Type field

The Payload Type field shall indicate the type of data contained in remainder of the RLC/MAC block. The encoding of the Payload Type field is shown in Table 8.

**Table 8: Payload Type field**

bit	
2 1	Payload Type
0 0	RLC/MAC block contains an RLC data block
0 1	RLC/MAC block contains an RLC/MAC control block
All others	Reserved. In this version of the protocol, the mobile station shall ignore all fields of the RLC/MAC block except for the USF field

#### 10.4.8 Final block indicator (FBI) bit

The Final block indicator (FBI) bit indicates that the downlink RLC data block is the last RLC data block of the downlink TBF.

**Table 9: Final block indicator bit**

bit	
1	Final block indicator
0	Current block is not last RLC data block in TBF
1	Current block is last RLC data block in TBF

#### 10.4.9 TLLI Indicator (TI) bit

The TLLI Indicator (TI) bit indicates the presence of an optional TLLI field within the RLC data block.

**Table 10: TLLI Indicator (TI) bit**

bit	
1	TLLI indicator (TI) bit
0	TLLI field is not present
1	TLLI field is present

#### 10.4.10 Temporary Flow Identifier (TFI) field

The TFI identifies the Temporary Block Flow (TBF) to which the RLC data block belongs. The TFI field is 7 bits in length and is encoded as a binary number with range 0 to 127.

#### 10.4.11 Extension (E) Bit

The Extension (E) bit is used to indicate the presence of an optional octet in the RLC data block header.

**Table 11: Extension (E) bit**

bit	
1	E bit
0	Extension octet follows immediately
1	No extension octet follows

#### 10.4.12 Block Sequence Number (BSN) field

The Block Sequence Number (BSN) field carries the sequence number of each RLC data block within the TBF. The BSN is 7 bits in length and is encoded as a binary number with range 0 to 127.

#### 10.4.13 More (M) bit

The M bit, along with the E bit and the Length Indicator (LI), are used to delimit LLC frames within a TBF. When the M bit is present it indicates whether or not another LLC frame follows the current one within the RLC data block. The function of the M and E bits when they occur in the same octet is defined in Table 12.

**Table 12: M bit and E bit**

bit		
<u>M</u>	<u>E</u>	
0	0	Reserved. In this version of the protocol, if received by the the mobile station it shall ignore all fields of the RLC/MAC block except for the Payload Type field, the RRBP field, the S/P bit, and the USF field
0	1	no LLC data after the current LLC frame, no more extension octets
1	0	a new LLC frame starts after the current LLC frame and ends before the end of the RLC information field, there is another extension octet
1	1	a new LLC frame starts after the current LLC frame and continues until the end of the RLC information field, no more extension octets

#### 10.4.14 Length Indicator (LI) field

The Length indicator is used to delimit LLC frames within the RLC data block. The first Length Indicator shall indicate the number of octets of the RLC data field belong to the first LLC frame, the second Length Indicator shall indicate the number of octets of the RLC data field belong to the second LLC frame, etc. The final RLC data block of a TBF shall have a Length indicator field unless the final LLC frame fills the RLC data block precisely. The LI field is 6 bits in length and shall be encoded as a binary number with range 1 to 52. The value 0 shall indicate that no RLC frame boundary exists and that the M bit shall be ignored and that the E bit shall be interpreted as having the value '1'. All

other values are reserved, and in this version of the protocol, the mobile station shall ignore all fields of the RLC data block except for the USF field.

### 10.4.15 TLLI field

The TLLI field contains a TLLI encoded as the contents of the TLLI information element defined in GSM 04.08.

### 10.4.16 RLC data field

The RLC data field contains octets from one or more LLC PDUs. The RLC data field may contain parts of one or two LLC PDUs and all of an arbitrary number of LLC PDUs. The E bit, the M bit, and the Length Indicator delimit the RLC data field into LLC frames. If the last LLC frame of the TBF does not fill the entire RLC data field, an extension octet shall be used to indicate the number of valid RLC data octets and the remainder of the RLC data field shall be filled with filler octets with the value '00101011'. Only the last RLC data block of the TBF may contain filler octets.

### 10.4.17 Control message contents field

The Control message contents field shall contain one RLC/MAC control message. Only one RLC/MAC control message shall be transported per Control message contents field (i.e., RLC control block).

If the RLC/MAC control message does not fill the RLC control block, filler octets with value "00101011" shall be used to fill the remainder of the RLC control block as defined in GSM 04.06. The receiver of the RLC/MAC control message determines the length of the RLC/MAC control message by interpreting the RLC/MAC control message.

---

## 11 Message functional definitions and contents

This clause defines the structure of the RLC/MAC control messages. These are non-standard L3 messages as defined in GSM 04.07. The formats for the messages are valid only for the PDCH. The format for RLC/MAC control messages for use on the CCCH are defined in GSM 04.08.

Each definition given in the present clause includes:

- a) a brief description of the message direction and use;
- b) A CSN.1 description of the message information elements and fields (see GSM 04.07). Definition of information elements may immediately follow the definition of the message. If the definition of an information element immediately follows the message definition, the information element name ends with "struct". Otherwise the information element name ends with "IE" and the definition of the information element is defined in Clause 12 or in GSM 04.08;
- c) A note specifying, where appropriate, conditions for information elements or fields with presence requirement C or O in the relevant message which together with other conditions specified in GSM 04.60 define when the information elements shall be included or not, what non-presence of such information elements or fields means, and - for IEs with presence requirement C - the static conditions for presence and/or non-presence of the information elements or fields (see GSM 04.07);
- d) A table follows which contains a definition for each field referenced in the message definition or in an information element struct immediately following the message definition.

Bit fields within RLC/MAC messages shall have the highest numbered bit of the bit field in the highest numbered bit of the lowest number octet. The mapping of an 11 bit field is illustrated in Figure 7.

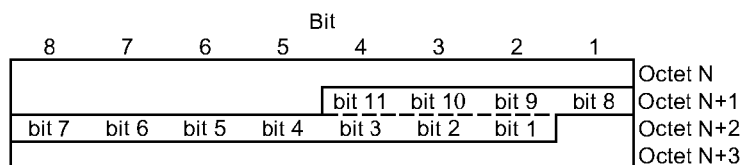

Figure 7: Field mapping within RLC/MAC messages

All RLC/MAC control messages are 22 octets in length (see subclause 10.3). For messages less than 22 octets in length, padding is used to fill up the message up to the desired length. The padding uses a particular sequence of bits, of fixed position, i.e., the value of a padding bit depends on its position relative to the start of the message. The padding sequence is the repetition of octet 00101011, starting on an octet boundary.

The notations “L” and “H” are used to denote the respectively the bit value corresponding to the padding spare bit for that position, and the other value (see GSM 04.07).

## 11.1 Handling of erroneous protocol data

Handling of unknown, unforeseen, and erroneous protocol data shall be as defined in clause 8 of GSM 04.08

## 11.2 RLC/MAC control messages

Table 13 summarises the RLC/MAC control messages. For each control message, the mobile identifier shall be a fixed number of bits from the beginning of the message.

Table 13: RLC/MAC control messages

<b>Uplink TBF establishment messages:</b>	<b>Reference</b>
Packet Access Reject	11.2.1
Packet Channel Request	11.2.5
Packet Queueing Notification	11.2.15
Packet Resource Request	11.2.16
Packet Uplink Assignment	11.2.29
Packet Uplink Assignment bis	11.2.30
<b>Downlink TBF establishment messages:</b>	<b>Reference</b>
Packet Downlink Assignment	11.2.7
<b>TBF release messages:</b>	<b>Reference</b>
Packet TBF Release	11.2.26
<b>Paging messages:</b>	<b>Reference</b>
Packet Paging Request	11.2.10
<b>RLC messages:</b>	<b>Reference</b>
Packet Downlink Ack/Nack	11.2.6
Packet Uplink Ack/Nack	11.2.28
<b>System information messages:</b>	<b>Reference</b>
Packet System Information Type 1	11.2.18
Packet System Information Type 2	11.2.19
Packet System Information Type 3	11.2.20
Packet System Information Type 3 bis	11.2.21
Packet System Information Type 4	11.2.22
Packet System Information Type 5	11.2.23
Packet System Information Type 5 bis	11.2.24
Packet System Information Type 6	11.2.25
<b>Miscellaneous messages:</b>	<b>Reference</b>
Packet Control Acknowledgement	11.2.2
Packet Cell Change Failure	11.2.3
Packet Cell Change Order	11.2.4
Packet Dummy Control Block	11.2.8
Packet Measurement Report	11.2.9
Packet PDCH Release	11.2.11
Packet Polling Request	11.2.12
Packet Power Control/Timing Advance	11.2.13
Packet PRACH Parameters	11.2.14
Spare	11.2.17
Packet TBF Status	11.2.27

### 11.2.1 Packet Access Reject

The Packet Access Reject is broadcast on the downlink PAGCH by the network to indicate that the network has rejected the MSs access request. This message may contain fields addressing more than one mobile station.

Message type: Packet Access Reject

Direction: network to mobile station

Table 14: PACKET ACCESS REJECT information elements

```

< Packet Access Rejectmessage content > ::=
  < MESSAGE_TYPE : bit (6) >
  < PAGE_MODE : bit (2) >
  < Reject : Reject struct >
  < spare padding > ;

< Reject struct > ::=
  { L < Packet Request Reference : Packet Request Reference IE >
  | H < TLLI : bit (32) > }
  { 0 | 1 < WAIT_INDICATION : bit (8) > }
  < ALLOCATION_REFERENCE : bit (2) >
  { 0 | 1 < Reject : Reject struct > } ;

```

Table 15: PACKET ACCESS REJECT information element details

**PAGE\_MODE** (2 bit field)

This field describes which type of page mode used, i.e. either normal paging, extended paging, paging reorganization or same as before from the previous page mode. The mobile station shall ignore this field if the message is received on the PACCH. Coding of this field is defined in GSM 04.08.

**Packet Request Reference IE**

This information element is defined in subclause 12.11.

## TLLI (32 bit field)

This information field is defined in subclause 12.16.

**WAIT\_INDICATION** (8 bit field)

The Wait Indication information element indicates the time the mobile station shall wait before attempting another channel request. If this field is present the cause value is "Wait". If this field is not present, the cause value is "Read System Information". This field is coded as the binary representation of the T3172 timeout value in seconds. Range 0 to 255.

**ALLOCATION\_REFERENCE** (2 bit field)

This field is used only for Fixed Allocation operation. This field is defined in subclause 12.5.

## 11.2.2 Packet Control Acknowledgement

This message is sent in the PACCH. It consists of three different formats. The format to be used by the mobile station is indicated in System Information parameters. The order of bit transmission is defined in GSM 04.04.

The PACKET CONTROL ACKNOWLEDGEMENT message is formatted as either an RLC/MAC control block or as 4 access bursts. The System Information parameter CONTROL\_ACK\_TYPE indicates which format the mobile station shall use.

The RLC/MAC control block format is shown in table 16 and table 17.

The access burst format is 11 bits or 8 bits long and is coded as shown in Table 18 and Table 19. If the System Information parameter ACCESS\_BURST\_TYPE indicates 11 bit access, the mobile station shall transmit the 11 bit format. If the System Information parameter ACCESS\_BURST\_TYPE indicates 8 bit access, the mobile station shall transmit the 8 bit format. The mobile station shall transmit the access burst four times, one time in each TDMA frame of the uplink radio block.

Message type: Packet Control Acknowledgement

Direction: mobile station to network

**Table 16: PACKET CONTROL ACKNOWLEDGEMENT  
RLC/MAC control block information elements**

<p>&lt; Packet Control Acknowledgement message content &gt; ::=</p> <p>&lt; <b>MESSAGE_TYPE</b> : bit (6) &gt;</p> <p>&lt; <b>TLLI</b> : bit (32) &gt;</p> <p>&lt; spare padding &gt; ;</p>
---

**Table 17: PACKET CONTROL ACKNOWLEDGEMENT  
RLC/MAC control block information element details**

**TLLI** (32 bit field)

This field contains the TLLI of the mobile station. This field is encoded as defined in clause 12.16.

**Table 18: PACKET CONTROL ACKNOWLEDGEMENT 11 bit message content**

bits	
<u>11</u> ..... <u>1</u>	<u>Packet Control Acknowledgement</u>
1 1 1 1 1 1 0 0 1 1 1	Packet Control Acknowledgement
All other values	reserved

**Table 19: PACKET CONTROL ACKNOWLEDGEMENT 8 bit message content**

bits	
<u>8</u> ..... <u>1</u>	<u>Packet Control Acknowledgement</u>
0 1 1 1 1 1 1 1	Packet Control Acknowledgement
All other values	reserved

### 11.2.3 Packet Cell Change Failure

The Packet Cell Change Failure message is sent by the mobile station to the network on the PACCH to indicate that a commanded cell change order has failed.

Message type: Packet Cell Change Failure

Direction: mobile station to network

**Table 20: PACKET CELL CHANGE FAILURE message content**

<p>&lt; Packet Cell Change Failure message content &gt; ::=</p> <p>&lt; <b>MESSAGE_TYPE</b> : bit (6) &gt;</p> <p>&lt; <b>TLLI</b> : bit (32) &gt;</p> <p>&lt; <b>ARFCN</b> : bit (10) &gt;</p> <p>&lt; <b>BSIC</b> : bit (6) &gt;</p> <p>&lt; <b>CAUSE</b> : bit (8) &gt; ;</p>
--

**Table 21: PACKET CELL CHANGE FAILURE information element details**

<b>TLLI</b> (32 bit field) This field is defined in clause 12.16.	
<b>ARFCN</b> (10 bit field) This field contains the BCH frequency of the new cell on which the failure occurred. This field is encoded as the ARFCN defined in GSM 04.08. Range 0 to 1023	
<b>BSIC</b> (6 bit field) This field contains the BSIC of the BCH frequency of the new cell on which the failure occurred. This field is encoded as the BSIC value defined in GSM 04.08. Range 0 to 63	
<b>CAUSE</b> (8 bit field) This field indicates the cause of the cell change order failure on the target cell.	
Bit	
<u>8 7 6 5 4 3 2 1</u>	
0 0 0 0 0 0 0 0	Frequency not implemented
0 0 0 0 0 0 0 1	No response on target cell
0 0 0 0 0 0 1 0	Immediate Assign Reject or Packet Access Reject on target cell
All others	Reserved

## 11.2.4 Packet Cell Change Order

The Packet Cell Change Order message is sent by the network on the PCCCH or PACCH. The message commands the mobile to leave the current cell and change to a new cell.

Message type: Packet Cell Change Order

Direction: network to mobile station

**Table 22: PACKET CELL CHANGE ORDER message content**

< Packet Cell Change Order message content > ::=
< <b>MESSAGE_TYPE</b> : bit (6) >
< <b>TLLI</b> : bit (32) >
< <b>ARFCN</b> : bit (10) >
< <b>BSIC</b> : bit (6) >
< <b>NETWORK_CONTROL_ORDER</b> : bit (2) >



**Table 23: PACKET CELL CHANGE ORDER information element details**

<b>TLLI</b> (32 bit field) This field is defined in clause 12.16.	
<b>ARFCN</b> (10 bit field) This field contains the BCH frequency of the new cell. This field is encoded as the ARFCN defined in GSM 04.08. Range 0 to 1023	
<b>BSIC</b> (6 bit field) This field contains the BSIC of the BCH frequency of the new cell. This field is encoded as the BSIC value defined in GSM 04.08. Range 0 to 63	
<b>NETWORK_CONTROL_ORDER</b> (2 bit field) The NETWORK_CONTROL_ORDER field contains the network control order that the mobile station shall apply in the new cell. This field is coded according to the following table:	
bit	
<u>2</u> <u>1</u>	
0 0	NC0 - Normal MS controlled cell re-selection; No measurement reporting;
0 1	NC1 - Normal MS controlled cell re-selection; The MS shall send measurement reports;
1 0	NC2 - Network controlled cell re-selection; The MS shall send measurement reports;
1 1	The MS shall use the NC value from the System Information of the new cell

### 11.2.5 Packet Channel Request

This message is sent in random mode on the PRACH. It does not follow the basic format. The possible formats are presented directly below, without reference to information fields. The order of bit transmission is defined in GSM 04.04.

The message is 11 bits or 8 bits long. If the System Information parameter ACCESS\_BURST\_TYPE indicates 11 bit access, the mobile station shall transmit the 11 bit format. If the System Information parameter ACCESS\_BURST\_TYPE indicates 8 bit access, the mobile station shall transmit the 8 bit format.

The 11 bit format is coded as shown in Table 24.

The 8 bit format is coded as shown in Table 25.

Multislot class field is filled with "m", Priority field is filled with "p", Circuit Mode Channel Request field is filled with "x", Number of Blocks field is filled with "n", and Random Reference field is filled with "r".

**Table 24: PACKET CHANNEL REQUEST 11 bit message content**

bits	
11 .....1	<u>Packet Channel Access</u>
0 mmmmm pp rrr	One Phase Access Request
1 0 0 n n n pp rrr	Short Access Request
1 1 0 0 0 0 pp rrr	Two Phase Access Request
1 1 0 0 0 1 rrrrr	Page Response
1 1 0 0 1 0 rrrrr	Cell Update
1 1 0 0 1 1 rrrrr	Mobility Management procedure
1 1 0 1 0 0 rrrrr	Measurement Report
All others	Reserved

**Table 25: PACKET CHANNEL REQUEST 8 bit message content**

bits	
8 .....1	<u>Packet Channel Access</u>
1 mmmmm rrr	One Phase Access Request
0 0 n n n rrr	Short Access Request
0 1 0 0 0 rrr	Two Phase Access Request
0 1 0 0 1 rrr	Page Response
0 1 0 1 0 rrr	Cell Update
0 1 0 1 1 rrr	Mobility Management procedure
0 1 1 0 0 rrr	Measurement Report
All others	Reserved

**ACCESS TYPE**

This information field indicates the reason for requesting the access. This field has a variable length from 1 to 6 bits.

**MULTISLOT CLASS (m)**

This information field indicates the multislot class of the ME. The content of this field is defined in GSM 05.02, Annex B. This field is 5 bits in length.

**PRIORITY (p)**

This information field indicates the requested Priority. This field is 2 bits in length and is coded as shown in Table 26. The 8 bit format has a default priority of Priority Level 4.

**Table 26: PACKET CHANNEL REQUEST - Priority**

bits	
<u>2 1</u>	<u>Priority</u>
0 0	Priority Level 1 (Highest priority)
0 1	Priority Level 2
1 0	Priority Level 3
1 1	Priority Level 4 (Lower priority)

**NUMBER OF BLOCKS (n)**

This information field indicates the number of blocks requested during a mobile originated Temporary Block Flow. This field is 3 bits in length and is coded as shown in Table 27.

**Table 27: PACKET CHANNEL REQUEST - Number of Blocks**

bits	
<u>3 2 1</u>	<u>Number of RLC data blocks</u>
0 0 0	1 RLC data block
0 0 1	2 RLC data blocks
...	
1 1 1	8 RLC data blocks

**RANDOM REFERENCE (R)**

This is an unformatted field.

## 11.2.6 Packet Downlink Ack/Nack

The Packet Downlink Ack/Nack is sent from the mobile station to the network on the PACCH to indicate the status of downlink RLC data blocks received and to report the channel quality of the downlink. The mobile station may optionally initiate an uplink TBF or request a temporary suspension of the downlink TBF.

Message type: Packet Downlink Ack/Nack

Direction: mobile station to network

**Table 28: PACKET DOWNLINK ACK/NACK information elements**

```

< Packet Downlink Ack/Nack message content > ::=
  < MESSAGE_TYPE : bit (6) >
  < DOWNLINK_TFI : bit (7) >
  { L | H < Ack/Nack Description : Ack/Nack Description IE > }
  < Channel Quality Report : Channel Quality Report struct >
  < CHANNEL_CODING_REQUESTED : bit (2) >
  < TBF_RELEASE : bit (1) >
  { L | H < Channel Request Description : Channel Request Description IE > }
  { H { < Suspend Request : Suspend Request struct > } * L }
  < spare padding > ;

< Channel Quality Report struct > ::=
  < C_VALUE : bit (6) >
  < RXQUAL : bit (3) >
  < SIGN_VAR : bit (6) >
  { 0 | 1 < I_LEVEL_TN0 : bit (6) > }
  { 0 | 1 < I_LEVEL_TN1 : bit (6) > }
  { 0 | 1 < I_LEVEL_TN2 : bit (6) > }
  { 0 | 1 < I_LEVEL_TN3 : bit (6) > }
  { 0 | 1 < I_LEVEL_TN4 : bit (6) > }
  { 0 | 1 < I_LEVEL_TN5 : bit (6) > }
  { 0 | 1 < I_LEVEL_TN6 : bit (6) > }
  { 0 | 1 < I_LEVEL_TN7 : bit (6) > };

< Suspend Request struct > ::=
  { < SUSPEND_REQUEST : bit (3) >
    < SUSPEND_STARTING_TIME : bit (16) > };

```

**Table 29: PACKET DOWNLINK ACK/NACK information element details****DOWNLINK\_TFI** (7 bit field)

This field contains the TFI of the mobile station's downlink TBF. This field is defined in clause 12.15.

**Ack/Nack Description IE**

If the downlink TBF is operating in RLC acknowledged mode, the mobile station shall include the Ack/Nack Description IE. If the downlink TBF is operating in RLC unacknowledged mode, the mobile station shall not include the Ack/Nack Description IE. This information element is defined in clause 12.3.

**CHANNEL\_CODING\_REQUESTED** (2 bit field)

This field is defined in clause 12.

**TBF\_RELEASE** (1 bit field)

This field indicates if the mobile station is requesting to terminate the downlink TBF.

- 0 Termination of TBF is not requested
- 1 Termination of TBF is requested

**Channel Request Description IE**

This information element is defined in clause 12.7.

**Table 29 (continued): PACKET DOWNLINK ACK/NACK information element details****SUSPEND\_REQUEST** (3 bit field)

The Suspend Request field indicates how many block periods the mobile station desires to suspend the downlink TBF and the uplink TBF, if one exists.

bit

3 2 1

0 0 0 suspend 1 block period

0 0 1 suspend 2 block period

0 1 0 suspend 3 block period

:

1 1 1 suspend 8 block period

**SUSPEND\_STARTING\_TIME** (16 bit field)

This field indicates the TDMA framenumbers of the first TDMA frame of the first block period of the suspension. This field is encoded as the Starting Time information element in GSM 04.08.

**C\_VALUE** (6 bit field)

This field contains the value of the C parameter calculated by the mobile station (see GSM 05.08). This field is encoded as the binary representation of the C parameter value defined in GSM 05.08.

Range 0 to 63

**RXQUAL** (3 bits)

This field contains the RXQUAL parameter field calculated by the mobile station (see GSM 05.08). This field is encoded as defined in GSM 04.08.

Range 0 to 7

**SIGN\_VAR** (6 bits)

This field contains the signal variance parameter SIGN\_VAR calculated by the mobile station (see GSM 05.08).

bit

6 5 4 3 2 1

0 0 0 0 0 0 0dB<sup>2</sup> to 0.25 dB<sup>2</sup>

0 0 0 0 0 1 >0.25 dB<sup>2</sup> to 0.50 dB<sup>2</sup>

0 0 0 0 1 0 >0.50 dB<sup>2</sup> to 0.75 dB<sup>2</sup>

: : :

1 1 1 1 1 0 >15.50 dB<sup>2</sup> to 15.75 dB<sup>2</sup>

1 1 1 1 1 1 >15.75 dB<sup>2</sup>

**GAMMA\_TN0** (6 bit field)**GAMMA\_TN1** (6 bit field)**GAMMA\_TN2** (6 bit field)**GAMMA\_TN3** (6 bit field)**GAMMA\_TN4** (6 bit field)**GAMMA\_TN5** (6 bit field)**GAMMA\_TN6** (6 bit field)**GAMMA\_TN7** (6 bit field)

These fields contain the  $\gamma$  value calculated on timeslots 0 through 7, respectively. The  $\gamma$  value is defined in GSM 05.08.

These fields are transferred only when the mobile station is in packet transfer mode. These fields are encoded as defined for the mapping defined in GSM 05.08 for the received signal strength (RXLEV).

Range 0 to 63

## 11.2.7 Packet Downlink Assignment

The Packet Downlink Assignment is sent by the network to the mobile station to assign downlink resources to the mobile station.

For a mobile station assigned to operate in the fixed allocation MAC mode, the network may assign regularly repeating intervals during which the mobile station shall measure neighbour cell power levels.

ETSI

Message type: Packet Downlink Assignment

Direction: network to mobile station

**Table 30: PACKET DOWNLINK ASSIGNMENT information elements**

<pre> &lt; Packet Downlink Assignment message content &gt; ::=   &lt; MESSAGE_TYPE : bit (6) &gt;   &lt; PAGE_MODE : bit (2) &gt;   &lt; Referenced address : Referenced address struct &gt;   &lt; 2_MESSAGE_DOWNLINK_ASSIGNMENT : bit(1) &gt;   &lt; MAC_MODE : bit (2) &gt;   &lt; RLC_MODE : bit (1) &gt;   &lt; TIMESLOT_ALLOCATION : bit (8) &gt;   &lt; Packet Timing Advance : Packet Timing Advance IE &gt;   &lt; Frequency Parameters : Frequency Parameters IE &gt;   { L   H &lt; Power Control Parameters : Power Control Parameters IE &gt; }   { L   H &lt; DOWNLINK_TFI_ASSIGNMENT : bit (7) &gt; }   { L   H &lt; TBF_STARTING_TIME : bit (16) &gt; }   { L   H &lt; Measurement Mapping : Measurement Mapping struct &gt; }   &lt; spare padding &gt; ;  &lt;Referenced Address struct &gt; ::=   { 0 &lt; Global TFI : Global TFI IE &gt;       1 &lt; TLLI : bit (32) &gt; }  &lt; Measurement Mapping struct &gt; ::=   &lt; MEASUREMENT_STARTING_TIME : bit (16) &gt;   &lt; MEASUREMENT_INTERVAL : bit (5) &gt;   &lt; MEASUREMENT_BITMAP : bit (8) &gt; ; </pre>
---

NOTE: Not all of the optional information elements and fields can be included due to message length limitations.

**Table 31: PACKET DOWNLINK ASSIGNMENT information element details**

<p><b>PAGE_MODE</b> (2 bit field) This field describes which type of page mode used, i.e. either normal paging, extended paging, paging reorganization or same as before from the previous page mode. The mobile station shall ignore this field if the message is received on the PACCH. Coding of this field is defined in GSM 04.08.</p> <p><b>Referenced address struct</b> This information element contains the address of the mobile station addressed by the message.</p> <p><b>Global TFI IE</b> This information element contains the TFI of the mobile station's downlink TBF or uplink TBF. This field is defined in clause 12.10.</p> <p><b>TLLI</b> (32 bit field) This field is defined in subclause 12.16.</p> <p><b>2_MESSAGE_DOWNLINK_ASSIGNMENT</b> (2 bit field) This information field indicates whether the PACKET DOWNLINK ASSIGNMENT message is self contained or if another message contains part of the assignment.</p> <p>0 this PACKET DOWNLINK ASSIGNMENT message is self contained 1 a PACKET SYSTEM INFORMATION TYPE 2 message is part of this assignment</p>
--

Table 31 (continued): PACKET DOWNLINK ASSIGNMENT information element details

<p><b>MAC_MODE</b> (1 bit field) This information field indicates the medium access method to be used during the TBF.</p> <p>Bit <u>2 1</u> 0 0 Dynamic Allocation 0 1 Extended Dynamic Allocation 1 0 Fixed Allocation 1 1 Reserved</p> <p><b>RLC_MODE</b> (1 bit field) This field indicates the RLC mode of the requested TBF.</p> <p>0 RLC acknowledged mode 1 RLC unacknowledged mode</p> <p><b>TIMESLOT_ALLOCATION</b> (8 bit field) This field is defined in subclause 12.18.</p> <p><b>Packet Timing Advance IE</b> This information element is defined in subclause 12.12.</p> <p><b>Power Control Parameters IE</b> This information element is defined in subclause 12.13.</p> <p><b>Frequency Parameters IE</b> This information element is defined in subclause 12.8.</p> <p><b>DOWNLINK_TFI_ASSIGNMENT</b> (7 bit field) This information element, if present, assigns the TFI to the mobile station to identify to downlink TBF described by this message. TFI is encoded as defined in subclause 12.15.</p> <p><b>TBF_STARTING_TIME</b> (16 bit field) The TBF Starting Time field contains a starting time that indicates the framenummer during which the assigned TBF may start. If no downlink TBF is in progress, the mobile station need not monitor the TFI field of downlink RLC data blocks until the indicated framenummer. After the indicated framenummer, the mobile station shall operate as during a downlink TBF. If a downlink TBF is already in progress, the mobile station shall continue to use the parameters of the existing TBF until the TBF starting time occurs. When the indicated framenummer occurs, the mobile station shall immediately begin to use the new parameters assigned. This field is encoded the same as the Starting Time information element defined in GSM 04.08.</p> <p><b>MEASUREMENT_STARTING_TIME</b> (16 bit field) The Measurement Starting Time field contains a starting time that indicates the framenummer during which the first assigned measurement period shall occur. The mobile station must make one or more neighbour cell power measurements during the assigned framenummer and during the following 3 TDMA frames. This field is encoded the same as the Starting Time information element defined in GSM 04.08.</p> <p><b>MEASUREMENT_BITMAP</b> (8 bit field) This information field indicates the timeslots assigned for use during measurement periods. The field as a bitmap where each bit corresponds with a timeslot number. Bit 1 corresponds to TS0; Bit 2 to TS1...</p> <p><u>bit Timeslot value</u> 0 Timeslot is not assigned 1 Timeslot is assigned</p>
--

**Table 31 (continued): PACKET DOWNLINK ASSIGNMENT information element details**

<b>MEASUREMENT_INTERVAL</b> (5 bit field)	
The Measurement Interval field indicates the number of block periods from the start of one assigned measurement period to the beginning of the next measurement period.	
Bits	
<u>5 4 3 2 1</u>	
0 0 0 0	make measurements during every block period
0 0 0 1	make measurements during every other block period
0 0 1 0	make measurements during every 3 <sup>rd</sup> block period
...	
1 1 1 1	make measurements during every 32 <sup>nd</sup> block period

### 11.2.8 Packet Dummy Control Block

The PACKET DUMMY CONTROL BLOCK message is sent from the mobile station to the network when the mobile station has no other block to transmit. It is also sent by the network as a fill message with no content.

Message type: Packet Dummy Control Block

Direction: mobile station to network and network to mobile station

**Table 32: PACKET DUMMY CONTROL BLOCK information elements**

< Packet Dummy Control Block message content > ::= < MESSAGE_TYPE : bit (6) > { L   H < TLLI : bit (32) > } < spare padding > ;
--

**Table 33: PACKET DUMMY CONTROL BLOCK information element details**

<b>TLLI</b> (32 bit field)
This field, only populated when sent by the MS, contains the TLLI of the mobile station. This field is encoded as defined in clause 12.16.

### 11.2.9 Packet Measurement Report

The Packet Measurement is sent by the mobile station on the uplink PACCH. The message may contain measurement results from the Ready state measurements or from the packet idle mode measurements, but not both simultaneously.

Message type: Packet Measurement Report

Direction: mobile station to network



Table 34: PACKET MEASUREMENT REPORT message content

<pre> &lt; Packet Measurement Report message content &gt; ::=   &lt; MESSAGE_TYPE : bit (6) &gt;   &lt; TLLI : bit (32) &gt;   &lt; PSI5_CHANGE_MARK : bit (2) &gt;   &lt; RR_CONN_OR_ANONYMOUS &gt; : bit (1) &gt;   { L &lt; Ready State Measurement Report : Ready State Measurement Report struct &gt;     H &lt; Idle Mode Measurement Report : Idle Mode Measurement Report struct &gt; }   &lt; spare padding &gt; ;  &lt; Ready State Measurement Report struct &gt; ::=   &lt; RXLEV_SERVING_CELL : bit (6) &gt;   { L   H &lt; INTERFERNCE_SERVING_CELL &gt; }   &lt; NUMBER_OF_MEASUREMENTS : bit (3) &gt;   {     &lt; FREQUENCY_N : bit (5) &gt;     &lt; RXLEV_N : bit (6) &gt; } * 6 ;  &lt; Idle Mode Measurement Report struct &gt; ::=   &lt; NUMBER_OF_MEASUREMENTS : bit (3) &gt;   {     &lt; FREQUENCY_N : bit (5) &gt;     &lt; FREQUENCY_LIST_TYPE_USED: bit (1) &gt;     { L   H &lt; BSIC_N : bit (6) &gt; }     &lt; RXLEV_N : bit (6) &gt; } * 6 ; </pre>
---

Table 35: PACKET MEASUREMENT REPORT information element details

<p><b>TLLI</b> (32 bit field) This field contains the TLLI of the mobile station. This field is encoded as defined in clause 12.16.</p> <p><b>RR_CONN_OR_ANONYMOUS</b> (1 bit field) This field indicates whether the mobile station has an RR connection active or is operating with anonymous access.</p> <p>0     no RR connection active and no anonymous access 1     RR connection active or anonymous access</p> <p><b>PSI5_CHANGE_MARK</b> (2 bit field) This field shall contain the value of the PSI5_CHANGE_MARK in the PSI5 or PSI5 bis message containing the list of frequencies to measure.</p> <p><b>RXLEV_SERVING_CELL</b> (6 bit field) This field contains the value of the RXLEV parameter for the serving cell calculated by the mobile station (see GSM 05.08). This field is encoded as the binary representation of the RXLEV parameter value defined in GSM 05.08. Range 0 to 63</p>
---

**Table 35 (continued): PACKET MEASUREMENT REPORT information element details****FREQUENCY\_LIST\_TYPE\_USED** (2 bit field)

This field indicates the value of the FREQUENCY\_LIST\_TYPE of the frequency list in the PSI5 or PSI5 bis message containing the assigned list of frequencies to measure.

**NUMBER\_OF\_MEASUREMENTS** (3 bit field)

This field indicates the number of valid measurements following. Valid measurement data shall be put into the following fields starting with the first field, then the second, etc.

bit

3 2 1

0 0 0 1 measurement

0 0 1 2 measurements

...

1 1 1 8 measurements

**FREQUENCY\_N** (5 bit field)

This field indicates the frequency upon which the measurement was made. This field is an index into the Frequency List in the PSI5 or PSI5 bis message used to assign the frequencies to measure.

Range 0 to 31

**BSIC\_N** (6 bit field)

This field indicates the BSIC of the frequency upon which the measurement was made. This field shall be included only if the Frequency List Type is type 1 or type 2. For type 1, this field is included if the BSIC was decoded and shall not be included if the BSIC was not decoded. This field is encoded as the BSIC value defined in GSM 04.08.

Range 0 to 63

**RXLEV\_N** (6 bit field)

This field indicates the measured RXLEV of the frequency upon which the measurement was made (see GSM 05.08).

This field is encoded as the RXLEV value defined in GSM 04.08.

Range 0 to 63

## 11.2.10 Packet Paging Request

This message is sent on the PCCCH by the network to up to four mobile stations to trigger channel access by these for either TBF or RR connection establishment. The mobile stations are identified either by IMSI, TMSI or TLLI. Depending on the identity used 2, 3 or 4 mobile stations can be addressed. Special requirements for the transmission of this message apply, see GSM 05.02.

Message type: Packet PAGING REQUEST MESSAGE

Direction: network to mobile station

Table 36: PACKET PAGING REQUEST message content

```

< Packet Paging Request message content > ::=
  < MESSAGE_TYPE : bit (6) >
  < PAGE_MODE : bit (2) >
  { L | H < PERSISTENCE_LEVEL : bit (4) > }
  { H { < Repeated Page info : Repeated Page info struct > } * L }
  < spare padding > ;

< Repeated Page info struct > ::=
  { L { L < PTMSI : bit (32) >                -- Page request for TBF establishment
    | H < LENGTH_INDICATOR : bit (4) >
      < IMSI : bit string > }
  | H < CHANNEL_NEEDED : bit (2) >        -- Page request for RR conn. Establishment
    < RR_PRIORITY : bit (3) >
    { L < TMSI : bit (32) >
      | H < LENGTH_INDICATOR : bit (4) >
        < IMSI : bit string > } } };

```

**Table 37: PACKET PAGING REQUEST information element details****PAGE\_MODE** (2 bit field)

This field describes which type of page mode used, i.e. either normal paging, extended paging, paging reorganization or same as before from the previous page mode. The mobile station shall ignore this field if message is received on the PACCH. Coding of this field is defined in GSM 04.08.

**PERSISTENCE\_LEVEL** (4 bit field for each priority 1...4)

This field is defined in subclause 12.14, PRACH Control Parameters.

**Repeated Page info struct**

The Repeated Page info struct is repeated as many times as required to fulfil the number of wanted paged mobiles. If the Paging Request Message is used with only TLLIs or TMSIs, the field can be repeated up to four times within one message. If the Paging Request Message is used with only IMSIs, the field can be repeated up to two times within one message.

The first bit in the Repeated Page info field indicates if = 0 that this is a page request for TBF connection establishment and if = 1 that it is a page request for RR connection establishment or a dummy page message.

A page request for TBF connection establishment can either be addressed with TLLI or IMSI.

A page request for RR connection establishment contains optionally a Channel Needed and a Priority parameter. And can either be addressed with TMSI or IMSI.

**PTMSI** (32 bit field)

The Packet Temporary Mobile Station Identity (PTMSI) is defined in GSM 03.03. This field is encoded as a binary number.

Range 0 to 4294967295

**LENGTH\_INDICATOR** (4 bit field)

The Length Indicator field indicates the length in number of nibbles of IMSI or Address Type No\_Address field.

**IMSI** (bit field)

The International Mobile Subscriber Identity (IMSI) is variable length and is defined in GSM 03.03. This field is encoded as the Mobile Identity information element defined in GSM 04.08.

**TMSI** (32 bit field)

TMSI is a unique Temporary Mobile Subscriber Identity (TMSI) is associated with the mobile subscriber and defined in GSM 03.03. This field is coded as a binary number.

Range 0 to 4294967295

**CHANNEL\_NEEDED** (2 bit field)

The channel needed field indicates which type of channel is needed for the mobile station for the transaction linked to the paging procedure. The field is coded according to following table:

2 1

0 0 Any channel

0 1 SDCCH

1 0 TCH/F (Full rate)

1 1 TCH/H or TCH/F (Dual rate)

**RR\_PRIORITY** (3 bit field)

The RR\_PRIORITY field relates to Mobile Station Identity i. When the page relates to a paging request to trigger RR connection establishment, the RR\_PRIORITY field is coded as the priority field defined in GSM 04.08.

## 11.2.11 Packet PDCH Release

The Packet PDCH Release may be broadcast on a downlink PDCH in any radio block to notify MSs that one or more PDCHs will be immediately released and become unavailable for packet data traffic.

Message type: Packet PDCH Release

Direction: network to mobile station

**Table 38: PACKET PDCH RELEASE information elements**

```
< Packet PDCH Release message content > ::=
  < MESSAGE_TYPE : bit (6) >
  { L | H < TIMESLOTS_AVAILABLE : bit (8) > }
  < spare padding >
```

**Table 39: PACKET PDCH RELEASE information element details**

### **TIMESLOTS\_AVAILABLE** (8 bit field)

This information field indicates the timeslots assigned for GPRS use on the current MAIO or ARFCN. If this field is not present, the timeslot on which the message was sent is the timeslot being released. Bit 8 indicates the status of timeslot 0, bit 7 indicates the status of timeslot 1, etc.

- 0 Timeslot is not assigned
- 1 Timeslot is assigned

## 11.2.12 Packet Polling Request

The PACKET POLLING REQUEST is sent from the network to the mobile station to solicit four PACKET CONTROL ACKNOWLEDGEMENT messages from the mobile station.

Message type: Packet Polling Request

Direction: network to mobile station

**Table 40: PACKET POLLING REQUEST information elements**

```
< Packet Polling Request message content > ::=
  < MESSAGE_TYPE : bit (6) >
  { L L < TQI : bit (16) >
    | L H < TLLI : bit (32) >
    | H L < Global TFI : Global TFI IE >
  }
  < spare padding >
```

**Table 41: PACKET POLLING REQUEST information element details**

### **TQI** (16 bit field)

This field is defined in subclause 12.17.

### **TLLI** (32 bit field)

This field is defined in subclause 12.16.

### **Global TFI IE**

This information element contains the TFI of the mobile station's downlink TBF or uplink TBF. This field is defined in clause 12.10.

Note : value HH is forbidden.

### 11.2.13 Packet Power/Timing Update

The Packet Power/Timing Update is by the network to the mobile station on the downlink on PACCH in order to update the mobile station timing advance or power control parameters.

Message type: Packet Power/Timing Update

Direction: network to mobile station

**Table 42: PACKET POWER/TIMING ADVANCE information elements**

```

< Packet Power/Timing Advance message content > ::=
  < MESSAGE_TYPE : bit (6) >
  < Referenced Address : Referenced Address struct >
  { L | H < Global Power Control Parameters : Global Power Control Parameters IE > }
  { L { < Packet Timing Advance : Packet Timing Advance IE >
        < Power Control Parameters : Power Control parameters IE > }
    | H { L < Packet Timing Advance : Packet Timing Advance IE >
          | H < Power Control Parameters : Power Control parameters IE > } }
  < spare padding > ;

< Referenced Address struct > ::=
  { 0 < GLOBAL_TFI : Global TFI IE >
    | 1 { 0 < TQI : bit (16) >
          | 1 < Packet Request Reference : Packet Request Reference IE > } } ;

```

**Table 43: PACKET POWER/TIMING ADVANCE information element details**

**Global Power Control Parameters IE**

This information field is defined in subclause 12.9.

**Packet Timing Advance IE**

This information field is defined in subclause 12.12.

**Power Control Parameters IE**

This information field is defined in subclause 12.13.

**Referenced Address struct**

This information element indicates the identity of the mobile station to which this message is addressed. All other mobile stations shall ignore this message.

**Global TFI IE**

This information element contains the TFI of the mobile station's downlink TBF or uplink TBF. This field is defined in clause 12.10.

**TQI (16 bit field)**

This field is defined in subclause 12.17.

**Packet Request Reference IE**

This information element is defined in subclause 12.11.

### 11.2.14 Packet PRACH Parameters

The PACKET PRACH PARAMETERS message may be broadcast by the network on PAGCH in order to update the PRACH parameters in between Packet System Information messages containing PRACH parameters.

Message type: Packet PRACH Parameters

Direction: network to mobile station

**Table 44: PACKET PRACH PARAMETERS information elements**

<p>&lt; Packet PRACH Parameters message content &gt; ::=</p> <ul style="list-style-type: none"> <li>&lt; <b>MESSAGE_TYPE</b> : bit (6) &gt;</li> <li>&lt; <b>PRACH Control Parameters</b> : PRACH Control Parameters IE &gt;</li> <li>&lt; spare padding &gt;</li> </ul>
--

**Table 45: PACKET PRACH PARAMETERS information element details****PRACH Control Parameters IE**

This information element is defined in subclause 12.14.

### 11.2.15 Packet Queueing Notification

The Packet Queueing Notification is broadcast by the network on the PAGCH notify the mobile station that it is being placed in queue. The message allocates a Temporary Queueing Identity to the mobile station.

Message type: Packet Queueing Notification

Direction: network to mobile station

**Table 46: PACKET QUEUEING NOTIFICATION information elements**

<p>&lt; Packet Queueing Notification message content &gt; ::=</p> <ul style="list-style-type: none"> <li>&lt; <b>MESSAGE_TYPE</b> : bit (6) &gt;</li> <li>&lt; <b>PAGE_MODE</b> : bit (2) &gt;</li> <li>&lt; <b>Packet Request Reference</b> : Packet Request Reference struct &gt;</li> <li>&lt; <b>TQI</b> : bit (16) &gt;</li> <li>&lt; spare padding &gt;</li> </ul>
--

**Table 47: PACKET QUEUEING NOTIFICATION information element details****PAGE\_MODE** (2 bit field)

This field describes which type of page mode used, i.e. either normal paging, extended paging, paging reorganization or same as before from the previous page mode. The mobile station shall ignore this field if the message is received on the PACCH. Coding of this field is defined in GSM 04.08.

**Packet Request Reference IE**

This information element is defined in subclause 12.11.

**TQI** (16 bit field)

This information field is defined in subclause 12.17.

### 11.2.16 Packet Resource Request

The Packet Resource Request message is sent by the mobile station to the network on the uplink PACCH to request a change in the uplink resources assigned.

Message type: Packet Resource Request

Direction: mobile station to network

Table 48: PACKET RESOURCE REQUEST information elements

```
< Packet Resource Request message content > ::=
  < MESSAGE_TYPE : bit (6) >
  { L | H < Global TFI : Global TFI IE > }
  < Global TFI : Global TFI IE >
  < MAC_MODE : bit (2) >
  < TLLI : bit (32) >
  < Mobile Radio Capabilities : Mobile Radio Capabilities IE >
  < Channel Request Description : Channel Request Description IE >
  < CHANNEL_CODING_REQUESTED : bit (2) >
  { L | H < MA_CHANGE_MARK : bit (2) > }
  { L | H < ALLOCATION_REFERENCE : bit (2) > }
  < C_VALUE : bit (6) >
  < RXQUAL : bit (3) >
  < SIGN_VAR : bit (6) >
  < spare_padding > ;
```

NOTE 1: The MS shall include the ALLOCATION\_REFERENCE information element if the MS Multislot Class field of the MS Classmark contains a value of 19 or greater (see GSM 05.02).



**Table 49: PACKET RESOURCE REQUEST information element details**

<b>Global TFI IE</b>	
This information element contains the TFI of the mobile station's uplink TBF, if available, or the TFI of the mobile station's downlink TBF. If no TFI is available, this field is omitted. This field is defined in clause 12.10.	
<b>MAC_MODE</b> (1 bit field)	
This information field indicates the medium access method to be used during the TBF.	
Bit	
<u>2 1</u>	
0 0	Dynamic Allocation
0 1	Extended Dynamic Allocation
1 0	Fixed Allocation
1 1	Reserved
<b>TLLI</b> (32 bit field)	
This field is defined in Clause 12.16.	
<b>Mobile Radio Capabilities IE</b>	
<b>MS Classmark 4 IE</b>	
This information element is defined in GSM 04.08.	
<b>CHANNEL_CODING_REQUESTED</b> (2 bit field)	
This field is defined in Clause 12.6.	
<b>MA_CHANGE_MARK</b> (2 bit field)	
This field contains the mobile station's stored MA_CHANGE_MARK for the current cell. If the mobile station does not have a valid MA_CHANGE_MARK for the current cell, the mobile station shall omit this field. The coding of this field is network dependent.	
<b>ALLOCATION_REFERENCE</b> (2 bit field)	
This field is defined in Clause 12.5.	
<b>C_VALUE</b> (6 bit field)	
This field contains the value of the C parameter calculated by the mobile station (see GSM 05.08). This field is encoded as the binary representation of the C parameter value defined in GSM 05.08.	
Range 0 to 63	
<b>RXQUAL</b> (3 bits)	
This field contains the RXQUAL parameter field calculated by the mobile station (see GSM 05.08). This field is encoded as defined in GSM 04.08.	
Range 0 to 7	
<b>SIGN_VAR</b> (6 bits)	
This field contains the signal variance parameter SIGN_VAR calculated by the mobile station (see GSM 05.08).	
bit	
<u>6 5 4 3 2 1</u>	
0 0 0 0 0 0	0dB <sup>2</sup> to 0.25 dB <sup>2</sup>
0 0 0 0 0 1	>0.25 dB <sup>2</sup> to 0.50 dB <sup>2</sup>
0 0 0 0 1 0	>0.50 dB <sup>2</sup> to 0.75 dB <sup>2</sup>
: : :	
1 1 1 1 1 0	>15.50 dB <sup>2</sup> to 15.75 dB <sup>2</sup>
1 1 1 1 1 1	>15.75 dB <sup>2</sup>

## 11.2.17 Spare

## 11.2.18 Packet System Information Type 1

This message is sent by the network on the PBCCH or PACCH giving information for Cell selection, for control of the PRACH, for description of the control channel(s) and optional global power control parameters. Special requirements for the transmission of this message apply on the PBCCH, see GSM 05.02

Message type: PACKET SYSTEM INFORMATION TYPE 1

Direction: network to mobile station

**Table 50: PSI1 information elements**

<pre> &lt; PSI1 message content &gt; ::=   &lt; PSI1 message type &gt; : bit (6) &gt;   { L   H &lt; Global TFI &gt; : Global TFI IE &gt; }   &lt; Common parameters &gt; : Common parameters struct &gt;   &lt; PRACH Control Parameters &gt; : PRACH Control Parameters IE &gt;   &lt; Control Channel Description &gt; : Control Channel Description struct &gt;   &lt; Global Power Control Parameters &gt; : Global Power Control Parameters IE &gt;   &lt; spare padding &gt; ;  &lt; Common parameters struct &gt; ::=   &lt; BCCH_CHANGE_MARK &gt; : bit (3) &gt;   &lt; PBCCH_CHANGE_MARK &gt; : bit (3) &gt;   &lt; BA_GIND &gt; : bit (1) &gt;   &lt; NETWORK_CONTROL_ORDER1 &gt; : bit (1) &gt;   &lt; BS_CV_MAX &gt; : bit (4) &gt;   &lt; CONTROL_ACK_TYPE &gt; : bit (1) ;   { 0   1 &lt; PAN_DEC &gt; : bit (3) &gt;     &lt; PAN_INC &gt; : bit (3) &gt;     &lt; PAN_MAX &gt; : bit (3) &gt; };  &lt; Control Channel Description struct &gt; ::=   &lt; BS_PBCCH_BLKs &gt; : bit (2) &gt;   { 0   1 &lt; BS_PCC_CHANS &gt; : bit (4) &gt; }   { 0   1 &lt; BS_PAG_BLKs_RES &gt; : bit (4) &gt; }   { 0   1 &lt; BS_PRACH_BLKs &gt; : bit (4) &gt; }   &lt; DRX_TIMER_MAX &gt; : bit (3) &gt;   &lt; EXT_DYN_ALLOCATION_SUPPORTED &gt; : bit (1) &gt;   &lt; FIXED_ALLOCATION_SUPPORTED &gt; : bit (1) &gt;   &lt; CONTROL_CH_REL &gt; : bit (1) &gt; </pre>
--

**Table 51: PSI1 information element details****PRACH Control Parameters IE**

This information element is defined in subclause 12.14.

**Global TFI IE**

If present, this information element indicates the mobile station to which this message is addressed. If this field is present, all other mobile stations shall ignore the contents of this message. If this field is not present, all mobile stations shall act upon this message. This field is defined in subclause 12.10.

**Global Power Control Parameters IE**

This information element is defined in subclause 12.9.

**Common parameters struct****BCCH\_CHANGE\_MARK** (3 bit field)

The BCCH\_CHANGE\_MARK field is a 3 bit value changed each time the BCCH System Information defined in subclause 5. Has been changed. The coding of the field is network dependent.

**PBCCH\_CHANGE\_MARK** (3 bit field)

The PBCCH\_CHANGE\_MARK field is a 3 bit value changed each time any information has been changed in other system information messages on PBCCH. The coding of the field is network dependent.

**BA\_GIND** (1 bit field)

The BA\_GIND field indicates the sequence number of BA(GPRS).

**NETWORK\_CONTROL\_ORDER1** (1 bit field)

The NETWORK\_CONTROL\_ORDER1 field indicates if set = 0 that the mobile station is in control of the cell selection in both packet idle mode and packet transfer mode (= NC0 in GSM 05.08) and that the mobile station shall not send any measurement reports to the network (= NC0 and = EM0 in GSM 05.08). It also indicates that the Optional PSI5 and the PSI5 bis messages are not broadcast.

If set = 1 the mobile station shall send measurement reports for cell selection and/or for extended measurements to the network. Further cell re-selection and measurement details are included in PSI5 and optionally in the PSI5 bis messages.

**BS\_CV\_MAX** (4 bit field)

The BS\_CV\_MAX field is 4 bits in length and ranges from 1 to 15. The value 0 is reserved.

**Packet Ack/Nack (PAN) parameters****PAN\_DEC** (3 bit field)

This field contains the value of PAN\_DEC (see subclause 9.3). This field is encoded as a binary number.  
Range: 0 to 7

**PAN\_INC** (3 bit field)

This field contains the value of PAN\_INC (see subclause 9.3). This field is encoded as a binary number.  
Range: 0 to 7

**PAN\_MAX** (3 bit field)

This field defines the maximum value allowed for counter N3102.

Bit

3 2 1

0 0 0 maximum value allowed for counter N3102 is 4

0 0 1 maximum value allowed for counter N3102 is 8

...

1 1 1 maximum value allowed for counter N3102 is 32

Table 51 (continued): PSI1 information element details

**Control Channel Description struct****BS\_PBCCH\_BLKs** (2 bit field)

The BS\_PBCCH\_BLKs field indicates the number of blocks allocated to the PBCCH in the multiframe. The field is coded according to the following table:

bit	
<u>2 1</u>	
0 0	Block B0 used for PBCCH
0 1	Block B0, B6 used for PBCCH
1 0	Block B0, B6, B3 used for PBCCH
1 1	Block B0, B6, B3, B9 used for PBCCH

**BS\_PCC\_CHANS** (4 bit field)

The BS\_PCC\_CHANS field indicates the number of PDCHs carrying PCCCH and PBCCH. (See GSM 05.02). The field is optional and if not included it shall be interpreted as the default value of 1 PCCCH channel. If included, the field is coded according to the following table:

bit	
<u>4 3 2 1</u>	
0 0 0 0	1 PCCCH/PBCCH channel
0 0 0 1	2 PCCCH/PBCCH channels
...	
1 1 1 1	16 PCCCH/PBCCH channels

**BS\_PAG\_BLKs\_RES** (4 bit field)

The BS\_PAG\_BLKs\_RES field indicates the number of blocks on each PDCH carrying the PCCCH per multiframe where neither packet paging nor PBCCH should appear. This number corresponds therefore to the number of blocks reserved for PAGCH in the 51 frame multiframe case and to the number of blocks reserved for PAGCH, PDTCH and PACCH for the 52 frames multiframe case. (See GSM 05.02). The field is optional and if not included it shall be interpreted as the default value of 0 blocks reserved for PAGCH, PDTCH and PACCH. If included, the field is coded according to the following table:

bit	
<u>4 3 2 1</u>	
0 0 0 0	0 blocks reserved for PAGCH, PDTCH and PACCH
0 0 0 1	1 blocks reserved for PAGCH, PDTCH and PACCH
...	
1 1 0 0	12 blocks reserved for PAGCH, PDTCH and PACCH

All other values reserved.

Table 51 (continued): PSI1 information element details

**BS\_PRACH\_BLKs** (4 bit field)

The BS\_PRACH\_BLKs field indicates the number of blocks reserved in a fixed way to the PRACH channel on any PDCH carrying PCCCH and PBCCH(Only for 52 type PCCCH)(See GSM 05.02). The field is optional and if not included it shall be interpreted as no Block reserved for PRACH. If included, the field is coded according to the following table:

bit	
4	3 2 1
0 0 0 0	No block reserved for PRACH (default)
0 0 0 1	Block B0 reserved for PRACH
0 0 1 0	Block B0, B6 reserved for PRACH
0 0 1 1	Block B0, B6, B3 reserved for PRACH
0 1 0 0	Block B0, B6, B3, B9 reserved for PRACH
0 1 0 1	Block B0, B6, B3, B9, B1 reserved for PRACH
0 1 1 0	Block B0, B6, B3, B9, B1, B7 reserved for PRACH
0 1 1 1	Block B0, B6, B3, B9, B1, B7, B4 reserved for PRACH
1 0 0 0	Block B0, B6, B3, B9, B1, B7, B4, B10 reserved for PRACH
1 0 0 1	Block B0, B6, B3, B9, B1, B7, B4, B10, B2 reserved for PRACH
1 0 1 0	Block B0, B6, B3, B9, B1, B7, B4, B10, B2, B8 reserved for PRACH
1 0 1 1	Block B0, B6, B3, B9, B1, B7, B4, B10, B2, B8, B5 reserved for PRACH
1 1 0 0	Block B0, B6, B3, B9, B1, B7, B4, B10, B2, B8, B5, B11 reserved for PRACH

All other values reserved.

**DRX\_TIMER\_MAX** (3 bit field)

The DRX\_TIMER\_MAX field indicates the maximum value allowed for the mobile station to request for Non-DRX mode after packet transfer mode (upper limit for the mobile station timer [T3194]).

Bit	
3	2 1
0 0 0	No Non-DRX mode after packet transfer mode
0 0 1	Max. 1 sec Non-DRX mode after packet transfer mode
0 1 0	Max 2 sec
0 1 1	Max 4 sec
1 0 0	Max 8 sec
1 0 1	Max 16 sec
1 1 0	Max 32 sec
1 1 1	Max 64 sec

**EXT\_DYN\_ALLOCATION\_SUPPORTED** (1 bit field)

The EXT\_DYN\_ALLOCATION\_SUPPORTED field contains one bit set to 0 if the Extended Dynamic Allocation procedure is not supported and to 1 if the Extended Dynamic Allocation procedure is supported by the network.

**FIXED\_ALLOCATION\_SUPPORTED** (1 bit field)

The FIXED\_ALLOCATION\_SUPPORTED field contains one bit set to 0 if fixed allocation is not supported and to 1 if fixed allocation is supported by the network.

**CONTROL\_CH\_REL** (1 bit field)

The CONTROL\_CH\_REL field indicates if set = 1 that the last PDCH carrying PCCCH and PBCCH will be released shortly. All mobile stations on PCCCH shall then as soon as this information has been received return to CCCH and there obey the information sent on BCCH as specified in GSM 04.08. If the field is set = 0, no channel release is pending.

**CONTROL\_ACK\_TYPE** (1 bit field)

The CONTROL\_ACK\_TYPE field indicates the format of the PACKET CONTROL ACKNOWLEDGEMENT the MS shall transmit when polled.

- 0 PACKET CONTROL ACKNOWLEDGEMENT format is four access bursts
- 1 PACKET CONTROL ACKNOWLEDGEMENT format is RLC/MAC control block

## 11.2.19 Packet System Information Type 2

This message is sent by the network on the PBCCH or PACCH giving information of reference frequency lists, mobile allocations and PCCCH channel descriptions applicable for packet access in the cell. A consistent set of these messages is required to completely decode the information.

Message type: PACKET SYSTEM INFORMATION TYPE 2

Direction: network to mobile station

**Table 52: PSI2 information elements**

<pre> &lt; PACKET SYSTEM INFORMATION TYPE 2 &gt; ::=   &lt; MESSAGE_TYPE : bit (6) &gt;   &lt; PAGE_MODE : bit (2) &gt;   &lt; MA_CHANGE_MARK : bit (2) &gt;   &lt; PSI2_INDEX : bit (3) &gt;   &lt; PSI2_COUNT : bit (3) &gt; { L   H &lt; Referenced Address : Referenced Address struct &gt; }   { 0   1 &lt; UPLINK_OR_DOWNLINK_ASSIGNMENT : bit(1) &gt; }   { L   H &lt; List of Reference Frequency lists : Reference frequency list struct &gt; }   { L   H &lt; Mobile Allocation list : Mobile Allocation list struct &gt; }   { L   H &lt; PCCCH description list : PCCCH description list struct &gt; }   &lt; spare padding &gt; ;  &lt;Referenced Address struct &gt; ::=   { 0 &lt; TLLI : bit(32) &gt;     1 { 0 &lt; GLOBAL_TFI : bit (8) &gt;     1 { 0 &lt; TQI : bit (16) &gt;     1 &lt; Packet Request Reference : Packet Request Reference IE &gt; } } } ;  &lt; Reference frequency list struct &gt; ::=   &lt; Reference Frequency list : octet string &gt; { L   H &lt; Reference frequency list struct &gt; } ;  &lt; Mobile Allocation list struct &gt; ::=   &lt; Mobile Allocation struct &gt; { L   H &lt; Mobile Allocation list struct &gt; } ;  &lt; Mobile Allocation struct &gt; ::=   &lt; SI1_CA_INDICATION: bit &gt;   { 0   1 &lt; RFL number list : RFL number list struct &gt; }   { 0 &lt; MA_LENGTH : bit (6) &gt;   &lt; MA_BITMAP : bit string &gt;     1 { 0   1 &lt; ARFCN index list struct &gt; } }   { 0   1 &lt; HSN : bit (6) &gt; }   &lt; TSC : bit (3) &gt; ;  &lt; RFL number list struct &gt; ::=   &lt; RFL_NUMBER : bit (4) &gt;   { 0   1 &lt; RFL number list struct &gt; } ;  &lt; ARFCN index list struct &gt; ::=   &lt; ARFCN_INDEX : bit (6) &gt;   { 0   1 &lt; ARFCN index list struct &gt; } ;  &lt; PCCCH description list struct &gt; ::=   &lt; PCCCH description struct &gt;   { 0   1 &lt; PCCCH description list struct &gt; } ; </pre>
--

(continued)

ETSI

Table 53 (concluded): PSI2 information elements

```

< PCCCH description struct > ::=
  { 0 < MA_NUMBER : bit (4) >
    < MAIO : bit (6) >
  | 1 < ARFCN : bit (10) >
    < TSC : bit (3) > }
  < TIMESLOT_ALLOCATION : bit (8) >
  { 0 | 1 < STARTING_TIME : bit (16) > };

```

Table 54: PSI2 information element details

<p><b>MA_CHANGE_MARK</b> (2 bit field) The purpose of the MA_CHANGE_MARK field is to identify a consistent set of the PSI group A messages. The coding of the MA_CHANGE_MARK field is network dependent.</p> <p><b>PSI2_INDEX</b> (3 bit field) and <b>PSI2_COUNT</b> (3 bit field) The purpose of the PSI2_INDEX field and the PSI2_COUNT field is to indicate the number of individual messages within the sequence of PSI2 messages and to assign an index to identify each one of them. The PSI2_INDEX field is binary coded, range: 0 to 7, and provides an index to identify the individual PSI2 message. The PSI2_COUNT field is binary coded, range: 0 to 7, and provides the PSI2_INDEX value for the last (highest indexed) message in the sequence of PSI2 messages.</p> <p><b>UPLINK_OR_DOWNLINK_ASSIGNMENT</b> :(1 bit field) If present, this field indicates that this message is associated with a PACKET UPLINK ASSIGNMENT or a PACKET DOWNLINK ASSIGNMENT message.</p> <p>0 this message is associated with a PACKET UPLINK ASSIGNMENT message 1 this message is associated with a PACKET DOWNLINK ASSIGNMENT message</p> <p><b>Referenced Address struct</b> This information element contains the address of the mobile station addressed by the message.</p> <p><b>Global TFI IE</b> (8 bit field) This field identifies an uplink or downlink TFI to which this message applies. This field is defined in subclause 12.10.</p> <p><b>TQI</b> (16 bit field) This field is defined in subclause 12.17.</p> <p><b>Packet Request Reference IE</b> This information element is defined in subclause 12.11.</p> <p><b>TLLI</b> (32 bit field) This field is defined in subclause 12.16.</p> <p><b>Reference Frequency list</b> (variable length information element) The purpose of the Reference Frequency list information element is to provide a reference frequency list to be used for the decoding of a mobile allocation. The coding of the Reference Frequency list information element is defined by the LV format of the type 4 information element Frequency List defined in GSM 04.08. Several formats of the information element Frequency List are available.</p> <p><b>SI1_CA_INDICATION</b> (1 bit field) The SI1_CA_INDICATION field indicates if the cell channel description defined in SI 1 message on BCCH shall be included in the reference frequency list for the decoding of the mobile allocation:</p> <p>0 cell channel description defined in SI1 message shall not be included in the reference frequency list; 1 cell channel description defined in SI1 message shall be included in the reference frequency list.</p>
--

(continued)

ETSI

**Table 55 (concluded): PSI2 information element details**

<p><b>MA_LENGTH</b> (6 bit field) and <b>MA_BITMAP</b> (variable length, 1 to 64 bit field)</p> <p>The purpose of the MA_BITMAP field is to define the set of frequencies in a mobile allocation. The MA_LENGTH field specifies the length of the MA_BITMAP field. MA_LENGTH is binary coded, range: 0 to 63. The value of MA_LENGTH equals NF-1. NF is the number of bit positions in the MA_BITMAP field which shall equal the number of frequencies in the reference frequency list.</p> <p>The first bit position in the MA_BITMAP corresponds to ARFCN_INDEX = NF-1, the last bit position corresponds to ARFCN_INDEX = 0. Each bit position is coded:</p> <p>0 corresponding frequency does not belong to mobile allocation; 1 corresponding frequency belongs to mobile allocation.</p> <p><b>HSN</b> (6 bit field)</p> <p>The purpose of the HSN field is to provide a hopping sequence number (HSN) for the physical channel description. The HSN field is binary coded, range: 0 to 63, see GSM 05.02. Default value: HSN = 0.</p> <p><b>TSC</b> (3 bit field)</p> <p>The purpose of the TSC field is to provide a training sequence code (TSC) for the physical channel description. The TSC field is binary coded, range: 0 to 7, see GSM 05.02.</p> <p><b>RFL_NUMBER</b> (4 bit field)</p> <p>The purpose of this field is to provide a reference to a Reference Frequency list information element to be included in the definition of a reference frequency list. This field is binary coded, range: 0 to 15.</p> <p><b>ARFCN_INDEX</b> (6 bit field)</p> <p>The purpose of the ARFCN_INDEX field is to provide a reference to a certain frequency included in a reference frequency list. The ARFCN_INDEX field is binary coded, range: 0 to 63.</p> <p><b>MA_NUMBER</b> (4 bit field)</p> <p>The purpose of the MA_NUMBER field is to refer to a mobile allocation and a corresponding HSN value for the decoding of a physical channel description. The MA_NUMBER field is binary coded, range: 0 to 15.</p> <p><b>MAIO</b> (6 bit field)</p> <p>The purpose of the MAIO field is to provide a mobile allocation index offset (MAIO) value for the physical channel description. The MAIO field is binary coded, range: 0 to 63, see GSM 05.02.</p> <p><b>ARFCN</b> (10 bit field)</p> <p>The purpose of the ARFCN field is to define a radio frequency. The ARFCN field is binary coded, range: 0 to 1023, see GSM 05.05.</p> <p><b>TIMESLOT_ALLOCATION</b> (8 bit field)</p> <p>This field is defined in subclause 12.18.</p> <p><b>STARTING_TIME</b> (16 bit field)</p> <p>The Starting Time field contains a starting time that indicates the framenummer during which the indicated PCCCH description becomes valid. This field is encoded the same as the Starting Time information element defined in GSM 04.08.</p>
---

### 11.2.19.1 PSI2 message set

The information in the PSI2 type of message may be divided into a set of different segments which are sent in a set of N PSI2 messages. Each message may provide one or more reference frequency lists, one or more mobile allocations and one or more PCCCH descriptions.

A consistent set of PSI2 messages is identified by an identical value in the MA\_CHANGE\_MARK field, the value of N-1 in the PSI2\_COUNT field and PSI2\_INDEX values ranging from 0 to N-1.

A consistent set of the PSI2 messages is required to decode the information. To decode the contents of a consistent set of PSI2 messages, the different kind of information structures, i.e., the reference frequency lists, the mobile allocations and the PCCCH descriptions, shall be arranged in the order defined by the ascending order of the PSI2\_INDEX value and the order in which they appear in each PSI2 message.

ETSI



### 11.2.19.2 Reference frequency list

A set of PSI2 messages may contain a number of reference frequency lists. The presence of reference frequency lists is conditional. The reference frequency lists shall be provided as required for the decoding of mobile allocations.

Each reference frequency list is assigned a RFL number value, defined by the position of appearance within the ordered set of PSI2 messages, starting with the RFL number value 0 for the first reference frequency list, and ending with the RFL number value  $NC-1$  for the last reference frequency list.  $NC$  is the total number of reference frequency lists contained in a consistent set of PSI2 messages.

A reference frequency list for the decoding of a mobile allocation is defined by the union of the radio frequencies contained in a set of referenced reference frequency lists, and optionally, the radio frequencies contained in the cell channel description defined by SI 1 message on BCCH. Each radio frequency appearing in the reference frequency list shall be accounted once. The radio frequencies are arranged in the ascending order of ARFCN, except that  $ARFCN = 0$ , if included, is put last.

Each frequency in the reference frequency list defined by a set of reference frequency lists, and optionally, the cell channel description in SI 1 message, is assigned an ARFCN\_INDEX value, defined by the position within the reference frequency list, starting with 0 in the first position and ending with  $NF-1$  in the last position.  $NF$  is the total number of frequencies contained in the reference frequency list.

### 11.2.19.3 Mobile Allocation

A consistent set of PSI2 messages may contain a number of mobile allocations associated with a corresponding HSN value. The presence of mobile allocations is conditional. The mobile allocations shall be provided as required for the decoding of physical channel descriptions.

Each mobile allocation is assigned a MA\_NUMBER value, defined by the position of appearance within the ordered set of PSI2 messages, starting with the MA\_NUMBER value 0 for the first mobile allocation, and ending with the MA\_NUMBER value  $NM-1$  for the last mobile allocation.  $NM$  is the total number of mobile allocations contained in a consistent set of PSI2 messages.

The mobile allocation defines the set of ARFCNs which may be allocated to a physical channel, see GSM 05.02. The coding of the mobile allocation refers to one or more reference frequency lists provided in the set of PSI2 messages, or to the cell channel description provided in the SI1 message on BCCH. Each mobile allocation is associated with a HSN value and a TSC value.

There are two alternative formats for the coding of the mobile allocation, the MA\_BITMAP format and the ARFCN index list format. Using the MA\_BITMAP format, the mobile allocation is defined as the set of radio frequencies indicated by the bitmap. Using the ARFCN\_INDEX list format, the mobile allocation is defined by all frequencies included in the reference frequency list, reduced by those frequencies optionally present in the ARFCN index list.

### 11.2.19.4 PCCCH description

A consistent set of PSI2 messages shall contain a number of physical channel descriptions, defining the set of PCCCHs present in the cell. Each PCCCH corresponds to a specific value of the parameter PCCCH\_GROUP ( $0 \dots KC-1$ ), see GSM 05.02.  $KC$  is the number of PCCCHs present in the cell. The order of the PCCCHs in the set of PSI2 messages is defined by the order in which the PCCCH description structs appear within the set of PSI2 messages. In case there are more than one PCCCH specified within one PCCCH description struct, the relative order between them is defined by the ascending order of the timeslot number (TN). The first PCCCH in order correspond to the PCCCH\_GROUP value 0, the last PCCCH in order correspond to the PCCCH\_GROUP value  $KC-1$ .

There are two alternative formats for the coding of the physical channel description, the MA format and the ARFCN format. The MA format shall be used for a frequency hopping physical channel. Using the MA format, a set of physical channels, using a common carrier, may be defined. The definition comprises a mobile allocation, referenced by the MA\_NUMBER value, an MAIO value and a TIMESLOT\_BITMAP. Using the ARFCN format, a set of non-hopping physical channels may be defined by a ARFCN value, identifying the non-hopping carrier, a TSC value and a TIMESLOT\_BITMAP.

## 11.2.20 Packet System Information Type 3

This message is sent by the network on the PBCCH or PACCH giving information of the BCCH allocation (BA\_GPRS) in the neighbour cells and cell selection parameters for serving cell and non-serving cells. Special requirements for the transmission of this message apply on the PBCCH, see GSM 05.02.

Message type: PACKET SYSTEM INFORMATION TYPE 3

Direction: network to mobile station

**Table 56: PSI3 information elements**

<pre> &lt; PSI3 message content &gt; ::=   &lt; MESSAGE_TYPE : bit (6) &gt;   &lt; PSI3_CHANGE_MARK : bit (2) &gt;   &lt; PSI3_BIS_COUNT : bit (3) &gt;   { L   H &lt; Global TFI : Global TFI IE &gt; }   &lt; Serving Cell parameters : Serving Cell params struct &gt;   &lt; General Cell Selection parameter : Gen Cell Sel struct &gt;   &lt; Neighbour Cell parameters : Neighbour Cell params struct &gt;   &lt; spare padding &gt;;  &lt; Serving Cell params struct &gt; ::=   &lt; RA_CODE : bit (8) &gt;   &lt; GPRS_RXLEV_ACCESS_MIN : bit (6) &gt;   &lt; GPRS_MS_TXPWR_MAX_CCH : bit (5) &gt;   { 0   1 &lt; HCS Serving Cell parameters : HCS struct &gt; }  &lt; HCS struct &gt; ::=   &lt; GPRS_PRIORITY_CLASS : bit (3) &gt;   &lt; GPRS_HCS_THR : bit (5) &gt;  &lt; Gen Cell Sel struct &gt; ::=   &lt; GPRS_CELL_RESELECT_HYSTERESIS : bit (3) &gt;   &lt; C31_HYST : bit (1) &gt;   { 0   1 &lt; RA_RESELECT_HYSTERESIS : bit (3) &gt; }  &lt; Neighbour Cell params struct &gt; ::=   { 1 &lt; START_FREQUENCY : bit (10) &gt;     &lt; Cell selection params : Cell Selection struct &gt;     &lt; NR_OF_REMAINING_CELLS : bit (4) &gt;     &lt; FREQ_DIFF_LENGTH : bit (3) &gt;     { &lt; FREQUENCY_DIFF : bit (n) &gt;       &lt; Cell selection params : Cell Selection struct &gt; } * } * 0;  &lt; Cell Selection struct &gt; ::=   &lt; BSIC : bit (6) &gt;   &lt; SAME_RA_AS_SERVING_CELL : bit (1) &gt;   { 0   1 &lt; GPRS_RXLEV_ACCESS_MIN : bit (6) &gt;     &lt; GPRS_MS_TXPWR_MAX_CCH : bit (5) &gt; }   { 0   1 &lt; GPRS_TEMPORARY_OFFSET : bit (3) &gt;     &lt; GPRS_PENALTY_TIME : bit (5) &gt; }   { 0   1 &lt; GPRS_RESELECT_OFFSET : bit (5) &gt; }   { 0   1 &lt; HCS params : HCS struct &gt; } </pre>
---

**Table 57: PSI3 information element details****PSI3\_CHANGE\_MARK** (2 bit field)

The PSI3 change mark field is changed each time information has been updated in any of the PSI3 or PSI3 bis messages. A new value indicates that the mobile station shall re-read the information from the PSI3 and all PSI3 bis messages. The coding of this field is network dependent.

Range: 0-3.

**PSI3\_BIS\_COUNT** (3 bit field)

This field is coded as the binary representation of the PSI3 bis index (in the PSI3 bis message) for the last (highest indexed) individual PSI3 bis message.

Range: 0-7.

**Global TFI IE**

If present, this information element indicates the mobile station to which this message is addressed. If this field is present, all other mobile stations shall ignore the contents of this message. If this field is not present, all mobile stations shall act upon this message. This field is defined in subclause 12.10.

**RA\_CODE** (8 bit field)

The RA\_CODE field is coded as the binary representation of the "Routeing Area Code (RAC)" specified in GSM 03.03.

**GPRS\_RXLEV\_ACCESS\_MIN** (6 bit field)

The GPRS\_RXLEV\_ACCESS\_MIN field is coded as the binary representation of the "RXLEV\_ACCESS\_MIN" defined in GSM 05.08. It is the minimum received level at the mobile station required for access to the system.

**GPRS\_MS\_TXPWR\_MAX\_CCH** (5 bit field)

The GPRS\_MS\_TXPWR\_MAX\_CCH field is coded as the binary representation of the "MS\_TXPWR\_MAX\_CCH" defined in GSM 05.08. It is the maximum TX power a mobile station may use when accessing the system until otherwise commanded.

**GPRS\_RESELECT\_OFFSET** (5 bit field)

GPRS\_RESELECT\_OFFSET is used by the mobile station to apply a positive or negative offset and a hysteresis to the GPRS cell reselection criterion. Default value is 0 dB. If the field is omitted from the message, the default value shall be used by the mobile station.

Bit	
<u>5</u> <u>4</u> <u>3</u> <u>2</u> <u>1</u>	
0 0 0 0 0	-52 dB
0 0 0 0 1	-48 dB
...	
0 1 0 1 0	-12 dB
0 1 0 1 1	-10 dB
...	
1 0 1 1 0	+12 dB
1 0 1 1 1	+16 dB
...	
1 1 1 1 1	+48 dB

If the HCS struct is omitted for the serving cell, HCS is not used and the HCS parameters for the other cells shall be neglected. Otherwise GPRS\_PRIORITY\_CLASS and GPRS\_HCS\_THR are defined.

**GPRS\_PRIORITY\_CLASS** (3 bit field)

The GPRS\_PRIORITY\_CLASS field contains the binary representation of the HCS priority for the cell.

Table 57 (continued): PSI3 information element details

**GPRS\_HCS\_THR** (5 bit field)

The GPRS\_HCS\_THR is the HCS signal strength threshold

bit	
5	4 3 2 1
0 0 0 0 0	-110 dB
0 0 0 0 1	-108 dB
...	...
1 1 1 1 1	-48 dB

**GPRS\_CELL\_RESELECT\_HYSTERESIS** (3 bit field)

The GPRS\_CELL\_RESELECT\_HYSTERESIS field indicates the Additional Hysteresis which applies in Ready state for cells in same RA. This field is encoded according to the following table:

bit	
3	2 1
0 0 0	0 dB
0 0 1	2 dB
0 1 0	4 dB
0 1 1	6 dB
1 0 0	8 dB
1 0 1	10 dB
1 1 0	12 dB
1 1 1	14 dB

**C31\_HYST** (1 bit field)

The C31\_HYST field indicates if set to 1 that the GPRS\_RESELECT\_HYSTERESIS shall be applied to the C31 criterion.

**RA\_RESELECT\_HYSTERESIS** (3 bit field)

The RA\_RESELECT\_HYSTERESIS field indicates in both STANDBY and READY state the additional hysteresis which applies when selecting a cell in a new Routing Area. If this field is not present, the default value is GPRS\_CELL\_RESELECT\_HYSTERESIS. This field is encoded according to the following table:

bit	
3	2 1
0 0 0	0 dB
0 0 1	2 dB
0 1 0	4 dB
0 1 1	6 dB
1 0 0	8 dB
1 0 1	10 dB
1 1 0	12 dB
1 1 1	14 dB

The Neighbour cell parameters (BA-GPRS) are used to specify one or several groups of neighbouring cells and their corresponding cell selection parameters. Preferably cells with several common cell selection parameters can be grouped together. If PSI3 is not sufficient to specify the cell selection parameters of all neighbouring cells, the remaining frequency groups are specified in PSI3bis.

**START\_FREQUENCY** (10 bit field)

The Start Frequency defines the ARFCN for the BCCH frequency of the first cell in the list.

Table 57 (continued): PSI3 information element details

**FREQ\_DIFF\_LENGTH** (3 bit field)

The Freq Diff length field specifies the number of bits to be used for the Frequency diff field in the current Frequency group. The field is coded according to the following table

<u>3</u>	<u>2</u>	<u>1</u>	
0	0	0	1 bit
0	0	1	2 bits
...			
1	1	1	8 bits

**NR\_OF\_REMAINING\_CELLS** (4 bit field)

This field specifies the remaining number of cells that are defined in the frequency group. For each of them the parameters 'Frequency diff' and 'Cell selection params' will be repeated.

Range 1-16.

**Cell Selection params**

The first field of the Cell Selection struct, *BSIC*, defines the BSIC of the cell and then comes the field *same RA as serving cell*. Then follows none, some, or all of the fields *GPRS\_RXLEV\_ACCESS\_MIN*, *GPRS\_MS\_TXPWR\_MAX\_CCH*, *GPRS\_TEMPORARY\_OFFSET*, *GPRS\_PENALTY\_TIME*, *GPRS\_RESELECT\_OFFSET* and *HCS* params. If fields are omitted, the values for these parameters are the same as for the preceding cell.

**BSIC** (6 bit field)

The BSIC field is coded as the "Base Station Identity Code" defined in GSM 03.03. One BSIC for each carrier in BA(GPRS) is defined.

**SAME\_RA\_AS\_SERVING\_CELL** (1 bit field)

The same RA as serving cell field contains one bit, set to

- 0 if the cell is in a Routeing Area different from the serving cell, or
- 1 if the cell is in the same Routeing Area as the serving cell.

**GPRS\_TEMPORARY\_OFFSET** (3 bit field)

The *GPRS\_TEMPORARY\_OFFSET* field indicates the negative offset to C32 that the mobile station shall use for duration of *GPRS\_PENALTY\_TIME*. It is used by the mobile station as part of its calculation of C32 for the cell reselection process.

Bit			
<u>3</u>	<u>2</u>	<u>1</u>	
0	0	0	0 dB
0	0	1	10 dB
0	1	0	20 dB
0	1	1	30 dB
1	0	0	40 dB
1	0	1	50 dB
1	1	0	60 dB
1	1	1	infinity

Table 57 (continued): PSI3 information element details

<b>GPRS_PENALTY_TIME</b> (5 bit field)	
The GPRS_PENALTY_TIME defines the length of time for which GPRS_TEMPORARY_OFFSET is active.	
Bit	
<u>5 4 3 2 1</u>	
0 0 0 0 0	10 seconds
0 0 0 0 1	20 seconds
...	
1 1 1 1 1	320 seconds
<b>FREQUENCY_DIFF</b> ("Freq Diff length" bit field)	
The Frequency Diff field specifies the difference in ARFCN to the BCCH carrier in the next cell to be defined. Note that the difference can be zero if two specified cells use the same frequency.	

### 11.2.21 Packet System Information Type 3 bis

This optional message is sent by the network on the PBCCH and PACCH giving information of the BCCH allocation in the neighbour cells and cell selection parameters for non-serving cells. If all information not fit into one PSI3bis message, the PSI3bis message can be repeated. Special requirements for the transmission of this message apply on PBCCH, see GSM 05.02.

Message type: PACKET SYSTEM INFORMATION TYPE 3 bis

Direction: network to mobile station

Table 58: PSI3 bis information elements

<pre> &lt; PSI3 bis message content &gt; ::=   &lt; MESSAGE_TYPE : bit (6) &gt;   &lt; PSI3_BIS_CHANGE_MARK : bit (2) &gt;   &lt; PSI3_BIS_INDEX : bit (3) &gt;   { L   H &lt; Global TFI : Global TFI IE &gt; }   &lt; Neighbour cell parameters : Neighbour cell params struct &gt;   &lt; spare padding &gt;  &lt; Neighbour cell params struct &gt; ::=   { 1 &lt; START_FREQUENCY : bit (10) &gt;     &lt; Cell selection params : Cell Selection struct &gt;     &lt; NR_OF_REMAINING_CELLS : bit (4) &gt;     &lt; FREQUENCY_DIFF_LENGTH : bit (3) &gt;     { &lt; FREQUENCY_DIFF : bit (n) &gt;       &lt; Cell selection params : Cell Selection struct &gt; } * } * 0 ;  &lt; Cell Selection struct &gt; ::=   &lt; BSIC : bit (6) &gt;   &lt; SAME_RA_AS_SERVING_CELL : bit (1) &gt;   { 0   1 &lt; GPRS_RXLEV_ACCESS_MIN : bit (6) &gt;     &lt; GPRS_MS_TXPWR_MAX_CCH : bit (5) &gt; }   { 0   1 &lt; GPRS_TEMPORARY_OFFSET : bit (3) &gt;     &lt; GPRS_PENALTY_TIME : bit (5) &gt; }   { 0   1 &lt; GPRS_RESELECT_OFFSET : bit (5) &gt; }   { 0   1 &lt; HCS params : HCS struct &gt; }  &lt; HCS struct &gt; ::=   &lt; GPRS_PRIORITY_CLASS : bit (3) &gt;   &lt; GPRS_HCS_THR : bit (5) &gt; </pre>
--

**Table 59: PSI3 bis information element details****PSI3\_BIS\_CHANGE\_MARK** (2 bit field)

This field is changed each time information has been updated in the actual individual PSI3 bis message. A new value indicates that the mobile station shall re-read the information from this PSI3 bis message. The coding of this field is network dependent.

Range: 0 - 3

**PSI3\_BIS\_INDEX** (3 bit field)

The PSI3\_BIS\_INDEX field is used to distinguish individual PSI3 bis messages containing information about different neighbour cells. The field can take the binary representation of the values 0 to n, where n is the index of the last PSI3 bis message. (PSI3 bis count).

**Global TFI IE**

If present, this information element indicates the mobile station to which this message is addressed. If this field is present, all other mobile stations shall ignore the contents of this message. If this field is not present, all mobile stations shall act upon this message. This field is defined in subclause 12.10.

**Neighbour cell params struct**

The coding of the Neighbour cell parameters is described under PSI3.

## 11.2.22 Packet System Information Type 4

This message is optionally sent by the network on the PBCCH and PACCH giving information directing the mobile station to make measurements on a list of serving cell PDCHs, during the idle frame of those PDCHs. Special requirements for the transmission of this message apply on PBCCH, see GSM 05.02.

Message type: PACKET SYSTEM INFORMATION TYPE 4

Direction: network to mobile station

**Table 60: PSI4 information elements**

```

< PSI4 message content > ::=
  < MESSAGE_TYPE : bit (6) >
  < PSI4_CHANGE_MARK : bit (2) >
  < PSI4_COUNT : bit (3) >
  < PSI4_INDEX : bit (3) >
  { L | H < Global TFI : Global TFI IE > }
  < Channel List for Interference measurements : Channel List struct >
  < spare padding > ;

< Channel List struct > ::=
  < Channel group struct >
  { 0 | 1 < Channel list struct > };

< Channel Group struct > ::=
  { 0 < ARFCN : bit (10) >
    | 1 < MA_NUMBER : bit (4) >
      < MAIO : bit (6) > }
  < TIMESLOT_ALLOCATION > : bit (8);

```

NOTE: All assigned PDCH(s) shall have a 52 frame multiframe.

**Table 61: PSI4 information element details**

The PSI4 message is optional and is only sent if indicated by the Power Control parameter INT\_MEAS\_CHANNEL\_LIST\_AVAIL (see subclause 12.3.x).

Depending on the size of the list more than one PSI4 messages can be required to broadcast the total list. The PSI4 count parameter therefore indicates the last (highest indexed) PSI4 message. The sequence number of each PSI4 message is then indicated by the Message Sequence number parameter.

The PSI4 message contains a list of channels within the present cell which shall be used by the mobile station for interference measurements in packet idle mode (see GSM 05.08). The channel list is defined by a Channel list struct which contains one or more Channel Group struct. The Channel Group struct can have two alternative coding formats, the MA format or the ARFCN format. The MA format shall be used for frequency hopping physical channels.

Using the MA format, a set of physical channels, using a common carrier, may be defined. The definition comprises a mobile allocation specified in the PSI2 message and referenced by the MA\_NUMBER value, a MAIO value and a TIMESLOT\_ALLOCATION bit map.

Using the ARFCN format, a set of non-hopping physical channels may be defined by a ARFCN value, identifying the radio frequency, and a TIMESLOT\_BITMAP.

**PSI4\_CHANGE\_MARK** (2 bit field)

The PSI4 change mark field is changed each time information has been updated in any of the individual PSI4 messages. A new value indicates that the mobile station shall re-read the information from all PSI4 messages. The coding of this field is network dependent.

Range: 0 - 3.

**Table 61 (continued): PSI4 information element details**

**PSI4\_COUNT** (3 bit field)

The PSI4 count field is coded as the binary representation of the last (highest indexed) individual PSI4 message.  
Range: 0 - 7.

**PSI4\_INDEX** (3 bit field)

The PSI4 index field is used to distinguish individual PSI4 messages. The field can take the binary representation of the values 0 to n, where n is the index of the last PSI4 message. (PSI4 count).  
Range: 0 - 7.

**Global TFI IE**

If present, this information element indicates the mobile station to which this message is addressed. If this field is present, all other mobile stations shall ignore the contents of this message. If this field is not present, all mobile stations shall act upon this message. This field is defined in subclause 12.10.

**ARFCN** (Absolute RF channel number) (10 bit field)

The ARFCN is coded as the binary representation of the absolute RF channel number (see GSM 05.05).  
Range: 0 to 1023.

**MA\_NUMBER** (4 bit field)

The purpose of the MA\_NUMBER field is to refer to a mobile allocation and a corresponding HSN value defined in the PSI2 message for the decoding of a physical channel description. The MA\_NUMBER field is binary coded.  
Range: 0 - 15.

**MAIO** (Mobile allocation index offset) (6 bit field)

The MAIO field is coded as the binary representation of the mobile allocation index offset as defined in GSM 05.02.  
Range: 0 to 63.

**TIMESLOT\_ALLOCATION** (8 bit field)

This field is defined in subclause 12.18.



### 11.2.23 Packet System Information Type 5

This optional message is sent by the network on the PBCCH or PACCH giving information for measurement reporting and network controlled cell reselection. If all information does not fit into one message, the remaining information will be sent in the PSI5 bis message. The message is sent on PBCCH only if so indicated in PSI1.

Message type: PACKET SYSTEM INFORMATION TYPE 5

Direction: network to mobile station

**Table 62: PSI5 information elements**

<pre> &lt; PSI5 message content &gt; ::=   &lt; MESSAGE_TYPE : bit (6) &gt;   &lt; PSI5_CHANGE_MARK : bit (2) &gt;   &lt; PSI5_BIS_EXISTS : bit (1) &gt;   &lt; NETWORK_CONTROL_ORDER : bit (2) &gt;   { L   H { L &lt; Global TFI : Global TFI IE &gt;       H &lt; TLLI : bit string 32 &gt; } }   { L   H &lt; Ready State Parameters : Ready State Parameters struct &gt; }   { L   H &lt; Idle Mode Parameters : Idle Mode Parameters struct &gt; }   &lt; spare padding &gt;  &lt; Ready State Parameters struct &gt; ::=   &lt; READY_REPORTING_PERIOD_IDLE : bit (3) &gt;   &lt; READY_REPORTING_PERIOD_TRANSFER : bit (3) &gt;   &lt; Ready Frequency lists : { 1 &lt; Frequency list struct &gt; } * 0 &gt; };  &lt; Idle Mode Parameters struct &gt; ::=   &lt; IDLE_MEASUREMENT_ORDER : bit (2) &gt;   &lt; IDLE_REPORTING_PERIOD : bit (3) &gt;   &lt; Idle Frequency Lists : { 1 &lt; Frequency list struct &gt; } * 0 &gt; };  &lt; Frequency list struct &gt; ::=   &lt; FREQUENCY_LIST_TYPE : bit (2) &gt;   &lt; START_FREQUENCY : bit (10) &gt;   &lt; FREQ_DIFF_LENGTH : bit (3) &gt;   &lt; NR_OF_FREQUENCIES : bit (5) &gt;   { &lt; FREQUENCY_DIFF : bit (n) &gt; } * ; </pre>
---

**Table 63: PSI5 information element details**

**PSI5\_CHANGE\_MARK** (2 bit field)

The PSI5\_CHANGE\_MARK field is changed each time information has been updated in either of the individual messages PSI5 or PSI5 bis.. A new value indicates that the mobile station shall re-read the information in both messages. The coding of this field is network dependent.

Range: 0 to 3.

**PSI5\_BIS\_EXISTS** (1 bit field)

Indicates if set = 1 that the PSI5 bis message is broadcast and that the parameter group

Ext\_Measurement\_Reporting\_struct with it's Frequency list struct is included in that message. If set = 0 the PSI5 bis message is not broadcast. And the optional parameters for the Ext\_Measurement\_Reporting\_struct may be included in the PSI5 message.

Table 63 (continued): PSI5 information element details

**Global TFI IE**

If present, this information element indicates the mobile station to which this message is addressed. If this field is present, all other mobile stations shall ignore the contents of this message. If this field is not present and the TLLI field is also not present, all mobile stations shall act upon this message. This field is defined in subclause 12.10.

**TLLI (32 bit field)**

If present, this field indicates the mobile station to which this message is addressed. If this field is present, all other mobile stations shall ignore the contents of this message. If this field is not present and the Global TFI field is also not present, all mobile stations shall act upon this message. This field is defined in subclause 12.16.

**NETWORK\_CONTROL\_ORDER (2 bit field)**

The NETWORK\_CONTROL\_ORDER field is coded according to the following table:

bit

2 1

0 0	NC0 - Normal MS controlled cell re-selection; No measurement reporting;
0 1	NC1 - Normal MS controlled cell re-selection; The MS shall send measurement reports;
1 0	NC2 - Network controlled cell re-selection; The MS shall send measurement reports;
1 1	Reset - applies only on PCCCH and PACCH, otherwise reserved on PBCCH.

**READY\_REPORTING\_PERIOD\_IDLE (3 bit field)****READY\_REPORTING\_PERIOD\_TRANSFER (3 bit field)**

These fields indicate the time period for measurement reporting for packet idle mode and packet transfer mode, respectively. The field is coded according to the following table:

bits

3 2 1

0 0 0	104 TDMA frames
0 0 1	208 TDMA frames
0 1 0	416 TDMA frames
0 1 1	832 TDMA frames
1 0 0	1664 TDMA frames
1 0 1	3328 TDMA frames
1 1 0	6656 TDMA frames
1 1 1	13312 TDMA frames

**IDLE\_MEASUREMENT\_ORDER (2 bit field)**

The IDLE\_MEASUREMENT\_ORDER field indicates to the mobile station how to interpret the rest of the packet idle mode measurement parameters. This field is coded according to the following table:

bit

2 1

0 0	EM0 - The MS shall not perform extended measurements;
0 1	EM1 - The MS shall send measurement reports in accordance with the other IDLE_XXX parameters;
1 0	Reserved for RESET;
1 1	Reserved.

Table 63 (continued): PSI5 information element details

**IDLE\_REPORTING\_PERIOD** (3 bit field)

The IDLE\_REPORTING\_PERIOD field indicates the time interval between packet idle mode measurement reports. This field is coded according to the following table:

bit	
3	2 1
0 0 0	60 sec
0 0 1	120 sec
0 1 0	240 sec
0 1 1	480 sec
1 0 0	960 sec
1 0 1	1920 sec
1 1 0	3840 sec
1 1 1	7680 sec

**Ready Frequency Lists and Idle Frequency Lists**

The Ready Frequency Lists and Idle Frequency Lists structs may each contain multiple lists where each list is of a different type.

**FREQUENCY\_LIST\_TYPE** (2 bit field)

The FREQUENCY\_LIST\_TYPE indicates the type of reporting to which the frequencies on the list are subject. This field is coded according to the following table (see GSM 05.08):

bit	
2	1
0 0	Type 1 - FREQUENCY_LIST specifies the frequencies to be measured;
0 1	Type 2 - FREQUENCY_LIST specifies the frequencies to be measured;
1 0	Type 3 - FREQUENCY_LIST specifies the frequencies to be measured;
1 1	Reserved. In this version of the protocol the mobile station shall ignore the entire list containing this field.

**START\_FREQUENCY** (10 bit field)

The START\_FREQUENCY defines the ARFCN for the first carrier in the list (F(0)).

**FREQ\_DIFF\_LENGTH** (3 bit field)

The FREQ\_DIFF\_LENGTH field specifies the number of bits to be used for the Frequency diff field in the current Frequency group. The field is coded according to the following table

bit	
3	2 1
0 0 0	1 bit
0 0 1	2 bits
...	
1 1 1	8 bits

**NR\_OF\_FREQUENCIES** (5 bit field)

The NR\_OF\_FREQUENCIES field specifies the number of frequencies (ARFCNs) and Frequency Diff parameters that are defined in the frequency group struct (in addition to the Start Frequency).

**FREQUENCY\_DIFF** ("Freq Diff length" bit field)

Each FREQUENCY\_DIFF parameter field specifies the difference in frequency to the next carrier to be defined. The Frequency Diff parameter encodes a non negative integer in binary format (W). The length of the field is defined by the Freq Diff length parameter. Note that the difference can be zero in which case the mobile station shall measure the same frequency twice and report them individually.

Each frequency following the start frequency (ARFCN(0)) and belonging to the Frequency List struct is then calculated by the formula  $ARFCN(n) = ARFCN(n-1) + W(n)$ ,  $n=1, \dots, \text{'Nr of Frequencies'}$

## 11.2.24 Packet System Information Type 5 bis

This optional message is sent by the network on the PBCCH or PACCH giving information for measurement reporting and network controlled cell reselection. If all information does not fit into one message, the remaining information will be sent in the PSI5 bis message. The message is sent on PBCCH only if so indicated in PSI5.

Message type: PACKET SYSTEM INFORMATION TYPE 5 bis

Direction: network to mobile station

**Table 64: PSI5 bis information elements**

<pre> &lt; PSI5 bis message content &gt; ::=   &lt; MESSAGE_TYPE : bit (6) &gt;   &lt; PSI5_CHANGE_MARK : bit (2) &gt;   { L   H &lt; Global TFI : Global TFI IE &gt; }   { L   H &lt; Ready State Parameters : Ready State Parameters struct &gt; }   { L   H &lt; Idle Mode Parameters : Idle Mode Parameters struct &gt; }   &lt; spare padding &gt;  &lt; Ready State Parameters struct &gt; ::=   &lt; READY_REPORTING_PERIOD_IDLE : bit (3) &gt;   &lt; READY_REPORTING_PERIOD_TRANSFER : bit (3) &gt;   &lt; READY_FREQUENCY_LISTS : { 1 &lt; Frequency list struct &gt; } * 0 &gt; };  &lt; Idle Mode Parameters struct &gt; ::=   &lt; IDLE_MEASUREMENT_ORDER : bit (2) &gt;   &lt; IDLE_REPORTING_PERIOD : bit (3) &gt;   &lt; IDLE_FREQUENCY_LISTS : { 1 &lt; Frequency list struct &gt; } * 0 &gt; };  &lt; Frequency list struct &gt; ::=   &lt; FREQUENCY_LIST_TYPE : bit (2) &gt;   &lt; START_FREQUENCY : bit (10) &gt;   &lt; FREQ_DIFF_LENGTH : bit (3) &gt;   &lt; NR_OF_FREQUENCIES : bit (5) &gt;   { &lt; FREQUENCY_DIFF : bit (n) &gt; } * ; </pre>
--

**Table 65: PSI5 bis information element details**

For description of the fields see Table : <i>PSI5</i> information elements.
---

## 11.2.25 Packet System Information Type 6

This message is optionally sent by the network on the PBCCH giving information for scheduling of PBCCH messages.

Message type: PACKET SYSTEM INFORMATION TYPE 6

Direction: network to mobile station

Table 66: PSI6 information elements

<pre> &lt; PSI6 message content &gt; ::=   &lt; Message type : bit (6) &gt;   { L   H &lt; Global TFI : Global TFI IE &gt; }   &lt; Scheduling info : Scheduling info struct &gt;   &lt; spare padding &gt; ;  &lt; Scheduling info struct &gt; ::=   &lt; Info type : Info type struct &gt;   &lt; Positions : Positions struct &gt;   { 0   1 &lt; Scheduling info : Scheduling info struct &gt; } ;  &lt; Info type struct &gt; ::=   0 &lt; INFO_TYPE : bit (4) &gt;     1 0 &lt; INFO_TYPE : bit (5) &gt;     1 1 &lt; INFO_TYPE : bit (6) &gt;;  &lt; Positions struct &gt; ::=   &lt; Position : Position struct &gt;   { 0   1 &lt; Positions : Positions struct &gt; }  &lt; Position &gt; ::=   &lt; MODULUS : bit (4)&gt;   &lt; RELATIVE_POSITION : bit (1) &gt; ; -- length depends on modulus </pre>
--

Table 67: PSI6 information element details

<p><b>Global TFI IE</b> If present, this information element indicates the mobile station to which this message is addressed. If this field is present, all other mobile stations shall ignore the contents of this message. If this field is not present, all mobile stations shall act upon this message. This field is defined in subclause 12.10.</p> <p><b>INFO_TYPE</b> (4 to 6 bits) This field contains a binary encoded non-negative integer number assigned to a type of information sent on the PBCCH. All values indicate unknown, unnecessary information and are reserved for future use.</p> <p><b>MODULUS</b> (4 bits) This field encodes the <b>position modulus</b>, according to the following encoding method. Let N be the integer encoded in binary in the <b>modulus</b> field; the <b>position modulus</b> is then defined as follows :</p> <p style="padding-left: 40px;">If N=0, the <b>position modulus</b> is 0, if N&gt;0, the <b>position modulus</b> is <math>2^{N+1}</math>.</p> <p><b>RELATIVE_POSITION</b> This field contains the N+1 bit binary encoding of a non-negative integer number <math>&lt; 2^{N+1}</math>. This field is 0 bits if the non-negative integer n contained in the <b>MODULUS</b> field is 0, otherwise it is n+1 bits.</p>
---

### 11.2.25.1 Attributes

The *scheduling info* indicates one or more information types (in *info type*) together with their *positions*. Here, a *position* specifies at which relative position P (specified in **RELATIVE\_POSITION**) modulo a position modulus M (specified in **modulus**) messages of the given information type are sent on the PBCCH. Precisely, messages of the given information type are sent in the multiframes for which

$$((\text{framenumbers}) \text{ DIV } R) \bmod (M) = P,$$

where R is the value of the PCCCH\_TYPE field defined in the SYSTEM INFORMATION TYPE 13 message (see GSM 04.08).

## 11.2.26 Packet TBF Release

The Packet TBF Release message is sent by the network to the mobile station to initiate termination of an uplink TBF.

Message type: Packet TBF Release

Direction: network to mobile station

**Table 68: PACKET TBF RELEASE information elements**

<pre> &lt; Packet TBF Release message content &gt; ::=   &lt; MESSAGE_TYPE : bit (6) &gt;   &lt; UPLINK_TFI : bit (7) &gt;   &lt; TBF_RELEASE_CAUSE : bit (8) &gt;   &lt; spare padding &gt; </pre>
---

**Table 69: PACKET TBF RELEASE information element details**

<p><b>UPLINK_TFI</b> (7 bit field) This field indicates which TBF is to be released. This field is coded the same as the TFI field defined in subclause 12.15.</p> <p><b>TBF_RELEASE_CAUSE</b> (8 bit field) This field indicates the reason for the release of the TBF. This field is encoded according to the following table:</p> <table> <tr> <td>Bits</td> <td></td> </tr> <tr> <td><u>8 7 6 5 4 3 2 1</u></td> <td></td> </tr> <tr> <td>0 0 0 0 0 0 0 0</td> <td>Normal release</td> </tr> <tr> <td>0 0 0 0 0 0 1 0</td> <td>Invalid Priority</td> </tr> </table> <p>All other values are reserved</p>	Bits		<u>8 7 6 5 4 3 2 1</u>		0 0 0 0 0 0 0 0	Normal release	0 0 0 0 0 0 1 0	Invalid Priority
Bits								
<u>8 7 6 5 4 3 2 1</u>								
0 0 0 0 0 0 0 0	Normal release							
0 0 0 0 0 0 1 0	Invalid Priority							

## 11.2.27 Packet TBF Status

This message is sent from the mobile station to the network on the uplink PACCH to indicate status of the uplink TBF. This message is sent only by a mobile station operating in fixed allocation medium access mode.

Message type: Packet TBF Status

Direction: mobile station to network

**Table 70: PACKET TBF STATUS information elements**

<pre> &lt; Packet TBF Status message content &gt; ::=   &lt; MESSAGE_TYPE : bit (6) &gt;   &lt; UPLINK_TFI : bit (7) &gt;   &lt; TBF_STATUS_CAUSE : bit (8) &gt;   &lt; spare padding &gt; </pre>
---

**Table 71: PACKET TBF STATUS information element details****UPLINK\_TFI** (7 bit field)

This field identifies the uplink TBF whose status is indicated. This field is coded the same as the TFI field defined in subclause 12.15.

**TBF\_STATUS\_CAUSE** (8 bit field)

The TBF Status information element indicates a change of status of the TBF. This field is encoded according to the following table:

Bits	
8 7 6 5 4 3 2 1	
0 0 0 0 0 0 0 0	Ready Block Count is below threshold
All other values	Reserved

**11.2.28 Packet Uplink Ack/Nack**

The PACKET UPLINK ACK/NACK message is sent by the network to the mobile station indicate the status of the received RLC data blocks. This message may also update the timing advance and power control parameters. A fixed allocation mobile station may also be assigned uplink resources.

Message type: Packet Uplink Ack/Nack

Direction: network to mobile station

**Table 72: PACKET UPLINK ACK/NACK information elements**

```

< Packet Uplink Ack/Nack message content > ::=
  < MESSAGE_TYPE : bit (6) >
  < UPLINK_TFI : bit (7) >
  < CHANNEL_CODING_COMMAND : bit (2) >
  < Ack/Nack Description : Ack/Nack Description struct >
  { L | H < CONTENTION_RESOLUTION_TLLI : bit (32) > }
  { L | H < Packet Timing Advance : Packet Timing Advance IE > }
  { L <TIMESLOT_ALLOCATION : bit (8) >
  | H < Power Control Parameters : Power Control Parameters IE > }
  { L | H < ALLOCATION_REFERENCE : bit (2) > }
  { L | H < Fixed Allocation parameters : Fixed Allocation struct > } ;
  < spare padding > ;

< Fixed Allocation struct > ::=
  { L { < REPEAT_ALLOCATION : bit (1) >
    < TS_OVERRIDE : bit(8) > }
  | H { < TBF_STARTING_TIME : bit (16) >
    { L | H < BLOCKS_OR_BLOCK_PERIODS : bit(1) >
      < ALLOCATION_BITMAP_LENGTH : bit(7) > }
    < ALLOCATION_BITMAP : bit (n) > } }

```

**Table 73: PACKET UPLINK ACK/NACK information element details****UPLINK\_TFI** (7 bit field)

This field identifies the uplink TBF to which this message applies. This field is coded the same as the TFI field defined in subclause 12.15.

**CHANNEL\_CODING\_COMMAND** (2 bit field)

The Channel Coding Indicator field indicates the channel coding scheme that the mobile station shall use when transmitting on the uplink.

Bits

2 1	value
0 0	CS-1
0 1	CS-2
1 0	CS-3
1 1	CS-4

**Ack/Nack Description IE**

This information element is defined in subclause 12.3.

**CONTENTION\_RESOLUTION\_TLLI** (32 bit field)

The CONTENTION\_RESOLUTION\_TLLI field is present only if the network has decoded one of the uplink RLC data blocks containing the TLLI. The mobile station shall perform the contention resolution function if the TLLI information element is present. This field contains a TLLI, which is defined in subclause 12.16.

**Packet Timing Advance IE**

This information element, if present, contains the timing advance command for the mobile station. If this information element is not present, the MS shall, if it has a valid timing advance value, continue to use its previous timing advance value, and if the MS does not have a valid timing advance value, the MS shall not transmit until it receives a valid timing advance value. This information element is defined in subclause 12.12.

**TIMESLOT\_ALLOCATION** (8 bit field)

This field is defined in subclause 12.18.

**Power Control Parameters IE**

This information element, if present, contains power control command for the mobile station. If this information element is not present, the MS shall continue to use the previous power. This information element is defined in subclause 12.13.

**ALLOCATION\_REFERENCE** (2 bit field)

The network shall include the ALLOCATION\_REFERENCE field if the fixed allocation is in response to a request from the mobile station. If the fixed resource allocation has been autonomously generated by the network then the network shall not include ALLOCATION\_REFERENCE field. This information element is defined in subclause 12.5.

**REPEAT\_ALLOCATION** (1 bit field)

This indicates whether the mobile's current allocation repeats after it ends.

- 0 do not repeat the current allocation after it ends
- 1 repeat the current allocation when it ends

**TS\_OVERRIDE** (8 bit field)

This is defined in subclause 12.19.

**BLOCKS\_OR\_BLOCK\_PERIODS** (1 bit field)

This indicates if the ALLOCATION\_BITMAP is to be interpreted as blocks or block periods.

- 0 the ALLOCATION\_BITMAP is to be interpreted as blocks
- 1 the ALLOCATION\_BITMAP is to be interpreted as block periods

**ALLOCATION\_BITMAP\_LENGTH** (7 bit field)

This field specifies the number of bits in the ALLOCATION\_BITMAP.

Range 0 to 127

(continued)

ETSI



**Table 74 (concluded): PACKET UPLINK ACK/NACK information element details****TBF\_STARTING\_TIME** (16 bit field)

The TBF Starting Time field contains a starting time that indicates the earliest framenummer during which the assigned TBF may start. If no uplink TBF is in progress, the mobile station shall not monitor the USF field of downlink radio blocks until the indicated framenummer. If an uplink TBF is in progress, the mobile station shall continue to use parameters of the existing TBF until the starting time occurs. When the indicated TDMA framenummer occurs, the mobile station shall immediately begin to use the new assigned uplink TBF parameters. This field is encoded as the Starting Time information element defined in GSM 04.08.

**ALLOCATION\_BITMAP** (variable length field)

The ALLOCATION\_BITMAP field is variable length. If the ALLOCATION\_BITMAP\_LENGTH field is not present, the ALLOCATION\_BITMAP fills the remainder of the message. This field is defined in subclause 12.4.

### 11.2.29 Packet Uplink Assignment

The Packet Uplink Assignment is sent by the network to the mobile station to assign uplink resources. The mobile station may be addressed by TFI, TQI, or Packet Request Reference depending upon the procedure used.

Message type: Packet Uplink Assignment

Direction: network to mobile station

Table 75: PACKET UPLINK ASSIGNMENT information elements

```

< Packet Uplink Assignment message content > ::=
  < MESSAGE_TYPE : bit (6) >
  < PAGE_MODE : bit (2) >
  < Referenced Address : Referenced Address struct >
  < MAC_MODE : bit (2) >

  < CHANNEL_CODING_COMMAND : bit (2) >
  < RESPONSE_INDICATOR : bit (1) >
  < TLLI_BLOCK_CHANNEL_CODING : bit (1) >
  { L | H < UPLINK_TFI_ASSIGNMENT : bit (7) >
  < Packet Timing Advance : Packet Timing Advance IE >
  { L | H < 2_MESSAGE_ASSIGNMENT_TYPE : bit(1) > }
  { L | H < CONTENTION_RESOLUTION_TLLI : bit (32) > }
  { L < TIMESLOT_ALLOCATION : bit (8) >
  { L | H < Power Control Parameters : Power Control Parameters IE > }
  { L | H < Frequency Parameters : Frequency Parameters IE > }
  { L | H < RLC_DATA_BLOCKS_GRANTED : bit (8) > }
  { L { L { L | H < TBF_STARTING_TIME : bit (16) > }
  < USF_TN0 : bit (3) >
  < USF_TN1 : bit (3) >
  < USF_TN2 : bit (3) >
  < USF_TN3 : bit (3) >
  < USF_TN4 : bit (3) >
  < USF_TN5 : bit (3) >
  < USF_TN6 : bit (3) >
  < USF_TN7 : bit (3) >
  < USF_GRANULARITY : bit (1) > }
  | H { < TIMESLOT_NUMBER : bit (3) >
  < TBF_STARTING_TIME : bit (16) > }
  | H { L | H < ALLOCATION_REFERENCE : bit (2) > }
  < TBF_STARTING_TIME : bit (16) >
  { L | H < BLOCKS_OR_BLOCK_PERIODS : bit (1) >
  < ALLOCATION_BITMAP_LENGTH : bit (7) > }
  ALLOCATION_BITMAP : bit (n) > } } }
  < spare padding > ;

<Referenced Address struct > ::=
  { 0 < TLLI : bit(32) >
  (Text modified by CR A024r3:
  | 1 { 0 < GLOBAL_TFI : bit (8) > )
  (Text modified by CR A015r1:
  { 0 < Global TFI : Global TFI IE > )
  | 1 { 0 < TQI : bit (16) >
  | 1 < Packet Request Reference : Packet Request Reference IE > } } } ;

```

NOTE: If the ALLOCATION\_BITMAP\_LENGTH is not present, then the ALLOCATION\_BITMAP field is variable length and fills the remainder of the message.

**Table 76: PACKET UPLINK ASSIGNMENT information element details**

<p><b>PAGE_MODE</b> (2 bit field) This field describes which type of page mode used, i.e. either normal paging, extended paging, paging reorganization or same as before from the previous page mode. The mobile station shall ignore this field if the message is received on the PACCH. Coding of this field is defined in GSM 04.08.</p> <p><b>Referenced Address struct</b> This information element contains the address of the mobile station addressed by the message.</p> <p><b>Global TFI IE</b> (8 bit field) This information element identifies the uplink TFI, if available, or the downlink TFI, to which this message applies. This field is defined in subclause 12.10.</p> <p><b>TQI</b> (16 bit field) This field is defined in subclause 12.17.</p> <p><b>Packet Request Reference IE</b> This information element is defined in subclause 12.11.</p> <p><b>2_MESSAGE_ASSIGNMENT_TYPE</b> (1 bit field) This field, if present, indicates the type of message that contains the second part of the assignment.</p> <p>0 a PACKET SYSTEM INFORMATION TYPE 2 message is part of this assignment 1 a PACKET UPLINK ASSIGNMENT bis message is part of this assignment</p> <p><b>MAC_MODE</b> (8 bit field) This information field indicates the medium access method to be used during the TBF.</p> <p>Bit <u>2 1</u> 0 0 Dynamic Allocation 0 1 Extended Dynamic Allocation 1 0 Fixed Allocation 1 1 Reserved</p> <p><b>TIMESLOT_ALLOCATION</b> (8 bit field) This field is defined in subclause 12.18.</p> <p><b>CHANNEL_CODING_COMMAND</b> (2 bit field) The Channel Coding Indicator field indicates the channel coding scheme that the mobile station shall use when transmitting on the uplink.</p> <p>Bits <u>2 1</u> <u>value</u> 0 0 CS-1 0 1 CS-2 1 0 CS-3 1 1 CS-4</p> <p><b>RESPONSE_INDICATOR</b> (1 bit field) This bit indicates whether the mobile station shall use the allocated uplink resource to transmit a PACKET RESOURCE REQUEST message or may use the uplink resource for any purpose.</p> <p>0 one phase packet access 1 two phase access or single block packet access</p>
---

**Table 76 (continued): PACKET UPLINK ASSIGNMENT information element details****TLLI\_BLOCK\_CHANNEL\_CODING** (1 bit field)

This field indicates the channel coding command that the mobile station shall use for any RLC data block containing a TLLI field in the RLC data block header. This field is coded as shown:

- 0 the MS shall use CS-1 for any RLC data block containing a TLLI in the RLC data block header
- 1 the MS shall use the value commanded in the CHANNEL\_CODING\_COMMAND for any RLC data block containing a TLLI in the RLC data block header

**UPLINK\_TFI\_ASSIGNMENT** (7 bit field)

This information element, if present, assigns the contained TFI to the mobile station to identify to uplink TBF described by this message. This field is coded the same as the TFI field defined in subclause 12.15.

**Packet Timing Advance IE**

This information element, if present, contains the timing advance command for the mobile station. If this information element is not present, the MS shall, if it has a valid timing advance value, continue to use its previous timing advance value, and if the MS does not have a valid timing advance value, the MS shall not transmit until it receives a valid timing advance value. This information element is defined in subclause 12.12.

**CONTENTION\_RESOLUTION\_TLLI** (32 bit field)

This information element, if present, contains the TLLI of the mobile station to which the PACKET UPLINK ASSIGNMENT message is addressed. This information element is format as the TLLI information element (see subclause 12.16).

**Power Control Parameters IE**

This information element, if present, contains power control command for the mobile station. If this information element is not present, the MS shall continue to use the previous power. This information element is defined in subclause 12.13.

**Frequency Parameters IE**

This information element, if present, assigns frequency parameters to the uplink TBF. If this information element is not present the mobile station shall use its previously assigned frequency parameters. This information element is defined in subclause 12.8.

**RLC\_DATA\_BLOCKS\_GRANTED** (8 bit field)

The RLC/MAC blocks Granted field assigns a fixed number of RLC data blocks that the mobile station shall transmit during the uplink TBF. If the RLC\_DATA\_BLOCKS\_GRANTED field is present the mobile station shall transmit only the assigned number of RLC data blocks. Otherwise the duration of the uplink TBF is undefined. Retransmissions of negatively acknowledged RLC data blocks do not apply toward the maximum number. This field is encoded as a binary number as shown:

bit	
<u>8 7 6 5 4 3 2 1</u>	
0 0 0 0 0 0 0 0	9 RLC data blocks
0 0 0 0 0 0 0 1	10 RLC data blocks
...	
1 1 1 1 1 1 0 0	261 RLC data blocks
All others	Reserved

**Table 76 (continued): PACKET UPLINK ASSIGNMENT information element details****TBF\_STARTING\_TIME** (16 bit field)

The TBF Starting Time field contains a starting time that indicates the earliest framenummer during which the assigned TBF may start. If no uplink TBF is in progress, the mobile station shall not monitor the USF field of downlink radio blocks until the indicated framenummer. If an uplink TBF is in progress, the mobile station shall continue to use parameters of the existing TBF until the starting time occurs. When the indicated TDMA framenummer occurs, the mobile station shall immediately begin to use the new assigned uplink TBF parameters. This field is encoded as the Starting Time information element defined in GSM 04.08.

**USF for Timeslot Number 0 (TN0)** (3 bit field)**USF for Timeslot Number 1 (TN1)** (3 bit field)**USF for Timeslot Number 2 (TN2)** (3 bit field)**USF for Timeslot Number 3 (TN3)** (3 bit field)**USF for Timeslot Number 4 (TN4)** (3 bit field)**USF for Timeslot Number 5 (TN5)** (3 bit field)**USF for Timeslot Number 6 (TN6)** (3 bit field)**USF for Timeslot Number 7 (TN7)** (3 bit field)

These fields indicate the USF value assigned to the MS for timeslots 0 to 7. These fields are encoded as a binary presentation of the USF value as defined in subclause 10.4.1.

**USF\_GRANULARITY** (1 bit field)

This information field indicates the USF granularity to be applied by the mobile station when it is assigned a TBF using Dynamic Allocation.

0 the mobile station shall transmit one RLC/MAC block

1 the mobile station shall transmit four consecutive RLC/MAC blocks

**TIMESLOT\_NUMBER** (3 bit field)

This field indicates the timeslot assigned for transfer of a single RLC/MAC block on the uplink. This field is coded as the binary representation of the timeslot number as defined in GSM 05.10.

Range 0 to 7

**ALLOCATION\_REFERENCE** (2 bit field)

This information element is defined in subclause 12.5.

**BLOCKS\_OR\_BLOCK\_PERIODS** (1 bit field)

This indicates if the ALLOCATION\_BITMAP is to be interpreted as blocks or block periods.

0 the ALLOCATION\_BITMAP is to be interpreted as blocks

1 the ALLOCATION\_BITMAP is to be interpreted as block periods

**ALLOCATION\_BITMAP\_LENGTH** (7 bit field)

This specifies the number of bits in the ALLOCATION\_BITMAP.

Range 0 to 127

**ALLOCATION\_BITMAP** (variable length field)

If The ALLOCATION\_BITMAP field is variable length. If the ALLOCATION\_BITMAP\_LENGTH field is not present, the ALLOCATION\_BITMAP fills the remainder of the message. If the BLOCKS\_OR\_BLOCK\_PERIODS field is not present, then the ALLOCATION\_BITMAP should be interpreted as blocks. This field is defined in subclause 12.4. If the 2\_MESSAGE\_ASSIGNMENT\_TYPE indicates that a PACKET UPLINK ASSIGNMENT bis is the second message of a two message assignment, then the ALLOCATION\_BITMAP field is ignored.

### 11.2.30 Packet Uplink Assignment bis

The Packet Uplink Assignment bis is sent by the network to the mobile station as part of a 2 message fixed allocation uplink assignment. This message can only be interpreted in conjunction with the associated PACKET UPLINK ASSIGNMENT message. The mobile station may be addressed by TFI, TQI, TLLI or Packet Request Reference depending upon the procedure used.

Message type: Packet Uplink Assignment bis

Direction: network to mobile station

**Table 77: PACKET UPLINK ASSIGNMENT bis information elements**

<pre> &lt; Packet Uplink Assignment bis message content &gt; ::=   &lt; MESSAGE_TYPE : bit (6) &gt;   &lt; PAGE_MODE : bit (2) &gt;   &lt; Referenced Address : Referenced Address struct &gt;   &lt; TBF_STARTING_TIME : bit (16) &gt;   { L   H &lt; BLOCKS_OR_BLOCK_PERIODS : bit (1) &gt;     &lt; ALLOCATION_BITMAP_LENGTH : bit (7) &gt; }   &lt; ALLOCATION_BITMAP : bit (n) &gt; };  &lt;Referenced Address struct &gt; ::=   { 0 &lt; TLLI : bit(32) &gt;     1 { 0 &lt; GLOBAL_TFI : bit (8) &gt;         1 { 0 &lt; TQI : bit (16) &gt;             1 &lt; Packet Request Reference : Packet Request Reference IE &gt; } } }; </pre>
---

NOTE: If the ALLOCATION\_BITMAP\_LENGTH is not present, then the ALLOCATION\_BITMAP field is variable length and fills the remainder of the message.

**Table 78: PACKET UPLINK ASSIGNMENT bis information element details**

<p><b>PAGE_MODE</b> (2 bit field) This field describes which type of page mode used, i.e. either normal paging, extended paging, paging reorganization or same as before from the previous page mode. The mobile station shall ignore this field if the message is received on the PACCH. Coding of this field is defined in GSM 04.08.</p> <p><b>Referenced Address struct</b> This information element contains the address of the mobile station addressed by the message.</p> <p><b>Global TFI IE</b> (8 bit field) This field identifies the uplink TFI, if available, or the downlink TFI, to which this message applies. This field is defined in subclause 12.10.</p> <p><b>TQI</b> (16 bit field) This field is defined in subclause 12.17.</p> <p><b>Packet Request Reference IE</b> This information element is defined in subclause 12.11.</p> <p><b>TLLI</b> (32 bit field) This field is defined in subclause 12.16.</p> <p><b>TBF_STARTING_TIME</b> (16 bit field) The TBF Starting Time field contains a starting time that indicates the earliest framenummer during which the assigned TBF may start. If no uplink TBF is in progress, the mobile station shall not monitor the USF field of downlink radio blocks until the indicated framenummer. If an uplink TBF is in progress, the mobile station shall continue to use parameters of the existing TBF until the starting time occurs. When the indicated TDMA framenummer occurs, the mobile station shall immediately begin to use the new assigned uplink TBF parameters. This field is encoded as the Starting Time information element defined in GSM 04.08.</p> <p><b>BLOCKS_OR_BLOCK_PERIODS</b> (1 bit field) This indicates if the ALLOCATION_BITMAP is to be interpreted as blocks or block periods.</p> <p>0 the ALLOCATION_BITMAP is to be interpreted as blocks 1 the ALLOCATION_BITMAP is to be interpreted as block periods</p> <p><b>ALLOCATION_BITMAP_LENGTH</b> (7 bit field) This specifies the number of bits in the ALLOCATION_BITMAP. Range 0 to 127</p> <p><b>ALLOCATION_BITMAP</b> (variable length field) The ALLOCATION_BITMAP field is variable length. If the ALLOCATION_BITMAP_LENGTH field is not present, the ALLOCATION_BITMAP fills the remainder of the message. This field is defined in subclause 12.4.</p>
---

### 11.2.31 Packet Timeslot Reconfigure

The Packet Timeslot Reconfigure is sent by the network to the mobile station to assign uplink and downlink resources.

Message type: Packet Timeslot Reconfigure

Direction: network to mobile station

Table 79: PACKET TIMESLOT RECONFIGURE information elements

```

6 < Packet Timeslot Reconfigure message content > ::=
8   < MESSAGE_TYPE : bit (6) >
2   < GLOBAL_TFI : bit(8) >
2   < MAC_MODE : bit (2) >
2   < CHANNEL_CODING_COMMAND : bit (2) >
1   < Packet Timing Advance : Packet Timing Advance IE >
1   < DOWNLINK_RLC_MODE : bit(1) >
1   < UPLINK_RLC_MODE : bit (1) >
9   { L | H < 2_MESSAGE_ASSIGNMENT_TYPE : bit(1) > }
8   { L | H < GLOBAL_TFI_ASSIGNMENT : bit (8) > }
8   < DOWNLINK_TIMESLOT_ALLOCATION : bit (8) >
18  { L < UPLINK_TIMESLOT_ALLOCATION
15  | H < Power Control Parameters : Power Control Parameters IE > }
15  { L | H < Frequency Parameters : Frequency Parameters IE > }
1   { L | H < RLC_DATA_BLOCKS_GRANTED : bit (8) > }
1   { L { L | H < TBF_STARTING_TIME : bit (16) > }
0     < USF_TN0 : bit (3) >
0     < USF_TN1 : bit (3) >
0     < USF_TN2 : bit (3) >
0     < USF_TN3 : bit (3) >
0     < USF_TN4 : bit (3) >
0     < USF_TN5 : bit (3) >
0     < USF_TN6 : bit (3) >
0     < USF_TN7 : bit (3) >
0     < USF_GRANULARITY : bit (1) >
4     | H { L | H < ALLOCATION_REFERENCE : bit (2) > }
1       { L | H < Measurement Mapping : Measurement Mapping struct > }
16      < TBF_STARTING_TIME : bit (16) >
2       { L | H < BLOCKS_OR_BLOCK_PERIODS : bit (1) >
7         < ALLOCATION_BITMAP_LENGTH : bit (7) > }
94      < ALLOCATION_BITMAP : bit (n) > }
176    < spare padding > ;

< Measurement Mapping struct > ::=
   < MEASUREMENT_STARTING_TIME : bit (16) >
   < MEASUREMENT_INTERVAL : bit (5) >
   < MEASUREMENT_BITMAP : bit (8) > ;

```



**Table 80: PACKET UPLINK ASSIGNMENT information element details**

<b>Global TFI IE</b> (8 bit field)	
This field identifies the uplink TFI, if available, or the downlink TFI, to which this message applies. This field is defined in subclause 12.10.	
<b>MAC_MODE</b> (8 bit field)	
This information field indicates the medium access method to be used during the TBFs.	
Bit	
<u>2 1</u>	
0 0	Dynamic Allocation
0 1	Extended Dynamic Allocation
1 0	Fixed Allocation
1 1	Reserved
<b>CHANNEL_CODING_COMMAND</b> (2 bit field)	
The Channel Coding Indicator field indicates the channel coding scheme that the mobile station shall use when transmitting on the uplink.	
Bits	
<u>2 1</u>	<u>value</u>
0 0	CS-1
0 1	CS-2
1 0	CS-3
1 1	CS-4

**Table 80 (continued): PACKET UPLINK ASSIGNMENT information element details**

<p><b>Packet Timing Advance IE</b>                  This information element, if present, contains the timing advance command for the mobile station. If this information element is not present, the MS shall, if it has a valid timing advance value, continue to use its previous timing advance value, and if the MS does not have a valid timing advance value, the MS shall not transmit until it receives a valid timing advance value. This information element is defined in subclause 12.12.</p> <p><b>DOWNLINK_RLC_MODE</b> (1 bit field)                  This field indicates the RLC mode of the requested TBF.</p> <p>0 RLC acknowledged mode                  1 RLC unacknowledged mode</p> <p><b>UPLINK_RLC_MODE</b> (1 bit field)                  This field indicates the RLC mode of the requested TBF.</p> <p>0 RLC acknowledged mode                  1 RLC unacknowledged mode</p> <p><b>2_MESSAGE_ASSIGNMENT_TYPE</b> (1 bit field)                  This field, if present, indicates the type of message that contains the second part of the assignment.</p> <p>0 a PACKET SYSTEM INFORMATION TYPE 2 message is part of this assignment                  1 a PACKET UPLINK ASSIGNMENT bis message is part of this assignment</p> <p><b>GLOBAL_TFI_ASSIGNMENT</b> (8 bit field)                  This information element, if present, assigns the contained TFI to the mobile station to identify to an uplink or downlink TBF described by this message. This field is coded the same as the GLOBAL_TFI field defined in subclause 12.10.</p> <p><b>UPLINK_TIMESLOT_ALLOCATION</b> (8 bit field)                  This field is defined in subclause 12.18.</p> <p><b>DOWNLINK_TIMESLOT_ALLOCATION</b> (8 bit field)                  This field is defined in subclause 12.18.</p> <p><b>Power Control Parameters IE</b>                  This information element, if present, contains power control command for the mobile station. If this information element is not present, the MS shall continue to use the previous power. This information element is defined in subclause 12.13.</p> <p><b>Frequency Parameters IE</b>                  This information element, if present, assigns frequency parameters to the uplink TBF. If this information element is not present the mobile station shall use its previously assigned frequency parameters. This information element is defined in subclause 12.8.</p> <p><b>RLC_DATA_BLOCKS_GRANTED</b> (8 bit field)                  The RLC/MAC blocks Granted field assigns a fixed number of RLC data blocks that the mobile station shall transmit during the uplink TBF. If the RLC_DATA_BLOCKS_GRANTED field is present the mobile station shall transmit only the assigned number of RLC data blocks. Otherwise the duration of the uplink TBF is undefined. Retransmissions of negatively acknowledged RLC data blocks do not apply toward the maximum number. This field is encoded as a binary number as shown:</p> <table style="margin-left: 40px;"> <tr> <td style="text-align: center;">bit</td> <td></td> </tr> <tr> <td style="text-align: center;"><u>8 7 6 5 4 3 2 1</u></td> <td></td> </tr> <tr> <td>0 0 0 0 0 0 0 0</td> <td>9 RLC data blocks</td> </tr> <tr> <td>0 0 0 0 0 0 0 1</td> <td>10 RLC data blocks</td> </tr> <tr> <td style="text-align: center;">...</td> <td></td> </tr> <tr> <td>1 1 1 1 1 1 0 0</td> <td>261 RLC data blocks</td> </tr> <tr> <td>All others</td> <td>Reserved</td> </tr> </table>	bit		<u>8 7 6 5 4 3 2 1</u>		0 0 0 0 0 0 0 0	9 RLC data blocks	0 0 0 0 0 0 0 1	10 RLC data blocks	...		1 1 1 1 1 1 0 0	261 RLC data blocks	All others	Reserved
bit														
<u>8 7 6 5 4 3 2 1</u>														
0 0 0 0 0 0 0 0	9 RLC data blocks													
0 0 0 0 0 0 0 1	10 RLC data blocks													
...														
1 1 1 1 1 1 0 0	261 RLC data blocks													
All others	Reserved													

**Table 80 (continued): PACKET UPLINK ASSIGNMENT information element details****TBF\_STARTING\_TIME** (16 bit field)

The TBF Starting Time field contains a starting time that indicates the earliest framenummer during which the assigned TBF may start. If no uplink TBF is in progress, the mobile station shall not monitor the USF field of downlink radio blocks until the indicated framenummer. If an uplink TBF is in progress, the mobile station shall continue to use parameters of the existing TBF until the starting time occurs. When the indicated TDMA framenummer occurs, the mobile station shall immediately begin to use the new assigned uplink TBF parameters. This field is encoded as the Starting Time information element defined in GSM 04.08.

**USF for Timeslot Number 0 (TN0)** (3 bit field)**USF for Timeslot Number 1 (TN1)** (3 bit field)**USF for Timeslot Number 2 (TN2)** (3 bit field)**USF for Timeslot Number 3 (TN3)** (3 bit field)**USF for Timeslot Number 4 (TN4)** (3 bit field)**USF for Timeslot Number 5 (TN5)** (3 bit field)**USF for Timeslot Number 6 (TN6)** (3 bit field)**USF for Timeslot Number 7 (TN7)** (3 bit field)

These fields indicate the USF value assigned to the MS for timeslots 0 to 7. These fields are encoded as a binary presentation of the USF value as defined in subclause 10.4.1.

**USF\_GRANULARITY** (1 bit field)

This information field indicates the USF granularity to be applied by the mobile station when it is assigned a TBF using Dynamic Allocation.

- 0 the mobile station shall transmit one RLC/MAC block
- 1 the mobile station shall transmit four consecutive RLC/MAC blocks

**ALLOCATION\_REFERENCE** (2 bit field)

This information element is defined in subclause 12.5.

**BLOCKS\_OR\_BLOCK\_PERIODS** (1 bit field)

This indicates if the ALLOCATION\_BITMAP is to be interpreted as blocks or block periods.

- 0 the ALLOCATION\_BITMAP is to be interpreted as blocks
- 1 the ALLOCATION\_BITMAP is to be interpreted as block periods

**ALLOCATION\_BITMAP\_LENGTH** (7 bit field)

This specifies the number of bits in the ALLOCATION\_BITMAP.

Range 0 to 127

**ALLOCATION\_BITMAP** (variable length field)

The ALLOCATION\_BITMAP field is variable length. If the ALLOCATION\_BITMAP\_LENGTH field is not present, the ALLOCATION\_BITMAP fills the remainder of the message. If the BLOCKS\_OR\_BLOCK\_PERIODS field is not present, then the ALLOCATION\_BITMAP should be interpreted as blocks. This field is defined in subclause 12.4.

**Table 80 (concluded): PACKET UPLINK ASSIGNMENT information element details**

<b>MEASUREMENT_STARTING_TIME</b> (16 bit field)	
The Measurement Starting Time field contains a starting time that indicates the framenumbers during which the first assigned measurement period shall occur. The mobile station must make one or more neighbour cell power measurements during the assigned framenumbers and during the following 3 TDMA frames. This field is encoded the same as the Starting Time information element defined in GSM 04.08.	
<b>MEASUREMENT_BITMAP</b> (8 bit field)	
This information field indicates the timeslots assigned for use during measurement periods. The field as a bitmap where each bit corresponds with a timeslot number. Bit 1 corresponds to TS0; Bit 2 to TS1...	
<u>bit</u>	<u>Timeslot value</u>
0	Timeslot is not assigned
1	Timeslot is assigned
<b>MEASUREMENT_INTERVAL</b> (5 bit field)	
The Measurement Interval field indicates the number of block periods from the start of one assigned measurement period to the beginning of the next measurement period.	
Bits	
<u>5 4 3 2 1</u>	
0 0 0 0 0	make measurements during every block period
0 0 0 0 1	make measurements during every other block period
0 0 0 1 0	make measurements during every 3 <sup>rd</sup> block period
...	
1 1 1 1 1	make measurements during every 32 <sup>nd</sup> block period

---

## 12 Information element coding

### 12.1 Overview

Information elements used within the context of only one RLC control message are defined in clause 11. All other information elements are defined within the present clause.

### 12.2 Message Type

All RLC control messages, with the exception of the PACKET CONTROL ACKNOWLEDGEMENT and PACKET CHANNEL REQUEST, follow the same non-standard format (see GSM 04.07). Each message, with the exception of the two listed above, have a 6 bit message type field.

The RLC control messages are separated into two groups, uplink and downlink. The messages types are assigned to the messages independently within each group of RLC control messages, uplink or downlink. The downlink message types are further divided into non-System Information and System Information messages. The non-System information messages have bit 6 set to '0' and the System Information message bit 6 set to '1'.

**Table 81: Message types for RLC/MAC control messages**

bit	
6	5 4 3 2 1
<b>Uplink Messages</b>	
0 0 0 0 0 0	Packet Cell Change Failure
0 0 0 0 0 1	Packet Control Acknowledgement
0 0 0 0 1 0	Packet Downlink Ack/Nack
0 0 0 0 1 1	Packet Dummy Control Block
0 0 0 1 0 0	Packet Measurement Report
0 0 0 1 0 1	Packet Resource Request
0 0 0 1 1 0	Packet TBF Status
All others	Reserved
bit	
6	5 4 3 2 1
<b>Downlink Messages</b>	
0 0 0 0 0 1	Packet Access Reject
0 0 0 0 1 0	Packet Cell Change Failure
0 0 0 0 1 1	Packet Cell Change Order
0 0 0 1 0 0	Packet Downlink Assignment
0 0 0 1 0 1	Packet Paging Request
0 0 0 1 1 0	Packet PDCH Release
0 0 0 1 1 1	Packet Polling Request
0 0 1 0 0 0	Packet Power Control/Timing Advance
0 0 1 0 0 1	Packet PRACH Parameters
0 0 1 0 1 0	Packet Queueing Notification
0 0 1 0 1 1	Spare
0 0 1 1 0 0	Packet TBF Release
0 0 1 1 0 1	Packet Uplink Ack/Nack
0 0 1 1 1 0	Packet Uplink Assignment
0 0 1 1 1 1	Packet Uplink Assignment bis
1 0 0 0 0 1	Packet System Information Type 1
1 0 0 0 1 0	Packet System Information Type 2
1 0 0 0 1 1	Packet System Information Type 3
1 0 0 1 0 0	Packet System Information Type 3 bis
1 0 0 1 0 1	Packet System Information Type 4
1 0 0 1 1 0	Packet System Information Type 5
1 0 0 1 1 1	Packet System Information Type 5 bis
1 0 1 0 0 0	Packet System Information Type 6
All others	Reserved

## 12.3 Ack/Nack Description

The Ack/Nack Description information element contains the RLC parameters used to acknowledge or negatively acknowledge a group of RLC data blocks.

**Table 82: Ack/Nack Description information elements**

```

< Ack/Nack Description IE > ::=
{
  < FINAL_ACK_INDICATION : bit (1) >
  < STARTING_SEQUENCE_NUMBER : bit (7) >
  < RECEIVED_BLOCK_BITMAP : bit (64) > } ;

```

**Table 83: Ack/Nack Description information element details**

<p><b>FINAL_ACK_INDICATION</b> (1 bit field)</p> <p>This field indicates whether the entire TBF is being acknowledged. If the entire TBF is being acknowledged, the SSN and RBB fields contain no information and shall be ignored.</p> <p>0 retransmission are requested and the TBF is incomplete  1 no retransmissions are requested and this message indicates acknowledgement of all RLC data in the TBF</p> <p><b>STARTING_SEQUENCE_NUMBER (SSN)</b> (7 bit field)</p> <p>The SSN contains the value of V(R) when this information element was transmitted. This field is encoded as the binary representation of V(R).  Range 0 to 127</p> <p><b>RECEIVE_BLOCK_BITMAP (RBB)</b> (64 bit field)</p> <p>The RBB is a bitmap representing Block Sequence Numbers. The bitmap is indexed relative to SSN as follows:</p> $\text{BSN} = (\text{SSN} - \text{bit\_number} - 1) \text{ modulo } 128, \quad \text{for bit\_number} = 0 \text{ to } 63.$ <p>The BSN values represented range from <math>(\text{SSN} - 1) \text{ mod } 128</math> to <math>(\text{SSN} - 64) \text{ mod } 128</math>.</p> <p>The value of each bit is encoded as:</p> <p>0 Negative acknowledgement of the RLC data block with <math>\text{BSN} = (\text{SSN} - \text{bit\_number} - 1) \text{ mod } 128</math>  1 Positive acknowledgement of the RLC data block with <math>\text{BSN} = (\text{SSN} - \text{bit\_number} - 1) \text{ mod } 128</math></p>
--

## 12.4 ALLOCATION\_BITMAP

The ALLOCATION\_BITMAP represents uplink radio blocks, each bit representing one radio block or an entire block period. Each bit indicates whether the mobile station is permitted to transmit during the corresponding uplink radio block or radio block period.

**Table 84: ALLOCATION\_BITMAP information element details**

<p><b>ALLOCATION_BITMAP</b> (variable length field)</p> <p>The ALLOCATION_BITMAP represents uplink radio blocks or radio block periods, each bit representing one radio block or an entire radio block.</p> <p>If the BLOCKS_OR_BLOCK_PERIODS field indicates blocks, the bitmap describes a two dimensional array of radio blocks. The number of columns in the array is variable and is equal to the number of timeslots allocated in the TIMESLOT_ALLOCATION. The array is indexed as follows:</p> $\text{radio block}[x,y]$ $x = (L - n) / \text{NTS}, \quad \text{for } n = 0 \text{ to } L,$ $y = (L - n) \bmod \text{NTS} \quad \text{for } n = 0 \text{ to } L,$ <p>where:</p> <p>x = block period relative to TBF_STARTING_TIME, range 0 to L / NTS - 1;</p> <p>y = timeslot number of the assigned timeslots in the TIMESLOT_BITMAP, range 0 to NTS-1;</p> <p>L = number of bits in the ALLOCATION_BITMAP - 1;</p> <p>n = bit number index into the ALLOCATION_BITMAP, range 0 to L;</p> <p>TBF_STARTING_TIME indicates the first block period of the assigned allocation;</p> <p>NTS = number of timeslots assigned in the TIMESLOT_ALLOCATION, range 1 to 8;</p> <p>The division operation is integer division;</p> <p>The modulo operation is integer modulo.</p> <p>The value of each bit is encoded as:</p> <p>0 radio block[x,y] is not part of the assigned allocation</p> <p>1 radio block[x,y] is part of the assigned allocation</p> <p>If the BLOCKS_OR_BLOCK_PERIODS field indicates block periods, the bitmap describes a one dimensional array of block periods. For each block period indicated as part of the allocation in the bitmap, each of the timeslots indicated in the TIMESLOT_ALLOCATION is assigned as part of the allocation. The array is indexed as follows:</p> $\text{block period}[z]$ $z = n \quad \text{for } n = 0 \text{ to } L,$ <p>where:</p> <p>L = number of bits in the ALLOCATION_BITMAP - 1;</p> <p>z = block period relative to TBF_STARTING_TIME;</p> <p>n = bit number index into the ALLOCATION_BITMAP, range 0 to L;</p> <p>TBF_STARTING_TIME indicates the first block period of the assigned allocation;</p> <p>NTS = number of timeslots assigned in the TIMESLOT_ALLOCATION, range 1 to 8.</p> <p>The value of each bit is encoded as:</p> <p>0 block period[n] is not part of the assigned allocation</p> <p>1 block period[n] is part of the assigned allocation</p>
---

## 12.5 ALLOCATION\_REFERENCE

The Acknowledgement Reference field allows the mobile station to associate messages sent on the uplink containing requests for resource with the corresponding resource allocation messages received on the downlink. The mobile station sets the ALLOCATION\_REFERENCE field to a value with each request resources and the network echoes the ALLOCATION\_REFERENCE field in the corresponding resource allocation message.

**Table 85: ALLOCATION\_REFERENCE information element details**

### ALLOCATION\_REFERENCE (2 bit field)

The ALLOCATION\_REFERENCE field is used only by half duplex MSs. When sent on the uplink, the ALLOCATION\_REFERENCE field contains a 2 bit number that the mobile station shall increment following each allocation request within an uplink TBF. The ALLOCATION\_REFERENCE is set to the value '00' for the initial resource request. In the case of a one phase access, the ALLOCATION\_REFERENCE is implicitly set to the value '00'.

When sent on the downlink, the ALLOCATION\_REFERENCE contains the value of the ALLOCATION\_REFERENCE field in the message that requested the resource being assigned. This allows the mobile station to unambiguously determine how many allocation request message may be queued by the network.

The ALLOCATION\_REFERENCE field is encoded as a 2 bit binary number.

## 12.6 CHANNEL\_CODING\_REQUESTED

The CHANNEL\_CODING\_REQUESTED field is sent by the mobile station to indicate to the network which channel coding rate the mobile station desires the network to use on the downlink.

**Table 86: CHANNEL\_CODING\_REQUESTED information element details**

### CHANNEL\_CODING\_REQUESTED (2 bit field)

This field indicates to network the channel coding scheme (see GSM 05.03) that the network should use on the downlink. The field is encoded according to the following table:

bits	value
0 0	CS-1
0 1	CS-2
1 0	CS-3
1 1	CS-4

## 12.7 Channel Request Description

The Channel Request Description information element is sent by the mobile station to the network to request uplink resources.

**Table 87: Channel Request Description information elements**

```
< Channel Request Description IE > ::=
    <REQUESTED_BANDWIDTH : bit(16) >
    < PRIORITY : bit (2) >
    < RLC_MODE : bit (1) >
    < LLC_FRAME_TYPE : bit (1) >
    < RLC_OCTET_COUNT : bit (8) >
```

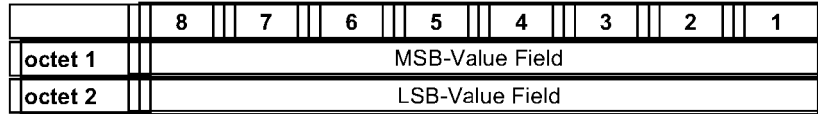

**Table 88: Channel Request Description information element details**

**REQUESTED\_BANDWIDTH** (16 bits field)

This field indicates the useful uplink bandwidth requested. The bit rate field is the binary encoding of the rate information expressed in 100 bits/s, starting from 0 x 100 bits/s until 65535 x 100 bits/s.

The throughput granted by BSS may be higher to cope with protocol overhead and retransmissions.



**PRIORITY** (2 bit field)  
 This field indicates the priority of the requested TBF. The priority is encoded as the priority field of the Packet Channel Request (see 11.2.5).

**RLC\_MODE** (1 bit field)  
 This field indicates the RLC mode of the requested TBF.

0 RLC acknowledged mode  
 1 RLC unacknowledged mode

**LLC\_FRAME\_TYPE** (1 bit field)  
 This field indicates the type of the first LLC frame to be transmitted over the requested uplink TBF.

0 LLC frame is SACK or NACK  
 1 LLC frame is not SACK or NACK

**RLC\_OCTET\_COUNT** (8 bit field)  
 The RLC\_OCTET\_COUNT field indicates the number octets of RLC data the mobile station wishes to transfer. If the dynamic allocation or extended dynamic allocation medium access method is used, the highest value "1 1 1 1 1 1 1" shall be interpreted as a request for an open ended TBF by the mobile station. If the fixed allocation medium access method is used, the highest value "1 1 1 1 1 1 1" shall be interpreted as a request for 12900 to 12949 octets.

bit

8 7 6 5 4 3 2 1

0 0 0 0 0 0 0 0    150 to 199 octets  
 0 0 0 0 0 0 0 1    200 to 249 octets  
 0 0 0 0 0 0 1 0    250 to 299 octets  
           :   :   :  
 1 1 1 1 1 1 1 1    12900 to 12949 octets or Open Ended TBF

## 12.8 Frequency Parameters

The Downlink Channel Description information element assigns downlink resources to the mobile station.

**Table 89: Frequency Parameters information elements**

```
< Frequency Parameters IE > ::=
  { 0 < ARFCN : bit (10) >
    < TSC : bit (3) >
  | 1 < MA_NUMBER : bit (4) >
    < MAIO : bit (6) >
    < MA_CHANGE_MARK : bit (2) }
```

**Table 90: Frequency Parameters information element details**

### ARFCN (10 bit field)

This field contains the frequency of the assigned carrier. This field is encoded as the ARFCN defined in GSM 04.08. Range 0 to 1023

### TSC (3 bit field)

The purpose of the TSC field is to provide a training sequence code (TSC) for the physical channel description. The TSC field is binary coded, see GSM 05.02.

Range 0 to 7

### MA\_NUMBER (4 bit field)

This information field indicates the mobile allocation to be used for the assigned PDCHs. This field is an index into the MA list broadcast in the System Information on BCCH or PBCCH. All of the timeslots indicated in the TIMESLOT\_ALLOCATION have the same mobile allocation. Mobile Allocation is encoded as a binary number. Range 0 to 15.

### MAIO (6 bit field)

This field contains the MAIO of the assigned channel. This field is encoded as the MAIO defined in GSM 04.08. Range 0 to 1023

### MA\_CHANGE\_MARK (2 bit field)

The purpose of the MA\_CHANGE\_MARK field is to identify the set of PSI group A messages that were used when the network formulated this assignment message. The mobile station shall verify that the value of MA\_CHANGE\_MARK in this message matches the value of MA\_CHANGE\_MARK the mobile station has stored as part of the PSI2 message(s) read earlier. The coding of the MA\_CHANGE\_MARK field is network dependent.

## 12.9 Global Power Control Parameters

The Global Power Control Parameters information element contains parameters the mobile station shall use to determine its TX power level.

**Table 91: Global Power Control Parameters information elements**

```
< Global Power Control Parameters IE > ::=
  < ALPHA : bit (4) >
  < T_AVG_W : bit (5) >
  < T_AVG_T : bit (5) >
  < Pb : bit (4) >
  < PC_MEAS_CHAN : bit (1) >
  < INT_MEAS_CHANNEL_LIST_AVAIL : bit (1) >
  { 0 | 1 < N_AVG_I : bit (4) > } ;
```

**Table 92: Global Power Control Parameters information element details****ALPHA** (4 bit field)

The ALPHA power control parameter field is coded according to the following table:

bits

4 3 2 1

0 0 0 0     $\alpha = 0.0$

0 0 0 1     $\alpha = 0.1$

0 0 1 0     $\alpha = 0.2$

∴

1 0 0 1     $\alpha = 0.9$

1 0 1 0     $\alpha = 1.0$

All other values are reserved.

**T\_AVG\_W** (5 bit field)

The T\_AVG\_W parameter is a signal strength filter period for power control in packet idle mode.  $2^{(k/2)} / 6$  multiframe,  $k = 0, 1, 2, \dots, 25$ . All other values are reserved.

**T\_AVG\_T** (5 bit field)

The T\_AVG\_T parameter is a signal strength filter period for power control in packet transfer mode.  $2^{(k/2)} / 6$  multiframe,  $k = 0, 1, 2, \dots, 25$ ; All other values are reserved.

**Pb** (4 bit field)

The Pb parameter is a power reduction value used by the BTS on PBCCH blocks, relative to the output power used on BCCH. The field is coded according to the following table:

bits

4 3 2 1

0 0 0 0    Pb = 0 dB

0 0 0 1    Pb = -2 dB

0 0 1 0    Pb = -4 dB

∴

1 1 1 1    Pb = -30 dB

**PC\_MEAS\_CHAN** (1 bit field)

The PC\_MEAS\_CHAN parameter indicates where the mobile station shall measure the received power level on the downlink for the purpose of the uplink power control.

0 downlink measurements for power control shall be made on BCCH

1 downlink measurements for power control shall be made on PDCH

**N\_AVG\_I** (4 bit field)

The N\_AVG\_I parameter is an interfering signal strength filter constant for power control  $2^{(k/2)}$ ,  $k=0,1,\dots,15$ .

**INT\_MEAS\_CHANNEL\_LIST\_AVAIL** (1 bit field)

Indicates if the optional PSI4 message is broadcast. If broadcast it contains the Channel List for interference measurements.

0 PSI4 message not broadcast

1 PSI4 message broadcast

## 12.10 Global TFI

The Global TFI (Temporary Flow Identifier) information element contains either an uplink TFI or a downlink TFI. The uplink or downlink TFI identifies a single Temporary Block Flow.

**Table 93: Global TFI information elements**

```
< Global TFI IE > ::=
  { 0 < UPLINK_TFI : bit (7) >
    | 1 < DOWNLINK_TFI : bit (7) > } ;
```

**Table 94: Global TFI information element details**

**UPLINK\_TFI** (7 bit field)

This field identifies an uplink TBF. This field is coded the same as the TFI field defined in subclause 12.15.

**DOWNLINK\_TFI** (7 bit field)

This field identifies a downlink TBF. This field is coded the same as the TFI field defined in subclause 12.15.

## 12.11 Packet Request Reference

The purpose of the Packet Request Reference information element is to provide the information field sent in the Packet Channel Request and the framenumber, FN modulo 42432, in which the Packet Channel Request was received.

**Table 95: Packet Request Reference information elements**

```
< Packet Request Reference IE > ::=
  < RANDOM_ACCESS_INFORMATION value : bit (11) >
  < FRAME_NUMBER : bit (16) >
```

**Table 96: Packet Request Reference information element details**

**RA, Random Access Information** (11 bit field)

This is an unformatted 11 bit field. If the System Information parameter Access Burst Type indicates 11 bit access bursts are to be used, all 11 bits of this field are valid. Otherwise, only bits 8 through 1 are valid and bits 11 through 9 shall be set to '0'.

	Bit
	11 10 9 8 7 6 5 4 3 2 1
Access Burst Type indicates 11	X X X X X X X X X X X
Access Burst Type indicates 8	0 0 0 X X X X X X X X

**FRAME\_NUMBER** (16 bit field)

This field is encoded the same as the Starting Time information element defined in GSM 04.08.

## 12.12 Packet Timing Advance

The Packet Timing Advance field describes the timing advance mode and timing advance value assigned to the mobile station.

**Table 97: Packet Timing Advance information elements**

```
< Packet Timing Advance IE > ::=
  { 0 | 1 < TIMING_ADVANCE_VALUE : bit (6) > }
  { 0 | 1 < TIMING_ADVANCE_INDEX : bit (4) >
    < TIMING_ADVANCE_TIMESLOT_NUMBER : bit (3) > }
```

**Table 98: Packet Timing Advance information element details****TIMING\_ADVANCE\_VALUE** (6 bit field)

If the **TIMING\_ADVANCE\_VALUE** field is present, the mobile station shall immediately use the value contained therein. If the **TIMING\_ADVANCE\_VALUE** field is not present the mobile station shall use its previous timing advance. If the mobile station does not have a previous timing advance the mobile station shall not transmit until it receives a valid timing advance. The Timing Advance value field is encoded the same as the Timing Advance value of the Timing Advance information element defined in GSM 04.08

**TIMING\_ADVANCE\_INDEX** (4 bit field)

If the **TIMING\_ADVANCE\_INDEX** and **TIMING\_ADVANCE\_TIMESLOT\_NUMBER** fields are present the mobile station shall immediately begin operation of the Continuous Timing Advance procedure. If these two fields are not present the mobile station shall stop operation of the Continuous Timing Advance procedure. This information field is encoded as a binary representation of the Timing Advance Index defined in GSM 05.02.

Range 0 to 15.

**TIMING\_ADVANCE\_TIMESLOT\_NUMBER** (3 bit field)

This field indicates the timeslot assigned for Continuous Timing Advance operation on the PTCCH. This field is coded as the binary representation of the timeslot number as defined in GSM 05.10.

Range 0 to 7

## 12.13 Power Control Parameters

The Power Control parameters information element contains parameters the mobile station shall use to determine its TX power level.

**Table 99: Power Control Parameters information elements**

```

< Power Control Parameters IE > ::=
  < ALPHA : bit (4) >
  { 0 | 1 < GAMMA_TN0 : bit (5) > }
  { 0 | 1 < GAMMA_TN1 : bit (5) > }
  { 0 | 1 < GAMMA_TN2 : bit (5) > }
  { 0 | 1 < GAMMA_TN3 : bit (5) > }
  { 0 | 1 < GAMMA_TN4 : bit (5) > }
  { 0 | 1 < GAMMA_TN5 : bit (5) > }
  { 0 | 1 < GAMMA_TN6 : bit (5) > }
  { 0 | 1 < GAMMA_TN7 : bit (5) > }

```

Table 100: Power Control Parameters information element details

<p><b>ALPHA</b> (4 bit field)</p> <p>The ALPHA Power control parameter field is coded according to the following table:</p> <p>bits</p> <table> <tr> <td><u>4</u> <u>3</u> <u>2</u> <u>1</u></td> <td></td> </tr> <tr> <td>0 0 0 0</td> <td><math>\alpha = 0.0</math></td> </tr> <tr> <td>0 0 0 1</td> <td><math>\alpha = 0.1</math></td> </tr> <tr> <td>: : :</td> <td></td> </tr> <tr> <td>1 0 0 1</td> <td><math>\alpha = 0.9</math></td> </tr> <tr> <td>1 0 1 0</td> <td><math>\alpha = 1.0</math></td> </tr> </table> <p>All other values are reserved.</p> <p><b>GAMMA_TN0</b> (5 bit field)  <b>GAMMA_TN1</b> (5 bit field)  <b>GAMMA_TN2</b> (5 bit field)  <b>GAMMA_TN3</b> (5 bit field)  <b>GAMMA_TN4</b> (5 bit field)  <b>GAMMA_TN5</b> (5 bit field)  <b>GAMMA_TN6</b> (5 bit field)  <b>GAMMA_TN7</b> (5 bit field)</p> <p>The GAMMA_TN0..7 fields are the binary representation of the parameter <math>\Gamma_{CH}</math> for MS output power control in units of 2 dB, see GSM 05.08. GAMMA_TN0 contains the gamma value for timeslot number 0, GAMMA_TN1 contains the gamma value for timeslot number 1, etc.</p>	<u>4</u> <u>3</u> <u>2</u> <u>1</u>		0 0 0 0	$\alpha = 0.0$	0 0 0 1	$\alpha = 0.1$	: : :		1 0 0 1	$\alpha = 0.9$	1 0 1 0	$\alpha = 1.0$
<u>4</u> <u>3</u> <u>2</u> <u>1</u>												
0 0 0 0	$\alpha = 0.0$											
0 0 0 1	$\alpha = 0.1$											
: : :												
1 0 0 1	$\alpha = 0.9$											
1 0 1 0	$\alpha = 1.0$											

## 12.14 PRACH Control Parameters

The purpose of the PRACH Control Parameters information element is to provide parameters used to control the PRACH utilization.

Table 101: PRACH Control Parameters information elements

<pre> &lt; PRACH Control Parameters IE &gt; ::=   &lt; ACCESS_BURST_TYPE : bit (1) &gt;   &lt; RANDOM_ACC_RETRY : bit (1) &gt;   &lt; MAX_RETRANS : bit (2) &gt;<sup>4</sup>   &lt; ACC_CONTR_CLASS : bit (16)   { L { &lt; TX_INT : bit (4) &gt;     &lt; S : bit (4) &gt;     &lt; PRIORITY_ACCESS_THR : bit (3) &gt; }     H &lt; PERSISTENCE_LEVEL : bit (4) &gt;<sup>4</sup> } ; </pre>
--

**Table 102: PRACH Control Parameters information element details****ACCESS\_BURST\_TYPE** (1 bit field)

The ACCESS\_BURST\_TYPE field indicates if 8 or 11 bit access burst shall be used. The field is coded according to the following table:

0	8 bit access burst shall be used
1	11 bit access burst shall be used

**RANDOM\_ACCESS\_RETRY** (1 bit field)

The RANDOM\_ACCESS\_RETRY field indicates if set = 0 that random access retry to another cell is not allowed. If the field is set = 1 indicates that random access retry to other cell is allowed.

**Persistence Control Parameters**

The persistence control are used for control of the random access and includes the following parameters:

MAX\_RETRANS, PRIORITY\_ACCESS\_THR, TX\_INT, S, RO\_PRI and K\_IJ. The parameters TX\_INT, S and PRIORITY\_ACCESS\_THR are conditional to the parameters RO\_PRI and K\_IJ. The persistence control procedures are specified in subclause 7.1.1 3.

**PRIORITY\_ACCESS\_THR** (3 bit field)

The PRIORITY\_ACCESS\_THR field indicates whether or not a mobile station of a certain priority class is authorised to do a random access for request of a GPRS service. The field is coded according to the following table:

bits	
<u>3 2 1</u>	
0 0 0	packet access is not allowed in the cell;
0 0 1	spare, shall be interpreted as '000' (packet access not allowed);
0 1 0	spare, shall be interpreted as '000' (packet access not allowed);
0 1 1	packet access is allowed for Priority class 1;
1 0 0	packet access is allowed for Priority class 1 to 2;
1 0 1	packet access is allowed for Priority class 1 to 3;
1 1 0	packet access is allowed for Priority class 1 to 4;
1 1 1	spare, shall be interpreted as '110' (packet access allowed).

**TX\_INT** (4 bit field)

Number of slots to spread transmission of the random access. The field is coded according to the following table:

bits	
<u>4 3 2 1</u>	
0 0 0 0	3 slots used to spread transmission
0 0 0 1	4 slots used to spread transmission
0 0 1 0	5 slots used to spread transmission
0 0 1 1	6 slots used to spread transmission
0 1 0 0	7 slots used to spread transmission
0 1 0 1	8 slots used to spread transmission
0 1 1 0	9 slots used to spread transmission
0 1 1 1	10 slots used to spread transmission
1 0 0 0	11 slots used to spread transmission
1 0 0 1	12 slots used to spread transmission
1 0 1 0	14 slots used to spread transmission
1 0 1 1	16 slots used to spread transmission
1 1 0 0	20 slots used to spread transmission
1 1 0 1	25 slots used to spread transmission
1 1 1 0	32 slots used to spread transmission
1 1 1 1	50 slots used to spread transmission

**Table 102 (continued): PRACH Control Parameters information element details****S (4 bit field)**

S is a parameter used for calculation of number of slots between two successive Channel request messages. The field is coded according to the following table:

bits				
<u>4</u>	<u>3</u>	<u>2</u>	<u>1</u>	
0	0	0	0	S = 41
0	0	0	1	S = 52
0	0	1	0	S = 55
0	0	1	1	S = 58
0	1	0	0	S = 76
0	1	0	1	S = 86
0	1	1	0	S = 109
0	1	1	1	S = 115
1	0	0	0	S = 163
1	0	0	1	S = 217

All other values reserved.

**MAX\_RETRANS (2 bit field for each priority 1..4)**

Indicates for each priority level 1 to 4 the maximum number of retransmissions allowed. Priority 1 represents the highest priority. The field is coded with two bits per priority level according to the following table where the first two bits refer to Priority 1, the second two bits to Priority 2 .....

bits		
<u>2</u>	<u>1</u>	
0	0	1 retransmission allowed
0	1	2 retransmissions allowed
1	0	4 retransmissions allowed
1	1	7 retransmissions allowed

**PERSISTENCE\_LEVEL (4 bit field for each priority 1..4)**

The PERSISTENCE\_LEVEL field indicates the values of the access persistence level P(i) for each priority i (i = 1..4) where priority 1 represents the highest priority of a LLC PDU to be transmitted.

Bits				
<u>4</u>	<u>3</u>	<u>2</u>	<u>1</u>	
0	0	0	0	persistence level 0
0	0	0	1	persistence level 1
0	0	1	0	persistence level 2
0	0	1	1	persistence level 3
0	1	0	0	persistence level 4
:::				
1	1	1	0	persistence level 14
1	1	1	1	persistence level 16

**ACC\_CONTR\_CLASS (16 bit field)**

Access Control Class N (bit 1-16). For a mobile station with Access Control Class =N access is not barred if the Access Control Class N bit is coded with a "0"; N = 0, 1, ..., 9, 11, ..., 15.

Bits:	<u>16</u>	<u>15</u>	<u>14</u>	<u>13</u>	<u>12</u>	<u>11</u>	<u>10</u>	<u>9</u>	<u>8</u>	<u>7</u>	<u>6</u>	<u>5</u>	<u>4</u>	<u>3</u>	<u>2</u>	<u>1</u>
Class N:	15	14	13	12	11	-	9	8	7	6	5	4	3	2	1	0

## 12.15 Temporary Flow Identifier (TFI)

The Temporary Flow Identifier (TFI) uniquely identifies either a single uplink Temporary Block Flow (TBF) or a single downlink Temporary Block Flow (TBF).



**Table 103: TFI information element details**

<p><b>TFI</b> (7 bit field)  The Temporary Flow Identifier field identifies either an uplink or downlink Temporary Block Flow (TBF). This field is encoded as a binary number.  Range 0 to 127</p>
--

## 12.16 Temporary Logical Link Identity (TLLI)

The Temporary Logical Link Identity (TLLI) is associated with the GPRS subscriber. TLLI is defined in GSM 03.03.

**Table 104: TLLI information element details**

<p><b>TLLI</b> (32 bit field)  The TLLI field is encoded as a binary number.  Range 0 to 4294967295</p>
---

## 12.17 Temporary Queueing Identifier (TQI)

The Temporary Queueing Identifier (TQI) field identifies a mobile station during the queueing procedure. The contents of this field are operator defined.

**Table 105: TQI information element details**

<p><b>TQI</b> (16 bit field)  The Temporary Queueing Identifier field is an unformatted field.</p>
--

## 12.18 TIMESLOT\_ALLOCATION

The TIMESLOT\_ALLOCATION field indicates the timeslots for use during a TBF.

**Table 106: TIMESLOT\_ALLOCATION information element details**

<p><b>TIMESLOT_ALLOCATION</b> (8 bit field)  This information field indicates the timeslots assigned for use during the TBF. Bit 8 indicates the status of timeslot 0, bit 7 indicates the status of timeslot 1, etc. At least one timeslot must be assigned.</p> <p>0 Timeslot is not assigned  1 Timeslot is assigned</p>
---

## 12.19 TS\_OVERRIDE

The TS\_OVERRIDE field indicates the timeslots whose allocation should be overridden during a TBF.

**Table 107: TS\_OVERRIDE information element details**

<p><b>TS_OVERRIDE</b> (8 bit field)  This information field indicates which the timeslots whose allocation should be overridden. The override applies for one repeated allocation. Bit 8 indicates the status of timeslot 0, bit 7 indicates the status of timeslot 1, etc. At least one timeslot must be assigned.</p> <p>0 The mobile shall use the ALLOCATION_BITMAP during the allocation to determine during which radio blocks it shall transmit  1 The mobile shall transmit on all uplink radio blocks during the allocation</p>
--

## 13 Timers and counters

The tables in clause 13.1 and 13.2 specifies the timers used in RLC/MAC protocol signalling. The denotation of columns is defined as follows:

timer ::= name of the timer;

started ::= under which conditions the timer is started;

stopped ::= under which conditions the timer is stopped;

action at expiry ::= which actions the GPRS entity shall perform at expiry;

value ::= the duration between setting the timer and expiry of the timer (“s” denotes “second(s)” “xx - yy” means that any value between xx and yy is permitted).

### 13.1 Timers on the Mobile Station side

**Table 108: Specification of timers used in GPRS on the Mobile Station side**

timer	started	stopped	action at expiry	value
T3160	At sending of first PACKET CHANNEL REQUEST messages with network steered method on PRACH	On receipt of a PACKET UPLINK ASSIGNMENT or PACKET QUEUING NOTIFICATION or a PACKET ACCESS REJECT message	Stop sending PACKET CHANNEL	5 sec
T3162	On receipt of a PACKET QUEUING NOTIFICATION or a PACKET ACCESS REJECT message indicating WAIT. Restarted on receipt of a PACKET POLLING message	On receipt of a PACKET UPLINK ASSIGNMENT or PACKET ACCESS REJECT with WAIT Indication > 250	Abort Packet access procedure; indicate Packet access failure to upper layers and Return to packet idle mode listening to its paging subchannel	15 sec
T3164	On receipt of a PACKET UPLINK ASSIGNMENT	At sending of the first RLC/MAC block	A new packet access procedure may be initiated	5 sec
T3166	At sending of the first RLC/MAC block at one phase access	On receipt of a PACKET UPLINK ACK/NACK	Immediately stop transmitting on the assigned TBF; a TBF establishment failure has occurred or the contention resolution procedures has failed	5 sec
T3168	At sending the PACKET RESOURCE REQUEST message	On receipt of a PACKET UPLINK ASSIGNMENT message	Same as T3166	5 sec
T3170	After having made M + 1 attempts to send a PACKET CHANNEL REQUEST message or at expiry of T3160	On receipt of a PACKET UPLINK ASSIGNMENT or PACKET QUEUING NOTIFICATION message	Abort Packet access procedure; indicate Packet access failure to upper layers	5 sec
T3172	On receipt of a PACKET ACCESS REJECT message	On receipt of a PACKET UPLINK ASSIGNMENT message	Packet Access in the cell no longer prohibited	assigned in message
T3174	On receipt of a PACKET CELL CHANGE ORDER message	On receipt of a response to CHANNEL REQUEST or PACKET CHANNEL REQUEST in the new cell	Return to old cell and send PACKET CELL CHANGE FAILURE	5 sec
T3176	Expiry of T3174	After sending of PACKET CELL CHANGE FAILURE message	Stop cell change order failure procedure.	5 sec
T3180	When transmitting an RLC/MAC block to the network	When detecting an assigned USF value on assigned PDCH	Perform Abnormal release with random access procedure	5 sec
T3182	After sending the last data block (with CV = 0), or Upon detecting a transmit window stall condition	On receipt of the PACKET UPLINK ACK/NACK message	Abnormal release with random access	5 sec

ETSI

**Table 108 (continued): Specification of timers used in GPRS on the Mobile Station side**

<b>timer</b>	<b>started</b>	<b>stopped</b>	<b>action at expiry</b>	<b>value</b>
T3184	On receipt of a PACKET UPLINK ACK/NACK message	On receipt of PACKET UPLINK ACK/NACK message (T3184 is also reset)	Abnormal release with random access	5 sec
T3186	At sending of a PACKET RESOURCE REQUEST message on the PACCH	On receipt of a Fixed Resource Assignment Message or Packet Reject	Resend the PACKET RESOURCE REQUEST message	5 sec
T3188	If a new fixed allocation has been requested, when all data has been sent on the assigned allocation	On receipt of PACKET UPLINK ASSIGNMENT, or PACKET UPLINK ACK/NACK message containing a fixed allocation	Resend the last allocation request if it needs more data to complete the TBF	5 sec
T3190	At reception of the PACKET DOWNLINK ASSIGNMENT message	On receipt of data on the new resources	Abnormal release with return to CCCH or PCCCH	5 sec
T3192	At reception of the final RLC data block during downlink TBF, when no RLC data block retransmissions are requested	Restarted at reception of a repeated final RLC data block	Release the resources, stop monitoring the PDCHs, and begin to monitor the paging channel	5 sec
T3194	When leaving packet transfer mode and returning to packet idle mode in non-DRX mode	When leaving packet idle mode in non-DRX mode and going back to packet transfer mode	Return to DRX mode	3 sec
T3198	When transmitting RLC data block	none	Accept negative acknowledgement for RLC data block	see clause 9.1.3

**T3160:** Wait for Packet Uplink Assignment or Packet Queuing Notification or Packet Access Reject after first Packet Channel Request

This timer is used on the mobile station side to define when to stop waiting for a Packet Uplink Assignment, Packet Queuing Notification or Packet Access Reject and repeat the access procedure.

**T3162:** Wait for Packet Uplink Assignment after reception of Packet Queuing Notification or Packet Reject

This timer is used on the mobile station side after received Packet Queuing Notification or Packet Access Reject to define when to stop waiting for a Packet Immediate Assignment and repeat the access procedure.

**T3164:** Wait for Uplink State Flag After Assignment

This timer is used on the mobile station side to define when to stop waiting for the USF determining the assigned portion of the uplink channel and repeat the procedure for random access. In multislot operation, it is enough that the assigned USF is noted on one of the uplink PDCHs. This timer is not used by the half-duplex mobile when fixed allocations are assigned.

**T3166:** Wait for Packet Uplink ACK/NACK after sending of first data block

This timer is used on the mobile station side to define when to stop waiting for a Packet Uplink ACK/NACK after sending of the first data block.

**T3168:** Wait for Packet Uplink Assignment message

This timer is used on the mobile station side to define when to stop waiting for a Packet Uplink Assignment message after sending of a Packet Resource request message.

**T3170:** Wait for Packet Uplink Assignment after having done (M+1) Packet Channel Requests.

This timer is used on the mobile station side when having made M + 1 attempts to send a Packet Channel Request. At expiry of timer T3170, the Packet Uplink Assignment procedure is aborted.

ETSI

- T3172:** Wait for Packet Uplink Assignment after Packet Access Reject message has been received.
- This timer is used on the mobile station side on receipt of a Packet Access Reject message corresponding to one of the mobile station's 3 last Packet Channel Request messages. If T3172 expires before receiving an assignment message, the mobile station returns to packet idle mode.
- After T3172 expiry packet Access is no longer prohibited in the cell but no Channel Request message shall be sent as a response to a page until a Paging Request message for the mobile station is received.
- T3174:** Wait for response on new cell after Packet Cell Change Order .
- This timer is used on the mobile station side on receipt of a PACKET CELL CHANGE ORDER message. The timer is stopped upon successful access on the new cell. On expiry, the mobile station returns to the old cell and send PACKET CELL CHANGE FAILURE message.
- T3176:** Stop Cell Change failure procedure .
- This timer started when T3174 expires.. The timer is stopped upon transmission of the PACKET CELL CHANGE FAILURE message. On expiry, the mobile station stops attempting to send the PACKET CELL CHANGE FAILURE message.
- T3180:** Wait for Uplink State Flag After Data Block
- This timer is used on the mobile station side to define when to stop waiting for the USF determining the assigned portion of the uplink channel after the pervious RLC/MAC block is sent. In multislot operation, it is enough that the assigned USF is noted on one of the uplink PDCHs. If expired, the mobile station repeats the procedure for random access. This timer does not apply to fixed allocation transfers.
- T3182:** Wait for Acknowledgement
- This timer is used on the mobile station side to define when to stop waiting for temporary Packet Uplink Ack/Nack after the last RLC data block has been sent for the current send window or for the entire Temporary Block Flow.
- T3184:** No Ack/Nack Received
- This timer is used on the mobile station side to decide when to stop waiting for a Packet Uplink Ack/Nack. (This timer does not apply to mobiles performing a dynamic allocation transfer).
- T3186:** Wait for Allocation Response
- This array of 4 timers is used on the mobile station side to decide when to stop waiting for a response to an in-band resource request. (This timer does not apply to a mobile performing a dynamic allocation transfer).
- T3188:** Allocation Exhausted
- This timer is used on the mobile station side to decide when to stop waiting to receive additional resources from the network. (This timer does not apply to a mobile performing a dynamic allocation transfer).
- T3190:** Wait for Valid Downlink Data Received from the Network
- This timer is used on the mobile station side to stop waiting for the valid data from the network side either following the initial Packet Downlink Assignment or after some previous downlink RLC/MAC block.
- T3192:** Wait for release of the TBF after reception of the final block

This timer is used on the mobile station side when the mobile station has received all of the RLC data blocks. When timer T3192 expires the mobile station shall release the resources associated with the TBF (e.g., USF bits, TFI) and begin to monitor its paging channel.

**T3194:** Non DRX mode in Packet Idle Mode

T3194 is used by the mobile station if a non-DRX timer has been negotiated with the network in the GPRS Attach procedure. T3194 is started when the mobile station leaves packet transfer mode and enters packet idle mode. When T3194 expires, the mobile station enters DRX state.

**T3196:** Wait for Suspend Notification (This section is removed by CR A022r1)

T3196 is used by the mobile station to stop waiting for PACKET SUSPEND NOTIFICATION. T3196 is started when the mobile station sends a request for suspend in a PACKET DOWNLINK ACK/NACK. When T3196 expires, the mobile station resends the request for suspend in next Packet DL ack/nack. )

**T3198:** RLC timer

T3198 is an array of 64 timers used by the mobile station to control when it will accept a negative acknowledgement for an RLC data block.

## 13.2 Timers on the network side

**Table 109: Specification of timers used in GPRS on the Network side**

timer	started	stopped	action at expiry	typical value
T3169	If counter N3101 = N3101_MAX, or if counter N3103 = N3103_MAX	none	The network releases USF and TFI resources.	5 sec
T3191	When the last RLC data block is sent	When the final PACKET DOWNLINK ACK/NACK is received	The network releases USF and TFI resources.	10 sec

**T3169:** Wait for Reuse of USF and TFI after the mobile station uplink assignment is invalid

This timer is used on the network side to define when the current uplink assignment is surely invalid on the mobile station side so that the assigned USF(s) and TFI can be reused on the uplink. During that period the corresponding USF(s) is not broadcast. The value for T3169 is > T3180.

Its value is network dependent.

**T3191:** Wait for reuse of USF and TFI after sending of the last RLC Data Block

This timer is used on the network side to define when the current assignment is surely invalid on the mobile station side so that the USF(s) and TFI can be reused.

Its value is network dependent.

## 13.3 Counters on the Mobile Station side

**N3100:** This counter is used by the mobile station to count the number of outstanding PACKET RESOURCE REQUEST messages sent while in fixed allocation mode.

**N3102** At each cell reselection the mobile station shall set the counter N3102 to the value defined by the optional broadcast parameter PAN\_MAX. Whenever the mobile station receives a Packet Ack/Nack that allows the advancement of V(S), the mobile station shall increment N3102 by the broadcast value PAN\_INC, however N3102 shall never exceed the value PAN\_MAX. Each time T3182 expires the mobile station shall decrement N3102 by the broadcast value PAN\_DEC. When  $N3102 \leq 0$  is reached, the mobile station shall perform an abnormal release with cell re-selection.

**N3104** When the mobile station sends the first RLC/MAC block the counter N3104 shall be initialized to 1. For each new RLC/MAC block the mobile station sends it shall increment N3104 by 1 until the first correct PACKET UPLINK ACK/NACK message is received. Then N3104 shall not be further incremented. If the N3104 counter is greater than N3104\_MAX the contention resolution may have failed and the mobile station shall immediately stop transmitting on the assigned TBF.

N3104\_MAX shall have the value:

$N3104\_MAX = 3 * BS\_CV\_MAX * \text{number of uplink timeslots assigned.}$

## 13.4 Counters on the Network side

**N3101:** When the network after setting USF, receives a valid data block from the mobile station, it will reset counter N3101. The network will increment counter N3101 for each USF for which no data is received. N3101max shall be greater than 8.

**N3103:** If the network does not receive the PACKET CONTROL ACKNOWLEDGEMENT message in the scheduled block, it shall set and increment counter N3103 and retransmit the PACKET UPLINK ACK/NACK message. If counter N3103 exceeds its limit, the network shall start timer T3169.

---

## Annex A (informative): Bibliography

- 1) ITU-T I.130, Method for the Characterization of Telecommunication Services Supported by an ISDN
- 2) ITU-T Q.65, Stage 2 of the Method for Characterization of the Services Supported by an ISDN
- 3) DIS 8886, OSI Data Link Service Definition
- 4) DIS 10022, OSI Physical Service Definition
- 5) ISO 10039, Medium Access Control Service Definition
- 6) ISO 4335, HDLC Procedures
- 7) ISO 7478, Multilink Procedures
- 8) ISO 7498, OSI Basic Reference Model and Layer Service Conventions

# Annex B (informative): RLC data block encoding

## B.1 Example 1

Figure B.1 provides an example of the use of the Length indicator in conjunction with the M and E bits. In the example, LLC frame 1 continues from a previous RLC data block and ends in the RLC data block shown. LLC frame 2 follows LLC frame 1 and is completely contained within the RLC data block. LLC frame 3 follows LLC frame 2, beginning in the RLC data block shown, and continues into the next RLC data block.

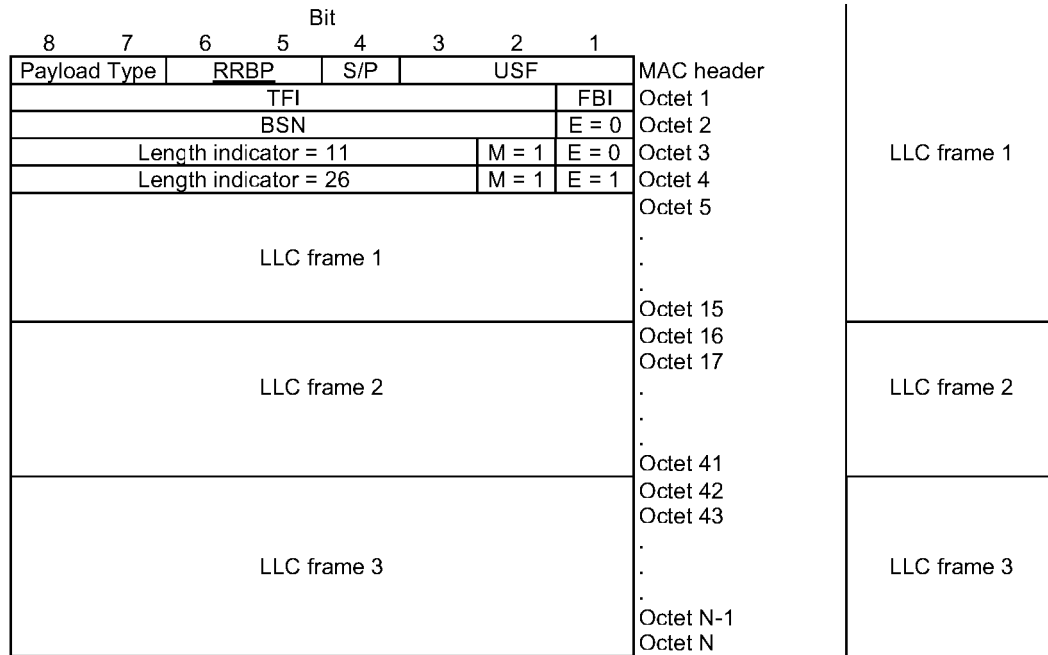

Figure B.1: Length indicator (LI) example



## B.2 Example 2

Figure B.2 provides an example of the use of the Length indicator when the end of an LLC frame fits within an RLC/MAC data block but the addition of the length indicator octet (to indicate the LLC frame boundary) causes the LLC frame to extend into another RLC/MAC data block. In the example, LLC frame 1 continues from a previous RLC data block and has 20 remaining octets. The first 19 octets are placed into RLC/MAC data block N, the Length Indicator is set to 0 (to indicate that the LLC frame does not end within the current RLC/MAC data block), and the 20<sup>th</sup> octet is placed in RLC/MAC data block N+1.

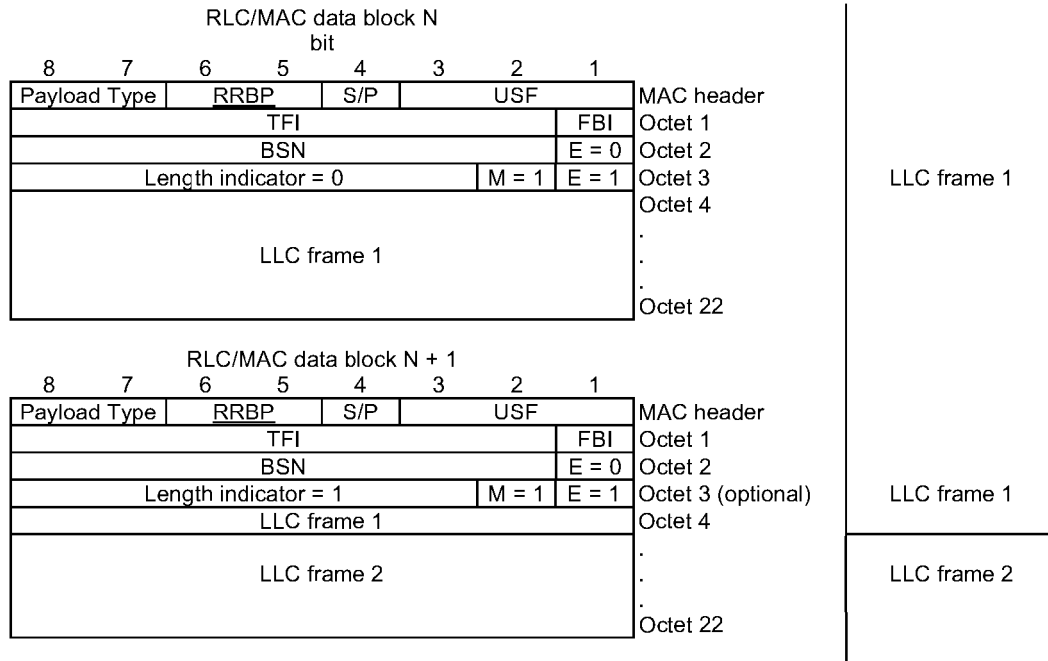

Figure B.2: Length indicator (LI) example

# Annex C (informative): Message Sequence Diagrams

The following figures illustrate message sequences for:

- one phase mobile originated access (figure C.1); and
- network originated access (figure C.2).

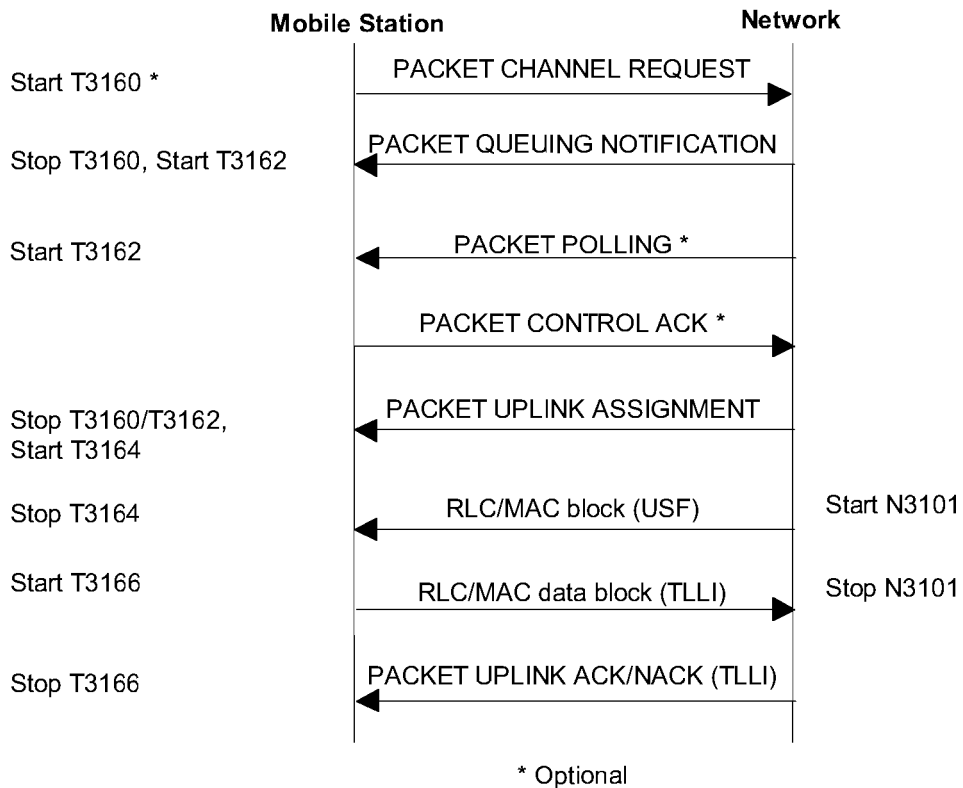

Figure C.1: Message Sequence Diagram for one phase packet access

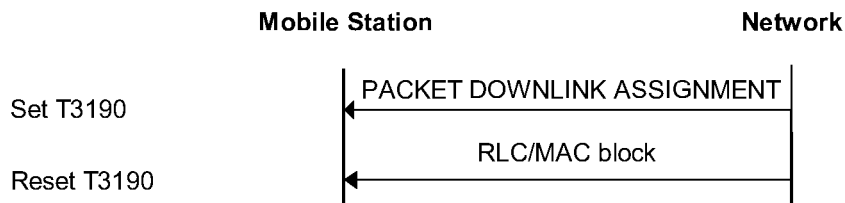
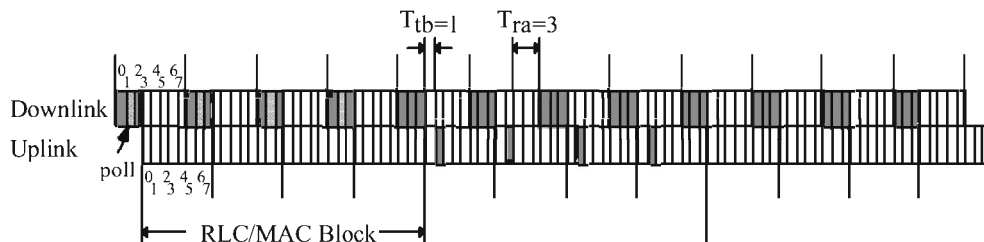

Figure C.2: TBF establishment initiated by the network

## Annex D (informative): Examples of Fixed Allocation Timeslot Assignment

This annex presents several examples of the timeslot assignments possible when using the fixed allocation medium access mechanism. The timing of mobile station neighbour cell power measurements and mobile station requirements for monitoring for downlink PACCH are pointed out.

Figure D.1 shows a multislot class 4 mobile station assigned a 3 timeslot downlink TBF and no uplink TBF. In this example the PACKET DOWNLINK ASSIGNMENT message does not assign Measurement Mapping parameters to the mobile station, therefore the mobile station is required to make a neighbour cell power measurement in 24 of every 26 TDMA frames. Note that in all TDMA frames the  $T_{ra}$  parameter is met and thus the mobile station is able to make a neighbour cell power measurement in every frame. In the first RLC/MAC block of the example, the mobile station is polled on timeslot 1 with  $RRBP = 0$ . In the second RLC/MAC block the mobile station responds to the poll by transmitting on timeslot 1. This transmission on timeslot 1 obeys the  $T_{tb}$  and  $T_{ra}$  parameters of multislot class 4 without any downlink timeslots being omitted.



**Figure D.1: Multislot Class 4 ( $R_x=3$ ,  $T_x=1$ ,  $Sum=4$ ), 3 timeslot downlink TBF, with a poll on timeslot 1 (the natural timeslot)**

Figure D.2 shows a multislot class 4 mobile station assigned a 3 timeslot downlink TBF and no uplink TBF. In this example the PACKET DOWNLINK ASSIGNMENT message does not assign Measurement Mapping parameters to the mobile station, therefore the mobile station is required to make a neighbour cell power measurement in 24 of every 26 TDMA frames. Note that in all TDMA frames the  $T_{ra}$  parameter is met and thus the mobile station is able to make a neighbour cell power measurement in every frame. In the first RLC/MAC block of the example, the mobile station is polled on timeslot 0 with  $RRBP = 0$ . In the second RLC/MAC block the mobile station responds to the poll by transmitting on timeslot 0. This transmission on timeslot 0 does not obey the  $T_{tb}$  and  $T_{ra}$  parameters of multislot class 4, therefore both the mobile station and the network must omit downlink timeslot 2 in RLC/MAC block 2.

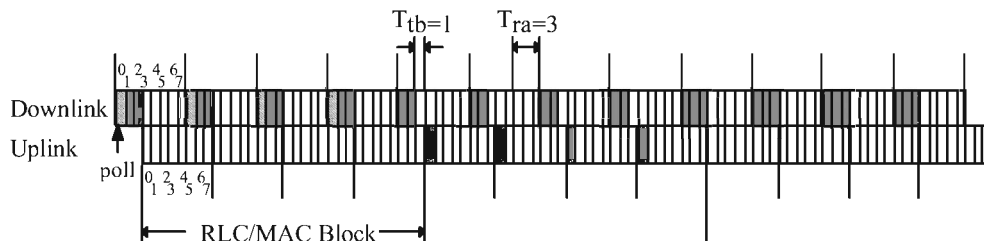

**Figure D.2: Multislot Class 4 ( $R_x=3$ ,  $T_x=1$ ,  $Sum=4$ ), 3 timeslot downlink TBF, with a poll on timeslot 0**

Figure D.3 shows a multislot class 4 mobile station assigned a 3 timeslot downlink TBF and no uplink TBF. In this example the PACKET DOWNLINK ASSIGNMENT message does not assign Measurement Mapping parameters to the mobile station, therefore the mobile station is required to make a neighbour cell power measurement in 24 of every 26 TDMA frames. Note that in all TDMA frames the  $T_{ra}$  parameter is met and thus the mobile station is able to make a neighbour cell power measurement in every frame. In the first RLC/MAC block of the example, the mobile station is polled on timeslot 2 with  $RRBP = 0$ . In the second RLC/MAC block the mobile station responds to the poll by transmitting on timeslot 2. This transmission on timeslot 2 does not obey the  $T_{tb}$  and  $T_{ra}$  parameters of multislot class 4, therefore both the mobile station and the network must omit downlink timeslot 0 in RLC/MAC block 2.

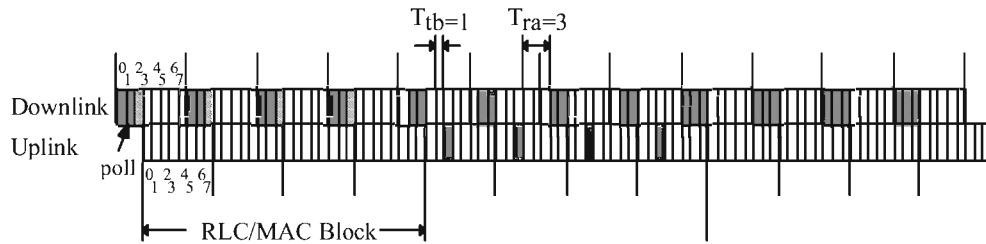

**Figure D.3: Multislot Class 4 (Rx=3, Tx=1, Sum=4), 3 timeslot downlink TBF, with a poll on timeslot 2**

Figure D.4 shows a multislot class 4 mobile station assigned a 3 timeslot downlink TBF and a 1 timeslot uplink TBF. In this example the PACKET DOWNLINK ASSIGNMENT message does not assign Measurement Mapping parameters to the mobile station, therefore the mobile station is required to make a neighbour cell power measurement in 24 of every 26 TDMA frames. Note that in all TDMA frames the  $T_{ra}$  parameter is met and thus the mobile station is able to make a neighbour cell power measurement in every frame. In the first RLC/MAC block of the example, the mobile station is polled on timeslot 2 with  $RRBP = 0$ . In the second RLC/MAC block the mobile station responds to the poll by transmitting on timeslot 2. This transmission on timeslot 2 does not obey the  $T_{tb}$  and  $T_{ra}$  parameters of multislot class 4, therefore both the mobile station and the network must omit downlink timeslot 0 in RLC/MAC block 2.

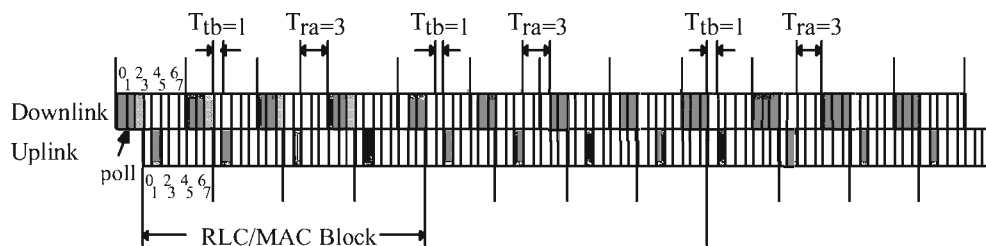

**Figure D.4: Multislot Class 4 (Rx=3, Tx=1, Sum=4), 3 timeslot downlink TBF and a 1 timeslot uplink TBF, with a poll on timeslot 2**

Figure D.5 shows a multislot class 3 mobile station assigned a 2 timeslot uplink TBF and no uplink TBF. Note that in all TDMA frames the  $T_{ra}$  parameter is met and thus the mobile station is able to required a neighbour cell power measurement in every frame. Note that the  $T_{tb}$  and  $T_{ra}$  parameters of multislot class 3 require the mobile station to monitor timeslot 0 for downlink PACCH in every TDMA frame.

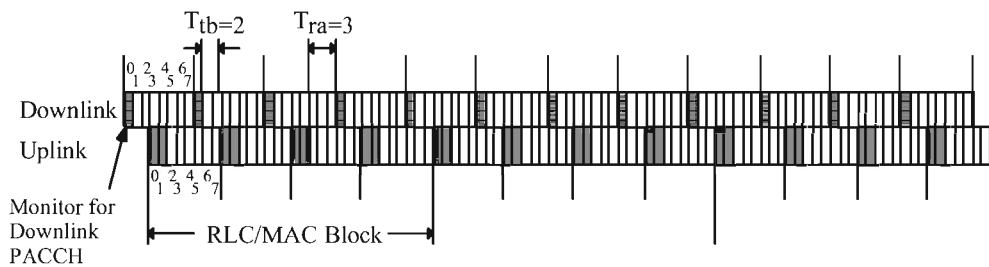

**Figure D.5: Multislot Class 3 (Rx=2, Tx=2, Sum=3), 2 timeslot uplink TBF**

Figure D.6 shows a multislot class 3 mobile station assigned a 2 timeslot uplink TBF and no downlink TBF. Note that in all TDMA frames the  $T_{ra}$  parameter is met and thus the mobile station is required to make a neighbour cell power measurement in every frame. In the second RLC/MAC block of the example, the fixed allocation bitmap does not allocate timeslot 0 to the mobile station. Note that the  $T_{tb}$  and  $T_{ra}$  parameters of multislot class 3 require the mobile station to monitor timeslot 0 and timeslot 1 for downlink PACCH in RLC/MAC block 2.

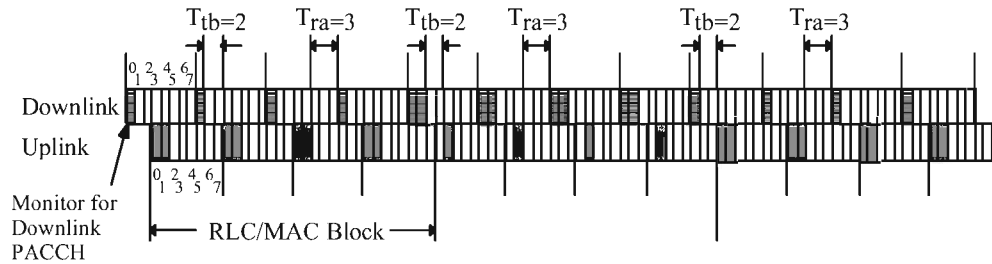

**Figure D.6: Multislot Class 3 (Rx=2, Tx=2,Sum=3), 2 timeslot uplink TBF, the first uplink timeslot in the second block is not allocated in the Allocation Bitmap**

Figure D.7 shows a multislot class 3 mobile station assigned a 2 timeslot uplink TBF and no downlink TBF. Note that in all TDMA frames the  $T_{ra}$  parameter is met and thus the mobile station is required to make a neighbour cell power measurement in every frame. In the second RLC/MAC block of the example, the fixed allocation bitmap does not allocate timeslot 0 or timeslot 1 to the mobile station. Note that the  $T_{tb}$  and  $T_{ra}$  parameters of multislot class 3 require the mobile station to monitor timeslot 0 and timeslot 1 for downlink PACCH in RLC/MAC block 2.

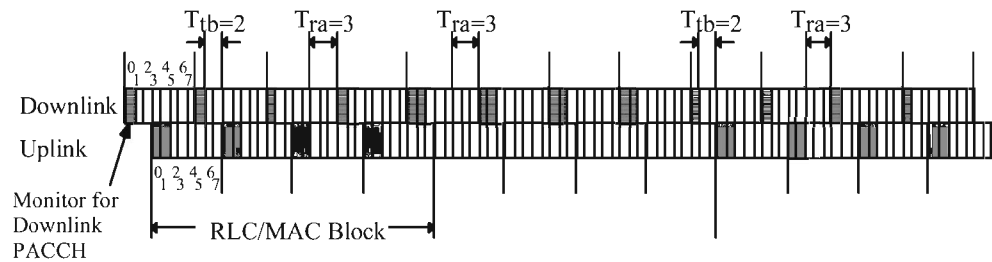

**Figure D.7: Multislot Class 3 (Rx=2, Tx=2,Sum=3), 2 timeslot uplink TBF, both uplink timeslots in the second block are not allocated in the Allocation Bitmap**

Figure D.8 shows a multislot class 13 mobile station, capable of transmitting and receiving simultaneously, assigned a 3 timeslot downlink TBF and a 3 timeslot uplink TBF. In this example the PACKET DOWNLINK ASSIGNMENT message does not assign Measurement Mapping parameters to the mobile station, therefore the mobile station is required to make a neighbour cell power measurement in 24 of every 26 TDMA frames. Note that in all TDMA frames the  $T_{ra}$  parameter is met and thus the mobile station is required to make a neighbour cell power measurement in every frame. Note also that the  $T_{tb}$  and  $T_{ra}$  parameters of multislot class 13 allow non-adjacent timeslots to be used in either the uplink or the downlink.

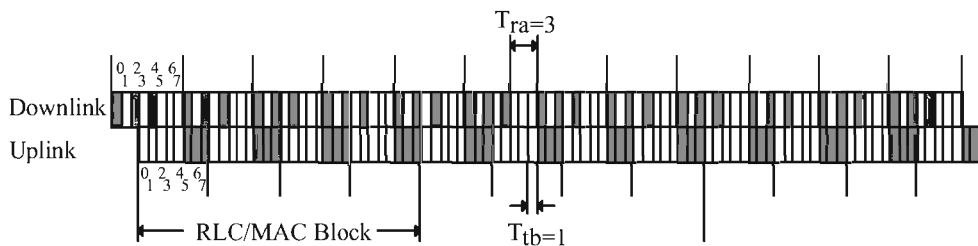

**Figure D. 8: Multislot Class 13 (Rx=3, Tx=3,Sum=NA), 3 timeslot downlink TBF, 3 timeslot uplink TBF**

Figure D.9 shows a multislot class 13 mobile station assigned a 3 timeslot downlink TBF and a 3 timeslot uplink TBF. In this example the PACKET DOWNLINK ASSIGNMENT message does not assign Measurement Mapping parameters to the mobile station, therefore the mobile station is required to make a neighbour cell power measurement in 24 of every 26 TDMA frames. Note that in all TDMA frames the  $T_{ra}$  parameter is met and thus the mobile station is able to make a neighbour cell power measurement in every frame. In the first RLC/MAC block of the example, the mobile station is polled on timeslot 2 with  $RRBP = 0$ . In the second RLC/MAC block the mobile station responds to the poll by transmitting on timeslot 2. This transmission on timeslot 2 would force the mobile station to exceed its maximum

number of Tx timeslots during RLC/MAC block 2, therefore both the mobile station and the network must omit uplink timeslot 7 in that block.

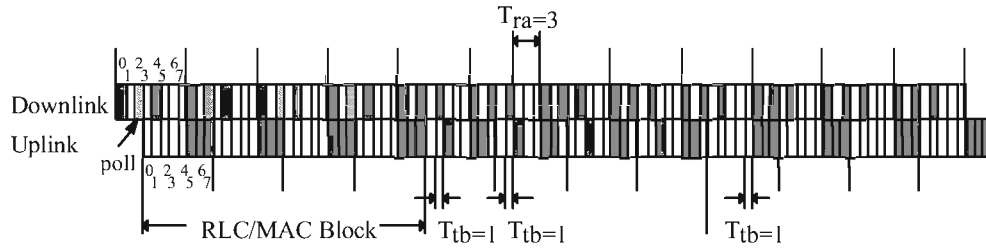

**Figure D.9: Multislot Class 13 (Rx=3, Tx=3, Sum=NA), 3 timeslot downlink TBF, 3 timeslot uplink TBF, poll on timeslot 2**

Figure D.10 shows a multislot class 21 mobile station assigned a 6 timeslot downlink TBF and no uplink TBF. In this example the PACKET DOWNLINK ASSIGNMENT message does not assign Measurement Mapping parameters to the mobile station, therefore the mobile station is required to make a neighbour cell power measurement in 24 of every 26 TDMA frames. Note that in all TDMA frames the  $T_{ra}$  parameter is met and thus the mobile station is able to make a neighbour cell power measurement in every frame. In the first RLC/MAC block of the example, the mobile station is polled on timeslot 2 with  $RRBP = 0$ . In the second RLC/MAC block the mobile station responds to the poll by transmitting on timeslot 2. This transmission on timeslot 2 does not obey the  $T_{tb}$  and  $T_{ra}$  parameters of multislot class 21, therefore both the mobile station and the network must omit downlink timeslots 4 and 5 in RLC/MAC block 2.

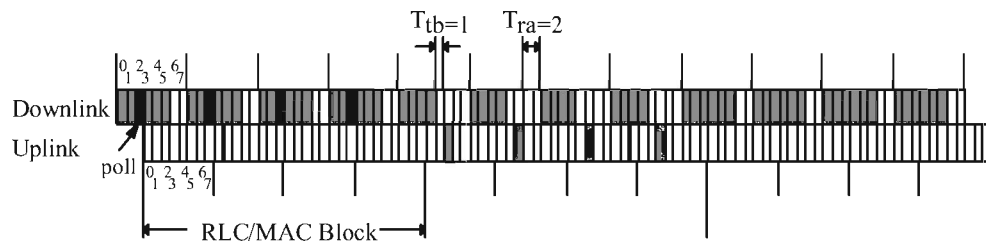

**Figure D.10: Multislot Class 21 (Rx=6, Tx=4, Sum=NA), 6 timeslot downlink TBF, no measurement blocks assigned, poll on timeslot 2**

Figure D.11 shows a multislot class 21 mobile station assigned a 6 timeslot downlink TBF and no uplink TBF. In this example the PACKET DOWNLINK ASSIGNMENT message does not assign Measurement Mapping parameters to the mobile station, therefore the mobile station is required to make a neighbour cell power measurement in 24 of every 26 TDMA frames. Note that in all TDMA frames the  $T_{ra}$  parameter is met and thus the mobile station is able to make a neighbour cell power measurement in every frame. In the first RLC/MAC block of the example, the mobile station is polled on timeslot 0 with  $RRBP = 0$ . In the second RLC/MAC block the mobile station responds to the poll by transmitting on timeslot 0. This transmission on timeslot 0 does not obey the  $T_{tb}$  and  $T_{ra}$  parameters of multislot class 21, therefore both the mobile station and the network must omit downlink timeslots 2, 3, 4 and 5 in RLC/MAC block 2.

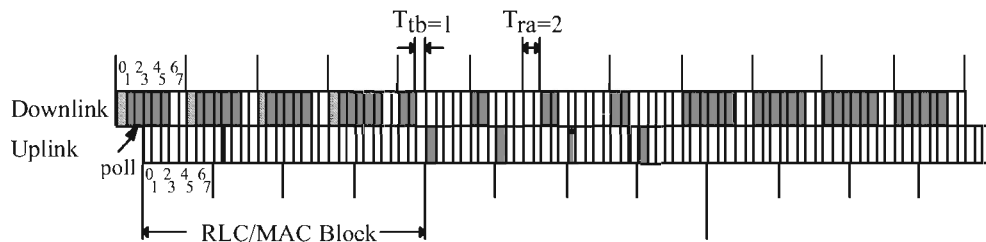

**Figure D.11: Multislot Class 21 (Rx=6, Tx=4, Sum=NA), 6 timeslot downlink TBF, no measurement blocks assigned, poll on timeslot 0**

Figure D.12 shows a multislot class 21 mobile station assigned a 4 timeslot uplink TBF and no downlink TBF. Note that in all TDMA frames the  $T_{ra}$  parameter is met and thus the mobile station is required to make a neighbour cell power measurement in every frame. Note also that the timeslot configuration and the  $T_{tb}$  and  $T_{ra}$  parameters of multislot class 21 require the mobile station to monitor timeslot 1 for downlink PACCH in every TDMA frame.

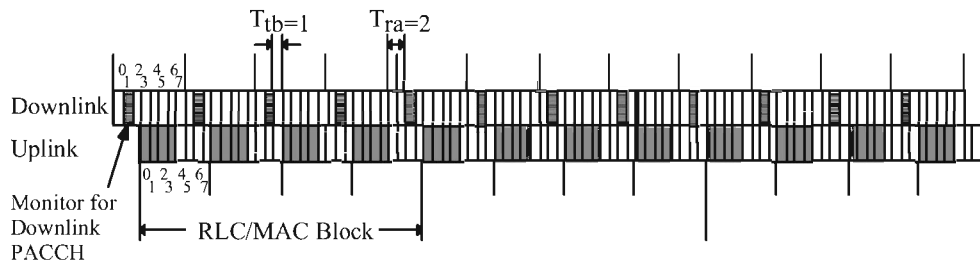

**Figure D.12: Multislot Class 21 (Rx=6, Tx=4, Sum=NA), 4 timeslot uplink TBF**

Figure D.13 shows a multislot class 21 mobile station assigned a 4 timeslot uplink TBF and no downlink TBF. Note that in all TDMA frames the  $T_{ra}$  parameter is met and thus the mobile station is required to make a neighbour cell power measurement in every frame. Note also that the timeslot configuration and the  $T_{tb}$  and  $T_{ra}$  parameters of multislot class 21 require the mobile station to monitor timeslot 1 for downlink PACCH in every TDMA frame. In the second RLC/MAC block of the example, the fixed allocation bitmap does not allocate timeslot 0 to the mobile station. Note that the  $T_{tb}$  and  $T_{ra}$  parameters of multislot class 3 require the mobile station to monitor timeslot 2 in addition to timeslot 1 for downlink PACCH in RLC/MAC block 2.

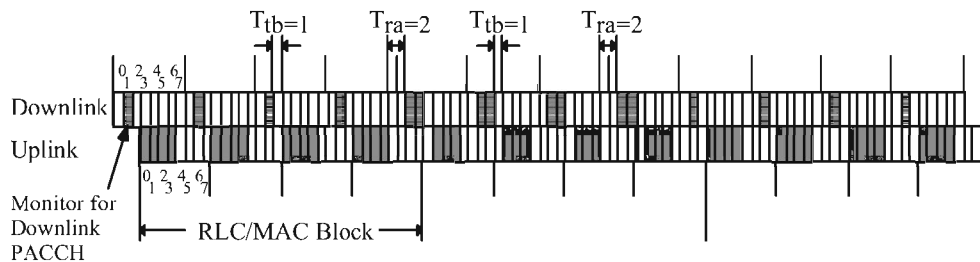

**Figure D.13: Multislot Class 21 (Rx=6, Tx=4, Sum=NA), 4 timeslot uplink TBF, extra PACCH opportunity**

Figure D.14 shows a multislot class 21 mobile station assigned a 4 timeslot uplink TBF and no downlink TBF. Note that in many TDMA frames the  $T_{ra}$  parameter is not met and thus the mobile station is not able to make a neighbour cell power measurement in every frame. In the second RLC/MAC block of the example, the fixed allocation bitmap does not allocate timeslot 2 and timeslot 4 to the mobile station. Note that the  $T_{tb}$  and  $T_{ra}$  parameters of multislot class 3 require the mobile station to monitor timeslot 6 for downlink PACCH in RLC/MAC block 2. Note also that the  $T_{ra}$  parameter requires the mobile station to make a neighbour cell power measurement in each TDMA of RLC/MAC block 2.

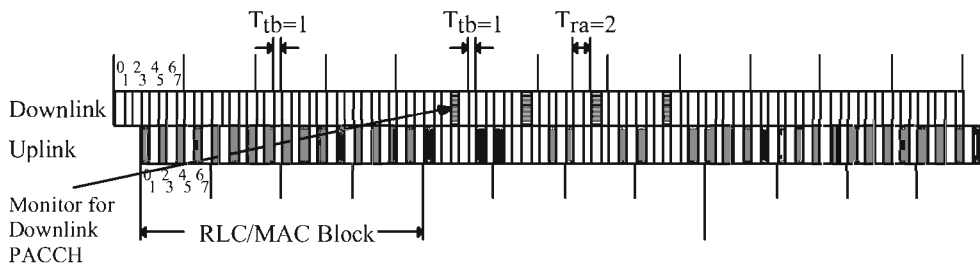

**Figure D.14: Multislot Class 21 (Rx=6, Tx=4, Sum=NA), 4 timeslot uplink TBF, with a PACCH opportunity due to a gap in Fixed Allocation**

Figure D.15 shows a multislot class 21 mobile station assigned a 4 timeslot uplink TBF and no downlink TBF. In the second RLC/MAC block of the example, the mobile station transitions to an assignment consisting of a 6 timeslot downlink TBF and no uplink TBF. Note that the transition occurs when the mobile station has exhausted its current fixed allocation. Note that the  $T_{rb}$  parameter is used to define the gap between Tx and Rx because an adjacent cell power measurement is not required during the gap.

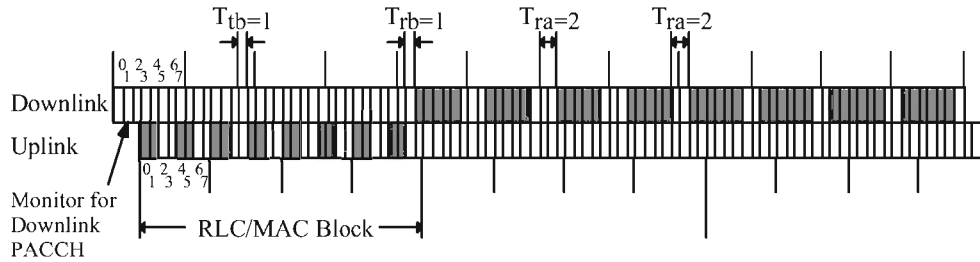

**Figure D.15: Multislot Class 21 (Rx=6, Tx=4, Sum=NA), 4 timeslot uplink TBF, with a transition to a 6 timeslot downlink timeslot**

Figure D.16 shows a multislot class 21 mobile station assigned a 6 timeslot downlink TBF and no uplink TBF. In the second RLC/MAC block of the example, the mobile station has been assigned a 2 timeslot Measurement Mapping block. Note that the  $T_{ra}$  parameter does not apply because the Measurement Capabilities takes precedence when the mobile station has been assigned Measurement Mapping parameters. Note also that a gap of three timeslot is created even though the mobile station omitted decoding of only 2 radio blocks. The mobile station is required to perform neighbour cell power measurements in all 3 timeslots of the 4 gaps.

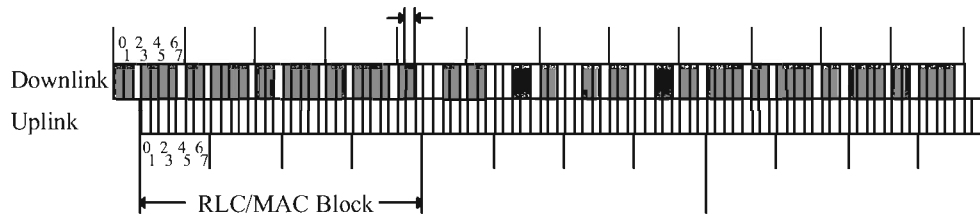
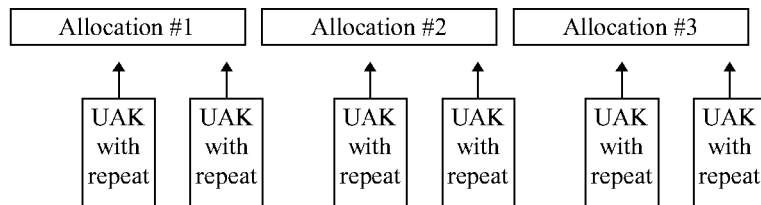

**Figure D.16: Multislot Class 21 (Rx=6, Tx=4, Sum=NA), 6 timeslot downlink TBF, no uplink TBF, with a 2 timeslot Measurement Mapping block**



## Annex E (informative): Repeated Fixed Allocations

The following figures illustrate some of the procedures for repeated fixed allocations.



**Figure E.1 Repeated Fixed Allocation**

Figure E.1 shows the normal procedures for repeated allocation. During allocation #1, the mobile has decoded two uplink ack/nack messages each indicating that the bitmap should repeat. At the end of allocation #1, the mobile station shall automatically repeat the bitmap and start allocation #2.

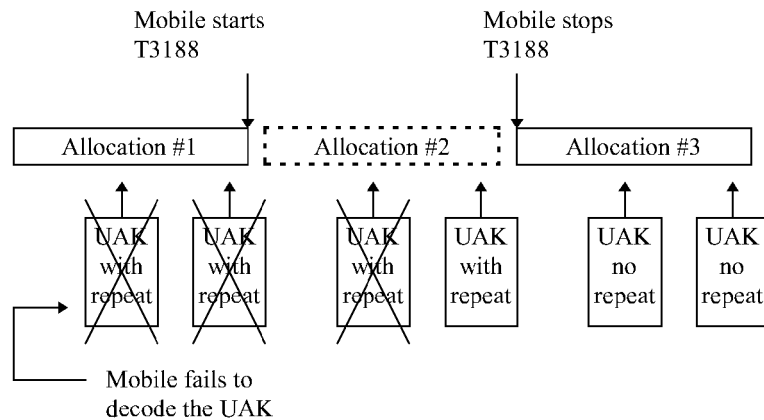

**Figure E.2 Repeated Fixed Allocation with Missed ACK**

Figure E.2 illustrates the mobile station's behaviour when it fails to decode any uplink ack/nack messages indicating that it should repeat. When allocation #1 ends, the mobile will stop transmitting at the end of its allocation. It will start timer T3188 and wait to receive either an assignment or an uplink ack/nack. When it receives an uplink ack/nack with repeat, it shall wait for the next allocation boundary to begin transmitting. In this example, the uplink ack/nack that it receives in allocation #2 also indicates that it should repeat. Therefore, the mobile station shall repeat a third allocation.

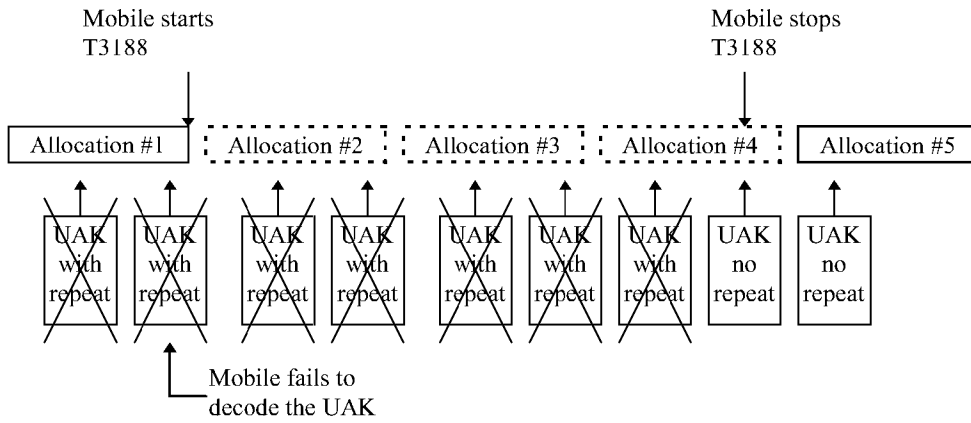

**Figure E.3 Multiple Missed Uplink Ack/Nacks**

In Figure E.3 the mobile station has missed many allocation periods. The mobile station keeps track of where each allocation would have started and when it receives an uplink ack/nack, it shall continue transmitting using the repeated allocation at the next natural allocation boundary..

---

## Annex F (informative): Document change History

Document history		
Date	Status	Comments
17 March 1998	6.0.0	Approved at SMG#25 (not for Publication)
16 July 1998	6.1.0	Incorporated CRs approved by SMG#26: A001r1, A002r2, A003, A004r2, A005, A006r2, A007, A009, A0010, A011r2, A012, A014, A015r1, A016r1, A017r1, A018, A019r1, A020r1, A021r2, A022r1, A024r3, A026r1, A027r2, A028, A029r2

---

## History

Document history		
V6.1.0	August 1998	Public Enquiry PE 9851: 1998-08-21 to 1998-12-18