

A Mobile Base Station Phased Array Antenna

C. Alakija and S.P. Stapleton
School of Engineering Science
Simon Fraser University
Burnaby, BC, Canada

ABSTRACT

A mobile communications base station antenna, which utilizes a cylindrical array design, is presented. A scanning antenna beam can be achieved by arranging a number of travelling wave patch antennas in a cylindrical array configuration. Using a switching matrix, different subsets of antenna elements, in the array, can be excited, thus producing a narrow steerable beam. Narrow scanning beams allow these base station antennas to retain both the high gain characteristic of directional antennas as well as the multidirectional characteristic of omnidirectional antennas. For a given transmit power such base station antennas can broadcast greater distances than omnidirectional base station antennas, while still being able to communicate with users in a 360° radius (at different time intervals). An alternative perspective is that scanning antennas can be placed in much closer proximity than omnidirectional antennas with the same co-channel interference. This decrease in cell size means that a larger number of mobile users can be concentrated in a smaller area without increasing spectrum allocation.

INTRODUCTION

In recent years the need for adaptive antennas in mobile communication systems has been steadily growing. High system capacity requirements make issues such as spectral efficiency and frequency reuse extremely important in the field of mobile communications. Co-channel interference limits the capacity achievable in present day systems.

In cellular systems, frequency reuse is accomplished by dividing coverage areas into cells. Frequencies are then allocated to each cell in a way that no two adjacent cells use the same frequencies. Further frequency reuse can be accomplished by dividing each cell into sectors. However, sectorization has disadvantages in terms of antenna cost and mounting costs. Furthermore, the hardware associated with sectorization may not be used efficiently due to the variable nature of system loading and the fixed nature of sector antennas. If base-station antennas exist which have variable beam directions and widths, then sector sizes can be dynamically adapted to accommodate the users in them.

In mobile communication systems with light or moderate loading, issues other than throughput may be of prime concern. Some mobile communication systems may be allocated only a single channel making sectorization impossible. In this case it may be desirable to increase the coverage radius and/or reduce the transmit power of the base station. A base station antenna that has a high gain and is steerable can be used to accomplish these goals. High gain means that transmitted power

levels can be reduced without any degradation of received signal strength. This is a great advantage for portable units since using lower portable transmit power translates to longer battery life and simpler RF hardware design.

In digital mobile networks, in Figure 1, this scanning beam antenna can be used to realize improved performance in throughput.

Since the gain of this antenna is higher than that for an omnidirectional antenna, the mobile sites can be located further away or alternatively the transmit power can be reduced for the same coverage area. The beam scans rapidly until it locates a mobile user requesting to transmit and then it locks on to that user so data transmission can occur. Locking can occur by constantly monitoring the power level at ± 1 beamwidth. At this time, mobile stations transmitting from other directions are blocked, reducing network collisions. Once the call is complete, the beam then continues scanning looking for other users.

Reduced co-channel interference is also an advantage obtained. Due to the directionality of the base station antenna beam, there is less co-channel interference power received from other the base stations. This means that base stations can be placed in closer proximity to one another resulting in an increase in the number of users on the network.

An antenna which has a shaped beam in the vertical plane can also be used to realize advantages over omnidirectional antennas. Antennas, such as the dipole, have omnidirectional antenna patterns which waste power by radiating in directions where no users are present. By pattern shaping in the elevation plane, (Figure 2), the wasted power, being radiated upward and into the ground, can be reduced. Interference into adjacent cells could also be reduced. The increased gain realized by producing antennas with shaped beams would also mean that lower power levels could be used to transmit further distances.

SYSTEM DESCRIPTION

Cylindrical arrays have been utilized in the past for radar and beacon applications [1]. The topology for the scanning cylindrical array antenna is shown in Figure 3. The beam direction is chosen by applying power to a subset of elements on the appropriate side of the array (Figure 4). This is done by using an RF switching matrix to route power to the desired elements.

The proposed antenna system has three major sub-systems: the radiating elements, the beam forming feed and the switching matrix. A block diagram showing the major system components is shown in Figure 5. Another possible system configuration is shown in Figure 6. By

combining a number of feed networks into a single antenna system, an antenna with multiple independently steerable beams is achieved.

TRAVELLING WAVE MICROSTRIP PATCH RADIATORS

The radiating elements chosen for the antenna array were rectangular microstrip patches [2]. Patches are desirable due to their low cost and their extremely low profile. They are inexpensive to manufacture and due to the use of printed circuit techniques in their production, the design is highly repeatable. Since they are low profile, they also can be shaped conformally to cylindrical surfaces. They are ideal elements to use in cylindrical arrays since they have low back radiation.

There are some problems with patch antennas which make their use somewhat less attractive. Power efficiency of a patch antenna is usually quite low since the radiation resistance is typically on the order of a few hundred ohms. Since a patch antenna behaves much like a cavity resonator, it has a narrow VSWR-bandwidth, typically in the order of 2%. Wider VSWR-bandwidths, in the order of 7%, can be obtained using travelling wave antennas.

One of the difficulties in making patch antenna arrays cost and power efficient is in coming up with suitable feed networks for the array. Corporate feeds are both lossy, space consuming and complex for shaped patterns. For this reason the travelling wave antenna is ideally suited for microstrip patch arrays. This type of antenna achieves the desired current distribution by varying the width and spacing of patches spaced along a microstrip feedline. It has been shown in [4] that the desired shaped antenna pattern can be obtained using a travelling wave patch array while at the same time maintaining good antenna power efficiency.

H-PLANE PATTERNS

The cylindrical shape of this antenna increases the difficulty in analyzing the far field radiation pattern analytically. To compensate for this difficulty, a program was written which plots the radiation pattern of a cylindrical array of patches with arbitrary element excitation. Selection of appropriate array parameters can be accomplished by relating the theory used for periodic linear arrays to the cylindrical array. The main parameters to vary are the array radius, the number of elements, and the magnitude and phase of the power radiated by the elements.

The geometry used to analyze a circular array [3] is shown in Figure 7. Assuming far-field conditions and linear polarization the radiation pattern from the array can be expressed by the following summation [3].

$$E_{\theta}(\theta, \phi) = \sum_{n=1}^N I_n SF'_n(\theta, \phi - \phi_n) e^{jka \sin \theta \cos(\phi - \phi_n)} \quad (1)$$

The term $SF'_n(\theta, \phi - \phi_n)$ takes into account the magnitude variations of each patch as a function of angle. The term I_n is a complex number representing the square-root-magnitude and phase, ζ , of the power to each patch. The propagation constant is represented as k .

The phase of the current distribution is chosen to compensate for the curvature of the cylinder. Figure 8 shows the geometries involved in calculating the phase distribution. Using simple geometry,

$$c = a - a \cos \phi_n \quad (2)$$

Any phase shift which is constant to all elements can be deleted with no change to the pattern. Therefore, the phase distribution should be

$$\zeta = -ka \cos \phi_n \quad (3)$$

A cosine amplitude distribution along the array surface was chosen in order to achieve a good tradeoff between beamwidth and sidelobe level. The chosen current distribution was found to give quite reasonable antenna patterns. This current distribution can however, be varied to cater to other pattern shapes. By altering the phase distribution, wider pattern beamwidths can be obtained. This characteristic can be used to add another dimension of flexibility to the antenna in terms of variable sector size. Figure 9 shows different patterns obtained by varying the phase distribution.

The number of elements needed for the array is mainly determined by the desired beamwidth and the scanning step size. The number of elements may also be adjusted to allow for switching matrix optimization. Since the radiators used do not produce much radiation past 90 degrees it is not useful to excite elements that are more than 90 degrees from boresight. Otherwise, back lobes may increase considerably which will interfere with adjacent cells. It was found that a 32 element cylindrical array in which 8 elements are excited at a time will achieve a 12 degree scanning step size and a 20 degree beamwidth. Calculations show that a narrower beam can be obtained by increasing the number of elements which are excited in the array (Figure 10).

In linear arrays, the optimum spacing for maximum directivity and no grating lobes is $\lambda/2$ [3]. For a cylindrical array a similar analogy can be made. If the problem is looked at geometrically, a circular-sector array in which the sector angle is small can be approximated as a linear array. So if the elements are spaced a distance of $\lambda/2$ then the cylinder radius, a , must be chosen so that

$$\frac{2\pi a}{N} = \frac{\lambda}{2} \quad (4)$$

$$a = \frac{\lambda}{2\phi_n} \quad (5)$$

Calculations show that this radius is indeed close to the optimum value. Figure 11 shows the antenna pattern for circular arrays with varying values of radius. For an 800 MHz antenna, (5) gives a radius value of 0.95m. The figure also shows that by making the radius slightly larger, the beamwidth becomes narrower at the cost of higher side lobes. Making the radius smaller reduces side lobe levels at the cost of a wider beamwidth.

CONCLUSIONS

The use of cylindrical array scanning antennas in the mobile communication field looks quite promising. The antenna can be used to realize advantages such as reduced portable transmit power, reduced co-channel interference, hardware savings, low manufacturing costs, low installation costs, and increased system capacity. Work is proceeding on the fabrication of a subset of the system.

REFERENCES

- [1] J.E. Boyns et-al, "Step-Scanned Circular-Array Antenna," *IEEE Trans. Antennas and Propagat*, Vol. AP-18, No. 5, pp. 590-596, Sept. 1970.
- [2] A.G. Demeryd, "Linearly Polarized Microstrip Antennas," *IEEE Trans. Antennas and Propagat*, Vol. AP-24, No. 6, pp. 846-851, Nov. 1976.
- [3] C.A.Balanis, *Antenna Theory*, New York:Harper & Row, 1982
- [4] C. Alakija, *A Power Efficient Pattern Synthesis Algorithm for Travelling Wave Microstrip Patch Antenna Arrays: Application to Mobile Base Station Antennas*, Masters Thesis, Simon Fraser University, 1991.

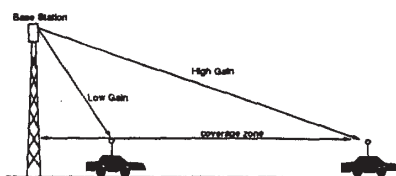

Figure 2: The need for elevation plane pattern shaping.

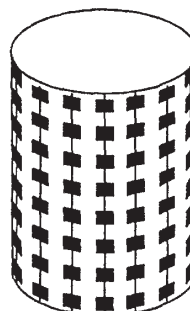

Figure 3: Cylindrical array of travelling wave patch antennas.

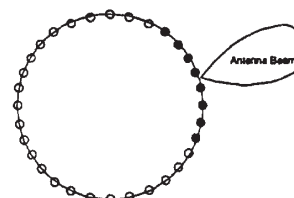

Figure 4: Sub element array excitation.

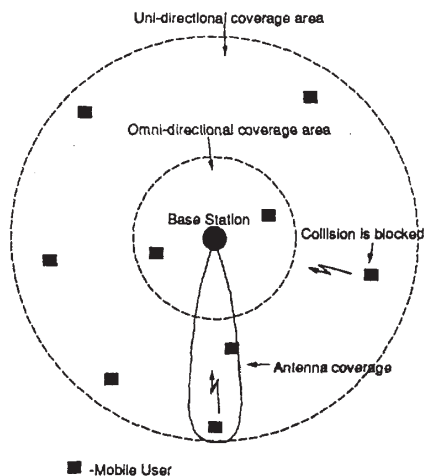

Figure 1: Digital communication system with scanning beam.

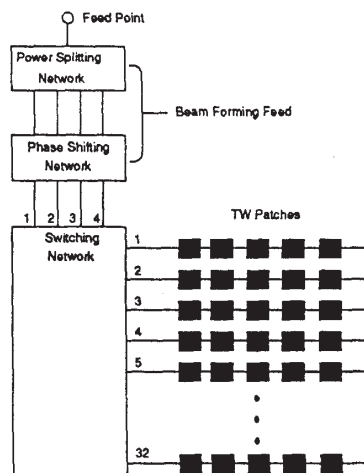

Figure 5: Scanning array system diagram.

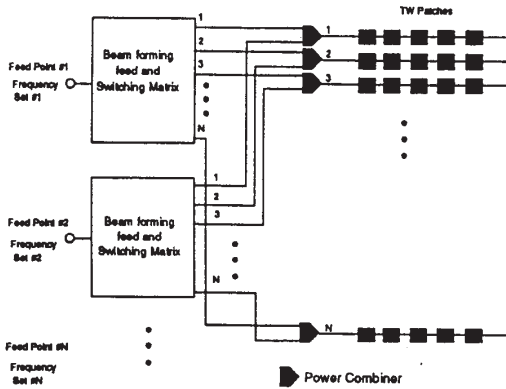

Figure 6: Scanning array with multiple beams.

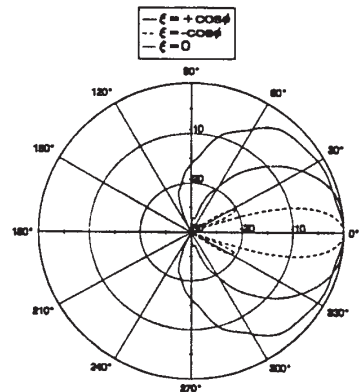

Figure 9: Simulated cylindrical array patterns with different phase distributions.

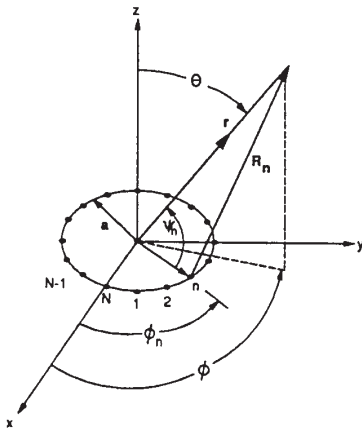

Figure 7: Circular array geometry.

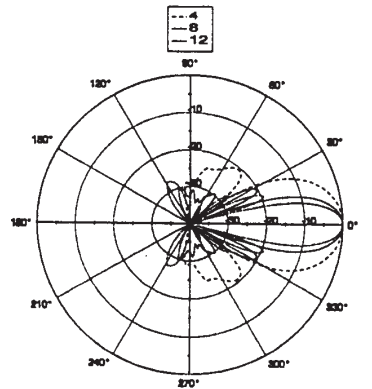

Figure 10: Patterns of a 32 element array with varying number of excited elements.

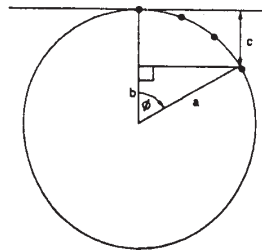

Figure 8: Geometry for calculating phase distribution.

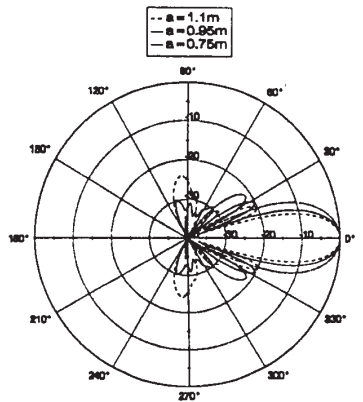

Figure 11: Antenna patterns versus array radius.