



US005590273A

United States Patent [19]

[11] Patent Number: **5,590,273**

Balbinot

[45] Date of Patent: **Dec. 31, 1996**

[54] **MICROCONTROLLER INTEGRATED CIRCUIT WITH READ ONLY MEMORY CONTAINING A GENERIC PROGRAM**

4,490,783	12/1984	McDonough et al.	364/200
4,641,308	2/1987	Sacarisen et al.	371/16
4,797,808	1/1989	Bellay et al. .	
5,157,781	10/1992	Harwood et al. .	
5,202,978	4/1993	Nozuyama	395/575

[75] Inventor: **Jean-Pierre Balbinot, Le Kremlin-Bicetre, France**

Primary Examiner—Robert W. Beausoliel, Jr.
Assistant Examiner—Norman M. Wright
Attorney, Agent, or Firm—Sughrue, Mion, Zinn, Macpeak & Seas

[73] Assignee: **Alcatel Mobile Communication France, Paris, France**

[21] Appl. No.: **593,283**

[22] Filed: **Jan. 30, 1996**

[57] ABSTRACT

Related U.S. Application Data

A microcontroller integrated circuit comprises a processor core which exchanges data with at least one data processing and/or storage device. The integrated circuit comprises a mask-programmed read only memory containing a generic program such as a test program which can be executed by the microcontroller. The generic program includes a basic function for writing data into the data processing and/or storage device or devices. The write function is used to load a downloading program. Because a downloading program is not permanently stored in the read only memory, the microcontroller can be tested independently of the application program, and remains standard with regard to the type of memory component with which it can be used in a system.

[63] Continuation of Ser. No. 272,073, Jul. 8, 1994, abandoned.

[30] Foreign Application Priority Data

Jul. 13, 1993 [FR] France 93 08626

[51] Int. Cl.⁶ **G06F 11/00**

[52] U.S. Cl. **395/182.01**

[58] Field of Search 395/180, 181, 395/182.13, 182.18, 182.16, 182.21, 182.01, 600; 5/650

[56] References Cited

U.S. PATENT DOCUMENTS

4,435,763 3/1984 Bellay et al. 364/200

20 Claims, 3 Drawing Sheets

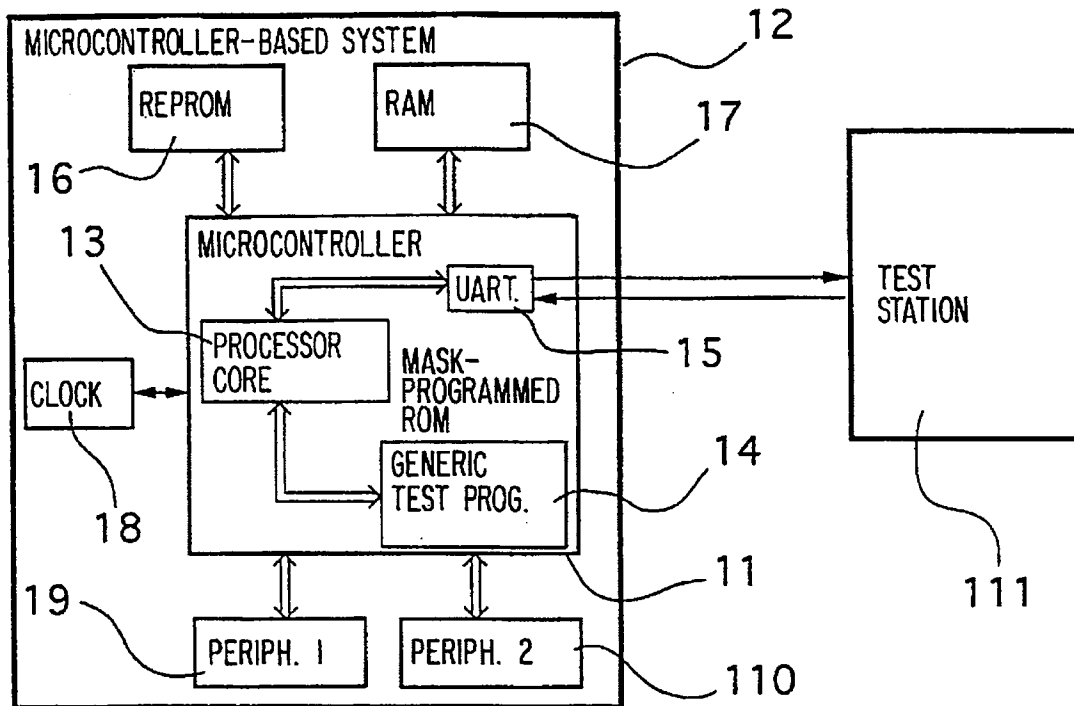

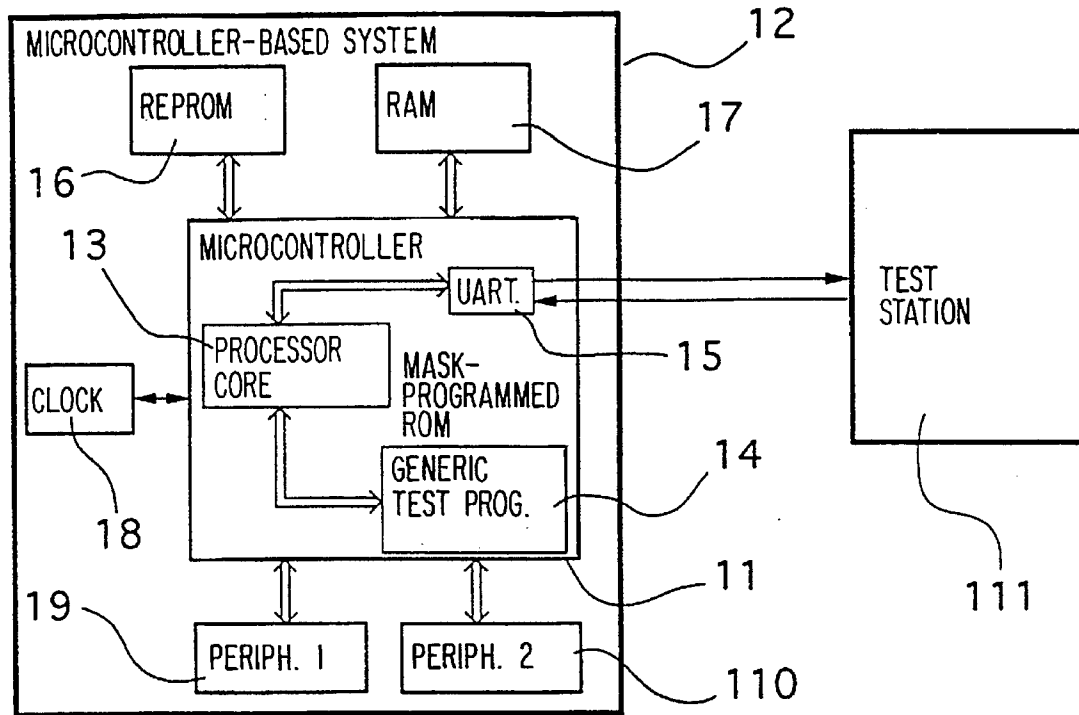

Fig. 1

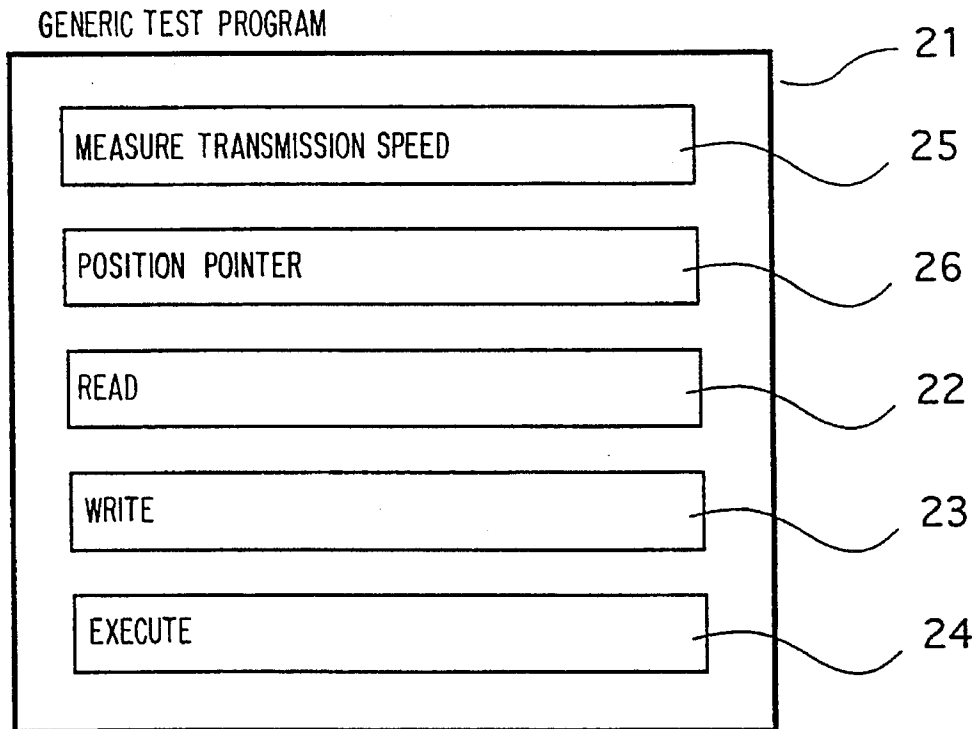

Fig. 2

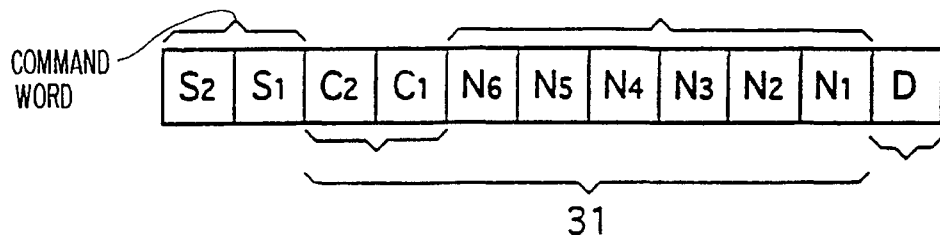

Fig. 3

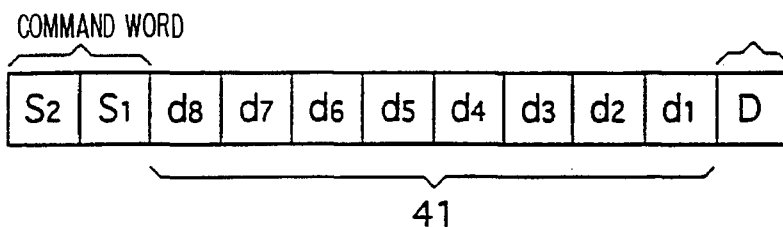

Fig. 4

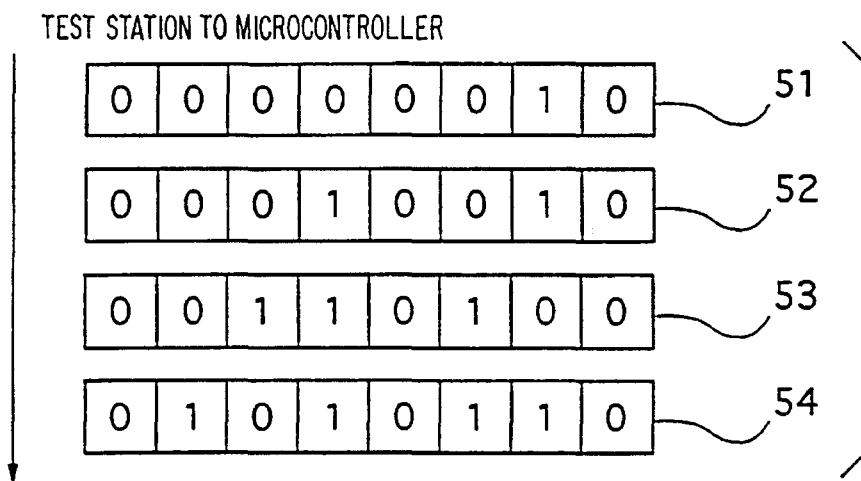

Fig. 5

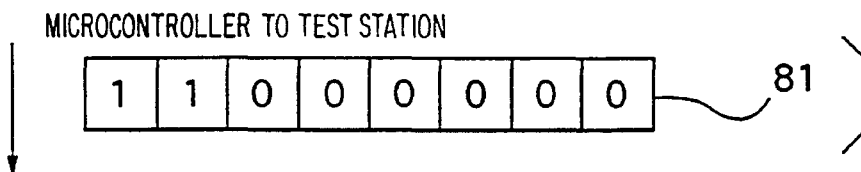

Fig. 8

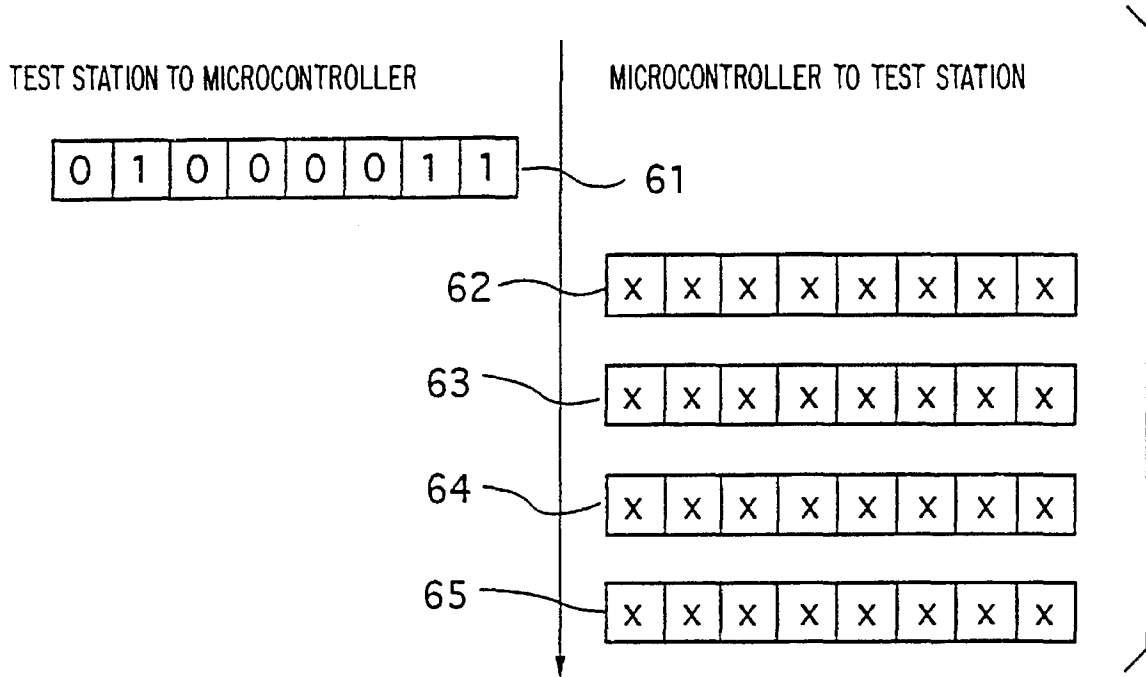

Fig. 6

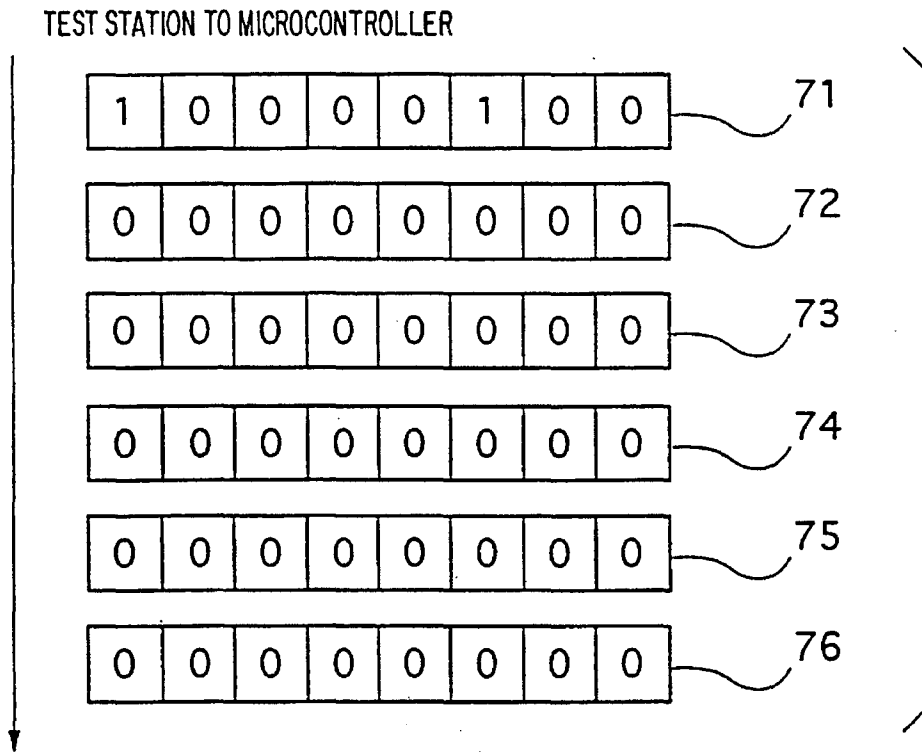

Fig. 7

MICROCONTROLLER INTEGRATED CIRCUIT WITH READ ONLY MEMORY CONTAINING A GENERIC PROGRAM

This is a continuation of application Ser. No. 08/272,073
filed Jul. 8, 1994, now abandoned.

BACKGROUND OF THE INVENTION

1. Field of the Invention

The field of the invention is that of electronic integrated circuits.

2. Description of the Prior Art

To be more precise, the invention concerns a microcontroller integrated circuit. A microcontroller is usually a VLSI (Very Large Scale integration) integrated circuit containing all or most of the components of a "computer". Its function is not predefined but depends on the program that it executes, with the result that in respect of potential applications it is very much a general purpose device.

A microcontroller necessarily comprises a processor core including a command sequencer (which is a device distributing various control signals to the other components according to the instructions of a program), an arithmetic and logic unit (for processing the data) and registers (which are specialized memory units).

The other components of the "computer" can be either internal or external to the microcontroller, however. In other words, the other components are integrated into either the microcontroller or auxiliary circuits.

These other components of the "computer" are data processing and/or storage devices, for example read only or random access memory containing the program to be executed, clocks and interfaces (serial or parallel).

As a general rule, a system based on a microcontroller therefore comprises a microchip containing the microcontroller, and a plurality of microchips containing the external data processing and/or storage devices which are not integrated into the microcontroller. A microcontroller-based system of this kind comprises, for example, one or more printed circuit boards on which the microcontroller and the other components are mounted.

It is the application program, i.e. the program which is executed by the microcontroller, which determines the overall operation of the microcontroller system. Each application program is therefore specific to a separate application.

In most current applications the application program is too large to be held in the microcontroller and is therefore stored in a memory external to the microcontroller. This program memory, which has only to be read, not written, is generally a reprogrammable read only memory (REPRM).

After the application program has been programmed in memory and then started in order to be executed by the microcontroller, the microcontroller system may not function as expected.

In the least unfavorable situation this is a minor dysfunction of the system and the microcontroller is still able to dialog with a test station via a serial or parallel interface. This test station is then able to determine the nature of the problem and indicate precisely the type of correction (software and/or physical) to be applied to the system for it to operate correctly.

Unfortunately, most dysfunctions of a microcontroller-based system result in a total system lock-up, preventing any dialog with a test station. It is then impossible to determine

the type of fault, i.e. whether it is a physical fault (in the microcontroller itself, in an external read only memory, in a peripheral device, on a bus, etc) or a software fault (i.e. an error in the application program). The troubleshooting technique usually employed in these cases of total lock-up is based on the use of sophisticated test devices requiring the application of probes to the pins of the various integrated circuits of the microcontroller-based system under test.

There are various problems associated with the use of such test devices for troubleshooting a microcontroller-based system. The probes used in these test devices are very fragile, difficult to apply because of the small size of the circuit and their close packing, and may not make good contact with the circuit.

Also, because of their high cost, these test devices are not mass produced. Consequently, faulty microcontroller-based systems cannot be repaired immediately, wherever they happen to be located at the time, but must first be returned to a place where a test device is available.

Troubleshooting a microcontroller-based system in this way is time-consuming, irksome and costly.

To avoid the need for direct action on the microcontroller-based system each time the application program executed by the microcontroller of the system is changed, it is standard practise to use a downloadable read only memory to store the application program, a loading program being written into a mask-programmed read only memory of the microcontroller. The mask-programmed read only memory of the microcontroller is integrated into the microcontroller and programmed once and for all during manufacture of the microcontroller.

To change the application program the microcontroller is reset by running the downloading program. This downloading program can then communicate with a workstation connected to the microcontroller by an appropriate transmission line, this workstation containing the new application program to be written into the microcontroller. The downloading program receives the new application program and loads it into a read only memory external to the microcontroller.

Although this solution avoids the need for direct action on the microcontroller-based system (which would entail removing from the system the reprogrammable read only memories containing the application program, writing into these memories the new application program using an appropriate programming device and then replacing them in the system), it nevertheless has a major drawback, namely specialization of the microcontroller during manufacture.

Each type of reprogrammable memory is associated with a different downloading program because the programming parameters (voltage to be applied, duration for which the voltage is to be applied, etc) vary with the technology employed. The downloading program is written once and for all into the mask-programmed internal memory of the microcontroller and the latter is therefore restricted to using memory components of the type for which this downloading program was written. In other words, the microcontroller is not a standard component and this increases its cost of manufacture.

One object of the invention is to overcome these various drawbacks of the prior art.

To be more precise, an object of the invention is to provide a microcontroller circuit which can verify quickly, simply, reliably and at low cost the operation of a system based on the microcontroller.

Another object of the invention is to provide a microcontroller integrated circuit which can accurately locate the

Explore Litigation Insights

Docket Alarm provides insights to develop a more informed litigation strategy and the peace of mind of knowing you're on top of things.

Real-Time Litigation Alerts



Keep your litigation team up-to-date with **real-time alerts** and advanced team management tools built for the enterprise, all while greatly reducing PACER spend.

Our comprehensive service means we can handle Federal, State, and Administrative courts across the country.

Advanced Docket Research



With over 230 million records, Docket Alarm's cloud-native docket research platform finds what other services can't. Coverage includes Federal, State, plus PTAB, TTAB, ITC and NLRB decisions, all in one place.

Identify arguments that have been successful in the past with full text, pinpoint searching. Link to case law cited within any court document via Fastcase.

Analytics At Your Fingertips



Learn what happened the last time a particular judge, opposing counsel or company faced cases similar to yours.

Advanced out-of-the-box PTAB and TTAB analytics are always at your fingertips.

API

Docket Alarm offers a powerful API (application programming interface) to developers that want to integrate case filings into their apps.

LAW FIRMS

Build custom dashboards for your attorneys and clients with live data direct from the court.

Automate many repetitive legal tasks like conflict checks, document management, and marketing.

FINANCIAL INSTITUTIONS

Litigation and bankruptcy checks for companies and debtors.

E-DISCOVERY AND LEGAL VENDORS

Sync your system to PACER to automate legal marketing.