

Surface-Micromachined Free-Space Fiber Optic Switches With Integrated Microactuators for Optical Fiber Communication Systems

Shi-Sheng Lee, Ed Motamedi*, and Ming C. Wu

UCLA, Room 63-128 Engineering 4 Building

405 Hilgard Avenue, Los Angeles, CA 90095, USA, lee@icsl.ucla.edu

*Rockwell Science Center, Thousand Oaks, CA 91360, USA

SUMMARY

We report on a novel surface-micromachined free-space fiber optic switch with integrated microactuators for optical fiber communication systems. The switch consists of an out-of-plane micromirror driven by integrated scratch drive actuators, and balanced by a spring. A fall time and a rise time of 15 ms and 6 ms have been achieved, respectively. The switch is equipped with the fail-safe feature as required by the FDDI optical bypass switch. In addition, a vibration g-test has been conducted while the switch is transmitting data. Error free operation up to 89 g's has been achieved for vibration frequencies from 200 Hz to 10 kHz.

Keywords: Optical Switch, Surface-Micromachining, Microactuators

INTRODUCTION

Optical fiber offers many advantages compared with electric cables, including high bandwidth, low loss, light weight, immunity from lightning strikes and the resultant current surges, and no electromagnetic interference. Fiber optic networks such as fiber distributed data interface (FDDI) are widely accepted and supported by the industry as one of the international standards for high-speed local area networks (LAN).

Fiber optic switches are used in the network to reconfigure the network and/or increase its reliability. For example, FDDI fiber optic network employs optional 2x2 fiber optic switches, called optical bypass switches, to bypass the failed nodes. When the FDDI node is powered on, the bypass switch routes the incoming signal from ring into the station, and directs the transmitted signal from the station to the ring. When the FDDI node is powered off or failed, the optical bypass switch allows the data signals to bypass the node and maintain the ring continuity. Since the switch introduces additional optical loss, fiber optic switches should be designed to minimize the insertion loss. The switch can be realized by free-space approach or waveguide approach. The free-space approach [1-3] offers a number of advantages over the conventional waveguide approach [4]. It has lower

coupling loss and smaller cross talk. Conventional free-space fiber optic switches employ bulk optical elements and are very expensive. Recently, there has been a growing interest in applying micromachining technology to improve the performance and reduce the cost of optomechanical switches. Bulk-micromachined Si has been combined with external actuators to implement 2x2 switches [1]. A bulk micromachined 2x2 matrix switch has also been demonstrated [2]. Deep reactive ion etching has been employed to realize a 2x2 switch on silicon on insulator wafer [3]. However, they often require unique processes and special processing techniques, such as extra thick SOI (silicon-on-insulator) wafers and deep RIE (reactive ion etching) machine.

Surface-micromachining technique, based on the standard CMOS processes, on the other hand, offers greater flexibility for realizing free-space optical systems on a single chip. Three-dimensional micro-optical elements, micropositioners, and microactuators can be fabricated by a single unified process [5-6]. Previously, we have used the surface-micromachined technique to demonstrate a 2x2 fiber optic switches [7]. Lower insertion loss has been demonstrated. In this paper, we report on the performance of a fully actuated 2x2 fiber optic switch. A vibration test up to 89'g has also been conducted for an active switch, and the experimental results will be discussed in the paper.

DESIGN AND FABRICATION

The schematic diagram of the switch is shown in Figure 1. It consists of a moveable 3D micromirror, four fiber guiding rails, and microactuators. The out-of-plane 3D micromirror is realized by the micro-hinge technology [8] and is integrated on a translation stage. It is positioned at the center of the switch and allowed to move along the x-axis. The mirror has been coated with a 500 nm-thick gold layer to increase the reflectivity. The switch operates in REFLECTION state without activating any actuators. The micromirror can be pulled away from the center of fibers by a set of six integrated scratch drive actuator (SDA) [9], which will change the switch from REFLECTION to TRANSMISSION state. A pull-in spring has been integrate with the micromirror to

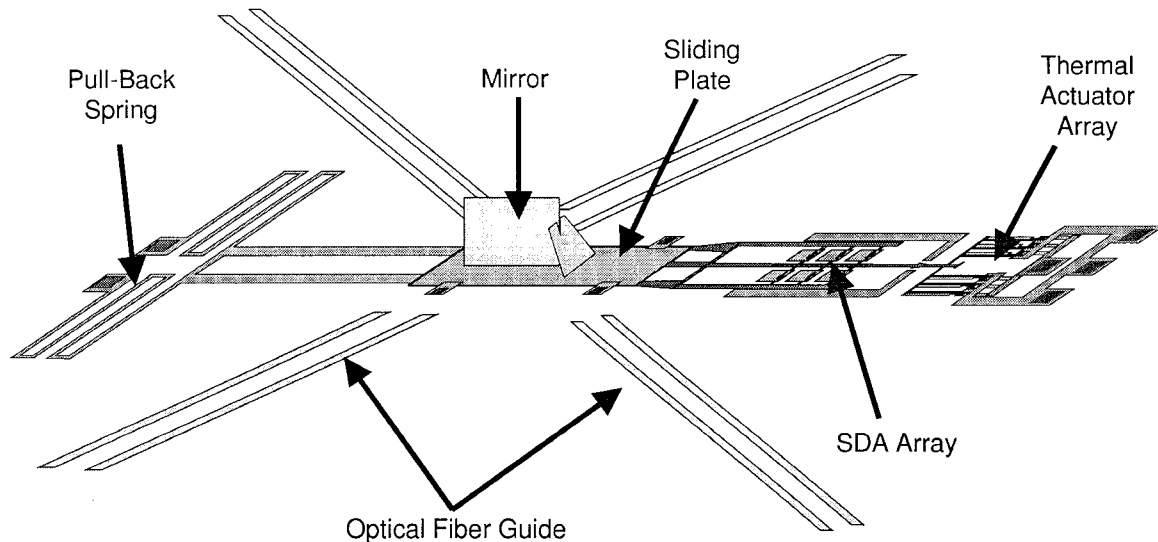

Figure 1: Schematic diagram of the surface-micromachined 2x2 free-space fiber optic switch

implement the “fail-safe” feature of the FDDI optical bypass switch. The micromirror can be held at the TRANSMISSION state by applying a DC bias to the SDA. When the DC voltage is released, or when power failure occurs, the pull-in spring will return the switch to the REFLECTION state. Alternatively, the switch can also be held at the TRANSMISSION state by locking the translation stage into a mechanical latch so that no DC power is required. The mechanical latch can be released by an integrated thermal actuator array [10]. In this configuration, the actuators are actuated only during the switching time, therefore the overall power consumption of the switch is very small. The SDAs are driven by a sinusoidal voltage source. The minimum amplitude of applied voltage is 80V. Thermal actuators can be driven by a voltage source as small as 5V in amplitude.

The switch is fabricated using the three-layer polysilicon surface-micromachining technology offered by MEMS Technology Application Center at North Carolina (MCNC) under Defense Advanced Research Projects Agency (DARPA) supported Multi-User MEMS Processes (MUMPs). Figure 2 shows the scanning electron micrograph (SEM) of the mirror with the sliding plate and the microactuators. The fabrication process of the switch is summarized in the following: First, a 0.5- μm -thick polysilicon is deposited on the silicon substrate coated with low-stress silicon nitride. This layer of polysilicon serves as an electrical contact where it is needed. Before the deposition of the first structural polysilicon layer (poly1), a 2.0- μm -thick sacrificial phosphosilicate glass (PSG) layer is deposited. The sliding plate, part of the mirror hinge assembly and thermal actuators are defined on the poly1 layer.

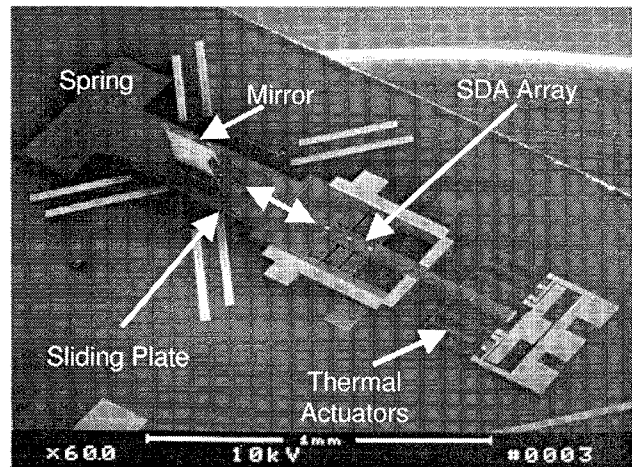

Figure 2: SEM of the switch

A 0.75- μm -thick PSG layer is then deposited before the deposition of the 1.5- μm -thick second structural polysilicon layer (poly2). The mirror, sliding plate guide rail, part of the mirror hinge assembly and SDAs are defined on poly2 layer. At the final processing step, a 0.5- μm -thick gold layer is deposited on the surfaces of the mirror and electrical contacts to increase the reflectivity and electrical conductivity, respectively.

EXPERIMENTS AND RESULTS

Switching Test

In the switching experiment, four multimode optical fibers with 62.5 μm core diameters are attached to the Si substrate. The insertion losses have been characterized to be 1.3 dB and 1.9 dB [7] for the

TRANSMISSION and REFLECTION states, respectively. The fiber-to-fiber spacing is 80 μm and the fiber tip has been melted to form hemispherical microlenses. A commercial optical transceiver from Hewlett Packard Company (HP) is used as the light source and the receiver. The switching characteristics is measured by monitoring the reflected signal on a HP real-time digital oscilloscope.

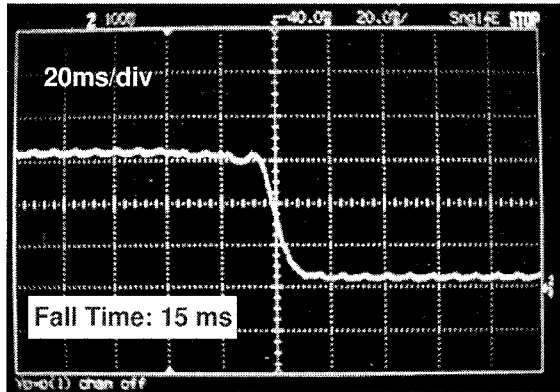

(a)

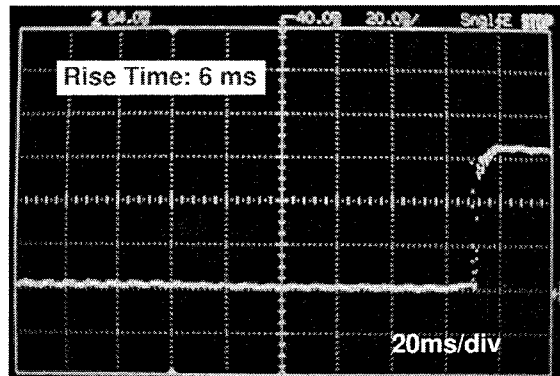

(b)

Figure 3: Response of the photodetector during the switching for: (a) from THROUGH state to CROSS state, (b) vice versa.

Figure 3(a) shows the fall time of the optical switch when the micromirror is pulled away by the SDAs. When the SDA is biased at peak voltage of 100 V at 30 kHz, a fall time of 15 ms has been achieved. Since the speed of the SDA is proportional to the actuating frequency, higher switching speed can be achieved by operating the SDA at higher frequencies. The speed of the SDA versus applied signal frequencies are plotted in Figure 4. We have successfully actuated SDAs up to 50kHz (limited by our power supply). At 50kHz, the SDAs are moving at a speed of 2.5 mm/sec, which corresponds to a step size of 25nm per cycle. The switching from TRANSMISSION state to REFLECTION state is achieved by actuating the thermal actuator to release the latch. The switching characteristics is shown in Fig. 3(b). The micromirror is

pulled back to the center by the pull-in spring. A rise time of 6 ms has been achieved.

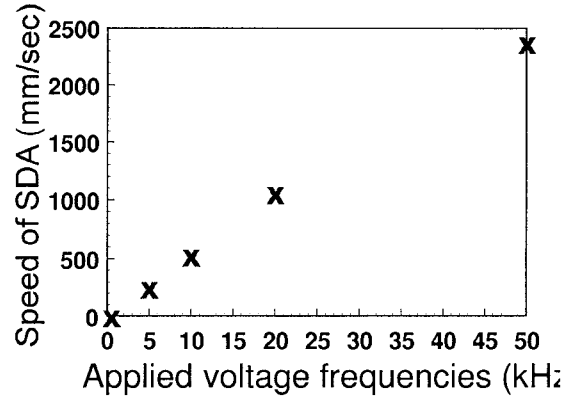

Figure 4: Plot of SDA speed applied voltage

Vibration Test

We have also performed the vibration test of the surface-micromachined fiber optic switch at Rockwell Science Center. The purpose of this test is to investigate the robustness of the surface-micromachined fiber optic switch against external vibrations. In particular, quantitative measurement in terms of the data bit error rate (BER) has been obtained. To the authors' knowledge, this is the first time such measurement was ever performed.

The schematic diagram of the experimental setup is shown in Figure 5. In this experiment, we prepared the

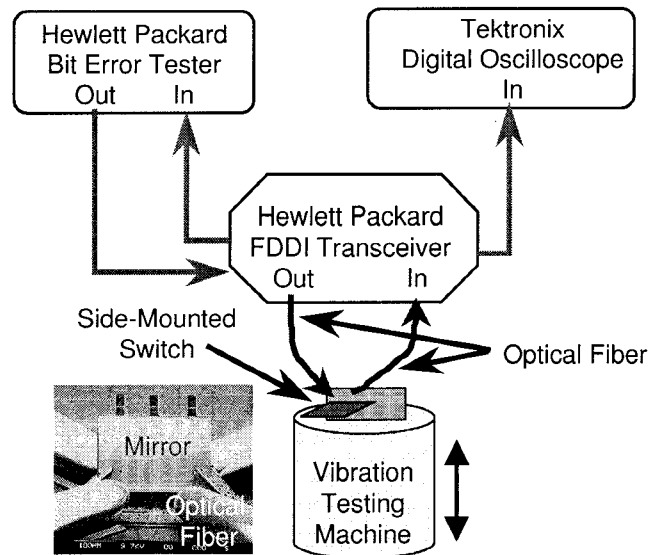

Figure 5: The experimental setup

1A4.07P

MEMS switch in the REFLECTION mode. Two multimode optical fibers are attached to the Si substrate for *in situ* monitoring of the optical signals during vibration. The switch is mounted in the Unholtz-Dickie vibration-testing machine with the hinged micromirror facing the axis of the vibration. The photograph of the experimental setup is shown in Figure 6. Since the hinged micromirror is most sensitive to vibration in this direction, this measurement result should be considered as the worst case of vibrations in three axes. An HP bit error rate tester is used to drive the optical transceiver and measure the error rate, and a Tektronix real-time digital oscilloscope is used to record the eye diagram.

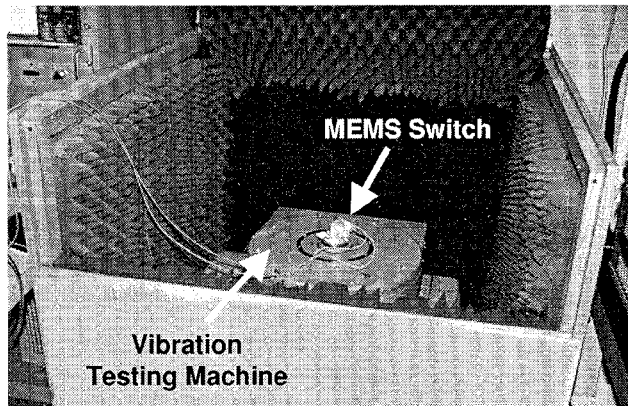

Figure 6: The photograph of the switch mounted on the vibration testing machine

The performance of the MEMS optical switch under vibration is evaluated by measuring the bit error rate of the received optical signal in the REFLECTION mode. A 2^{23} -1 bit long random test patterns at 100 MHz clock rate are used to investigate the vibration sensitivity at a wide range of frequencies. Error-free operation up to 89's (equipment-limited) was observed for vibration frequencies from 200 Hz to 10 kHz. Comparison of the receiving sensitivity with and without vibration shows that there is virtually no effect of vibration of this scale. No mechanical failure observed throughout the entire test. A measured eye diagram of the received signal under 150Hz, 50g vibration is shown in Figure 5. Clear open eyes were observed.

CONCLUSION

A 2×2 free-space fiber optic switches with integrated microactuators have been demonstrated using the surface-micromachining technology. The switch has achieved fall time and rise time of 15 ms and 6 ms, respectively. Higher speed operation is possible by operating the scratch drive actuator at higher frequencies. We have performed the vibration test of the surface-

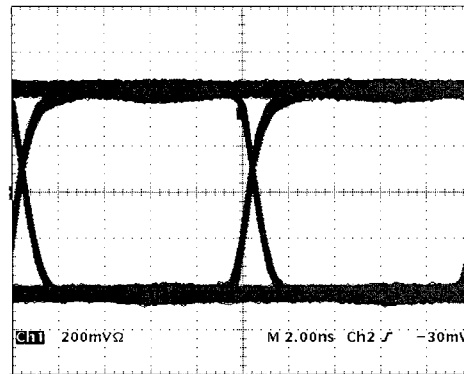

Figure 7: A measured eye diagram of the device at 50 g'' and 150 Hz of an external vibration

micromachined fiber optic switch. This is the first time such measurement was ever performed. Error-free operation up to 89 g's has been achieved for vibration frequencies from 200Hz to 10kHz. The robustness and the batch fabrication process make this switch an attractive candidate for low cost opto-mechanical switches for fiber optic communications.

This project is supported by DARPA.

REFERENCES

- [1] M. F. Dautartas, A. M. Benzoni, Y. C. Chen and G. E. Blonder, "A silicon-based moving-mirror optical switch", J. of Lightwave Technology, Vol. 10, No. 8, pp. 1078-85, August, 1992.
- [2] H. Toshiyoshi, H. Fujita, "Optical crossconnection by silicon micromachined torsion mirrors", Digest. IEEE/LEOS 1996 Summer Topical Meetings, pp 63-64, Keystone, CO, 5-9, Aug., 1996
- [3] C. Marsner, M.-A. Gretillat, N. F. de Rooji, et al, " Vertical mirrors fabricated by reactive ion etching for fiber optical switching applications", .10th IEEE International MEMS Workshop, pp. 349-54, 1997
- [4] L. A. Field, D. L. Burriesci, P. R. Robrish, R. C. Ruby, " Micromachined 1x2 optical-fiber switch", International Solid-State Sensors and Actuators Conference - TRANSDUCERS '95, Stockholm, Sweden, 25-29 June, 1995. Sensors and Actuators A (Physical), vol.A53, (no.1-3):311-16,May 1996
- [5] L. Y. Lin, S. S. Lee, K. S. J. Pister and M. C. Wu, "Micro-machined three-dimensional micro-optics for integrated free-space optical system", IEEE Photonic Technology Letters, Vol. 6, No. 12, December, 1994.
- [6] S. S. Lee, L. Y. Lin, K. S. J. Pister and M. C. Wu, " Hybrid integration of 8x1 micromachined micro-Fresnel lens arrays and 8x1 vertical-cavity surface-emitting laser arrays for free-space optical interconnect", in Tech. Dig. of The 40th International Electron Device Meeting (IEDM'94), December 11-14, 1994.
- [7] S. S. Lee, L. Y. Lin, and M. C. Wu, "Realization of FDDI optical bypass switches using surface micromachining technology," Proc. SPIE on Micromachining and Microfabrication, Austin, TX, Oct. 23-24, 1995
- [8] K. S. J. Pister, M. W. Judy, S. R. Burgett, and R. S. Fearing, "Microfabricated hinges", Sensors and Actuators A-Physical, Vol. 33, no. 3, p. 249(1992)
- [9] T. Akiyama and H. Fujita, "A quantitative analysis of scratch drive actuator using buckling motion", Pro. 8th IEEEInternational MEMS Workshop, pp. 310 - 315, 1995
- [10] J. Comtois, V. Bright and M Phipps, "Thermal microactuators for surface-micromachining processes", Pro. SPIE, Vol. 2642, pp. 10 - 21,1995