

18. (Canceled)
19. (Canceled)
20. (Canceled)
21. (Canceled)
22. (Canceled)
23. (Canceled)
24. (Canceled)
25. (Canceled)
26. (Canceled)
27. (Canceled)
28. (Canceled)
29. (Canceled)
30. (Canceled)
31. (Canceled)
32. (Canceled)
33. (Canceled)
34. (Canceled)
35. (Canceled)
36. (Canceled)
37. (Canceled)
38. (Canceled)

40. (Added) A cellular communication device comprising:
- a cellular communication module operable to receive an incoming telephonic communication;
 - a memory module operable to store plural audio formats of one or more audio files received via a cellular communication network independent of the incoming telephonic communication; and
 - a processor operable to alter a playing of at least one of the audio files in response to the incoming telephonic communication.
41. (Added) The device of Claim 40 further comprising the processor operable to stop playing of the audio file in response to the incoming telephonic communication.
42. (Added) The device of Claim 40 further comprising the processor operable to enable a user to alter the playing of the at least one audio file to answer the incoming telephonic communication.
43. (Added) The device of Claim 40 further comprising the processor operable to enable sequential playing of plural audio files.
44. (Added) The device of Claim 43 further comprising the processor operable to first play a WAV file and second play an MP3 file.
45. (Added) The device of Claim 43 further comprising the processor operable to first play a MP3 file and second play a WAV file.
46. (Added) The device of Claim 43 wherein the plural audio files include WAV files.
47. (Added) The device of Claim 40, wherein at least one of the audio files includes a streaming audio formatted file.

48. (Added) The device of Claim 40, further comprising the processor operable to pause playing of the audio file in response to the incoming telephonic communication.
49. (Added) The device of Claim 48, further comprising the processor operable to enable listening of a telephone call upon a user answering the incoming telephonic communication.
50. (Added) The device of Claim 40, further comprising a Bluetooth communication module operable to communicate an output to a wireless speaker, the output including the playing of the at least one of the audio files or the incoming telephonic communication.
51. (Added) The device of Claim 50, further comprising a PDA.
52. (Added) The device of Claim 40, further comprising a cellular telephone.
53. (Added) The device of Claim 40 further comprising a WAP browser operable to access a list of downloadable preformatted audio files.
54. (Added) The device of Claim 40 further comprising the communication module operable to receive an audio file selected via an Internet website accessed external to the cellular communication device.
55. (Added) The device of Claim 53 further comprising a media player operable to play user selected media downloaded outside of a web browsing environment.

56. (Added) A cellular communication device comprising:
- a processor operable to play plural audio formats;
 - a communication module operable to receive an audio file selected by a user accessing an Internet website accessible external to the cellular communication device and operable to provide the user access to plural audio files via a user login page;
 - a memory operable to store plural formats of audio files; and
 - a Bluetooth communication module operable to communicate an in process playing of at least one of the audio files or a telephonic communication to a wireless speaker.
57. (Added) The device of Claim 56 further comprising:
- output means for providing an audio output;
 - input means for selecting the audio file; and
 - browsing means for viewing available preformatted audio and media files.
58. (Added) The device of Claim 56 further comprising a removable memory device operable to store at least one audio file.

59. (Added) A method for managing audio outputs for a cellular communication device comprising:
- playing an audio file received via a cellular communication;
 - detecting an incoming cellular telephone call; and
 - altering playing of the audio file in response to detecting the cellular telephone call.
60. (Added) The method of Claim 59 further comprising playing a second audio file stored within a memory of the cellular device.
61. (Added) The method of Claim 60, further comprising:
- receiving the second audio file independent of the incoming cellular telephone call;
 - storing the second audio file within the memory; and
 - playing the second audio file after detecting the incoming cellular telephone call.
62. (Added) The method of Claim 59, further comprising playing a second audio file received via a non-wireless communication network.
63. (Added) The method of Claim 59, further comprising:
- enabling access to a streaming media link within a user interface of the cellular communication device;
 - detecting selection of the streaming media links; and
 - receiving the selected streaming media.
64. (Added) The method of Claim 63, further comprising altering playing of the streaming media in response to receiving the cellular telephone call.
65. (Added) The method of Claim 63, further comprising enabling access to streaming audio.

66. (Added) The method of Claim 63, further comprising enabling access to a broadcast video.

67. (Added) The method of Claim 64, wherein the streaming media comprises streaming audio.

68. (Added) A wireless communication system comprising:
- an Internet website provided in association with a cellular communication device operable to receive and play an audio file selected by a user accessing the Internet website external to the cellular communication device;
 - a wireless communication network operable to communicate the audio file to the cellular communication device identified through a user logging into the Internet website; and
 - a digital engine operable to determine availability of the cellular communication device and to communicate the audio file to the cellular communication device.
69. (Added) The system of Claim 68, further comprising the Internet website operable to present a user login page in association with identifying the cellular communication device.
70. (Added) The system of Claim 69, further comprising the Internet website operable to provide access to downloadable software operable to be communicated to the cellular communication device.
71. (Added) The system of Claim 68, further comprising the cellular communication device operable to alter playing of the audio file in response to receiving a telephone communication communicated via the wireless communication network.
72. (Added) The system of Claim 68, further comprising the Internet website presenting a link to a selectable preformatted audio file operable to be communicated to the identified cellular communication device.
73. (Added) The system of Claim 72 wherein the preformatted audio files may be categorized within the Internet website by at least two of:

genre;
artist;
most popular;
newest;
most viewed; and
favorites.

74. (Added) The system of Claim 68 further comprising the digital engine operable to enable access to streaming audio information.

75. (Added) The system of Claim 74 further comprising the digital engine operable to provide links to streaming audio accessible by the cellular communication device.

76. (Added) The system of Claim 69 further comprising the digital engine operable to communication the audio file to the wherein the audio file may be communicated to the wireless communication device independent of a user being logged into the Internet website.

77. (Added) The system of Claim 69 further comprising the digital engine operable to enable access to a WAP enabled Internet website operable to initiate downloading of the audio file via the cellular communication network.

78. (Added) The system of Claim 68 further comprising the digital engine operable to provide access to a broadcast.

79. (Added) The system of Claim 78 further comprising the digital engine operable to provide access to an on-line video broadcast.

80. (Added) The system of Claim 78 further comprising the digital engine operable to provide access to an on-line radio broadcast.

81. (Added) The system of Claim 78 wherein the cellular communication device is operable to alter playing of an accessed broadcast in response to an incoming cellular telephone call.

REMARKS

This Application has been reviewed in light of the Final Office Action mailed February 7, 2005 by the Office. At the time of this Office Action, Claims 11, 14-16, 18-21, 23, 26, 27, 29, 31, 32, and 34-39 were pending in this Application. All pending claims have been cancelled without prejudice. In order to advance prosecution of this case, Claims 40-81 have been added. It is believed that the added claims do not involve any introduction of new matter, whereby entry is believed to be in order and is respectfully requested. The Applicants respectfully request reconsideration and favorable action in this case.

I. Claims 40-81 are distinguishable over the Prior Art of record

The Examiner depended primarily on Baughan (U.S. Patent # 6,510,210 B1) and Shanahan (U.S. Patent # 6,496,692 B1) in the Final Office Action. The current claim limitations presented in Claims 40-81 are not present, either alone or in combination with, Baughan, Shanahan or the prior art of record.

Specifically, Baughan is directed toward providing only non-cellular based wireless communication of audio files through the use of a Local Area Network (16) connected to a public network (17) via a home gateway 12 having a cable modem 13. Such an arrangement severely limits the mobility of a user. Baughan further states the motivation for his invention as “the market for cordless telephony devices is potentially larger than that for mobile telephones (i.e. cellular phones) and the costs of ownership and usage potentially less” (See Baughan Col 2, lines 56-59).

Shanahan, though cellular based, is primarily directed toward formatting and programming user-defined information into an electronic device (See Abstract, FIG. 8). Shanahan is silent on playing of audio files independent of telephone calls and teaches away from storage of various preformatted audio files and uses a file processor that converts data 106, 162, 172 to a single file format (See FIGs 8, 10 and 11).

Baughan and Shanahan, neither alone or in combination with the prior art of record, disclose all of the limitations of Claims 40-81. In particular Baughen, Shanahan, and the prior art of record fail to disclose the cellular communication device as recited in Claim 40. The cellular communication device of Claim 40 includes a cellular communication module operable to receive an incoming telephonic communication and a memory module operable to store plural audio formats of one or more audio files received via a cellular communication network independent of the incoming telephonic communication and a processor operable to alter a playing of at least one of the audio files in response to the incoming telephonic communication. Neither Baughen, Shanahan or the prior art of record disclose each of the elements of Claim 40. Additionally, Claims 41-55 which depend from and provide further limitations to Claim 40, are distinguishable from the prior art of record.

Baughan, Shanahan and the prior art of record also fail to disclose a cellular communication device as recited in Claim 56. In particular, Claim 56 includes a processor operable to play plural audio formats and a communication module operable to receive an

audio file selected by a user accessing an Internet website accessible external to the cellular communication device and operable to provide the user access to plural audio files via a user login page. Claim 56 further includes a limitation of a memory operable to store plural formats of audio files and a Bluetooth communication module operable to communicate an in process playing of at least one of the audio files or a telephonic communication to a wireless speaker. Neither Baughen, Shanahan or the prior art of record disclose each of the elements of Claim 56. Additionally, Claims 57-58 which depend from and provide further limitations to Claim 56, are also distinguishable from the prior art of record.

Baughan, Shanahan and the prior art of record fail to disclose a method for managing audio outputs for a cellular communication device as recited in Claim 59. The method includes playing an audio file received via a cellular communication, detecting an incoming cellular telephone call and altering playing of the audio file in response to detecting the cellular telephone call. Neither Baughen, Shanahan or the prior art of record disclose each of the elements of Claim 59. Additionally, Claims 60-67 which depend from and provide further limitations to Claim 59, are distinguishable from the prior art of record.

Finally, Baughan, Shanahan and the prior art of record fail to disclose a wireless communication system as recited in Claim 68. The system includes an Internet website provided in association with a cellular communication device operable to receive and play an audio file selected by a user accessing the Internet website external to the cellular communication device. The system further includes a wireless communication network operable to communicate the audio file to the cellular communication device identified through a user logging into the Internet website. The system of Claim 68 also includes a digital engine operable to determine availability of the cellular communication device and to communicate the audio file to the cellular communication device. Neither Baughen, Shanahan, or the prior art of record disclose each of the elements of Claim 68.

Additionally, Claims 69-81 which depend from and provide further limitations to Claim 68, are distinguishable from the prior art of record.

CONCLUSION

The Applicants have reviewed the prior art of record and have made an earnest attempt to place this case in condition for allowance. For the foregoing reasons, and for reasons clearly apparent, the Applicants respectfully request full allowance of all pending claims. If there are any matters that can be discussed by telephone to further the prosecution of the Application, Applicants invite the Examiner to contact the undersigned at 512-773-2900 at the Examiner's convenience.

Respectfully Submitted,
White et al

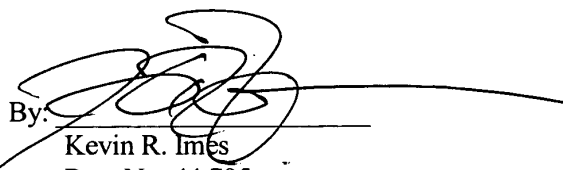
By: 
Kevin R. Imes
Reg. No. 44,795

Kevin R. Imes
2001 So. Mopac #624
Austin, Texas 78746
Telephone: (512) 773-2900
Facsimile: (512) 342-8713

54



UNITED STATES PATENT AND TRADEMARK OFFICE

UNITED STATES DEPARTMENT OF COMMERCE
United States Patent and Trademark Office
Address: COMMISSIONER FOR PATENTS
P.O. Box 1450
Alexandria, Virginia 22313-1450
www.uspto.gov

APPLICATION NO.	FILING DATE	FIRST NAMED INVENTOR	ATTORNEY DOCKET NO.	CONFIRMATION NO.
09/537,812	03/28/2000	Russell W. White	111111.1111	4698
	7590 03/04/2005		EXAMINER PEREZ GUTIERREZ, RAFAEL	
Russell W White 10704 Redmond Austin, TX 78739			ART UNIT 2686	PAPER NUMBER

DATE MAILED: 03/04/2005

Please find below and/or attached an Office communication concerning this application or proceeding.

Interview Summary	Application No.	Applicant(s)	
	09/537,812	White et al.	
	Examiner	Art Unit	
	Rafael Perez-Gutierrez	2686	

All participants (applicant, applicant's representative, PTO personnel):

- (1) Rafael Perez-Gutierrez. (3) _____
(2) Kevin R. Imes. (4) _____

Date of Interview: 01 March 2005.

Type: a) Telephonic b) Video Conference
c) Personal [copy given to: 1) applicant 2) applicant's representative]

Exhibit shown or demonstration conducted: d) Yes e) No.
If Yes, brief description: _____

Claim(s) discussed: 34 and 36-38.

Identification of prior art discussed: Baughan (U.S. Patent # 6,510,210 B1) and Shanahan (U.S. Patent # 6,496,692 B1).

Agreement with respect to the claims f) was reached. g) was not reached. h) N/A.

Substance of Interview including description of the general nature of what was agreed to if an agreement was reached, or any other comments: The Examiner and Mr. Imes thoroughly discussed the prior art in view of the above-mentioned claims. Mr. Imes proposed incorporating dependent claims 36-38 into claim 34 and the Examiner provided additional suggestions for amending the claims. No agreement was reached.

(A fuller description, if necessary, and a copy of the amendments which the examiner agreed would render the claims allowable, if available, must be attached. Also, where no copy of the amendments that would render the claims allowable is available, a summary thereof must be attached.)

THE FORMAL WRITTEN REPLY TO THE LAST OFFICE ACTION MUST INCLUDE THE SUBSTANCE OF THE INTERVIEW. (See MPEP Section 713.04). If a reply to the last Office action has already been filed, APPLICANT IS GIVEN ONE MONTH FROM THIS INTERVIEW DATE, OR THE MAILING DATE OF THIS INTERVIEW SUMMARY FORM, WHICHEVER IS LATER, TO FILE A STATEMENT OF THE SUBSTANCE OF THE INTERVIEW. See Summary of Record of Interview requirements on reverse side or on attached sheet.

Examiner Note: You must sign this form unless it is an Attachment to a signed Office action.

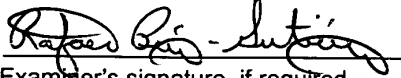
Examiner's signature, if required

Summary of Record of Interview Requirements

Manual of Patent Examining Procedure (MPEP), Section 713.04, Substance of Interview Must be Made of Record

A complete written statement as to the substance of any face-to-face, video conference, or telephone interview with regard to an application must be made of record in the application whether or not an agreement with the examiner was reached at the interview.

Title 37 Code of Federal Regulations (CFR) § 1.133 Interviews Paragraph (b)

In every instance where reconsideration is requested in view of an interview with an examiner, a complete written statement of the reasons presented at the interview as warranting favorable action must be filed by the applicant. An interview does not remove the necessity for reply to Office action as specified in §§ 1.111, 1.135. (35 U.S.C. 132)

37 CFR §1.2 Business to be transacted in writing.

All business with the Patent or Trademark Office should be transacted in writing. The personal attendance of applicants or their attorneys or agents at the Patent and Trademark Office is unnecessary. The action of the Patent and Trademark Office will be based exclusively on the written record in the Office. No attention will be paid to any alleged oral promise, stipulation, or understanding in relation to which there is disagreement or doubt.

The action of the Patent and Trademark Office cannot be based exclusively on the written record in the Office if that record is itself incomplete through the failure to record the substance of interviews.

It is the responsibility of the applicant or the attorney or agent to make the substance of an interview of record in the application file, unless the examiner indicates he or she will do so. It is the examiner's responsibility to see that such a record is made and to correct material inaccuracies which bear directly on the question of patentability.

Examiners must complete an Interview Summary Form for each interview held where a matter of substance has been discussed during the interview by checking the appropriate boxes and filling in the blanks. Discussions regarding only procedural matters, directed solely to restriction requirements for which interview recordation is otherwise provided for in Section 812.01 of the Manual of Patent Examining Procedure, or pointing out typographical errors or unreadable script in Office actions or the like, are excluded from the interview recordation procedures below. Where the substance of an interview is completely recorded in an Examiners Amendment, no separate Interview Summary Record is required.

The Interview Summary Form shall be given an appropriate Paper No., placed in the right hand portion of the file, and listed on the "Contents" section of the file wrapper. In a personal interview, a duplicate of the Form is given to the applicant (or attorney or agent) at the conclusion of the interview. In the case of a telephone or video-conference interview, the copy is mailed to the applicant's correspondence address either with or prior to the next official communication. If additional correspondence from the examiner is not likely before an allowance or if other circumstances dictate, the Form should be mailed promptly after the interview rather than with the next official communication.

The Form provides for recordation of the following information:

- Application Number (Series Code and Serial Number)
- Name of applicant
- Name of examiner
- Date of interview
- Type of interview (telephonic, video-conference, or personal)
- Name of participant(s) (applicant, attorney or agent, examiner, other PTO personnel, etc.)
- An indication whether or not an exhibit was shown or a demonstration conducted
- An identification of the specific prior art discussed
- An indication whether an agreement was reached and if so, a description of the general nature of the agreement (may be by attachment of a copy of amendments or claims agreed as being allowable). Note: Agreement as to allowability is tentative and does not restrict further action by the examiner to the contrary.
- The signature of the examiner who conducted the interview (if Form is not an attachment to a signed Office action)

It is desirable that the examiner orally remind the applicant of his or her obligation to record the substance of the interview of each case. It should be noted, however, that the Interview Summary Form will not normally be considered a complete and proper recordation of the interview unless it includes, or is supplemented by the applicant or the examiner to include, all of the applicable items required below concerning the substance of the interview.

A complete and proper recordation of the substance of any interview should include at least the following applicable items:

- 1) A brief description of the nature of any exhibit shown or any demonstration conducted,
- 2) an identification of the claims discussed,
- 3) an identification of the specific prior art discussed,
- 4) an identification of the principal proposed amendments of a substantive nature discussed, unless these are already described on the Interview Summary Form completed by the Examiner,
- 5) a brief identification of the general thrust of the principal arguments presented to the examiner,
(The identification of arguments need not be lengthy or elaborate. A verbatim or highly detailed description of the arguments is not required. The identification of the arguments is sufficient if the general nature or thrust of the principal arguments made to the examiner can be understood in the context of the application file. Of course, the applicant may desire to emphasize and fully describe those arguments which he or she feels were or might be persuasive to the examiner.)
- 6) a general indication of any other pertinent matters discussed, and
- 7) if appropriate, the general results or outcome of the interview unless already described in the Interview Summary Form completed by the examiner.

Examiners are expected to carefully review the applicant's record of the substance of an interview. If the record is not complete and accurate, the examiner will give the applicant an extendable one month time period to correct the record.

Examiner to Check for Accuracy

If the claims are allowable for other reasons of record, the examiner should send a letter setting forth the examiner's version of the statement attributed to him or her. If the record is complete and accurate, the examiner should place the indication, "Interview Record OK" on the paper recording the substance of the interview along with the date and the examiner's initials.

72



UNITED STATES PATENT AND TRADEMARK OFFICE

UNITED STATES DEPARTMENT OF COMMERCE
United States Patent and Trademark Office
Address: COMMISSIONER FOR PATENTS
P.O. Box 1450
Alexandria, Virginia 22313-1450
www.uspto.gov

APPLICATION NO.	FILING DATE	FIRST NAMED INVENTOR	ATTORNEY DOCKET NO.	CONFIRMATION NO.
-----------------	-------------	----------------------	---------------------	------------------

09/537,812	03/28/2000	Russell W. White	111111.1111	4698
------------	------------	------------------	-------------	------

7590 02/07/2005
 Russell W White
 10704 Redmond
 Austin, TX 78739

EXAMINER

PEREZ GUTIERREZ, RAFAEL

ART UNIT	PAPER NUMBER
----------	--------------

2686

DATE MAILED: 02/07/2005

Please find below and/or attached an Office communication concerning this application or proceeding.

Office Action Summary	Application No. 09/537,812	Applicant(s) White et al.	
	Examiner Rafael Perez-Gutierrez	Art Unit 2686	

-- The MAILING DATE of this communication appears on the cover sheet with the correspondence address --
Period for Reply

A SHORTENED STATUTORY PERIOD FOR REPLY IS SET TO EXPIRE 3 MONTH(S) FROM THE MAILING DATE OF THIS COMMUNICATION.

- Extensions of time may be available under the provisions of 37 CFR 1.136(a). In no event, however, may a reply be timely filed after SIX (6) MONTHS from the mailing date of this communication.
- If the period for reply specified above is less than thirty (30) days, a reply within the statutory minimum of thirty (30) days will be considered timely.
- If NO period for reply is specified above, the maximum statutory period will apply and will expire SIX (6) MONTHS from the mailing date of this communication.
- Failure to reply within the set or extended period for reply will, by statute, cause the application to become ABANDONED (35 U.S.C. § 133). Any reply received by the Office later than three months after the mailing date of this communication, even if timely filed, may reduce any earned patent term adjustment. See 37 CFR 1.704(b).

Status

- 1) Responsive to communication(s) filed on 01 September 2004.
- 2a) This action is **FINAL**. 2b) This action is non-final.
- 3) Since this application is in condition for allowance except for formal matters, prosecution as to the merits is closed in accordance with the practice under *Ex parte Quayle*, 1935 C.D. 11, 453 O.G. 213.

Disposition of Claims

- 4) Claim(s) 11,14-16,18-21,23,26,27,29,31,32 and 34-39 is/are pending in the application.
 - 4a) Of the above claim(s) _____ is/are withdrawn from consideration.
- 5) Claim(s) _____ is/are allowed.
- 6) Claim(s) 11,14-16,18-21,23,26,27,29,31,32 and 34-39 is/are rejected.
- 7) Claim(s) _____ is/are objected to.
- 8) Claim(s) _____ are subject to restriction and/or election requirement.

Application Papers

- 9) The specification is objected to by the Examiner.
- 10) The drawing(s) filed on 01 September 2004 is/are: a) accepted or b) objected to by the Examiner. Applicant may not request that any objection to the drawing(s) be held in abeyance. See 37 CFR 1.85(a). Replacement drawing sheet(s) including the correction is required if the drawing(s) is objected to. See 37 CFR 1.121(d).
- 11) The oath or declaration is objected to by the Examiner. Note the attached Office Action or form PTO-152.

Priority under 35 U.S.C. § 119

- 12) Acknowledgment is made of a claim for foreign priority under 35 U.S.C. § 119(a)-(d) or (f).
 - a) All b) Some * c) None of:
 - 1. Certified copies of the priority documents have been received.
 - 2. Certified copies of the priority documents have been received in Application No. _____.
 - 3. Copies of the certified copies of the priority documents have been received in this National Stage application from the International Bureau (PCT Rule 17.2(a)).

* See the attached detailed Office action for a list of the certified copies not received.

Attachment(s)

- 1) Notice of References Cited (PTO-892)
- 2) Notice of Draftsperson's Patent Drawing Review (PTO-948)
- 3) Information Disclosure Statement(s) (PTO-1449 or PTO/SB/08)
Paper No(s)/Mail Date _____
- 4) Interview Summary (PTO-413)
Paper No(s)/Mail Date. _____
- 5) Notice of Informal Patent Application (PTO-152)
- 6) Other: _____

Art Unit: 2686

DETAILED ACTION

1. This Action is in response Applicant's amendment filed on September 1, 2004. **Claims 11, 14-16, 18-21, 23, 26, 27, 29, 31, 32, and 34-39** are now pending in the present application. **This Action is made FINAL.**

Drawings

2. The replacement drawing sheets received via facsimile transmission on September 1, 2004 are acknowledged by the Examiner. However, replacement drawing sheets submitted via facsimile transmission are not acceptable due to their poor quality. The Examiner suggests the Applicant to mail the replacement drawing sheets to the Office.

3. Corrected drawing sheets in compliance with 37 CFR 1.121(d) are required in reply to the Office Action to avoid abandonment of the application. Any amended replacement drawing sheet should include all of the figures appearing on the immediate prior version of the sheet, even if only one figure is being amended. The figure or figure number of an amended drawing should not be labeled as "amended". If a drawing figure is to be canceled, the appropriate figure must be removed from the replacement sheet, and where necessary, the remaining figures must be renumbered and appropriate changes made to the brief description of the several views of the drawings for consistency. Additional replacement sheets may be necessary to show the renumbering of the remaining figures. The replacement sheet(s) should be labeled "Replacement

Art Unit: 2686

Sheet” in the page header (as per 37 CFR 1.84(c)) so as not to obstruct any portion of the drawing figures. If the changes are not accepted by the Examiner, the Applicant will be notified and informed of any required corrective action in the next Office Action. If a response to the present Office Action fails to include proper drawing corrections, corrected drawings or arguments therefor, the response can be held **NON-RESPONSIVE** and/or the application could be **ABANDONED** since the objections/corrections to the drawings are no longer held in abeyance.

Claim Objections

4. **Claims 14, 21, and 23** are objected to because of the following informalities:
- a) On **lines 2 and 3** of **claim 14**, insert --web-- before “browsing”;
 - b) On **line 2** of **claim 21**, replace “communications” with --communication-- after “short-range”; and
 - c) On **line 2** of **claim 23**, replace ““Bluetooth”” with --Bluetooth-- after “a”.
- Appropriate correction is required.

Claim Rejections - 35 USC § 103

5. The following is a quotation of 35 U.S.C. 103(a) which forms the basis for all obviousness rejections set forth in this Office Action:

(a) A patent may not be obtained though the invention is not identically disclosed or described as set forth in

Art Unit: 2686

section 102 of this title, if the differences between the subject matter sought to be patented and the prior art are such that the subject matter as a whole would have been obvious at the time the invention was made to a person having ordinary skill in the art to which said subject matter pertains. Patentability shall not be negated by the manner in which the invention was made.

This application currently names joint inventors. In considering patentability of the claims under 35 U.S.C. 103(a), the Examiner presumes that the subject matter of the various claims was commonly owned at the time any inventions covered therein were made absent any evidence to the contrary. Applicant is advised of the obligation under 37 CFR 1.56 to point out the inventor and invention dates of each claim that was not commonly owned at the time a later invention was made in order for the Examiner to consider the applicability of 35 U.S.C. 103(c) and potential 35 U.S.C. 102(e), (f) or (g) prior art under 35 U.S.C. 103(a).

The factual inquiries set forth in *Graham v. John Deere Co.*, 383 U.S. 1, 148 USPQ 459 (1966), that are applied for establishing a background for determining obviousness under 35 U.S.C. 103(a) are summarized as follows:

1. Determining the scope and contents of the prior art.
 2. Ascertaining the differences between the prior art and the claims at issue.
 3. Resolving the level of ordinary skill in the pertinent art.
 4. Considering objective evidence present in the application indicating obviousness or nonobviousness.
6. **Claims 11, 14-16, 18-20, 23, 26, 27, 29, 31, 32, and 34-39** are rejected under 35 U.S.C. 103(a) as being unpatentable over **Baughan (U.S. Patent # 6,510,210 B1)** in view of **Shanahan (U.S. Patent # 6,496,692 B1)**, both newly cited.

Consider **claim 11**, Baughan clearly shows and discloses a method for communicating selected audio information (e.g., MP3 audio files (column 2 lines 50-52, column 3 lines 33-39, and column 4 lines 4-9) to a consumer (electronic) device 10, 30, 50 (figures 2, 3 and 5), the

Art Unit: 2686

method comprising:

maintaining data (e.g., music titles) associated with selectable audio information (e.g., MP3 audio files) (column 3 lines 33-39 and column 5 lines 20-27);

communication information associated with the selectable audio information (e.g., a menu and menu item selection data associated with, for example, MP3 files) for presentation within a graphical user interface (GUI) of a web browser (i.e., the consumer (electronic) device 10, 30, 50 includes a display screen and selections buttons (reads on the GUI) that allow the user to browse through the selectable audio information located in a remote application server 21 (figure 2) (reads on the web browser) and select the desired information) (figures 2, 3, and 5, column 2 lines 3-9 and 36-41, column 3 lines 24-53, column 4 lines 36-51 and 58-63, column 5 lines 36-45, column 6 lines 52-59, and column 7 lines 23-38);

receiving an input from a user identifying the selected audio information (e.g., selection of an MP file) (column 2 lines 47-56, column 3 line 66 - column 4 line 17, column 4 lines 30-51 and 58-63, and column 5 lines 36-45), the selected audio information comprising a MP3 music file configure to be stored within a store (memory) of the consumer (electronic) device 10, 30, 50 operable to play and pause the MP3 music file in response to an incoming telephone call (figures 2, 3, and 5, column 2 lines 47-56, column 4 lines 30-51, column 4 line 58 - column 5 line 2, and column 6 lines 52-67);

receiving information identifying the consumer (electronic) device 10, 30, 50 (e.g., subscription information that validates the user's access to the selected audio information) (column 4 lines 21-29 and column 5 lines 20-27 and 46-49);

Art Unit: 2686

initiating wireless communication of the selected audio information (e.g., selected MP3 files) to the consumer (electronic) device 10, 30, 50 (column 1 lines 43-65, column 2 lines 36-41, column 3 lines 24-39, column 4 lines 30-51, and column 5 lines 3-45).

Although, Baughan further discloses that the consumer (electronic) device 10, 30, 50 can be a combined mobile (cellular) telephone/MP3 player (column 1 lines 13-22, column 2 lines 48-59, and column 7 lines 12-42), Baughan does not specifically disclose that the incoming telephone call is an incoming cellular telephone call.

In the same field of endeavor, Shanahan clearly show and discloses an electronic device operable to play a music file in response to an incoming wireless (cellular) telephone call (abstract, figures 1 and 5-7, column 2 line 65 - column 3 line 40, column 7 line 60 - column 8 line 5, column 8 line 64 - column 9 line 2, and column 9 line 61 - column 10 line 17).

Therefore, it would have been obvious to a person of ordinary skill in the art at the time the invention was made to, in response to an incoming cellular telephone call as taught by Shanahan, play and pause a music file in the device taught by Baughan for the purpose of answering an incoming cellular telephone call.

Consider **claim 14**, and **as applied to claim 11 above**, Baughan, as modified by Shanahan, further disclose that the interface operates in the web browsing environment (i.e., since the MP3 audio files are stored in remote application server 21) and the wireless communication operates outside the browsing environment (figures 2, 3, and 5, column 2 lines 3-9 and 36-41, column 3 lines 24-53, column 4 lines 36-51 and 58-63, column 5 lines 36-45, column 6 lines 52-59, and column 7 lines 23-38) and the music file has an MP3 format (column

Art Unit: 2686

2 lines 51-53 and column 3 lines 33-39).

Consider **claim 15**, and **as applied to claim 11 above**, Baughan clearly shows and discloses the claimed invention except that the wireless communication comprises communicating via a cellular communications network.

In the same field of endeavor, Shanahan clearly show and discloses an electronic device operable to download selected audio information (e.g., music files) via a wireless (cellular) communications network (column 2 line 65 - column 3 line 40).

Therefore, it would have been obvious to a person of ordinary skill in the art at the time the invention was made to communicate the selected audio information via a cellular communications network as taught by Shanahan in the method taught by Baughan for the purpose of providing the selected audio information to cellular telephone subscribers.

Consider **claims 16, 29, and 32**, Baughan clearly shows and discloses a consumer (electronic) device 10, 30, 50 (figures 2, 3 and 5) for receiving selected audio information (e.g., MP3 audio files or MP3 streaming audio (reads on claims 29 and 32)) (column 2 lines 50-52, column 3 lines 33-39, and column 4 lines 4-9) via wireless communication (column 3 lines 24-39 and column 4 lines 30-51), the consumer (electronic) device 10, 30, 50 comprising:

a short-range RF communication module 102 operably coupled to a processor module (i.e., media agents 103 and device controllers 105) (figures 2 and 3, column 3 lines 24-39 and 44-53, and column 4 lines 30-35);

a store (storage medium) (figures 2 and 3) operable to store selected audio information that comprises an MP3 audio file (column 2 lines 47-56 and column 4 lines 30-51);

Art Unit: 2686

the processor module (i.e., media agents 103 and device controllers 105) (figures 2 and 3) coupled to the store (storage medium) and operable to stop an in process playing of the MP audio file in response to receiving an incoming telephone call (column 4 line 58 - column 5 line 2); and a display operable to display a web browser within a user interface 101 (figures 2 and 3, column 2 lines 3-9 and 36-41, column 3 lines 24-53, column 4 lines 36-51 and 58-63, column 5 lines 36-45, column 6 lines 52-59, and column 7 lines 23-38).

Although, Baughan further discloses that the consumer (electronic) device 10, 30, 50 can be a combined mobile (cellular) telephone/MP3 player (column 1 lines 13-22, column 2 lines 48-59, and column 7 lines 12-42), Baughan does not specifically disclose a long-range communication module operable to receive wireless communication information.

In the same field of endeavor, Shanahan clearly show and discloses an electronic device 500 comprising, among other components, a receiver/transmitter circuit 520 (long-range communication module) operable to receive wireless communication information (figure 7 and column 9 line 61 - column 10 line 21).

Therefore, it would have been obvious to a person of ordinary skill in the art at the time the invention was made to incorporate a long-range communication module as taught by Shanahan in the device taught by Baughan for the purpose of providing cellular telephone communications.

Consider **claim 18**, and **as applied to claim 16 above**, Baughan clearly shows and discloses the claimed invention except that the processor is operable to play a different audio file in response to receiving the incoming telephone call.

Art Unit: 2686

In the same field of endeavor, Shanahan clearly show and discloses an electronic device operable to play different music (audio) files in response to receiving incoming telephone calls in order to identify callers (abstract, figures 1 and 5-7, column 2 line 65 - column 3 line 40, column 7 line 60 - column 8 line 5, column 8 line 64 - column 9 line 2, and column 9 line 61 - column 10 line 17).

Therefore, it would have been obvious to a person of ordinary skill in the art at the time the invention was made to play a different audio file in response to receiving an incoming telephone call as taught by Shanahan in the device taught by Baughan for the purpose of identify a caller.

Consider **claim 19**, and **as applied to claim 16 above**, Baughan, as modified by Shanahan, further disclose that the processor module (i.e., media agents 103 and device controllers 105) (figures 2 and 3) outputs an audio signal indirectly to an audio speaker in connection with playing the audio file (figures 2 and 3, column 2 lines 48-56, column 3 lines 44-53, and column 4 lines 30-51).

Consider **claim 20**, and **as applied to claim 16 above**, since the device 10, 30 of Baughan, as modified by Shanahan, has music playing capabilities (column 2 lines 48-56 and column 4 lines 58-67), it is clearly inherent that software for processing the selected information is included in the device 10, 30.

Consider **claim 23**, and **as applied to claim 16 above**, Baughan, as modified by Shanahan, further disclose that the short-range RF communication module 102 is operable with the Bluetooth communication standard (column 3 lines 24-39 and column 4 lines 30-35).

Art Unit: 2686

Consider **claims 26 and 27**, and **as applied to claim 16 above**, Baughan, as modified by Shanahan, further disclose that the consumer (electronic) device 10, 30, 50 (figures 2, 3, and 5) is a cordless (wireless) telephone operable to communicate with a short-range RF communication network such as DECT (column 3 lines 24-39, column 4 lines 30-35 and 58-67, and column 6 lines 52-67).

Consider **claim 31**, and **as applied to claim 26 above**, Baughan, as modified by Shanahan, discloses the claimed invention except that the long-range communication module is operable to receive the incoming telephone call.

In the same field of endeavor, Shanahan also show and discloses an electronic device 500 comprising, among other components, a receiver/transmitter circuit 520 (long-range communication module) operable to receive an incoming telephone call (figure 7 and column 9 line 61 - column 10 line 21).

Therefore, it would have been obvious to a person of ordinary skill in the art at the time the invention was made to receive the incoming telephone call via a long-range communication module as taught by Shanahan in the device taught by Baughan for the purpose of providing cellular telephone communications.

Consider **claims 34 and 36**, Baughan clearly shows and discloses a consumer (electronic) device 10, 30, 50 (figures 2, 3 and 5) for communicating selected audio information (e.g., MP3 audio files) (column 2 lines 50-52, column 3 lines 33-39, and column 4 lines 4-9) via wireless communication (column 3 lines 24-39 and column 4 lines 30-51), the consumer (electronic) device 10, 30, 50 comprising:

Art Unit: 2686

a short-range RF communication module 102 operable to communicate at about 2.4 GHz (inherent since it communicates using Bluetooth) (figures 2 and 3, column 3 lines 24-39 and 44-53, and column 4 lines 30-35);

a store (storage medium) (figures 2 and 3) operably coupled to a communication module 102 and operable to store the selected audio information (column 2 lines 47-56 and column 4 lines 30-51); and

the processor module (i.e., media agents 103 and device controllers 105) (figures 2 and 3) operable to alter a playing of the selected audio information in association with an incoming telephonic communication (column 4 line 58 - column 5 line 2),

wherein the store (storage medium) and the short-range RF communication module 102 are encased within the device 10, 30 (figures 2 and 3 and column 3 lines 24-53).

Although, Baughan further discloses that the consumer (electronic) device 10, 30, 50 can be a combined mobile (cellular) telephone/MP3 player (column 1 lines 13-22, column 2 lines 48-59, and column 7 lines 12-42), Baughan does not specifically disclose that the communication module is a long-range RF communication module.

In the same field of endeavor, Shanahan clearly show and discloses an electronic device 500 comprising, among other components, a receiver/transmitter circuit 520 (long-range communication module) coupled to a memory (not shown) through a processor 530 (figure 7 and column 9 line 61 - column 10 line 21).

Therefore, it would have been obvious to a person of ordinary skill in the art at the time the invention was made to incorporate a long-range communication module as taught by

Art Unit: 2686

Shanahan in the device taught by Baughan for the purpose of providing cellular telephone communications.

Consider **claim 35**, and **as applied to claim 34 above**, Baughan, as modified by Shanahan, further disclose that the consumer (electronic) device 10, 30, 50 (figures 2, 3, and 5) comprises a display operable to display a web browser (user interface) within a user interface hardware 101 operably associated with a web browsing environment (figures 2 and 3, column 2 lines 3-9 and 36-41, column 3 lines 24-53, column 4 lines 36-51 and 58-63, column 5 lines 36-45, column 6 lines 52-59, and column 7 lines 23-38).

Consider **claim 37**, and **as applied to claim 36 above**, Baughan, as modified by Shanahan, further disclose that the device 10, 30, 50 is operable to pause the selected audio information at a time subsequent to receiving the incoming telephonic communication (column 4 line 58 - column 5 line 2).

Consider **claim 38**, and **as applied to claim 36 above**, Baughan, as modified by Shanahan, further disclose that the device 10, 30, 50 further comprises:

a display operable to display a user interface within a user interface hardware 101 (figures 2 and 3, column 2 lines 3-9 and 36-41, column 3 lines 24-53, column 4 lines 36-51 and 58-63, column 5 lines 36-45, column 6 lines 52-59, and column 7 lines 23-38); and

wherein the selected audio information includes an MP3 audio file received and stored within the store (storage medium) prior to receiving the incoming telephonic communication (column 2 lines 47-56, column 4 lines 30-51, column 4 line 58 - column 5 line 2, and column 6 lines 52-67).

Art Unit: 2686

However, Baughan does not specifically disclose that the selected audio information is received via the long-range RF communication module.

In the same field of endeavor, Shanahan also show and discloses an electronic device 500 comprising, among other components, a receiver/transmitter circuit 520 (long-range communication module) operable to receive selected audio information to be stored in a memory (not shown) for subsequent use (figure 7 and column 9 line 61 - column 10 line 39).

Therefore, it would have been obvious to a person of ordinary skill in the art at the time the invention was made to incorporate a long-range communication module as taught by Shanahan in the device taught by Baughan for the purpose of receiving the selected audio information via cellular telephone communications.

Consider **claim 39**, and **as applied to claim 34 above**, Baughan clearly shows and discloses the claimed invention except that the processor module is further operable to start a playing of a different audio file in connection with receiving an indication of the incoming telephonic communication.

In the same field of endeavor, Shanahan clearly show and discloses an electronic device operable to play different music (audio) files in response to receiving incoming telephone calls in order to identify callers (abstract, figures 1 and 5-7, column 2 line 65 - column 3 line 40, column 7 line 60 - column 8 line 5, column 8 line 64 - column 9 line 2, and column 9 line 61 - column 10 line 17).

Therefore, it would have been obvious to a person of ordinary skill in the art at the time the invention was made to play a different audio file in response to receiving an incoming

Art Unit: 2686

telephone call as taught by Shanahan in the device taught by Baughan for the purpose of identify a caller.

7. **Claim 21** is rejected under 35 U.S.C. 103(a) as being unpatentable over **Baughan (U.S. Patent # 6,510,210 B1)** in view of **Shanahan (U.S. Patent # 6,496,692 B1)** as applied to **claim 16 above**, and further in view of **well known prior art (MPEP 2144.03)**.

Consider **claim 21**, and **as applied to claim 16 above**, Baughan, as modified by Shanahan, clearly show and disclose the claimed invention except that the short-range RF communication module 102 (figures 2 and 3) is operable to scan frequencies.

However, the Examiner takes Official Notice of the fact that short-range RF communication modules such as Bluetooth are well known in the art to operate by scanning frequencies for the purpose of locating an available frequency channel.

Therefore, it would have been obvious to a person of ordinary skill in the art at the time the invention was made to slightly modify the device of Baughan, as modified by Shanahan, to allow the short-range RF communication module to scan frequencies for purpose of locating an available frequency channel.

Response to Arguments

8. Applicant's arguments with respect to **claims 11, 16, and 34** have been considered but are moot in view of the new ground(s) of rejection.

Art Unit: 2686

Conclusion

9. Applicant's amendment necessitated the new ground(s) of rejection presented in this Office Action. Accordingly, **THIS ACTION IS MADE FINAL**. See MPEP § 706.07(a).

Applicant is reminded of the extension of time policy as set forth in 37 CFR 1.136(a).

A shortened statutory period for reply to this final action is set to expire **THREE MONTHS** from the mailing date of this action. In the event a first reply is filed within **TWO MONTHS** of the mailing date of this final action and the advisory action is not mailed until after the end of the **THREE-MONTH** shortened statutory period, then the shortened statutory period will expire on the date the advisory action is mailed, and any extension fee pursuant to 37 CFR 1.136(a) will be calculated from the mailing date of the advisory action. In no event, however, will the statutory period for reply expire later than **SIX MONTHS** from the date of this final action.

10. Any response to this Office Action should be **faxed to (703) 872-9306 or mailed to:**

Commissioner for Patents
P.O. Box 1450
Alexandria, VA 22313-1450

Hand-delivered responses should be brought to

Customer Service Window
Randolph Building
401 Dulany Street
Alexandria, VA 22314

Art Unit: 2686

11. Any inquiry concerning this communication or earlier communications from the Examiner should be directed to Rafael Perez-Gutierrez whose telephone number is (703) 308-8996. The Examiner can normally be reached on Monday-Thursday from 6:30am to 5:00pm.

If attempts to reach the Examiner by telephone are unsuccessful, the Examiner's supervisor, Marsha D. Banks-Harold can be reached on (703) 305-4379. The fax phone number for the organization where this application or proceeding is assigned is (703) 872-9306.

Information regarding the status of an application may be obtained from the Patent Application Information Retrieval (PAIR) system. Status information for published applications may be obtained from either Private PAIR or Public PAIR. Status information for unpublished applications is available through Private PAIR only. For more information about the PAIR system, see <http://pair-direct.uspto.gov>. Should you have questions on access to the Private PAIR system, contact the Electronic Business Center (EBC) at 866-217-9197 (toll-free).

Any inquiry of a general nature or relating to the status of this application or proceeding should be directed to the receptionist whose telephone number is (703) 305-4700 or call customer service at (703) 306-0377.

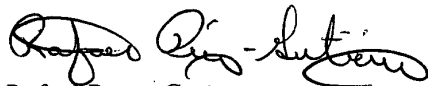

Rafael Perez-Gutierrez
R.P.G./rpg **RAFAEL PEREZ-GUTIERREZ**
PATENT EXAMINER

February 5, 2005

Notice of References Cited	Application/Control No. 09/537,812	Applicant(s)/Patent Under Reexamination White et al.	
	Examiner Rafael Perez-Gutierrez	Art Unit 2686	Page 1 of 1

U.S. PATENT DOCUMENTS

*	Document Number Country Code-Number-Kind Code	Date MM-YYYY	Name	Classification
A	US-6,496,692 B1	12-2002	Shanahan	455/418
B	US-6,510,210 B1	01-2003	Baughan	379/90.01
C	US-2003/0008646 A1	01-2003	Shanahan	455/418
D	US-2005/0010633 A1	01-2005	Shanahan	709/200
E	US-			
F	US-			
G	US-			
H	US-			
I	US-			
J	US-			
K	US-			
L	US-			
M	US-			

FOREIGN PATENT DOCUMENTS

*	Document Number Country Code-Number-Kind Code	Date MM-YYYY	Country	Name	Classification
N					
O					
P					
Q					
R					
S					
T					

NON-PATENT DOCUMENTS

*	Include as applicable: Author, Title Date, Publisher, Edition or Volume, Pertinent Pages)
U	
V	
W	
X	

*A copy of this reference is not being furnished with this Office action. (See MPEP § 707.05(a).)
Dates in MM-YYYY format are publication dates. Classifications may be US or foreign.

ISSUE SI IP STAPLE AREA (for additional cross references)

POSITION	INITIALS	ID NO.	DATE
FEE DETERMINATION	LW	108904	4/4/00
O.I.P.E. CLASSIFIER			
FORMALITY REVIEW	M.M. P. K. S.		5-30-00
RESPONSE FORMALITY REVIEW			

NOT AVAILABLE COPY

INDEX OF CLAIMS

- ✓ Rejected
- u Allowed
- (Through numeral) Canceled
- + Restricted
- N Non-elected
- I Interference
- A Appeal
- O Objected

Claim	Final	Original	Date
1	X	X	1/10/00
2	X	X	1/10/00
3	X	X	1/10/00
4	X	X	1/10/00
5	X	X	1/10/00
6	X	X	1/10/00
7	X	X	1/10/00
8	X	X	1/10/00
9	X	X	1/10/00
10	X	X	1/10/00
11	X	X	1/10/00
12	X	X	1/10/00
13	X	X	1/10/00
14	X	X	1/10/00
15	X	X	1/10/00
16	X	X	1/10/00
17	X	X	1/10/00
18	X	X	1/10/00
19	X	X	1/10/00
20	X	X	1/10/00
21	X	X	1/10/00
22	X	X	1/10/00
23	X	X	1/10/00
24	X	X	1/10/00
25	X	X	1/10/00
26	X	X	1/10/00
27	X	X	1/10/00
28	X	X	1/10/00
29	X	X	1/10/00
30	X	X	1/10/00
31	X	X	1/10/00
32	X	X	1/10/00
33	X	X	1/10/00
34	X	X	1/10/00
35	X	X	1/10/00
36	X	X	1/10/00
37	X	X	1/10/00
38	X	X	1/10/00
39	X	X	1/10/00
40	X	X	1/10/00
41	X	X	1/10/00
42	X	X	1/10/00
43	X	X	1/10/00
44	X	X	1/10/00
45	X	X	1/10/00
46	X	X	1/10/00
47	X	X	1/10/00
48	X	X	1/10/00
49	X	X	1/10/00
50	X	X	1/10/00

Claim	Final	Original	Date
51			
52			
53			
54			
55			
56			
57			
58			
59			
60			
61			
62			
63			
64			
65			
66			
67			
68			
69			
70			
71			
72			
73			
74			
75			
76			
77			
78			
79			
80			
81			
82			
83			
84			
85			
86			
87			
88			
89			
90			
91			
92			
93			
94			
95			
96			
97			
98			
99			
100			

Claim	Final	Original	Date
101			
102			
103			
104			
105			
106			
107			
108			
109			
110			
111			
112			
113			
114			
115			
116			
117			
118			
119			
120			
121			
122			
123			
124			
125			
126			
127			
128			
129			
130			
131			
132			
133			
134			
135			
136			
137			
138			
139			
140			
141			
142			
143			
144			
145			
146			
147			
148			
149			
150			

If more than 150 claims or 10 actions staple additional sheet here

11 SET INSIDE

T AVAILABLE COPY

SEARCHED			
Class	Sub.	Date	Exmr.
455	412.1	7/16/02	ART
	414.1		
	556.1		
	Expanded done search 4/28/05		ART
	updated search	5/17/04	R.P.G.
455	3.01	5/17/04	R.P.G.
	3.03	5/17/04	R.P.G.
	3.04	5/17/04	R.P.G.
	410	5/17/04	R.P.G.
	411	5/17/04	R.P.G.
	414.2	5/17/04	R.P.G.
	414.3	5/17/04	R.P.G.
	517	5/17/04	R.P.G.
	41.2	3/17/04	R.P.G.
	556.2	5/17/04	R.P.G.
709	217	5/17/04	R.P.G.
	218	5/17/04	R.P.G.
	219	5/17/04	R.P.G.
	Updated search	2/17/05	R.P.G.

INTERFERENCE SEARCHED			
Class	Sub.	Date	Exmr.

SEARCH NOTES (INCLUDING SEARCH STRATEGY)		
	Date	Exmr.
Also performed various keyword searches. See search enclosed for details	7/11/02	ART
EAST image and keyword search in USPAT, US-PGRAS, DERWEAST, IPO, JP00, EISA, TDA	5/17/04	R.P.G.
WIPO database http://ip.espacenet.com	5/17/04	R.P.G.
EPO Database http://ip.espacenet.com	5/17/04	R.P.G.
IEEE Xplore http://ieeexplore.ieee.org Xplore/Doc/Wat.jpg	5/17/04	R.P.G.
Inventor names search in PALM EPO and EAST	5/17/04	R.P.G.

(RIGHT OUTSIDE)

Ref #	Hits	Search Query	DBs	Default Operator	Plurals	Time Stamp
S1	13	((audio adj file with (wireless or RF)) and Internet and (GUI or (graphical adj user adj interface)) and (@rlad<"20000328" or @ad<"200003828"))	US-PGPUB; USPAT; EPO; JPO; DERWENT; IBM_TDB	OR	ON	2004/05/18 08:40
S2	4	((("20040002904") or ("20040002359") or ("20040006769") or ("20040005039"))).PN.	US-PGPUB; USPAT; USOCR; EPO; JPO; DERWENT; IBM_TDB	OR	OFF	2004/01/28 17:48
S3	1	gantt.xa. and (xm or satellite).as.	US-PGPUB; USPAT; EPO; JPO; DERWENT; IBM_TDB	OR	ON	2004/05/17 07:41
S4	64	(xm near2 satellite).as.	US-PGPUB; USPAT; EPO; JPO; DERWENT; IBM_TDB	OR	ON	2004/05/17 09:25
S5	55	((wireless or RF) same (download\$3 with (audio or mp3 or music))) and (Internet or server or web) and ((graphical adj2 interface) or GUI) and brows\$3	US-PGPUB; USPAT; EPO; JPO; DERWENT; IBM_TDB	OR	ON	2004/05/17 09:30
S6	11	((((wireless or RF) same (download\$3 with (audio or mp3 or music))) and (Internet or server or web) and ((graphical adj2 interface) or GUI) and brows\$3) and (@rlad<"20000328" or @ad<"20000328"))	US-PGPUB; USPAT; EPO; JPO; DERWENT; IBM_TDB	OR	ON	2005/01/27 07:57
S7	36	(russell near2 white).in. or (kevin near2 imes).in.	US-PGPUB; USPAT; EPO; JPO; DERWENT; IBM_TDB	OR	ON	2004/05/17 13:01

S8	41	gsm with "2.0 GHZ"		OR	ON	2004/05/17 14:19
S9	41	(gsm with "2.0 GHZ") and (@rlad<"20000328" or @ad<"200003828")	US-PGPUB; USPAT; EPO; JPO; DERWENT; IBM_TDB	OR	ON	2005/01/27 13:33
S10	2	"6247130".uref.	US-PGPUB; USPAT; EPO; JPO; DERWENT; IBM_TDB	OR	ON	2004/05/17 15:59
S11	2	"6247130".pn.	US-PGPUB; USPAT; EPO; JPO; DERWENT; IBM_TDB	OR	ON	2004/05/17 15:59
S12	3	("5991399" "6009410" "6038595").PN.	USPAT	OR	ON	2004/05/17 15:59
S13	3	((("6587835" or ("6014569" or ("6247130"))).PN.	USPAT; USOCR	OR	OFF	2004/05/18 08:40
S14	101	((music or audio or mp3 or wav) near3 play\$3) with ((incoming adj2 (call or communication)) or (call near2 alert\$3))	US-PGPUB; USPAT; EPO; JPO; DERWENT; IBM_TDB	OR	ON	2005/01/27 09:03
S15	37	S14 and (@rlad<"20000328" or @ad<"20000328")	US-PGPUB; USPAT; EPO; JPO; DERWENT; IBM_TDB	OR	ON	2005/01/27 09:05
S16	3	((("20030008646" or ("6496692"))).PN.	US-PGPUB; USPAT; EPO; JPO; DERWENT; IBM_TDB	OR	OFF	2005/01/27 08:15

S17	2	("6496692").URPN.							2005/01/27 08:49
S18	80	("5414444" "5461666" "5479510" "5481599" "5483580" "5483581" "5485370" "5486686" "5487671" "5490210" "5490251" "5499288" "5510777" "5513272" "5517605" "5526620" "5530852" "5533115" "5534855" "5537586" "5542046" "5544255" "5544322" "5548726" "5550976" "5551021" "5572571" "5583763" "5598461" "5606597" "5608786" "5612682" "5613012" "5623531" "5661802" "5687227" "5689825" "5727047" "5732216" "5796728" "5799063" "5828956" "5835495" "5842124" "5884262" "5915001" "5926756" "5930703" "5933328" "5940752" "5940775" "5948059" "5952918" "5953638" "5999094" "5999599" "6002761" "6018654" "6018656" "6035018" "6035189" "6058161" "6073003" "6088730" "6091947" "6094587" "6101242" "6122526" "6137525" "6144722" "6167130" "6167278" "6179682" "6219413" "6222838" "6226532" "6229990" "6243375" "6256378" "6366791"),PN.	USPAT US-PGPUB; USPAT; USOCR	OR OR	ON ON	2005/01/27 08:51			
S19	202	combin\$6 with ((music or audio or mp3 or wav) near3 play\$3) with (telephone or phone)							2005/01/27 09:09
S20	34	S19 and (@rlad<"20000328" or @ad<"20000328")							2005/01/27 09:42
S21	85	((music or audio or mp3 or wav) near3 play\$3) with (telephone or phone)) same ((incoming adj2 (call or communication)) or (call near2 alert\$3))							2005/01/27 09:23
S23	30	S21 and (@rlad<"20000328" or @ad<"20000328")							2005/01/27 09:26

S24	4077	((music or audio or mp3 or wav) near3 play\$3) with (telephone or phone)	US-PGPUB; USPAT; EPO; JPO; DERWENT; IBM_TDB	OR	ON	2005/01/27 09:40
S25	4	S24 and ((stop\$4 or paus\$5 or alter\$3) near3 (music or audio or mp3)) with ((incoming adj2 (call or communication)) or (call near2 alert\$3))	US-PGPUB; USPAT; EPO; JPO; DERWENT; IBM_TDB	OR	ON	2005/01/27 09:41
S26	1	S25 and (@rlad<"20000328" or @ad<"20000328")	US-PGPUB; USPAT; EPO; JPO; DERWENT; IBM_TDB	OR	ON	2005/01/27 09:26
S27	1	anvekar.in. and 455/560.ccis.	US-PGPUB; USPAT; EPO; JPO; DERWENT; IBM_TDB	OR	ON	2005/01/27 09:34
S28	3877	((music or audio or mp3 or wav) near3 play\$3) with ((portable or mobile or cellular or radio or wireless or handheld) adj3 (station or device or terminal or telephone or phone))	US-PGPUB; USPAT; EPO; JPO; DERWENT; IBM_TDB	OR	ON	2005/01/27 09:40
S29	4	S28 and ((stop\$4 or paus\$5 or alter\$3) near3 (music or audio or mp3)) with ((incoming adj2 (call or communication)) or (call near2 alert\$3))	US-PGPUB; USPAT; EPO; JPO; DERWENT; IBM_TDB	OR	ON	2005/01/27 09:41
S30	5	S28 and ((stop\$4 or paus\$5 or alter\$3) near5 (music or audio or mp3)) with ((incoming adj2 (call or communication)) or (call near2 alert\$3))	US-PGPUB; USPAT; EPO; JPO; DERWENT; IBM_TDB	OR	ON	2005/01/27 09:43

S31	1	S30 and (@rld<"20000328" or @ad<"20000328")	US-PGPUB; USPAT; EPO; JPO; DERWENT; IBM_TDB	OR	ON	2005/01/27 09:43
S32	34	S28 and ((stop\$4 or paus\$5 or alter\$3) near5 (music or audio or mp3)) with (call or communication)	US-PGPUB; USPAT; EPO; JPO; DERWENT; IBM_TDB	OR	ON	2005/01/27 10:40
S33	2	S32 and (@rld<"20000328" or @ad<"20000328")	US-PGPUB; USPAT; EPO; JPO; DERWENT; IBM_TDB	OR	ON	2005/01/27 09:43
S34	1	("6510210").URPN.	USPAT	OR	ON	2005/01/27 10:01
S35	5	("5802467" "5901366" "5963624" "6192340" "6223029").PN.	US-PGPUB; USPAT; USOCR	OR	ON	2005/01/27 10:02
S36	34	S20 and (@rld<"20000328" or @ad<"20000328")	US-PGPUB; USPAT; EPO; JPO; DERWENT; IBM_TDB	OR	ON	2005/01/27 10:37
S37	4631	((stop\$4 or paus\$5 or alter\$3) near5 (music or audio or mp3)) and (@rld<"20000328" or @ad<"20000328")	US-PGPUB; USPAT; EPO; JPO; DERWENT; IBM_TDB	OR	ON	2005/01/27 11:09
S38	1	S37 and 455/567.ccls.	US-PGPUB; USPAT; EPO; JPO; DERWENT; IBM_TDB	OR	ON	2005/01/27 10:47

S39	2	("6167253").PN.		US-PGPUB; USPAT; EPO; JPO; DERWENT; IBM_TDB	OR	OFF	2005/01/27 10:57
S40	2	("6407750").PN.		US-PGPUB; USPAT; EPO; JPO; DERWENT; IBM_TDB	OR	OFF	2005/01/27 10:59
S41	6	((("6014569") or ("6496205") or ("6088730"))).PN.		US-PGPUB; USPAT; EPO; JPO; DERWENT; IBM_TDB	OR	OFF	2005/01/27 11:02
S42	8056	((stop\$4 or paus\$5 or alter\$3) with (music or audio or mp3)) and (@rlad<"20000328" or @ad<"20000328")		US-PGPUB; USPAT; EPO; JPO; DERWENT; IBM_TDB	OR	ON	2005/01/27 11:10
S43	183	((stop\$4 or paus\$5 or alter\$3) with (music or audio or mp3) with call) and (@rlad<"20000328" or @ad<"20000328")		US-PGPUB; USPAT; EPO; JPO; DERWENT; IBM_TDB	OR	ON	2005/01/27 11:11
S44	102	((stop\$4 or paus\$5 or alter\$3) near5 (music or audio or mp3)) with call) and (@rlad<"20000328" or @ad<"20000328")		US-PGPUB; USPAT; EPO; JPO; DERWENT; IBM_TDB	OR	ON	2005/01/27 11:12
S45	3877	((music or audio or mp3 or wav) near3 play\$3) with ((portable or mobile or cellular or radio or wireless or handheld) adj3 (station or device or terminal or telephone or phone))		US-PGPUB; USPAT; EPO; JPO; DERWENT; IBM_TDB	OR	ON	2005/01/27 13:33

S46	29	S45 and (455/556.1-556.2.ccls.)	US-PGPUB; USPAT; EPO; JPO; DERWENT; IBM_TDB	OR	ON	2005/01/27 13:57
S47	1	S46 and (@rlad<"20000328" or @ad<"20000328")	US-PGPUB; USPAT; EPO; JPO; DERWENT; IBM_TDB	OR	ON	2005/01/27 13:33

BEST AVAILABLE COPY

PATENT APPLICATION FEE DETERMINATION RECORD
Effective October 1, 2003

Application or Docket Number
09/537812

CLAIMS AS FILED - PART I

	(Column 1)	(Column 2)
TOTAL CLAIMS		
FOR	NUMBER FILED	NUMBER EXTRA
TOTAL CHARGEABLE CLAIMS	minus 20 = *	*
INDEPENDENT CLAIMS	minus 3 = *	*
MULTIPLE DEPENDENT CLAIM PRESENT <input type="checkbox"/>		

SMALL ENTITY TYPE <input type="checkbox"/>		OR	OTHER THAN SMALL ENTITY	
RATE	FEE		RATE	FEE
BASIC FEE	375.00	OR	BASIC FEE	750.00
X\$ 9=		OR	X\$18=	
X43=		OR	X\$6=	
+140=		OR	+280=	
TOTAL		OR	TOTAL	

* If the difference in column 1 is less than zero, enter "0" in column 2

01/04 **CLAIMS AS AMENDED - PART II**

	(Column 1)	(Column 2)	(Column 3)
AMENDMENT A	CLAIMS REMAINING AFTER AMENDMENT		HIGHEST NUMBER PREVIOUSLY PAID FOR
	Total	* <u>20</u> Minus	** <u>25</u> =
	Independent	* <u>3</u> Minus	*** <u>4</u> =
FIRST PRESENTATION OF MULTIPLE DEPENDENT CLAIM <input type="checkbox"/>			

SMALL ENTITY TYPE <input type="checkbox"/>		OR	OTHER THAN SMALL ENTITY	
RATE	ADDITIONAL FEE		RATE	ADDITIONAL FEE
X\$ 9=		OR	X\$18=	
X43=		OR	X\$6=	
+140=		OR	+280=	
TOTAL ADDIT. FEE		OR	TOTAL ADDIT. FEE	

	(Column 1)	(Column 2)	(Column 3)
AMENDMENT B	CLAIMS REMAINING AFTER AMENDMENT		HIGHEST NUMBER PREVIOUSLY PAID FOR
	Total	* Minus	** =
	Independent	* Minus	*** =
FIRST PRESENTATION OF MULTIPLE DEPENDENT CLAIM <input type="checkbox"/>			

RATE	ADDITIONAL FEE	OR	RATE	ADDITIONAL FEE
X\$ 9=		OR	X\$18=	
X43=		OR	X\$6=	
+140=		OR	+280=	
TOTAL ADDIT. FEE		OR	TOTAL ADDIT. FEE	

	(Column 1)	(Column 2)	(Column 3)
AMENDMENT C	CLAIMS REMAINING AFTER AMENDMENT		HIGHEST NUMBER PREVIOUSLY PAID FOR
	Total	* Minus	** =
	Independent	* Minus	*** =
FIRST PRESENTATION OF MULTIPLE DEPENDENT CLAIM <input type="checkbox"/>			

RATE	ADDITIONAL FEE	OR	RATE	ADDITIONAL FEE
X\$ 9=		OR	X\$18=	
X43=		OR	X\$6=	
+140=		OR	+280=	
TOTAL ADDIT. FEE		OR	TOTAL ADDIT. FEE	

* If the entry in column 1 is less than the entry in column 2, write "0" in column 3.
 ** If the "Highest Number Previously Paid For" IN THIS SPACE is less than 20, enter "20."
 *** If the "Highest Number Previously Paid For" IN THIS SPACE is less than 3, enter "3."
 The "Highest Number Previously Paid For" (Total or Independent) is the highest number found in the appropriate box in column 1.

Index of Claims

Application No.

09/537812

Applicant(s)

Examiner

Art Unit

✓	Rejected
=	Allowed

-	(Through numeral) Cancelled
+	Restricted

N	Non-Elected
I	Interference

A	Appeal
O	Objected

Claim		Date	
Final	Original		
	8/12/03		
1			
2			
3			
4			
5			
6			
7			
8			
9			
10			
11			
12			
13			
14			
15			
16			
17			
18			
19			
20			
21			
22			
23			
24			
25			
26			
27			
28			
29			
30			
31			
32			
33			
34			
35			
36			
37			
38			
39			
40			
41			
42			
43			
44			
45			
46			
47			
48			
49			
50			

Claim		Date	
Final	Original		
51			
52			
53			
54			
55			
56			
57			
58			
59			
60			
61			
62			
63			
64			
65			
66			
67			
68			
69			
70			
71			
72			
73			
74			
75			
76			
77			
78			
79			
80			
81			
82			
83			
84			
85			
86			
87			
88			
89			
90			
91			
92			
93			
94			
95			
96			
97			
98			
99			
100			

Claim		Date	
Final	Original		
101			
102			
103			
104			
105			
106			
107			
108			
109			
110			
111			
112			
113			
114			
115			
116			
117			
118			
119			
120			
121			
122			
123			
124			
125			
126			
127			
128			
129			
130			
131			
132			
133			
134			
135			
136			
137			
138			
139			
140			
141			
142			
143			
144			
145			
146			
147			
148			
149			
150			

BEST AVAILABLE COPY

001
RECEIVED
CENTRAL FAX CENTER
SEP 01 2004

FACSIMILE COVER SHEET

DATE: **September 1, 2004**
TO: **USPTO** FAX NO.: **703-872-9306**
FROM: **Kevin Imes**
RE: **RESPONSE TO OFFICE ACTION**

U.S. APP NO.: **09/537,812**

FILING DATE.: **03/28/2000**

APPLICANT(S): **Russell W. White, et al.**

ATTY DKT NO.: **11111.1111**

TITLE: **SYSTEM AND METHOD FOR COMMUNICATING SELECTED INFORMATION TO AN ELECTRONIC DEVICE**

NO. OF PAGES (INCL. COVER SHEET): **18**

MESSAGE:

Attached please find:

- Response to Office Action (14 pgs.);
- PTO/SB/21 PTO Transmittal (1 pg.);
- Replacement Sheets (2 pgs.);

PTO/SB/21 (02-04)
 Approved for use through 07/31/2008. OMB 0651-0031
 U.S. Patent and Trademark Office: U.S. DEPARTMENT OF COMMERCE

Under the Paperwork Reduction Act of 1995, no persons are required to respond to a collection of information unless it displays a valid OMB control number.

TRANSMITTAL FORM (to be used for all correspondence after initial filing)	Application Number	09/537,812	
	Filing Date	03/28/2004	
	First Named Inventor	Russell W. White	
	Art Unit	2686	
	Examiner Name	Perez-Gutierrez, R	
Total Number of Pages in This Submission	16	Attorney Docket Number	111111.1111

ENCLOSURES (Check all that apply)		
<input type="checkbox"/> Fee Transmittal Form	<input checked="" type="checkbox"/> Drawing(s)	<input type="checkbox"/> After Allowance communication to Technology Center (TC)
<input type="checkbox"/> Fee Attached	<input type="checkbox"/> Licensing-related Papers	<input type="checkbox"/> Appeal Communication to Board of Appeals and Interferences
<input checked="" type="checkbox"/> Amendment/Reply	<input type="checkbox"/> Petition	<input type="checkbox"/> Appeal Communication to TC (Appeal Notice, Brief, Reply Brief)
<input type="checkbox"/> After Final	<input type="checkbox"/> Petition to Convert to a Provisional Application	<input type="checkbox"/> Proprietary Information
<input type="checkbox"/> Affidavits/declaration(s)	<input type="checkbox"/> Power of Attorney, Revocation	<input type="checkbox"/> Status Letter
<input type="checkbox"/> Extension of Time Request	<input type="checkbox"/> Change of Correspondence Address	<input type="checkbox"/> Other Enclosure(s) (please identify below):
<input type="checkbox"/> Express Abandonment Request	<input type="checkbox"/> Terminal Disclaimer	
<input type="checkbox"/> Information Disclosure Statement	<input type="checkbox"/> Request for Refund	
<input type="checkbox"/> Certified Copy of Priority Document(s)	<input type="checkbox"/> CD, Number of CD(s) _____	
<input type="checkbox"/> Response to Missing Parts/Incomplete Application	Remarks	
<input type="checkbox"/> Response to Missing Parts under 37 CFR 1.52 or 1.53		

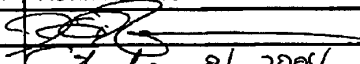
SIGNATURE OF APPLICANT, ATTORNEY, OR AGENT	
Firm or Individual name	Kevin R. Imes
Signature	
Date	September 01, 2004

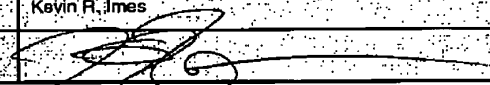
CERTIFICATE OF TRANSMISSION/MAILING		
I hereby certify that this correspondence is being facsimile transmitted to the USPTO or deposited with the United States Postal Service with sufficient postage as first class mail in an envelope addressed to: Commissioner for Patents, P.O. Box 1450, Alexandria, VA 22313-1450 on the date shown below:		
Typed or printed name	Kevin R. Imes	
Signature		Date
		09/01/04

This collection of information is required by 37 CFR 1.5. The information is required to obtain or retain a benefit by the public which is to file (and by the USPTO to process) an application. Confidentiality is governed by 35 U.S.C. 122 and 37 CFR 1.14. This collection is estimated to 2 hours to complete, including gathering, preparing, and submitting the completed application form to the USPTO. Time will vary depending upon the individual case. Any comments on the amount of time you require to complete this form and/or suggestions for reducing this burden, should be sent to the Chief Information Officer, U.S. Patent and Trademark Office, U.S. Department of Commerce, P.O. Box 1450, Alexandria, VA 22313-1450. DO NOT SEND FEES OR COMPLETED FORMS TO THIS ADDRESS. SEND TO: Commissioner for Patents, P.O. Box 1450, Alexandria, VA 22313-1450.

If you need assistance in completing the form, call 1-800-PTO-9199 and select option 2.

RECEIVED
CENTRAL FAX CENTER PATENT
SEP 01 2004

IN THE UNITED STATES PATENT AND TRADEMARK OFFICE

Applicant(s): Russell W. White, et al.

Title: SYSTEM AND METHOD FOR COMMUNICATING SELECTED
INFORMATION TO AN ELECTRONIC DEVICE

App. No.: 09/537,812 Filed: 03/28/2000

Examiner: Perez-Gutierrez, R. Group Art Unit: 2686

Atty. Dkt. No.: 111111.1111 Confirmation No.: 4698

Box Non-Fee Amendment
Commissioner for Patents
PO Box 1450
Alexandria, VA 22313-1450

RESPONSE TO OFFICE ACTION

Dear Sir:

In response to the Office Action mailed June 1, 2004, please amend the above-identified application as follows:

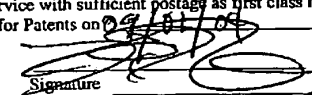
CERTIFICATE OF TRANSMISSION/MAILING	
I hereby certify that this correspondence is being facsimile transmitted to the USPTO or deposited with the United States Postal Service with sufficient postage as first class mail, in an envelope addressed to the Commissioner for Patents on 09/01/04	
Kevin R. Jones Typed or Printed Name	 Signature

IN THE SPECIFICATION

Please amend the paragraph on page 37, lines 9-22 as follows:

Upon selecting a device, the method proceeds to step 805 where the method determines the destination of the selected audio information. If the information is to be sent to a device via a wire line connection, the method proceeds to step 813 where playlist data is sent to a user via a wire line connection. The method may then proceed to step 814 where the playlist is executed at the device. If the information is to be sent to a device requiring wireless communication, the method proceeds to step 806 where the information is formatted for communicating the information to a wireless electronic device. For example, a wireless PDA device may be selected as a destination device for the selected audio information. The PDA device may include an audio player, such as an MP3 player operable to play or execute MP3 audio files. In such an embodiment, the method could format the information such that the information may be wirelessly communicated and subsequently played by the MP3 player.

Please amend the paragraph on page 38, lines 14-25 as follows:

Upon communicating the selected information, the method may proceed to step 810 where the playlist may be executed at step 812. For example, a user may select a continuous communication of selected audio information (e.g. several hours of music. Internet broadcast, etc.). As such, the method may continuously play or execute the received audio information. In another embodiment, the method may proceed to step 811 where the method may store or buffer the received information until it is desirable to execute the received selected audio information. As such, upon executing the selected audio information, the method may proceed to step 809 where the method may repeat.

IN THE DRAWINGS:

Replacement sheets are provided for FIGs. 1 and 6. The revised figures show the appropriate reference numbers as indicated by the specification.

CLAIM AMENDMENTS:

This listing of claims will replace all prior versions, and listings, of claims in the application:

1. (Canceled)
2. (Canceled)
3. (Canceled)
4. (Canceled)
5. (Canceled)
6. (Canceled)
7. (Canceled)
8. (Canceled)
9. (Canceled)
10. (Canceled)
11. (Currently amended) A method for communicating selected audio information to an electronic device, the method comprising:
 - ~~maintaining data associated with the selected audio information using a digital engine;~~
 - ~~initiating wireless communication of the data to the electronic device;~~
 - ~~presenting communicating information associated with the selectable audio information for presentation within a graphical user interface associated with a communication network of a web browser;~~
 - receiving an input from a user identifying the selected audio information; ~~the~~ selected audio information comprising a music file configured to be stored within a memory of an electronic device operable to play and pause the music file in response to an incoming cellular telephone call; ~~and~~
 - ~~receiving an input from a user~~ information identifying the electronic device; and ~~the input~~
 - ~~including a reference identifying the electronic device.~~

initiating wireless communication of the selected audio information to the electronic device.

12. (Canceled)

13. (Canceled)

14. (Currently amended) The method of Claim ~~11~~¹² wherein the interface operates in a browsing environment and the wireless communication operates outside the browsing environment and the music file has a format selected from a group consisting of an MP3 format, a MIDI format, and a WAV format.

15. (Original) The method of Claim 11 wherein the wireless communication comprises communicating via a cellular communications network.

16. (Currently amended) An electronic device for receiving selected audio information via wireless communication, the device comprising:
a long-range communication module operable to receive wireless communication of information;
a short-range RF communication module operably coupled to a processor module;
~~a storage medium operably coupled to the short range RF communication module, the storage medium operable to store selected audio information that comprises an audio file;~~
the processor module coupled to the storage medium, the processor module operable to stop an in process playing of the audio file in response to receiving an incoming telephone call~~process received selected audio information;~~ and
a display operable to display a web browser within a user interface.

17. (Canceled)

18. (Currently amended) The device as recited in Claim 16; ~~wherein the~~ further comprising the processor operable to play a different audio file in response to receiving the incoming telephone call. ~~device is a handheld computing device.~~

19. (Currently amended) The device as recited in Claim ~~16~~⁸ wherein the processor module outputs ~~handheld computing device is a personal digital assistant (PDA).~~ an audio signal indirectly to an audio speaker in connection with playing the audio file.

- 20. (Original) The device as recited in Claim 16 further comprising software for processing the selected information.
- 21. (Previously amended) The device as recited in Claim 16, wherein the short-range communications module is operable to scan frequencies.
- 22. (Canceled)
- 23. (Previously Amended) The device as recited in Claim 16 wherein the short-range RF communication module is operable with a "Bluetooth" communication standard.
- 24. (Canceled)
- 25. (Canceled)
- 26. (Currently amended) The ~~system device~~ of Claim ~~16~~ wherein the electronic device is a further comprising a wireless telephone.
- 27. (Currently amended) The ~~system device~~ of Claim 26 wherein the wireless telephone is operable to communicate with a short-range wireless communication network.
- 28. (Canceled)
- 29. (Currently amended) The ~~system device~~ of Claim ~~16~~ wherein the selected audio information further comprises streaming audio information.
- 30. (Canceled)
- 31. (Currently amended) The device as recited in Claim ~~26,16~~ further comprising a wireless telephone, wherein the long-range communication module is operable to receive the incoming telephone call information received by the long-range communication module comprises a voice call.
- 32. (Previously presented) The device as recited in Claim 16 wherein the audio file includes at least one of a WAV file, an MP3 file or a MIDI file.
- 33. (Canceled)
- 34. (Currently amended) An electronic device for communicating selected audio information via wireless communication, the device comprising:
~~a short range RF communication module operable to communicate about 2.4 GHz;~~

a storage medium operably coupled to the a long-range RF communication module, the storage medium operable to store the selected audio information; and

a processor module ~~coupled to the communication module~~, the processor module operable to process the selected audio information to play/alter a playing of the selected audio information in association with an incoming telephonic communication.

35. (Previously presented) The device as recited in Claim 34 further comprising a display operable to display a user interface operably associated with a web browsing environment.

36. (Currently amended) The device as recited in Claim ~~34~~ further comprising a cellular phone ~~operable to communicate with a cellular phone network including a short-range RF communication module operable to~~ communicate at about 2.4 GHz, wherein the storage medium and the short-range RF communication module are encased within the cellular phone.

37. (Currently amended) The device as recited in Claim 36 wherein the cellular phone is operable to pause the playing of the selected audio information at a time subsequent to receiving the incoming telephonic communication. ~~communicate the selected audio information~~

38. (Currently amended) The device as recited in Claim ~~36~~³⁴, further comprising:

a display operable to display a user interface; and

~~a cellular phone operable to communicate with a cellular phone network; and wherein the processor is operable to process selected audio information in association with receiving a telephonic communication, wherein the selected audio information includes an audio file selected, by the user of the cellular phone and received via the long-range RF communication module, and stored within the storage medium prior to receiving the incoming telephonic communication.~~

39. (Currently amended) The device as recited in Claim ~~34~~³⁷ further comprising the processor ~~operable to process the selected audio information in~~

~~association with receiving a telephonic communication, wherein the processor module is further operable to start a playing of a different audio file in connection with receiving an indication of the incoming telephonic communication. the selected audio information includes an audio file selected by the user of the cellular phone and received and stored within the storage medium prior to receiving the telephonic communication.~~

REMARKS

Applicants appreciate the time taken by Examiner Perez-Gutierrez to prepare the Office Action of June 1, 2004. Applicants further appreciate the time taken by Examiner Perez-Gutierrez to engage in a telephonic interview on August 18, 2004 – the substance of which is described in the Interview Summary mailed on August 25, 2004.

With respect to the outstanding § 102 and § 103 rejections of claims 1, 4, 8-10, 16, 18-20, 23, 26-29, and 31-39, Applicants respectfully traverse and submit that each of these claims is allowable.

To simplify the issues presented and to facilitate full allowance of the now pending claims, claims 11, 14, 16, 19, 26, 29, 31, 34, and 36 - 39 have been amended. Claims 1, 4, 8-10, 13, 28, and 30 have been cancelled without prejudice. These claims have been cancelled to advance the remaining claims to allowance and not for reasons related to patentability of the cancelled claims. Applicants intend to pursue protection for the subject matter of the cancelled claims in to-be-filed continuing applications.

No Claims have been added. No new subject matter has been added. Applicants respectfully request that the Examiner issue a Notice of Allowance for claims 11, 14-16, 18-21, 23, 26, 27, 29, 31, 32, and 34-39.

Drawing Objections

Figures 1, 6, and 8, are objected to under 37 CFR 1.83(a) and 1.84(p)(5). Replacement sheets including proposed corrections for Figures 1 and 6 are included herewith. Regarding the objection of Figure 8, Applicants respectfully request that the specification be amended as indicated herein. Applicants submit that the proposed corrections and amendments overcome the Drawing Objections and request that the objections be removed.

Claim Objections

Claim 19 is objected to for an informality related to proper antecedent basis. As mentioned above, claim 19 has been amended. Applicants submit that as amended Claim

19 is not objectionable and is fully allowable. Applicants respectfully request full allowance of Claim 19.

Claim Rejections – 35 U.S.C. § 112

Claim 14 is rejected under 35 U.S.C. § 112 as being indefinite. As mentioned above, claim 14 has been amended. Applicants submit that, as amended, Claim 14 is fully allowable. Applicants respectfully request full allowance of Claim 14.

Claim Rejections – 35 U.S.C. § 102

Claims 1, 4, 8-10, 16, 18-20, 23, 26-29, and 31-39 are rejected under 35 U.S.C. § 102 as being anticipated by U.S. Patent No. 6,587,835 (Treyz, et al.). As mentioned above, claims 1, 4, 8-10, and 28, have been cancelled without prejudice. Claims 18-20, 23, 26 – 29 and 31 – 33, depend from independent claim 16, which has been amended. Claims 35 – 39 depend from independent claim 34, which has also been amended.

Applicants respectfully point out that independent claims 16 and 34, each include a limitation that is completely missing from Treyz, et al. **Both independent claims include a limitation related to altering the playing of an audio file in response to an incoming telephone call. The audio file in question existed at the telephonic device prior to receiving the incoming call – the file was not included with the incoming call.**

Treyz, et al. fails to disclose, teach, or suggest, altering or stopping the playing of a stored audio file in response to an incoming telephone call. In fact, Treyz, et al. fails to disclose doing anything in response to an incoming telephone call.

Treyz et al. does mention once, in passing, the ability to receive a telephone call – “handheld computing device 12 may be used to provide the user with an opportunity to send and receive e-mail, telephone calls, voice mail, paging messages, data service feeds, and any other suitable information or messages.” Col. 16, lines 60-63, but this disclosure in Treyz, et al. is unrelated to the currently pending claims. Applicants are attempting to claim a device that alters the playing of a stored audio file in response to an indication of incoming telephone call – Treyz et al. never mentions any such capability.

The Examiner has pointed out that Treyz, et al. does mention that “[i]f the user receives an incoming message, handheld computing device 12 may be used to present the message to the user at step 140.” Col. 17, lines 5-7. Again, this disclosure in Treyz et al. misses the mark. Unlike the embodiment currently claimed, the shopping assistant of Treyz, et al. is merely receiving a message and presenting that same message to a user.

In their current forms, claim 16 recites a “processor module operable to **stop an in process playing of the audio file in response to receiving an indication of an incoming telephone call**” (emphasis added), and claim 34 recites “a processor module operable to **alter a playing of the selected audio information in association with an incoming telephonic communication**” (emphasis added). As mentioned above, Treyz, et al. fails to disclose doing anything in response to an incoming telephone call or stopping the playing of an audio file for any reason. For at least these reasons, Treyz, et al. cannot anticipate Claim 16, Claim 34, or the claims depending there from.

All of the currently pending claims relate to embodiments of Applicants’ invention that facilitate storing an audio file (like an MP3 file) on a wirelessly enabled device and altering the playing of the file in response to an incoming telephone call. For example, a person may be storing an MP3 file on her cellular telephone, someone may call the telephone, and the telephone may begin playing the MP3 file. In practice, the person may hear the MP3 music start to play and know that someone is calling her cellular telephone. Similarly, the same person may be using her cellular telephone as an MP3 player. An incoming call signal may be recognized at the telephone, and the telephone may, for example, automatically reduce the volume of the MP3 music, stop the playing of the music, pause the playing (which may involve stopping the playing and restarting the playing at some later point in time), and/or otherwise alter the playing. In fact, in some cases, some of these capabilities may be combined. A device may be playing a first song. An incoming call signal may be received. The device may stop the playing of the first song and begin playing a different song.

Treyz, et al., does not relate in any way to these ideas. Treyz et al. describes a shopping assistant. Treyz et al. completely lacks any mention, teaching, disclosure, etc. of the above-discussed limitations. As such, Applicants submit that Treyz et al. cannot

anticipate any currently pending claim and that in light of the amendments to claims 16 and 34, Claims 16, 18-20, 23, 26, 27, 29, and 31-39 are fully allowable over Treyz et al. As such, Applicants respectfully request full allowance of Claims 16, 18-20, 23, 26, 27, 29, and 31-39.

Claim Rejections – 35 U.S.C. § 103

Claims 5-7 and 21 are rejected under 35 U.S.C. § 103(a) as being unpatentable over Treyz, et al. in view of allegedly well-known prior art. As mentioned above, Applicants respectfully traverse.

Claims 5-7 have been canceled without prejudice.

Claim 21 depends from claim 16, which has been amended to include a “processor module operable to **stop an in process playing of the audio file in response to receiving an indication of an incoming telephone call**” (emphasis added). As mentioned above, neither Treyz et al. nor the allegedly well-known prior art discloses, teaches, or even suggests, this limitation. Applicants submit that in light of the amendment to claim 16, claim 21 is fully allowable. As such, Applicants respectfully request full allowance of Claim 21.

Additionally, Applicants submit that any reliance on the disclosure of Treyz et al. in combination with a wide area wireless technology having always-on capabilities (such as GSM or CDMA) is improper. Treyz et al. actively teaches away from such a combination.

Treyz et al. discloses “a handheld computing device ... to provide a user with shopping assistance services.” See Treyz et al. Abstract. While Treyz et al. does mention cellular networks a handful of times in its more than 150 pages, when reference is made to cellular networks, the reference is largely derisive. In fact, Treyz et al. goes out of its way to suggest that cellular network resources are “too scarce to provide a practical [always-on] data communication link.” Col. 51, lines 1-10. According to Treyz et al., in an always-on configuration, considerations (like scarce wide-area resources) dictate using local communication links. See *Id.*

Claims 11, 13-15, and 30 are rejected under 35 U.S.C. § 103(a) as being unpatentable over Treyz, et al. in view of U.S. Patent No. 6,014,569 (Bottum). Applicants respectfully traverse the rejection. To expedite allowance of claims 11, 14, and 15, Claims 13 and 30 have been canceled without prejudice.

Like Treyz et al., Bottum completely lacks any mention of affecting the playing of an audio file in response to an incoming telephone call. Moreover, Bottum does not relate to devices that are capable of receiving telephone calls – let alone doing something in response to a telephone call.

Claims 14 and 15 depend from claim 11, which has been amended to include the limitation of **“a music file configured to be stored within a memory of an electronic device operable to play and pause the music file in response to an incoming cellular telephone call”** (emphasis added). As indicated above, neither Treyz et al. nor Bottum discloses, teaches, or even suggests, this limitation. As such, Applicants submit that Claims 11, 14, and 15, are fully allowable. Applicants respectfully request full allowance of Claims 11, 14, and 15.

Conclusion

Each of the independent claims, as amended, includes a limitation related to affecting the playing of an audio file in response to an incoming telephone call. The cited references fail to teach, disclose, or even suggest such a feature. In light of this failing in the art and for other reasons not discussed herein, Applicants submit that each of the currently pending independent claims is in condition for allowance.

Since each of independent claims 11, 16, and 34, is allowable, each of the dependent claims is likewise allowable over the relied upon references. Moreover, the dependent claims include additional features not discussed herein or found in the cited references.

Thus, for at least the foregoing reasons, Applicants respectfully submit that the present application is now in condition for allowance and reconsideration is respectfully requested. Accordingly, the Examiner is requested to issue a Notice of Allowance for all pending claims.

If, for any reason, the Office is unable to allow the Application on the next Office Action, and believes a telephone interview would be helpful, the Examiner is respectfully requested to contact the undersigned attorney or agent. Applicant(s) does not believe that any additional fees are due.

Sept 1st 2004
Date

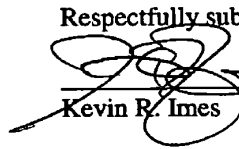
Respectfully submitted,

Kevin R. Imes

Atty. Docket No.: 111111.1111
Applicant: Russell W. White, et al.

REPLACEMENT SHEET

1/9

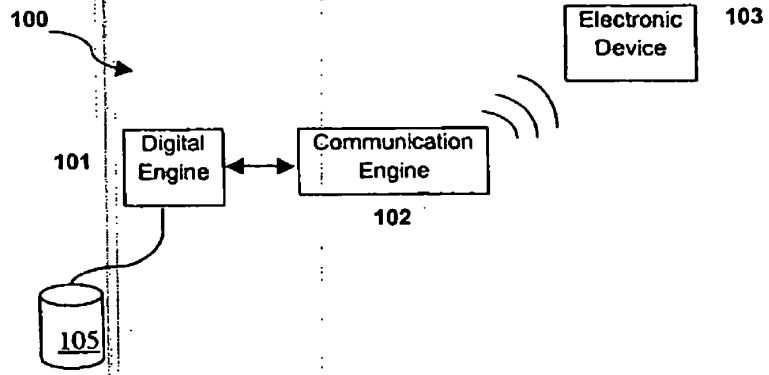

FIG. 1

6/9

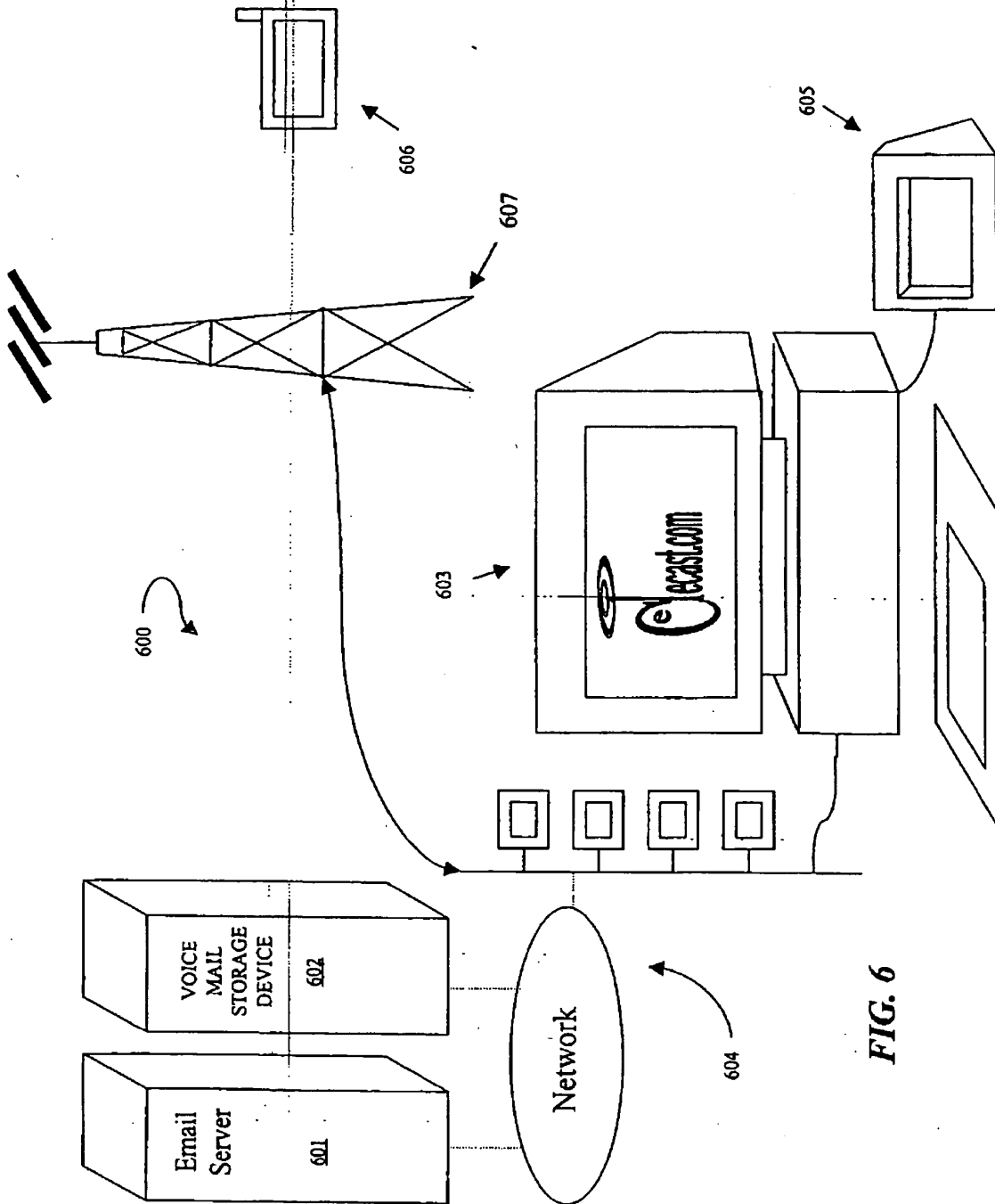

FIG. 6



UNITED STATES PATENT AND TRADEMARK OFFICE

UNITED STATES DEPARTMENT OF COMMERCE
United States Patent and Trademark Office
Address: COMMISSIONER FOR PATENTS
P.O. Box 1450
Alexandria, Virginia 22313-1450
www.uspto.gov

APPLICATION NO.	FILING DATE	FIRST NAMED INVENTOR	ATTORNEY DOCKET NO.	CONFIRMATION NO.
09/537,812	03/28/2000	Russell W. White	111111.1111	4698

7590
Russell W White
10704 Redmond
Austin, TX 78739

08/25/2004

EXAMINER

PEREZ GUTIERREZ, RAFAEL

ART UNIT PAPER NUMBER

2686

DATE MAILED: 08/25/2004

13

Please find below and/or attached an Office communication concerning this application or proceeding.

Interview Summary

Application No.

09/537,812

Applicant(s)

White et al.

Examiner

Rafael Perez-Gutierrez

Art Unit

2686

All participants (applicant, applicant's representative, PTO personnel):

(1) Rafael Perez-Gutierrez.

(3) Russell W. White.

(2) Kevin R. Imes.

(4) _____.

Date of Interview: 18 August 2004.

Type: a) Telephonic b) Video Conference
c) Personal [copy given to: 1) applicant 2) applicant's representative]

Exhibit shown or demonstration conducted: d) Yes e) No.
If Yes, brief description: _____.

Claim(s) discussed: 11, 16, and 34.

Identification of prior art discussed: Treyz et al. (U.S. Patent # 6,587,835 B1).

Agreement with respect to the claims f) was reached. g) was not reached. h) N/A.

Substance of Interview including description of the general nature of what was agreed to if an agreement was reached, or any other comments: See Continuation Sheet.

(A fuller description, if necessary, and a copy of the amendments which the examiner agreed would render the claims allowable, if available, must be attached. Also, where no copy of the amendments that would render the claims allowable is available, a summary thereof must be attached.)

THE FORMAL WRITTEN REPLY TO THE LAST OFFICE ACTION MUST INCLUDE THE SUBSTANCE OF THE INTERVIEW. (See MPEP Section 713.04). If a reply to the last Office action has already been filed, APPLICANT IS GIVEN ONE MONTH FROM THIS INTERVIEW DATE, OR THE MAILING DATE OF THIS INTERVIEW SUMMARY FORM, WHICHEVER IS LATER, TO FILE A STATEMENT OF THE SUBSTANCE OF THE INTERVIEW. See Summary of Record of Interview requirements on reverse side or on attached sheet.

Examiner Note: You must sign this form unless it is an Attachment to a signed Office action.

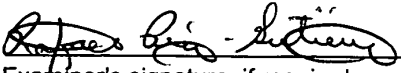
Examiner's signature, if required

Summary of Record of Interview Requirements

Manual of Patent Examining Procedure (MPEP), Section 713.04, Substance of Interview Must be Made of Record

A complete written statement as to the substance of any face-to-face, video conference, or telephone interview with regard to an application must be made of record in the application whether or not an agreement with the examiner was reached at the interview.

Title 37 Code of Federal Regulations (CFR) § 1.133 Interviews Paragraph (b)

In every instance where reconsideration is requested in view of an interview with an examiner, a complete written statement of the reasons presented at the interview as warranting favorable action must be filed by the applicant. An interview does not remove the necessity for reply to Office action as specified in §§ 1.111, 1.135. (35 U.S.C. 132)

37 CFR §1.2 Business to be transacted in writing.

All business with the Patent and Trademark Office should be transacted in writing. The personal attendance of applicants or their attorneys or agents at the Patent and Trademark Office is unnecessary. The action of the Patent and Trademark Office will be based exclusively on the written record in the Office. No attention will be paid to any alleged oral promise, stipulation, or understanding in relation to which there is disagreement or doubt.

The action of the Patent and Trademark Office cannot be based exclusively on the written record in the Office if that record is itself incomplete through the failure to record the substance of interviews.

It is the responsibility of the applicant or the attorney or agent to make the substance of an interview of record in the application file, unless the examiner indicates he or she will do so. It is the examiner's responsibility to see that such a record is made and to correct material inaccuracies which bear directly on the question of patentability.

Examiners must complete an Interview Summary Form for each interview held where a matter of substance has been discussed during the interview by checking the appropriate boxes and filling in the blanks. Discussions regarding only procedural matters, directed solely to restriction requirements for which interview recordation is otherwise provided for in Section 812.01 of the Manual of Patent Examining Procedure, or pointing out typographical errors or unreadable script in Office actions or the like, are excluded from the interview recordation procedures below. Where the substance of an interview is completely recorded in an Examiners Amendment, no separate Interview Summary Record is required.

The Interview Summary Form shall be given an appropriate Paper No., placed in the right hand portion of the file, and listed on the "Contents" section of the file wrapper. In a personal interview, a duplicate of the Form is given to the applicant (or attorney or agent) at the conclusion of the interview. In the case of a telephone or video-conference interview, the copy is mailed to the applicant's correspondence address either with or prior to the next official communication. If additional correspondence from the examiner is not likely before an allowance or if other circumstances dictate, the Form should be mailed promptly after the interview rather than with the next official communication.

The Form provides for recordation of the following information:

- Application Number (Series Code and Serial Number)
- Name of applicant
- Name of examiner
- Date of interview
- Type of interview (telephonic, video-conference, or personal)
- Name of participant(s) (applicant, attorney or agent, examiner, other PTO personnel, etc.)
- An indication whether or not an exhibit was shown or a demonstration conducted
- An identification of the specific prior art discussed
- An indication whether an agreement was reached and if so, a description of the general nature of the agreement (may be by attachment of a copy of amendments or claims agreed as being allowable). Note: Agreement as to allowability is tentative and does not restrict further action by the examiner to the contrary.
- The signature of the examiner who conducted the interview (if Form is not an attachment to a signed Office action)

It is desirable that the examiner orally remind the applicant of his or her obligation to record the substance of the interview of each case. It should be noted, however, that the Interview Summary Form will not normally be considered a complete and proper recordation of the interview unless it includes, or is supplemented by the applicant or the examiner to include, all of the applicable items required below concerning the substance of the interview.

A complete and proper recordation of the substance of any interview should include at least the following applicable items:

- 1) A brief description of the nature of any exhibit shown or any demonstration conducted,
- 2) an identification of the claims discussed,
- 3) an identification of the specific prior art discussed,
- 4) an identification of the principal proposed amendments of a substantive nature discussed, unless these are already described on the Interview Summary Form completed by the Examiner,
- 5) a brief identification of the general thrust of the principal arguments presented to the examiner,
(The identification of arguments need not be lengthy or elaborate. A verbatim or highly detailed description of the arguments is not required. The identification of the arguments is sufficient if the general nature or thrust of the principal arguments made to the examiner can be understood in the context of the application file. Of course, the applicant may desire to emphasize and fully describe those arguments which he or she feels were or might be persuasive to the examiner.)
- 6) a general indication of any other pertinent matters discussed, and
- 7) if appropriate, the general results or outcome of the interview unless already described in the Interview Summary Form completed by the examiner.

Examiners are expected to carefully review the applicant's record of the substance of an interview. If the record is not complete and accurate, the examiner will give the applicant an extendable one month time period to correct the record.

Examiner to Check for Accuracy

If the claims are allowable for other reasons of record, the examiner should send a letter setting forth the examiner's version of the statement attributed to him or her. If the record is complete and accurate, the examiner should place the indication, "Interview Record OK" on the paper recording the substance of the interview along with the date and the examiner's initials.

Continuation of Substance of Interview including description of the general nature of what was agreed to if an agreement was reached, or any other comments: The Examiner, Mr. White, and Mr. Imes discussed a proposed amendment to the above-mentioned claims. Specifically, the limitation of managing playing of the audio file in response to receiving an indication of an incoming telephone call was discussed. The Examiner suggested to further specify the type of managing playing (e.g., stopping, pausing) performed in the above-mentioned claims. Mr. White and Mr. Imes advised the Examiner that they will consider the above suggestion when preparing a formal response.



UNITED STATES PATENT AND TRADEMARK OFFICE

UNITED STATES DEPARTMENT OF COMMERCE
United States Patent and Trademark Office
Address: COMMISSIONER FOR PATENTS
P.O. Box 1450
Alexandria, Virginia 22313-1450
www.uspto.gov

APPLICATION NO.	FILING DATE	FIRST NAMED INVENTOR	ATTORNEY DOCKET NO.	CONFIRMATION NO.
09/537,812	03/28/2000	Russell W. White	111111.1111	4698

7590 06/01/2004
Russell W White
10704 Redmond
Austin, TX 78739

EXAMINER

PEREZ GUTIERREZ, RAFAEL

ART UNIT PAPER NUMBER

2686

12

DATE MAILED: 06/01/2004

Please find below and/or attached an Office communication concerning this application or proceeding.

Office Action Summary

Application No. 09/537,812	Applicant(s) White et al.	
Examiner Rafael Perez-Gutierrez	Art Unit 2686	

-- The MAILING DATE of this communication appears on the cover sheet with the correspondence address --

Period for Reply

A SHORTENED STATUTORY PERIOD FOR REPLY IS SET TO EXPIRE 3 MONTH(S) FROM THE MAILING DATE OF THIS COMMUNICATION.

- Extensions of time may be available under the provisions of 37 CFR 1.136(a). In no event, however, may a reply be timely filed after SIX (6) MONTHS from the mailing date of this communication.
- If the period for reply specified above is less than thirty (30) days, a reply within the statutory minimum of thirty (30) days will be considered timely.
- If NO period for reply is specified above, the maximum statutory period will apply and will expire SIX (6) MONTHS from the mailing date of this communication.
- Failure to reply within the set or extended period for reply will, by statute, cause the application to become ABANDONED (35 U.S.C. § 133). Any reply received by the Office later than three months after the mailing date of this communication, even if timely filed, may reduce any earned patent term adjustment. See 37 CFR 1.704(b).

Status

- 1) Responsive to communication(s) filed on 18 February 2003.
- 2a) This action is FINAL. 2b) This action is non-final.
- 3) Since this application is in condition for allowance except for formal matters, prosecution as to the merits is closed in accordance with the practice under *Ex parte Quayle*, 1935 C.D. 11, 453 O.G. 213.

Disposition of Claims

- 4) Claim(s) 1,4-11,13-16,18-21,23 and 26-39 is/are pending in the application.
4a) Of the above claim(s) _____ is/are withdrawn from consideration.
- 5) Claim(s) _____ is/are allowed.
- 6) Claim(s) 1,4-11,13-16,18-21,23 and 26-39 is/are rejected.
- 7) Claim(s) _____ is/are objected to.
- 8) Claim(s) _____ are subject to restriction and/or election requirement.

Application Papers

- 9) The specification is objected to by the Examiner.
- 10) The drawing(s) filed on 28 March 2000 is/are: a) accepted or b) objected to by the Examiner.
Applicant may not request that any objection to the drawing(s) be held in abeyance. See 37 CFR 1.85(a).
Replacement drawing sheet(s) including the correction is required if the drawing(s) is objected to. See 37 CFR 1.121(d).
- 11) The oath or declaration is objected to by the Examiner. Note the attached Office Action or form PTO-152.

Priority under 35 U.S.C. § 119

- 12) Acknowledgment is made of a claim for foreign priority under 35 U.S.C. § 119(a)-(d) or (f).
a) All b) Some * c) None of:
1. Certified copies of the priority documents have been received.
2. Certified copies of the priority documents have been received in Application No. _____.
3. Copies of the certified copies of the priority documents have been received in this National Stage application from the International Bureau (PCT Rule 17.2(a)).
* See the attached detailed Office action for a list of the certified copies not received.

Attachment(s)

- 1) Notice of References Cited (PTO-892)
- 2) Notice of Draftsperson's Patent Drawing Review (PTO-948)
- 3) Information Disclosure Statement(s) (PTO-1449 or PTO/SB/08)
Paper No(s)/Mail Date _____.
- 4) Interview Summary (PTO-413)
Paper No(s)/Mail Date. _____.
- 5) Notice of Informal Patent Application (PTO-152)
- 6) Other: _____.

Art Unit: 2686

DETAILED ACTION

1. This Action is in response to the telephone interview of June 13, 2003 between SPE William G. Trost IV and Russell W. White. As result of said interview, the Final Office Action mailed on April 30, 2003 has been withdrawn. Applicant's amendments filed on September 19, 2002; December 2, 2002; and February 18, 2003 have been properly entered in the application. **Claims 1, 4-11, 13-16, 18-21, 23, 26-39** are now pending in the present application. **This Action is made NON-FINAL.**

Drawings

2. The drawings are objected to under 37 CFR 1.83(a) because **figure 1** fails to show **storage device 105** as described in the specification on **page 10 lines 23 and 24**. Any structural detail that is essential for a proper understanding of the disclosed invention should be shown in the drawing. MPEP § 608.02(d).
3. The drawings are objected to as failing to comply with 37 CFR 1.84(p)(5) because they do not include the following reference number mentioned in the description on **page 31 line 30**: On **figure 6**, reference number **607** identifying the tower is not shown in figure 6.
4. The drawings are objected to as failing to comply with 37 CFR 1.84(p)(5) because they include the following reference numbers not mentioned in the description: On **figure 8**, reference

Art Unit: 2686

numbers **812, 813, and 814** are not mentioned in the description.

5. Applicant is required to submit a proposed drawing correction in reply to this Office Action. However, formal correction of the noted defect may be deferred until after the Examiner has considered the proposed drawing correction. Failure to timely submit the proposed drawing correction will result in the **ABANDONMENT** of the application.

Claim Objections

6. **Claim 19** is objected to because of the following informality: On **line 2** of **claim 19**, replace “low power” with --short-range-- before “RF” in order to provide proper antecedent basis. Appropriate correction is required.

Claim Rejections - 35 USC § 112

7. The following is a quotation of the second paragraph of 35 U.S.C. 112:

The specification shall conclude with one or more claims particularly pointing out and distinctly claiming the subject matter which the applicant regards as his invention.

Claim 14 is rejected under 35 U.S.C. 112, second paragraph, as being indefinite for failing to particularly point out and distinctly claim the subject matter which Applicant regards as the invention.

Claim 14 depends upon canceled **claim 12**, therefore, it is considered indefinite. For

Art Unit: 2686

purposes of applying prior art, **claim 14** is being examined as being dependent on **claim 11**.

Claim Rejections - 35 USC § 102

8. The following is a quotation of the appropriate paragraphs of 35 U.S.C. 102 that form the basis for the rejections under this section made in this Office Action:

A person shall be entitled to a patent unless -- (e) the invention was described in (1) an application for patent, published under section 122(b), by another filed in the United States before the invention by the applicant for patent or (2) a patent granted on an application for patent by another filed in the United States before the invention by the applicant for patent, except that an international application filed under the treaty defined in section 351(a) shall have the effects for purposes of this subsection of an application filed in the United States only if the international application designated the United States and was published under Article 21(2) of such treaty in the English language.

Claims 1, 4, 8-10, 16, 18-20, 23, 26-29, and 31-39 are rejected under 35 U.S.C. 102(e) as being anticipated by **Treyz et al. (U.S. Patent # 6,587,835 B1)**, newly cited.

Consider **claims 1, 26-29**, Treyz et al. clearly show and disclose a system 998 (figure 107) for communicating selected information to a handheld computing (electronic) device 12 (wireless telephone operable to communicate with a short-range wireless communication network) (figure 107 and column 9 line 57 - column 10 line 3, column 13 lines 23-38, column 15 lines 29-35 and 49-53, column 60 lines 59-62, column 61 lines 18-24, and column 62 lines 7-15 and 43-47), the system 998 comprising:

an audio kiosk 1000 (digital engine) (figure 107) operable to maintain data associated with selectable audio information, the audio information comprising an audio file (e.g., an MP3 file) or streaming audio information (e.g., when the user samples the audio) (column 60 lines 57-64, column 61 lines 25-30, and column 61 line 66 - column 62 line 4);

Art Unit: 2686

wireless communications circuitry 1014 (communication engine) (figure 107) communicatively coupled to the audio kiosk 1000 (digital engine), the wireless communications circuitry 1014 (communication engine) operable to initiate wireless communication of the data to the handheld computing (electronic) device 12 (figure 110 step 1064, column 60 lines 59-62, column 61 lines 18-24, and column 62 lines 7-15 and 43-47);

a display 1012 (graphical user interface) (figures 107-109) operably coupled to the audio kiosk 1000 (digital engine) to provide available information to a user of a communication network (e.g., the store) and to receive an input (e.g., artist, title, or category (figure 108)) from the user identifying a selected portion of the selectable information (figure 110 step 1060, column 61 lines 16-24, column 61 line 41 - column 62 line 15, and column 62 lines 28-33); and

wherein the display 1012 (interface) operates in a web browsing environment (e.g., when the audio files are stored in a remote server (column 61 lines 25-27) or when the user fills an order through the Internet 1022 (column 61 lines 34-36 and column 62 lines 19-27)) and the wireless communication operates outside the browsing environment (column 60 lines 57-62, column 61 lines 16-30, and column 62 lines 7-15 and 43-47).

Consider **claim 4**, and **as applied to claim 1 above**, Treyz et al. further disclose that the wireless communication comprises communicating through a remote wireless link (column 62 lines 7-15), wherein said remote wireless link is through a cellular communications network (column 13 lines 39-47).

Consider **claims 8-10**, and **as applied to claim 1 above**, Treyz et al. also disclose that the wireless communication comprises communicating via a local (short-range) RF (microwave)

Art Unit: 2686

wireless link such as Bluetooth link operating at 2.4 GHz (column 13 lines 22-38, column 60 lines 59-62, column 61 lines 18-24, and column 62 lines 10-15).

Consider **claims 16, 18, 23, and 31-39**, Treyz et al. clearly show and disclose a handheld computing (electronic) device 12 (wireless telephone) (figures 4-6 and 107-109 and column 9 line 57 - column 10 line 3) for communicating/receiving selected audio information (streaming audio information (e.g., when the user samples the audio) (column 60 lines 57-64, column 61 lines 25-30, and column 61 line 66 - column 62 line 4)) via wireless communication (figure 110 step 1064, column 60 lines 59-62, column 61 lines 18-24, and column 62 lines 7-15 and 43-47), the device 12 comprising:

wireless communications circuitry 96 (long-range communication module) (figure 4) operable to receive wireless communication of information (e.g., voice calls via a wireless (cellular) network) (column 15 lines 29-35);

a short-range RF communication module (either wireless communications circuitry 96 or 104 (e.g., Bluetooth operating at 2.4 GHz) (figure 4) operably coupled to a processor module 64 (figure 4, column 13 lines 23-38, and column 15 lines 3-7, 29-35 and 49-53);

a storage medium 72 (figure 4) operably coupled to the short-range RF communication module (either wireless communications circuitry 96 or 104) (figure 4), the storage medium 72 (figure 4) operable to store selected audio information that comprises an audio file (e.g., an MP3 file) (column 15 lines 8-10, column 60 lines 57-64, column 61 lines 25-30, column 61 line 66 - column 62 line 4, and column 62 lines 7-15);

the processor module 64 (figure 4) coupled to the storage medium 72, the processor

Art Unit: 2686

module 64 operable to process/play received selected audio information (column 62 lines 7-15);
and

a display 80, 118 (figures 4 and 5) operable to display a web browser within a user interface (column 12 lines 28-37 and column 16 lines 15-22).

Consider **claim 19**, and **as applied to claim 16 above**, Treyz et al. also disclose that the short-range RF communication module (either wireless communications circuitry 96 or 104) (figure 4) outputs audio information indirectly to an audio speaker 114 (figure 4) (i.e., audio files are download and then played by the user) (column 60 lines 57-64 and column 62 lines 7-15).

Consider **claim 20**, and **as applied to claim 16 above**, since the handheld computing (electronic) device 12 of Treyz et al. can be an MP3 player (column 60 lines 62-64), it is clearly inherent that software for processing the selected information is included in the device 12.

Claim Rejections - 35 USC § 103

9. The following is a quotation of 35 U.S.C. 103(a) which forms the basis for all obviousness rejections set forth in this Office Action:

(a) A patent may not be obtained though the invention is not identically disclosed or described as set forth in section 102 of this title, if the differences between the subject matter sought to be patented and the prior art are such that the subject matter as a whole would have been obvious at the time the invention was made to a person having ordinary skill in the art to which said subject matter pertains. Patentability shall not be negated by the manner in which the invention was made.

This application currently names joint inventors. In considering patentability of the claims under 35 U.S.C. 103(a), the Examiner presumes that the subject matter of the various claims was commonly owned at the time any inventions covered therein were made absent any

Art Unit: 2686

evidence to the contrary. Applicant is advised of the obligation under 37 CFR 1.56 to point out the inventor and invention dates of each claim that was not commonly owned at the time a later invention was made in order for the Examiner to consider the applicability of 35 U.S.C. 103(c) and potential 35 U.S.C. 102(e), (f) or (g) prior art under 35 U.S.C. 103(a).

The factual inquiries set forth in *Graham v. John Deere Co.*, 383 U.S. 1, 148 USPQ 459 (1966), that are applied for establishing a background for determining obviousness under 35 U.S.C. 103(a) are summarized as follows:

1. Determining the scope and contents of the prior art.
2. Ascertaining the differences between the prior art and the claims at issue.
3. Resolving the level of ordinary skill in the pertinent art.
4. Considering objective evidence present in the application indicating obviousness or nonobviousness.

10. **Claims 5-7 and 21** are rejected under 35 U.S.C. 103(a) as being unpatentable over **Treyz et al. (U.S. Patent # 6,587,835 B1)**, newly cited, in view of **well known prior art (MPEP 2144.03)**.

Consider **claims 5 and 7**, and **as applied to claim 4 above**, Treyz et al. clearly show and disclose the claimed invention except that the cellular communications network comprises a global system for mobile communications (GSM) network or a code division multiple access (CDMA) network.

However, the Examiner takes Official Notice of the fact that a cellular communications network comprising a GSM or a CDMA network is notoriously well known in the art.

Therefore, it would have been obvious to a person of ordinary skill in the art at the time

Art Unit: 2686

the invention was made to slightly modify the system of Treyz et al. to include a GSM or a CDMA network as known in the art for purpose of serving a majority of users.

Consider **claim 6**, and **as applied to claim 5 above**, Treyz et al., as modified above, clearly show and disclose the claimed invention except that the GSM network operates between 1.7 GHz and 2.0 GHz.

However, the Examiner takes Official Notice of the fact a GSM network operating at PCS frequencies (i.e., 1.9 GHz) is notoriously well known in the art.

Therefore, it would have been obvious to a person of ordinary skill in the art at the time the invention was made to further modify the system of Treyz et al. to operate the GSM network between 1.7 GHz and 2.0 GHz for purpose of serving PCS subscribers.

Consider **claim 21**, and **as applied to claim 16 above**, Treyz et al. clearly show and disclose the claimed invention except that the short-range RF communication module (either wireless communications circuitry 96 or 104) (figure 4) is operable to scan frequencies.

However, the Examiner takes Official Notice of the fact that short-range RF communication modules such as Bluetooth are well known in the art to operate by scanning frequencies for the purpose of locating an available frequency channel.

Therefore, it would have been obvious to a person of ordinary skill in the art at the time the invention was made to slightly modify the device of Treyz et al. to allow the short-range RF communication module to scan frequencies for purpose of locating an available frequency channel.

Art Unit: 2686

11. **Claims 11, 13-15, and 30** are rejected under 35 U.S.C. 103(a) as being unpatentable over **Treyz et al. (U.S. Patent # 6,587,835 B1)**, newly cited, in view of **Bottum (U.S. Patent # 6,014,569)**, of record.

Consider **claims 11, 13, and 30**, Treyz et al. clearly show and disclose a method for communicating selected information to a handheld computing (electronic) device 12 (figure 107), the method comprising:

maintaining data associated with the selected audio information using an audio kiosk 1000 (digital engine) (figure 107) (column 60 lines 57-62 and column 61 lines 25-30);

initiating wireless communication of the data to the handheld computing (electronic) device 12 (figure 110 step 1064, column 60 lines 59-62, column 61 lines 18-24, and column 62 lines 7-15 and 43-47);

presenting, in a web browsing environment (column 61 lines 25-27 and 34-36 and column 62 lines 19-27), information associated with audio information within a display 1012 (graphical user interface) (figures 107-109) associated a communication network (e.g., the store) (column 61 lines 16-24, column 61 line 41 - column 62 line 15, and column 62 lines 28-33); and

receiving an input (e.g., artist, title, or category (figure 108)) from a user identifying the selected information (figure 110 step 1060, column 61 lines 16-24, column 61 line 41 - column 62 line 15, and column 62 lines 28-33).

However, Treyz et al. do not specifically disclose the steps of receiving an input from a user identifying the handheld computing (electronic) device 12, the input including a reference identifying the handheld computing (electronic) device 12 and presenting in formation associated

Art Unit: 2686

with identifying handheld computing (electronic) device 12 (claim 13).

In the same field of endeavor, Bottum clearly shows and discloses a method for communicating selected audio information (abstract) comprising, among other steps, the step of receiving an input (ID data) from a user identifying a mobile interactive radio 150 (electronic device) (reads on presenting information associated with identifying the mobile interactive radio 150 (electronic device)), the input including a reference (ID of radio) identifying the mobile interactive radio 150 (electronic device) (figure 1, figure 3 step 330, column 3 lines 54-61, and column 5 lines 20-55).

Therefore, it would have been obvious to a person of ordinary skill in the art at the time the invention was made to incorporate the step of receiving an input from a user identifying the device taught by Bottum into the method of Treyz et al. for the purpose of enhancing the security by transmitting the audio information only to authorized subscribers (Bottum; column 2 lines 20-24).

Consider **claim 14**, and **as applied to claim 11 above**, Treyz et al., as modified by Bottum, further disclose wherein the display 1012 (interface) operates in a web browsing environment (e.g., when the audio files are stored in a remote server (column 61 lines 25-27) or when the user fills an order through the Internet 1022 (column 61 lines 34-36 and column 62 lines 19-27)) and the wireless communication operates outside the browsing environment (column 60 lines 57-62, column 61 lines 16-30, and column 62 lines 7-15 and 43-47).

Consider **claim 15**, and **as applied to claim 11 above**, Treyz et al., as modified by Bottum, also disclose that the wireless communication comprises communicating through a

Art Unit: 2686

remote wireless link (column 62 lines 7-15), wherein said remote wireless link is through a cellular communications network (column 13 lines 39-47).

Response to Arguments

12. Applicant's arguments with respect to **claims 1, 11, 16, and 34** have been considered but are moot in view of the new ground(s) of rejection.

Conclusion

13. Any response to this Office Action should be **faxed to (703) 872-9306 or mailed to:**

Commissioner for Patents
P.O. Box 1450
Alexandria, VA 22313-1450

Hand-delivered responses should be brought to

Crystal Park II
2021 Crystal Drive
Arlington, VA 22202
Sixth Floor (Receptionist)

14. Any inquiry concerning this communication or earlier communications from the Examiner should be directed to Rafael Perez-Gutierrez whose telephone number is (703) 308-8996. The Examiner can normally be reached on Monday-Thursday from 6:30am to 5:00pm.

Art Unit: 2686

If attempts to reach the Examiner by telephone are unsuccessful, the Examiner's supervisor, Marsha D. Banks-Harold can be reached on (703) 305-4379. The fax phone number for the organization where this application or proceeding is assigned is (703) 872-9306.

Information regarding the status of an application may be obtained from the Patent Application Information Retrieval (PAIR) system. Status information for published applications may be obtained from either Private PAIR or Public PAIR. Status information for unpublished applications is available through Private PAIR only. For more information about the PAIR system, see <http://pair-direct.uspto.gov>. Should you have questions on access to the Private PAIR system, contact the Electronic Business Center (EBC) at 866-217-9197 (toll-free).

Any inquiry of a general nature or relating to the status of this application or proceeding should be directed to the receptionist whose telephone number is (703) 305-4700 or call customer service at (703) 306-0377.

Rafael Perez-Gutierrez
R.P.G./rpg **RAFAEL PEREZ-GUTIERREZ**
PATENT EXAMINER

May 18, 2004

CHARLES APPIAH
PRIMARY EXAMINER

Notice of References Cited	Application/Control No. 09/537,812	Applicant(s)/Patent Under Reexamination White et al.	
	Examiner Rafael Perez-Gutierrez	Art Unit 2686	Page 1 of 1

U.S. PATENT DOCUMENTS

*	Document Number Country Code-Number-Kind Code	Date MM-YYYY	Name	Classification
A	US 5,587,835 B1	07-2003	Treyz et al.	705/14
B	US-			
C	US-			
D	US-			
E	US-			
F	US-			
G	US-			
H	US-			
I	US-			
J	US-			
K	US-			
L	US-			
M	US-			

FOREIGN PATENT DOCUMENTS

*	Document Number Country Code-Number-Kind Code	Date MM-YYYY	Country	Name	Classification
N					
O					
P					
Q					
R					
S					
T					

NON-PATENT DOCUMENTS

*	Include as applicable: Author, Title Date, Publisher, Edition or Volume, Pertinent Pages)
U	
V	
W	
X	

*A copy of this reference is not being furnished with this Office action. (See MPEP § 707.05(a).)
Dates in MM-YYYY format are publication dates. Classifications may be US or foreign.



L Number	Hits	Search Text	DB	Time stamp
6	3	("6587835" or ("6014569" or ("6247130").PN. (audio adj file) with (wireless or RF)) and Internet and (GUI or (graphical adj user adj interface)) and (@riad<20000328 or @ad<200003828)	USPAT; US-PGPUB; EPO; JPO; DERWENT; IBM_TDB	2004/05/18 08:40 2004/05/18 08:40
-	13	(("20040002904") or ("20040002359") or ("20040006769") or ("20040005039").PN.	USPAT; US-PGPUB; EPO; JPO; DERWENT; IBM_TDB	2004/01/28 17:48
-	4	gantt.xa. and (xm or satellite).as.	USPAT; US-PGPUB; EPO; JPO; DERWENT; IBM_TDB	2004/05/17 07:41
-	1	(xm near2 satellite).as.	USPAT; US-PGPUB; EPO; JPO; DERWENT; IBM_TDB	2004/05/17 09:25
-	64	((wireless or RF) same (download\$3 with (audio or mp3 or music)) and (Internet or server or web) and ((graphical adj2 interface) or GUI) and brows\$3	USPAT; US-PGPUB; EPO; JPO; DERWENT; IBM_TDB	2004/05/17 09:30
-	55	((wireless or RF) same (download\$3 with (audio or mp3 or music)) and (Internet or server or web) and ((graphical adj2 interface) or GUI) and brows\$3) and (@riad<20000328 or @ad<20000328)	USPAT; US-PGPUB; EPO; JPO; DERWENT; IBM_TDB	2004/05/17 10:57
-	11	(russell near2 white).in. or (kevin near2 imes).in.	USPAT; US-PGPUB; EPO; JPO; DERWENT; IBM_TDB	2004/05/17 13:01
-	36	gsm with "2.0 GHZ"	USPAT; US-PGPUB; EPO; JPO; DERWENT; IBM_TDB	2004/05/17 14:19
-	41			

-	41	(gsm with "2.0 GHZ") and (@riad<20000328 or @ad<200003828)	USPAT; US-PGPUB; EPO; JPO; DERWENT; IBM_TDB	2004/05/17 14:19
-	2	6247130.uref.	USPAT; US-PGPUB; EPO; JPO; DERWENT; IBM_TDB	2004/05/17 15:59
-	2	6247130.pn.	USPAT; US-PGPUB; EPO; JPO; DERWENT; IBM_TDB	2004/05/17 15:59
-	3	("5991399" "6009410" "6038595").PN.	USPAT; US-PGPUB; EPO; JPO; DERWENT; IBM_TDB	2004/05/17 15:59

07/09/2003 09:58

5125271159

PAGE 01

w/letter re: Interview summary
7/21/03
A.S.

RECEIVED
7/19/03 MS

Official

PATENT APPLICATION 09/537,812

IN THE UNITED STATES PATENT AND TRADEMARK OFFICE

In re Application of: White et al.

Date Filed: March 28, 2000

Serial No.: 09/537,812

Examiner: Andrew T. Harry

Group Art Unit: 2684

Title: SYSTEM AND METHOD FOR COMMUNICATING SELECTED INFORMATION TO AN ELECTRONIC DEVICE

<p>Box Non-Fee Amendment Assistant Commissioner for Patents Washington, D.C. 20231</p>	<p>CERTIFICATE OF FACSIMILE TRANSMISSION</p> <p>Date of Facsimile Transmitted: July 9, 2003</p> <p>I hereby certify that this correspondence is being faxed to the United States Patent and Trademark Office at 703-872-9314 to the attention of:</p> <p>Box Non-Fee Amendment Assistant Commissioner for Patents Washington, D.C. 20231</p> <p>Russell W. White</p> <p>Print Name: _____ Signature: <i>R. White</i></p>
--	--

SUBSTANCE OF INTERVIEW STATEMENT TRANSMITTAL

Dear Sir or Madam:

As requested by Supervisory Patent Examiner William Trost, transmitted herewith for filing in the above-identified patent application is the following document:

1. Statement regarding the substance of January 22, 2003 interview (2 pages).

No additional fee is required.

RESPECTFULLY SUBMITTED,
White et al.

[Signature]

Kevin R. Innes
Reg. No. 44,795

Russell White
10704 Redmond Rd.
Austin, Texas 78739
Telephone: (512) 301-5518

Received from <5125271159> at 7/9/03 11:45:38 AM [Eastern Daylight Time]

RECEIVED
7/9/03 MS

Official

PATENT APPLICATION 09/537,812

1

IN THE UNITED STATES PATENT AND TRADEMARK OFFICE

In re Application of: White et al.

Date Filed: March 28, 2000

Serial No.: 09/537,812

Examiner: Andrew T. Harry

Group Art Unit: 2684

Title: SYSTEM AND METHOD FOR COMMUNICATING SELECTED INFORMATION
TO AN ELECTRONIC DEVICE

Box Non-Fee Amendment
Assistant Commissioner for Patents
Washington, D.C. 20231

Statement Regarding the Substance of January 22, 2003 Interview

Dear Sir:

Applicants would like to reiterate their appreciation for the time taken by Examiner Harry and then Supervisory Patent Examiner (SPE) Hunter during the Examiner's telephonic interview on Wednesday, January 22, 2003. A brief summary of that interview was provided with Applicants' communication dated February 18, 2003.

During the January 22, 2003 interview, there was no exhibit shown, and the participants of the interview were: Examiner Andrew T. Harry; SPE Daniel Hunter; Kevin Imes; and, Russell White.

Prior art was not discussed in detail during the interview. The participants discussed claims 1, 11, 16, and 34 and the status of those claims, which were on final at the time. The participants reached an agreement that the Final Office Action mailed on December 2, 2002 would not be entered but vacated instead.

During the January 22nd interview, the participants agreed that the Final Office Action mailed on December 2, 2002 did not, among other things, address the currently pending

PATENT APPLICATION 09/537,812

2

claims or provide an explanation of what art Examiner Harry was relying on and how the art of record was being interpreted to form the basis of the rejections.

SPE Hunter indicated that a new search would likely be performed and that the Applicants could amend the claims, if they wished, into a form Applicants would like examined. SPE Hunter also requested a brief explanation of short-range (e.g., Bluetooth, 802.11, etc.) and long-range (e.g., GSM technologies, like GPRS, EDGE, etc.) communication techniques as well as a brief explanation of file-based communications and streaming-based communications.

Applicants agreed to provide both a clean and a marked-up copy of the claims to be examined. Applicants further agreed to provide information relating to short-range and long-range communication techniques as well as file-based and streaming communication technology.

RESPECTFULLY SUBMITTED,

White et al.

Date: July 9, 2003

By:

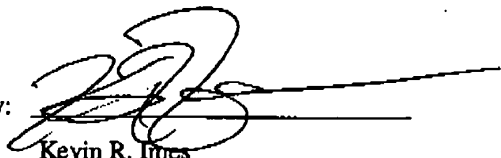

Kevin R. Iltis

Reg. No. 44,795

Russell White
10704 Redmond Rd.
Austin, Texas 78739
Telephone: (512) 301-5518



UNITED STATES PATENT AND TRADEMARK OFFICE

UNITED STATES DEPARTMENT OF COMMERCE
United States Patent and Trademark Office
Address: COMMISSIONER FOR PATENTS
P.O. Box 1450
Alexandria, Virginia 22313-1450
www.uspto.gov

APPLICATION NO.	FILING DATE	FIRST NAMED INVENTOR	ATTORNEY DOCKET NO.	CONFIRMATION NO.
09/537,812	03/28/2000	Russell W. White	111111.1111	4698

7590 06/17/2003
Russell W White
10704 Redmond
Austin, TX 78739

EXAMINER

HARRY, ANDREW T

ART UNIT PAPER NUMBER

2683

DATE MAILED: 06/17/2003

Please find below and/or attached an Office communication concerning this application or proceeding.

Interview Summary	Application No. 09/537,812	Applicant(s) WHITE ET AL.	
	Examiner William G Trost	Art Unit 2683	

All participants (applicant, applicant's representative, PTO personnel):

- (1) William G Trost. (3) Kevin Imes.
 (2) Russell White. (4) _____.

Date of Interview: 13 June 2003.

Type: a) Telephonic b) Video Conference
 c) Personal [copy given to: 1) applicant 2) applicant's representative]

Exhibit shown or demonstration conducted: d) Yes e) No.
 If Yes, brief description: _____.

Claim(s) discussed: 1, 11, 16 and 34.

Identification of prior art discussed: N/A.

Agreement with respect to the claims f) was reached. g) was not reached. h) N/A.

Substance of Interview including description of the general nature of what was agreed to if an agreement was reached, or any other comments: See Continuation Sheet.

(A fuller description, if necessary, and a copy of the amendments which the examiner agreed would render the claims allowable, if available, must be attached. Also, where no copy of the amendments that would render the claims allowable is available, a summary thereof must be attached.)

THE FORMAL WRITTEN REPLY TO THE LAST OFFICE ACTION MUST INCLUDE THE SUBSTANCE OF THE INTERVIEW. (See MPEP Section 713.04). If a reply to the last Office action has already been filed, APPLICANT IS GIVEN ONE MONTH FROM THIS INTERVIEW DATE TO FILE A STATEMENT OF THE SUBSTANCE OF THE INTERVIEW. See Summary of Record of Interview requirements on reverse side or on attached sheet.

 WILLIAM TROST
 SUPERVISORY PATENT EXAMINER
 TECHNOLOGY CENTER 2600

Examiner Note: You must sign this form unless it is an Attachment to a signed Office action.

 Examiner's signature, if required

Summary of Record of Interview Requirements

Manual of Patent Examining Procedure (MPEP), Section 713.04, Substance of Interview Must be Made of Record

A complete written statement as to the substance of any face-to-face, video conference, or telephone interview with regard to an application must be made of record in the application whether or not an agreement with the examiner was reached at the interview.

Title 37 Code of Federal Regulations (CFR) § 1.133 Interviews

Paragraph (b)

In every instance where reconsideration is requested in view of an interview with an examiner, a complete written statement of the reasons presented at the interview as warranting favorable action must be filed by the applicant. An interview does not remove the necessity for reply to Office action as specified in §§ 1.111, 1.135. (35 U.S.C. 132)

37 CFR §1.2 Business to be transacted in writing.

All business with the Patent or Trademark Office should be transacted in writing. The personal attendance of applicants or their attorneys or agents at the Patent and Trademark Office is unnecessary. The action of the Patent and Trademark Office will be based exclusively on the written record in the Office. No attention will be paid to any alleged oral promise, stipulation, or understanding in relation to which there is disagreement or doubt.

The action of the Patent and Trademark Office cannot be based exclusively on the written record in the Office if that record is itself incomplete through the failure to record the substance of interviews.

It is the responsibility of the applicant or the attorney or agent to make the substance of an interview of record in the application file, unless the examiner indicates he or she will do so. It is the examiner's responsibility to see that such a record is made and to correct material inaccuracies which bear directly on the question of patentability.

Examiners must complete an Interview Summary Form for each interview held where a matter of substance has been discussed during the interview by checking the appropriate boxes and filling in the blanks. Discussions regarding only procedural matters, directed solely to restriction requirements for which interview recordation is otherwise provided for in Section 812.01 of the Manual of Patent Examining Procedure, or pointing out typographical errors or unreadable script in Office actions or the like, are excluded from the interview recordation procedures below. Where the substance of an interview is completely recorded in an Examiners Amendment, no separate Interview Summary Record is required.

The Interview Summary Form shall be given an appropriate Paper No., placed in the right hand portion of the file, and listed on the "Contents" section of the file wrapper. In a personal interview, a duplicate of the Form is given to the applicant (or attorney or agent) at the conclusion of the interview. In the case of a telephone or video-conference interview, the copy is mailed to the applicant's correspondence address either with or prior to the next official communication. If additional correspondence from the examiner is not likely before an allowance or if other circumstances dictate, the Form should be mailed promptly after the interview rather than with the next official communication.

The Form provides for recordation of the following information:

- Application Number (Series Code and Serial Number)
- Name of applicant
- Name of examiner
- Date of interview
- Type of interview (telephonic, video-conference, or personal)
- Name of participant(s) (applicant, attorney or agent, examiner, other PTO personnel, etc.)
- An indication whether or not an exhibit was shown or a demonstration conducted
- An identification of the specific prior art discussed
- An indication whether an agreement was reached and if so, a description of the general nature of the agreement (may be by attachment of a copy of amendments or claims agreed as being allowable). Note: Agreement as to allowability is tentative and does not restrict further action by the examiner to the contrary.
- The signature of the examiner who conducted the interview (if Form is not an attachment to a signed Office action)

It is desirable that the examiner orally remind the applicant of his or her obligation to record the substance of the interview of each case. It should be noted, however, that the Interview Summary Form will not normally be considered a complete and proper recordation of the interview unless it includes, or is supplemented by the applicant or the examiner to include, all of the applicable items required below concerning the substance of the interview.

A complete and proper recordation of the substance of any interview should include at least the following applicable items:

- 1) A brief description of the nature of any exhibit shown or any demonstration conducted,
- 2) an identification of the claims discussed,
- 3) an identification of the specific prior art discussed,
- 4) an identification of the principal proposed amendments of a substantive nature discussed, unless these are already described on the Interview Summary Form completed by the Examiner,
- 5) a brief identification of the general thrust of the principal arguments presented to the examiner,
(The identification of arguments need not be lengthy or elaborate. A verbatim or highly detailed description of the arguments is not required. The identification of the arguments is sufficient if the general nature or thrust of the principal arguments made to the examiner can be understood in the context of the application file. Of course, the applicant may desire to emphasize and fully describe those arguments which he or she feels were or might be persuasive to the examiner.)
- 6) a general indication of any other pertinent matters discussed, and
- 7) if appropriate, the general results or outcome of the interview unless already described in the Interview Summary Form completed by the examiner.

Examiners are expected to carefully review the applicant's record of the substance of an interview. If the record is not complete and accurate, the examiner will give the applicant an extendable one month time period to correct the record.

Examiner to Check for Accuracy

If the claims are allowable for other reasons of record, the examiner should send a letter setting forth the examiner's version of the statement attributed to him or her. If the record is complete and accurate, the examiner should place the indication, "Interview Record OK" on the paper recording the substance of the interview along with the date and the examiner's initials.

Continuation of Substance of Interview including description of the general nature of what was agreed to if an agreement was reached, or any other comments: Applicant's representative pointed out that the Office Action of 4/30/03 contained claim rejections which do not seem to address the currently pending claims. Applicants also discussed that it was not clear where Examiner Harry was interpreting the prior art with respect to the newly added "long range" / "short range" RF communications. Spe Trost noted that claims 34-39 were submitted in the previous amendment while applicants only submitted claims 34-38. This was attributed to a clerical error in Applicants file. SPE Trost further stated that the previous action will be vacated and a new office action issued shortly.

7/29



UNITED STATES PATENT AND TRADEMARK OFFICE

UNITED STATES DEPARTMENT OF COMMERCE
United States Patent and Trademark Office
Address: COMMISSIONER OF PATENTS AND TRADEMARKS
Washington, D.C. 20231
www.uspto.gov

APPLICATION NO.	FILING DATE	FIRST NAMED INVENTOR	ATTORNEY DOCKET NO.	CONFIRMATION NO.
09/537,812	03/28/2000	Russell W. White	111111.1111	4698

7590 04/30/2003
 Russell W White
 10704 Redmond
 Austin, TX 78739

EXAMINER

HARRY, ANDREW T

ART UNIT	PAPER NUMBER
2683	9

DATE MAILED: 04/30/2003

Please find below and/or attached an Office communication concerning this application or proceeding.

P24

Office Action Summary

Application No.

09/537,812

Applicant(s)

WHITE ET AL.

Examiner

Andrew T Harry

Art Unit

2683

-- The MAILING DATE of this communication appears on the cover sheet with the correspondence address --

Period for Reply

A SHORTENED STATUTORY PERIOD FOR REPLY IS SET TO EXPIRE 3 MONTH(S) FROM THE MAILING DATE OF THIS COMMUNICATION.

- Extensions of time may be available under the provisions of 37 CFR 1.136(a). In no event, however, may a reply be timely filed after SIX (6) MONTHS from the mailing date of this communication.
- If the period for reply specified above is less than thirty (30) days, a reply within the statutory minimum of thirty (30) days will be considered timely.
- If NO period for reply is specified above, the maximum statutory period will apply and will expire SIX (6) MONTHS from the mailing date of this communication.
- Failure to reply within the set or extended period for reply will, by statute, cause the application to become ABANDONED (35 U.S.C. § 133).
- Any reply received by the Office later than three months after the mailing date of this communication, even if timely filed, may reduce any earned patent term adjustment. See 37 CFR 1.704(b).

Status

- 1) Responsive to communication(s) filed on 18 February 2003.
- 2a) This action is **FINAL**. 2b) This action is non-final.
- 3) Since this application is in condition for allowance except for formal matters, prosecution as to the merits is closed in accordance with the practice under *Ex parte Quayle*, 1935 C.D. 11, 453 O.G. 213.

Disposition of Claims

4) Claim(s) 1,4-11,13-16,18-21,23 and 26-37 is/are pending in the application.

4a) Of the above claim(s) _____ is/are withdrawn from consideration.

5) Claim(s) _____ is/are allowed.

6) Claim(s) 1, 4-11, 13-16, 18-21, 23, and 26-37 is/are rejected.

7) Claim(s) _____ is/are objected to.

8) Claim(s) _____ are subject to restriction and/or election requirement.

Application Papers

9) The specification is objected to by the Examiner.

10) The drawing(s) filed on 28 March 2000 is/are: a) accepted or b) objected to by the Examiner.

Applicant may not request that any objection to the drawing(s) be held in abeyance. See 37 CFR 1.85(a).

11) The proposed drawing correction filed on _____ is: a) approved b) disapproved by the Examiner.

If approved, corrected drawings are required in reply to this Office action.

12) The oath or declaration is objected to by the Examiner.

Priority under 35 U.S.C. §§ 119 and 120

13) Acknowledgment is made of a claim for foreign priority under 35 U.S.C. § 119(a)-(d) or (f).

a) All b) Some * c) None of:

1. Certified copies of the priority documents have been received.

2. Certified copies of the priority documents have been received in Application No. _____.

3. Copies of the certified copies of the priority documents have been received in this National Stage application from the International Bureau (PCT Rule 17.2(a)).

* See the attached detailed Office action for a list of the certified copies not received.

14) Acknowledgment is made of a claim for domestic priority under 35 U.S.C. § 119(e) (to a provisional application).

a) The translation of the foreign language provisional application has been received.

15) Acknowledgment is made of a claim for domestic priority under 35 U.S.C. §§ 120 and/or 121.

Attachment(s)

1) Notice of References Cited (PTO-892)

2) Notice of Draftsperson's Patent Drawing Review (PTO-948)

3) Information Disclosure Statement(s) (PTO-1449) Paper No(s) _____.

4) Interview Summary (PTO-413) Paper No(s) _____.

5) Notice of Informal Patent Application (PTO-152)

6) Other:

DETAILED ACTION

Response to Amendment

The Examiner has received the Applicant's amendment filed February 18, 2003. Claims 38 and 39 have been added and claims 8, 11, 16, 21, 23, 27, 31, 34 and 37 have been amended.

Response to Arguments

Applicant should submit an argument under the heading "Remarks" pointing out disagreements with the examiner's contentions. Applicant must also discuss the references applied against the claims, explaining how the claims avoid the references or distinguish from them.

The Applicant has submitted remarks clarifying what is perceived as being the claimed invention but fails to provide any persuasive arguments describing how the instant invention is allowable over the prior art made of record.

Claim Rejections - 35 USC § 112

Claims 27, 31 and 34 were rejected under 35 U.S.C. 112, second paragraph, as being indefinite for failing to particularly point out and distinctly claim the subject matter which applicant regards as the invention. The Applicant has overcome this rejection and the prior art rejection of claims 27, 31 and 34 follow in this action.

Streaming Audio Discussion

The Applicant goes to great lengths to describe the differences between an 'audio file' and 'streaming audio' in his remarks. However, the examiner maintains that 'streaming audio' is transferred as an 'audio file' and can be stored on the receiving device as such. The invention as claimed provides no teachings of any other definition or significant difference between 'streaming audio' and the transferring of an 'audio file'. Furthermore, *Cerf* as described in Fig 1 shows that a laptop, wireless PDA/cellular phone, or internet radio has access to the internet. One of ordinary skill in the art obviously knows that devices with wireless access to the Internet are typically equipped with a browser and also that the Internet contains various websites with downloadable audio data to be played. Therefore these devices could clearly access the internet and download an audio file from any one of the sources available to do so on the Internet.

Claim Rejections - 35 USC § 103

The following is a quotation of 35 U.S.C. 103(a) which forms the basis for all obviousness rejections set forth in this Office action:

(a) A patent may not be obtained though the invention is not identically disclosed or described as set forth in section 102 of this title, if the differences between the subject matter sought to be patented and the prior art are such that the subject matter as a whole would have been obvious at the time the invention was made to a person having ordinary skill in the art to which said subject matter pertains. Patentability shall not be negated by the manner in which the invention was made.

Claims 1, 4-11, 13-16, 18-21, 23, and 26-33 are rejected under 35 U.S.C. 103(a) as being unpatentable over ***Cerf et al. US Patent 6,418,138*** ("*Cerf*").

As pertaining to **claims 1 and 11**, Cerf describes a system and method for communicating selected information to an electronic device (see Cerf abstract), the system comprising:

a digital engine operable to maintain data associated with selectable audio information, the audio information comprising an audio file (see Cerf col. 3 line 35 – col. 4 line 5, Cerf describes the idea of Internet radio and how it manages audio information, and the user is able to select a specific channel, and clearly if the information transmitted is a file); and

a communication engine communicatively coupled to the digital engine (see Cerf col. 4 lines 6 – 49, in this section Cerf describes how the Proxy server is connected to the internet and acts as a communication engine for the internet to the mobile users.), the communication engine operable to initiate wireless communication of the data to the electronic device (see Cerf col. 5 lines 10 – 28, Cerf describes an example of how the digital audio data is transmitted from the internet through the proxy server out to the wireless mobile user.);

a graphical user interface operably coupled to the digital engine to provide available information to a user of a communication network and to receive an input from the user identifying a selected portion of the selectable information (see Cerf, col. 4 lines 28-50);

wherein the interface operates in a web browsing environment and the wireless communication operates outside the browsing environment (see Cerf, col. 3 lines 35-67);

said communication engine must also receive a registration from the electronic device including a reference identifying the electronic device (see Cerf, col. 5 lines 34-56).

Cerf does not use the exact terminology that may be used in the instant invention; however, it would have been obvious to one of ordinary skill in the art that the spirit of Cerf's

Application/Control Number: 09/537,812

Art Unit: 2683

disclosure is similar to that of the claimed invention. To further proceed with prosecution it is suggested that the applicant be more specific with their claims and describe how their "selected audio information" may be different from the selectable channels of audio files (essentially selectable audio information) described by Cerf.

As pertaining to **claims 4 – 10, and 15** Cerf teaches that the audio data is retrieved by a PDA, laptop, or Internet radio via a wireless link between the mobile station and the "radio tower" (see Cerf col. 3 lines 20 – 25 and fig. 2), which is connected to a proxy server which is connected to the internet. Cerf, however, is silent on the wireless method used to transmit the data from the radio tower to the mobile device. It would have been obvious to one of ordinary skill in the art at the time of the invention to use the transmission method that would best fit the design of the system. Some of the transmission methods available at the time of the invention included cellular (which typically used CDMA as a method of transmission), global system for mobile communications (which is operated between 1.7 and 2.0 GHz), or a high-speed low-power microwave wireless link like Bluetooth, which operates around 2.4 GHz. The use of any of these protocols at the time of the invention would have been obvious to one of ordinary skill in the art based on the design choice of the system designer.

As pertaining to **claim 26**, Cerf describes the characteristics of the wireless devices that are adaptable to be used in his system and that his system is operable on most any wireless link that would allow his devices to connect to the internet including cellular (which typically used CDMA as a method of transmission), global system for mobile communications (which is operated between 1.7 and 2.0 GHz), or a high-speed low-power microwave wireless link like

Bluetooth, which operates around 2.4 GHz. The use of any of these protocols at the time of the invention would have been obvious to one of ordinary skill in the art based on the design choice of the system designer. (see Cerf, col. 4 lines 1-6, this indicates that a cellular phone could be used as all the components described are included in modern cellular telephones).

As pertaining to **claim 29**, Cerf describes that the audio information further comprises streaming audio information (see Cerf, col. 4 line 14).

As pertaining to **claim 30**, Cerf describes that the information is presented in a web-browsing environment (see Cerf, col. 4 lines 28-40).

As pertaining to **claim 31**, since the device in Cerf's disclosure can be a PDA/cellular phone operating on a cellular system, the long range communication could clearly include a voice call (see Cerf, col. 4 lines 1-6, this indicates that a cellular phone could be used as all the components described are included in modern cellular telephones).

As pertaining to **claim 13**, Cerf's method further comprises:

presenting information associated with the electronic device (see Cerf col. 5 line 66 – col 6 line 5); and

receiving an input from a user identifying the electronic device (see Cerf col. 6 lines 10 – 14).

As pertaining to **claim 14**, in Cerf's system and method the interface operates in a browsing environment (see Cerf col. 6 lines 23 – 30, Cerf describes that the user is able to look around and retrieve information from the proxy server regarding current broadcast options) and the wireless communication operates outside the browsing environment (see Cerf col. 5 lines 10 – 28).

As pertaining to **claims 16, 18, 19, 28, and 32** Cerf describes an electronic device for receiving selected audio information via wireless communication, the device comprising:

a communication module operable to receive wireless communication of the information (see Cerf col. 1 lines 15 – 27) ;

a RF communication module operably coupled to a processor module (see Cerf, col. 4 lines 1-6, Cerf does not describe specific power characteristics or speed characteristics of the terminal, but it would have been obvious to one of ordinary skill in the art that Cerf's link could be accomplished by using a multitude of various wireless technologies available at the time of the invention).

Cerf describes that a laptop computer or a PDA may be used as the mobile device in his system to implement his wireless radio concept (see Cerf fig. 2 and col. 5 lines 58 – 61), however Cerf does not specifically describe the capabilities in terms of processing of his mobile device (see Cerf col. 7 lines 10 – 18). However, it would have been obvious to one of ordinary skill in the art at the time of the invention that the laptop computer or PDA would include a storage medium operably coupled to the communication module, the storage medium operable to store the selected audio information and a processor module coupled to the communication module, the processor module operable to process the received selected audio information. It would have been obvious to a skilled artisan at the time of the invention that all laptops and PDAs would include processors capable of processing received data, and memory that would have been capable of storing data that would have been downloaded to these devices. Additionally, is very well known in the art that traditional ways of saving audio files include

WAV, MP3, and MIDI formats and the file would be stored in one of these formats. This would have allowed the users of these devices to actually listen to the audio music that they were downloading and to store the audio information that would have been downloaded to the device so that they may listen to it at a later time.

Cerf's device does have a display operable to display a web browser within a user interface (see Cerf, col. 4 lines 28-40).

As pertaining to **claim 33**, Cerf describes that the audio information further comprises streaming audio information (see Cerf, col. 4 line 14).

As pertaining to **claim 20**, Cerf's device as modified above in claim 16 further comprises software for processing the selected information (see Cerf col. 7 lines 11 – 18).

As pertaining to **claim 21**, Cerf's device as modified above regarding claims 17 and 23 describes that some of the various transmission techniques that would have been used to transmit the data include various wireless technologies. Many of these technologies are frequency and time hopped systems, and therefore the system would have been capable of scanning the various frequency channels.

As pertaining to **claim 23**, Cerf as modified above regarding claim 16, teaches that the audio data is retrieved by a PDA, laptop, or Internet radio via a wireless link between the mobile station and the "radio tower" (see Cerf col. 3 lines 20 – 25 and fig. 2), which is connected to a

proxy server which is connected to the internet. Cerf, however, is silent on the wireless method used to transmit the data from the radio tower to the mobile device. It would have been obvious to one of ordinary skill in the art at the time of the invention to use the transmission method that would best fit the design of the system. Some of the transmission methods available at the time of the invention included cellular (which typically used CDMA as a method of transmission), global system for mobile communications (which is operated between 1.7 and 2.0 GHz), or a high-speed low-power microwave wireless link like Bluetooth, which operates around 2.4 GHz. The use of any of these protocols at the time of the invention would have been obvious to one of ordinary skill in the art based on the design choice of the system designer. Also if the device used by the user would be a PDA or laptop computer it would have been obvious to one of ordinary skill in the art at the time of the invention that a cellular or other modem would have been used to receive the transmitted signal.

The following is a second rejection of claims 1 – 23 using an alternative prior art publication.

Claim Rejections - 35 USC § 102

(e) the invention was described in a patent granted on an application for patent by another filed in the United States before the invention thereof by the applicant for patent, or on an international application by another who has fulfilled the requirements of paragraphs (1), (2), and (4) of section 371(c) of this title before the invention thereof by the applicant for patent.

The changes made to 35 U.S.C. 102(e) by the American Inventors Protection Act of 1999 (AIPA) do not apply to the examination of this application as the application being examined was not (1) filed on or after November 29, 2000, or (2) voluntarily published under 35 U.S.C.

Application/Control Number: 09/537,812

Art Unit: 2683

122(b). Therefore, this application is examined under 35 U.S.C. 102(e) prior to the amendment by the AIPA (pre-AIPA 35 U.S.C. 102(e)).

Claims 1, 11, 13-14, 16, 18 - 21 and 23 are rejected under 35 U.S.C. 102(e) as being anticipated by **Bottum U.S. Patent 6,014,569** (Bottum).

As pertaining to **claim 1**, Bottum describes a system for communicating selected information to an electronic device (see Bottum abstract), the system comprising:

a digital engine operable to maintain data associated with selected audio information (see Bottum fig. 1 item 104 col. 2 lines 63 – 64); and

a communication engine communicatively coupled to the digital engine, the communication engine operable to initiate wireless communication of the data to the electronic device (see Bottum fig. 1 items 110 and 120 and col. 2 line 63 – col. 3 line 20).

a graphical user interface operably coupled to the digital engine to provide available information to a user of a communications network and to receive an input from the user identifying a selected portion of the selectable information (see Bottum, col. 4 lines 1-16); and

wherein the interface operates in a web browsing environment and the wireless communication operates outside the browsing environment (see Bottum, col. 4 lines 23-34)

As pertaining to **claim 11**, Bottum describes a method for communicating selected audio information to an electronic device (see Bottum abstract), the method comprising:

maintaining data associated with the selected audio information using a digital engine (see Bottum fig. 1 item 104 col. 2 lines 63 – 64); and

initiating wireless communication of the data to the electronic device (see Bottum fig. 1 items 110 and 120 and col. 2 line 63 – col. 3 line 20).

presenting information associated with audio information within a graphical user interface associated with a communication network (see Bottum, col. 4 lines 1-16);

receiving an input from a user identifying the selected information (see Bottum, col. 4 lines 1-16);

receiving an input from a user identifying the electronic device (see Bottum, col. 3 lines 54-67);

As pertaining to **claim 13**, Bottum's method further comprises:

presenting information associated with the electronic device; and

receiving an input from a user identifying the electronic device (see Bottum col. 3 line 54 – col. 4 line 16).

As pertaining to **claim 14**, the interface in Bottum's method operates in a browsing environment (see Bottum col. 3 lines 60 – 67, Bottum describes that the user is capable of requesting a menu of available audio options i.e. browsing) and the wireless communication operates outside the browsing environment (see Bottum fig. 1 items 110 and 120 and col. 2 line 63 – col. 3 line 20, Bottum describes nothing in regards to browsing in regards to the wireless communications).

As pertaining to **claim 16**, Bottum describes an electronic device for receiving selected audio information via wireless communication (see Bottum abstract), the device comprising:

- a communication module operable to receive wireless communication of the selected audio information (see Bottum col. 2 lines 59 and 60);
- a storage medium operably coupled to the communication module, the storage medium operable to store the selected audio information (see Bottum col. 7 lines 33 – 48); and
- a processor module coupled to the communication module, the processor module operable to process the received selected audio information (see Bottum col. 3 lines 15 – 32, the laptops obviously contain both processing and memory capabilities that may be used with the receiver).

As pertaining to **claim 18**, Bottum's device could be a handheld computing device (see Bottum fig. 2, and col. 3 lines 20 – 32, a laptop is also considered a hand-held device).

As pertaining to **claim 20**, Bottum's device further comprises software for processing the selected information (see Bottum col. 3 lines 26 – 30).

As pertaining to **claim 21**, the communications module in Bottum's device is operable to scan frequencies (see Bottum col. 13-16).

Claim Rejections - 35 USC § 103

The following is a quotation of 35 U.S.C. 103(a) which forms the basis for all obviousness rejections set forth in this Office action:

(a) A patent may not be obtained though the invention is not identically disclosed or described as set forth in section 102 of this title, if the differences between the subject matter sought to be patented and the prior art are such that the subject matter as a whole would have been obvious at the time the invention was made to a person having ordinary skill in the art to which said subject matter pertains. Patentability shall not be negated by the manner in which the invention was made.

Claims 4 – 10, 15, 19, 23 are rejected under 35 U.S.C. 103(a) as being unpatentable over Bottum.

As pertaining to **claims 4 – 10, 15, and 23** Bottum teaches that the audio data is retrieved by a PDA/ laptop, or Internet radio via a wireless link between the mobile station and the wireless service provider, and Bottum describes that that service could be various different types of wireless service an equipment (see Bottum fig. 1 items 110 and 120 and col. 2 line 63 – col. 3 line 31). Bottum however, does not disclose all possible wireless methods that could be used to transmit the data from the radio tower to the mobile device. It would have been obvious to one of ordinary skill in the art at the time of the invention to use the transmission method that would best fit the design of the system. Some of the transmission methods available at the time of the invention included cellular (which typically used CDMA as a method of transmission), global system for mobile communications (which is operated between 1.7 and 2.0 GHz), or a high-speed low-power microwave wireless link like Bluetooth, which operates around 2.4 GHz. The use of any of these protocols at the time of the invention would have been obvious to one of ordinary skill in the art based on the design choice of the system designer.

As pertaining to **claim 19**, Bottum's device describes that it is possible to use a laptop with a cellular modem to receive the requested audio signal (see Bottum col. 3 lines 15 – 20), however Bottum does not disclose specifically that a PDA may be used to download the digital audio data. It would have been obvious to one of ordinary skill in the art at the time of the invention to know that a PDA possessed the same basic functionalities as a laptop computer and that given a users specific needs they could have used a PDA with a cellular modem to download and process the digital music in a similar manner as would have been accomplished in a laptop computer. The smaller PDA would have allowed the user to be significantly more mobile and to take the device places that a laptop may have been an inconvenience.

Newly Addressed claims 34-37

Claim Rejections - 35 USC § 103

The following is a quotation of 35 U.S.C. 103(a) which forms the basis for all obviousness rejections set forth in this Office action:

(a) A patent may not be obtained though the invention is not identically disclosed or described as set forth in section 102 of this title, if the differences between the subject matter sought to be patented and the prior art are such that the subject matter as a whole would have been obvious at the time the invention was made to a person having ordinary skill in the art to which said subject matter pertains. Patentability shall not be negated by the manner in which the invention was made.

Claims 34-37 are rejected under 35 U.S.C. 103(a) as being unpatentable over **Cerf**.

As pertaining to **claims 34-39** Cerf describes an electronic device for receiving selected audio information via wireless communication, the device comprising:

a communication module operable to receive wireless communication of the information (see Cerf col. 1 lines 15 – 27) ;

a RF communication module operably coupled to a processor module (see Cerf, col. 4 lines 1-6, Cerf does not describe specific power characteristics or speed characteristics of the terminal, but it would have been obvious to one of ordinary skill in the art that Cerf's link could be accomplished by using a multitude of various wireless technologies available at the time of the invention).

Cerf describes that a laptop computer or a PDA may be used as the mobile device in his system to implement his wireless radio concept (see Cerf fig. 2 and col. 5 lines 58 – 61), however Cerf does not specifically describe the capabilities in terms of processing of his mobile device (see Cerf col. 7 lines 10 – 18). However, it would have been obvious to one of ordinary skill in the art at the time of the invention that the laptop computer or PDA would include a storage medium operably coupled to the communication module, the storage medium operable to store the selected audio information and a processor module coupled to the communication module, the processor module operable to process the received selected audio information. It would have been obvious to a skilled artisan at the time of the invention that all laptops and PDAs would include processors capable of processing received data, and memory that would have been capable of storing data that would have been downloaded to these devices. Additionally, is very well known in the art that traditional ways of saving audio files include WAV, MP3, and MIDI formats and the file would be stored in one of these formats. This would have allowed the users of these devices to actually listen to the audio music that they were

downloading and to store the audio information that would have been downloaded to the device so that they may listen to it at a later time.

Additionally it would have been obvious to one of ordinary skill in the art that a PDA could be used also as a cellular phone serving both to download data and answer telephone calls.

Cerf's device does have a display operable to display a web browser within a user interface (see Cerf, col. 4 lines 28-40).

Conclusion

Applicant's amendment necessitated the new ground(s) of rejection presented in this Office action. Accordingly, **THIS ACTION IS MADE FINAL**. See MPEP § 706.07(a). Applicant is reminded of the extension of time policy as set forth in 37 CFR 1.136(a).

A shortened statutory period for reply to this final action is set to expire THREE MONTHS from the mailing date of this action. In the event a first reply is filed within TWO MONTHS of the mailing date of this final action and the advisory action is not mailed until after the end of the THREE-MONTH shortened statutory period, then the shortened statutory period will expire on the date the advisory action is mailed, and any extension fee pursuant to 37 CFR 1.136(a) will be calculated from the mailing date of the advisory action. In no event, however, will the statutory period for reply expire later than SIX MONTHS from the date of this final action.

The prior art made of record and not relied upon is considered pertinent to applicant's disclosure.

Application/Control Number: 09/537,812

Art Unit: 2683

- A. Gershman et al. U.S. Patent 6,401,085 teaches a mobile communication and computing system and method.
- B. Logan et al. U.S. Patent 6,199,076 teaches an audio program player including a dynamic program selection controller.
- C. Treyz et al. U.S. Patent 6,526,335 teaches an automobile personal computer system.
- D. Steele et al. Pub. No. US 2002/0046084 teaches a remotely configurable multimedia entertainment and information system with location based advertising.
- E. Fritsch U.S. Patent 6,247,130 teaches the distribution of musical products by a web site vendor over the Internet.
- F. Gioscia et al. U.S. Patent 6,407,750 teaches broadcast and recorded music management system particularly for use in automobile.
- G. White et al. U.S. patent 6,496,205 teaches a user interface for controlling audio functions in a web browser.
- H. Liu U.S. Patent 5,953,005 teaches a system and method for on-line multimedia access.

Any inquiry concerning this communication or earlier communications from the examiner should be directed to Andrew T Harry whose telephone number is 703-305-4749. The examiner can normally be reached on M-F 8:30 - 5:00.

If attempts to reach the examiner by telephone are unsuccessful, the examiner's supervisor, William Trost can be reached on 703-308-5318. The fax phone numbers for the organization where this application or proceeding is assigned are 703-872-9314 for regular communications and 703-872-9314 for After Final communications.

Application/Control Number: 09/537,812

Art Unit: 2683

Any inquiry of a general nature or relating to the status of this application or proceeding should be directed to the receptionist whose telephone number is 703-305-4700.

ATH
ATH
April 23, 2003

W. Trost
WILLIAM TROST
SUPERVISORY PATENT EXAMINER
TECHNOLOGY CENTER 2600

Notice of References Cited

Application/Control No.
09/537,812

Applicant(s)/Patent Under
Reexamination
WHITE ET AL.

Examiner
Andrew T Harry

Art Unit
2683

Page 1 of 1

U.S. PATENT DOCUMENTS

*		Document Number Country Code-Number-Kind Code	Date MM-YYYY	Name	Classification
	A	US-6,401,085 ✓	06-2002	Gershman et al.	707/4
	B	US-6,199,076 ✓	03-2001	Logan et al.	715/501.1
	C	US-6,526,335 ✓	02-2003	Treyz et al.	711
	D	US-2002/0046084 ✓	04-2002	STEELE et al.	705/14
	E	US-6,247,130 ✓	06-2001	Fritsch, Bernhard	713/171
	F	US-6,407,750 ✓	06-2002	Gioscia et al.	345/716
	G	US-6,496,205 ✓	12-2002	White et al.	345/824
	H	US-5,953,005 ✓	09-1999	Liu, James C.	715/500.1
	I	US-			
	J	US-			
	K	US-			
	L	US-			
	M	US-			

FOREIGN PATENT DOCUMENTS

*		Document Number Country Code-Number-Kind Code	Date MM-YYYY	Country	Name	Classification
	N					
	O					
	P					
	Q					
	R					
	S					
	T					

NON-PATENT DOCUMENTS

*		Include as applicable: Author, Title Date, Publisher, Edition or Volume, Pertinent Pages)
	U	
	V	
	W	
	X	

*A copy of this reference is not being furnished with this Office action. (See MPEP § 707.05(a).)
Dates in MM-YYYY format are publication dates. Classifications may be US or foreign.

PATENT APPLICATION

IN THE UNITED STATES PATENT AND TRADEMARK OFFICE

In re Application of: White et al.
Date Filed: March 28, 2000
Serial No.: 09/537,812
Examiner: Andrew T. Harry
Group Art Unit: 2684
Title: SYSTEM AND METHOD FOR COMMUNICATING SELECTED INFORMATION TO AN ELECTRONIC DEVICE

<p>Box Non-Fee Amendment Assistant Commissioner for Patents Washington, D.C. 20231</p>	<p align="center">CERTIFICATE OF FACSIMILE TRANSMISSION</p> <p>Date of Facsimile Transmitted: I hereby certify that this correspondence is being faxed to the United States Patent and Trademark Office at 703-872-9314 to the attention of:</p> <p>Box Non-Fee Amendment Assistant Commissioner for Patents Washington, D.C. 20231</p> <p><i>Russell White</i> Print Name <i>R White</i> Signature</p>
--	---

FINAL OFFICE ACTION TRANSMITTAL

Dear Sir or Madam:

Transmitted herewith for filing in the above-identified patent application are the following documents:

1. Amendment (16 pages).
2. Paper A - "Short-Range Wireless Connectivity: A Complementary Comparison" by Puneet Gupta (2 Pages)
3. Paper B- CCI Dictionary Definition for Streaming Audio (1 Page)
4. Paper C- Streaming Sound - a whatis definition (2 Pages)

No additional fee is required.

RESPECTFULLY SUBMITTED,

White et al.



Kevin R. Imes
Reg. No. 44,795

Russell White
10704 Redmond Rd.
Austin, Texas 78739
Telephone: (512) 301-5518

PATENT APPLICATION

#8/CNE

max

2/20/03

1

IN THE UNITED STATES PATENT AND TRADEMARK OFFICE

In re Application of: White et al.

Date Filed: March 28, 2000

Serial No.: 09/537,812

Examiner: Andrew T. Harry

Group Art Unit: 2684

Title: SYSTEM AND METHOD FOR COMMUNICATING SELECTED INFORMATION TO AN ELECTRONIC DEVICE

Box Non-Fee Amendment
Assistant Commissioner for Patents
Washington, D.C. 20231

*Please enter
max 4/23/03*

Dear Sir:

Applicants appreciate the time taken by Examiner Harry and Examiner Hunter for the Examiner's interview on Wednesday, January 22, 2003. Per our conversation, you agreed not to enter the Final Office Action mailed on December 2, 2002. Applicants have amended the claims in light of our conversation during the Examiners interview to further clarify the invention. Applicants request that the Examiner reconsider the application in view of the following amendments and remarks. Please amend the Application as follows:

AMENDMENTS

IN THE CLAIMS:

Please refer to the attached sheets showing a marked-up version and non-marked up version of the amendments to the claims.

ATTORNEY DOCKET

PATENT APPLICATION

2

REMARKS

To expedite allowance and further clarify the claimed embodiment, Applicants have added Claims 38 and 39, and amended Claims 8, 11, 16, 21, 23, 27, 31, 34 and 37. Applicants respectfully submit that Claims 8, 11, 16, 21, 23, 27, 31, 34, 37, 38, and 39 are now fully allowable. Applicants submit that all claims pending in this application are fully allowable and respectfully request reconsideration and favorable action in this case.

High Speed Low Power Communication Module Discussion

Examiners stated that the limitation of 'high speed low power' is indefinite. Applicants have amended the application to further clarify the invention to include a 'short-range' communication module and a 'long-range' communication module. Applicants have included a reference providing a definition of a short-range communication.

In one of the references provided, Short-Range Wireless Connectivity: A Complementary Comparison by *Puneet Gupta*, the author explains that the short-range wireless technology known as Bluetooth "is a high-speed, low-power microwave wireless link technology".

Streaming Audio Discussion

Examiners stated that an 'audio file' is equivalent to 'streaming audio'. Applicants have provided a definition of streaming audio to clarify the differences between audio files and streaming audio. For example, "...streaming audio includes playing audio or video immediately as it is downloaded from the Internet, rather than storing it in a file on the receiving computer first." A second reference defines streaming audio as "...streaming sound is played as it arrives. The alternative is a sound recording that doesn't start playing until the entire file has arrived." In other words, by downloading and storing the file, an electronic device incorporating teachings of the present invention will be able to play music without break-ups, pauses, and music stoppages attendant to streaming systems.

Received from < 5125271159 > at 2/18/03 4:09:18 PM [Eastern Standard Time]

ATTORNEY DOCKET

PATENT APPLICATION

3

Applicants submit that Claim 1 is drawn toward the selection of audio files and not streaming audio. One skilled in the art can appreciate a discernable difference between an 'audio file' and 'streaming audio'.

Identifying an Electronic Device Discussion

Applicants have amended Claim 11 to further clarify the invention. In particular, Applicants would like to point out the added limitation of 'receiving an input from a user identifying the electronic device, the input including a reference identifying the electronic device' includes providing a reference to identify an electronic device.

CONCLUSION

Applicants have made an earnest effort to place this case in condition for allowance in light of the amendments and remarks set forth above. Applicants respectfully request reconsideration of the rejection and allowance of Claims 1, 4-11, 13-16, 18-21, 23 and 26-39.

Applicants believe that no further fee is due.

RESPECTFULLY SUBMITTED,

White et al.

Date: February 18, 2003

Russell White
10704 Redmond Rd.
Austin, Texas 78739
Telephone: (512) 301-5518

By: 

Kevin R. Imes

Reg. No. 44,795

Received from <5125271159> at 2/18/03 4:09:18 PM [Eastern Standard Time]

PATENT APPLICATION

1

MARKED UP VERSION OF THE AMENDED CLAIMS

IN THE CLAIMS

Claims 38 and 39 have been added. Claims 8, 11, 16, 21, 23, 27, 31, 34 and 37 have been amended as follows:

1. A system for communicating selected information to an electronic device, the system comprising:
 - a digital engine operable to maintain data associated with selectable audio information, the audio information comprising an audio file;
 - a communication engine communicatively coupled to the digital engine, the communication engine operable to initiate wireless communication of the data to the electronic device;
 - a graphical user interface operably coupled to the digital engine to provide available information to a user of a communication network and to receive an input from the user identifying a selected portion of the selectable information; and
 - wherein the interface operates in a web browsing environment and the wireless communication operates outside the browsing environment.
2. **(Deleted per First Amendment)** The system of Claim 1 further comprising an interface operably coupled to the digital engine, the interface operable to provide available information to a user of a communication network, and to receive an input from the user identifying the selected information.
3. **(Deleted per First Amendment)** The system of Claim 2, wherein the interface operates in a browsing environment and the wireless communication operates outside the browsing environment.
4. The system of Claim 1, wherein the wireless communication comprises communication via a cellular communications network.
5. The system of Claim 4, wherein the cellular communication network comprises a global system for mobile communications network.

Received from <5125271159> at 2/18/03 4:09:18 PM [Eastern Standard Time]

PATENT APPLICATION

2

6. The system of Claim 5, wherein the global system for mobile communications network operates between about 1.7 GHz and 2.0 GHz.

7. The system of Claim 4, wherein the cellular communication network comprises a code-division multiple access network.

C 8. (Amend) The system of Claim 1, wherein the wireless communication comprises communicating via a [high-speed, low-power] short-range microwave wireless link.

9. The system of Claim 8, wherein the wireless link comprises a Bluetooth link.

10. The system of Claim 8, wherein the wireless link operates around 2.4 GHz.

Received from <5125271159> at 2/18/03 4:09:18 PM [Eastern Standard Time]

PATENT APPLICATION

3

C₂

11. (Amend) A method for communicating selected audio information to an electronic device, the method comprising:

- maintaining data associated with the selected audio information using a digital engine;
- initiating wireless communication of the data to the electronic device;
- presenting information associated with audio information within a graphical user interface associated with a communication network;
- receiving an input from a user identifying the selected information; and
- receiving an input from a user identifying the electronic device, the input including a reference identifying the electronic device.

12. (Deleted per First Amendment) The method of Claim 11 further comprising:

- presenting information associated with audio information within an interface associated with a communication network; and
- receiving an input from a user identifying the selected information.

13. The method of Claim 11 further comprising presenting information associated with identifying the electronic device.

14. The method of Claim 12 wherein the interface operates in a web browsing environment and the wireless communication operate outside the browsing environment.

15. The method of Claim 11 wherein the wireless communication comprises communicating via a cellular communications network.

PATENT APPLICATION

4

16. (Amend) An electronic device for receiving selected audio information via wireless communication, the device comprising:

a long-range communication module operable to receive wireless communication of information;

a [low-power] short-range RF communication module operably coupled to a processor module;

a storage medium operably coupled to the [high speed, low-power] short-range RF communication module, the storage medium operable to store selected audio information that comprises an audio file;

the [a] processor module coupled to the storage medium, the processor module operable to process received selected audio information; and

a display operable to display a web browser within a user interface.

17. (Deleted per First Amendment) The device as recited in Claim 16, wherein the communication module comprises a cellular modem.

18. The device as recited in Claim 16, wherein the device is a handheld computing device.

19. The device as recited in Claim 16, wherein low power RF module outputs audio information indirectly to an audio speaker.

20. The device as recited in Claim 16 further comprising software for processing the selected audio information.

21. (Amend) The device as recited in Claim 16, wherein the short-range communication[s] module is operable to scan frequencies.

22. (Deleted per First Amendment) The device as recited in Claim 16, further comprising a display operable to display a user interface.

02/18/2003 15:09

5125271159

PAGE 09

PATENT APPLICATION

5

C5 23. (Amend) The device as recited in Claim 16 wherein the [high speed low-power] short-range RF communication module is operable with a 'Bluetooth' communication standard.

Received from <5125271159> at 2/18/03 4:09:18 PM [Eastern Standard Time]

PATENT APPLICATION

6

24. **(Deleted per First Amendment)** A method for communicating selected audio information to an electronic device, the method comprising:
presenting information associated with audio information within an interface associated with a communication network;
receiving an input from a user identifying the selected information;
maintaining data associated with the selected audio information using digital engine; and
initiating wireless communication of the data to the electronic device.

25. **(Deleted per First Amendment)** The method of Claim 24 wherein the interface operates in a browsing environment and the wireless communication operates outside the browsing environment.

Received from <5125271159> at 2/18/03 4:09:18 PM [Eastern Standard Time]

PATENT APPLICATION

7

26. The system of Claim 1 further comprising a wireless telephone.

C₆ 27. (Amend) The system of Claim 26 wherein the wireless telephone is operable to communicate with a [low-power, high speed] short-range wireless communication network.

28. The system of Claim 1 wherein the audio information includes at least one of a WAV file, an MP3 file or a MIDI file.

29. The system of Claim 1 wherein the audio information further comprises streaming audio information.

30. The method of Claim 11 further comprising presenting the information in a web browsing environment.

C₇ 31. (Amend) The device as recited in Claim 16 further comprising a wireless telephone, wherein the information received by the long-range communication module comprises a voice call.

32. The device as recited in Claim 16 wherein the audio file includes at least one of a WAV file, an MP3 file or a MIDI file.

33. The device as recited in Claim 32 wherein the audio information comprises streaming audio information.

PATENT APPLICATION

34. (Amend) An electronic device for communicating selected audio information via wireless communication, the device comprising:

a [high speed, low-power] short-range RF communication module operable to communicate about 2.4 GHz;

a storage medium operably coupled to the communication module, the storage medium operable to store the selected audio information; and

a processor module coupled to the communication module, the processor module operable to process the selected audio information to play the selected audio information.

C8

35. The device as recited in Claim 34 further comprising a display operable to display a user interface operably associated with a web browsing environment.

36. The device as recited in Claim 35 further comprising a cellular phone operable to communicate with a cellular phone network.

37. (Amend) The device as recited in Claim [35] 36 wherein the cellular phone is operable to communicate the selected audio information.

C9

38. (Added) The device as recited in Claim 34, further comprising:
a display operable to display a user interface;
a cellular phone operable to communicate with a cellular phone network; and
wherein the processor is operable to process selected audio information in association with receiving a telephonic communication, wherein the selected audio information includes an audio file selected by the user of the cellular phone and received and stored within the storage medium prior to receiving the telephonic communication.

C10

39. (Added) The device as recited in Claim 37 further comprising the processor operable to process the selected audio information in association with receiving a telephonic communication, wherein the selected audio information includes an audio file selected by the user of the cellular phone and received and stored within the storage medium prior to receiving the telephonic communication.

Received from < 5125271159 > at 2/18/03 4:09:18 PM [Eastern Standard Time]

PATENT APPLICATION

9

NON-MARKED UP VERSION OF THE AMENDED CLAIMS

1. A system for communicating selected information to an electronic device, the system comprising:
 - a digital engine operable to maintain data associated with selectable audio information, the audio information comprising an audio file;
 - a communication engine communicatively coupled to the digital engine, the communication engine operable to initiate wireless communication of the data to the electronic device;
 - a graphical user interface operably coupled to the digital engine to provide available information to a user of a communication network and to receive an input from the user identifying a selected portion of the selectable information; and
 - wherein the interface operates in a web browsing environment and the wireless communication operates outside the browsing environment.
2. **(Deleted per First Amendment)** The system of Claim 1 further comprising an interface operably coupled to the digital engine, the interface operable to provide available information to a user of a communication network, and to receive an input from the user identifying the selected information.
3. **(Deleted per First Amendment)** The system of Claim 2, wherein the interface operates in a browsing environment and the wireless communication operates outside the browsing environment.
4. The system of Claim 1, wherein the wireless communication comprises communication via a cellular communications network.
5. The system of Claim 4, wherein the cellular communication network comprises a global system for mobile communications network.

PATENT APPLICATION

10

6. The system of Claim 5, wherein the global system for mobile communications network operates between about 1.7 GHz and 2.0 GHz.

7. The system of Claim 4, wherein the cellular communication network comprises a code-division multiple access network.

8. (Amend) The system of Claim 1, wherein the wireless communication comprises communicating via a short-range microwave wireless link.

9. The system of Claim 8, wherein the wireless link comprises a Bluetooth link.

10. The system of Claim 8, wherein the wireless link operates around 2.4 GHz.

PATENT APPLICATION

11

11. **(Amend)** A method for communicating selected audio information to an electronic device, the method comprising:
- maintaining data associated with the selected audio information using a digital engine;
 - initiating wireless communication of the data to the electronic device;
 - presenting information associated with audio information within a graphical user interface associated with a communication network;
 - receiving an input from a user identifying the selected information; and
 - receiving an input from a user identifying the electronic device, the input including a reference identifying the electronic device.
12. **(Deleted per First Amendment)** The method of Claim 11 further comprising:
- presenting information associated with audio information within an interface associated with a communication network; and
 - receiving an input from a user identifying the selected information.
13. The method of Claim 11 further comprising presenting information associated with identifying the electronic device.
14. The method of Claim 12 wherein the interface operates in a web browsing environment and the wireless communication operate outside the browsing environment.
15. The method of Claim 11 wherein the wireless communication comprises communicating via a cellular communications network.

PATENT APPLICATION

12

16. **(Amend)** An electronic device for receiving selected audio information via wireless communication, the device comprising:
- a long-range communication module operable to receive wireless communication of information;
 - a short-range RF communication module operably coupled to a processor module;
 - a storage medium operably coupled to the short-range RF communication module, the storage medium operable to store selected audio information that comprises an audio file;
 - the processor module coupled to the storage medium, the processor module operable to process received selected audio information; and
 - a display operable to display a web browser within a user interface.
17. **(Deleted per First Amendment)** The device as recited in Claim 16, wherein the communication module comprises a cellular modem.
18. The device as recited in Claim 16, wherein the device is a handheld computing device.
19. The device as recited in Claim 16, wherein low power RF module outputs audio information indirectly to an audio speaker.
20. The device as recited in Claim 16 further comprising software for processing the selected audio information.
21. **(Amend)** The device as recited in Claim 16, wherein the short-range communication module is operable to scan frequencies.
22. **(Deleted per First Amendment)** The device as recited in Claim 16, further comprising a display operable to display a user interface.

02/18/2003 15:09

5125271159

PAGE 17

PATENT APPLICATION

13

23. (Amend) The device as recited in Claim 16 wherein the short-range RF communication module is operable with a 'Bluetooth' communication standard.

Received from < 5125271159 > at 2/18/03 4:09:18 PM [Eastern Standard Time]

PATENT APPLICATION

14

24. **(Deleted per First Amendment)** A method for communicating selected audio information to an electronic device, the method comprising:
presenting information associated with audio information within an interface associated with a communication network;
receiving an input from a user identifying the selected information;
maintaining data associated with the selected audio information using digital engine; and
initiating wireless communication of the data to the electronic device.

25. **(Deleted per First Amendment)** The method of Claim 24 wherein the interface operates in a browsing environment and the wireless communication operates outside the browsing environment.

PATENT APPLICATION

15

26. The system of Claim 1 further comprising a wireless telephone.
27. (Amend) The system of Claim 26 wherein the wireless telephone is operable to communicate with a short-range wireless communication network.
28. The system of Claim 1 wherein the audio information includes at least one of a WAV file, an MP3 file or a MIDI file.
29. The system of Claim 1 wherein the audio information further comprises streaming audio information.
30. The method of Claim 11 further comprising presenting the information in a web browsing environment.
31. (Amend) The device as recited in Claim 16 further comprising a wireless telephone, wherein the information received by the long-range communication module comprises a voice call.
32. The device as recited in Claim 16 wherein the audio file includes at least one of a WAV file, an MP3 file or a MIDI file.
33. The device as recited in Claim 32 wherein the audio information comprises streaming audio information.

PATENT APPLICATION

16

34. **(Amend)** An electronic device for communicating selected audio information via wireless communication, the device comprising:

a short-range RF communication module operable to communicate about 2.4 GHz;

a storage medium operably coupled to the communication module, the storage medium operable to store the selected audio information; and

a processor module coupled to the communication module, the processor module operable to process the selected audio information to play the selected audio information.

35. The device as recited in Claim 34 further comprising a display operable to display a user interface operably associated with a web browsing environment.

36. The device as recited in Claim 35 further comprising a cellular phone operable to communicate with a cellular phone network.

37. **(Amend)** The device as recited in Claim 36 wherein the cellular phone is operable to communicate the selected audio information.

38. **(Added)** The device as recited in Claim 34, further comprising:

a display operable to display a user interface;

a cellular phone operable to communicate with a cellular phone network; and

wherein the processor is operable to process selected audio information in association with receiving a telephonic communication, wherein the selected audio information includes an audio file selected by the user of the cellular phone and received and stored within the storage medium prior to receiving the telephonic communication.

39. **(Added)** The device as recited in Claim 37 further comprising the processor operable to process the selected audio information in association with receiving a telephonic communication, wherein the selected audio information includes an audio file selected by the user of the cellular phone and received and stored within the storage medium prior to receiving the telephonic communication.



HOME NEWS IT-CAREERS DOWNLOADS STORE TUTORIALS COMMUNITY

- Channels**
- WAP
 - Communications
 - PDA
 - Voice
 - SMS
 - Location Based
 - Bluetooth
 - Java

Premier Sponsors

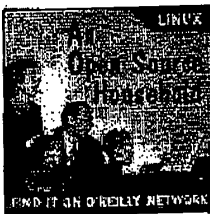

Newsletter

Email Address:

.....

HTML Text



Short-Range Wireless Connectivity: A Complementary Comparison (cont.)

by Puneet Gupta

INDEX

- > [Introduction](#)
- > [Bluetooth](#)
- > [IrDA](#)
- > [Bluetooth vs. IrDA](#)
- > [HomeRF](#)
- > [Bluetooth vs. SWAP](#)
- > [References](#)

Bluetooth

Bluetooth is a high-speed, low-power microwave wireless link technology, designed to connect phones, laptops, PDAs and other portable equipment together with little or no work by the user. Unlike infra-red, Bluetooth does not require line-of-sight positioning of connected units. The technology uses modifications of existing wireless LAN techniques but is most notable for its small size and low cost. Whenever any Bluetooth-enabled devices come within range of each other, they instantly transfer address information and establish small networks between each other, without the user being involved.

Features:

- Operates in the 2.56 GHZ ISM band which is globally available (no license required)
- Uses FHSS (Frequency hop spread spectrum)
- Can support upto 8 devices in a piconet
- Omni-directional, non line of sight transmission through walls
- 10m to 100m range
- Low cost, \$20
- 1mW power
- Extended range with external power amplifier



Elimi with c

Content

(100 meters)

- [Articles](#)
- [Columns](#)
- [Training](#)
- [Weblog](#)
- [Library](#)
- [Glossary](#)

Next: IrDA



Career Center

- [Career Center Home](#)
- [View Jobs](#)
- [Post A Job](#)
- [Resumes/CVs](#)
- [Resource Center](#)

Marketplace

- [Marketplace Home](#)
- [Software Products](#)
- [Wireless Market Data](#)
- [Technical Books](#)

News

- [Daily News](#)
- [Around The Web](#)
- [Submit News](#)
- [Events Calendar](#)
- [Unsubscribe](#)
- [Delivery Options](#)

Community

- [Discussion Boards](#)
- [Mailing List](#)
- [Mailing List Archives](#)

About Us

- [About WirelessDevNet](#)
- [Wireless Source Disks](#)
- [Partners](#)
- [About GeoComm](#)
- [Advertising Information](#)



Wireless Developer Network - A GeoComm Trade Community
 Copyright © 2000 GeoComm International Corporation. All Rights Reserved
 Send Comments to:
feedback@wirelessdevnet.com
 (850) 897-0858

Paper B

COMPUTER User
High-Tech Dictionary

Definition: streaming

Playing audio or video immediately as it is downloaded from the Internet, rather than storing it in a file on the receiving computer first. Streaming is accomplished by way of web browser plug-ins, which decompress and play the file in real time; a fast computer and fast connection are necessary.

Explore the TechTarget Network at SearchTechTarget.com.

Activate your FREE membership today | Log-in

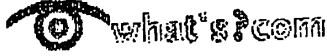

FREE Conferences >>

What's.com Word of the Day:
> [data scrubbing](#)



What's.com Target Search™

Search our IT-specific encyclopedia for:

or jump to a topic:

[Advanced Search](#)

Browse alphabetically:

[A](#) [B](#) [C](#) [D](#) [E](#) [F](#) [G](#) [H](#) [I](#) [J](#) [K](#) [L](#) [M](#) [N](#) [O](#) [P](#) [Q](#) [R](#) [S](#) [T](#) [U](#) [V](#) [W](#) [X](#) [Y](#) [Z](#) <#>

[All Categories](#) → [PCs](#) → [Multimedia & Graphics](#)

EXPLORE THIS AREA: RICH-MEDIA ADVERTISEMENT

streaming sound

Streaming sound is sound that is played as it arrives. The alternative is a sound recording (such as a WAV file) that doesn't start playing until the entire file has arrived. Support for streaming sound may require a [plug-in](#) player or come with the [browser](#). Leading providers of streaming sound include Progressive Networks' RealAudio and Macromedia's Shockwave for Director (which includes an animation player as well).

Last updated on: Jul 31, 2001

What's New

Learn more about:

> [CIM/WBEM initiatives](#)

🔗 [Site Map for whatis.com](#)

🔗 [IT Quiz: Common Vulnerabilities](#)

🔗 [Challenge: How do you spot a slacker?](#)

🔗 [IT Crossword Puzzle](#)

🔗 [Discussion Forums](#)

http://whatis.techtarget.com/definition/0,,sid9_gci213054,00.html

2/18/2003

Received from < 5125271159 > at 2/18/03 4:09:18 PM [Eastern Standard Time]

paper C

- [Recently added/updated](#)
- [Order the whatis.com book](#)

Email a friend:

Send this page to a friend! [Email a friend!](#)

Note: Email addresses will only be used to send site content to your friend(s).



[About Us](#) | [Contact Us](#) | [For Advertisers](#) | [For Business Partners](#) | [Career Center](#) [Contacts](#) | [Awards](#)

WhatIs.com is part of the TechTarget network of industry-specific IT Web sites

APPLICATIONS

[SearchCIO.com](#)
[SearchCRM.com](#)
[SearchSAP.com](#)

CORE TECHNOLOGIES

[SearchDatabase.com](#)
[SearchSecurity.com](#)
[SearchStorage.com](#)
[SearchSystemsManagement.com](#)
[SearchWebServices.com](#)
[WhatIs.com](#)

PLATFORMS

[Search390.com](#)
[Search400.com](#)
[SearchDomino.com](#)
[SearchSolaris.com](#)
[SearchWin2000.com](#)
[SearchWindowsManageability.com](#)



DEVELOPMENT

[SearchVB.com](#)

NETWORKING

[SearchNetworking.com](#)

[TechTarget Enterprise IT Conferences](#) | [TechTarget Corporate Web Site](#) | [Media Kit](#)

Explore [SearchTechTarget.com](#), the guide to the TechTarget network of industry-specific IT Web sites.

All Rights Reserved, Copyright 2000 - 2003, TechTarget

[Read our Privacy Statement](#)

PR4



UNITED STATES PATENT AND TRADEMARK OFFICE

UNITED STATES DEPARTMENT OF COMMERCE
United States Patent and Trademark Office
Address: COMMISSIONER OF PATENTS AND TRADEMARKS
Washington, D.C. 20231
www.uspto.gov

APPLICATION NO.	FILING DATE	FIRST NAMED INVENTOR	ATTORNEY DOCKET NO.	CONFIRMATION NO.
09/537,812	03/28/2000	Russell W. White	111111.1111	4698

7590
 Russell W White
 10704 Redmond
 Austin, TX 78739

01/29/2003

EXAMINER

HARRY, ANDREW T

ART UNIT	PAPER NUMBER
2684	7

DATE MAILED: 01/29/2003

Please find below and/or attached an Office communication concerning this application or proceeding.

7

Summary of Record of Interview Requirements

Manual of Patent Examining Procedure (MPEP), Section 713.04, Substance of Interview Must be Made of Record

A complete written statement as to the substance of any face-to-face, video conference, or telephone interview with regard to an application must be made of record in the application whether or not an agreement with the examiner was reached at the interview.

Title 37 Code of Federal Regulations (CFR) § 1.133 Interviews

Paragraph (b)

In every instance where reconsideration is requested in view of an interview with an examiner, a complete written statement of the reasons presented at the interview as warranting favorable action must be filed by the applicant. An interview does not remove the necessity for reply to Office action as specified in §§ 1.111, 1.135. (35 U.S.C. 132)

37 CFR §1.2 Business to be transacted in writing.

All business with the Patent or Trademark Office should be transacted in writing. The personal attendance of applicants or their attorneys or agents at the Patent and Trademark Office is unnecessary. The action of the Patent and Trademark Office will be based exclusively on the written record in the Office. No attention will be paid to any alleged oral promise, stipulation, or understanding in relation to which there is disagreement or doubt.

The action of the Patent and Trademark Office cannot be based exclusively on the written record in the Office if that record is itself incomplete through the failure to record the substance of interviews.

It is the responsibility of the applicant or the attorney or agent to make the substance of an interview of record in the application file, unless the examiner indicates he or she will do so. It is the examiner's responsibility to see that such a record is made and to correct material inaccuracies which bear directly on the question of patentability.

Examiners must complete an Interview Summary Form for each interview held where a matter of substance has been discussed during the interview by checking the appropriate boxes and filling in the blanks. Discussions regarding only procedural matters, directed solely to restriction requirements for which interview recordation is otherwise provided for in Section 812.01 of the Manual of Patent Examining Procedure, or pointing out typographical errors or unreadable script in Office actions or the like, are excluded from the interview recordation procedures below. Where the substance of an interview is completely recorded in an Examiners Amendment, no separate Interview Summary Record is required.

The Interview Summary Form shall be given an appropriate Paper No., placed in the right hand portion of the file, and listed on the "Contents" section of the file wrapper. In a personal interview, a duplicate of the Form is given to the applicant (or attorney or agent) at the conclusion of the interview. In the case of a telephone or video-conference interview, the copy is mailed to the applicant's correspondence address either with or prior to the next official communication. If additional correspondence from the examiner is not likely before an allowance or if other circumstances dictate, the Form should be mailed promptly after the interview rather than with the next official communication.

The Form provides for recordation of the following information:

- Application Number (Series Code and Serial Number)
- Name of applicant
- Name of examiner
- Date of interview
- Type of interview (telephonic, video-conference, or personal)
- Name of participant(s) (applicant, attorney or agent, examiner, other PTO personnel, etc.)
- An indication whether or not an exhibit was shown or a demonstration conducted
- An identification of the specific prior art discussed
- An indication whether an agreement was reached and if so, a description of the general nature of the agreement (may be by attachment of a copy of amendments or claims agreed as being allowable). Note: Agreement as to allowability is tentative and does not restrict further action by the examiner to the contrary.
- The signature of the examiner who conducted the interview (if Form is not an attachment to a signed Office action)

It is desirable that the examiner orally remind the applicant of his or her obligation to record the substance of the interview of each case unless both applicant and examiner agree that the examiner will record same. Where the examiner agrees to record the substance of the interview, or when it is adequately recorded on the Form or in an attachment to the Form, the examiner should check the appropriate box at the bottom of the Form which informs the applicant that the submission of a separate record of the substance of the interview as a supplement to the Form is not required.

It should be noted, however, that the Interview Summary Form will not normally be considered a complete and proper recordation of the interview unless it includes, or is supplemented by the applicant or the examiner to include, all of the applicable items required below concerning the substance of the interview.

A complete and proper recordation of the substance of any interview should include at least the following applicable items:

- 1) A brief description of the nature of any exhibit shown or any demonstration conducted,
- 2) an identification of the claims discussed,
- 3) an identification of the specific prior art discussed,
- 4) an identification of the principal proposed amendments of a substantive nature discussed, unless these are already described on the Interview Summary Form completed by the Examiner,
- 5) a brief identification of the general thrust of the principal arguments presented to the examiner,
(The identification of arguments need not be lengthy or elaborate. A verbatim or highly detailed description of the arguments is not required. The identification of the arguments is sufficient if the general nature or thrust of the principal arguments made to the examiner can be understood in the context of the application file. Of course, the applicant may desire to emphasize and fully describe those arguments which he or she feels were or might be persuasive to the examiner.)
- 6) a general indication of any other pertinent matters discussed, and
- 7) if appropriate, the general results or outcome of the interview unless already described in the Interview Summary Form completed by the examiner.

Examiners are expected to carefully review the applicant's record of the substance of an interview. If the record is not complete and accurate, the examiner will give the applicant an extendable one month time period to correct the record.

Examiner to Check for Accuracy

If the claims are allowable for other reasons of record, the examiner should send a letter setting forth the examiner's version of the statement attributed to him or her. If the record is complete and accurate, the examiner should place the indication, "Interview Record OK" on the paper recording the substance of the interview along with the date and the examiner's initials.

Continuation of Substance of Interview including description of the general nature of what was agreed to if an agreement was reached, or any other comments: The discussion began with the Examiner explaining that the Applicant's amendment filed December 8, 2002 would not be entered since it did not include a clean set of the claims as amended. A new amendment with a clean set of claims is required as the current amendment is deemed as being unresponsive. Furthermore, the Examiner's response to the Amendment, originally classified as being a final rejection, may be classified as being non-final and the Applicant may take into account the Examiner's remarks in that response while crafting his new Amendment which will be entered upon reception by the office.

The discussion then turned to specific language that the Applicant used in his claims and how that language was being interpreted by the Examiner. Specifically the Examiner's rejection of claims 27, 31, and 34 as being indefinite for using the terms "high speed" and "low power". This claim language was discussed and the Applicant was informed that more specific claim language would need to be used to further describe his claimed invention. The Applicant was referred to the specification for the technology that they intend to use for the communications to further limit the claim language. The Applicant then pointed out that Cerf did not teach the ability for the wireless radio device to have a cellular telephone functionality as claimed in claim 26. The Examiner takes note of this argument and notified the Applicant that based on the Argument in the forthcoming Amendment the Examiner will provide prior art evidence to back up his rejection that a PDA and a cellular phone can be one, and the same device.

The Discussion then turned to claim 1 and the definition of audio files and how they were claimed to be downloaded by the Applicant's invention. It was noted by the Examiner that the language in claim 1 could read to be interpreted as downloading any type of audio whether it be streaming audio or downloading a complete audio file then playing it. The Applicant claims no distinct way of transporting or encapsulating the audio data that makes his claimed invention unique over the prior art made of record.

The Applicant then pointed out what his interpretation of a browsing environment was as claimed. However, the claims were not sufficiently limiting to reflect his limited vision of what, exactly, a browsing environment was that would make his invention unique over the prior art.

No Agreements were made regarding any specific claim language that would put the prior art in a condition for allowance over the prior art made of record.



11/27/03

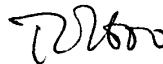



UNITED STATES PATENT AND TRADEMARK OFFICE

UNITED STATES DEPARTMENT OF COMMERCE
United States Patent and Trademark Office
Address: COMMISSIONER OF PATENTS AND TRADEMARKS
Washington, D.C. 20231
www.uspto.gov

APPLICATION NO.	FILING DATE	FIRST NAMED INVENTOR	ATTORNEY DOCKET NO.	CONFIRMATION NO.
09/537,812	03/28/2000	Russell W. White	111111.1111	4698

7590 01/02/2003
Russell W White
10704 Redmond
Austin, TX 78739

EXAMINER

HARRY, ANDREW T

ART UNIT PAPER NUMBER

2684

6

DATE MAILED: 01/02/2003

Please find below and/or attached an Office communication concerning this application or proceeding.

Office Action Summary	Application No. 09/537,812	Applicant(s) WHITE ET AL.	
	Examiner Andrew T Harry	Art Unit 2684	

-- The MAILING DATE of this communication appears on the cover sheet with the correspondence address --

Period for Reply

A SHORTENED STATUTORY PERIOD FOR REPLY IS SET TO EXPIRE 3 MONTH(S) FROM THE MAILING DATE OF THIS COMMUNICATION.

- Extensions of time may be available under the provisions of 37 CFR 1.136(a). In no event, however, may a reply be timely filed after SIX (6) MONTHS from the mailing date of this communication.
- If the period for reply specified above is less than thirty (30) days, a reply within the statutory minimum of thirty (30) days will be considered timely.
- If NO period for reply is specified above, the maximum statutory period will apply and will expire SIX (6) MONTHS from the mailing date of this communication.
- Failure to reply within the set or extended period for reply will, by statute, cause the application to become ABANDONED (35 U.S.C. § 133).
- Any reply received by the Office later than three months after the mailing date of this communication, even if timely filed, may reduce any earned patent term adjustment. See 37 CFR 1.704(b).

Status

- 1) Responsive to communication(s) filed on 02 December 2002.
- 2a) This action is **FINAL**. 2b) This action is non-final.
- 3) Since this application is in condition for allowance except for formal matters, prosecution as to the merits is closed in accordance with the practice under *Ex parte Quayle*, 1935 C.D. 11, 453 O.G. 213.

Disposition of Claims

- 4) Claim(s) 1,4-11,13-16,18-21,23 and 26-37 is/are pending in the application.
- 4a) Of the above claim(s) _____ is/are withdrawn from consideration.
- 5) Claim(s) _____ is/are allowed.
- 6) Claim(s) 1,4-11,13-16,18-21,23 and 26-37 is/are rejected.
- 7) Claim(s) _____ is/are objected to.
- 8) Claim(s) _____ are subject to restriction and/or election requirement.

Application Papers

- 9) The specification is objected to by the Examiner.
- 10) The drawing(s) filed on 28 March 2000 is/are: a) accepted or b) objected to by the Examiner.
Applicant may not request that any objection to the drawing(s) be held in abeyance. See 37 CFR 1.85(a).
- 11) The proposed drawing correction filed on _____ is: a) approved b) disapproved by the Examiner.
If approved, corrected drawings are required in reply to this Office action.
- 12) The oath or declaration is objected to by the Examiner.

Priority under 35 U.S.C. §§ 119 and 120

- 13) Acknowledgment is made of a claim for foreign priority under 35 U.S.C. § 119(a)-(d) or (f).
a) All b) Some * c) None of:
1. Certified copies of the priority documents have been received.
2. Certified copies of the priority documents have been received in Application No. _____ .
3. Copies of the certified copies of the priority documents have been received in this National Stage application from the International Bureau (PCT Rule 17.2(a)).
* See the attached detailed Office action for a list of the certified copies not received.
- 14) Acknowledgment is made of a claim for domestic priority under 35 U.S.C. § 119(e) (to a provisional application).
a) The translation of the foreign language provisional application has been received.
- 15) Acknowledgment is made of a claim for domestic priority under 35 U.S.C. §§ 120 and/or 121.

Attachment(s)

- | | |
|--|--|
| 1) <input type="checkbox"/> Notice of References Cited (PTO-892) | 4) <input type="checkbox"/> Interview Summary (PTO-413) Paper No(s). _____ . |
| 2) <input type="checkbox"/> Notice of Draftsperson's Patent Drawing Review (PTO-948) | 5) <input type="checkbox"/> Notice of Informal Patent Application (PTO-152) |
| 3) <input type="checkbox"/> Information Disclosure Statement(s) (PTO-1449) Paper No(s) _____ . | 6) <input type="checkbox"/> Other: _____ |

DETAILED ACTION

Response to Amendment

The Examiner has received and entered the Applicant's amendment filed December 2, 2002. The Amendment fails to put the application in condition for allowance based on the claim rejections (prior art and other) stated below.

Claim Rejections - 35 USC § 112

The following is a quotation of the second paragraph of 35 U.S.C. 112:

The specification shall conclude with one or more claims particularly pointing out and distinctly claiming the subject matter which the applicant regards as his invention.

1. Claims 27,31, and 34 are rejected under 35 U.S.C. 112, second paragraph, as being indefinite for failing to particularly point out and distinctly claim the subject matter which applicant regards as the invention.

The terms "high speed" and "low power" in claims 27, 31, and 34 is a relative term which renders the claim indefinite. The terms "high speed" and "low power" are not defined by the claim, the specification does not provide a standard for ascertaining the requisite degree, and one of ordinary skill in the art would not be reasonably apprised of the scope of the invention. Claims 35-37 depend from claim 34 and are therefore also rejected as they depend from a rejected independent claim.

Claim Rejections - 35 USC § 103

Art Unit: 2684

The following is a quotation of 35 U.S.C. 103(a) which forms the basis for all obviousness rejections set forth in this Office action:

(a) A patent may not be obtained though the invention is not identically disclosed or described as set forth in section 102 of this title, if the differences between the subject matter sought to be patented and the prior art are such that the subject matter as a whole would have been obvious at the time the invention was made to a person having ordinary skill in the art to which said subject matter pertains. Patentability shall not be negated by the manner in which the invention was made.

2. Claims 1, 4-11, 13-16, 18-21, and 23 are rejected under 35 U.S.C. 103(a) as being unpatentable over **Cerf et al. US Patent 6,418,138** ("Cerf").

As pertaining to **claims 1 and 11**, Cerf describes a system and method for communicating selected information to an electronic device (see Cerf abstract), the system comprising:

a digital engine operable to maintain data associated with selectable audio information, the audio information comprising an audio file (see Cerf col. 3 line 35 – col. 4 line 5, Cerf describes the idea of Internet radio and how it manages audio information, and the user is able to select a specific channel, and clearly if the information transmitted is a file); and

a communication engine communicatively coupled to the digital engine (see Cerf col. 4 lines 6 – 49, in this section Cerf describes how the Proxy server is connected to the internet and acts as a communication engine for the internet to the mobile users.), the communication engine operable to initiate wireless communication of the data to the electronic device (see Cerf col. 5 lines 10 – 28, Cerf describes an example of how the digital audio data is transmitted from the internet through the proxy server out to the wireless mobile user.);

a graphical user interface operably coupled to the digital engine to provide available information to a user of a communication network and to receive an input from the user identifying a selected portion of the selectable information (see Cerf, col. 4 lines 28-50).

wherein the interface operates in a web browsing environment and the wireless communication operates outside the browsing environment (see Cerf, col. 3 lines 35-67).

Cerf does not use the exact terminology that may be used in the instant invention; however, it would have been obvious to one of ordinary skill in the art that the spirit of Cerf's disclosure is similar to that of the claimed invention. To further proceed with prosecution it is suggested that the applicant be more specific with their claims and describe how their "selected audio information" may be different from the selectable channels of audio files (essentially selectable audio information) described by Cerf.

As pertaining to **claims 4 – 10, and 15** Cerf teaches that the audio data is retrieved by a PDA, laptop, or Internet radio via a wireless link between the mobile station and the "radio tower" (see Cerf col. 3 lines 20 – 25 and fig. 2), which is connected to a proxy server which is connected to the internet. Cerf, however, is silent on the wireless method used to transmit the data from the radio tower to the mobile device. It would have been obvious to one of ordinary skill in the art at the time of the invention to use the transmission method that would best fit the design of the system. Some of the transmission methods available at the time of the invention included cellular (which typically used CDMA as a method of transmission), global system for mobile communications (which is operated between 1.7 and 2.0 GHz), or a high-speed low-power microwave wireless link like Bluetooth, which operates around 2.4 GHz. The use of any

Art Unit: 2684

of these protocols at the time of the invention would have been obvious to one of ordinary skill in the art based on the design choice of the system designer.

As pertaining to **claim 26**, Cerf describes the characteristics of the wireless devices that are adaptable to be used in his system (see Cerf, col. 4 lines 1-6, this indicates that a cellular phone could be used as all the components described are included in modern cellular telephones).

As pertaining to **claim 29**, Cerf describes that the audio information further comprises streaming audio information (see Cerf, col. 4 line 14).

As pertaining to **claim 30**, Cerf describes that the information is presented in a web-browsing environment (see Cerf, col. 4 lines 28-40).

As pertaining to **claim 13**, Cerf's method further comprises:

presenting information associated with the electronic device (see Cerf col. 5 line 66 – col 6 line 5); and

receiving an input from a user identifying the electronic device (see Cerf col. 6 lines 10 – 14).

As pertaining to **claim 14**, in Cerf's system and method the interface operates in a browsing environment (see Cerf col. 6 lines 23 – 30, Cerf describes that the user is able to look around and retrieve information from the proxy server regarding current broadcast options) and the wireless communication operates outside the browsing environment (see Cerf col. 5 lines 10 – 28).

As pertaining to **claims 16, 18, 19, 28, and 32** Cerf describes an electronic device for receiving selected audio information via wireless communication, the device comprising:

a communication module operable to receive wireless communication of the information (see Cerf col. 1 lines 15 – 27) ;

a RF communication module operably coupled to a processor module (see Cerf, col. 4 lines 1-6, Cerf does not describe specific power characteristics of the terminal, but “low-power” as claimed appears to be quite ambiguous and puts no limitations on the actual power of the device)

Cerf describes that a laptop computer or a PDA may be used as the mobile device in his system to implement his wireless radio concept (see Cerf fig. 2 and col. 5 lines 58 – 61), however Cerf does not specifically describe the capabilities in terms of processing of his mobile device (see Cerf col. 7 lines 10 – 18). However, it would have been obvious to one of ordinary skill in the art at the time of the invention that the laptop computer or PDA would include a storage medium operably coupled to the communication module, the storage medium operable to store the selected audio information and a processor module coupled to the communication module, the processor module operable to process the received selected audio information. It would have been obvious to a skilled artisan at the time of the invention that all laptops and PDAs would include processors capable of processing received data, and memory that would have been capable of storing data that would have been downloaded to these devices. Additionally, is very well known in the art that traditional ways of saving audio files include WAV, MP3, and MIDI formats and the file would be stored in one of these formats. This would have allowed the users of these devices to actually listen to the audio music that they were

downloading and to store the audio information that would have been downloaded to the device so that they may listen to it at a later time.

Cerf's device does have a display opearable to display a web browser within a user interface (see Cerf, col. 4 lines 28-40).

As pertaining to **claim 33**, Cerf describes that the audio information further comprises streaming audio information (see Cerf, col. 4 line 14).

As pertaining to **claim 20**, Cerf's device as modified above in claim 16 further comprises software for processing the selected information (see Cerf col. 7 lines 11 – 18).

As pertaining to **claim 21**, Cerf's device as modified above regarding claims 17 and 23 describes that some of the various transmission techniques that would have been used to transmit the data include CDMA. CDMA is a frequency and time hopped system, and therefore the system would have been capable of scanning the various CDMA frequency channels.

As pertaining to **claim 23**, Cerf as modified above regarding claim 16, teaches that the audio data is retrieved by a PDA, laptop, or Internet radio via a wireless link between the mobile station and the "radio tower" (see Cerf col. 3 lines 20 – 25 and fig. 2), which is connected to a proxy server which is connected to the internet. Cerf, however, is silent on the wireless method used to transmit the data from the radio tower to the mobile device. It would have been obvious to one of ordinary skill in the art at the time of the invention to use the transmission method that

Art Unit: 2684

would best fit the design of the system. Some of the transmission methods available at the time of the invention included cellular (which typically used CDMA as a method of transmission), global system for mobile communications (which is operated between 1.7 and 2.0 GHz), or a high-speed low-power microwave wireless link like Bluetooth, which operates around 2.4 GHz. The use of any of these protocols at the time of the invention would have been obvious to one of ordinary skill in the art based on the design choice of the system designer. Also if the device used by the user would be a PDA or laptop computer it would have been obvious to one of ordinary skill in the art at the time of the invention that a cellular or other modem would have been used to receive the transmitted signal.

The following is a second rejection of claims 1 – 25 using an alternative prior art publication.

Claim Rejections - 35 USC § 102

(e) the invention was described in a patent granted on an application for patent by another filed in the United States before the invention thereof by the applicant for patent, or on an international application by another who has fulfilled the requirements of paragraphs (1), (2), and (4) of section 371(c) of this title before the invention thereof by the applicant for patent.

The changes made to 35 U.S.C. 102(e) by the American Inventors Protection Act of 1999 (AIPA) do not apply to the examination of this application as the application being examined was not (1) filed on or after November 29, 2000, or (2) voluntarily published under 35 U.S.C. 122(b). Therefore, this application is examined under 35 U.S.C. 102(e) prior to the amendment by the AIPA (pre-AIPA 35 U.S.C. 102(e)).

3. Claims 1, 11, 13-14, 16, 18 - 21 and 23 are rejected under 35 U.S.C. 102(e) as being anticipated by **Bottum U.S. Patent 6,014,569** (Bottum).

As pertaining to **claim 1**, Bottum describes a system for communicating selected information to an electronic device (see Bottum abstract), the system comprising:

a digital engine operable to maintain data associated with selected audio information (see Bottum fig. 1 item 104 col. 2 lines 63 – 64); and

a communication engine communicatively coupled to the digital engine, the communication engine operable to initiate wireless communication of the data to the electronic device (see Bottum fig. 1 items 110 and 120 and col. 2 line 63 – col. 3 line 20).

a graphical user interface operably coupled to the digital engine to provide available information to a user of a communications network and to receive an input from the user identifying a selected portion of the selectable information (see Bottum, col. 4 lines 1-16); and

wherein the interface operates in a web browsing environment and the wireless communication operates outside the browsing environment (see Bottum, col. 4 lines 23-34)

As pertaining to **claim 29**, Bottum describes that the audio information further comprises streaming audio information (see Bottum, fig. 1).

As pertaining to **claim 11**, Bottum describes a method for communicating selected audio information to an electronic device (see Bottum abstract), the method comprising:

maintaining data associated with the selected audio information using a digital engine (see Bottum fig. 1 item 104 col. 2 lines 63 – 64); and

initiating wireless communication of the data to the electronic device (see Bottum fig. 1 items 110 and 120 and col. 2 line 63 – col. 3 line 20).

presenting information associated with audio information within a graphical user interface associated with a communication network (see Bottum, col. 4 lines 1-16);

receiving an input from a user identifying the selected information (see Bottum, col. 4 lines 1-16);

receiving an input from a user identifying the electronic device (see Bottum, col. 3 lines 54-67);

As pertaining to **claim 30**, Bottum describes that the information is presented in a web-browsing environment (see Bottum, col. 4 lines 1-16).

As pertaining to **claim 13**, Bottum's method further comprises:

presenting information associated with the electronic device; and

receiving an input from a user identifying the electronic device (see Bottum col. 3 line 54 – col. 4 line 16).

As pertaining to **claim 14**, the interface in Bottum's method operates in a browsing environment (see Bottum col. 3 lines 60 – 67, Bottum describes that the user is capable of requesting a menu of available audio options i.e. browsing) and the wireless communication

operates outside the browsing environment (see Bottum fig. 1 items 110 and 120 and col. 2 line 63 – col. 3 line 20, Bottum describes nothing in regards to browsing in regards to the wireless communications).

As pertaining to claim 16, Bottum describes an electronic device for receiving selected audio information via wireless communication (see Bottum abstract), the device comprising:

a communication module operable to receive wireless communication of the selected audio information (see Bottum col. 2 lines 59 and 60);

a storage medium operably coupled to the communication module, the storage medium operable to store the selected audio information (see Bottum col. 7 lines 33 – 48); and

a processor module coupled to the communication module, the processor module operable to process the received selected audio information (see Bottum col. 3 lines 15 – 32, the laptops obviously contain both processing and memory capabilities that may be used with the receiver).

As pertaining to **claim 18**, Bottum's device could be a handheld computing device (see Bottum fig. 2, and col. 3 lines 20 – 32, a laptop is also considered a hand-held device).

As pertaining to **claim 20**, Bottum's device further comprises software for processing the selected information (see Bottum col. 3 lines 26 – 30).

As pertaining to **claim 21**, the communications module in Bottum's device is operable to scan frequencies (see Bottum col. 13-16).

Claim Rejections - 35 USC § 103

The following is a quotation of 35 U.S.C. 103(a) which forms the basis for all obviousness rejections set forth in this Office action:

(a) A patent may not be obtained though the invention is not identically disclosed or described as set forth in section 102 of this title, if the differences between the subject matter sought to be patented and the prior art are such that the subject matter as a whole would have been obvious at the time the invention was made to a person having ordinary skill in the art to which said subject matter pertains. Patentability shall not be negated by the manner in which the invention was made.

4. Claims 4 – 10, 15, 19, 23 are rejected under 35 U.S.C. 103(a) as being unpatentable over Bottum.

As pertaining to **claims 4 – 10, 15, and 23** Bottum teaches that the audio data is retrieved by a PDA/ laptop, or Internet radio via a wireless link between the mobile station and the wireless service provider, and Bottum describes that that service could be various different types of wireless service an equipment (see Bottum fig. 1 items 110 and 120 and col. 2 line 63 – col. 3 line 31). Bottum however, does not disclose all possible wireless methods that could be used to transmit the data from the radio tower to the mobile device. It would have been obvious to one of ordinary skill in the art at the time of the invention to use the transmission method that would best fit the design of the system. Some of the transmission methods available at the time of the invention included cellular (which typically used CDMA as a method of transmission), global system for mobile communications (which is operated between 1.7 and 2.0 GHz), or a high-speed low-power microwave wireless link like Bluetooth, which operates around 2.4 GHz. The use of any of these protocols at the time of the invention would have been obvious to one of ordinary skill in the art based on the design choice of the system designer.

As pertaining to **claim 19**, Bottum's device describes that it is possible to use a laptop with a cellular modem to receive the requested audio signal (see Bottum col. 3 lines 15 – 20), however Bottum does not disclose specifically that a PDA may be used to download the digital audio data. It would have been obvious to one of ordinary skill in the art at the time of the invention to know that a PDA possessed the same basic functionalities as a laptop computer and that given a users specific needs they could have used a PDA with a cellular modem to download and process the digital music in a similar manner as would have been accomplished in a laptop computer. The smaller PDA would have allowed the user to be significantly more mobile and to take the device places that a laptop may have been an inconvenience.

Conclusion

Applicant's amendment necessitated the new ground(s) of rejection presented in this Office action. Accordingly, **THIS ACTION IS MADE FINAL**. See MPEP § 706.07(a). Applicant is reminded of the extension of time policy as set forth in 37 CFR 1.136(a).

A shortened statutory period for reply to this final action is set to expire **THREE MONTHS** from the mailing date of this action. In the event a first reply is filed within **TWO MONTHS** of the mailing date of this final action and the advisory action is not mailed until after the end of the **THREE-MONTH** shortened statutory period, then the shortened statutory period will expire on the date the advisory action is mailed, and any extension fee pursuant to 37 CFR 1.136(a) will be calculated from the mailing date of the advisory action. In no event,

Art Unit: 2684

however, will the statutory period for reply expire later than SIX MONTHS from the date of this final action.

As an **additional** note the Examiner would like to state that major claim modifications will be needed to allow the Applicants invention to overcome the prior art made of record. The Applicants may consider spotlighting **specifically** in their claims how their invention is distinct from the Cerf and Bottum references.

Any inquiry concerning this communication or earlier communications from the examiner should be directed to Andrew T Harry whose telephone number is 703-305-4749. The examiner can normally be reached on M-F 8:30 - 5:00.

If attempts to reach the examiner by telephone are unsuccessful, the examiner's supervisor, Daniel Hunter can be reached on 703-308-6732. The fax phone numbers for the organization where this application or proceeding is assigned are 703-872-9314 for regular communications and 703-872-9314 for After Final communications.

Any inquiry of a general nature or relating to the status of this application or proceeding should be directed to the receptionist whose telephone number is 703-305-4700.

ATH
December 26, 2002

DANIEL HUNTER
SUPERVISORY PATENT EXAMINER
TECHNOLOGY CENTER 2600

Official

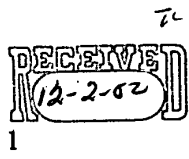

PATENT APPLICATION

#5/BOEJ
MAY

12/8/02

IN THE UNITED STATES PATENT AND TRADEMARK OFFICE

In re Application of: White et al.

Date Filed: March 28, 2000

Serial No.: 09/537,812

Examiner: Andrew T. Harry

Group Art Unit: 2684

Title: SYSTEM AND METHOD FOR COMMUNICATING SELECTED INFORMATION TO AN ELECTRONIC DEVICE

Box Non-Fee Amendment
Assistant Commissioner for Patents
Washington, D.C. 20231

*Please Don't
Enter*

Dear Sir:

RESPONSE TO FINAL OFFICE ACTION

In response to the Office Action mailed October 31, 2002, Applicants request that the Examiner reconsider the application in view of the following amendments and remarks.

Please amend the Application as follows:

AMENDMENTS

IN THE CLAIMS:

Please refer to the attached sheets showing a marked-up version of the amendments to the claims.

ATTORNEY DOCKET

PATENT APPLICATION

2

REMARKS

Applicants appreciate the time taken by the Examiner to carefully review Applicants' present application and for an Examiner's Interview on November 27, 2002. Applicants have carefully reviewed the Office Action mailed October 31, 2002. Claims 1-11, 13-16, 18-21 and 26-37 are pending in this Application. Claims 1-11, 13-16, 18-21 and 26-37 stand rejected by the Examiner under 35 U.S.C. §112 first paragraph.

To expedite allowance and further clarify the claimed embodiment, Applicants have amended Claims 1, 11, and 34. Accordingly, Applicants respectfully submit that, as amended, Claims 1, 11, and 34 are now fully allowable. Applicants submit that all claims pending in this application are fully allowable and respectfully request reconsideration and favorable action in this case.

Rejections under 35 U.S.C. § 112 first paragraph

Claims 1, 4-10, 11, 13-16, 18-21, and 26-37 are rejected under 35 U.S.C., first paragraph as containing subject matter that is not supported in the specification. The Examiner states that Claims 1, 11, 16 and 34 all contain newly added subject matter. Specifically, the Examiner states that the "interface operably coupled to the digital engine," the "interface associated with a communication network," a "low-power RF communication module operably coupled to a processor module" and a "processor module coupled to the communication module" all contain newly added subject matter. Applicants respectfully traverse.

CLAIM 1

Claim 1, as amended includes, in addition to other elements, a graphical user interface operably coupled to the digital engine to provide available information to a user of a communication network and to receive an input from the user to identify a selected portion of the selectable information.

Applicants respectfully submit that this element does not include newly added subject matter. The amended language of Claim 1 was recited in dependent Claims 2 and 3 within the application as originally filed. Moreover, Applicants submit that the specification

ATTORNEY DOCKET

PATENT APPLICATION

3

provides more than sufficient disclosure to enable one skilled in the art to make and/or use the embodiment of Claim 1. (See, e.g., page 11, line 23 through page 12, line 18). Applicants provided on pages 11 and 12 of the specification disclose a detailed and enabling description of a user interface coupled to a digital engine. The user interface embodiment of pages 11 and 12 facilitates: (1) the presentation of available information to a user of a communication network; and (2) the receipt of an input from the user to identify a selected portion of the information.

Specifically, the specification recites that a "digital engine 101 may be used in association with an Internet website configured to provide access to selectable information." One of ordinary skill could create a website with selectable information that may be presented to a user within a user interface (e.g., an Internet browser) without undue experimentation. Further description for allowing one of ordinary skill in the art to provide such an interface may also be found on Page 25 lines 9 through 29.

CLAIM 11

Claim 11, as amended, includes the step – presenting information associated with audio information within a graphical user interface associated with a communication network.

Applicants respectfully submit that the element is not newly added subject matter as it was recited in dependent Claim 12 within the application as originally filed. Additionally, Applicants submit that the specification is provided in such a way as to enable one skilled in the art to make and/or use the invention. Page 11 line 23 through page 12 line 18 provide a detailed description of presenting information associated with audio information within a user interface associated with a communication network. In the specific example of pages 11 and 12, an "Internet website for displaying selectable audio information" is described. One of ordinary skill could create a website with selectable audio information that may be presented to a user within a user interface (e.g. an Internet browser) without undue experimentation. Further description for allowing one of ordinary skill in the art to provide such an interface may also be found on Page 25 lines 9 through 29.

ATTORNEY DOCKET

PATENT APPLICATION

4

CLAIM 16

Claim 16 includes, in addition to other elements, -- a low-power RF communication module operably coupled to a processor module.

Applicants respectfully submit that the element is not newly added subject matter as it was recited in dependent Claim 8 as originally filed. Claim 8 discloses a communication engine including a low-power microwave wireless link. Additionally, Applicants submit that the specification is provided in such a way as to enable one skilled in the art to make and/or use the invention. Page 21 line 25 through page 22 line 32 provide a detailed description of a low power RF communication module operably coupled to a processor. Specifically, electronic device 300 includes a communication module 301 coupled to a processor module 302 and is provided as a low-power communication module operable to proximally or locally communicate with an automobile stereo, home stereo, etc. Low-power RF communication may be provided via a Bluetooth link or through transmitting audio information over a specific frequency at low power.

One of ordinary skill in the art may provide a communication module coupled to a processor for communicating an audio signal and/or audio information over a selected frequency, such as 93.7 MHz or 2.4Ghz without undue experimentation.

CLAIM 34

Claim 34 as amended includes, in addition to other elements, -- a processor module coupled to the communication module, the processor module operable to process the selected audio information to play the selected audio information.

Applicants respectfully submit that the element is not newly added subject matter as it was recited in Claim 16 within the application as originally filed. Additionally, Applicants submit that the specification is provided in such a way as to enable one skilled in the art to make and/or use the invention. Page 20 line 1 through page 21 line 13 provides a detailed description of one embodiment of a processor module coupled to a communication module. Specifically, an electronic device 300 includes a communication module 301 coupled to a processor 302. One of ordinary skill could couple processor 302 to communication module

ATTORNEY DOCKET

PATENT APPLICATION

5

301 without undue experimentation. Additionally, Page 21 lines 5 – 12 provide a detailed description of one embodiment of an electronic device 300 including a communication module 301 coupled to a processor 302 operable as an audio player configured to play digital representations of music. For example, electronic device 300 may include an MP3 player operable to process the audio information into an audio signal. One of ordinary skill could enable a processor to process audio information to play audio information using a player, such as an MP3 player. Accordingly, Applicants request the Examiner withdraw the rejection of Claim 34 and Claims 35-37 which depend from Claim 34.

The Examiner further states that the Applicants provide no description of any such interface that facilitates the transformation of the digital audio data stored in the digital engine into a wireless signal for consumption by a mobile user. Applicants respectfully submit that several descriptions are provided. For example, page 37 line 9 through page 38 line 25 describes one embodiment for determining a destination for selected audio information and formatting the information for communicating the information to a wireless electronic device that includes an audio player, such as an MP3 player operable to play or execute MP3 audio files. Additionally, page 13 line 15 through page 16 line 23 provides several embodiments for communicating audio information via a wireless signal for consumption by a mobile user. For example a communication engine 102 may include a conduit to interface information with a wireless communication network that configures the information into a format operable to be transmitted via the wireless communication. Depending on the type of destination for the information and type of communication, the information is formatted accordingly. For example, a wireless communication device may receive packets of information having a specific size and format. As such communication engine 102 could format the information into a desired specification as needed. Several different types of wireless communication networks may be used including GSM, Digital Satellite communication, SB, Radio bands, DRC, TDMA, CDMA , spread spectrum, etc. One of ordinary skill could, without undue experimentation, transform the digital audio data stored in a digital engine into a wireless signal using one or more of the above wireless communication network for communicating the information to a mobile user.

ATTORNEY DOCKET

PATENT APPLICATION

6

Given that Claims 4-10 depend from Claim 1, Claims 13-15 depend from Claim 11, and Claims 18-21 and 23 depend from Claim 16, Applicants respectfully submit that Claims 4-10, 13-15, 18-21, 23 are allowable. As such, Applicants respectfully request that the Examiner withdraw the rejections and allow Claims 1, 4-10, 11, 13-15, 16, 18-21, and 23.

CONCLUSION

Applicants have made an earnest effort to place this case in condition for allowance in light of the amendments and remarks set forth above. Applicants respectfully request reconsideration of the rejection and allowance of Claims 1, 4-11, 13-16, 18-21, 23 and 26-37.

In addition, Applicants respectfully request that the Examiner reconsider the Final nature of the October 31, 2002 Office Action, as Applicants submit that the action should not have been final.

The attached pages are captioned "**Version with Markings to Show Changes Made.**" Applicants believe that no further fee is due.

RESPECTFULLY SUBMITTED,

White et al.

Date: December 2, 2002

Russell White
10704 Redmond Rd.
Austin, Texas 78739
Telephone: (512) 301-5518

By: 

Kevin R. Imes

Reg. No. 44,795

PATENT APPLICATION

1

VERSION WITH MARKINGS TO SHOW CHANGES MADE

IN THE CLAIMS

Claims 1, 11 and 34 have been amended as follows:

1. **(Twice Amended)** A system for communicating selected information to an electronic device, the system comprising:

a digital engine operable to maintain data associated with selectable audio information, the audio information comprising an audio file;

a communication engine communicatively coupled to the digital engine, the communication engine operable to initiate wireless communication of the data to the electronic device;

a[n] graphical user interface operably coupled to the digital engine to provide available information to a user of a communication network and to receive an input from the user identifying a selected portion of the selectable information; and

wherein the interface operates in a web browsing environment and the wireless communication operates outside the browsing environment.

b1

11. **(Twice Amended)** A method for communicating selected audio information to an electronic device, the method comprising:

maintaining data associated with the selected audio information using a digital engine; [and]

initiating wireless communication of the data to the electronic device[.];

presenting information associated with audio information within a[n] graphical user interface associated with a communication network;

receiving an input from a user identifying the selected information; and

receiving an input from a user identifying the electronic device.

Sub C2
b2

34. **(Amend)** An electronic device for communicating selected audio information via wireless communication, the device comprising:

Sub C8
B3

PATENT APPLICATION

2

VERSION WITH MARKINGS TO SHOW CHANGES MADE

Cont
Sub
C3

B3
cont''

a high speed, low-power RF communication module operable to communicate about 2.4 GHz;

a storage medium operably coupled to the communication module, the storage medium operable to store the selected audio information; and

a processor module coupled to the communication module, the processor module operable to process the selected audio information to play the selected audio information.

Official

PATENT APPLICATION

IN THE UNITED STATES PATENT AND TRADEMARK OFFICE

In re Application of: White et al.

Date Filed: March 28, 2000

Serial No.: 09/537,812

Examiner: Andrew T. Harry

Group Art Unit: 2684

Title: SYSTEM AND METHOD FOR COMMUNICATING SELECTED INFORMATION TO AN ELECTRONIC DEVICE

Box Non-Fee Amendment
Assistant Commissioner for Patents
Washington, D.C. 20231

CERTIFICATE OF FACSIMILE TRANSMISSION	
Date of Facsimile Transmitted:	I hereby certify that this correspondence is being faxed to the United States Patent and Trademark Office at 703-308-9051 to the attention of:
Box Non-Fee Amendment	Assistant Commissioner for Patents
Assistant Commissioner for Patents	Washington, D.C. 20231
Print Name	RUSSELL WHITE
Signature	<i>R White</i>

FINAL OFFICE ACTION TRANSMITTAL

Dear Sir or Madam:

Transmitted herewith for filing in the above-identified patent application are the following documents:

- 1. Response to Final Office Action (8 pages).

No additional fee is required.

RESPECTFULLY SUBMITTED,
White et al.

Kevin R. Imes
Reg. No. 44,795

Russell White
10704 Redmond Rd.
Austin, Texas 78739
Telephone: (512) 301-5518

MB



UNITED STATES PATENT AND TRADEMARK OFFICE

UNITED STATES DEPARTMENT OF COMMERCE
United States Patent and Trademark Office
Address: COMMISSIONER OF PATENTS AND TRADEMARKS
Washington, D.C. 20231
www.uspto.gov

APPLICATION NO.	FILING DATE	FIRST NAMED INVENTOR	ATTORNEY DOCKET NO.	CONFIRMATION NO.
09/537,812	03/28/2000	Russell W. White	111111.1111	4698

7590 10/31/2002
Russell W White
10704 Redmond
Austin, TX 78739

EXAMINER
HARRY, ANDREW T

ART UNIT PAPER NUMBER

2684 4
DATE MAILED: 10/31/2002

Please find below and/or attached an Office communication concerning this application or proceeding.

MB

Office Action Summary

Application No.

09/537,812

Applicant(s)

WHITE ET AL.

Examiner

Andrew T Harry

Art Unit

2684

-- The MAILING DATE of this communication appears on the cover sheet with the correspondence address --

Period for Reply

A SHORTENED STATUTORY PERIOD FOR REPLY IS SET TO EXPIRE 3 MONTH(S) FROM THE MAILING DATE OF THIS COMMUNICATION.

- Extensions of time may be available under the provisions of 37 CFR 1.136(a). In no event, however, may a reply be timely filed after SIX (6) MONTHS from the mailing date of this communication.
- If the period for reply specified above is less than thirty (30) days, a reply within the statutory minimum of thirty (30) days will be considered timely.
- If NO period for reply is specified above, the maximum statutory period will apply and will expire SIX (6) MONTHS from the mailing date of this communication.
- Failure to reply within the set or extended period for reply will, by statute, cause the application to become ABANDONED (35 U.S.C. § 133).
- Any reply received by the Office later than three months after the mailing date of this communication, even if timely filed, may reduce any earned patent term adjustment. See 37 CFR 1.704(b).

Status

- 1) Responsive to communication(s) filed on 19 September 2002.
- 2a) This action is **FINAL**. 2b) This action is non-final.
- 3) Since this application is in condition for allowance except for formal matters, prosecution as to the merits is closed in accordance with the practice under *Ex parte Quayle*, 1935 C.D. 11, 453 O.G. 213.

Disposition of Claims

- 4) Claim(s) 1-11,13-16,18-21 and 26-37 is/are pending in the application.
- 4a) Of the above claim(s) _____ is/are withdrawn from consideration.
- 5) Claim(s) _____ is/are allowed.
- 6) Claim(s) 1-11,13-16,18-21 and 26-37 is/are rejected.
- 7) Claim(s) _____ is/are objected to.
- 8) Claim(s) _____ are subject to restriction and/or election requirement.

Application Papers

- 9) The specification is objected to by the Examiner.
- 10) The drawing(s) filed on 28 March 2000 is/are: a) accepted or b) objected to by the Examiner.
Applicant may not request that any objection to the drawing(s) be held in abeyance. See 37 CFR 1.85(a).
- 11) The proposed drawing correction filed on _____ is: a) approved b) disapproved by the Examiner.
If approved, corrected drawings are required in reply to this Office action.
- 12) The oath or declaration is objected to by the Examiner.

Priority under 35 U.S.C. §§ 119 and 120

- 13) Acknowledgment is made of a claim for foreign priority under 35 U.S.C. § 119(a)-(d) or (f).
a) All b) Some * c) None of:
1. Certified copies of the priority documents have been received.
2. Certified copies of the priority documents have been received in Application No. _____.
3. Copies of the certified copies of the priority documents have been received in this National Stage application from the International Bureau (PCT Rule 17.2(a)).
* See the attached detailed Office action for a list of the certified copies not received.
- 14) Acknowledgment is made of a claim for domestic priority under 35 U.S.C. § 119(e) (to a provisional application).
a) The translation of the foreign language provisional application has been received.
- 15) Acknowledgment is made of a claim for domestic priority under 35 U.S.C. §§ 120 and/or 121.

Attachment(s)

- 1) Notice of References Cited (PTO-892)
- 2) Notice of Draftsperson's Patent Drawing Review (PTO-948)
- 3) Information Disclosure Statement(s) (PTO-1449) Paper No(s) _____.
- 4) Interview Summary (PTO-413) Paper No(s). _____.
- 5) Notice of Informal Patent Application (PTO-152)
- 6) Other: _____.

DETAILED ACTION

Response to Amendment

Claims 2-3, 17, 22, and 24-25 have been cancelled and the Examiner has entered new claims 26-37 for consideration.

1. The Applicant's amendment filed September 19, 2002 has been received, and the Examiner has reviewed *amended* independent **claims 1, 11, 16**, as well as *new claim 34*. Please see the enclosed rejection regarding the above-mentioned claims.

Response to Arguments

2. Applicant's arguments with respect to claims 1-11, 13-16, 18-21, and 26-37 have been considered but are moot in view of the new ground(s) of rejection.

Claim Rejections - 35 USC § 112

The following is a quotation of the first paragraph of 35 U.S.C. 112:

The specification shall contain a written description of the invention, and of the manner and process of making and using it, in such full, clear, concise, and exact terms as to enable any person skilled in the art to which it pertains, or with which it is most nearly connected, to make and use the same and shall set forth the best mode contemplated by the inventor of carrying out his invention.

3. Claims 1-11, 13-16, 18-21, and 26-37 are rejected under 35 U.S.C. 112, first paragraph, as containing subject matter which was not described in the specification in such a way as to enable one skilled in the art to which it pertains, or with which it is most nearly connected, to make and/or use the invention.

Claims 1, 11, 16, and 34 all contain newly added subject matter pertaining to the “interface operably coupled to the digital engine,” the “interface associated with a communication network,” a “low-power RF communication module operably coupled to a processor module,” and a “processor module coupled to the communication module.” None of the claimed interface type devices are adequately described in the specification as required. It is known in the art that there are various content switch, or content enabling devices which vary greatly depending on the application for which they are used. In this case, the Applicant provides no description of any such enabler or interface that facilitates the transformation of the digital audio data stored in the digital engine into a wireless signal for consumption by a mobile user. The Applicant suggests such a content enabler or content switch type device in their amended claim language, but an adequate description in the specification is absent.

Claims 1-10, 13-15, 18-21, and 26-33, and 35-37 depend from claims 1, 11, 16, and 34 and are therefore rejected on the same grounds.

Conclusion

Applicant's amendment necessitated the new ground(s) of rejection presented in this Office action. Accordingly, **THIS ACTION IS MADE FINAL**. See MPEP § 706.07(a). Applicant is reminded of the extension of time policy as set forth in 37 CFR 1.136(a).

A shortened statutory period for reply to this final action is set to expire **THREE MONTHS** from the mailing date of this action. In the event a first reply is filed within **TWO MONTHS** of the mailing date of this final action and the advisory action is not mailed until after the end of the **THREE-MONTH** shortened statutory period, then the shortened statutory period

Art Unit: 2684

will expire on the date the advisory action is mailed, and any extension fee pursuant to 37 CFR 1.136(a) will be calculated from the mailing date of the advisory action. In no event, however, will the statutory period for reply expire later than SIX MONTHS from the date of this final action.

Any inquiry concerning this communication or earlier communications from the examiner should be directed to Andrew T Harry whose telephone number is 703-305-4749. The examiner can normally be reached on M-F 8:30 - 5:00.

If attempts to reach the examiner by telephone are unsuccessful, the examiner's supervisor, Daniel Hunter can be reached on 703-308-6732. The fax phone numbers for the organization where this application or proceeding is assigned are 703-872-9314 for regular communications and 703-872-9314 for After Final communications.

Any inquiry of a general nature or relating to the status of this application or proceeding should be directed to the receptionist whose telephone number is 703-305-4700.

ATH
October 23, 2002

WILLIAM CUMMING
PRIMARY EXAMINER

Phone: 512.989.3388
800 Honeysuckle Lane
Pflugerville, Texas 78660
512.989.3388



12/13/02

Fax

To: Denise Hopkins **From:** Kevin Ines
Fax: 703.872.9314 **Date:** September 25, 2002
Phone: 703.308.9492 **Pages:** 18 w/cover
Re: Claims and Preliminary Amendment **CC:**

Urgent For Review Please Comment Please Reply Please Recycle

•Comments:

Dear Denise,

Enclosed are the non-amended claims for case #09/537,812 and the preliminary amendment for case # 09/874,423. Feel free to call me if you have any additional questions.

Thanks,

Kevin

ATTY DOCKET NO.

IN THE UNITED STATES PATENT AND TRADEMARK OFFICE
IN THE UNITED STATES PATENT AND TRADEMARK OFFICE

In re Application of: White et al.
Date Filed: March 28, 2000
Serial No.: 09/537,812
Examiner: Andrew T. Harry
Group Art Unit: 2684
Title: SYSTEM AND METHOD FOR COMMUNICATING SELECTED INFORMATION
TO AN ELECTRONIC DEVICE

Box Non-Fee Amendment
Assistant Commissioner for Patents
Washington, D.C. 20231

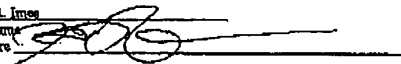
CERTIFICATE OF FACSIMILE TRANSMISSION
Date of Facsimile Transmitted: <u>September 25, 2002</u> I hereby certify that this correspondence is being faxed to the United States Patent and Trademark Office at 703-308-9051 to the attention of:
Box Non-Fee Amendment Assistant Commissioner for Patents Washington, D.C. 20231
Kevin R. Imes Print Name Signature 

PRELIMINARY AMENDMENT TRANSMITTAL

Dear Sir or Madam:

Transmitted herewith for filing in the above-identified patent application are the following documents:

1. Non-Amended Claims (5 pages).

RESPECTFULLY SUBMITTED,
White et al.

By: 

Kevin R. Imes
Reg. No. 44,795

Kevin R. Imes
800 Honeysuckle Lane
Pflugerville, Texas 78660
Telephone: (512) 989-3388

Received from < > at 9/25/02 3:16:16 PM [Eastern Daylight Time]

Samsung Ex. 1218 p. 470

1. *(amended)* A system for communicating selected information to an electronic device, the system comprising:

a digital engine operable to maintain data associated with selected audio information; and

a communication engine communicatively coupled to the digital engine, the communication engine operable to initiate wireless communication of the data to the electronic device.

2. The system of Claim 1 further comprising an interface operably coupled to the digital engine, the interface operable to provide available information to a user of a communication network, and to receive an input from the user identifying the selected information.

3. The system of Claim 2, wherein the interface operates in a browsing environment and the wireless communication operates outside the browsing environment.

4. The system of Claim 1, wherein the wireless communication comprises communication via a cellular communications network.

5. The system of Claim 4, wherein the cellular communication network comprises a global system for mobile communications network.

6. The system of Claim 5, wherein the global system for mobile communications network operates between about 1.7 GHz and 2.0 GHz.

7. The system of Claim 4, wherein the cellular communication network comprises a code-division multiple access network.

8. The system of Claim 1, wherein the wireless communication comprises communicating via a high-speed, low-power microwave wireless link.

9. The system of Claim 8, wherein the wireless link comprises a Bluetooth link.
10. The system of Claim 8, wherein the wireless link operates around 2.4 GHz.

02

11. (Amended) A method for communicating selected audio information to an electronic device, the method comprising:

maintaining data associated with the selected audio information using a digital engine; and

initiating wireless communication of the data to the electronic device.

12. The method of Claim 11 further comprising:

presenting information associated with audio information within an interface associated with a communication network; and

receiving an input from a user identifying the selected information.

03

13. (Amended) The method of Claim 11 further comprising:

presenting information associated with the electronic device; and

receiving an input from a user identifying the electronic device.

14. (Amended) The method of Claim 12 wherein the interface operates in a browsing environment and the wireless communication operate outside the browsing environment.

15. The method of Claim 11 wherein the wireless communication comprises communicating via a cellular communications network.

16. ^(Amended) An electronic device for receiving selected audio information via wireless communication, the device comprising:

a communication module operable to receive wireless communication of the selected audio information;

a storage medium operably coupled to the communication module, the storage medium operable to store the selected audio information; and

a processor module coupled to the communication module, the processor module operable to process the received selected audio information.

17. The device as recited in Claim 16, wherein the communication module comprises a cellular modem.

18. The device as recited in Claim 16, wherein the device is a handheld computing device.

19. ^(Amended) The device as recited in Claim 18 wherein the handheld computing device is a personal digital assistant (PDA).

20. The device as recited in Claim 16 further comprising software for processing the selected audio information.

21. The device as recited in Claim 16, wherein the communications module is operable to scan frequencies.

22. The device as recited in Claim 16, further comprising a display operable to display a user interface.

23. ^(Amended) The device as recited in Claim 16 wherein the communication module is operable with a 'Bluetooth' communication standard.

24. A method for communicating selected audio information to an electronic device, the method comprising:

presenting information associated with audio information within an interface associated with a communication network;

receiving an input from a user identifying the selected information;

maintaining data associated with the selected audio information using digital engine; and

initiating wireless communication of the data to the electronic device.

25. The method of Claim 24 wherein the interface operates in a browsing environment and the wireless communication operates outside the bro



AO

PATENT APPLICATION

2684
#3A
9/23/02
DT

IN THE UNITED STATES PATENT AND TRADEMARK OFFICE

In re Application of: White et al.

Date Filed: March 28, 2000

Serial No.: 09/537,812

Examiner: Andrew T. Harry

Group Art Unit: 2684

RECEIVED

SEP 23 2002

Technology Center 2600

Title: SYSTEM AND METHOD FOR COMMUNICATING SELECTED INFORMATION TO AN ELECTRONIC DEVICE

Box Non-Fee Amendment
Assistant Commissioner for Patents
Washington, D.C. 20231

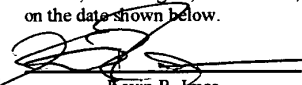
I hereby certify that this correspondence is being deposited with the United States Postal Service as Express Mail No. _____ addressed to: Assistant Commissioner of Patents, Washington, D.C. 20231, on the date shown below.

Kevin R. James
September 16, 2002
Date

Dear Sir:

RESPONSE TO OFFICE ACTION

In response to the Office Action mailed July 18, 2002, Applicants request that the Examiner reconsider the application in view of the following amendments and remarks.

Please amend the Application as follows:

AMENDMENTSIN THE CLAIMS:

For the convenience of the Examiner, all pending claims of the present application are shown below in clean form whether or not an amendment has been made. Please refer to the attached sheets showing a marked-up version of the amendments to the claims.

REMARKS

Applicants appreciate the time taken by the Examiner to carefully review Applicants' present application and for an Examiner's Interview on August 26, 2002. Applicants have carefully reviewed the Office Action mailed July 18, 2002. Claims 1-25 are pending in this Application. Claims 1-25 stand rejected by the Examiner under 35 U.S.C. §102 and 35 U.S.C. §103.

To expedite allowance and further clarify the invention, Applicants have amended Claims 1, 11, 13-14, 16, 19 and 23. Accordingly, Applicants respectfully submit that, as amended, Claims 1, 11, 13-14, 16 and 23 are now fully allowable. Applicants have also added Claims 26-37.

While Applicants are not abandoning the subject matter of Claims 2, 3, 12, 22, 24, and 25, Applicants have withdrawn Claims 2, 3, 12, 22, 24, and 25 from consideration in this application. Applicants submit that all claims pending in this application are fully allowable and respectfully request reconsideration and favorable action in this case.

Rejections under 35 U.S.C. § 102(e)

Claims 1-3, 11-14 stand rejected by the Examiner under 35 U.S.C. § 102(e) as being anticipated by United States Patent No. 6,418,138, issued to Cerf et al. ("Cerf"). Additionally, Claims 1-3, 11-14, 16-18, 20-22 stand rejected by the Examiner under 35 U.S.C. § 102(e) as being anticipated by United States Patent No. 6,014,569, issued to Bottum ("Bottum"). Applicants respectfully traverse. Applicants submit that Claims 1, 11, and 16 as amended, are patentable over Cerf and Bottum.

Cerf discloses a communication system including mobile units distributed within a wireless communication network, which are connected to a packet switched network (See Cerf Abstract).

Bottum discloses a method and apparatus for providing asynchronous audio data to a mobile interactive radio (See Bottum Abstract).

Claim 1, (as amended), recites a system for communicating selected information to an electronic device. The system includes, in addition to other elements, **a digital engine operable to maintain data associated with selectable audio information, the audio information including an audio file.** The system further includes **a communication engine communicatively coupled to the digital engine, the communication engine operable to initiate wireless communication of the data to the electronic device and an interface [that] operates in a web browsing environment and wireless communication [that] operates outside the browsing environment.**

Applicants respectfully submit that Cerf and Bottum fail to disclose each and every element of Applicants' invention as amended. Cerf and Bottum fail to teach (and disclose) **a digital engine operable to maintain data associated with selectable audio information, the audio information including an audio file.** Further, Cerf and Bottum fail to teach (and disclose) **an interface [that] operates in a web browsing environment and wireless communication [that] operates outside the browsing environment.** The Examiner states that Cerf discloses each and every element of Claim 1. However, Cerf discloses an Internet radio for listening to 'live radio programs' (See Cerf Col 4, lines 7-17) and Bottum discloses an apparatus for providing 'asynchronous audio data' (See Bottum Abstract). Neither Cerf nor Bottum disclose providing **a digital engine operable to maintain data associated with selectable audio information, the audio information including an audio file.** Additionally, neither Cerf nor Bottum disclose **an interface that can provide available information to a user of a communication network and can receive an input from the user identifying a selected portion of information.**

Moreover, neither Cerf nor Bottum disclose a system that operates in two distinct environments. Certainly, Cerf and Bottum fail to disclose **an interface [that] operates in a web browsing environment and a wireless communication [that] operates outside the**

browsing environment. As such, Cerf and Bottum fail to disclose the recited limitations and, therefore, cannot anticipate Claim 1.

Claim 11, (as amended), recites a method for communicating selected audio information to an electronic device. The method includes, in addition to other elements, **presenting information associated with audio information within an interface associated with a communication network, receiving an input from a user identifying the selected information and receiving an input from a user identifying the electronic device.**

Applicants respectfully submit that Cerf and Bottum fail to disclose each and every element of Applicants' invention as amended. Cerf and Bottum fail to teach (and disclose) **presenting information associated with audio information within an interface associated with a communication network, receiving an input from a user identifying the selected information and receiving an input from a user identifying the electronic device.** The Examiner states that each element is disclosed or taught within Cerf (Col 6 lines 19-22, Col 5 line 66 – Col 6 line 5, Col 6 lines 10-14) and Bottum (Col 3 line 54- Col 4 line 16). However, all elements are not present within Cerf or Bottum. For example, neither Cerf nor Bottum teach **receiving an input from a user identifying the electronic device.** Cerf discloses “...a type of plan [that] may be determined from a table stored within a proxy server” (see Cerf Col 6 lines 10-14). Determining a type of plan from a table is not equivalent to **receiving an input from a user identifying the electronic device** as recited in Claim 11. Additionally, Bottum discloses “receiving instructions from a user” (see Bottum Col 3 line 54 – Col 4 line 16) but fails to disclose **receiving an input from a user identifying the electronic device** as recited in Claim 11. As such, Cerf and Bottum fail to teach and disclose the recited limitations and, therefore, cannot anticipate Claim 11.

Claim 16, (as amended), recites an electronic device for receiving selected audio information via wireless communication. The electronic device includes, in addition to other elements, a **communication module operable to receive wireless communication, low-power RF communication module, a storage medium operable to store selected audio information that comprises an audio file, and a display operable to display a web browser within a user interface.** Applicants respectfully submit that Bottum fails to disclose each and every element of Applicants' invention as amended. Bottum fails to teach

(and disclose) each of the above cited limitations. Bottum discloses providing asynchronous audio data to a mobile interactive radio -- not a **communication module** and a **low-power RF communication module**. In light of these and other failings in the Bottum disclosure, Bottum cannot anticipate Claim 16.

As discussed above, Cerf and Bottum fail to disclose the recited limitations and, therefore, cannot anticipate amended Claims 1, 11, and 16. Given that Claims 4-10 depend from Claim 1, Claims 13-15 depend from Claim 11, and Claims 18-21 and 23 depend from Claim 16, Applicants respectfully submit that Claims 4-10, 13-15, 18-21, 23 are allowable. As such, Applicants respectfully request that the Examiner withdraw the rejections and allow Claims 1, 4-10, 11, 13-15, 16, 18-21, and 23.

Rejections under 35 U.S.C. §103(a)

Claims 4-10 and 15-23 stand rejected by the Examiner under 35 U.S.C. § 103(a) as being unpatentable over Cerf. Additionally, Claims 4-10, 15 and 23 stand rejected by the Examiner under 35 U.S.C. § 103(a) as being unpatentable over Bottum.

Applicant respectfully traverses this rejection. According to the Manual of Patent Examining procedure:

To establish a *prima facie* case of obviousness, three basic criteria must be met. First, there must be some suggestion or motivation, either in the references themselves or in the knowledge generally available to one of ordinary skill in the art, to modify the reference or to combine reference teachings. Second, there must be a reasonable expectation of success. Finally, the prior art reference (or references when combined) must teach or suggest all the claim limitations.

The teaching or suggestion to make the claimed combination and the reasonable expectation of success must both be found in the prior art, not in applicant's disclosure. *In re Vaeck*, 947 F.2d 488, 20 U.S.P.Q.2d 1438 (Fed. Cir. 1991).

Manual of Patent Examining Procedure, § 2143.

The above rejection is improper for the following reasons. First, the proposed combination does not teach or suggest every limitation of the claimed invention. In order to make obvious Applicants' claimed invention, the references cited by the Examiner must disclose all claimed limitations. *In re Royka*, 490 F.2d 981, 180 U.S.P.Q. 580 (C.C.P.A.

1974). As explained above, neither Cerf nor Bottum disclose all the claimed limitations. Second, there is no motivation to combine Cerf with 'ordinary skill in the art' to make obvious the Applicants' claimed invention. Additionally, there is no motivation to combine Bottum with 'ordinary skill in the art' to make obvious the Applicants' claimed invention.

Cerf discloses a communication system including mobile units distributed within a wireless communication network which are connected to a packet switched network (See Cerf Abstract). Bottum discloses methods and apparatus for providing asynchronous audio data to a mobile interactive radio (See Bottum Abstract).

As discussed above in the sections relating to the 102 rejection, Cerf and Bottum fail to teach all of the limitations of Claims 1, 11 and 16. For example, Claim 1, (as amended), recites a system for communicating selected information to an electronic device. The system includes, in addition to other elements, **a digital engine operable to maintain data associated with selectable audio information, the audio information including an audio file.** The system further includes **a communication engine communicatively coupled to the digital engine, the communication engine operable to initiate wireless communication of the data to the electronic device and an interface [that] operates in a web browsing environment and the wireless communication operates outside the browsing environment.** Cerf and Bottum fail to teach each of these Claim1 limitations. As such, Neither Cerf nor Bottom, either alone or in combination with 'ordinary skill in the art' can render obvious Claims 4-10 which depend from Claim 1.

Claim 11, (as amended), recites a method for communicating selected audio information to an electronic device. The method includes, in addition to other elements, **presenting information associated with audio information within an interface associated with a communication network, receiving an input from a user identifying the selected information and receiving an input from a user identifying the electronic device.** As such, Neither Cerf nor Bottom, either alone or in combination with 'ordinary skill in the art' can render obvious Claim 15 which depends from Claim 11.

Claim 16, (as amended), recites an electronic device for receiving selected audio information via wireless communication. The electronic device includes, in addition to other elements, **a communication module and a low-power RF communication module.** Claim

16 also includes a **display operable to display a web browser within a user interface**. Cerf and Bottum fail to teach all of the limitations of Claim 16. As such, Neither Cerf nor Bottum, either alone or in combination with ‘ordinary skill in the art’ can render obvious Claim 23, which depends from Claim 16.

Applicants would also like to address the Examiner’s rejection of Claims 8, 9, 10 and 23 directed towards using a high speed, low power communication module. The Examiner stated that one skilled in the art could implement using low power communication with the systems disclosed by either Cerf or Bottum. Conversely, each system disclosed by Cerf and Bottum specifically require the use of long range wireless communication (See Cerf Figure 2 and Bottum Col 2 line 64 – Col 3 line 20). Each system teaches away from using low power communication and would be rendered useless if a low power communication module was implemented. As such, neither Cerf nor Bottum, either alone or in combination with ‘ordinary skill in the art’ can render obvious Claims 8, 9, and 10 which depend from Claim 1 or Claim 23 which depends from Claim 16.

Accordingly, Applicants request the Examiner to withdraw the rejections to Claims 4-10, 15 and 23 under 35 U.S.C. §103(a).

CONCLUSION

Applicants have made an earnest effort to place this case in condition for allowance in light of the amendments and remarks set forth above. Applicants respectfully request reconsideration of the rejection and allowance of Claims 1, 4-11, 13-16, 18-21, and 23, as amended. Applicants also request consideration and favorable allowance of newly added Claims 26-29 which depend from amended Claim 1, Claim 30 which depends from amended Claim 11, and Claims 30-33 which depend from Claim 16. Additionally, Applicants respectfully request expedient consideration and favorable allowance of newly added Claims 34-37.

The attached pages are captioned "**Version with Markings to Show Changes Made.**" Applicants believe that no further fee is due.

ATTORNEY DOCKET

PATENT APPLICATION

8

RESPECTFULLY SUBMITTED,

White et al.

Date: September 16, 2002

Russell White

10704 Redmond Rd.

Austin, Texas 78739

Telephone: (512) 301-5518

By: 

Kevin R. Imes

Reg. No. 44,795



VERSION WITH MARKINGS TO SHOW CHANGES MADE

IN THE CLAIMS

Claims 2-3, 12, 17, 22, 24-25 have been withdrawn. Claims 1, 11, 13-14, 16, 19, and 23 have been amended as follows:

1. **(Amended)** A system for communicating selected information to an electronic device, the system comprising:

a digital engine operable to maintain data associated with [selected] selectable audio information, the audio information comprising an audio file; [and]

a communication engine communicatively coupled to the digital engine, the communication engine operable to initiate wireless communication of the data to the electronic device[.];

an interface operably coupled to the digital engine to provide available information to a user of a communication network and to receive an input from the user identifying a selected portion of the selectable information; and

wherein the interface operates in a web browsing environment and the wireless communication operates outside the browsing environment.

Sub B
a₁

2. **(Delete)** The system of Claim 1 further comprising an interface operably coupled to the digital engine, the interface operable to provide available information to a user of a communication network, and to receive an input from the user identifying the selected information.

3. **(Delete)** The system of Claim 2, wherein the interface operates in a browsing environment and the wireless communication operates outside the browsing environment.

4. The system of Claim 1, wherein the wireless communication comprises communication via a cellular communications network.

VERSION WITH MARKINGS TO SHOW CHANGES MADE

5. The system of Claim 4, wherein the cellular communication network comprises a global system for mobile communications network.

6. The system of Claim 5, wherein the global system for mobile communications network operates between about 1.7 GHz and 2.0 GHz.

7. The system of Claim 4, wherein the cellular communication network comprises a code-division multiple access network.

8. The system of Claim 1, wherein the wireless communication comprises communicating via a high-speed, low-power microwave wireless link.

9. The system of Claim 8, wherein the wireless link comprises a Bluetooth link.

10. The system of Claim 8, wherein the wireless link operates around 2.4 GHz.

VERSION WITH MARKINGS TO SHOW CHANGES MADE

11. **(Amend)** A method for communicating selected audio information to an electronic device, the method comprising:

maintaining data associated with the selected audio information using a digital engine; [and]

initiating wireless communication of the data to the electronic device[.];

presenting information associated with audio information within an interface associated with a communication network;

receiving an input from a user identifying the selected information; and

receiving an input from a user identifying the electronic device.

12. **(Delete)** The method of Claim 11 further comprising:

presenting information associated with audio information within an interface associated with a communication network; and

receiving an input from a user identifying the selected information.

13. **(Amend)** The method of Claim 11 further comprising[.];

presenting information associated with identifying the electronic device. [; and

receiving an input from a user identifying the electronic device.]

14. **(Amend)** The method of Claim 12 wherein the interface operates in a web browsing environment and the wireless communication operate outside the browsing environment.

15. The method of Claim 11 wherein the wireless communication comprises communicating via a cellular communications network.

VERSION WITH MARKINGS TO SHOW CHANGES MADE

16. **(Amend)** An electronic device for receiving selected audio information via wireless communication, the device comprising:

Sub
C3
A4

a communication module operable to receive wireless communication of [the selected audio] information;

a low-power RF communication module operably coupled to a processor module;

a storage medium operably coupled to the high speed, low-power communication module, the storage medium operable to store selected audio information that comprises an audio file; [and]

a processor module coupled to the [communication module] storage medium, the processor module operable to process [the] received selected audio information[.]; and

a display operable to display a web browser within a user interface.

17. **(Delete)** The device as recited in Claim 16, wherein the communication module comprises a cellular modem.

18. The device as recited in Claim 16, wherein the device is a handheld computing device.

A5

19. **(Amended)** The device as recited in Claim [18]16, wherein low power RF module outputs audio information indirectly to an audio speaker. [the handheld computing device is a personal digital assistant (PDA).]

20. The device as recited in Claim 16 further comprising software for processing the selected audio information.

21. The device as recited in Claim 16, wherein the communications module is operable to scan frequencies.

VERSION WITH MARKINGS TO SHOW CHANGES MADE

22. **(Delete)** The device as recited in Claim 16, further comprising a display operable to display a user interface.

Sub
A6 G →

23. **(Amended)** The device ~~as recited~~ in Claim 16 wherein the high speed low-power communication module is operable with a 'Bluetooth' communication standard.

VERSION WITH MARKINGS TO SHOW CHANGES MADE

24. **(Delete)** A method for communicating selected audio information to an electronic device, the method comprising:

presenting information associated with audio information within an interface associated with a communication network;

receiving an input from a user identifying the selected information;

maintaining data associated with the selected audio information using digital engine; and

initiating wireless communication of the data to the electronic device.

25. **(Delete)** The method of Claim 24 wherein the interface operates in a browsing environment and the wireless communication operates outside the browsing environment.

VERSION WITH MARKINGS TO SHOW CHANGES MADE

PLEASE ADD THE FOLLOWING CLAIMS 26-37:

/ 26. (Add) The system of Claim 1 further comprising a wireless telephone.

Sub
C6

~~27. (Add) The system of Claim 26 wherein the wireless telephone is operable to communicate with a low-power, highspeed wireless communication network.~~

/ 28. (Add) The system of Claim 1 wherein the audio information includes at least one of a WAV file, an MP3 file or a MIDI file.

A7

/ 29. (Add) The system of Claim 1 wherein the audio information further comprises streaming audio information.

/ 30. (Add) The method of Claim 11 further comprising presenting the information in a web browsing environment.

Sub
G7

~~31. (Add) The device as recited in Claim 16 further comprising a wireless telephone, wherein the information received by the communication module comprises a voice call.~~

/ 32. (Add) The device as recited in Claim 16 wherein the audio file includes at least one of a WAV file, an MP3 file or a MIDI file.

/ 33. (Add) The device as recited in Claim 32 wherein the audio information comprises streaming audio information.

VERSION WITH MARKINGS TO SHOW CHANGES MADE

34. (Add) An electronic device for communicating selected audio information via wireless communication, the device comprising:

Sub
B3 >

a high speed, lower-power RF communication module operable to communicate about 2.4 GHz;

a storage medium operably coupled to the communication module, the storage medium operable to store the selected audio information; and

a processor module coupled to the communication module, the processor module operable to process the selected audio information;

35. (Add) The device as recited in Claim 34 further comprising a display operable to display a user interface operably associated with a web browsing environment.

36. (Add) The device as recited in Claim 35 further comprising a cellular phone operable to communicate with a cellular phone network.

Sub
C9 >

37. (Add) The device as recited in Claim 35 wherein the cellular phone is operable to communicate the selected audio information.

Add
C10 >



UNITED STATES PATENT AND TRADEMARK OFFICE

UNITED STATES DEPARTMENT OF COMMERCE
United States Patent and Trademark Office
Address: COMMISSIONER OF PATENTS AND TRADEMARKS
Washington, D.C. 20231
www.uspto.gov

APPLICATION NO.	FILING DATE	FIRST NAMED INVENTOR	ATTORNEY DOCKET NO.	CONFIRMATION NO.
09/537,812	03/28/2000	Russell W. White	11111.1111	4698

7590 07/18/2002
Russell W White
10704 Redmond
Austin, TX 78739

EXAMINER

HARRY, ANDREW T

ART UNIT PAPER NUMBER

2684

2

DATE MAILED: 07/18/2002

Please find below and/or attached an Office communication concerning this application or proceeding.

61

Office Action Summary	Application No. 09/537,812	Applicant(s) WHITE ET AL.	
	Examiner Andrew T Harry	Art Unit 2684	

-- The MAILING DATE of this communication appears on the cover sheet with the correspondence address --

Period for Reply

A SHORTENED STATUTORY PERIOD FOR REPLY IS SET TO EXPIRE 3 MONTH(S) FROM THE MAILING DATE OF THIS COMMUNICATION.

- Extensions of time may be available under the provisions of 37 CFR 1.136(a). In no event, however, may a reply be timely filed after SIX (6) MONTHS from the mailing date of this communication.
- If the period for reply specified above is less than thirty (30) days, a reply within the statutory minimum of thirty (30) days will be considered timely.
- If NO period for reply is specified above, the maximum statutory period will apply and will expire SIX (6) MONTHS from the mailing date of this communication.
- Failure to reply within the set or extended period for reply will, by statute, cause the application to become ABANDONED (35 U.S.C. § 133).
- Any reply received by the Office later than three months after the mailing date of this communication, even if timely filed, may reduce any earned patent term adjustment. See 37 CFR 1.704(b).

Status

- 1) Responsive to communication(s) filed on _____.
- 2a) This action is FINAL. 2b) This action is non-final.
- 3) Since this application is in condition for allowance except for formal matters, prosecution as to the merits is closed in accordance with the practice under *Ex parte Quayle*, 1935 C.D. 11, 453 O.G. 213.

Disposition of Claims

- 4) Claim(s) 1-25 is/are pending in the application.
 - 4a) Of the above claim(s) _____ is/are withdrawn from consideration.
- 5) Claim(s) _____ is/are allowed.
- 6) Claim(s) 1-25 is/are rejected.
- 7) Claim(s) _____ is/are objected to.
- 8) Claim(s) _____ are subject to restriction and/or election requirement.

Application Papers

- 9) The specification is objected to by the Examiner.
- 10) The drawing(s) filed on 28 March 2000 is/are: a) accepted or b) objected to by the Examiner.

Applicant may not request that any objection to the drawing(s) be held in abeyance. See 37 CFR 1.85(a).
- 11) The proposed drawing correction filed on _____ is: a) approved b) disapproved by the Examiner.

If approved, corrected drawings are required in reply to this Office action.
- 12) The oath or declaration is objected to by the Examiner.

Priority under 35 U.S.C. §§ 119 and 120

- 13) Acknowledgment is made of a claim for foreign priority under 35 U.S.C. § 119(a)-(d) or (f).
 - a) All b) Some * c) None of:
 - 1. Certified copies of the priority documents have been received.
 - 2. Certified copies of the priority documents have been received in Application No. _____.
 - 3. Copies of the certified copies of the priority documents have been received in this National Stage application from the International Bureau (PCT Rule 17.2(a)).
 - * See the attached detailed Office action for a list of the certified copies not received.
- 14) Acknowledgment is made of a claim for domestic priority under 35 U.S.C. § 119(e) (to a provisional application).
 - a) The translation of the foreign language provisional application has been received.
- 15) Acknowledgment is made of a claim for domestic priority under 35 U.S.C. §§ 120 and/or 121.

Attachment(s)

- 1) Notice of References Cited (PTO-892)
- 2) Notice of Draftsperson's Patent Drawing Review (PTO-948)
- 3) Information Disclosure Statement(s) (PTO-1449) Paper No(s) _____.
- 4) Interview Summary (PTO-413) Paper No(s). _____.
- 5) Notice of Informal Patent Application (PTO-152)
- 6) Other:

DETAILED ACTION

Claim Rejections - 35 USC § 102

(e) the invention was described in a patent granted on an application for patent by another filed in the United States before the invention thereof by the applicant for patent, or on an international application by another who has fulfilled the requirements of paragraphs (1), (2), and (4) of section 371(c) of this title before the invention thereof by the applicant for patent.

The changes made to 35 U.S.C. 102(e) by the American Inventors Protection Act of 1999 (AIPA) do not apply to the examination of this application as the application being examined was not (1) filed on or after November 29, 2000, or (2) voluntarily published under 35 U.S.C. 122(b). Therefore, this application is examined under 35 U.S.C. 102(e) prior to the amendment by the AIPA (pre-AIPA 35 U.S.C. 102(e)).

1. Claims 1 – 3, 11 – 14, and 24 – 25 are rejected under 35 U.S.C. 102(e) as being anticipated by **Cerf et al. U.S. Patent 6,418,138** (Cerf).

As pertaining to **claims 1 and 11**, Cerf describes a system and method for communicating selected information to an electronic device (see Cerf abstract), the system comprising:

a digital engine operable to maintain data associated with selected audio information (see Cerf col. 3 line 35 – col. 4 line 5, Cerf describes the idea of Internet radio and how it manages audio information); and

a communication engine communicatively coupled to the digital engine (see Cerf col. 4 lines 6 – 49, in this section Cerf describes how the Proxy server is connected to the internet and

Art Unit: 2684

acts as a communication engine for the internet to the mobile users.), the communication engine operable to initiate wireless communication of the data to the electronic device (see Cerf col. 5 lines 10 – 28, Cerf describes an example of how the digital audio data is transmitted from the internet through the proxy server out to the wireless mobile user.).

As pertaining to **claim 2 and 12**, Cerf's system and method also includes an interface operably coupled to the digital engine, the interface operable to provide available information to a user of a communication network (see Cerf col. 5 lines 10 – 28), and to receive an input from the user identifying the selected information (see Cerf col. 6 lines 19 – 22).

As pertaining to **claims 3 and 14**, in Cerf's system and method the interface operates in a browsing environment (see Cerf col. 6 lines 23 – 30, Cerf describes that the user is able to look around and retrieve information from the proxy server regarding current broadcast options) and the wireless communication operates outside the browsing environment (see Cerf col. 5 lines 10 – 28).

As pertaining to **claim 13**, Cerf's method further comprises:

presenting information associated with the electronic device (see Cerf col. 5 line 66 – col 6 line 5); and

receiving an input from a user identifying the electronic device (see Cerf col. 6 lines 10 – 14).

As pertaining to **claim 24**, Cerf describes a method for communicating selected audio information to an electronic device (see Cerf abstract), the method comprising:

presenting information associated with audio information within an interface associated with a communication network (see cerf col. 5 line 66 – col. 6 line 5);

receiving an input from a user identifying the selected information (see Cerf col. 6 lines 23 – 42, Cerf describes that the user can input a selection as to the type of programming they would like);

maintaining data associated with the selected audio information using digital engine (see Cerf col. 3 line 35 – col. 4 line 5, Cerf describes the idea of Internet radio and how it manages audio information); and

initiating wireless communication of the data to the electronic device (see Cerf col. 5 lines 10 – 28, Cerf describes an example of how the digital audio data is transmitted from the internet through the proxy server out to the wireless mobile user.).

As pertaining to **claim 25**, the interface in Cerf's method operates in a browsing environment (see Cerf col. 6 lines 23 – 30, Cerf describes that the user is able to look around and retrieve information from the proxy server regarding current broadcast options) and the wireless communication operates outside the browsing environment (see Cerf col. 5 lines 10 – 28).

Claim Rejections - 35 USC § 103

The following is a quotation of 35 U.S.C. 103(a) which forms the basis for all obviousness rejections set forth in this Office action:

(a) A patent may not be obtained though the invention is not identically disclosed or described as set forth in section 102 of this title, if the differences between the subject matter sought to be patented and the prior art are such that the subject matter as a whole would have been obvious at the time the invention was made to a person having ordinary skill in the art to which said subject matter pertains. Patentability shall not be negatived by the manner in which the invention was made.

2. Claims 4 – 10, and 15 – 23 are rejected under 35 U.S.C. 103(a) as being unpatentable over Cerf.

As pertaining to **claims 4 – 10, and 15** Cerf teaches that the audio data is retrieved by a PDA, laptop, or Internet radio via a wireless link between the mobile station and the “radio tower” (see Cerf col. 3 lines 20 – 25 and fig. 2), which is connected to a proxy server which is connected to the internet. Cerf, however, is silent on the wireless method used to transmit the data from the radio tower to the mobile device. It would have been obvious to one of ordinary skill in the art at the time of the invention to use the transmission method that would best fit the design of the system. Some of the transmission methods available at the time of the invention included cellular (which typically used CDMA as a method of transmission), global system for mobile communications (which is operated between 1.7 and 2.0 GHz), or a high-speed low-power microwave wireless link like Bluetooth, which operates around 2.4 GHz. The use of any of these protocols at the time of the invention would have been obvious to one of ordinary skill in the art based on the design choice of the system designer.

As pertaining to **claims 16, 18, 19**, Cerf describes an electronic device for receiving selected audio information via wireless communication, the device comprising:

a communication module operable to receive wireless communication of the selected audio information (see Cerf col. 1 lines 15 – 27) ;

Cerf describes that a laptop computer or a PDA may be used as the mobile device in his system to implement his wireless radio concept (see Cerf fig. 2 and col. 5 lines 58 – 61), however Cerf does not specifically describe the capabilities in terms of processing of his mobile device (see Cerf col. 7 lines 10 – 18). However, it would have been obvious to one of ordinary skill in the art at the time of the invention that the laptop computer or PDA would include a storage medium operably coupled to the communication module, the storage medium operable to store the selected audio information and a processor module coupled to the communication module, the processor module operable to process the received selected audio information. It would have been obvious to a skilled artisan at the time of the invention that all laptops and PDAs would include processors capable of processing received data, and memory that would have been capable of storing data that would have been downloaded to these devices. This would have allowed the users of these devices to actually listen to the audio music that they were downloading and to store the audio information that would have been downloaded to the device so that they may listen to it at a later time.

As pertaining to **claims 17 and 23**, Cerf as modified above regarding claim 16, teaches that the audio data is retrieved by a PDA, laptop, or Internet radio via a wireless link between the mobile station and the “radio tower” (see Cerf col. 3 lines 20 – 25 and fig. 2), which is connected

to a proxy server which is connected to the internet. Cerf, however, is silent on the wireless method used to transmit the data from the radio tower to the mobile device. It would have been obvious to one of ordinary skill in the art at the time of the invention to use the transmission method that would best fit the design of the system. Some of the transmission methods available at the time of the invention included cellular (which typically used CDMA as a method of transmission), global system for mobile communications (which is operated between 1.7 and 2.0 GHz), or a high-speed low-power microwave wireless link like Bluetooth, which operates around 2.4 GHz. The use of any of these protocols at the time of the invention would have been obvious to one of ordinary skill in the art based on the design choice of the system designer. Also if the device used by the user would be a PDA or laptop computer it would have been obvious to one of ordinary skill in the art at the time of the invention that a cellular or other modem would have been used to receive the transmitted signal.

As pertaining to **claim 20**, Cerf's device as modified above in claim 16 further comprises software for processing the selected information (see Cerf col. 7 lines 11 – 18).

As pertaining to **claim 21**, Cerf's device as modified above regarding claims 17 and 23 describes that some of the various transmission techniques that would have been used to transmit the data include CDMA. CDMA is a frequency and time hopped system, and therefore the system would have been capable of scanning the various CDMA frequency channels.

As pertaining to **claim 22**, Cerf's device as modified above in claim 16 further comprises a display operable to display a user interface (see Cerf fig 4 item 70 and col. 4 lines 1 – 6, also Cerf describes that a PDA or laptop computer could be used to receive the wireless audio data, and these obviously have a display).

The following is a second rejection of claims 1 – 25 using an alternative prior art publication.

Claim Rejections - 35 USC § 102

(e) the invention was described in a patent granted on an application for patent by another filed in the United States before the invention thereof by the applicant for patent, or on an international application by another who has fulfilled the requirements of paragraphs (1), (2), and (4) of section 371(c) of this title before the invention thereof by the applicant for patent.

The changes made to 35 U.S.C. 102(e) by the American Inventors Protection Act of 1999 (AIPA) do not apply to the examination of this application as the application being examined was not (1) filed on or after November 29, 2000, or (2) voluntarily published under 35 U.S.C. 122(b). Therefore, this application is examined under 35 U.S.C. 102(e) prior to the amendment by the AIPA (pre-AIPA 35 U.S.C. 102(e)).

3. Claims 1 – 3, 11 – 14, 16 – 18, 20 – 22, and 24 – 25 are rejected under 35 U.S.C. 102(e) as being anticipated by **Bottum U.S. Patent 6,014,569** (Bottum).

As pertaining to **claim 1**, Bottum describes a system for communicating selected information to an electronic device (see Bottum abstract), the system comprising:

a digital engine operable to maintain data associated with selected audio information (see Bottum fig. 1 item 104 col. 2 lines 63 – 64); and

a communication engine communicatively coupled to the digital engine, the communication engine operable to initiate wireless communication of the data to the electronic device (see Bottum fig. 1 items 110 and 120 and col. 2 line 63 – col. 3 line 20).

As pertaining to **claim 2**, Bottum's system further comprises an interface operably coupled to the digital engine, the interface operable to provide available information to a user of a communication network (see Bottum fig. 1 items 110 and 120 and col. 2 line 63 – col. 3 line 20), and to receive an input from the user identifying the selected information (see Bottum col.3 lines 54 – 67).

As pertaining to **claim 3**, Bottum's interface operates in a browsing environment (see Bottum col. 3 lines 60 – 67, Bottum describes that the user is capable of requesting a menu of available audio options i.e. browsing) and the wireless communication operates outside the browsing environment (see Bottum fig. 1 items 110 and 120 and col. 2 line 63 – col. 3 line 20, Bottum describes nothing in regards to browsing in regards to the wireless communications).

As pertaining to **claim 11**, Bottum describes a method for communicating selected audio information to an electronic device (see Bottum abstract), the method comprising:

maintaining data associated with the selected audio information using a digital engine (see Bottum fig. 1 item 104 col. 2 lines 63 – 64); and

Application/Control Number: 09/537,812
Art Unit: 2684

initiating wireless communication of the data to the electronic device (see Bottum fig. 1 items 110 and 120 and col. 2 line 63 – col. 3 line 20).

As pertaining to **claim 12**, Bottum's method of further comprises:

presenting information associated with audio information within an interface associated with a communication network environment (see Bottum col. 3 lines 60 – 67, Bottum describes that the user is capable of requesting a menu of available audio options i.e. browsing); and receiving an input from a user identifying the selected information (see Bottum col. 4 lines 1 – 16).

As pertaining to **claim 13**, Bottum's method further comprises:

presenting information associated with the electronic device; and receiving an input from a user identifying the electronic device (see Bottum col. 3 line 54 – col. 4 line 16).

As pertaining to **claim 14**, the interface in Bottum's method operates in a browsing environment (see Bottum col. 3 lines 60 – 67, Bottum describes that the user is capable of requesting a menu of available audio options i.e. browsing) and the wireless communication operates outside the browsing environment (see Bottum fig. 1 items 110 and 120 and col. 2 line 63 – col. 3 line 20, Bottum describes nothing in regards to browsing in regards to the wireless communications).

As pertaining to claim 16, Bottum describes an electronic device for receiving selected audio information via wireless communication (see Bottum abstract), the device comprising:

a communication module operable to receive wireless communication of the selected audio information (see Bottum col. 2 lines 59 and 60);

a storage medium operably coupled to the communication module, the storage medium operable to store the selected audio information (see Bottum col. 7 lines 33 – 48); and

a processor module coupled to the communication module, the processor module operable to process the received selected audio information (see Bottum col. 3 lines 15 – 32, the laptops obviously contain both processing and memory capabilities that may be used with the receiver).

As pertaining to **claim 17**, the communication device in Bottum's communication module can comprise a cellular modem (see Bottum col. 3 lines 9 – 12).

As pertaining to **claim 18**, Bottum's device could be a handheld computing device (see Bottum fig. 2, and col. 3 lines 20 – 32, a laptop is also considered a hand-held device).

As pertaining to **claim 20**, Bottum's device further comprises software for processing the selected information (see Bottum col. 3 lines 26 – 30).

As pertaining to **claim 21**, the communications module in Bottum's device is operable to scan frequencies (see Bottum col. 13 – 16).

As pertaining to **claim 22**, Bottum's device further comprises a display operable to display a user interface (see col. 3 lines 17 – 19, obviously if it is a laptop it has a display, and fig. 2 item 232, the alternative embodiment also includes a display).

As pertaining to **claim 24**, Bottum describes a method for communicating selected audio information to an electronic device (see Bottum abstract), the method comprising:

presenting information associated with audio information within an interface associated with a communication network (see Bottum col. 4 lines 1 – 16);

receiving an input from a user identifying the selected information (see Bottum col. 4 lines 6 – 10);

maintaining data associated with the selected audio information using digital engine (see Bottum col. 4 line 35 – 48); and

initiating wireless communication of the data to the electronic device (see Bottum col. 4 lines 44 – 48 and fig. 1 items 110 and 120 and col. 2 line 63 – col. 3 line 20).

As pertaining to **claim 25**, In Bottum's method the interface operates in a browsing environment (see Bottum col. 3 lines 60 – 67, Bottum describes that the user is capable of requesting a menu of available audio options i.e. browsing) and the wireless communication operates outside the browsing environment (see Bottum fig. 1 items 110 and 120 and col. 2 line 63 – col. 3 line 20, Bottum describes nothing in regards to browsing in regards to the wireless communications).

Claim Rejections - 35 USC § 103

The following is a quotation of 35 U.S.C. 103(a) which forms the basis for all obviousness rejections set forth in this Office action:

(a) A patent may not be obtained though the invention is not identically disclosed or described as set forth in section 102 of this title, if the differences between the subject matter sought to be patented and the prior art are such that the subject matter as a whole would have been obvious at the time the invention was made to a person having ordinary skill in the art to which said subject matter pertains. Patentability shall not be negated by the manner in which the invention was made.

4. Claims 4 – 10, 15, 19, 23 are rejected under 35 U.S.C. 103(a) as being unpatentable over Bottum.

As pertaining to **claims 4 – 10, 15, and 23** Bottum teaches that the audio data is retrieved by a PDA/ laptop, or Internet radio via a wireless link between the mobile station and the wireless service provider, and Bottum describes that that service could be various different types of wireless service an equipment (see Bottum fig. 1 items 110 and 120 and col. 2 line 63 – col. 3 line 31). Bottum however, does not disclose all possible wireless methods that could be used to transmit the data from the radio tower to the mobile device. It would have been obvious to one of ordinary skill in the art at the time of the invention to use the transmission method that would best fit the design of the system. Some of the transmission methods available at the time of the invention included cellular (which typically used CDMA as a method of transmission), global system for mobile communications (which is operated between 1.7 and 2.0 GHz), or a high-speed low-power microwave wireless link like Bluetooth, which operates around 2.4 GHz. The use of any of these protocols at the time of the invention would have been obvious to one of ordinary skill in the art based on the design choice of the system designer.

As pertaining to **claim 19**, Bottum's device describes that it is possible to use a laptop with a cellular modem to receive the requested audio signal (see Bottum col. 3 lines 15 – 20), however Bottum does not disclose specifically that a PDA may be used to download the digital audio data. It would have been obvious to one of ordinary skill in the art at the time of the invention to know that a PDA possessed the same basic functionalities as a laptop computer and that given a users specific needs they could have used a PDA with a cellular modem to download and process the digital music in a similar manner as would have been accomplished in a laptop computer. The smaller PDA would have allowed the user to be significantly more mobile and to take the device places that a laptop may have been an inconvenience.

Conclusion

The prior art made of record and not relied upon is considered pertinent to applicant's disclosure.

B. Boys U.S. Patent 6,314,094 describes a mobile wireless Internet portable radio.

C. Bottum U.S. Patent 6,014,569 describes a mobile interactive radio.

D. Kato et al. U.S. Patent 6,088,730 teaches methods and apparatus for downloading data between an information processing device and an external device via a wireless communications technique.

E. Ito U.S. Patent 6,236,832 describes a method for transmitting music-related information over a mobile phone network to a requesting user.

Application/Control Number: 09/537,812
Art Unit: 2684

F. Goodman U.S. Patent 5,594,779 describes a mobile audio program selection system using a public switched telephone network.

G. Farris et al. U.S. Patent 6,167,253 describes a mobile data/message/electronic mail download system utilizing network-centric protocol such as java.

H. Indekeu et al. U.S. Patent 5,694,120 describes a method for selecting information services from a menu in selective call transceivers.

I. Farris et al. U.S. Patent 6,029,064 teaches a mobile audio program selection system using public switched telephone network.

J. Walsh et al. U.S. Patent 6,144,848 describes a handheld remote computer control and methods for secured interactive real-time telecommunications.

Any inquiry concerning this communication or earlier communications from the examiner should be directed to Andrew T Harry whose telephone number is 703-305-4749. The examiner can normally be reached on M-F 8:30 - 5:00.

If attempts to reach the examiner by telephone are unsuccessful, the examiner's supervisor, Daniel Hunter can be reached on 703-308-6732. The fax phone numbers for the organization where this application or proceeding is assigned are 703-872-9314 for regular communications and 703-872-9314 for After Final communications.

Any inquiry of a general nature or relating to the status of this application or proceeding should be directed to the receptionist whose telephone number is 703-305-4700.

Application/Control Number: 09/537,812

Art Unit: 2684

ATH
July 14, 2002



DANIEL HUNTER
SUPERVISORY PATENT EXAMINER
TECHNOLOGY CENTER 2600

Notice of References Cited	Application/Control No. 09/537,812	Applicant(s)/Patent Under Reexamination WHITE ET AL.	
	Examiner Andrew T Harry	Art Unit 2684	Page 1 of 1

U.S. PATENT DOCUMENTS

*	Document Number Country Code-Number-Kind Code	Date MM-YYYY	Name	Classification
A	US-6,418,138	07-2002	Cerf et al.	370/352
B	US-6,314,094 ✓	11-2001	Boys, Donald Robert Martin	370/352
C	US-6,014,569 ✓	01-2000	Bottum, Joshua	370/913
D	US-6,088,730 ✓	07-2000	Kato et al.	455/556
E	US-6,236,832 ✓	05-2001	Ito, Seigo	455/3.06
F	US-5,594,779 ✓	01-1997	Goodman, William	455/3.04
G	US-6,167,253 ✓	12-2000	Farris et al.	455/412
H	US-5,694,120 ✓	12-1997	Indekeu et al.	340/7.23
I	US-6,029,064 ✓	02-2000	Farris et al.	455/412
J	US-6,144,848 ✓	11-2000	Walsh et al.	235/379
K	US-			
L	US-			
M	US-			

FOREIGN PATENT DOCUMENTS

*	Document Number Country Code-Number-Kind Code	Date MM-YYYY	Country	Name	Classification
N					
O					
P					
Q					
R					
S					
T					

NON-PATENT DOCUMENTS

*	Include as applicable: Author, Title Date, Publisher, Edition or Volume, Pertinent Pages)
U	
V	
W	
X	

*A copy of this reference is not being furnished with this Office action. (See MPEP § 707.05(a).)
Dates in MM-YYYY format are publication dates. Classifications may be US or foreign.

L Number	Hits	Search Text	DB	Time stamp
1	90	455/\$.ccls. and @ad<20000328 and radio and audio and internet and broadcast and (select or selectively) and memory	USPAT; US-PGPUB; EPO; JPO; DERWENT; IBM_TDB	2002/07/11 10:20
2	9	455/412.ccls. and @ad<20000328 and radio and audio and internet and broadcast and (select or selectively) and memory	USPAT; US-PGPUB; EPO; JPO; DERWENT; IBM_TDB	2002/07/11 10:18
3	75	455/\$.ccls. and @ad<20000328 and radio and audio and internet and broadcast and (select or selectively) and memory and (store or storage)	USPAT; US-PGPUB; EPO; JPO; DERWENT; IBM_TDB	2002/07/11 10:20
-	116	455/414.ccls. and @ad<20000328 and audio	USPAT; US-PGPUB; EPO; JPO; DERWENT; IBM_TDB	2002/07/08 11:39
-	89	455/414.ccls. and @ad<20000328 and audio and digital	USPAT; US-PGPUB; EPO; JPO; DERWENT; IBM_TDB	2002/07/08 11:48
-	11	455/414.ccls. and @ad<20000328 and audio and digital and music	USPAT; US-PGPUB; EPO; JPO; DERWENT; IBM_TDB	2002/07/08 11:17
-	5	("5694120" "5694455" "5732324" "6014569" "6029064").PN.	USPAT	2002/07/08 11:29
-	5	("5694120" "5694455" "5732324" "6014569" "6029064").PN.	USPAT	2002/07/08 11:31
-	0	6236832.URPN.	USPAT	2002/07/08 11:31
-	60	("4124773" "4481382" "4577067" "4599490" "4750198" "4754495" "4799253" "4812843" "4849811" "4893327" "4905301" "4922518" "4932046" "4954958" "4972455" "5008925" "5010399" "5020091" "5020092" "5020093" "5105197" "5111534" "5119397" "5119502" "5121126" "5131020" "5148471" "5177780" "5206641" "5218629" "5222120" "5243640" "5247347" "5247698" "5251249" "5257400" "5307400" "5313515" "5319641" "5329578" "5353287" "5353331" "5353352" "5369681" "5371898" "5418784" "5436960" "5440336" "5444768" "5457732" "5487101" "5506887" "5559860" "5594779" "5692032" "5694455" "5727159" "5745551" "5802299" "5841979").PN.	USPAT USPAT	2002/07/08 11:31
-	2	6167253.URPN.	USPAT	2002/07/08 11:34
-	3	6144848.URPN.	USPAT	2002/07/08 11:35
-	19	("4471218" "4516016" "4569421" "4797920" "4857716" "4947028" "4961220" "4978305" "4988849" "5109222" "5204768" "5221838" "5324922" "5340966" "5347646" "5365050" "5365577" "5465291" "5483052").PN.	USPAT	2002/07/08 11:35
-	6	455/\$.ccls. and @ad<20000328 and ("internet radio")	USPAT; US-PGPUB; EPO; JPO; DERWENT; IBM_TDB	2002/07/08 11:47

-	269	455/\$.ccls. and @ad<20000328 and radio and audio and internet	USPAT; US-PGPUB; EPO; JPO; DERWENT; IBM_TDB	2002/07/08 11:48
-	91	455/556.ccls. and @ad<20000328 and audio and digital	USPAT; US-PGPUB; EPO; JPO; DERWENT; IBM_TDB	2002/07/08 11:48
-	139	455/\$.ccls. and @ad<20000328 and radio and audio and internet and broadcast	USPAT; US-PGPUB; EPO; JPO; DERWENT; IBM_TDB	2002/07/10 09:05
-	109	455/\$.ccls. and @ad<20000328 and radio and audio and internet and broadcast and (select or selectively)	USPAT; US-PGPUB; EPO; JPO; DERWENT; IBM_TDB	2002/07/11 10:17
-	1	6397075.pn.	USPAT; US-PGPUB; EPO; JPO; DERWENT; IBM_TDB	2002/07/08 18:21
-	0	6397075.URPN.	USPAT	2002/07/08 18:22
-	54	455/\$.ccls. and @ad<20000328 and audio and internet and ("PDA" or "personal digital assistant")	USPAT; US-PGPUB; EPO; JPO; DERWENT; IBM_TDB	2002/07/10 09:06

3-29-00

A

JC695 U.S. PTO
03/28/00

ATTORNEY DOCKET NO.
111111.1111

PATENT APPLICATION

APPLICATION FOR U.S. PATENT UNDER 37 C.F.R. § 1.53(b)
TRANSMITTAL FORM

JC564 U.S. PTO
09/537812
03/28/00

Box Patent Application
ASSISTANT COMMISSIONER FOR PATENTS
Washington, D.C. 20231

09537812-032800

Sir:

Transmitted herewith for filing is the patent application
of:

Inventors or Application Identifier: Russell W. White, et al.

Entitled: **SYSTEM AND METHOD FOR COMMUNICATING
SELECTED INFORMATION TO AN ELECTRONIC DEVICE**

Enclosed are: X Specification (50 pages)
 X Drawing(s) (9 Sheets Informal)

X Signed Declaration.

Information Disclosure Statement (IDS) PTO-1449 with copies
of references cited.

X Certificate of Mailing

X Return Receipt Postcard

An Assignment of the invention to _____ is attached.
A cover sheet in compliance with 37 C.F.R. §§ 3.28 and 3.31 is
included with the Assignment recordation fee of \$40.00 pursuant
to 37 C.F.R. § 1.21(h).

Verified Statement Claiming Small Entity Status - Independent
Inventors is enclosed.

AUS01:201780.1

Attorney's Docket:
111111.1111
Page 2

PATENT APPLICATION

FEE CALCULATION					FEE
			Number Extra	Rate	Basic Fee
	Number				\$ 345.00
Total Claims:	25	- 20 =	5	X \$9 =	\$ 45.00
Independent Claims	4	- 3 =	1	X \$39 =	\$ 39.00
TOTAL FILING FEE =					\$ 429.00

Enclosed is a check in the amount of \$429.00 to satisfy filing fee requirements under 37 C.F.R. § 1.16.

Respectfully submitted,

Kevin R. Imes
Reg. No. 44,795

Date: March 28, 2000

Correspondence Address:
Russell W. White
10704 Redmond
Austin, Texas 78739
(512) 301-5518

AUS01:201780.1

Applicant or Patentee: Russell W. White, et. al.
Serial or Patent No:
Filed or Issued: March 28, 2000
Title: **System and Method for Communicating Selected Information to an Electronic Device**

Attorney's
Docket No. 111111.1111

VERIFIED STATEMENT (DECLARATION) CLAIMING SMALL ENTITY STATUS
(37 CFR 1.9(f) and 1.27(b)) -- INDEPENDENT INVENTOR

As below named inventor, I hereby declare that I qualify as an independent inventor as defined in 37 CFR 1.9(c) for purposes of paying reduced fees to the Patent and Trademark Office regarding the invention entitled .

the specification filed herewith.
 application serial number _____, filed _____
 patent number _____, issued _____.

I have not assigned, granted, conveyed or licensed and am under no obligation under contract or law to assign, grant, convey or license, any rights in the invention to any person who would not qualify as an independent inventor under 37 CFR 1.9(c) if that person had made the invention, or to any concern which would not qualify as a small business concern under 37 CFR 1.9(d) or a nonprofit organization under 37 CFR 1.9(e).

Each person, concern or organization to which I have assigned, granted, conveyed, or licensed or am under an obligation under contract or law to assign, grant, convey, or license any rights in the invention is listed below.*

No such person, concern, or organization
 Persons, concerns or organizations listed below*

*NOTE: Separate verified statements are required from each named person, concern or organization having rights to the invention averring to their status as small entities. (37 CFR 1.27)

NAME: Russell W. White
ADDRESS: 10704 Redmond
Austin, Texas 78739

INDIVIDUAL SMALL BUSINESS CONCERN NONPROFIT ORGANIZATION

NAME: Kevin R. Imes
ADDRESS: P.O. Box 208
Pflugerville, Texas 78691-0208

INDIVIDUAL SMALL BUSINESS CONCERN NONPROFIT ORGANIZATION

NAME:
ADDRESS:

INDIVIDUAL SMALL BUSINESS CONCERN NONPROFIT ORGANIZATION

NAME:
ADDRESS:

INDIVIDUAL SMALL BUSINESS CONCERN NONPROFIT ORGANIZATION

I acknowledge the duty to file, in this application or patent, notification of any change in status resulting in loss of entitlement to small entity status prior to paying, or at the time of paying, the earliest of the issue fee or any maintenance fee due after the date on which status as a small entity is no longer appropriate. (37 CFR 1.28(b)).

I hereby declare that all statements made herein of my own knowledge are true and that all statements made on information and belief are believed to be true; and further that these statements were made with the knowledge that willful false statements and the like so made are punishable by fine or imprisonment, or both, under section 1001 of Title 18 of the United States Code, and that such willful false statements may jeopardize the validity of the application, any patent issuing thereon, or any patent to which this verified statement is directed.

Russell W. White
NAME OF INVENTOR

Signature of Inventor

3/28/00
Date

Kevin R. Imes
NAME OF INVENTOR

Signature of Inventor

March 28, 2000
Date

BACKGROUND OF THE INVENTION

The first commercial radio stations in the United States began operation around 1920. Today, there may be as many as 12,000 radio stations in the United States programming in several distinct formats. When broadcasting their respective signals, these radio stations often use an analog signal, which may be modulated based on frequency or amplitude. Frequency modulated (FM) radio appears to be the dominant entertainment medium while amplitude modulated (AM) radio seems to be a popular outlet for news and information.

Unfortunately, analog radio may be unable to provide the sound quality and consistency that radio listeners desire. As such, several broadcasting related companies have begun to consider a movement to digital radio. Unlike analog radio reception, digital radio reception may be able to provide compact disk (CD) quality sound while remaining virtually immune to interference. Being immune to interference may result in reducing static growls or 'multipath' echoes, echoes caused by signal reflections off buildings or topographical features.

Some countries, like Canada and many European countries, may choose to have digital radio operate in a single digital radio band such as the L-band between 1452-1492 megahertz (MHz). This band would allow the reception of both terrestrially and satellite-originated signals. By comparison, FM radio typically operates between 88 and 108 MHz while AM radio typically operates between 0.525 and 1.705 MHz. Neither of these bands allows for easy transmission via satellite.

Canada proposed using the L-Band for digital radio as early as 1992. Several countries throughout the world

00550-72550

SUMMARY OF THE INVENTION

In accordance with teachings of the present disclosure, a system and method for communicating selected information to an electronic device are disclosed that provide significant advantages over prior developed systems. The disclosed embodiments allow a radio listener to create a personal playlist and to listen to this playlist in a wireless atmosphere while enjoying CD quality sound.

According to one aspect of the present disclosure, a system incorporating teachings of the present invention may include a digital engine operable to maintain data representing the selected information in a digital format. In some embodiments, the digital engine may be communicatively coupled to a graphical user interface that allows a user to identify the selected information. The system may also include a communication engine communicatively coupled to the digital engine, the communication engine may be operable to wirelessly communicate the data representing the selected information to an electronic device.

The wireless communication may involve communicating via a cellular communications network. The cellular communications network may be, for example, the global system for mobile communications network (GSM), which may operate around 1.8 GHz or 1.9 GHz. The cellular communications network may also involve, for example, the code-division multiple access network (CDMA). In some embodiments, the wireless communication may involve communicating via a high-speed, low-power microwave wireless link. For example, the wireless link may

include a Bluetooth link, which may operate around 2.4 GHz.

According to another aspect of the present invention, a system for communicating selected information to an electronic device is disclosed. The system includes a digital engine operable to maintain data associated with selected audio information and a communication engine communicatively coupled to the digital engine, the communication engine operable to initiate wireless communication of the data to the electronic device.

According to another aspect of the present invention, a method for communicating selected audio information to an electronic device is provided. The method includes maintaining data associated with the selected audio information using a digital engine, and initiating wireless communication of the data to the electronic device.

According to another aspect of the present invention, an electronic device for receiving selected audio information via wireless communication is provided. The device includes a communication module operable to receive wireless communication of the selected audio information, a storage medium operably coupled to the communication module, the storage medium operable to store the selected audio information, and a processor module coupled to the communication module, the processor module operable to process the received selected audio information.

According to another aspect of the present invention, a method for communicating selected audio information to an electronic device is provided. The

BRIEF DESCRIPTION OF THE DRAWINGS

A more complete understanding of the present
embodiments and advantages thereof may be acquired by
referring to the following description taken in
5 conjunction with the accompanying drawings, in which like
reference numbers indicate like features, and wherein:

FIGURE 1 depicts a general system for wirelessly
communicating selective information to an electronic
device in accordance with one aspect of the present
10 invention;

FIGURE 2 illustrates a block diagram of a method of
wirelessly communicating selected information to an
electronic device;

FIGURE 3 illustrates an electronic device operable
15 to receive selected audio information in accordance with
the teachings of the present invention;

FIGURE 4 illustrates a graphical user interface
(GUI) for displaying selectable audio information
according to one aspect of the present invention;

FIGURE 5A illustrates a portable radio system having
20 a mount for an electronic device according to one
embodiment of the present invention;

FIGURE 5B illustrates automobile console having a
mount for coupling an electronic device according to one
25 aspect of the present invention;

FIGURE 6 illustrates a block diagram of a system for
communicating voice mail messages using email according
to one embodiment of the present invention;

FIGURE 7 illustrates a flow chart for providing
30 voice email messages according to one embodiment of the
present invention;

DETAILED DESCRIPTION OF THE INVENTION

The conceptual groundwork for the present invention includes wirelessly communicating selective information to an electronic device. According to one aspect, a user
5 may interact with the Internet to select information, such as audio information, and wirelessly communicate the selected information to an electronic device. The electronic device receives the information via a wireless communications network and processes the information
10 accordingly. In a particularized form, a user may select information from an Internet website operable to allow selectivity of audio information such a songs, on-line radio stations, on-line broadcasts, streaming audio, or other selectable information. Upon selecting the audio
15 information, information or data associated with the selected audio information is wirelessly communicated to an electronic device. The electronic device may then be used to process the selected audio information. In this manner, a user may receive selective audio information
20 via a wireless electronic device.

In one form, the electronic device may be operable to communicate with an individual's automobile audio system. A user may select audio information utilizing a personal computer with access to a website operable to
25 display selectable audio information. The selected audio information may then be wirelessly communicated to the electronic device associated with an automobile's audio system. Therefore, upon receiving the selected audio information, a user may access and play the received
30 audio information utilizing the electronic device in association with the automobiles audio system.

The present invention is not limited to communicating only audio information. One skilled in the art can appreciate that other types of information, such as video, textual, etc. may be communicated utilizing the systems and methods disclosed herein without departing from the spirit and scope of the present invention. Additionally, it will be understood that information may be formatted in a plurality of ways at different phases of communication without losing the underlying content of the selected information. For example, an audio file may be formatted, segmented, compressed, modified, etc. for the purpose of providing or communicating the audio invention. Therefore, the term 'audio information' or 'information' is used in a general sense to relate to audio information in all phases of communication.

FIGURE 1 depicts a general system for wirelessly communicating selective information to an electronic device in accordance with one aspect of the present invention. The system, illustrated generally at 100, includes a digital engine 101 coupled to a communications engine 102. Communications engine 102 is remotely coupled to an electronic device 103. Digital engine 101 may be directly or indirectly coupled to storage device 105 operable to store information.

Digital engine 101 maintains information or data associated with selected information in a digital format. The information may be stored within storage device 105 or other storage devices operable to maintain data or information associated with the selected information. Communications engine 102 is communicatively coupled to digital engine 101 and operable to wirelessly communicate the selected information to electronic device 103.

During operation, audio information may be selected by a user utilizing a personal computer or other devices operable to communicate with an information network. Digital engine 102 is operable to maintain information associated with the selected audio information. For example, the information could be several songs or titles configured as an audio file and formatted in a digital format such as an MP3 file, wave file, etc. The maintained information may also be a reference to a network location where an audio file may be stored, a network location where a network broadcast of audio information may be located, etc. or other network locations having information associated with the selected audio information. Therefore, digital engine 101 may maintain a plurality of different types of information or data associated with the selected audio information. System 100, utilizing communication engine 102, may wirelessly communicate data or information associated with the selected audio information to electronic device 105 thereby providing wireless communication of selected information to an electronic device operable to receive wireless communications.

In one embodiment, digital engine 101 may be used in association with an Internet website configured to provide access to selectable information. The Internet website operably associated with digital engine 101 allows a user to select information to be wirelessly communicated to electronic device 105 utilizing a network environment. The Internet website may include several different types of information related to audio information. FIGURE 4, described in greater detail below, illustrates one embodiment of providing an

Internet website for displaying selectable audio information. For example, the Internet website may include music and/or artist search engines, playlists, top 10 charts, artists by genre, and other information associated with audio information. A user may select information associated with the audio information and digital engine 101 can maintain the information or data associated with the selected information in a digital format. Communications engine 102 coupled to digital engine 101 may wirelessly communicate data associated with the selected audio information to electronic device 103. Therefore, a user may access and select audio information via an Internet website and wirelessly communicate the data to an electronic device. As such, system 100 advantageously allows for wireless communication of selected audio information to electronic devices that may be remotely located from a conventional terrestrial communication network.

Electronic device 105 may be configured in a plurality of ways for receiving wireless communication of selected audio information. In one embodiment, electronic device 105 may be operable as a component configured to receive a cellular signal comprising the selected information communicated by the communication engine. For example, a device having a cellular modem may be operable to receive the information at specified intervals. Upon receiving the information the electronic device may process the received information. Electronic devices are described in more detail below and may include a network radio, a modular device, an audio system, a personal digital assistant (PDA), a cellular phone, or other electronic devices operable to receive

information wirelessly communicated by communication engine 102.

Communications engine 102 may be operable to wirelessly communicate selected information to electronic device 103 in a plurality of ways. The present invention advantageously allows for several different embodiments of wirelessly communicating selected audio information to electronic device 103 and is not limited to any specific configuration described below.

Several different types or combinations of wireless communication may be realized by the present invention. Communications engine 102 may be operable to wirelessly communicate the selected information from a information network, such as the Internet, to an electronic device operable to receive wireless communications. In one embodiment, communications engine 102 may comprise a conduit to interface information with a wireless communication network. The conduit may configure the information located within the information network into a format operable to be transmitted via wireless communication. For example, a wireless device may be operable to receive packets of information having a specific size and in a specific format. In such an embodiment, communications engine 102 could format the information into a desirable format for wirelessly communicating the information to electronic device 103.

Several types of wireless communication may be used by communications engine 102 to communicate the selected information to an electronic device. Communications networks such as GSM, Digital Satellite communication, SB, Radio bands, DRC, SuperDRC or other systems or types of transmission such as TDMA, CDMA, spread spectrum, etc.

or frequencies such as between about 1.7 GHz and 2.0 GHz may be realized by the present invention for communicating information or data representing the selected audio information to electronic device 103.

5 In one embodiment, the selective information may be communicated using a digital broadcast signal. Digital broadcast includes providing information via a signal such as AM, FM, and the like. Digital information may be included or encoded as a sub-carrier within the broadcast
10 signal and received by electronic device 103. A digital sub-carrier may include a selective bandwidth of frequencies for a specific radio station (i.e. 6 MHz for FM). The selective information may be wirelessly
15 communicated to electronic device 103 utilizing a communication engine 102 operable to communicate the selective information via a digital FM signal. In this manner, selective information may be communicated within digital FM sub-carriers to an electronic device operable to receive the information. For example, a user may
20 subscribe to communicate the information via an FM sub-carrier and receive the selective data through wireless communication via a specified FM sub-carrier.

 In one embodiment, the selected information may be formatted and transmitted to achieve a desirable
25 transmission rate. For example, conventional systems may transmit information at a speed of 10 kilobits per second. Therefore, for 1 megabyte of information to be communicated to an electronic device, a transmission time of approximately 800 seconds may be required. The
30 present invention may allow for a relative increase in transmission speed by removing the requirement that information be communicated asynchronously to an

5 electronic device. For example, conventional wireless communication utilize a specified frequency to communicate information in two directions (i.e. cellular phones). As such, information is communicated across a channel in an asynchronous manner to provide a continuous audio signal to the recipient. The present invention advantageously allows for signals to be transmitted to an electronic device in a less than asynchronous manner. For example, if a user selected a song to be wirelessly communicated to an electronic device, system 100 could communicate the information in a less than asynchronous manner allowing the selected information to be transmitted efficiently thereby decreasing the overall download time for the selected audio information.

10
15 In one embodiment, the selected information may be compressed and transmitted across the same frequency but at different phases thereby allowing plural signals having different phases to be wirelessly communicated to an electronic device. Therefore, the electronic device may be operable to receive multiple phased signals and process the selective information accordingly.

20
25 In one embodiment, the information may be wirelessly communicated at a relatively slow transmission rate. For example, a user may schedule when the selected audio information may be used by electronic device 103. The user may select several different audio tracks or songs to be transmitted to an electronic device associated with the user's vehicle such that the user can listen to the user selected audio information during the drive home at the end of a work day. Therefore, it may be desirable to utilize a slower transfer speed due to the extended amount of time available prior to actual use of the

30

selected audio information. In this manner, communications networks having less or slower transfer rates may be used to wirelessly communicate the selected audio information to the electronic device.

5 In another embodiment, high speed wireless communication networks may be used to communicate the selected audio information. For example, a user may want to listen to an Internet broadcast of an Internet radio station. Therefore, high speed communication may be
10 required to wirelessly communicate or stream the selected audio information to an electronic device.

In another embodiment, a hybrid of wireless communication rates may be deployed depending on the requirements of the selected audio information and/or the
15 electronic device. For example, the selected audio information may first be transmitted to the electronic device via high speed communication until enough information has been wirelessly communicated and buffered into a memory device operably associated with the
20 electronic device. Upon communicating a certain percentage of the selected audio information, slower communication speeds may then be used to communicate additional selected audio information.

Therefore, system 100 may be configured in a
25 plurality of ways to communicate selected information to electronic device 103. Digital engine 101 may be used to maintain data or information associated with the selected information and communication engine 102, communicatively coupled to digital engine 101, may wirelessly
30 communicate selected information to electronic device 103.

FIGURE 2 illustrates a block diagram of a method of wirelessly communicating selected information to an electronic device. The method may be used in association with the system illustrated in FIGURE 1 or other systems operable to utilize the method of FIGURE 2.

The method begins generally at step 200. At step 201 selectable audio information may be accessed utilizing a network communications device. For example, selectable audio information may be displayed at an Internet website accessible by a personal computer. In another embodiment, the selectable information may be accessed utilizing a wireless communications device such as, a cellular phone, a PDA device, or other devices operable to provide access to the selectable audio information. Upon accessing the selectable information, the method proceeds to step 202 where a user can identify or select audio information to be wirelessly communicated to an electronic device. For example, a user may select a entire album to be wirelessly communicated to a PDA device.

Upon the user selecting the audio information, the method proceeds to step 203 where the method maintains information associated with the selected information. In one embodiment, the information may be an audio file, such as a wave file, and MP3 file, etc. representative of the selected audio information. In another embodiment, a network location that comprises a file representing the selected information may be maintained. Another example may include a network location of a network broadcast of audio information. Therefore, the method at step 203 may maintain several different types of information associated with the selected audio information.

Upon maintaining information or data associated with the selected information, the method proceeds to step 204 where the method wirelessly communicates information associated with the selected information to an electronic device. For example, if an audio file associated with the selected audio information was maintained, the method would communicate the audio file to the electronic device. In another embodiment, a link or network address broadcasting the selected audio information may be accessed and, at step 204, wirelessly communicated to an electronic device. In another embodiment, a combination of different types of audio information may be wirelessly communicated to an electronic device. Upon transmitting the selected audio information, the method proceeds to step 205 where the method ends.

Selected audio information may be communicated in a plurality of ways as described above including communicating via a cellular communications network to an electronic device operable to receive cellularly communicated signals. For example, the information may be selected from a website operable to display selectable information. Upon selecting the audio information, a data file representing the selected audio information may be wirelessly communicated to an electronic device thereby allowing a user to select audio information via the Internet and wirelessly communicate the information to an electronic device. In some embodiments, the wireless communication to an electronic device may occur in an off-line environment. For example, a user may go "off-line" to access a website and select information and then go "off-line" or end the browsing session. The wireless communication may then occur while the user is

off-line thereby removing the confines of using an active or on-line browsing environment (i.e. Internet radio broadcast, streaming audio, etc.) for accessing selected information.

5 Therefore, the method of FIGURE 2 allows for information, such as audio information, to be communicated from a network location such as a web site, to an electronic device via wireless communication. The present invention advantageously allows users to access
10 and download information accessible by a network location to an electronic device operable to receive wireless communications thereby reducing the need for land lines, terrestrial communication networks, etc. for communicating selective information.

15 In one embodiment, the method of FIGURE 2 may be deployed in association with a Internet website operable to display selectable links for downloading information. The information may include audio information such as MP3's, streaming audio, streaming, Internet broadcasts, etc. selectable by a user and operable to be wirelessly
20 communicated to an electronic device. By providing a user with a website of selectable audio information operable to be wireless communicated to an electronic device, a user may customize information communicated to an electronic device. In one embodiment, a user may
25 communicate information to an electronic device that may not be owned by the user. For example the method of FIGURE 2 could be modified to allow a user to wirelessly communicate audio information to a plurality of
30 electronic devices that may or may not be owned by the user.

FIGURE 3 illustrates an electronic device operable to receive selected audio information in accordance with the teachings of the present invention. Electronic device 300 includes a communication module 301 such as a transceiver coupled to storage medium 302 such as a high speed buffer, programmable memory, or other devices operable to store information. Electronic device 300 may also include processor 302 operably associated with communication module 301 and storage medium 302.

Processor 302 may be operable to process wirelessly communicated selected information and in one embodiment may be integrated as part of communication module 301 of storage medium 302. In the same manner, as larger scale integration of electronic devices proliferate, communication module 301, processor 302, and storage medium 303 may be integrated into one communication component or device operable as electronic device 300.

Processor 302 may be operable using software that may be stored within storage medium 302. In one embodiment, software upgrades may be communicated to electronic device 300 via wireless communication allowing for efficient system upgrades for electronic device 300. Storage medium 302 may include one or several different types of storage devices. For example, storage medium 302 may include programmable gate arrays, ROM devices, RAM devices, EEPROMs, minidisks or other memory devices operable to store information.

During use, electronic device 300 receives wireless communications of selective information. The information may be transmitted via a wireless communications network and received by electronic device 300 via transceiver 301. Transceiver 301 may be operable to convert the

received wireless communication signal into a desirable format and store the received information within storage medium 302. The received information may then be processed by electronic device 300.

5 In one embodiment, electronic device 300 may be operable as an audio player configured to play digital representations of music. For example, electronic device 300 may also include an MP3 player operable to process the received information into an audio signal.

10 Therefore, electronic device 300 may be used to receive wirelessly communicated MP3 audio files and play these files using an MP3 player when desired.

15 In another embodiment, electronic device 300 may be configured as a PDA wherein the PDA includes a web browser operable to wirelessly communicate with the Internet. The PDA device may include a user interface allowing a user to select information to be wirelessly communicated to electronic device 300. By providing a website of selectable information, the PDA devices may
20 provide an efficient embodiment for electronic device 300 in that it allows a user to access and select information using a wireless communication network and receive the selected information using the same or different wireless communication network.

25 In yet another embodiment, electronic device 300 may be configured as a component operable to receive selective information via wireless communication and communicate the information to a second electronic device such as an automobile sound system, home stereo, etc.
30 For example, electronic device 300 may utilize transceiver 301 to receive wirelessly communicated information. Electronic device 300 may then be coupled to

an automobile sound system using an interface and
communicate the received information to the automobile
sound system. In this manner, electronic device 300 may
be used to provide the automobile sound system with audio
5 files received via wireless communication.

In another embodiment, electronic device 300 may be
operable to communicate the received audio information to
an audio system via a localized communications signaling
network. One such network may include utilizing
10 'Bluetooth' communication standard used to provide
communication between electronic devices in a proximal
setting.

In one embodiment, electronic device 300 may be
integrated into an audio component such as a radio
15 receiver. Electronic device 300 integrated into an audio
component may be configured to process digital audio
files wirelessly communicated to an audio component.

In another embodiment, electronic device 300 may be
operable to communicate with an analog receiver at a
20 predetermined frequency. For example, a specific
frequency may be selected (i.e. 93.7 MHz) for
communicating the wireless received selected information
from electronic device 300 to a localized audio system.
Electronic device 300 communication of the wirelessly
25 received information allows a conventional receiver to
receive the selected audio information. In one
embodiment, the conventional receiver may be configured
to receive a digital sub-carrier, on-carrier, or other
within a specified frequency. Therefore, electronic
30 device 300 may be operable to locally transmit the signal
at a specific frequency thereby allowing the conventional
receiver to receive the information.

In another embodiment, electronic device 300 may be operable to scan plural bandwidths to receive the selective information. For example, transceiver 301 may be operable to receive selective information across
5 several frequencies and process the received information accordingly.

In another embodiment, electronic device 300 may be operable to scan several frequencies to obtain the desirable information. For example, a user may select
10 several Internet broadcasts comprised of streaming audio information. Therefore, the information may be transmitted across several wireless frequencies receivable by electronic device 300. Electronic device
15 300 may then be operable to allow a user to scan wirelessly communicated Internet broadcast signals thereby providing a user selected virtual broadcast radio network.

In another embodiment, electronic device 300 may include a user interface operable to communicate with a
20 an Internet website operable to display selectable audio information. The Internet website may be configured as a user preferred environment displaying a users selected audio information, Internet broadcast selections, streaming audio selections, etc. With a display device
25 for displaying a Website having selectable information, electronic device 300 may allow a user to select audio information via a user interface and receive the selected information via wireless communication thereby providing a customizable WebRadio device for the user.

In another embodiment, electronic device 300 may be
30 a modular device configured to be coupled to, for example, a portion of a cars interior. For example,

electronic device 300 may be mounted to a portion of a car's console thereby providing a removably coupled electronic device operable to wirelessly receive selected audio information. As a removable device, electronic device 300 may be also be coupled to a home audio system, a portable radio system or other systems thereby providing a versatile electronic device operable to receive wirelessly communicated selected audio information.

In another embodiment, electronic device 300 may be operable as a PDA and/or a cellular phone that may be mounted to an automobile's console. Electronic device 300 may then integrate with a user's automobile to provide an all encompassing communications device. For example, electronic device 300 configured as a PDA and cellular phone may allow for communication with a users email account, voice mail account, the Internet, as well as allowing for the receipt of selected audio information via wireless communication. Electronic device 300 may be operable in a hands-free mode allowing a user to maintain safe driving fundamentals. During use, electronic device 300 may be processing selective audio information for communicating with an automobile audio system and may further be operating to receive incoming cellular calls. Electronic device 300 may be set-up by the user to pause the music being played and allow the received cellular call to be communicated either via an independent speaker or utilizing the automobiles audio system. Additionally, electronic device 300 may be operable to adjust the listening level of an automobiles audio system, play received voice mail messages, allow a user to view the Internet, etc.

In one embodiment, electronic device 300 may be operable as a dual mode electronic device capable of receiving both digital and analog wireless communication signals. In this manner, electronic device may efficiently utilize available bandwidth for receiving selected information from a communications engine. For example, transceiver 301 may be a wireless communications modem operable to receive digital or analog signals.

FIGURE 4 illustrates a graphical user interface (GUI) for displaying selectable audio information according to one aspect of the present invention. The GUI may be operable with a computer system, cellular device, PDA, or other electronic devices or systems operable to display the GUI of FIGURE 4.

The GUI, shown generally at 400, may be displayed using a conventional web browser 402 such as MICROSOFT's INTERNET EXPLORER, a WAP browser, or other browsers operable to display the audio information. Browser 402 includes browser functions, shown collectively at 403, for navigating a network such as the Internet or an intranet. Homepage 401 may be displayed using browser 402 and may include several functions, features, information, etc. related to audio information. Home page 402 may be developed using several different types of programming (i.e. HTML, XML, Java, etc.) used to developing a network location or web-site. The present invention is not limited to any one specific type of software and may be realized in plurality of ways as can be appreciated by those skilled in the art.

Homepage 401 may also include Log-in region 410 allowing a user to log into homepage 401 and display a user preferred environment. For example, a user may want

Radio Dial 412 to appear when a user logs into homepage 401. In another embodiment, a user may want to view a current playlist selected by the user or the status of wirelessly communicated playlist. A user may also
5 provide demographic information allowing advertisers to access the demographic information and provide advertisements based upon the demographic information. For example, an advertiser may want to target Hispanic females in the 21-25 year old age group. Through
10 providing demographic information to advertisers, when a user logs into homepage 401 selective advertising can be "targeted" for a group of users.

Homepage 401 may also include several tabs for efficiently navigating homepage 401. Library tab 405 may
15 be provided to allow a user to browse available audio information that may be presented by title, genre, artist, decade, culture, etc. Store tab 407 may also be provided for locating items available for purchase such as CDs, PDA devices, MP3 players, wireless communication
20 hardware, interfaces, software or other types of products that may be purchased while on-line. Chat tab 408 may also be provided allowing a user to chat with other user's of home page 401. For example, a guest musical artist may be available to chat with visitors of home
25 page 401 via chat page associated with chat tab 408. Home page 401 may also include contest tab 409 for displaying current contests, prizes, and/or winners.

Radio tab 406 may also be provided for displaying audio information. For example, radio tab 406 may
30 display a collective menu 411 of selectable functions or features associated with audio information. Top ten lists may be provided to a user based on several

different billboard polls or genres. A search engine may be provided allowing a user to search for a specific type of audio information such as an artist, song title, genre, Internet radio station, etc. In one embodiment, a user may input the lyrics to a song within the search engine. As such, the search engine may locate several different songs having the desirable lyrics and allow a user to select the search results. A user may also use a select a device feature that allows a user to select a destination device for communicating selected audio information. For example, a user may want to communicate a playlist to several different devices such as a PDA, a home computer system, a work computer system, etc. As such, a user can communicate selective information to several devices without having to download the information separately for each device.

A send a friend link may also be provided allowing a user to send selective audio information to a friend's electronic device. A user may also join a group comprised of individuals that select a certain genre of music to be communicated to the user's electronic device. For example, a user may want to join a group that plays only 50's swing music. As such, the user could communicate the group's selected songs to the user's electronic device. A user may also utilize an email account provided by homepage 401 allowing a user to correspond with others via email. A user may also access a list of guest DJ's that may provide playlists of songs chosen by the guest DJ and selectable by a user.

In one embodiment, a user's radio dial 412 may be provided when a registered user logs into homepage 401. As such, radio dial 412 may include several functional

5 buttons similar to conventional systems such as a volume control and a station control. However, radio dial 412 surpasses the limitations of conventional systems through providing a programmable radio dial of user customized audio information. Radio dial 412 includes several stations that may be programmed using program interface 413. The preset stations may include several different types of user customized preset information such as user selected playlists, internet broadcast stations, top 10
10 lists, group playlists, artist's selected lists, on-line radio station, conventional radio stations, Internet phone, cellular phone, etc. and other functions, features, or information associated with audio information.

15 Radio dial 412 may also be displayed as a separate user interface and in some embodiments, does not require a 'browsing' environment to view radio dial 412. For example, an electronic device, such as a PDA, having a display may graphically present radio dial 412 to a user.
20 One example may be using electronic device in association with an automobile audio system. Electronic device may display radio dial 412 and may allow a user to navigate, modify, select, adjust volume, access daytimer, access phone lists, etc. or perform other functions while the
25 electronic device is used in association with an automobile sound system. Therefore, radio dial 412 may be operable as an application for use with several different types of electronic devices (i.e. computer systems, portable computing devices, cellular phones, etc.) operable to display radio dial 412 and in come
30 embodiments may be wirelessly communicated to an electronic device.

In another embodiment, homepage 401 may allow a user to select when to download the information to an electronic device. For example, a user may want to listen to a certain genre of music at a specific time of day thereby allowing a user to select the information. As such, a user may select a different playlist for every day of the week thereby allowing a user to listen to different songs on different days of the week. The user can further identify when the selected playlist should be available for listening. For example, if a user wanted to listen to "playlist #1" on Monday morning during the drive into work between 8:00 am and 9:00 am, the user would enter the time and the day playlist #1 would be available for listening. In this manner, the playlist may be communicated to the electronic device thereby allowing a user to listen to selective audio information at a desirable time.

FIGURE 5A illustrates a portable radio system having a mount for an electronic device according to one embodiment of the present invention. Portable radio 500 includes a mount 501 operable to receive electronic device 502. Mount 501 may include a connector operable to provide communications and power to electronic device 502. During use, electronic device 502 when mounted within portable radio 500 communicates with portable radio to provide remotely received selective audio information.

In one embodiment, electronic device 502 may include a user interface allowing a user to access the Internet. Therefore, selective audio information located on the Internet may be accessed by the user and remotely

communicated to electronic device 502 coupled to portable radio 500.

In another embodiment, portable radio 500 may include memory operably located within for storing downloaded information. For example, portable radio 500 may include 32 MB of RAM allowing electronic device 502 to receive selective information and download the selective information to memory located within portable radio 500. In this manner, the downloaded music may be operable to be played within portable radio 500 while allowing electronic device to be removed from portable radio 500.

Therefore, portable radio 500 including electronic device 502 allows a user to communicate selected audio information to portable radio 500.

FIGURE 5B illustrates automobile console having a mount for coupling an electronic device according to one aspect of the present invention. Console 510 includes mount 511 operable to receive electronic device 512. Mount 511 may be located in many different locations within an automobile such as coupled to a sun visor, center console, dash board, floor board, etc. Mount 511 allows the user to couple electronic device 512 to the automobile and provide an interface for communication between electronic device 512 and the automobile audio system. Mount 511 may also include a power connection that allows electronic device 512 to use the automobiles power during use. The power connection may also be used in association with a recharging circuit operable to recharge a power supply within the electronic device.

During operation, electronic device 512 coupled to mount 511 may receive selected audio information via

wireless communication and communicate the selective information to the automobile audio system. In one embodiment, the automobile may include memory operable associated with the automobile for storing information. 5 The memory may be used in association with mount 511 and electronic device 512 to store the selected audio information. In this manner, voluminous audio information can be stored within the memory allowing electronic device 512 to receive additional information.

10 In one embodiment, a mount may be provided for a home audio system (not shown) for downloading selected audio information for use with a home audio system. For example, a mount device may be coupled to a home stereo system such that the upon placing an electronic device 15 such as electronic device 500 within the mount, selected audio information may be communicated to the home audio system thereby allowing a home audio system to be used in association with an electronic device.

20 FIGURE 6 illustrates a block diagram of a system for communicating voice mail messages using email according to one embodiment of the present invention. The system, indicated generally at 600, includes email server 601 coupled to a voice mail storage device 602. System 600 further includes a computer system or network terminal 25 603 such as a computer coupled to network 604. System 600 further includes mount 605 for mounting electronic device 606 for hardwire communication of information. Device 606 may also communicate with network 604 using a wirelessly communication network operably associated with 30 network 604 and coupled, for example, via tower 607.

During operation, system 600 communicates voice mail messages to a user utilizing email server 601. For

example, if a user receives a voice mail message, email server 601 would be notified and a voice mail message would be sent to the user's email account in the form of an email message. For example, a voice mail message would be sent to a user's email account within intranet 604 in the form of an audio file as an attachment to the email. Upon receiving the email, a user may click on the audio file representing the voice mail message to hear the message left by a caller.

In one embodiment, a user may be accessing the Internet via a phone line and, as such, be unable to receive notification that a voice mail message has been received. System 600 would receive the voice mail message and send an email comprising the voice mail message to the user email account. In this manner, a user can remain connected to the network and receive voice mail without having to log off or disconnect from the Internet.

In one embodiment, a user may receive the voice mail message via a portable electronic device. For example, a user may be using remote device 605 operable to receive wirelessly communicated information. System 600 would receive the voice mail message and forward the voice mail message to a user's portable electronic device 606. In this manner, a user may be capable of receiving voice emails at remote locations.

In another embodiment, a user may subscribe to use an Internet email account that may be operably associated with system 600. Utilizing an Internet email account may allow a user the flexibility to check voice email messages from any location in the world. For example, a user may access a "Hotmail" email account while traveling

on business in a foreign country. The user, upon gaining access to the "Hotmail" account, would be able to listen to voice mail messages sent to the user via the "Hotmail" email account.

5 Through utilizing an email account to receive voice mail messages, a user may be afforded great flexibility in communicating voice mail messages. For example, a user may be able to forward a voice mail message received in the form of an email to one or a plurality of other email accounts. In this manner, a voice email message may be sent efficiently to other email users. For example, a user may maintain a distribution list of individuals working on a particular project that may have a need to hear certain voice email messages. In this manner, a user may efficiently disseminate information to other individuals while adding additional textual information to the body of the email allowing a user to comment on the original voice email message.

10
15
20 In another embodiment, a user may forward a received voice email message to another account operable to receive forwarded voice email messages. For example, system 600 may be operable to receive an email message having a voice mail message as an attachment. The system would then be operable to forward the voice mail message to specified phone number, separate email account, and/or voice mail account, etc. thereby providing a user flexibility in receiving voice email.

25
30 In one embodiment, a user may utilize an email account to establish an answering service for voice mails. For example, a user's telephone number may be operable with an email account to provide an answering service. A user may record a message for a specified

phone number or extension and, upon receiving an incoming call, the recorded message may be played back to incoming call's initiator. System 600 would then forward the received voice email message via an email account to the user. For example, a user may have an account set up at a home residence for receiving voicemail messages via a user defined email account. The user could then forward all received voice mails from the home account to an email account at a place of work. Therefore, the user may have complete access to received voicemail messages. In the same manner, a user could set up their work phone number to forward an voice email messages to the users home email account thereby allowing a user to receive voice email at a home email account.

Therefore, system 600 may be operable in a plurality of ways to provide email messages comprised of voicemail messages received via a voice mail or email account.

FIGURE 7 illustrates a flow chart for providing voice email messages according to one embodiment of the present invention. The method begins at step 701 where a voice mail message is left for a user. The message could be at a residence, place of business, etc. The method then proceeds to step 702 where the message may be stored as an audio file within a database operable to store a file comprised of the voice mail message. Upon storing the file, the method proceeds to step 703 where an electronic mail message may be generated. The electronic mail message may be addressed to the recipient of the voice mail message. The method then proceeds to step 704 where the audio file representing the voice mail message is attached to the electronic message.

Upon attaching the audio file, the method then proceeds to step 705 where the email message may be sent to the email address. Upon sending the email message the method proceeds to step 706 where the method determines
5 if the email message should be sent to a wireless electronic device. If the message is not to be sent to a wireless device, the method proceeds to step 720 where the method ends. If the message is to be sent to a wireless electronic device, the method proceeds to step
10 707 where a signal may be sent to the wireless electronic device and at step 708 an indication is provided to the electronic device indicating that a voice email message has been received via a user's email account. The method may then proceed to step 709 where the user decides
15 whether or not to listen to the voice email message. If the user decides not to listen to the voice email message, the method may proceed to step 710 where the method ends. If the user decides to listen to the voice email message, the method proceeds to step 711 where a
20 request may be sent by the electronic device requesting the voice email message be forwarded to the user's electronic device. At step 712, the voice email message may be sent to the user's electronic device. Upon forwarding the voicemail message to the user the method
25 may proceed to step 720 where the method ends.

As such, FIGURE 7 depicts one method of providing an email message comprised of a voice mail message. Certainly, other methods may be deployed as advancements in technology are made without departing for the spirit
30 and scope of the present invention.

FIGURE 8 illustrates a flow diagram of a method for providing selected audio information to an electronic

device according to one embodiment of the present invention. The method begins at step 800 where a user accesses a webpage via the Internet. The webpage may be a home page illustrated in FIGURE 4 or other web pages operable to display selectable references to audio information. The method proceeds to step 801 where a user selects desirable audio information. For example, a user may select a single song, a plurality different songs, an entire album, a broadcast station, streaming audio, etc. or other selectable audio information. Upon the user selecting a reference to audio information, the method may proceed to step 802 where a playlist may be created that represents the user's selected audio information. The playlist may be variable in size and comprised of a plurality of different types of available audio information. Upon creating a playlist, the method may proceed to step 803 where information associated with the playlist is obtained. For example, a list of network or URL locations comprised of the desirable audio information may be obtained. In this manner, desirable audio information may be obtained from many different sources such as URLs, network addresses, hard drives, databases comprised of audio information, etc. The sources may be accessed to obtain the selected audio information.

Upon obtaining data associated with the customized playlist, the method may proceed to step 804 where the user is prompted for a destination for the playlist. For example, a user may want to communicate the selected audio information to a remote electronic device, a automobile audio system, a home stereo system, a home computer, an electronic device coupled to a home network

or computer system, etc. or other locations or devices operable to receive the selected audio information. In one embodiment, a user may select a device owned by a friend to accept the selected audio information. For example, a husband may want to send a romantic playlist to his wife on their anniversary. In this situation, the husband would select his wife's electronic device as the receiving device for the selected audio information.

Upon selecting a device, the method proceeds to step 805 where the method determines the destination of the selected audio information. If the information is to be sent to a device requiring wireless communication, the method proceeds to step 806 where the information is formatted for communicating the information to a wireless electronic device. For example, a wireless PDA device may be selected as a destination device for the selected audio information. The PDA device may include an audio player, such as an MP3 player operable to play or execute MP3 audio files. In such an embodiment, the method could format the information such that the information may be wirelessly communicated and subsequently played by the MP3 player.

Upon formatting the information, the method may then proceed to step 807 where the audio information is wirelessly communicated to the selected device. In some embodiments, the device may be operable to receive a limited amount of information based upon storage capacity of the device (i.e., 16 Megabytes). In such a case, the method may divide the information into component parts and periodically communicate the component parts, such as packets, to the electronic device. Upon communicating the audio information, the method may then proceed to

step 808 where the signal may be received by the destination or electronic device. The method may then proceed to step 809 where the method determines if all of the audio information has been received. For example, if 5 16 Mbytes or 32 Mbytes of selected audio information was initially transmitted due to capacity limitations of the selected device, the method may query the selected device to determine if capacity is available. If available memory exists, the method may proceed to step 807 where 10 the method may communicate additional audio information based upon the amount of available memory. The method repeats until all of the selected audio information has been transmitted.

Upon communicating the selected information, the 15 method may proceed to step 810 where the playlist may be executed. For example, a user may select a continuous communication of selected audio information (e.g. several hours of music, Internet broadcast, etc.). As such, the method may continuously play or execute the received 20 audio information. In another embodiment, the method may proceed to step 811 where the method may store or buffer the received information until it is desirable to execute the received selected audio information. As such, upon executing the selected audio information, the method may 25 proceed to step 809 where the method may repeat.

In one embodiment, a user may elect to download a broadcast of an on-line radio station. For example, a user may want to listen to a radio station located in a remote location wherein conventional radio receivers 30 could not receive the desired broadcast. For example, a person living in Houston, Texas may not be able to receive a radio broadcast signal from a radio station in

Seattle, Washington utilizing a conventional radio receiver. In accordance with the teachings of the present invention, a user may select an on-line broadcast or radio station as all or a part of the selected audio information. The user may then receive radio broadcasts without having to use a home computer system or conventional radio receiver.

At step 804, a user may select a device that does not require remote communication of information. For example, a user may elect to communicate the selected audio information to device, such as a personal computer, PDA device, MP3 player, etc. coupled via a network connection to the Internet or an Intranet. The user may receive the selected playlist at the determined device for eventual playing. In one embodiment, a user may select a plurality of devices as destination devices for receiving downloads of the selected audio information. For example, the user may want to download the information to a home stereo system, a PDA device, and an automobile stereo. As such, the selected information may be communicated to more than one destination device. In addition, the format of the download may match or conform to the selected destination device(s).

The present invention may be configured in a plurality of ways to communicate desirable audio information to users by allowing users to select desirable audio information and transmitting the desirable audio information to a specified destination thereby allowing a user to receive on-demand customized audio information. Moreover, the download may occur in an off-line environment, allowing a user to enjoy the

selected audio information accessed on-line without having to be on-line or utilizing a browsing environment.

In one embodiment of the present invention, the method of FIGURE 8 may be modified to allow a user to select a "user group" for receiving customized audio information. For example, a "user group" may include user's that only like to listen to contemporary jazz wherein a user may request a certain song. Therefore, a virtual request line may be created for a specific genre of music allowing "members" to transmit audio information to the "group".

In another embodiment of the present invention, the method may be modified to allow a user to select a specific genre to be transmitted to the users device. For example, a user may elect to have random country and western music transmitted to a destination device. The user could efficiently create a radio station format and have the format received at a destination device.

In a further embodiment, a user may select a group of genres to be downloaded to a desirable device. As such, the method may be modified to allow a user to select several different genres to download random music within the specified genres.

In another embodiment, a user may elect to download the same music as another individual. For example, a user may want to download the same music as their best friend. Therefore the user could elect to download the same music as their friend or group of friends. In another example, a user may want to listen to the same music that an artist listens to on a specific weekday of evening. For example, a user may want to listen to the same music that Barry White listens to on a Saturday

night. Therefore, the user may select "Barry White's" Saturday night playlist and receive the same playlist Barry White receives on Saturday night.

5 In another embodiment, the method of FIGURE 8 may be modified to allow a user to manipulate songs post download. For example, a user may want to store, delete, replay, copy, forward, etc. received audio information. Therefore, the method of FIGURE 4 may be modified such that a user can manipulate or process the received audio
10 information in a plurality of ways.

In one embodiment of the present invention, an on-line radio station may be provided. For example, the radio station may be created for transmitting audio or on-line broadcasts. The on-line broadcaster's or hosts
15 may create their own format for broadcast. For example, an on-line radio station may be provided that transmits only children's songs. Prior to conception of the present invention, conventional radio stations could not afford to transmit music such as children's songs to
20 conventional radio receivers. The present invention, by providing a medium for transmitting selectable audio information, enables the existence of on-line broadcasting with little or no overhead for a host. A user may select an on-line broadcast for on-line or off-
25 line delivery.

In another embodiment, on-line broadcast of audio information representing books or novels may be provided to individuals such as the visually impaired. For example, an on-line broadcast station may provide
30 several hours of audio information broadcast representing books or novels to be broadcast with very little overhead.

FIGURE 9 illustrates an automobile console having a mount for an electronic device according to one embodiment of the present invention. Console 900 includes a conventional audio system 901 comprised of a receiver 902 and CD player 903. Interface 904 may be coupled to audio system 901 via plug 905 and cable 908, which may be coupled to an auxiliary line into audio system 901. Interface 904 may also include contact 906 for contacting electronic device 907. Cable 908 may be a multiple conductive cable for providing power from the automobiles power system via a protection circuit or fuse 909 for powering electronic device 907. In one embodiment, interface 904 may be operable to recharge electronic device 907 utilizing a power source associated with an automobile.

During operation, electronic device 907 may be mounted within interface 904. Electronic device 907 may also be powered or recharged via power line 910 and communicate with the systems audio system via interface cable or bus line 911. Audio information communicated to electronic device 907 may be transferred to audio system 901 such that a user may listen to selected audio information. For example, a user may have previously selected a plurality of audio files to be transmitted to electronic device 907. Electronic device 905 may communicate the selected audio information to the automobiles audio system utilizing interface 901 thereby allowing the user to listen to selected audio information. In one embodiment, cable 908 may be custom installed to audio system 901. For example, the cable may be coupled to an auxiliary line for the system's radio or may be coupled to CD player line 912. In

another embodiment, a radio manufacturer may provide interface 904 as a standard interface integrated into the audio system thereby allowing communication between electronic device 907, audio system 901 and/or console 900.

Electronic device 907 may include a plurality of different types of devices. For example, electronic device 907 may include a PDA device operable to store selected audio information. The information may be either remotely downloaded using an Internet web browser and wireless communication to the PDA device. In another embodiment, selected audio information may communicated to a PDA device via a hard wire coupled to a computer system interfacing with the Internet.

In another embodiment, electronic device 907 may include an audio file player operable to play audio files such as MP3's, etc. The audio files may be remotely or locally communicated to electronic device 907 and upon coupling to audio system 901, the audio files may be transmitted to audio system 901 in a form receivable by audio system 901.

Although the disclosed embodiments have been described in detail, it should be understood that various changes, substitutions and alterations can be made to the embodiments without departing from their spirit and scope.

WHAT IS CLAIMED IS:

1. A system for communicating selected information to an electronic device, the system comprising:

a digital engine operable to maintain data associated with selected audio information; and

a communication engine communicatively coupled to the digital engine, the communication engine operable to initiate wireless communication of the data to the electronic device.

2. The system of Claim 1 further comprising an interface operably coupled to the digital engine, the interface operable to provide available information to a user of a communication network, and to receive an input from the user identifying the selected information.

3. The system of Claim 2, wherein the interface operates in a browsing environment and the wireless communication operates outside the browsing environment.

4. The system of Claim 1, wherein the wireless communication comprises communicating via a cellular communications network.

5. The system of Claim 4, wherein the cellular communication network comprises a global system for mobile communications network.

6. The system of Claim 5, wherein the global system for mobile communications network operates between about 1.7 GHz and 2.0 GHz.

11. A method for communicating selected audio information to an electronic device, the method comprising:

5 maintaining data associated with the selected audio information using a digital engine; and
initiating wireless communication of the data to the electronic device.

12. The method of Claim 11 further comprising:

10 presenting information associated with audio information within an interface associated with a communication network; and

receiving an input from a user identifying the selected information.

13. The method of Claim 11 further comprising:

15 presenting information associated with the electronic device; and

20 receiving an input from a user identifying the electronic device.

14. The method of Claim 12 wherein the interface operates in a browsing environment and the wireless communication operates outside the browsing environment.

25 15. The method of Claim 11 wherein the wireless communication comprises communicating via a cellular communications network.

30

16. An electronic device for receiving selected audio information via wireless communication, the device comprising:

5 a communication module operable to receive wireless communication of the selected audio information;

a storage medium operably coupled to the communication module, the storage medium operable to store the selected audio information; and

10 a processor module coupled to the communication module, the processor module operable to process the received selected audio information.

17. The device as recited in Claim 16, wherein the communication module comprises a cellular modem.

15 18. The device as recited in Claim 16, wherein the device is a handheld computing device.

20 19. The device as recited in Claim 18 wherein the handheld computing device is a personal digital assistant (PDA).

25 20. The device as recited in Claim 16 further comprising software for processing the selected information.

21. The device as recited in Claim 16, wherein the communications module is operable to scan frequencies.

30 22. The device as recited in Claim 16, further comprising a display operable to display a user interface.

SYSTEM AND METHOD FOR COMMUNICATING
SELECTED INFORMATION TO AN ELECTRONIC DEVICE

ABSTRACT OF THE DISCLOSURE

Disclosed are a system and method for communicating
selected information to an electronic device. The
disclosed system may include a digital engine operable to
5 maintain data representing the selected information in a
digital format. In some embodiments, the digital engine
may be communicatively coupled to a graphical user
interface that allows a user to identify the selected
information. The system may also include a communication
10 engine communicatively coupled to the digital engine, the
communication engine may be operable to wirelessly
communicate the data representing the selected
information to an electronic device.

15

FIG. 1

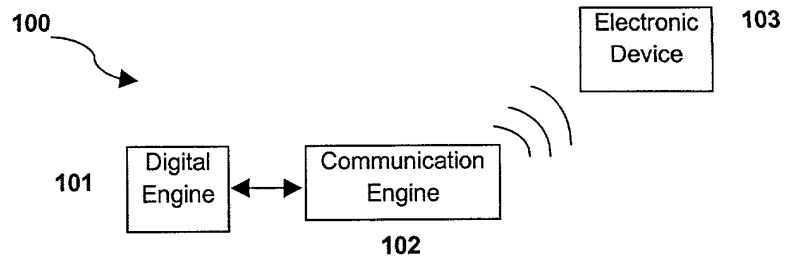

00000-ETNLSB

FIG. 4

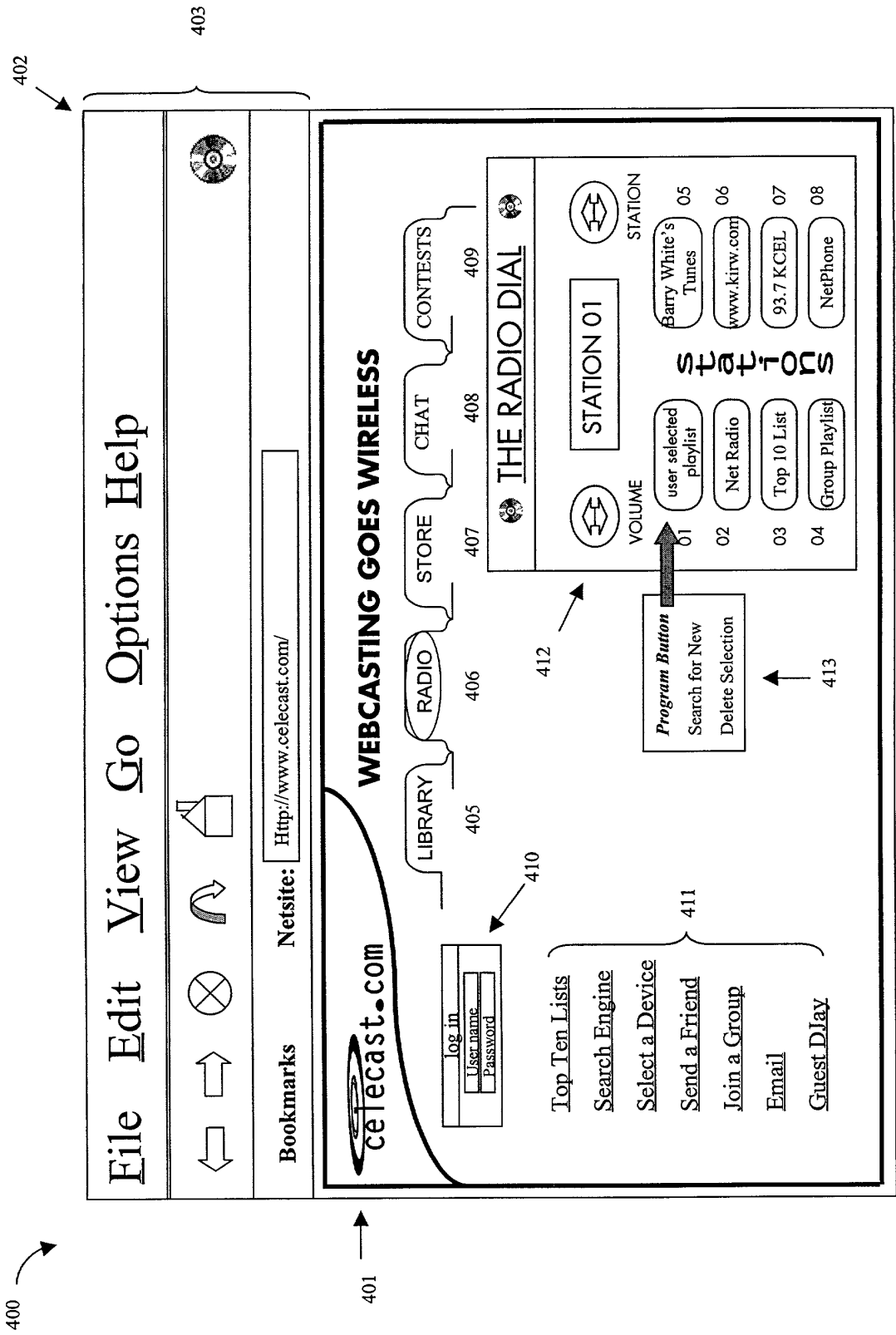
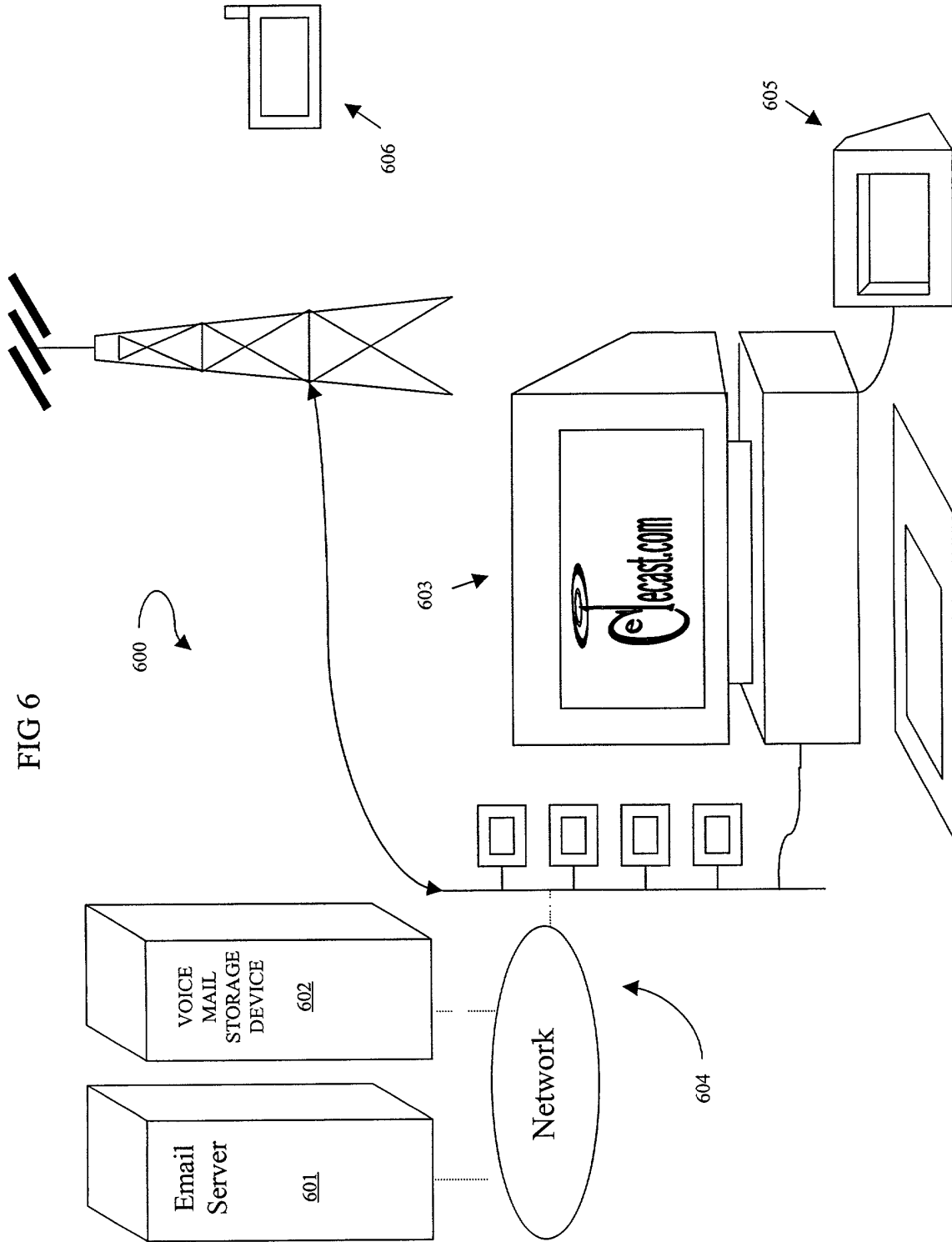
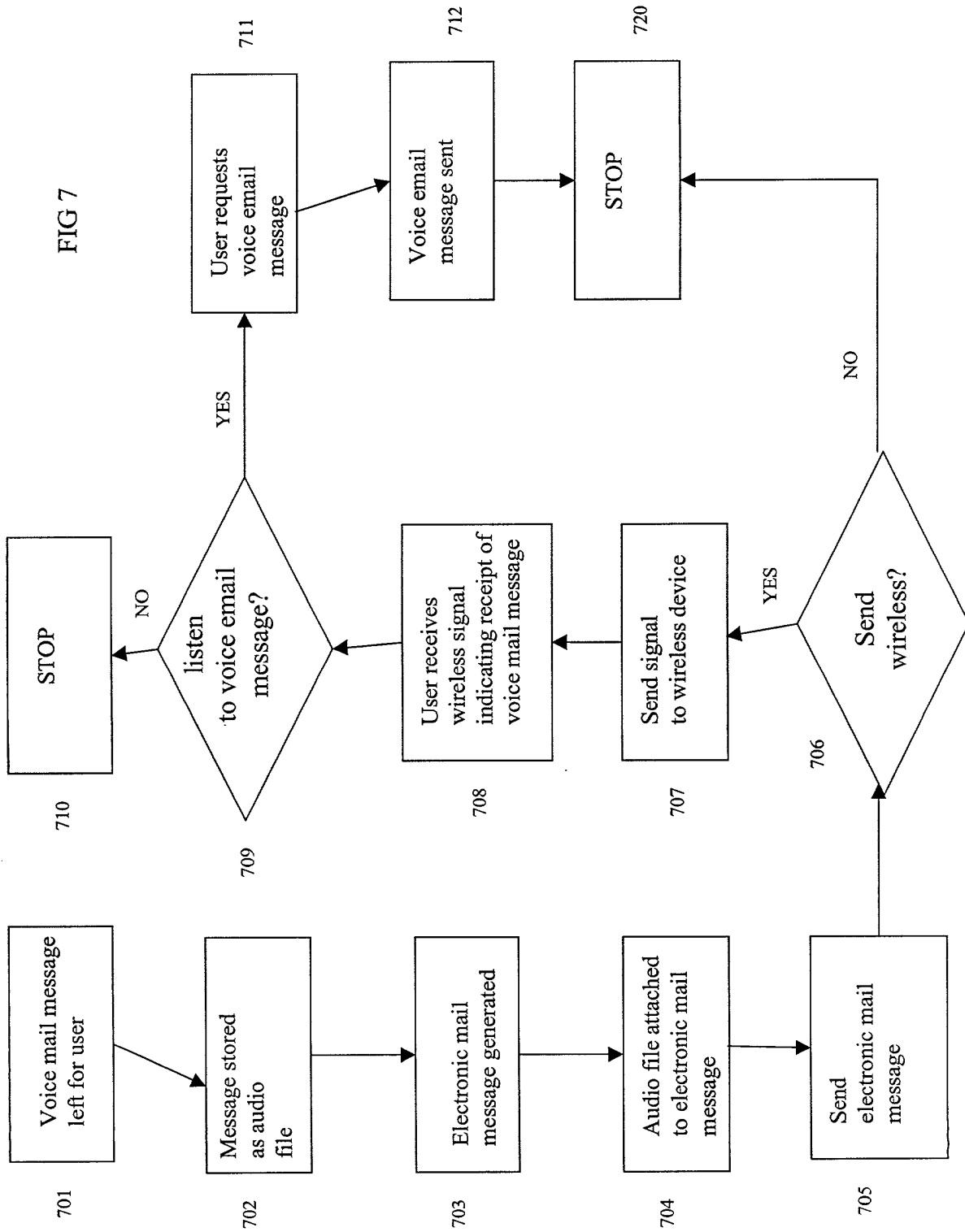

FIG 6





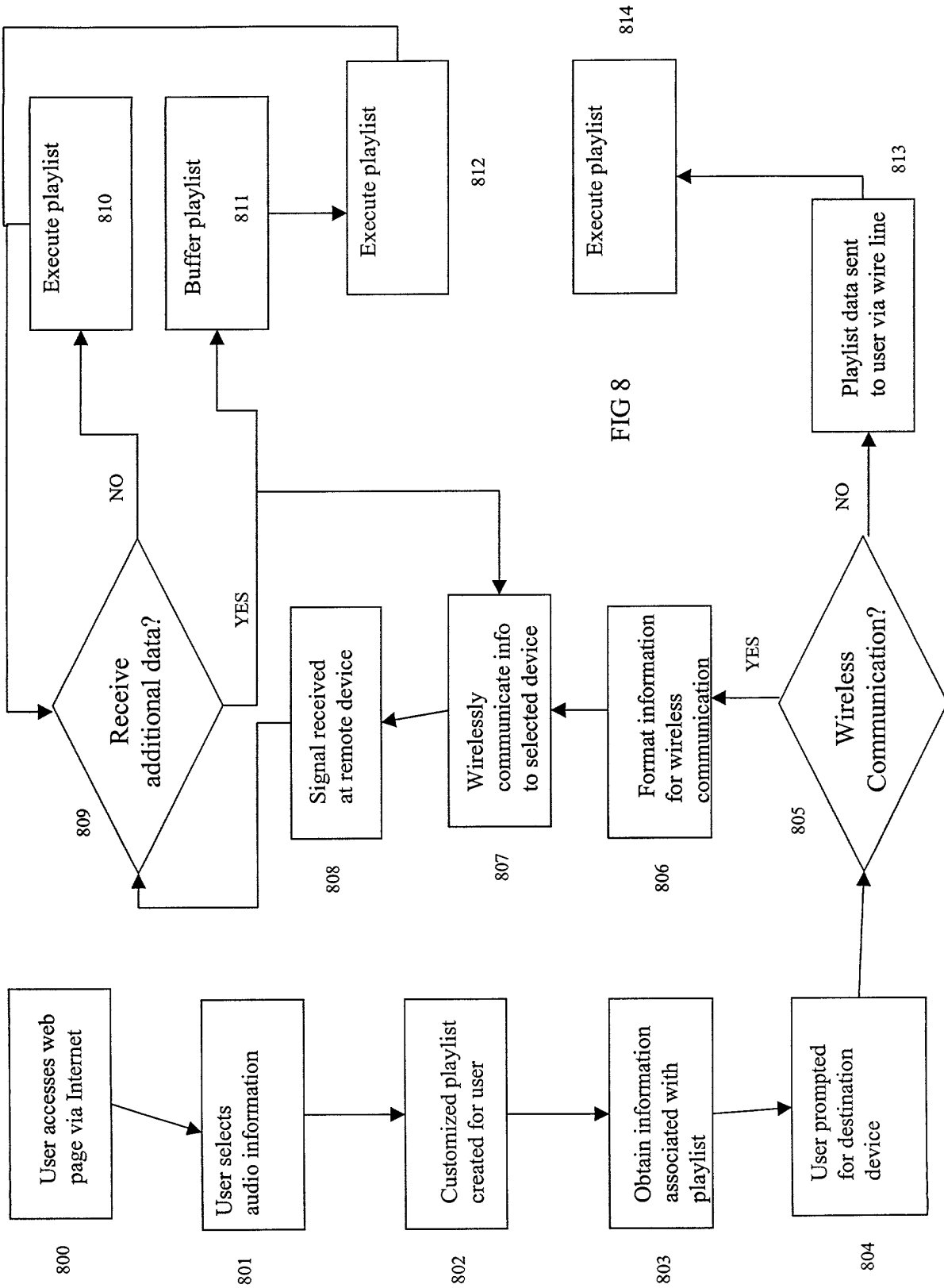

FIG 8

093794-03800

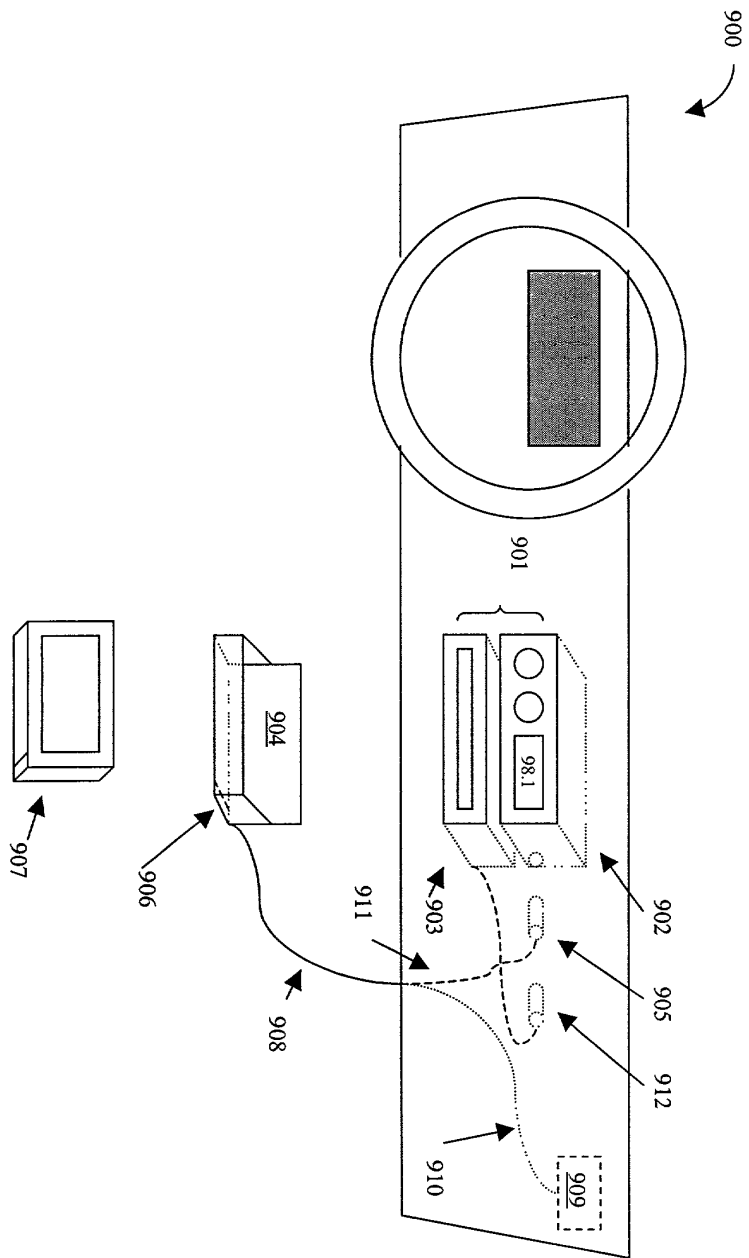

FIG 9

DECLARATION

As a below named inventor, I declare that:

My residence, post office address and citizenship are as stated below next to my name, that I believe I am the original, first and joint inventor of the subject matter which is claimed and for which a patent is sought on the invention or design entitled **System and Method for Communicating Selected Information to an Electronic Device**, the specification of which (check one):

X is attached hereto; or
 was filed on _____ as
Patent Application Serial No. _____
and was amended on _____
(if applicable);

that I have reviewed and understand the contents of the above-identified specification, including the claims, as amended by any amendment referred to above; and that I acknowledge the duty to disclose to the U.S. Patent and Trademark Office all information known to me to be material to patentability as defined in 37 C.F.R. § 1.56.

I hereby claim foreign priority benefits under 35 U.S.C. § 119 of any foreign application(s) for patent or inventor's certificate listed below and have also identified below any foreign application(s) for patent or inventor's certificate having a filing date before that of the application on which priority is claimed:

<u>Number</u>	<u>Country</u>	<u>Date Filed</u>	<u>Priority Claimed (Yes) (No)</u>
None.			

I hereby claim the benefit under 35 U.S.C. § 120 of any United States application(s) listed below and, insofar as the subject matter of each of the claims of this application is not disclosed in the prior United States application(s) in the manner provided by the first paragraph of 35 U.S.C. § 112, I acknowledge the duty to disclose to the U.S. Patent and Trademark Office all information known to me to be material to patentability as defined in 37 C.F.R. § 1.56 which became available between the filing date of the prior application(s) and the national or PCT international filing date of this application:

<u>Application</u>	<u>Date Filed</u>	<u>Status</u>
<u>Serial Number</u>	<u>Date Filed</u>	<u>Status</u>

None.

I declare that all statements made herein of my own knowledge are true and that all statements made on information and belief are believed to be true; and further that these statements were made with the knowledge that willful false statements and the like so made are punishable by fine or imprisonment, or both, under Section 1001 of Title 18 of the United States Code, and that such willful false statements may jeopardize the validity of the application or any patent issuing thereon.

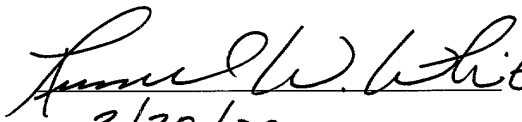
Full name of joint inventor:	Russell W. White
Inventor's signature	
Date	<u>3/28/00</u>
Residence (City, County, State)	Austin (Travis County) Texas
Citizenship	United States of America
Post Office Address:	10704 Redmond Austin, Texas 78739

T AVAILABLE COPY

SEARCHED			
Class	Sub.	Date	Exmr.
455	412.1 414.1 556.1	7/10/02	ATF
	Updated above search	Expanded 4/28/03	ATF
		5/17/04	R.P.G.
455	3.01 3.03 3.04 410 411 414.2 414.3 517 41.2 556.2	5/17/04 5/17/04 5/17/04 5/17/04 5/17/04 5/17/04 5/17/04 5/17/04 5/17/04	R.P.G. R.P.G. R.P.G. R.P.G. R.P.G. R.P.G. R.P.G. R.P.G. R.P.G.
709	217 218 219	5/17/04 5/17/04 5/17/04	R.P.G. R.P.G. R.P.G.

INTERFERENCE SEARCHED			
Class	Sub.	Date	Exmr.

SEARCH NOTES (INCLUDING SEARCH STRATEGY)		
	Date	Exmr.
Also performed various keyword searches. See search enclosed for details	7/11/02	ATF
EAST Image and Keyword search in USPT, US-PGRUS, DERWENT, IPO, JPO, EISA - TDA	5/17/04	R.P.G.
WIPO database http://ip.espacenet.com	5/17/04	R.P.G.
EPO Database http://ep.espacenet.com	5/17/04	R.P.G.
IEEE Xplore http://ieeexplore.ieee.org Xplore/Dyn Web	5/17/04	R.P.G.
Inventor names search in PALM ExPO and EAST	5/17/04	R.P.G.

(RIGHT OUTSIDE)

ISSUE SHEET STAPLE AREA (for additional cross references)

POSITION	INITIALS	ID NO.	DATE
FEE DETERMINATION	<i>LW</i>	<i>68904</i>	<i>4/4/00</i>
O.I.P.E. CLASSIFIER			
FORMALITY REVIEW	<i>M.M.</i>	<i>7163P</i>	<i>5-30-00</i>
RESPONSE FORMALITY REVIEW			

NOT AVAILABLE COPY

INDEX OF CLAIMS

- ✓ Rejected
- Allowed
- (Through numeral) Canceled
- Restricted
- N Non-elected
- I Interference
- A Appeal
- O Objected

Claim	Date
Final	
Original	
1	1/1/02
2	1/1/02
3	1/1/02
4	1/1/02
5	1/1/02
6	1/1/02
7	1/1/02
8	1/1/02
9	1/1/02
10	1/1/02
11	1/1/02
12	1/1/02
13	1/1/02
14	1/1/02
15	1/1/02
16	1/1/02
17	1/1/02
18	1/1/02
19	1/1/02
20	1/1/02
21	1/1/02
22	1/1/02
23	1/1/02
24	1/1/02
25	1/1/02
26	1/1/02
27	1/1/02
28	1/1/02
29	1/1/02
30	1/1/02
31	1/1/02
32	1/1/02
33	1/1/02
34	1/1/02
35	1/1/02
36	1/1/02
37	1/1/02
38	1/1/02
39	1/1/02
40	1/1/02
41	1/1/02
42	1/1/02
43	1/1/02
44	1/1/02
45	1/1/02
46	1/1/02
47	1/1/02
48	1/1/02
49	1/1/02
50	1/1/02

Claim	Date
Final	
Original	
51	
52	
53	
54	
55	
56	
57	
58	
59	
60	
61	
62	
63	
64	
65	
66	
67	
68	
69	
70	
71	
72	
73	
74	
75	
76	
77	
78	
79	
80	
81	
82	
83	
84	
85	
86	
87	
88	
89	
90	
91	
92	
93	
94	
95	
96	
97	
98	
99	
100	

Claim	Date
Final	
Original	
101	
102	
103	
104	
105	
106	
107	
108	
109	
110	
111	
112	
113	
114	
115	
116	
117	
118	
119	
120	
121	
122	
123	
124	
125	
126	
127	
128	
129	
130	
131	
132	
133	
134	
135	
136	
137	
138	
139	
140	
141	
142	
143	
144	
145	
146	
147	
148	
149	
150	

If more than 150 claims or 10 actions
staple additional sheet here

(1 SET INSIDE)

3-29-00

A

PATENT APPLICATION

ATTORNEY DOCKET NO.
111111.1111

JC685 U.S. PTO
03/28/00

APPLICATION FOR U.S. PATENT UNDER 37 C.F.R. § 1.53(b)
TRANSMITTAL FORM

JC564 U.S. PTO
09/537612
03/28/00

Box Patent Application
ASSISTANT COMMISSIONER FOR PATENTS
Washington, D.C. 20231

09537612-032800

Sir:

Transmitted herewith for filing is the patent application
of:

Inventors or Application Identifier: Russell W. White, et al.

Entitled: **SYSTEM AND METHOD FOR COMMUNICATING
SELECTED INFORMATION TO AN ELECTRONIC DEVICE**

Enclosed are: X Specification (50 pages)
 X Drawing(s) (9 Sheets Informal)

 X Signed Declaration.

 Information Disclosure Statement (IDS) PTO-1449 with copies
of references cited.

 X Certificate of Mailing

 X Return Receipt Postcard

 An Assignment of the invention to _____ is attached.
A cover sheet in compliance with 37 C.F.R. §§ 3.28 and 3.31 is
included with the Assignment recordation fee of \$40.00 pursuant
to 37 C.F.R. § 1.21(h).

Verified Statement Claiming Small Entity Status - Independent
Inventors is enclosed.

AUS01:201780.1

PATENT APPLICATION

Attorney's Docket:
111111.1111
Page 2

FEE CALCULATION					FEE
	Number		Number Extra	Rate	Basic Fee
					\$ 345.00
Total Claims:	25	- 20 =	5	X \$9 =	\$ 45.00
Independent Claims	4	- 3 =	1	X \$39 =	\$ 39.00
TOTAL FILING FEE =					\$ 429.00

Enclosed is a check in the amount of \$429.00 to satisfy filing fee requirements under 37 C.F.R. § 1.16.

Respectfully submitted,

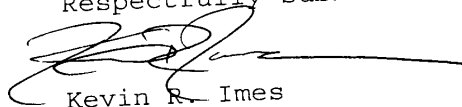

Kevin R. Imes
Reg. No. 44,795

Date: March 28, 2000

Correspondence Address:
Russell W. White
10704 Redmond
Austin, Texas 78739
(512) 301-5518

000000-2702500

ATTORNEY DOCKET NO.
111111.1111

IN THE UNITED STATES PATENT AND TRADEMARK OFFICE

In re Application of: Russell W. White, et al.
Date Filed: March 28, 2000
Title: **SYSTEM AND METHOD FOR
COMMUNICATING SELECTED
INFORMATION TO AN ELECTRONIC
DEVICE**

JC564 U.S. PTO
09/537812
03/28/00

Box Patent Application
Honorable Assistant Commissioner
of Patents
Washington, D.C. 20231

Dear Sir:

CERTIFICATE OF MAILING BY EXPRESS MAIL

I hereby certify that the attached Transmittal, Patent Application, Declaration, Verified Statement Claiming Small Entity Status - Individual Inventor and Informal Drawings are being deposited with the United States Postal Service "Express Mail Post Office to Addressee" service under 37 C.F.R. 1.10 on this 28th day of March, 2000, and is addressed to Box Patent Application, the Assistant Commissioner of Patents, Washington, D.C. 20231.

Kevin R. Imes

Express Mail Receipt
No. EL519494037US
Attorney's Docket: 111111.1111

AUS01:201795.1

FIG. 4

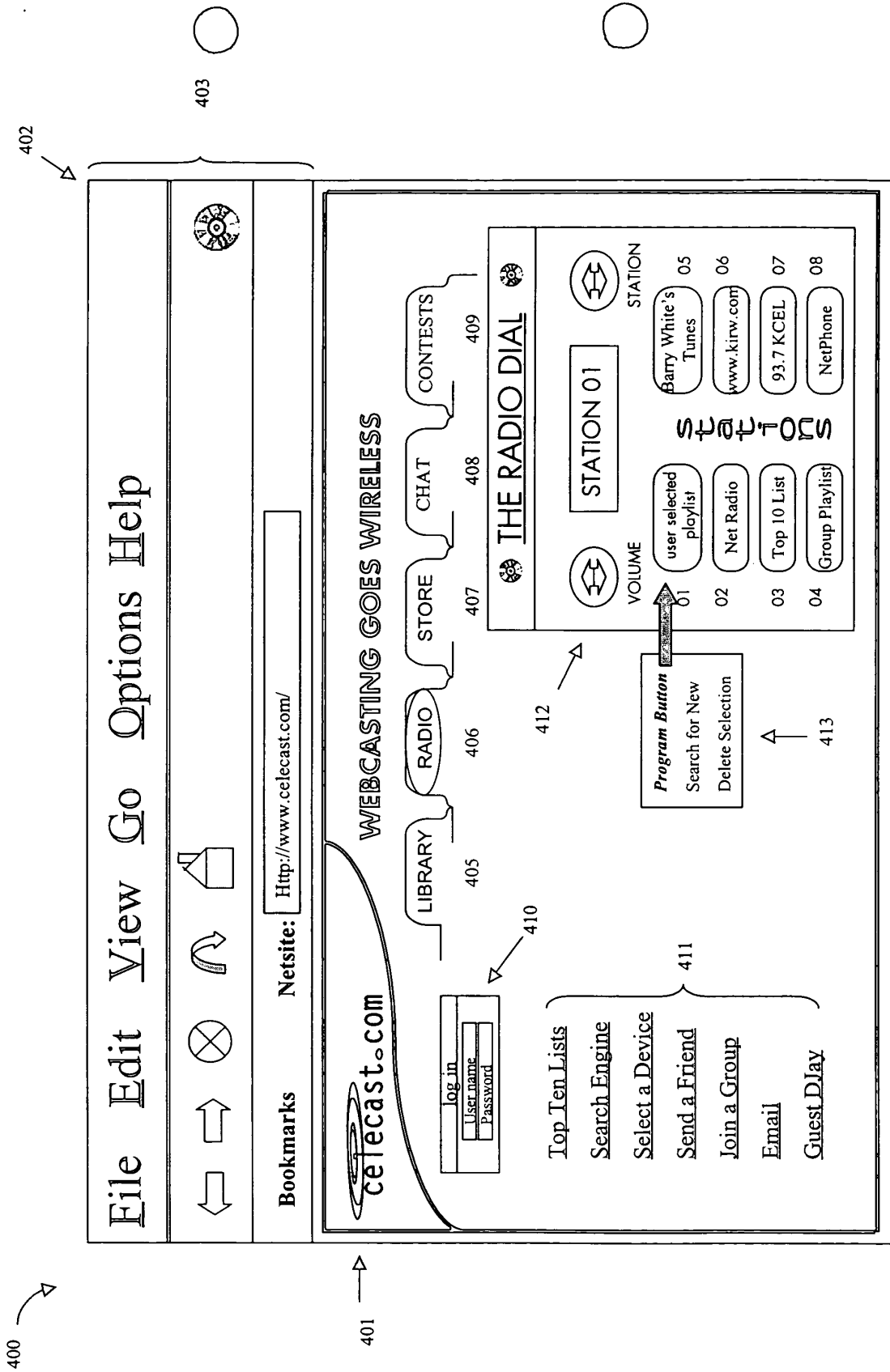

FIG 5A

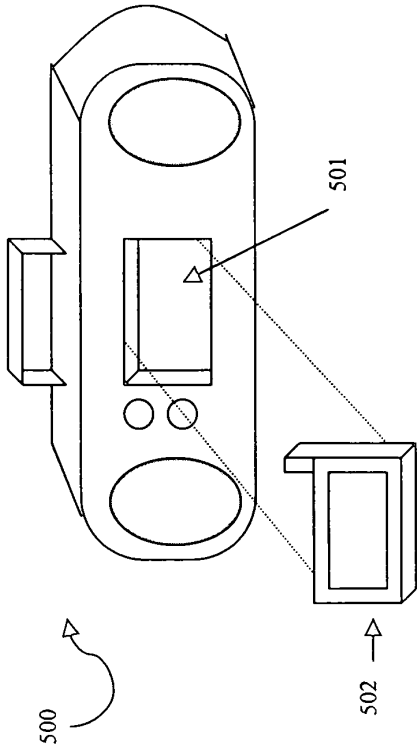
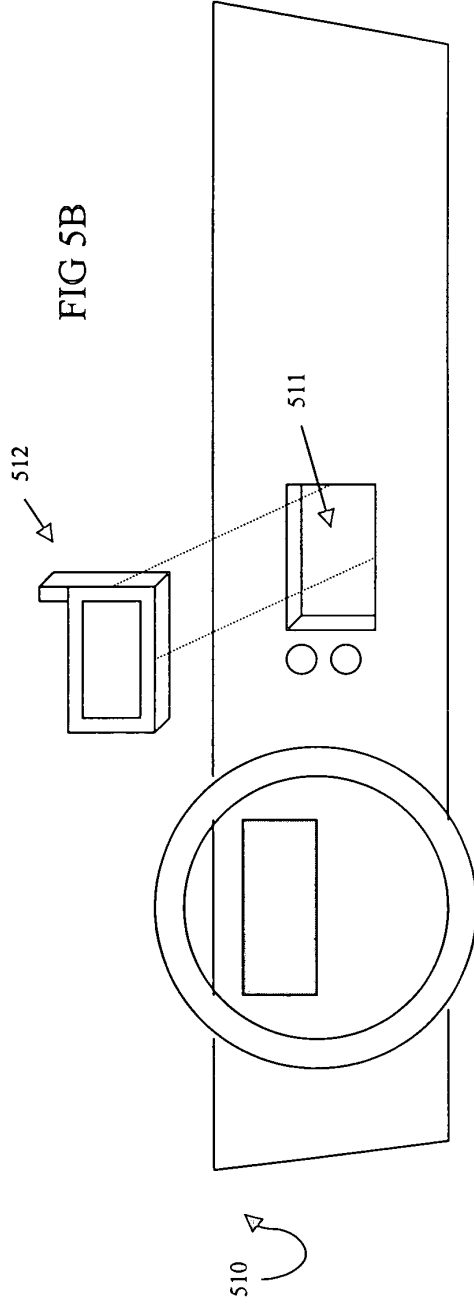
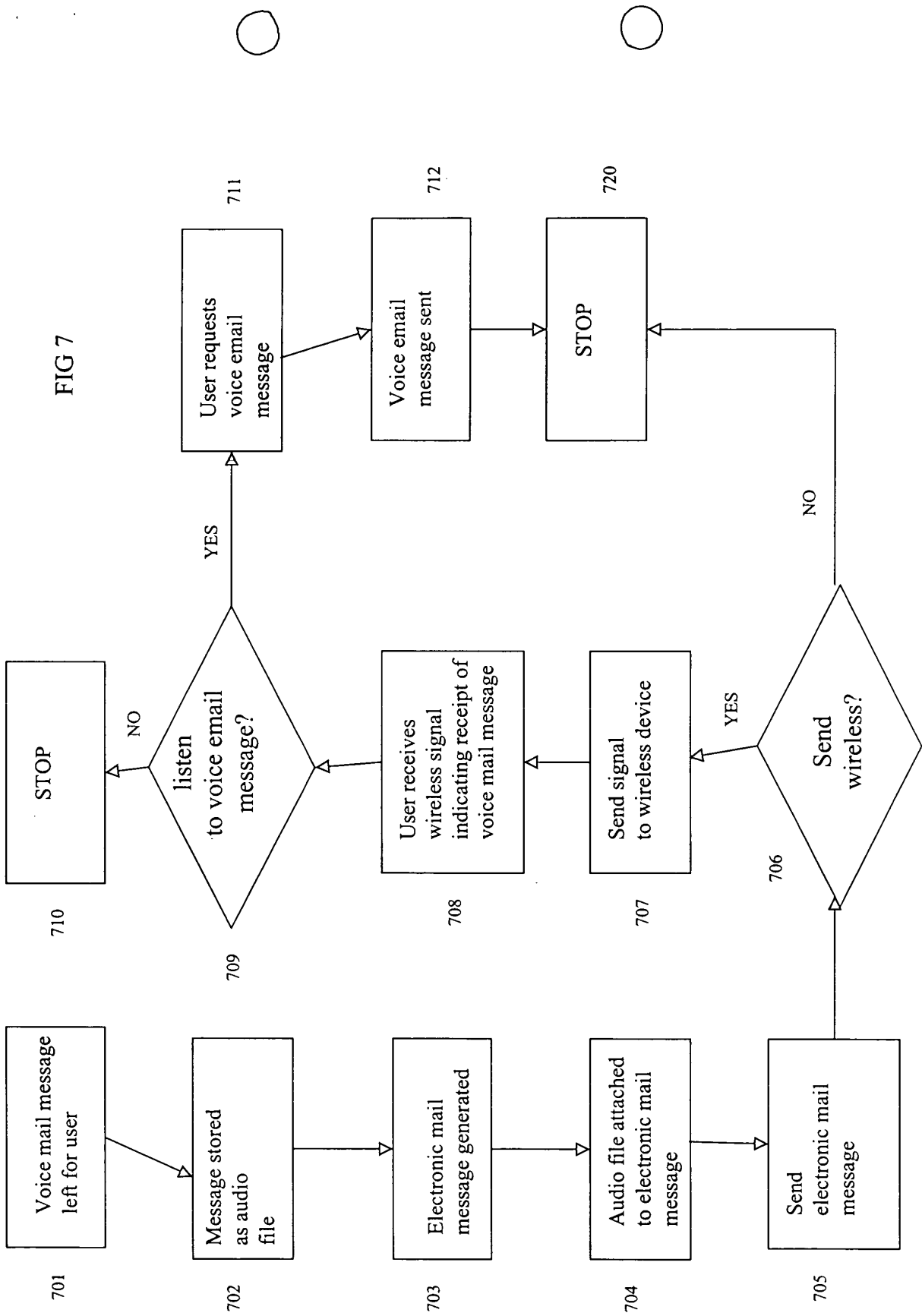

FIG 5B





00537842-032200

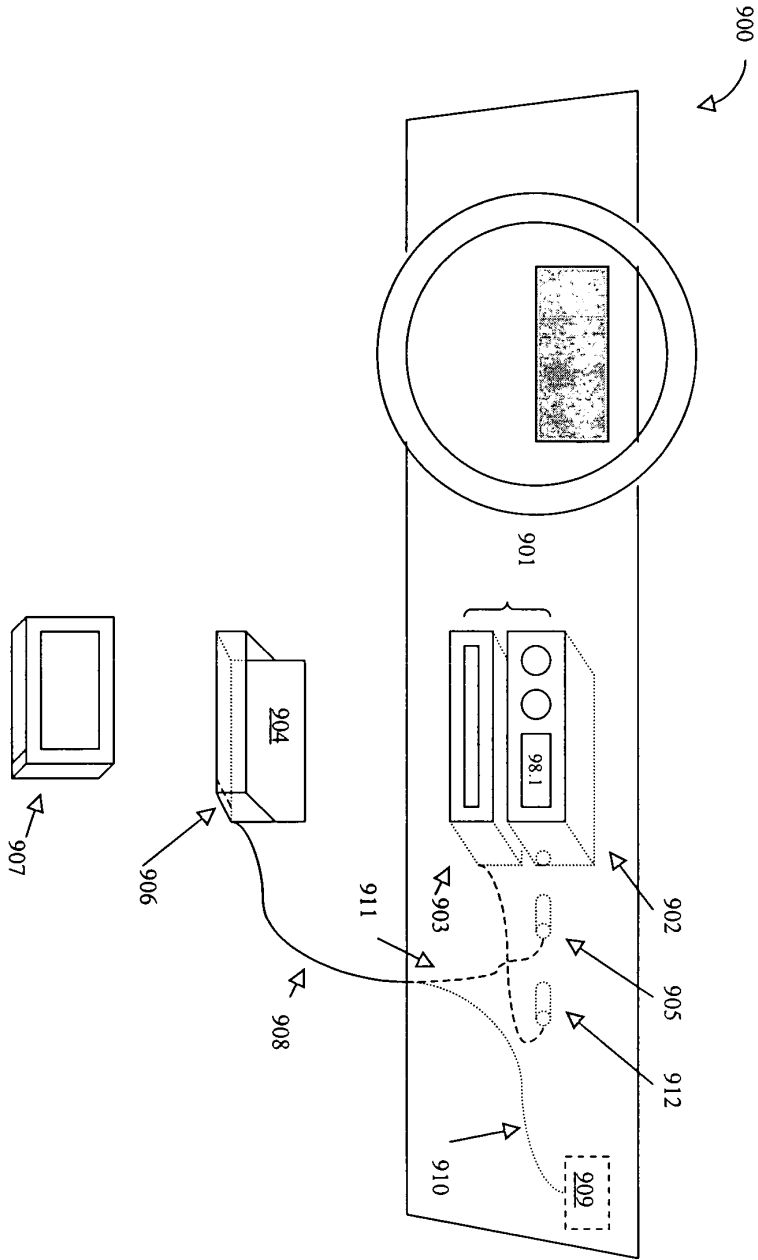

FIG 9

BACKGROUND OF THE INVENTION

The first commercial radio stations in the United States began operation around 1920. Today, there may be as many as 12,000 radio stations in the United States programming in several distinct formats. When broadcasting their respective signals, these radio stations often use an analog signal, which may be modulated based on frequency or amplitude. Frequency modulated (FM) radio appears to be the dominant entertainment medium while amplitude modulated (AM) radio seems to be a popular outlet for news and information.

Unfortunately, analog radio may be unable to provide the sound quality and consistency that radio listeners desire. As such, several broadcasting related companies have begun to consider a movement to digital radio. Unlike analog radio reception, digital radio reception may be able to provide compact disk (CD) quality sound while remaining virtually immune to interference. Being immune to interference may result in reducing static growls or 'multipath' echoes, echoes caused by signal reflections off buildings or topographical features.

Some countries, like Canada and many European countries, may choose to have digital radio operate in a single digital radio band such as the L-band between 1452-1492 megahertz (MHz). This band would allow the reception of both terrestrially and satellite-originated signals. By comparison, FM radio typically operates between 88 and 108 MHz while AM radio typically operates between 0.525 and 1.705 MHz. Neither of these bands allows for easy transmission via satellite.

Canada proposed using the L-Band for digital radio as early as 1992. Several countries throughout the world

include a Bluetooth link, which may operate around 2.4 GHz.

According to another aspect of the present invention, a system for communicating selected information to an electronic device is disclosed. The system includes a digital engine operable to maintain data associated with selected audio information and a communication engine communicatively coupled to the digital engine, the communication engine operable to initiate wireless communication of the data to the electronic device.

According to another aspect of the present invention, a method for communicating selected audio information to an electronic device is provided. The method includes maintaining data associated with the selected audio information using a digital engine, and initiating wireless communication of the data to the electronic device.

According to another aspect of the present invention, an electronic device for receiving selected audio information via wireless communication is provided. The device includes a communication module operable to receive wireless communication of the selected audio information, a storage medium operably coupled to the communication module, the storage medium operable to store the selected audio information, and a processor module coupled to the communication module, the processor module operable to process the received selected audio information.

According to another aspect of the present invention, a method for communicating selected audio information to an electronic device is provided. The

