

Receipt date: 01/18/2011

Doc code: IDS

Doc description: Information Disclosure Statement (IDS) Filed

PTO/SB/08a (01-10)

Approved for use through 07/31/2012. OMB 0651-0031

U.S. Patent and Trademark Office; U.S. DEPARTMENT OF COMMERCE

Under the Paperwork Reduction Act of 1995, no persons are required to respond to a collection of information unless it contains a valid OMB control number.

INFORMATION DISCLOSURE STATEMENT BY APPLICANT (Not for submission under 37 CFR 1.99)	Application Number		12495190
	Filing Date		2009-06-30
	First Named Inventor	Russell W. White, et al.	
	Art Unit		2617
	Examiner Name	Erika A. Gary	
	Attorney Docket Number		AFF.004C7US

U.S.PATENTS						
Examiner Initial*	Cite No	Patent Number	Kind Code ¹	Issue Date	Name of Patentee or Applicant of cited Document	Pages, Columns, Lines where Relevant Passages or Relevant Figures Appear
	1	7149543		2006-12-12	Kumar II	
	2	7321783		2008-01-22	Kim	
	3	5991640		1999-11-23	Lilja	
	4	6823255		2004-11-23	Sass	
	5	6259892		2001-07-10	Helferich	
	6	5914941		1999-07-22	Janky	
	7	6487663		2002-11-26	Jaisimha	
	8	6658247		2003-12-02	Saito	

Receipt date: 01/18/2011

INFORMATION DISCLOSURE STATEMENT BY APPLICANT (Not for submission under 37 CFR 1.99)	Application Number		12495190	
	Filing Date		2009-06-30	
	First Named Inventor	Russell W. White, et al.		
	Art Unit	2617		
	Examiner Name	Erika A. Gary		
	Attorney Docket Number	AFF.004C7US		

9	6007228		1999-12-28	Agarwal	
10	5341350		1994-08-23	Frank	

If you wish to add additional U.S. Patent citation information please click the Add button.

U.S.PATENT APPLICATION PUBLICATIONS

Examiner Initial*	Cite No	Publication Number	Kind Code ¹	Publication Date	Name of Patentee or Applicant of cited Document	Pages, Columns, Lines where Relevant Passages or Relevant Figures Appear
	1	20020010759		2002-01-24	Hitson	
	2	20020164973		2002-11-07	Janik	

If you wish to add additional U.S. Published Application citation information please click the Add button.

FOREIGN PATENT DOCUMENTS

Examiner Initial*	Cite No	Foreign Document Number ³	Country Code ²	Kind Code ⁴	Publication Date	Name of Patentee or Applicant of cited Document	Pages, Columns, Lines where Relevant Passages or Relevant Figures Appear	T ⁵
	1	EP 0744839	EP		1996-11-27	Grewe		<input type="checkbox"/>
	2	H08-6875	JP		1996-01-12	Taishinji		<input checked="" type="checkbox"/>
	3	H11-288558	JP		1999-10-19	Menju		<input checked="" type="checkbox"/>

Receipt date: 01/18/2011

INFORMATION DISCLOSURE STATEMENT BY APPLICANT (Not for submission under 37 CFR 1.99)	Application Number	12495190
	Filing Date	2009-06-30
	First Named Inventor	Russell W. White, et al.
	Art Unit	2617
	Examiner Name	Erika A. Gary
	Attorney Docket Number	AFF.004C7US

4	H11-164058	JP		1999-06-18	Sato	<input checked="" type="checkbox"/>
5	H08-252976	JP		1998-04-14	Tanaka	<input checked="" type="checkbox"/>
6	WO 2000/54462	WO		2000-09-14	Bae	<input type="checkbox"/>

If you wish to add additional Foreign Patent Document citation information please click the Add button

NON-PATENT LITERATURE DOCUMENTS

Examiner Initials*	Cite No	Include name of the author (in CAPITAL LETTERS), title of the article (when appropriate), title of the item (book, magazine, journal, serial, symposium, catalog, etc), date, pages(s), volume-issue number(s), publisher, city and/or country where published.	T ⁵
	1	Affinity Labs of Texas, LLC, v. BMW North America, LLC, et al., Civil Action No. 9:08CV164, Order Denying Defendant's Motion For Summary Judgment of Non-Infringement of the '833 Patent, filed October 07, 2010, pages 1 - 5.	<input type="checkbox"/>
	2	Affinity Labs of Texas, LLC, v. Hyundai Motor America, Inc.; Hyundai Motor Manufacturing Alabama LLC.; Volkswagen Group of America, Inc.; and Kia Motors America, Inc., Civil Action No. 9:08CV164, Jury Verdict Form, filed October 28, 2010, pages 1 - 16.	<input type="checkbox"/>
	3	Affinity Labs of Texas, LLC, vs. BMW North America, LLC, et al., Docket 9:08CV164, October 27, 2010, Volume 8 of ___, Pages 2100 Through 2633, Reporter's Transcript of Jury Trial, pages 1 - 88.	<input type="checkbox"/>
	4	Affinity Labs of Texas, LLC, vs. BMW North America, LLC, et al., Docket 9:08CV164, October 28, 2010, Volume 9 of 9, Pages 2634 Through 2824, Reporter's Transcript of Jury Trial, pages 1 - 19.	<input type="checkbox"/>
	5	Affinity Labs of Texas, LLC, Plaintiff and Counter-Claim Defendant, vs. Apple Inc., Defendant and Counter-Claim Plaintiff, Case No. 09-4436-CW, Apple Inc.'s First Invalidity Contentions Pursuant To Patent Local Rule 3-3, filed January 5, 2011, pages 1-25, with accompanying Appendixes A-G.	<input type="checkbox"/>

If you wish to add additional non-patent literature document citation information please click the Add button

Receipt date: 01/18/2011

INFORMATION DISCLOSURE STATEMENT BY APPLICANT (Not for submission under 37 CFR 1.99)	Application Number	12495190
	Filing Date	2009-06-30
	First Named Inventor	Russell W. White, et al.
	Art Unit	2617
	Examiner Name	Erika A. Gary
	Attorney Docket Number	AFF.004C7US

EXAMINER SIGNATURE			
Examiner Signature	/Erika Gary/ (02/17/2011)	Date Considered	02/17/2011
*EXAMINER: Initial if reference considered, whether or not citation is in conformance with MPEP 609. Draw line through a citation if not in conformance and not considered. Include copy of this form with next communication to applicant.			
<small>¹ See Kind Codes of USPTO Patent Documents at www.USPTO.GOV or MPEP 901.04. ² Enter office that issued the document, by the two-letter code (WIPO Standard ST.3). ³ For Japanese patent documents, the indication of the year of the reign of the Emperor must precede the serial number of the patent document. ⁴ Kind of document by the appropriate symbols as indicated on the document under WIPO Standard ST.16 if possible. ⁵ Applicant is to place a check mark here if English language translation is attached.</small>			

Receipt date: 01/18/2011

Doc code: IDS

Doc description: Information Disclosure Statement (IDS) Filed

PTO/SB/08a (01-10)

Approved for use through 07/31/2012. OMB 0651-0031

U.S. Patent and Trademark Office; U.S. DEPARTMENT OF COMMERCE

Under the Paperwork Reduction Act of 1995, no persons are required to respond to a collection of information unless it contains a valid OMB control number.

INFORMATION DISCLOSURE STATEMENT BY APPLICANT (Not for submission under 37 CFR 1.99)	Application Number		12495190
	Filing Date		2009-06-30
	First Named Inventor	Russell W. White, et al.	
	Art Unit		2617
	Examiner Name	Erika A. Gary	
	Attorney Docket Number		AFF.004C7US

U.S.PATENTS						
Examiner Initial*	Cite No	Patent Number	Kind Code ¹	Issue Date	Name of Patentee or Applicant of cited Document	Pages, Columns, Lines where Relevant Passages or Relevant Figures Appear
	1	7149543		2006-12-12	Kumar II	
	2	7321783		2008-01-22	Kim	
	3	5991640		1999-11-23	Lilja	
	4	6823255		2004-11-23	Sass	
	5	6259892		2001-07-10	Helferich	
	6	5914941		1999-07-22	Janky	
	7	6487663		2002-11-26	Jaisimha	
	8	6658247		2003-12-02	Saito	

Receipt date: 01/18/2011

INFORMATION DISCLOSURE STATEMENT BY APPLICANT (Not for submission under 37 CFR 1.99)	Application Number		12495190	
	Filing Date		2009-06-30	
	First Named Inventor	Russell W. White, et al.		
	Art Unit	2617		
	Examiner Name	Erika A. Gary		
	Attorney Docket Number	AFF.004C7US		

9	6007228		1999-12-28	Agarwal	
10	5341350		1994-08-23	Frank	

If you wish to add additional U.S. Patent citation information please click the Add button.

U.S.PATENT APPLICATION PUBLICATIONS

Examiner Initial*	Cite No	Publication Number	Kind Code ¹	Publication Date	Name of Patentee or Applicant of cited Document	Pages, Columns, Lines where Relevant Passages or Relevant Figures Appear
	1	20020010759		2002-01-24	Hitson	
	2	20020164973		2002-11-07	Janik	

If you wish to add additional U.S. Published Application citation information please click the Add button.

FOREIGN PATENT DOCUMENTS

Examiner Initial*	Cite No	Foreign Document Number ³	Country Code ²	Kind Code ⁴	Publication Date	Name of Patentee or Applicant of cited Document	Pages, Columns, Lines where Relevant Passages or Relevant Figures Appear	T ⁵
	1	EP 0744839	EP		1996-11-27	Grewe		<input type="checkbox"/>
	2	H08-6875	JP		1996-01-12	Taishinji		<input checked="" type="checkbox"/>
	3	H11-288558	JP		1999-10-19	Menju		<input checked="" type="checkbox"/>

Receipt date: 01/18/2011

INFORMATION DISCLOSURE STATEMENT BY APPLICANT (Not for submission under 37 CFR 1.99)	Application Number		12495190	
	Filing Date		2009-06-30	
	First Named Inventor	Russell W. White, et al.		
	Art Unit	2617		
	Examiner Name	Erika A. Gary		
	Attorney Docket Number	AFF.004C7US		

4	H11-164058	JP		1999-06-18	Sato	<input checked="" type="checkbox"/>
5	H08-252976	JP		1998-04-14	Tanaka	<input checked="" type="checkbox"/>
6	WO 2000/54462	WO		2000-09-14	Bae	<input type="checkbox"/>

If you wish to add additional Foreign Patent Document citation information please click the Add button

NON-PATENT LITERATURE DOCUMENTS

Examiner Initials*	Cite No	Include name of the author (in CAPITAL LETTERS), title of the article (when appropriate), title of the item (book, magazine, journal, serial, symposium, catalog, etc), date, pages(s), volume-issue number(s), publisher, city and/or country where published.	T ⁵
	1	Affinity Labs of Texas, LLC, v. BMW North America, LLC, et al., Civil Action No. 9:08CV164, Order Denying Defendant's Motion For Summary Judgment of Non-Infringement of the '833 Patent, filed October 07, 2010, pages 1 - 5.	<input type="checkbox"/>
	2	Affinity Labs of Texas, LLC, v. Hyundai Motor America, Inc.; Hyundai Motor Manufacturing Alabama LLC.; Volkswagen Group of America, Inc.; and Kia Motors America, Inc., Civil Action No. 9:08CV164, Jury Verdict Form, filed October 28, 2010, pages 1 - 16.	<input type="checkbox"/>
	3	Affinity Labs of Texas, LLC, vs. BMW North America, LLC, et al., Docket 9:08CV164, October 27, 2010, Volume 8 of ___, Pages 2100 Through 2633, Reporter's Transcript of Jury Trial, pages 1 - 88.	<input type="checkbox"/>
	4	Affinity Labs of Texas, LLC, vs. BMW North America, LLC, et al., Docket 9:08CV164, October 28, 2010, Volume 9 of 9, Pages 2634 Through 2824, Reporter's Transcript of Jury Trial, pages 1 - 19.	<input type="checkbox"/>
	5	Affinity Labs of Texas, LLC, Plaintiff and Counter-Claim Defendant, vs. Apple Inc., Defendant and Counter-Claim Plaintiff, Case No. 09-4436-CW, Apple Inc.'s First Invalidity Contentions Pursuant To Patent Local Rule 3-3, filed January 5, 2011, pages 1-25, with accompanying Appendixes A-G.	<input type="checkbox"/>

If you wish to add additional non-patent literature document citation information please click the Add button

Receipt date: 01/18/2011

INFORMATION DISCLOSURE STATEMENT BY APPLICANT (Not for submission under 37 CFR 1.99)	Application Number	12495190
	Filing Date	2009-06-30
	First Named Inventor	Russell W. White, et al.
	Art Unit	2617
	Examiner Name	Erika A. Gary
	Attorney Docket Number	AFF.004C7US

EXAMINER SIGNATURE			
Examiner Signature	/Erika Gary/ (02/17/2011)	Date Considered	02/17/2011
*EXAMINER: Initial if reference considered, whether or not citation is in conformance with MPEP 609. Draw line through a citation if not in conformance and not considered. Include copy of this form with next communication to applicant.			
<small>¹ See Kind Codes of USPTO Patent Documents at www.USPTO.GOV or MPEP 901.04. ² Enter office that issued the document, by the two-letter code (WIPO Standard ST.3). ³ For Japanese patent documents, the indication of the year of the reign of the Emperor must precede the serial number of the patent document. ⁴ Kind of document by the appropriate symbols as indicated on the document under WIPO Standard ST.16 if possible. ⁵ Applicant is to place a check mark here if English language translation is attached.</small>			

Receipt date: 01/26/2011

Doc code: IDS

Doc description: Information Disclosure Statement (IDS) Filed

PTO/SB/08a (01-10)

Approved for use through 07/31/2012. OMB 0651-0031

U.S. Patent and Trademark Office; U.S. DEPARTMENT OF COMMERCE

Under the Paperwork Reduction Act of 1995, no persons are required to respond to a collection of information unless it contains a valid OMB control number.

INFORMATION DISCLOSURE STATEMENT BY APPLICANT (Not for submission under 37 CFR 1.99)	Application Number		12495190	
	Filing Date		2009-06-30	
	First Named Inventor	Russell W. White, et al.		
	Art Unit		2617	
	Examiner Name	Erika A. Gary		
	Attorney Docket Number		AFF.004C7US	

U.S.PATENTS						
Examiner Initial*	Cite No	Patent Number	Kind Code ¹	Issue Date	Name of Patentee or Applicant of cited Document	Pages,Columns,Lines where Relevant Passages or Relevant Figures Appear
	1	6248946		2001-06-19	Dwek	
	2	5572442		1996-11-05	Schulhof	
	3	6338044		2002-01-08	Cook	
	4	5797089		1998-08-18	Nguyen	
	5	6330247		2001-12-11	Chang	
	6	5737706		1998-04-07	Seazholtz	

If you wish to add additional U.S. Patent citation information please click the Add button.

U.S.PATENT APPLICATION PUBLICATIONS						
Examiner Initial*	Cite No	Publication Number	Kind Code ¹	Publication Date	Name of Patentee or Applicant of cited Document	Pages,Columns,Lines where Relevant Passages or Relevant Figures Appear

Receipt date: 01/26/2011 INFORMATION DISCLOSURE STATEMENT BY APPLICANT (Not for submission under 37 CFR 1.99)	Application Number		12495190	
	Filing Date		2009-06-30	
	First Named Inventor	Russell W. White, et al.		
	Art Unit		2617	
	Examiner Name	Erika A. Gary		
	Attorney Docket Number		AFF.004C7US	

1	20010042107		2001-11-15	Palm	
---	-------------	--	------------	------	--

If you wish to add additional U.S. Published Application citation information please click the Add button.

FOREIGN PATENT DOCUMENTS

Examiner Initial*	Cite No	Foreign Document Number ³	Country Code ² i	Kind Code ⁴	Publication Date	Name of Patentee or Applicant of cited Document	Pages, Columns, Lines where Relevant Passages or Relevant Figures Appear	T ⁵
	1	EP 984584	EP		2000-08-03	Lippert		<input type="checkbox"/>

If you wish to add additional Foreign Patent Document citation information please click the Add button

NON-PATENT LITERATURE DOCUMENTS

Examiner Initials*	Cite No	Include name of the author (in CAPITAL LETTERS), title of the article (when appropriate), title of the item (book, magazine, journal, serial, symposium, catalog, etc), date, pages(s), volume-issue number(s), publisher, city and/or country where published.	T ⁵
	1	Sony Corporation, Sony Portable MiniDisc Recorder MZ-R90/MZ-R91 Operating Instructions, Doc. No. 3-867-571-22(1), 1999, pp. 1-55.	<input type="checkbox"/>
	2	Empeg Car User Guide, 1999, pp. 1-19.	<input type="checkbox"/>
	3	Empeg Car User Guide (2000) pp. 1-48	<input type="checkbox"/>
	4	Crowe, Mike. Empeg Car Beta 10a, March 25, 2000, 3 pages.	<input type="checkbox"/>
	5	Emplode Help, (date unknown, contended by defendant Apple Corp. to be prior art under one or more of 35 U.S.C. 102 (a), (b), (f) and (g)) 25 pages.	<input type="checkbox"/>

Receipt date: 01/26/2011 INFORMATION DISCLOSURE STATEMENT BY APPLICANT (Not for submission under 37 CFR 1.99)	Application Number	12495190
	Filing Date	2009-06-30
	First Named Inventor	Russell W. White, et al.
	Art Unit	2617
	Examiner Name	Erika A. Gary
	Attorney Docket Number	AFF.004C7US

6	"MP3 Portable Player Goes Elite" The Mac Observer, Nov. 17, 1999, 3 pages.	<input type="checkbox"/>
7	"MP3 in Your Car Has Arrived" (date unknown, contended by defendant Apple Corp. to be prior art under one or more of 35 U.S.C. 102 (a), (b), (f) and (g)) 1 page.	<input type="checkbox"/>
8	Photos from Comdex Fall 1999, Nov. 1999, 9 pages.	<input type="checkbox"/>
9	Photos from LinuxWorld Expo, Winter 1999, Mar. 1-4, 1999, 22 pages.	<input type="checkbox"/>
10	Craig Knudsen, "MP3 Linux Players," Linux Journal, Jul. 1, 1999, pp. 1-3.	<input type="checkbox"/>
11	riocar.org – Empeg Car History, (date unknown, contended by defendant Apple Corp. to be prior art under one or more of 35 U.S.C. 102 (a), (b), (f) and (g)), 4 pages.	<input type="checkbox"/>
12	"Visteon: For Your Listening Pleasure - Any Music, Any Time, Anywhere," Presswire, Jan. 5, 2000, 1 page.	<input type="checkbox"/>
13	Photographs in email to Hugo Fiennes, Sept. 22, 1999, 4 pages.	<input type="checkbox"/>
14	HP Jornada 420 User's Manual, 1999, pp. 1-142.	<input type="checkbox"/>
15	IEEE Standard 802.11b, 1999 Edition (Wireless LAN Medium Access Control and Physical Layer Specifications: Higher-Speed Physical Layer Extension in the 2.4 GHz Band) Sep. 16, 1999, 96 pages.	<input type="checkbox"/>
16	RealPlayer Plus G2 Manual, 1999, pp. 1-81.	<input type="checkbox"/>

Receipt date: 01/26/2011 INFORMATION DISCLOSURE STATEMENT BY APPLICANT (Not for submission under 37 CFR 1.99)	Application Number		12495190
	Filing Date		2009-06-30
	First Named Inventor	Russell W. White, et al.	
	Art Unit		2617
	Examiner Name	Erika A. Gary	
	Attorney Docket Number		AFF.004C7US

17	IEEE Standard 802.11a, 1999 Edition (Wireless LAN Medium Access Control and Physical Layer Specifications: High-Speed Physical Layer in the 5GHz Band), 1999, 91 pages.	<input type="checkbox"/>
18	Rod Underhill & Nat Gertler, "The Complete Idiot's Guide to MP3: Music on the Internet," 1999, 44 pages.	<input type="checkbox"/>
19	Bill Mann, "I Want My MP3! How to Download, Rip, & Play Digital Music," McGraw-Hill 2000, 175 pages.	<input type="checkbox"/>
20	IEEE Standard 802.11, 1997 Edition (Wireless LAN Medium Access Control and Physical Layer Specifications), 1997, pp. 1-145.	<input type="checkbox"/>
21	IEEE Standard 802.3ab, 1999 Edition (802.3 Physical Layer Specification for 1000 Mb/s Operation on Four Pairs of Category 5 or Better Balanced Twisted Pair Cable (1000BASE-T) 1999, 140 pages.	<input type="checkbox"/>
22	IBM Wireless Modem for Cellular/CDPD - Quick Reference, Oct. 1995, pp. 1-20.	<input type="checkbox"/>
23	Creative Sound Blaster Live! Platinum product, documentation, and software: Creative Technology Ltd., Creative Sound Blaster Live! Platinum Getting Started, Sept. 1999, 93 pages.	<input type="checkbox"/>
24	psa[play Getting Started Guide, (date unknown, contended by defendant Apple Corp. to be prior art under one or more of 35 U.S.C. 102 (a), (b), (f) and (g)), pp. 1-16.	<input type="checkbox"/>
25	psa[play Getting Started Guide, 2000, pp. 1-16.	<input type="checkbox"/>
26	Rio 800 User Guide, 2001, pp. 1-38.	<input type="checkbox"/>
27	Rio 800 Digital Audio Player—Getting Started, 2000, pp. 1-19.	<input type="checkbox"/>

Receipt date: 01/26/2011 INFORMATION DISCLOSURE STATEMENT BY APPLICANT (Not for submission under 37 CFR 1.99)	Application Number		12495190
	Filing Date		2009-06-30
	First Named Inventor	Russell W. White, et al.	
	Art Unit		2617
	Examiner Name	Erika A. Gary	
	Attorney Docket Number		AFF.004C7US

28	Rio 600 Getting Started Guide, 2001, pp. 1-169.	<input type="checkbox"/>
29	Rio 600 User Guide, March 2001, pp 1-38.	<input type="checkbox"/>

If you wish to add additional non-patent literature document citation information please click the Add button

EXAMINER SIGNATURE

Examiner Signature	/Erika Gary/ (02/17/2011)	Date Considered	02/17/2011
--------------------	---------------------------	-----------------	------------

*EXAMINER: Initial if reference considered, whether or not citation is in conformance with MPEP 609. Draw line through a citation if not in conformance and not considered. Include copy of this form with next communication to applicant.

¹ See Kind Codes of USPTO Patent Documents at www.USPTO.GOV or MPEP 901.04. ² Enter office that issued the document, by the two-letter code (WIPO Standard ST.3). ³ For Japanese patent documents, the indication of the year of the reign of the Emperor must precede the serial number of the patent document. ⁴ Kind of document by the appropriate symbols as indicated on the document under WIPO Standard ST.16 if possible. ⁵ Applicant is to place a check mark here if English language translation is attached.

Receipt date: 01/26/2011

Doc code: IDS

Doc description: Information Disclosure Statement (IDS) Filed

PTO/SB/08a (01-10)

Approved for use through 07/31/2012. OMB 0651-0031

U.S. Patent and Trademark Office; U.S. DEPARTMENT OF COMMERCE

Under the Paperwork Reduction Act of 1995, no persons are required to respond to a collection of information unless it contains a valid OMB control number.

INFORMATION DISCLOSURE STATEMENT BY APPLICANT (Not for submission under 37 CFR 1.99)	Application Number		12495190	
	Filing Date		2009-06-30	
	First Named Inventor	Russell W. White, et al.		
	Art Unit		2617	
	Examiner Name	Erika A. Gary		
	Attorney Docket Number		AFF.004C7US	

U.S.PATENTS						
Examiner Initial*	Cite No	Patent Number	Kind Code ¹	Issue Date	Name of Patentee or Applicant of cited Document	Pages,Columns,Lines where Relevant Passages or Relevant Figures Appear
	1	6248946		2001-06-19	Dwek	
	2	5572442		1996-11-05	Schulhof	
	3	6338044		2002-01-08	Cook	
	4	5797089		1998-08-18	Nguyen	
	5	6330247		2001-12-11	Chang	
	6	5737706		1998-04-07	Seazholtz	

If you wish to add additional U.S. Patent citation information please click the Add button.

U.S.PATENT APPLICATION PUBLICATIONS						
Examiner Initial*	Cite No	Publication Number	Kind Code ¹	Publication Date	Name of Patentee or Applicant of cited Document	Pages,Columns,Lines where Relevant Passages or Relevant Figures Appear

Receipt date: 01/26/2011 INFORMATION DISCLOSURE STATEMENT BY APPLICANT (Not for submission under 37 CFR 1.99)	Application Number		12495190	
	Filing Date		2009-06-30	
	First Named Inventor	Russell W. White, et al.		
	Art Unit		2617	
	Examiner Name	Erika A. Gary		
	Attorney Docket Number		AFF.004C7US	

1	20010042107		2001-11-15	Palm	
---	-------------	--	------------	------	--

If you wish to add additional U.S. Published Application citation information please click the Add button.

FOREIGN PATENT DOCUMENTS

Examiner Initial*	Cite No	Foreign Document Number ³	Country Code ² i	Kind Code ⁴	Publication Date	Name of Patentee or Applicant of cited Document	Pages, Columns, Lines where Relevant Passages or Relevant Figures Appear	T ⁵
	1	EP 984584	EP		2000-08-03	Lippert		<input type="checkbox"/>

If you wish to add additional Foreign Patent Document citation information please click the Add button

NON-PATENT LITERATURE DOCUMENTS

Examiner Initials*	Cite No	Include name of the author (in CAPITAL LETTERS), title of the article (when appropriate), title of the item (book, magazine, journal, serial, symposium, catalog, etc), date, pages(s), volume-issue number(s), publisher, city and/or country where published.	T ⁵
	1	Sony Corporation, Sony Portable MiniDisc Recorder MZ-R90/MZ-R91 Operating Instructions, Doc. No. 3-867-571-22(1), 1999, pp. 1-55.	<input type="checkbox"/>
	2	Empeg Car User Guide, 1999, pp. 1-19.	<input type="checkbox"/>
	3	Empeg Car User Guide (2000) pp. 1-48	<input type="checkbox"/>
	4	Crowe, Mike. Empeg Car Beta 10a, March 25, 2000, 3 pages.	<input type="checkbox"/>
	5	Emplode Help, (date unknown, contended by defendant Apple Corp. to be prior art under one or more of 35 U.S.C. 102 (a), (b), (f) and (g)) 25 pages.	<input type="checkbox"/>

Receipt date: 01/26/2011 INFORMATION DISCLOSURE STATEMENT BY APPLICANT (Not for submission under 37 CFR 1.99)	Application Number	12495190
	Filing Date	2009-06-30
	First Named Inventor	Russell W. White, et al.
	Art Unit	2617
	Examiner Name	Erika A. Gary
	Attorney Docket Number	AFF.004C7US

6	"MP3 Portable Player Goes Elite" The Mac Observer, Nov. 17, 1999, 3 pages.	<input type="checkbox"/>
7	"MP3 in Your Car Has Arrived" (date unknown, contended by defendant Apple Corp. to be prior art under one or more of 35 U.S.C. 102 (a), (b), (f) and (g)) 1 page.	<input type="checkbox"/>
8	Photos from Comdex Fall 1999, Nov. 1999, 9 pages.	<input type="checkbox"/>
9	Photos from LinuxWorld Expo, Winter 1999, Mar. 1-4, 1999, 22 pages.	<input type="checkbox"/>
10	Craig Knudsen, "MP3 Linux Players," Linux Journal, Jul. 1, 1999, pp. 1-3.	<input type="checkbox"/>
11	riocar.org – Empeg Car History, (date unknown, contended by defendant Apple Corp. to be prior art under one or more of 35 U.S.C. 102 (a), (b), (f) and (g)), 4 pages.	<input type="checkbox"/>
12	"Visteon: For Your Listening Pleasure - Any Music, Any Time, Anywhere," Presswire, Jan. 5, 2000, 1 page.	<input type="checkbox"/>
13	Photographs in email to Hugo Fiennes, Sept. 22, 1999, 4 pages.	<input type="checkbox"/>
14	HP Jornada 420 User's Manual, 1999, pp. 1-142.	<input type="checkbox"/>
15	IEEE Standard 802.11b, 1999 Edition (Wireless LAN Medium Access Control and Physical Layer Specifications: Higher-Speed Physical Layer Extension in the 2.4 GHz Band) Sep. 16, 1999, 96 pages.	<input type="checkbox"/>
16	RealPlayer Plus G2 Manual, 1999, pp. 1-81.	<input type="checkbox"/>

Receipt date: 01/26/2011 INFORMATION DISCLOSURE STATEMENT BY APPLICANT (Not for submission under 37 CFR 1.99)	Application Number		12495190
	Filing Date		2009-06-30
	First Named Inventor	Russell W. White, et al.	
	Art Unit		2617
	Examiner Name	Erika A. Gary	
	Attorney Docket Number		AFF.004C7US

17	IEEE Standard 802.11a, 1999 Edition (Wireless LAN Medium Access Control and Physical Layer Specifications: High-Speed Physical Layer in the 5GHz Band), 1999, 91 pages.	<input type="checkbox"/>
18	Rod Underhill & Nat Gertler, "The Complete Idiot's Guide to MP3: Music on the Internet," 1999, 44 pages.	<input type="checkbox"/>
19	Bill Mann, "I Want My MP3! How to Download, Rip, & Play Digital Music," McGraw-Hill 2000, 175 pages.	<input type="checkbox"/>
20	IEEE Standard 802.11, 1997 Edition (Wireless LAN Medium Access Control and Physical Layer Specifications), 1997, pp. 1-145.	<input type="checkbox"/>
21		<input type="checkbox"/>
22	IBM Wireless Modem for Cellular/CDPD - Quick Reference, Oct. 1995, pp. 1-20.	<input type="checkbox"/>
23	Creative Sound Blaster Live! Platinum product, documentation, and software: Creative Technology Ltd., Creative Sound Blaster Live! Platinum Getting Started, Sept. 1999, 93 pages.	<input type="checkbox"/>
24	psa[play Getting Started Guide, (date unknown, contended by defendant Apple Corp. to be prior art under one or more of 35 U.S.C. 102 (a), (b), (f) and (g)), pp. 1-16.	<input type="checkbox"/>
25	psa[play Getting Started Guide, 2000, pp. 1-16.	<input type="checkbox"/>
26	Rio 800 User Guide, 2001, pp. 1-38.	<input type="checkbox"/>
27	Rio 800 Digital Audio Player—Getting Started, 2000, pp. 1-19.	<input type="checkbox"/>

Receipt date: 01/26/2011 INFORMATION DISCLOSURE STATEMENT BY APPLICANT (Not for submission under 37 CFR 1.99)	Application Number		12495190
	Filing Date		2009-06-30
	First Named Inventor	Russell W. White, et al.	
	Art Unit		2617
	Examiner Name	Erika A. Gary	
	Attorney Docket Number		AFF.004C7US

28	Rio 600 Getting Started Guide, 2001, pp. 1-169.	<input type="checkbox"/>
29	Rio 600 User Guide, March 2001, pp 1-38.	<input type="checkbox"/>

If you wish to add additional non-patent literature document citation information please click the Add button

EXAMINER SIGNATURE

Examiner Signature	/Erika Gary/ (02/17/2011)	Date Considered	02/17/2011
--------------------	---------------------------	-----------------	------------

*EXAMINER: Initial if reference considered, whether or not citation is in conformance with MPEP 609. Draw line through a citation if not in conformance and not considered. Include copy of this form with next communication to applicant.

¹ See Kind Codes of USPTO Patent Documents at www.USPTO.GOV or MPEP 901.04. ² Enter office that issued the document, by the two-letter code (WIPO Standard ST.3). ³ For Japanese patent documents, the indication of the year of the reign of the Emperor must precede the serial number of the patent document. ⁴ Kind of document by the appropriate symbols as indicated on the document under WIPO Standard ST.16 if possible. ⁵ Applicant is to place a check mark here if English language translation is attached.

Receipt date: 01/26/2011

Doc code: IDS

Doc description: Information Disclosure Statement (IDS) Filed

PTO/SB/08a (01-10)

Approved for use through 07/31/2012. OMB 0651-0031

U.S. Patent and Trademark Office; U.S. DEPARTMENT OF COMMERCE

Under the Paperwork Reduction Act of 1995, no persons are required to respond to a collection of information unless it contains a valid OMB control number.

INFORMATION DISCLOSURE STATEMENT BY APPLICANT (Not for submission under 37 CFR 1.99)	Application Number		12495190	
	Filing Date		2009-06-30	
	First Named Inventor	Russell W. White, et al.		
	Art Unit		2617	
	Examiner Name	Erika A. Gary		
	Attorney Docket Number		AFF.004C7US	

U.S.PATENTS						
Examiner Initial*	Cite No	Patent Number	Kind Code ¹	Issue Date	Name of Patentee or Applicant of cited Document	Pages,Columns,Lines where Relevant Passages or Relevant Figures Appear
	1	6248946		2001-06-19	Dwek	
	2	5572442		1996-11-05	Schulhof	
	3	6338044		2002-01-08	Cook	
	4	5797089		1998-08-18	Nguyen	
	5	6330247		2001-12-11	Chang	
	6	5737706		1998-04-07	Seazholtz	

If you wish to add additional U.S. Patent citation information please click the Add button.

U.S.PATENT APPLICATION PUBLICATIONS						
Examiner Initial*	Cite No	Publication Number	Kind Code ¹	Publication Date	Name of Patentee or Applicant of cited Document	Pages,Columns,Lines where Relevant Passages or Relevant Figures Appear

Receipt date: 01/26/2011 INFORMATION DISCLOSURE STATEMENT BY APPLICANT (Not for submission under 37 CFR 1.99)	Application Number		12495190	
	Filing Date		2009-06-30	
	First Named Inventor	Russell W. White, et al.		
	Art Unit		2617	
	Examiner Name	Erika A. Gary		
	Attorney Docket Number		AFF.004C7US	

1	20010042107		2001-11-15	Palm	
---	-------------	--	------------	------	--

If you wish to add additional U.S. Published Application citation information please click the Add button.

FOREIGN PATENT DOCUMENTS

Examiner Initial*	Cite No	Foreign Document Number ³	Country Code ² i	Kind Code ⁴	Publication Date	Name of Patentee or Applicant of cited Document	Pages, Columns, Lines where Relevant Passages or Relevant Figures Appear	T ⁵
	1	EP 984584	EP		2000-08-03	Lippert		<input type="checkbox"/>

If you wish to add additional Foreign Patent Document citation information please click the Add button

NON-PATENT LITERATURE DOCUMENTS

Examiner Initials*	Cite No	Include name of the author (in CAPITAL LETTERS), title of the article (when appropriate), title of the item (book, magazine, journal, serial, symposium, catalog, etc), date, pages(s), volume-issue number(s), publisher, city and/or country where published.	T ⁵
	1	Sony Corporation, Sony Portable MiniDisc Recorder MZ-R90/MZ-R91 Operating Instructions, Doc. No. 3-867-571-22(1), 1999, pp. 1-55.	<input type="checkbox"/>
	2	Empeg Car User Guide, 1999, pp. 1-19.	<input type="checkbox"/>
	3	Empeg Car User Guide (2000) pp. 1-48	<input type="checkbox"/>
	4	Crowe, Mike. Empeg Car Beta 10a, March 25, 2000, 3 pages.	<input type="checkbox"/>
	5	Emplode Help, (date unknown, contended by defendant Apple Corp. to be prior art under one or more of 35 U.S.C. 102 (a), (b), (f) and (g)) 25 pages.	<input type="checkbox"/>

Receipt date: 01/26/2011 INFORMATION DISCLOSURE STATEMENT BY APPLICANT (Not for submission under 37 CFR 1.99)	Application Number	12495190
	Filing Date	2009-06-30
	First Named Inventor	Russell W. White, et al.
	Art Unit	2617
	Examiner Name	Erika A. Gary
	Attorney Docket Number	AFF.004C7US

6	"MP3 Portable Player Goes Elite" The Mac Observer, Nov. 17, 1999, 3 pages.	<input type="checkbox"/>
7	"MP3 in Your Car Has Arrived" (date unknown, contended by defendant Apple Corp. to be prior art under one or more of 35 U.S.C. 102 (a), (b), (f) and (g)) 1 page.	<input type="checkbox"/>
8	Photos from Comdex Fall 1999, Nov. 1999, 9 pages.	<input type="checkbox"/>
9	Photos from LinuxWorld Expo, Winter 1999, Mar. 1-4, 1999, 22 pages.	<input type="checkbox"/>
10	Craig Knudsen, "MP3 Linux Players," Linux Journal, Jul. 1, 1999, pp. 1-3.	<input type="checkbox"/>
11	riocar.org – Empeg Car History, (date unknown, contended by defendant Apple Corp. to be prior art under one or more of 35 U.S.C. 102 (a), (b), (f) and (g)), 4 pages.	<input type="checkbox"/>
12	"Visteon: For Your Listening Pleasure - Any Music, Any Time, Anywhere," Presswire, Jan. 5, 2000, 1 page.	<input type="checkbox"/>
13	Photographs in email to Hugo Fiennes, Sept. 22, 1999, 4 pages.	<input type="checkbox"/>
14	HP Jornada 420 User's Manual, 1999, pp. 1-142.	<input type="checkbox"/>
15	IEEE Standard 802.11b, 1999 Edition (Wireless LAN Medium Access Control and Physical Layer Specifications: Higher-Speed Physical Layer Extension in the 2.4 GHz Band) Sep. 16, 1999, 96 pages.	<input type="checkbox"/>
16	RealPlayer Plus G2 Manual, 1999, pp. 1-81.	<input type="checkbox"/>

Receipt date: 01/26/2011 INFORMATION DISCLOSURE STATEMENT BY APPLICANT (Not for submission under 37 CFR 1.99)	Application Number		12495190
	Filing Date		2009-06-30
	First Named Inventor	Russell W. White, et al.	
	Art Unit		2617
	Examiner Name	Erika A. Gary	
	Attorney Docket Number		AFF.004C7US

17	IEEE Standard 802.11a, 1999 Edition (Wireless LAN Medium Access Control and Physical Layer Specifications: High-Speed Physical Layer in the 5GHz Band), 1999, 91 pages.	<input type="checkbox"/>
18	Rod Underhill & Nat Gertler, "The Complete Idiot's Guide to MP3: Music on the Internet," 1999, 44 pages.	<input type="checkbox"/>
19	Bill Mann, "I Want My MP3! How to Download, Rip, & Play Digital Music," McGraw-Hill 2000, 175 pages.	<input type="checkbox"/>
20	IEEE Standard 802.11, 1997 Edition (Wireless LAN Medium Access Control and Physical Layer Specifications), 1997, pp. 1-145.	<input type="checkbox"/>
21		<input type="checkbox"/>
22	IBM Wireless Modem for Cellular/CDPD - Quick Reference, Oct. 1995, pp. 1-20.	<input type="checkbox"/>
23	Creative Sound Blaster Live! Platinum product, documentation, and software: Creative Technology Ltd., Creative Sound Blaster Live! Platinum Getting Started, Sept. 1999, 93 pages.	<input type="checkbox"/>
24	psa[play Getting Started Guide, (date unknown, contended by defendant Apple Corp. to be prior art under one or more of 35 U.S.C. 102 (a), (b), (f) and (g)), pp. 1-16.	<input type="checkbox"/>
25	psa[play Getting Started Guide, 2000, pp. 1-16.	<input type="checkbox"/>
26	Rio 800 User Guide, 2001, pp. 1-38.	<input type="checkbox"/>
27	Rio 800 Digital Audio Player—Getting Started, 2000, pp. 1-19.	<input type="checkbox"/>

Receipt date: 01/26/2011 INFORMATION DISCLOSURE STATEMENT BY APPLICANT (Not for submission under 37 CFR 1.99)	Application Number		12495190
	Filing Date		2009-06-30
	First Named Inventor	Russell W. White, et al.	
	Art Unit		2617
	Examiner Name	Erika A. Gary	
	Attorney Docket Number		AFF.004C7US

28	Rio 600 Getting Started Guide, 2001, pp. 1-169.	<input type="checkbox"/>
29	Rio 600 User Guide, March 2001, pp 1-38.	<input type="checkbox"/>

If you wish to add additional non-patent literature document citation information please click the Add button

EXAMINER SIGNATURE

Examiner Signature	/Erika Gary/ (02/17/2011)	Date Considered	02/17/2011
--------------------	---------------------------	-----------------	------------

*EXAMINER: Initial if reference considered, whether or not citation is in conformance with MPEP 609. Draw line through a citation if not in conformance and not considered. Include copy of this form with next communication to applicant.

¹ See Kind Codes of USPTO Patent Documents at www.USPTO.GOV or MPEP 901.04. ² Enter office that issued the document, by the two-letter code (WIPO Standard ST.3). ³ For Japanese patent documents, the indication of the year of the reign of the Emperor must precede the serial number of the patent document. ⁴ Kind of document by the appropriate symbols as indicated on the document under WIPO Standard ST.16 if possible. ⁵ Applicant is to place a check mark here if English language translation is attached.

Receipt date: 01/27/2011

Doc code: IDS

Doc description: Information Disclosure Statement (IDS) Filed

PTO/SB/08a (01-10)

Approved for use through 07/31/2012. OMB 0651-0031

U.S. Patent and Trademark Office; U.S. DEPARTMENT OF COMMERCE

Under the Paperwork Reduction Act of 1995, no persons are required to respond to a collection of information unless it contains a valid OMB control number.

INFORMATION DISCLOSURE STATEMENT BY APPLICANT (Not for submission under 37 CFR 1.99)	Application Number		12495190	
	Filing Date		2009-06-30	
	First Named Inventor	Russell W. White, et al.		
	Art Unit		2617	
	Examiner Name	Erika A. Gary		
	Attorney Docket Number		AFF.004C7US	

U.S.PATENTS						
Examiner Initial*	Cite No	Patent Number	Kind Code ¹	Issue Date	Name of Patentee or Applicant of cited Document	Pages,Columns,Lines where Relevant Passages or Relevant Figures Appear
	1					

If you wish to add additional U.S. Patent citation information please click the Add button.

U.S.PATENT APPLICATION PUBLICATIONS						
Examiner Initial*	Cite No	Publication Number	Kind Code ¹	Publication Date	Name of Patentee or Applicant of cited Document	Pages,Columns,Lines where Relevant Passages or Relevant Figures Appear
	1					

If you wish to add additional U.S. Published Application citation information please click the Add button.

FOREIGN PATENT DOCUMENTS								
Examiner Initial*	Cite No	Foreign Document Number ³	Country Code ²	Kind Code ⁴	Publication Date	Name of Patentee or Applicant of cited Document	Pages,Columns,Lines where Relevant Passages or Relevant Figures Appear	T ⁵
	1							<input type="checkbox"/>

If you wish to add additional Foreign Patent Document citation information please click the Add button

NON-PATENT LITERATURE DOCUMENTS			
Examiner Initials*	Cite No	Include name of the author (in CAPITAL LETTERS), title of the article (when appropriate), title of the item (book, magazine, journal, serial, symposium, catalog, etc), date, pages(s), volume-issue number(s), publisher, city and/or country where published.	T ⁵

Receipt date: 01/27/2011 INFORMATION DISCLOSURE STATEMENT BY APPLICANT (Not for submission under 37 CFR 1.99)	Application Number		12495190
	Filing Date		2009-06-30
	First Named Inventor	Russell W. White, et al.	
	Art Unit		2617
	Examiner Name	Erika A. Gary	
	Attorney Docket Number		AFF.004C7US

1	The Rio 500 Getting Started Guide, 1999, pp. 1-2.	<input type="checkbox"/>
2	"Visteon's Mobile Office Solutions Give Busy Commuters More of What They Need - Time," Canada Newswire, Sept. 15, 1999, 3 pages.	<input type="checkbox"/>
3	Hiatt, "RIAA Sues Napster, Claiming 'Music Piracy'," MTV News, Dec. 8, 1999, 3 pages.	<input type="checkbox"/>
4	Sony VAIO Notebook Computer User Guide PCG-731/PCG-735, 1998, pp. 1-131.	<input type="checkbox"/>
5	Sony VAIO Notebook Computer User Guide PCG-812, 1998, pp. 1-144.	<input type="checkbox"/>
6	Sony VAIO Notebook Computer User Guide PCG-838, 1999, pp. 1-121.	<input type="checkbox"/>
7	Sony Service Manual PCG-731/735/737, 1997, pp. 1-22.	<input type="checkbox"/>
8	Sony Service Manual PCG-723/729, 1998, pp. 1-22.	<input type="checkbox"/>
9		<input type="checkbox"/>
10	Sony Service Manual PCG-812/818, 1998, pp. 1 - 22.	<input type="checkbox"/>
11	Sony Service Manual PCG-838, 1999, pp. 1 - 22.	<input type="checkbox"/>

Receipt date: 01/27/2011 INFORMATION DISCLOSURE STATEMENT BY APPLICANT (Not for submission under 37 CFR 1.99)	Application Number		12495190
	Filing Date		2009-06-30
	First Named Inventor	Russell W. White, et al.	
	Art Unit		2617
	Examiner Name	Erika A. Gary	
	Attorney Docket Number		AFF.004C7US

12	"Digital Download Provider Musicmaker.com Partners With Download Directory Listen.com; Offers Nearly 100,000 Downloadable Tracks Via the Online Directory," PR Newswire, Sept. 15, 1999, pp. 1-3.	<input type="checkbox"/>
13	MP3.com prospectus, Jul. 21, 1999, pp. 1 - 81.	<input type="checkbox"/>
14	Ana Orubeondo, "Trim AirCard 300 Eases Power Demands," InfoWorld, Volume 21, Issue 48. Nov. 29, 1999. pg 46 & 50.	<input type="checkbox"/>
15	"Net Music Firms to Tap Public Market," Billboard. Jul. 17, 1999. pp. 1 - 2.	<input type="checkbox"/>
16	"Cellular for Notebook PCs." CIO Vo.. 13, No. 1. Oct. 1, 1999, pg. 90.	<input type="checkbox"/>
17	"Briefs," Network World. Volume 16, no. 24. Aug. 23, 1999, pg. 27.	<input type="checkbox"/>
18	The MusicMatch.com website (date unknown, contended by defendant Apple Corp. to be prior art under one or more of 35 U.S.C. 102 (a), (b), (f) and (g)) 32 pages.	<input type="checkbox"/>
19	The MusicMaker.com website (date unknown, contended by defendant Apple Corp. to be prior art under one or more of 35 U.S.C. 102 (a), (b), (f) and (g)), 10 pages.	<input type="checkbox"/>
20	Qualcomm QCP-1960 User Manual. Apr. 1999, pp. 1 - 76.	<input type="checkbox"/>
21	Samsung SCH-3500 User Manual. 1999, pp. 1 - 108.	<input type="checkbox"/>
22	Motorola Digital StarTAC User Guide. Mar. 1999, pp. 1 - 118.	<input type="checkbox"/>

Receipt date: 01/27/2011 INFORMATION DISCLOSURE STATEMENT BY APPLICANT (Not for submission under 37 CFR 1.99)	Application Number		12495190
	Filing Date		2009-06-30
	First Named Inventor	Russell W. White, et al.	
	Art Unit		2617
	Examiner Name	Erika A. Gary	
	Attorney Docket Number		AFF.004C7US

23	Nokia 9110 Quick Guide/Accessories Guide. 1999, pp. 1-31.	<input type="checkbox"/>
24	"MP3.com and i-drive.com Join Forces to Store and Manage MP3 Files," Business Wire, Oct. 7, 1999, pp. 1-3.	<input type="checkbox"/>
25	Nomad User Guide, Jun. 1999, pp. 1-34.	<input type="checkbox"/>
26	Nomad II Getting Started Manual, Jan. 2000, pp. 1 - 38.	<input type="checkbox"/>
27	GSM 03.64 version 6.2.0 Release 1997, European Telecommunications Standards Institute, 1999, pp. 1 - 42.	<input type="checkbox"/>
28	The i-Drive.com website (date unknown, contended by defendant Apple Corp. to be prior art under one or more of 35 U.S.C. 102 (a), (b), (f) and (g)) 6 pages.	<input type="checkbox"/>
29	GSM 03.64 version 7.0.0 Release 1997, European Telecommunications Standards Institute, 1999, pp. 1-42.	<input type="checkbox"/>
30	Specification of the Bluetooth System Version 1.0B (Vol. 1), Telefonaktiebolaget LM Ericsson et al. Dec. 1, 1999, pp. 1-1082.	<input type="checkbox"/>
31	Specification of the Bluetooth System Version 1.0B (Vol. 2), Telefonaktiebolaget LM Ericsson et al. Dec. 1, 1999, pp. 1-440.	<input type="checkbox"/>
32	The MP3.com website (date unknown, contended by defendant Apple Corp. to be prior art under one or more of 35 U.S.C. 102 (a), (b), (f) and (g)) Screenshots from MP3.com website (date unknown, contended by defendant Apple Corp. to be prior art under one or more of 35 U.S.C. 102 (a), (b), (f) and (g)), 6 pages.	<input type="checkbox"/>
33	MP3.com and i-drive.com Join Forces to Store and Manage MP3 Files, Business Wire, Oct. 7, 1999, pp. 1-3.	<input type="checkbox"/>

Receipt date: 01/27/2011 INFORMATION DISCLOSURE STATEMENT BY APPLICANT (Not for submission under 37 CFR 1.99)	Application Number		12495190
	Filing Date		2009-06-30
	First Named Inventor	Russell W. White, et al.	
	Art Unit		2617
	Examiner Name	Erika A. Gary	
	Attorney Docket Number		AFF.004C7US

34	The EMusic.com website (formerly www.goodnoise.com) (date unknown, contended by defendant Apple Corp. to be prior art under one or more of 35 U.S.C. 102 (a), (b), (f) and (g)) 2 pages.	<input type="checkbox"/>
35	EMusic.com prospectus, Sept. 24, 1999, pp. 1 - 61, F1 - F41.	<input type="checkbox"/>
36	"Logging On; Setting Sound Free From the CD," The Washington Post, Mar. 3, 2000, pp. 1-3.	<input type="checkbox"/>
37	"Music Factory; Retailers Struggle to Expand Listening Options Online," Contra Costa Times Mar. 19, 2000, pp. 1-2.	<input type="checkbox"/>
38	The MyPlay.com website (date unknown, contended by defendant Apple Corp. to be prior art under one or more of 35 U.S.C. 102 (a), (b), (f) and (g)) 1 page.	<input type="checkbox"/>
39	Myplay.com Launches Today, PR Newswire. Oct. 13, 1999, pp. 1-2.	<input type="checkbox"/>
40	Myplay, Inc. Launches Consumer Online Music Service, PR Newswire, Oct. 13, 1999, pp. 1-3.	<input type="checkbox"/>
41	Empeg.com, "Does Your Car Stereo Run Linux," (date unknown, contended by defendant Apple Corp. to be prior art under one or more of 35 U.S.C. 102 (a), (b), (f) and (g)), 2 pages.	<input type="checkbox"/>
42	TIA/EIA Interim Standard, Cellular Digital Packet Data, System Specification - Part 403, Mobile Data Link Protocol, Telecommunications Industry Association. Dec. 1997, 83 pages.	<input type="checkbox"/>
43	"The Listen Up Player from Audio Highway" 1996. 1 page.	<input type="checkbox"/>
44	"Audio Highway Announces The Listen Up Player," Audio Highway Press Release, Sept. 23, 1996, 2 pages.	<input type="checkbox"/>

Receipt date: 01/27/2011 INFORMATION DISCLOSURE STATEMENT BY APPLICANT (Not for submission under 37 CFR 1.99)	Application Number		12495190
	Filing Date		2009-06-30
	First Named Inventor	Russell W. White, et al.	
	Art Unit		2617
	Examiner Name	Erika A. Gary	
	Attorney Docket Number		AFF.004C7US

45	MPMan F-10 and F-20 digital audio players and review article "MP3 Player Saehan MPMAN F20 Review", X-bit labs, July 14, 1999. 6 pages.	<input type="checkbox"/>
46	Menta, "RIAA Sues Music Startup Napster for \$20 Billion" Newswire, Jan. 11, 2000, 4 pages.	<input type="checkbox"/>
47	Boehrlart, "Artists to Napster: Drop Dead" Salon.com, Mar. 24, 2000. 3 pages.	<input type="checkbox"/>

If you wish to add additional non-patent literature document citation information please click the Add button

EXAMINER SIGNATURE

Examiner Signature	/Erika Gary/ (02/17/2011)	Date Considered	02/17/2011
--------------------	---------------------------	-----------------	------------

*EXAMINER: Initial if reference considered, whether or not citation is in conformance with MPEP 609. Draw line through a citation if not in conformance and not considered. Include copy of this form with next communication to applicant.

¹ See Kind Codes of USPTO Patent Documents at www.USPTO.GOV or MPEP 901.04. ² Enter office that issued the document, by the two-letter code (WIPO Standard ST.3). ³ For Japanese patent documents, the indication of the year of the reign of the Emperor must precede the serial number of the patent document. ⁴ Kind of document by the appropriate symbols as indicated on the document under WIPO Standard ST.16 if possible. ⁵ Applicant is to place a check mark here if English language translation is attached.

Receipt date: 01/27/2011

Doc code: IDS

Doc description: Information Disclosure Statement (IDS) Filed

PTO/SB/08a (01-10)

Approved for use through 07/31/2012. OMB 0651-0031

U.S. Patent and Trademark Office; U.S. DEPARTMENT OF COMMERCE

Under the Paperwork Reduction Act of 1995, no persons are required to respond to a collection of information unless it contains a valid OMB control number.

INFORMATION DISCLOSURE STATEMENT BY APPLICANT (Not for submission under 37 CFR 1.99)	Application Number		12495190	
	Filing Date		2009-06-30	
	First Named Inventor	Russell W. White, et al.		
	Art Unit		2617	
	Examiner Name	Erika A. Gary		
	Attorney Docket Number		AFF.004C7US	

U.S.PATENTS						
Examiner Initial*	Cite No	Patent Number	Kind Code ¹	Issue Date	Name of Patentee or Applicant of cited Document	Pages,Columns,Lines where Relevant Passages or Relevant Figures Appear
	1					

If you wish to add additional U.S. Patent citation information please click the Add button.

U.S.PATENT APPLICATION PUBLICATIONS						
Examiner Initial*	Cite No	Publication Number	Kind Code ¹	Publication Date	Name of Patentee or Applicant of cited Document	Pages,Columns,Lines where Relevant Passages or Relevant Figures Appear
	1					

If you wish to add additional U.S. Published Application citation information please click the Add button.

FOREIGN PATENT DOCUMENTS								
Examiner Initial*	Cite No	Foreign Document Number ³	Country Code ²	Kind Code ⁴	Publication Date	Name of Patentee or Applicant of cited Document	Pages,Columns,Lines where Relevant Passages or Relevant Figures Appear	T ⁵
	1							<input type="checkbox"/>

If you wish to add additional Foreign Patent Document citation information please click the Add button

NON-PATENT LITERATURE DOCUMENTS			
Examiner Initials*	Cite No	Include name of the author (in CAPITAL LETTERS), title of the article (when appropriate), title of the item (book, magazine, journal, serial, symposium, catalog, etc), date, pages(s), volume-issue number(s), publisher, city and/or country where published.	T ⁵

Receipt date: 01/27/2011 INFORMATION DISCLOSURE STATEMENT BY APPLICANT (Not for submission under 37 CFR 1.99)	Application Number		12495190
	Filing Date		2009-06-30
	First Named Inventor	Russell W. White, et al.	
	Art Unit		2617
	Examiner Name	Erika A. Gary	
	Attorney Docket Number		AFF.004C7US

1	The Rio 500 Getting Started Guide, 1999, pp. 1-2.	<input type="checkbox"/>
2	"Visteon's Mobile Office Solutions Give Busy Commuters More of What They Need - Time," Canada Newswire, Sept. 15, 1999, 3 pages.	<input type="checkbox"/>
3	Hiatt, "RIAA Sues Napster, Claiming 'Music Piracy'," MTV News, Dec. 8, 1999, 3 pages.	<input type="checkbox"/>
4	Sony VAIO Notebook Computer User Guide PCG-731/PCG-735, 1998, pp. 1-131.	<input type="checkbox"/>
5	Sony VAIO Notebook Computer User Guide PCG-812, 1998, pp. 1-144.	<input type="checkbox"/>
6	Sony VAIO Notebook Computer User Guide PCG-838, 1999, pp. 1-121.	<input type="checkbox"/>
7	Sony Service Manual PCG-731/735/737, 1997, pp. 1-22.	<input type="checkbox"/>
8	Sony Service Manual PCG-723/729, 1998, pp. 1-22.	<input type="checkbox"/>
9	Sony VAIO Notebook Computer User Guide PCG-838, 1999. pp. 1 - 121.	<input type="checkbox"/>
10	Sony Service Manual PCG-812/818, 1998, pp. 1 - 22.	<input type="checkbox"/>
11	Sony Service Manual PCG-838, 1999, pp. 1 - 22.	<input type="checkbox"/>

Receipt date: 01/27/2011 INFORMATION DISCLOSURE STATEMENT BY APPLICANT (Not for submission under 37 CFR 1.99)	Application Number	12495190
	Filing Date	2009-06-30
	First Named Inventor	Russell W. White, et al.
	Art Unit	2617
	Examiner Name	Erika A. Gary
	Attorney Docket Number	AFF.004C7US

12	"Digital Download Provider Musicmaker.com Partners With Download Directory Listen.com; Offers Nearly 100,000 Downloadable Tracks Via the Online Directory," PR Newswire, Sept. 15, 1999, pp. 1-3.	<input type="checkbox"/>
13	MP3.com prospectus, Jul. 21, 1999, pp. 1 - 81.	<input type="checkbox"/>
14	Ana Orubeondo, "Trim AirCard 300 Eases Power Demands," InfoWorld, Volume 21, Issue 48. Nov. 29, 1999. pg 46 & 50.	<input type="checkbox"/>
15	"Net Music Firms to Tap Public Market," Billboard. Jul. 17, 1999. pp. 1 - 2.	<input type="checkbox"/>
16	"Cellular for Notebook PCs." CIO Vo.. 13, No. 1. Oct. 1, 1999, pg. 90.	<input type="checkbox"/>
17	"Briefs," Network World. Volume 16, no. 24. Aug. 23, 1999, pg. 27.	<input type="checkbox"/>
18	The MusicMatch.com website (date unknown, contended by defendant Apple Corp. to be prior art under one or more of 35 U.S.C. 102 (a), (b), (f) and (g)) 32 pages.	<input type="checkbox"/>
19	The MusicMaker.com website (date unknown, contended by defendant Apple Corp. to be prior art under one or more of 35 U.S.C. 102 (a), (b), (f) and (g)), 10 pages.	<input type="checkbox"/>
20	Qualcomm QCP-1960 User Manual. Apr. 1999, pp. 1 - 76.	<input type="checkbox"/>
21	Samsung SCH-3500 User Manual. 1999, pp. 1 - 108.	<input type="checkbox"/>
22	Motorola Digital StarTAC User Guide. Mar. 1999, pp. 1 - 118.	<input type="checkbox"/>

Receipt date: 01/27/2011 INFORMATION DISCLOSURE STATEMENT BY APPLICANT (Not for submission under 37 CFR 1.99)	Application Number		12495190
	Filing Date		2009-06-30
	First Named Inventor	Russell W. White, et al.	
	Art Unit		2617
	Examiner Name	Erika A. Gary	
	Attorney Docket Number		AFF.004C7US

23	Nokia 9110 Quick Guide/Accessories Guide. 1999, pp. 1-31.	<input type="checkbox"/>
24	"MP3.com and i-drive.com Join Forces to Store and Manage MP3 Files," Business Wire, Oct. 7, 1999, pp. 1-3.	<input type="checkbox"/>
25	Nomad User Guide, Jun. 1999, pp. 1-34.	<input type="checkbox"/>
26	Nomad II Getting Started Manual, Jan. 2000, pp. 1 - 38.	<input type="checkbox"/>
27	GSM 03.64 version 6.2.0 Release 1997, European Telecommunications Standards Institute, 1999, pp. 1 - 42.	<input type="checkbox"/>
28	The i-Drive.com website (date unknown, contended by defendant Apple Corp. to be prior art under one or more of 35 U.S.C. 102 (a), (b), (f) and (g)) 6 pages.	<input type="checkbox"/>
29	GSM 03.64 version 7.0.0 Release 1997, European Telecommunications Standards Institute, 1999, pp. 1-42.	<input type="checkbox"/>
30	Specification of the Bluetooth System Version 1.0B (Vol. 1), Telefonaktiebolaget LM Ericsson et al. Dec. 1, 1999, pp. 1-1082.	<input type="checkbox"/>
31	Specification of the Bluetooth System Version 1.0B (Vol. 2), Telefonaktiebolaget LM Ericsson et al. Dec. 1, 1999, pp. 1-440.	<input type="checkbox"/>
32	The MP3.com website (date unknown, contended by defendant Apple Corp. to be prior art under one or more of 35 U.S.C. 102 (a), (b), (f) and (g)) Screenshots from MP3.com website (date unknown, contended by defendant Apple Corp. to be prior art under one or more of 35 U.S.C. 102 (a), (b), (f) and (g)), 6 pages.	<input type="checkbox"/>
33	MP3.com and i-drive.com Join Forces to Store and Manage MP3 Files, Business Wire, Oct. 7, 1999, pp. 1-3.	<input type="checkbox"/>

Receipt date: 01/27/2011 INFORMATION DISCLOSURE STATEMENT BY APPLICANT (Not for submission under 37 CFR 1.99)	Application Number		12495190
	Filing Date		2009-06-30
	First Named Inventor	Russell W. White, et al.	
	Art Unit		2617
	Examiner Name	Erika A. Gary	
	Attorney Docket Number		AFF.004C7US

34	The EMusic.com website (formerly www.goodnoise.com) (date unknown, contended by defendant Apple Corp. to be prior art under one or more of 35 U.S.C. 102 (a), (b), (f) and (g)) 2 pages.	<input type="checkbox"/>
35	EMusic.com prospectus, Sept. 24, 1999, pp. 1 - 61, F1 - F41.	<input type="checkbox"/>
36	"Logging On; Setting Sound Free From the CD," The Washington Post, Mar. 3, 2000, pp. 1-3.	<input type="checkbox"/>
37	"Music Factory; Retailers Struggle to Expand Listening Options Online," Contra Costa Times Mar. 19, 2000, pp. 1- 2.	<input type="checkbox"/>
38	The MyPlay.com website (date unknown, contended by defendant Apple Corp. to be prior art under one or more of 35 U.S.C. 102 (a), (b), (f) and (g)) 1 page.	<input type="checkbox"/>
39	Myplay.com Launches Today, PR Newswire. Oct. 13, 1999, pp. 1-2.	<input type="checkbox"/>
40	Myplay, Inc. Launches Consumer Online Music Service, PR Newswire, Oct. 13, 1999, pp. 1-3.	<input type="checkbox"/>
41	Empeg.com, "Does Your Car Stereo Run Linux," (date unknown, contended by defendant Apple Corp. to be prior art under one or more of 35 U.S.C. 102 (a), (b), (f) and (g)), 2 pages.	<input type="checkbox"/>
42	TIA/EIA Interim Standard, Cellular Digital Packet Data, System Specification - Part 403, Mobile Data Link Protocol, Telecommunications Industry Association. Dec. 1997, 83 pages.	<input type="checkbox"/>
43	"The Listen Up Player from Audio Highway" 1996. 1 page.	<input type="checkbox"/>
44	"Audio Highway Announces The Listen Up Player," Audio Highway Press Release, Sept. 23, 1996, 2 pages.	<input type="checkbox"/>

Receipt date: 01/27/2011 INFORMATION DISCLOSURE STATEMENT BY APPLICANT (Not for submission under 37 CFR 1.99)	Application Number		12495190
	Filing Date		2009-06-30
	First Named Inventor	Russell W. White, et al.	
	Art Unit		2617
	Examiner Name	Erika A. Gary	
	Attorney Docket Number		AFF.004C7US

45	MPMan F-10 and F-20 digital audio players and review article "MP3 Player Saehan MPMAN F20 Review", X-bit labs, July 14, 1999. 6 pages.	<input type="checkbox"/>
46	Menta, "RIAA Sues Music Startup Napster for \$20 Billion" Newswire, Jan. 11, 2000, 4 pages.	<input type="checkbox"/>
47	Boehrlart, "Artists to Napster: Drop Dead" Salon.com, Mar. 24, 2000. 3 pages.	<input type="checkbox"/>

If you wish to add additional non-patent literature document citation information please click the Add button

EXAMINER SIGNATURE

Examiner Signature	/Erika Gary/ (02/17/2011)	Date Considered	02/17/2011
--------------------	---------------------------	-----------------	------------

*EXAMINER: Initial if reference considered, whether or not citation is in conformance with MPEP 609. Draw line through a citation if not in conformance and not considered. Include copy of this form with next communication to applicant.

¹ See Kind Codes of USPTO Patent Documents at www.USPTO.GOV or MPEP 901.04. ² Enter office that issued the document, by the two-letter code (WIPO Standard ST.3). ³ For Japanese patent documents, the indication of the year of the reign of the Emperor must precede the serial number of the patent document. ⁴ Kind of document by the appropriate symbols as indicated on the document under WIPO Standard ST.16 if possible. ⁵ Applicant is to place a check mark here if English language translation is attached.

Receipt date: 01/27/2011

Doc code: IDS

Doc description: Information Disclosure Statement (IDS) Filed

PTO/SB/08a (01-10)

Approved for use through 07/31/2012. OMB 0651-0031

U.S. Patent and Trademark Office; U.S. DEPARTMENT OF COMMERCE

Under the Paperwork Reduction Act of 1995, no persons are required to respond to a collection of information unless it contains a valid OMB control number.

INFORMATION DISCLOSURE STATEMENT BY APPLICANT (Not for submission under 37 CFR 1.99)	Application Number		12495190	
	Filing Date		2009-06-30	
	First Named Inventor	Russell W. White, et al.		
	Art Unit		2617	
	Examiner Name	Erika A. Gary		
	Attorney Docket Number		AFF.004C7US	

U.S.PATENTS						
Examiner Initial*	Cite No	Patent Number	Kind Code ¹	Issue Date	Name of Patentee or Applicant of cited Document	Pages,Columns,Lines where Relevant Passages or Relevant Figures Appear
	1					

If you wish to add additional U.S. Patent citation information please click the Add button.

U.S.PATENT APPLICATION PUBLICATIONS						
Examiner Initial*	Cite No	Publication Number	Kind Code ¹	Publication Date	Name of Patentee or Applicant of cited Document	Pages,Columns,Lines where Relevant Passages or Relevant Figures Appear
	1					

If you wish to add additional U.S. Published Application citation information please click the Add button.

FOREIGN PATENT DOCUMENTS								
Examiner Initial*	Cite No	Foreign Document Number ³	Country Code ²	Kind Code ⁴	Publication Date	Name of Patentee or Applicant of cited Document	Pages,Columns,Lines where Relevant Passages or Relevant Figures Appear	T ⁵
	1							<input type="checkbox"/>

If you wish to add additional Foreign Patent Document citation information please click the Add button

NON-PATENT LITERATURE DOCUMENTS			
Examiner Initials*	Cite No	Include name of the author (in CAPITAL LETTERS), title of the article (when appropriate), title of the item (book, magazine, journal, serial, symposium, catalog, etc), date, pages(s), volume-issue number(s), publisher, city and/or country where published.	T ⁵

Receipt date: 01/27/2011 INFORMATION DISCLOSURE STATEMENT BY APPLICANT (Not for submission under 37 CFR 1.99)	Application Number		12495190
	Filing Date		2009-06-30
	First Named Inventor	Russell W. White, et al.	
	Art Unit		2617
	Examiner Name	Erika A. Gary	
	Attorney Docket Number		AFF.004C7US

1	The Rio 500 Getting Started Guide, 1999, pp. 1-2.	<input type="checkbox"/>
2	"Visteon's Mobile Office Solutions Give Busy Commuters More of What They Need - Time," Canada Newswire, Sept. 15, 1999, 3 pages.	<input type="checkbox"/>
3	Hiatt, "RIAA Sues Napster, Claiming 'Music Piracy'," MTV News, Dec. 8, 1999, 3 pages.	<input type="checkbox"/>
4	Sony VAIO Notebook Computer User Guide PCG-731/PCG-735, 1998, pp. 1-131.	<input type="checkbox"/>
5	Sony VAIO Notebook Computer User Guide PCG-812, 1998, pp. 1-144.	<input type="checkbox"/>
6	Sony VAIO Notebook Computer User Guide PCG-838, 1999, pp. 1-121.	<input type="checkbox"/>
7	Sony Service Manual PCG-731/735/737, 1997, pp. 1-22.	<input type="checkbox"/>
8	Sony Service Manual PCG-723/729, 1998, pp. 1-22.	<input type="checkbox"/>
9		<input type="checkbox"/>
10	Sony Service Manual PCG-812/818, 1998, pp. 1 - 22.	<input type="checkbox"/>
11	Sony Service Manual PCG-838, 1999, pp. 1 - 22.	<input type="checkbox"/>

Receipt date: 01/27/2011 INFORMATION DISCLOSURE STATEMENT BY APPLICANT (Not for submission under 37 CFR 1.99)	Application Number		12495190
	Filing Date		2009-06-30
	First Named Inventor	Russell W. White, et al.	
	Art Unit		2617
	Examiner Name	Erika A. Gary	
	Attorney Docket Number		AFF.004C7US

12	"Digital Download Provider Musicmaker.com Partners With Download Directory Listen.com; Offers Nearly 100,000 Downloadable Tracks Via the Online Directory," PR Newswire, Sept. 15, 1999, pp. 1-3.	<input type="checkbox"/>
13	MP3.com prospectus, Jul. 21, 1999, pp. 1 - 81.	<input type="checkbox"/>
14	Ana Orubeondo, "Trim AirCard 300 Eases Power Demands," InfoWorld, Volume 21, Issue 48. Nov. 29, 1999. pg 46 & 50.	<input type="checkbox"/>
15	"Net Music Firms to Tap Public Market," Billboard. Jul. 17, 1999. pp. 1 - 2.	<input type="checkbox"/>
16	"Cellular for Notebook PCs." CIO Vo.. 13, No. 1. Oct. 1, 1999, pg. 90.	<input type="checkbox"/>
17	"Briefs," Network World. Volume 16, no. 24. Aug. 23, 1999, pg. 27.	<input type="checkbox"/>
18	The MusicMatch.com website (date unknown, contended by defendant Apple Corp. to be prior art under one or more of 35 U.S.C. 102 (a), (b), (f) and (g)) 32 pages.	<input type="checkbox"/>
19	The MusicMaker.com website (date unknown, contended by defendant Apple Corp. to be prior art under one or more of 35 U.S.C. 102 (a), (b), (f) and (g)), 10 pages.	<input type="checkbox"/>
20	Qualcomm QCP-1960 User Manual. Apr. 1999, pp. 1 - 76.	<input type="checkbox"/>
21	Samsung SCH-3500 User Manual. 1999, pp. 1 - 108.	<input type="checkbox"/>
22	Motorola Digital StarTAC User Guide. Mar. 1999, pp. 1 - 118.	<input type="checkbox"/>

Receipt date: 01/27/2011 INFORMATION DISCLOSURE STATEMENT BY APPLICANT (Not for submission under 37 CFR 1.99)	Application Number		12495190
	Filing Date		2009-06-30
	First Named Inventor	Russell W. White, et al.	
	Art Unit		2617
	Examiner Name	Erika A. Gary	
	Attorney Docket Number		AFF.004C7US

23	Nokia 9110 Quick Guide/Accessories Guide. 1999, pp. 1-31.	<input type="checkbox"/>
24	"MP3.com and i-drive.com Join Forces to Store and Manage MP3 Files," Business Wire, Oct. 7, 1999, pp. 1-3.	<input type="checkbox"/>
25	Nomad User Guide, Jun. 1999, pp. 1-34.	<input type="checkbox"/>
26	Nomad II Getting Started Manual, Jan. 2000, pp. 1 - 38.	<input type="checkbox"/>
27	GSM 03.64 version 6.2.0 Release 1997, European Telecommunications Standards Institute, 1999, pp. 1 - 42.	<input type="checkbox"/>
28	The i-Drive.com website (date unknown, contended by defendant Apple Corp. to be prior art under one or more of 35 U.S.C. 102 (a), (b), (f) and (g)) 6 pages.	<input type="checkbox"/>
29	GSM 03.64 version 7.0.0 Release 1997, European Telecommunications Standards Institute, 1999, pp. 1-42.	<input type="checkbox"/>
30		<input type="checkbox"/>
31		<input type="checkbox"/>
32	The MP3.com website (date unknown, contended by defendant Apple Corp. to be prior art under one or more of 35 U.S.C. 102 (a), (b), (f) and (g)) Screenshots from MP3.com website (date unknown, contended by defendant Apple Corp. to be prior art under one or more of 35 U.S.C. 102 (a), (b), (f) and (g)), 6 pages.	<input type="checkbox"/>
33	MP3.com and i-drive.com Join Forces to Store and Manage MP3 Files, Business Wire, Oct. 7, 1999, pp. 1-3.	<input type="checkbox"/>

Receipt date: 01/27/2011 INFORMATION DISCLOSURE STATEMENT BY APPLICANT (Not for submission under 37 CFR 1.99)	Application Number	12495190
	Filing Date	2009-06-30
	First Named Inventor	Russell W. White, et al.
	Art Unit	2617
	Examiner Name	Erika A. Gary
	Attorney Docket Number	AFF.004C7US

34	The EMusic.com website (formerly www.goodnoise.com) (date unknown, contended by defendant Apple Corp. to be prior art under one or more of 35 U.S.C. 102 (a), (b), (f) and (g)) 2 pages.	<input type="checkbox"/>
35	EMusic.com prospectus, Sept. 24, 1999, pp. 1 - 61, F1 - F41.	<input type="checkbox"/>
36	"Logging On; Setting Sound Free From the CD," The Washington Post, Mar. 3, 2000, pp. 1-3.	<input type="checkbox"/>
37	"Music Factory; Retailers Struggle to Expand Listening Options Online," Contra Costa Times Mar. 19, 2000, pp. 1-2.	<input type="checkbox"/>
38	The MyPlay.com website (date unknown, contended by defendant Apple Corp. to be prior art under one or more of 35 U.S.C. 102 (a), (b), (f) and (g)) 1 page.	<input type="checkbox"/>
39	Myplay.com Launches Today, PR Newswire. Oct. 13, 1999, pp. 1-2.	<input type="checkbox"/>
40	Myplay, Inc. Launches Consumer Online Music Service, PR Newswire, Oct. 13, 1999, pp. 1-3.	<input type="checkbox"/>
41	Empeg.com, "Does Your Car Stereo Run Linux," (date unknown, contended by defendant Apple Corp. to be prior art under one or more of 35 U.S.C. 102 (a), (b), (f) and (g)), 2 pages.	<input type="checkbox"/>
42	TIA/EIA Interim Standard, Cellular Digital Packet Data, System Specification - Part 403, Mobile Data Link Protocol, Telecommunications Industry Association. Dec. 1997, 83 pages.	<input type="checkbox"/>
43	"The Listen Up Player from Audio Highway" 1996. 1 page.	<input type="checkbox"/>
44	"Audio Highway Announces The Listen Up Player," Audio Highway Press Release, Sept. 23, 1996, 2 pages.	<input type="checkbox"/>

Receipt date: 01/27/2011 INFORMATION DISCLOSURE STATEMENT BY APPLICANT (Not for submission under 37 CFR 1.99)	Application Number		12495190
	Filing Date		2009-06-30
	First Named Inventor	Russell W. White, et al.	
	Art Unit		2617
	Examiner Name	Erika A. Gary	
	Attorney Docket Number		AFF.004C7US

45	MPMan F-10 and F-20 digital audio players and review article "MP3 Player Saehan MPMan F20 Review", X-bit labs, July 14, 1999. 6 pages.	<input type="checkbox"/>
46	Menta, "RIAA Sues Music Startup Napster for \$20 Billion" Newswire, Jan. 11, 2000, 4 pages.	<input type="checkbox"/>
47	Boehrlart, "Artists to Napster: Drop Dead" Salon.com, Mar. 24, 2000. 3 pages.	<input type="checkbox"/>

If you wish to add additional non-patent literature document citation information please click the Add button

EXAMINER SIGNATURE

Examiner Signature	/Erika Gary/ (02/17/2011)	Date Considered	02/17/2011
--------------------	---------------------------	-----------------	------------

*EXAMINER: Initial if reference considered, whether or not citation is in conformance with MPEP 609. Draw line through a citation if not in conformance and not considered. Include copy of this form with next communication to applicant.

¹ See Kind Codes of USPTO Patent Documents at www.USPTO.GOV or MPEP 901.04. ² Enter office that issued the document, by the two-letter code (WIPO Standard ST.3). ³ For Japanese patent documents, the indication of the year of the reign of the Emperor must precede the serial number of the patent document. ⁴ Kind of document by the appropriate symbols as indicated on the document under WIPO Standard ST.16 if possible. ⁵ Applicant is to place a check mark here if English language translation is attached.

Receipt date: 01/31/2011

Doc code: IDS

Doc description: Information Disclosure Statement (IDS) Filed

PTO/SB/08a (01-10)

Approved for use through 07/31/2012. OMB 0651-0031

U.S. Patent and Trademark Office; U.S. DEPARTMENT OF COMMERCE

Under the Paperwork Reduction Act of 1995, no persons are required to respond to a collection of information unless it contains a valid OMB control number.

INFORMATION DISCLOSURE STATEMENT BY APPLICANT (Not for submission under 37 CFR 1.99)	Application Number		12495190	
	Filing Date		2009-06-30	
	First Named Inventor	Russell W. White, et al.		
	Art Unit		2617	
	Examiner Name	Erika A. Gary		
	Attorney Docket Number		AFF.004C7US	

U.S.PATENTS						
Examiner Initial*	Cite No	Patent Number	Kind Code ¹	Issue Date	Name of Patentee or Applicant of cited Document	Pages,Columns,Lines where Relevant Passages or Relevant Figures Appear
	1					

If you wish to add additional U.S. Patent citation information please click the Add button.

U.S.PATENT APPLICATION PUBLICATIONS						
Examiner Initial*	Cite No	Publication Number	Kind Code ¹	Publication Date	Name of Patentee or Applicant of cited Document	Pages,Columns,Lines where Relevant Passages or Relevant Figures Appear
	1					

If you wish to add additional U.S. Published Application citation information please click the Add button.

FOREIGN PATENT DOCUMENTS								
Examiner Initial*	Cite No	Foreign Document Number ³	Country Code ²	Kind Code ⁴	Publication Date	Name of Patentee or Applicant of cited Document	Pages,Columns,Lines where Relevant Passages or Relevant Figures Appear	T ⁵
	1							<input type="checkbox"/>

If you wish to add additional Foreign Patent Document citation information please click the Add button

NON-PATENT LITERATURE DOCUMENTS			
Examiner Initials*	Cite No	Include name of the author (in CAPITAL LETTERS), title of the article (when appropriate), title of the item (book, magazine, journal, serial, symposium, catalog, etc), date, pages(s), volume-issue number(s), publisher, city and/or country where published.	T ⁵

Receipt date: 01/31/2011 INFORMATION DISCLOSURE STATEMENT BY APPLICANT (Not for submission under 37 CFR 1.99)	Application Number		12495190
	Filing Date		2009-06-30
	First Named Inventor	Russell W. White, et al.	
	Art Unit		2617
	Examiner Name	Erika A. Gary	
	Attorney Docket Number		AFF.004C7US

1	Riocar dot org, "rio car dot org Geek Guide," empeg car Mk.1, July 16, 2010, 4 pages.	<input type="checkbox"/>
2	The MP3.com website (date unknown, contended by defendant Apple Corp. to be prior art under one or more of 35 U.S.C. 102 (a), (b), (f) and (g)) Screenshots from MP3.com website (date unknown, contended by defendant Apple Corp. to be prior art under one or more of 35 U.S.C. 102 (a), (b), (f) and (g)), 8 pages.	<input type="checkbox"/>

If you wish to add additional non-patent literature document citation information please click the Add button

EXAMINER SIGNATURE

Examiner Signature	/Erika Gary/ (02/17/2011)	Date Considered	02/17/2011
--------------------	---------------------------	-----------------	------------

*EXAMINER: Initial if reference considered, whether or not citation is in conformance with MPEP 609. Draw line through a citation if not in conformance and not considered. Include copy of this form with next communication to applicant.

¹ See Kind Codes of USPTO Patent Documents at www.USPTO.GOV or MPEP 901.04. ² Enter office that issued the document, by the two-letter code (WIPO Standard ST.3). ³ For Japanese patent documents, the indication of the year of the reign of the Emperor must precede the serial number of the patent document. ⁴ Kind of document by the appropriate symbols as indicated on the document under WIPO Standard ST.16 if possible. ⁵ Applicant is to place a check mark here if English language translation is attached.

Receipt date: 12/09/2010

Doc code: IDS

Doc description: Information Disclosure Statement (IDS) Filed

PTO/SB/08a (01-10)

Approved for use through 07/31/2012. OMB 0651-0031

U.S. Patent and Trademark Office; U.S. DEPARTMENT OF COMMERCE

Under the Paperwork Reduction Act of 1995, no persons are required to respond to a collection of information unless it contains a valid OMB control number.

INFORMATION DISCLOSURE STATEMENT BY APPLICANT (Not for submission under 37 CFR 1.99)	Application Number	12495190
	Filing Date	2009-06-30
	First Named Inventor	Russell W. White, Jr.
	Art Unit	2617
	Examiner Name	Erika A. Gary
	Attorney Docket Number	AFF.0004C7US

U.S.PATENTS						
Examiner Initial*	Cite No	Patent Number	Kind Code ¹	Issue Date	Name of Patentee or Applicant of cited Document	Pages, Columns, Lines where Relevant Passages or Relevant Figures Appear
	1	5797089		1998-08-18	Nguyen, et al.	
	2	5991640		1999-11-23	Lilja, et al.	
	3	6338044		2002-01-08	Cook, et al.	
	4	7549007		2009-06-16	Smith, et al.	
	5	7139626		2006-11-21	Kataoka, et al.	
	6	5852775		1998-12-22	Hidary	
	7	5889852		1999-03-30	Rosecrans, et al.	
	8	6007228		1999-12-28	Agarwal, et al.	

Receipt date: 12/09/2010

**INFORMATION DISCLOSURE
STATEMENT BY APPLICANT**
(Not for submission under 37 CFR 1.99)

Application Number	12495190
Filing Date	2009-06-30
First Named Inventor	Russell W. White, Jr.
Art Unit	2617
Examiner Name	Erika A. Gary
Attorney Docket Number	AFF.0004C7US

9	7562392		2009-07-14	Rhoads, et al.	
10	6633932		2003-10-14	Bork, et al.	

If you wish to add additional U.S. Patent citation information please click the Add button.

U.S.PATENT APPLICATION PUBLICATIONS

Examiner Initial*	Cite No	Publication Number	Kind Code ¹	Publication Date	Name of Patentee or Applicant of cited Document	Pages, Columns, Lines where Relevant Passages or Relevant Figures Appear
1						

If you wish to add additional U.S. Published Application citation information please click the Add button.

FOREIGN PATENT DOCUMENTS

Examiner Initial*	Cite No	Foreign Document Number ³	Country Code ²	Kind Code ⁴	Publication Date	Name of Patentee or Applicant of cited Document	Pages, Columns, Lines where Relevant Passages or Relevant Figures Appear	T ⁵
1								<input type="checkbox"/>

If you wish to add additional Foreign Patent Document citation information please click the Add button

NON-PATENT LITERATURE DOCUMENTS

Examiner Initials*	Cite No	Include name of the author (in CAPITAL LETTERS), title of the article (when appropriate), title of the item (book, magazine, journal, serial, symposium, catalog, etc), date, pages(s), volume-issue number(s), publisher, city and/or country where published.	T ⁵
	1	CAI, JIAN, et al., "General Packet Radio Service in GSM," IEEE Communications Magazine, October 1997.	<input type="checkbox"/>
	2	RealNetworks, "RealPlayer Plus G2 Manual," Copyright 1998-1999.	<input type="checkbox"/>

Receipt date: 12/09/2010

**INFORMATION DISCLOSURE
STATEMENT BY APPLICANT**
(Not for submission under 37 CFR 1.99)

Application Number		12495190
Filing Date		2009-06-30
First Named Inventor	Russell W. White, Jr.	
Art Unit	2617	
Examiner Name	Erika A. Gary	
Attorney Docket Number	AFF.0004C7US	

3	RATHBONE, ANDY, "MP3 for Dummies," IDG Books Worldwide, Copyright 1999.	<input type="checkbox"/>
4	Affinity Labs of Texas, LLC v. BMW North America, LLC, et al., C.A. No. 9:08CV164 and Affinity Labs of Texas, LLC v. Alpine Electronics of America, Inc., et al., C.A. No. 9:08CV171, Eastern District of Texas, Order Construing Claim Terms of United States Pates No. 7,324,833, December 18, 2009, pp. 1-31.	<input type="checkbox"/>
5	Exhibit B to Third Party Requester's Comments to Patent Owner's Supplemental Reply of July 26, 2010 filed August 25, 2010 in Reexamination No. 95/001,262 (Declaration of Dr. Bruce Maggs dated August 25, 2010).	<input type="checkbox"/>
6	Exhibit A to Third Party Requester's Comments to Patent Owner's Reply of September 9, 2010 filed October 12, 2010 in Reexamination No. 95/001,263 (Declaration of Dr. Bruce Maggs dated October 12, 2010).	<input type="checkbox"/>
7	Nokia, "Quick Guide - Accessories Guide," Copyright 1999.	<input type="checkbox"/>

If you wish to add additional non-patent literature document citation information please click the Add button

EXAMINER SIGNATURE

Examiner Signature	/Erika Gary/ (02/17/2011)	Date Considered	02/17/2011
--------------------	---------------------------	-----------------	------------

*EXAMINER: Initial if reference considered, whether or not citation is in conformance with MPEP 609. Draw line through a citation if not in conformance and not considered. Include copy of this form with next communication to applicant.

¹ See Kind Codes of USPTO Patent Documents at www.USPTO.GOV or MPEP 901.04. ² Enter office that issued the document, by the two-letter code (WIPO Standard ST.3). ³ For Japanese patent documents, the indication of the year of the reign of the Emperor must precede the serial number of the patent document. ⁴ Kind of document by the appropriate symbols as indicated on the document under WIPO Standard ST.16 if possible. ⁵ Applicant is to place a check mark here if English language translation is attached.

Doc code: IDS

PTO/SB/08a (01-10)

Doc description: Information Disclosure Statement (IDS) Filed

Approved for use through 07/31/2012. OMB 0651-0031

U.S. Patent and Trademark Office; U.S. DEPARTMENT OF COMMERCE

Under the Paperwork Reduction Act of 1995, no persons are required to respond to a collection of information unless it contains a valid OMB control number.

INFORMATION DISCLOSURE STATEMENT BY APPLICANT (Not for submission under 37 CFR 1.99)	Application Number		12495115
	Filing Date		2009-06-30
	First Named Inventor	Russell W. White, Jr.	
	Art Unit	2617	
	Examiner Name	Erika A. Gary	
	Attorney Docket Number	AFF.0004C6US	

U.S.PATENTS						
Examiner Initial*	Cite No	Patent Number	Kind Code ¹	Issue Date	Name of Patentee or Applicant of cited Document	Pages, Columns, Lines where Relevant Passages or Relevant Figures Appear
	1	5797089		1998-08-18	Nguyen, et al.	
	2	5991640		1999-11-23	Lilja, et al.	
	3	6338044		2002-01-08	Cook, et al.	
	4	7549007		2009-06-16	Smith, et al.	
	5	7139626		2006-11-21	Kataoka, et al.	
	6	5852775		1998-12-22	Hidary	
	7	5889852		1999-03-30	Rosecrans, et al.	
	8	6007228		1999-12-28	Agarwal, et al.	

/Erika Gary/ (02/17/2011)

02/17/2011

Receipt date: 12/16/2010

Doc code: IDS

Doc description: Information Disclosure Statement (IDS) Filed

PTO/SB/08a (01-10)

Approved for use through 07/31/2012. OMB 0651-0031

U.S. Patent and Trademark Office; U.S. DEPARTMENT OF COMMERCE

Under the Paperwork Reduction Act of 1995, no persons are required to respond to a collection of information unless it contains a valid OMB control number.

INFORMATION DISCLOSURE STATEMENT BY APPLICANT (Not for submission under 37 CFR 1.99)	Application Number		12495190	
	Filing Date		2009-06-30	
	First Named Inventor	Russell White, et al.		
	Art Unit	2617		
	Examiner Name	Erika A. Gary		
	Attorney Docket Number	AFF.0004C7US		

U.S.PATENTS [Remove](#)

Examiner Initial*	Cite No	Patent Number	Kind Code ¹	Issue Date	Name of Patentee or Applicant of cited Document	Pages,Columns,Lines where Relevant Passages or Relevant Figures Appear
	1	4802492		1989-02-07	Grunstein	

If you wish to add additional U.S. Patent citation information please click the Add button. [Add](#)

U.S.PATENT APPLICATION PUBLICATIONS [Remove](#)

Examiner Initial*	Cite No	Publication Number	Kind Code ¹	Publication Date	Name of Patentee or Applicant of cited Document	Pages,Columns,Lines where Relevant Passages or Relevant Figures Appear
	1					

If you wish to add additional U.S. Published Application citation information please click the Add button. [Add](#)

FOREIGN PATENT DOCUMENTS [Remove](#)

Examiner Initial*	Cite No	Foreign Document Number ³	Country Code ² j	Kind Code ⁴	Publication Date	Name of Patentee or Applicant of cited Document	Pages,Columns,Lines where Relevant Passages or Relevant Figures Appear	T ⁵
	1	JP 3056721	JP		1998-12-02			<input type="checkbox"/>
	2	JP 10-356742	JP		2002-10-02			<input type="checkbox"/>

If you wish to add additional Foreign Patent Document citation information please click the Add button [Add](#)

NON-PATENT LITERATURE DOCUMENTS [Remove](#)

Receipt date: 12/16/2010 INFORMATION DISCLOSURE STATEMENT BY APPLICANT (Not for submission under 37 CFR 1.99)	Application Number		12495190
	Filing Date		2009-06-30
	First Named Inventor	Russell White, et al.	
	Art Unit		2617
	Examiner Name	Erika A. Gary	
	Attorney Docket Number		AFF.0004C7US

Examiner Initials*	Cite No	Include name of the author (in CAPITAL LETTERS), title of the article (when appropriate), title of the item (book, magazine, journal, serial, symposium, catalog, etc), date, pages(s), volume-issue number(s), publisher, city and/or country where published.	T ⁵
	1	U.S. Patent and Trademark Office, Office Action mailed May 24, 2010 with Reply filed on July 23, 2010 and supplemental reply filed on July 26, 2010 for U.S. patent reexamination no. 95/001,262.	<input type="checkbox"/>
	2	Third Party Requester's Comments to Patent Owner's Supplemental Reply of July 26, 2010 Pursuant to 37 C.F.R 1.947, filed on August 25, 2010 for U.S. patent reexamination no. 95/001,262.	<input type="checkbox"/>
	3	U.S. Patent and Trademark Office, Office Action mailed August 2, 2010 with Reply filed on October 1, 2010 for U.S. patent reexamination no. 95/001,266.	<input type="checkbox"/>
	4	U.S. Patent and Trademark Office, Office Action mailed July 7, 2009 with Reply filed on September 9, 2009 for U.S. patent reexamination no. 95/001,263.	<input type="checkbox"/>
	5	Third Party Requester's Comments to Patent Owner's Supplemental Reply of September 9, 2010 Pursuant to 37 C.F.R 1.947, filed on October 12, 2010 for U.S. patent reexamination no. 95/001,263.	<input type="checkbox"/>
	6	U.S. Patent and Trademark Office, Office Action mailed September 2, 2010 with Reply filed on November 2, 2010 for U.S. patent reexamination no. 95/001,281	<input type="checkbox"/>
	7	Third Party Requester's Comments to Patent Owner's Reply of October 1, 2010 Pursuant to 37 C.F.R 1.947, filed on November 1, 2010 for U.S. patent reexamination no. 95/001,266	<input type="checkbox"/>

If you wish to add additional non-patent literature document citation information please click the Add button

EXAMINER SIGNATURE

Examiner Signature	/Erika Gary/ (02/17/2011)	Date Considered	02/17/2011
--------------------	---------------------------	-----------------	------------

*EXAMINER: Initial if reference considered, whether or not citation is in conformance with MPEP 609. Draw line through a citation if not in conformance and not considered. Include copy of this form with next communication to applicant.

¹ See Kind Codes of USPTO Patent Documents at www.USPTO.GOV or MPEP 901.04. ² Enter office that issued the document, by the two-letter code (WIPO Standard ST.3). ³ For Japanese patent documents, the indication of the year of the reign of the Emperor must precede the serial number of the patent document. ⁴ Kind of document by the appropriate symbols as indicated on the document under WIPO Standard ST.16 if possible. ⁵ Applicant is to place a check mark here if English language translation is attached.

INFORMATION DISCLOSURE STATEMENT BY APPLICANT (Not for submission under 37 CFR 1.99)	Application Number		12015320	
	Filing Date		2008-01-16	
	First Named Inventor		Russell W. White	
	Art Unit		2617	
	Examiner Name		Erika A. Gary	
	Attorney Docket Number		AFF.0004C5US	

1	U.S. Patent and Trademark Office, Office Action in Inter Partes Reexamination of Patent No. 7440772, Reexamination Control No. 95001286, Office Action issued on August 2, 2010, 14 pages.	<input type="checkbox"/>
---	--------------------------------------------------------------------------------------------------------------------------------------------------------------------------------------------	--------------------------

If you wish to add additional non-patent literature document citation information please click the Add button

EXAMINER SIGNATURE

Examiner Signature	/Erika Gary/ (02/17/2011)	Date Considered	02/17/2011
--------------------	---------------------------	-----------------	------------

***EXAMINER:** Initial if reference considered, whether or not citation is in conformance with MPEP 609. Draw line through a citation if not in conformance and not considered. Include copy of this form with next communication to applicant.

¹ See Kind Codes of USPTO Patent Documents at www.USPTO.GOV or MPEP 901.04. ² Enter office that issued the document, by the two-letter code (WIPO Standard ST.3). ³ For Japanese patent documents, the indication of the year of the reign of the Emperor must precede the serial number of the patent document. ⁴ Kind of document by the appropriate symbols as indicated on the document under WIPO Standard ST.16 if possible. ⁶ Applicant is to place a check mark here if English language translation is attached.

INFORMATION DISCLOSURE STATEMENT BY APPLICANT (Not for submission under 37 CFR 1.99)	Application Number		12015320	
	Filing Date		2008-01-16	
	First Named Inventor	Russell W. White, et al.		
	Art Unit	2617		
	Examiner Name	Erika A. Gary		
	Attorney Docket Number	AFF.004C5US		

1	U.S. Patent and Trademark Office, Office Action in Inter Partes Reexamination of Patent No. 7486926, Control No. 95/001,263, Office Action issued July 9, 2010, 20 pgs.	<input type="checkbox"/>
---	-------------------------------------------------------------------------------------------------------------------------------------------------------------------------	--------------------------

If you wish to add additional non-patent literature document citation information please click the Add button

EXAMINER SIGNATURE

Examiner Signature	/Erika Gary/ (02/17/2011)	Date Considered	02/17/2011
--------------------	---------------------------	-----------------	------------

*EXAMINER: Initial if reference considered, whether or not citation is in conformance with MPEP 809. Draw line through a citation if not in conformance and not considered. Include copy of this form with next communication to applicant.

¹ See Kind Codes of USPTO Patent Documents at www.USPTO.GOV or MPEP 901.04. ² Enter office that issued the document, by the two-letter code (WIPO Standard ST.3). ³ For Japanese patent documents, the indication of the year of the reign of the Emperor must precede the serial number of the patent document. ⁴ Kind of document by the appropriate symbols as indicated on the document under WIPO Standard ST.18 if possible. ⁵ Applicant is to place a check mark here if English language translation is attached.

INFORMATION DISCLOSURE STATEMENT BY APPLICANT (Not for submission under 37 CFR 1.99)	Application Number		12015320
	Filing Date		2008-01-16
	First Named Inventor	Russell W. White, et al.	
	Art Unit	2617	
	Examiner Name	Erika A. Gary	
	Attorney Docket Number	AFF.004C5US	

1	U.S. Patent and Trademark Office, Office Action in Inter Partes Reexamination dated June 14, 2010 in U.S. application no. 95/001,223.	<input type="checkbox"/>
2	U.S. Patent and Trademark Office, Ex Parte Reexamination Communication Transmittal Form dated June 14, 2010 providing "Decision, Sua Sponte, To Merge Reexamination Proceedings," in U.S. application no. 95/001,223.	<input type="checkbox"/>

If you wish to add additional non-patent literature document citation information please click the Add button

EXAMINER SIGNATURE

Examiner Signature	/Erika Gary/ (02/17/2011)	Date Considered	02/17/2011
--------------------	---------------------------	-----------------	------------

*EXAMINER: Initial if reference considered, whether or not citation is in conformance with MPEP 609. Draw line through a citation if not in conformance and not considered. Include copy of this form with next communication to applicant.

¹ See Kind Codes of USPTO Patent Documents at www.USPTO.GOV or MPEP 901.04. ² Enter office that issued the document, by the two-letter code (WIPO Standard ST.3). ³ For Japanese patent documents, the indication of the year of the reign of the Emperor must precede the serial number of the patent document. ⁴ Kind of document by the appropriate symbols as indicated on the document under WIPO Standard ST.16 if possible. ⁵ Applicant is to place a check mark here if English language translation is attached.

INFORMATION DISCLOSURE STATEMENT BY APPLICANT (Not for submission under 37 CFR 1.99)	Application Number		12015320
	Filing Date		2008-01-16
	First Named Inventor	Russell W. White, et al.	
	Art Unit	2617	
	Examiner Name	Erika A. Gary	
	Attorney Docket Number	AFF.004C5US	

1	U.S. Patent And Trademark Office, Office Action in Inter Partes Reexamination mailed on May 24, 2010, in U.S. application reexamination serial no. 95/001,262.	<input type="checkbox"/>
---	----------------------------------------------------------------------------------------------------------------------------------------------------------------	--------------------------

If you wish to add additional non-patent literature document citation information please click the Add button

EXAMINER SIGNATURE

Examiner Signature	/Erika Gary/ (02/17/2011)	Date Considered	02/17/2011
--------------------	---------------------------	-----------------	------------

***EXAMINER:** Initial if reference considered, whether or not citation is in conformance with MPEP 809. Draw line through a citation if not in conformance and not considered. Include copy of this form with next communication to applicant.

¹ See Kind Codes of USPTO Patent Documents at www.USPTO.GOV or MPEP 901.04. ² Enter office that issued the document, by the two-letter code (WIPO Standard ST.3). ³ For Japanese patent documents, the indication of the year of the reign of the Emperor must precede the serial number of the patent document. ⁴ Kind of document by the appropriate symbols as indicated on the document under WIPO Standard ST.16 if possible. ⁵ Applicant is to place a check mark here if English language translation is attached.

Doc code: IDS

Doc description: Information Disclosure Statement (IDS) Filed

PTO/SB/08a (07-09)

Approved for use through 07/31/2012. OMB 0651-0031

U.S. Patent and Trademark Office; U.S. DEPARTMENT OF COMMERCE

Under the Paperwork Reduction Act of 1995, no persons are required to respond to a collection of information unless it contains a valid OMB control number.

INFORMATION DISCLOSURE STATEMENT BY APPLICANT (Not for submission under 37 CFR 1.99)	Application Number	12015320
	Filing Date	2008-01-16
	First Named Inventor	Russell W. White, et al.
	Art Unit	2617
	Examiner Name	Erika A. Gary
	Attorney Docket Number	AFF.004C5US

U.S.PATENTS						
Examiner Initial*	Cite No	Patent Number	Kind Code ¹	Issue Date	Name of Patentee or Applicant of cited Document	Pages, Columns, Lines where Relevant Passages or Relevant Figures Appear
	1	6009363		1999-12-28	Beckert	
	2	6023232		2000-02-08	Eitzenberger	
	3	6151634		2000-11-21	Glaser	
	4	6453281		2002-09-17	Walters	
	5	6678215		2004-01-13	Treyz	

If you wish to add additional U.S. Patent citation information please click the Add button.

U.S.PATENT APPLICATION PUBLICATIONS						
Examiner Initial*	Cite No	Publication Number	Kind Code ¹	Publication Date	Name of Patentee or Applicant of cited Document	Pages, Columns, Lines where Relevant Passages or Relevant Figures Appear
	1	20010042107		2001-11-15	Palm	

If you wish to add additional U.S. Published Application citation information please click the Add button.

FOREIGN PATENT DOCUMENTS						
--------------------------	--	--	--	--	--	--

INFORMATION DISCLOSURE STATEMENT BY APPLICANT (Not for submission under 37 CFR 1.99)	Application Number		12015320	
	Filing Date		2008-01-16	
	First Named Inventor	Russell W. White, et al.		
	Art Unit	2617		
	Examiner Name	Erika A. Gary		
	Attorney Docket Number	AFF.004C5US		

Examiner Initial*	Cite No	Foreign Document Number ³	Country Code ²	Kind Code ⁴	Publication Date	Name of Patentee or Applicant of cited Document	Pages, Columns, Lines where Relevant Passages or Relevant Figures Appear	T ⁵
	1							<input type="checkbox"/>

If you wish to add additional Foreign Patent Document citation information please click the Add button

NON-PATENT LITERATURE DOCUMENTS

Examiner Initials*	Cite No	Include name of the author (in CAPITAL LETTERS), title of the article (when appropriate), title of the item (book, magazine, journal, serial, symposium, catalog, etc), date, pages(s), volume-issue number(s), publisher, city and/or country where published.	T ⁵
	1	AFFINITY LABS OF TEXAS, LLC, Plaintiff, v., BMW NORTH AMERICA, LLC, et al., Civil Action No. 9:08CV164, AFFINITY LABS OF TEXAS, LLC, Plaintiff, v., ALPINE ELECTRONICS OF AMERICA, INC., et al., Civil Action No. 9:08CV171, Order Construing Claim Terms of Unites States Patent No. 7,634,228, Filed on May 10, 2010, Pages 1-27.	<input type="checkbox"/>
	2	D. PETERS, et al., "Car Multimedia - Mobile Multimedia for the 21st Century," October 5-6, 2000, Pages 1-58.	<input type="checkbox"/>
	3	STEPHAN HARTWIG, et al., "Mobile Multimedia - Challenges and Opportunities Invited Paper," June 19, 2000, Pages 1-12.	<input type="checkbox"/>
	4	JOHN HANAN, "Car Audio Has Come Far since the 8-Track," Knight Ridder/Tribune Business News, December 17, 1999, Pages 1-2.	<input type="checkbox"/>
	5	BUSINESS WIRE, "Lobjects Announces New Digital Audio Player Technology for the Next-Generation Auto PC," August 4, 1999, Pages 1-2.	<input type="checkbox"/>
	6	JASON MESERVE, "Windows Media Player now available for WinCe, (from Microsoft) (Product Announcement)," Network World, March 8, 2000, Pages 1-2.	<input type="checkbox"/>
	7	BUSINESS WIRE, "'HUM" MP3 Software Turns Windows CE Handheld Computers Into Portable Music Players," May 24, 1999, Pages 1-2.	<input type="checkbox"/>

INFORMATION DISCLOSURE STATEMENT BY APPLICANT (Not for submission under 37 CFR 1.99)	Application Number	12015320
	Filing Date	2008-01-16
	First Named Inventor	Russell W. White, et al.
	Art Unit	2617
	Examiner Name	Erika A. Gary
	Attorney Docket Number	AFF.004C5US

8	CHRIS De HERRERA, "Windows CE 2.0 Auto PC Pictures," Chris De Herrera's Windows CE Website, Revised January 11, 1999, Pages 1-3.	<input type="checkbox"/>
9	JOHN MURRAY, "Inside Microsoft Windows CE," Microsoft Press, 1998, Pages 1-20.	<input type="checkbox"/>
10	COMPAQ, INTEL, MICROSOFT, NEC, "Universal Serial Bus Device Class Definition for Audio Devices," Release 1.0, March 18, 1998, Pages 1-130.	<input type="checkbox"/>
11	COMPAQ, INTEL, MICROSOFT, NEC, "Universal Serial Bus Specification," Revision 1.1, September 23, 1998, Pages 1-327.	<input type="checkbox"/>
12	VESA, VIDEO ELECTRONICS STANDARDS ASSOCIATION, "VESA Plug and Display (P&D) Standard," Version 1, Revision 0, June 11, 1997, Pages 1-109.	<input type="checkbox"/>
13	AFFINITY LABS OF TEXAS, LLC, Plaintiff, v., BMW NORTH AMERICA, LLC, et al., Defendants, Case No. 9:08-cv-00164-RC, First Amended Answer And Counterclaim Of Defendant Volkswagen Group Of America, Inc. To Third Amended Complaint, Filed on April 9, 2010, Pages 1-57.	<input type="checkbox"/>
14	AFFINITY LABS OF TEXAS, LLC, Plaintiff, v., BMW NORTH AMERICA, LLC, et al., Defendants, Case No. 9:08-cv-00164-RC, Amended Answer And Counterclaim Of Defendants Hyundai Motor America, Hyundai Motor Manufacturing Alabama, LLC, And KIA Motors America, Inc. To Plaintiff Affinity Labs Of Texas, LLC's Third Amended Complaint, Filed on April 9, 2010, Pages 1-22.	<input type="checkbox"/>
15	AFFINITY LABS OF TEXAS, LLC, Plaintiff, v., BMW NORTH AMERICA, LLC, et al., Defendants, Case No. 9:08-cv-00164-RC, Plaintiff's Reply To Amended Answer And Counterclaim Of Defendants Hyundai Motor America, Hyundai Motor Manufacturing Alabama, LLC And KIA Motors America, Inc. To Plaintiff Affinity Labs of Texas, LLC's Third Amended Complaint, Filed on April 27, 2010, Pages 1-7.	<input type="checkbox"/>
16	AFFINITY LABS OF TEXAS, LLC, Plaintiff, v., BMW NORTH AMERICA, LLC, et al., Defendants, Case No. 9:08-cv-00164-RC, Plaintiff's Reply To First Amended Answer And Counterclaim Of Defendant Volkswagen Group Of America, Inc. To Third Amended Complaint, Filed on April 27, 2010, Pages 1-7.	<input type="checkbox"/>
17	PANASONIC, "Portable DVD/Video CD/CD Player, Operating Instructions, DVC-L10D," 1998, Pages 1-84.	<input type="checkbox"/>
18	CLARION Car Audio and Beyond, "1998 Car Audio & Security Product Catalog," 1998, Pages 1-24.	<input type="checkbox"/>

INFORMATION DISCLOSURE STATEMENT BY APPLICANT (Not for submission under 37 CFR 1.99)	Application Number	12015320
	Filing Date	2008-01-16
	First Named Inventor	Russell W. White, et al.
	Art Unit	2817
	Examiner Name	Erika A. Gary
	Attorney Docket Number	AFF.004C5US

19	CLARION Car Audio and Beyond, "1999 Car Audio & Security Product," 1999, Pages 1-60.	<input type="checkbox"/>
20	JAMIE ANDERSON, "Driving our way soon: the e-car," The Times, November 9, 2000, Pages 1-4.	<input type="checkbox"/>
21	CLARION Auto PC, "Clarion Auto PC Owner's Manual," 1998, Pages 1-177.	<input type="checkbox"/>
22	DELPHI Automotive Systems, "The Personal Productivity Vehicle," 1998, Pages 1-2.	<input type="checkbox"/>
23	DELPHI Delco Electronics Systems, "On-Board Architecture," 1997, Pages 1-2.	<input type="checkbox"/>
24	JANET BRAUNSTEIN, "Diversified Software Industries: Enabling digital instrument panels," January 10, 2001, Pages 1-2.	<input type="checkbox"/>
25	MICROSOFT PressPass, "Microsoft Previews New Devices Using Windows CE for Automotive 2.0," January 2000, Pages 1-2.	<input type="checkbox"/>
26	JOHN TOWNLEY, "Countdown to Clarion," Automeia, Pages 1-4.	<input type="checkbox"/>
27	GINA HERTEL, "A Voice-Activated Co-Pilot: ICES," Odds & Ends, January 2000, Vol. 8, Issue 1, Pages 1-5.	<input type="checkbox"/>
28	KAMI BUCHHOLZ, "Diversified Software launches IVIS," Automotive Engineering Online, 2009, one page.	<input type="checkbox"/>
29	EMPEG Car webpage, http://web.archive.org/web/19990430033318/www.empeg.com/main.html , April 30, 1999, one page.	<input type="checkbox"/>

INFORMATION DISCLOSURE STATEMENT BY APPLICANT (Not for submission under 37 CFR 1.99)	Application Number		12015320
	Filing Date		2008-01-16
	First Named Inventor	Russell W. White, et al.	
	Art Unit		2817
	Examiner Name	Erika A. Gary	
	Attorney Docket Number		AFF.004C5US

30	CLARION AutoPC, "Frequently Asked Questions," 1998, Pages 1-3.	<input type="checkbox"/>
31	CLARION AutoPC, "Frequently Asked Questions," 1999, Pages 1-9.	<input type="checkbox"/>
32	STEREOPHILE, "Clarion Debuts World's First Automobile PC/Stereo," December 5, 1998, Pages 1-3.	<input type="checkbox"/>
33	STEVE WHALLEY, "Peripherals To Go: USB In AutoPC," Pages 1-2.	<input type="checkbox"/>
34	GREGORY L. WHITE, "After AutoPC's Hard Ride, Detroit Tries Rebooting In-Car Computers," The Wall Street Journal, Pages 1-3.	<input type="checkbox"/>
35	AFFINITY LABS OF TEXAS, LLC, Plaintiff, v., BMW NORTH AMERICA, LLC, et al., Defendants, Civil Action No. 9:08-CV-164, Order Denying Defendant's Motion to Dismiss, Filed on September 2, 2009, Pages 1-7.	<input type="checkbox"/>

If you wish to add additional non-patent literature document citation information please click the Add button

EXAMINER SIGNATURE

Examiner Signature	/Erika Gary/ (02/17/2011)	Date Considered	02/17/2011
--------------------	---------------------------	-----------------	------------

*EXAMINER: Initial if reference considered, whether or not citation is in conformance with MPEP 809. Draw line through a citation if not in conformance and not considered. Include copy of this form with next communication to applicant.

¹ See Kind Codes of USPTO Patent Documents at www.USPTO.GOV or MPEP 901.04. ² Enter office that issued the document, by the two-letter code (WIPO Standard ST.3). ³ For Japanese patent documents, the indication of the year of the reign of the Emperor must precede the serial number of the patent document. ⁴ Kind of document by the appropriate symbols as indicated on the document under WIPO Standard ST.16 if possible. ⁵ Applicant is to place a check mark here if English language translation is attached.

INFORMATION DISCLOSURE STATEMENT BY APPLICANT (Not for submission under 37 CFR 1.99)	Application Number		12015320
	Filing Date		2008-01-16
	First Named Inventor	Russell White, et al.	
	Art Unit		2617
	Examiner Name	Erika A. Gary	
	Attorney Docket Number		AFF.004C5US

1	Affinity Labs of Texas, LLC (Plaintiff) v. BMW North America, LLC, et al. (Defendants), Case No. 9:08-cv-00164-RC, Answer and Counterclaim of Defendant Volkswagen Group of America, Inc., to Third Amended Complaint, Pages 1-48, filed on January 15, 2010.	<input type="checkbox"/>
2	Affinity Labs of Texas, LLC (Plaintiff) v. Alpine Electronics of America, Inc., et al. (Defendants), Civil Action No. 9:08-cv-171, Order Denying Without Prejudice Defendants' Motion for Summary Judgment, one page, filed on February 25, 2010.	<input type="checkbox"/>

If you wish to add additional non-patent literature document citation information please click the Add button

EXAMINER SIGNATURE

Examiner Signature	/Erika Gary/ (02/17/2011)	Date Considered	02/17/2011
--------------------	---------------------------	-----------------	------------

*EXAMINER: Initial if reference considered, whether or not citation is in conformance with MPEP 809. Draw line through a citation if not in conformance and not considered. Include copy of this form with next communication to applicant.

¹ See Kind Codes of USPTO Patent Documents at www.USPTO.GOV or MPEP 801.04. ² Enter office that issued the document, by the two-letter code (WIPO Standard ST.3). ³ For Japanese patent documents, the indication of the year of the reign of the Emperor must precede the serial number of the patent document. ⁴ Kind of document by the appropriate symbols as indicated on the document under WIPO Standard ST.16 if possible. ⁵ Applicant is to place a check mark here if English language translation is attached.

Doc code: IDS

Doc description: Information Disclosure Statement (IDS) Filed

PTO/SB/08a (07-09)

Approved for use through 07/31/2012. OMB 0651-0031
 U.S. Patent and Trademark Office; U.S. DEPARTMENT OF COMMERCE

Under the Paperwork Reduction Act of 1995, no persons are required to respond to a collection of information unless it contains a valid OMB control number.

INFORMATION DISCLOSURE STATEMENT BY APPLICANT (Not for submission under 37 CFR 1.99)	Application Number	12015320
	Filing Date	2008-01-16
	First Named Inventor	Russell White, et al.
	Art Unit	2617
	Examiner Name	Erika A. Gary
	Attorney Docket Number	AFF.004C5US

U.S. PATENTS						
Examiner Initial*	Cite No	Patent Number	Kind Code ¹	Issue Date	Name of Patentee or Applicant of cited Document	Pages, Columns, Lines where Relevant Passages or Relevant Figures Appear
	1	4807292		1989-02-21	Sorscher	
	2	6975835		2005-12-13	Lake, et al.	
	3	6956833		2005-10-18	Yukie, et al.	
	4	6915272		2005-07-05	Zilliacus	
	5	6907112		2005-06-14	Guedalia, et al.	
	6	6792615		2004-09-14	Rowe, et al.	
	7	6792263		2004-09-14	Kite	
	8	6788528		2004-09-07	Enners, et al.	

INFORMATION DISCLOSURE STATEMENT BY APPLICANT (Not for submission under 37 CFR 1.99)	Application Number	12015320
	Filing Date	2008-01-16
	First Named Inventor	Russell White, et al.
	Art Unit	2617
	Examiner Name	Erika A. Gary
	Attorney Docket Number	AFF.004C5US

9	6772212		2004-08-03	Lau, et al.	
10	6741980		2004-05-25	Langseth, et al.	
11	6721710		2004-04-13	Lueck	
12	6671715		2003-12-30	Langseth, et al.	
13	6591085		2003-07-08	Grady	
14	6587835		2003-07-01	Treyz, et al.	
15	6516466		2003-02-04	Jackson	
16	6510210		2003-01-21	Baughan	
17	6509716		2003-01-21	Yi	
18	6496692		2002-12-17	Shanahan	
19	6496205		2002-12-17	White, et al.	

INFORMATION DISCLOSURE STATEMENT BY APPLICANT (Not for submission under 37 CFR 1.99)	Application Number	12015320
	Filing Date	2008-01-16
	First Named Inventor	Russell White, et al.
	Art Unit	2617
	Examiner Name	Erika A. Gary
	Attorney Docket Number	AFF.004C5US

20	6420975		2002-07-16	DeLine, et al.	
21	6418138		2002-07-09	Cerf, et al.	
22	6401085		2002-06-04	Gershman, et al.	
23	6396769		2002-05-28	Polany	
24	6339706		2002-01-15	Tillgren, et al.	
25	6314094		2001-11-06	Boys	
26	6292440		2001-09-18	Lee	
27	6247130		2001-06-12	Fritsch	
28	6240297		2001-05-29	Jadoul	
29	6236832		2001-05-22	Ito	
30	6232539		2001-05-15	Looney, et al.	

INFORMATION DISCLOSURE STATEMENT BY APPLICANT (Not for submission under 37 CFR 1.99)	Application Number	12015320
	Filing Date	2008-01-16
	First Named Inventor	Russell White, et al.
	Art Unit	2617
	Examiner Name	Erika A. Gary
	Attorney Docket Number	AFF.004C5US

	31	6199076		2001-03-06	Logan, et al.	
	32	6167253		2000-12-26	Farris, et al.	
	33	6144848		2000-11-07	Walsh, et al.	
	34	6088730		2000-07-11	Kato, et al.	
	35	6061306		2000-05-09	Buchheim	
	36	6029064		2000-02-22	Farris, et al.	
	37	6014569		2000-01-11	Bottum	
	38	5953657		1999-09-14	Ghisler	
	39	5953005		1999-09-14	Liu	
	40	5940767		1999-08-17	Bourgeois, et al.	
	41	5900564		1999-05-04	Kurakake	

INFORMATION DISCLOSURE STATEMENT BY APPLICANT (Not for submission under 37 CFR 1.99)	Application Number	12015320
	Filing Date	2008-01-16
	First Named Inventor	Russell White, et al.
	Art Unit	2617
	Examiner Name	Erika A. Gary
	Attorney Docket Number	AFF.004C5US

42	5870680		1999-02-09	Guerlin, et al.	
43	5774793		1998-06-30	Cooper, et al.	
44	5694120		1997-12-02	Indekeu, et al.	
45	5594779		1997-01-14	Goodman	

If you wish to add additional U.S. Patent citation information please click the Add button.

U.S. PATENT APPLICATION PUBLICATIONS

Examiner Initial*	Cite No	Publication Number	Kind Code ¹	Publication Date	Name of Patentee or Applicant of cited Document	Pages, Columns, Lines where Relevant Passages or Relevant Figures Appear
	1	20050010633		2005-01-03	Shanahan	
	2	20040078274		2004-04-22	Aamio	
	3	20030008646		2003-01-09	Shanahan	
	4	20020046084		2002-04-18	Steele, et al.	
	5	20020023028		2002-02-01	Quarendon	

If you wish to add additional U.S. Published Application citation information please click the Add button.

Doc code: IDS

Doc description: Information Disclosure Statement (IDS) Filed

PTO/SB/08a (07-09)

Approved for use through 07/31/2012. OMB 0651-0031
U.S. Patent and Trademark Office; U.S. DEPARTMENT OF COMMERCE

Under the Paperwork Reduction Act of 1995, no persons are required to respond to a collection of information unless it contains a valid OMB control number.

INFORMATION DISCLOSURE STATEMENT BY APPLICANT (Not for submission under 37 CFR 1.99)	Application Number	12015320
	Filing Date	2008-01-16
	First Named Inventor	Russell White, et al.
	Art Unit	2617
	Examiner Name	Erika A. Gary
	Attorney Docket Number	AFF.004C5US

U.S. PATENTS

Examiner Initial*	Cite No	Patent Number	Kind Code†	Issue Date	Name of Patentee or Applicant of cited Document	Pages, Columns, Lines where Relevant Passages or Relevant Figures Appear
	1	5587560		1996-12-24	Crooks, et al.	
	2	5589090		1996-12-17	Otte	
	3	5450471		1995-09-12	Hanawa, et al.	
	4	6571282		2003-05-27	Bowman-Amuah	
	5	6550057		2003-04-15	Bowman-Amuah	
	6	6549949		2003-04-15	Bowman-Amuah	
	7	6539396		2003-03-25	Bowman-Amuah	
	8	6529948		2003-03-04	Bowman-Amuah	

INFORMATION DISCLOSURE STATEMENT BY APPLICANT (Not for submission under 37 CFR 1.99)	Application Number	12015320
	Filing Date	2008-01-16
	First Named Inventor	Russell White, et al.
	Art Unit	2617
	Examiner Name	Erika A. Gary
	Attorney Docket Number	AFF.004C5US

9	6529909		2003-03-04	Bowman-Amuah	
10	6502213		2002-12-31	Bowman-Amuah	
11	6501832		2002-12-31	Bowman-Amuah	
12	6496850		2002-12-17	Bowman-Amuah	
13	6477665		2002-11-05	Bowman-Amuah	
14	6477580		2002-11-05	Bowman-Amuah	
15	6442748		2002-08-27	Bowman-Amuah	
16	6438594		2002-08-20	Bowman-Amuah	
17	6434628		2002-08-13	Bowman-Amuah	
18	6434568		2002-08-13	Bowman-Amuah	
19	6339832		2002-01-15	Bowman-Amuah	

INFORMATION DISCLOSURE STATEMENT BY APPLICANT (Not for submission under 37 CFR 1.99)	Application Number	12015320
	Filing Date	2008-01-16
	First Named Inventor	Russell White, et al.
	Art Unit	2617
	Examiner Name	Erika A. Gary
	Attorney Docket Number	AFF.004C5US

20	6335927		2002-01-01	Elliott, et al.	
21	6332163		2001-12-18	Bowman-Amuah	
22	6289382		2001-09-11	Bowman-Amuah	
23	6253061		2001-08-26	Heferich	
24	6233430		2001-05-15	Heferich	
25	6122403		2000-09-19	Rhoads	
26	5999525		1999-12-07	Krishnaswamy, et al.	
27	5867494		1999-02-02	Krishnaswamy, et al.	
28	5732216		1998-03-24	Logan, et al.	
29	5721827		1998-02-24	Logan, et al.	
30	7149772		2006-12-12	Kalavade	

INFORMATION DISCLOSURE STATEMENT BY APPLICANT (Not for submission under 37 CFR 1.99)	Application Number	12015320
	Filing Date	2008-01-16
	First Named Inventor	Russell White, et al.
	Art Unit	2817
	Examiner Name	Erika A. Gary
	Attorney Docket Number	AFF.004C5US

31	7145898		2006-12-05	Elliott	
32	7130807		2006-10-31	Mikurak	
33	7124101		2006-10-17	Mikurak	
34	6978127		2005-10-20	Bulthuis, et al.	
35	6909708		2005-06-21	Krishnaswamy, et al.	
36	6904449		2005-08-07	Quinones	
37	6091067		2005-05-31	Kalavade	
38	6888929		2005-05-03	Saylor, et al.	
39	6842906		2005-01-11	Bowman-Amuah	
40	6792086		2005-04-04	Saylor, et al.	
41	6754181		2004-09-04	Elliott, et al.	

INFORMATION DISCLOSURE STATEMENT BY APPLICANT (Not for submission under 37 CFR 1.99)	Application Number		12015320	
	Filing Date		2008-01-16	
	First Named Inventor		Russell White, et al.	
	Art Unit		2617	
	Examiner Name		Erika A. Gary	
	Attorney Docket Number		AFF.004C5US	

42	6742015		2004-05-25	Bowman-Amuah	
43	6731625		2004-05-04	Eastep, et al.	
44	6715145		2004-03-30	Bowman-Amuah	
45	6707889		2004-03-16	Saylor, et al.	
46	6697824		2004-02-24	Bowman-Amuah	
47	6671818		2003-12-20	Mikurak	
48	6640249		2003-10-28	Bowman-Amuah	
49	6640244		2003-10-28	Bowman-Amuah	
50	6640238		2003-10-28	Bowman-Amuah	

If you wish to add additional U.S. Patent citation information please click the Add button.

U.S.PATENT APPLICATION PUBLICATIONS

Examiner Initial*	Cite No	Publication Number	Kind Code ¹	Publication Date	Name of Patentee or Applicant of cited Document	Pages, Columns, Lines where Relevant Passages or Relevant Figures Appear
-------------------	---------	--------------------	------------------------	------------------	-------------------------------------------------	--------------------------------------------------------------------------

Doc code: IDS

Doc description: Information Disclosure Statement (IDS) Filed

PTO/SB/08a (07-09)

Approved for use through 07/31/2012. OMB 0651-0031

U.S. Patent and Trademark Office; U.S. DEPARTMENT OF COMMERCE

Under the Paperwork Reduction Act of 1995, no persons are required to respond to a collection of information unless it contains a valid OMB control number.

INFORMATION DISCLOSURE STATEMENT BY APPLICANT (Not for submission under 37 CFR 1.99)	Application Number		12015320
	Filing Date		2008-01-16
	First Named Inventor	Russell White, et al.	
	Art Unit		2617
	Examiner Name	Erika A. Gary	
	Attorney Docket Number		AFF.004C5US

U.S. PATENTS						
Examiner Initial*	Cite No	Patent Number	Kind Code†	Issue Date	Name of Patentee or Applicant of cited Document	Pages, Columns, Lines where Relevant Passages or Relevant Figures Appear
	1	6636242		2003-10-21	Bowman-Amuah	
	2	6615253		2003-09-02	Bowman-Amuah	
	3	6615199		2003-09-02	Bowman-Amuah	
	4	6606744		2003-08-12	Mikurak	
	5	6606660		2003-08-12	Bowman-Amuah	
	6	6601234		2003-07-29	Bowman-Amuah	
	7	6601192		2003-07-29	Bowman-Amuah	
	8	6578068		2003-07-10	Bowman-Amuah	

INFORMATION DISCLOSURE STATEMENT BY APPLICANT (Not for submission under 37 CFR 1.99)	Application Number		12015320	
	Filing Date		2008-01-16	
	First Named Inventor	Russell White, et al.		
	Art Unit	2617		
	Examiner Name	Erika A. Gary		
	Attorney Docket Number	AFF.004C5US		

	9	6587836		2003-07-01	Treyz, et al.	
	10	6510210		2003-01-21	Baughan	
	11	6509716		2003-01-21	Yi	
	12	6496692		2002-12-17	Shanahan	
	13	6396769		2002-05-28	Polany	
	14	6240297		2001-05-29	Jadoul	
	15	6061306		2000-05-09	Buchheim	
	16	5953659		1999-09-14	Ghisler	
	17	5940767		1999-08-17	Bourgeois	
	18	5870680		1999-02-09	Guerlin, et al.	
	19	5774793		1998-06-30	Cooper, et al.	

INFORMATION DISCLOSURE STATEMENT BY APPLICANT (Not for submission under 37 CFR 1.99)	Application Number	12015320
	Filing Date	2008-01-16
	First Named Inventor	Russell White, et al.
	Art Unit	2617
	Examiner Name	Erika A. Gary
	Attorney Docket Number	AFF.004C5US

20	5587560		1996-12-24	Crooks, et al.	
21	5586090		1996-12-17	Otte	
22	5450471		1995-09-12	Hanawa, et al.	
23	7020704		2008-03-28	Lipscomb, et al.	
24	7343414		2008-03-11	Lipscomb, et al.	
25	6728531		2004-04-27	Lee	
26	6526335		2003-02-25	Treyz	
27	6160551		2000-12-12	Naughton	
28	6192340		2001-02-20	Abecassis	

If you wish to add additional U.S. Patent citation information please click the Add button.

U.S.PATENT APPLICATION PUBLICATIONS

Examiner Initial*	Cite No	Publication Number	Kind Code ¹	Publication Date	Name of Patentee or Applicant of cited Document	Pages, Columns, Lines where Relevant Passages or Relevant Figures Appear
-------------------	---------	--------------------	------------------------	------------------	-------------------------------------------------	--------------------------------------------------------------------------

INFORMATION DISCLOSURE STATEMENT BY APPLICANT (Not for submission under 37 CFR 1.99)	Application Number	12015320
	Filing Date	2008-01-16
	First Named Inventor	Russell White, et al.
	Art Unit	2617
	Examiner Name	Erika A. Gary
	Attorney Docket Number	AFF.004C5US

1						
---	--	--	--	--	--	--

If you wish to add additional U.S. Published Application citation information please click the Add button.

FOREIGN PATENT DOCUMENTS

Examiner Initial*	Cite No	Foreign Document Number ³	Country Code ²	Kind Code ⁴	Publication Date	Name of Patentee or Applicant of cited Document	Pages, Columns, Lines where Relevant Passages or Relevant Figures Appear	T ⁵
	1	H08-79814	JP		1996-03-22	Konishi		<input type="checkbox"/>

If you wish to add additional Foreign Patent Document citation information please click the Add button

NON-PATENT LITERATURE DOCUMENTS

Examiner Initials*	Cite No	Include name of the author (in CAPITAL LETTERS), title of the article (when appropriate), title of the item (book, magazine, journal, serial, symposium, catalog, etc), date, pages(s), volume-issue number(s), publisher, city and/or country where published.	T ⁵
	1	AFFINITY LABS OF TEXAS, LLC (Plaintiff) v. BMW NORTH AMERICA, LLC, ET AL. (Defendants), Civil Action No. 9:08CV164 and AFFINITY LABS OF TEXAS, LLC (Plaintiff) v. ALPINE ELECTRONICS OF AMERICA, INC., ET AL., Civil Action No. 9:08CV171, "Order Construing Claim Terms of United States Patent No. 7,324,833, issued on December 18, 2009, Pages 1-31.	<input type="checkbox"/>
	2	REAL NETWORKS, Inc., RealJukebox Plus Manual, 1999, Pages 1-90.	<input type="checkbox"/>

If you wish to add additional non-patent literature document citation information please click the Add button

EXAMINER SIGNATURE

Examiner Signature	/Erika Gary/ (02/17/2011)	Date Considered	02/17/2011
--------------------	---------------------------	-----------------	------------

*EXAMINER: Initial if reference considered, whether or not citation is in conformance with MPEP 609. Draw line through a citation if not in conformance and not considered. Include copy of this form with next communication to applicant.

¹ See Kind Codes of USPTO Patent Documents at www.USPTO.GOV or MPEP 901.04. ² Enter office that issued the document, by the two-letter code (WIPO Standard ST.3). ³ For Japanese patent documents, the indication of the year of the reign of the Emperor must precede the serial number of the patent document. ⁴ Kind of document by the appropriate symbols as indicated on the document under WIPO Standard ST.16 if possible. ⁵ Applicant is to place a check mark here if English language translation is attached.

Doc code: IDS

Doc description: Information Disclosure Statement (IDS) Filed

PTO/SB/08a (07-09)

Approved for use through 07/31/2012. OMB 0851-0031
U.S. Patent and Trademark Office; U.S. DEPARTMENT OF COMMERCE

Under the Paperwork Reduction Act of 1995, no persons are required to respond to a collection of information unless it contains a valid OMB control number.

INFORMATION DISCLOSURE STATEMENT BY APPLICANT (Not for submission under 37 CFR 1.99)	Application Number	12015320
	Filing Date	2008-01-16
	First Named Inventor	Russell White, et al.
	Art Unit	2617
	Examiner Name	Erika A. Gary
	Attorney Docket Number	AFF.004C5US

U.S. PATENTS

Examiner Initial*	Cite No	Patent Number	Kind Code ¹	Issue Date	Name of Patentee or Applicant of cited Document	Pages, Columns, Lines where Relevant Passages or Relevant Figures Appear
	1	5974333		1999-10-26	Chen	
	2	6418330		2002-07-09	Samsung	
	3	6587127		2003-07-01	Leeke, et al.	
	4	7123936		2006-10-17	Rydbeck, et al.	
	5	6177950		2001-01-23	Robb	
	6	6510325		2003-01-21	Mack, II, et al.	
	7	62788842		2001-08-21	Kim	
	8	7339993		2008-03-04	Brooks	

INFORMATION DISCLOSURE STATEMENT BY APPLICANT (Not for submission under 37 CFR 1.99)	Application Number	12015320
	Filing Date	2008-01-16
	First Named Inventor	Russell White, et al.
	Art Unit	2617
	Examiner Name	Erika A. Gary
	Attorney Docket Number	AFF.004C5US

9	6917923		2005-12-06	Dimenstein	
10	6157619		2000-12-05	Ozluturk	
11	6609105		2003-08-19	Van Zoest, et al.	
12	6353637		2002-03-05	Mansour, et al.	
13	7444353		2008-10-28	Chen	
14	5963916		1999-10-05	Kaplan	
15	5956651		1999-09-21	Willkie	

If you wish to add additional U.S. Patent citation information please click the Add button.

U.S. PATENT APPLICATION PUBLICATIONS

Examiner Initial*	Cite No	Publication Number	Kind Code ¹	Publication Date	Name of Patentee or Applicant of cited Document	Pages, Columns, Lines where Relevant Passages or Relevant Figures Appear
	1					

If you wish to add additional U.S. Published Application citation information please click the Add button.

FOREIGN PATENT DOCUMENTS

INFORMATION DISCLOSURE STATEMENT BY APPLICANT (Not for submission under 37 CFR 1.99)	Application Number	12015320
	Filing Date	2008-01-16
	First Named Inventor	Russell White, et al.
	Art Unit	2617
	Examiner Name	Erika A. Gary
	Attorney Docket Number	AFF.004C5US

Examiner Initial*	Cite No	Foreign Document Number ³	Country Code ²	Kind Code ⁴	Publication Date	Name of Patentee or Applicant of cited Document	Pages, Columns, Lines where Relevant Passages or Relevant Figures Appear	T ⁵
	1	WO 00/70523	WO		2000-11-23	Digimarc Corporation		<input type="checkbox"/>

If you wish to add additional Foreign Patent Document citation information please click the Add button

NON-PATENT LITERATURE DOCUMENTS

Examiner Initials*	Cite No	Include name of the author (in CAPITAL LETTERS), title of the article (when appropriate), title of the item (book, magazine, journal, serial, symposium, catalog, etc), date, pages(s), volume-issue number(s), publisher, city and/or country where published.	T ⁵
	1	Nokia 9110 Communicator User Manual, Copyright 1999.	<input type="checkbox"/>
	2	Sony, "Sony Notebook Computer User Guide PCG-717/719," User Guide, 1997.	<input type="checkbox"/>
	3	AirCard, "Sierra Wireless Announces First Cellular Network Interface Card for Notebook PCs," June 21, 1999.	<input type="checkbox"/>
	4	MusicMatch Internet Music System, " MusicMatch Jukebox Reviews," March 4, 2000, May 8, 1999, August 29, 1999, May 8, 1999, February 4, 1997, August 12, 1999, January 24, 2000, January 25, 2000, February 22, 2000, Pages 1-32.	<input type="checkbox"/>
	5	Bluetooth, "Specification of the Bluetooth System, Profiles," December 1, 1999.	<input type="checkbox"/>
	6	Bluetooth, "Specification of the Bluetooth System, Profiles," December 1, 1999.	<input type="checkbox"/>
	7	J. SCHNEIDAWIND, "Big Blue Unveiling," USA Today, November 23, 1992, page 2B.	<input type="checkbox"/>

INFORMATION DISCLOSURE STATEMENT BY APPLICANT (Not for submission under 37 CFR 1.99)	Application Number	12015320
	Filing Date	2008-01-16
	First Named Inventor	Russell White, et al.
	Art Unit	2617
	Examiner Name	Erika A. Gary
	Attorney Docket Number	AFF.004C5US

8	Nokia Suomi, "Range of suspension GSM products unveiled: Nokia's innovations offer a new dimension to mobile communication," March 13, 1996, 1 page.	<input type="checkbox"/>
9	Nokia 9000i User's Manual, Copyright 1995-1997.	<input type="checkbox"/>
10	FCC Website, "Broadband PCS," available at http://wireless.fcc.gov/services/index.htm?job=service_home&id=broadband_pcs (accessed November 9, 2009).	<input type="checkbox"/>
11	RealNetworks, "RealPlayer plus, RealPlayer 7 Plus User Manual," Copyright 2000, March 6, 2000.	<input type="checkbox"/>
12	DAVID POGUE, "SoundJam MP Digital Audio System Manual," 1999.	<input type="checkbox"/>
13	iTunes Wikipedia Page, http://en.wikipedia.org/wiki/iTunes , accessed July 31, 2009.	<input type="checkbox"/>
14	K. JOST, "The Car as a Mobile-Media Platform," Automotive Engineering International, May 1998, Pages 49-53.	<input type="checkbox"/>
15	S.K. KIRSCHNER, "Wired Wheels," Popular Science, March 1998, Pages 54-55.	<input type="checkbox"/>
16	R. LIND, et al., "The Network Vehicle - A Glimpse into the Future of Mobile Multi-Media," 17th AIAA/IEEE/SAE Digital Avionics Sys. Conference Proceedings, October 31 to November 7, 1998, at I21-1 to I21-8.	<input type="checkbox"/>

If you wish to add additional non-patent literature document citation information please click the Add button

EXAMINER SIGNATURE

Examiner Signature	/Erika Gary/ (02/17/2011)	Date Considered	02/17/2011
--------------------	---------------------------	-----------------	------------

*EXAMINER: Initial if reference considered, whether or not citation is in conformance with MPEP 609. Draw line through a citation if not in conformance and not considered. Include copy of this form with next communication to applicant.

INFORMATION DISCLOSURE STATEMENT BY APPLICANT (Not for submlsion under 37 CFR 1.99)	Application Number		12015320
	Filing Date		2008-01-16
	First Named Inventor	Russell White, et al.	
	Art Unit	2617	
	Examiner Name	Erika A. Gary	
	Attorney Docket Number	AFF.004CSUS	

1	Request for Inter Partes Reexamination of U.S. Patent No. 7,187,947, filed on November 13, 2009, with accompanying Claim Charts.	<input type="checkbox"/>
2	Request for Inter Partes Reexamination of U.S. Patent No. 7,440,772, filed on November 13, 2009, with accompanying Claim Charts.	<input type="checkbox"/>
3	Request for Inter Partes Reexamination of U.S. Patent No. 7,324,833, filed on November 13, 2009, with accompanying Claim Charts.	<input type="checkbox"/>
4	Request for Inter Partes Reexamination of U.S. Patent No. 7,486,926, filed on November 13, 2009, with accompanying Claim Charts.	<input type="checkbox"/>
5	Request for Inter Partes Reexamination of U.S. Patent No. 7,634,228, filed on February 3, 2010, with accompanying Claim Charts.	<input type="checkbox"/>

If you wish to add additional non-patent literature document citation information please click the Add button

EXAMINER SIGNATURE

Examiner Signature	/Erika Gary/ (02/17/2011)	Date Considered	02/17/2011
--------------------	---------------------------	-----------------	------------

*EXAMINER: Initial if reference considered, whether or not citation is in conformance with MPEP 609. Draw line through a citation if not in conformance and not considered. Include copy of this form with next communication to applicant.

¹ See Kind Codes of USPTO Patent Documents at www.USPTO.GOV or MPEP 901.04. ² Enter office that issued the document, by the two-letter code (WIPO Standard ST.3). ³ For Japanese patent documents, the indication of the year of the reign of the Emperor must precede the serial number of the patent document. ⁴ Kind of document by the appropriate symbols as indicated on the document under WIPO Standard ST.16 if possible. ⁵ Applicant is to place a check mark here if English language translation is attached.

Doc code: IDS

Doc description: Information Disclosure Statement (IDS) Filed

PTO/SB/08a (01-09)

Approved for use through 02/28/2009. OMB 0851-0031

U.S. Patent and Trademark Office; U.S. DEPARTMENT OF COMMERCE

Under the Paperwork Reduction Act of 1995, no persons are required to respond to a collection of information unless it contains a valid OMB control number.

INFORMATION DISCLOSURE STATEMENT BY APPLICANT (Not for submission under 37 CFR 1.99)	Application Number		12015320	
	Filing Date		2008-01-16	
	First Named Inventor	Russell W. White, et al.		
	Art Unit	2617		
	Examiner Name	Erika A. Gary		
	Attorney Docket Number	AFF.004C5US		

U.S. PATENTS Remove

Examiner Initial*	Cite No	Patent Number	Kind Code ¹	Issue Date	Name of Patentee or Applicant of cited Document	Pages, Columns, Lines where Relevant Passages or Relevant Figures Appear
	1	5539658		1996-07-23	McCullough, Timothy L.	
	2	6675233		2004-01-26	Du	

If you wish to add additional U.S. Patent citation information please click the Add button. Add

U.S. PATENT APPLICATION PUBLICATIONS Remove

Examiner Initial*	Cite No	Publication Number	Kind Code ¹	Publication Date	Name of Patentee or Applicant of cited Document	Pages, Columns, Lines where Relevant Passages or Relevant Figures Appear
	1	20030126335		2003-07-03	Silvester, Kelan C.	

If you wish to add additional U.S. Published Application citation information please click the Add button. Add

FOREIGN PATENT DOCUMENTS Remove

Examiner Initial*	Cite No	Foreign Document Number ³	Country Code ² j	Kind Code ⁴	Publication Date	Name of Patentee or Applicant of cited Document	Pages, Columns, Lines where Relevant Passages or Relevant Figures Appear	T ⁵
	1	DE 19 651 308 A1	DE		1996-10-12	Becker GmbH		<input type="checkbox"/>

If you wish to add additional Foreign Patent Document citation information please click the Add button. Add

NON-PATENT LITERATURE DOCUMENTS Remove

INFORMATION DISCLOSURE STATEMENT BY APPLICANT (Not for submission under 37 CFR 1.99)	Application Number		12015320
	Filing Date		2008-01-16
	First Named Inventor	Russell W. White, et al.	
	Art Unit		2617
	Examiner Name	Erika A. Gary	
	Attorney Docket Number		AFF.004C5US

Examiner Initials*	Cite No	Include name of the author (in CAPITAL LETTERS), title of the article (when appropriate), title of the item (book, magazine, journal, serial, symposium, catalog, etc), date, pages(s), volume-issue number(s), publisher, city and/or country where published.	T ⁵
	1	"Universal Serial Bus Specification," Revision 1.1, September 23, 1998, pages ii-106.	<input type="checkbox"/>
	2	Reply to Office Action Mailed August 5, 2009 in Reexamination Control No. 90/010,333 of U.S. Patent No. 7,324,833 (along with a Supplemental Reply and Second Supplemental Reply).	<input type="checkbox"/>
	3	Response to "Notice of Failure to Comply with Inter Partes Reexamination Request Filing Requirements (37 CFR 1.915(d)) filed on September 22, 2009. Requestor: Volkswagen Group of America, Inc. with Replacement Request for Inter Partes Reexamination of U.S. Patent No. 7,324,833 and Claim Charts A-JJ.	<input type="checkbox"/>
	4	The United States Patent And Trademark Office, Office Action Mailed November 9, 2007 in related patent application serial no. 10/947,755.	<input type="checkbox"/>

If you wish to add additional non-patent literature document citation information please click the Add button

EXAMINER SIGNATURE

Examiner Signature	/Erika Gary/ (02/17/2011)	Date Considered	02/17/2011
--------------------	---------------------------	-----------------	------------

*EXAMINER: Initial if reference considered, whether or not citation is in conformance with MPEP 609. Draw line through a citation if not in conformance and not considered. Include copy of this form with next communication to applicant.

¹ See Kind Codes of USPTO Patent Documents at www.USPTO.GOV or MPEP 901.04. ² Enter office that issued the document, by the two-letter code (WIPO Standard ST.3). ³ For Japanese patent documents, the indication of the year of the reign of the Emperor must precede the serial number of the patent document. ⁴ Kind of document by the appropriate symbols as indicated on the document under WIPO Standard ST.16 if possible. ⁵ Applicant is to place a check mark here if English language translation is attached.

Receipt date: 01/26/2011

Doc code: IDS

Doc description: Information Disclosure Statement (IDS) Filed

PTO/SB/08a (01-10)

Approved for use through 07/31/2012. OMB 0651-0031

U.S. Patent and Trademark Office; U.S. DEPARTMENT OF COMMERCE

Under the Paperwork Reduction Act of 1995, no persons are required to respond to a collection of information unless it contains a valid OMB control number.

INFORMATION DISCLOSURE STATEMENT BY APPLICANT (Not for submission under 37 CFR 1.99)	Application Number		12495190	
	Filing Date		2009-06-30	
	First Named Inventor	Russell W. White, et al.		
	Art Unit		2617	
	Examiner Name	Erika A. Gary		
	Attorney Docket Number		AFF.004C7US	

U.S.PATENTS						
Examiner Initial*	Cite No	Patent Number	Kind Code ¹	Issue Date	Name of Patentee or Applicant of cited Document	Pages,Columns,Lines where Relevant Passages or Relevant Figures Appear
	1	6248946		2001-06-19	Dwek	
	2	5572442		1996-11-05	Schulhof	
	3	6338044		2002-01-08	Cook	
	4	5797089		1998-08-18	Nguyen	
	5	6330247		2001-12-11	Chang	
	6	5737706		1998-04-07	Seazholtz	

If you wish to add additional U.S. Patent citation information please click the Add button.

U.S.PATENT APPLICATION PUBLICATIONS						
Examiner Initial*	Cite No	Publication Number	Kind Code ¹	Publication Date	Name of Patentee or Applicant of cited Document	Pages,Columns,Lines where Relevant Passages or Relevant Figures Appear

Receipt date: 01/26/2011 INFORMATION DISCLOSURE STATEMENT BY APPLICANT (Not for submission under 37 CFR 1.99)	Application Number		12495190	
	Filing Date		2009-06-30	
	First Named Inventor	Russell W. White, et al.		
	Art Unit		2617	
	Examiner Name	Erika A. Gary		
	Attorney Docket Number		AFF.004C7US	

1	20010042107		2001-11-15	Palm	
---	-------------	--	------------	------	--

If you wish to add additional U.S. Published Application citation information please click the Add button.

FOREIGN PATENT DOCUMENTS

Examiner Initial*	Cite No	Foreign Document Number ³	Country Code ² i	Kind Code ⁴	Publication Date	Name of Patentee or Applicant of cited Document	Pages, Columns, Lines where Relevant Passages or Relevant Figures Appear	T ⁵
	1	EP 984584	EP		2000-08-03	Lippert		<input type="checkbox"/>

If you wish to add additional Foreign Patent Document citation information please click the Add button

NON-PATENT LITERATURE DOCUMENTS

Examiner Initials*	Cite No	Include name of the author (in CAPITAL LETTERS), title of the article (when appropriate), title of the item (book, magazine, journal, serial, symposium, catalog, etc), date, pages(s), volume-issue number(s), publisher, city and/or country where published.	T ⁵
	1	Sony Corporation, Sony Portable MiniDisc Recorder MZ-R90/MZ-R91 Operating Instructions, Doc. No. 3-867-571-22(1), 1999, pp. 1-55.	<input type="checkbox"/>
	2	Empeg Car User Guide, 1999, pp. 1-19.	<input type="checkbox"/>
	3	Empeg Car User Guide (2000) pp. 1-48	<input type="checkbox"/>
	4	Crowe, Mike. Empeg Car Beta 10a, March 25, 2000, 3 pages.	<input type="checkbox"/>
	5	Emplode Help, (date unknown, contended by defendant Apple Corp. to be prior art under one or more of 35 U.S.C. 102 (a), (b), (f) and (g)) 25 pages.	<input type="checkbox"/>

Receipt date: 01/26/2011 INFORMATION DISCLOSURE STATEMENT BY APPLICANT (Not for submission under 37 CFR 1.99)	Application Number	12495190
	Filing Date	2009-06-30
	First Named Inventor	Russell W. White, et al.
	Art Unit	2617
	Examiner Name	Erika A. Gary
	Attorney Docket Number	AFF.004C7US

6	"MP3 Portable Player Goes Elite" The Mac Observer, Nov. 17, 1999, 3 pages.	<input type="checkbox"/>
7	"MP3 in Your Car Has Arrived" (date unknown, contended by defendant Apple Corp. to be prior art under one or more of 35 U.S.C. 102 (a), (b), (f) and (g)) 1 page.	<input type="checkbox"/>
8	Photos from Comdex Fall 1999, Nov. 1999, 9 pages.	<input type="checkbox"/>
9	Photos from LinuxWorld Expo, Winter 1999, Mar. 1-4, 1999, 22 pages.	<input type="checkbox"/>
10	Craig Knudsen, "MP3 Linux Players," Linux Journal, Jul. 1, 1999, pp. 1-3.	<input type="checkbox"/>
11	riocar.org – Empeg Car History, (date unknown, contended by defendant Apple Corp. to be prior art under one or more of 35 U.S.C. 102 (a), (b), (f) and (g)), 4 pages.	<input type="checkbox"/>
12	"Visteon: For Your Listening Pleasure - Any Music, Any Time, Anywhere," Presswire, Jan. 5, 2000, 1 page.	<input type="checkbox"/>
13	Photographs in email to Hugo Fiennes, Sept. 22, 1999, 4 pages.	<input type="checkbox"/>
14	HP Jornada 420 User's Manual, 1999, pp. 1-142.	<input type="checkbox"/>
15	IEEE Standard 802.11b, 1999 Edition (Wireless LAN Medium Access Control and Physical Layer Specifications: Higher-Speed Physical Layer Extension in the 2.4 GHz Band) Sep. 16, 1999, 96 pages.	<input type="checkbox"/>
16	RealPlayer Plus G2 Manual, 1999, pp. 1-81.	<input type="checkbox"/>

Receipt date: 01/26/2011 INFORMATION DISCLOSURE STATEMENT BY APPLICANT (Not for submission under 37 CFR 1.99)	Application Number		12495190
	Filing Date		2009-06-30
	First Named Inventor	Russell W. White, et al.	
	Art Unit		2617
	Examiner Name	Erika A. Gary	
	Attorney Docket Number		AFF.004C7US

17	IEEE Standard 802.11a, 1999 Edition (Wireless LAN Medium Access Control and Physical Layer Specifications: High-Speed Physical Layer in the 5GHz Band), 1999, 91 pages.	<input type="checkbox"/>
18	Rod Underhill & Nat Gertler, "The Complete Idiot's Guide to MP3: Music on the Internet," 1999, 44 pages.	<input type="checkbox"/>
19	Bill Mann, "I Want My MP3! How to Download, Rip, & Play Digital Music," McGraw-Hill 2000, 175 pages.	<input type="checkbox"/>
20	IEEE Standard 802.11, 1997 Edition (Wireless LAN Medium Access Control and Physical Layer Specifications), 1997, pp. 1-145.	<input type="checkbox"/>
21	IEEE Standard 802.3ab, 1999 Edition (802.3 Physical Layer Specification for 1000 Mb/s Operation on Four Pairs of Category 5 or Better Balanced Twisted Pair Cable (1000BASE-T) 1999, 140 pages.	<input type="checkbox"/>
22	IBM Wireless Modem for Cellular/CDPD - Quick Reference, Oct. 1995, pp. 1-20.	<input type="checkbox"/>
23	Creative Sound Blaster Live! Platinum product, documentation, and software: Creative Technology Ltd., Creative Sound Blaster Live! Platinum Getting Started, Sept. 1999, 93 pages.	<input type="checkbox"/>
24	psa[play Getting Started Guide, (date unknown, contended by defendant Apple Corp. to be prior art under one or more of 35 U.S.C. 102 (a), (b), (f) and (g)), pp. 1-16.	<input type="checkbox"/>
25	psa[play Getting Started Guide, 2000, pp. 1-16.	<input type="checkbox"/>
26	Rio 800 User Guide, 2001, pp. 1-38.	<input type="checkbox"/>
27	Rio 800 Digital Audio Player—Getting Started, 2000, pp. 1-19.	<input type="checkbox"/>

Receipt date: 01/26/2011 INFORMATION DISCLOSURE STATEMENT BY APPLICANT (Not for submission under 37 CFR 1.99)	Application Number		12495190
	Filing Date		2009-06-30
	First Named Inventor	Russell W. White, et al.	
	Art Unit		2617
	Examiner Name	Erika A. Gary	
	Attorney Docket Number		AFF.004C7US

28	Rio 600 Getting Started Guide, 2001, pp. 1-169.	<input type="checkbox"/>
29	Rio 600 User Guide, March 2001, pp 1-38.	<input type="checkbox"/>

If you wish to add additional non-patent literature document citation information please click the Add button

EXAMINER SIGNATURE

Examiner Signature	/Erika Gary/ (02/17/2011)	Date Considered	02/17/2011
--------------------	---------------------------	-----------------	------------

*EXAMINER: Initial if reference considered, whether or not citation is in conformance with MPEP 609. Draw line through a citation if not in conformance and not considered. Include copy of this form with next communication to applicant.

¹ See Kind Codes of USPTO Patent Documents at www.USPTO.GOV or MPEP 901.04. ² Enter office that issued the document, by the two-letter code (WIPO Standard ST.3). ³ For Japanese patent documents, the indication of the year of the reign of the Emperor must precede the serial number of the patent document. ⁴ Kind of document by the appropriate symbols as indicated on the document under WIPO Standard ST.16 if possible. ⁵ Applicant is to place a check mark here if English language translation is attached.

Receipt date: 01/27/2011

Doc code: IDS

Doc description: Information Disclosure Statement (IDS) Filed

PTO/SB/08a (01-10)

Approved for use through 07/31/2012. OMB 0651-0031

U.S. Patent and Trademark Office; U.S. DEPARTMENT OF COMMERCE

Under the Paperwork Reduction Act of 1995, no persons are required to respond to a collection of information unless it contains a valid OMB control number.

INFORMATION DISCLOSURE STATEMENT BY APPLICANT (Not for submission under 37 CFR 1.99)	Application Number		12495190	
	Filing Date		2009-06-30	
	First Named Inventor	Russell W. White, et al.		
	Art Unit		2617	
	Examiner Name	Erika A. Gary		
	Attorney Docket Number		AFF.004C7US	

U.S.PATENTS						
Examiner Initial*	Cite No	Patent Number	Kind Code ¹	Issue Date	Name of Patentee or Applicant of cited Document	Pages,Columns,Lines where Relevant Passages or Relevant Figures Appear
	1					

If you wish to add additional U.S. Patent citation information please click the Add button.

U.S.PATENT APPLICATION PUBLICATIONS						
Examiner Initial*	Cite No	Publication Number	Kind Code ¹	Publication Date	Name of Patentee or Applicant of cited Document	Pages,Columns,Lines where Relevant Passages or Relevant Figures Appear
	1					

If you wish to add additional U.S. Published Application citation information please click the Add button.

FOREIGN PATENT DOCUMENTS								
Examiner Initial*	Cite No	Foreign Document Number ³	Country Code ²	Kind Code ⁴	Publication Date	Name of Patentee or Applicant of cited Document	Pages,Columns,Lines where Relevant Passages or Relevant Figures Appear	T ⁵
	1							<input type="checkbox"/>

If you wish to add additional Foreign Patent Document citation information please click the Add button

NON-PATENT LITERATURE DOCUMENTS			
Examiner Initials*	Cite No	Include name of the author (in CAPITAL LETTERS), title of the article (when appropriate), title of the item (book, magazine, journal, serial, symposium, catalog, etc), date, pages(s), volume-issue number(s), publisher, city and/or country where published.	T ⁵

Receipt date: 01/27/2011 INFORMATION DISCLOSURE STATEMENT BY APPLICANT (Not for submission under 37 CFR 1.99)	Application Number		12495190
	Filing Date		2009-06-30
	First Named Inventor	Russell W. White, et al.	
	Art Unit		2617
	Examiner Name	Erika A. Gary	
	Attorney Docket Number		AFF.004C7US

1	The Rio 500 Getting Started Guide, 1999, pp. 1-2.	<input type="checkbox"/>
2	"Visteon's Mobile Office Solutions Give Busy Commuters More of What They Need - Time," Canada Newswire, Sept. 15, 1999, 3 pages.	<input type="checkbox"/>
3	Hiatt, "RIAA Sues Napster, Claiming 'Music Piracy'," MTV News, Dec. 8, 1999, 3 pages.	<input type="checkbox"/>
4	Sony VAIO Notebook Computer User Guide PCG-731/PCG-735, 1998, pp. 1-131.	<input type="checkbox"/>
5	Sony VAIO Notebook Computer User Guide PCG-812, 1998, pp. 1-144.	<input type="checkbox"/>
6	Sony VAIO Notebook Computer User Guide PCG-838, 1999, pp. 1-121.	<input type="checkbox"/>
7	Sony Service Manual PCG-731/735/737, 1997, pp. 1-22.	<input type="checkbox"/>
8	Sony Service Manual PCG-723/729, 1998, pp. 1-22.	<input type="checkbox"/>
9		<input type="checkbox"/>
10	Sony Service Manual PCG-812/818, 1998, pp. 1 - 22.	<input type="checkbox"/>
11	Sony Service Manual PCG-838, 1999, pp. 1 - 22.	<input type="checkbox"/>

Receipt date: 01/27/2011 INFORMATION DISCLOSURE STATEMENT BY APPLICANT (Not for submission under 37 CFR 1.99)	Application Number	12495190
	Filing Date	2009-06-30
	First Named Inventor	Russell W. White, et al.
	Art Unit	2617
	Examiner Name	Erika A. Gary
	Attorney Docket Number	AFF.004C7US

12	"Digital Download Provider Musicmaker.com Partners With Download Directory Listen.com; Offers Nearly 100,000 Downloadable Tracks Via the Online Directory," PR Newswire, Sept. 15, 1999, pp. 1-3.	<input type="checkbox"/>
13	MP3.com prospectus, Jul. 21, 1999, pp. 1 - 81.	<input type="checkbox"/>
14	Ana Orubeondo, "Trim AirCard 300 Eases Power Demands," InfoWorld, Volume 21, Issue 48. Nov. 29, 1999. pg 46 & 50.	<input type="checkbox"/>
15	"Net Music Firms to Tap Public Market," Billboard. Jul. 17, 1999. pp. 1 - 2.	<input type="checkbox"/>
16	"Cellular for Notebook PCs." CIO Vo.. 13, No. 1. Oct. 1, 1999, pg. 90.	<input type="checkbox"/>
17	"Briefs," Network World. Volume 16, no. 24. Aug. 23, 1999, pg. 27.	<input type="checkbox"/>
18	The MusicMatch.com website (date unknown, contended by defendant Apple Corp. to be prior art under one or more of 35 U.S.C. 102 (a), (b), (f) and (g)) 32 pages.	<input type="checkbox"/>
19	The MusicMaker.com website (date unknown, contended by defendant Apple Corp. to be prior art under one or more of 35 U.S.C. 102 (a), (b), (f) and (g)), 10 pages.	<input type="checkbox"/>
20	Qualcomm QCP-1960 User Manual. Apr. 1999, pp. 1 - 76.	<input type="checkbox"/>
21	Samsung SCH-3500 User Manual. 1999, pp. 1 - 108.	<input type="checkbox"/>
22	Motorola Digital StarTAC User Guide. Mar. 1999, pp. 1 - 118.	<input type="checkbox"/>

Receipt date: 01/27/2011 INFORMATION DISCLOSURE STATEMENT BY APPLICANT (Not for submission under 37 CFR 1.99)	Application Number		12495190
	Filing Date		2009-06-30
	First Named Inventor	Russell W. White, et al.	
	Art Unit		2617
	Examiner Name	Erika A. Gary	
	Attorney Docket Number		AFF.004C7US

23	Nokia 9110 Quick Guide/Accessories Guide. 1999, pp. 1-31.	<input type="checkbox"/>
24	"MP3.com and i-drive.com Join Forces to Store and Manage MP3 Files," Business Wire, Oct. 7, 1999, pp. 1-3.	<input type="checkbox"/>
25	Nomad User Guide, Jun. 1999, pp. 1-34.	<input type="checkbox"/>
26	Nomad II Getting Started Manual, Jan. 2000, pp. 1 - 38.	<input type="checkbox"/>
27	GSM 03.64 version 6.2.0 Release 1997, European Telecommunications Standards Institute, 1999, pp. 1 - 42.	<input type="checkbox"/>
28	The i-Drive.com website (date unknown, contended by defendant Apple Corp. to be prior art under one or more of 35 U.S.C. 102 (a), (b), (f) and (g)) 6 pages.	<input type="checkbox"/>
29	GSM 03.64 version 7.0.0 Release 1997, European Telecommunications Standards Institute, 1999, pp. 1-42.	<input type="checkbox"/>
30	Specification of the Bluetooth System Version 1.0B (Vol. 1), Telefonaktiebolaget LM Ericsson et al. Dec. 1, 1999, pp. 1-1082.	<input type="checkbox"/>
31	Specification of the Bluetooth System Version 1.0B (Vol. 2), Telefonaktiebolaget LM Ericsson et al. Dec. 1, 1999, pp. 1-440.	<input type="checkbox"/>
32	The MP3.com website (date unknown, contended by defendant Apple Corp. to be prior art under one or more of 35 U.S.C. 102 (a), (b), (f) and (g)) Screenshots from MP3.com website (date unknown, contended by defendant Apple Corp. to be prior art under one or more of 35 U.S.C. 102 (a), (b), (f) and (g)), 6 pages.	<input type="checkbox"/>
33	MP3.com and i-drive.com Join Forces to Store and Manage MP3 Files, Business Wire, Oct. 7, 1999, pp. 1-3.	<input type="checkbox"/>

Receipt date: 01/27/2011 INFORMATION DISCLOSURE STATEMENT BY APPLICANT (Not for submission under 37 CFR 1.99)	Application Number	12495190
	Filing Date	2009-06-30
	First Named Inventor	Russell W. White, et al.
	Art Unit	2617
	Examiner Name	Erika A. Gary
	Attorney Docket Number	AFF.004C7US

34	The EMusic.com website (formerly www.goodnoise.com) (date unknown, contended by defendant Apple Corp. to be prior art under one or more of 35 U.S.C. 102 (a), (b), (f) and (g)) 2 pages.	<input type="checkbox"/>
35	EMusic.com prospectus, Sept. 24, 1999, pp. 1 - 61, F1 - F41.	<input type="checkbox"/>
36	"Logging On; Setting Sound Free From the CD," The Washington Post, Mar. 3, 2000, pp. 1-3.	<input type="checkbox"/>
37	"Music Factory; Retailers Struggle to Expand Listening Options Online," Contra Costa Times Mar. 19, 2000, pp. 1-2.	<input type="checkbox"/>
38	The MyPlay.com website (date unknown, contended by defendant Apple Corp. to be prior art under one or more of 35 U.S.C. 102 (a), (b), (f) and (g)) 1 page.	<input type="checkbox"/>
39	Myplay.com Launches Today, PR Newswire. Oct. 13, 1999, pp. 1-2.	<input type="checkbox"/>
40	Myplay, Inc. Launches Consumer Online Music Service, PR Newswire, Oct. 13, 1999, pp. 1-3.	<input type="checkbox"/>
41	Empeg.com, "Does Your Car Stereo Run Linux," (date unknown, contended by defendant Apple Corp. to be prior art under one or more of 35 U.S.C. 102 (a), (b), (f) and (g)), 2 pages.	<input type="checkbox"/>
42	TIA/EIA Interim Standard, Cellular Digital Packet Data, System Specification - Part 403, Mobile Data Link Protocol, Telecommunications Industry Association. Dec. 1997, 83 pages.	<input type="checkbox"/>
43	"The Listen Up Player from Audio Highway" 1996. 1 page.	<input type="checkbox"/>
44	"Audio Highway Announces The Listen Up Player," Audio Highway Press Release, Sept. 23, 1996, 2 pages.	<input type="checkbox"/>

Receipt date: 01/27/2011 INFORMATION DISCLOSURE STATEMENT BY APPLICANT (Not for submission under 37 CFR 1.99)	Application Number		12495190
	Filing Date		2009-06-30
	First Named Inventor	Russell W. White, et al.	
	Art Unit		2617
	Examiner Name	Erika A. Gary	
	Attorney Docket Number		AFF.004C7US

45	MPMan F-10 and F-20 digital audio players and review article "MP3 Player Saehan MPMan F20 Review", X-bit labs, July 14, 1999. 6 pages.	<input type="checkbox"/>
46	Menta, "RIAA Sues Music Startup Napster for \$20 Billion" Newswire, Jan. 11, 2000, 4 pages.	<input type="checkbox"/>
47	Boehrlart, "Artists to Napster: Drop Dead" Salon.com, Mar. 24, 2000. 3 pages.	<input type="checkbox"/>

If you wish to add additional non-patent literature document citation information please click the Add button

EXAMINER SIGNATURE

Examiner Signature	/Erika Gary/ (02/17/2011)	Date Considered	02/17/2011
--------------------	---------------------------	-----------------	------------

*EXAMINER: Initial if reference considered, whether or not citation is in conformance with MPEP 609. Draw line through a citation if not in conformance and not considered. Include copy of this form with next communication to applicant.

¹ See Kind Codes of USPTO Patent Documents at www.USPTO.GOV or MPEP 901.04. ² Enter office that issued the document, by the two-letter code (WIPO Standard ST.3). ³ For Japanese patent documents, the indication of the year of the reign of the Emperor must precede the serial number of the patent document. ⁴ Kind of document by the appropriate symbols as indicated on the document under WIPO Standard ST.16 if possible. ⁵ Applicant is to place a check mark here if English language translation is attached.

INFORMATION DISCLOSURE STATEMENT BY APPLICANT (Not for submission under 37 CFR 1.99)	Application Number		12495190	
	Filing Date		2009-06-30	
	First Named Inventor	Russell W. White, et al.		
	Art Unit	2617		
	Examiner Name	Erika A. Gary		
	Attorney Docket Number	AFF.004C7US		

U.S.PATENTS						
Examiner Initial*	Cite No	Patent Number	Kind Code ¹	Issue Date	Name of Patentee or Applicant of cited Document	Pages,Columns,Lines where Relevant Passages or Relevant Figures Appear
	1					

If you wish to add additional U.S. Patent citation information please click the Add button.

U.S.PATENT APPLICATION PUBLICATIONS						
Examiner Initial*	Cite No	Publication Number	Kind Code ¹	Publication Date	Name of Patentee or Applicant of cited Document	Pages,Columns,Lines where Relevant Passages or Relevant Figures Appear
	1					

If you wish to add additional U.S. Published Application citation information please click the Add button.

FOREIGN PATENT DOCUMENTS								
Examiner Initial*	Cite No	Foreign Document Number ³	Country Code ²	Kind Code ⁴	Publication Date	Name of Patentee or Applicant of cited Document	Pages,Columns,Lines where Relevant Passages or Relevant Figures Appear	T ⁵
	1							<input type="checkbox"/>

If you wish to add additional Foreign Patent Document citation information please click the Add button

NON-PATENT LITERATURE DOCUMENTS			
Examiner Initials*	Cite No	Include name of the author (in CAPITAL LETTERS), title of the article (when appropriate), title of the item (book, magazine, journal, serial, symposium, catalog, etc), date, pages(s), volume-issue number(s), publisher, city and/or country where published.	T ⁵

INFORMATION DISCLOSURE STATEMENT BY APPLICANT (Not for submission under 37 CFR 1.99)	Application Number	12495190
	Filing Date	2009-06-30
	First Named Inventor	Russell W. White, et al.
	Art Unit	2617
	Examiner Name	Erika A. Gary
	Attorney Docket Number	AFF.004C7US

1	Riocar dot org, "rio car dot org Geek Guide," empeg car Mk.1, July 16, 2010, 4 pages.	<input type="checkbox"/>
2	The MP3.com website (date unknown, contended by defendant Apple Corp. to be prior art under one or more of 35 U.S.C. 102 (a), (b), (f) and (g)) Screenshots from MP3.com website (date unknown, contended by defendant Apple Corp. to be prior art under one or more of 35 U.S.C. 102 (a), (b), (f) and (g)), 8 pages.	<input type="checkbox"/>

If you wish to add additional non-patent literature document citation information please click the Add button

EXAMINER SIGNATURE

Examiner Signature		Date Considered	
--------------------	--	-----------------	--

*EXAMINER: Initial if reference considered, whether or not citation is in conformance with MPEP 609. Draw line through a citation if not in conformance and not considered. Include copy of this form with next communication to applicant.

¹ See Kind Codes of USPTO Patent Documents at www.USPTO.GOV or MPEP 901.04. ² Enter office that issued the document, by the two-letter code (WIPO Standard ST.3). ³ For Japanese patent documents, the indication of the year of the reign of the Emperor must precede the serial number of the patent document. ⁴ Kind of document by the appropriate symbols as indicated on the document under WIPO Standard ST.16 if possible. ⁵ Applicant is to place a check mark here if English language translation is attached.

INFORMATION DISCLOSURE STATEMENT BY APPLICANT (Not for submission under 37 CFR 1.99)	Application Number	12495190
	Filing Date	2009-06-30
	First Named Inventor	Russell W. White, et al.
	Art Unit	2617
	Examiner Name	Erika A. Gary
	Attorney Docket Number	AFF.004C7US

CERTIFICATION STATEMENT

Please see 37 CFR 1.97 and 1.98 to make the appropriate selection(s):

That each item of information contained in the information disclosure statement was first cited in any communication from a foreign patent office in a counterpart foreign application not more than three months prior to the filing of the information disclosure statement. See 37 CFR 1.97(e)(1).

OR

That no item of information contained in the information disclosure statement was cited in a communication from a foreign patent office in a counterpart foreign application, and, to the knowledge of the person signing the certification after making reasonable inquiry, no item of information contained in the information disclosure statement was known to any individual designated in 37 CFR 1.56(c) more than three months prior to the filing of the information disclosure statement. See 37 CFR 1.97(e)(2).

See attached certification statement.

Fee set forth in 37 CFR 1.17 (p) has been submitted herewith.

None

SIGNATURE

A signature of the applicant or representative is required in accordance with CFR 1.33, 10.18. Please see CFR 1.4(d) for the form of the signature.

Signature	/Mark J. Rozman/	Date (YYYY-MM-DD)	2011-01-31
Name/Print	Mark J. Rozman	Registration Number	42117

This collection of information is required by 37 CFR 1.97 and 1.98. The information is required to obtain or retain a benefit by the public which is to file (and by the USPTO to process) an application. Confidentiality is governed by 35 U.S.C. 122 and 37 CFR 1.14. This collection is estimated to take 1 hour to complete, including gathering, preparing and submitting the completed application form to the USPTO. Time will vary depending upon the individual case. Any comments on the amount of time you require to complete this form and/or suggestions for reducing this burden, should be sent to the Chief Information Officer, U.S. Patent and Trademark Office, U.S. Department of Commerce, P.O. Box 1450, Alexandria, VA 22313-1450. **DO NOT SEND FEES OR COMPLETED FORMS TO THIS ADDRESS. SEND TO: Commissioner for Patents, P.O. Box 1450, Alexandria, VA 22313-1450.**

Privacy Act Statement

The Privacy Act of 1974 (P.L. 93-579) requires that you be given certain information in connection with your submission of the attached form related to a patent application or patent. Accordingly, pursuant to the requirements of the Act, please be advised that: (1) the general authority for the collection of this information is 35 U.S.C. 2(b)(2); (2) furnishing of the information solicited is voluntary; and (3) the principal purpose for which the information is used by the U.S. Patent and Trademark Office is to process and/or examine your submission related to a patent application or patent. If you do not furnish the requested information, the U.S. Patent and Trademark Office may not be able to process and/or examine your submission, which may result in termination of proceedings or abandonment of the application or expiration of the patent.

The information provided by you in this form will be subject to the following routine uses:

1. The information on this form will be treated confidentially to the extent allowed under the Freedom of Information Act (5 U.S.C. 552) and the Privacy Act (5 U.S.C. 552a). Records from this system of records may be disclosed to the Department of Justice to determine whether the Freedom of Information Act requires disclosure of these records.
2. A record from this system of records may be disclosed, as a routine use, in the course of presenting evidence to a court, magistrate, or administrative tribunal, including disclosures to opposing counsel in the course of settlement negotiations.
3. A record in this system of records may be disclosed, as a routine use, to a Member of Congress submitting a request involving an individual, to whom the record pertains, when the individual has requested assistance from the Member with respect to the subject matter of the record.
4. A record in this system of records may be disclosed, as a routine use, to a contractor of the Agency having need for the information in order to perform a contract. Recipients of information shall be required to comply with the requirements of the Privacy Act of 1974, as amended, pursuant to 5 U.S.C. 552a(m).
5. A record related to an International Application filed under the Patent Cooperation Treaty in this system of records may be disclosed, as a routine use, to the International Bureau of the World Intellectual Property Organization, pursuant to the Patent Cooperation Treaty.
6. A record in this system of records may be disclosed, as a routine use, to another federal agency for purposes of National Security review (35 U.S.C. 181) and for review pursuant to the Atomic Energy Act (42 U.S.C. 218(c)).
7. A record from this system of records may be disclosed, as a routine use, to the Administrator, General Services, or his/her designee, during an inspection of records conducted by GSA as part of that agency's responsibility to recommend improvements in records management practices and programs, under authority of 44 U.S.C. 2904 and 2906. Such disclosure shall be made in accordance with the GSA regulations governing inspection of records for this purpose, and any other relevant (i.e., GSA or Commerce) directive. Such disclosure shall not be used to make determinations about individuals.
8. A record from this system of records may be disclosed, as a routine use, to the public after either publication of the application pursuant to 35 U.S.C. 122(b) or issuance of a patent pursuant to 35 U.S.C. 151. Further, a record may be disclosed, subject to the limitations of 37 CFR 1.14, as a routine use, to the public if the record was filed in an application which became abandoned or in which the proceedings were terminated and which application is referenced by either a published application, an application open to public inspections or an issued patent.
9. A record from this system of records may be disclosed, as a routine use, to a Federal, State, or local law enforcement agency, if the USPTO becomes aware of a violation or potential violation of law or regulation.

Electronic Patent Application Fee Transmittal

Application Number:	12495190
Filing Date:	30-Jun-2009
Title of Invention:	Method For Content Delivery
First Named Inventor/Applicant Name:	Russell W. White
Filer:	Mark J. Rozman/Stephanie Petreas
Attorney Docket Number:	AFF.0004C7US

Filed as Large Entity

Utility under 35 USC 111(a) Filing Fees

Description	Fee Code	Quantity	Amount	Sub-Total in USD(\$)
Basic Filing:				
Pages:				
Claims:				
Miscellaneous-Filing:				
Petition:				
Patent-Appeals-and-Interference:				
Post-Allowance-and-Post-Issuance:				
Extension-of-Time:				

Description	Fee Code	Quantity	Amount	Sub-Total in USD(\$)
Miscellaneous:				
Submission- Information Disclosure Stmt	1806	1	180	180
Total in USD (\$)				180

Electronic Acknowledgement Receipt

EFS ID:	9339927
Application Number:	12495190
International Application Number:	
Confirmation Number:	2380
Title of Invention:	Method For Content Delivery
First Named Inventor/Applicant Name:	Russell W. White
Customer Number:	21906
Filer:	Mark J. Rozman/Stephanie Petreas
Filer Authorized By:	Mark J. Rozman
Attorney Docket Number:	AFF.0004C7US
Receipt Date:	31-JAN-2011
Filing Date:	30-JUN-2009
Time Stamp:	12:55:27
Application Type:	Utility under 35 USC 111(a)

Payment information:

Submitted with Payment	yes
Payment Type	Deposit Account
Payment was successfully received in RAM	\$180
RAM confirmation Number	10931
Deposit Account	201504
Authorized User	

The Director of the USPTO is hereby authorized to charge indicated fees and credit any overpayment as follows:

Charge any Additional Fees required under 37 C.F.R. Section 1.21 (Miscellaneous fees and charges)

File Listing:					
Document Number	Document Description	File Name	File Size(Bytes)/ Message Digest	Multi Part /.zip	Pages (if appl.)
1	Information Disclosure Statement (IDS) Filed (SB/08)	AFF004C7IDSAppleFtpMiscDocsTOFILE.pdf	37399 3a7fd8987e94f69322e9078965e9d4e12161332e	no	4
Warnings:					
Information:					
This is not an USPTO supplied IDS fillable form					
2	NPL Documents	RiocarDotOrgGeekGuide.pdf	592922 7693b83cbe8125149987267ccdb04b1f57d90008	no	4
Warnings:					
Information:					
3	NPL Documents	MP3dotCom.pdf	610600 731d634cc6ff6b2ff54a25d0b84abcaf2e104d4	no	8
Warnings:					
Information:					
4	Fee Worksheet (PTO-875)	fee-info.pdf	30361 2cc7134b50dd6641185a36d077e9246679318033	no	2
Warnings:					
Information:					
Total Files Size (in bytes):			1271282		

This Acknowledgement Receipt evidences receipt on the noted date by the USPTO of the indicated documents, characterized by the applicant, and including page counts, where applicable. It serves as evidence of receipt similar to a Post Card, as described in MPEP 503.

New Applications Under 35 U.S.C. 111

If a new application is being filed and the application includes the necessary components for a filing date (see 37 CFR 1.53(b)-(d) and MPEP 506), a Filing Receipt (37 CFR 1.54) will be issued in due course and the date shown on this Acknowledgement Receipt will establish the filing date of the application.

National Stage of an International Application under 35 U.S.C. 371

If a timely submission to enter the national stage of an international application is compliant with the conditions of 35 U.S.C. 371 and other applicable requirements a Form PCT/DO/EO/903 indicating acceptance of the application as a national stage submission under 35 U.S.C. 371 will be issued in addition to the Filing Receipt, in due course.

New International Application Filed with the USPTO as a Receiving Office

If a new international application is being filed and the international application includes the necessary components for an international filing date (see PCT Article 11 and MPEP 1810), a Notification of the International Application Number and of the International Filing Date (Form PCT/RO/105) will be issued in due course, subject to prescriptions concerning national security, and the date shown on this Acknowledgement Receipt will establish the international filing date of the application.

INFORMATION DISCLOSURE STATEMENT BY APPLICANT (Not for submission under 37 CFR 1.99)	Application Number		12495190	
	Filing Date		2009-06-30	
	First Named Inventor	Russell W. White, et al.		
	Art Unit		2617	
	Examiner Name	Erika A. Gary		
	Attorney Docket Number		AFF.004C7US	

U.S.PATENTS						
Examiner Initial*	Cite No	Patent Number	Kind Code ¹	Issue Date	Name of Patentee or Applicant of cited Document	Pages,Columns,Lines where Relevant Passages or Relevant Figures Appear
	1					

If you wish to add additional U.S. Patent citation information please click the Add button.

U.S.PATENT APPLICATION PUBLICATIONS						
Examiner Initial*	Cite No	Publication Number	Kind Code ¹	Publication Date	Name of Patentee or Applicant of cited Document	Pages,Columns,Lines where Relevant Passages or Relevant Figures Appear
	1					

If you wish to add additional U.S. Published Application citation information please click the Add button.

FOREIGN PATENT DOCUMENTS								
Examiner Initial*	Cite No	Foreign Document Number ³	Country Code ²	Kind Code ⁴	Publication Date	Name of Patentee or Applicant of cited Document	Pages,Columns,Lines where Relevant Passages or Relevant Figures Appear	T ⁵
	1							<input type="checkbox"/>

If you wish to add additional Foreign Patent Document citation information please click the Add button

NON-PATENT LITERATURE DOCUMENTS			
Examiner Initials*	Cite No	Include name of the author (in CAPITAL LETTERS), title of the article (when appropriate), title of the item (book, magazine, journal, serial, symposium, catalog, etc), date, pages(s), volume-issue number(s), publisher, city and/or country where published.	T ⁵

**INFORMATION DISCLOSURE
STATEMENT BY APPLICANT**
(Not for submission under 37 CFR 1.99)

Application Number	12495190
Filing Date	2009-06-30
First Named Inventor	Russell W. White, et al.
Art Unit	2617
Examiner Name	Erika A. Gary
Attorney Docket Number	AFF.004C7US

1	The Rio 500 Getting Started Guide, 1999, pp. 1-2.	<input type="checkbox"/>
2	"Visteon's Mobile Office Solutions Give Busy Commuters More of What They Need - Time," Canada Newswire, Sept. 15, 1999, 3 pages.	<input type="checkbox"/>
3	Hiatt, "RIAA Sues Napster, Claiming 'Music Piracy'," MTV News, Dec. 8, 1999, 3 pages.	<input type="checkbox"/>
4	Sony VAIO Notebook Computer User Guide PCG-731/PCG-735, 1998, pp. 1-131.	<input type="checkbox"/>
5	Sony VAIO Notebook Computer User Guide PCG-812, 1998, pp. 1-144.	<input type="checkbox"/>
6	Sony VAIO Notebook Computer User Guide PCG-838, 1999, pp. 1-121.	<input type="checkbox"/>
7	Sony Service Manual PCG-731/735/737, 1997, pp. 1-22.	<input type="checkbox"/>
8	Sony Service Manual PCG-723/729, 1998, pp. 1-22.	<input type="checkbox"/>
9		<input type="checkbox"/>
10	Sony Service Manual PCG-812/818, 1998, pp. 1 - 22.	<input type="checkbox"/>
11	Sony Service Manual PCG-838, 1999, pp. 1 - 22.	<input type="checkbox"/>

**INFORMATION DISCLOSURE
STATEMENT BY APPLICANT**
(Not for submission under 37 CFR 1.99)

Application Number	12495190
Filing Date	2009-06-30
First Named Inventor	Russell W. White, et al.
Art Unit	2617
Examiner Name	Erika A. Gary
Attorney Docket Number	AFF.004C7US

12	"Digital Download Provider Musicmaker.com Partners With Download Directory Listen.com; Offers Nearly 100,000 Downloadable Tracks Via the Online Directory," PR Newswire, Sept. 15, 1999, pp. 1-3.	<input type="checkbox"/>
13	MP3.com prospectus, Jul. 21, 1999, pp. 1 - 81.	<input type="checkbox"/>
14	Ana Orubeondo, "Trim AirCard 300 Eases Power Demands," InfoWorld, Volume 21, Issue 48. Nov. 29, 1999. pg 46 & 50.	<input type="checkbox"/>
15	"Net Music Firms to Tap Public Market," Billboard. Jul. 17, 1999. pp. 1 - 2.	<input type="checkbox"/>
16	"Cellular for Notebook PCs." CIO Vo.. 13, No. 1. Oct. 1, 1999, pg. 90.	<input type="checkbox"/>
17	"Briefs," Network World. Volume 16, no. 24. Aug. 23, 1999, pg. 27.	<input type="checkbox"/>
18	The MusicMatch.com website (date unknown, contended by defendant Apple Corp. to be prior art under one or more of 35 U.S.C. 102 (a), (b), (f) and (g)) 32 pages.	<input type="checkbox"/>
19	The MusicMaker.com website (date unknown, contended by defendant Apple Corp. to be prior art under one or more of 35 U.S.C. 102 (a), (b), (f) and (g)), 10 pages.	<input type="checkbox"/>
20	Qualcomm QCP-1960 User Manual. Apr. 1999, pp. 1 - 76.	<input type="checkbox"/>
21	Samsung SCH-3500 User Manual. 1999, pp. 1 - 108.	<input type="checkbox"/>
22	Motorola Digital StarTAC User Guide. Mar. 1999, pp. 1 - 118.	<input type="checkbox"/>

**INFORMATION DISCLOSURE
STATEMENT BY APPLICANT**
(Not for submission under 37 CFR 1.99)

Application Number	12495190
Filing Date	2009-06-30
First Named Inventor	Russell W. White, et al.
Art Unit	2617
Examiner Name	Erika A. Gary
Attorney Docket Number	AFF.004C7US

23	Nokia 9110 Quick Guide/Accessories Guide. 1999, pp. 1-31.	<input type="checkbox"/>
24	"MP3.com and i-drive.com Join Forces to Store and Manage MP3 Files," Business Wire, Oct. 7, 1999, pp. 1-3.	<input type="checkbox"/>
25	Nomad User Guide, Jun. 1999, pp. 1-34.	<input type="checkbox"/>
26	Nomad II Getting Started Manual, Jan. 2000, pp. 1 - 38.	<input type="checkbox"/>
27	GSM 03.64 version 6.2.0 Release 1997, European Telecommunications Standards Institute, 1999, pp. 1 - 42.	<input type="checkbox"/>
28	The i-Drive.com website (date unknown, contended by defendant Apple Corp. to be prior art under one or more of 35 U.S.C. 102 (a), (b), (f) and (g)) 6 pages.	<input type="checkbox"/>
29	GSM 03.64 version 7.0.0 Release 1997, European Telecommunications Standards Institute, 1999, pp. 1-42.	<input type="checkbox"/>
30	Specification of the Bluetooth System Version 1.0B (Vol. 1), Telefonaktiebolaget LM Ericsson et al. Dec. 1, 1999, pp. 1-1082.	<input type="checkbox"/>
31	Specification of the Bluetooth System Version 1.0B (Vol. 2), Telefonaktiebolaget LM Ericsson et al. Dec. 1, 1999, pp. 1-440.	<input type="checkbox"/>
32	The MP3.com website (date unknown, contended by defendant Apple Corp. to be prior art under one or more of 35 U.S.C. 102 (a), (b), (f) and (g)) Screenshots from MP3.com website (date unknown, contended by defendant Apple Corp. to be prior art under one or more of 35 U.S.C. 102 (a), (b), (f) and (g)), 6 pages.	<input type="checkbox"/>
33	MP3.com and i-drive.com Join Forces to Store and Manage MP3 Files, Business Wire, Oct. 7, 1999, pp. 1-3.	<input type="checkbox"/>

**INFORMATION DISCLOSURE
STATEMENT BY APPLICANT**
(Not for submission under 37 CFR 1.99)

Application Number	12495190
Filing Date	2009-06-30
First Named Inventor	Russell W. White, et al.
Art Unit	2617
Examiner Name	Erika A. Gary
Attorney Docket Number	AFF.004C7US

34	The EMusic.com website (formerly www.goodnoise.com) (date unknown, contended by defendant Apple Corp. to be prior art under one or more of 35 U.S.C. 102 (a), (b), (f) and (g)) 2 pages.	<input type="checkbox"/>
35	EMusic.com prospectus, Sept. 24, 1999, pp. 1 - 61, F1 - F41.	<input type="checkbox"/>
36	"Logging On; Setting Sound Free From the CD," The Washington Post, Mar. 3, 2000, pp. 1-3.	<input type="checkbox"/>
37	"Music Factory; Retailers Struggle to Expand Listening Options Online," Contra Costa Times Mar. 19, 2000, pp. 1- 2.	<input type="checkbox"/>
38	The MyPlay.com website (date unknown, contended by defendant Apple Corp. to be prior art under one or more of 35 U.S.C. 102 (a), (b), (f) and (g)) 1 page.	<input type="checkbox"/>
39	Myplay.com Launches Today, PR Newswire. Oct. 13, 1999, pp. 1-2.	<input type="checkbox"/>
40	Myplay, Inc. Launches Consumer Online Music Service, PR Newswire, Oct. 13, 1999, pp. 1-3.	<input type="checkbox"/>
41	Empeg.com, "Does Your Car Stereo Run Linux," (date unknown, contended by defendant Apple Corp. to be prior art under one or more of 35 U.S.C. 102 (a), (b), (f) and (g)), 2 pages.	<input type="checkbox"/>
42	TIA/EIA Interim Standard, Cellular Digital Packet Data, System Specification - Part 403, Mobile Data Link Protocol, Telecommunications Industry Association. Dec. 1997, 83 pages.	<input type="checkbox"/>
43	"The Listen Up Player from Audio Highway" 1996. 1 page.	<input type="checkbox"/>
44	"Audio Highway Announces The Listen Up Player," Audio Highway Press Release, Sept. 23, 1996, 2 pages.	<input type="checkbox"/>

INFORMATION DISCLOSURE STATEMENT BY APPLICANT (Not for submission under 37 CFR 1.99)	Application Number	12495190
	Filing Date	2009-06-30
	First Named Inventor	Russell W. White, et al.
	Art Unit	2617
	Examiner Name	Erika A. Gary
	Attorney Docket Number	AFF.004C7US

45	MPMan F-10 and F-20 digital audio players and review article "MP3 Player Saehan MPMan F20 Review", X-bit labs, July 14, 1999. 6 pages.	<input type="checkbox"/>
46	Menta, "RIAA Sues Music Startup Napster for \$20 Billion" Newswire, Jan. 11, 2000, 4 pages.	<input type="checkbox"/>
47	Boehrlart, "Artists to Napster: Drop Dead" Salon.com, Mar. 24, 2000. 3 pages.	<input type="checkbox"/>

If you wish to add additional non-patent literature document citation information please click the Add button

EXAMINER SIGNATURE

Examiner Signature		Date Considered	
--------------------	--	-----------------	--

*EXAMINER: Initial if reference considered, whether or not citation is in conformance with MPEP 609. Draw line through a citation if not in conformance and not considered. Include copy of this form with next communication to applicant.

¹ See Kind Codes of USPTO Patent Documents at www.USPTO.GOV or MPEP 901.04. ² Enter office that issued the document, by the two-letter code (WIPO Standard ST.3). ³ For Japanese patent documents, the indication of the year of the reign of the Emperor must precede the serial number of the patent document. ⁴ Kind of document by the appropriate symbols as indicated on the document under WIPO Standard ST.16 if possible. ⁵ Applicant is to place a check mark here if English language translation is attached.

INFORMATION DISCLOSURE STATEMENT BY APPLICANT (Not for submission under 37 CFR 1.99)	Application Number	12495190
	Filing Date	2009-06-30
	First Named Inventor	Russell W. White, et al.
	Art Unit	2617
	Examiner Name	Erika A. Gary
	Attorney Docket Number	AFF.004C7US

CERTIFICATION STATEMENT

Please see 37 CFR 1.97 and 1.98 to make the appropriate selection(s):

That each item of information contained in the information disclosure statement was first cited in any communication from a foreign patent office in a counterpart foreign application not more than three months prior to the filing of the information disclosure statement. See 37 CFR 1.97(e)(1).

OR

That no item of information contained in the information disclosure statement was cited in a communication from a foreign patent office in a counterpart foreign application, and, to the knowledge of the person signing the certification after making reasonable inquiry, no item of information contained in the information disclosure statement was known to any individual designated in 37 CFR 1.56(c) more than three months prior to the filing of the information disclosure statement. See 37 CFR 1.97(e)(2).

See attached certification statement.

Fee set forth in 37 CFR 1.17 (p) has been submitted herewith.

None

SIGNATURE

A signature of the applicant or representative is required in accordance with CFR 1.33, 10.18. Please see CFR 1.4(d) for the form of the signature.

Signature	/Mark J. Rozman/	Date (YYYY-MM-DD)	2011-01-27
Name/Print	Mark J. Rozman	Registration Number	42117

This collection of information is required by 37 CFR 1.97 and 1.98. The information is required to obtain or retain a benefit by the public which is to file (and by the USPTO to process) an application. Confidentiality is governed by 35 U.S.C. 122 and 37 CFR 1.14. This collection is estimated to take 1 hour to complete, including gathering, preparing and submitting the completed application form to the USPTO. Time will vary depending upon the individual case. Any comments on the amount of time you require to complete this form and/or suggestions for reducing this burden, should be sent to the Chief Information Officer, U.S. Patent and Trademark Office, U.S. Department of Commerce, P.O. Box 1450, Alexandria, VA 22313-1450. **DO NOT SEND FEES OR COMPLETED FORMS TO THIS ADDRESS. SEND TO: Commissioner for Patents, P.O. Box 1450, Alexandria, VA 22313-1450.**

Privacy Act Statement

The Privacy Act of 1974 (P.L. 93-579) requires that you be given certain information in connection with your submission of the attached form related to a patent application or patent. Accordingly, pursuant to the requirements of the Act, please be advised that: (1) the general authority for the collection of this information is 35 U.S.C. 2(b)(2); (2) furnishing of the information solicited is voluntary; and (3) the principal purpose for which the information is used by the U.S. Patent and Trademark Office is to process and/or examine your submission related to a patent application or patent. If you do not furnish the requested information, the U.S. Patent and Trademark Office may not be able to process and/or examine your submission, which may result in termination of proceedings or abandonment of the application or expiration of the patent.

The information provided by you in this form will be subject to the following routine uses:

1. The information on this form will be treated confidentially to the extent allowed under the Freedom of Information Act (5 U.S.C. 552) and the Privacy Act (5 U.S.C. 552a). Records from this system of records may be disclosed to the Department of Justice to determine whether the Freedom of Information Act requires disclosure of these records.
2. A record from this system of records may be disclosed, as a routine use, in the course of presenting evidence to a court, magistrate, or administrative tribunal, including disclosures to opposing counsel in the course of settlement negotiations.
3. A record in this system of records may be disclosed, as a routine use, to a Member of Congress submitting a request involving an individual, to whom the record pertains, when the individual has requested assistance from the Member with respect to the subject matter of the record.
4. A record in this system of records may be disclosed, as a routine use, to a contractor of the Agency having need for the information in order to perform a contract. Recipients of information shall be required to comply with the requirements of the Privacy Act of 1974, as amended, pursuant to 5 U.S.C. 552a(m).
5. A record related to an International Application filed under the Patent Cooperation Treaty in this system of records may be disclosed, as a routine use, to the International Bureau of the World Intellectual Property Organization, pursuant to the Patent Cooperation Treaty.
6. A record in this system of records may be disclosed, as a routine use, to another federal agency for purposes of National Security review (35 U.S.C. 181) and for review pursuant to the Atomic Energy Act (42 U.S.C. 218(c)).
7. A record from this system of records may be disclosed, as a routine use, to the Administrator, General Services, or his/her designee, during an inspection of records conducted by GSA as part of that agency's responsibility to recommend improvements in records management practices and programs, under authority of 44 U.S.C. 2904 and 2906. Such disclosure shall be made in accordance with the GSA regulations governing inspection of records for this purpose, and any other relevant (i.e., GSA or Commerce) directive. Such disclosure shall not be used to make determinations about individuals.
8. A record from this system of records may be disclosed, as a routine use, to the public after either publication of the application pursuant to 35 U.S.C. 122(b) or issuance of a patent pursuant to 35 U.S.C. 151. Further, a record may be disclosed, subject to the limitations of 37 CFR 1.14, as a routine use, to the public if the record was filed in an application which became abandoned or in which the proceedings were terminated and which application is referenced by either a published application, an application open to public inspections or an issued patent.
9. A record from this system of records may be disclosed, as a routine use, to a Federal, State, or local law enforcement agency, if the USPTO becomes aware of a violation or potential violation of law or regulation.

Electronic Acknowledgement Receipt

EFS ID:	9318275
Application Number:	12495190
International Application Number:	
Confirmation Number:	2380
Title of Invention:	Method For Content Delivery
First Named Inventor/Applicant Name:	Russell W. White
Customer Number:	21906
Filer:	Mark J. Rozman/Stephanie Petreas
Filer Authorized By:	Mark J. Rozman
Attorney Docket Number:	AFF.0004C7US
Receipt Date:	27-JAN-2011
Filing Date:	30-JUN-2009
Time Stamp:	12:29:13
Application Type:	Utility under 35 USC 111(a)

Payment information:

Submitted with Payment	no
------------------------	----

File Listing:

Document Number	Document Description	File Name	File Size(Bytes)/ Message Digest	Multi Part /.zip	Pages (if appl.)
1	Information Disclosure Statement (IDS) Filed (SB/08)	AFF004C7IDSAppleFtpIDS2of2 ToFile.pdf	56430 <small>b511b620c54064c45fed8c5b6079f108d42e8a5a</small>	no	8

Warnings:

Information:

This is not an USPTO supplied IDS fillable form					
2	NPL Documents	MyPlayLaunchesToday.pdf	226444	no	2
			211cd854cf9c018a1365bbf81e3a1ed3783637		
Warnings:					
Information:					
3	NPL Documents	MyPlayLaunchesConsumer.pdf	228618	no	3
			a19e008f9e867acc2396f0ae4586f0260207124c		
Warnings:					
Information:					
4	NPL Documents	TIAEIAinterimStandard.pdf	3745550	no	83
			ef4f10a9f4245905389cbd72abc857c5fdaf346		
Warnings:					
The page size in the PDF is too large. The pages should be 8.5 x 11 or A4. If this PDF is submitted, the pages will be resized upon entry into the Image File Wrapper and may affect subsequent processing					
Information:					
5	NPL Documents	rio500gettingstartedguide.pdf	847771	no	2
			9921b83ee971851fa851aaf44b315e08896348		
Warnings:					
Information:					
6	NPL Documents	sonyservicemanual731.pdf	3554067	no	22
			63b4dc0e245252a7278e5511bffb54659dcad41e		
Warnings:					
Information:					
7	NPL Documents	sonyservicemanual723.pdf	3348369	no	22
			ff601cdab94ffd5c1920b1b87a9b3ecd579dfda8		
Warnings:					
Information:					
8	NPL Documents	sonyservicemanual812.pdf	3664157	no	22
			193786270146572fea845c44fc15440d396f23db		
Warnings:					
Information:					
9	NPL Documents	sonyservicemanual838.pdf	3565502	no	22
			7c753e86213e29efef38e47d67a143d1bb30a7e91		
Warnings:					
Information:					

10	NPL Documents	MusicMatchWebSite.pdf	5519286	no	32
			cd0985b7bb815a40e88e1bec3a88180a6ead5910		

Warnings:

Information:

11	NPL Documents	Mp3dotcomandidrivejoin.pdf	41062	no	3
			55ac2bad9bc37fee6a5f0a33a3b7e4b15e8933ea		

Warnings:

Information:

Total Files Size (in bytes):	24797256
-------------------------------------	----------

This Acknowledgement Receipt evidences receipt on the noted date by the USPTO of the indicated documents, characterized by the applicant, and including page counts, where applicable. It serves as evidence of receipt similar to a Post Card, as described in MPEP 503.

New Applications Under 35 U.S.C. 111

If a new application is being filed and the application includes the necessary components for a filing date (see 37 CFR 1.53(b)-(d) and MPEP 506), a Filing Receipt (37 CFR 1.54) will be issued in due course and the date shown on this Acknowledgement Receipt will establish the filing date of the application.

National Stage of an International Application under 35 U.S.C. 371

If a timely submission to enter the national stage of an international application is compliant with the conditions of 35 U.S.C. 371 and other applicable requirements a Form PCT/DO/EO/903 indicating acceptance of the application as a national stage submission under 35 U.S.C. 371 will be issued in addition to the Filing Receipt, in due course.

New International Application Filed with the USPTO as a Receiving Office

If a new international application is being filed and the international application includes the necessary components for an international filing date (see PCT Article 11 and MPEP 1810), a Notification of the International Application Number and of the International Filing Date (Form PCT/RO/105) will be issued in due course, subject to prescriptions concerning national security, and the date shown on this Acknowledgement Receipt will establish the international filing date of the application.

INFORMATION DISCLOSURE STATEMENT BY APPLICANT (Not for submission under 37 CFR 1.99)	Application Number		12495190	
	Filing Date		2009-06-30	
	First Named Inventor	Russell W. White, et al.		
	Art Unit	2617		
	Examiner Name	Erika A. Gary		
	Attorney Docket Number	AFF.004C7US		

U.S.PATENTS						
Examiner Initial*	Cite No	Patent Number	Kind Code ¹	Issue Date	Name of Patentee or Applicant of cited Document	Pages,Columns,Lines where Relevant Passages or Relevant Figures Appear
	1					

If you wish to add additional U.S. Patent citation information please click the Add button.

U.S.PATENT APPLICATION PUBLICATIONS						
Examiner Initial*	Cite No	Publication Number	Kind Code ¹	Publication Date	Name of Patentee or Applicant of cited Document	Pages,Columns,Lines where Relevant Passages or Relevant Figures Appear
	1					

If you wish to add additional U.S. Published Application citation information please click the Add button.

FOREIGN PATENT DOCUMENTS								
Examiner Initial*	Cite No	Foreign Document Number ³	Country Code ²	Kind Code ⁴	Publication Date	Name of Patentee or Applicant of cited Document	Pages,Columns,Lines where Relevant Passages or Relevant Figures Appear	T ⁵
	1							<input type="checkbox"/>

If you wish to add additional Foreign Patent Document citation information please click the Add button

NON-PATENT LITERATURE DOCUMENTS			
Examiner Initials*	Cite No	Include name of the author (in CAPITAL LETTERS), title of the article (when appropriate), title of the item (book, magazine, journal, serial, symposium, catalog, etc), date, pages(s), volume-issue number(s), publisher, city and/or country where published.	T ⁵

**INFORMATION DISCLOSURE
STATEMENT BY APPLICANT**
(Not for submission under 37 CFR 1.99)

Application Number		12495190
Filing Date		2009-06-30
First Named Inventor	Russell W. White, et al.	
Art Unit		2617
Examiner Name	Erika A. Gary	
Attorney Docket Number		AFF.004C7US

1	The Rio 500 Getting Started Guide, 1999, pp. 1-2.	<input type="checkbox"/>
2	"Visteon's Mobile Office Solutions Give Busy Commuters More of What They Need - Time," Canada Newswire, Sept. 15, 1999, 3 pages.	<input type="checkbox"/>
3	Hiatt, "RIAA Sues Napster, Claiming 'Music Piracy'," MTV News, Dec. 8, 1999, 3 pages.	<input type="checkbox"/>
4	Sony VAIO Notebook Computer User Guide PCG-731/PCG-735, 1998, pp. 1-131.	<input type="checkbox"/>
5	Sony VAIO Notebook Computer User Guide PCG-812, 1998, pp. 1-144.	<input type="checkbox"/>
6	Sony VAIO Notebook Computer User Guide PCG-838, 1999, pp. 1-121.	<input type="checkbox"/>
7	Sony Service Manual PCG-731/735/737, 1997, pp. 1-22.	<input type="checkbox"/>
8	Sony Service Manual PCG-723/729, 1998, pp. 1-22.	<input type="checkbox"/>
9		<input type="checkbox"/>
10	Sony Service Manual PCG-812/818, 1998, pp. 1 - 22.	<input type="checkbox"/>
11	Sony Service Manual PCG-838, 1999, pp. 1 - 22.	<input type="checkbox"/>

**INFORMATION DISCLOSURE
STATEMENT BY APPLICANT**
(Not for submission under 37 CFR 1.99)

Application Number	12495190
Filing Date	2009-06-30
First Named Inventor	Russell W. White, et al.
Art Unit	2617
Examiner Name	Erika A. Gary
Attorney Docket Number	AFF.004C7US

12	"Digital Download Provider Musicmaker.com Partners With Download Directory Listen.com; Offers Nearly 100,000 Downloadable Tracks Via the Online Directory," PR Newswire, Sept. 15, 1999, pp. 1-3.	<input type="checkbox"/>
13	MP3.com prospectus, Jul. 21, 1999, pp. 1 - 81.	<input type="checkbox"/>
14	Ana Orubeondo, "Trim AirCard 300 Eases Power Demands," InfoWorld, Volume 21, Issue 48. Nov. 29, 1999. pg 46 & 50.	<input type="checkbox"/>
15	"Net Music Firms to Tap Public Market," Billboard. Jul. 17, 1999. pp. 1 - 2.	<input type="checkbox"/>
16	"Cellular for Notebook PCs." CIO Vo.. 13, No. 1. Oct. 1, 1999, pg. 90.	<input type="checkbox"/>
17	"Briefs," Network World. Volume 16, no. 24. Aug. 23, 1999, pg. 27.	<input type="checkbox"/>
18	The MusicMatch.com website (date unknown, contended by defendant Apple Corp. to be prior art under one or more of 35 U.S.C. 102 (a), (b), (f) and (g)) 32 pages.	<input type="checkbox"/>
19	The MusicMaker.com website (date unknown, contended by defendant Apple Corp. to be prior art under one or more of 35 U.S.C. 102 (a), (b), (f) and (g)), 10 pages.	<input type="checkbox"/>
20	Qualcomm QCP-1960 User Manual. Apr. 1999, pp. 1 - 76.	<input type="checkbox"/>
21	Samsung SCH-3500 User Manual. 1999, pp. 1 - 108.	<input type="checkbox"/>
22	Motorola Digital StarTAC User Guide. Mar. 1999, pp. 1 - 118.	<input type="checkbox"/>

**INFORMATION DISCLOSURE
STATEMENT BY APPLICANT**
(Not for submission under 37 CFR 1.99)

Application Number	12495190
Filing Date	2009-06-30
First Named Inventor	Russell W. White, et al.
Art Unit	2617
Examiner Name	Erika A. Gary
Attorney Docket Number	AFF.004C7US

23	Nokia 9110 Quick Guide/Accessories Guide. 1999, pp. 1-31.	<input type="checkbox"/>
24	"MP3.com and i-drive.com Join Forces to Store and Manage MP3 Files," Business Wire, Oct. 7, 1999, pp. 1-3.	<input type="checkbox"/>
25	Nomad User Guide, Jun. 1999, pp. 1-34.	<input type="checkbox"/>
26	Nomad II Getting Started Manual, Jan. 2000, pp. 1 - 38.	<input type="checkbox"/>
27	GSM 03.64 version 6.2.0 Release 1997, European Telecommunications Standards Institute, 1999, pp. 1 - 42.	<input type="checkbox"/>
28	The i-Drive.com website (date unknown, contended by defendant Apple Corp. to be prior art under one or more of 35 U.S.C. 102 (a), (b), (f) and (g)) 6 pages.	<input type="checkbox"/>
29	GSM 03.64 version 7.0.0 Release 1997, European Telecommunications Standards Institute, 1999, pp. 1-42.	<input type="checkbox"/>
30	Specification of the Bluetooth System Version 1.0B (Vol. 1), Telefonaktiebolaget LM Ericsson et al. Dec. 1, 1999, pp. 1-1082.	<input type="checkbox"/>
31	Specification of the Bluetooth System Version 1.0B (Vol. 2), Telefonaktiebolaget LM Ericsson et al. Dec. 1, 1999, pp. 1-440.	<input type="checkbox"/>
32	The MP3.com website (date unknown, contended by defendant Apple Corp. to be prior art under one or more of 35 U.S.C. 102 (a), (b), (f) and (g)) Screenshots from MP3.com website (date unknown, contended by defendant Apple Corp. to be prior art under one or more of 35 U.S.C. 102 (a), (b), (f) and (g)), 6 pages.	<input type="checkbox"/>
33	MP3.com and i-drive.com Join Forces to Store and Manage MP3 Files, Business Wire, Oct. 7, 1999, pp. 1-3.	<input type="checkbox"/>

**INFORMATION DISCLOSURE
STATEMENT BY APPLICANT**
(Not for submission under 37 CFR 1.99)

Application Number	12495190
Filing Date	2009-06-30
First Named Inventor	Russell W. White, et al.
Art Unit	2617
Examiner Name	Erika A. Gary
Attorney Docket Number	AFF.004C7US

34	The EMusic.com website (formerly www.goodnoise.com) (date unknown, contended by defendant Apple Corp. to be prior art under one or more of 35 U.S.C. 102 (a), (b), (f) and (g)) 2 pages.	<input type="checkbox"/>
35	EMusic.com prospectus, Sept. 24, 1999, pp. 1 - 61, F1 - F41.	<input type="checkbox"/>
36	"Logging On; Setting Sound Free From the CD," The Washington Post, Mar. 3, 2000, pp. 1-3.	<input type="checkbox"/>
37	"Music Factory; Retailers Struggle to Expand Listening Options Online," Contra Costa Times Mar. 19, 2000, pp. 1- 2.	<input type="checkbox"/>
38	The MyPlay.com website (date unknown, contended by defendant Apple Corp. to be prior art under one or more of 35 U.S.C. 102 (a), (b), (f) and (g)) 1 page.	<input type="checkbox"/>
39	Myplay.com Launches Today, PR Newswire. Oct. 13, 1999, pp. 1-2.	<input type="checkbox"/>
40	Myplay, Inc. Launches Consumer Online Music Service, PR Newswire, Oct. 13, 1999, pp. 1-3.	<input type="checkbox"/>
41	Empeg.com, "Does Your Car Stereo Run Linux," (date unknown, contended by defendant Apple Corp. to be prior art under one or more of 35 U.S.C. 102 (a), (b), (f) and (g)), 2 pages.	<input type="checkbox"/>
42	TIA/EIA Interim Standard, Cellular Digital Packet Data, System Specification - Part 403, Mobile Data Link Protocol, Telecommunications Industry Association. Dec. 1997, 83 pages.	<input type="checkbox"/>
43	"The Listen Up Player from Audio Highway" 1996. 1 page.	<input type="checkbox"/>
44	"Audio Highway Announces The Listen Up Player," Audio Highway Press Release, Sept. 23, 1996, 2 pages.	<input type="checkbox"/>

INFORMATION DISCLOSURE STATEMENT BY APPLICANT (Not for submission under 37 CFR 1.99)	Application Number	12495190
	Filing Date	2009-06-30
	First Named Inventor	Russell W. White, et al.
	Art Unit	2617
	Examiner Name	Erika A. Gary
	Attorney Docket Number	AFF.004C7US

45	MPMan F-10 and F-20 digital audio players and review article "MP3 Player Saehan MPMAN F20 Review", X-bit labs, July 14, 1999. 6 pages.	<input type="checkbox"/>
46	Menta, "RIAA Sues Music Startup Napster for \$20 Billion" Newswire, Jan. 11, 2000, 4 pages.	<input type="checkbox"/>
47	Boehrlart, "Artists to Napster: Drop Dead" Salon.com, Mar. 24, 2000. 3 pages.	<input type="checkbox"/>

If you wish to add additional non-patent literature document citation information please click the Add button

EXAMINER SIGNATURE

Examiner Signature		Date Considered	
--------------------	--	-----------------	--

*EXAMINER: Initial if reference considered, whether or not citation is in conformance with MPEP 609. Draw line through a citation if not in conformance and not considered. Include copy of this form with next communication to applicant.

¹ See Kind Codes of USPTO Patent Documents at www.USPTO.GOV or MPEP 901.04. ² Enter office that issued the document, by the two-letter code (WIPO Standard ST.3). ³ For Japanese patent documents, the indication of the year of the reign of the Emperor must precede the serial number of the patent document. ⁴ Kind of document by the appropriate symbols as indicated on the document under WIPO Standard ST.16 if possible. ⁵ Applicant is to place a check mark here if English language translation is attached.

INFORMATION DISCLOSURE STATEMENT BY APPLICANT (Not for submission under 37 CFR 1.99)	Application Number	12495190
	Filing Date	2009-06-30
	First Named Inventor	Russell W. White, et al.
	Art Unit	2617
	Examiner Name	Erika A. Gary
	Attorney Docket Number	AFF.004C7US

CERTIFICATION STATEMENT

Please see 37 CFR 1.97 and 1.98 to make the appropriate selection(s):

That each item of information contained in the information disclosure statement was first cited in any communication from a foreign patent office in a counterpart foreign application not more than three months prior to the filing of the information disclosure statement. See 37 CFR 1.97(e)(1).

OR

That no item of information contained in the information disclosure statement was cited in a communication from a foreign patent office in a counterpart foreign application, and, to the knowledge of the person signing the certification after making reasonable inquiry, no item of information contained in the information disclosure statement was known to any individual designated in 37 CFR 1.56(c) more than three months prior to the filing of the information disclosure statement. See 37 CFR 1.97(e)(2).

- See attached certification statement.
- Fee set forth in 37 CFR 1.17 (p) has been submitted herewith.
- None

SIGNATURE

A signature of the applicant or representative is required in accordance with CFR 1.33, 10.18. Please see CFR 1.4(d) for the form of the signature.

Signature	/Mark J. Rozman/	Date (YYYY-MM-DD)	2011-01-27
Name/Print	Mark J. Rozman	Registration Number	42117

This collection of information is required by 37 CFR 1.97 and 1.98. The information is required to obtain or retain a benefit by the public which is to file (and by the USPTO to process) an application. Confidentiality is governed by 35 U.S.C. 122 and 37 CFR 1.14. This collection is estimated to take 1 hour to complete, including gathering, preparing and submitting the completed application form to the USPTO. Time will vary depending upon the individual case. Any comments on the amount of time you require to complete this form and/or suggestions for reducing this burden, should be sent to the Chief Information Officer, U.S. Patent and Trademark Office, U.S. Department of Commerce, P.O. Box 1450, Alexandria, VA 22313-1450. **DO NOT SEND FEES OR COMPLETED FORMS TO THIS ADDRESS. SEND TO: Commissioner for Patents, P.O. Box 1450, Alexandria, VA 22313-1450.**

Privacy Act Statement

The Privacy Act of 1974 (P.L. 93-579) requires that you be given certain information in connection with your submission of the attached form related to a patent application or patent. Accordingly, pursuant to the requirements of the Act, please be advised that: (1) the general authority for the collection of this information is 35 U.S.C. 2(b)(2); (2) furnishing of the information solicited is voluntary; and (3) the principal purpose for which the information is used by the U.S. Patent and Trademark Office is to process and/or examine your submission related to a patent application or patent. If you do not furnish the requested information, the U.S. Patent and Trademark Office may not be able to process and/or examine your submission, which may result in termination of proceedings or abandonment of the application or expiration of the patent.

The information provided by you in this form will be subject to the following routine uses:

1. The information on this form will be treated confidentially to the extent allowed under the Freedom of Information Act (5 U.S.C. 552) and the Privacy Act (5 U.S.C. 552a). Records from this system of records may be disclosed to the Department of Justice to determine whether the Freedom of Information Act requires disclosure of these records.
2. A record from this system of records may be disclosed, as a routine use, in the course of presenting evidence to a court, magistrate, or administrative tribunal, including disclosures to opposing counsel in the course of settlement negotiations.
3. A record in this system of records may be disclosed, as a routine use, to a Member of Congress submitting a request involving an individual, to whom the record pertains, when the individual has requested assistance from the Member with respect to the subject matter of the record.
4. A record in this system of records may be disclosed, as a routine use, to a contractor of the Agency having need for the information in order to perform a contract. Recipients of information shall be required to comply with the requirements of the Privacy Act of 1974, as amended, pursuant to 5 U.S.C. 552a(m).
5. A record related to an International Application filed under the Patent Cooperation Treaty in this system of records may be disclosed, as a routine use, to the International Bureau of the World Intellectual Property Organization, pursuant to the Patent Cooperation Treaty.
6. A record in this system of records may be disclosed, as a routine use, to another federal agency for purposes of National Security review (35 U.S.C. 181) and for review pursuant to the Atomic Energy Act (42 U.S.C. 218(c)).
7. A record from this system of records may be disclosed, as a routine use, to the Administrator, General Services, or his/her designee, during an inspection of records conducted by GSA as part of that agency's responsibility to recommend improvements in records management practices and programs, under authority of 44 U.S.C. 2904 and 2906. Such disclosure shall be made in accordance with the GSA regulations governing inspection of records for this purpose, and any other relevant (i.e., GSA or Commerce) directive. Such disclosure shall not be used to make determinations about individuals.
8. A record from this system of records may be disclosed, as a routine use, to the public after either publication of the application pursuant to 35 U.S.C. 122(b) or issuance of a patent pursuant to 35 U.S.C. 151. Further, a record may be disclosed, subject to the limitations of 37 CFR 1.14, as a routine use, to the public if the record was filed in an application which became abandoned or in which the proceedings were terminated and which application is referenced by either a published application, an application open to public inspections or an issued patent.
9. A record from this system of records may be disclosed, as a routine use, to a Federal, State, or local law enforcement agency, if the USPTO becomes aware of a violation or potential violation of law or regulation.

Electronic Acknowledgement Receipt

EFS ID:	9320084
Application Number:	12495190
International Application Number:	
Confirmation Number:	2380
Title of Invention:	Method For Content Delivery
First Named Inventor/Applicant Name:	Russell W. White
Customer Number:	21906
Filer:	Mark J. Rozman/Stephanie Petreas
Filer Authorized By:	Mark J. Rozman
Attorney Docket Number:	AFF.0004C7US
Receipt Date:	27-JAN-2011
Filing Date:	30-JUN-2009
Time Stamp:	14:38:31
Application Type:	Utility under 35 USC 111(a)

Payment information:

Submitted with Payment	no
------------------------	----

File Listing:

Document Number	Document Description	File Name	File Size(Bytes)/ Message Digest	Multi Part /.zip	Pages (if appl.)
1	Information Disclosure Statement (IDS) Filed (SB/08)	AFF004C7IDSAppleFtpIDS2of2 ToFile.pdf	56430 <small>b511b620c54064c45fed8c5b6079f108d42e8a5a</small>	no	8

Warnings:

Information:

This is not an USPTO supplied IDS fillable form					
2	NPL Documents	NomadllGettingStarted.pdf	7452088 11a7260ecf3e58ef6a7c926baff20ebd3719d58	no	46
Warnings:					
Information:					
3	NPL Documents	EMusicDotCom.pdf	78309 ed6245cceb18659f81a12944f81217541ba2f614	no	2
Warnings:					
Information:					
4	NPL Documents	theListenUpPlayerFrom.pdf	1542455 6cd31284c8a029e15bd412485ceefd8cbfd0295a	no	1
Warnings:					
Information:					
5	NPL Documents	audioHighwayAnnoucesNewDevice.pdf	3804556 d63d8502cc0f81a2d64691395e17eb3afb910ddd	no	2
Warnings:					
Information:					
6	NPL Documents	MPManreviews.pdf	668380 fb373a815d2ae3be055b3aafd08e984a308f036a	no	6
Warnings:					
Information:					
7	NPL Documents	Menta.pdf	79172 f6dc095861160c00f1f5399e701c8c8295be61c3	no	4
Warnings:					
Information:					
8	NPL Documents	Boehlert.pdf	84944 d4001633853a14bbc8a72a0de9ffc8d2eb4984f	no	3
Warnings:					
Information:					
Total Files Size (in bytes):			13766334		

This Acknowledgement Receipt evidences receipt on the noted date by the USPTO of the indicated documents, characterized by the applicant, and including page counts, where applicable. It serves as evidence of receipt similar to a Post Card, as described in MPEP 503.

New Applications Under 35 U.S.C. 111

If a new application is being filed and the application includes the necessary components for a filing date (see 37 CFR 1.53(b)-(d) and MPEP 506), a Filing Receipt (37 CFR 1.54) will be issued in due course and the date shown on this Acknowledgement Receipt will establish the filing date of the application.

National Stage of an International Application under 35 U.S.C. 371

If a timely submission to enter the national stage of an international application is compliant with the conditions of 35 U.S.C. 371 and other applicable requirements a Form PCT/DO/EO/903 indicating acceptance of the application as a national stage submission under 35 U.S.C. 371 will be issued in addition to the Filing Receipt, in due course.

New International Application Filed with the USPTO as a Receiving Office

If a new international application is being filed and the international application includes the necessary components for an international filing date (see PCT Article 11 and MPEP 1810), a Notification of the International Application Number and of the International Filing Date (Form PCT/RO/105) will be issued in due course, subject to prescriptions concerning national security, and the date shown on this Acknowledgement Receipt will establish the international filing date of the application.

INFORMATION DISCLOSURE STATEMENT BY APPLICANT (Not for submission under 37 CFR 1.99)	Application Number		12495190	
	Filing Date		2009-06-30	
	First Named Inventor	Russell W. White, et al.		
	Art Unit		2617	
	Examiner Name	Erika A. Gary		
	Attorney Docket Number		AFF.004C7US	

U.S.PATENTS						
Examiner Initial*	Cite No	Patent Number	Kind Code ¹	Issue Date	Name of Patentee or Applicant of cited Document	Pages,Columns,Lines where Relevant Passages or Relevant Figures Appear
	1					

If you wish to add additional U.S. Patent citation information please click the Add button.

U.S.PATENT APPLICATION PUBLICATIONS						
Examiner Initial*	Cite No	Publication Number	Kind Code ¹	Publication Date	Name of Patentee or Applicant of cited Document	Pages,Columns,Lines where Relevant Passages or Relevant Figures Appear
	1					

If you wish to add additional U.S. Published Application citation information please click the Add button.

FOREIGN PATENT DOCUMENTS								
Examiner Initial*	Cite No	Foreign Document Number ³	Country Code ²	Kind Code ⁴	Publication Date	Name of Patentee or Applicant of cited Document	Pages,Columns,Lines where Relevant Passages or Relevant Figures Appear	T ⁵
	1							<input type="checkbox"/>

If you wish to add additional Foreign Patent Document citation information please click the Add button

NON-PATENT LITERATURE DOCUMENTS			
Examiner Initials*	Cite No	Include name of the author (in CAPITAL LETTERS), title of the article (when appropriate), title of the item (book, magazine, journal, serial, symposium, catalog, etc), date, pages(s), volume-issue number(s), publisher, city and/or country where published.	T ⁵

**INFORMATION DISCLOSURE
STATEMENT BY APPLICANT**
(Not for submission under 37 CFR 1.99)

Application Number	12495190
Filing Date	2009-06-30
First Named Inventor	Russell W. White, et al.
Art Unit	2617
Examiner Name	Erika A. Gary
Attorney Docket Number	AFF.004C7US

1	The Rio 500 Getting Started Guide, 1999, pp. 1-2.	<input type="checkbox"/>
2	"Visteon's Mobile Office Solutions Give Busy Commuters More of What They Need - Time," Canada Newswire, Sept. 15, 1999, 3 pages.	<input type="checkbox"/>
3	Hiatt, "RIAA Sues Napster, Claiming 'Music Piracy'," MTV News, Dec. 8, 1999, 3 pages.	<input type="checkbox"/>
4	Sony VAIO Notebook Computer User Guide PCG-731/PCG-735, 1998, pp. 1-131.	<input type="checkbox"/>
5	Sony VAIO Notebook Computer User Guide PCG-812, 1998, pp. 1-144.	<input type="checkbox"/>
6	Sony VAIO Notebook Computer User Guide PCG-838, 1999, pp. 1-121.	<input type="checkbox"/>
7	Sony Service Manual PCG-731/735/737, 1997, pp. 1-22.	<input type="checkbox"/>
8	Sony Service Manual PCG-723/729, 1998, pp. 1-22.	<input type="checkbox"/>
9	Sony VAIO Notebook Computer User Guide PCG-838, 1999. pp. 1 - 121.	<input type="checkbox"/>
10	Sony Service Manual PCG-812/818, 1998, pp. 1 - 22.	<input type="checkbox"/>
11	Sony Service Manual PCG-838, 1999, pp. 1 - 22.	<input type="checkbox"/>

**INFORMATION DISCLOSURE
STATEMENT BY APPLICANT**

(Not for submission under 37 CFR 1.99)

Application Number		12495190
Filing Date		2009-06-30
First Named Inventor	Russell W. White, et al.	
Art Unit		2617
Examiner Name	Erika A. Gary	
Attorney Docket Number		AFF.004C7US

12	"Digital Download Provider Musicmaker.com Partners With Download Directory Listen.com; Offers Nearly 100,000 Downloadable Tracks Via the Online Directory," PR Newswire, Sept. 15, 1999, pp. 1-3.	<input type="checkbox"/>
13	MP3.com prospectus, Jul. 21, 1999, pp. 1 - 81.	<input type="checkbox"/>
14	Ana Orubeondo, "Trim AirCard 300 Eases Power Demands," InfoWorld, Volume 21, Issue 48. Nov. 29, 1999. pg 46 & 50.	<input type="checkbox"/>
15	"Net Music Firms to Tap Public Market," Billboard. Jul. 17, 1999. pp. 1 - 2.	<input type="checkbox"/>
16	"Cellular for Notebook PCs." CIO Vo.. 13, No. 1. Oct. 1, 1999, pg. 90.	<input type="checkbox"/>
17	"Briefs," Network World. Volume 16, no. 24. Aug. 23, 1999, pg. 27.	<input type="checkbox"/>
18	The MusicMatch.com website (date unknown, contended by defendant Apple Corp. to be prior art under one or more of 35 U.S.C. 102 (a), (b), (f) and (g)) 32 pages.	<input type="checkbox"/>
19	The MusicMaker.com website (date unknown, contended by defendant Apple Corp. to be prior art under one or more of 35 U.S.C. 102 (a), (b), (f) and (g)), 10 pages.	<input type="checkbox"/>
20	Qualcomm QCP-1960 User Manual. Apr. 1999, pp. 1 - 76.	<input type="checkbox"/>
21	Samsung SCH-3500 User Manual. 1999, pp. 1 - 108.	<input type="checkbox"/>
22	Motorola Digital StarTAC User Guide. Mar. 1999, pp. 1 - 118.	<input type="checkbox"/>

**INFORMATION DISCLOSURE
STATEMENT BY APPLICANT**
(Not for submission under 37 CFR 1.99)

Application Number	12495190
Filing Date	2009-06-30
First Named Inventor	Russell W. White, et al.
Art Unit	2617
Examiner Name	Erika A. Gary
Attorney Docket Number	AFF.004C7US

23	Nokia 9110 Quick Guide/Accessories Guide. 1999, pp. 1-31.	<input type="checkbox"/>
24	"MP3.com and i-drive.com Join Forces to Store and Manage MP3 Files," Business Wire, Oct. 7, 1999, pp. 1-3.	<input type="checkbox"/>
25	Nomad User Guide, Jun. 1999, pp. 1-34.	<input type="checkbox"/>
26	Nomad II Getting Started Manual, Jan. 2000, pp. 1 - 38.	<input type="checkbox"/>
27	GSM 03.64 version 6.2.0 Release 1997, European Telecommunications Standards Institute, 1999, pp. 1 - 42.	<input type="checkbox"/>
28	The i-Drive.com website (date unknown, contended by defendant Apple Corp. to be prior art under one or more of 35 U.S.C. 102 (a), (b), (f) and (g)) 6 pages.	<input type="checkbox"/>
29	GSM 03.64 version 7.0.0 Release 1997, European Telecommunications Standards Institute, 1999, pp. 1-42.	<input type="checkbox"/>
30	Specification of the Bluetooth System Version 1.0B (Vol. 1), Telefonaktiebolaget LM Ericsson et al. Dec. 1, 1999, pp. 1-1082.	<input type="checkbox"/>
31	Specification of the Bluetooth System Version 1.0B (Vol. 2), Telefonaktiebolaget LM Ericsson et al. Dec. 1, 1999, pp. 1-440.	<input type="checkbox"/>
32	The MP3.com website (date unknown, contended by defendant Apple Corp. to be prior art under one or more of 35 U.S.C. 102 (a), (b), (f) and (g)) Screenshots from MP3.com website (date unknown, contended by defendant Apple Corp. to be prior art under one or more of 35 U.S.C. 102 (a), (b), (f) and (g)), 6 pages.	<input type="checkbox"/>
33	MP3.com and i-drive.com Join Forces to Store and Manage MP3 Files, Business Wire, Oct. 7, 1999, pp. 1-3.	<input type="checkbox"/>

**INFORMATION DISCLOSURE
STATEMENT BY APPLICANT**
(Not for submission under 37 CFR 1.99)

Application Number	12495190
Filing Date	2009-06-30
First Named Inventor	Russell W. White, et al.
Art Unit	2617
Examiner Name	Erika A. Gary
Attorney Docket Number	AFF.004C7US

34	The EMusic.com website (formerly www.goodnoise.com) (date unknown, contended by defendant Apple Corp. to be prior art under one or more of 35 U.S.C. 102 (a), (b), (f) and (g)) 2 pages.	<input type="checkbox"/>
35	EMusic.com prospectus, Sept. 24, 1999, pp. 1 - 61, F1 - F41.	<input type="checkbox"/>
36	"Logging On; Setting Sound Free From the CD," The Washington Post, Mar. 3, 2000, pp. 1-3.	<input type="checkbox"/>
37	"Music Factory; Retailers Struggle to Expand Listening Options Online," Contra Costa Times Mar. 19, 2000, pp. 1- 2.	<input type="checkbox"/>
38	The MyPlay.com website (date unknown, contended by defendant Apple Corp. to be prior art under one or more of 35 U.S.C. 102 (a), (b), (f) and (g)) 1 page.	<input type="checkbox"/>
39	Myplay.com Launches Today, PR Newswire. Oct. 13, 1999, pp. 1-2.	<input type="checkbox"/>
40	Myplay, Inc. Launches Consumer Online Music Service, PR Newswire, Oct. 13, 1999, pp. 1-3.	<input type="checkbox"/>
41	Empeg.com, "Does Your Car Stereo Run Linux," (date unknown, contended by defendant Apple Corp. to be prior art under one or more of 35 U.S.C. 102 (a), (b), (f) and (g)), 2 pages.	<input type="checkbox"/>
42	TIA/EIA Interim Standard, Cellular Digital Packet Data, System Specification - Part 403, Mobile Data Link Protocol, Telecommunications Industry Association. Dec. 1997, 83 pages.	<input type="checkbox"/>
43	"The Listen Up Player from Audio Highway" 1996. 1 page.	<input type="checkbox"/>
44	"Audio Highway Announces The Listen Up Player," Audio Highway Press Release, Sept. 23, 1996, 2 pages.	<input type="checkbox"/>

INFORMATION DISCLOSURE STATEMENT BY APPLICANT (Not for submission under 37 CFR 1.99)	Application Number	12495190
	Filing Date	2009-06-30
	First Named Inventor	Russell W. White, et al.
	Art Unit	2617
	Examiner Name	Erika A. Gary
	Attorney Docket Number	AFF.004C7US

45	MPMan F-10 and F-20 digital audio players and review article "MP3 Player Saehan MPMAN F20 Review", X-bit labs, July 14, 1999. 6 pages.	<input type="checkbox"/>
46	Menta, "RIAA Sues Music Startup Napster for \$20 Billion" Newswire, Jan. 11, 2000, 4 pages.	<input type="checkbox"/>
47	Boehrlart, "Artists to Napster: Drop Dead" Salon.com, Mar. 24, 2000. 3 pages.	<input type="checkbox"/>

If you wish to add additional non-patent literature document citation information please click the Add button

EXAMINER SIGNATURE

Examiner Signature		Date Considered	
--------------------	--	-----------------	--

*EXAMINER: Initial if reference considered, whether or not citation is in conformance with MPEP 609. Draw line through a citation if not in conformance and not considered. Include copy of this form with next communication to applicant.

¹ See Kind Codes of USPTO Patent Documents at www.USPTO.GOV or MPEP 901.04. ² Enter office that issued the document, by the two-letter code (WIPO Standard ST.3). ³ For Japanese patent documents, the indication of the year of the reign of the Emperor must precede the serial number of the patent document. ⁴ Kind of document by the appropriate symbols as indicated on the document under WIPO Standard ST.16 if possible. ⁵ Applicant is to place a check mark here if English language translation is attached.

INFORMATION DISCLOSURE STATEMENT BY APPLICANT (Not for submission under 37 CFR 1.99)	Application Number	12495190
	Filing Date	2009-06-30
	First Named Inventor	Russell W. White, et al.
	Art Unit	2617
	Examiner Name	Erika A. Gary
	Attorney Docket Number	AFF.004C7US

CERTIFICATION STATEMENT

Please see 37 CFR 1.97 and 1.98 to make the appropriate selection(s):

That each item of information contained in the information disclosure statement was first cited in any communication from a foreign patent office in a counterpart foreign application not more than three months prior to the filing of the information disclosure statement. See 37 CFR 1.97(e)(1).

OR

That no item of information contained in the information disclosure statement was cited in a communication from a foreign patent office in a counterpart foreign application, and, to the knowledge of the person signing the certification after making reasonable inquiry, no item of information contained in the information disclosure statement was known to any individual designated in 37 CFR 1.56(c) more than three months prior to the filing of the information disclosure statement. See 37 CFR 1.97(e)(2).

See attached certification statement.

Fee set forth in 37 CFR 1.17 (p) has been submitted herewith.

None

SIGNATURE

A signature of the applicant or representative is required in accordance with CFR 1.33, 10.18. Please see CFR 1.4(d) for the form of the signature.

Signature	/Mark J. Rozman/	Date (YYYY-MM-DD)	2011-01-27
Name/Print	Mark J. Rozman	Registration Number	42117

This collection of information is required by 37 CFR 1.97 and 1.98. The information is required to obtain or retain a benefit by the public which is to file (and by the USPTO to process) an application. Confidentiality is governed by 35 U.S.C. 122 and 37 CFR 1.14. This collection is estimated to take 1 hour to complete, including gathering, preparing and submitting the completed application form to the USPTO. Time will vary depending upon the individual case. Any comments on the amount of time you require to complete this form and/or suggestions for reducing this burden, should be sent to the Chief Information Officer, U.S. Patent and Trademark Office, U.S. Department of Commerce, P.O. Box 1450, Alexandria, VA 22313-1450. **DO NOT SEND FEES OR COMPLETED FORMS TO THIS ADDRESS. SEND TO: Commissioner for Patents, P.O. Box 1450, Alexandria, VA 22313-1450.**

Privacy Act Statement

The Privacy Act of 1974 (P.L. 93-579) requires that you be given certain information in connection with your submission of the attached form related to a patent application or patent. Accordingly, pursuant to the requirements of the Act, please be advised that: (1) the general authority for the collection of this information is 35 U.S.C. 2(b)(2); (2) furnishing of the information solicited is voluntary; and (3) the principal purpose for which the information is used by the U.S. Patent and Trademark Office is to process and/or examine your submission related to a patent application or patent. If you do not furnish the requested information, the U.S. Patent and Trademark Office may not be able to process and/or examine your submission, which may result in termination of proceedings or abandonment of the application or expiration of the patent.

The information provided by you in this form will be subject to the following routine uses:

1. The information on this form will be treated confidentially to the extent allowed under the Freedom of Information Act (5 U.S.C. 552) and the Privacy Act (5 U.S.C. 552a). Records from this system of records may be disclosed to the Department of Justice to determine whether the Freedom of Information Act requires disclosure of these records.
2. A record from this system of records may be disclosed, as a routine use, in the course of presenting evidence to a court, magistrate, or administrative tribunal, including disclosures to opposing counsel in the course of settlement negotiations.
3. A record in this system of records may be disclosed, as a routine use, to a Member of Congress submitting a request involving an individual, to whom the record pertains, when the individual has requested assistance from the Member with respect to the subject matter of the record.
4. A record in this system of records may be disclosed, as a routine use, to a contractor of the Agency having need for the information in order to perform a contract. Recipients of information shall be required to comply with the requirements of the Privacy Act of 1974, as amended, pursuant to 5 U.S.C. 552a(m).
5. A record related to an International Application filed under the Patent Cooperation Treaty in this system of records may be disclosed, as a routine use, to the International Bureau of the World Intellectual Property Organization, pursuant to the Patent Cooperation Treaty.
6. A record in this system of records may be disclosed, as a routine use, to another federal agency for purposes of National Security review (35 U.S.C. 181) and for review pursuant to the Atomic Energy Act (42 U.S.C. 218(c)).
7. A record from this system of records may be disclosed, as a routine use, to the Administrator, General Services, or his/her designee, during an inspection of records conducted by GSA as part of that agency's responsibility to recommend improvements in records management practices and programs, under authority of 44 U.S.C. 2904 and 2906. Such disclosure shall be made in accordance with the GSA regulations governing inspection of records for this purpose, and any other relevant (i.e., GSA or Commerce) directive. Such disclosure shall not be used to make determinations about individuals.
8. A record from this system of records may be disclosed, as a routine use, to the public after either publication of the application pursuant to 35 U.S.C. 122(b) or issuance of a patent pursuant to 35 U.S.C. 151. Further, a record may be disclosed, subject to the limitations of 37 CFR 1.14, as a routine use, to the public if the record was filed in an application which became abandoned or in which the proceedings were terminated and which application is referenced by either a published application, an application open to public inspections or an issued patent.
9. A record from this system of records may be disclosed, as a routine use, to a Federal, State, or local law enforcement agency, if the USPTO becomes aware of a violation or potential violation of law or regulation.

Electronic Patent Application Fee Transmittal

Application Number:	12495190
Filing Date:	30-Jun-2009
Title of Invention:	Method For Content Delivery
First Named Inventor/Applicant Name:	Russell W. White
Filer:	Mark J. Rozman/Stephanie Petreas
Attorney Docket Number:	AFF.0004C7US

Filed as Large Entity

Utility under 35 USC 111(a) Filing Fees

Description	Fee Code	Quantity	Amount	Sub-Total in USD(\$)
Basic Filing:				
Pages:				
Claims:				
Miscellaneous-Filing:				
Petition:				
Patent-Appeals-and-Interference:				
Post-Allowance-and-Post-Issuance:				
Extension-of-Time:				

Description	Fee Code	Quantity	Amount	Sub-Total in USD(\$)
Miscellaneous:				
Submission- Information Disclosure Stmt	1806	1	180	180
Total in USD (\$)				180

Electronic Acknowledgement Receipt

EFS ID:	9317978
Application Number:	12495190
International Application Number:	
Confirmation Number:	2380
Title of Invention:	Method For Content Delivery
First Named Inventor/Applicant Name:	Russell W. White
Customer Number:	21906
Filer:	Mark J. Rozman/Stephanie Petreas
Filer Authorized By:	Mark J. Rozman
Attorney Docket Number:	AFF.0004C7US
Receipt Date:	27-JAN-2011
Filing Date:	30-JUN-2009
Time Stamp:	12:00:16
Application Type:	Utility under 35 USC 111(a)

Payment information:

Submitted with Payment	yes
Payment Type	Deposit Account
Payment was successfully received in RAM	\$180
RAM confirmation Number	11142
Deposit Account	201504
Authorized User	

The Director of the USPTO is hereby authorized to charge indicated fees and credit any overpayment as follows:

Charge any Additional Fees required under 37 C.F.R. Section 1.19 (Document supply fees)

File Listing:					
Document Number	Document Description	File Name	File Size(Bytes)/ Message Digest	Multi Part /.zip	Pages (if appl.)
1	Information Disclosure Statement (IDS) Filed (SB/08)	AFF004C7IDSAppleFtpIDS2of2 TOFILE.pdf	56478 ad244d5c0826e4883c2b8814534483dc76393959	no	8
Warnings:					
Information:					
This is not an USPTO supplied IDS fillable form					
2	NPL Documents	sonynotebookcomputersuserg uidepgc731.pdf	4096016 831ad061ceaa1e0abc199e7fd4cb12ae8705f79	no	131
Warnings:					
Information:					
3	NPL Documents	sonynotebookcomputersuserg uidepgc812.pdf	4058100 9ebf44641367da565d3949ba77e20370589e32e3	no	144
Warnings:					
Information:					
4	NPL Documents	sonynotebookcomputersuserg uidepgc838.pdf	8865230 dc6c9a5f9c24efa0e5e5483399193c8f352d930	no	121
Warnings:					
Information:					
5	NPL Documents	DigitalDownloadProviderMusic Maker.pdf	228166 0d6224c682938ac5595b3c76f9482ef1301a068a	no	3
Warnings:					
Information:					
6	NPL Documents	MP3dotcomProspectus.pdf	589545 889b974d7690ab66d05c445eed9055cf8122bbfd	no	69
Warnings:					
Information:					
7	NPL Documents	Orubeondo.pdf	2900790 ed45f4e1e45dc8d033dcd88aab7c908a1565eb22	no	3
Warnings:					
Information:					
8	NPL Documents	NetMusicFirmsToTap.pdf	225872 4ee2fe3af1515c1e5e1dc5219abb279fe195f992	no	2
Warnings:					
Information:					

9	NPL Documents	CellularForNotebookPcs.pdf	667401	no	3
			dfd3e9aa3ac9e7887f7fb00a66a43fe8dbde92e3		
Warnings:					
Information:					
10	NPL Documents	Briefs.pdf	2927787	no	3
			65792d2c165f5a6e6a33e85d0ac4255de6261206		
Warnings:					
Information:					
11	NPL Documents	MusicMatchWebSite.pdf	7117704	no	32
			26dfd2c6432d9b3475bc8e27775a338685ba267c		
Warnings:					
Information:					
12	NPL Documents	QualcommUserManual.pdf	3072873	no	79
			7df71e192698c12a141333eff88300eb6d94702		
Warnings:					
Information:					
13	NPL Documents	SamsungSCH3500UserManual.pdf	5611123	no	111
			229de15f9ece63c58c7f637ed7db6754da936dec		
Warnings:					
Information:					
14	NPL Documents	MotorolaStarTacUserManual.pdf	6688162	no	119
			a0ce6d8b0006f734d925a838e8e7c8e9070442c6		
Warnings:					
Information:					
15	NPL Documents	Nokia9110QuickGuide.pdf	1327518	no	36
			474bdac27aa1c2c1cf6deaa34cc0e591622bd556		
Warnings:					
Information:					
16	NPL Documents	NomadUserGuide.pdf	7491346	no	40
			eb52e790c97cbc47b24b2061dc888b2c53ee1b25		
Warnings:					
Information:					
17	NPL Documents	GSMver620.pdf	2301243	no	42
			e22f7ac6b4f9fce72d213e7183eafd57ef52df10		
Warnings:					
Information:					

18	NPL Documents	GSMver700.pdf	2463221 76486514a1eb5e5328b849b648768432d08a2e51	no	42
Warnings:					
Information:					
19	NPL Documents	EMusicdotcomProspectus.pdf	646019 cf94769b9427e9423c6a5c452282890516241b3f	no	85
Warnings:					
Information:					
20	NPL Documents	LoggingOnSettingSoundFree.pdf	232030 7d104eba94fa9ac7585aed269e829b2c5963983	no	3
Warnings:					
Information:					
21	NPL Documents	MusicFactoryRetailersStruggle.pdf	226489 0cabc32599a39c98efd022ec55e1649fc2c6a21	no	2
Warnings:					
Information:					
22	Fee Worksheet (PTO-875)	fee-info.pdf	30360 efb707672cd8f26886b2864ff4cd6f7ae43e4018	no	2
Warnings:					
Information:					
Total Files Size (in bytes):				61823473	
<p>This Acknowledgement Receipt evidences receipt on the noted date by the USPTO of the indicated documents, characterized by the applicant, and including page counts, where applicable. It serves as evidence of receipt similar to a Post Card, as described in MPEP 503.</p> <p><u>New Applications Under 35 U.S.C. 111</u> If a new application is being filed and the application includes the necessary components for a filing date (see 37 CFR 1.53(b)-(d) and MPEP 506), a Filing Receipt (37 CFR 1.54) will be issued in due course and the date shown on this Acknowledgement Receipt will establish the filing date of the application.</p> <p><u>National Stage of an International Application under 35 U.S.C. 371</u> If a timely submission to enter the national stage of an international application is compliant with the conditions of 35 U.S.C. 371 and other applicable requirements a Form PCT/DO/EO/903 indicating acceptance of the application as a national stage submission under 35 U.S.C. 371 will be issued in addition to the Filing Receipt, in due course.</p> <p><u>New International Application Filed with the USPTO as a Receiving Office</u> If a new international application is being filed and the international application includes the necessary components for an international filing date (see PCT Article 11 and MPEP 1810), a Notification of the International Application Number and of the International Filing Date (Form PCT/RO/105) will be issued in due course, subject to prescriptions concerning national security, and the date shown on this Acknowledgement Receipt will establish the international filing date of the application.</p>					

INFORMATION DISCLOSURE STATEMENT BY APPLICANT (Not for submission under 37 CFR 1.99)	Application Number		12495190	
	Filing Date		2009-06-30	
	First Named Inventor	Russell W. White, et al.		
	Art Unit	2617		
	Examiner Name	Erika A. Gary		
	Attorney Docket Number	AFF.004C7US		

U.S.PATENTS						
Examiner Initial*	Cite No	Patent Number	Kind Code ¹	Issue Date	Name of Patentee or Applicant of cited Document	Pages,Columns,Lines where Relevant Passages or Relevant Figures Appear
	1					

If you wish to add additional U.S. Patent citation information please click the Add button.

U.S.PATENT APPLICATION PUBLICATIONS						
Examiner Initial*	Cite No	Publication Number	Kind Code ¹	Publication Date	Name of Patentee or Applicant of cited Document	Pages,Columns,Lines where Relevant Passages or Relevant Figures Appear
	1					

If you wish to add additional U.S. Published Application citation information please click the Add button.

FOREIGN PATENT DOCUMENTS								
Examiner Initial*	Cite No	Foreign Document Number ³	Country Code ²	Kind Code ⁴	Publication Date	Name of Patentee or Applicant of cited Document	Pages,Columns,Lines where Relevant Passages or Relevant Figures Appear	T ⁵
	1							<input type="checkbox"/>

If you wish to add additional Foreign Patent Document citation information please click the Add button

NON-PATENT LITERATURE DOCUMENTS			
Examiner Initials*	Cite No	Include name of the author (in CAPITAL LETTERS), title of the article (when appropriate), title of the item (book, magazine, journal, serial, symposium, catalog, etc), date, pages(s), volume-issue number(s), publisher, city and/or country where published.	T ⁵

**INFORMATION DISCLOSURE
STATEMENT BY APPLICANT**
(Not for submission under 37 CFR 1.99)

Application Number		12495190
Filing Date		2009-06-30
First Named Inventor	Russell W. White, et al.	
Art Unit		2617
Examiner Name	Erika A. Gary	
Attorney Docket Number		AFF.004C7US

1	The Rio 500 Getting Started Guide, 1999, pp. 1-2.	<input type="checkbox"/>
2	"Visteon's Mobile Office Solutions Give Busy Commuters More of What They Need - Time," Canada Newswire, Sept. 15, 1999, 3 pages.	<input type="checkbox"/>
3	Hiatt, "RIAA Sues Napster, Claiming 'Music Piracy'," MTV News, Dec. 8, 1999, 3 pages.	<input type="checkbox"/>
4	Sony VAIO Notebook Computer User Guide PCG-731/PCG-735, 1998, pp. 1-131.	<input type="checkbox"/>
5	Sony VAIO Notebook Computer User Guide PCG-812, 1998, pp. 1-144.	<input type="checkbox"/>
6	Sony VAIO Notebook Computer User Guide PCG-838, 1999, pp. 1-121.	<input type="checkbox"/>
7	Sony Service Manual PCG-731/735/737, 1997, pp. 1-22.	<input type="checkbox"/>
8	Sony Service Manual PCG-723/729, 1998, pp. 1-22.	<input type="checkbox"/>
9		<input type="checkbox"/>
10	Sony Service Manual PCG-812/818, 1998, pp. 1 - 22.	<input type="checkbox"/>
11	Sony Service Manual PCG-838, 1999, pp. 1 - 22.	<input type="checkbox"/>

**INFORMATION DISCLOSURE
STATEMENT BY APPLICANT**
(Not for submission under 37 CFR 1.99)

Application Number	12495190
Filing Date	2009-06-30
First Named Inventor	Russell W. White, et al.
Art Unit	2617
Examiner Name	Erika A. Gary
Attorney Docket Number	AFF.004C7US

12	"Digital Download Provider Musicmaker.com Partners With Download Directory Listen.com; Offers Nearly 100,000 Downloadable Tracks Via the Online Directory," PR Newswire, Sept. 15, 1999, pp. 1-3.	<input type="checkbox"/>
13	MP3.com prospectus, Jul. 21, 1999, pp. 1 - 81.	<input type="checkbox"/>
14	Ana Orubeondo, "Trim AirCard 300 Eases Power Demands," InfoWorld, Volume 21, Issue 48. Nov. 29, 1999. pg 46 & 50.	<input type="checkbox"/>
15	"Net Music Firms to Tap Public Market," Billboard. Jul. 17, 1999. pp. 1 - 2.	<input type="checkbox"/>
16	"Cellular for Notebook PCs." CIO Vo.. 13, No. 1. Oct. 1, 1999, pg. 90.	<input type="checkbox"/>
17	"Briefs," Network World. Volume 16, no. 24. Aug. 23, 1999, pg. 27.	<input type="checkbox"/>
18	The MusicMatch.com website (date unknown, contended by defendant Apple Corp. to be prior art under one or more of 35 U.S.C. 102 (a), (b), (f) and (g)) 32 pages.	<input type="checkbox"/>
19	The MusicMaker.com website (date unknown, contended by defendant Apple Corp. to be prior art under one or more of 35 U.S.C. 102 (a), (b), (f) and (g)), 10 pages.	<input type="checkbox"/>
20	Qualcomm QCP-1960 User Manual. Apr. 1999, pp. 1 - 76.	<input type="checkbox"/>
21	Samsung SCH-3500 User Manual. 1999, pp. 1 - 108.	<input type="checkbox"/>
22	Motorola Digital StarTAC User Guide. Mar. 1999, pp. 1 - 118.	<input type="checkbox"/>

**INFORMATION DISCLOSURE
STATEMENT BY APPLICANT**
(Not for submission under 37 CFR 1.99)

Application Number	12495190
Filing Date	2009-06-30
First Named Inventor	Russell W. White, et al.
Art Unit	2617
Examiner Name	Erika A. Gary
Attorney Docket Number	AFF.004C7US

23	Nokia 9110 Quick Guide/Accessories Guide. 1999, pp. 1-31.	<input type="checkbox"/>
24	"MP3.com and i-drive.com Join Forces to Store and Manage MP3 Files," Business Wire, Oct. 7, 1999, pp. 1-3.	<input type="checkbox"/>
25	Nomad User Guide, Jun. 1999, pp. 1-34.	<input type="checkbox"/>
26	Nomad II Getting Started Manual, Jan. 2000, pp. 1 - 38.	<input type="checkbox"/>
27	GSM 03.64 version 6.2.0 Release 1997, European Telecommunications Standards Institute, 1999, pp. 1 - 42.	<input type="checkbox"/>
28	The i-Drive.com website (date unknown, contended by defendant Apple Corp. to be prior art under one or more of 35 U.S.C. 102 (a), (b), (f) and (g)) 6 pages.	<input type="checkbox"/>
29	GSM 03.64 version 7.0.0 Release 1997, European Telecommunications Standards Institute, 1999, pp. 1-42.	<input type="checkbox"/>
30		<input type="checkbox"/>
31		<input type="checkbox"/>
32	The MP3.com website (date unknown, contended by defendant Apple Corp. to be prior art under one or more of 35 U.S.C. 102 (a), (b), (f) and (g)) Screenshots from MP3.com website (date unknown, contended by defendant Apple Corp. to be prior art under one or more of 35 U.S.C. 102 (a), (b), (f) and (g)), 6 pages.	<input type="checkbox"/>
33	MP3.com and i-drive.com Join Forces to Store and Manage MP3 Files, Business Wire, Oct. 7, 1999, pp. 1-3.	<input type="checkbox"/>

**INFORMATION DISCLOSURE
STATEMENT BY APPLICANT**
(Not for submission under 37 CFR 1.99)

Application Number	12495190
Filing Date	2009-06-30
First Named Inventor	Russell W. White, et al.
Art Unit	2617
Examiner Name	Erika A. Gary
Attorney Docket Number	AFF.004C7US

34	The EMusic.com website (formerly www.goodnoise.com) (date unknown, contended by defendant Apple Corp. to be prior art under one or more of 35 U.S.C. 102 (a), (b), (f) and (g)) 2 pages.	<input type="checkbox"/>
35	EMusic.com prospectus, Sept. 24, 1999, pp. 1 - 61, F1 - F41.	<input type="checkbox"/>
36	"Logging On; Setting Sound Free From the CD," The Washington Post, Mar. 3, 2000, pp. 1-3.	<input type="checkbox"/>
37	"Music Factory; Retailers Struggle to Expand Listening Options Online," Contra Costa Times Mar. 19, 2000, pp. 1- 2.	<input type="checkbox"/>
38	The MyPlay.com website (date unknown, contended by defendant Apple Corp. to be prior art under one or more of 35 U.S.C. 102 (a), (b), (f) and (g)) 1 page.	<input type="checkbox"/>
39	Myplay.com Launches Today, PR Newswire. Oct. 13, 1999, pp. 1-2.	<input type="checkbox"/>
40	Myplay, Inc. Launches Consumer Online Music Service, PR Newswire, Oct. 13, 1999, pp. 1-3.	<input type="checkbox"/>
41	Empeg.com, "Does Your Car Stereo Run Linux," (date unknown, contended by defendant Apple Corp. to be prior art under one or more of 35 U.S.C. 102 (a), (b), (f) and (g)), 2 pages.	<input type="checkbox"/>
42	TIA/EIA Interim Standard, Cellular Digital Packet Data, System Specification - Part 403, Mobile Data Link Protocol, Telecommunications Industry Association. Dec. 1997, 83 pages.	<input type="checkbox"/>
43	"The Listen Up Player from Audio Highway" 1996. 1 page.	<input type="checkbox"/>
44	"Audio Highway Announces The Listen Up Player," Audio Highway Press Release, Sept. 23, 1996, 2 pages.	<input type="checkbox"/>

**INFORMATION DISCLOSURE
STATEMENT BY APPLICANT**
(Not for submission under 37 CFR 1.99)

Application Number	12495190
Filing Date	2009-06-30
First Named Inventor	Russell W. White, et al.
Art Unit	2617
Examiner Name	Erika A. Gary
Attorney Docket Number	AFF.004C7US

45	MPMan F-10 and F-20 digital audio players and review article "MP3 Player Saehan MPMAN F20 Review", X-bit labs, July 14, 1999. 6 pages.	<input type="checkbox"/>
46	Menta, "RIAA Sues Music Startup Napster for \$20 Billion" Newswire, Jan. 11, 2000, 4 pages.	<input type="checkbox"/>
47	Boehrlart, "Artists to Napster: Drop Dead" Salon.com, Mar. 24, 2000. 3 pages.	<input type="checkbox"/>

If you wish to add additional non-patent literature document citation information please click the Add button

EXAMINER SIGNATURE

Examiner Signature	Date Considered
--------------------	-----------------

*EXAMINER: Initial if reference considered, whether or not citation is in conformance with MPEP 609. Draw line through a citation if not in conformance and not considered. Include copy of this form with next communication to applicant.

¹ See Kind Codes of USPTO Patent Documents at www.USPTO.GOV or MPEP 901.04. ² Enter office that issued the document, by the two-letter code (WIPO Standard ST.3). ³ For Japanese patent documents, the indication of the year of the reign of the Emperor must precede the serial number of the patent document. ⁴ Kind of document by the appropriate symbols as indicated on the document under WIPO Standard ST.16 if possible. ⁵ Applicant is to place a check mark here if English language translation is attached.

INFORMATION DISCLOSURE STATEMENT BY APPLICANT (Not for submission under 37 CFR 1.99)	Application Number	12495190
	Filing Date	2009-06-30
	First Named Inventor	Russell W. White, et al.
	Art Unit	2617
	Examiner Name	Erika A. Gary
	Attorney Docket Number	AFF.004C7US

CERTIFICATION STATEMENT

Please see 37 CFR 1.97 and 1.98 to make the appropriate selection(s):

That each item of information contained in the information disclosure statement was first cited in any communication from a foreign patent office in a counterpart foreign application not more than three months prior to the filing of the information disclosure statement. See 37 CFR 1.97(e)(1).

OR

That no item of information contained in the information disclosure statement was cited in a communication from a foreign patent office in a counterpart foreign application, and, to the knowledge of the person signing the certification after making reasonable inquiry, no item of information contained in the information disclosure statement was known to any individual designated in 37 CFR 1.56(c) more than three months prior to the filing of the information disclosure statement. See 37 CFR 1.97(e)(2).

See attached certification statement.

Fee set forth in 37 CFR 1.17 (p) has been submitted herewith.

None

SIGNATURE

A signature of the applicant or representative is required in accordance with CFR 1.33, 10.18. Please see CFR 1.4(d) for the form of the signature.

Signature	/Mark J. Rozman/	Date (YYYY-MM-DD)	2011-01-27
Name/Print	Mark J. Rozman	Registration Number	42117

This collection of information is required by 37 CFR 1.97 and 1.98. The information is required to obtain or retain a benefit by the public which is to file (and by the USPTO to process) an application. Confidentiality is governed by 35 U.S.C. 122 and 37 CFR 1.14. This collection is estimated to take 1 hour to complete, including gathering, preparing and submitting the completed application form to the USPTO. Time will vary depending upon the individual case. Any comments on the amount of time you require to complete this form and/or suggestions for reducing this burden, should be sent to the Chief Information Officer, U.S. Patent and Trademark Office, U.S. Department of Commerce, P.O. Box 1450, Alexandria, VA 22313-1450. **DO NOT SEND FEES OR COMPLETED FORMS TO THIS ADDRESS. SEND TO: Commissioner for Patents, P.O. Box 1450, Alexandria, VA 22313-1450.**

Privacy Act Statement

The Privacy Act of 1974 (P.L. 93-579) requires that you be given certain information in connection with your submission of the attached form related to a patent application or patent. Accordingly, pursuant to the requirements of the Act, please be advised that: (1) the general authority for the collection of this information is 35 U.S.C. 2(b)(2); (2) furnishing of the information solicited is voluntary; and (3) the principal purpose for which the information is used by the U.S. Patent and Trademark Office is to process and/or examine your submission related to a patent application or patent. If you do not furnish the requested information, the U.S. Patent and Trademark Office may not be able to process and/or examine your submission, which may result in termination of proceedings or abandonment of the application or expiration of the patent.

The information provided by you in this form will be subject to the following routine uses:

1. The information on this form will be treated confidentially to the extent allowed under the Freedom of Information Act (5 U.S.C. 552) and the Privacy Act (5 U.S.C. 552a). Records from this system of records may be disclosed to the Department of Justice to determine whether the Freedom of Information Act requires disclosure of these records.
2. A record from this system of records may be disclosed, as a routine use, in the course of presenting evidence to a court, magistrate, or administrative tribunal, including disclosures to opposing counsel in the course of settlement negotiations.
3. A record in this system of records may be disclosed, as a routine use, to a Member of Congress submitting a request involving an individual, to whom the record pertains, when the individual has requested assistance from the Member with respect to the subject matter of the record.
4. A record in this system of records may be disclosed, as a routine use, to a contractor of the Agency having need for the information in order to perform a contract. Recipients of information shall be required to comply with the requirements of the Privacy Act of 1974, as amended, pursuant to 5 U.S.C. 552a(m).
5. A record related to an International Application filed under the Patent Cooperation Treaty in this system of records may be disclosed, as a routine use, to the International Bureau of the World Intellectual Property Organization, pursuant to the Patent Cooperation Treaty.
6. A record in this system of records may be disclosed, as a routine use, to another federal agency for purposes of National Security review (35 U.S.C. 181) and for review pursuant to the Atomic Energy Act (42 U.S.C. 218(c)).
7. A record from this system of records may be disclosed, as a routine use, to the Administrator, General Services, or his/her designee, during an inspection of records conducted by GSA as part of that agency's responsibility to recommend improvements in records management practices and programs, under authority of 44 U.S.C. 2904 and 2906. Such disclosure shall be made in accordance with the GSA regulations governing inspection of records for this purpose, and any other relevant (i.e., GSA or Commerce) directive. Such disclosure shall not be used to make determinations about individuals.
8. A record from this system of records may be disclosed, as a routine use, to the public after either publication of the application pursuant to 35 U.S.C. 122(b) or issuance of a patent pursuant to 35 U.S.C. 151. Further, a record may be disclosed, subject to the limitations of 37 CFR 1.14, as a routine use, to the public if the record was filed in an application which became abandoned or in which the proceedings were terminated and which application is referenced by either a published application, an application open to public inspections or an issued patent.
9. A record from this system of records may be disclosed, as a routine use, to a Federal, State, or local law enforcement agency, if the USPTO becomes aware of a violation or potential violation of law or regulation.

Electronic Acknowledgement Receipt

EFS ID:	9321988
Application Number:	12495190
International Application Number:	
Confirmation Number:	2380
Title of Invention:	Method For Content Delivery
First Named Inventor/Applicant Name:	Russell W. White
Customer Number:	21906
Filer:	Mark J. Rozman/Stephanie Petreas
Filer Authorized By:	Mark J. Rozman
Attorney Docket Number:	AFF.0004C7US
Receipt Date:	27-JAN-2011
Filing Date:	30-JUN-2009
Time Stamp:	16:14:02
Application Type:	Utility under 35 USC 111(a)

Payment information:

Submitted with Payment	no
------------------------	----

File Listing:

Document Number	Document Description	File Name	File Size(Bytes)/ Message Digest	Multi Part /.zip	Pages (if appl.)
1	Information Disclosure Statement (IDS) Filed (SB/08)	AFF004C7IDSAppleFtpIDS2of2 ToFile.pdf	56121 <small>eb1a34413e85d0063802cd8093580adef1967f87</small>	no	8

Warnings:

Information:

This is not an USPTO supplied IDS fillable form					
2	NPL Documents	IDriveDotCom.pdf	122639 786318345a165dd8a2d8f16e15fce7fc594aeac9	no	6
Warnings:					
Information:					
3	NPL Documents	Mp3dotcomandidrivejoin02.pdf	87719 053007666b4c85bcd2ef734855dbc8f472f57afa	no	3
Warnings:					
Information:					
4	NPL Documents	MyPlayWebsite.pdf	10418 cbc94bc08f52f0f15dadc3168801b9a2bf6a952	no	1
Warnings:					
Information:					
5	NPL Documents	EmpegDotCom.pdf	59928 fb15bcc85d6da32708e70531dfa88b6bd0b5e608	no	2
Warnings:					
Information:					
6	NPL Documents	MP3dotCom.pdf	97560 2aafe2712b7505640207f805e5fe45f169dd16b8	no	2
Warnings:					
Information:					
Total Files Size (in bytes):			434385		
<p>This Acknowledgement Receipt evidences receipt on the noted date by the USPTO of the indicated documents, characterized by the applicant, and including page counts, where applicable. It serves as evidence of receipt similar to a Post Card, as described in MPEP 503.</p> <p><u>New Applications Under 35 U.S.C. 111</u> If a new application is being filed and the application includes the necessary components for a filing date (see 37 CFR 1.53(b)-(d) and MPEP 506), a Filing Receipt (37 CFR 1.54) will be issued in due course and the date shown on this Acknowledgement Receipt will establish the filing date of the application.</p> <p><u>National Stage of an International Application under 35 U.S.C. 371</u> If a timely submission to enter the national stage of an international application is compliant with the conditions of 35 U.S.C. 371 and other applicable requirements a Form PCT/DO/EO/903 indicating acceptance of the application as a national stage submission under 35 U.S.C. 371 will be issued in addition to the Filing Receipt, in due course.</p> <p><u>New International Application Filed with the USPTO as a Receiving Office</u> If a new international application is being filed and the international application includes the necessary components for an international filing date (see PCT Article 11 and MPEP 1810), a Notification of the International Application Number and of the International Filing Date (Form PCT/RO/105) will be issued in due course, subject to prescriptions concerning national security, and the date shown on this Acknowledgement Receipt will establish the international filing date of the application.</p>					

INFORMATION DISCLOSURE STATEMENT BY APPLICANT (Not for submission under 37 CFR 1.99)	Application Number		12495190	
	Filing Date		2009-06-30	
	First Named Inventor	Russell W. White, et al.		
	Art Unit	2617		
	Examiner Name	Erika A. Gary		
	Attorney Docket Number	AFF.004C7US		

U.S.PATENTS						
Examiner Initial*	Cite No	Patent Number	Kind Code ¹	Issue Date	Name of Patentee or Applicant of cited Document	Pages,Columns,Lines where Relevant Passages or Relevant Figures Appear
	1	6248946		2001-06-19	Dwek	
	2	5572442		1996-11-05	Schulhof	
	3	6338044		2002-01-08	Cook	
	4	5797089		1998-08-18	Nguyen	
	5	6330247		2001-12-11	Chang	
	6	5737706		1998-04-07	Seazholtz	

If you wish to add additional U.S. Patent citation information please click the Add button.

U.S.PATENT APPLICATION PUBLICATIONS						
Examiner Initial*	Cite No	Publication Number	Kind Code ¹	Publication Date	Name of Patentee or Applicant of cited Document	Pages,Columns,Lines where Relevant Passages or Relevant Figures Appear

INFORMATION DISCLOSURE STATEMENT BY APPLICANT (Not for submission under 37 CFR 1.99)	Application Number	12495190
	Filing Date	2009-06-30
	First Named Inventor	Russell W. White, et al.
	Art Unit	2617
	Examiner Name	Erika A. Gary
	Attorney Docket Number	AFF.004C7US

1	20010042107		2001-11-15	Palm	
---	-------------	--	------------	------	--

If you wish to add additional U.S. Published Application citation information please click the Add button.

FOREIGN PATENT DOCUMENTS

Examiner Initial*	Cite No	Foreign Document Number ³	Country Code ² i	Kind Code ⁴	Publication Date	Name of Patentee or Applicant of cited Document	Pages, Columns, Lines where Relevant Passages or Relevant Figures Appear	T ⁵
	1	EP 984584	EP		2000-08-03	Lippert		<input type="checkbox"/>

If you wish to add additional Foreign Patent Document citation information please click the Add button

NON-PATENT LITERATURE DOCUMENTS

Examiner Initials*	Cite No	Include name of the author (in CAPITAL LETTERS), title of the article (when appropriate), title of the item (book, magazine, journal, serial, symposium, catalog, etc), date, pages(s), volume-issue number(s), publisher, city and/or country where published.	T ⁵
	1	Sony Corporation, Sony Portable MiniDisc Recorder MZ-R90/MZ-R91 Operating Instructions, Doc. No. 3-867-571-22(1), 1999, pp. 1-55.	<input type="checkbox"/>
	2	Empeg Car User Guide, 1999, pp. 1-19.	<input type="checkbox"/>
	3	Empeg Car User Guide (2000) pp. 1-48	<input type="checkbox"/>
	4	Crowe, Mike. Empeg Car Beta 10a, March 25, 2000, 3 pages.	<input type="checkbox"/>
	5	Emplode Help, (date unknown, contended by defendant Apple Corp. to be prior art under one or more of 35 U.S.C. 102 (a), (b), (f) and (g)) 25 pages.	<input type="checkbox"/>

**INFORMATION DISCLOSURE
STATEMENT BY APPLICANT**
(Not for submission under 37 CFR 1.99)

Application Number	12495190
Filing Date	2009-06-30
First Named Inventor	Russell W. White, et al.
Art Unit	2617
Examiner Name	Erika A. Gary
Attorney Docket Number	AFF.004C7US

6	"MP3 Portable Player Goes Elite" The Mac Observer, Nov. 17, 1999, 3 pages.	<input type="checkbox"/>
7	"MP3 in Your Car Has Arrived" (date unknown, contended by defendant Apple Corp. to be prior art under one or more of 35 U.S.C. 102 (a), (b), (f) and (g)) 1 page.	<input type="checkbox"/>
8	Photos from Comdex Fall 1999, Nov. 1999, 9 pages.	<input type="checkbox"/>
9	Photos from LinuxWorld Expo, Winter 1999, Mar. 1-4, 1999, 22 pages.	<input type="checkbox"/>
10	Craig Knudsen, "MP3 Linux Players," Linux Journal, Jul. 1, 1999, pp. 1-3.	<input type="checkbox"/>
11	riocar.org – Empeg Car History, (date unknown, contended by defendant Apple Corp. to be prior art under one or more of 35 U.S.C. 102 (a), (b), (f) and (g)), 4 pages.	<input type="checkbox"/>
12	"Visteon: For Your Listening Pleasure - Any Music, Any Time, Anywhere," Presswire, Jan. 5, 2000, 1 page.	<input type="checkbox"/>
13	Photographs in email to Hugo Fiennes, Sept. 22, 1999, 4 pages.	<input type="checkbox"/>
14	HP Jornada 420 User's Manual, 1999, pp. 1-142.	<input type="checkbox"/>
15	IEEE Standard 802.11b, 1999 Edition (Wireless LAN Medium Access Control and Physical Layer Specifications: Higher-Speed Physical Layer Extension in the 2.4 GHz Band) Sep. 16, 1999, 96 pages.	<input type="checkbox"/>
16	RealPlayer Plus G2 Manual, 1999, pp. 1-81.	<input type="checkbox"/>

**INFORMATION DISCLOSURE
STATEMENT BY APPLICANT**
(Not for submission under 37 CFR 1.99)

Application Number		12495190
Filing Date		2009-06-30
First Named Inventor	Russell W. White, et al.	
Art Unit		2617
Examiner Name	Erika A. Gary	
Attorney Docket Number		AFF.004C7US

17	IEEE Standard 802.11a, 1999 Edition (Wireless LAN Medium Access Control and Physical Layer Specifications: High-Speed Physical Layer in the 5GHz Band), 1999, 91 pages.	<input type="checkbox"/>
18	Rod Underhill & Nat Gertler, "The Complete Idiot's Guide to MP3: Music on the Internet," 1999, 44 pages.	<input type="checkbox"/>
19	Bill Mann, "I Want My MP3! How to Download, Rip, & Play Digital Music," McGraw-Hill 2000, 175 pages.	<input type="checkbox"/>
20	IEEE Standard 802.11, 1997 Edition (Wireless LAN Medium Access Control and Physical Layer Specifications), 1997, pp. 1-145.	<input type="checkbox"/>
21	IEEE Standard 802.3ab, 1999 Edition (802.3 Physical Layer Specification for 1000 Mb/s Operation on Four Pairs of Category 5 or Better Balanced Twisted Pair Cable (1000BASE-T) 1999, 140 pages.	<input type="checkbox"/>
22	IBM Wireless Modem for Cellular/CDPD - Quick Reference, Oct. 1995, pp. 1-20.	<input type="checkbox"/>
23	Creative Sound Blaster Live! Platinum product, documentation, and software: Creative Technology Ltd., Creative Sound Blaster Live! Platinum Getting Started, Sept. 1999, 93 pages.	<input type="checkbox"/>
24	psa[play Getting Started Guide, (date unknown, contended by defendant Apple Corp. to be prior art under one or more of 35 U.S.C. 102 (a), (b), (f) and (g)), pp. 1-16.	<input type="checkbox"/>
25	psa[play Getting Started Guide, 2000, pp. 1-16.	<input type="checkbox"/>
26	Rio 800 User Guide, 2001, pp. 1-38.	<input type="checkbox"/>
27	Rio 800 Digital Audio Player—Getting Started, 2000, pp. 1-19.	<input type="checkbox"/>

**INFORMATION DISCLOSURE
STATEMENT BY APPLICANT**
(Not for submission under 37 CFR 1.99)

Application Number		12495190
Filing Date		2009-06-30
First Named Inventor	Russell W. White, et al.	
Art Unit		2617
Examiner Name	Erika A. Gary	
Attorney Docket Number		AFF.004C7US

28	Rio 600 Getting Started Guide, 2001, pp. 1-169.	<input type="checkbox"/>
29	Rio 600 User Guide, March 2001, pp 1-38.	<input type="checkbox"/>

If you wish to add additional non-patent literature document citation information please click the Add button

EXAMINER SIGNATURE

Examiner Signature		Date Considered	
--------------------	--	-----------------	--

*EXAMINER: Initial if reference considered, whether or not citation is in conformance with MPEP 609. Draw line through a citation if not in conformance and not considered. Include copy of this form with next communication to applicant.

¹ See Kind Codes of USPTO Patent Documents at www.USPTO.GOV or MPEP 901.04. ² Enter office that issued the document, by the two-letter code (WIPO Standard ST.3). ³ For Japanese patent documents, the indication of the year of the reign of the Emperor must precede the serial number of the patent document. ⁴ Kind of document by the appropriate symbols as indicated on the document under WIPO Standard ST.16 if possible. ⁵ Applicant is to place a check mark here if English language translation is attached.

INFORMATION DISCLOSURE STATEMENT BY APPLICANT (Not for submission under 37 CFR 1.99)	Application Number	12495190
	Filing Date	2009-06-30
	First Named Inventor	Russell W. White, et al.
	Art Unit	2617
	Examiner Name	Erika A. Gary
	Attorney Docket Number	AFF.004C7US

CERTIFICATION STATEMENT

Please see 37 CFR 1.97 and 1.98 to make the appropriate selection(s):

That each item of information contained in the information disclosure statement was first cited in any communication from a foreign patent office in a counterpart foreign application not more than three months prior to the filing of the information disclosure statement. See 37 CFR 1.97(e)(1).

OR

That no item of information contained in the information disclosure statement was cited in a communication from a foreign patent office in a counterpart foreign application, and, to the knowledge of the person signing the certification after making reasonable inquiry, no item of information contained in the information disclosure statement was known to any individual designated in 37 CFR 1.56(c) more than three months prior to the filing of the information disclosure statement. See 37 CFR 1.97(e)(2).

- See attached certification statement.
- Fee set forth in 37 CFR 1.17 (p) has been submitted herewith.
- None

SIGNATURE

A signature of the applicant or representative is required in accordance with CFR 1.33, 10.18. Please see CFR 1.4(d) for the form of the signature.

Signature	/Mark J. Rozman/	Date (YYYY-MM-DD)	2011-01-26
Name/Print	Mark J. Rozman	Registration Number	42117

This collection of information is required by 37 CFR 1.97 and 1.98. The information is required to obtain or retain a benefit by the public which is to file (and by the USPTO to process) an application. Confidentiality is governed by 35 U.S.C. 122 and 37 CFR 1.14. This collection is estimated to take 1 hour to complete, including gathering, preparing and submitting the completed application form to the USPTO. Time will vary depending upon the individual case. Any comments on the amount of time you require to complete this form and/or suggestions for reducing this burden, should be sent to the Chief Information Officer, U.S. Patent and Trademark Office, U.S. Department of Commerce, P.O. Box 1450, Alexandria, VA 22313-1450. **DO NOT SEND FEES OR COMPLETED FORMS TO THIS ADDRESS. SEND TO: Commissioner for Patents, P.O. Box 1450, Alexandria, VA 22313-1450.**

Privacy Act Statement

The Privacy Act of 1974 (P.L. 93-579) requires that you be given certain information in connection with your submission of the attached form related to a patent application or patent. Accordingly, pursuant to the requirements of the Act, please be advised that: (1) the general authority for the collection of this information is 35 U.S.C. 2(b)(2); (2) furnishing of the information solicited is voluntary; and (3) the principal purpose for which the information is used by the U.S. Patent and Trademark Office is to process and/or examine your submission related to a patent application or patent. If you do not furnish the requested information, the U.S. Patent and Trademark Office may not be able to process and/or examine your submission, which may result in termination of proceedings or abandonment of the application or expiration of the patent.

The information provided by you in this form will be subject to the following routine uses:

1. The information on this form will be treated confidentially to the extent allowed under the Freedom of Information Act (5 U.S.C. 552) and the Privacy Act (5 U.S.C. 552a). Records from this system of records may be disclosed to the Department of Justice to determine whether the Freedom of Information Act requires disclosure of these records.
2. A record from this system of records may be disclosed, as a routine use, in the course of presenting evidence to a court, magistrate, or administrative tribunal, including disclosures to opposing counsel in the course of settlement negotiations.
3. A record in this system of records may be disclosed, as a routine use, to a Member of Congress submitting a request involving an individual, to whom the record pertains, when the individual has requested assistance from the Member with respect to the subject matter of the record.
4. A record in this system of records may be disclosed, as a routine use, to a contractor of the Agency having need for the information in order to perform a contract. Recipients of information shall be required to comply with the requirements of the Privacy Act of 1974, as amended, pursuant to 5 U.S.C. 552a(m).
5. A record related to an International Application filed under the Patent Cooperation Treaty in this system of records may be disclosed, as a routine use, to the International Bureau of the World Intellectual Property Organization, pursuant to the Patent Cooperation Treaty.
6. A record in this system of records may be disclosed, as a routine use, to another federal agency for purposes of National Security review (35 U.S.C. 181) and for review pursuant to the Atomic Energy Act (42 U.S.C. 218(c)).
7. A record from this system of records may be disclosed, as a routine use, to the Administrator, General Services, or his/her designee, during an inspection of records conducted by GSA as part of that agency's responsibility to recommend improvements in records management practices and programs, under authority of 44 U.S.C. 2904 and 2906. Such disclosure shall be made in accordance with the GSA regulations governing inspection of records for this purpose, and any other relevant (i.e., GSA or Commerce) directive. Such disclosure shall not be used to make determinations about individuals.
8. A record from this system of records may be disclosed, as a routine use, to the public after either publication of the application pursuant to 35 U.S.C. 122(b) or issuance of a patent pursuant to 35 U.S.C. 151. Further, a record may be disclosed, subject to the limitations of 37 CFR 1.14, as a routine use, to the public if the record was filed in an application which became abandoned or in which the proceedings were terminated and which application is referenced by either a published application, an application open to public inspections or an issued patent.
9. A record from this system of records may be disclosed, as a routine use, to a Federal, State, or local law enforcement agency, if the USPTO becomes aware of a violation or potential violation of law or regulation.



(12) **EUROPEAN PATENT APPLICATION**

(43) Date of publication: **08.03.2000 Bulletin 2000/10** (51) Int Cl.7: **H04L 12/18, H04L 29/06**
 (21) Application number: **99306950.9**
 (22) Date of filing: **01.09.1999**

(84) Designated Contracting States:
AT BE CH CY DE DK ES FI FR GB GR IE IT LI LU MC NL PT SE
 Designated Extension States:
AL LT LV MK RO SI

(30) Priority: **04.09.1998 US 148244**
18.03.1999 US 272673

(71) Applicant: **America Online, Inc.**
Dulles, VA 20166 (US)

(72) Inventors:
 • **Lippert, Patrick**
Mission Viejo, California 92691 (US)

• **Enete, Noel**
Seal Beach, California 90740 (US)

• **Watson, Richard**
Austin, Texas 78751 (US)

• **Pai, Ashok**
Irvine, California 92612 (US)

• **Lippke, David**
Herndon, Virginia 20170 (US)

(74) Representative: **Charig, Raymond Julian**
Eric Potter Clarkson,
Park View House,
58 The Ropewalk
Nottingham NG1 5DD (GB)

(54) **Internet multimedia broadcast system**

(57) A method and system for playback of live and pre-recorded multimedia data in real-time over a large scale communication network, such as the world-wide web. The invention allows a user connected to a specialized network to play back a multimedia broadcast. The invention includes a process that allows multimedia content to be created and scheduled as a playlist. The playlist data is compressed and transmitted to a host system as part of a capture protocol. The captured playlist data may then be "broadcast" to users. A user may choose a channel selection from a playlist, and cause the selected item to be downloaded and played back by means of a playback tool. The host system includes a

highly efficient distribution system that allows a large number of users accessing the host through Terminal Information Handlers to rapidly access one or more channels of multimedia data. The system architecture provides a "fan out" mechanism that includes a master broadcast process that accepts a multi-stream data flow and then distributes the multi-stream data flow to essentially every Terminal Information Handler accessible to the host. The load of providing data streams is thus spread among a large number of Terminal Information Handlers, reducing access latency and providing support for hundreds of thousands of users over a large scale communication network.

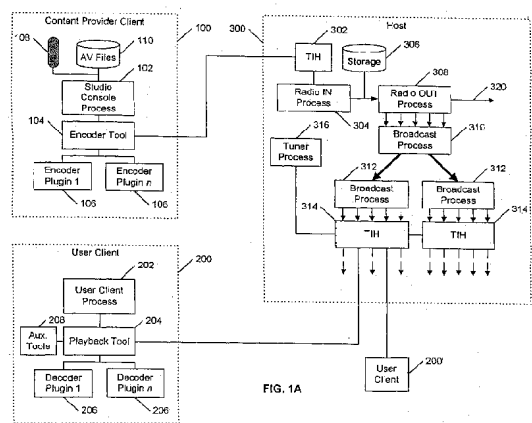

EP 0 984 584 A1

Description

TECHNICAL FIELD

[0001] This invention relates to a method and system for playback of live and pre-recorded multimedia data in real-time over a large scale communication network, such as the world-wide web.

BACKGROUND

[0002] The world wide web, or Internet, is a large scale communication network that has become increasingly popular with users for accessing data from a huge variety of sources. Currently, a large percentage of users access the Internet through modems, typically having a data rate between about 33.6 Kbps and 14.4 Kbps. For data such as text or simple graphics, such speeds are adequate to enable a "web browsing" experience that most users find enjoyable. These data rates are also acceptable for transmittal and playback of multimedia data (*e.g.*, audio, video, still images, text, hyperlinks, *etc.*) in real-time if the data is highly compressed. Accordingly, a number of schemes have been implemented for allowing users to access and download compressed multimedia data streams for local decompression and playback.

[0003] One such approach for real-time multimedia data playback utilizes the Internet multicast protocol. Multicasting includes transmitting a communication from one site to a group of selected receivers (multicasting differs from broadcasting in that a broadcast is sent to everyone who has the equipment or connection to receive it). Under this scheme, a user initiates an action (*e.g.*, selection of a uniform resource locator - URL - address) that requests that a multimedia data stream be transmitted from a server to the user's client system, for decompression and playback by a software process executing on the client. The request causes the router to which the user is coupled to access special multicast Internet addresses. The requested data is then supplied to the user (or "subscriber") by means of a multicasting backbone (MBone), which is a network of special Internet sites that supports Internet Protocol multicasting for a limited number of users. MBone provides a faster technology than the Internet for transmitting real-time audio and video programs.

[0004] A disadvantage of Internet multicasting is that a multicast event (*e.g.*, a live radio show) can only effectively support several hundreds to a few thousands of users with uninterrupted data streams. Due to bandwidth constraints and the lack of guaranteed quality of service for the Internet, adding more users may cause objectionable pauses in content (*e.g.*, pauses in multimedia playback). Thus, for some events, Internet multicasting cannot meet user demand.

[0005] Accordingly, there is a need for an architecture that can provide for playback of live and pre-recorded

multimedia data in real-time over a large scale communication network, such as the world-wide web, for a large number of users, typically in the hundreds of thousands of users. The present invention provides a method and system for such an architecture.

SUMMARY

[0006] The preferred embodiment of the invention allows a user connected to a specialized network having a "Multimedia Broadcast" feature to play back a multimedia broadcast. One aspect of the invention includes a Studio Console Process executing on a content provider client system that allows multimedia content to be created and scheduled as a "playlist". The data comprising a playlist may be pre-recorded or live. The playlist data is compressed under the control of the Studio Console Process and transmitted to a host system as part of a "capture" protocol controlled by a "radio IN" process. The captured playlist data may then be "broadcast" to users who "tune in" to a "live multimedia show", or stored for later broadcast. (In this context, "broadcast" simply means transmittal of a data stream to a user who selects content to be played back on the user's client system).

[0007] A user may choose a "channel" selection from a playlist, and cause the selected item to be downloaded and played back by means of a "playback tool". The data stream corresponding to the selected item optionally may include embedded non-audio content, such as hypertext links to other forms, URLs to web pages, static images, video images, *etc.*

[0008] The host system includes a highly efficient distribution system that allows a large number of users accessing the host through Terminal Information Handlers to rapidly access one or more channels of audio data augmented by non-audio multimedia data. In particular, the inventive system architecture provides a "fan out" mechanism that includes a master broadcast process that accepts a multi-stream data flow from a "radio OUT" process and then distributes the multi-stream data flow to essentially every Terminal Information Handler accessible to the host. The load of providing data streams is thus spread among a large number of Terminal Information Handlers, reducing access latency to typically less than about 3 seconds, and providing support for hundreds of thousands of users over a large scale communication network such as the world-wide web.

[0009] In particular, in one aspect the invention includes a system for playback of live and pre-recorded multimedia data in real-time over a large scale communication network, including a computer system having a plurality of terminal information handlers for managing general information flow to and from a plurality of users; an output process for assembling multiple multimedia data streams for distribution; at least one broadcast process, in communication with the output process, for distributing the assembled multiple multimedia data

streams to each of the terminal information handlers; and a selector process, in communication with the terminal information handlers, for receiving a channel request from a user through an terminal information handler associated with the user, mapping the channel request to a corresponding one of the multiple multimedia data streams, and enabling transmission of the corresponding one multimedia data stream to the user through the associated terminal information handler. In another aspect, the invention includes a corresponding method.

[0010] The details of one or more embodiments of the invention are set forth in the accompanying drawings and the description below. Other features, objects, and advantages of the invention will be apparent from the description and drawings, and from the claims.

DESCRIPTION OF DRAWINGS

[0011] FIG. 1A is block diagram of the preferred embodiment of the invention.

[0012] FIG. 1B is block diagram of a portion of an alternative embodiment of the invention.

[0013] FIG. 2 is a "screen shot" of one embodiment of a graphical user interface (GUI) for defining a data stream within a studio console process in accordance with the invention.

[0014] FIG. 3 is a "screen shot" of one embodiment of a GUI for defining a playlist schedule within a studio console process in accordance with the invention.

[0015] FIG. 4 is a "screen shot" of one embodiment of a GUI for displaying playback information and allowing selection of a playback channel within a user client process in accordance with the invention.

[0016] FIG. 5A is a block diagram showing the client-host architecture for a capture session.

[0017] FIG. 5B is a data flow diagram showing the data flow for establishing a capture session.

[0018] FIG. 5C is a data flow diagram showing the data flow for recording during a capture session.

[0019] FIG. 5D is a data flow diagram showing the data flow for ending a capture session.

[0020] FIG. 6A is a data flow diagram showing the data flow architecture for playback of a multimedia data stream.

[0021] FIG. 6B is a data flow diagram showing the data flow for starting a playback session.

[0022] FIG. 6C is a data flow diagram showing the data flow for switching a playback channel.

[0023] FIG. 6D is a data flow diagram showing the data flow for ending a playback session.

[0024] Like reference numbers and designations in the various drawings indicate like elements.

DETAILED DESCRIPTION

Overview

[0025] The preferred embodiment of the invention allows a user connected to a specialized network having a "Radio" feature (*e.g.*, the America Online network) to play back an audio broadcast that may be augmented with non-audio multimedia data, such as video and still images, URLs, text fields, *etc.* One aspect of the invention includes a Studio Console Process executing on a content provider client system that allows such content to be created and scheduled.

[0026] For example, the Studio Console Process enables a content provider to schedule a week's worth of prerecorded content that changes daily. The content provider uses a form in the Studio Console Process to assemble a "playlist" for each day. If the content provider then needs to conduct a live event on the Radio system, the content provider uses the Studio Console Process to override any existing playlist. When the live event is completed, the playlist resumes as originally scheduled.

[0027] The data comprising a playlist may be pre-recorded or live. The playlist data is compressed under the control of the Studio Console Process and transmitted to a host system as part of a "capture" process. The captured playlist data may then be "broadcast" to users who "tune in" to a "live multimedia show", or stored for later broadcast. (In this context, "broadcast" simply means transmittal of a data stream to a user who selects content to be played back on the user's client system).

[0028] A user may initiate a form that displays available playlists for one or more "channels" of a host system, choose a selection from a playlist, and cause the selected item to be downloaded and played back by means of a "playback tool". The data stream corresponding to the selected item optionally may include embedded non-audio content, such as hypertext links to other forms, URLs to web pages, static images, or video images.

[0029] The host system includes a highly efficient distribution system that allows a large number of users to rapidly access one or more channels of audio data augmented by non-audio data. The latency of access - the time between a request for playback of a particular channel and commencement of playback on a user client - is typically less than about 3 seconds, compared to tens of seconds for many prior art systems.

System Architecture - Content Provider Client

[0030] FIG. 1A is block diagram of the preferred embodiment of the invention. Content to be broadcast is typically developed by a content provider utilizing a content provider client 100. A Studio Console Process 102 executes on the content provider client 100. The Studio Console Process 102 allows a content provider to define ("author") a play list data stream to be uploaded to a

host 300 during a "capture" session for "broadcast" to users selecting the channel assigned to the playlist. (Details of a capture session are described below.) The playlist data stream includes audio content and may include images or other data which may be inserted into the data stream as the data is being compressed. In the preferred embodiment, the Studio Console Process 102 communicates with a separate encoder tool 104 that responds to and carries out the directions of the content provider input by means of the Studio Console Process 102. In particular, the encoder tool 104 selects one of a plurality of encoder "plugins" 106 to perform necessary data compression of the multimedia content of the data stream. The encoder tool 104 also packages the compressed multimedia content into packets for transmission to the host 300. In the preferred embodiment, audio data is given priority over non-audio data to reduce the likelihood of any objectionable interruption in audio playback. In general, other types of data may be appended to audio packets as long as the total transmission packet (e.g., an Internet protocol packet) does not exceed a target bit rate (e.g., 10 Kbps).

[0031] Audio content may come from "live" sources to the content provider client 100, such as an input to a computer sound card from a microphone 108 or "line-in" source (e.g., an analog or digital audio playback device such as an audio tape or CD player), or a direct input to the computer from a direct digital connection (e.g., CDRom player). Alternatively, audio content may come from pre-recorded ("canned") sound files, such as WAV and ART files, located on storage media 110 accessible to the content provider client 100.

[0032] Similarly, images (still or video) may come from "live" sources to the content provider client 100, such as video cameras. Still images can be from standard file formats, including ART, BMP, GIF or JPG (JPEG) formats. In the preferred embodiment, all such formats are re-compressed into a single format (ART) for the broadcast data stream.

[0033] One aspect of the invention is that a content provider may change an encoder plugin 106 "on-the-fly" to accommodate different content inputs as such inputs change. For example, an encoder plugin 106 particularly well-suited for speech may be used for a time (for example, while a conductor is explaining a music piece about to be played), and then an encoder plugin 106 particularly well-suited for music may be switched in when the source material changes (for example, when the music piece is being played).

[0034] FIG. 2 is a "screen shot" of one embodiment of a graphical user interface (GUI) for defining a data stream within the Studio Console Process 102. The preferred content definition GUI for the Studio Console Process 102 includes controls that allow the content provider to do at least the following in "authoring" a playlist entry:

- Select an audio source 150 ("live" or "canned") for

a data stream.

- Define an audio target 152 for the data stream (e.g., a file name for storage on the content provider client 100 or on the host 300 for later broadcast, or a channel name for a live broadcast).
- Select an encoder 154 for compressing the audio source data stream. The list of available encoders allows selection of varying degrees of compression, depending on the desired final sound quality and the nature of the audio source material (e.g., speech generally can be compressed more than music). Examples of such encoders include those available from Voxware, Inc. of Princeton, NJ. For example, the Voxware VR12 Speech Codec requires a bit rate of only 1.5 Kbps for speech, while a music codec may require as much as 10 Kbps.
- Define a "stream name" 156, which is a name for the data stream that is delivered to a user's playback tool whenever playback is started for a particular virtual channel.
- Define a "stream description" 158 that provides a detailed description of the data stream that can be delivered to a user's playback tool on demand. For example, the description may contain rich-text - HTML formatted text that may contain font and color information tags.
- Define "caption text" 160, which is simple text that can appear within the data stream. In the preferred embodiment, when a playback tool receives a complete caption string, the caption string is forwarded to an auxiliary tool for display in a text field on a form, if the field exists. The caption text may be used for closed captioning or for other "headline" updates, and is preferably in "rich text format" (RTF). The caption text may also included hyperlinks.
- Select image data 162 that can be delivered appended to and interleaved with the audio data. The image data is inserted in the data stream wherever available space is found after the audio packets (a target bit rate for the data stream is set at authoring time) to expedite transfer to the client. When data is received at the playback tool, it is forwarded to an auxiliary tool for rendering. The original image data may be in any of a variety of formats, such as the well-known ART, BMP, GIF or JPG (JPEG) image formats, but is preferably transformed into a single multimedia ART format for broadcast. A number of images may be linked to form a "slide show". To save space in the data stream itself, a global ID reference to an image or video data may be delivered instead of an image itself. The global ID is passed by the user's playback tool to an aux-

iliary tool for rendering. This approach is useful if the referenced data resides on the client's system (*i.e.*, the data was downloaded previously). Video data can also be delivered appended to and interleaved with the audio data. As with image data, video data is inserted in the data stream wherever available space is found after the audio packets. However, a significant amount of bandwidth is required for video data, even for highly compressed video images, and thus should be limited for low-bandwidth users. When video data is received at the playback tool, it is forwarded to an auxiliary tool for rendering.

- Select or define URLs 164 that can be delivered appended to and interleaved with the audio data. When URLs are received at the playback tool, they forwarded to an auxiliary tool which attaches them to a button or image on a form (if one exists) displayed to the user. When the button or image is selected by the user, the attached URL is activated in conventional fashion.

[0035] The Studio Console Process 102 also may be used to schedule playlist content on a channel for an extended period of time. FIG. 3 is a "screen shot" of one embodiment of a GUI for defining a playlist schedule within the Studio Console Process 102. The preferred playlist definition GUI for the Studio Console Process 102 includes controls that allow the content provider to do at least the following in scheduling a playlist:

- Define a schedule 170 of start and stop times for each of a plurality of audio content files.
- Select a channel 172 on which multimedia content will be made available to users.
- Define a release date 174 for the playlist.
- Check the overall start and stop times 176 and file characteristics 178 for the playlist content.

System Architecture - User Client

[0036] FIG. 1A also shows a user client 200. In the preferred embodiment, a User Client Process 202 communicates through a playback tool 204 across a network (*e.g.*, the Internet) with the host 300 to access playlists and select a channel for playback. The User Client Process 202 responds to and carries out the directions of a user by means of the playback tool 204. In particular, the playback tool 204 selects one of a plurality of decoder plugins 206 to perform necessary data decompression of the multimedia content of a received data stream. The playback tool 204 also parses multimedia packets received from the host 300. In particular, the playback tool 204 processes all audio data internally, but forwards

all non-audio data to one or more auxiliary tools 208, each of which can manage and render such data.

[0037] In the preferred embodiment, while a data stream may contain all types of data, each particular calling form displayed by the User Client Process 202 notifies the auxiliary tools 208 of the data that pertain to the form. That way, different forms can have different presentations for the same data stream. For example, one small form may only have start and stop buttons for the audio portion of the stream with no image box. The auxiliary tools 208 would not try to render any accompanying image data. Another, larger form may have an image box that is updated by an auxiliary tool 208 whenever a new image appears in the data stream.

[0038] In the preferred embodiment, the user client process 202 provides the ability for a user to play back a particular playlist selection until a different channel is selected or the playback session is ended. Multimedia content may be delivered in a one-time transmission or may be continuously broadcast in a looping manner. In either event, the user is able to join an active broadcast at any point during its transmission.

[0039] FIG. 4 is a "screen shot" of one embodiment of a GUI for displaying playback information and allowing selection of a playback channel within the User Client Process 202. (Details of a playback session are described below.) The preferred playback GUI includes controls that allow the user to do at least the following:

- Display a playlist 400 of stream names for selectable data streams.
- Display a stream description 404 for a selected stream name.
- Display accompanying caption text 406.
- Display accompanying graphics 408.
- Display active link buttons 410 for accompanying URLs.
- Include other desired or convenient controls, such as a stop button 412. For example, if the user presses the stop button 412, the playback tool 204 should blank out the stream name, stream description, link button, and caption text. The playback tool 204 could also display a default name, such as "no station selected". The playback tool 204 may also cause a blank image sent to the appropriate auxiliary tool 208 if the user presses the stop button 412 while an image is being rendered. A standard graphic can be displayed instead.

System Architecture - Host Broadcast System Architecture

[0040] Referring to FIG. 1A, a playlist of multimedia

content generated by a content provider client 100 is transferred in conventional fashion over a network (e.g., the Internet) to a host 300. The host 300 generally includes one or more "front-end" Terminal Information Handlers (TIH) 302 that manage general information flow to and from the host 300 for multiple users. For example, on the America Online network, each TIH 302 can manage about 63 concurrent users. A radio IN process 304 executing on the host 300 receives data from a content provider client 100 that is transmitted by means of "ri" (radio input) messages. The radio IN process 304 generally stores multimedia content as files in a storage device 306 that is accessible to the host 300 for later broadcast or for archiving of the multimedia content. However, the radio IN process 304 may also be used to directly transfer the received multimedia content to a radio OUT process 308 for broadcast to users requesting playback.

[0041] In accordance with a primary aspect of the invention, the radio OUT process 308 provides multiple data streams of multimedia content for access by users. In particular, the radio OUT process 308 may access multiple data streams from one or more storage devices 306, or accept "live" feeds of multimedia content from the radio IN process 304 (e.g., a live interview or live reporting from the scene of a news event). Thus, the radio OUT process 308 gathers and assembles the data packets representing such multimedia content data streams into a "broader" multi-stream data flow.

[0042] In order to provide a highly efficient distribution system that allows a large number of users to rapidly access one or more channels of multimedia data, the inventive system architecture provides a "fan out" mechanism that includes a master broadcast process 312. The broadcast process 312 accepts the multi-stream data flow from the radio OUT process 310 and then distributes the multi-stream data flow (shown as thick arrows in FIG. 1A) along with instances of itself 312 to essentially every terminal information handler 314 accessible to the host 300. (Although only two instances of the broadcast process 312 and two TIHs 314 are shown, any number may be selected). Thus, the load of providing data streams is spread among a large number of Terminal Information Handlers 314.

[0043] For example, in the America Online network, one instance of each broadcast process would be distributed within an internal network to a "pod", each comprising a large number of individual servers. Coupled to each pod in a ring are multiple TIHs 314. Executing on each pod is an instance of the broadcast process 312, which circulates the multi-stream data flow among all TIHs within the pod. In this manner, any one channel of multimedia data stream within the multi-stream data flow is available for transmittal to a user requesting playback with very little delay. As noted above, in one embodiment of the invention, the access latency is typically less than about 3 seconds.

[0044] FIG. 1B is block diagram of a portion of an al-

ternative embodiment of the invention. In this embodiment, the Terminal Information Handlers are configured hierarchically. A multi-stream data flow from a broadcast process 350 is transmitted to a top-level terminal front end processor (TFEP) 352 of conventional design, which controls multiple TIHs 354. The TFEP 352 then re-transmits the multi-stream data flow to dependent TIHs 354, reducing data traffic within the overall system compared to the ring architecture referenced above. Multiple user clients 356 may then access selected channels of the multi-stream data flow through the TIHs 354.

[0045] Once the multi-stream data flow content is available in the TIHs 314, any channel of the multi-stream data flow is available for transmittal to a user requesting playback. To allow a user to select a particular channel, a tuner process 318 executing within the host 300 is coupled to each TIH 314. The tuner process 318 intercepts channel requests from users and commands the TIH 314 with which the user is in communication to deliver a particular multimedia data stream to that user from the multi-stream data flow. Thereafter, packets from that data stream are transmitted to the requesting user (see below for further discussion of playback sessions).

[0046] An additional function of the tuner process 318 is that it can "map" a channel name to a channel number. For internal efficiencies, each channel of the multi-stream data flow is given a channel number. However, it may be desirable to give one or more channel names to each channel number. Thus, channel "1" may be assigned the channel name of "The AOL Radio Hour" on one playback list form displayable to users for a particular time slot, but be assigned the channel name of "The Motley Fool" on the same or another playback list form for a different time slot. Accordingly, in the preferred embodiment, the tuner process 318 maintains a map of channel names to channel numbers. The tuner process 318 then maps an incoming channel name from a user's channel request to the corresponding channel number. That channel number is then used to select the corresponding data stream on the TIH 314 to transmit to the user.

[0047] The inventive architecture may also be used in conjunction with conventional Internet multicast systems by providing a connection 320 from the radio OUT process 308 to a multicast server system, in known fashion. This capability may be useful when a channel is expected to have a relatively small audience which would not tax the "fan out" characteristics of the multicast system. However, for large "fan out" needs, the inventive architecture provides the advantages noted above.

Capture Session

[0048] FIG. 5A is a block diagram showing the client-host architecture for a capture session. A content provider is provided with the Studio Console Process 102,

encoder tool 104, and encoder plugins 106 described above, which may be considered to be a single "capture tool" 502 executing on a content provider client 100. The capture tool 502 communicates with the host 300 over a network through a Send function 504, which takes care of the details of data transmission in known fashion. The host 300 communicates with the capture tool 502 through a Terminal Information Handler (TIH) 302, as described above. The capture process requires only one host process, the radio IN process 304, whose function is to receive data from a content provider that is transmitted by means of "ri" (radio input) messages. The radio IN process 304 stores multimedia content as files in a storage device 306 that are accessible to the host 300 for later broadcast. There are three phases of a capture session: Starting the capture session, Recording, and Ending the capture session.

[0049] For a live input (e.g., a microphone capture), initiating a capture session will start recording, compressing the multimedia data using the selected encoder plugin 106, packetizing the compressed multimedia data as a data stream, and uploading the data stream to the host 300. Since the data is compressed and transmitted while the "live" data (e.g., voice from a microphone) is being recorded, the author has no ability to edit and review the content. This option will most likely be used for unrehearsed content. For pre-recorded input (e.g., a WAV file), initiating a capture session will start compressing the multimedia data using the selected encoder plugin 106, packetizing the compressed multimedia data as a data stream, and uploading the data stream to the host 300. Because the input data is file based, the author has the ability to edit and review content off-line before submitting it to the host 300.

[0050] FIG. 5B is a data flow diagram showing the data flow for establishing a capture session (the representation of the Send function 504 and TIH 302 from FIG. 5 have been omitted for clarity). To establish a capture session, the user invokes a "connect" function 506 in a form 508 of the capture tool 502, which uploads a CLIENT_CONNECT message 510 to the radio IN process 304 within the host 300. The radio IN process 304 returns the same message 512 to acknowledge that a connection has been established.

[0051] FIG. 5C is a data flow diagram showing the data flow for recording during a capture session. After the host 300 has been informed that the content provider client 100 will be sending data, the capture tool 502 initiates transfer of multimedia content with an "rc" (radio control) START_STREAM message 514. The radio IN process 304 returns the same message 516 to acknowledge the start of data transmission and opens 515 a file to store the data stream. The initialization message is then followed by "ri" (radio input) DATA messages 518-1 to 518-n from the capture tool 502. The DATA messages contain the audio data and any supplemental data appended to the audio data. At the end of the data stream, the capture tool 502 sends an "rc" (radio control)

END_STREAM message 520. The radio IN process 304 returns the same message 522 to acknowledge the end of data transmission and closes 523 the data file used to store the data stream.

5 **[0052]** FIG. 5D is a data flow diagram showing the data flow for ending a capture session. The capture session is stopped by closing the open form 508 of the capture tool 502 or by pressing the appropriate cancel control. When this happens, the capture tool 502 sends an "rc" (radio control) CLIENT_DISCONNECT message 524 to the radio IN process 304. The radio IN process 304 returns the same message 526 to acknowledge that the connection has been terminated. When this occurs, the capture tool 502 is shutdown by the content provider client 100.

Playback Session

[0053] FIG. 6A is a data flow diagram showing the data flow architecture for playback of a multimedia data stream. A user is provided with a user client process 202, playback tool 204, and decoder plugins 206 as described above, which may be considered to be a single "playback tool" executing on the user client 200. The playback tool includes a playback form 602 to accept user selection of a channel. The channel selected is communicated to the processes described above with respect to FIG. 1A, which may be considered to be a single "broadcast system" 604 from the user's perspective.

[0054] The broadcast system 604 manages the delivery of radio control messages ("rc") and radio broadcast ("rb") data to the user client 200 through a Terminal Information Handler, as described above. There are four phases of playback sessions: Start Playback, Playback, Switching Channels, and Ending Playback.

[0055] FIG. 6B is a data flow diagram showing the data flow for starting a playback session. To establish a playback session, the user uses the playback tool to download a selection form from the host 300. In particular, the broadcast system 604 will have initialized the playback form 602 with the available channels. A channel is selected from the playback form 602, and the playback tool notifies the broadcast system 604 of the selected channel through a CHANNEL REQUEST command message 606.

[0056] Once the broadcast system 604 has been informed that the user client 200 has selected a particular radio channel for playback (i.e., the tuner process 316 receives an "rw" token with a channel name), the broadcast system 604 initiates the broadcast with a "rc" (radio control) START_CMD message 608. This initialization message is immediately followed by "rb" (radio broadcast) data messages 610. The data messages 612 preferably alternate header information and multimedia data. In the preferred embodiment, an identical header token is repeated with every data transmission so that users can join in the broadcast at any particular moment.

The final "rb" data packet 614 transmitted contains an "end-of-file" (EOF) identifier. In the preferred embodiment, if the playback content loops, the first data header will be transmitted again, and the broadcast will restart. Otherwise, a special "rc" STOP_PLAY_0 message (not shown) is sent to shut down that particular channel.

[0057] FIG. 6C is a data flow diagram showing the data flow for switching a playback channel. The basic process is similar to the process described for FIG. 6B. However, when a program is playing, the user can request a different program using the playback form 602. The playback tool notifies the broadcast system 604 of the new selected channel through a channel request message 606'. The broadcast system 604 then initiates the new broadcast with a "rc" (radio control) START_CMD message 608'. This initialization message is immediately followed by "rb" (radio broadcast) data messages 610' for the new channel. Whenever a new channel is started, the stream name and stream description is sent to the appropriate auxiliary tool 208 for display if provided by the playback form 602.

[0058] FIG. 6D is a data flow diagram showing the data flow for ending a playback session. The playback session is stopped by closing the open playback form 602 or by pressing the appropriate cancel control. When this happens, a TERMINATE SESSION command message 616 is sent to the broadcast system 604 to force a STOP_PLAY_0 618 message to be sent back to the user client 200. When this occurs, the playback tool is shut-down.

Computer Implementation

[0059] The invention may be implemented in hardware or software, or a combination of both. However, preferably, the invention is implemented by means of a computer program executing on one or more programmable systems each comprising at least one processor, a data storage system (including volatile and non-volatile memory and/or storage elements), at least one input device, and at least one output device. Program code is applied to input data to perform the functions described herein and generate output information. The output information is applied to one or more output devices, in known fashion.

[0060] Each such program may be implemented in any desired computer language (including machine, assembly, high level procedural, or object oriented programming languages) to communicate with a computer system. In any case, the language may be a compiled or interpreted language.

[0061] Each such computer program is preferably stored on a storage media or device (e.g., ROM or magnetic media) readable by a general or special purpose programmable computer, for configuring and operating the computer when the storage media or device is read by the computer to perform the procedures described herein. The inventive system may also be considered to

be implemented as a computer-readable storage medium, configured with a computer program, where the storage medium so configured causes a computer to operate in a specific and predefined manner to perform the functions described herein.

[0062] A number of embodiments of the present invention have been described. Nevertheless, it will be understood that various modifications may be made without departing from the spirit and scope of the invention. For example, while specific controls have been shown in FIGS. 2-4, other controls may be used to provide similar functionality. Further, while FIGS. 5A-5D and 6A-6D show preferred messaging and data flow protocols, other messaging and data flow protocols may be used to provide similar functionality. Accordingly, other embodiments are within the scope of the following claims.

Claims

1. A system for playback of live and pre-recorded multimedia data in real-time over a large scale communication network, including:
 - (a) a computer system having a plurality of terminal information handlers for managing general information flow to and from a plurality of users;
 - (b) an output process for assembling multiple multimedia data streams for distribution;
 - (c) at least one broadcast process, in communication with the output process, for distributing the assembled multiple multimedia data streams to each of the terminal information handlers; and
 - (d) a selector process, in communication with the terminal information handlers, for receiving a channel request from a user through an terminal information handler associated with the user, mapping the channel request to a corresponding one of the multiple multimedia data streams, and enabling transmission of the corresponding one multimedia data stream to the user through the associated terminal information handler.
2. The system of claim 1, further including an input process for receiving multimedia data streams for distribution.
3. The system of claim 1, further including at least one storage device for storing multimedia data streams for later transmission.
4. A method for playback of live and pre-recorded mul-

timedia data in real-time over a large scale communication network, including the steps of:

(a) providing a plurality of terminal information handlers for managing general information flow to and from a plurality of users; 5

(b) assembling multiple multimedia data streams for distribution; 10

(c) distributing the assembled multiple multimedia data streams to each of the terminal information handlers; and

(d) receiving a channel request from a user through an terminal information handler associated with the user, mapping the channel request to a corresponding one of the multiple multimedia data streams, and enabling transmission of the corresponding one multimedia data stream to the user through the associated terminal information handler. 15 20

5. The method of claim 4, further including the step of receiving multimedia data streams for distribution. 25

6. The method of claim 4, further including the step of storing multimedia data streams for later transmission. 30

35

40

45

50

55

9

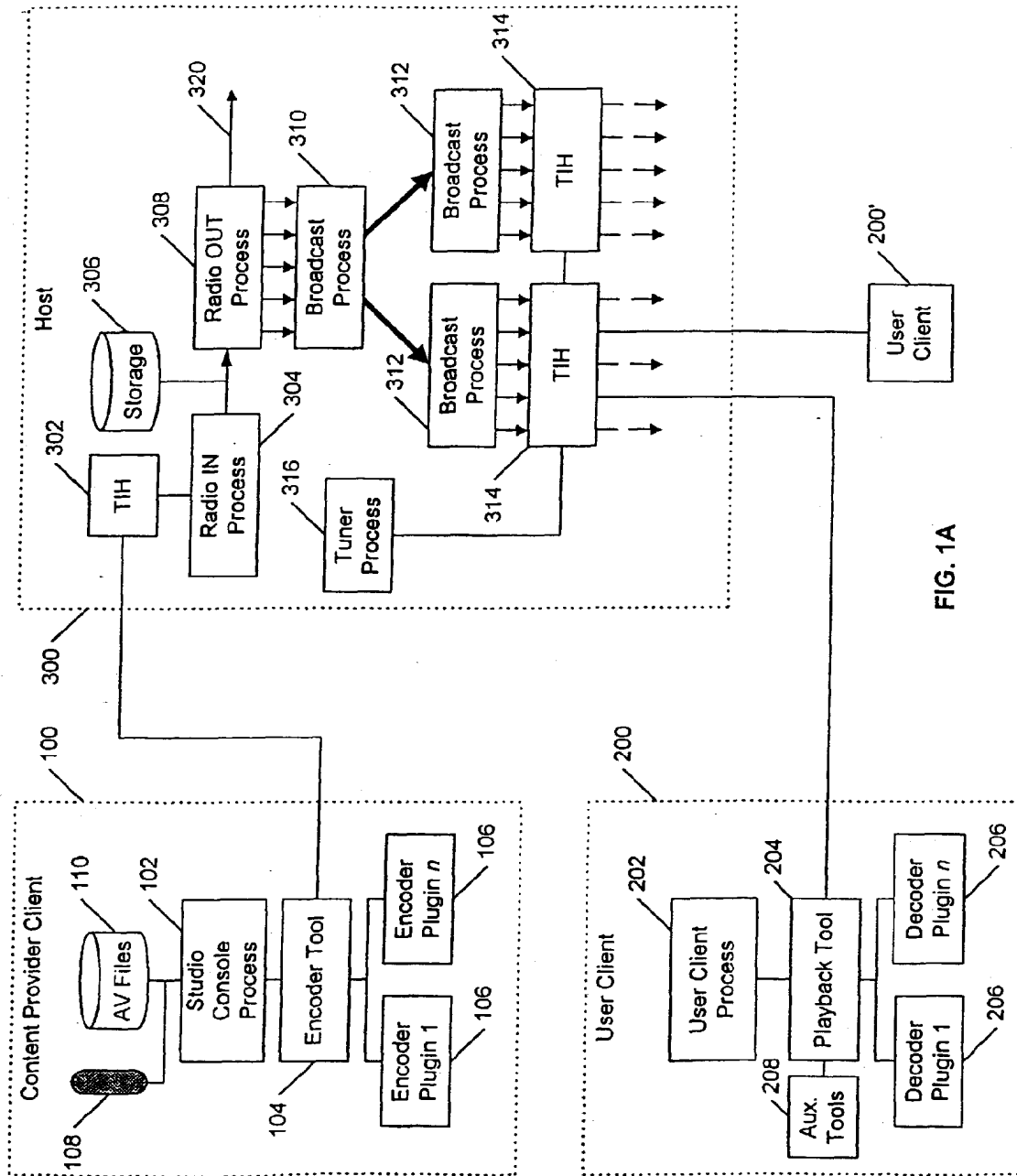
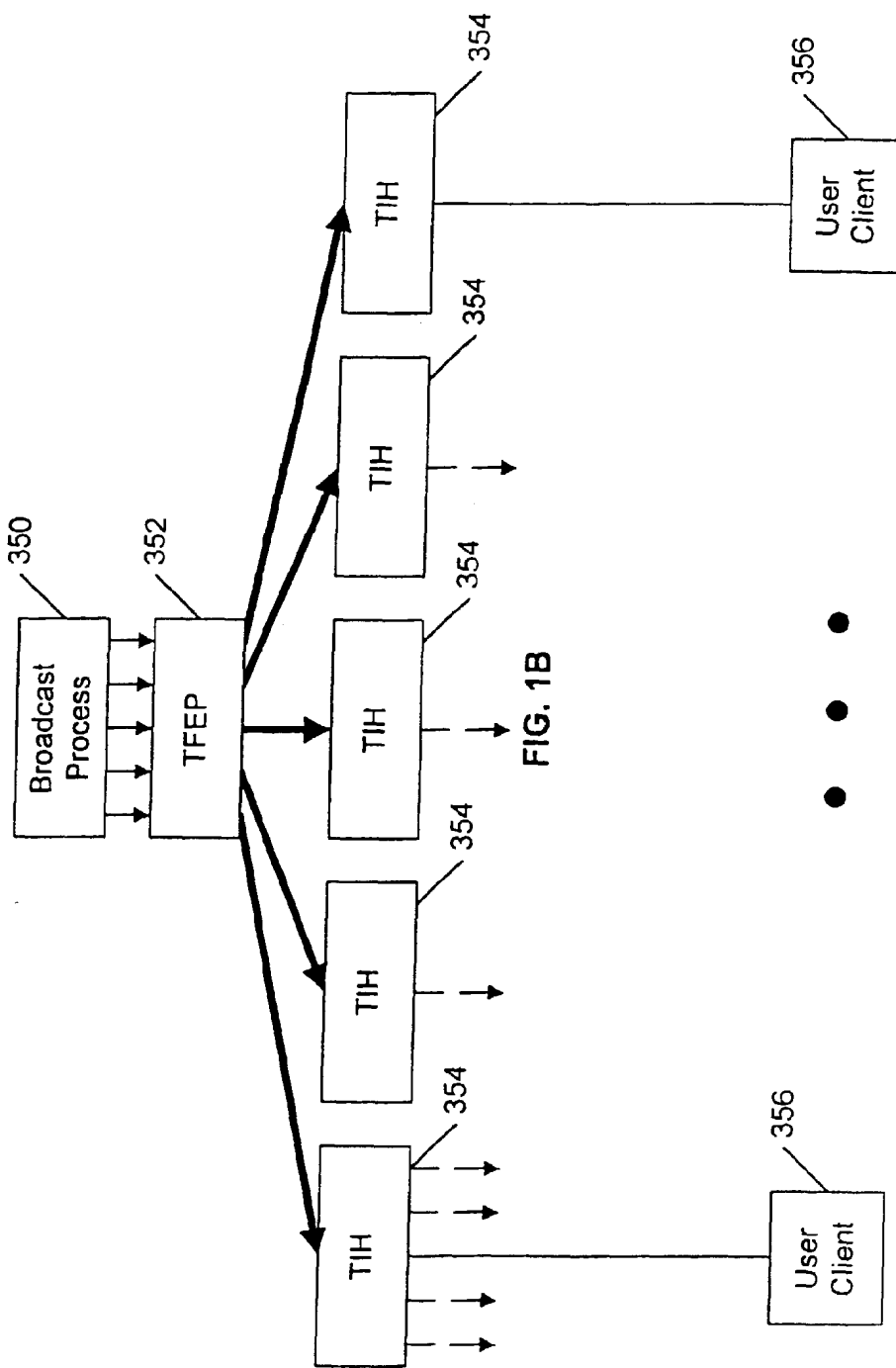

FIG. 1A



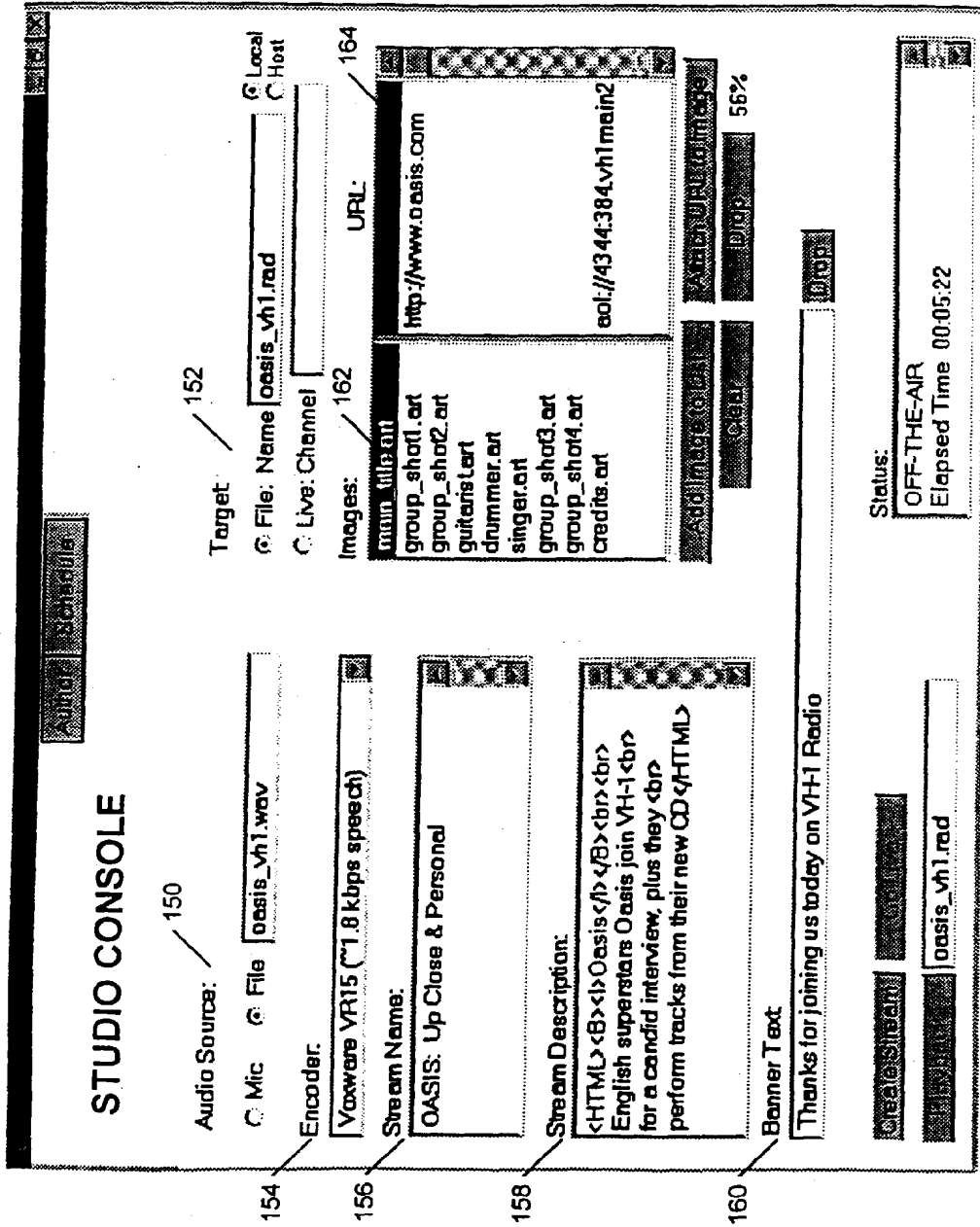

FIG. 2

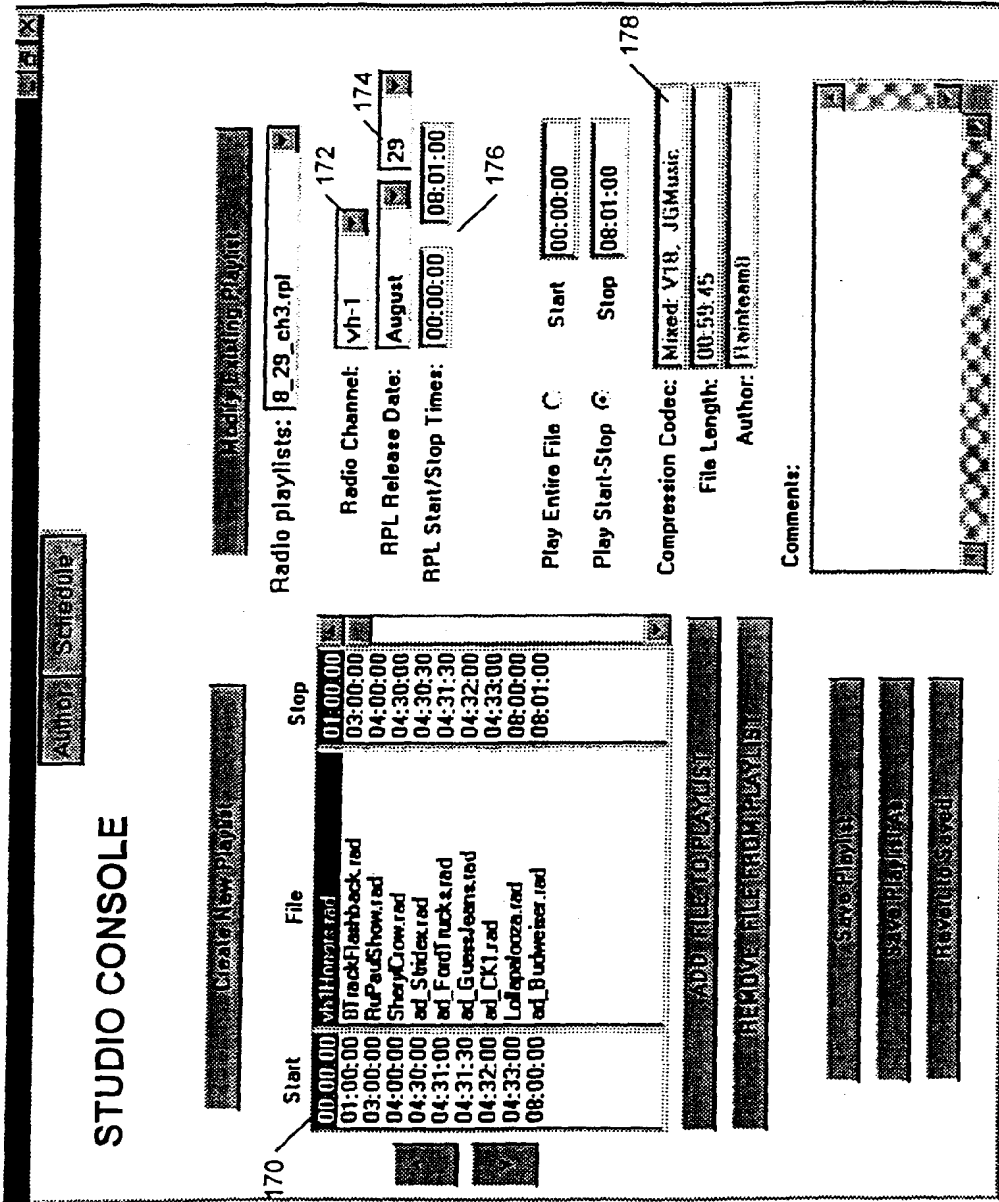

FIG. 3

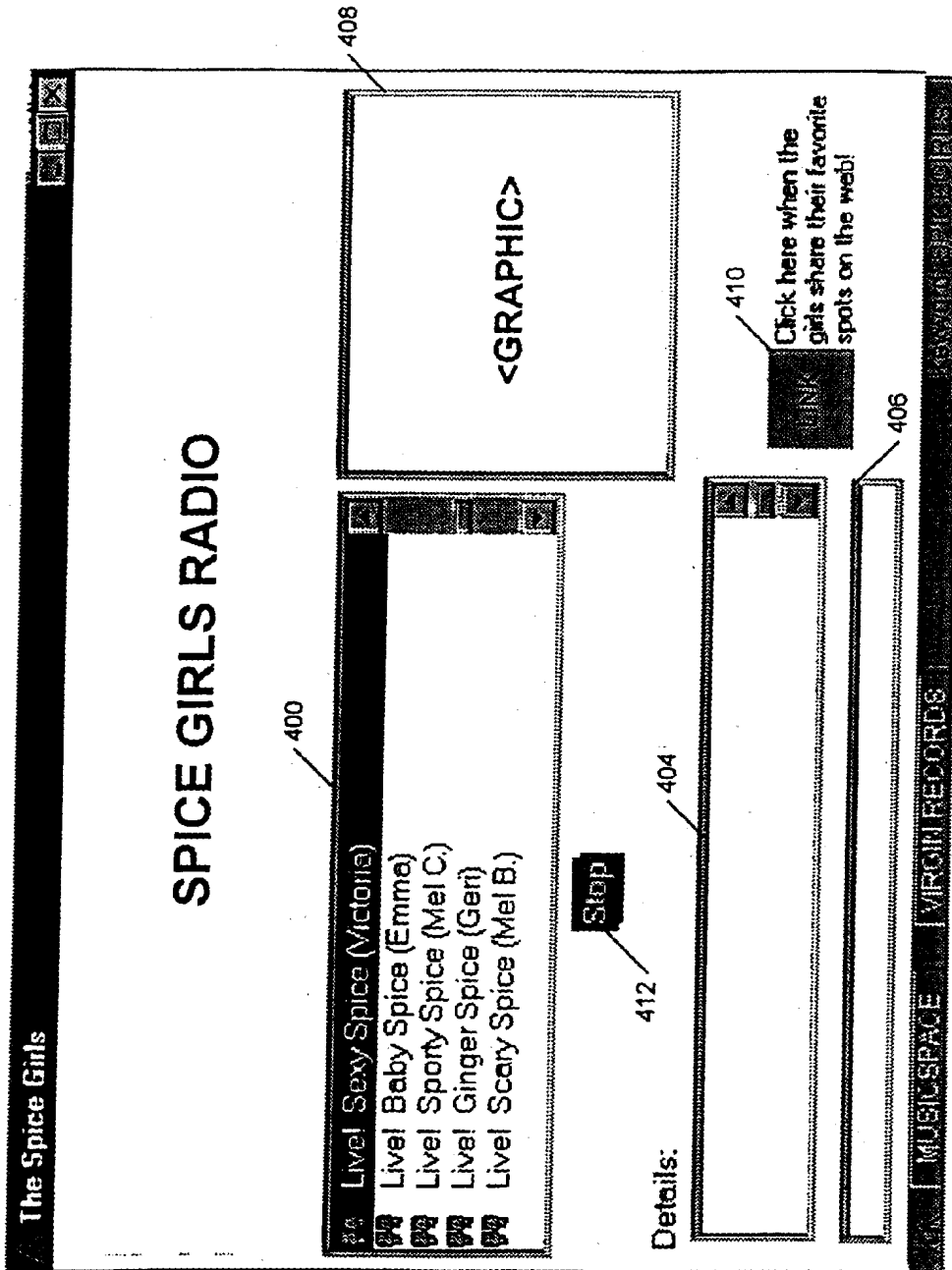

FIG. 4

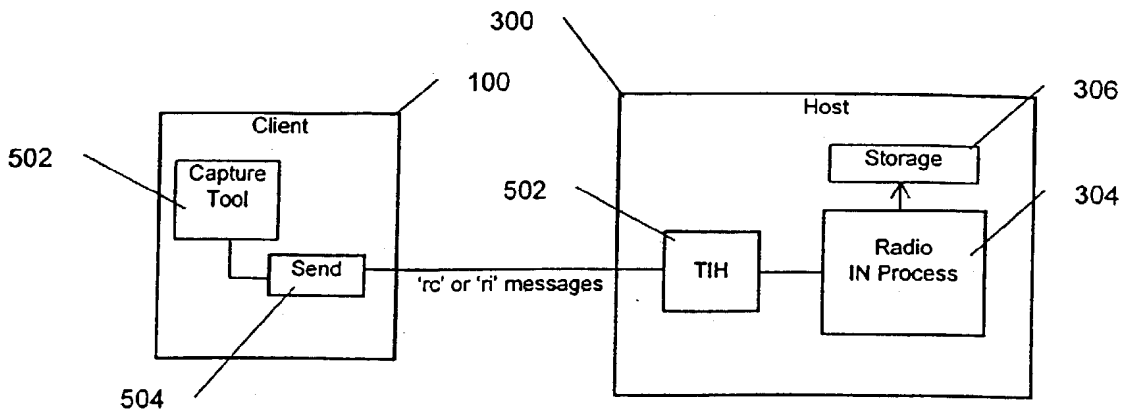

FIG. 5A

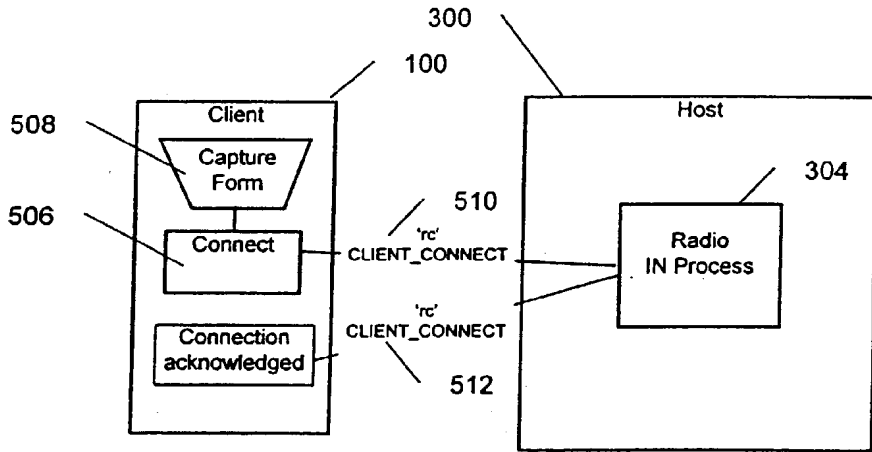

FIG. 5B

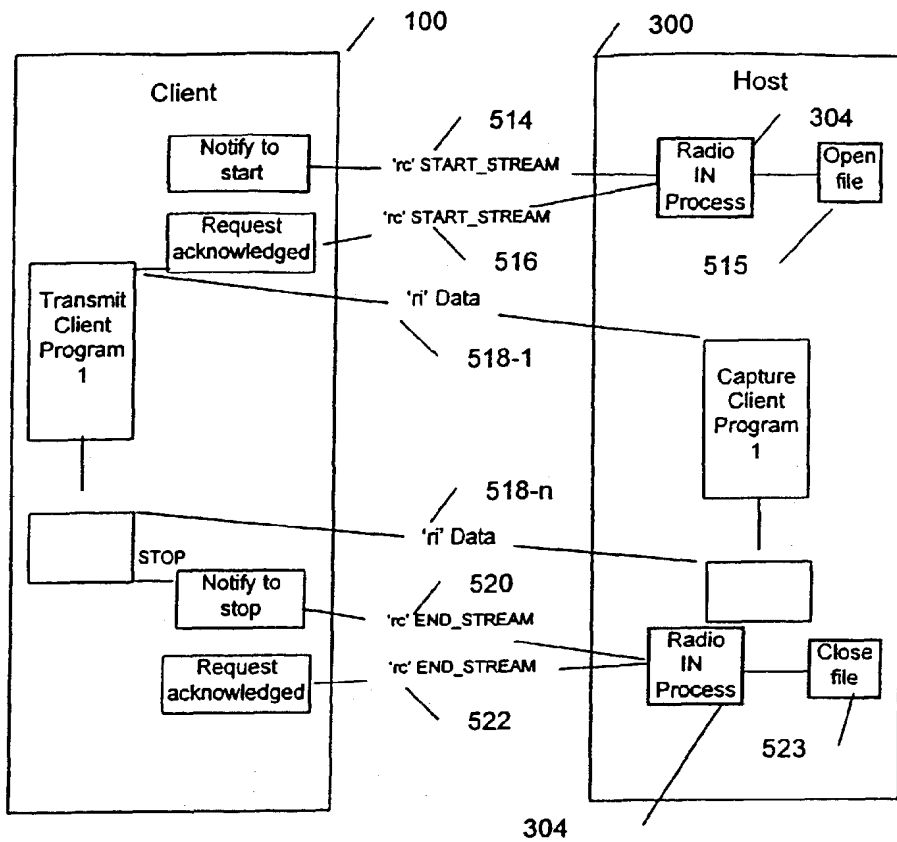

FIG. 5C

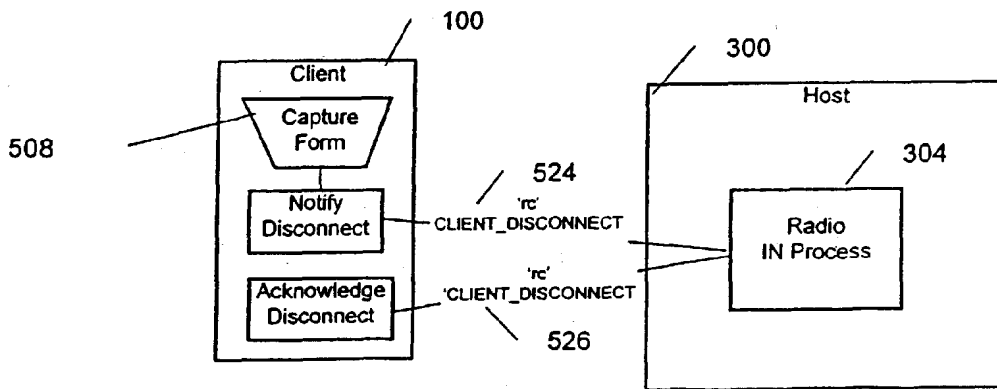

FIG. 5D

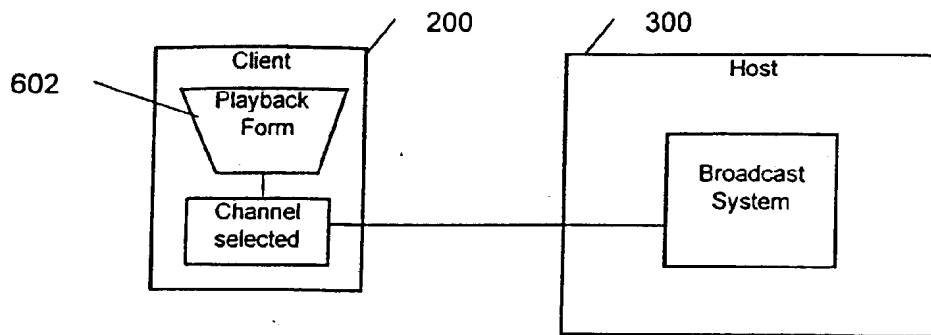

FIG. 6A

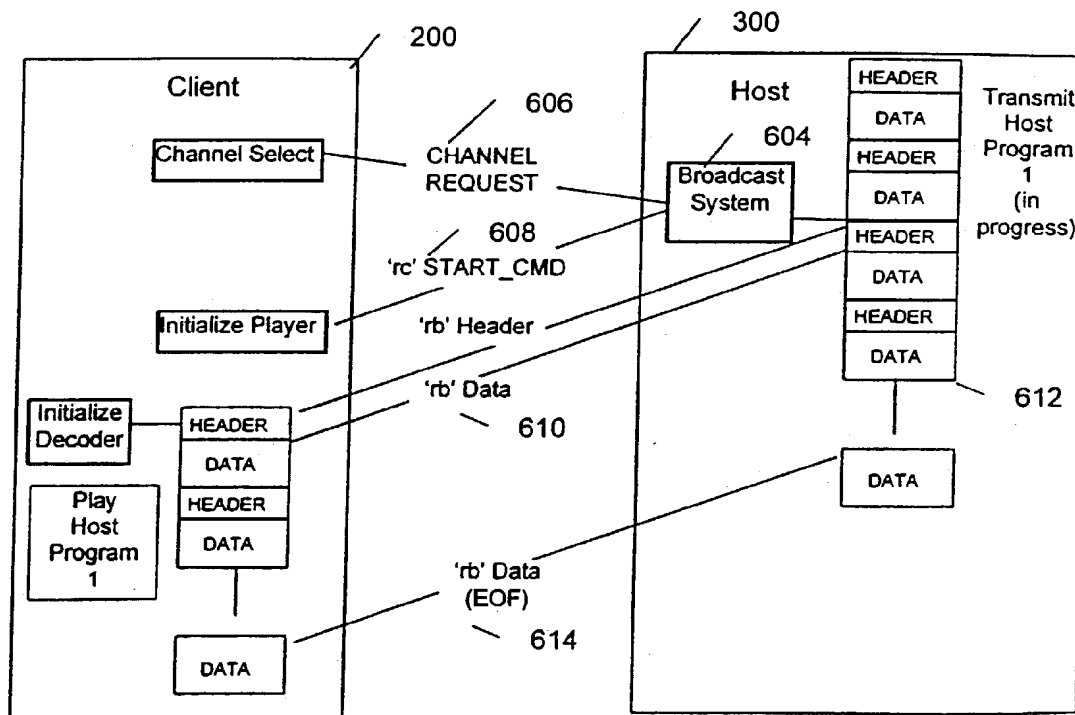

FIG. 6B

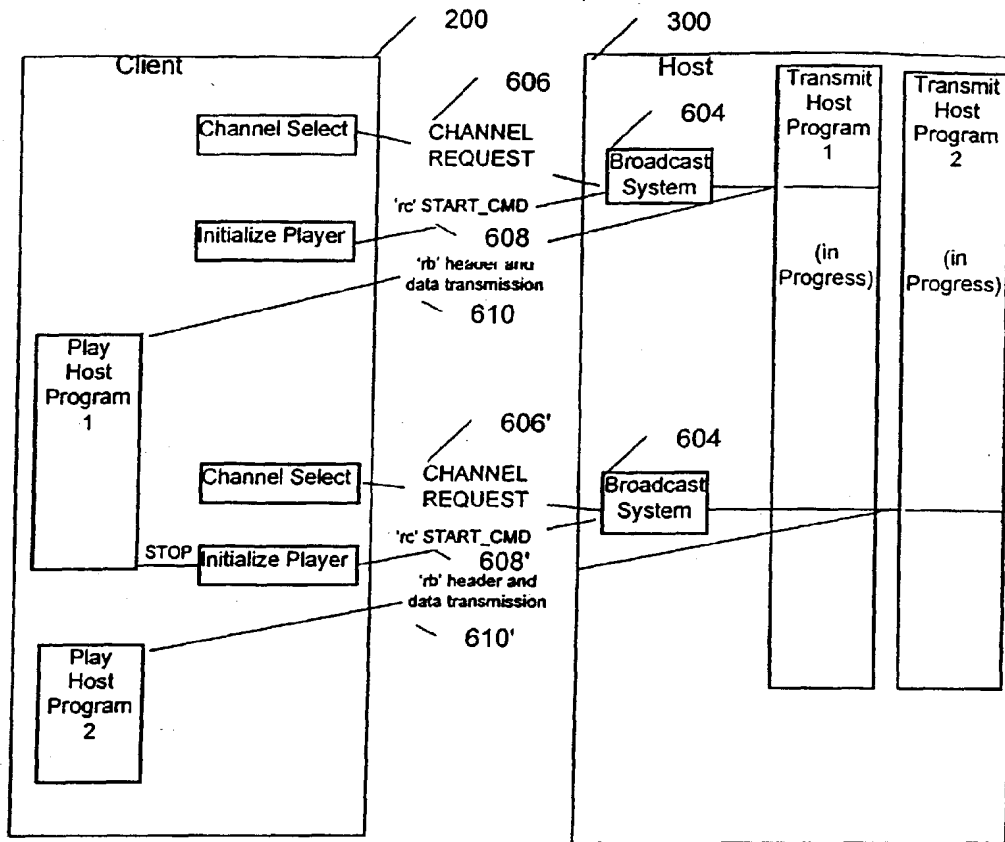

FIG. 6C

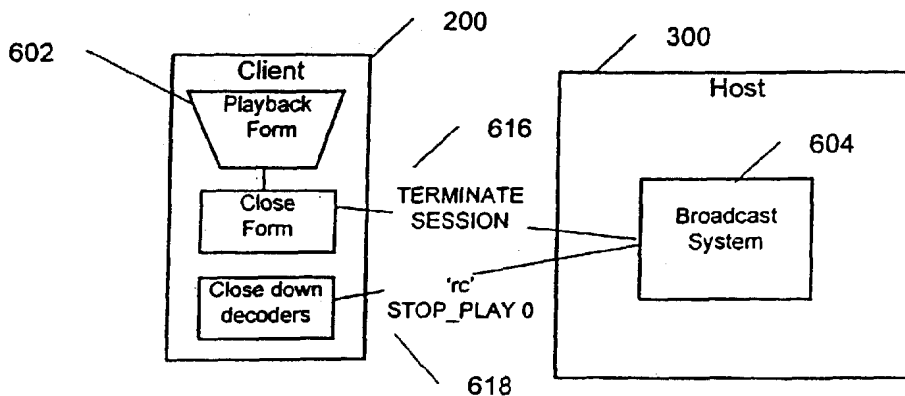

FIG. 6D



European Patent Office

EUROPEAN SEARCH REPORT

Application Number
EP 99 30 6950

DOCUMENTS CONSIDERED TO BE RELEVANT			
Category	Citation of document with indication, where appropriate, of relevant passages	Relevant to claim	CLASSIFICATION OF THE APPLICATION (Int.Cl.7)
X	US 5 778 187 A (BUTTERWORTH JAMES F ET AL) 7 July 1998 (1998-07-07) * abstract * * column 1, line 5 - line 15 * * column 3, line 4 - column 4, line 38 * * column 6, line 6 - line 21 * * column 17, line 4 - line 31 * * figure 18 *	1-6	H04L12/18 H04L29/06
X	US 5 557 724 A (KEMBEL JOHN ET AL) 17 September 1996 (1996-09-17) * abstract * * column 4, line 2 - line 60 * * column 8, line 1 - line 21 * * column 8, line 62 - column 9, line 6 * * column 10, line 53 - line 60 * * figures 1,3,15-18 *	1-6	
			TECHNICAL FIELDS SEARCHED (Int.Cl.7)
			H04L
The present search report has been drawn up for all claims			
Place of search THE HAGUE		Date of completion of the search 17 December 1999	Examiner Poggio, F
CATEGORY OF CITED DOCUMENTS		T : theory or principle underlying the invention E : earlier patent document, but published on, or after the filing date D : document cited in the application L : document cited for other reasons & : member of the same patent family, corresponding document	
X : particularly relevant if taken alone Y : particularly relevant if combined with another document of the same category A : technological background O : non-written disclosure P : intermediate document			

EPO FORM 1503 03.88 (P04-001)

**ANNEX TO THE EUROPEAN SEARCH REPORT
ON EUROPEAN PATENT APPLICATION NO.**

EP 99 30 6950

This annex lists the patent family members relating to the patent documents cited in the above-mentioned European search report. The members are as contained in the European Patent Office EDP file on The European Patent Office is in no way liable for these particulars which are merely given for the purpose of information.

17-12-1999

Patent document cited in search report	Publication date	Patent family member(s)	Publication date
US 5778187 A	07-07-1998	AU 3002097 A	26-11-1997
		WO 9742582 A	13-11-1997
		US 5983005 A	09-11-1999
US 5557724 A	17-09-1996	NONE	

EPO FORM P0459

For more details about this annex : see Official Journal of the European Patent Office, No. 12/82

Electronic Patent Application Fee Transmittal

Application Number:	12495190
Filing Date:	30-Jun-2009
Title of Invention:	Method For Content Delivery
First Named Inventor/Applicant Name:	Russell W. White
Filer:	Mark J. Rozman/Stephanie Petreas
Attorney Docket Number:	AFF.0004C7US

Filed as Large Entity

Utility under 35 USC 111(a) Filing Fees

Description	Fee Code	Quantity	Amount	Sub-Total in USD(\$)
Basic Filing:				
Pages:				
Claims:				
Miscellaneous-Filing:				
Petition:				
Patent-Appeals-and-Interference:				
Post-Allowance-and-Post-Issuance:				
Extension-of-Time:				

Description	Fee Code	Quantity	Amount	Sub-Total in USD(\$)
Miscellaneous:				
Submission- Information Disclosure Stmt	1806	1	180	180
Total in USD (\$)				180

Electronic Acknowledgement Receipt

EFS ID:	9313157
Application Number:	12495190
International Application Number:	
Confirmation Number:	2380
Title of Invention:	Method For Content Delivery
First Named Inventor/Applicant Name:	Russell W. White
Customer Number:	21906
Filer:	Mark J. Rozman/Stephanie Petreas
Filer Authorized By:	Mark J. Rozman
Attorney Docket Number:	AFF.0004C7US
Receipt Date:	26-JAN-2011
Filing Date:	30-JUN-2009
Time Stamp:	16:15:38
Application Type:	Utility under 35 USC 111(a)

Payment information:

Submitted with Payment	yes
Payment Type	Deposit Account
Payment was successfully received in RAM	\$180
RAM confirmation Number	3665
Deposit Account	201504
Authorized User	

The Director of the USPTO is hereby authorized to charge indicated fees and credit any overpayment as follows:

Charge any Additional Fees required under 37 C.F.R. Section 1.21 (Miscellaneous fees and charges)

File Listing:					
Document Number	Document Description	File Name	File Size(Bytes)/ Message Digest	Multi Part /.zip	Pages (if appl.)
1	Information Disclosure Statement (IDS) Filed (SB/08)	AFF004C7IDSAppleFtpIDS1of2 TOFILE.pdf	52151 4bc12dbd824b9dbf7a4f9acc5bf05183cdbc00e44	no	7
Warnings:					
Information:					
This is not an USPTO supplied IDS fillable form					
2	Foreign Reference	EP984584.pdf	575543 607000cf59afc8e9d0e741445470eab54302037b	no	20
Warnings:					
Information:					
3	NPL Documents	SonyPortableMinidiscMzR90.pdf	2696172 eaba2ba3cbfe2f50c557f74512c89a6ce534a22b	no	56
Warnings:					
The page size in the PDF is too large. The pages should be 8.5 x 11 or A4. If this PDF is submitted, the pages will be resized upon entry into the Image File Wrapper and may affect subsequent processing					
Information:					
4	NPL Documents	EmpegCarUserGuide1999.pdf	2714710 53e282b9bdd0bab8b3d3c1e9d573591892fdce18	no	19
Warnings:					
Information:					
5	NPL Documents	EmpegCarUserGuide2000.pdf	870439 d8b88ae6954626bd1fe6f7a22443703cfa50c09b	no	50
Warnings:					
Information:					
6	NPL Documents	MP3portablePlayerGoesElite.pdf	798095 7f431be2d55e77d0fca5afc97008a06c057a3405	no	3
Warnings:					
Information:					
7	NPL Documents	IEEE80211b.pdf	1118208 00666fe21bfba98936d95a3d795707f6fc38c6d3	no	96
Warnings:					
Information:					
8	NPL Documents	UnderhillAndGertler.pdf	5191454 07e685d2dbb355ea3e3fd680d9ff33d3ded3dde78	no	44

Warnings:					
Information:					
9	Fee Worksheet (PTO-875)	fee-info.pdf	30362	no	2
			71ea705713a167db876e9dc3a0b30ead9b0f9d76		
Warnings:					
Information:					
Total Files Size (in bytes):				14047134	
<p>This Acknowledgement Receipt evidences receipt on the noted date by the USPTO of the indicated documents, characterized by the applicant, and including page counts, where applicable. It serves as evidence of receipt similar to a Post Card, as described in MPEP 503.</p> <p><u>New Applications Under 35 U.S.C. 111</u> If a new application is being filed and the application includes the necessary components for a filing date (see 37 CFR 1.53(b)-(d) and MPEP 506), a Filing Receipt (37 CFR 1.54) will be issued in due course and the date shown on this Acknowledgement Receipt will establish the filing date of the application.</p> <p><u>National Stage of an International Application under 35 U.S.C. 371</u> If a timely submission to enter the national stage of an international application is compliant with the conditions of 35 U.S.C. 371 and other applicable requirements a Form PCT/DO/EO/903 indicating acceptance of the application as a national stage submission under 35 U.S.C. 371 will be issued in addition to the Filing Receipt, in due course.</p> <p><u>New International Application Filed with the USPTO as a Receiving Office</u> If a new international application is being filed and the international application includes the necessary components for an international filing date (see PCT Article 11 and MPEP 1810), a Notification of the International Application Number and of the International Filing Date (Form PCT/RO/105) will be issued in due course, subject to prescriptions concerning national security, and the date shown on this Acknowledgement Receipt will establish the international filing date of the application.</p>					

INFORMATION DISCLOSURE STATEMENT BY APPLICANT (Not for submission under 37 CFR 1.99)	Application Number		12495190	
	Filing Date		2009-06-30	
	First Named Inventor	Russell W. White, et al.		
	Art Unit		2617	
	Examiner Name	Erika A. Gary		
	Attorney Docket Number		AFF.004C7US	

U.S.PATENTS						
Examiner Initial*	Cite No	Patent Number	Kind Code ¹	Issue Date	Name of Patentee or Applicant of cited Document	Pages,Columns,Lines where Relevant Passages or Relevant Figures Appear
	1	6248946		2001-06-19	Dwek	
	2	5572442		1996-11-05	Schulhof	
	3	6338044		2002-01-08	Cook	
	4	5797089		1998-08-18	Nguyen	
	5	6330247		2001-12-11	Chang	
	6	5737706		1998-04-07	Seazholtz	

If you wish to add additional U.S. Patent citation information please click the Add button.

U.S.PATENT APPLICATION PUBLICATIONS						
Examiner Initial*	Cite No	Publication Number	Kind Code ¹	Publication Date	Name of Patentee or Applicant of cited Document	Pages,Columns,Lines where Relevant Passages or Relevant Figures Appear

INFORMATION DISCLOSURE STATEMENT BY APPLICANT (Not for submission under 37 CFR 1.99)	Application Number	12495190
	Filing Date	2009-06-30
	First Named Inventor	Russell W. White, et al.
	Art Unit	2617
	Examiner Name	Erika A. Gary
	Attorney Docket Number	AFF.004C7US

1	20010042107		2001-11-15	Palm	
---	-------------	--	------------	------	--

If you wish to add additional U.S. Published Application citation information please click the Add button.

FOREIGN PATENT DOCUMENTS

Examiner Initial*	Cite No	Foreign Document Number ³	Country Code ² i	Kind Code ⁴	Publication Date	Name of Patentee or Applicant of cited Document	Pages, Columns, Lines where Relevant Passages or Relevant Figures Appear	T ⁵
	1	EP 984584	EP		2000-08-03	Lippert		<input type="checkbox"/>

If you wish to add additional Foreign Patent Document citation information please click the Add button

NON-PATENT LITERATURE DOCUMENTS

Examiner Initials*	Cite No	Include name of the author (in CAPITAL LETTERS), title of the article (when appropriate), title of the item (book, magazine, journal, serial, symposium, catalog, etc), date, pages(s), volume-issue number(s), publisher, city and/or country where published.	T ⁵
	1	Sony Corporation, Sony Portable MiniDisc Recorder MZ-R90/MZ-R91 Operating Instructions, Doc. No. 3-867-571-22(1), 1999, pp. 1-55.	<input type="checkbox"/>
	2	Empeg Car User Guide, 1999, pp. 1-19.	<input type="checkbox"/>
	3	Empeg Car User Guide (2000) pp. 1-48	<input type="checkbox"/>
	4	Crowe, Mike. Empeg Car Beta 10a, March 25, 2000, 3 pages.	<input type="checkbox"/>
	5	Emplode Help, (date unknown, contended by defendant Apple Corp. to be prior art under one or more of 35 U.S.C. 102 (a), (b), (f) and (g)) 25 pages.	<input type="checkbox"/>

**INFORMATION DISCLOSURE
STATEMENT BY APPLICANT**
(Not for submission under 37 CFR 1.99)

Application Number	12495190
Filing Date	2009-06-30
First Named Inventor	Russell W. White, et al.
Art Unit	2617
Examiner Name	Erika A. Gary
Attorney Docket Number	AFF.004C7US

6	"MP3 Portable Player Goes Elite" The Mac Observer, Nov. 17, 1999, 3 pages.	<input type="checkbox"/>
7	"MP3 in Your Car Has Arrived" (date unknown, contended by defendant Apple Corp. to be prior art under one or more of 35 U.S.C. 102 (a), (b), (f) and (g)) 1 page.	<input type="checkbox"/>
8	Photos from Comdex Fall 1999, Nov. 1999, 9 pages.	<input type="checkbox"/>
9	Photos from LinuxWorld Expo, Winter 1999, Mar. 1-4, 1999, 22 pages.	<input type="checkbox"/>
10	Craig Knudsen, "MP3 Linux Players," Linux Journal, Jul. 1, 1999, pp. 1-3.	<input type="checkbox"/>
11	riocar.org – Empeg Car History, (date unknown, contended by defendant Apple Corp. to be prior art under one or more of 35 U.S.C. 102 (a), (b), (f) and (g)), 4 pages.	<input type="checkbox"/>
12	"Visteon: For Your Listening Pleasure - Any Music, Any Time, Anywhere," Presswire, Jan. 5, 2000, 1 page.	<input type="checkbox"/>
13	Photographs in email to Hugo Fiennes, Sept. 22, 1999, 4 pages.	<input type="checkbox"/>
14	HP Jornada 420 User's Manual, 1999, pp. 1-142.	<input type="checkbox"/>
15	IEEE Standard 802.11b, 1999 Edition (Wireless LAN Medium Access Control and Physical Layer Specifications: Higher-Speed Physical Layer Extension in the 2.4 GHz Band) Sep. 16, 1999, 96 pages.	<input type="checkbox"/>
16	RealPlayer Plus G2 Manual, 1999, pp. 1-81.	<input type="checkbox"/>

**INFORMATION DISCLOSURE
STATEMENT BY APPLICANT**

(Not for submission under 37 CFR 1.99)

Application Number	12495190
Filing Date	2009-06-30
First Named Inventor	Russell W. White, et al.
Art Unit	2617
Examiner Name	Erika A. Gary
Attorney Docket Number	AFF.004C7US

17	IEEE Standard 802.11a, 1999 Edition (Wireless LAN Medium Access Control and Physical Layer Specifications: High-Speed Physical Layer in the 5GHz Band), 1999, 91 pages.	<input type="checkbox"/>
18	Rod Underhill & Nat Gertler, "The Complete Idiot's Guide to MP3: Music on the Internet," 1999, 44 pages.	<input type="checkbox"/>
19	Bill Mann, "I Want My MP3! How to Download, Rip, & Play Digital Music," McGraw-Hill 2000, 175 pages.	<input type="checkbox"/>
20	IEEE Standard 802.11, 1997 Edition (Wireless LAN Medium Access Control and Physical Layer Specifications), 1997, pp. 1-145.	<input type="checkbox"/>
21	IEEE Standard 802.3ab, 1999 Edition (802.3 Physical Layer Specification for 1000 Mb/s Operation on Four Pairs of Category 5 or Better Balanced Twisted Pair Cable (1000BASE-T) 1999, 140 pages.	<input type="checkbox"/>
22	IBM Wireless Modem for Cellular/CDPD - Quick Reference, Oct. 1995, pp. 1-20.	<input type="checkbox"/>
23	Creative Sound Blaster Live! Platinum product, documentation, and software: Creative Technology Ltd., Creative Sound Blaster Live! Platinum Getting Started, Sept. 1999, 93 pages.	<input type="checkbox"/>
24	psa[play Getting Started Guide, (date unknown, contended by defendant Apple Corp. to be prior art under one or more of 35 U.S.C. 102 (a), (b), (f) and (g)), pp. 1-16.	<input type="checkbox"/>
25	psa[play Getting Started Guide, 2000, pp. 1-16.	<input type="checkbox"/>
26	Rio 800 User Guide, 2001, pp. 1-38.	<input type="checkbox"/>
27	Rio 800 Digital Audio Player—Getting Started, 2000, pp. 1-19.	<input type="checkbox"/>

INFORMATION DISCLOSURE STATEMENT BY APPLICANT (Not for submission under 37 CFR 1.99)	Application Number		12495190
	Filing Date		2009-06-30
	First Named Inventor	Russell W. White, et al.	
	Art Unit		2617
	Examiner Name	Erika A. Gary	
	Attorney Docket Number		AFF.004C7US

28	Rio 600 Getting Started Guide, 2001, pp. 1-169.	<input type="checkbox"/>
29	Rio 600 User Guide, March 2001, pp 1-38.	<input type="checkbox"/>

If you wish to add additional non-patent literature document citation information please click the Add button

EXAMINER SIGNATURE

Examiner Signature		Date Considered	
--------------------	--	-----------------	--

*EXAMINER: Initial if reference considered, whether or not citation is in conformance with MPEP 609. Draw line through a citation if not in conformance and not considered. Include copy of this form with next communication to applicant.

¹ See Kind Codes of USPTO Patent Documents at www.USPTO.GOV or MPEP 901.04. ² Enter office that issued the document, by the two-letter code (WIPO Standard ST.3). ³ For Japanese patent documents, the indication of the year of the reign of the Emperor must precede the serial number of the patent document. ⁴ Kind of document by the appropriate symbols as indicated on the document under WIPO Standard ST.16 if possible. ⁵ Applicant is to place a check mark here if English language translation is attached.

INFORMATION DISCLOSURE STATEMENT BY APPLICANT (Not for submission under 37 CFR 1.99)	Application Number	12495190
	Filing Date	2009-06-30
	First Named Inventor	Russell W. White, et al.
	Art Unit	2617
	Examiner Name	Erika A. Gary
	Attorney Docket Number	AFF.004C7US

CERTIFICATION STATEMENT

Please see 37 CFR 1.97 and 1.98 to make the appropriate selection(s):

That each item of information contained in the information disclosure statement was first cited in any communication from a foreign patent office in a counterpart foreign application not more than three months prior to the filing of the information disclosure statement. See 37 CFR 1.97(e)(1).

OR

That no item of information contained in the information disclosure statement was cited in a communication from a foreign patent office in a counterpart foreign application, and, to the knowledge of the person signing the certification after making reasonable inquiry, no item of information contained in the information disclosure statement was known to any individual designated in 37 CFR 1.56(c) more than three months prior to the filing of the information disclosure statement. See 37 CFR 1.97(e)(2).

- See attached certification statement.
- Fee set forth in 37 CFR 1.17 (p) has been submitted herewith.
- None

SIGNATURE

A signature of the applicant or representative is required in accordance with CFR 1.33, 10.18. Please see CFR 1.4(d) for the form of the signature.

Signature	/Mark J. Rozman/	Date (YYYY-MM-DD)	2011-01-26
Name/Print	Mark J. Rozman	Registration Number	42117

This collection of information is required by 37 CFR 1.97 and 1.98. The information is required to obtain or retain a benefit by the public which is to file (and by the USPTO to process) an application. Confidentiality is governed by 35 U.S.C. 122 and 37 CFR 1.14. This collection is estimated to take 1 hour to complete, including gathering, preparing and submitting the completed application form to the USPTO. Time will vary depending upon the individual case. Any comments on the amount of time you require to complete this form and/or suggestions for reducing this burden, should be sent to the Chief Information Officer, U.S. Patent and Trademark Office, U.S. Department of Commerce, P.O. Box 1450, Alexandria, VA 22313-1450. **DO NOT SEND FEES OR COMPLETED FORMS TO THIS ADDRESS. SEND TO: Commissioner for Patents, P.O. Box 1450, Alexandria, VA 22313-1450.**

Privacy Act Statement

The Privacy Act of 1974 (P.L. 93-579) requires that you be given certain information in connection with your submission of the attached form related to a patent application or patent. Accordingly, pursuant to the requirements of the Act, please be advised that: (1) the general authority for the collection of this information is 35 U.S.C. 2(b)(2); (2) furnishing of the information solicited is voluntary; and (3) the principal purpose for which the information is used by the U.S. Patent and Trademark Office is to process and/or examine your submission related to a patent application or patent. If you do not furnish the requested information, the U.S. Patent and Trademark Office may not be able to process and/or examine your submission, which may result in termination of proceedings or abandonment of the application or expiration of the patent.

The information provided by you in this form will be subject to the following routine uses:

1. The information on this form will be treated confidentially to the extent allowed under the Freedom of Information Act (5 U.S.C. 552) and the Privacy Act (5 U.S.C. 552a). Records from this system of records may be disclosed to the Department of Justice to determine whether the Freedom of Information Act requires disclosure of these records.
2. A record from this system of records may be disclosed, as a routine use, in the course of presenting evidence to a court, magistrate, or administrative tribunal, including disclosures to opposing counsel in the course of settlement negotiations.
3. A record in this system of records may be disclosed, as a routine use, to a Member of Congress submitting a request involving an individual, to whom the record pertains, when the individual has requested assistance from the Member with respect to the subject matter of the record.
4. A record in this system of records may be disclosed, as a routine use, to a contractor of the Agency having need for the information in order to perform a contract. Recipients of information shall be required to comply with the requirements of the Privacy Act of 1974, as amended, pursuant to 5 U.S.C. 552a(m).
5. A record related to an International Application filed under the Patent Cooperation Treaty in this system of records may be disclosed, as a routine use, to the International Bureau of the World Intellectual Property Organization, pursuant to the Patent Cooperation Treaty.
6. A record in this system of records may be disclosed, as a routine use, to another federal agency for purposes of National Security review (35 U.S.C. 181) and for review pursuant to the Atomic Energy Act (42 U.S.C. 218(c)).
7. A record from this system of records may be disclosed, as a routine use, to the Administrator, General Services, or his/her designee, during an inspection of records conducted by GSA as part of that agency's responsibility to recommend improvements in records management practices and programs, under authority of 44 U.S.C. 2904 and 2906. Such disclosure shall be made in accordance with the GSA regulations governing inspection of records for this purpose, and any other relevant (i.e., GSA or Commerce) directive. Such disclosure shall not be used to make determinations about individuals.
8. A record from this system of records may be disclosed, as a routine use, to the public after either publication of the application pursuant to 35 U.S.C. 122(b) or issuance of a patent pursuant to 35 U.S.C. 151. Further, a record may be disclosed, subject to the limitations of 37 CFR 1.14, as a routine use, to the public if the record was filed in an application which became abandoned or in which the proceedings were terminated and which application is referenced by either a published application, an application open to public inspections or an issued patent.
9. A record from this system of records may be disclosed, as a routine use, to a Federal, State, or local law enforcement agency, if the USPTO becomes aware of a violation or potential violation of law or regulation.

Electronic Acknowledgement Receipt

EFS ID:	9313339
Application Number:	12495190
International Application Number:	
Confirmation Number:	2380
Title of Invention:	Method For Content Delivery
First Named Inventor/Applicant Name:	Russell W. White
Customer Number:	21906
Filer:	Mark J. Rozman/Stephanie Petreas
Filer Authorized By:	Mark J. Rozman
Attorney Docket Number:	AFF.0004C7US
Receipt Date:	26-JAN-2011
Filing Date:	30-JUN-2009
Time Stamp:	16:25:04
Application Type:	Utility under 35 USC 111(a)

Payment information:

Submitted with Payment	no
------------------------	----

File Listing:

Document Number	Document Description	File Name	File Size(Bytes)/ Message Digest	Multi Part /.zip	Pages (if appl.)
1	Information Disclosure Statement (IDS) Filed (SB/08)	AFF004C7IDSAppleFtpIDS1of2 TOFILE.pdf	52151 <small>4bc12dbd824b9dbf7a4f9acc5bf05183cdb 00e44</small>	no	7

Warnings:

Information:

This is not an USPTO supplied IDS fillable form					
2	NPL Documents	IEEEstandard80211.pdf	25358316 0ce6b48248e6fb416821bac7f0dbb95a8aa7754d2	no	459
Warnings:					
Information:					
3	NPL Documents	IBMwirelessModemQuickRef.pdf	800536 4da738e7259b8cfe85a738989cdfed6c4546e7d	no	26
Warnings:					
The page size in the PDF is too large. The pages should be 8.5 x 11 or A4. If this PDF is submitted, the pages will be resized upon entry into the Image File Wrapper and may affect subsequent processing					
Information:					
4	NPL Documents	psaplayGettingStartedGuide.pdf	481123 c7765ae3787cb4cf78ebd81833ac5d342ba52dd	no	10
Warnings:					
The page size in the PDF is too large. The pages should be 8.5 x 11 or A4. If this PDF is submitted, the pages will be resized upon entry into the Image File Wrapper and may affect subsequent processing					
Information:					
5	NPL Documents	Rio800usersGuide.pdf	1569512 c2e235df093b7f8a55f956e25ac8a5d000f6cdd6	no	38
Warnings:					
Information:					
6	NPL Documents	Rio600gettingStartedGuide.pdf	1400117 d029ec9d1ee29ebdddb6bae3952eae78c7dbce8c	no	178
Warnings:					
Information:					
7	NPL Documents	Rio600usersGuide.pdf	2245478 1d8c02d05f268c983ef6b1f07d2500ca369d3dfa	no	38
Warnings:					
Information:					
Total Files Size (in bytes):			31907233		

This Acknowledgement Receipt evidences receipt on the noted date by the USPTO of the indicated documents, characterized by the applicant, and including page counts, where applicable. It serves as evidence of receipt similar to a Post Card, as described in MPEP 503.

New Applications Under 35 U.S.C. 111

If a new application is being filed and the application includes the necessary components for a filing date (see 37 CFR 1.53(b)-(d) and MPEP 506), a Filing Receipt (37 CFR 1.54) will be issued in due course and the date shown on this Acknowledgement Receipt will establish the filing date of the application.

National Stage of an International Application under 35 U.S.C. 371

If a timely submission to enter the national stage of an international application is compliant with the conditions of 35 U.S.C. 371 and other applicable requirements a Form PCT/DO/EO/903 indicating acceptance of the application as a national stage submission under 35 U.S.C. 371 will be issued in addition to the Filing Receipt, in due course.

New International Application Filed with the USPTO as a Receiving Office

If a new international application is being filed and the international application includes the necessary components for an international filing date (see PCT Article 11 and MPEP 1810), a Notification of the International Application Number and of the International Filing Date (Form PCT/RO/105) will be issued in due course, subject to prescriptions concerning national security, and the date shown on this Acknowledgement Receipt will establish the international filing date of the application.

INFORMATION DISCLOSURE STATEMENT BY APPLICANT (Not for submission under 37 CFR 1.99)	Application Number		12495190	
	Filing Date		2009-06-30	
	First Named Inventor	Russell W. White, et al.		
	Art Unit		2617	
	Examiner Name	Erika A. Gary		
	Attorney Docket Number		AFF.004C7US	

U.S.PATENTS						
Examiner Initial*	Cite No	Patent Number	Kind Code ¹	Issue Date	Name of Patentee or Applicant of cited Document	Pages,Columns,Lines where Relevant Passages or Relevant Figures Appear
	1	6248946		2001-06-19	Dwek	
	2	5572442		1996-11-05	Schulhof	
	3	6338044		2002-01-08	Cook	
	4	5797089		1998-08-18	Nguyen	
	5	6330247		2001-12-11	Chang	
	6	5737706		1998-04-07	Seazholtz	

If you wish to add additional U.S. Patent citation information please click the Add button.

U.S.PATENT APPLICATION PUBLICATIONS						
Examiner Initial*	Cite No	Publication Number	Kind Code ¹	Publication Date	Name of Patentee or Applicant of cited Document	Pages,Columns,Lines where Relevant Passages or Relevant Figures Appear

INFORMATION DISCLOSURE STATEMENT BY APPLICANT (Not for submission under 37 CFR 1.99)	Application Number	12495190
	Filing Date	2009-06-30
	First Named Inventor	Russell W. White, et al.
	Art Unit	2617
	Examiner Name	Erika A. Gary
	Attorney Docket Number	AFF.004C7US

1	20010042107		2001-11-15	Palm	
---	-------------	--	------------	------	--

If you wish to add additional U.S. Published Application citation information please click the Add button.

FOREIGN PATENT DOCUMENTS

Examiner Initial*	Cite No	Foreign Document Number ³	Country Code ² i	Kind Code ⁴	Publication Date	Name of Patentee or Applicant of cited Document	Pages, Columns, Lines where Relevant Passages or Relevant Figures Appear	T ⁵
	1	EP 984584	EP		2000-08-03	Lippert		<input type="checkbox"/>

If you wish to add additional Foreign Patent Document citation information please click the Add button

NON-PATENT LITERATURE DOCUMENTS

Examiner Initials*	Cite No	Include name of the author (in CAPITAL LETTERS), title of the article (when appropriate), title of the item (book, magazine, journal, serial, symposium, catalog, etc), date, pages(s), volume-issue number(s), publisher, city and/or country where published.	T ⁵
	1	Sony Corporation, Sony Portable MiniDisc Recorder MZ-R90/MZ-R91 Operating Instructions, Doc. No. 3-867-571-22(1), 1999, pp. 1-55.	<input type="checkbox"/>
	2	Empeg Car User Guide, 1999, pp. 1-19.	<input type="checkbox"/>
	3	Empeg Car User Guide (2000) pp. 1-48	<input type="checkbox"/>
	4	Crowe, Mike. Empeg Car Beta 10a, March 25, 2000, 3 pages.	<input type="checkbox"/>
	5	Emplode Help, (date unknown, contended by defendant Apple Corp. to be prior art under one or more of 35 U.S.C. 102 (a), (b), (f) and (g)) 25 pages.	<input type="checkbox"/>

**INFORMATION DISCLOSURE
STATEMENT BY APPLICANT**
(Not for submission under 37 CFR 1.99)

Application Number	12495190
Filing Date	2009-06-30
First Named Inventor	Russell W. White, et al.
Art Unit	2617
Examiner Name	Erika A. Gary
Attorney Docket Number	AFF.004C7US

6	"MP3 Portable Player Goes Elite" The Mac Observer, Nov. 17, 1999, 3 pages.	<input type="checkbox"/>
7	"MP3 in Your Car Has Arrived" (date unknown, contended by defendant Apple Corp. to be prior art under one or more of 35 U.S.C. 102 (a), (b), (f) and (g)) 1 page.	<input type="checkbox"/>
8	Photos from Comdex Fall 1999, Nov. 1999, 9 pages.	<input type="checkbox"/>
9	Photos from LinuxWorld Expo, Winter 1999, Mar. 1-4, 1999, 22 pages.	<input type="checkbox"/>
10	Craig Knudsen, "MP3 Linux Players," Linux Journal, Jul. 1, 1999, pp. 1-3.	<input type="checkbox"/>
11	riocar.org – Empeg Car History, (date unknown, contended by defendant Apple Corp. to be prior art under one or more of 35 U.S.C. 102 (a), (b), (f) and (g)), 4 pages.	<input type="checkbox"/>
12	"Visteon: For Your Listening Pleasure - Any Music, Any Time, Anywhere," Presswire, Jan. 5, 2000, 1 page.	<input type="checkbox"/>
13	Photographs in email to Hugo Fiennes, Sept. 22, 1999, 4 pages.	<input type="checkbox"/>
14	HP Jornada 420 User's Manual, 1999, pp. 1-142.	<input type="checkbox"/>
15	IEEE Standard 802.11b, 1999 Edition (Wireless LAN Medium Access Control and Physical Layer Specifications: Higher-Speed Physical Layer Extension in the 2.4 GHz Band) Sep. 16, 1999, 96 pages.	<input type="checkbox"/>
16	RealPlayer Plus G2 Manual, 1999, pp. 1-81.	<input type="checkbox"/>

**INFORMATION DISCLOSURE
STATEMENT BY APPLICANT**
(Not for submission under 37 CFR 1.99)

Application Number		12495190
Filing Date		2009-06-30
First Named Inventor	Russell W. White, et al.	
Art Unit		2617
Examiner Name	Erika A. Gary	
Attorney Docket Number		AFF.004C7US

17	IEEE Standard 802.11a, 1999 Edition (Wireless LAN Medium Access Control and Physical Layer Specifications: High-Speed Physical Layer in the 5GHz Band), 1999, 91 pages.	<input type="checkbox"/>
18	Rod Underhill & Nat Gertler, "The Complete Idiot's Guide to MP3: Music on the Internet," 1999, 44 pages.	<input type="checkbox"/>
19	Bill Mann, "I Want My MP3! How to Download, Rip, & Play Digital Music," McGraw-Hill 2000, 175 pages.	<input type="checkbox"/>
20	IEEE Standard 802.11, 1997 Edition (Wireless LAN Medium Access Control and Physical Layer Specifications), 1997, pp. 1-145.	<input type="checkbox"/>
21		<input type="checkbox"/>
22	IBM Wireless Modem for Cellular/CDPD - Quick Reference, Oct. 1995, pp. 1-20.	<input type="checkbox"/>
23	Creative Sound Blaster Live! Platinum product, documentation, and software: Creative Technology Ltd., Creative Sound Blaster Live! Platinum Getting Started, Sept. 1999, 93 pages.	<input type="checkbox"/>
24	psa[play Getting Started Guide, (date unknown, contended by defendant Apple Corp. to be prior art under one or more of 35 U.S.C. 102 (a), (b), (f) and (g)), pp. 1-16.	<input type="checkbox"/>
25	psa[play Getting Started Guide, 2000, pp. 1-16.	<input type="checkbox"/>
26	Rio 800 User Guide, 2001, pp. 1-38.	<input type="checkbox"/>
27	Rio 800 Digital Audio Player—Getting Started, 2000, pp. 1-19.	<input type="checkbox"/>

INFORMATION DISCLOSURE STATEMENT BY APPLICANT (Not for submission under 37 CFR 1.99)	Application Number		12495190
	Filing Date		2009-06-30
	First Named Inventor	Russell W. White, et al.	
	Art Unit		2617
	Examiner Name	Erika A. Gary	
	Attorney Docket Number		AFF.004C7US

28	Rio 600 Getting Started Guide, 2001, pp. 1-169.	<input type="checkbox"/>
29	Rio 600 User Guide, March 2001, pp 1-38.	<input type="checkbox"/>

If you wish to add additional non-patent literature document citation information please click the Add button

EXAMINER SIGNATURE

Examiner Signature		Date Considered	
--------------------	--	-----------------	--

*EXAMINER: Initial if reference considered, whether or not citation is in conformance with MPEP 609. Draw line through a citation if not in conformance and not considered. Include copy of this form with next communication to applicant.

¹ See Kind Codes of USPTO Patent Documents at www.USPTO.GOV or MPEP 901.04. ² Enter office that issued the document, by the two-letter code (WIPO Standard ST.3). ³ For Japanese patent documents, the indication of the year of the reign of the Emperor must precede the serial number of the patent document. ⁴ Kind of document by the appropriate symbols as indicated on the document under WIPO Standard ST.16 if possible. ⁵ Applicant is to place a check mark here if English language translation is attached.

INFORMATION DISCLOSURE STATEMENT BY APPLICANT (Not for submission under 37 CFR 1.99)	Application Number	12495190
	Filing Date	2009-06-30
	First Named Inventor	Russell W. White, et al.
	Art Unit	2617
	Examiner Name	Erika A. Gary
	Attorney Docket Number	AFF.004C7US

CERTIFICATION STATEMENT

Please see 37 CFR 1.97 and 1.98 to make the appropriate selection(s):

That each item of information contained in the information disclosure statement was first cited in any communication from a foreign patent office in a counterpart foreign application not more than three months prior to the filing of the information disclosure statement. See 37 CFR 1.97(e)(1).

OR

That no item of information contained in the information disclosure statement was cited in a communication from a foreign patent office in a counterpart foreign application, and, to the knowledge of the person signing the certification after making reasonable inquiry, no item of information contained in the information disclosure statement was known to any individual designated in 37 CFR 1.56(c) more than three months prior to the filing of the information disclosure statement. See 37 CFR 1.97(e)(2).

See attached certification statement.

Fee set forth in 37 CFR 1.17 (p) has been submitted herewith.

None

SIGNATURE

A signature of the applicant or representative is required in accordance with CFR 1.33, 10.18. Please see CFR 1.4(d) for the form of the signature.

Signature	/Mark J. Rozman/	Date (YYYY-MM-DD)	2011-01-26
Name/Print	Mark J. Rozman	Registration Number	42117

This collection of information is required by 37 CFR 1.97 and 1.98. The information is required to obtain or retain a benefit by the public which is to file (and by the USPTO to process) an application. Confidentiality is governed by 35 U.S.C. 122 and 37 CFR 1.14. This collection is estimated to take 1 hour to complete, including gathering, preparing and submitting the completed application form to the USPTO. Time will vary depending upon the individual case. Any comments on the amount of time you require to complete this form and/or suggestions for reducing this burden, should be sent to the Chief Information Officer, U.S. Patent and Trademark Office, U.S. Department of Commerce, P.O. Box 1450, Alexandria, VA 22313-1450. **DO NOT SEND FEES OR COMPLETED FORMS TO THIS ADDRESS. SEND TO: Commissioner for Patents, P.O. Box 1450, Alexandria, VA 22313-1450.**

Privacy Act Statement

The Privacy Act of 1974 (P.L. 93-579) requires that you be given certain information in connection with your submission of the attached form related to a patent application or patent. Accordingly, pursuant to the requirements of the Act, please be advised that: (1) the general authority for the collection of this information is 35 U.S.C. 2(b)(2); (2) furnishing of the information solicited is voluntary; and (3) the principal purpose for which the information is used by the U.S. Patent and Trademark Office is to process and/or examine your submission related to a patent application or patent. If you do not furnish the requested information, the U.S. Patent and Trademark Office may not be able to process and/or examine your submission, which may result in termination of proceedings or abandonment of the application or expiration of the patent.

The information provided by you in this form will be subject to the following routine uses:

1. The information on this form will be treated confidentially to the extent allowed under the Freedom of Information Act (5 U.S.C. 552) and the Privacy Act (5 U.S.C. 552a). Records from this system of records may be disclosed to the Department of Justice to determine whether the Freedom of Information Act requires disclosure of these records.
2. A record from this system of records may be disclosed, as a routine use, in the course of presenting evidence to a court, magistrate, or administrative tribunal, including disclosures to opposing counsel in the course of settlement negotiations.
3. A record in this system of records may be disclosed, as a routine use, to a Member of Congress submitting a request involving an individual, to whom the record pertains, when the individual has requested assistance from the Member with respect to the subject matter of the record.
4. A record in this system of records may be disclosed, as a routine use, to a contractor of the Agency having need for the information in order to perform a contract. Recipients of information shall be required to comply with the requirements of the Privacy Act of 1974, as amended, pursuant to 5 U.S.C. 552a(m).
5. A record related to an International Application filed under the Patent Cooperation Treaty in this system of records may be disclosed, as a routine use, to the International Bureau of the World Intellectual Property Organization, pursuant to the Patent Cooperation Treaty.
6. A record in this system of records may be disclosed, as a routine use, to another federal agency for purposes of National Security review (35 U.S.C. 181) and for review pursuant to the Atomic Energy Act (42 U.S.C. 218(c)).
7. A record from this system of records may be disclosed, as a routine use, to the Administrator, General Services, or his/her designee, during an inspection of records conducted by GSA as part of that agency's responsibility to recommend improvements in records management practices and programs, under authority of 44 U.S.C. 2904 and 2906. Such disclosure shall be made in accordance with the GSA regulations governing inspection of records for this purpose, and any other relevant (i.e., GSA or Commerce) directive. Such disclosure shall not be used to make determinations about individuals.
8. A record from this system of records may be disclosed, as a routine use, to the public after either publication of the application pursuant to 35 U.S.C. 122(b) or issuance of a patent pursuant to 35 U.S.C. 151. Further, a record may be disclosed, subject to the limitations of 37 CFR 1.14, as a routine use, to the public if the record was filed in an application which became abandoned or in which the proceedings were terminated and which application is referenced by either a published application, an application open to public inspections or an issued patent.
9. A record from this system of records may be disclosed, as a routine use, to a Federal, State, or local law enforcement agency, if the USPTO becomes aware of a violation or potential violation of law or regulation.

Electronic Acknowledgement Receipt

EFS ID:	9313911
Application Number:	12495190
International Application Number:	
Confirmation Number:	2380
Title of Invention:	Method For Content Delivery
First Named Inventor/Applicant Name:	Russell W. White
Customer Number:	21906
Filer:	Mark J. Rozman/Stephanie Petreas
Filer Authorized By:	Mark J. Rozman
Attorney Docket Number:	AFF.0004C7US
Receipt Date:	26-JAN-2011
Filing Date:	30-JUN-2009
Time Stamp:	16:56:21
Application Type:	Utility under 35 USC 111(a)

Payment information:

Submitted with Payment	no
------------------------	----

File Listing:

Document Number	Document Description	File Name	File Size(Bytes)/ Message Digest	Multi Part /.zip	Pages (if appl.)
1	NPL Documents	EmpegCarSoftwareBeta10.pdf	30432 c23dd85271cf244eca73353d9caa9c0290a592f3	no	3

Warnings:

Information:

2	NPL Documents	emplodehelp.pdf	11350284	no	25
			f7c673b33611ea2754d179a650a5c5f1f52f425		
Warnings:					
Information:					
3	NPL Documents	Mp3InYourCarHasArrived.pdf	114455	no	1
			d854e681efac802dbe0d9509f4d6240520d948ae		
Warnings:					
Information:					
4	NPL Documents	PhotosFromComdexFall1999.pdf	1821386	no	9
			e040431da10f9d562638de3b299a620924f9e00f		
Warnings:					
Information:					
5	NPL Documents	PhotosFromLinuxWorld1999.pdf	5006304	no	22
			0e72e4f50439c93c138a21739420b8ba03bafb58		
Warnings:					
Information:					
6	NPL Documents	VisteonForYourListeningPleasure.pdf	1504250	no	1
			b1d9e8e4465b58771cd6225996191b47a962808b		
Warnings:					
Information:					
7	NPL Documents	photosInEmailToHugo.pdf	1930184	no	4
			47e4cb479405778d08e0a32804c79f3224ead631		
Warnings:					
Information:					
8	NPL Documents	HPJornada420UsersManual.pdf	1855171	no	146
			cc32d138b89cd232d31380b3f6bd28960edd332c		
Warnings:					
Information:					
9	NPL Documents	RealPlayerPlusG2Man.pdf	1377402	no	84
			1e499de04b641bf59e10f74b8adddb983d5eca66		
Warnings:					
Information:					
10	NPL Documents	CreativeSoundBlasterLive.pdf	1449487	no	93
			104f0b0d3105693cfc1b85cb2bb591aad646dd5		
Warnings:					
Information:					

11	NPL Documents	psaplayGettingStartedGuide.pdf	325476 f7355938171eb8501e9918c1b30d4f9563788004	no	10
Warnings:					
Information:					
12	NPL Documents	Rio800gettingStarted.pdf	323659 b0d991a18f91a70ed665ed8ee5a2af494c373b39	no	20
Warnings:					
Information:					
13	Information Disclosure Statement (IDS) Filed (SB/08)	AFF004C7IDSAppleFtpIDS1of2 TOFILE.pdf	51913 4cb982db4a42a1ed711102422bbfb49a3de11407	no	7
Warnings:					
Information:					
This is not an USPTO supplied IDS fillable form					
Total Files Size (in bytes):			27140403		
<p>This Acknowledgement Receipt evidences receipt on the noted date by the USPTO of the indicated documents, characterized by the applicant, and including page counts, where applicable. It serves as evidence of receipt similar to a Post Card, as described in MPEP 503.</p> <p><u>New Applications Under 35 U.S.C. 111</u> If a new application is being filed and the application includes the necessary components for a filing date (see 37 CFR 1.53(b)-(d) and MPEP 506), a Filing Receipt (37 CFR 1.54) will be issued in due course and the date shown on this Acknowledgement Receipt will establish the filing date of the application.</p> <p><u>National Stage of an International Application under 35 U.S.C. 371</u> If a timely submission to enter the national stage of an international application is compliant with the conditions of 35 U.S.C. 371 and other applicable requirements a Form PCT/DO/EO/903 indicating acceptance of the application as a national stage submission under 35 U.S.C. 371 will be issued in addition to the Filing Receipt, in due course.</p> <p><u>New International Application Filed with the USPTO as a Receiving Office</u> If a new international application is being filed and the international application includes the necessary components for an international filing date (see PCT Article 11 and MPEP 1810), a Notification of the International Application Number and of the International Filing Date (Form PCT/RO/105) will be issued in due course, subject to prescriptions concerning national security, and the date shown on this Acknowledgement Receipt will establish the international filing date of the application.</p>					

INFORMATION DISCLOSURE STATEMENT BY APPLICANT (Not for submission under 37 CFR 1.99)	Application Number		12495190	
	Filing Date		2009-06-30	
	First Named Inventor	Russell W. White, et al.		
	Art Unit		2617	
	Examiner Name	Erika A. Gary		
	Attorney Docket Number		AFF.004C7US	

U.S.PATENTS						
Examiner Initial*	Cite No	Patent Number	Kind Code ¹	Issue Date	Name of Patentee or Applicant of cited Document	Pages,Columns,Lines where Relevant Passages or Relevant Figures Appear
	1	6248946		2001-06-19	Dwek	
	2	5572442		1996-11-05	Schulhof	
	3	6338044		2002-01-08	Cook	
	4	5797089		1998-08-18	Nguyen	
	5	6330247		2001-12-11	Chang	
	6	5737706		1998-04-07	Seazholtz	

If you wish to add additional U.S. Patent citation information please click the Add button.

U.S.PATENT APPLICATION PUBLICATIONS						
Examiner Initial*	Cite No	Publication Number	Kind Code ¹	Publication Date	Name of Patentee or Applicant of cited Document	Pages,Columns,Lines where Relevant Passages or Relevant Figures Appear

INFORMATION DISCLOSURE STATEMENT BY APPLICANT (Not for submission under 37 CFR 1.99)	Application Number	12495190
	Filing Date	2009-06-30
	First Named Inventor	Russell W. White, et al.
	Art Unit	2617
	Examiner Name	Erika A. Gary
	Attorney Docket Number	AFF.004C7US

1	20010042107		2001-11-15	Palm	
---	-------------	--	------------	------	--

If you wish to add additional U.S. Published Application citation information please click the Add button.

FOREIGN PATENT DOCUMENTS

Examiner Initial*	Cite No	Foreign Document Number ³	Country Code ² i	Kind Code ⁴	Publication Date	Name of Patentee or Applicant of cited Document	Pages, Columns, Lines where Relevant Passages or Relevant Figures Appear	T ⁵
	1	EP 984584	EP		2000-08-03	Lippert		<input type="checkbox"/>

If you wish to add additional Foreign Patent Document citation information please click the Add button

NON-PATENT LITERATURE DOCUMENTS

Examiner Initials*	Cite No	Include name of the author (in CAPITAL LETTERS), title of the article (when appropriate), title of the item (book, magazine, journal, serial, symposium, catalog, etc), date, pages(s), volume-issue number(s), publisher, city and/or country where published.	T ⁵
	1	Sony Corporation, Sony Portable MiniDisc Recorder MZ-R90/MZ-R91 Operating Instructions, Doc. No. 3-867-571-22(1), 1999, pp. 1-55.	<input type="checkbox"/>
	2	Empeg Car User Guide, 1999, pp. 1-19.	<input type="checkbox"/>
	3	Empeg Car User Guide (2000) pp. 1-48	<input type="checkbox"/>
	4	Crowe, Mike. Empeg Car Beta 10a, March 25, 2000, 3 pages.	<input type="checkbox"/>
	5	Emplode Help, (date unknown, contended by defendant Apple Corp. to be prior art under one or more of 35 U.S.C. 102 (a), (b), (f) and (g)) 25 pages.	<input type="checkbox"/>

**INFORMATION DISCLOSURE
STATEMENT BY APPLICANT**
(Not for submission under 37 CFR 1.99)

Application Number	12495190
Filing Date	2009-06-30
First Named Inventor	Russell W. White, et al.
Art Unit	2617
Examiner Name	Erika A. Gary
Attorney Docket Number	AFF.004C7US

6	"MP3 Portable Player Goes Elite" The Mac Observer, Nov. 17, 1999, 3 pages.	<input type="checkbox"/>
7	"MP3 in Your Car Has Arrived" (date unknown, contended by defendant Apple Corp. to be prior art under one or more of 35 U.S.C. 102 (a), (b), (f) and (g)) 1 page.	<input type="checkbox"/>
8	Photos from Comdex Fall 1999, Nov. 1999, 9 pages.	<input type="checkbox"/>
9	Photos from LinuxWorld Expo, Winter 1999, Mar. 1-4, 1999, 22 pages.	<input type="checkbox"/>
10	Craig Knudsen, "MP3 Linux Players," Linux Journal, Jul. 1, 1999, pp. 1-3.	<input type="checkbox"/>
11	riocar.org – Empeg Car History, (date unknown, contended by defendant Apple Corp. to be prior art under one or more of 35 U.S.C. 102 (a), (b), (f) and (g)), 4 pages.	<input type="checkbox"/>
12	"Visteon: For Your Listening Pleasure - Any Music, Any Time, Anywhere," Presswire, Jan. 5, 2000, 1 page.	<input type="checkbox"/>
13	Photographs in email to Hugo Fiennes, Sept. 22, 1999, 4 pages.	<input type="checkbox"/>
14	HP Jornada 420 User's Manual, 1999, pp. 1-142.	<input type="checkbox"/>
15	IEEE Standard 802.11b, 1999 Edition (Wireless LAN Medium Access Control and Physical Layer Specifications: Higher-Speed Physical Layer Extension in the 2.4 GHz Band) Sep. 16, 1999, 96 pages.	<input type="checkbox"/>
16	RealPlayer Plus G2 Manual, 1999, pp. 1-81.	<input type="checkbox"/>

**INFORMATION DISCLOSURE
STATEMENT BY APPLICANT**
(Not for submission under 37 CFR 1.99)

Application Number	12495190
Filing Date	2009-06-30
First Named Inventor	Russell W. White, et al.
Art Unit	2617
Examiner Name	Erika A. Gary
Attorney Docket Number	AFF.004C7US

17	IEEE Standard 802.11a, 1999 Edition (Wireless LAN Medium Access Control and Physical Layer Specifications: High-Speed Physical Layer in the 5GHz Band), 1999, 91 pages.	<input type="checkbox"/>
18	Rod Underhill & Nat Gertler, "The Complete Idiot's Guide to MP3: Music on the Internet," 1999, 44 pages.	<input type="checkbox"/>
19	Bill Mann, "I Want My MP3! How to Download, Rip, & Play Digital Music," McGraw-Hill 2000, 175 pages.	<input type="checkbox"/>
20	IEEE Standard 802.11, 1997 Edition (Wireless LAN Medium Access Control and Physical Layer Specifications), 1997, pp. 1-145.	<input type="checkbox"/>
21		<input type="checkbox"/>
22	IBM Wireless Modem for Cellular/CDPD - Quick Reference, Oct. 1995, pp. 1-20.	<input type="checkbox"/>
23	Creative Sound Blaster Live! Platinum product, documentation, and software: Creative Technology Ltd., Creative Sound Blaster Live! Platinum Getting Started, Sept. 1999, 93 pages.	<input type="checkbox"/>
24	psa[play Getting Started Guide, (date unknown, contended by defendant Apple Corp. to be prior art under one or more of 35 U.S.C. 102 (a), (b), (f) and (g)), pp. 1-16.	<input type="checkbox"/>
25	psa[play Getting Started Guide, 2000, pp. 1-16.	<input type="checkbox"/>
26	Rio 800 User Guide, 2001, pp. 1-38.	<input type="checkbox"/>
27	Rio 800 Digital Audio Player—Getting Started, 2000, pp. 1-19.	<input type="checkbox"/>

INFORMATION DISCLOSURE STATEMENT BY APPLICANT (Not for submission under 37 CFR 1.99)	Application Number	12495190
	Filing Date	2009-06-30
	First Named Inventor	Russell W. White, et al.
	Art Unit	2617
	Examiner Name	Erika A. Gary
	Attorney Docket Number	AFF.004C7US

28	Rio 600 Getting Started Guide, 2001, pp. 1-169.	<input type="checkbox"/>
29	Rio 600 User Guide, March 2001, pp 1-38.	<input type="checkbox"/>

If you wish to add additional non-patent literature document citation information please click the Add button

EXAMINER SIGNATURE

Examiner Signature		Date Considered	
--------------------	--	-----------------	--

*EXAMINER: Initial if reference considered, whether or not citation is in conformance with MPEP 609. Draw line through a citation if not in conformance and not considered. Include copy of this form with next communication to applicant.

¹ See Kind Codes of USPTO Patent Documents at www.USPTO.GOV or MPEP 901.04. ² Enter office that issued the document, by the two-letter code (WIPO Standard ST.3). ³ For Japanese patent documents, the indication of the year of the reign of the Emperor must precede the serial number of the patent document. ⁴ Kind of document by the appropriate symbols as indicated on the document under WIPO Standard ST.16 if possible. ⁵ Applicant is to place a check mark here if English language translation is attached.

INFORMATION DISCLOSURE STATEMENT BY APPLICANT (Not for submission under 37 CFR 1.99)	Application Number	12495190
	Filing Date	2009-06-30
	First Named Inventor	Russell W. White, et al.
	Art Unit	2617
	Examiner Name	Erika A. Gary
	Attorney Docket Number	AFF.004C7US

CERTIFICATION STATEMENT

Please see 37 CFR 1.97 and 1.98 to make the appropriate selection(s):

That each item of information contained in the information disclosure statement was first cited in any communication from a foreign patent office in a counterpart foreign application not more than three months prior to the filing of the information disclosure statement. See 37 CFR 1.97(e)(1).

OR

That no item of information contained in the information disclosure statement was cited in a communication from a foreign patent office in a counterpart foreign application, and, to the knowledge of the person signing the certification after making reasonable inquiry, no item of information contained in the information disclosure statement was known to any individual designated in 37 CFR 1.56(c) more than three months prior to the filing of the information disclosure statement. See 37 CFR 1.97(e)(2).

See attached certification statement.

Fee set forth in 37 CFR 1.17 (p) has been submitted herewith.

None

SIGNATURE

A signature of the applicant or representative is required in accordance with CFR 1.33, 10.18. Please see CFR 1.4(d) for the form of the signature.

Signature	/Mark J. Rozman/	Date (YYYY-MM-DD)	2011-01-26
Name/Print	Mark J. Rozman	Registration Number	42117

This collection of information is required by 37 CFR 1.97 and 1.98. The information is required to obtain or retain a benefit by the public which is to file (and by the USPTO to process) an application. Confidentiality is governed by 35 U.S.C. 122 and 37 CFR 1.14. This collection is estimated to take 1 hour to complete, including gathering, preparing and submitting the completed application form to the USPTO. Time will vary depending upon the individual case. Any comments on the amount of time you require to complete this form and/or suggestions for reducing this burden, should be sent to the Chief Information Officer, U.S. Patent and Trademark Office, U.S. Department of Commerce, P.O. Box 1450, Alexandria, VA 22313-1450. **DO NOT SEND FEES OR COMPLETED FORMS TO THIS ADDRESS. SEND TO: Commissioner for Patents, P.O. Box 1450, Alexandria, VA 22313-1450.**

Privacy Act Statement

The Privacy Act of 1974 (P.L. 93-579) requires that you be given certain information in connection with your submission of the attached form related to a patent application or patent. Accordingly, pursuant to the requirements of the Act, please be advised that: (1) the general authority for the collection of this information is 35 U.S.C. 2(b)(2); (2) furnishing of the information solicited is voluntary; and (3) the principal purpose for which the information is used by the U.S. Patent and Trademark Office is to process and/or examine your submission related to a patent application or patent. If you do not furnish the requested information, the U.S. Patent and Trademark Office may not be able to process and/or examine your submission, which may result in termination of proceedings or abandonment of the application or expiration of the patent.

The information provided by you in this form will be subject to the following routine uses:

1. The information on this form will be treated confidentially to the extent allowed under the Freedom of Information Act (5 U.S.C. 552) and the Privacy Act (5 U.S.C. 552a). Records from this system of records may be disclosed to the Department of Justice to determine whether the Freedom of Information Act requires disclosure of these records.
2. A record from this system of records may be disclosed, as a routine use, in the course of presenting evidence to a court, magistrate, or administrative tribunal, including disclosures to opposing counsel in the course of settlement negotiations.
3. A record in this system of records may be disclosed, as a routine use, to a Member of Congress submitting a request involving an individual, to whom the record pertains, when the individual has requested assistance from the Member with respect to the subject matter of the record.
4. A record in this system of records may be disclosed, as a routine use, to a contractor of the Agency having need for the information in order to perform a contract. Recipients of information shall be required to comply with the requirements of the Privacy Act of 1974, as amended, pursuant to 5 U.S.C. 552a(m).
5. A record related to an International Application filed under the Patent Cooperation Treaty in this system of records may be disclosed, as a routine use, to the International Bureau of the World Intellectual Property Organization, pursuant to the Patent Cooperation Treaty.
6. A record in this system of records may be disclosed, as a routine use, to another federal agency for purposes of National Security review (35 U.S.C. 181) and for review pursuant to the Atomic Energy Act (42 U.S.C. 218(c)).
7. A record from this system of records may be disclosed, as a routine use, to the Administrator, General Services, or his/her designee, during an inspection of records conducted by GSA as part of that agency's responsibility to recommend improvements in records management practices and programs, under authority of 44 U.S.C. 2904 and 2906. Such disclosure shall be made in accordance with the GSA regulations governing inspection of records for this purpose, and any other relevant (i.e., GSA or Commerce) directive. Such disclosure shall not be used to make determinations about individuals.
8. A record from this system of records may be disclosed, as a routine use, to the public after either publication of the application pursuant to 35 U.S.C. 122(b) or issuance of a patent pursuant to 35 U.S.C. 151. Further, a record may be disclosed, subject to the limitations of 37 CFR 1.14, as a routine use, to the public if the record was filed in an application which became abandoned or in which the proceedings were terminated and which application is referenced by either a published application, an application open to public inspections or an issued patent.
9. A record from this system of records may be disclosed, as a routine use, to a Federal, State, or local law enforcement agency, if the USPTO becomes aware of a violation or potential violation of law or regulation.

Electronic Acknowledgement Receipt

EFS ID:	9314525
Application Number:	12495190
International Application Number:	
Confirmation Number:	2380
Title of Invention:	Method For Content Delivery
First Named Inventor/Applicant Name:	Russell W. White
Customer Number:	21906
Filer:	Mark J. Rozman/Stephanie Petreas
Filer Authorized By:	Mark J. Rozman
Attorney Docket Number:	AFF.0004C7US
Receipt Date:	26-JAN-2011
Filing Date:	30-JUN-2009
Time Stamp:	17:34:49
Application Type:	Utility under 35 USC 111(a)

Payment information:

Submitted with Payment	no
------------------------	----

File Listing:

Document Number	Document Description	File Name	File Size(Bytes)/ Message Digest	Multi Part /.zip	Pages (if appl.)
1	Information Disclosure Statement (IDS) Filed (SB/08)	AFF004C7IDSAppleFtpIDS1of2 TOFILE.pdf	51913 <small>4cb982db4a42a1ed711102422bbfb49a3de 11407</small>	no	7

Warnings:

Information:

This is not an USPTO supplied IDS fillable form					
2	NPL Documents	Knudsen.pdf	183190 a455b3b0fa2e98b8441e3adbddcb61e67c1834dc	no	7
Warnings:					
Information:					
3	NPL Documents	RiocarDotOrgToFile.pdf	23745 f163ba7891449ff1a1de28a2313b489650b2dc92	no	2
Warnings:					
Information:					
4	NPL Documents	IEEE80211a1of2.pdf	1183780 b49168b6b9e24332a1b7dc1d074efe7e9a93a44	no	48
Warnings:					
Information:					
5	NPL Documents	IEEE80211a2of2.pdf	1063297 56bc9c2ddd7de0e95a914c2bc157f6c5221708d8	no	43
Warnings:					
Information:					
6	NPL Documents	Mann1of2.pdf	5179148 66248d524e592155af5859675301b3170d22bfd1	no	94
Warnings:					
Information:					
7	NPL Documents	Mann2of2.pdf	4465068 e536de8b71d1940d878b8fcb1542e73b9ba4ea0f	no	81
Warnings:					
Information:					
Total Files Size (in bytes):			12150141		

This Acknowledgement Receipt evidences receipt on the noted date by the USPTO of the indicated documents, characterized by the applicant, and including page counts, where applicable. It serves as evidence of receipt similar to a Post Card, as described in MPEP 503.

New Applications Under 35 U.S.C. 111

If a new application is being filed and the application includes the necessary components for a filing date (see 37 CFR 1.53(b)-(d) and MPEP 506), a Filing Receipt (37 CFR 1.54) will be issued in due course and the date shown on this Acknowledgement Receipt will establish the filing date of the application.

National Stage of an International Application under 35 U.S.C. 371

If a timely submission to enter the national stage of an international application is compliant with the conditions of 35 U.S.C. 371 and other applicable requirements a Form PCT/DO/EO/903 indicating acceptance of the application as a national stage submission under 35 U.S.C. 371 will be issued in addition to the Filing Receipt, in due course.

New International Application Filed with the USPTO as a Receiving Office

If a new international application is being filed and the international application includes the necessary components for an international filing date (see PCT Article 11 and MPEP 1810), a Notification of the International Application Number and of the International Filing Date (Form PCT/RO/105) will be issued in due course, subject to prescriptions concerning national security, and the date shown on this Acknowledgement Receipt will establish the international filing date of the application.

IN THE UNITED STATES PATENT AND TRADEMARK OFFICE

Applicant:	Russell W. White et al.	§	Group Art Unit:	2617
		§		
Serial No.:	12/495,190	§		
		§	Examiner:	Erika A. Gary
Filed:	June 30, 2009	§		
		§		
For:	Method for Content Delivery	§	Atty. Dkt. No.:	AFF.0004C7US
		§		

Mail Stop Amendment
Commissioner for Patents
P.O. Box 1450
Alexandria, VA 22313-1450

REPLY TO OFFICE ACTION MAILED SEPTEMBER 17, 2010

Sir:

In response to the Office Action mailed September 17, 2010, please amend the above-referenced patent application as follows:

Amendments to the Specification begin on page 2 of this paper.

Amendments to the Claims begin on page 3 of this paper; and

Remarks/Arguments begin on page 8 of this paper.

Date of Deposit: <u>January 18, 2011</u> I hereby certify under 37 CFR § 1.8 this correspondence is being deposited via EFS on the date indicated above. /Stephanie Petreas/ Stephanie Petreas

Amendments to the Specification:

Please replace paragraph beginning on page 2, paragraph 1 with the following amended paragraph:

This application is a continuation of U.S. ~~patent application Serial No. 12/015,320, filed January 16, 2008~~ Patent No. 7,778,595, which issued on August 17, 2010 entitled "Method for Managing Media," which is a continuation of U.S. Patent No. 7,324,833, which issued on January 29, 2008, which is a continuation of U.S. Patent No. 7,187,947, which issued on March 6, 2007, the disclosures of which are all hereby incorporated herein by reference in their entirety for all purposes.

Amendments to the Claims:

This listing of claims will replace all prior versions, and listings, of claims in the application:

Listing of Claims:

Claims 1-18 (Canceled)

Claim 19 (previously presented): A method for content delivery, comprising:
maintaining a network resource that is accessible to a remote electronic device, the remote electronic device being capable of wireless communication, wherein the network resource facilitates access to a selectable piece of media content;

storing a first collection of instructions on at least one storage device, wherein the first collection of instructions are executable by a processor of a computing device to present a graphical user interface for the network resource; and

storing a different collection of instructions on the at least one storage device, wherein the different collection of instructions are executable by a processor of the remote electronic device: (1) to access a website; (2) to recognize selection of an icon presented on a display of the remote electronic device, wherein the icon is associated with content that is deliverable as a streaming media; (3) to present an other icon comprising the word “store” on the display; (4) to locally store a playlist; and (5) to switch between a set of communication rates at which the remote electronic device can wirelessly receive a first portion and a second portion of the content, wherein the set of communication rates comprise at least a first data rate and a second data rate that is slower than the first data rate.

Claim 20 (canceled)

Claim 21 (currently amended): The method of Claim [[20]] 19, wherein [[the]] one of the set of communication [[rate]] rates is 10 Kbps.

Claim 22 (previously presented): The method of Claim 19, further comprising communicating information from a network location for use by the remote electronic device via

a computing device that already has the first collection of instructions and is operable to execute the first collection of instructions in connection with accessing the network resource.

Claim 23 (previously presented): The method of Claim 22, further comprising communicating a software upgrade for the remote electronic device.

Claim 24 (currently amended): The method of Claim 19, further comprising:
maintaining a ~~store~~ resource that can be accessed in response to a selection of the other icon comprising the word “store” on the display of the remote electronic device; and
making a piece of software available at the ~~store~~ resource, wherein the piece of software includes instructions executable by the processor of the remote electronic device.

Claim 25 (currently amended): The method of Claim 19, further comprising providing a copy of the first collection of instructions to ~~a user~~ the remote electronic device.

Claim 26 (currently amended): The method of Claim 19, further comprising providing a copy of the different collection of instructions to ~~a user~~ the remote electronic device.

Claim 27 (previously presented): The method of Claim 19, wherein the content is segmented into a plurality of portions.

Claim 28 (previously presented): The method of Claim 27, wherein the different collection of instructions are further executable by the processor of the remote electronic device to receive communication of the plurality of segments in connection with outputting the content.

Claim 29 (previously presented): The method of Claim 19, wherein the different collection of instructions are further executable by the processor of the remote electronic device to receive at least one portion of the content in a compressed format and to process the at least one portion.

Claim 30 (currently amended): A method for content delivery, comprising:
maintaining a network resource that is accessible to a cellular telephone, the cellular telephone being capable of wireless communication, wherein the network resource facilitates access to media content;

storing a collection of instructions on at least one storage device, wherein the collection of instructions are executable by a processor of the cellular telephone:

(1) to present ~~presenting~~ a graphical user interface on a display of ~~an electronic device~~ the cellular telephone ~~that is capable of wireless communication;~~

(2) to recognize ~~recognizing~~ selection of an icon presented on the display, wherein the icon is associated with content that is deliverable as a streaming media; and
~~accessing a listing of network locations from which information associated with the content may be obtained; and~~

(3) ~~executing instructions at the electronic device~~ to direct [[a]] the processor in the ~~electronic device~~ cellular telephone to switch between a set of communication rates at which the ~~electronic device~~ cellular telephone receives a first portion and a second portion of the media content, wherein the set of ~~wireless~~ communication rates comprises at least a first data rate and a second data rate that is slower than the first data rate.

Claim 31 (currently amended): The method of Claim 30, ~~further comprising~~
~~utilizing wherein~~ a portion of the collection of instructions are utilized at the ~~electronic device~~ cellular telephone to switch between at least two of the set of communication rates.

Claim 32 (currently amended): The method of Claim 30, ~~further comprising:~~
~~executing instructions at the electronic device~~ wherein a portion of the collection of instructions are executed by the processor of the cellular telephone to direct the processor in the ~~electronic device~~ cellular telephone to present an other icon comprising the word “store” on the display;

to access ~~accessing~~ a network based ~~store~~ resource in response to a selection of the other icon comprising the word “store”; and

to ~~select~~ selecting a piece of software available at the ~~store~~ network based resource, wherein the piece of software includes instructions executable by the processor of the ~~electronic device~~ cellular telephone.

Claim 33 (currently amended): The method of Claim 30, further comprising ~~receiving~~ providing a software upgrade to the cellular telephone.

Claims 34 - 35 (canceled)

Claim 36 (currently amended): The method of Claim 30, ~~further comprising~~ wherein switching between the first data rate and the second data rate is based on an amount of the media content that has been buffered in the ~~electronic device~~ cellular telephone.

Claim 37 (previously presented): A system for content delivery, comprising:
a portable device having a display, a local rechargeable battery, a wireless communication system, and a processor;
a physical interface of the portable device, the physical interface configured to connect to an interface system that includes a cable having multiple conductive elements, wherein the physical interface is designed such that a different electronic device can be communicatively coupled with the physical interface of the portable device using the interface system in a manner that allows the different electronic device to recharge the local rechargeable battery using at least one of the multiple conductive elements and to communicate with the portable device using at least one other of the multiple conductive elements; and
a computer-readable medium having stored instructions that when executed are operable to cause the processor: (1) to present an icon on the display, the icon associated with content that is deliverable as streaming media; (2) to recognize a selection of the icon; and (3) to switch between a set of communication rates at which the portable device receives a first portion and a second portion of the content, wherein the set of communication rates comprise at least a first data rate and a second data rate that is slower than the first data rate.

Claim 38 (previously presented): The system of Claim 37, further comprising the interface system and the different electronic device, wherein at least a portion of the different electronic device is a component of an automobile sound system and the interface system utilizes at least one bus to communicatively couple with the different electronic device.

Claim 39 (previously presented): The system of Claim 37, further comprising the interface system and the different electronic device, wherein at least a portion of the different electronic device is a component of a stereo system and the interface system utilizes at least one bus to communicatively couple with the different electronic device.

Claim 40 (previously presented): The system of Claim 37, wherein the stored instructions are further operable to cause the processor: (1) to obtain a listing of network locations at which to access the streaming media; and (2) to cause a first of the network locations to be accessed to facilitate a streaming delivery of the streaming media.

Claim 41 (previously presented): The system of Claim 37, wherein the content is selected from a group consisting of a song and a video.

REMARKS/ARGUMENTS

Applicants gratefully acknowledge the indication that claims 19, 22, 23 and 27-29 are allowed.

Provided herewith is a Terminal Disclaimer and thus it is respectfully submitted that the double patenting rejection is overcome.

The Specification has been amended as requested and thus it is respectfully submitted that the objection to the Specification is overcome.

Regarding the §112, first paragraph rejection as to claims 24-26, claim 24 has been amended to recite the presence of a resource. Support exists throughout the Specification for such a resource. For example, reference can be made to FIG. 1 and paragraphs 23-24 of the Specification that describe a digital engine and a storage device that maintain data or information associated with selected information. Furthermore, it must be remembered that there is no *in haec verba* requirement that the exact language appear in the claims as in the Specification. M.P.E.P. §2163. Instead, all that is needed is that the Specification must reasonably convey to those skilled in the art that Applicants were “in possession” of the claimed invention. M.P.E.P. §2163.02. Accordingly, it is respectfully submitted that the rejection is overcome.

Further with regard to the §112 rejection of claims 25 and 26, the claims have been amended to recite that the copy of instruction collections are sent to a remote electronic device. Support for this subject matter can be found throughout the Specification. For example, it is described in paragraph 45 that software upgrades can be communicated to an electronic device. Accordingly, it is respectfully submitted that the rejection is overcome.

Claim 32 has been amended in similar manner as to claim 24 with regard to the §112 rejection and accordingly it is respectfully that this rejection is also overcome.

Pending claims 30, 31, 33 and 36 stand rejected under 35 U.S.C. §103(a) over U.S. Patent No. 6,587,127 (Leeke) in view of U.S. Patent No. 6,405,256 (Lin). Applicants respectfully traverse the rejection. Here, independent claim 30 has been amended to include subject matter from independent claim 19, which stands allowed. In light of this amendment, it is respectfully submitted that the prior art rejection to these claims is overcome.

STATEMENT OF THE SUBSTANCE OF THE INTERVIEW

The undersigned and Applicants gratefully acknowledge and appreciate the Examiner's time and consideration extended during a telephonic interview which occurred on December 7, 2010. Taking part in the interview were Examiner Gary, Russell White, and the undersigned. While agreement was not explicitly reached, in light of the above amendments and remarks it is respectfully submitted that all pending claims are in condition for allowance.

Discussed during the interview were various topics, including claims in accordance with the above amendment, the §112 rejections, the prior art, status of a litigation involving patents related to the present application, and IDS-type disclosure issues. Specifically, as to the amended claims, discussed was the §112 support in the original specification and drawings for the subject matter of the claims, including the subject matter added by the above amendment.

Regarding a lawsuit involving U.S. Patent Nos. 7,324,833 and 7,634,228 related to the present application (one of which was examined by Examiner Gary), Applicant explained that a jury verdict of valid and infringed was reached in the matter of *Affinity Labs of Texas, LLC v. BMW of North America, LLC et al*, Docket 9:08CV164 (E.D. Tex., Lufkin Division).

Regarding IDS-type disclosure issues, discussed were pending litigations and reexaminations. Applicants indicated that they would continue to cite material from these matters in accordance with the guidelines previously indicated by the Examiner in parent application 12/015,320 (now U.S. Patent No. 7,778,595). For ease of reference, reproduced below are these guidelines from a Response to Office Action Mailed November 12, 2009 (as filed on March 12, 2010).

Regarding future disclosure materials, the Examiner indicated that she did not want to receive the grants of the reexamination requests. Applicants appreciate the Examiner's concern regarding the volume of disclosure materials, and Applicants will provide, going forward, additional prior art documents discovered, along with substantive non-discovery rulings of courts in litigations involving related patents, Office Actions, and Responses from reexaminations involving related patents and related applications. But, at the Examiner's request, papers filed by the parties with the courts in such litigations and papers granting reexamination will not be provided to the Examiner. Applicants discussed that during the prosecution of U.S. Patent No. 7,634,228, Examiner Gelin indicated that he did not want to receive papers from re-examinations and pending litigations other than substantive rulings of court and Office Actions/Responses. If Applicants have misunderstood the Examiner's wishes regarding disclosure materials, Applicants respectfully request the Examiner to address the same in the next paper.

Accordingly, provided herewith is an Information Disclosure Statement including such subject matter. Further, as above, if Applicants have misunderstood the Examiner's wishes regarding disclosure materials, it is respectfully requested that the Examiner so indicate in the next paper.

The application is believed to be in condition for allowance and the Examiner's prompt action in accordance therewith is respectfully requested. The Commissioner is authorized to charge any additional fees or credit any overpayment to Deposit Account No. 20-1504.

Respectfully submitted,

Date: January 18, 2011

/Mark J. Rozman/
Mark J. Rozman
Registration No. 42,117
TROP, PRUNER & HU, P.C.
1616 S. Voss Road, Suite 750
Houston, Texas 77057-2631
(512) 418-9944 [Phone]
(713) 468-8883 [Fax]
Customer No.: 21906

INFORMATION DISCLOSURE STATEMENT BY APPLICANT (Not for submission under 37 CFR 1.99)	Application Number	12495190
	Filing Date	2009-06-30
	First Named Inventor	Russell W. White, et al.
	Art Unit	2617
	Examiner Name	Erika A. Gary
	Attorney Docket Number	AFF.004C7US

U.S.PATENTS

Examiner Initial*	Cite No	Patent Number	Kind Code ¹	Issue Date	Name of Patentee or Applicant of cited Document	Pages, Columns, Lines where Relevant Passages or Relevant Figures Appear
	1	7149543		2006-12-12	Kumar II	
	2	7321783		2008-01-22	Kim	
	3	5991640		1999-11-23	Lilja	
	4	6823255		2004-11-23	Sass	
	5	6259892		2001-07-10	Helferich	
	6	5914941		1999-07-22	Janky	
	7	6487663		2002-11-26	Jaisimha	
	8	6658247		2003-12-02	Saito	

**INFORMATION DISCLOSURE
STATEMENT BY APPLICANT**
(Not for submission under 37 CFR 1.99)

Application Number		12495190
Filing Date		2009-06-30
First Named Inventor	Russell W. White, et al.	
Art Unit	2617	
Examiner Name	Erika A. Gary	
Attorney Docket Number	AFF.004C7US	

9	6007228		1999-12-28	Agarwal	
10	5341350		1994-08-23	Frank	

If you wish to add additional U.S. Patent citation information please click the Add button.

U.S.PATENT APPLICATION PUBLICATIONS

Examiner Initial*	Cite No	Publication Number	Kind Code ¹	Publication Date	Name of Patentee or Applicant of cited Document	Pages, Columns, Lines where Relevant Passages or Relevant Figures Appear
	1	20020010759		2002-01-24	Hitson	
	2	20020164973		2002-11-07	Janik	

If you wish to add additional U.S. Published Application citation information please click the Add button.

FOREIGN PATENT DOCUMENTS

Examiner Initial*	Cite No	Foreign Document Number ³	Country Code ²	Kind Code ⁴	Publication Date	Name of Patentee or Applicant of cited Document	Pages, Columns, Lines where Relevant Passages or Relevant Figures Appear	T ⁵
	1	EP 0744839	EP		1996-11-27	Grewe		<input type="checkbox"/>
	2	H08-6875	JP		1996-01-12	Taishinji		<input checked="" type="checkbox"/>
	3	H11-288558	JP		1999-10-19	Menju		<input checked="" type="checkbox"/>

**INFORMATION DISCLOSURE
STATEMENT BY APPLICANT**
(Not for submission under 37 CFR 1.99)

Application Number	12495190
Filing Date	2009-06-30
First Named Inventor	Russell W. White, et al.
Art Unit	2617
Examiner Name	Erika A. Gary
Attorney Docket Number	AFF.004C7US

4	H11-164058	JP		1999-06-18	Sato	<input checked="" type="checkbox"/>
5	H08-252976	JP		1998-04-14	Tanaka	<input checked="" type="checkbox"/>
6	WO 2000/54462	WO		2000-09-14	Bae	<input type="checkbox"/>

If you wish to add additional Foreign Patent Document citation information please click the Add button

NON-PATENT LITERATURE DOCUMENTS

Examiner Initials*	Cite No	Include name of the author (in CAPITAL LETTERS), title of the article (when appropriate), title of the item (book, magazine, journal, serial, symposium, catalog, etc), date, pages(s), volume-issue number(s), publisher, city and/or country where published.	T ⁵
	1	Affinity Labs of Texas, LLC, v. BMW North America, LLC, et al., Civil Action No. 9:08CV164, Order Denying Defendant's Motion For Summary Judgment of Non-Infringement of the '833 Patent, filed October 07, 2010, pages 1 - 5.	<input type="checkbox"/>
	2	Affinity Labs of Texas, LLC, v. Hyundai Motor America, Inc.; Hyundai Motor Manufacturing Alabama LLC.; Volkswagen Group of America, Inc.; and Kia Motors America, Inc., Civil Action No. 9:08CV164, Jury Verdict Form, filed October 28, 2010, pages 1 - 16.	<input type="checkbox"/>
	3	Affinity Labs of Texas, LLC, vs. BMW North America, LLC, et al., Docket 9:08CV164, October 27, 2010, Volume 8 of ___, Pages 2100 Through 2633, Reporter's Transcript of Jury Trial, pages 1 - 88.	<input type="checkbox"/>
	4	Affinity Labs of Texas, LLC, vs. BMW North America, LLC, et al., Docket 9:08CV164, October 28, 2010, Volume 9 of 9, Pages 2634 Through 2824, Reporter's Transcript of Jury Trial, pages 1 - 19.	<input type="checkbox"/>
	5	Affinity Labs of Texas, LLC, Plaintiff and Counter-Claim Defendant, vs. Apple Inc., Defendant and Counter-Claim Plaintiff, Case No. 09-4436-CW, Apple Inc.'s First Invalidity Contentions Pursuant To Patent Local Rule 3-3, filed January 5, 2011, pages 1-25, with accompanying Appendixes A-G.	<input type="checkbox"/>

If you wish to add additional non-patent literature document citation information please click the Add button

**INFORMATION DISCLOSURE
STATEMENT BY APPLICANT**
(Not for submission under 37 CFR 1.99)

Application Number	12495190	
Filing Date	2009-06-30	
First Named Inventor	Russell W. White, et al.	
Art Unit	2617	
Examiner Name	Erika A. Gary	
Attorney Docket Number	AFF.004C7US	

EXAMINER SIGNATURE

Examiner Signature		Date Considered	
--------------------	--	-----------------	--

***EXAMINER:** Initial if reference considered, whether or not citation is in conformance with MPEP 609. Draw line through a citation if not in conformance and not considered. Include copy of this form with next communication to applicant.

¹ See Kind Codes of USPTO Patent Documents at www.USPTO.GOV or MPEP 901.04. ² Enter office that issued the document, by the two-letter code (WIPO Standard ST.3). ³ For Japanese patent documents, the indication of the year of the reign of the Emperor must precede the serial number of the patent document. ⁴ Kind of document by the appropriate symbols as indicated on the document under WIPO Standard ST.16 if possible. ⁵ Applicant is to place a check mark here if English language translation is attached.

**INFORMATION DISCLOSURE
STATEMENT BY APPLICANT**
(Not for submission under 37 CFR 1.99)

Application Number	12495190
Filing Date	2009-06-30
First Named Inventor	Russell W. White, et al.
Art Unit	2617
Examiner Name	Erika A. Gary
Attorney Docket Number	AFF.004C7US

CERTIFICATION STATEMENT

Please see 37 CFR 1.97 and 1.98 to make the appropriate selection(s):

That each item of information contained in the information disclosure statement was first cited in any communication from a foreign patent office in a counterpart foreign application not more than three months prior to the filing of the information disclosure statement. See 37 CFR 1.97(e)(1).

OR

That no item of information contained in the information disclosure statement was cited in a communication from a foreign patent office in a counterpart foreign application, and, to the knowledge of the person signing the certification after making reasonable inquiry, no item of information contained in the information disclosure statement was known to any individual designated in 37 CFR 1.56(c) more than three months prior to the filing of the information disclosure statement. See 37 CFR 1.97(e)(2).

See attached certification statement.

Fee set forth in 37 CFR 1.17 (p) has been submitted herewith.

None

SIGNATURE

A signature of the applicant or representative is required in accordance with CFR 1.33, 10.18. Please see CFR 1.4(d) for the form of the signature.

Signature	/Mark J. Rozman/	Date (YYYY-MM-DD)	2011-01-18
Name/Print	Mark J. Rozman	Registration Number	42117

This collection of information is required by 37 CFR 1.97 and 1.98. The information is required to obtain or retain a benefit by the public which is to file (and by the USPTO to process) an application. Confidentiality is governed by 35 U.S.C. 122 and 37 CFR 1.14. This collection is estimated to take 1 hour to complete, including gathering, preparing and submitting the completed application form to the USPTO. Time will vary depending upon the individual case. Any comments on the amount of time you require to complete this form and/or suggestions for reducing this burden, should be sent to the Chief Information Officer, U.S. Patent and Trademark Office, U.S. Department of Commerce, P.O. Box 1450, Alexandria, VA 22313-1450. **DO NOT SEND FEES OR COMPLETED FORMS TO THIS ADDRESS. SEND TO: Commissioner for Patents, P.O. Box 1450, Alexandria, VA 22313-1450.**



INTERNATIONAL APPLICATION PUBLISHED UNDER THE PATENT COOPERATION TREATY (PCT)

<p>(51) International Patent Classification ⁷ : H04L 12/28</p>	<p>A1</p>	<p>(11) International Publication Number: WO 00/54462 (43) International Publication Date: 14 September 2000 (14.09.00)</p>
<p>(21) International Application Number: PCT/KR00/00157 (22) International Filing Date: 29 February 2000 (29.02.00) (30) Priority Data: 1999/7857 10 March 1999 (10.03.99) KR (71) Applicant (for all designated States except US): MPIC [KR/KR]; Suite 201, Bumdari Bldg, 601-16, Yoksam-Dong, Kangnam-Ku, Seoul 135-080 (KR). (72) Inventors; and (75) Inventors/Applicants (for US only): BAE, Yong Kook [KR/KR]; 101-206, Gangchon Apt., Dongbu Ichon-Dong, Yongsan-Ku, Seoul 140-030 (KR). OH, Won Taek [KR/KR]; 314-301, Jukong Apt., 20-9, Banpo-Dong, Seocho-Ku, Seoul 137-040 (KR). (74) Agent: KIM, Samsoo; 3rd floor, Dukwon Bldg, 637-19, Yoksam-dong, Kangnam-ku, Seoul 135-080 (KR).</p>		<p>(81) Designated States: AE, AL, AM, AT, AU, AZ, BA, BB, BG, BR, BY, CA, CH, CN, CR, CU, CZ, DE, DK, DM, EE, ES, FI, GB, GD, GE, GH, GM, HR, HU, ID, IL, IN, IS, JP, KE, KG, KP, KR, KZ, LC, LK, LR, LS, LT, LU, LV, MA, MD, MG, MK, MN, MW, MX, NO, NZ, PL, PT, RO, RU, SD, SE, SG, SI, SK, SL, TJ, TM, TR, TT, TZ, UA, UG, US, UZ, VN, YU, ZA, ZW, ARIPO patent (GH, GM, KE, LS, MW, SD, SL, SZ, TZ, UG, ZW), Eurasian patent (AM, AZ, BY, KG, KZ, MD, RU, TJ, TM), European patent (AT, BE, CH, CY, DE, DK, ES, FI, FR, GB, GR, IE, IT, LU, MC, NL, PT, SE), OAPI patent (BF, BJ, CF, CG, CI, CM, GA, GN, GW, ML, MR, NE, SN, TD, TG).</p> <p>Published With international search report. In English translation (filed in Korean).</p>

(54) Title: METHOD AND APPARATUS FOR TRANSFERRING AUDIO FILES

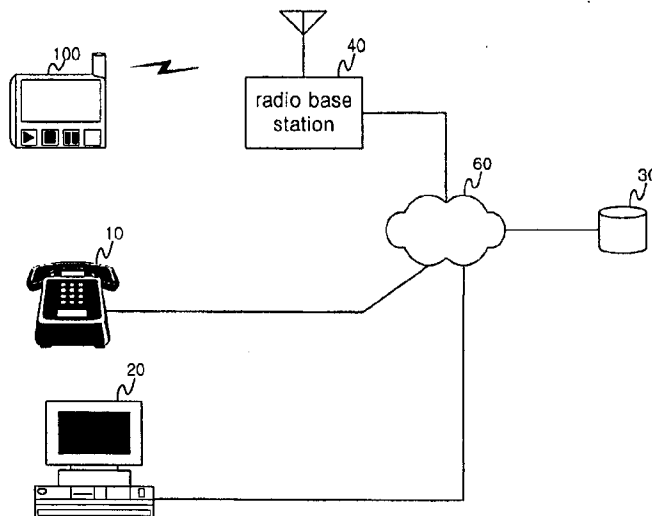

(57) Abstract

A music file downloading method wherein a desired music file can readily be selected and downloaded by the user and the expense thereof can easily be settled, and a music file reproduction apparatus employing said music file downloading method. If the user selects a desired tune over a communication network (60), then a music file server (30) having music files stored therein sends the music file of the selected tune to a radio base station (40) together with an identifier. The radio base station (40) receives the music file of the selected tune and the identifier from the music file server (30) and transmits them to the music file reproduction apparatus by radio. The music file reproduction apparatus stores the music file transmitted from the radio base station (40) in its memory when the identifier transmitted from the base station is identical with its unique identifier.

FOR THE PURPOSES OF INFORMATION ONLY

Codes used to identify States party to the PCT on the front pages of pamphlets publishing international applications under the PCT.

AL	Albania	ES	Spain	LS	Lesotho	SI	Slovenia
AM	Armenia	FI	Finland	LT	Lithuania	SK	Slovakia
AT	Austria	FR	France	LU	Luxembourg	SN	Senegal
AU	Australia	GA	Gabon	LV	Latvia	SZ	Swaziland
AZ	Azerbaijan	GB	United Kingdom	MC	Monaco	TD	Chad
BA	Bosnia and Herzegovina	GE	Georgia	MD	Republic of Moldova	TG	Togo
BB	Barbados	GH	Ghana	MG	Madagascar	TJ	Tajikistan
BE	Belgium	GN	Guinea	MK	The former Yugoslav Republic of Macedonia	TM	Turkmenistan
BF	Burkina Faso	GR	Greece	ML	Mali	TR	Turkey
BG	Bulgaria	HU	Hungary	MN	Mongolia	TT	Trinidad and Tobago
BJ	Benin	IE	Ireland	MR	Mauritania	UA	Ukraine
BR	Brazil	IL	Israel	MW	Malawi	UG	Uganda
BY	Belarus	IS	Iceland	MX	Mexico	US	United States of America
CA	Canada	IT	Italy	NE	Niger	UZ	Uzbekistan
CF	Central African Republic	JP	Japan	NL	Netherlands	VN	Viet Nam
CG	Congo	KE	Kenya	NO	Norway	YU	Yugoslavia
CH	Switzerland	KG	Kyrgyzstan	NZ	New Zealand	ZW	Zimbabwe
CI	Côte d'Ivoire	KP	Democratic People's Republic of Korea	PL	Poland		
CM	Cameroon	KR	Republic of Korea	PT	Portugal		
CN	China	KZ	Kazakstan	RO	Romania		
CU	Cuba	LC	Saint Lucia	RU	Russian Federation		
CZ	Czech Republic	LI	Liechtenstein	SD	Sudan		
DE	Germany	LK	Sri Lanka	SE	Sweden		
DK	Denmark	LR	Liberia	SG	Singapore		
EE	Estonia						

METHOD AND APPARATUS FOR TRANSFERRING AUDIO FILES

Technical Field of the Invention

5 The present invention relates generally to a method and apparatus for downloading music files, and in particular to a music file downloading method which enables a user to select and download a desired music file readily and settle the expense thereof easily, and to a music file reproduction apparatus employing said music file downloading method.

10

Background of the Invention

 With the development of audio compression technique, music file decoding techniques having sound quality comparable to that of a compact disc and yet have a small size have recently been proposed one after another. 15 Among them, a motion pictures experts group 1 (MPEG -1) layer 3 (MP3) format technique is most widely used at the present. In this MP3 technique, a computer downloads and reproduces an MP3 file, or a portable MP3 player downloads and reproduces the MP3 file directly so that it can be used as an 20 alternative to a conventional portable cassette player.

 However, conventionally, it has been necessary to use a computer in order to download a music file to an MP3 player. Namely, the computer needs to be connected to a music file database for downloading a music file therefrom to the MP3 player.

25 The construction of a conventional MP3 player and a conventional

method for downloading a music file to an MP3 player is described hereinafter with reference to Figs. 6 and 7.

Fig. 6 is a chart illustrating a conventional method for downloading a music file to a conventional MP3 player and Fig. 7 is a block diagram showing
5 an internal construction of the conventional MP3 player.

First, the user connects an MP3 player 500 to a communication port of a computer 20 via a cable 50. Then, in order to download a desired music file, the user connects the computer 20 via a communication network 60 to a music file server or a database 30 in which the desired music file is stored. The
10 music file server requests the user to select a music file. If the user selects a music file in response to instructions displayed on a screen of the computer 20, then the selected music file is downloaded from the database 30 to the MP3 player 500 via the computer 20. The music file server stores information about the music file downloading by the user and charges the user later a purchasing
15 price on the basis of the stored information. Alternatively, the server may collect the selling price from the user in a way that it sends the music file only to users who have paid the purchasing price in advance.

After the selected music file is downloaded to the MP3 player 500 via the computer 20 in the above manner, it is stored in a memory 120 through a
20 data interface 130 under control of a controller 110 in the MP3 player 500. For the memory 120, a nonvolatile memory such as a flash memory or an electrically erasable and programmable read only memory (EEPROM) whose contents are not erased even when power is not applied thereto, is used.

If the user applies a reproduction start instruction to the MP3 player 500
25 via an input unit 150 for reproduction of the music file stored in the above

manner, then the controller 110 reads the stored music file from the memory 120 and transfers it to an MP3 decoder 160. Subsequently, the MP3 decoder 160 converts the music file transferred by the controller 110 into an analog signal and outputs the converted analog signal as music through a speaker or
5 earphones.

However, the calculation of a downloading fee becomes a problem in downloading and reproducing digital music in the above manner. Generally, systems for charging the fee for downloading digital music may be classified into two types, one based on a downloading time and the other based on the
10 number of downloaded music titles. Since the fee for downloading one or two titles is within the range from several hundred Korean won to two thousand at most in any of the two systems, it is difficult to settlement such small amounts by credit card or giro. Of course, the download fee can be contained within a communication service fee in the case where the user is a member of a charged
15 communication service such as Chollian or Hitel in Korea. However, the number of users using the Internet is recently on a rapidly increasing trend and thus, they frequently access a music file server directly over the Internet, without intervention of a communication service. As a result, there is a need for effective means for rapid settling of the downloading fee.

20 Further, a large amount of time and inconvenient line connections are required in downloading data to a MP3 player, because the downloading operation is performed only via the computer.

Detailed Description of the Invention

25

The present invention has been made in view of the above problems, and it is an objective of the present invention to provide a music file downloading method which is capable of readily settling the downloading fees when music files (including multimedia files such as animation files, moving picture files, etc.) are downloaded.

It is another objective of the present invention to provide a music file downloading method which is capable of readily downloading a music file, and a music file reproduction apparatus employing said a music file downloading method.

In accordance with the present invention, the above and other objectives can be achieved by providing a method for downloading music files to a music file reproduction apparatus which includes a radio circuit with a unique identifier, comprising the steps of: allowing a user to select a tune over a communication network; allowing a music file server having the music files stored therein to send the selected tune from the stored music files to a radio base station together with an identifier; allowing the radio base station to receive the selected music file and the identifier from the music file server and transmit them to the music file reproduction apparatus by radio; and allowing the music file reproduction apparatus to store the music file transmitted from the radio base station in its memory if the identifier transmitted from the base station is identical with its unique identifier.

Brief Description of the Drawings

The above and other objectives and other advantages of the present

invention will be more clearly understood from the following description taken in conjunction with the accompanying drawings, in which:

Fig. 1 is a chart illustrating a music file downloading method in accordance with the preferred embodiment of the present invention;

5 Fig. 2 is a block diagram showing an internal construction of a music file reproduction apparatus in accordance with the preferred embodiment of the present invention;

Fig. 3 shows examples of an internal construction of a radio interface in Fig. 2, wherein:

10 Fig. 3a is a block diagram showing the construction of the radio interface for a reception-dedicated type; and

Fig. 3b is a block diagram showing the construction of the radio interface for a two-way type;

15 Fig. 4 is a chart illustrating an example of a music file downloading method using a mobile telephone with music file reproduction function (in accordance with an alternative embodiment of the present invention?);

Fig. 5 is a block diagram showing an internal construction of the mobile telephone with music file reproduction function (in accordance with the alternative embodiment of the present invention?);

20 Fig. 6 is a chart illustrating a conventional method for downloading a music file to a conventional music file reproduction apparatus; and

Fig. 7 is a block diagram showing an internal construction of the conventional music file reproduction apparatus.

25 Description of the Preferred Embodiment

Fig. 1 is a chart illustrating a music file downloading method in accordance with the preferred embodiment of the present invention and Fig. 2 is a block diagram showing an internal construction of a music file reproduction apparatus in accordance with the preferred embodiment of the present invention. As shown in Fig. 2, the subject music file reproduction apparatus 100 comprises a radio interface 180 and an identifier (ID) storage unit 190 in addition to the construction (contained within a dotted block) of a conventional music file reproduction apparatus.

10 In the present embodiment, the user accesses an existing voice or data communication network to select a desired tune. The music file of the selected tune is then downloaded by radio to the music file reproduction apparatus 100 on the basis of a unique ID of the apparatus, which is stored in the ID storage unit 190.

15 First, a description of the operation of selecting a desired tune using a general telephone in accordance with the preferred embodiment of the present invention is given. The user accesses an automatic response system (ARS) connected to a communication network 60 using a telephone 10. As an example of the ARS a 700 service may be used. Then, the ARS requests the user to enter his ID (e.g., a telephone or call number of a mobile telephone or
20 pager to which the music is to be downloaded). Upon receiving such a request from the ARS, the user enters his ID using dial buttons of the telephone 10.

After receiving the user's ID, the ARS sends a plurality of voice information messages to the user for selection of the tune. For example, the
25 ARS outputs an initial voice information message, "Push number 1 if the genre

of your desired tune is classics, number 2 for pop song, number 3 for Korean pop song, number 4 for trot, number 5 for newest song, number 6 for jazz and number 7 for Korean classics.” If the user selects number 2, then the ARS outputs a voice information message, “Push number 1 if the genre of your
5 desired tune is ballad, number 2 for dance music, number 3 for trot, number 4 for rock, number 5 for R&B and number 6 for the others.” If the user selects number 1, then the ARS outputs a voice information message, “Love Me Tender by Elvis Presley is number 01, Angel of the Morning by Juice Newton is number 02, ..., .” If the user selects number 01, then the ARS outputs a
10 voice information message, “You have selected Love Me Tender by Elvis Presley. Push number 1 if it is correct and number 2 if not.” If the user selects number 1, the tune selection is completed.

Alternatively, a voice recognition technique may be applied to the ARS. In such a case, upon receiving the user’s ID, the ARS outputs a voice
15 information message, “Select a desired tune.” If the user says “Love Me Tender”, then the ARS outputs a voice information message, “Select a singer.” If the user says “Elvis Presley”, then the ARS outputs a voice information message, “You have selected Love Me Tender of Elvis Presley. Push number
20 1 if it is correct and number 2 if not.” If the user selects number 1, the tune selection is completed.

Next, a description of the operation of selecting a desired tune using both a general telephone and a computer in accordance with the preferred embodiment of the present invention is given. The user connects a server
30 via the communication network 60 using a computer 20 in which music lists are stored. The communication network 60 may be, for example, the Internet.
25

The server displays a list of categories on a screen of the computer 20. For example, the category list may be displayed as follows:

1. Pop Song 2. Korean Pop Song 3. Old Song
4. Newest Song 5. Jazz 6. Light Music
5 7. Classics 8. Korean Classics 9. Meditation Music

If the user selects a pop song category by clicking on it (or entering “1”), then the server displays a list of tunes belonging to the pop song category on the computer screen. For example, the tune list may be displayed as follows:

- 10 001. Love Me Tender/Elvis Presley
002. Angel of the Morning/Juice Newton
003. Abracadabra/Steve Miller Band
004. Again/Janet Jackson
....
15 Previous Page Next Page

in case the tunes belonging to the selected category are large in number, they can be displayed over several pages and the user can travel from one page to another using a “Previous Page” or a “Next Page” button.

The user, after deciding desired tune for purchasing in his mind,
20 accesses the ARS connected to the communication network 60 using the telephone 10. The ARS, which may provide the 700 service as stated previously, requests the user to enter his ID. In response to such a request from the ARS, the user enters his ID using dial buttons of the telephone 10. After receiving the user’s ID, the ARS sends a voice information message,
25 “Select a desired tune.” If the user selects number 001, then the ARS outputs a

voice information message, "You have selected Love Me Tender by Elvis Presley. Push number 1 if it is right and number 2 if wrong." If the user selects number 1, the tune selection is completed.

Next, a description of the operation of selecting a desired tune using a
5 computer in accordance with the preferred embodiment of the present invention is given. The user accesses the music file server 30 connected to the communication network 60 using the computer 20. The communication network 60 may be the Internet as stated previously. The music file server 30 requests the user to enter his ID and password. In this case, the user must
10 register in the music file server 30 (or join it as a member) before downloading a desired music file therefrom. Upon registering at the music file server 30, the user receives a unique ID therefrom and can lock it with a password. If the user enters his ID and password, then the music file server 30 authenticates whether the password is valid. In the case where the password is not valid, the
15 server 30 requests the user to enter his password again or cuts the connection thereto.

In the case where the password is valid, the music file server 30 displays a list of categories on the screen of the computer 20. For example, the category list may be displayed as follows:

- 20 1. Pop Song 2. Korean Pop Song 3. Old Song
 4. Newest Song 5. Jazz 6. Light Music
 7. Classics 8. Korean Classics 9. Meditative Music

If the user selects a pop song category by clicking on it (or entering "1"), then the music file server 30 displays a list of tunes belonging to the pop
25 song category on the computer screen. For example, the tune list may be

displayed as follows:

001. Love Me Tender/Elvis Presley

002. Angel of the Morning/Juice Newton

003. Abracadabra/Steve Miller Band

5 004. Again/Janet Jackson

....

Previous Page

Next Page

In case the tunes belonging to the selected category are large in number, they can be displayed over several pages and the user can travel from one page
10 to another using a "Previous Page" button or a "Next Page" button.

If the user selects a desired tune, then the music file server 30 displays a message, "Download ?", on the computer screen. If the user selects "Yes", the music file server 30 sends a music file of the selected tune formatted for example for MP3 to a radio base station 40. At this time, the music file of the
15 selected tune is sent to the radio base station 40 together with the user's ID.

Upon receiving the music file from the music file server 30 together with the user's ID, the radio base station 40 transmits the received music file by radio together with a radio ID corresponding to the received user's ID. Then, the music file reproduction apparatus 100 receives the transmitted music
20 file and radio ID through the radio interface 180. If the radio ID received through the radio interfacc 180 is identical with the ID stored in the ID storage unit 190, the received music file is stored in a memory 120 and the music file downloading step is thus completed.

Here, the user's ID and the radio ID may be the same or different from
25 each other. For example, in the case where an interface of a mobile telephone

is used as the radio interface 180, a telephone number of the mobile telephone may be used as the user's ID as well. Alternatively, a different user's ID may be registered in the server and it can be linked to the telephone number of the mobile telephone by the server.

5 Fig. 3 shows examples of an internal construction of the radio interface 180 in Fig. 2, wherein Fig. 3a is a block diagram showing the construction of the radio interface 180 for a reception-dedicated type and Fig. 3b is a block diagram showing the construction of the radio interface 180 for a two-way type. An example of the reception-dedicated interface may be an interface of a
10 pager, and an example of the two-way interface may be an interface of a mobile telephone.

A general pager can receive but cannot send data. As a result, the construction of such a pager can be made simple as shown in Fig. 3a and thus, it can easily be added to the construction of a conventional music file
15 reproduction apparatus such as an MP3 player.

The base station 40 modulates music file data from the music file server 30 into a radio frequency (RF) signal and transmits the modulated RF signal by radio. The transmitted RF signal is received at an antenna Ant of the reproduction apparatus 100 and converted into an electrical signal, which is
20 then amplified by an amplifier AMP and demodulated into a base-band signal by a demodulator 181. A base-band circuit 182 converts the base-band signal from the demodulator 181 into a signal readable by a controller 110 and outputs the converted signal to the controller 110 through a data interface 130.

The controller 110 detects the radio ID from the output signal from the
25 base-band circuit 182 and compares it with the ID stored in the ID storage unit

190 to determine whether the two IDs are identical to each other. If the radio ID is identical to the ID stored in the ID storage unit 190, then the controller 110 stores the received music file data in the memory 120. As a result, the downloading of the music file is completed.

5 Further, in the case where the music file reproduction apparatus 100 comprises the pager circuitry as mentioned above, it can be used as a pager as well as a player, resulting in the convenience in use.

Next, a description of the radio interface with the two-way construction as in the mobile telephone is given. In the case where the mobile telephone
10 employs a cellular system, it has to periodically transmit its ID to a mobile switching center because a cell in which it is located must be recognized by the switching center. For this reason, the radio interface must comprise both transmission and reception circuits as shown in Fig. 3b even when it performs only the receiving function of music file data. In this case, the music file data
15 reception operation of the radio interface is performed in a similar manner to that of the pager circuitry and thus, a detailed description thereof is omitted.

Next, a description of a music file downloading method using a mobile telephone with a music file reproduction function in accordance with an alternative embodiment of the present invention is given with reference to
20 Figs. 4 and 5. Fig. 4 is a chart illustrating the music file downloading method in accordance with the alternative embodiment of the present invention and Fig. 5 is a block diagram showing an internal construction of the mobile telephone with the music file reproduction function in accordance with the alternative embodiment of the present invention.

25 A conventional mobile telephone comprises typically a nonvolatile

memory such as a flash memory and a circuitry capable of receiving a music file by radio. Thus, as seen from Fig. 5, the present invention can readily be implemented by adding a decoder 290 capable of decoding the received music file, to the existing construction of the mobile telephone.

5 First, the user accesses the ARS connected to the communication network 60 using a mobile telephone 200 to select a desired tune. The tune selection operation using the mobile telephone 200 is performed in the same manner as that using a general telephone, stated previously with reference to Fig. 1, and a detailed description thereof will thus be omitted.

10 If the user selects a desired tune, the music file server 30 sends a music file of the selected tune to the base station 40, which in turn transmits it to the mobile telephone 200 by radio. In the mobile telephone 200, RF signal from the base station 40 is demodulated by a radio circuit 220, converted into the original music file by a base-band circuit 230 and then stored in a memory
15 280.

The radio transmission of the music file can be conducted over a channel other than the traffic channel if the mobile telephone is connected to the ARS over the traffic channel. Alternatively, if the traffic channel is disconnected with the ARS, it may be newly occupied and used to transmit the
20 music file.

The operation of reproducing the music file stored in the memory 280 as mentioned above is performed in the following manner. First, if the user pushes a music play button on the mobile telephone, a controller 210 in the mobile telephone detects a corresponding signal from an input unit 260 and
25 transfers the music file data from the memory 280 to the music file decoder

(MP3 decoder in the present embodiment) 290 in response to the detected signal.

Upon receiving the music file data from the memory 280, the decoder 290 converts it into an analog signal, which is then amplified to a predetermined level and outputted to a speaker SP or an earphone/headphone
5 by an audio circuit 240. As a result, the user can listen to music.

Next, a description of a process of charging a fee for downloading a music file is given.

First, it is preferable that the downloading fee is appended to telephone
10 charges through the ARS, in a manner similar to that of Korea Telecom's current practice in charging additional service fees for use of a 700 service. In the case where the music file reproduction apparatus is also used as a pager or mobile telephone, it is possible to append music file downloading fee to the call or telephone charges on the pager or mobile telephone. This makes the fee
15 settlement very easy and reduces significantly the expenses associated with the fee settlement. A system for charging the downloading fee can be implemented based either on a downloading time or the number of downloaded music tunes.

Alternatively, in the case where the user pays his membership fee on a
20 monthly or yearly basis to hold the membership, he may freely download while he maintains his membership, or a predetermined number of tunes.

Although the preferred embodiments of the present invention have been described for illustrative purposes, those skilled in the art will appreciate that various modifications, additions and substitutions are possible, without
25 departing from the scope and spirit of the invention.

For example, although the music file and the associated reproduction apparatus have been described respectively as MP3 file and MP3 player in the present embodiments, the present invention is not limited thereto. Namely, the music file includes files coded in any other coding manner and also any coded
5 contents other than music, such as a voice of a specific person (e.g., a star performer), a lecture on English or other languages, sounds of nature, for example song of the birds, roar of the cataracts, etc.

Further, the present invention is applicable to multimedia files such as animation file, motion picture file, etc. as well.

10

Industrial Applicability

As apparent from the above description, according to the present invention, a downloading fee can readily be settled when a music file is
15 downloaded. Further, the music file can readily be downloaded to a music file reproduction apparatus. These result in high convenience in use.

What is claimed is:

1. A method for downloading music files to a music file reproduction apparatus which includes a radio circuit with a unique identifier, comprising
5 the steps of:

a) allowing a user to select a tune over a communication network;

b) allowing a music file server having music files stored therein to send the stored music file corresponding to the selected tune to a radio base station together with an identifier;

10 c) allowing said radio base station to receive the music file of the selected tune and the identifier from said music file server and transmit the music file of the selected tune and the identifier to said music file reproduction apparatus by radio; and

d) allowing said music file reproduction apparatus to store said music
15 file transmitted from said radio base station in its memory when the identifier transmitted from said base station is the same as said unique identifier.

2. The method as set forth in Claim 1, wherein said step a) includes the steps of:

20 a-1) allowing the user to access an automatic response system using a telephone;

a-2) allowing the user to enter his identifier using dial buttons of said telephone;

a-3) allowing the user to enter a title of the desired tune; and

25 a-4) allowing said automatic response system to send the user's

identifier and the tune title or its code to said music file server.

3. The method as set forth in Claim 1, wherein said step a) includes the steps of:

- 5 a-1) allowing the user to access said music file server over a data communication network using a computer;
- a-2) allowing the user to enter his identifier and password; and
- a-3) allowing the user to select a title of the desired tune.

10 4. The method as set forth in any one of Claims 1 to 3, wherein said radio circuit of said music file reproduction apparatus includes a circuitry of a pager and wherein said step c) includes the step of transmitting the received music file and identifier to said music file reproduction apparatus by radio according to a data transmission system of said pager.

15

5. The method as set forth in any one of Claims 1 to 3, wherein said radio circuit of said music file reproduction apparatus includes a circuitry of a mobile telephone and wherein said step c) includes the step of transmitting the received music file and identifier to said music file reproduction apparatus by

20 radio according to a data transmission system of said mobile telephone.

6. A music file reproduction apparatus comprising:

a memory for storing music file therein;

a data interface for receiving the music file;

25 a decoder for converting said music file into an analog signal;

an input unit for sensing a user's key operation; and
a controller for controlling said memory, data interface, decoder and
input unit, wherein said apparatus further comprises:

an identifier storage unit for storing a unique identifier of said apparatus
5 therein; and

a radio interface for receiving radio data with the same identifier as said
unique identifier and transferring it to said data interface.

7. The apparatus as set forth in Claim 6, wherein said radio interface
10 includes:

an antenna for converting an electromagnetic wave signal into an
electrical signal;

a demodulator for demodulating the electrical signal from said antenna
into a base-band signal; and

15 a base-band circuit for extracting a data signal from the base-band
signal from said demodulator and transferring it to said data interface.

8. The apparatus as set forth in Claim 6, wherein said radio interface
includes:

20 an antenna for converting an electromagnetic wave signal into an
electrical signal and vice versa;

a demodulator for demodulating the electrical signal from said antenna
into a base-band signal;

a modulator for modulating a base-band signal into an electrical signal
25 at a radio frequency;

a duplexer for transferring said electrical signal from said antenna to said demodulator and said electrical signal from said modulator to said antenna, respectively; and

a base-band circuit for extracting a data signal from said base-band
5 signal from said demodulator, transferring it to said data interface and
converting data from said data interface into said base-band signal to be
modulated by said modulator.

9. A mobile telephone having a music file reproduction function,
10 comprising:

a memory for storing data therein;

an antenna for converting an electromagnetic wave signal into an
electrical signal and vice versa;

a radio circuit for processing a radio frequency signal from or to said
15 antenna;

an audio circuit for processing an audio signal;

a base-band circuit for converting said audio signal from said audio
circuit into a base-band signal, transferring the converted base-band signal to
said radio circuit, processing a base-band signal from said radio circuit and
20 transferring the resultant signal to said audio circuit;

an input unit for sensing a user's key operation;

a display unit for providing a visual indication of the current operation
state to the user;

an identifier storage unit for storing a unique identifier of said mobile
25 telephone;

a controller for controlling the entire operation of said mobile telephone; and

a music file decoder for converting a music file stored in said memory into an audio signal and transferring it to said audio circuit;

5 said controller, upon receiving a music file with the same identifier as said unique identifier stored in said identifier storage unit, stores the received music file in said memory and transfers said music file stored in said memory to said music file decoder in response to a user's music file play instruction from said input unit.

【DRAWINGS】

【Fig.1】

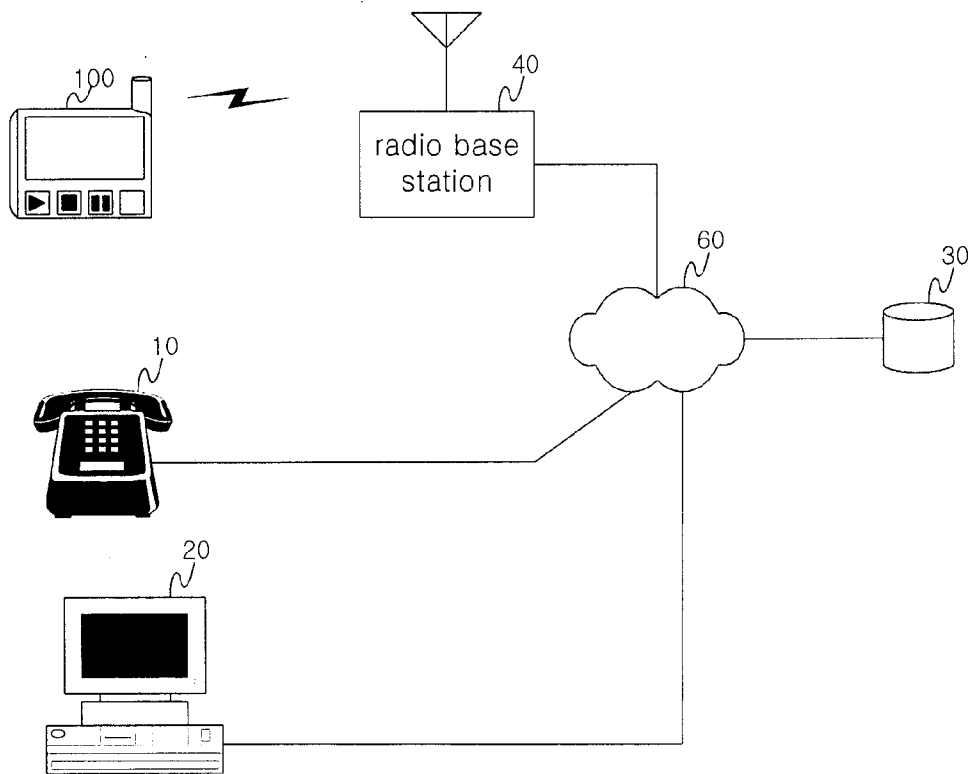

【Fig.2】

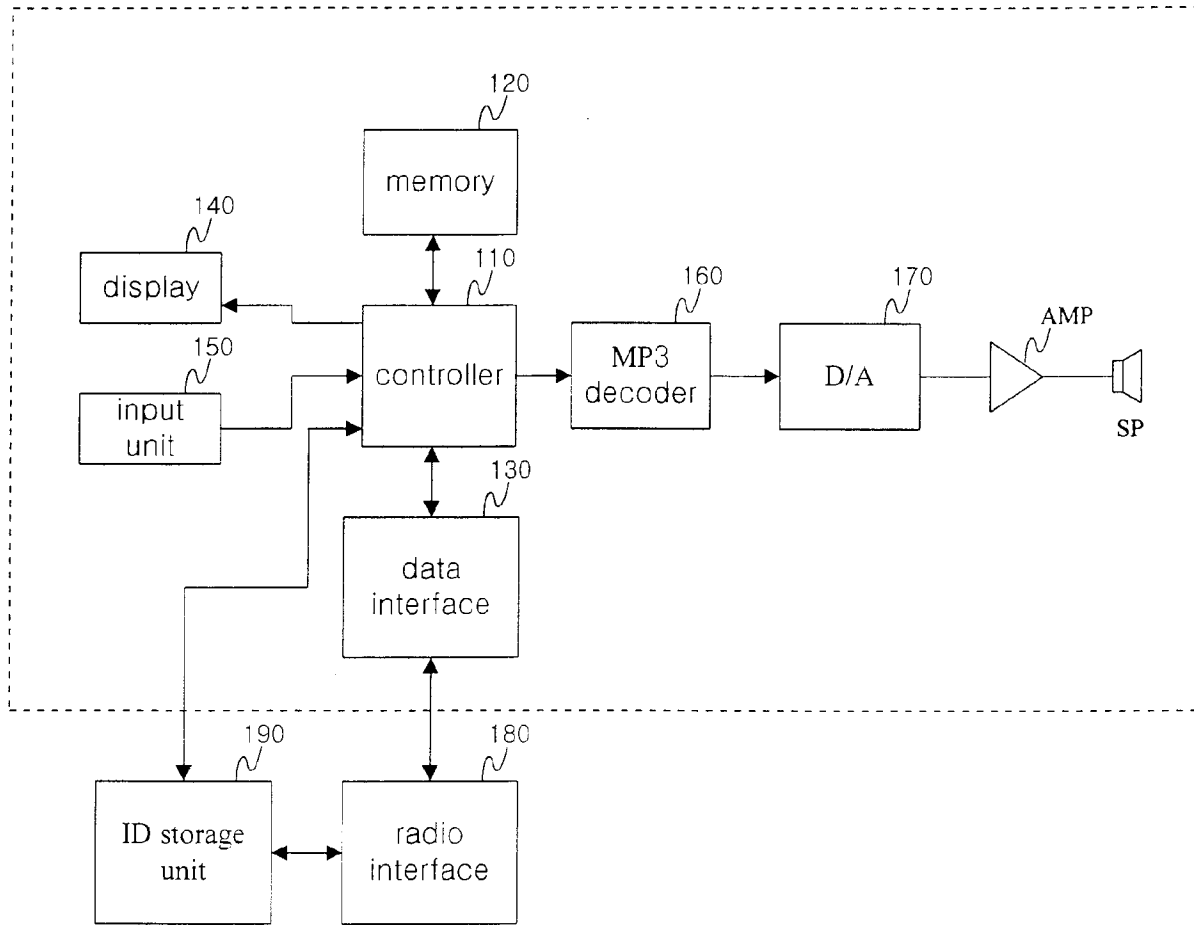

【Fig.3a】

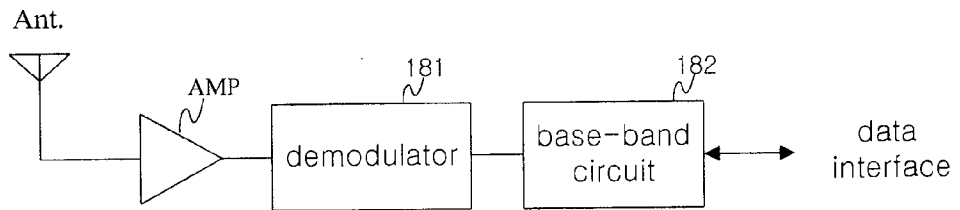

【Fig.3b】

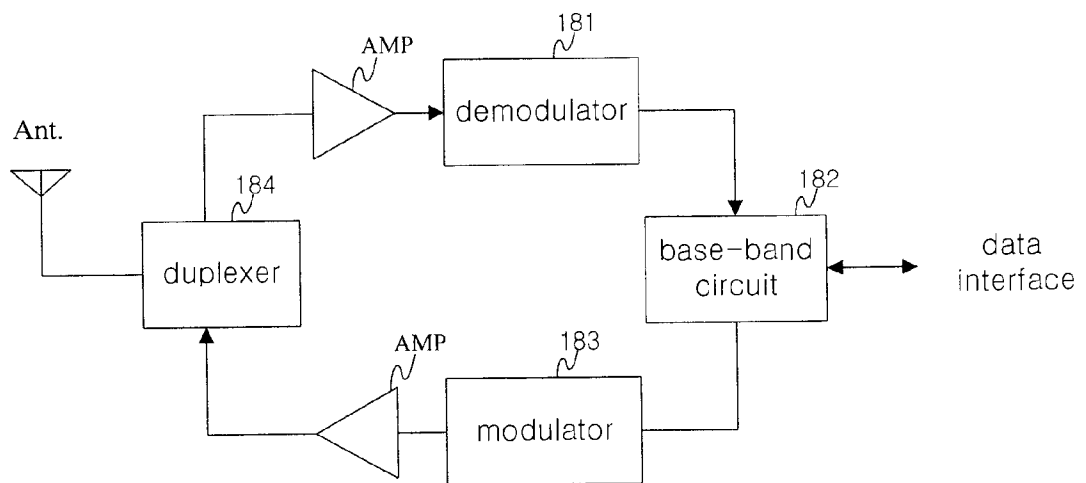

【Fig.4】

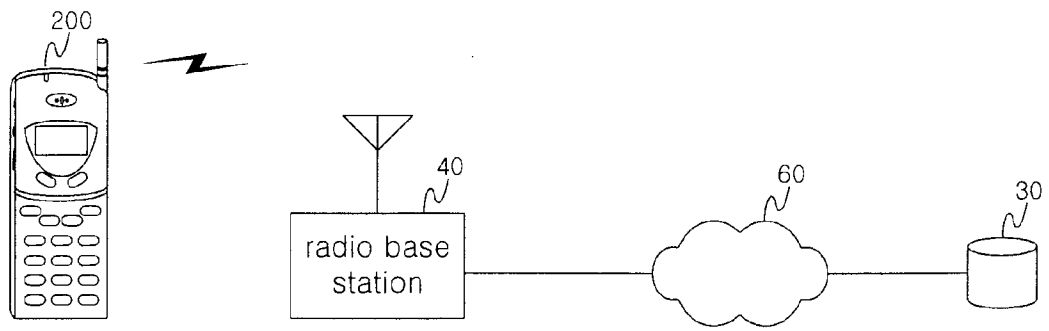

【Fig.5】

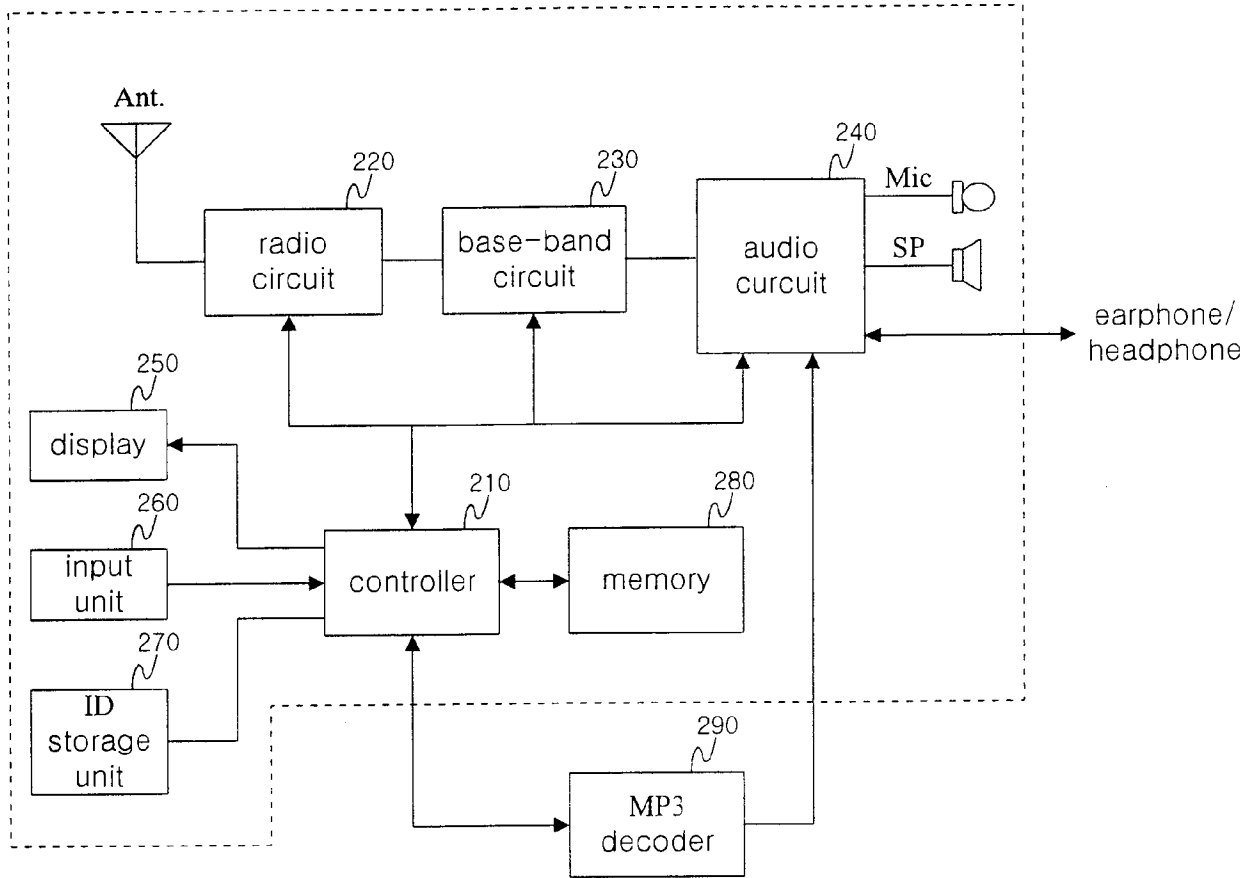

【Fig.6】

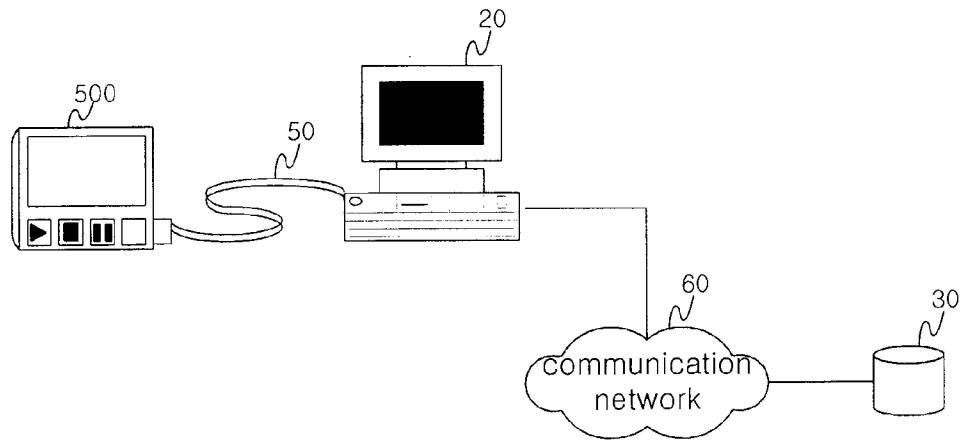

【Fig.7】

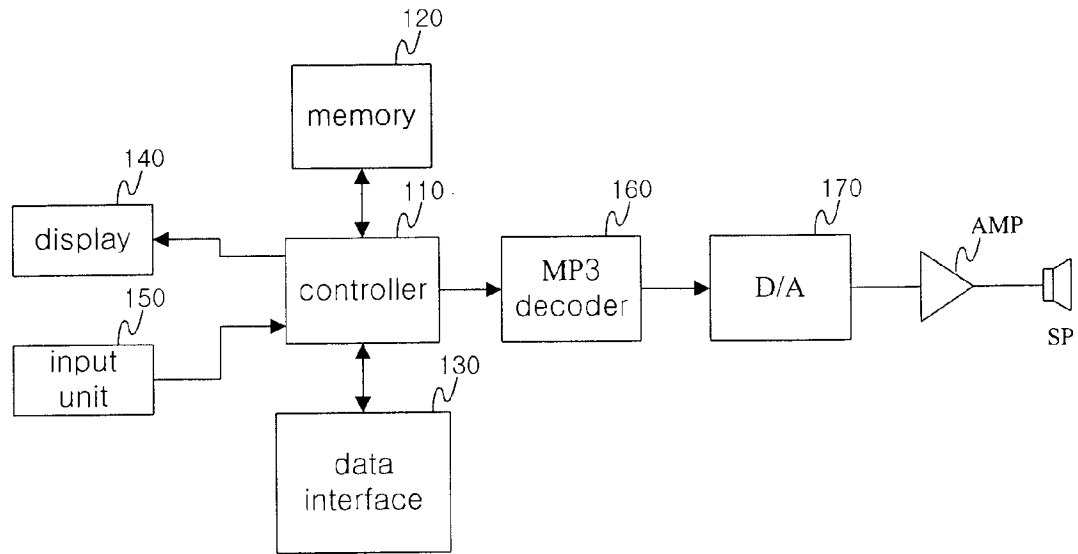

INTERNATIONAL SEARCH REPORT

International application No.
PCT:KR00/00157

A. CLASSIFICATION OF SUBJECT MATTER				
IPC7 H04L 12/28				
According to International Patent Classification (IPC) or to both national classification and IPC				
B. FIELDS SEARCHED				
Minimum documentation searched (classification system followed by classification symbols) IPC7: H04L, H04M, G06F				
Documentation searched other than minimum documentation to the extent that such documents are included in the fields searched Korean Patents and Applications for Inventions since 1975 Korean Utility Models and Applications for Utility Models since 1975				
Electronic data base consulted during the international search (name of data base and, where practicable, search terms used) IEL				
C. DOCUMENTS CONSIDERED TO BE RELEVANT				
Category*	Citation of document, with indication, where appropriate, of the relevant passages	Relevant to claim No.		
Y	US 5,629,867 : abstract, column 1(summary of the invention) claim 1-4, 6-10	1-3, 6		
Y	US 5,809,246 : abstract claim 1, 10, 24	1-3, 6		
A	US 5,987,132 : abstract, FIG.1	1		
A	US 5,867,495 abstract claim 1, 10	1, 6		
<input type="checkbox"/> Further documents are listed in the continuation of Box C. <input checked="" type="checkbox"/> See patent family annex.				
<table style="width: 100%; border: none;"> <tr> <td style="width: 50%; border: none; vertical-align: top;"> * Special categories of cited documents: "A" document defining the general state of the art which is not considered to be of particular relevance "E" earlier application or patent but published on or after the international filing date "L" document which may throw doubts on priority claim(s) or which is cited to establish the publication date of citation or other special reason (as specified) "O" document referring to an oral disclosure, use, exhibition or other means "P" document published prior to the international filing date but later than the priority date claimed </td> <td style="width: 50%; border: none; vertical-align: top;"> "T" later document published after the international filing date or priority date and not in conflict with the application but cited to understand the principle or theory underlying the invention "X" document of particular relevance; the claimed invention cannot be considered novel or cannot be considered to involve an inventive step when the document is taken alone "Y" document of particular relevance; the claimed invention cannot be considered to involve an inventive step when the document is combined with one or more other such documents, such combination being obvious to a person skilled in the art "&" document member of the same patent family </td> </tr> </table>			* Special categories of cited documents: "A" document defining the general state of the art which is not considered to be of particular relevance "E" earlier application or patent but published on or after the international filing date "L" document which may throw doubts on priority claim(s) or which is cited to establish the publication date of citation or other special reason (as specified) "O" document referring to an oral disclosure, use, exhibition or other means "P" document published prior to the international filing date but later than the priority date claimed	"T" later document published after the international filing date or priority date and not in conflict with the application but cited to understand the principle or theory underlying the invention "X" document of particular relevance; the claimed invention cannot be considered novel or cannot be considered to involve an inventive step when the document is taken alone "Y" document of particular relevance; the claimed invention cannot be considered to involve an inventive step when the document is combined with one or more other such documents, such combination being obvious to a person skilled in the art "&" document member of the same patent family
* Special categories of cited documents: "A" document defining the general state of the art which is not considered to be of particular relevance "E" earlier application or patent but published on or after the international filing date "L" document which may throw doubts on priority claim(s) or which is cited to establish the publication date of citation or other special reason (as specified) "O" document referring to an oral disclosure, use, exhibition or other means "P" document published prior to the international filing date but later than the priority date claimed	"T" later document published after the international filing date or priority date and not in conflict with the application but cited to understand the principle or theory underlying the invention "X" document of particular relevance; the claimed invention cannot be considered novel or cannot be considered to involve an inventive step when the document is taken alone "Y" document of particular relevance; the claimed invention cannot be considered to involve an inventive step when the document is combined with one or more other such documents, such combination being obvious to a person skilled in the art "&" document member of the same patent family			
Date of the actual completion of the international search <p style="text-align: center;">15 JUNE 2000 (15.06.2000)</p>		Date of mailing of the international search report <p style="text-align: center;">19 JUNE 2000 (19.06.2000)</p>		
Name and mailing address of the ISA/KR Korean Industrial Property Office Government Complex-Taejon, Dunsan-dong, So-ku, Taejon Metropolitan City 302-701, Republic of Korea Facsimile No. 82-42-472-7140		Authorized officer <p style="text-align: center;">LEE, Saang Woong</p> Telephone No. 82-42-481-5714		



INTERNATIONAL SEARCH REPORT

Information on patent family members

International application No.

PCT/KR00/00157

Patent document cited in search report	Publication date	Patent family member(s)	Publication date
US 5,629,867	05. 13. 97	None	
US 5,809,246	09. 15. 98	None	
US 5,987,132	11. 16. 99	None	
US 5,867,495	02. 02. 99	None	



(12) **EUROPEAN PATENT APPLICATION**

(43) Date of publication:
27.11.1996 Bulletin 1996/48

(51) Int Cl.®: **H04B 1/20**

(21) Application number: **96303614.0**

(22) Date of filing: **21.05.1996**

(84) Designated Contracting States:
DE ES FR GB IT

- **Singer, Howard M.**
Marlboro, New Jersey 07746 (US)
- **Shelby, Kevin Alan**
Red Bank, New Jersey 07701 (US)

(30) Priority: **22.05.1995 US 447336**

(71) Applicant: **AT&T IPM Corp.**
Coral Gables, Florida 33134 (US)

(74) Representative:
Buckley, Christopher Simon Thirsk et al
Lucent Technologies,
5 Mornington Road
Woodford Green, Essex IG8 0TU (GB)

(72) Inventors:
 • **Grewe, Anthony James**
Holmdel, New Jersey 07733 (US)

(54) **Remote control for home audio system**

(57) A remote control unit (30) for use with an in-home audio player adapted to play pre-recorded music stored on a semiconductor music chip storage medium is, in a preferred embodiment, a battery powered, hand held device which enables customized music selections to be made at the audio player from a distant position. The remote control unit includes an LCD display (40), a series of control buttons (44) and an infrared communications interface (42) for transmitting to and receiving data from the audio player. A docking port is included in the audio player for mating with the remote control in order to download general content information stored in memory of the audio player regarding each of the music chips which it has loaded. A processor within the remote control guides the user through a menu driven software routine for making music selections at the player. A user scrolls through the various menus by use of a navigation pointer (46). Soft keys (51-56) on the remote take on different functions depending on the location within the menu driven software routine. For example, a user can choose to play individual music tracks according to a category of music, musical artist or specific song. Other functions of the remote include play, pause, scan (forward and reverse) and fast scan, as well as On/Off and volume control.

FIG. 3

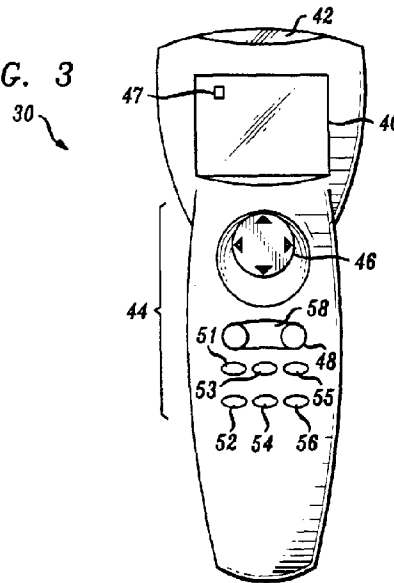

Description**RELATED APPLICATIONS**

The present patent application is related to U.S. Patent Application Serial No. 08/447322, entitled Smart Tray for Audio Player, and having a filing date of May 22, 1995, that application having common inventors and assignee and being incorporated herein by reference.

FIELD OF THE INVENTION

The present invention relates to a remote control unit for an in-home audio player, and more particularly to a remote control unit having a docking arrangement with the audio player for downloading of information to the remote control.

BACKGROUND OF THE INVENTION

The prior art is replete with various remote control units adapted to communicate with a host of different control devices including televisions, VCRs and audio equipment. Depending on the application for the remote control unit, common functional capabilities may include On/Off, volume control, and selection control, e.g., channel or music track selection, fast forward, rewind, scan, etc. With regard to remote control of audio equipment, it is many times desirable to have the ability to make content related selections from a music collection stored in a jukebox type device. Such a device may, for example, take the form of a compact disc (CD ROM) player having multiple disc storage capability.

Compact discs and other recording mediums, however, have some significant disadvantages in regard to the remote access of content information. For one, current recording technologies do not normally include the ability to register the content of the information stored thereon prior to selection at the player. In other words, in order to gain any information regarding the contents of a particular music selection, that selection will first have to be manually selected at the player or by remote. In the alternative, some music players may be manually programmed to play certain selections based upon user input wherein the selections can then be remotely activated.

In either circumstance, there is no way to automatically search and play music by category, for example, by artist, music type, etc., unless a user has prior knowledge with regard to the selection. Such knowledge must include at a minimum the precise location of a selection on the recording medium, a way in which to direct the player apparatus to that location, and a searchable index keyed to the selection and the locations. Largely because of limitations in the recording media, many of these functions cannot be accomplished cost effectively or efficiently at the player, and certainly not from a remote control.

An emerging technological innovation for the recording of consumer directed audio is the storage of pre-recorded audio on a medium known as semiconductor music chips. Digital data stored on the music chips is accessed by means of a solid state audio player having a digital signal processor which converts the stored digital data into audio signals. Up until recently the storage of digital data for reproduction of popular music albums on a single semiconductor chip was not viable because of the amount of memory needed and the costs associated with same. As data compression techniques have further developed, however, the storage of full length albums on modestly sized semiconductor chips has become a reality. The storage of music selections on semiconductor music chips allows for greater flexibility as to the type of information that can be stored and also in the manner in which such information is accessed. For example, content information by way of music category and artist may be stored within the semiconductor music chips and then accessed at the player so that general music selections can be made without prior knowledge by a user. The ability to perform remote selections based on general content information greatly enhances the attractiveness of a solid state music system using the semiconductor chip music storage medium.

It is therefore an object of the present invention, to provide a remote control unit for an audio system wherein general content and selection information from the recording medium are readily available for remote selection by a user. It is further an object of the present invention to provide a remote control unit wherein the selection information available at the remote is easily updated.

SUMMARY OF THE INVENTION

The present invention is a remote control unit for use with an in-home audio player. The audio player is adapted to play pre-recorded music stored on a semiconductor music chip storage medium. In accordance with one preferred embodiment of the invention, the remote unit is a battery powered, hand held device which enables customized music selections to be made at the audio player from a distant position. Typical range of the remote is comparable to that of standard commercial television remotes. The remote control unit includes an LCD display, a series of control buttons and an infrared communications interface for transmitting to and receiving data from the audio player. A docking port is included in the audio player for mating with the remote control in order to download general content information stored in memory of the audio player in regard to each of the music chips which it has loaded. The download procedure is initiated by one or more predetermined button presses on either the remote or player, and the information is transmitted over an interface utilizing infrared energy.

A processor within the remote control guides the user through a menu driven software routine for making

music selections at the player. A user scrolls through the various menus by use of a navigation pointer. Soft keys on the remote take on different functions depending on the location within the menu driven software routine. For example, a user can choose to play individual music tracks according to a category of music, musical artist or specific song. Other functions of the remote include play, pause, scan (forward and reverse) and fast scan, as well as ON/OFF and volume control.

BRIEF DESCRIPTION OF THE FIGURES

For a better understanding of the present invention, reference may be had to the following description of exemplary embodiments thereof, considered in conjunction with the accompanying drawings, in which:

FIG. 1 shows a block diagram for one preferred embodiment of a solid state audio player used in conjunction with the present invention remote control;
 FIG. 2 shows one preferred embodiment of a solid state in-home audio player shown in conjunction with the present invention remote control;
 FIG. 3 shows a top plan view of the present invention audio player remote control;
 FIG. 4 shows one example of a software screen display for the present invention remote wherein the navigation pointer may be used to scroll there-through;
 FIG. 5 shows a second example screen display illustrating use of the soft key functions;
 FIG. 6 shows an exemplary representation of an individual header stored within a music chip; and
 FIG. 7 shows a block diagram for one preferred embodiment of the present invention remote control unit.

DETAILED DESCRIPTION OF THE DRAWINGS

The present invention is a remote control unit used with a solid state audio system that plays music recorded on a semiconductor music chip recording medium. Referring to FIG. 1, there is shown a block diagram of one preferred embodiment of a solid state audio system 10 which utilizes the present invention remote control 30. One or more music chips 16 are coupled to an audio player 12 by means of a music storage tray 20. The audio player 12 is operated by means of a digital signal processor (DSP) 14 which communicates through the music tray 20 in order to access information from the music chips.

Besides the DSP 14 and music tray 20, a stereo coder/decoder (codec) 18, keypad 22, display 24, and remote control interface 26 are included as part of the main hardware architecture of the audio player. The remote control unit 30 communicates to the audio player 12 by means of the remote control interface 26. The keypad, display and remote interface are coupled to asso-

ciated interface logic in the form of an applications specific integrated circuit (ASIC) 27 and comprise the user interface which allows for the making of custom music selections. The audio player 12 is responsible for decoding a bit stream read from a selected music chip 16 and outputting the music through an output device, such as speakers or headphones 28.

The music chips 16 used with the audio player 12 are essentially memory devices having digital data stored thereon which corresponds to pre-recorded music. The pre-recorded audio data is stored on the chip 16 in a compressed format by means of an audio coding algorithm. The algorithm reduces the amount of digital information necessary to be stored from a master recording, while still reproducing essentially the same audio quality when the data is read back. Encoding by means of the algorithm is necessary in order to store sufficient quantities of data so that the music on the chips 16 may have times of play comparable to that of current day albums. Other information pertaining to the musical content of the chip, including a music category, artist and specific addressing information, is stored in a series of headers which are downloaded to the audio player once the chip is loaded. For a more detailed explanation of the data storage protocol associated with the music chips, see related U.S. Patent application Serial No. 08/447321, entitled Data Protocol for a Music Chip and assigned to the present assignee herein.

Referring to FIG. 2 in connection with FIG. 1, there is shown an exemplary embodiment of the audio player 12, which utilizes the present invention remote control unit 30. The player 12 is a semi-stationary device for home/commercial use and is intended to blend and connect with a user's current entertainment system. The player 12 includes a base portion 32 and a tiered upper portion 34 which includes the music trays 20. The base portion houses the DSP 14, the codec 18, and associated logic for interfacing with the user. The remote control unit 30 is included with the system as part of the user interface for performing user functions at a distance. A docking port 38 adapted to receive the remote control unit 30 is included in the base, wherein music selection information is downloaded to the remote in order that the user may perform intelligent selections. In a preferred embodiment of the invention the remote control interface 26 located within the docking port utilizes an infrared communications scheme wherein information is transmitted optically to and from the remote through the remote interface. It will be understood, however, that a plug-in docking arrangement may also be utilized, wherein the remote and audio player make physical contact in order to accomplish the downloading.

Referring to FIG. 3, there is shown one preferred embodiment for the present invention remote control device 30. Included within the remote is an LCD display 40, a communications interface portion 42 and a series of selection buttons 44. The selection buttons include but are not limited to a navigation pointer 46, volume/

power control combination button 48 and a set of "soft" function keys 51-56. The navigation pointer 46 controls a cursor 47 which appears on the LCD display 40, wherein cursor movement takes place in at least four different directions corresponding to the indicators on the pointer. Multi-directional, i.e., diagonal, movement may also be available depending on the firmware routine utilized in the remote 30. The function of the navigational pointer 46 is similar to that of a joystick mechanism or mouse, wherein a portion of the display may be selected after movement of the cursor 47 thereto.

The volume/power control is implemented using a combination switch 48 capable of three separate outputs. In one preferred application, depressing the combination switch 48 on one side of the switch corresponds to a decrease in volume while depression of the switch on the opposite side produces an increase in volume. Depressing the combination switch 48 in a center region 58 thereof produces a contact closure on both sides of the switch to provide a third output which turns the audio player On and Off. A more detailed explanation of the combination switch mechanism is included in related U. S. Patent Application Serial No.08/447328, entitled Button Interface For A State Machine.

The soft function keys 51-56 are used to choose various functions encoded in the menu driven software of the remote. The individual keys will take on different functions depending on the menu status of the LCD display 40. FIG. 4 illustrates an exemplary usage of the soft keys 51-56 wherein the LCD 40 displays six commonly used remote commands. Icons 61-66 representative of each of the commands, i.e., forward 61, reverse 62, fast forward 63, fast reverse 64, play 65 and pause 66, are shown on the display 40 and an individual soft key 51-56 corresponds to each of the commands. Depression of a soft key acts to execute the appropriate selection.

FIG. 5 shows an exemplary display screen wherein the navigational pointer would be advantageously utilized. A matrix is represented on the display 40 which corresponds to the music chips included on a single music storage tray. Textual and/or graphical representations 68 are included for each of the chips loaded into a tray 20. The navigational pointer 46 is used to manipulate the cursor 47 to a desired selection within the matrix. The selection may be carried out, for example, by clicking or depressing the pointer 46 for execution of the selection, similar to the manner in which buttons on a mouse peripheral are "clicked". The selection command will either move the user to the next level of the menu display program within the remote 30 or fully execute the selection. In the alternative to information being displayed in matrix form, it will be understood that information will be displayed in tabular form wherein a user scrolls through the display utilizing the pointer 46. In addition, it will be understood, that the button layout presented with respect to FIG. 3 is merely exemplary and that a person skilled in the art may choose other configurations to accomplish similar functionality.

As discussed with respect to FIG. 2, content information from the music player is downloaded to the remote control unit 30 when the remote is docked within the docking port 38 of the audio player 12. A button or command sequence is entered on the base of the audio player 12 in order to initiate the downloading process. As an alternative, one or more keys on the remote unit could also be utilized to initiate the download procedure.

Content information which is downloaded to the remote is stored in the individual music chips 16 in a series of headers. Each music chip that is inserted into the audio player will have a section of memory allocated to a table of contents. Track selections on the chip will be listed as part of this table of contents by individual headers. The table of contents will include information on play times song titles, music category and artist. Providing this information allows the chip 16 to self-register when it is loaded into a storage tray 20 of the audio player 12 so that a user need not first access individual chips to gain content information. Referring to FIG. 6, there is shown one preferred embodiment of an individual header 80 which will correspond to a single track on one of the music chips 16. The individual header contains a music category 82 to which the track belongs, for example, classical, jazz, country, rock, etc. Also included in the individual header 80 is an artist field 84 for indication of the artist and addressing information 86 detailing start and end addresses for each track selection. Individual header information is self-registered with RAM on the audio player once a chip 16 is inserted and powered up.

The individual header concept allows a user to make music selections by category of music or artist which lends greater overall flexibility to the system. For example, a user may select to randomly hear Country Western songs over the course of an evening, or to hear songs from a specific artist, for example, Billy Joel. Music play may be performed randomly, sequentially, or by specific content as requested by the user. This header information is downloaded from the music chips into the audio player, for example, into memory associated with each of the individual storage trays. This same information, or information corresponding thereto is then transferred to the remote upon docking and execution of appropriate download commands. Transfer of the content selection information enables a user to make intelligent selections at the remote in regard to general or specific content without having to view the display on the audio player.

Referring to FIG. 7 in connection with FIG. 1, there is shown a block diagram of one preferred embodiment for the present invention remote control unit 30. As described with respect to FIG. 3, the remote includes the LCD 40 and buttons 44 for input of user commands. The LCD and Buttons are coupled to a processor 90 by means of a logic interface 92. A bi-directional bus 94 is coupled from the processor 90 to an infrared transmit/receive circuit 96 in the communications interface 42. The transmit/receive circuit 96 is adapted to convert a

digital bit stream from the remote 30 and transmit corresponding infrared energy in a known manner and at a frequency receivable by that of the remote interface 26 of the audio player 12. The remote interface receives the infrared energy and reconverts the information to digital form where it is handled by the processor 14 of the audio player 12. In a similar fashion the transmit/receive circuit 96 receives infrared communications from the audio player when the remote 30 is docked. This information is converted and processed digitally by the remote. The infrared transmission scheme is advantageous because of the relatively low power consumption required for transmissions. As will be understood, the remote control 30 is powered utilizing standard sized commercially available batteries. A firmware routine stored in memory of the remote is responsible for implementation of the menu driven selection routines. It will be understood that selection capability of the remote 30 varies according to the selection information which is downloaded during docking.

From the above, it should be understood that the embodiments described, in regard to the drawings, are merely exemplary and that a person skilled in the art may make variations and modifications to the shown embodiments without departing from the spirit and scope of the invention. For example, as an alternative to the two-way infrared transmission scheme shown, the remote control unit may be adapted to physically attach to the audio player in a plug-in arrangement to accomplish downloading. Data will then be transferred between the coupled leads of the audio player and remote. Remote commands, however, will continue to be transmitted using infrared energy. All such variations and modifications are intended to be included within the scope of the invention as defined in the appended claims.

Claims

1. In an audio system wherein pre-recorded music is digitally encoded in addressable memory of integrated circuit music chips and music from said chips is played on an associated solid state audio player, and wherein general description information regarding individual track selections of said music chips is downloaded to said audio player to assist in making music selections, a remote control apparatus for making remote music selections at said solid state audio player, said remote control apparatus comprising:

transmit/receive means for remotely transmitting to and receiving information from said audio player, said transmit/receive means being adapted to mate with a corresponding transmit/receive means on said audio player, wherein said general description information is down-

loaded and stored in memory of said remote control apparatus;
 selection means for enabling a user to enter commands at said remote control apparatus pertaining to said music selections to be made; and
 processing means coupled to said transmit/receive means, said selection means and said memory, said processing means being operative to process said user commands and generate a corresponding output signal to said transmit/receive means.

- 2. The apparatus of Claim 1, further including display means coupled to said processing means, wherein said display means enables said user to view said general description information downloaded to said remote control.
- 3. The apparatus of Claim 2, wherein said processing means is operable to run a menu driven selection program and wherein said selection program is viewable from said display means.
- 4. The apparatus of Claim 3, wherein said selection means includes a navigational pointer, said navigational pointer being adapted to selectively maneuver a cursor across said display means to make selections in accordance with said menu driven selection program.
- 5. The apparatus of Claim 1, wherein said transmit/receive means includes an infrared interface means, said infrared interface means being operative to transmit and receive said information to and from said audio player utilizing infrared energy.
- 6. The apparatus of Claim 1, wherein said selection means includes a combination switch, said combination switch being adapted to produce three separate output signals depending on the manner in which said switch is depressed.
- 7. The apparatus of Claim 3, wherein said selection means includes a series of soft control buttons, said soft control buttons corresponding to a selection choice generated on said display means from said menu driven selection program.
- 8. The apparatus of Claim 7, including at least six of said soft control buttons, wherein on a specific display screen, each of said at least six soft control buttons corresponds to a command selected from the group consisting of play, pause, forward scan, reverse scan, fast forward and fast reverse.
- 9. An improved remote control apparatus for a home audio player, wherein said home audio player is

adapted to play pre-recorded music from a storage medium of semiconductor music chips and wherein content information in the form of a series of headers pertaining to individual tracks of audio on said music chips is registered in said audio player, the improvement therewith comprising:

docking station included within said remote, wherein said docking station is adapted to interface in close proximity with a corresponding docking port on said audio player, whereby said content information regarding said individual tracks of audio is downloaded to said remote, thereby facilitating intelligent music selections by a user.

10. The apparatus of Claim 9, wherein said docking station includes an infrared transmit/receive circuit for communicating with said audio player by way of infrared energy.

11. The apparatus of Claim 9, further including display means for display of said content information downloaded to said remote control.

12. The apparatus of Claim 11, further including processing means, wherein said processing means is operable to run a menu driven selection program and wherein said selection program is viewable from said display means.

13. The apparatus of Claim 9, further including selection means for enabling a user to enter commands at said remote control apparatus pertaining to music selections which are to be made.

14. The apparatus of Claim 12, further a navigational pointer adapted to selectively maneuver a cursor across said display means to make selections in accordance with said menu driven selection program.

15. The apparatus of Claim 9, further including a combination switch, said combination switch being adapted to produce three separate output signals depending on the manner in which said switch is depressed.

16. The apparatus of Claim 12, including a series of soft control buttons, said soft control buttons corresponding to a selection choice generated on said display means from said menu driven selection program.

17. A method for making remote music selections at an audio player adapted to play music recorded on integrated circuit music chips, wherein content descriptive information pertaining to individual tracks of audio is stored in a series of headers in each of said music chips and said content descriptive information is transferred to said audio player upon en-

abling said music chips, said audio player further being adapted to dock with a remote control unit for transfer of said content descriptive information thereto, said method comprising the steps of:

storing said content descriptive information in memory of said audio player;
docking said remote control unit at a docking port of said audio player,
whereby said content descriptive information is downloaded and stored within said remote control; and
manually entering selection commands at said remote based upon said content descriptive information, wherein said selection commands are remotely communicated to said audio player.

18. The method of Claim 17, further including the step of viewing said content descriptive information on a display means on said remote control.

19. The method of Claim 18, wherein said content descriptive information is viewed in the context of a menu driven software program.

20. The method of Claim 17, wherein said content descriptive information and said command selections are transmitted using infrared energy.

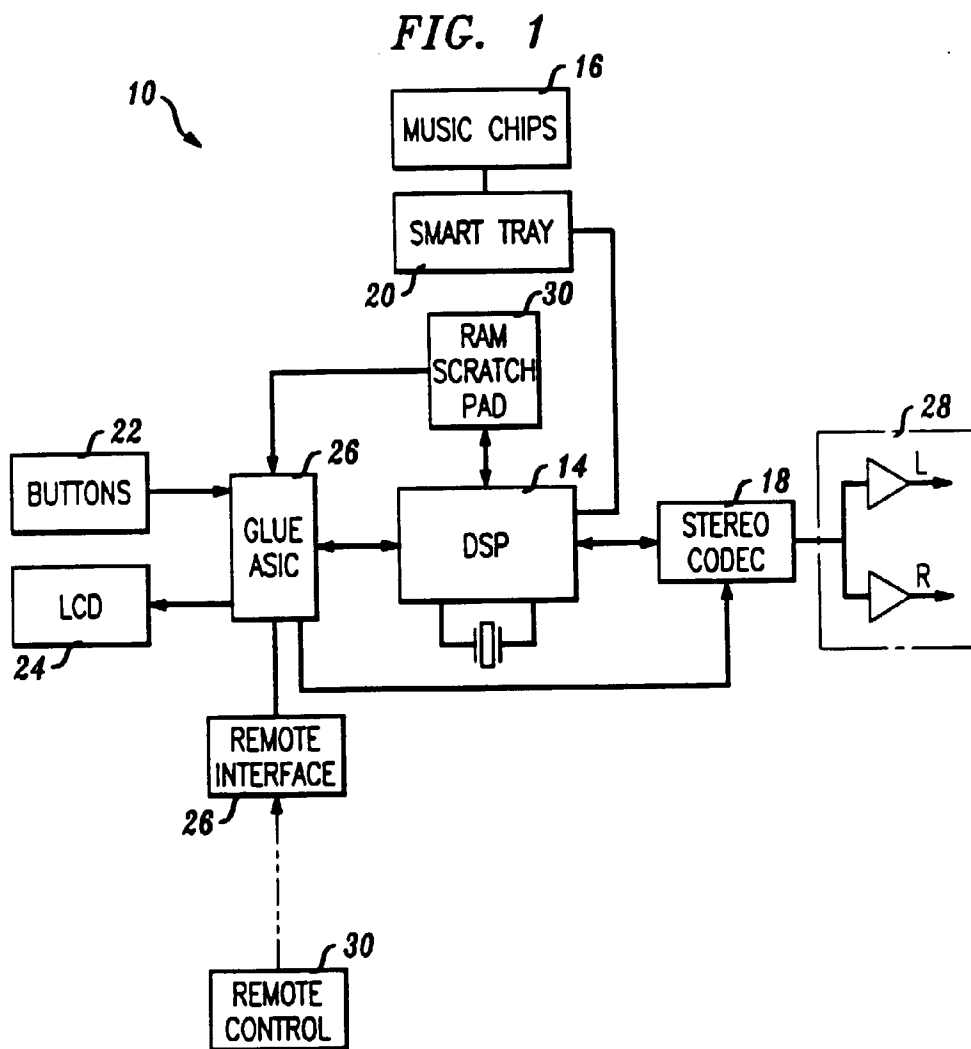

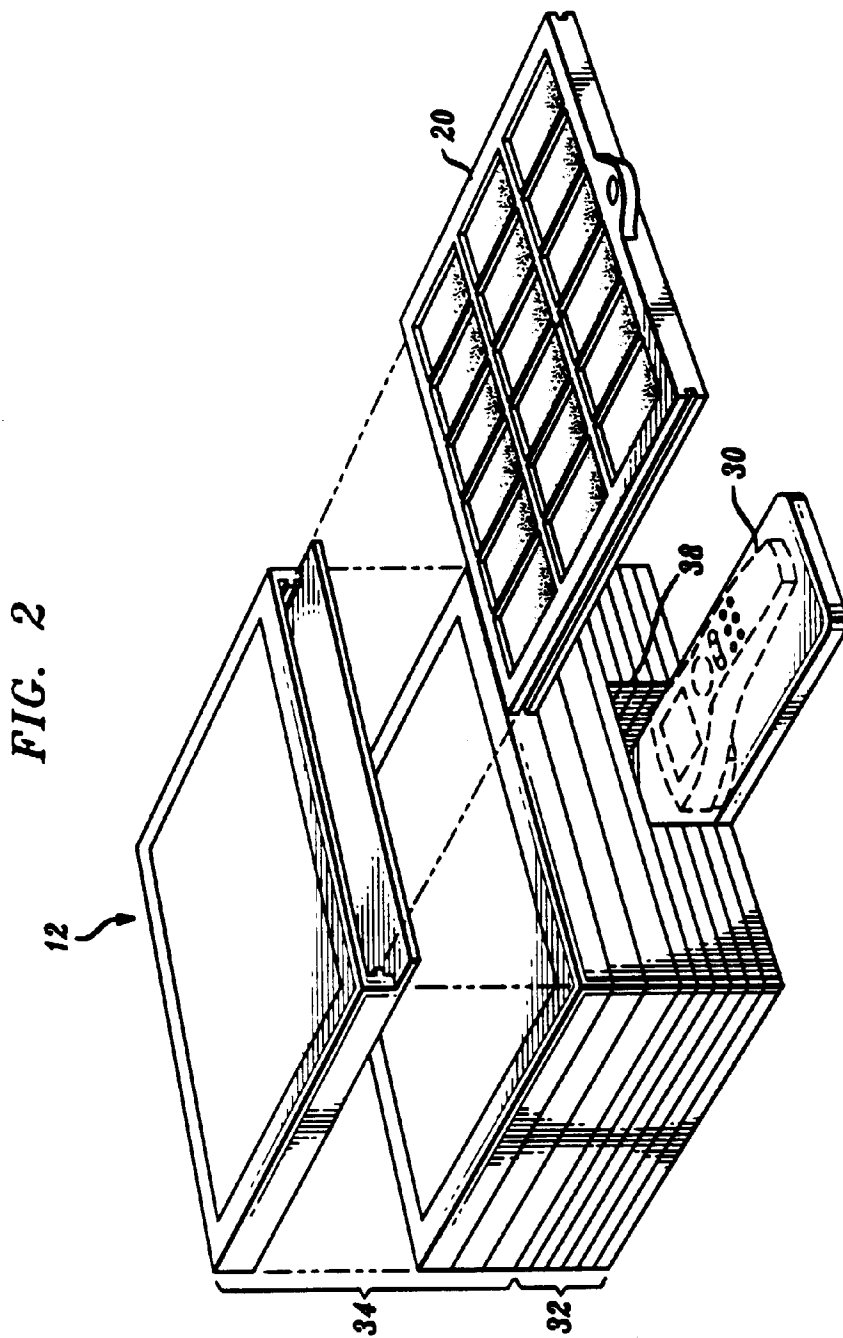

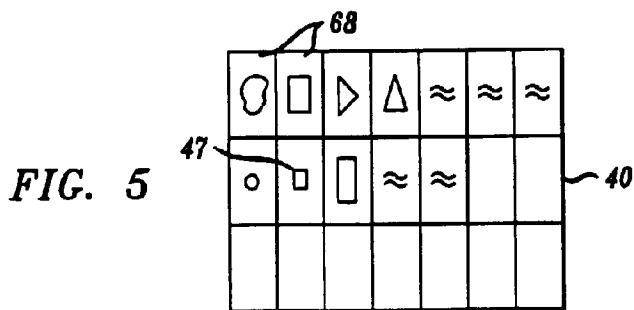
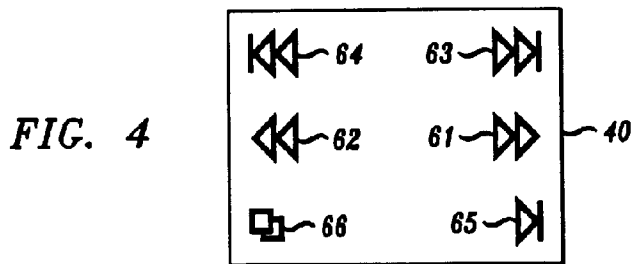
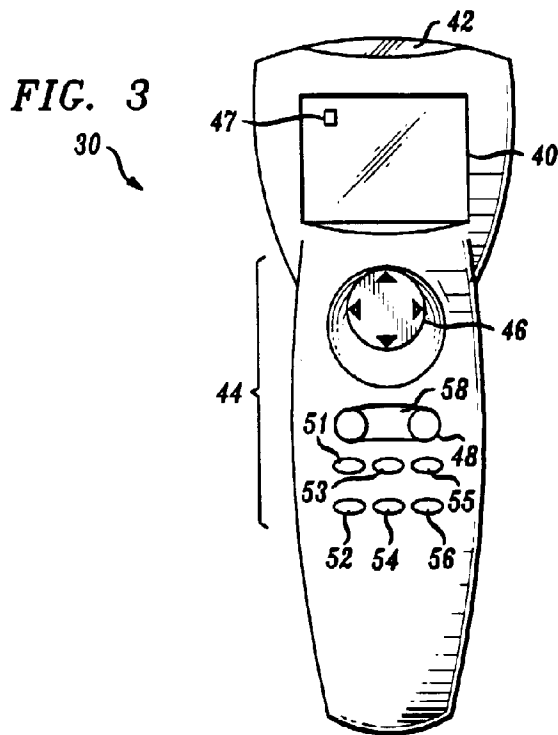

FIG. 6

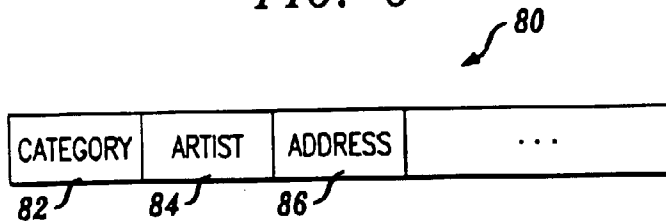
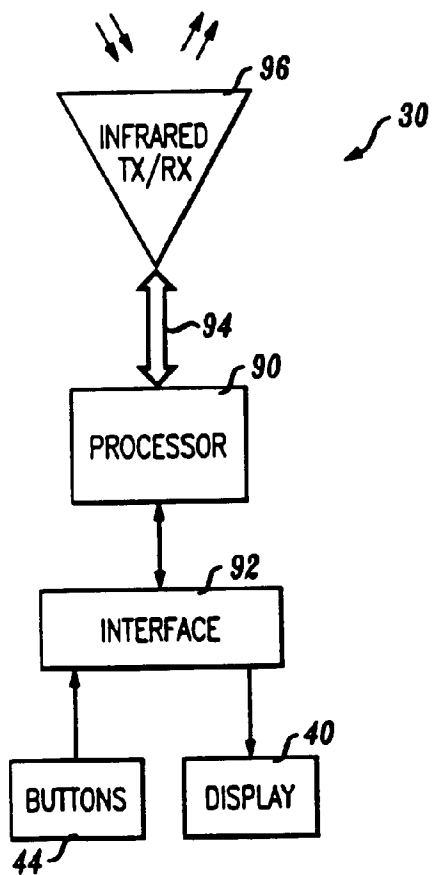

FIG. 7



(19) Japanese Patent Office (JP) (11) Patent Application Laid-Open Disclosure No. H11-288558

(12) Gazette of Unexamined Patent Applications (A)

(43) Date Disclosed: October 19, 1999

(51) Int. Cl. ⁶	Ident. No.	FI	
G11B 20/10	301	G11B 20/10	301Z
H04Q 7/38		H04B 7/26	109M

Examination Request Status: Not yet requested Number of Claims: 10, FD (total 12 pages)

(21) App. Number: H10-192502	(71) Applicant: 000001443 Casio Computer Co., Ltd. 1-6-2 Honcho Shibuya-ku Tokyo
(22) Date Filed: June 23, 1998	
(31) Priority Claim Number: H10-42901	(72) Inventors: Menju, Yoshitsugu and Morishige, Akira
(32) Priority Date: February 9, 1998	c/o Casio Computer Co., Ltd. Hamura Technology Center
(33) Country of Priority Claim: Japan (JP)	3-2-1, Sakae-cho, Hamura City Tokyo
	(74) Agent, Patent Agent Kashima, Hidemi

(54) PORTABLE MUSIC SOUND REPRODUCING DEVICE AND MUSIC SOUND REPRODUCING SYSTEM

(57) Abstract:

PROBLEM TO BE SOLVED: To provide a portable music sound reproducing device and a music sound reproducing system which can reproduce desired music sound without considering change of a recording medium, storage capacity, and the like.

SOLUTION: A communication section 10 receives music data from a service center on a communication channel. Music data is stored in a storage medium 12. A control section 14 reads out music data from the storage medium 12 in accordance with user instructions, and supplies the data to a music sound processing section 18. After the music sound processing section 18 demodulates the music data (MPEG audio) read out from the music data, the section converts the demodulated music data into an analog signal, and outputs it from an output section 19, controlling volume, tone, and the like.

[Claims]

[Claim 1] A portable music sound reproduction device comprising:

a receiving means for receiving music sound data;
a storage means for storing music sound data which was received by the receiving means;
a reproduction means for reproducing the music sound data which was stored by the storing means.

[Claim 2] The portable music sound reproduction device according to Claim 1 further comprising a request means which advances a request to send music sound data wherein the receiving means receives music sound data that was sent in response to the request to send by the request means.

[Claim 3] The portable music sound reproduction device according to Claim 1 wherein the storage means is a storage medium capable of writing over electrical, magnetic or optical information.

[Claim 4] A music sound reproduction system comprising:

a collection device providing a collection means for collecting a plurality of music sound data and a sending means for sending music sound data collected by the collection means;
a portable music sound reproduction device further comprising:
a receiving means for receiving music sound data sent from the sending means of the collection device;
a storage means for storing music sound data received by the receiving means; and
a reproduction means for reproducing music data stored by the storage means.

[Claim 5] The music sound reproduction system according to Claim 4 wherein the collection device is a service center which provides every kind of information to terminals along with managing communications among terminals by communications lines.

[Claim 6] The music sound reproduction system according to Claim 5 wherein the service center notifies what was registered to the portable music sound reproduction device when music sound data is newly registered.

[Claim 7] The music sound reproduction system according to Claim 4 wherein the collection device is an information processing device installed within the home.

[Claim 8] The music sound reproduction system according to Claim 7 wherein the portable music sound reproduction device provides a sending means for sending music sound data stored by the storage means and the information processing device provides a receiving means for receiving music sound data sent from the sending means of the portable music sound reproduction device and a holding means for holding music sound data received by the receiving means.

[Claim 9] The music sound reproduction system according to Claim 7 or Claim 8 wherein the information processing device provides an editing means for editing music sound data held by the holding means.

[Claim 10] The music sound reproduction system according to any one of the Claims 4-9 wherein the storage means is a storage medium capable of writing over electrical, magnetic or optical information.

[Detailed Description of the Invention]

[0001]

[Technical Field of the Invention] The present invention relates to a portable music sound reproduction device and a music sound reproduction system which receives music sound data sent from external apparatus and which reproduces the received music sound data.

[0002]

[Description of Related Art] Conventionally, portable music sound reproduction devices are known which reproduce (or record) music sound which is recorded on magnetic tape, magnetic discs such as MD or optical discs such as CD which can be carried by the user when listening anywhere to music sounds. The portable music sound reproduction device is driven by dry batteries or chargeable secondary batteries.

[0003]

[Problems that the Invention is to Solve] However, when conventional portable music sound reproduction devices use magnetic tape, magnetic discs such as MD for recording medium, in order to reproduce the desired track, the original is each time edited (including dubbing) and must be recorded on magnetic tape or magnetic disc, requiring manual labor. At the same time, when using optical discs such as CDs, because they are read only, the recorded information is fixed, and cannot be edited.

[0004] In addition, with all of the portable music sound reproduction devices, because of the recording capacity limits of the recording medium, in order to reproduce tracks other than those recorded, a plurality of recording medium which record the desired tracks are carried and again manual labor is required as the recording mediums must be replaced.

[0005] The present invention provides a portable music sound reproduction device which can reproduce desired music sound and a music sound reproduction system which does not consider changes in recording medium or storage capacity, etc.

[0006]

[Means for Solving the Problems] In order to achieve the previously described goals, the portable music sound reproduction device according to the invention of Claim 1 comprises a receiving means for receiving music sound data, a storage means for storing music sound data received by the receiving means, and a reproduction means for reproducing music sound data stored by the storage means.

[0007] In addition, as a new configuration, as for example in Claim 2, there is provided a request means for sending out a request to send music sound data and the communications means receives music sound data which is sent in response to the request to send by the request means.

[0008] In addition, as a new configuration, the storage means, as for example, in Claim 3, may be a storage medium capable of overwriting electrical, magnetic or optical information.

[0009] In addition, in order to achieve the previously described goals, the music sound reproduction system according to the invention of Claim 4 comprises a collection device providing a collection means for collecting a plurality of music sound data and a sending means for sending music sound data collected by the collection means; a portable music

sound reproduction device further comprising: a receiving means for receiving music sound data sent from the sending means of the collection device; a storage means for storing music sound data received by the receiving means; and a reproduction means for reproducing music data stored by the storage means.

[0010] In addition, as a new configuration, the collection device, as in, for example, Claim 5, may be a service center which provides every kind of information along with managing communications among terminals by communications lines.

[0011] In addition, as a new configuration, the service center, as in, for example, Claim 6, may notify registration to the portable music sound reproduction device when music sound data is newly registered.

[0012] In addition, as a new configuration, the collection device, as, for example in Claim 7, may be an information processing device installed in the home.

[0013] In addition, as a new configuration, the portable music sound reproduction device, as in, for example, Claim 8, may provide a sending means for sending music sound data stored by the storage means and the information processing device provides a receiving means for receiving music sound data sent from the sending means of the portable music sound reproduction device and a holding means for holding music sound data received by the receiving means.

[0014] In addition, as a new configuration, as in, for example, Claim 9, the information processing device may provide an editing means for editing music sound data held by the holding means.

[0015] In addition, as a new configuration, as in, for example, Claim 10, the storage means may be a storage medium which can overwrite electrical, magnetic or optical information.

[0016]

[Embodiments] Below, a description is given of embodiments of the present invention, referencing the drawings, as one embodiment used appropriately for a portable-type headphone stereo device, using the PHS communication system.

A. Embodiment Constitution

A-1. Communication System Constitution

Fig. 1 is a block diagram showing the constitution of a communications system for PHS terminals according to an embodiment of the present invention. In the figure, 1 denotes a communications line network, a usual analog telephone line network (PSTN network) spread throughout the country, or a digital line network (for example, ISDN network). In the communications line network 1, the public base station 2 of the PHS communications system, the service center 3 which provides every kind of service to non-illustrated PHS terminals or headphone stereo device 6 and the home base station 5 installed in the home are connected.

[0017] The public base station 2 is installed in a non-specific place inside or outside of a room, and has a service area (range which electromagnetic waves can reach: communications area) whose radius is several hundred meters centered on itself. By communicating wirelessly with PHS terminals which exist within the service center or with the portable-type headphone stereo device 6, the public base station 2 is a relay station which connects PHS terminals or the headphone stereo device 6 to the communications line network 1.

[0018] The service center 3, along with storing in the database 4 location registration information, certification information, and accounting information and managing communications among PHS terminals by controlling the communications line network 1, collects every kind of data in the database and provides every kind of service which gives to the user collected data in response to requests from the PHS terminals. More particularly, in the present invention, music sound data is collected in the database 4 which is provided to the portable type headphone stereo device 6. The music sound data in addition to characteristic track data, includes information related to the track (for example, track title, release data, and artist). Moreover, the music sound data is described in detail later. In addition, when the user of the headphone stereo device 6 receives reception service of the music sound data, user registration is performed by the service center 3.

[0019] In user registration, when the user downloads music sound data, the tastes of the user for specifying some kinds of music sound data (genre, artist's name) are registered or the music sound data is newly registered and when the latest information is registered, registration occurs for every user whether or not notification is made. At this time, classification information becomes necessary at the service center for classifying the user (headphone stereo device 6), but the classification information may be attached during user registration or when the apparatus is purchased. When the service center 3 is designated by notification, music sound data is newly registered and when the latest information is registered, notification is made to the user (headphone stereo device 6).

[0020] The home base station 5 functioning as a PHS base unit (self-management base station function) and by wireless or cable is beforehand registered as a cordless handset. When performing data transfer between the headphone stereo device 6 or the later described computer 7 or when performing data transfer by means of the communications line network 1 between apparatus outside the home or by the later described service center 3 and the headphone stereo device 6 within the home or the later described computer 7, mediation is performed between apparatus. Moreover, in addition to the headphone stereo device 6 and the computer 7 at the home base station 5, it is permissible to connect every kind of apparatus (drawings omitted: PHS terminals, PDA, consumer electronics) within the home wirelessly or by cable. The headphone stereo device 6 is carried by the user and is a reproduction device for music sound data driven by batteries. Send requests for music sound data are made to the service center 3 or computer 7 by means of the home base 5 within the home and by public base stations outside of the home. The music sound data which was sent is stored in specific storage medium and the headphone stereo device 6 generates this music sound data. Because every kind of information is attached to the music sound data, as previously described, in addition to the track data, in reality, reproduction is accomplished by retrieving track data from the music sound data.

[0021] The computer 7 through the modem 8 which is used wirelessly (permissible to be used by cable), sends and receives music sound data among headphone stereo devices 6 by means of the home base station 5. The computer 7, in addition to backing up the music sound data received by the headphone stereo device 6, sends once again the backed up music sound data to the headphone stereo device 6. In addition, the computer 7 replaces the sequence of the backed up music sound data and performs editing of a plurality of

music sound data that have been grouped. In response to requests from the headphone stereo device 6, it is possible to send the edited music sound data.

[0022] A-2. Headphone Stereo Device Constitution

Fig. 2 is a conceptual view showing the exterior structure of the headphone stereo device and Fig. 3 is a block diagram showing the structure of a headphone stereo device according to embodiments of the present invention. In the figures, 10 denotes a communications section, having a communications function equivalent to a so-called PHS terminal and by means of the antenna ATN sends and receives every kind of requests wirelessly between the public base station 2 or home base 5. In addition to receiving music sound data from the service center 3 on the communications line network 1, it sends and receives music sound data among computers 7.

[0023] The storage device 11 has a storage medium 12 which can hold and erase data. The storage medium 12 is formed by magnetic or optical storage medium or semiconductor memory. This storage medium 12 is installed fixed to the storage device 11 or packaged as to be freely attachable or detachable. The key input section 13 is formed from every kind of switch which performs moving mode instructions and instructions of every kind of function (music sound data receiving, reproduction and backup). More particularly, this embodiment is executed by instruction from the key input section 13 and by the control section 14 with later described reception of music sound data, reproduction of the received music sound data and backup of the received music sound data. The states of these switches are supplied to the control section 14.

[0024] Next, the control section 14 controls the entire device following specific programs. Programs are executed by the control section 14 or various parameters are stored in the ROM 15. In addition, RAM 16 is used as a working area where data generated by following control of the control section 14 is housed. The display section 17 is a liquid crystal display displaying every kind of data such as music sound data lists. In addition, the music sound processing section 18 converts to analog signals, after restoring track data (for example, track data compressed by MPEG audio) retrieved from among the music sound data stored in the storage medium 12 and after controlling the volume and tone, sends the analog signals to the output section 19. The output section 19 is an earphone or headphone and outputs voice signals from the music sound processing section 18. The power supply 20 is formed from dry batteries or chargeable secondary batteries and supplies power to each of the previously described sections. Moreover, it is permissible to operate by power from adapters which convert commercial power into predetermined direct current voltage.

[0025] A-3. Sending and Receiving Data Constitution

Next, Fig. 4 is a conceptual diagram showing the data constitution which is sent and received between the headphone stereo device and the service center or computer. Between the headphone stereo device 6 and the service center 3 or computer 7 commands such as download requests for music sound data or backup requests for music sound data and the music sound data itself are sent and received. Consequently, using this embodiment, there results the sending and receiving of data consisting of the formation shown in Fig. 4. As shown in the figure, the frame is formed from codes, data or control codes and CRC. A code is data in which it is shown whether the data following the next is music sound data or it is a command showing every kind of request. Following the code are music sound data or control codes. Finally, there is a check bit for performing

error detection and a CRC (cyclic code) follows showing the final (final music sound data or control frame).

[0026] A-4. Music Sound Data Formation

Next, Fig. 5 is a conceptual diagram showing the formation of music sound data. In the figure, the music sound data is formed from the record company, the artist, genre, release date, record title, track data (for example, MPEG audio: below, the same), track title, track sequence, user information, and copy count. Within the information, more particularly, the user information is classification information for classifying the user when during user registration a track is deemed a favorite. In addition, in place of the copy count, at least more than one terminal ID is stored and reproduction is possible only for the terminal shown by the terminal ID. From this ability, along with the possibility of preventing distribution of the music sound data without constraints, it becomes possible to control the reproduction count (copy count).

[0027] In addition, the copy count is information showing how many times the music sound data has been download and is referenced when determining the popularity and royalties. In addition, the copy count, found at the service center, is used as a basis for judging whether to maintain the track's registration or cancel (eliminate) it. That is, it is permissible to provide a service wherein there is shortening of the registration maintenance period for music sound data (track) having a low copy count and continuing registration maintenance even exceeding periods for music sound data (track) which have high copy counts or show increasing copy counts. It goes without saying that the copy count is data for preventing limitless copying of the music sound data.

[0028] In addition, the data is track data itself and is registered as MPEG audio.

Furthermore, using the headphone stereo device 6, from the received music sound data, the record company, artist, and track title are retrieved and displayed on the display section 17. The user designates the track which should be reproduced by confirming the information displayed on the display section 17. In addition, the music sound processing section 18 of the headphone stereo device 6 provides a function for reproducing track data registered using MPEG audio.

[0029] B. Embodiment Operation

Next, a description is given for the operation of the headphone stereo device, the home base station, the computer, and the service center according to the previously described embodiment.

[0030] B-1. Download from the Service Center

First, a description is given for the operation when requesting a download of music sound data to the service center 3 from the headphone stereo device 6. Here, Fig. 6 is a flowchart for describing the operation when downloading music sound data from the service center 3. First, the headphone stereo device 6 determines whether or not there is a request operation for downloading the music sound data and if there is such a request, the program proceeds to step S12, and the track title to download is input by the user.

[0031] Moreover, without directly inputting the track title, for example, after designating the track genre, the artist is designated, and the track title for this artist may be designated. In this case, the genre, artist, and track title are sent in sequence from the service center 3 and in this case, selection (designation) is made by the user of the headphone stereo device 6 and the selection is narrowed down one by one.

[0032] Concretely, first, a genre list for tracks collected by the database 4 is sent from the service center 3 and this genre list is displayed on the display section 17 of the headphone stereo device 6 and the desired genre is designated by the user. Next, a list of the artists of the designated genre is sent from the service center 3 and once again, an artist is designated by the user. Furthermore, the track of the designated artist is sent from the service center 3 and the track title is designated by the user. In addition, it is permissible to designate based on related information (for example, drama or CM).

[0033] When the track title is input or designated, next, using step S14, along with the track title, a request demand is sent out. Subsequently, using step S16, the program waits to receive the music sound data for the designated track title. The request demand is sent to the service center 3 through the public base station 2 or the home base station 5. The service center 3 determines whether or not there has been a service request, using step S30, and if there has been a service request from the headphone stereo device 6, using step S32, the music sound data which has been collected in database 4 is searched using the track title requested and using step S34, the relevant music sound data is sent out. At this time, the copy count of the music sound data is incremented by 1, determination is made whether or not a specific maximum copy count has been exceeded, and if not, the relevant music sound data is sent out, and if exceeded, the music sound data is not sent out and notification is made.

[0034] In addition, if a terminal ID is added in place of copy count in the music sound data, the relevant music sound data is sent out only when the request demand matches the terminal ID of the headphone stereo device 6. Moreover, the terminal ID of the headphone stereo device 6 which performed the request demand is pre-stored in the device and is sent to the service center 3 when the request demand is made. The service center 3 notifies when the ID terminal is not matched. The music sound data is sent to the headphone stereo device 6 by means of the public base station 2 or the home base station 5. In the headphone stereo device 6, the determination result of step S16 becomes "YES", the program proceeds to step S18 and the received music sound data is stored in the storage medium 12.

[0035] Moreover, in the previously described processing, the track title is designated so that download of the music sound data only occurs for this track, designation is by genre or artist and it is permissible to download all of the music sound data of this genre or artist or in response to the free capacity of the storage medium 12. In addition, it is desirable that the downloaded data be encoded.

[0036] B-2. Download from the Computer

Next, a description is given for the operation when requesting download of music sound data to the computer 7 from the headphone stereo device 6. Here, Fig. 7 is a flowchart for describing the operation when downloading music sound data from the computer 7. First, determination is made by the headphone stereo device 6 whether or not a request operation has been made to the computer 7 for downloading music sound data and if so, the program proceeds to step S42 and the request items are input (or selected) for selecting the track that the user wishes to download. There is additional data, as shown in Fig. 5, that is attached as request items, such as, for example, the genre, artist, album title, etc.

[0037] If request items are input (or selected), next, a list demand is sent out in accordance with the requested items, using step S44. The list demand is sent out to the

computer 7 through the home base station 5, if the demand is within the area of the home base station 5 and through the public base station 2 and the home base station 5, if outside the area of the home base station 5. Moreover, there may be no direct input of the track title in the same way as with the previously described downloading from the service center 3. However, generally, the count of the tracks, which are registered by the computer 7 (back up), compared to the tracks which are registered by the service center, is rather small.

[0038] Consequently, when downloading from the computer 7, because it is not clear whether or not the music sound data of the track for download is registered, it is efficient, as described above, compared to directly inputting the track title, to designate the desired track from among a downloaded list using entries. Thus, directly inputting the track title is effective when small volumes of music sound data are registered in the computer 7.

[0039] Using the headphone stereo device 6, after sending a list demand, in step S46, the program waits to receive the list from the computer 7. In contrast, using the computer 7, in step S60, a determination is made whether or not there has been a list demand and if so, in step S62, in accordance with the item demanded (for example, genre, artist, album title, etc.) the list (list of artist name and track titles, etc.) of relevant music sound data from among the music sound data registered in the computer 7 is sent out. This list is sent to the headphone stereo device 6 through the home base station 5 or the public base station 2 and home base station 5.

[0040] Using the headphone stereo device 6, when receiving the list, in step S48, the received list is displayed on the display section 17. For example, when the user designates a genre, a list of artists of the designated genre or a list of the track titles of the designated genre are displayed on the display section 17 at this time. The user selects the desired artist or track from the displayed list. In this case, one or more selections are possible for the artist or track title. When the user selects the artist or track title, in step S52, a request demand is sent out along with the artist or track title. Subsequently, in step S54, the program waits until receipt of the music sound data of the designated artist or track title. This request demand is sent to the computer 7 through the home station 5 or the public base station 2 and the home station 5.

[0041] The computer 7 determines whether or not, in step S64, there has been a request demand and as there has been a request demand from the headphone stereo device 6, in step S66, music sound data collected in the database 4 is searched for the request demanded artist or track title and in step S68, the relevant music sound data is sent out. The relevant music sound data is sent to the headphone stereo device 6 by means of the home base station 5 or the public base station 2 and the home base station 5. Using the headphone stereo device 6, the determination result of the step S54 becomes "Yes", the program proceeds to step S56 and the received music sound data is stored in the storage medium 12.

[0042] Using the previously described processing, in the computer 7, several of the tracks that the user desired be reproduced are edited (reordered or grouped) and the edited tracks (music sound data) may be downloaded to the headphone stereo device 6. In this case, for edited grouping, an arbitrary number is attached, an arbitrary keyword is attached and during download, if this number or keyword is designated, compared to when selecting the genre or artist or track title, etc., along with being able to easily download the user's desired track (several), it is possible to easily reproduce.

[0043] B-3. Reproduction Processing

Next, a description is given for the operation when reproducing the music sound data (track data) downloaded to the storage medium 12 of the headphone stereo device 6. Here, Fig. 8 is a flowchart for describing the operation when reproducing the track data using the headphone stereo device 6. First, in step S80, a determination is made whether or not a designation has been made for track data that must be reproduced and when there has been track data designated, in step S82, the user selects the track data to be reproduced. As for the selection method, as described previously, currently, following the music sound data stored in the storage medium 12, a list is displayed of the genre and artists' names and a selection is made from among this list or when displaying a list of track titles, a selection is made from among this list. At the same time, when track data has not been designated, in step S84, currently, all of the track data which was stored in the storage medium 12 is selected as the reproduction object.

[0044] Next, in step S86, the program waits until there is a reproduction instruction operation. If there is a reproduction instruction operation, the program proceeds to step S88, retrieves from the corresponding music sound data the selected music data in step S82 or step S84, reproduces it using the music sound processing section 18, and outputs using the output section 19. A determination is made whether or not the data is the final data using step S90 for every single track completion and if reproduction of all the selected track data is not completed, the program returns to step S88 and the next track data is reproduced. Next, until completion of the reproduction of all the selected track data, reproduction is repeated using step S88. During reproduction, it is permissible to display information (artist's name, track title, and information related to this artist) related to the track data during the current reproduction on the display section 17. This processing is completed when reproduction of all the selected track data is completed.

[0045] B-4. Backup Processing

Next, a description is given for the operation when backing up music sound data to the computer 7 from the headphone stereo device 6. Here, Fig. 9 is a flowchart for describing the operation when backing up music sound data. First, in the headphone stereo device 6, in step S100, a determination is made whether or not the user has demanded back up operations and if so, the program proceeds to step S102, and a list of music sound data that was stored in the storage medium 12 is displayed. Next, in step S104, the user selects the music sound data that must be backed up to the computer 7. The user selects from among a list of music sound data displayed on the display section 17 the music sound data that the user desires to be backed up. Moreover, using this embodiment, the music sound data that must be backed up is selected, but all of the music sound data stored in the storage medium 12 may be backed up. In this case, selection of the music sound data is not necessary.

[0046] If music sound data for backup is selected, next, a back up demand is sent using step S106. The backup demand is sent to the computer 7 by means of the home base station 5 when the headphone stereo device 6 is within the area of the home base station 5. At the same time, the demand is sent to the computer 7 by means of a neighborhood public base station 2 and the home base station 5 when the headphone stereo device 6 is outside the area of the home base station 5.

[0047] In contrast, the computer 7, in step S120, makes a determination whether or not a backup demand has been received and if a backup demand has been received from the

headphone stereo device 6, the program proceeds to step S12, and a determination is made whether or not the music sound data that must be backed up has been received. From this determination, the computer 7 waits to receive the music sound data.

[0048] At the same time, the headphone stereo device 6, using step S108, reads from the storage medium 12 the music sound data that must be backed up and sends it. In step S110, a determination is made whether or not to send all of the music sound data, and when there is music sound data that will not be sent among the music sound data that must be backed up, the program returns to step S108 and reads out from the storage medium 12 the following music sound data and sends it. Next, all of the music sound data that must be backed up is read out in sequence from the storage medium 12 and sent. This music sound data, in the same way as with the backup demand, is sent to the computer by means of the home base station 5 or by means of a neighborhood base station 2 and the home base station 5. If the sending of all of the music sound that must be backed up is completed, the program proceeds to step S112 and a backup completion command is sent to the computer 7 by means of the home base station 5 or the public base station 2.

[0049] The computer 7, when receiving the music sound data from the headphone stereo device 6, proceeds to step S124, and stores the received music sound data in a housed (or externally attached) hard disk. Besides the hard disk, a transferable magnetic storage medium (floppy disk) or optical magnetic disk (MO, CD-W) or an attachable/detachable semiconductor memory (flash memory) may be used. In step S126, a determination is made whether or not the backup completion command has been received, and if not, the program returns to step S122, the following music sound data is received and in step S124, the received music sound data is stored. Next, the steps S122, S124, and S126 are repeated and all of the music sound data to be backed up is received in sequence and stored. If all of the music sound data to be backed up has been received and stored, and the backup completion command has been received, this processing is completed.

[0050] Using this embodiment, a detailed description is omitted, but it is possible, as previously described, for the user to edit the music sound data which was backed up by the computer 7. For example, the storage sequence of the music sound data can be changed and grouping of favorite tracks can be considered. It is possible to sometimes change the storage sequence and to group favorites, so as to simplify the operation of selecting tracks with the previously described headphone stereo device 6 during downloading. In addition, when grouping, in reality, there is consideration of grouping of the music sound data, but in addition, a list is formed which enumerates the favorite tracks and tracks (music sound data) to be downloaded from this list and this list may be designated. Of course, there may be multiple lists. In this case, it becomes possible for the music sound data to be described as overlapping on multiple lists and it is possible to more efficiently use the music sound data.

[0051] B-5. New Registration Notification Processing

Next, a description is made for the operation when notifying the headphone stereo device 6 from the service center when new music sound data has been newly registered. Here, Fig. 10 is a flowchart for describing the operation for new registration notification. First, in the service center 3, a determination is made whether or not there is new music sound data (possible multiples) in the database 4. Moreover, a description is omitted for the new music sound data registration method. When new music sound data has been registered, the program proceeds to step S132, and for the previously described user registration, a

call is made to the headphone stereo device 6 of the user for which new registration notification is established using a telephone number set during user registration. Using step S134, a determination is made whether or not there has been a response. From this determination, the service center 3 waits for a response from the headphone stereo device 6.

[0052] At the same time, using the headphone stereo device 6, in step S150, a determination is made whether or not there has been an incoming signal from the service center 3 and if so, a line is connected automatically and a response is made to the service center 3. The response is received, and the service center 3, in step S136, sends out a new registration notification for notifying that new music sound data has been registered. At this time, in order to notify the user of the headphone stereo device 6 that some music sound data has been registered, information (track title, artist name, etc.) may also be attached for the new music sound data for updating notifications.

[0053] Along with the headphone stereo device 6, in step S154, after receiving new registration notification from the service center 3, this new registration notification is displayed on the display section 17 and the user is notified. When attaching information (track title, artist name, etc.) for the new music sound data to the new registration notification, it is permissible to also display this information. Accordingly, the user of the headphone stereo device 6 can be notified automatically of new music sound data registration through user pre-registration. Moreover, it is permissible to output specific sounds (beep, melody) in addition to the display of the new registration notification. The user, when confirming new registration notifications, can designate downloading of the newly registered music sound data through the key input section 13.

[0054] Next, in step S156, it is determined whether or not the user has performed a download instruction operation. When the user has not directed a download instruction, this processing is completed without further processing. In this case, also at the service center 3, in step S138, a determination is made whether or not a download demand has been received from the headphone stereo device 6, and as described above, without the user directing a download instruction, when a download demand has not been sent from the headphone stereo device 6, this processing is completed without further processing. That is, in this case, only new registration notification is performed to the headphone stereo device 6.

[0055] At the same time, when the user has directed a download instruction, the headphone stereo device 6, in step S158, sends a download demand to the service center 3. In contrast, at the service center 3, the judgment result of step S138 becomes "Yes", and the program proceeds to step S140. In step S140, new registered music sound data is read out from the database 4, and after sending to the corresponding headphone stereo device 6, in step S142, a determination is made whether or not there is a final music sound data. In addition, when there is new music sound data, the program returns to step S140 and the next new music sound data is sent to the headphone stereo device 6. Next, step S140 is repeated until receipt of all the newly registered music sound data. When sending of all the newly registered music sound data has been completed, this processing is completed.

[0056] In contrast, the headphone stereo device 6, in step S160, determines whether or not the music sound data has been received and the new music sound data has been received from the service center 3, the program proceeds to step S162, and after storing

in the storage medium 12 the received new music sound data, in step S164, a determination is made whether or not the final music sound data is present. When the music sound data is not the final data, the program returns to step S160, the next new music sound data is received, and in step S162, the data is stored in the storage medium 12. Next, the steps S160 and S162 are repeatedly executed until receipt of all the newly registered music sound data. From this processing, the user of the headphone stereo device 6 can obtain, using a simplified operation, the music sound data newly registered at the service center 3. When the newly registered music sound data is completely received, this processing is completed.

[0057] Moreover, using the previously described embodiment, a description is made for only the music sound data of the contents of the service provider, and without restriction, there may be provided to the service center 3 the registration schedule date for the music sound data or an artist's activity details (a tour schedule, a TV program performance schedule, etc.) and ticket information (sales period, price, etc.)

[0058] In addition, using the previously described embodiment, when the new music sound data has been registered in the service center 3, automatically, notification is made to the headphone stereo device 6 as the target, but without restrictions, there are sometimes updates such as to the registration schedule date for the music sound data, artist activity details, or ticket information and also when there has been new registration, at any time, it is permissible to automatically send to the headphone stereo device 6 this information. Moreover, using the previously described embodiment, the present invention is used with PHS, but it is permissible to use the present invention in wireless communication systems such as portable telephone systems or paging systems (one way or two-way) or in cable communication systems such as ISDN.

[0059]

[Effect of the Invention] According to the invention in Claim 1, the music sound data received by the receiving means is stored by the storage means and because reproduction of the music sound data which is stored by the storage means is reproduced by the reproduction means, no consideration is given to replacement of the storage medium or storage capacity and an advantage is obtained because it is possible to reproduce the desired music sound.

[0060] In addition, according to the invention of Claim 2, when receiving the music sound data, because send requests are made by the request means and the music sound data which is sent in response to the send request is received by the receiving means, it is possible to receive music sound data as necessary with no consideration is given to replacement of the storage medium or storage capacity and an advantage is obtained because it is possible to reproduce the desired music sound.

[0061] In addition, according to the invention of Claim 3, because the storage means is a storage medium which can overwrite information magnetically or electrically, no consideration is given to replacement of the storage medium or storage capacity, the advantages are that it is possible to receive the desired music sound and to reproduce it.

[0062] In addition, according to the invention of Claim 4, using the collection device, multiple music sound data is collected by the collection means and by the sending means, the music sound data which is collected by the collection means is sent. At the same time, using the music sound reproduction device, the music sound data which was sent is received by the receiving means and the music sound data that was received is stored by

the storage means. Because reproduction of the music sound data which was stored by the storage means is reproduced by the reproduction means, if the music sound data is received as necessary, no consideration is given to replacement of the storage medium or storage capacity and an advantage is obtained because it is possible to reproduce the desired music sound.

[0063] In addition, according to the invention of Claim 5, along with managing the communications among terminals by communications lines, because the service center is a collection device providing to the terminal every kind of information, it is possible that the portable music sound reproduction device can receive music sound data as necessary anywhere if at a location accessible by the service center and no consideration is given to replacement of the storage medium or storage capacity and an advantage is obtained because it is possible to reproduce the desired music sound.

[0064] In addition, according to the invention of Claim 6, when new music sound data is registered, because notification is made of the registration to portable music sound devices from the service center, anywhere the location is accessible by the service center, it is possible to receive as necessary the latest music sound data, and no consideration is given to replacement of the storage medium or storage capacity and an advantage is obtained because it is possible to reproduce the desired music sound.

[0065] In addition, according to the invention of Claim 7, because the collection device is an information processing device installed within the home, if music sound data is received as necessary, no consideration is given to replacement of the storage medium or storage capacity and an advantage is obtained because it is possible to reproduce the desired music sound.

[0066] In addition, according to the invention of Claim 8, because the music sound data which is stored by the storage means of the portable music sound reproduction device is held by the holding means of the information processing device, it is possible, one time, to hold the received music sound data and if the held music sound data is once again received as necessary, no consideration is given to replacement of the storage medium or storage capacity and an advantage is obtained because it is possible to reproduce the desired music sound.

[0067] In addition, according to the invention of Claim 9, because the music sound data held by the holding means of the information processing device is edited by the editing means, for example, by grouping multiple music sound data, when receiving by the portable music sound reproduction device, if received by group units, along with being able to receive easily the desired tracks (multiples) of the user, no consideration is given to replacement of the storage medium or storage capacity and an advantage is obtained because it is possible to reproduce the desired music sound.

[0068] In addition, according to the invention of Claim 10, because the storage means is a storage medium which can overwrite information magnetically or electrically, no consideration is given to replacement of the storage medium or storage capacity, the desired music sound is received and an advantage is obtained because it is possible to reproduce the desired music sound.

[Brief Explanation of the Drawings]

[Fig. 1] A block diagram showing the structure of a communications system such as PHS terminals according to an embodiment of the present invention.

[Fig. 2] A conceptual diagram showing the exterior structure of the headphone stereo device.

[Fig. 3] A block diagram showing the structure of the headphone stereo device.

[Fig. 4] A conceptual diagram showing the data structure received between the headphone stereo device and the service center or computer.

[Fig. 5] A conceptual diagram showing the structure of the music sound data.

[Fig. 6] A flowchart for describing the operation when downloading music sound data from the service center 3.

[Fig. 7] A flowchart for describing the operation when downloading music sound data from the computer 7.

[Fig. 8] A flowchart for describing the operation when reproducing track data using the headphone stereo device 6.

[Fig. 9] A flowchart for describing the operation when backing up music sound data.

[Fig. 10] A flowchart for describing the operation when making new registration notification.

[Explanation of the Elements]

3- service center (sending means, collection device)

4- database (collection means, collection device)

6- headphone stereo device (portable music sound reproduction device)

7- computer (information processing device, holding means, editing means)

8- modem (receiving means)

10- communications section (receiving means, sending means)

11- storage device

12- storage medium (storage means)

13- key input section

14- control section (demand means)

15- ROM

16-RAM

17- display section

18- music sound processing section (reproduction means)

19- output section (reproduction means)

20- power supply section

[Fig. 4]

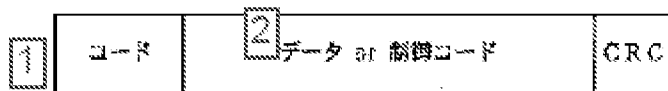

1- code, 2- data or control code

[Fig. 1]

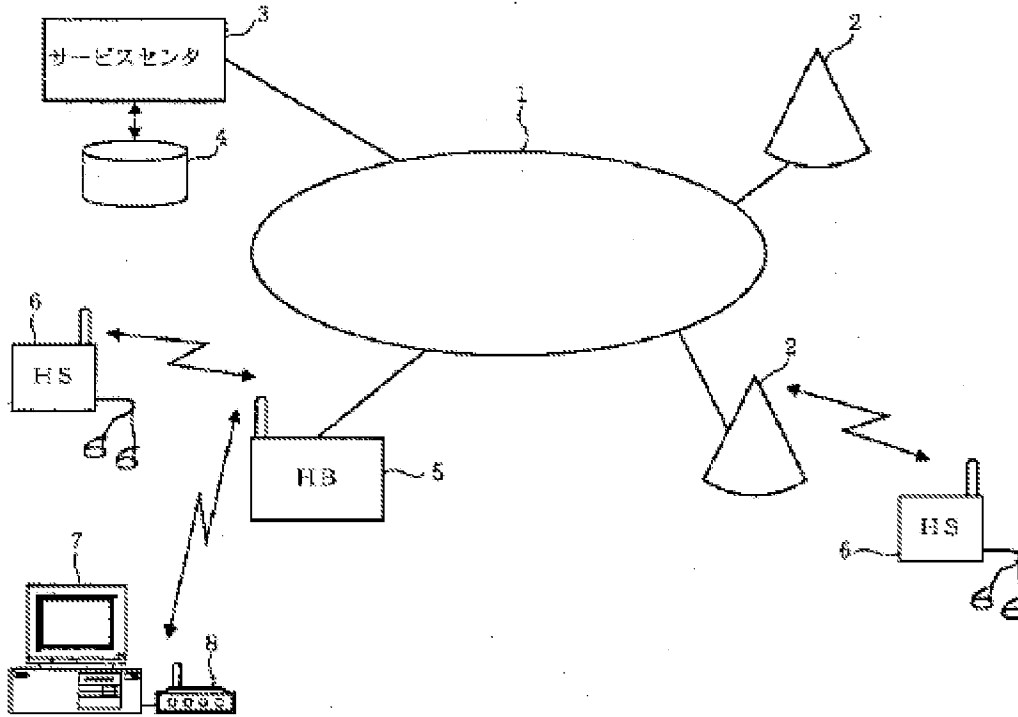

2- service center

[Fig. 2]

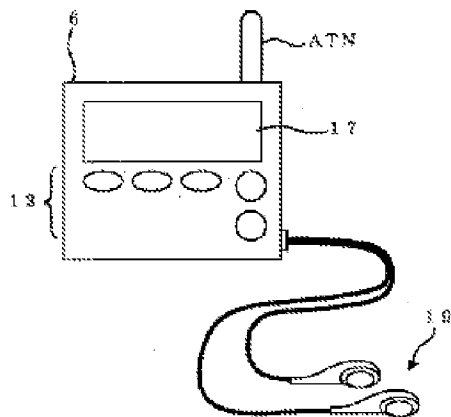

[Fig. 3]

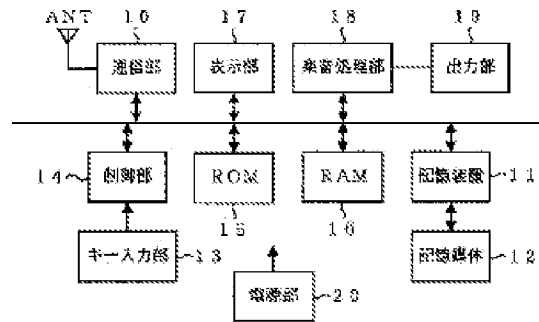

10- sending section, 11- storage device, 12- storage medium, 13- key input section ,
14-control section , 15- ROM, 16- RAM, 17- display section, 18- music sound
processing section, 19- output section, 20-power supply section

[Fig. 5]

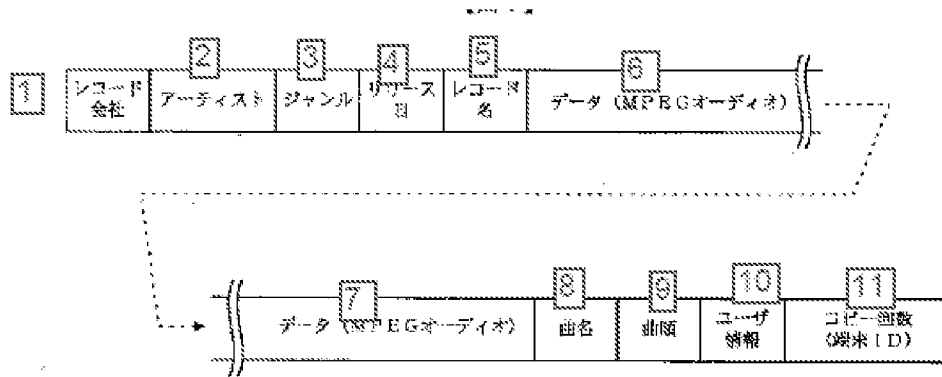

- 1- record company, 2-artist, 3- genre, 4- release date, 5- record title, 6-data (MPEG audio, 7- data (MPEG audio), 8- track title, 9- track sequence, 10- user information, 11- copy count (terminal ID)

[Fig. 6]

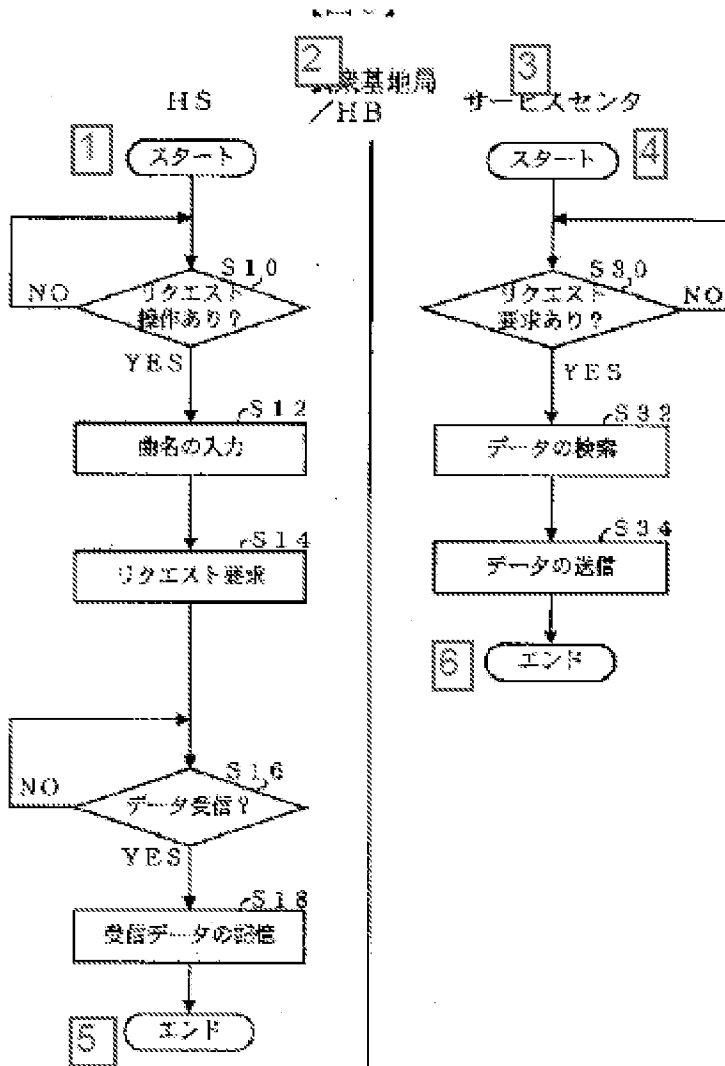

- 1- start, 2-public base station/HB, 3- service center, 4- end, 5- end, S10-request operation?, S12- track title input, S14- request demand, S16- data received?, S18- storage of received data, S30-request demand?, S32- search data, S34- send data

[Fig. 7]

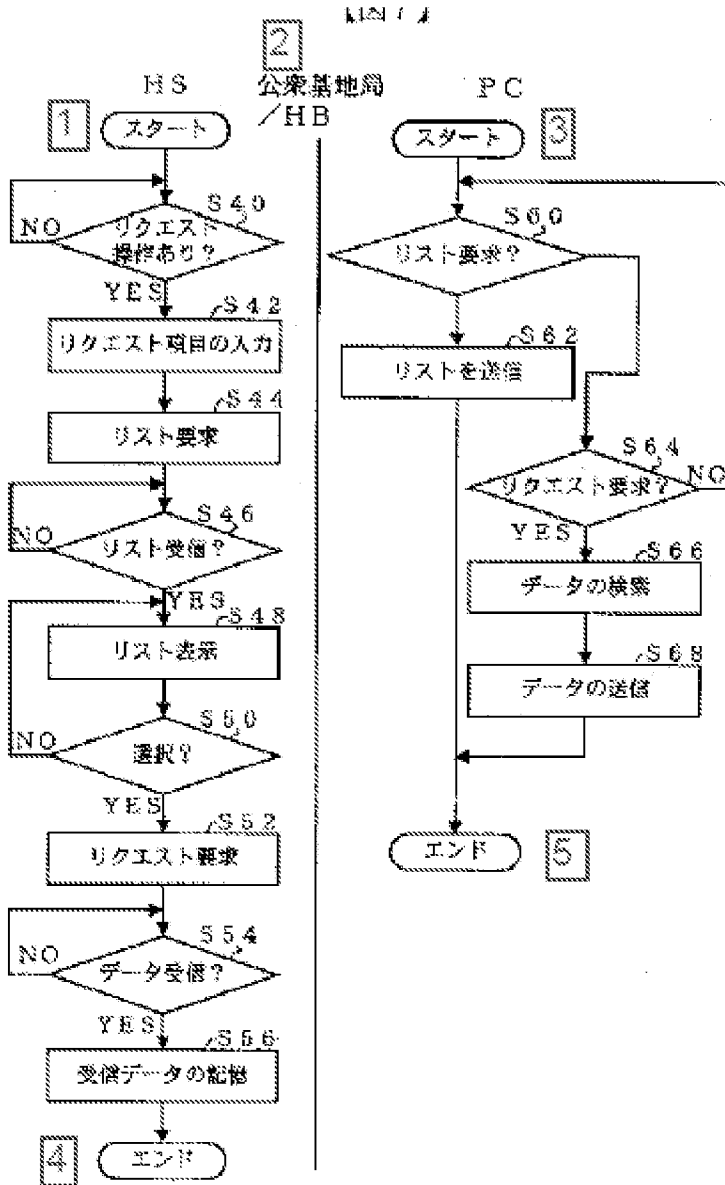

1- start, 2- public base station/HB, 3- start, 4-end, 5-end, S40- request operation?, S42- input of request item, S44- list demand, S46- list received, S48- list display, S50- selection, S52-request demand, S54- data received, S56- storage received data, S60- list demand?, S62- send list, S64-request demand?, S66-data search, S68-send data

[Fig. 8]

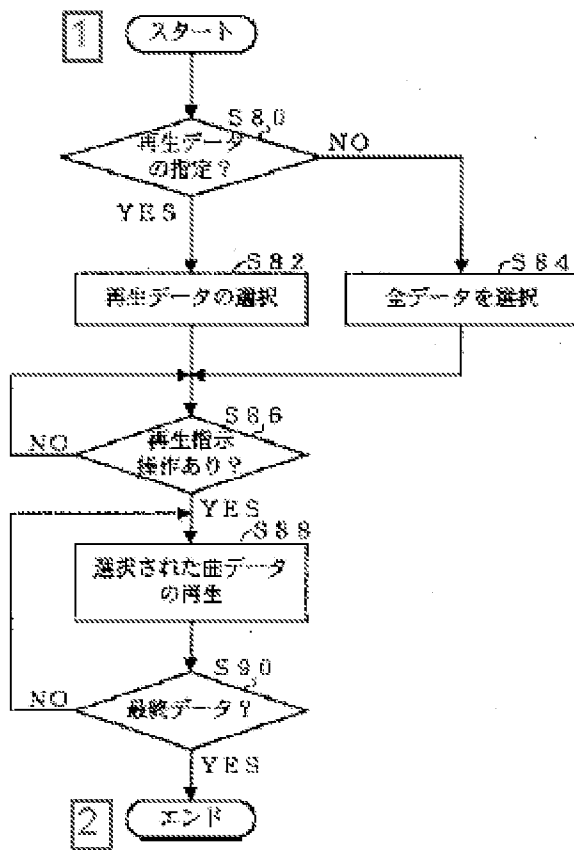

1-start, 2-end, S80- reproduce data instruction, S82- selection of reproduction data, S84- select all data, S86- reproduction instruction operation, S88- reproduction of selected track data, S90- last data

[Fig. 9]

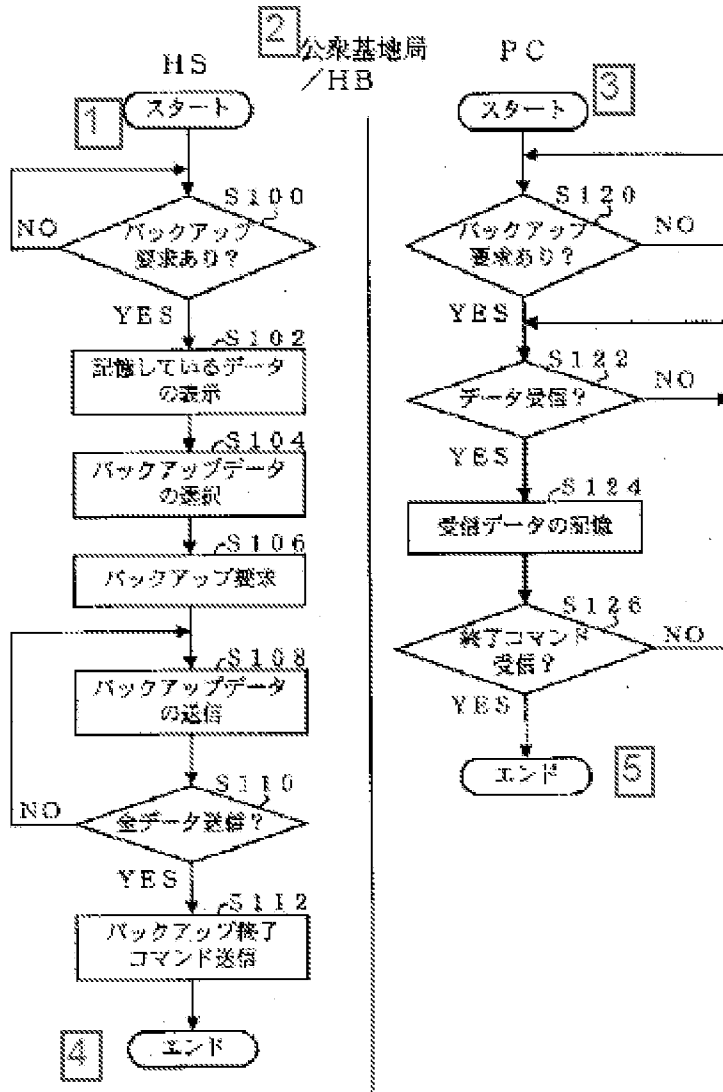

- 1- start, 2-public base station/HB, 3- start, 4-end, 5- end, S100- back up demand, S102- display data to be stored, S104- selection of the data to backup, S106- back up demand, S108- send backup data, S110- all data sent?, S112- backup completion command sent, S120- backup demand?, S122- data received, S124- received data storage, S126- completion command received?

[Fig. 10]

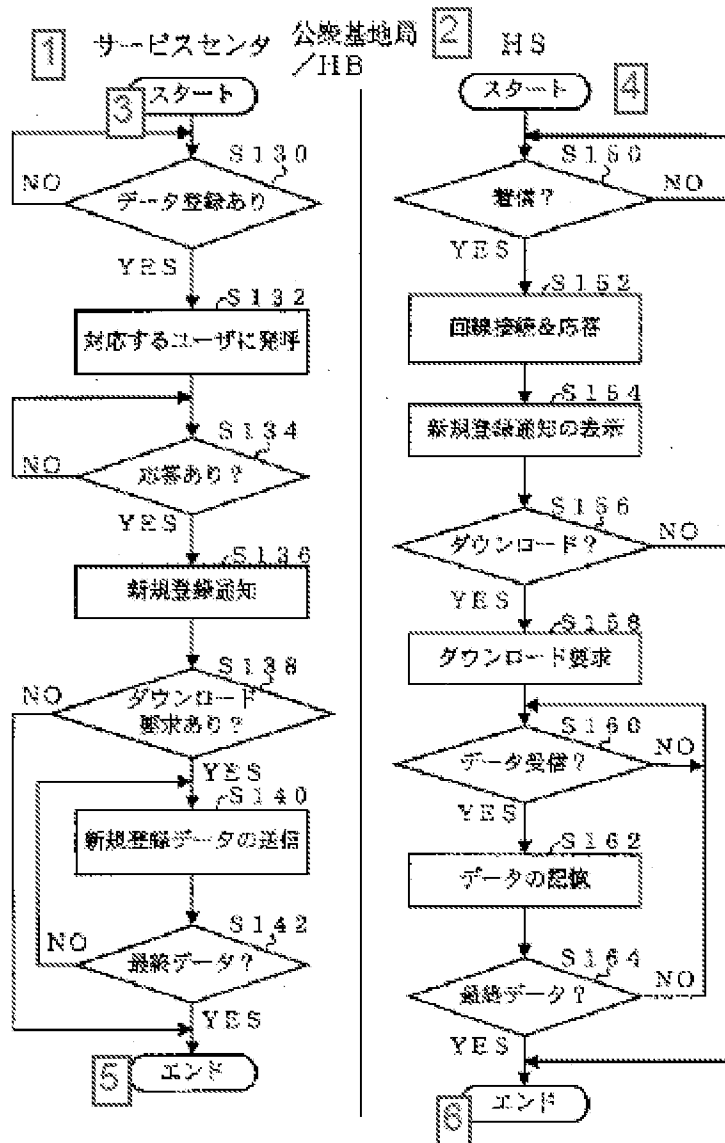

1-service center, 2-public base station/HB, 3-start, 4-start, 5-end, 6-end, S130-data registration?, S132-call by corresponding user, S134-response?, S136- new registration notification, S138-download demand?, S140- send new registration data, S142- final data, S150- incoming call?, S152- line connection and response, S154- display of new registration notification, S156- download?, S158- download demand, S160- data received?, S162- store data, S164-final data?

I, Robert Ginns, of California, USA, hereby declare that I am a professional translator/editor experienced in translating Japanese technical documents into English, and certify that the foregoing is a true and accurate translation to the best of my knowledge and capability.

Document Name: 07-Sato-JP11-164058.pdf

Translation Date: July 17, 2010

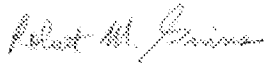

Translator's Signature

Date: July 17, 2010

Robert Ginns

19) JAPANESE PATENT OFFICE (JP) (11) Unexamined Patent Application (Kokai) Patent
(12) Bulletin of Unexamined Patent Applications (A) H11-164058

(43) Laid-Open Disclosure Date: June 18, 1999

(51) Int. Cl. ⁶	Classification No.	FI	
H04M 11/08		H04M 11/08	
H04B 7/24		H04B 7/24	C
H04M 3/42		H04M 3/42	Z

Request for Examination: Yes Number of claims: 4 OL (Total No. of Pages: 5)

(21) Application No.: H9-324660

(22) Filing Date: November 26, 1997

(71) Applicant 000233491
Hitachi Electronic Service Co., Ltd.
504-2 Shinano-cho, Totsuka-ku, Yokohama-shi Kanagawa

(72) Inventor Sato, Noboru
c/o Hitachi Electronic Service Co., Ltd.
504-2 Shinano-cho, Totsuka-ku, Yokohama-shi Kanagawa

(72) Inventor Yamagishi, Norikazu
c/o Hitachi Electronic Service Co., Ltd.
504-2 Shinano-cho, Totsuka-ku, Yokohama-shi Kanagawa

(72) Inventor Takesada, Mutsuharu
c/o Hitachi Electronic Service Co., Ltd.
504-2 Shinano-cho, Totsuka-ku, Yokohama-shi Kanagawa

(72) Inventor Iwasaki, Mina
c/o Hitachi Electronic Service Co., Ltd.
504-2 Shinano-cho, Totsuka-ku, Yokohama-shi Kanagawa

(74) Agent Patent Agent Numagata, Yoshiaki (3 others)

(54) [Title of the Invention] Portable Type Music Selection/Viewing System

(57) [Abstract]

[Problem] To provide a system supplying music software that a user selects by using a cell phone.

[Solution] The distribution center 10 which has server functions receives offers of music software from record production companies 20. The portable type music selection/viewing equipment 50 which connects through a public network 30 to the distribution center 10 has a main body 51 having a button input section, a display 52 established on the main body 51, and a receiver 54 for music. The user selects and requests from the distribution center. Along with outputting to the receiver the sounds of the received music software, the lyrics and the like are output to the display 52.

[Claims]

[Claim 1] A portable type music selection/viewing system comprising:

a record company which produces music software;
a distribution center having a server which receives offers of music from the record company; and
a portable type music selection/viewing equipment which connects with the distribution center through a public network;
wherein the portable type music selection/viewing equipment provides a means for transmitting the inputted selection information to the distribution center by means of a public network and for outputting music software which was sent from the distribution center as sound and text information.

[Claim 2] The portable type music selection/viewing system according to Claim 1 wherein the portable type music selection/viewing equipment further comprises:

a power supply section;
an integrated control section;
a memory section for telephone number registration;
a button input section;
a display section;
a transmitter and receiver control section;
a transmitter and a receiver;
an electric wave transmitting and receiving controller;
an antenna;
a control section for music;
an amplifier for music; and
a receiver for music.

[Claim 3] The portable type music selection/viewing system according to Claim 2 wherein the portable type music selection/viewing equipment provides a memory section for music which stores the received music software.

[Claim 4] The portable type music selection/viewing system according to Claim 3 wherein the portable type music selection/viewing equipment provides memory media for music as freely attachable and detachable which stores the music software.

[Detailed Description of the Invention]

[0001]

[Technical Field of the Invention] The present invention relates to a distribution system for music which uses cellular telephones.

[0002]

[Description of Related Art] For example, using portable type radios or televisions, it is possible to enjoy music software by receiving broadcast electromagnetic waves from earth stations or satellites. The reception of these broadcast electromagnetic waves are a unidirectional communication service from the broadcasting station and the user can

make no selection. In addition, the existence of communication karaoke systems requires music that the user selects from the center using wire circuits and it is possible to receive service.

[0003]

[Problems that the Invention is to Solve] Following the spread of cell phone systems, it has become possible to provide every kind of service in addition to telephone service for the user. The present invention provides a music selection/viewing system which uses wireless public networks.

[0004]

[Means for Solving the Problems] The music selection/viewing system of the present invention, as a fundamental means, provides a record company which produces music software, a distribution center having a server which receives offers of music from the record company, and a portable type music selection/viewing equipment which connects with the distribution center through a public network, wherein the portable type music selection/viewing equipment provides a means for transmitting the inputted selection information to the distribution center by means of a public network and for outputting music software which was sent from the distribution center as sound and text information. In addition, as a fundamental means, there is provided a power supply section, an integrated control section, a memory section for telephone number registration, a button input section, a display section, a transmitter and receiver control section, a transmitter and a receiver, an electric wave transmitting and receiving controller, an antenna, a control section for music, an amplifier for music, and a receiver for music. Furthermore, the portable type music selection/viewing equipment provides a memory section for music which stores the received music software. In addition, the portable type music selection/viewing equipment provides memory media for music as freely attachable and detachable which stores the music software.

[0005]

[Embodiments] Fig. 1 is a complete formation diagram of the present invention's portable type music selection/viewing equipment. The system, shown with the entire body as symbol 1, has a distribution center 10 with receiver and the distribution center 10 receives offers of music contents from record production companies 20. The portable type music selection/viewing equipment 50, 60, and 70 are connected to this distribution center through a public network 30.

[0006] The portable type music selection/viewing equipment 50 has the same structure as, for example, a cell phone, providing the necessary push buttons and display 52. The receiver 54 is connected to the main body 51. The user which has the portable type music selection/viewing equipment 50 operates the push buttons on top of the main body 51 and calls the distribution center 10 through the public network 30, receiving the desired music software through the public network 30. The received music software is amplified by the amp provided within the main body 51 of the portable music selection/viewing equipment and output is to the receiver 54.

[0007] The user who has put on the receiver, along with enjoying the music, can, as necessary, display the lyrics on the display 52 and enjoy karaoke. This portable type music selection/viewing equipment 50 is simplified and it is possible to receive offers of music only during line connections.

[0008] The portable type music selection/viewing equipment 60 shows a television which houses the memory device 666 within the main body 61. For the portable type music selection/viewing equipment of the television, push buttons are operated and calls made to the distribution center. The music software is offered along with output to the receiver 64 and display 62 and is stored by the memory device 66. Consequently, the user, even after cutting the connection with the public line 30, can enjoy the reproduction of music software within the memory device 66.

[0009] The portable type music selection/viewing equipment 70 provides the memory device 76 which can be attached or detached from the main body 71. This memory device 76 is a memory card like, for example, a magnetic card, magnetic tape, CD, DVD, or IC card. The user operates the push buttons of the main body 71 and when downloading music software to the memory device (media) 76 of the portable type music selection/viewing equipment, along with being able to enjoy this music software using the display 72 or receiver 74 of the portable type music selection/viewing equipment 70, this memory device can be removed and inserted in other audio units and it is possible to enjoy high quality reproduced music. In addition, it is possible to store the music software within the memory device 76 using other audio units. It is possible to enjoy music by inserting this memory device 76 in this portable type music selection/viewing equipment 70.

[0010] Fig. 2 is a structure diagram of the present invention's portable type music selection/viewing equipment having the functions of a portable telephone. The main body of the portable type music selection/viewing equipment is shown using the symbol 100 and has the integrated control section 110 which is connected to the power supply 130 and for the integrated control section 110, the memory section 120 for telephone number registration is connected. The button input control section 180, having the button input section 182 which the user operates, sends signals to the integrated control section 160 and the integrated control section 110, along with displaying operating details to the display 162 by means of the display control section 160, accesses the public network by means of the electromagnetic wave sending and receiving control section 140 and the antenna 150. If the user calls other telephones, switching equipment calls the telephone and using the transmitter 174 and receiver 172 which are connected to the sending and receiving control section 170, it is possible for the user to telephone other parties.

[0011] The control section for music 200 is connected to the integrated control section 110, the power supply 130, the electromagnetic wave sending and receiving section 140, the button input control section 180, and the display control section 160. The user operates the button input section 182 and when the command for calling the distribution center is output, along with displaying the details to the display section 162, the

electromagnetic sending and receiving control section 140 accesses the distribution center through a public network by means of the antenna 150.

[0012] When it is possible to access the distribution center, the user makes a selection and the distribution center sends the selected music software. The control section 200 for received music amplifies the signal using an amplification section for music and outputs sounds to the receiver 230 used for music which is inserted in the receiver jack 220. This sound output can be output also to the receiver 172 and information about lyrics is displayed on the display section 162.

[0013] The memory section for music 240 which is connected to the control section for music 200 stores music software. The memory media 250 such as magnetic cards, magnetic tape, CD, DVD, or IC cards, along with storing music software, is removable and can be used with other audio units.

[0014] Fig. 3 is a flow diagram of the processing used in the present invention's system. In step S10, music, lyrics, and images are registered from the record production company 20 to the distribution center 10 (change and deletion). In step S11, the user can select a track name, an artist's name, lyrics, track name No., and a composer's name, using the display and push buttons of the portable type music selection/viewing equipment. In step S12, the selected track and lyrics are sent from the distribution center to the user via a circuit.

[0015] In step S13, sounds are heard from the user's receiver, along with display of the lyrics and images on the display. With a memory device attached, it is possible to reproduce after registration and phone call completion. In step 14, if the transmission from the distribution center is complete, accounting is performed. The accounting is performed based on the NTT Q2 method. In step S15, if a telephone call is incoming during reproduction from the memory device, an interruption notice or indication is given.

[0016]

[Effect of the Invention] From the previous description of the invention, because it is possible for a user, using the cell phone, to enjoy music software, the application of public networks is expanded and service is improved.

[Brief Explanation of the Drawings]

[Fig. 1] A formation diagram of the present invention's portable type music selection/viewing system.

[Fig. 2] A formation diagram of the present invention's portable music selection/viewing system.

[Fig. 3] A flow diagram of the present invention's portable type music selection/viewing system.

[Explanation of the Elements]

10- distribution center

20- record production company

30- public network
50,60, 70- portable music selection/viewing equipment

[Fig. 1]

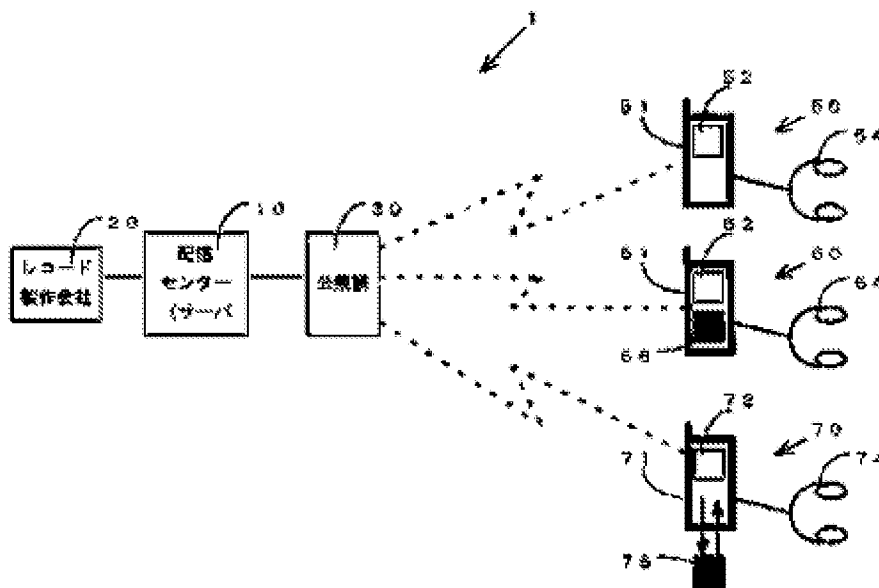

10-distribution center (server), 20- record production company, 30- public network

[Fig. 3]

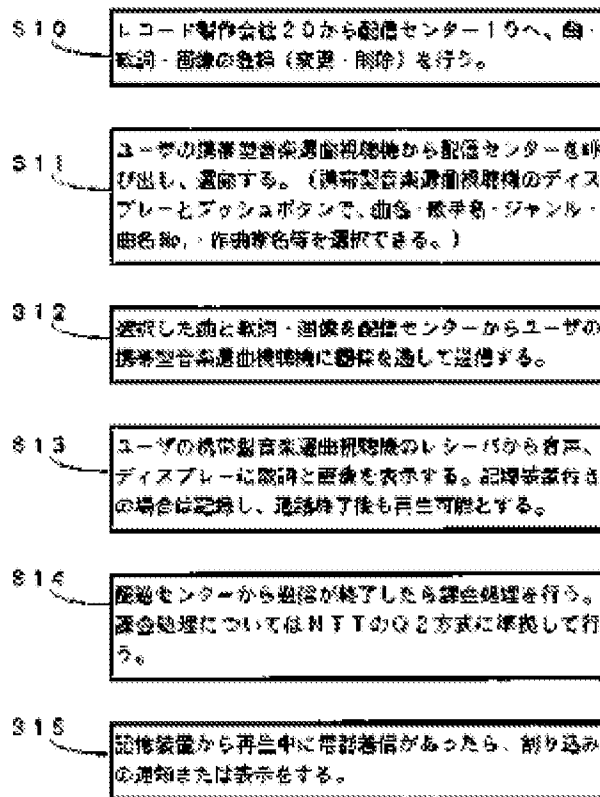

S10- perform registration of track, lyrics, and images to the distribution center 10 from the record production company 20.

S11- call distribution center from user of portable type music selection/viewing equipment and select. (Using push button and display of the portable type music selection/viewing equipment, it is possible to select the track name, artist's name, genre, and track No. and composer's name).

S12-Send by means of wire to the user's portable type music selection/viewing equipment from the distribution center the selected track, lyrics and images.

S13- Display the sounds from receiver of the user's portable type music selection/viewing equipment and the lyrics and images on the display. When a memory device is attached, it is possible to reproduce after registration and communications are completed.

S14- If the transmission from the distribution center is completed, perform accounting processing. Perform the accounting processing based on NTT's Q2 method.

S15- If there is an incoming telephone call during reproduction from the memory device, notify or display interruption.

[Fig. 2]

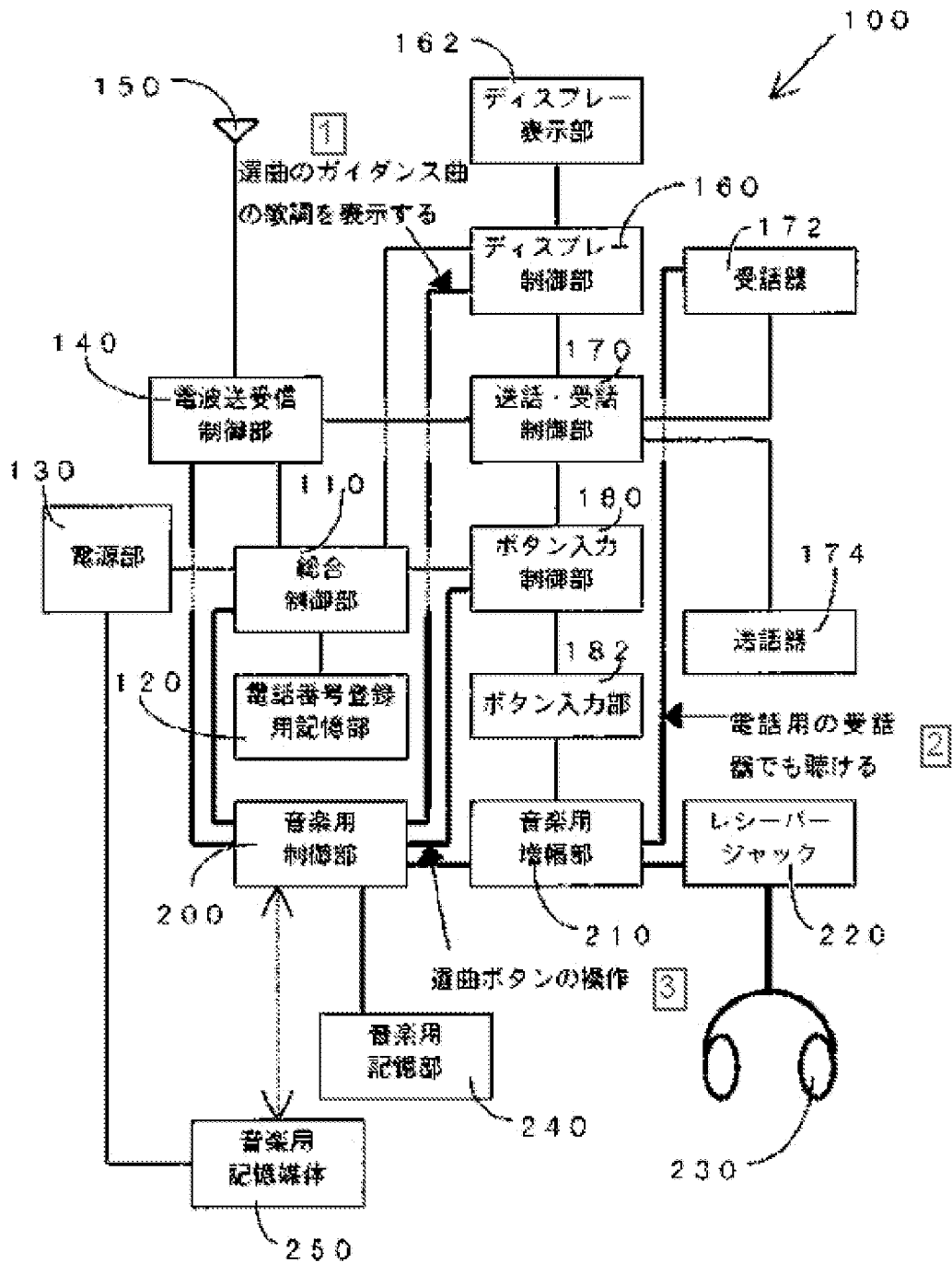

150- display lyrics of selected downloaded track, 2-hear also using telephone receiver, 3- operation of selected button, 110- integrated control section, 120- memory section used for telephone number registration, 130-power supply section, 140- electromagnetic wave reception control section, 160- display control section, 162- display section, 170-sending and receiving control section, 172- receiver, 174- transmitter, 180- button input control

section, 182- button input section, 200-music controller, 210- amplification section for music, 220- receiver jack, 240-memory section for music, 250- memory media for music

(19) JAPANESE PATENT OFFICE (JP)
(12) PUBLICATION OF UNEXAMINED PATENT APPLICATIONS (A)

(11) *Kokai* (Unexamined, Laid-Open) Patent Disclosure Number: H8-6875

(43) Date of Laid-Open Disclosure: January 12, 1996

(51) Int. Cl. ⁵	Identif. Symbol	Intra-office File Number	F1	Technology Display
G 06 F 13/00 17/30	351 G	7368-5E		
H 04 M	302	9194-5L G 60 F 15/403	320 A	

Examination Requested: not yet requested
Number of Claims 9 OL (total of 9 pages)

(21) Application Number: H6-136973

(22) Filing Date: June 20, 1994

(71) Applicant: 000004226
Nippon Telegraph & Telephone Corporation
3-19-2, Nishi Shinjuku, Shinjuku-ku, Tokyo

(72) Inventor: Kumi Taishinji
Nippon Telegraph & Telephone Corporation
1-1-6, Uchi Saiwai-cho, Chiyoda-ku, Tokyo

(72) Inventor: Kuni Kasahara
Nippon Telegraph & Telephone Corporation
1-1-6, Uchi Saiwai-cho, Chiyoda-ku, Tokyo

(72) Inventor: Tomohiko Arikawa
Nippon Telegraph & Telephone Corporation
1-1-6, Uchi Saiwai-cho, Chiyoda-ku, Tokyo

(74) Agent: Masataka Yoshida, Patent Agent

(54) [Title of the Invention] Multimedia Communication System and Terminal Apparatus Thereof

(57) [Abstract]

[Purpose] In order to match all media to a scale corresponding to a transmission capacity, to provide a multimedia communication system capable of creating representative information for which some information is thinned out by the information transfer side.

[Constitution] Representative information, with the amount of information reduced on the communication terminal device 11 to an extent that the original-like attribute of the received information is not lost, is extracted, and when requested by a mobile wireless communication terminal device 12, the representative information is transferred from the communication terminal device 11 to the mobile wireless communication terminal device 12 via the communication network 14 and the wireless base station 13.

[Effects] By receiving representative information, the mobile wireless communication terminal device 12, too, that has a limited information retention capacity, can easily keep track of the content of the information itself.

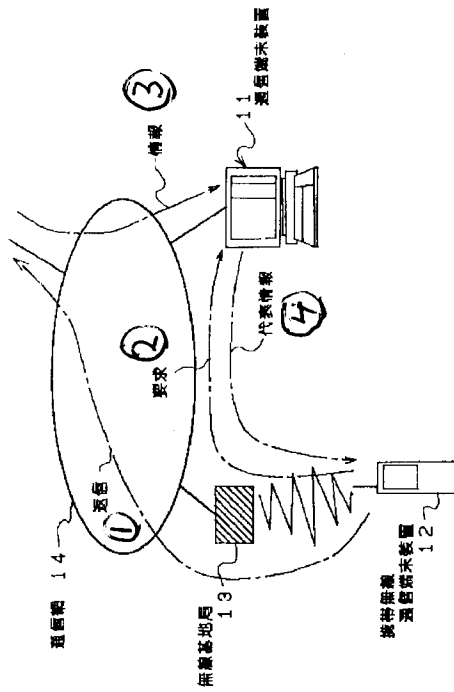

- 1 Reply
- 2 Request
- 3 Information
- 4 Representative information
- 14 Communication network
- 13 Wireless base station
- 12 Portable wireless communication terminal device
- 11 Communication terminal device

[What Is Claimed Is]

[Claim 1] A multimedia communication system, comprising: at least one first communication terminal device, at least one second communication terminal device, and a communication network that connects said first and second communication terminal devices; wherein said first communication terminal device comprises: a communication unit that sends and receives various types of information to and from the communication networks, a high-function processing unit that extracts representative information with a reduced amount of information from the received information to an extent that does not lose the original-like attribute, a communication recording unit that records in time-series the representative information obtained from said high-function processing unit, and a database unit that stores the received information and the representative information acquired from said high-function processing unit by associating them, such that keyword searches can be made on said stored information; wherein said second communication terminal device, which is portable, comprises: a communication unit that receives information and transmits new information, an icon display unit that separates media information from the received information and displays different types of icons based on the types of said media information, and a communication processing unit that performs the processing of selecting communication means and communication media from instructions input that corresponds to said icons and that is interactive.

[Claim 2] The multimedia communication system of Claim 1, wherein said first communication terminal device has an information transfer means that transfers extracted representative information to another communication terminal device.

[Claim 3] The multimedia communication system of Claim 1 or 2, wherein said first communication terminal device has an information transfer means that transfers the original information corresponding to the representative information based on instructions from said second communication terminal device to any communication terminal device.

[Claim 4] The multimedia communication system of Claim 1, 2, or 3, wherein said communication network and said first or second communication terminal device send and receive data wirelessly.

[Claim 5] The multimedia communication system of Claim 1, 2, 3, or 4, wherein the multimedia communication system comprises a video distribution center connected to said communication network, and wherein said first communication terminal device comprises a set top that makes it possible to display the video information from said video distribution center on a display unit as well as a means of extracting representative information from said video information.

[Claim 6] A multimedia communication terminal device, comprising: a communication unit that sends and receives various types of information to and from communication networks, a high-function processing unit that extracts representative information with a reduced amount of information from the received information to an extent that does not lose the original-like attribute, a communication recording unit that records in time-series the representative information obtained from said high-function processing unit, and a database unit that stores the received information and the representative information acquired from said high-function processing unit by associating them, such that keyword searches can be made on said stored information.

[Claim 7] The multimedia communication terminal device of Claim 6, wherein the device has an information transfer means that transfers said representative information to another communication terminal device.

[Claim 8] The multimedia communication terminal device of Claim 6, wherein the terminal device has an information transfer means that transfers the original information corresponding to

the representative information based on instructions from another communication terminal device to any communication terminal device.

[Claim 9] A multimedia communication terminal device, which is portable, comprising: a communication unit that receives information and transmits new information, an icon display unit that separates media information from the received information and displays different types of icons based on the types of said media information, and a communication processing unit that performs the processing of selecting communication means and communication media from instructions input that corresponds to said icons and that is interactive.

[Detailed Description of the Invention]

[0001]

[Field of Industry] This invention is directed to a multimedia communication system that performs information transfer services in multimedia communications and terminal devices thereof.

[0002]

[Prior Art] In recent years, there have been rapid advances in information transfer services in multimedia communications, leading to the provision of various services. For example, pagers (e.g., pocket bells) that call a person wirelessly and cause him or her to contact a given place, and pagers that implement bidirectional communications through the addition of a function that transmits handwritten characters and data have come to be provided, and the following services as information transfer services that use such pagers are known:

[0003] 1. Voice mail service, wherein when the caller dials a number assigned by a center, the center rings the pager that is called, and the call-receiving party accesses (telephones) a number assigned by the center to listen to the message. (Recruit "Delta Mail", TTM Comm-Net "Bell Voice", and the like). 2. A voice mail service, wherein a center on a network transfers and records an answering-machine-recorded message to the same company, and simultaneously uses a pager to call the away-from-phone party wirelessly. The called party can telephone the center to listen to said transferred and recorded message. (MIT Systems Laboratories, "Call Anywhere").

3. A monitoring system, wherein, when a machine that runs on an unattended basis fails, the event is conveyed to a pager through a modem, eight types of failures are recognized, and different codes corresponding to these failures are transmitted. (Kyowa System, "Communications Expert", Energy Support, "Pocket Bell Monitor.")

[0004]

[Problems to Be Solved by the Invention] In the conventional multimedia communication system described above, however, due to a transmission limited capacity of the pager to which information is transferred, the type of information that can be transferred is limited to voice and small amounts of data, and the conventional system is up against a first problem: the inability to transfer large-volume data and video information. There is also a second problem: the requirement that the terminal used to receive incoming calls in wireless calls be different from the terminal that makes a call in order to obtain an actual message. Also there is a third problem in that, because the communication is basically a bidirectional communication, it is not possible for the user to request repeated deliveries of a message if details on the first delivery were missed. Also, there is a fourth problem in that, whereas a bidirectional pager can make and receive calls using the same terminal equipment, a log of calls received cannot be saved. Also, there is a fifth problem in that the system does not provide a user interface that would permit initialing a new call based on log information on received calls.

[0005] In view of the above problems, an objective of the present invention, in order to match all media to a scale corresponding to a transmission capacity, is to provide a multimedia communication system capable of creating representative information for which some information is thinned out by the information transfer side. A second objective of the present invention is to

provide a multimedia communication system capable of transmitting new detailed information based on log information on incoming calls as well as requests for detailed information; a third objective of the present invention is to provide a multimedia communication system capable of associating representative information, a communications log, and incoming call data itself by storing a communications log. And a fourth objective of the present invention is to provide a multimedia communication system in which the user interface is structured in terms of information and that uses an icon display means for an easy-to-see display.

[0006]

[Means of Solving the Problems] In order to accomplish the above objectives, Claim 1 proposes the following multimedia communication system: a multimedia communication system, comprising: at least one first communication terminal device, at least one second communication terminal device, and a communication network that connects said first and second communication terminal devices; wherein said first communication terminal device comprises: a communication unit that sends and receives various types of information to and from the communication networks, a high-function processing unit that extracts representative information with a reduced amount of information from the received information to an extent that does not lose the original-like attribute, a communication recording unit that records in time-series the representative information obtained from said high-function processing unit, and a database unit that stores the received information and the representative information acquired from said high-function processing unit by associating them, such that keyword searches can be made on said stored information; wherein said second communication terminal device, which is portable, comprises: a communication unit that receives information and transmits new information, an icon display unit that separates media information from the received information and displays different types of icons based on the types of said media information, and a communication processing unit that performs the processing of selecting communication means and communication media from instructions input that corresponds to said icons and that is interactive.

[0007] Claim 2 proposes: in the multimedia communication system of Claim 1, said first communication terminal device has an information transfer means that transfers extracted representative information to another communication terminal device.

[0008] Claim 3 proposes: in the multimedia communication system of Claim 1 or 2, said first communication terminal device has an information transfer means that transfers the original information corresponding to the representative information based on instructions from said second communication terminal device to any communication terminal device.

[0009] Claim 4 proposes: in the multimedia communication system of Claim 1, 2, or 3, said communication network and said first or second communication terminal device send and receive data wirelessly.

[0010] Claim 5 proposes: in the multimedia communication system of Claim 1, 2, 3, or 4, the multimedia communication system comprises a video distribution center connected to said communication network, and said first communication terminal device comprises a set top that makes it possible to display the video information from said video distribution center on a display unit as well as a means of extracting representative information from said video information.

[0011] Claim 6 proposes: a multimedia communication terminal device, comprising: a communication unit that sends and receives various types of information to and from communication networks, a high-function processing unit that extracts representative information with a reduced amount of information from the received information to an extent that does not lose the original-like attribute, a communication recording unit that records in time-series the representative information obtained from said high-function processing unit,

and a database unit that stores the received information and the representative information acquired from said high-function processing unit by associating them, such that keyword searches can be made on said stored information.

[0012] Claim 7 proposes: in the multimedia communication terminal device of Claim 6, the device has an information transfer means that transfers said representative information to another communication terminal device.

[0013] Claim 8 proposes: in the multimedia communication terminal device of Claim 6, the terminal device has an information transfer means that transfers the original information corresponding to the representative information based on instructions from another communication terminal device to any communication terminal device.

[0014] Claim 9 proposes: a multimedia communication terminal device, which is portable, comprising: a communication unit that receives information and transmits new information, an icon display unit that separates media information from the received information and displays different types of icons based on the types of said media information, and a communication processing unit that performs the processing of selecting communication means and communication media from instructions input that corresponds to said icons and that is interactive.

[0015]

[Operation of the Invention] According to the multimedia communication system of Claim 1, communications are conducted through a communication network between the first communication terminal device and the second communication terminal device, between a first communication terminal device and another first communication terminal device, or between a second communication terminal device and another second communication terminal device. In this case, in said first communication terminal device, a communication unit sends and receives various types of information to and from said communication networks, a high-function processing unit extracts representative information with a reduced amount of information from the received information to an extent that does not lose the original-like attribute, and a communication recording unit records in time-series the representative information obtained from said high-function processing unit. Further, a database unit stores the received information and the representative information acquired from said high-function processing unit by associating them, such that keyword searches can be made on said stored information. In addition, in said second communication terminal device, a communication unit receives information and transmits new information, and an icon display unit separates media information from the received information and displays different types of icons based on the types of said media information. Further, a communication processing unit selects communication means and communication media from instructions input that corresponds to said icons and that is interactive.

[0016] According to Claim 2, an information transfer means transfers the representative information extracted in said first communication terminal device to another communication terminal device. In this manner, the second terminal device that has a small data storage capacity can also keep track of the contents of information by means of representative information.

[0017] According to Claim 3, the information transfer means of said first communication terminal device transfers the original information corresponding to the representative information based on instructions from said second communication terminal device to any communication terminal device. In this manner, the user who has the second communication terminal device, which is portable, can keep track of the content of details on information by means of representative information and view it by means of a handy first communication terminal device and other devices.

[0018] According to Claim 4, between said communication network and said first or second communication terminal device, data is sent and received wirelessly. In this manner, there is no restriction on the place of installation or use of communication terminal devices.

[0019] According to Claim 5, the set top for said first communication terminal device makes it possible to display the video information from the video distribution center on a display unit, to extract representative information from said video information, and to also transmit the representative information on said video information to another communication terminal device.

[0020] According to the multimedia communication system of Claim 6, a communication unit sends and receives various types of information to and from the communication networks, a high-function processing unit extracts representative information with a reduced amount of information from the received information to an extent that does not lose the original-like attribute, a communication recording unit records in time-series the representative information obtained from said high-function processing unit, and a database unit stores the received information and the representative information acquired from said high-function processing unit by associating them, such that keyword searches can be made on said stored information.

[0021] According to Claim 7, an information transfer means transfers said representative information to another communication terminal device. In this manner, even portable terminal devices that have a limited data storage capacity, for example, can keep track of the content of information by means of representative information.

[0022] According to Claim 8, information transfer means transfers the original information corresponding to the representative information based on instructions from another communication terminal device to any communication terminal device. In this manner, the user who has a portable communication terminal device, for example, with a small data storage capacity can view details on information, about which the content was tracked by means of representative information, by using a communication terminal device with a large data storage capacity that is located close to him or her.

[0023] According to the multimedia communication device of Claim 9, a communication unit receives information and transmits new information to another terminal device, and an icon display unit separates media information from the received information and displays different types of icons based on the types of said media information. Further, a communication processing unit selects communication means and communication media from instructions input that corresponds to said icons and that is interactive. In addition, [SOMETHING] [*Translator's note: the subject of the sentence missing*] is carried around and used by the user.

[0024]

[Embodiments] The following is an explanation of an embodiment of the present invention with references to drawings. FIG. 1 is a configuration diagram that shows the mode of communication network in the multimedia communication system of Embodiment 1 of the present invention. In the figure, Reference Number 11 denotes a communication terminal device; 12, a mobile wireless communication terminal device; 13, a wireless base station; and 14, a communication network.

[0025] The communication terminal device 11 is capable of conducting communications with the wireless base station 13 via the communication network 14. The portable wireless communication terminal device 12 is designed to wirelessly communicate with the wireless base station 13. In this manner, the portable wireless communication terminal device 12 can communicate with the communication terminal device 11 via the wireless base station 13 and the communication network 14.

[0026] FIG. 2 is a functional configuration diagram that depicts the communication terminal device 11 and the portable wireless communication terminal device 12 that implement the multimedia communication system described above. In the figure, (a) represents the functional configuration of the communication terminal device 11, and (b), the functional configuration of the portable wireless communication terminal device 12. The communication terminal device 11 comprises a communication unit 31, a high-function processing unit 32 connected to the communication unit 31,

a communication recording unit 33 connected to the communication unit 31 and the high-function processing unit 32, and a database unit 34 connected to said communication recording unit 33. The portable wireless communication terminal device 12 comprises a communication unit 41, an icon display unit connected to said communication unit 41, and a communication processing unit 43 connected to said icon display unit 42. Also, the high-function processing unit 32 extracts representative information that has the amount of information to be described later.

[0027] FIG. 3 shows an example of the graphical user interface (GUI) on the display screen of the icon display unit 42 for the portable wireless communication terminal device 12 described above. FIG. 4 shows an example of a media-specific functional icon.

[0028] As depicted in FIGs. 3 and 4, displayed on the icon display unit 42 are icons that correspond to various functions. When one of these icons is clicked on, icons that are lower-level than the clicked icon are displayed, and icons that are even lower in level exist.

[0029] An explanation of the operation of the embodiment of the above-described constitution follows. When information arrives on the communication terminal device 11 via the communication network 14, the communication terminal device 11 extracts representative information from said information, and calls the portable wireless communication terminal device 12 via the communication network 14 and the wireless base station 13. In this manner, the user of the portable wireless communication terminal device 12 confirms the call, and can view said representative information. Further, the user can access the communication terminal device 11 via the communication network 14 from the portable wireless communication terminal device 12 to acquire detailed information, and can reply to the sender of the message based on a call log based on the content of records in the communication processing unit 43.

[0030] In concrete terms, when information arrives from a source external to the communication terminal device 11, the communication unit 31 receives it, and the high-function processing unit 32 extracts representative information from said information. Although the information amount of the representative information depends on the storage capacity of said portable wireless communication terminal device 12, as an example, the representative information is extracted as follows:

[0031] 1. Voice, data (electronic mail): Basically, all such information is treated as representative information. If the amount of information involved is large, in the case of voice, the information is divided by time, and in the case of data, it is divided in terms of so many bytes from the beginning of the data.

2. Fax, and still images: The image is reduced, and the scale is transformed to suit the supported resolution on the wireless communication terminal device. If the amount of information is large in all cases, only the transmission part is reduced and transmitted.

3. Moving pictures: One scene between cut points is extracted, and the results are reduced and transmitted as a still image.

4. Pager: The data is transferred as is.

[0032] The extracted representative information is stored in time series in the communication recording unit 33, and it is transferred to the portable wireless communication terminal device 12 through the communication unit 31. The communication recording unit 33 being located above the database 34 in levels, the stored data in the communication recording unit 33 is structured in terms of media type, time of arrival, and representative information; it is stored in association with the original information which is stored in the database unit 34. In this manner, information retrieval can be performed easily through the use of keywords. The structured information is transferred to the portable wireless communication terminal device 12 via the communication unit 31.

[0033] On the portable wireless communication terminal device 12, the communication unit 41 receives the information transmitted from said communication terminal device 11, and the icon

display unit 11 displays it in the form of icons. Here, icons are characterized by the type of information received, such as media type and ultra-reduced images of representative information.

[0034] In concrete terms, the icon display unit 42 is comprised of a device such as a liquid crystal display unit + a touch panel, and interactions with the user are input into the device. As shown in FIGs. 2 and 3, when an icon is selected by means of interaction, representative information and function keys are displayed on the icon display unit 42.

[0035] The types of function keys provided vary depending on the media, as shown in FIG. 3; however, generally the following function keys are provided:

1. *reply*: Reply
2. *trans*: Transfer - to output moving pictures and the like to other terminal devices
3. *detail*: To request detailed information from a communication terminal device
4. *delete*: To delete data off the communication terminal device
5. *quit*: The default is to erase the icons on the wireless communication terminal device and return to a higher-level screen (the icon display screen)
6. *save*: To save the icon. After this processing, a *quit* will not erase the icon.

[0036] Based upon the specific function key selected, the communication processing unit 43 performs such procedures as assigning a destination address for performing communications, and [SOMETHING] [*Translator's note: the subject of sentence missing*] is transmitted from the communication unit 41 of the portable wireless communication terminal device 12. For example, if a request for detailed information is sent by return transmission from the communication terminal device 11, the request is received on the communication unit 31, the linked original information is fetched from the database unit 34 via the communication recording unit 33, and it is transmitted from the communication unit 31 to the portable wireless communication terminal device 12.

[0037] Next, an explanation of Embodiment 2 of the present invention follows. FIG. 5, which is a configuration diagram that shows Embodiment 2 of the present invention, depicts an embodiment in a video distribution service, such as CATV, or a video-on-demand service using CATV. In the figure, Reference Number 20 is a communication terminal device equipped with a monitor TV 21 and a set top 22. Reference Number 23 denotes a portable wireless communication terminal device; 24, a wireless base station; 25, a communication network; and 26, a video distribution center.

[0038] The set top 22, located between the monitor TV 21 and the communication network 25, permits the reception of videos from the video distribution center on the monitor TV 21, and performs communications with the wireless base station 24 and the video distribution center 26 through the communication network 25. In addition, the portable wireless communication terminal device 23 is designed to perform wireless communications with the wireless base station 24. In this manner, the portable wireless communication terminal device 23 can communicate with the set top 22 through the wireless base station 24 and the communication network 25. The configuration of the set top 22 is virtually the same as that of the communication terminal device 11 of Embodiment 1 described previously, and the configuration of the portable wireless communication terminal device 23 is similar to that of the portable wireless communication terminal device 12 of Embodiment 1.

[0039] According to the foregoing configuration, the user requests video information onto the set top 22 from the video distribution center 26 from the portable wireless communication terminal device 23 via the wireless base station 24 and the communication network 25. In this manner, the set top 22, accessing the video distribution center 26 and acquiring video information, extracts representative information from said video information and transmits it to said portable wireless communication terminal device 23. In this manner, the user can learn the video information acquired in terms of said representative information.

[0040] Specifically, when there is incoming video information from the video distribution center 26 onto the set top 22, the communication unit 31 receives it, and the high-function processing unit 32 extracts representative information from said video information. The information volume of this representative information is similar to the case in Embodiment 1 described previously.

[0041] The extracted representative information is stored in time series in the communication recording unit 33, and it is transferred to the portable wireless communication terminal device 23 through the communication unit 31. The communication recording unit 33 exists in a form that is overlaid on the database 34. The data in the communication recording unit 33 is structured in terms of media type, call arrival time, and representative information; it is stored in association with the original information stored in the database unit 34. The structured information is transferred to the portable wireless communication terminal device 23 through the communication unit 31.

[0042] In the portable wireless communication terminal device 23, the wireless communication unit 41 receives the information from the set top 22, and displays icons on the icon display unit 42. Stored below the icons is representative information. Here, the icons are characterized by media type, the ultra-reduced images of representative information, and by the information that is sent, as in the case of Embodiment 1.

[0043] Via the icon display unit 42, interactions from the user are input into the system. When an icon is selected by an interaction, the representative information and function keys appear on the icon display unit 42.

[0044] Based upon the specific function key selected, the communication processing unit 43 performs such procedures as assigning a destination address for performing communications, and [SOMETHING] [*Translator's note: the subject of sentence missing*] is transmitted from the communication unit 41 of the portable wireless communication terminal device 23. For example, if a request for detailed information is sent to the set top 22 by return transmission by specifying a reception-target communication terminal device, the request is received on the communication unit 31 in the set top 22. In the set top 22, the linked original information is fetched from the database unit 34 via the communication recording unit 33, and it is transmitted from the communication unit 31 to the specified communication terminal device (not shown in the figure) located near the user of the portable wireless communication terminal device 23. In this manner, the user of the portable wireless communication terminal device 23 can view details on the large-information-volume image information through the use of a handy communication terminal device.

[0045]

[Effects of the Invention] As explained above, according to the multimedia communication system of Claim 1 of the present invention, the first communication terminal device provides a high-function processing unit that creates representative information for which information is thinned out to some extent on the information transfer side in order to match any media to a scale corresponding to the transfer capacity. Therefore, the second communication terminal device, for example, also can keep track of the content of the information by receiving said representative information. Because a communication recording unit is provided in the first communication terminal device, a communication log can be stored, and representative information, the communication log, and the incoming call data itself can be saved in association. Further, because a communication processing unit is provided in the second communication terminal device, new information can be transmitted from the incoming log information and detailed information can be requested. Further, the provision of an icon display unit permits the structuring of information in the user interface, can display information in an easy-to-understand manner, and offers an excellent operability. This permits the implementation of bidirectional multimedia information transfer services so that the user can keep track of summary information anytime, anywhere, and can easily request for details on a given message.

[0046] According to Claim 2, in addition to the above effect, the information transfer side creates representative information by thinning out the information to some extent to match any media to a scale corresponding to the transfer capacity. In this manner, for example, the second communication terminal device, too, can easily keep track of large-capacity information contents by receiving said representative information.

[0047] According to Claim 3, in addition to the above effect, said first communication terminal device transfers to any other communication terminal device the original information corresponding to the representative information based on instructions from said second communication terminal device. Therefore, the user who has the second communication terminal device, which is portable, can easily view details on the information, about which the content was understood based upon representative information, through the use of a handy first communication terminal device and other devices.

[0048] According to Claim 4, in addition to the above effect, data is sent and received wirelessly between the communication network and said first or second communication terminal device; consequently, there are no restrictions on where the communication terminal devices are installed or used.

[0049] According to Claim 5, in addition to the above effect, representative information is extracted from the video information transmitted from the video distribution center, and representative information on said video information can also be transmitted to other communication terminal devices. Therefore, using a portable second terminal device, the content of large-volume video information can also be easily tracked.

[0050] Further, according to the multimedia communication terminal device of Claim 6, a high-function processing unit is provided that creates representative information for which information is thinned out to some extent by the information transfer side in order to match any media to a scale corresponding to the transmission capacity. Therefore, even with a communication terminal device with a small information accumulation capacity, the content of information can be tracked by receiving said representative information. In addition, the provision of a communication recording unit permits the storage of communication log and the saving of representative information, communication log, and the incoming call data itself by associating them.

[0051] According to Claim 7, in addition to the above effect, the information transfer side creates representative information by thinning out information to some extent and matches any media to a scale that corresponds to the transmission capacity. Therefore, even with a communication terminal device with a small information retention capacity, the content of information can be tracked by receiving said representative information.

[0052] According to Claim 8, in addition to the above effect, the original information corresponding to representative information based on instructions from another communication terminal device is transferred to another communication terminal device. Therefore, the user who owns a portable communication terminal device with a limited data retention capacity can easily view, as necessary, details on the information, about which the content was understood based upon representative information, through the use of a handy first communication terminal device and other devices that have a large data retention capacity.

[0053] Further, according to the multimedia communication terminal device of Claim 9, because a communication processing unit is provided, new information can be transmitted from the incoming log information and detailed information can be requested. Further, the provision of an icon display unit permits the structuring of information in the user interface, can display information in an easy-to-understand manner, and offers an excellent operability. In addition, the communication unit permits bidirectional communications so that the user can keep track of summary information anytime, anywhere, and can easily request for details on a given message.

[Brief Description of Drawings]

[FIG. 1] A configuration diagram showing the multimedia communication system of Embodiment 1 of the present invention.

[FIG. 2] A configuration diagram showing the communication terminal device and the portable wireless communication terminal device of Embodiment 1 of the present invention.

[FIG. 3] A diagram showing an example of GUI on the display screen of the portable wireless communication terminal device of Embodiment 1 of the present invention.

[FIG. 4] A diagram showing an example of media-specific icons in Embodiment 1 of the present invention.

[FIG. 5] A diagram showing a communication network mode for video distribution services, such as CATV, and video-on-demand services using CATV, in Embodiment 2 of the present invention.

[Explanation of Codes]

11 ... communication terminal device, 12 ... portable wireless communication terminal device, 13 ... wireless base station, 14 ... communication network, 20 ... communication terminal device, 21 ... monitor TV, 22 ... set top, 23 ... portable wireless communication terminal device, 24 ... wireless base station, 25 ... communication network, 26 ... video distribution center, 31 ... communication unit, 32 ... high-function processing unit, 33 ... communication recording unit, 34 ... database unit, 41 ... communication unit, 42 ... icon display unit, 43 ... communication processing unit

[FIG. 1]

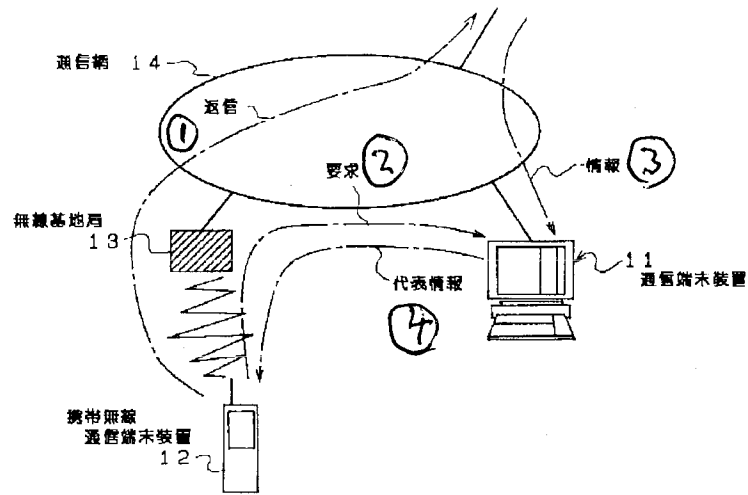

- 1 Reply
- 2 Request
- 3 Information
- 4 Representative information
- 14 Communication network
- 13 Wireless base station
- 12 Portable wireless communication terminal device
- 11 Communication terminal device

[FIG. 2]

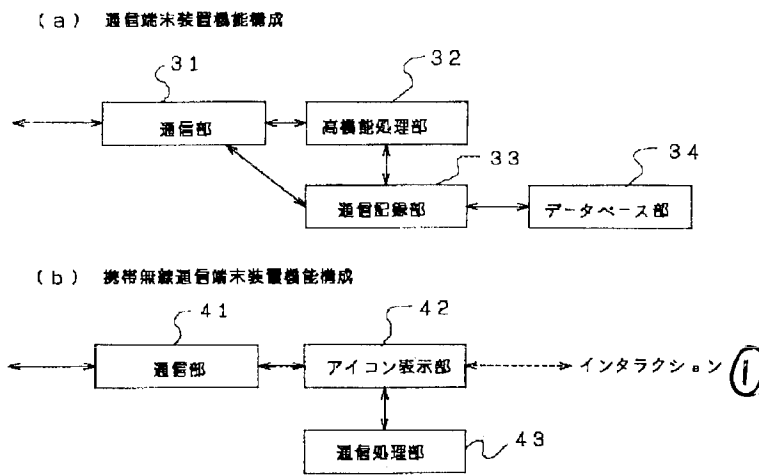

- (a) Configuration of communication terminal device functions
- 31 Communication unit
- 32 High-function processing unit
- 33 Communication recording unit
- 34 Database unit
- (b) Configuration of portable wireless communication terminal device functions
- 41 Communication unit
- 42 Icon display unit
- 1 Interaction
- 43 Communication processing unit

[FIG. 3]

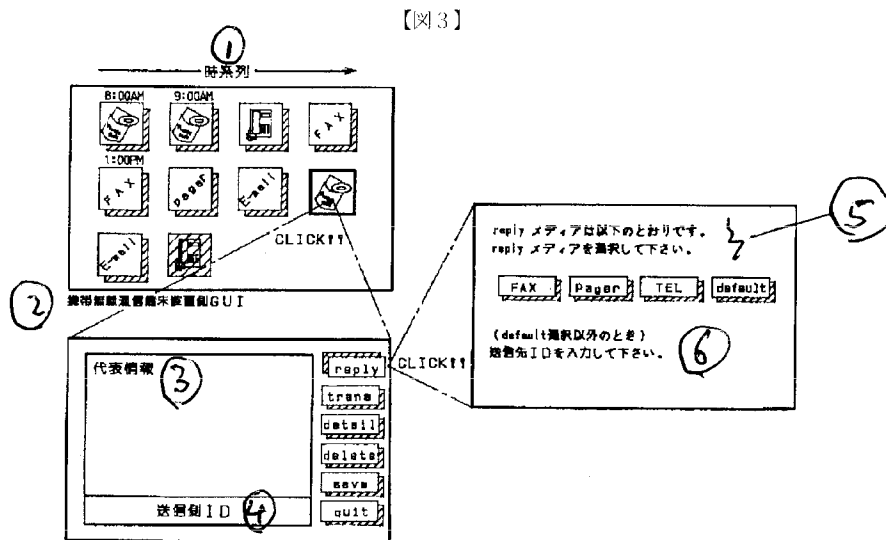

- 1 Time series
- 2 GUI on the portable wireless communication terminal device side
- 3 Representative information
- 4 Transmitter ID
- 5 reply: the following media are identified
reply: select a medium
- 6 (non-default case)
Enter the transmission destination ID

[FIG. 4]

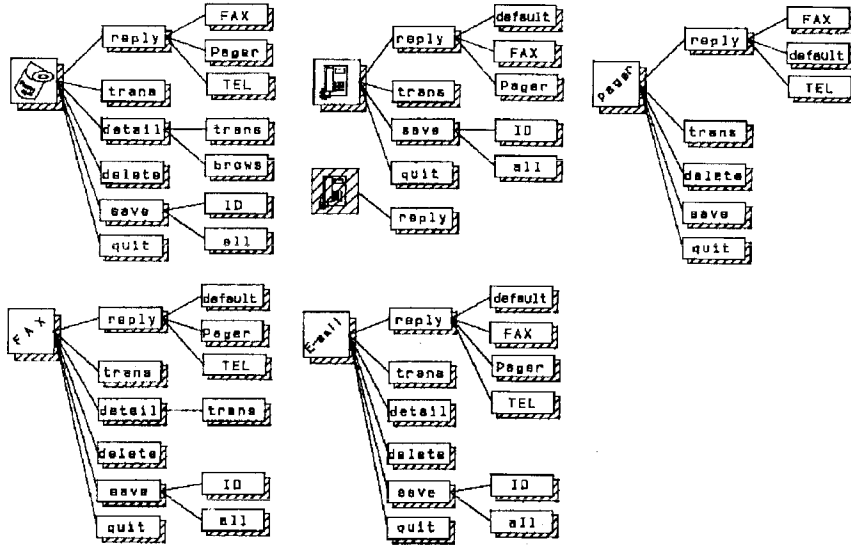

[FIG. 5]

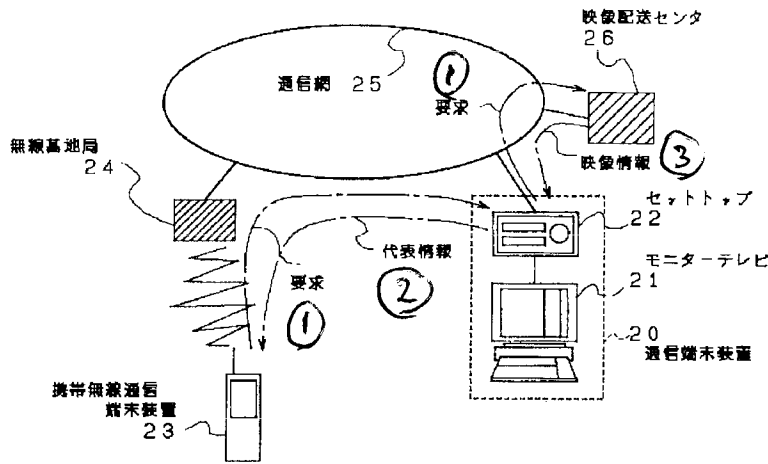

- 1 Request
- 2 Representative information
- 3 Video information
- 25 Communication network
- 24 Wireless base station
- 23 Portable wireless communication terminal device
- 26 Video distribution center
- 22 Set top
- 21 Monitor TV
- 20 Communication terminal device

I, Robert Ginns, of California, USA, hereby declare that I am a professional translator/editor experienced in translating Japanese technical documents into English, and certify that the foregoing is a true and accurate translation to the best of my knowledge and capability.

Document Name: 06-Tanaka-JP10-98512A_1

Translation Date: July 17, 2010

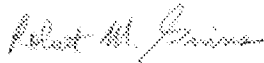

Translator's Signature

Date: July 17, 2010

Robert Ginns

19) JAPANESE PATENT OFFICE (JP) (11) Unexamined Patent Application (Kokai) Patent
(12) Bulletin of Unexamined Patent Applications (A) H10-98512

(43) Laid-Open Disclosure Date: April 14, 1998

(51) Int. Cl. ⁶	Classification No.	FI	
H04M 1/00		H04M 1/00	N
			U
H02J 7/00	301	H02J 7/00	301C
7/10		7/10	A
H04B 7/26		H04B 7/26	Y

Request for Examination: Not yet requested Number of claims: 2 OL (Total No. of Pages: 4)

(21) Application No.: H8-252976

(22) Filing Date: September 25, 1996

(71) Applicant 000006633
Kyocera Corp
5-22 Kitainoue-cho, Higashino, Yamashina-ku, Kyoto

(72) Inventor Tanaka, Toru
c/o Kyocera Yokohama Operations
2-1-1 Kagahara, Tsuzuki-ku, Yokohama Kanagawa

(54) [Title of the Invention] System Charger

(57) [Abstract]

[PROBLEM] The problem is one of making a telephone call if the cell telephone is removed from the charger while the battery is charging in a conventional cell telephone. In addition, with a conventional cellular recording medium/reproduction device, in order to hear audio while charging the battery, it is expected that an earphone is required.

[SOLUTION] Provide in a charger a plug which engages the earphone jack and a speaker of a cell phone or a portable recording medium/reproduction device.

[Claims]

[Claim 1] A system charger comprising:

a charger terminal for charging which is connected to the power supply battery terminal of a cell telephone;
a plug for engaging to an earphone jack of the cell telephone device; and
a means for performing hands-free telephone calls through the engaged earphone jack and plug or a means for recording audio.

[Claim 2] A system charger comprising:

a charger terminal for charging which is connected to the power supply battery terminal of a cell telephone;
a plug for engaging to an earphone jack of the cell phone device; and
a means for amplifying the reproduced sound of the recording medium/reproduction device through the engaged earphone jack and plug.

[Detailed Description of the Invention]

[0001]

[Technical Field] The present invention is related to a system charger which incorporates, in addition to the function of charging a cellular apparatus, functions other than realizing hands-free telephone calls, if the cellular apparatus is a cell phone.

[0002]

[Description of Related Art] Cellular apparatus of conventional cell phones or cellular type recording medium/reproduction devices (devices for hearing reproduced recordings by earphone) operate with a battery as a power supply. Because of this arrangement, if the battery's charge becomes low, the cellular apparatus is connected unaltered to the charger and the battery is charged or switching is made to an already charged battery.

[0003]

[Problems that the Invention is to Solve] However, it is difficult to make a telephone call while charging a battery connected to the charger, if the telephone call is made after the cell phone, using conventional cell phones, is removed from the charger. In this case, there is the requirement of making a telephone call without accomplishing full charge and in this case, there is concern that that telephone call will be interrupted midway through because of the battery depletion.

[0004] In addition, convention cellular recording medium/reproduction devices can make reproductions of recording medium while a battery, connected to a charger, charges, but, also in this case, it is expected that hearing is difficult as audio that is generated must be heard through an earphone.

[0005]

[Means for Solving the Problem] The first invention for solving the problems of conventional technology is a system charger comprised of

a charger terminal for charging which is connected to the power supply battery terminal of a cell phone;
a plug for engaging to an earphone jack of the cell phone device; and
a means for performing hands-free telephone calls through the engaged earphone jack and plug or a means for recording audio.

[0006] In addition, the second invention is a system charger comprised of

a charger terminal for charging which is connected to the power supply battery terminal of a cell phone;

a plug for engaging to an earphone jack of the cell phone device; and
a means for amplifying the reproduced sound of the recording medium/reproduction device through the engaged earphone jack and plug.

[0007]

[Embodiments] Fig. 1 is a block diagram of a cell phone charging system showing one embodiment of the present invention. 1 denotes a cell phone, and 2, every block of a system charger. The cell phone 1 is formed from the CPU 11, the wireless section 12, the incoming signal detector 13, the telephone circuit 14, the speaker sp, the microphone mc, the liquid crystal display section 15, the key operating section 16, the power supply circuit 17, the battery 18, the recording/reproducing circuit 19, the power supply battery terminals a1 and b1, and the earphone jack c1. The power supply battery terminals a1 and b1 and the earphone jack c1 are arranged on a side which connects with the system charger 2. The recording/reproduction circuit 19 has a recording medium such as an IC memory or MD and in addition to performing telephone call recording can transmit to the wireless circuits the recording contents through the telephone call circuit 14 and wireless section 12, while making a telephone call and can reproduce the recording contents using the speaker sp as well as recording voice from the microphone mc.

[0008] The system charger 2 is formed from the CPU 21, the incoming signal detector 22, the telephone call circuit 23, the ringer/speaker unit 24, the microphone unit (below mike unit) 25, the answering circuit 26, the key operation section 27, the AC-DC conversion circuit 28, the power supply circuit 29, the liquid crystal display section 30, the charging terminals a2 and b2 and the plug c2. The charging terminals a2 and b2 and the plug c2 are respectively arranged within a recess which contains the cell phone 1.

[0009] Moreover, the solid line connecting each block in the cell phone 1 and the system charger 2 shows a control path or voice path and the dotted line shows the power supply path.

[0010] When, for the previously described structure of the cell phone 1 and the system charger 2, the cell phone lies within a specific recess of the system charger 2 in order to charge the battery 17 of the cell phone 1, the plug c2 is inserted and connected (engaged) to the earphone jack c1 and when the plug c2 is completely inserted, the power supply battery terminals a1 and b1 are contact connected to the charging terminals a2 and b2. That is, the insertion connection (engagement) of the earphone jack c1 and the plug c2 and the power supply terminals a1 and b1 and the charging terminals a2 and b2 for the cell phone 1 and the system charger 2 result in a structure which is simultaneously completed in one connection operation. In addition, because the insertion connection of the earphone jack c1 and the plug c2 function as a position fixing structure, the power supply terminals a1 and b1 and the charging terminals a2 and b2 are assuredly connected and there is no concern for connection defects.

[0011] Under these connection conditions, when the CPU11 of the cell phone 1 detects incoming calls using the output of the incoming signal detector, incoming signals are generated and the incoming signals are made known to the system charger 2 through the voice path which connects the telephone call circuit 14 and earphone jack c1 and plug c2. When the incoming signal detector 22 of the system charger 2 detects incoming calls, the CPU21 is notified. At this time, the ringer/speaker 24 sounds a ringer under the control of the CPU 21. If a specific key of the key operation section 27 is pushed, an incoming response call from CPU 21 passes through the voice path which connects the telephone call path 23 and the plug c2 and is output to the cell phone. The CPU 11, which detected the incoming response call, which passed through the voice path and which connects the earphone jack c1 and the telephone circuit 14, wirelessly transmits the incoming response call by the wireless section 12 and starts the telephone call. Control of the cell phone by operation of the key operation section 27 has additional possibilities. There is output, through the voice path, to the cell phone 1 of control signals for performing, for example, dial signal generation or reproduction by the recording/reproduction circuit 19. This output is detected by the CPU 11 and every kind of control can be performed.

[0012] Subsequently, telephone calls are performed for the voice signals which are transmitted and received by the cell phone 1 passing through the wireless section 12, the telephone circuit 14, the voice path of the cell phone side of the earphone jack c1, and the voice path of the system charger 2 side of the plug c2, the telephone call circuit 23, the ringer-speaker section 24, and the mike section 25. This telephone

call is a hands-free telephone call, the ringer-speaker section 24 amplifies the voice, and the mike sensitivity for the mike section 25 is high as the mike section has a noise canceling function.

[0013] Moreover, the answering circuit 26 includes recording medium and the system charger 22 which connects the cell phone 1 functions as an answering telephone. Under conditions in which the system charger 2 is set to answering mode by the key operation section 27, when incoming signals are detected, the CPU 21 performs automatic incoming signal response and message transmission by the answering circuit 26 and messages for other sections are recorded. The recording medium is not limited to IC memory and may be cassette tape having long recording periods.

[0014] In addition, it is possible to reproduce the contents recorded in the recording/reproduction circuit 19 of the cell phone, passing through the telephone call circuit 14, the earphone jack c1, the plug c2, the telephone circuit 23, and the voice path of the ringer-speaker section 24.

[0015] Moreover, in the case where the recording medium, which provides the recording/reproduction circuit 19 of the cell phone 1, is a large capacity recording medium (cassette tape, etc.), this cell phone functions as a portability type recording/reproduction device. During transport, the non-illustrated earphone plug is inserted and connected to the earphone jack c1 and in addition to being able to make telephone calls by using the microphone and earphone which are connected by cord to the earphone plug, it is possible to hear audio from the earphone as reproduced from the recording medium. When the cell phone is placed in the system charger 2 at the time of returning home, it is possible to hear audio at high volume after reproduction of the recording medium from the ringer-speaker section 24, in addition to hands-free telephone conversations.

[0016] As described above, because there are hands-free telephone conversations during battery charging with the cell phone connected to the charger, it becomes unnecessary to remove from the charger the cell phone when there are incoming signals during battery charging and telephone conversations can occur without the worry of battery depletion. In addition, when the cell phone is used as a cellular recording/reproduction device, the earphone is not used during battery charging and it is possible to listen to audio at high volume after reproducing the recording medium.

[0017] As described above, a description has been made of a system charger for a cell phone as one embodiment of the present invention, but the present invention is not limited to this embodiment and without providing the functions of a cell phone, it goes without saying that it is possible to use the invention as a system charger of cellular apparatus having the function of only a cellular recording medium/reproduction device.

[0018]

[Effect of the Invention] According to the present invention as described above, by the cellular apparatus (cell phone, portable type recording medium/reproduction device) providing to a charger a plug which is inserted and connects to a provided earphone jack, and because it is possible to transmit and receive voice signals and control signals between the cellular apparatus and charger, it is not necessary to establish separate connection terminals on the side of the cellular apparatus, miniaturization is not adversely affected and cost increases do not occur. Furthermore, during terminal connection, in addition to the terminals used for charging, additional terminals for voice signals and control are required and there is some concern for connection defects. However, there is no concern for connection defects with the present invention, as the invention has a structure which connects the plug to the earphone jack.

[Brief Explanation of the Drawings]

[Fig. 1] A block diagram of the cell phone system showing one embodiment of the present invention.

[Explanation of the Elements]

1: Cell phone
2: System charger
11 21: CPU
12: Wireless section
13, 22: Arrival detecting section
14, 23: Speaking circuit
15, 30: Liquid crystal display section
16, 27: Key operation section
17, 29: Power supply circuit
18: Battery
19: Recording/reproduction circuit
24: Ringer speaker section
25: Microphone section (microphone section)
26: Answering circuit
28: AC-DC conversion circuit
a1, b1: Power supply battery terminals
a2, b2: Charging terminals
c1: Earphone jack
c2: Plug
sp: Speaker
mc: Microphone

[Fig. 1]

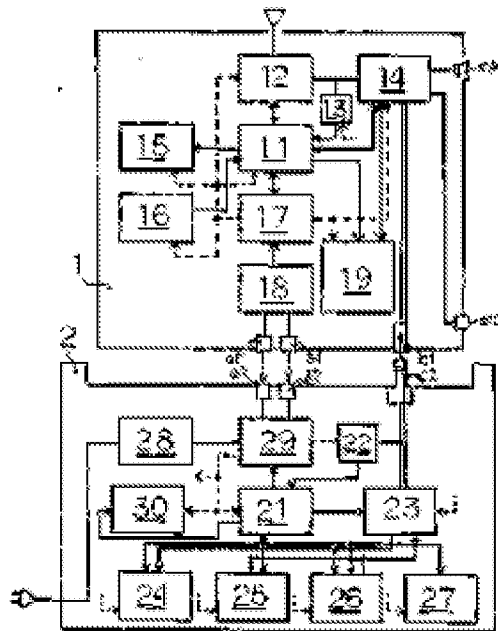

Electronic Patent Application Fee Transmittal

Application Number:	12495190
Filing Date:	30-Jun-2009
Title of Invention:	Method For Content Delivery
First Named Inventor/Applicant Name:	Russell W. White
Filer:	Mark J. Rozman/Stephanie Petreas
Attorney Docket Number:	AFF.0004C7US

Filed as Large Entity

Utility under 35 USC 111(a) Filing Fees

Description	Fee Code	Quantity	Amount	Sub-Total in USD(\$)
Basic Filing:				
Pages:				
Claims:				
Miscellaneous-Filing:				
Petition:				
Patent-Appeals-and-Interference:				
Post-Allowance-and-Post-Issuance:				
Extension-of-Time:				
Extension - 1 month with \$0 paid	1251	1	130	130

Description	Fee Code	Quantity	Amount	Sub-Total in USD(\$)
Miscellaneous:				
Submission- Information Disclosure Stmt	1806	1	180	180
Statutory or terminal disclaimer	1814	1	140	140
Total in USD (\$)				450

Electronic Acknowledgement Receipt

EFS ID:	9249816
Application Number:	12495190
International Application Number:	
Confirmation Number:	2380
Title of Invention:	Method For Content Delivery
First Named Inventor/Applicant Name:	Russell W. White
Customer Number:	21906
Filer:	Mark J. Rozman/Stephanie Petreas
Filer Authorized By:	Mark J. Rozman
Attorney Docket Number:	AFF.0004C7US
Receipt Date:	18-JAN-2011
Filing Date:	30-JUN-2009
Time Stamp:	14:29:55
Application Type:	Utility under 35 USC 111(a)

Payment information:

Submitted with Payment	yes
Payment Type	Deposit Account
Payment was successfully received in RAM	\$450
RAM confirmation Number	833
Deposit Account	201504
Authorized User	

The Director of the USPTO is hereby authorized to charge indicated fees and credit any overpayment as follows:

Charge any Additional Fees required under 37 C.F.R. Section 1.19 (Document supply fees)

Charge any Additional Fees required under 37 C.F.R. Section 1.21 (Miscellaneous fees and charges)

File Listing:					
Document Number	Document Description	File Name	File Size(Bytes)/ Message Digest	Multi Part /.zip	Pages (if appl.)
1	Amendment/Req. Reconsideration-After Non-Final Reject	AFF004C7USROA9-17-10.pdf	73599 11e6294fe6e60ceb8304936b1ee8279580599e29	no	10
Warnings:					
Information:					
2	Terminal Disclaimer Filed	AFF004C7USTerminalDisclaimer.pdf	47896 e2d613344e079f90194c865d5d3e953db28c0111	no	1
Warnings:					
Information:					
3	Information Disclosure Statement (IDS) Filed (SB/08)	AFF004C7USIDSToFile.pdf	117507 f054241b6f7ad0cfe0f13c57ca292e3cabef9140	no	5
Warnings:					
Information:					
This is not an USPTO supplied IDS fillable form					
4	Foreign Reference	ForDocBae.pdf	2861277 0c9780864de2982cd5ba95387ceb758ff1d8bfc4	no	31
Warnings:					
Information:					
5	Foreign Reference	ForDocGrewe.pdf	1332339 cc8a70f0d3ba73aa2f859566ba58532088062004	no	10
Warnings:					
Information:					
6	Foreign Reference	ForDocMenju.pdf	258016 9da413dd1ec0a1741a8770c1ccf899b6096a8859	no	22
Warnings:					
Information:					
7	Foreign Reference	ForDocSato.pdf	301359 d8a48a287c0f36bc79e98d012ef9512e433521d2	no	11
Warnings:					
Information:					
8	Foreign Reference	ForDocTaishinji.pdf	253642 c14c25fbc2ce7bc0420794e315f048408e6bdfba	no	17
Warnings:					
Information:					

9	Foreign Reference	ForDocTanaka.pdf	81683	no	7
			56ba6ba187b65593bc601161243100e68d8932f3		
Warnings:					
Information:					
10	NPL Documents	OrderDenyingMotion.pdf	137480	no	5
			f16d99da76a96b1b77d62939763cf5eed5397e4d		
Warnings:					
Information:					
11	NPL Documents	JuryVerdictForm.pdf	295953	no	16
			490645eeec6effe9814935f1a1a72f78e9ed94c		
Warnings:					
Information:					
12	Fee Worksheet (PTO-875)	fee-info.pdf	33635	no	2
			202bcec5111e274f0e4dc0c28d0c4099d65eee96		
Warnings:					
Information:					
Total Files Size (in bytes):			5794386		

This Acknowledgement Receipt evidences receipt on the noted date by the USPTO of the indicated documents, characterized by the applicant, and including page counts, where applicable. It serves as evidence of receipt similar to a Post Card, as described in MPEP 503.

New Applications Under 35 U.S.C. 111

If a new application is being filed and the application includes the necessary components for a filing date (see 37 CFR 1.53(b)-(d) and MPEP 506), a Filing Receipt (37 CFR 1.54) will be issued in due course and the date shown on this Acknowledgement Receipt will establish the filing date of the application.

National Stage of an International Application under 35 U.S.C. 371

If a timely submission to enter the national stage of an international application is compliant with the conditions of 35 U.S.C. 371 and other applicable requirements a Form PCT/DO/EO/903 indicating acceptance of the application as a national stage submission under 35 U.S.C. 371 will be issued in addition to the Filing Receipt, in due course.

New International Application Filed with the USPTO as a Receiving Office

If a new international application is being filed and the international application includes the necessary components for an international filing date (see PCT Article 11 and MPEP 1810), a Notification of the International Application Number and of the International Filing Date (Form PCT/RO/105) will be issued in due course, subject to prescriptions concerning national security, and the date shown on this Acknowledgement Receipt will establish the international filing date of the application.

Under the Paperwork Reduction Act of 1995, no persons are required to respond to a collection of information unless it displays a valid OMB control number.

**TERMINAL DISCLAIMER TO OBTAIN A DOUBLE PATENTING
REJECTION OVER A "PRIOR" PATENT**

 Docket Number (Optional)
AFF.004C7US

 In re Application of: **Russell W. White, et al.**

 Application No.: **12/495,190**

 Filed: **June 30, 2009**

 For: **Method For Content Delivery**

The owner, Affinity Labs of Texas, LLC, of 100 percent interest in the instant application hereby disclaims, except as provided below, the terminal part of the statutory term of any patent granted on the instant application which would extend beyond the expiration date of the full statutory term prior patent No. 7,778,595 as the term of said prior patent is defined in 35 U.S.C. 154 and 173, and as the term of said prior patent is presently shortened by any terminal disclaimer. The owner hereby agrees that any patent so granted on the instant application shall be enforceable only for and during such period that it and the prior patent are commonly owned. This agreement runs with any patent granted on the instant application and is binding upon the grantee, its successors or assigns.

In making the above disclaimer, the owner does not disclaim the terminal part of the term of any patent granted on the instant application that would extend to the expiration date of the full statutory term as defined in 35 U.S.C. 154 and 173 of the prior patent, "as the term of said prior patent is presently shortened by any terminal disclaimer," in the event that said prior patent later:

expires for failure to pay a maintenance fee;

is held unenforceable;

is found invalid by a court of competent jurisdiction;

is statutorily disclaimed in whole or terminally disclaimed under 37 CFR 1.321;

has all claims canceled by a reexamination certificate;

is reissued; or

is in any manner terminated prior to the expiration of its fully statutory term as presently shortened by any terminal disclaimer.

Check either box 1 or 2 below, if appropriate.

1. For submissions on behalf of a business/organization (e.g., corporation, partnership, university, government agency, etc.), the undersigned is empowered to act on behalf of the business/organization.

I hereby declare that all statements made herein of my own knowledge are true and that all statements made on information and belief are believed to be true; and further that these statements were made with the knowledge that willful false statements and the like so made are punishable by fine or imprisonment, or both, under Section 1001 of Title 18 of the United States Code and that such willful false statements may jeopardize the validity of the application or any patent issued thereon.

2. The undersigned is an attorney or agent of record. Reg. No. 42,117



Signature



Date

Mark J. Rozman

Typed or printed name

512-418-9944

Telephone Number

- Terminal disclaimer fee under 37 CFR 1.20(d) included.

WARNING: Information on this form may become public. Credit card information should not be included on this form. Provide credit card information and authorization on PTO-2038.

* Statement under 37 CFR 3.73(b) is required if terminal disclaimer is signed by the assignee (owner).
Form PTO/SB/96 may be used for making this certification. See MPEP § 324.

This collection of information is required by 37 CFR 1.321. The information is required to obtain or retain a benefit by the public which is to file (and by the USPTO to process) an application. Confidentiality is governed by 35 U.S.C. 122 and 37 CFR 1.11 and 1.14. This collection is estimated to take 12 minutes to complete, including gathering, preparing, and submitting the completed application form to the USPTO. Time will vary depending upon the individual case. Any comments on the amount of time you require to complete this form and/or suggestions for reducing this burden, should be sent to the Chief Information Officer, U.S. Patent and Trademark Office, U.S. Department of Commerce, P.O. Box 1450, Alexandria, VA 22313-1450. DO NOT SEND FEES OR COMPLETED FORMS TO THIS ADDRESS. SEND TO: Commissioner for Patents, P.O. Box 1450, Alexandria, VA 22313-1450.

If you need assistance in completing the form, call 1-800-PTO-9199 and select option 2.

INFORMATION DISCLOSURE STATEMENT BY APPLICANT (Not for submission under 37 CFR 1.99)	Application Number		12495190
	Filing Date		2009-06-30
	First Named Inventor	Russell W. White, et al.	
	Art Unit		2617
	Examiner Name	Erika A. Gary	
	Attorney Docket Number		AFF.004C7US

U.S.PATENTS

Examiner Initial*	Cite No	Patent Number	Kind Code ¹	Issue Date	Name of Patentee or Applicant of cited Document	Pages, Columns, Lines where Relevant Passages or Relevant Figures Appear
	1	7149543		2006-12-12	Kumar II	
	2	7321783		2008-01-22	Kim	
	3	5991640		1999-11-23	Lilja	
	4	6823255		2004-11-23	Sass	
	5	6259892		2001-07-10	Helferich	
	6	5914941		1999-07-22	Janky	
	7	6487663		2002-11-26	Jaisimha	
	8	6658247		2003-12-02	Saito	

**INFORMATION DISCLOSURE
STATEMENT BY APPLICANT**
(Not for submission under 37 CFR 1.99)

Application Number	12495190
Filing Date	2009-06-30
First Named Inventor	Russell W. White, et al.
Art Unit	2617
Examiner Name	Erika A. Gary
Attorney Docket Number	AFF.004C7US

9	6007228		1999-12-28	Agarwal	
10	5341350		1994-08-23	Frank	

If you wish to add additional U.S. Patent citation information please click the Add button.

U.S.PATENT APPLICATION PUBLICATIONS

Examiner Initial*	Cite No	Publication Number	Kind Code ¹	Publication Date	Name of Patentee or Applicant of cited Document	Pages, Columns, Lines where Relevant Passages or Relevant Figures Appear
	1	20020010759		2002-01-24	Hitson	
	2	20020164973		2002-11-07	Janik	

If you wish to add additional U.S. Published Application citation information please click the Add button.

FOREIGN PATENT DOCUMENTS

Examiner Initial*	Cite No	Foreign Document Number ³	Country Code ²	Kind Code ⁴	Publication Date	Name of Patentee or Applicant of cited Document	Pages, Columns, Lines where Relevant Passages or Relevant Figures Appear	T ⁵
	1	EP 0744839	EP		1996-11-27	Grewe		<input type="checkbox"/>
	2	H08-6875	JP		1996-01-12	Taishinji		<input checked="" type="checkbox"/>
	3	H11-288558	JP		1999-10-19	Menju		<input checked="" type="checkbox"/>

**INFORMATION DISCLOSURE
STATEMENT BY APPLICANT**
(Not for submission under 37 CFR 1.99)

Application Number	12495190
Filing Date	2009-06-30
First Named Inventor	Russell W. White, et al.
Art Unit	2617
Examiner Name	Erika A. Gary
Attorney Docket Number	AFF.004C7US

4	H11-164058	JP		1999-06-18	Sato	<input checked="" type="checkbox"/>
5	H08-252976	JP		1998-04-14	Tanaka	<input checked="" type="checkbox"/>
6	WO 2000/54462	WO		2000-09-14	Bae	<input type="checkbox"/>

If you wish to add additional Foreign Patent Document citation information please click the Add button

NON-PATENT LITERATURE DOCUMENTS

Examiner Initials*	Cite No	Include name of the author (in CAPITAL LETTERS), title of the article (when appropriate), title of the item (book, magazine, journal, serial, symposium, catalog, etc), date, pages(s), volume-issue number(s), publisher, city and/or country where published.	T ⁵
	1	Affinity Labs of Texas, LLC, v. BMW North America, LLC, et al., Civil Action No. 9:08CV164, Order Denying Defendant's Motion For Summary Judgment of Non-Infringement of the '833 Patent, filed October 07, 2010, pages 1 - 5.	<input type="checkbox"/>
	2	Affinity Labs of Texas, LLC, v. Hyundai Motor America, Inc.; Hyundai Motor Manufacturing Alabama LLC.; Volkswagen Group of America, Inc.; and Kia Motors America, Inc., Civil Action No. 9:08CV164, Jury Verdict Form, filed October 28, 2010, pages 1 - 16.	<input type="checkbox"/>
	3	Affinity Labs of Texas, LLC, vs. BMW North America, LLC, et al., Docket 9:08CV164, October 27, 2010, Volume 8 of ___, Pages 2100 Through 2633, Reporter's Transcript of Jury Trial, pages 1 - 88.	<input type="checkbox"/>
	4	Affinity Labs of Texas, LLC, vs. BMW North America, LLC, et al., Docket 9:08CV164, October 28, 2010, Volume 9 of 9, Pages 2634 Through 2824, Reporter's Transcript of Jury Trial, pages 1 - 19.	<input type="checkbox"/>
	5	Affinity Labs of Texas, LLC, Plaintiff and Counter-Claim Defendant, vs. Apple Inc., Defendant and Counter-Claim Plaintiff, Case No. 09-4436-CW, Apple Inc.'s First Invalidity Contentions Pursuant To Patent Local Rule 3-3, filed January 5, 2011, pages 1-25, with accompanying Appendixes A-G.	<input type="checkbox"/>

If you wish to add additional non-patent literature document citation information please click the Add button

**INFORMATION DISCLOSURE
STATEMENT BY APPLICANT**
(Not for submission under 37 CFR 1.99)

Application Number	12495190	
Filing Date	2009-06-30	
First Named Inventor	Russell W. White, et al.	
Art Unit	2617	
Examiner Name	Erika A. Gary	
Attorney Docket Number	AFF.004C7US	

EXAMINER SIGNATURE

Examiner Signature		Date Considered	
--------------------	--	-----------------	--

***EXAMINER:** Initial if reference considered, whether or not citation is in conformance with MPEP 609. Draw line through a citation if not in conformance and not considered. Include copy of this form with next communication to applicant.

¹ See Kind Codes of USPTO Patent Documents at www.USPTO.GOV or MPEP 901.04. ² Enter office that issued the document, by the two-letter code (WIPO Standard ST.3). ³ For Japanese patent documents, the indication of the year of the reign of the Emperor must precede the serial number of the patent document. ⁴ Kind of document by the appropriate symbols as indicated on the document under WIPO Standard ST.16 if possible. ⁵ Applicant is to place a check mark here if English language translation is attached.

**INFORMATION DISCLOSURE
STATEMENT BY APPLICANT**
(Not for submission under 37 CFR 1.99)

Application Number	12495190
Filing Date	2009-06-30
First Named Inventor	Russell W. White, et al.
Art Unit	2617
Examiner Name	Erika A. Gary
Attorney Docket Number	AFF.004C7US

CERTIFICATION STATEMENT

Please see 37 CFR 1.97 and 1.98 to make the appropriate selection(s):

That each item of information contained in the information disclosure statement was first cited in any communication from a foreign patent office in a counterpart foreign application not more than three months prior to the filing of the information disclosure statement. See 37 CFR 1.97(e)(1).

OR

That no item of information contained in the information disclosure statement was cited in a communication from a foreign patent office in a counterpart foreign application, and, to the knowledge of the person signing the certification after making reasonable inquiry, no item of information contained in the information disclosure statement was known to any individual designated in 37 CFR 1.56(c) more than three months prior to the filing of the information disclosure statement. See 37 CFR 1.97(e)(2).

See attached certification statement.

Fee set forth in 37 CFR 1.17 (p) has been submitted herewith.

None

SIGNATURE

A signature of the applicant or representative is required in accordance with CFR 1.33, 10.18. Please see CFR 1.4(d) for the form of the signature.

Signature	/Mark J. Rozman/	Date (YYYY-MM-DD)	2011-01-18
Name/Print	Mark J. Rozman	Registration Number	42117

This collection of information is required by 37 CFR 1.97 and 1.98. The information is required to obtain or retain a benefit by the public which is to file (and by the USPTO to process) an application. Confidentiality is governed by 35 U.S.C. 122 and 37 CFR 1.14. This collection is estimated to take 1 hour to complete, including gathering, preparing and submitting the completed application form to the USPTO. Time will vary depending upon the individual case. Any comments on the amount of time you require to complete this form and/or suggestions for reducing this burden, should be sent to the Chief Information Officer, U.S. Patent and Trademark Office, U.S. Department of Commerce, P.O. Box 1450, Alexandria, VA 22313-1450. **DO NOT SEND FEES OR COMPLETED FORMS TO THIS ADDRESS. SEND TO: Commissioner for Patents, P.O. Box 1450, Alexandria, VA 22313-1450.**

Electronic Acknowledgement Receipt

EFS ID:	9250019
Application Number:	12495190
International Application Number:	
Confirmation Number:	2380
Title of Invention:	Method For Content Delivery
First Named Inventor/Applicant Name:	Russell W. White
Customer Number:	21906
Filer:	Mark J. Rozman/Stephanie Petreas
Filer Authorized By:	Mark J. Rozman
Attorney Docket Number:	AFF.0004C7US
Receipt Date:	18-JAN-2011
Filing Date:	30-JUN-2009
Time Stamp:	14:38:12
Application Type:	Utility under 35 USC 111(a)

Payment information:

Submitted with Payment	no
------------------------	----

File Listing:

Document Number	Document Description	File Name	File Size(Bytes)/ Message Digest	Multi Part /.zip	Pages (if appl.)
1	Information Disclosure Statement (IDS) Filed (SB/08)	AFF004C7USIDSToFile.pdf	117507 <small>f054241b6f7ad0cfe0f13c57ca292e3cabef9 140</small>	no	5

Warnings:

Information:

This is not an USPTO supplied IDS fillable form					
2	NPL Documents	NPLDocAppleIncFirstAmendedInvalidityContentions.pdf	198271 fd1f98fb5357591d072bb67175f180232643978b	no	25
Warnings:					
Information:					
3	NPL Documents	NPLAppendixAwithAppleFirstAmendedInvalidityContention.pdf	110665 275cfe2a7a5b806a566c00b6046c919af836288	no	13
Warnings:					
Information:					
4	NPL Documents	NPLAppendixBwithAppleFirstAmendedInvalidityContention.pdf	1742146 3c9882fb5f5194d360d858193f5f38cf1fc5861d	no	207
Warnings:					
Information:					
5	NPL Documents	NPLAppendixCwithAppleFirstAmendedInvalidityContention.pdf	723958 4612d32e5b727c15339906d6cfe2c179b890070c	no	86
Warnings:					
Information:					
6	NPL Documents	NPLAppendixDwithAppleFirstAmendedInvalidityContention.pdf	2220912 160b7ec5690474cb4757a1f1ae5604c299c59fa8	no	273
Warnings:					
Information:					
7	NPL Documents	NPLAppendixEwithAppleFirstAmendedInvalidityContention.pdf	305648 b6e91e9a04de8d7fbc47b4b64c6e1aeb079b69e	no	43
Warnings:					
Information:					
8	NPL Documents	NPLAppendixFwithAppleFirstAmendedInvalidityContention.pdf	100404 86218bf065bed9ba038e97208ed00e70b66c1c2d	no	12
Warnings:					
Information:					
9	NPL Documents	NPLAppendixGwithAppleFirstAmendedInvalidityContention.pdf	153283 f02ec9147e44e47628f1f105446bda64e3fa652	no	21
Warnings:					
Information:					
10	NPL Documents	ReportersTranscriptonJMOL1.pdf	361363 f90c26ad141b21629716625e7e8389497377f76a	no	88

Warnings:					
Information:					
11	NPL Documents	ReportersTranscriptonJMOL2T oFile.pdf	93831 e831af0d621dac7c9caf25ce0c1f73ccbde63 0d8	no	19
Warnings:					
Information:					
Total Files Size (in bytes):			6127988		
<p>This Acknowledgement Receipt evidences receipt on the noted date by the USPTO of the indicated documents, characterized by the applicant, and including page counts, where applicable. It serves as evidence of receipt similar to a Post Card, as described in MPEP 503.</p> <p><u>New Applications Under 35 U.S.C. 111</u> If a new application is being filed and the application includes the necessary components for a filing date (see 37 CFR 1.53(b)-(d) and MPEP 506), a Filing Receipt (37 CFR 1.54) will be issued in due course and the date shown on this Acknowledgement Receipt will establish the filing date of the application.</p> <p><u>National Stage of an International Application under 35 U.S.C. 371</u> If a timely submission to enter the national stage of an international application is compliant with the conditions of 35 U.S.C. 371 and other applicable requirements a Form PCT/DO/EO/903 indicating acceptance of the application as a national stage submission under 35 U.S.C. 371 will be issued in addition to the Filing Receipt, in due course.</p> <p><u>New International Application Filed with the USPTO as a Receiving Office</u> If a new international application is being filed and the international application includes the necessary components for an international filing date (see PCT Article 11 and MPEP 1810), a Notification of the International Application Number and of the International Filing Date (Form PCT/RO/105) will be issued in due course, subject to prescriptions concerning national security, and the date shown on this Acknowledgement Receipt will establish the international filing date of the application.</p>					

Under the Paperwork Reduction Act of 1995, no persons are required to respond to a collection of information unless it displays a valid OMB control number.

PATENT APPLICATION FEE DETERMINATION RECORD Substitute for Form PTO-875	Application or Docket Number 12/495,190	Filing Date 06/30/2009	<input type="checkbox"/> To be Mailed
-----------------------------------------------------------------------------------	---------------------------------------------------	----------------------------------	---------------------------------------

APPLICATION AS FILED – PART I			OTHER THAN SMALL ENTITY				
	(Column 1)	(Column 2)	SMALL ENTITY <input type="checkbox"/>	OR		SMALL ENTITY	
FOR	NUMBER FILED	NUMBER EXTRA	RATE (\$)	FEE (\$)		RATE (\$)	FEE (\$)
<input type="checkbox"/> BASIC FEE <small>(37 CFR 1.16(a), (b), or (c))</small>	N/A	N/A	N/A		OR	N/A	
<input type="checkbox"/> SEARCH FEE <small>(37 CFR 1.16(k), (j), or (m))</small>	N/A	N/A	N/A			N/A	
<input type="checkbox"/> EXAMINATION FEE <small>(37 CFR 1.16(o), (p), or (q))</small>	N/A	N/A	N/A			N/A	
TOTAL CLAIMS <small>(37 CFR 1.16(j))</small>	minus 20 =	*	X \$ =			X \$ =	
INDEPENDENT CLAIMS <small>(37 CFR 1.16(h))</small>	minus 3 =	*	X \$ =			X \$ =	
<input type="checkbox"/> APPLICATION SIZE FEE <small>(37 CFR 1.16(s))</small>	If the specification and drawings exceed 100 sheets of paper, the application size fee due is \$250 (\$125 for small entity) for each additional 50 sheets or fraction thereof. See 35 U.S.C. 41(a)(1)(G) and 37 CFR 1.16(s).						
<input type="checkbox"/> MULTIPLE DEPENDENT CLAIM PRESENT <small>(37 CFR 1.16(j))</small>							
* If the difference in column 1 is less than zero, enter "0" in column 2.			TOTAL			TOTAL	

APPLICATION AS AMENDED – PART II					OTHER THAN SMALL ENTITY				
	(Column 1)	(Column 2)	(Column 3)		SMALL ENTITY	OR		SMALL ENTITY	
AMENDMENT	01/18/2011	CLAIMS REMAINING AFTER AMENDMENT	HIGHEST NUMBER PREVIOUSLY PAID FOR	PRESENT EXTRA	RATE (\$)	ADDITIONAL FEE (\$)		RATE (\$)	ADDITIONAL FEE (\$)
	Total <small>(37 CFR 1.16(i))</small>	* 20	Minus	** 23	=	0	OR	X \$2=	0
	Independent <small>(37 CFR 1.16(h))</small>	* 3	Minus	***3	=	0	OR	X \$220=	0
	<input type="checkbox"/> Application Size Fee <small>(37 CFR 1.16(s))</small>								
	<input type="checkbox"/> FIRST PRESENTATION OF MULTIPLE DEPENDENT CLAIM <small>(37 CFR 1.16(j))</small>						OR		
					TOTAL ADD'L FEE		OR	TOTAL ADD'L FEE	0

APPLICATION AS AMENDED – PART II					OTHER THAN SMALL ENTITY				
	(Column 1)	(Column 2)	(Column 3)		SMALL ENTITY	OR		SMALL ENTITY	
AMENDMENT		CLAIMS REMAINING AFTER AMENDMENT	HIGHEST NUMBER PREVIOUSLY PAID FOR	PRESENT EXTRA	RATE (\$)	ADDITIONAL FEE (\$)		RATE (\$)	ADDITIONAL FEE (\$)
	Total <small>(37 CFR 1.16(i))</small>	*	Minus	**	=		OR	X \$ =	
	Independent <small>(37 CFR 1.16(h))</small>	*	Minus	***	=		OR	X \$ =	
	<input type="checkbox"/> Application Size Fee <small>(37 CFR 1.16(s))</small>								
	<input type="checkbox"/> FIRST PRESENTATION OF MULTIPLE DEPENDENT CLAIM <small>(37 CFR 1.16(j))</small>						OR		
					TOTAL ADD'L FEE		OR	TOTAL ADD'L FEE	
* If the entry in column 1 is less than the entry in column 2, write "0" in column 3.					Legal Instrument Examiner: /DEBORAH NASH/				
** If the "Highest Number Previously Paid For" IN THIS SPACE is less than 20, enter "20".									
*** If the "Highest Number Previously Paid For" IN THIS SPACE is less than 3, enter "3".									
The "Highest Number Previously Paid For" (Total or Independent) is the highest number found in the appropriate box in column 1.									

This collection of information is required by 37 CFR 1.16. The information is required to obtain or retain a benefit by the public which is to file (and by the USPTO to process) an application. Confidentiality is governed by 35 U.S.C. 122 and 37 CFR 1.14. This collection is estimated to take 12 minutes to complete, including gathering, preparing, and submitting the completed application form to the USPTO. Time will vary depending upon the individual case. Any comments on the amount of time you require to complete this form and/or suggestions for reducing this burden, should be sent to the Chief Information Officer, U.S. Patent and Trademark Office, U.S. Department of Commerce, P.O. Box 1450, Alexandria, VA 22313-1450. DO NOT SEND FEES OR COMPLETED FORMS TO THIS ADDRESS. **SEND TO: Commissioner for Patents, P.O. Box 1450, Alexandria, VA 22313-1450.**

If you need assistance in completing the form, call 1-800-PTO-9199 and select option 2.

IN THE UNITED STATES PATENT AND TRADEMARK OFFICE

Applicants:	Russel White, et al.	§	Group Art Unit:	2617
		§		
Serial No.:	12/495,190	§		
		§	Examiner:	Erika A. Gary
Filed:	June 30, 2009	§		
		§		
For:	Method For Managing Media	§	Atty. Dkt. No.:	AFF.0004C7US
		§		

Commissioner for Patents
P.O. Box 1450
Alexandria, VA 22313-1450

INFORMATION DISCLOSURE STATEMENT

Dear Sir:

Under 35 USC 120, this application relies on the earlier filing date of application serial number 12/015,320, filed on January 16, 2008. The following references were submitted to and/or cited by the Office in the prior application and, therefore, are not provided in this application:

Please apply any charges or credits to Deposit Account No. 20-1504.

Respectfully submitted,

Date: December 16, 2010

/Mark J. Rozman/
Mark J. Rozman
Registration No. 42,117
TROP, PRUNER & HU, P.C.
1616 S. Voss Road, Suite 750
Houston, Texas 77057-2631
(512) 418-9944 [Phone]
(713) 468-8883 [Fax]
Customer No.: 21906

Date of Deposit: <u>December 16, 2010</u> I hereby certify under 37 CFR § 1.8 this correspondence is being deposited via EFS on the date indicated above. <u>/Stephanie Petreas/</u> Stephanie Petreas

INFORMATION DISCLOSURE STATEMENT BY APPLICANT (Not for submission under 37 CFR 1.99)	Application Number		12015320
	Filing Date		2008-01-16
	First Named Inventor	Russell W. White	
	Art Unit	2617	
	Examiner Name	Erika A. Gary	
	Attorney Docket Number	AFF.0004C5US	

	1	U.S. Patent and Trademark Office, Office Action in Inter Partes Reexamination of Patent No. 7440772, Reexamination Control No. 95001286, Office Action issued on August 2, 2010, 14 pages.	<input type="checkbox"/>
--	---	--------------------------------------------------------------------------------------------------------------------------------------------------------------------------------------------	--------------------------

If you wish to add additional non-patent literature document citation information please click the Add button

EXAMINER SIGNATURE

Examiner Signature		Date Considered	
--------------------	--	-----------------	--

***EXAMINER:** Initial if reference considered, whether or not citation is in conformance with MPEP 609. Draw line through a citation if not in conformance and not considered. Include copy of this form with next communication to applicant.

¹ See Kind Codes of USPTO Patent Documents at www.USPTO.GOV or MPEP 901.04. ² Enter office that issued the document, by the two-letter code (WIPO Standard ST.3). ³ For Japanese patent documents, the indication of the year of the reign of the Emperor must precede the serial number of the patent document. ⁴ Kind of document by the appropriate symbols as indicated on the document under WIPO Standard ST.16 if possible. ⁶ Applicant is to place a check mark here if English language translation is attached.

INFORMATION DISCLOSURE STATEMENT BY APPLICANT (Not for submission under 37 CFR 1.99)	Application Number		12015320
	Filing Date		2008-01-16
	First Named Inventor	Russell W. White, et al.	
	Art Unit	2617	
	Examiner Name	Erika A. Gary	
	Attorney Docket Number	AFF.004C5US	

1	U.S. Patent and Trademark Office, Office Action in Inter Partes Reexamination of Patent No. 7486926, Control No. 95/001,263, Office Action issued July 9, 2010, 20 pgs.	<input type="checkbox"/>
---	-------------------------------------------------------------------------------------------------------------------------------------------------------------------------	--------------------------

If you wish to add additional non-patent literature document citation information please click the Add button

EXAMINER SIGNATURE

Examiner Signature	Date Considered
--------------------	-----------------

*EXAMINER: Initial if reference considered, whether or not citation is in conformance with MPEP 809. Draw line through a citation if not in conformance and not considered. Include copy of this form with next communication to applicant.

¹ See Kind Codes of USPTO Patent Documents at www.USPTO.GOV or MPEP 901.04. ² Enter office that issued the document, by the two-letter code (WIPO Standard ST.3). ³ For Japanese patent documents, the indication of the year of the reign of the Emperor must precede the serial number of the patent document. ⁴ Kind of document by the appropriate symbols as indicated on the document under WIPO Standard ST.16 if possible. ⁵ Applicant is to place a check mark here if English language translation is attached.

INFORMATION DISCLOSURE STATEMENT BY APPLICANT (Not for submission under 37 CFR 1.99)	Application Number		12015320
	Filing Date		2008-01-16
	First Named Inventor	Russell W. White, et al.	
	Art Unit	2617	
	Examiner Name	Erika A. Gary	
	Attorney Docket Number	AFF.004C5US	

1	U.S. Patent and Trademark Office, Office Action in Inter Partes Reexamination dated June 14, 2010 in U.S. application no. 95/001,223.	<input type="checkbox"/>
2	U.S. Patent and Trademark Office, Ex Parte Reexamination Communication Transmittal Form dated June 14, 2010 providing "Decision, Sua Sponte, To Merge Reexamination Proceedings," in U.S. application no. 95/001,223.	<input type="checkbox"/>

If you wish to add additional non-patent literature document citation information please click the Add button

EXAMINER SIGNATURE

Examiner Signature		Date Considered	
--------------------	--	-----------------	--

***EXAMINER:** Initial if reference considered, whether or not citation is in conformance with MPEP 609. Draw line through a citation if not in conformance and not considered. Include copy of this form with next communication to applicant.

¹ See Kind Codes of USPTO Patent Documents at www.USPTO.GOV or MPEP 901.04. ² Enter office that issued the document, by the two-letter code (WIPO Standard ST.3). ³ For Japanese patent documents, the indication of the year of the reign of the Emperor must precede the serial number of the patent document. ⁴ Kind of document by the appropriate symbols as indicated on the document under WIPO Standard ST.16 if possible. ⁵ Applicant is to place a check mark here if English language translation is attached.

INFORMATION DISCLOSURE STATEMENT BY APPLICANT (Not for submission under 37 CFR 1.99)	Application Number		12015320
	Filing Date		2008-01-16
	First Named Inventor	Russell W. White, et al.	
	Art Unit	2817	
	Examiner Name	Erika A. Gary	
	Attorney Docket Number	AFF.004C5US	

	1	U.S. Patent And Trademark Office, Office Action in Inter Partes Reexamination mailed on May 24, 2010, in U.S. application reexamination serial no. 95/001,262.	<input type="checkbox"/>
--	---	----------------------------------------------------------------------------------------------------------------------------------------------------------------	--------------------------

If you wish to add additional non-patent literature document citation information please click the Add button

EXAMINER SIGNATURE

Examiner Signature		Date Considered	
--------------------	--	-----------------	--

***EXAMINER:** Initial if reference considered, whether or not citation is in conformance with MPEP 809. Draw line through a citation if not in conformance and not considered. Include copy of this form with next communication to applicant.

¹ See Kind Codes of USPTO Patent Documents at www.USPTO.GOV or MPEP 901.04. ² Enter office that issued the document, by the two-letter code (WIPO Standard ST.3). ³ For Japanese patent documents, the indication of the year of the reign of the Emperor must precede the serial number of the patent document. ⁴ Kind of document by the appropriate symbols as indicated on the document under WIPO Standard ST.16 if possible. ⁵ Applicant is to place a check mark here if English language translation is attached.

INFORMATION DISCLOSURE STATEMENT BY APPLICANT (Not for submission under 37 CFR 1.99)	Application Number	12015320
	Filing Date	2008-01-16
	First Named Inventor	Russell W. White, et al.
	Art Unit	2617
	Examiner Name	Erika A. Gary
	Attorney Docket Number	AFF.004C5US

U.S. PATENTS						
Examiner Initial*	Cite No	Patent Number	Kind Code ¹	Issue Date	Name of Patentee or Applicant of cited Document	Pages, Columns, Lines where Relevant Passages or Relevant Figures Appear
	1	6009363		1999-12-28	Beckert	
	2	6023232		2000-02-08	Eitzenberger	
	3	6151634		2000-11-21	Glaser	
	4	6453281		2002-09-17	Walters	
	5	6678215		2004-01-13	Treyz	

If you wish to add additional U.S. Patent citation information please click the Add button.

U.S. PATENT APPLICATION PUBLICATIONS						
Examiner Initial*	Cite No	Publication Number	Kind Code ¹	Publication Date	Name of Patentee or Applicant of cited Document	Pages, Columns, Lines where Relevant Passages or Relevant Figures Appear
	1	20010042107		2001-11-15	Palm	

If you wish to add additional U.S. Published Application citation information please click the Add button.

FOREIGN PATENT DOCUMENTS						
--------------------------	--	--	--	--	--	--

INFORMATION DISCLOSURE STATEMENT BY APPLICANT (Not for submission under 37 CFR 1.99)	Application Number	12015320
	Filing Date	2008-01-16
	First Named Inventor	Russell W. White, et al.
	Art Unit	2617
	Examiner Name	Erika A. Gary
	Attorney Docket Number	AFF.004C5US

Examiner Initial*	Cite No	Foreign Document Number ³	Country Code ²	Kind Code ⁴	Publication Date	Name of Patentee or Applicant of cited Document	Pages, Columns, Lines where Relevant Passages or Relevant Figures Appear	T ⁵
	1							<input type="checkbox"/>

If you wish to add additional Foreign Patent Document citation information please click the Add button

NON-PATENT LITERATURE DOCUMENTS

Examiner Initials*	Cite No	Include name of the author (in CAPITAL LETTERS), title of the article (when appropriate), title of the item (book, magazine, journal, serial, symposium, catalog, etc), date, pages(s), volume-issue number(s), publisher, city and/or country where published.	T ⁵
	1	AFFINITY LABS OF TEXAS, LLC, Plaintiff, v., BMW NORTH AMERICA, LLC, et al., Civil Action No. 9:08CV164, AFFINITY LABS OF TEXAS, LLC, Plaintiff, v., ALPINE ELECTRONICS OF AMERICA, INC., et al., Civil Action No. 9:08CV171, Order Construing Claim Terms of Unites States Patent No. 7,634,228, Filed on May 10, 2010, Pages 1-27.	<input type="checkbox"/>
	2	D. PETERS, et al., "Car Multimedia - Mobile Multimedia for the 21st Century," October 5-6, 2000, Pages 1-58.	<input type="checkbox"/>
	3	STEPHAN HARTWIG, et al., "Mobile Multimedia - Challenges and Opportunities Invited Paper," June 19, 2000, Pages 1-12.	<input type="checkbox"/>
	4	JOHN HANAN, "Car Audio Has Come Far since the 8-Track," Knight Ridder/Tribune Business News, December 17, 1999, Pages 1-2.	<input type="checkbox"/>
	5	BUSINESS WIRE, "Lobjects Announces New Digital Audio Player Technology for the Next-Generation Auto PC," August 4, 1999, Pages 1-2.	<input type="checkbox"/>
	6	JASON MESERVE, "Windows Media Player now available for WinCe, (from Microsoft) (Product Announcement)," Network World, March 8, 2000, Pages 1-2.	<input type="checkbox"/>
	7	BUSINESS WIRE, ""HUM" MP3 Software Turns Windows CE Handheld Computers Into Portable Music Players," May 24, 1999, Pages 1-2.	<input type="checkbox"/>

**INFORMATION DISCLOSURE
STATEMENT BY APPLICANT**
(Not for submission under 37 CFR 1.99)

Application Number	12015320
Filing Date	2008-01-16
First Named Inventor	Russell W. White, et al.
Art Unit	2617
Examiner Name	Erika A. Gary
Attorney Docket Number	AFF.004C5US

8	CHRIS De HERRERA, "Windows CE 2.0 Auto PC Pictures," Chris De Herrera's Windows CE Website, Revised January 11, 1999, Pages 1-3.	<input type="checkbox"/>
9	JOHN MURRAY, "Inside Microsoft Windows CE," Microsoft Press, 1998, Pages 1-20.	<input type="checkbox"/>
10	COMPAQ, INTEL, MICROSOFT, NEC, "Universal Serial Bus Device Class Definition for Audio Devices," Release 1.0, March 18, 1998, Pages 1-130.	<input type="checkbox"/>
11	COMPAQ, INTEL, MICROSOFT, NEC, "Universal Serial Bus Specification," Revision 1.1, September 23, 1998, Pages 1-327.	<input type="checkbox"/>
12	VESA, VIDEO ELECTRONICS STANDARDS ASSOCIATION, "VESA Plug and Display (P&D) Standard," Version 1, Revision 0, June 11, 1997, Pages 1-109.	<input type="checkbox"/>
13	AFFINITY LABS OF TEXAS, LLC, Plaintiff, v., BMW NORTH AMERICA, LLC, et al., Defendants, Case No. 9:08-cv-00164-RC, First Amended Answer And Counterclaim Of Defendant Volkswagen Group Of America, Inc. To Third Amended Complaint, Filed on April 9, 2010, Pages 1-57.	<input type="checkbox"/>
14	AFFINITY LABS OF TEXAS, LLC, Plaintiff, v., BMW NORTH AMERICA, LLC, et al., Defendants, Case No. 9:08-cv-00164-RC, Amended Answer And Counterclaim Of Defendants Hyundai Motor America, Hyundai Motor Manufacturing Alabama, LLC, And KIA Motors America, Inc. To Plaintiff Affinity Labs Of Texas, LLC's Third Amended Complaint, Filed on April 9, 2010, Pages 1-22.	<input type="checkbox"/>
15	AFFINITY LABS OF TEXAS, LLC, Plaintiff, v., BMW NORTH AMERICA, LLC, et al., Defendants, Case No. 9:08-cv-00164-RC, Plaintiff's Reply To Amended Answer And Counterclaim Of Defendants Hyundai Motor America, Hyundai Motor Manufacturing Alabama, LLC And KIA Motors America, Inc. To Plaintiff Affinity Labs of Texas, LLC's Third Amended Complaint, Filed on April 27, 2010, Pages 1-7.	<input type="checkbox"/>
16	AFFINITY LABS OF TEXAS, LLC, Plaintiff, v., BMW NORTH AMERICA, LLC, et al., Defendants, Case No. 9:08-cv-00164-RC, Plaintiff's Reply To First Amended Answer And Counterclaim Of Defendant Volkswagen Group Of America, Inc. To Third Amended Complaint, Filed on April 27, 2010, Pages 1-7.	<input type="checkbox"/>
17	PANASONIC, "Portable DVD/Video CD/CD Player, Operating Instructions, DVC-L10D," 1998, Pages 1-84.	<input type="checkbox"/>
18	CLARION Car Audio and Beyond, "1998 Car Audio & Security Product Catalog," 1998, Pages 1-24.	<input type="checkbox"/>

**INFORMATION DISCLOSURE
STATEMENT BY APPLICANT**
(Not for submission under 37 CFR 1.99)

Application Number	12015320
Filing Date	2008-01-16
First Named Inventor	Russell W. White, et al.
Art Unit	2817
Examiner Name	Erika A. Gary
Attorney Docket Number	AFF.004C5US

19	CLARION Car Audio and Beyond, "1999 Car Audio & Security Product," 1999, Pages 1-60.	<input type="checkbox"/>
20	JAMIE ANDERSON, "Driving our way soon: the e-car," The Times, November 9, 2000, Pages 1-4.	<input type="checkbox"/>
21	CLARION Auto PC, "Clarion Auto PC Owner's Manual," 1998, Pages 1-177.	<input type="checkbox"/>
22	DELPHI Automotive Systems, "The Personal Productivity Vehicle," 1998, Pages 1-2.	<input type="checkbox"/>
23	DELPHI Delco Electronics Systems, "On-Board Architecture," 1997, Pages 1-2.	<input type="checkbox"/>
24	JANET BRAUNSTEIN, "Diversified Software Industries: Enabling digital instrument panels," January 10, 2001, Pages 1-2.	<input type="checkbox"/>
25	MICROSOFT PressPass, "Microsoft Previews New Devices Using Windows CE for Automotive 2.0," January 2000, Pages 1-2.	<input type="checkbox"/>
26	JOHN TOWNLEY, "Countdown to Clarion," Automeia, Pages 1-4.	<input type="checkbox"/>
27	GINA HERTEL, "A Voice-Activated Co-Pilot: ICES," Odds & Ends, January 2000, Vol. 8, Issue 1, Pages 1-5.	<input type="checkbox"/>
28	KAMI BUCHHÖLZ, "Diversified Software launches IVIS," Automotive Engineering Online, 2009, one page.	<input type="checkbox"/>
29	EMPEG Car webpage, http://web.archive.org/web/19990430033318/www.empeg.com/main.html , April 30, 1999, one page.	<input type="checkbox"/>

INFORMATION DISCLOSURE STATEMENT BY APPLICANT (Not for submission under 37 CFR 1.99)	Application Number	12015320
	Filing Date	2008-01-16
	First Named Inventor	Russell W. White, et al.
	Art Unit	2817
	Examiner Name	Erika A. Gary
	Attorney Docket Number	AFF.004C5US

30	CLARION AutoPC, "Frequently Asked Questions," 1998, Pages 1-3.	<input type="checkbox"/>
31	CLARION AutoPC, "Frequently Asked Questions," 1999, Pages 1-9.	<input type="checkbox"/>
32	STEREOPHILE, "Clarion Debuts World's First Automobile PC/Stereo," December 5, 1998, Pages 1-3.	<input type="checkbox"/>
33	STEVE WHALLEY, "Peripherals To Go: USB In AutoPC," Pages 1-2.	<input type="checkbox"/>
34	GREGORY L. WHITE, "After AutoPC's Hard Ride, Detroit Tries Rebooting In-Car Computers," The Wall Street Journal, Pages 1-3.	<input type="checkbox"/>
35	AFFINITY LABS OF TEXAS, LLC, Plaintiff, v., BMW NORTH AMERICA, LLC, et al., Defendants, Civil Action No. 9:08-CV-164, Order Denying Defendant's Motion to Dismiss, Filed on September 2, 2009, Pages 1-7.	<input type="checkbox"/>

If you wish to add additional non-patent literature document citation information please click the Add button

EXAMINER SIGNATURE

Examiner Signature	Date Considered
--------------------	-----------------

*EXAMINER: Initial if reference considered, whether or not citation is in conformance with MPEP 809. Draw line through a citation if not in conformance and not considered. Include copy of this form with next communication to applicant.

¹ See Kind Codes of USPTO Patent Documents at www.USPTO.GOV or MPEP 901.04. ² Enter office that issued the document, by the two-letter code (WIPO Standard ST.3). ³ For Japanese patent documents, the indication of the year of the reign of the Emperor must precede the serial number of the patent document. ⁴ Kind of document by the appropriate symbols as indicated on the document under WIPO Standard ST.16 if possible. ⁵ Applicant is to place a check mark here if English language translation is attached.

**INFORMATION DISCLOSURE
STATEMENT BY APPLICANT**
(Not for submission under 37 CFR 1.99)

Application Number		12015320
Filing Date		2008-01-16
First Named Inventor	Russell White, et al.	
Art Unit	2617	
Examiner Name	Erika A. Gary	
Attorney Docket Number	AFF.004C5US	

1	Affinity Labs of Texas, LLC (Plaintiff) v. BMW North America, LLC, et al. (Defendants), Case No. 9:08-cv-00164-RC, Answer and Counterclaim of Defendant Volkswagen Group of America, Inc., to Third Amended Complaint, Pages 1-48, filed on January 15, 2010.	<input type="checkbox"/>
2	Affinity Labs of Texas, LLC (Plaintiff) v. Alpine Electronics of America, Inc., et al. (Defendants), Civil Action No. 9:08-cv-171, Order Denying Without Prejudice Defendants' Motion for Summary Judgment, one page, filed on February 25, 2010.	<input type="checkbox"/>

If you wish to add additional non-patent literature document citation information please click the Add button

EXAMINER SIGNATURE

Examiner Signature		Date Considered	
--------------------	--	-----------------	--

*EXAMINER: Initial if reference considered, whether or not citation is in conformance with MPEP 609. Draw line through a citation if not in conformance and not considered. Include copy of this form with next communication to applicant.

¹ See Kind Codes of USPTO Patent Documents at www.USPTO.GOV or MPEP 901.04. ² Enter office that issued the document, by the two-letter code (WIPO Standard ST.3). ³ For Japanese patent documents, the indication of the year of the reign of the Emperor must precede the serial number of the patent document. ⁴ Kind of document by the appropriate symbols as indicated on the document under WIPO Standard ST.16 if possible. ⁵ Applicant is to place a check mark here if English language translation is attached.

Doc code: IDS

Doc description: Information Disclosure Statement (IDS) Filed

PTO/SB/08a (07-09)

Approved for use through 07/31/2012. OMB 0651-0031
U.S. Patent and Trademark Office; U.S. DEPARTMENT OF COMMERCE

Under the Paperwork Reduction Act of 1995, no persons are required to respond to a collection of information unless it contains a valid OMB control number.

INFORMATION DISCLOSURE STATEMENT BY APPLICANT (Not for submission under 37 CFR 1.99)	Application Number	12015320
	Filing Date	2008-01-16
	First Named Inventor	Russell White, et al.
	Art Unit	2617
	Examiner Name	Erika A. Gary
	Attorney Docket Number	AFF.004C5US

U.S.PATENTS						
Examiner Initial*	Cite No	Patent Number	Kind Code ¹	Issue Date	Name of Patentee or Applicant of cited Document	Pages, Columns, Lines where Relevant Passages or Relevant Figures Appear
	1	4807292		1989-02-21	Sorscher	
	2	6975835		2005-12-13	Lake, et al.	
	3	6956833		2005-10-18	Yukie, et al.	
	4	6915272		2005-07-05	Zilliacus	
	5	6907112		2005-06-14	Guedalia, et al.	
	6	6792615		2004-09-14	Rowe, et al.	
	7	6792263		2004-09-14	Kite	
	8	6788528		2004-09-07	Enners, et al.	

**INFORMATION DISCLOSURE
STATEMENT BY APPLICANT**
(Not for submission under 37 CFR 1.99)

Application Number	12015320
Filing Date	2008-01-16
First Named Inventor	Russell White, et al.
Art Unit	2617
Examiner Name	Erika A. Gary
Attorney Docket Number	AFF.004C5US

9	6772212		2004-08-03	Lau, et al.	
10	6741980		2004-05-25	Langseth, et al.	
11	6721710		2004-04-13	Lueck	
12	6671715		2003-12-30	Langseth, et al.	
13	6591085		2003-07-08	Grady	
14	6587835		2003-07-01	Treyz, et al.	
15	6516466		2003-02-04	Jackson	
16	6510210		2003-01-21	Baughan	
17	6509716		2003-01-21	Yi	
18	6496692		2002-12-17	Shanahan	
19	6496205		2002-12-17	White, et al.	

**INFORMATION DISCLOSURE
STATEMENT BY APPLICANT**
(Not for submission under 37 CFR 1.99)

Application Number	12015320
Filing Date	2008-01-16
First Named Inventor	Russell White, et al.
Art Unit	2617
Examiner Name	Erika A. Gary
Attorney Docket Number	AFF.004C5US

20	6420975		2002-07-16	DeLine, et al.	
21	6418138		2002-07-09	Cerf, et al.	
22	6401085		2002-06-04	Gershman, et al.	
23	6396769		2002-05-28	Polany	
24	6339706		2002-01-15	Tillgren, et al.	
25	6314094		2001-11-06	Boys	
26	6292440		2001-09-18	Lee	
27	6247130		2001-06-12	Fritsch	
28	6240297		2001-05-29	Jadoul	
29	6236832		2001-05-22	Ito	
30	6232539		2001-05-15	Looney, et al.	

**INFORMATION DISCLOSURE
STATEMENT BY APPLICANT**
(Not for submlsion under 37 CFR 1.99)

Application Number	12015320
Filing Date	2008-01-16
First Named Inventor	Russell White, et al.
Art Unit	2617
Examiner Name	Erika A. Gary
Attorney Docket Number	AFF.004C5US

31	6199076		2001-03-06	Logan, et al.	
32	6167253		2000-12-26	Farris, et al.	
33	6144848		2000-11-07	Walsh, et al.	
34	6088730		2000-07-11	Kato, et al.	
35	6061306		2000-05-09	Buchheim	
36	6029064		2000-02-22	Farris, et al.	
37	6014569		2000-01-11	Botlum	
38	5953657		1999-09-14	Ghister	
39	5953005		1999-09-14	Liu	
40	5940767		1999-08-17	Bourgeois, et al.	
41	5900564		1999-05-04	Kurakake	

**INFORMATION DISCLOSURE
STATEMENT BY APPLICANT**
(Not for submission under 37 CFR 1.99)

Application Number	12015320
Filing Date	2008-01-16
First Named Inventor	Russell White, et al.
Art Unit	2617
Examiner Name	Erika A. Gary
Attorney Docket Number	AFF.004C5US

42	5870680		1999-02-09	Guerlin, et al.
43	5774793		1998-06-30	Cooper, et al.
44	5694120		1997-12-02	Indekeu, et al.
45	5594779		1997-01-14	Goodman

If you wish to add additional U.S. Patent citation information please click the Add button.

U.S. PATENT APPLICATION PUBLICATIONS

Examiner Initial*	Cite No	Publication Number	Kind Code ¹	Publication Date	Name of Patentee or Applicant of cited Document	Pages, Columns, Lines where Relevant Passages or Relevant Figures Appear
	1	20050010633		2005-01-03	Shanahan	
	2	20040078274		2004-04-22	Aamio	
	3	20030008646		2003-01-09	Shanahan	
	4	20020046084		2002-04-18	Steele, et al.	
	5	20020023028		2002-02-01	Quarendon	

If you wish to add additional U.S. Published Application citation information please click the Add button.

Doc code: IDS

Doc description: Information Disclosure Statement (IDS) Filed

PTO/SB/08a (07-09)

Approved for use through 07/31/2012. OMB 0651-0031
U.S. Patent and Trademark Office; U.S. DEPARTMENT OF COMMERCE

Under the Paperwork Reduction Act of 1995, no persons are required to respond to a collection of information unless it contains a valid OMB control number.

INFORMATION DISCLOSURE STATEMENT BY APPLICANT (Not for submission under 37 CFR 1.99)	Application Number	12015320
	Filing Date	2008-01-16
	First Named Inventor	Russell White, et al.
	Art Unit	2617
	Examiner Name	Erika A. Gary
	Attorney Docket Number	AFF.004C5US

U.S. PATENTS						
Examiner Initial*	Cite No	Patent Number	Kind Code†	Issue Date	Name of Patentee or Applicant of cited Document	Pages, Columns, Lines where Relevant Passages or Relevant Figures Appear
	1	5587560		1996-12-24	Crooks, et al.	
	2	5589090		1996-12-17	Otte	
	3	5450471		1995-09-12	Hanawa, et al.	
	4	6571282		2003-05-27	Bowman-Amuah	
	5	6550057		2003-04-15	Bowman-Amuah	
	6	6549949		2003-04-15	Bowman-Amuah	
	7	6539396		2003-03-25	Bowman-Amuah	
	8	6529948		2003-03-04	Bowman-Amuah	

INFORMATION DISCLOSURE STATEMENT BY APPLICANT (Not for submission under 37 CFR 1.99)	Application Number	12015320
	Filing Date	2008-01-16
	First Named Inventor	Russell White, et al.
	Art Unit	2617
	Examiner Name	Erika A. Gary
	Attorney Docket Number	AFF.004C5US

	9	6529909		2003-03-04	Bowman-Amuah	
	10	6502213		2002-12-31	Bowman-Amuah	
	11	6501832		2002-12-31	Bowman-Amuah	
	12	6496850		2002-12-17	Bowman-Amuah	
	13	6477665		2002-11-05	Bowman-Amuah	
	14	6477580		2002-11-05	Bowman-Amuah	
	15	6442748		2002-08-27	Bowman-Amuah	
	16	6438594		2002-08-20	Bowman-Amuah	
	17	6434628		2002-08-13	Bowman-Amuah	
	18	6434568		2002-08-13	Bowman-Amuah	
	19	6339832		2002-01-15	Bowman-Amuah	

INFORMATION DISCLOSURE STATEMENT BY APPLICANT (Not for submission under 37 CFR 1.99)	Application Number	12015320
	Filing Date	2008-01-16
	First Named Inventor	Russell White, et al.
	Art Unit	2617
	Examiner Name	Erika A. Gary
	Attorney Docket Number	AFF.004C5US

20	6335927		2002-01-01	Elliott, et al.	
21	6332163		2001-12-18	Bowman-Amuah	
22	6289382		2001-09-11	Bowman-Amuah	
23	6253061		2001-06-26	Helferich	
24	6233430		2001-05-15	Helferich	
25	6122403		2000-09-19	Rhoads	
26	5999525		1999-12-07	Krishnaswamy, et al.	
27	5867494		1999-02-02	Krishnaswamy, et al.	
28	5732216		1998-03-24	Logan, et al.	
29	5721827		1998-02-24	Logan, et al.	
30	7149772		2006-12-12	Kalavade	

**INFORMATION DISCLOSURE
STATEMENT BY APPLICANT**
(Not for submission under 37 CFR 1.99)

Application Number	12015320
Filing Date	2008-01-16
First Named Inventor	Russell White, et al.
Art Unit	2817
Examiner Name	Erika A. Gary
Attorney Docket Number	AFF.004C5US

31	7145898		2006-12-05	Elliott	
32	7130807		2006-10-31	Mikurak	
33	7124101		2006-10-17	Mikurak	
34	6978127		2005-10-20	Buithuis, et al.	
35	6909708		2005-06-21	Krishnaswamy, et al.	
36	6904449		2005-08-07	Quinones	
37	6091067		2005-05-31	Kalavade	
38	6888929		2005-05-03	Saylor, et al.	
39	6842906		2005-01-11	Bowman-Amuah	
40	6792086		2005-04-04	Saylor, et al.	
41	6754181		2004-09-04	Elliott, et al.	

**INFORMATION DISCLOSURE
STATEMENT BY APPLICANT**
(Not for submission under 37 CFR 1.99)

Application Number	12015320
Filing Date	2008-01-16
First Named Inventor	Russell White, et al.
Art Unit	2617
Examiner Name	Erika A. Gary
Attorney Docket Number	AFF.004C5US

42	6742015		2004-05-25	Bowman-Amuah	
43	6731625		2004-05-04	Eastep, et al.	
44	6715145		2004-03-30	Bowman-Amuah	
45	6707889		2004-03-16	Saylor, et al.	
46	6697824		2004-02-24	Bowman-Amuah	
47	6671818		2003-12-20	Mikurak	
48	6640249		2003-10-28	Bowman-Amuah	
49	6640244		2003-10-28	Bowman-Amuah	
50	6640238		2003-10-28	Bowman-Amuah	

If you wish to add additional U.S. Patent citation information please click the Add button.

U.S.PATENT APPLICATION PUBLICATIONS

Examiner Initial*	Cite No	Publication Number	Kind Code ¹	Publication Date	Name of Patentee or Applicant of cited Document	Pages, Columns, Lines where Relevant Passages or Relevant Figures Appear
-------------------	---------	--------------------	------------------------	------------------	-------------------------------------------------	--------------------------------------------------------------------------

Doc code: IDS

Doc description: Information Disclosure Statement (IDS) Filed

PTO/SB/08a (07-09)

Approved for use through 07/31/2012. OMB 0651-0031

U.S. Patent and Trademark Office; U.S. DEPARTMENT OF COMMERCE

Under the Paperwork Reduction Act of 1995, no persons are required to respond to a collection of information unless it contains a valid OMB control number.

INFORMATION DISCLOSURE STATEMENT BY APPLICANT (Not for submission under 37 CFR 1.99)	Application Number	12015320
	Filing Date	2008-01-16
	First Named Inventor	Russell White, et al.
	Art Unit	2617
	Examiner Name	Erika A. Gary
	Attorney Docket Number	AFF.004C5US

U.S.PATENTS

Examiner Initial*	Cite No	Patent Number	Kind Code†	Issue Date	Name of Patentee or Applicant of cited Document	Pages, Columns, Lines where Relevant Passages or Relevant Figures Appear
	1	6636242		2003-10-21	Bowman-Amuah	
	2	6615253		2003-09-02	Bowman-Amuah	
	3	6615199		2003-09-02	Bowman-Amuah	
	4	6606744		2003-08-12	Mikurak	
	5	6606660		2003-08-12	Bowman-Amuah	
	6	6601234		2003-07-29	Bowman-Amuah	
	7	6601192		2003-07-29	Bowman-Amuah	
	8	6578068		2003-07-10	Bowman-Amuah	

**INFORMATION DISCLOSURE
STATEMENT BY APPLICANT**
(Not for submission under 37 CFR 1.99)

Application Number		12015320
Filing Date		2008-01-16
First Named Inventor	Russell White, et al.	
Art Unit	2617	
Examiner Name	Erika A. Gary	
Attorney Docket Number	AFF.004C5US	

	9	6587836		2003-07-01	Treyz, et al.	
	10	6510210		2003-01-21	Baughan	
	11	6509716		2003-01-21	Yi	
	12	6496692		2002-12-17	Shanahan	
	13	6396769		2002-05-28	Polany	
	14	6240297		2001-05-29	Jadoul	
	15	6061306		2000-05-09	Buchheim	
	16	5953659		1999-09-14	Ghisler	
	17	5940767		1999-08-17	Bourgeois	
	18	5870680		1999-02-09	Guerlin, et al.	
	19	5774793		1998-06-30	Cooper, et al.	

INFORMATION DISCLOSURE STATEMENT BY APPLICANT (Not for submission under 37 CFR 1.99)	Application Number	12015320
	Filing Date	2008-01-16
	First Named Inventor	Russell White, et al.
	Art Unit	2617
	Examiner Name	Erika A. Gary
	Attorney Docket Number	AFF.004C5US

20	5587560		1996-12-24	Crooks, et al.	
21	5586090		1996-12-17	Otte	
22	5450471		1995-09-12	Hanawa, et al.	
23	7020704		2008-03-28	Lipscomb, et al.	
24	7343414		2008-03-11	Lipscomb, et al.	
25	6728531		2004-04-27	Lee	
26	6526335		2003-02-25	Treyz	
27	6160551		2000-12-12	Naughton	
28	6192340		2001-02-20	Abecassis	

If you wish to add additional U.S. Patent citation information please click the Add button.

U.S.PATENT APPLICATION PUBLICATIONS

Examiner Initial*	Cite No	Publication Number	Kind Code ¹	Publication Date	Name of Patentee or Applicant of cited Document	Pages, Columns, Lines where Relevant Passages or Relevant Figures Appear
-------------------	---------	--------------------	------------------------	------------------	-------------------------------------------------	--------------------------------------------------------------------------

INFORMATION DISCLOSURE STATEMENT BY APPLICANT (Not for submission under 37 CFR 1.99)	Application Number	12015320
	Filing Date	2008-01-16
	First Named Inventor	Russell White, et al.
	Art Unit	2617
	Examiner Name	Erika A. Gary
	Attorney Docket Number	AFF.004C5US

1						
---	--	--	--	--	--	--

If you wish to add additional U.S. Published Application citation information please click the Add button.

FOREIGN PATENT DOCUMENTS

Examiner Initial*	Cite No	Foreign Document Number ³	Country Code ²ⁱ	Kind Code ⁴	Publication Date	Name of Patentee or Applicant of cited Document	Pages, Columns, Lines where Relevant Passages or Relevant Figures Appear	T ⁵
	1	H08-79814	JP		1996-03-22	Konishi		<input type="checkbox"/>

If you wish to add additional Foreign Patent Document citation information please click the Add button

NON-PATENT LITERATURE DOCUMENTS

Examiner Initials*	Cite No	Include name of the author (in CAPITAL LETTERS), title of the article (when appropriate), title of the item (book, magazine, journal, serial, symposium, catalog, etc), date, pages(s), volume-issue number(s), publisher, city and/or country where published.	T ⁵
	1	AFFINITY LABS OF TEXAS, LLC (Plaintiff) v. BMW NORTH AMERICA, LLC, ET AL. (Defendants), Civil Action No. 9:08CV164 and AFFINITY LABS OF TEXAS, LLC (Plaintiff) v. ALPINE ELECTRONICS OF AMERICA, INC., ET AL., Civil Action No. 9:08CV171, "Order Construing Claim Terms of United States Patent No. 7,324,833, issued on December 18, 2009, Pages 1-31.	<input type="checkbox"/>
	2	REAL NETWORKS, Inc., RealJukebox Plus Manual, 1999, Pages 1-90.	<input type="checkbox"/>

If you wish to add additional non-patent literature document citation information please click the Add button

EXAMINER SIGNATURE

Examiner Signature		Date Considered	
--------------------	--	-----------------	--

*EXAMINER: Initial if reference considered, whether or not citation is in conformance with MPEP 609. Draw line through a citation if not in conformance and not considered. Include copy of this form with next communication to applicant.

¹ See Kind Codes of USPTO Patent Documents at www.USPTO.GOV or MPEP 901.04. ² Enter office that issued the document, by the two-letter code (WIPO Standard ST.3). ³ For Japanese patent documents, the indication of the year of the reign of the Emperor must precede the serial number of the patent document. ⁴ Kind of document by the appropriate symbols as indicated on the document under WIPO Standard ST.16 if possible. ⁵ Applicant is to place a check mark here if English language translation is attached.

Doc code: IDS

Doc description: Information Disclosure Statement (IDS) Filed

PTO/SB/08a (07-09)

Approved for use through 07/31/2012. OMB 0851-0031
U.S. Patent and Trademark Office; U.S. DEPARTMENT OF COMMERCE

Under the Paperwork Reduction Act of 1995, no persons are required to respond to a collection of information unless it contains a valid OMB control number.

INFORMATION DISCLOSURE STATEMENT BY APPLICANT (Not for submission under 37 CFR 1.99)	Application Number	12015320
	Filing Date	2008-01-16
	First Named Inventor	Russell White, et al.
	Art Unit	2617
	Examiner Name	Erika A. Gary
	Attorney Docket Number	AFF.004C5US

U.S. PATENTS

Examiner Initial*	Cite No	Patent Number	Kind Code ¹	Issue Date	Name of Patentee or Applicant of cited Document	Pages, Columns, Lines where Relevant Passages or Relevant Figures Appear
	1	5974333		1999-10-26	Chen	
	2	6418330		2002-07-09	Samsung	
	3	6587127		2003-07-01	Leeke, et al.	
	4	7123936		2006-10-17	Rydbeck, et al.	
	5	6177950		2001-01-23	Robb	
	6	6510325		2003-01-21	Mack, II, et al.	
	7	62788842		2001-08-21	Kim	
	8	7339993		2008-03-04	Brooks	

INFORMATION DISCLOSURE STATEMENT BY APPLICANT (Not for submission under 37 CFR 1.99)	Application Number	12015320
	Filing Date	2008-01-16
	First Named Inventor	Russell White, et al.
	Art Unit	2617
	Examiner Name	Erika A. Gary
	Attorney Docket Number	AFF.004C5US

9	6917923		2005-12-06	Dimenstein	
10	6157619		2000-12-05	Ozluturk	
11	6609105		2003-08-19	Van Zoest, et al.	
12	6353637		2002-03-05	Mansour, et al.	
13	7444353		2008-10-28	Chen	
14	5963916		1999-10-05	Kaplan	
15	5956651		1999-09-21	Willkie	

If you wish to add additional U.S. Patent citation information please click the Add button.

U.S.PATENT APPLICATION PUBLICATIONS

Examiner Initial*	Cite No	Publication Number	Kind Code ¹	Publication Date	Name of Patentee or Applicant of cited Document	Pages, Columns, Lines where Relevant Passages or Relevant Figures Appear
	1					

If you wish to add additional U.S. Published Application citation information please click the Add button.

FOREIGN PATENT DOCUMENTS

**INFORMATION DISCLOSURE
STATEMENT BY APPLICANT**
(Not for submission under 37 CFR 1.99)

Application Number	12015320
Filing Date	2008-01-16
First Named Inventor	Russell White, et al.
Art Unit	2617
Examiner Name	Erika A. Gary
Attorney Docket Number	AFF.004C5US

Examiner Initial*	Cite No	Foreign Document Number ³	Country Code ²	Kind Code ⁴	Publication Date	Name of Patentee or Applicant of cited Document	Pages, Columns, Lines where Relevant Passages or Relevant Figures Appear	T ⁵
	1	WO 00/70523	WO		2000-11-23	Digimarc Corporation		<input type="checkbox"/>

If you wish to add additional Foreign Patent Document citation information please click the Add button

NON-PATENT LITERATURE DOCUMENTS

Examiner Initials*	Cite No	Include name of the author (in CAPITAL LETTERS), title of the article (when appropriate), title of the item (book, magazine, journal, serial, symposium, catalog, etc), date, pages(s), volume-issue number(s), publisher, city and/or country where published.	T ⁵
	1	Nokia 9110 Communicator User Manual, Copyright 1999.	<input type="checkbox"/>
	2	Sony, "Sony Notebook Computer User Guide PCG-717/719," User Guide, 1997.	<input type="checkbox"/>
	3	AirCard, "Sierra Wireless Announces First Cellular Network Interface Card for Notebook PCs," June 21, 1999.	<input type="checkbox"/>
	4	MusicMatch Internet Music System, " MusicMatch Jukebox Reviews," March 4, 2000, May 8, 1999, August 29, 1999, May 8, 1999, February 4, 1997, August 12, 1999, January 24, 2000, January 25, 2000, February 22, 2000, Pages 1-32.	<input type="checkbox"/>
	5	Bluetooth, "Specification of the Bluetooth System, Profiles," December 1, 1999.	<input type="checkbox"/>
	6	Bluetooth, "Specification of the Bluetooth System, Profiles," December 1, 1999.	<input type="checkbox"/>
	7	J. SCHNEIDAWIND, "Big Blue Unveiling," USA Today, November 23, 1992, page 2B.	<input type="checkbox"/>

INFORMATION DISCLOSURE STATEMENT BY APPLICANT (Not for submission under 37 CFR 1.99)	Application Number	12015320
	Filing Date	2008-01-16
	First Named Inventor	Russell White, et al.
	Art Unit	2617
	Examiner Name	Erika A. Gary
	Attorney Docket Number	AFF.004C5US

8	Nokia Suomi, "Range of suspension GSM products unveiled: Nokia's innovations offer a new dimension to mobile communication," March 13, 1996, 1 page.	<input type="checkbox"/>
9	Nokia 9000i User's Manual, Copyright 1995-1997.	<input type="checkbox"/>
10	FCC Website, "Broadband PCS," available at http://wireless.fcc.gov/services/index.htm?job=service_home&id=broadband_pcs (accessed November 9, 2009).	<input type="checkbox"/>
11	RealNetworks, "RealPlayer plus, RealPlayer 7 Plus User Manual," Copyright 2000, March 6, 2000.	<input type="checkbox"/>
12	DAVID POGUE, "SoundJam MP Digital Audio System Manual," 1999.	<input type="checkbox"/>
13	iTunes Wikipedia Page, http://en.wikipedia.org/wiki/iTunes , accessed July 31, 2009.	<input type="checkbox"/>
14	K. JOST, "The Car as a Mobile-Media Platform," Automotive Engineering International, May 1998, Pages 49-53.	<input type="checkbox"/>
15	S.K. KIRSCHNER, "Wired Wheels," Popular Science, March 1998, Pages 54-55.	<input type="checkbox"/>
16	R. LIND, et al., "The Network Vehicle - A Glimpse into the Future of Mobile Multi-Media," 17th AIAA/IEEE/SAE Digital Avionics Sys. Conference Proceedings, October 31 to November 7, 1998, at I21-1 to I21-8.	<input type="checkbox"/>

If you wish to add additional non-patent literature document citation information please click the Add button

EXAMINER SIGNATURE

Examiner Signature		Date Considered	
--------------------	--	-----------------	--

*EXAMINER: Initial if reference considered, whether or not citation is in conformance with MPEP 609. Draw line through a citation if not in conformance and not considered. Include copy of this form with next communication to applicant.

**INFORMATION DISCLOSURE
STATEMENT BY APPLICANT**
(Not for submission under 37 CFR 1.99)

Application Number		12015320
Filing Date		2008-01-16
First Named Inventor	Russell White, et al.	
Art Unit	2617	
Examiner Name	Erika A. Gary	
Attorney Docket Number	AFF.004CSUS	

1	Request for Inter Partes Reexamination of U.S. Patent No. 7,187,947, filed on November 13, 2009, with accompanying Claim Charts.	<input type="checkbox"/>
2	Request for Inter Partes Reexamination of U.S. Patent No. 7,440,772, filed on November 13, 2009, with accompanying Claim Charts.	<input type="checkbox"/>
3	Request for Inter Partes Reexamination of U.S. Patent No. 7,324,833, filed on November 13, 2009, with accompanying Claim Charts.	<input type="checkbox"/>
4	Request for Inter Partes Reexamination of U.S. Patent No. 7,486,926, filed on November 13, 2009, with accompanying Claim Charts.	<input type="checkbox"/>
5	Request for Inter Partes Reexamination of U.S. Patent No. 7,634,228, filed on February 3, 2010, with accompanying Claim Charts.	<input type="checkbox"/>

If you wish to add additional non-patent literature document citation information please click the Add button

EXAMINER SIGNATURE

Examiner Signature		Date Considered	
--------------------	--	-----------------	--

*EXAMINER: Initial if reference considered, whether or not citation is in conformance with MPEP 609. Draw line through a citation if not in conformance and not considered. Include copy of this form with next communication to applicant.

¹ See Kind Codes of USPTO Patent Documents at www.USPTO.GOV or MPEP 901.04. ² Enter office that issued the document, by the two-letter code (WIPO Standard ST.3). ³ For Japanese patent documents, the indication of the year of the reign of the Emperor must precede the serial number of the patent document. ⁴ Kind of document by the appropriate symbols as indicated on the document under WIPO Standard ST.16 if possible. ⁵ Applicant is to place a check mark here if English language translation is attached.

INFORMATION DISCLOSURE STATEMENT BY APPLICANT (Not for submission under 37 CFR 1.99)	Application Number		12015320	
	Filing Date		2008-01-16	
	First Named Inventor	Russell W. White, et al.		
	Art Unit	2617		
	Examiner Name	Erika A. Gary		
	Attorney Docket Number	AFF.004C5US		

U.S.PATENTS							Remove
Examiner Initial*	Cite No	Patent Number	Kind Code ¹	Issue Date	Name of Patentee or Applicant of cited Document	Pages, Columns, Lines where Relevant Passages or Relevant Figures Appear	
	1	5539658		1996-07-23	McCullough, Timothy L.		
	2	6675233		2004-01-26	Du		

If you wish to add additional U.S. Patent citation information please click the Add button. Add

U.S.PATENT APPLICATION PUBLICATIONS							Remove
Examiner Initial*	Cite No	Publication Number	Kind Code ¹	Publication Date	Name of Patentee or Applicant of cited Document	Pages, Columns, Lines where Relevant Passages or Relevant Figures Appear	
	1	20030126335		2003-07-03	Silvester, Kelan C.		

If you wish to add additional U.S. Published Application citation information please click the Add button. Add

FOREIGN PATENT DOCUMENTS								Remove
Examiner Initial*	Cite No	Foreign Document Number ³	Country Code ² j	Kind Code ⁴	Publication Date	Name of Patentee or Applicant of cited Document	Pages, Columns, Lines where Relevant Passages or Relevant Figures Appear	T ⁵
	1	DE 19 651 308 A1	DE		1996-10-12	Becker GmbH		<input type="checkbox"/>

If you wish to add additional Foreign Patent Document citation information please click the Add button. Add

NON-PATENT LITERATURE DOCUMENTS							Remove
---------------------------------	--	--	--	--	--	--	--------

**INFORMATION DISCLOSURE
STATEMENT BY APPLICANT**
(Not for submission under 37 CFR 1.99)

Application Number		12015320
Filing Date		2008-01-16
First Named Inventor	Russell W. White, et al.	
Art Unit	2617	
Examiner Name	Erika A. Gary	
Attorney Docket Number	AFF.004C5US	

Examiner Initials*	Cite No	Include name of the author (in CAPITAL LETTERS), title of the article (when appropriate), title of the item (book, magazine, journal, serial, symposium, catalog, etc), date, pages(s), volume-issue number(s), publisher, city and/or country where published.	T ⁵
	1	"Universal Serial Bus Specification," Revision 1.1, September 23, 1998, pages ii-106.	<input type="checkbox"/>
	2	Reply to Office Action Mailed August 5, 2009 in Reexamination Control No. 90/010,333 of U.S. Patent No. 7,324,833 (along with a Supplemental Reply and Second Supplemental Reply).	<input type="checkbox"/>
	3	Response to "Notice of Failure to Comply with Inter Partes Reexamination Request Filing Requirements (37 CFR 1.915(d)) filed on September 22, 2009. Requestor: Volkswagen Group of America, Inc. with Replacement Request for Inter Partes Reexamination of U.S. Patent No. 7,324,833 and Claim Charts A-JJ.	<input type="checkbox"/>
	4	The United States Patent And Trademark Office, Office Action Mailed November 9, 2007 in related patent application serial no. 10/947,755.	<input type="checkbox"/>

If you wish to add additional non-patent literature document citation information please click the Add button

EXAMINER SIGNATURE

Examiner Signature	Date Considered
--------------------	-----------------

*EXAMINER: Initial if reference considered, whether or not citation is in conformance with MPEP 609. Draw line through a citation if not in conformance and not considered. Include copy of this form with next communication to applicant.

¹ See Kind Codes of USPTO Patent Documents at www.USPTO.GOV or MPEP 901.04. ² Enter office that issued the document, by the two-letter code (WIPO Standard ST.3). ³ For Japanese patent documents, the indication of the year of the reign of the Emperor must precede the serial number of the patent document. ⁴ Kind of document by the appropriate symbols as indicated on the document under WIPO Standard ST.16 if possible. ⁵ Applicant is to place a check mark here if English language translation is attached.

INFORMATION DISCLOSURE STATEMENT BY APPLICANT (Not for submission under 37 CFR 1.99)	Application Number		12495190	
	Filing Date		2009-06-30	
	First Named Inventor	Russell White, et al.		
	Art Unit		2617	
	Examiner Name	Erika A. Gary		
	Attorney Docket Number		AFF.0004C7US	

U.S.PATENTS							Remove
Examiner Initial*	Cite No	Patent Number	Kind Code ¹	Issue Date	Name of Patentee or Applicant of cited Document	Pages,Columns,Lines where Relevant Passages or Relevant Figures Appear	
	1	4802492		1989-02-07	Grunstein		

If you wish to add additional U.S. Patent citation information please click the Add button. Add

U.S.PATENT APPLICATION PUBLICATIONS							Remove
Examiner Initial*	Cite No	Publication Number	Kind Code ¹	Publication Date	Name of Patentee or Applicant of cited Document	Pages,Columns,Lines where Relevant Passages or Relevant Figures Appear	
	1						

If you wish to add additional U.S. Published Application citation information please click the Add button. Add

FOREIGN PATENT DOCUMENTS								Remove
Examiner Initial*	Cite No	Foreign Document Number ³	Country Code ² j	Kind Code ⁴	Publication Date	Name of Patentee or Applicant of cited Document	Pages,Columns,Lines where Relevant Passages or Relevant Figures Appear	T ⁵
	1	JP 3056721	JP		1998-12-02			<input type="checkbox"/>
	2	JP 10-356742	JP		2002-10-02			<input type="checkbox"/>

If you wish to add additional Foreign Patent Document citation information please click the Add button Add

NON-PATENT LITERATURE DOCUMENTS								Remove
---------------------------------	--	--	--	--	--	--	--	--------

INFORMATION DISCLOSURE STATEMENT BY APPLICANT (Not for submission under 37 CFR 1.99)	Application Number		12495190
	Filing Date		2009-06-30
	First Named Inventor	Russell White, et al.	
	Art Unit		2617
	Examiner Name	Erika A. Gary	
	Attorney Docket Number		AFF.0004C7US

Examiner Initials*	Cite No	Include name of the author (in CAPITAL LETTERS), title of the article (when appropriate), title of the item (book, magazine, journal, serial, symposium, catalog, etc), date, pages(s), volume-issue number(s), publisher, city and/or country where published.	T ⁵
	1	U.S. Patent and Trademark Office, Office Action mailed May 24, 2010 with Reply filed on July 23, 2010 and supplemental reply filed on July 26, 2010 for U.S. patent reexamination no. 95/001,262.	<input type="checkbox"/>
	2	Third Party Requester's Comments to Patent Owner's Supplemental Reply of July 26, 2010 Pursuant to 37 C.F.R 1.947, filed on August 25, 2010 for U.S. patent reexamination no. 95/001,262.	<input type="checkbox"/>
	3	U.S. Patent and Trademark Office, Office Action mailed August 2, 2010 with Reply filed on October 1, 2010 for U.S. patent reexamination no. 95/001,266.	<input type="checkbox"/>
	4	U.S. Patent and Trademark Office, Office Action mailed July 7, 2009 with Reply filed on September 9, 2009 for U.S. patent reexamination no. 95/001,263.	<input type="checkbox"/>
	5	Third Party Requester's Comments to Patent Owner's Supplemental Reply of September 9, 2010 Pursuant to 37 C.F.R 1.947, filed on October 12, 2010 for U.S. patent reexamination no. 95/001,263.	<input type="checkbox"/>
	6	U.S. Patent and Trademark Office, Office Action mailed September 2, 2010 with Reply filed on November 2, 2010 for U.S. patent reexamination no. 95/001,281	<input type="checkbox"/>
	7	Third Party Requester's Comments to Patent Owner's Reply of October 1, 2010 Pursuant to 37 C.F.R 1.947, filed on November 1, 2010 for U.S. patent reexamination no. 95/001,266	<input type="checkbox"/>

If you wish to add additional non-patent literature document citation information please click the Add button

EXAMINER SIGNATURE

Examiner Signature	Date Considered
--------------------	-----------------

*EXAMINER: Initial if reference considered, whether or not citation is in conformance with MPEP 609. Draw line through a citation if not in conformance and not considered. Include copy of this form with next communication to applicant.

¹ See Kind Codes of USPTO Patent Documents at www.USPTO.GOV or MPEP 901.04. ² Enter office that issued the document, by the two-letter code (WIPO Standard ST.3). ³ For Japanese patent documents, the indication of the year of the reign of the Emperor must precede the serial number of the patent document. ⁴ Kind of document by the appropriate symbols as indicated on the document under WIPO Standard ST.16 if possible. ⁵ Applicant is to place a check mark here if English language translation is attached.

**INFORMATION DISCLOSURE
STATEMENT BY APPLICANT**
(Not for submission under 37 CFR 1.99)

Application Number	12495190		
Filing Date	2009-06-30		
First Named Inventor	Russell White, et al.		
Art Unit	2617		
Examiner Name	Erika A. Gary		
Attorney Docket Number	AFF.0004C7US		

CERTIFICATION STATEMENT

Please see 37 CFR 1.97 and 1.98 to make the appropriate selection(s):

That each item of information contained in the information disclosure statement was first cited in any communication from a foreign patent office in a counterpart foreign application not more than three months prior to the filing of the information disclosure statement. See 37 CFR 1.97(e)(1).

OR

That no item of information contained in the information disclosure statement was cited in a communication from a foreign patent office in a counterpart foreign application, and, to the knowledge of the person signing the certification after making reasonable inquiry, no item of information contained in the information disclosure statement was known to any individual designated in 37 CFR 1.56(c) more than three months prior to the filing of the information disclosure statement. See 37 CFR 1.97(e)(2).

- See attached certification statement.
- Fee set forth in 37 CFR 1.17 (p) has been submitted herewith.
- None

SIGNATURE

A signature of the applicant or representative is required in accordance with CFR 1.33, 10.18. Please see CFR 1.4(d) for the form of the signature.

Signature	/Mark J. Rozman/	Date (YYYY-MM-DD)	2010-12-16
Name/Print	Mark J. Rozman	Registration Number	42117

This collection of information is required by 37 CFR 1.97 and 1.98. The information is required to obtain or retain a benefit by the public which is to file (and by the USPTO to process) an application. Confidentiality is governed by 35 U.S.C. 122 and 37 CFR 1.14. This collection is estimated to take 1 hour to complete, including gathering, preparing and submitting the completed application form to the USPTO. Time will vary depending upon the individual case. Any comments on the amount of time you require to complete this form and/or suggestions for reducing this burden, should be sent to the Chief Information Officer, U.S. Patent and Trademark Office, U.S. Department of Commerce, P.O. Box 1450, Alexandria, VA 22313-1450. **DO NOT SEND FEES OR COMPLETED FORMS TO THIS ADDRESS. SEND TO: Commissioner for Patents, P.O. Box 1450, Alexandria, VA 22313-1450.**

Privacy Act Statement

The Privacy Act of 1974 (P.L. 93-579) requires that you be given certain information in connection with your submission of the attached form related to a patent application or patent. Accordingly, pursuant to the requirements of the Act, please be advised that: (1) the general authority for the collection of this information is 35 U.S.C. 2(b)(2); (2) furnishing of the information solicited is voluntary; and (3) the principal purpose for which the information is used by the U.S. Patent and Trademark Office is to process and/or examine your submission related to a patent application or patent. If you do not furnish the requested information, the U.S. Patent and Trademark Office may not be able to process and/or examine your submission, which may result in termination of proceedings or abandonment of the application or expiration of the patent.

The information provided by you in this form will be subject to the following routine uses:

1. The information on this form will be treated confidentially to the extent allowed under the Freedom of Information Act (5 U.S.C. 552) and the Privacy Act (5 U.S.C. 552a). Records from this system of records may be disclosed to the Department of Justice to determine whether the Freedom of Information Act requires disclosure of these records.
2. A record from this system of records may be disclosed, as a routine use, in the course of presenting evidence to a court, magistrate, or administrative tribunal, including disclosures to opposing counsel in the course of settlement negotiations.
3. A record in this system of records may be disclosed, as a routine use, to a Member of Congress submitting a request involving an individual, to whom the record pertains, when the individual has requested assistance from the Member with respect to the subject matter of the record.
4. A record in this system of records may be disclosed, as a routine use, to a contractor of the Agency having need for the information in order to perform a contract. Recipients of information shall be required to comply with the requirements of the Privacy Act of 1974, as amended, pursuant to 5 U.S.C. 552a(m).
5. A record related to an International Application filed under the Patent Cooperation Treaty in this system of records may be disclosed, as a routine use, to the International Bureau of the World Intellectual Property Organization, pursuant to the Patent Cooperation Treaty.
6. A record in this system of records may be disclosed, as a routine use, to another federal agency for purposes of National Security review (35 U.S.C. 181) and for review pursuant to the Atomic Energy Act (42 U.S.C. 218(c)).
7. A record from this system of records may be disclosed, as a routine use, to the Administrator, General Services, or his/her designee, during an inspection of records conducted by GSA as part of that agency's responsibility to recommend improvements in records management practices and programs, under authority of 44 U.S.C. 2904 and 2906. Such disclosure shall be made in accordance with the GSA regulations governing inspection of records for this purpose, and any other relevant (i.e., GSA or Commerce) directive. Such disclosure shall not be used to make determinations about individuals.
8. A record from this system of records may be disclosed, as a routine use, to the public after either publication of the application pursuant to 35 U.S.C. 122(b) or issuance of a patent pursuant to 35 U.S.C. 151. Further, a record may be disclosed, subject to the limitations of 37 CFR 1.14, as a routine use, to the public if the record was filed in an application which became abandoned or in which the proceedings were terminated and which application is referenced by either a published application, an application open to public inspections or an issued patent.
9. A record from this system of records may be disclosed, as a routine use, to a Federal, State, or local law enforcement agency, if the USPTO becomes aware of a violation or potential violation of law or regulation.

Electronic Patent Application Fee Transmittal

Application Number:	12495190
Filing Date:	30-Jun-2009
Title of Invention:	Method For Content Delivery
First Named Inventor/Applicant Name:	Russell W. White
Filer:	Mark J. Rozman
Attorney Docket Number:	AFF.0004C7US

Filed as Large Entity

Utility under 35 USC 111(a) Filing Fees

Description	Fee Code	Quantity	Amount	Sub-Total in USD(\$)
Basic Filing:				
Pages:				
Claims:				
Miscellaneous-Filing:				
Petition:				
Patent-Appeals-and-Interference:				
Post-Allowance-and-Post-Issuance:				
Extension-of-Time:				

Description	Fee Code	Quantity	Amount	Sub-Total in USD(\$)
Miscellaneous:				
Submission- Information Disclosure Stmt	1806	1	180	180
Total in USD (\$)				180

Electronic Acknowledgement Receipt

EFS ID:	9055788
Application Number:	12495190
International Application Number:	
Confirmation Number:	2380
Title of Invention:	Method For Content Delivery
First Named Inventor/Applicant Name:	Russell W. White
Customer Number:	21906
Filer:	Mark J. Rozman
Filer Authorized By:	
Attorney Docket Number:	AFF.0004C7US
Receipt Date:	16-DEC-2010
Filing Date:	30-JUN-2009
Time Stamp:	17:31:45
Application Type:	Utility under 35 USC 111(a)

Payment information:

Submitted with Payment	yes
Payment Type	Deposit Account
Payment was successfully received in RAM	\$180
RAM confirmation Number	4481
Deposit Account	201504
Authorized User	

The Director of the USPTO is hereby authorized to charge indicated fees and credit any overpayment as follows:

Charge any Additional Fees required under 37 C.F.R. Section 1.21 (Miscellaneous fees and charges)

File Listing:					
Document Number	Document Description	File Name	File Size(Bytes)/ Message Digest	Multi Part /.zip	Pages (if appl.)
1	Information Disclosure Statement (IDS) Filed (SB/08)	AFF004C7IDSwithCopiesof1449 TOFILE.pdf	688485 e17e5ab7fd8fd388cda246a2c5c7d8235fac3bd1	no	32
Warnings:					
Information:					
This is not an USPTO supplied IDS fillable form					
2	Information Disclosure Statement (IDS) Filed (SB/08)	AFF004C7IDS.pdf	612326 8ec6faf1f06373344fb801eb1fa9c83d2714c5c5	no	4
Warnings:					
Information:					
3	NPL Documents	AFF004C6C7npl01.pdf	12404322 671bd2af154337ffe59ebccd32ec2369e97ca29	no	306
Warnings:					
Information:					
4	NPL Documents	AFF004C6C7npl02.pdf	4101160 c7406b58034fee2f1d91cf76d12c6e6d6752a46d	no	72
Warnings:					
Information:					
5	NPL Documents	AFF004C6C7npl03.pdf	4039057 7ab0a451260b270407da00781a06ad8c744e93b4	no	118
Warnings:					
Information:					
6	NPL Documents	AFF004C6C7npl04.pdf	8002903 3a8495ef9f9f25edcb25515191f8526012ec19c	no	193
Warnings:					
Information:					
7	NPL Documents	AFF004C6C7npl05.pdf	21547795 7879e1c326e996e4811f4cf208b4361f5aa2bf31	no	382
Warnings:					
Information:					
8	NPL Documents	AFF004C6C7npl06.pdf	13103717 885336517710693122547c787134f5c0871053a8	no	340
Warnings:					
Information:					

9	NPL Documents	AFF004C6C7npl07Part1of2.pdf	9420835 0b7ebc33183379c9ea16928f369919aae922bc20	no	160
Warnings:					
Information:					
10	NPL Documents	AFF004C6C7npl07Part2of2.pdf	3221836 69ccd24a1b7e321ee439a47851300d8653103d2c	no	122
Warnings:					
Information:					
11	Fee Worksheet (PTO-875)	fee-info.pdf	30140 9c0fc12880d63c94b7c62374450bf55e69fd8624	no	2
Warnings:					
Information:					
Total Files Size (in bytes):			77172576		

This Acknowledgement Receipt evidences receipt on the noted date by the USPTO of the indicated documents, characterized by the applicant, and including page counts, where applicable. It serves as evidence of receipt similar to a Post Card, as described in MPEP 503.

New Applications Under 35 U.S.C. 111

If a new application is being filed and the application includes the necessary components for a filing date (see 37 CFR 1.53(b)-(d) and MPEP 506), a Filing Receipt (37 CFR 1.54) will be issued in due course and the date shown on this Acknowledgement Receipt will establish the filing date of the application.

National Stage of an International Application under 35 U.S.C. 371

If a timely submission to enter the national stage of an international application is compliant with the conditions of 35 U.S.C. 371 and other applicable requirements a Form PCT/DO/EO/903 indicating acceptance of the application as a national stage submission under 35 U.S.C. 371 will be issued in addition to the Filing Receipt, in due course.

New International Application Filed with the USPTO as a Receiving Office

If a new international application is being filed and the international application includes the necessary components for an international filing date (see PCT Article 11 and MPEP 1810), a Notification of the International Application Number and of the International Filing Date (Form PCT/RO/105) will be issued in due course, subject to prescriptions concerning national security, and the date shown on this Acknowledgement Receipt will establish the international filing date of the application.

INFORMATION DISCLOSURE STATEMENT BY APPLICANT (Not for submission under 37 CFR 1.99)	Application Number		12495190
	Filing Date		2009-06-30
	First Named Inventor	Russell W. White, Jr.	
	Art Unit		2617
	Examiner Name	Erika A. Gary	
	Attorney Docket Number		AFF.0004C7US

U.S.PATENTS						
Examiner Initial*	Cite No	Patent Number	Kind Code ¹	Issue Date	Name of Patentee or Applicant of cited Document	Pages, Columns, Lines where Relevant Passages or Relevant Figures Appear
	1	5797089		1998-08-18	Nguyen, et al.	
	2	5991640		1999-11-23	Lilja, et al.	
	3	6338044		2002-01-08	Cook, et al.	
	4	7549007		2009-06-16	Smith, et al.	
	5	7139626		2006-11-21	Kataoka, et al.	
	6	5852775		1998-12-22	Hidary	
	7	5889852		1999-03-30	Rosecrans, et al.	
	8	6007228		1999-12-28	Agarwal, et al.	

**INFORMATION DISCLOSURE
STATEMENT BY APPLICANT**
(Not for submission under 37 CFR 1.99)

Application Number	12495190
Filing Date	2009-06-30
First Named Inventor	Russell W. White, Jr.
Art Unit	2617
Examiner Name	Erika A. Gary
Attorney Docket Number	AFF.0004C7US

9	7562392		2009-07-14	Rhoads, et al.	
10	6633932		2003-10-14	Bork, et al.	

If you wish to add additional U.S. Patent citation information please click the Add button.

U.S.PATENT APPLICATION PUBLICATIONS

Examiner Initial*	Cite No	Publication Number	Kind Code ¹	Publication Date	Name of Patentee or Applicant of cited Document	Pages, Columns, Lines where Relevant Passages or Relevant Figures Appear
1						

If you wish to add additional U.S. Published Application citation information please click the Add button.

FOREIGN PATENT DOCUMENTS

Examiner Initial*	Cite No	Foreign Document Number ³	Country Code ²	Kind Code ⁴	Publication Date	Name of Patentee or Applicant of cited Document	Pages, Columns, Lines where Relevant Passages or Relevant Figures Appear	T ⁵
1								<input type="checkbox"/>

If you wish to add additional Foreign Patent Document citation information please click the Add button

NON-PATENT LITERATURE DOCUMENTS

Examiner Initials*	Cite No	Include name of the author (in CAPITAL LETTERS), title of the article (when appropriate), title of the item (book, magazine, journal, serial, symposium, catalog, etc), date, pages(s), volume-issue number(s), publisher, city and/or country where published.	T ⁵
1		CAI, JIAN, et al., "General Packet Radio Service in GSM," IEEE Communications Magazine, October 1997.	<input type="checkbox"/>
2		RealNetworks, "RealPlayer Plus G2 Manual," Copyright 1998-1999.	<input type="checkbox"/>

**INFORMATION DISCLOSURE
STATEMENT BY APPLICANT**
(Not for submission under 37 CFR 1.99)

Application Number		12495190
Filing Date		2009-06-30
First Named Inventor	Russell W. White, Jr.	
Art Unit	2617	
Examiner Name	Erika A. Gary	
Attorney Docket Number	AFF.0004C7US	

3	RATHBONE, ANDY, "MP3 for Dummies," IDG Books Worldwide, Copyright 1999.	<input type="checkbox"/>
4	Affinity Labs of Texas, LLC v. BMW North America, LLC, et al., C.A. No. 9:08CV164 and Affinity Labs of Texas, LLC v. Alpine Electronics of America, Inc., et al., C.A. No. 9:08CV171, Eastern District of Texas, Order Construing Claim Terms of United States Pates No. 7,324,833, December 18, 2009, pp. 1-31.	<input type="checkbox"/>
5	Exhibit B to Third Party Requester's Comments to Patent Owner's Supplemental Reply of July 26, 2010 filed August 25, 2010 in Reexamination No. 95/001,262 (Declaration of Dr. Bruce Maggs dated August 25, 2010).	<input type="checkbox"/>
6	Exhibit A to Third Party Requester's Comments to Patent Owner's Reply of September 9, 2010 filed October 12, 2010 in Reexamination No. 95/001,263 (Declaration of Dr. Bruce Maggs dated October 12, 2010).	<input type="checkbox"/>
7	Nokia, "Quick Guide - Accessories Guide," Copyright 1999.	<input type="checkbox"/>

If you wish to add additional non-patent literature document citation information please click the Add button

EXAMINER SIGNATURE

Examiner Signature		Date Considered	
--------------------	--	-----------------	--

*EXAMINER: Initial if reference considered, whether or not citation is in conformance with MPEP 609. Draw line through a citation if not in conformance and not considered. Include copy of this form with next communication to applicant.

¹ See Kind Codes of USPTO Patent Documents at www.USPTO.GOV or MPEP 901.04. ² Enter office that issued the document, by the two-letter code (WIPO Standard ST.3). ³ For Japanese patent documents, the indication of the year of the reign of the Emperor must precede the serial number of the patent document. ⁴ Kind of document by the appropriate symbols as indicated on the document under WIPO Standard ST.16 if possible. ⁵ Applicant is to place a check mark here if English language translation is attached.

**INFORMATION DISCLOSURE
STATEMENT BY APPLICANT**
(Not for submission under 37 CFR 1.99)

Application Number	12495190
Filing Date	2009-06-30
First Named Inventor	Russell W. White, Jr.
Art Unit	2617
Examiner Name	Erika A. Gary
Attorney Docket Number	AFF.0004C7US

CERTIFICATION STATEMENT

Please see 37 CFR 1.97 and 1.98 to make the appropriate selection(s):

That each item of information contained in the information disclosure statement was first cited in any communication from a foreign patent office in a counterpart foreign application not more than three months prior to the filing of the information disclosure statement. See 37 CFR 1.97(e)(1).

OR

That no item of information contained in the information disclosure statement was cited in a communication from a foreign patent office in a counterpart foreign application, and, to the knowledge of the person signing the certification after making reasonable inquiry, no item of information contained in the information disclosure statement was known to any individual designated in 37 CFR 1.56(c) more than three months prior to the filing of the information disclosure statement. See 37 CFR 1.97(e)(2).

See attached certification statement.

Fee set forth in 37 CFR 1.17 (p) has been submitted herewith.

None

SIGNATURE

A signature of the applicant or representative is required in accordance with CFR 1.33, 10.18. Please see CFR 1.4(d) for the form of the signature.

Signature	/Mark J. Rozman/	Date (YYYY-MM-DD)	2010-12-09
Name/Print	Mark J. Rozman	Registration Number	42117

This collection of information is required by 37 CFR 1.97 and 1.98. The information is required to obtain or retain a benefit by the public which is to file (and by the USPTO to process) an application. Confidentiality is governed by 35 U.S.C. 122 and 37 CFR 1.14. This collection is estimated to take 1 hour to complete, including gathering, preparing and submitting the completed application form to the USPTO. Time will vary depending upon the individual case. Any comments on the amount of time you require to complete this form and/or suggestions for reducing this burden, should be sent to the Chief Information Officer, U.S. Patent and Trademark Office, U.S. Department of Commerce, P.O. Box 1450, Alexandria, VA 22313-1450. **DO NOT SEND FEES OR COMPLETED FORMS TO THIS ADDRESS. SEND TO: Commissioner for Patents, P.O. Box 1450, Alexandria, VA 22313-1450.**

Privacy Act Statement

The Privacy Act of 1974 (P.L. 93-579) requires that you be given certain information in connection with your submission of the attached form related to a patent application or patent. Accordingly, pursuant to the requirements of the Act, please be advised that: (1) the general authority for the collection of this information is 35 U.S.C. 2(b)(2); (2) furnishing of the information solicited is voluntary; and (3) the principal purpose for which the information is used by the U.S. Patent and Trademark Office is to process and/or examine your submission related to a patent application or patent. If you do not furnish the requested information, the U.S. Patent and Trademark Office may not be able to process and/or examine your submission, which may result in termination of proceedings or abandonment of the application or expiration of the patent.

The information provided by you in this form will be subject to the following routine uses:

1. The information on this form will be treated confidentially to the extent allowed under the Freedom of Information Act (5 U.S.C. 552) and the Privacy Act (5 U.S.C. 552a). Records from this system of records may be disclosed to the Department of Justice to determine whether the Freedom of Information Act requires disclosure of these records.
2. A record from this system of records may be disclosed, as a routine use, in the course of presenting evidence to a court, magistrate, or administrative tribunal, including disclosures to opposing counsel in the course of settlement negotiations.
3. A record in this system of records may be disclosed, as a routine use, to a Member of Congress submitting a request involving an individual, to whom the record pertains, when the individual has requested assistance from the Member with respect to the subject matter of the record.
4. A record in this system of records may be disclosed, as a routine use, to a contractor of the Agency having need for the information in order to perform a contract. Recipients of information shall be required to comply with the requirements of the Privacy Act of 1974, as amended, pursuant to 5 U.S.C. 552a(m).
5. A record related to an International Application filed under the Patent Cooperation Treaty in this system of records may be disclosed, as a routine use, to the International Bureau of the World Intellectual Property Organization, pursuant to the Patent Cooperation Treaty.
6. A record in this system of records may be disclosed, as a routine use, to another federal agency for purposes of National Security review (35 U.S.C. 181) and for review pursuant to the Atomic Energy Act (42 U.S.C. 218(c)).
7. A record from this system of records may be disclosed, as a routine use, to the Administrator, General Services, or his/her designee, during an inspection of records conducted by GSA as part of that agency's responsibility to recommend improvements in records management practices and programs, under authority of 44 U.S.C. 2904 and 2906. Such disclosure shall be made in accordance with the GSA regulations governing inspection of records for this purpose, and any other relevant (i.e., GSA or Commerce) directive. Such disclosure shall not be used to make determinations about individuals.
8. A record from this system of records may be disclosed, as a routine use, to the public after either publication of the application pursuant to 35 U.S.C. 122(b) or issuance of a patent pursuant to 35 U.S.C. 151. Further, a record may be disclosed, subject to the limitations of 37 CFR 1.14, as a routine use, to the public if the record was filed in an application which became abandoned or in which the proceedings were terminated and which application is referenced by either a published application, an application open to public inspections or an issued patent.
9. A record from this system of records may be disclosed, as a routine use, to a Federal, State, or local law enforcement agency, if the USPTO becomes aware of a violation or potential violation of law or regulation.

INFORMATION DISCLOSURE STATEMENT BY APPLICANT (Not for submission under 37 CFR 1.99)	Application Number		12495115
	Filing Date		2009-06-30
	First Named Inventor	Russell W. White, Jr.	
	Art Unit	2617	
	Examiner Name	Erika A. Gary	
	Attorney Docket Number	AFF.0004C6US	

U.S.PATENTS						
Examiner Initial*	Cite No	Patent Number	Kind Code ¹	Issue Date	Name of Patentee or Applicant of cited Document	Pages, Columns, Lines where Relevant Passages or Relevant Figures Appear
	1	5797089		1998-08-18	Nguyen, et al.	
	2	5991640		1999-11-23	Lilja, et al.	
	3	6338044		2002-01-08	Cook, et al.	
	4	7549007		2009-06-16	Smith, et al.	
	5	7139626		2006-11-21	Kataoka, et al.	
	6	5852775		1998-12-22	Hidary	
	7	5889852		1999-03-30	Rosecrans, et al.	
	8	6007228		1999-12-28	Agarwal, et al.	

Electronic Patent Application Fee Transmittal

Application Number:	12495190
Filing Date:	30-Jun-2009
Title of Invention:	Method For Content Delivery
First Named Inventor/Applicant Name:	Russell W. White
Filer:	Mark J. Rozman/Stephanie Petreas
Attorney Docket Number:	AFF.0004C7US

Filed as Large Entity

Utility under 35 USC 111(a) Filing Fees

Description	Fee Code	Quantity	Amount	Sub-Total in USD(\$)
Basic Filing:				
Pages:				
Claims:				
Miscellaneous-Filing:				
Petition:				
Patent-Appeals-and-Interference:				
Post-Allowance-and-Post-Issuance:				
Extension-of-Time:				

Description	Fee Code	Quantity	Amount	Sub-Total in USD(\$)
Miscellaneous:				
Submission- Information Disclosure Stmt	1806	1	180	180
Total in USD (\$)				180

Electronic Acknowledgement Receipt

EFS ID:	9001416
Application Number:	12495190
International Application Number:	
Confirmation Number:	2380
Title of Invention:	Method For Content Delivery
First Named Inventor/Applicant Name:	Russell W. White
Customer Number:	21906
Filer:	Mark J. Rozman/Stephanie Petreas
Filer Authorized By:	Mark J. Rozman
Attorney Docket Number:	AFF.0004C7US
Receipt Date:	09-DEC-2010
Filing Date:	30-JUN-2009
Time Stamp:	14:52:42
Application Type:	Utility under 35 USC 111(a)

Payment information:

Submitted with Payment	yes
Payment Type	Deposit Account
Payment was successfully received in RAM	\$180
RAM confirmation Number	1200
Deposit Account	201504
Authorized User	

The Director of the USPTO is hereby authorized to charge indicated fees and credit any overpayment as follows:

Charge any Additional Fees required under 37 C.F.R. Section 1.21 (Miscellaneous fees and charges)

File Listing:					
Document Number	Document Description	File Name	File Size(Bytes)/ Message Digest	Multi Part /.zip	Pages (if appl.)
1	Information Disclosure Statement (IDS) Filed (SB/08)	AFF004C7USIDStofile.pdf	179486 572e82dfffa854ef34a2ec4c027979742e4e8b7be	no	6
Warnings:					
Information:					
This is not an USPTO supplied IDS fillable form					
2	NPL Documents	GeneralPacketRadioServiceinG SM.pdf	868318 a873e00cf1926c6e373bb0bba89b04f9e4770c37	no	10
Warnings:					
Information:					
3	NPL Documents	RealNetworks- RealPlayerPlusG2Manual.pdf	2301378 b1216f896f2c8c8245274f08ee32d43d32b66841	no	84
Warnings:					
Information:					
4	NPL Documents	MP3forDummies.pdf	13260366 4e591a8d2c9a00e19f3a54c90dc8b656f80277e2	no	337
Warnings:					
Information:					
5	NPL Documents	OrderConstruingClaimTermsOf USPatent7324833dated12-18-0 9.pdf	904284 5fbb5eadae051d52ebab7382c8291713d6d6b66c	no	31
Warnings:					
Information:					
6	NPL Documents	AFF004B3- DeclarationofDrBruceMaggs. pdf	14673572 72dd75cfd0574a326840c21985cd7e116243cc05	no	312
Warnings:					
Information:					
7	Transmittal Letter	AFF004B6- DeclaratioanofDrBruceMaggs. pdf	8822524 35d5ced297bea06f4b4bd2c78d6f7f1fb3b7dcd5	no	188
Warnings:					
Information:					
8	NPL Documents	NokiaQuickGuide- AccessoriesGuide.pdf	520188 efd98a6a5619df89445574d4c30f3b1307963e40	no	35
Warnings:					
Information:					

9	Fee Worksheet (PTO-875)	fee-info.pdf	30360 0b444474e68e0c57dd0505890ba2067aa0 b32d28	no	2
---	-------------------------	--------------	-------------------------------------------------------	----	---

Warnings:

Information:

Total Files Size (in bytes):	41560476
-------------------------------------	----------

This Acknowledgement Receipt evidences receipt on the noted date by the USPTO of the indicated documents, characterized by the applicant, and including page counts, where applicable. It serves as evidence of receipt similar to a Post Card, as described in MPEP 503.

New Applications Under 35 U.S.C. 111

If a new application is being filed and the application includes the necessary components for a filing date (see 37 CFR 1.53(b)-(d) and MPEP 506), a Filing Receipt (37 CFR 1.54) will be issued in due course and the date shown on this Acknowledgement Receipt will establish the filing date of the application.

National Stage of an International Application under 35 U.S.C. 371

If a timely submission to enter the national stage of an international application is compliant with the conditions of 35 U.S.C. 371 and other applicable requirements a Form PCT/DO/EO/903 indicating acceptance of the application as a national stage submission under 35 U.S.C. 371 will be issued in addition to the Filing Receipt, in due course.

New International Application Filed with the USPTO as a Receiving Office

If a new international application is being filed and the international application includes the necessary components for an international filing date (see PCT Article 11 and MPEP 1810), a Notification of the International Application Number and of the International Filing Date (Form PCT/RO/105) will be issued in due course, subject to prescriptions concerning national security, and the date shown on this Acknowledgement Receipt will establish the international filing date of the application.



UNITED STATES PATENT AND TRADEMARK OFFICE

UNITED STATES DEPARTMENT OF COMMERCE
United States Patent and Trademark Office
Address: COMMISSIONER FOR PATENTS
P.O. Box 1450
Alexandria, Virginia 22313-1450
www.uspto.gov

APPLICATION NO.	FILING DATE	FIRST NAMED INVENTOR	ATTORNEY DOCKET NO.	CONFIRMATION NO.
12/495,190	06/30/2009	Russell W. White	AFF.0004C7US	2380
21906	7590	09/17/2010	EXAMINER	
TROP, PRUNER & HU, P.C. 1616 S. VOSS ROAD, SUITE 750 HOUSTON, TX 77057-2631			GARY, ERIKA A	
			ART UNIT	PAPER NUMBER
			2617	
			MAIL DATE	DELIVERY MODE
			09/17/2010	PAPER

Please find below and/or attached an Office communication concerning this application or proceeding.

The time period for reply, if any, is set in the attached communication.

Office Action Summary	Application No. 12/495,190	Applicant(s) WHITE ET AL.	
	Examiner Erika A. Gary	Art Unit 2617	

-- The MAILING DATE of this communication appears on the cover sheet with the correspondence address --

Period for Reply

A SHORTENED STATUTORY PERIOD FOR REPLY IS SET TO EXPIRE 3 MONTH(S) OR THIRTY (30) DAYS, WHICHEVER IS LONGER, FROM THE MAILING DATE OF THIS COMMUNICATION.

- Extensions of time may be available under the provisions of 37 CFR 1.136(a). In no event, however, may a reply be timely filed after SIX (6) MONTHS from the mailing date of this communication.
- If NO period for reply is specified above, the maximum statutory period will apply and will expire SIX (6) MONTHS from the mailing date of this communication.
- Failure to reply within the set or extended period for reply will, by statute, cause the application to become ABANDONED (35 U.S.C. § 133). Any reply received by the Office later than three months after the mailing date of this communication, even if timely filed, may reduce any earned patent term adjustment. See 37 CFR 1.704(b).

Status

- 1) Responsive to communication(s) filed on 30 June 2009.
- 2a) This action is **FINAL**.
- 2b) This action is non-final.
- 3) Since this application is in condition for allowance except for formal matters, prosecution as to the merits is closed in accordance with the practice under *Ex parte Quayle*, 1935 C.D. 11, 453 O.G. 213.

Disposition of Claims

- 4) Claim(s) 19-41 is/are pending in the application.
 - 4a) Of the above claim(s) _____ is/are withdrawn from consideration.
- 5) Claim(s) 19, 22, 23 and 27-29 is/are allowed.
- 6) Claim(s) 20, 21, 24-26, 30-41 is/are rejected.
- 7) Claim(s) _____ is/are objected to.
- 8) Claim(s) _____ are subject to restriction and/or election requirement.

Application Papers

- 9) The specification is objected to by the Examiner.
- 10) The drawing(s) filed on _____ is/are: a) accepted or b) objected to by the Examiner.
 - Applicant may not request that any objection to the drawing(s) be held in abeyance. See 37 CFR 1.85(a).
 - Replacement drawing sheet(s) including the correction is required if the drawing(s) is objected to. See 37 CFR 1.121(d).
- 11) The oath or declaration is objected to by the Examiner. Note the attached Office Action or form PTO-152.

Priority under 35 U.S.C. § 119

- 12) Acknowledgment is made of a claim for foreign priority under 35 U.S.C. § 119(a)-(d) or (f).
 - a) All b) Some * c) None of:
 - 1. Certified copies of the priority documents have been received.
 - 2. Certified copies of the priority documents have been received in Application No. _____.
 - 3. Copies of the certified copies of the priority documents have been received in this National Stage application from the International Bureau (PCT Rule 17.2(a)).

* See the attached detailed Office action for a list of the certified copies not received.

Attachment(s)

- 1) Notice of References Cited (PTO-892)
- 2) Notice of Draftperson's Patent Drawing Review (PTO-948)
- 3) Information Disclosure Statement(s) (PTO/SB/08)
Paper No(s)/Mail Date 8/20/09, 9/4/09, 9/11/09, 11/16/09.
- 4) Interview Summary (PTO-413)
Paper No(s)/Mail Date. _____.
- 5) Notice of Informal Patent Application
- 6) Other: _____.

DETAILED ACTION

Specification

1. The disclosure is objected to because of the following informalities: the first page of the specification should include that SN 12/015,320 is now US Patent Number 7,778,595.

Appropriate correction is required.

Claim Rejections - 35 USC § 112

2. The following is a quotation of the first paragraph of 35 U.S.C. 112:

The specification shall contain a written description of the invention, and of the manner and process of making and using it, in such full, clear, concise, and exact terms as to enable any person skilled in the art to which it pertains, or with which it is most nearly connected, to make and use the same and shall set forth the best mode contemplated by the inventor of carrying out his invention.

3. Claims 20, 24-26, and 32 are rejected under 35 U.S.C. 112, first paragraph, as failing to comply with the written description requirement. The claim(s) contains subject matter which was not described in the specification in such a way as to reasonably convey to one skilled in the relevant art that the inventor(s), at the time the application was filed, had possession of the claimed invention. The specification does not adequately teach that the communication rate is lower than 100 Kbps specifically. The specification also does not teach maintaining a store resource, and providing a copy of various collections of instructions to a user.

Claim Rejections - 35 USC § 103

Art Unit: 2617

4. The following is a quotation of 35 U.S.C. 103(a) which forms the basis for all obviousness rejections set forth in this Office action:

(a) A patent may not be obtained though the invention is not identically disclosed or described as set forth in section 102 of this title, if the differences between the subject matter sought to be patented and the prior art are such that the subject matter as a whole would have been obvious at the time the invention was made to a person having ordinary skill in the art to which said subject matter pertains. Patentability shall not be negated by the manner in which the invention was made.

5. Claims 30, 31, and 33-36 are rejected under 35 U.S.C. 103(a) as being unpatentable over Leeke et al., US Patent Number 6,587,127 (hereinafter Leeke) in view of Lin et al., US Patent Number 6,405,256 (hereinafter Lin).

Regarding claim 30, Leeke discloses a method for content delivery, comprising: presenting a graphical user interface on a display of an electronic device that is capable of wireless communication; recognizing selection of an icon presented on the display, wherein the icon is associated with content that is deliverable as a streaming media; accessing a listing of network locations from which information associated with the content may be obtained [col. 1: lines 15-16; col. 4: lines 8-9, 21-67; col. 7: lines 55-57; col. 12: lines 15-55].

What Leeke does not specifically disclose is executing instructions at the electronic device to direct a processor in the electronic device to switch between a set of communication rates at which the electronic device receives a first portion and a second portion of the content, wherein the set of wireless communication rates comprises at least a first data rate and a second data rate that is slower than the first data rate. However, Lin teaches this limitation [col. 3: lines 10-18].

At the time of the invention, it would have been obvious to one of ordinary skill in the art to modify Leeke to include Lin. The motivation for this modification, as

Art Unit: 2617

suggested by Lin, would have been to improve the performance of the data streaming [col. 3: lines 24-28].

Regarding claim 31, Lin teaches utilizing a portion of the instructions at the electronic device to switch between at least two of the set of communication rates [col. 3: lines 10-28].

Regarding claim 33, Leeke teaches receiving a software upgrade [col. 5: lines 46-48].

Regarding claim 34, Leeke teaches each of the presenting, recognizing, accessing, and executing steps are performed by one or more components of a portable device that is operable as a telephone [col. 4: lines 21-24].

Regarding claim 35, Leeke teaches each of the presenting, recognizing, accessing, and executing steps are performed by one or more components of a portable device that is not operable as a cellular telephone [col. 4: lines 21-24].

Regarding claim 36, Lin teaches switching between the first data rate and the second data rate based on an amount of the content that has been buffered in the electronic device [col. 3: lines 10-28].

Double Patenting

6. The nonstatutory double patenting rejection is based on a judicially created doctrine grounded in public policy (a policy reflected in the statute) so as to prevent the unjustified or improper timewise extension of the “right to exclude” granted by a patent and to prevent possible harassment by multiple assignees. A nonstatutory

Art Unit: 2617

obviousness-type double patenting rejection is appropriate where the conflicting claims are not identical, but at least one examined application claim is not patentably distinct from the reference claim(s) because the examined application claim is either anticipated by, or would have been obvious over, the reference claim(s). See, e.g., *In re Berg*, 140 F.3d 1428, 46 USPQ2d 1226 (Fed. Cir. 1998); *In re Goodman*, 11 F.3d 1046, 29 USPQ2d 2010 (Fed. Cir. 1993); *In re Longi*, 759 F.2d 887, 225 USPQ 645 (Fed. Cir. 1985); *In re Van Ornum*, 686 F.2d 937, 214 USPQ 761 (CCPA 1982); *In re Vogel*, 422 F.2d 438, 164 USPQ 619 (CCPA 1970); and *In re Thorington*, 418 F.2d 528, 163 USPQ 644 (CCPA 1969).

A timely filed terminal disclaimer in compliance with 37 CFR 1.321(c) or 1.321(d) may be used to overcome an actual or provisional rejection based on a nonstatutory double patenting ground provided the conflicting application or patent either is shown to be commonly owned with this application, or claims an invention made as a result of activities undertaken within the scope of a joint research agreement.

Effective January 1, 1994, a registered attorney or agent of record may sign a terminal disclaimer. A terminal disclaimer signed by the assignee must fully comply with 37 CFR 3.73(b).

7. Claims 37-41 are rejected on the ground of nonstatutory obviousness-type double patenting as being unpatentable over claims 1, 3, 5, 7, and 10 of U.S. Patent No. 7,778,595 in view of Lin.

Regarding claim 37, claim 1 of patent teaches a system for content delivery, comprising: a portable device having a display, a local rechargeable battery, a wireless

Art Unit: 2617

communication system, and a processor; a physical interface of the portable device, the physical interface configured to connect to an interface system that includes a cable having multiple conductive elements, wherein the physical interface is designed such that a different electronic device can be communicatively coupled with the physical interface of the portable device using the interface system in a manner that allows the different electronic device to recharge the local rechargeable battery using at least one of the multiple conductive elements and to communicate with the portable device using at least one other of the multiple conductive elements; and a computer-readable medium having stored instructions that when executed are operable to cause the processor: (1) to present an icon on the display, the icon associated with content that is deliverable as streaming media; (2) to recognize a selection of the icon.

What the patent does not teach is switching between a set of communication rates at which the portable device receives a first portion and a second portion of the content, wherein the set of communication rates comprise at least a first data rate and a second data rate that is slower than the first data rate. However, Lin teaches this limitation [col. 3: lines 10-18].

At the time of the invention, it would have been obvious to one of ordinary skill in the art to modify the patent to include Lin. The motivation for this modification, as suggested by Lin, would have been to improve the performance of the data streaming [col. 3: lines 24-28].

Regarding claim 38, claim 3 of the patent teaches the interface system and the different electronic device, wherein at least a portion of the different electronic device is

a component of an automobile sound system and the interface system utilizes at least one bus to communicatively couple with the different electronic device.

Regarding claim 39, claim 5 of the patent teaches the interface system and the different electronic device, wherein at least a portion of the different electronic device is a component of a stereo system and the interface system utilizes at least one bus to communicatively couple with the different electronic device.

Regarding claim 40, claims 1 and 10 of the patent teach the stored instructions are further operable to cause the processor: (1) to obtain a listing of network locations at which to access the streaming media; and (2) to cause a first of the network locations to be accessed to facilitate a streaming delivery of the streaming media.

Regarding claim 41, claim 7 of the patent teaches the content is selected from a group consisting of a song and a video.

Allowable Subject Matter

8. Claims 19, 22, 23 and 27-29 are allowed as prior art has not yet been found that teaches the method for content delivery in independent claim 19, comprising presenting an icon comprising the word “store” on the display in conjunction with the different collections of instructions executable by a processor of the remote electronic device to access a website, recognize an icon associated with streaming media content to be delivered, and switch between sets of communication rates.

Conclusion

Art Unit: 2617

9. Any inquiry concerning this communication or earlier communications from the examiner should be directed to Erika A. Gary whose telephone number is 571-272-7841. The examiner can normally be reached on Monday-Thursday.

If attempts to reach the examiner by telephone are unsuccessful, the examiner's supervisor, Dwayne Bost can be reached on 571-272-7023. The fax phone number for the organization where this application or proceeding is assigned is 571-273-8300.

Information regarding the status of an application may be obtained from the Patent Application Information Retrieval (PAIR) system. Status information for published applications may be obtained from either Private PAIR or Public PAIR. Status information for unpublished applications is available through Private PAIR only. For more information about the PAIR system, see <http://pair-direct.uspto.gov>. Should you have questions on access to the Private PAIR system, contact the Electronic Business Center (EBC) at 866-217-9197 (toll-free). If you would like assistance from a USPTO Customer Service Representative or access to the automated information system, call 800-786-9199 (IN USA OR CANADA) or 571-272-1000.

/EAG/
September 15, 2010

/Erika A. Gary/
Primary Examiner, Art Unit 2617

Notice of References Cited	Application/Control No. 12/495,190	Applicant(s)/Patent Under Reexamination WHITE ET AL.	
	Examiner Erika A. Gary	Art Unit 2617	Page 1 of 1

U.S. PATENT DOCUMENTS

*	Document Number Country Code-Number-Kind Code	Date MM-YYYY	Name	Classification
*	A US-6,405,256 B1	06-2002	Lin et al.	709/231
*	B US-6,587,127	07-2003	Leeke et al.	715/765
	C US-			
	D US-			
	E US-			
	F US-			
	G US-			
	H US-			
	I US-			
	J US-			
	K US-			
	L US-			
	M US-			

FOREIGN PATENT DOCUMENTS

*	Document Number Country Code-Number-Kind Code	Date MM-YYYY	Country	Name	Classification
	N				
	O				
	P				
	Q				
	R				
	S				
	T				

NON-PATENT DOCUMENTS

*	Document Number Country Code-Number-Kind Code	Date MM-YYYY	Country	Name	Classification
	Include as applicable: Author, Title Date, Publisher, Edition or Volume, Pertinent Pages)				
	U				
	V				
	W				
	X				

*A copy of this reference is not being furnished with this Office action. (See MPEP § 707.05(a).)
Dates in MM-YYYY format are publication dates. Classifications may be US or foreign.

Search Notes 	Application/Control No. 12495190	Applicant(s)/Patent Under Reexamination WHITE ET AL.
	Examiner Erika A Gary	Art Unit 2617

SEARCHED			
Class	Subclass	Date	Examiner
	see EAST search attached	9/14/10	EAG

SEARCH NOTES		
Search Notes	Date	Examiner
see EAST search attached	9/14/10	EAG

INTERFERENCE SEARCH			
Class	Subclass	Date	Examiner

--	--

UNITED STATES PATENT AND TRADEMARK OFFICE

UNITED STATES DEPARTMENT OF COMMERCE
United States Patent and Trademark Office
 Address: COMMISSIONER FOR PATENTS
 P.O. Box 1450
 Alexandria, Virginia 22313-1450
 www.uspto.gov

BIB DATA SHEET
CONFIRMATION NO. 2380

SERIAL NUMBER	FILING or 371(c) DATE	CLASS	GROUP ART UNIT	ATTORNEY DOCKET NO.	
12/495,190	06/30/2009	455	2617	AFF.0004C7US	
APPLICANTS Russell W. White, Austin, TX; Kevin R. Imes, Austin, TX;					
** CONTINUING DATA ***** This application is a CON of 12/015,320 01/16/2008 PAT 7,778,595 which is a CON of 10/947,755 09/23/2004 PAT 7,324,833 and is a CON of 09/537,812 03/28/2000 PAT 7,187,947					
** FOREIGN APPLICATIONS *****					
** IF REQUIRED, FOREIGN FILING LICENSE GRANTED ** 07/09/2009					
Foreign Priority claimed <input type="checkbox"/> Yes <input checked="" type="checkbox"/> No 35 USC 119(a-d) conditions met <input type="checkbox"/> Yes <input type="checkbox"/> No Verified and Acknowledged <u>/ERIKA A GARY/</u> Examiner's Signature	<input type="checkbox"/> Met after Allowance Initials	STATE OR COUNTRY TX	SHEETS DRAWINGS 9	TOTAL CLAIMS 18	INDEPENDENT CLAIMS 2
ADDRESS TROP, PRUNER & HU, P.C. 1616 S. VOSS ROAD, SUITE 750 HOUSTON, TX 77057-2631 UNITED STATES					
TITLE Method For Content Delivery					
FILING FEE RECEIVED 1246	FEES: Authority has been given in Paper No. _____ to charge/credit DEPOSIT ACCOUNT No. _____ for following:		<input type="checkbox"/> All Fees <input type="checkbox"/> 1.16 Fees (Filing) <input type="checkbox"/> 1.17 Fees (Processing Ext. of time) <input type="checkbox"/> 1.18 Fees (Issue) <input type="checkbox"/> Other _____ <input type="checkbox"/> Credit		

EAST Search History

EAST Search History (Prior Art)

Ref #	Hits	Search Query	DBs	Default Operator	Plurals	Time Stamp
L1	1	("7778595").PN.	USPAT	OR	OFF	2010/09/15 11:02
L2	1	1 and video	USPAT	ADJ	ON	2010/09/15 11:02
L3	1	("6587127").PN.	USPAT	OR	OFF	2010/09/15 11:11
L4	0	(content or streaming or media or audio or music or video or multimedia) with (streaming or download \$3) with data adj rate and (icon with word with store)	US-PGPUB; USPAT; USOCR; FPRS; EPO; JPO; DERWENT; IBM_TDB	ADJ	ON	2010/09/15 11:12
L5	30	(content or streaming or media or audio or music or video or multimedia) with (streaming or download \$3) and (icon with word with store)	US-PGPUB; USPAT; USOCR; FPRS; EPO; JPO; DERWENT; IBM_TDB	ADJ	ON	2010/09/15 11:12
L6	1	("7324833").PN.	USPAT	OR	OFF	2010/09/15 11:21
S1	2	((("6722212") or ("6061306")).PN.	USPAT	OR	OFF	2007/04/05 16:15
S2	2	((("6772212") or ("6061306")).PN.	USPAT	OR	OFF	2006/06/21 10:01
S3	84	(audio or stereo or music) with (car or vehicle or automobile) with (portable or mp3) with cable	US-PGPUB; USPAT; USOCR; EPO; JPO; DERWENT; IBM_TDB	OR	OFF	2006/06/21 10:08
S4	26	S3 and cable with power	US-PGPUB; USPAT; USOCR; EPO; JPO; DERWENT; IBM_TDB	OR	OFF	2006/06/21 10:09
S5	12	S3 and cable with power with (charg\$3 or recharg \$4)	US-PGPUB; USPAT; USOCR; EPO; JPO; DERWENT; IBM_TDB	OR	OFF	2006/06/21 10:09

S6	12	S5 and button	US-PGPUB; USPAT; USOCR; EPO; JPO; DERWENT; IBM_TDB	OR	OFF	2006/06/21 10:05
S7	12	(audio or stereo or music) with (car or vehicle or automobile) with (mp3) with cable	US-PGPUB; USPAT; USOCR; EPO; JPO; DERWENT; IBM_TDB	OR	OFF	2006/06/21 10:11
S8	2	S7 and cable with power	US-PGPUB; USPAT; USOCR; EPO; JPO; DERWENT; IBM_TDB	OR	OFF	2006/06/21 10:18
S9	0	S8 and cable with power with (charg\$3 or recharg \$4)	US-PGPUB; USPAT; USOCR; EPO; JPO; DERWENT; IBM_TDB	OR	OFF	2006/06/21 10:09
S10	10	S7 not S8	US-PGPUB; USPAT; USOCR; EPO; JPO; DERWENT; IBM_TDB	OR	OFF	2006/06/21 10:10
S11	16	(car or vehicle or automobile) with (mp3) with cable	US-PGPUB; USPAT; USOCR; EPO; JPO; DERWENT; IBM_TDB	OR	OFF	2006/06/21 10:13
S12	4	S11 not S7	US-PGPUB; USPAT; USOCR; EPO; JPO; DERWENT; IBM_TDB	OR	OFF	2006/06/21 10:12
S13	20	(car or vehicle or automobile) with (mp3 or mpeg or portable adj music) with cable	US-PGPUB; USPAT; USOCR; EPO; JPO; DERWENT; IBM_TDB	OR	OFF	2006/06/21 10:37
S14	4	S13 not S11	US-PGPUB; USPAT; USOCR; EPO; JPO; DERWENT; IBM_TDB	OR	OFF	2006/06/21 10:13
S15	2	(("6123309") or ("6042414")).PN.	USPAT	OR	OFF	2006/06/21 10:18
S16	893	(car or vehicle or automobile) with (mp3)	US-PGPUB; USPAT; USOCR; EPO; JPO; DERWENT; IBM_TDB	OR	OFF	2006/06/21 10:20

S17	306	S16 and (car or vehicle or automobile) with (mp3). ab.	US-PGPUB; USPAT; USOCR; EPO; JPO; DERWENT; IBM_TDB	OR	OFF	2006/06/21 10:33
S18	30	S17 and cable	US-PGPUB; USPAT; USOCR; EPO; JPO; DERWENT; IBM_TDB	OR	OFF	2006/06/21 10:30
S19	3	S18 and cable with power	US-PGPUB; USPAT; USOCR; EPO; JPO; DERWENT; IBM_TDB	OR	OFF	2006/06/21 10:21
S20	27	S18 not S19	US-PGPUB; USPAT; USOCR; EPO; JPO; DERWENT; IBM_TDB	OR	OFF	2006/06/21 10:21
S21	24	S17 and (wired or wire)	US-PGPUB; USPAT; USOCR; EPO; JPO; DERWENT; IBM_TDB	OR	OFF	2006/06/21 10:30
S22	3	S17 and ((wired or wire) with power)	US-PGPUB; USPAT; USOCR; EPO; JPO; DERWENT; IBM_TDB	OR	OFF	2006/06/21 10:31
S23	21	S21 not S22	US-PGPUB; USPAT; USOCR; EPO; JPO; DERWENT; IBM_TDB	OR	OFF	2006/06/21 10:31
S24	10	S23 not S20	US-PGPUB; USPAT; USOCR; EPO; JPO; DERWENT; IBM_TDB	OR	OFF	2006/06/21 10:31
S25	69	S17 and power	US-PGPUB; USPAT; USOCR; EPO; JPO; DERWENT; IBM_TDB	OR	OFF	2006/06/21 10:33
S26	12	S25 and port	US-PGPUB; USPAT; USOCR; EPO; JPO; DERWENT; IBM_TDB	OR	OFF	2006/06/21 10:33

S27	40	(car or vehicle or automobile) with (mp3 or mpeg or portable adj music or audio adj file) with (cable or cord or wire or wired or wires)	US-PGPUB; USPAT; USOCR; EPO; JPO; DERWENT; IBM_TDB	OR	OFF	2006/06/21 10:47
S28	6	S27 and (cable or cord or wire or wired or wires) with power	US-PGPUB; USPAT; USOCR; EPO; JPO; DERWENT; IBM_TDB	OR	OFF	2006/06/21 10:39
S29	34	S27 not S28	US-PGPUB; USPAT; USOCR; EPO; JPO; DERWENT; IBM_TDB	OR	OFF	2006/06/21 10:39
S30	471	((car or vehicle or automobile) with (mp3 or mpeg or portable adj music or audio adj file)) and (cable or cord or wire or wired or wires)	US-PGPUB; USPAT; USOCR; EPO; JPO; DERWENT; IBM_TDB	OR	OFF	2006/06/21 14:52
S31	83	S30 and (cable or cord or wire or wired or wires) with power	US-PGPUB; USPAT; USOCR; EPO; JPO; DERWENT; IBM_TDB	OR	OFF	2006/06/21 10:48
S32	219	S30 and (recharg\$4 or charg\$3)	US-PGPUB; USPAT; USOCR; EPO; JPO; DERWENT; IBM_TDB	OR	OFF	2006/06/21 10:48
S33	64	S31 and (recharg\$4 or charg\$3)	US-PGPUB; USPAT; USOCR; EPO; JPO; DERWENT; IBM_TDB	OR	OFF	2006/06/21 14:54
S34	3	S33 and ((car or vehicle or automobile) with (mp3 or mpeg or portable adj music or audio adj file)). ab.	US-PGPUB; USPAT; USOCR; EPO; JPO; DERWENT; IBM_TDB	OR	OFF	2006/06/21 10:49
S35	61	S33 not S34	US-PGPUB; USPAT; USOCR; EPO; JPO; DERWENT; IBM_TDB	OR	OFF	2006/06/21 10:49
S36	58	S35 not (S4 or S21)	US-PGPUB; USPAT; USOCR; EPO; JPO; DERWENT; IBM_TDB	OR	OFF	2006/06/21 10:49

S37	327	((car or vehicle or automobile) with (mp3 or mpeg or portable adj music or audio adj file or music or cd adj player or compact adj2 player)) and ((cable or cord or wire or wired or wires) with power)	US-PGPUB; USPAT; USOCR; EPO; JPO; DERWENT; IBM_TDB	OR	OFF	2006/06/21 15:15
S38	113	S37 and (recharg\$4 or charg\$3) with (power or battery)	US-PGPUB; USPAT; USOCR; EPO; JPO; DERWENT; IBM_TDB	OR	OFF	2006/06/21 15:16
S39	47	S38 and (cable or cord or wire or wired or wires) with (recharg\$4 or charg\$3) with (power or battery)	US-PGPUB; USPAT; USOCR; EPO; JPO; DERWENT; IBM_TDB	OR	OFF	2006/06/21 15:16
S40	3	S39 and ((car or vehicle or automobile) with (mp3 or mpeg or portable adj music or audio adj file or music or cd adj player or compact adj2 player)).ab.	US-PGPUB; USPAT; USOCR; EPO; JPO; DERWENT; IBM_TDB	OR	OFF	2006/06/21 15:17
S41	44	S39 not S40	US-PGPUB; USPAT; USOCR; EPO; JPO; DERWENT; IBM_TDB	OR	OFF	2006/06/21 14:56
S42	6	S41 and playlist\$	US-PGPUB; USPAT; USOCR; EPO; JPO; DERWENT; IBM_TDB	OR	OFF	2006/06/21 15:14
S43	38	S41 not S42	US-PGPUB; USPAT; USOCR; EPO; JPO; DERWENT; IBM_TDB	OR	OFF	2006/06/21 14:58
S44	66	S38 not S39	US-PGPUB; USPAT; USOCR; EPO; JPO; DERWENT; IBM_TDB	OR	OFF	2006/06/21 15:14
S45	2	S44 and playlist\$	US-PGPUB; USPAT; USOCR; EPO; JPO; DERWENT; IBM_TDB	OR	OFF	2006/06/21 15:17

S46	64	S44 not S45	US-PGPUB; USPAT; USOCR; EPO; JPO; DERWENT; IBM_TDB	OR	OFF	2006/06/21 15:15
S47	1290	((car or vehicle or automobile) with (mp3 or mpeg or portable adj music or audio adj file or music or cd adj player or compact adj2 player or audio)) and ((cable or cord or wire or wired or wires) with power)	US-PGPUB; USPAT; USOCR; EPO; JPO; DERWENT; IBM_TDB	OR	OFF	2006/06/21 15:15
S48	95	S47 and (cable or cord or wire or wired or wires) with (recharg\$4 or charg \$3) with (power or battery)	US-PGPUB; USPAT; USOCR; EPO; JPO; DERWENT; IBM_TDB	OR	OFF	2006/06/21 15:16
S49	48	S48 not S39	US-PGPUB; USPAT; USOCR; EPO; JPO; DERWENT; IBM_TDB	OR	OFF	2006/06/21 15:16
S50	112	S46 or S49	US-PGPUB; USPAT; USOCR; EPO; JPO; DERWENT; IBM_TDB	OR	OFF	2006/06/21 15:18
S51	0	S49 and playlist\$	US-PGPUB; USPAT; USOCR; EPO; JPO; DERWENT; IBM_TDB	OR	OFF	2006/06/21 15:17
S52	0	S49 and ((car or vehicle or automobile) with (mp3 or mpeg or portable adj music or audio adj file or music or cd adj player or compact adj2 player)).ab.	US-PGPUB; USPAT; USOCR; EPO; JPO; DERWENT; IBM_TDB	OR	OFF	2006/06/21 15:40
S53	2	S50 and ((car or vehicle or automobile) with (mp3 or mpeg or portable adj music or audio adj file or music or cd adj player or compact adj2 player)).ab.	US-PGPUB; USPAT; USOCR; EPO; JPO; DERWENT; IBM_TDB	OR	OFF	2007/02/21 16:14

S54	121	((car or vehicle or automobile) with (radio or stereo or sound adj system) with (mp3 or mpeg or portable adj music or audio adj file or music or cd adj player or compact adj2 player)) and ((cable or cord or wire) with (power))	US-PGPUB; USPAT; USOCR; EPO; JPO; DERWENT; IBM_TDB	OR	OFF	2007/02/21 16:34
S55	9	((car or vehicle or automobile) with (radio or stereo or sound adj system) with (mp3 or mpeg or portable adj music or audio adj file or music or cd adj player or compact adj2 player)) with ((cable or cord or wire) with (power))	US-PGPUB; USPAT; USOCR; EPO; JPO; DERWENT; IBM_TDB	OR	OFF	2007/02/21 16:34
S56	112	S54 not S55	US-PGPUB; USPAT; USOCR; EPO; JPO; DERWENT; IBM_TDB	OR	OFF	2007/02/21 16:34
S57	9	S56 and ((car or vehicle or automobile) with (radio or stereo or sound adj system) with (mp3 or mpeg or portable adj music or audio adj file or music or cd adj player or compact adj2 player)).ab. and ((cable or cord or wire) with (power))	US-PGPUB; USPAT; USOCR; EPO; JPO; DERWENT; IBM_TDB	OR	OFF	2007/02/21 16:38
S58	1	S56 and ((car or vehicle or automobile) with (radio or stereo or sound adj system) with (mp3 or mpeg or portable adj music or audio adj file or music or cd adj player or compact adj2 player)).clm. and ((cable or cord or wire) with (power)).clm.	US-PGPUB; USPAT; USOCR; EPO; JPO; DERWENT; IBM_TDB	OR	OFF	2007/02/21 16:38

S59	8	S56 and ((car or vehicle or automobile) with (radio or stereo or sound adj system) with (mp3 or mpeg or portable adj music or audio adj file or music or cd adj player or compact adj2 player)).clm. and ((cable or cord or wire) with (power))	US-PGPUB; USPAT; USOCR; EPO; JPO; DERWENT; IBM_TDB	OR	OFF	2007/02/21 16:38
S60	8	S59 not S57	US-PGPUB; USPAT; USOCR; EPO; JPO; DERWENT; IBM_TDB	OR	OFF	2007/02/21 16:42
S61	95	S56 not (S57 or S59)	US-PGPUB; USPAT; USOCR; EPO; JPO; DERWENT; IBM_TDB	OR	OFF	2007/02/21 16:42
S62	2	(("20030022703") or ("20010028717")).PN.	US-PGPUB	OR	OFF	2007/04/05 16:18
S63	2	(("6526335") or ("6563769")).PN.	US-PGPUB; USPAT	OR	OFF	2007/04/05 16:18
S64	22	((multimedia or mp3 or music or media adj player or audio adj file) with (receiv\$3 or receiver or radio or stereo or sound adj system) with (broadcast\$3 or transmit \$4)) with ((text\$3 adj information or metadata or title or associated adj information or artist) with (display\$3)) and (mp3 or digital adj audio adj file) and ((text\$3 adj information or metadata or title or artist or song or associated adj information) with display \$3)	US-PGPUB; USPAT; USOCR; FPRS; EPO; JPO; DERWENT; IBM_TDB	OR	ON	2007/11/26 18:22

S65	98	((multimedia or mp3 or music or media adj player or audio adj file) with (receiv\$3 or receiver or radio or stereo or sound adj system)) with ((text\$3 adj information or metadata or title or associated adj information or artist) with (display\$3)) and (mp3 or digital adj audio adj file or audio adj file) and ((text\$3 adj information or metadata or title or artist or song or associated adj information) with display \$3)	US-PGPUB; USPAT; USOCR; FPRS; EPO; JPO; DERWENT; IBM_TDB	OR	ON	2007/10/31 19:45
S66	76	S65 not S64	US-PGPUB; USPAT; USOCR; FPRS; EPO; JPO; DERWENT; IBM_TDB	OR	ON	2007/05/22 15:39
S67	1	("20020023028").PN.	US-PGPUB; USPAT	OR	OFF	2007/05/22 16:29
S68	1	S67 and display\$3	US-PGPUB; USPAT	OR	OFF	2007/05/22 16:30
S69	2	(("7065342") or ("6694200")).PN.	USPAT	OR	OFF	2007/10/31 18:08
S70	1	"6408332".PN.	USPAT; USOCR	OR	ON	2007/10/31 18:23
S71	1	"6332175".PN.	USPAT; USOCR	OR	ON	2007/10/31 18:26
S72	1	"5991727".PN.	USPAT; USOCR	OR	ON	2007/10/31 18:26
S73	1	"5914941".PN.	USPAT; USOCR	OR	ON	2007/10/31 18:26
S74	1	"5905632".PN.	USPAT; USOCR	OR	ON	2007/10/31 18:27
S75	1	"5870710".PN.	USPAT; USOCR	OR	ON	2007/10/31 18:27
S76	1	"5841979".PN.	USPAT; USOCR	OR	ON	2007/10/31 18:29
S77	1	"5839108".PN.	USPAT; USOCR	OR	ON	2007/10/31 18:30
S78	1	"5809520".PN.	USPAT; USOCR	OR	ON	2007/10/31 18:30
S79	1	"5787399".PN.	USPAT; USOCR	OR	ON	2007/10/31 18:31

S80	1	"5737491".PN.	USPAT; USOCR	OR	ON	2007/10/31 18:31
S81	1	"5680293".PN.	USPAT; USOCR	OR	ON	2007/10/31 18:32
S82	1	"5557541".PN.	USPAT; USOCR	OR	ON	2007/10/31 18:32
S83	1	"5511000".PN.	USPAT; USOCR	OR	ON	2007/10/31 18:34
S84	1	"5491774".PN.	USPAT; USOCR	OR	ON	2007/10/31 18:34
S85	1	"5490235".PN.	USPAT; USOCR	OR	ON	2007/10/31 18:35
S86	1	"5359698".PN.	USPAT; USOCR	OR	ON	2007/10/31 18:35
S87	1	"5195022".PN.	USPAT; USOCR	OR	ON	2007/10/31 18:36
S88	1	"5155662".PN.	USPAT; USOCR	OR	ON	2007/10/31 18:36
S89	1	"5195022".PN.	USPAT; USOCR	OR	ON	2007/10/31 18:36
S90	1	"5220520".PN.	USPAT; USOCR	OR	ON	2007/10/31 18:37
S91	7	"6694200".uref.	USPAT; USOCR	OR	ON	2007/10/31 18:43
S92	2	((("6681120") or ("6278884")).PN.	USPAT	OR	OFF	2007/10/31 18:43
S93	273	((multimedia or mp3 or music or media adj player or audio adj file) with (receiv\$3 or receiver or radio or stereo or sound adj system or car or automobile)) with ((text\$3 adj information or metadata or title or associated adj information or artist) with (display\$3)) and (mp3 or digital adj audio adj file or audio adj file or music) and ((text\$3 adj information or metadata or title or artist or song or associated adj information) with display \$3)	US-PGPUB; USPAT; USOCR; FPRS; EPO; JPO; DERWENT; IBM_TDB	OR	ON	2007/10/31 19:47

S94	142	S93 and (multimedia or mp3 or music or media adj player or audio adj file). ab.	US-PGPUB; USPAT; USOCR; FPRS; EPO; JPO; DERWENT; IBM_TDB	OR	ON	2007/10/31 19:47
S95	2	((("6681120") or ("6278884")).PN.	USPAT	OR	OFF	2007/11/07 10:51
S96	0	((multimedia or mp3 or music or media adj player or audio adj file) with (receiv\$3 or receiver or radio or stereo or sound adj system) with (broadcast\$3 or transmit \$4)) with ((text\$3 adj information or metadata or title or associated adj information or artist) with (display\$3)) and (mp3 or digital adj audio adj file) and ((text\$3 adj information or metadata or title or artist or song or associated adj information) with display \$3) and ((gui or graphical adj user adj interface) with ((soft adj (key or button)) or touch adj screen or touchscreen))	US-PGPUB; USPAT; USOCR; FPRS; EPO; JPO; DERWENT; IBM_TDB	OR	ON	2007/11/26 18:36
S97	0	((multimedia or mp3 or music or media adj player or audio adj file) with (receiv\$3 or receiver or radio or stereo or sound adj system) with (broadcast\$3 or transmit \$4)) with ((text\$3 adj information or metadata or title or associated adj information or artist) with (display\$3)) and (mp3 or digital adj audio adj file) and ((text\$3 adj information or metadata or title or artist or song or associated adj information) with display \$3) and ((gui or graphical adj user adj interface or menu) with ((soft adj (key or button)) or touch adj screen or touchscreen))	US-PGPUB; USPAT; USOCR; FPRS; EPO; JPO; DERWENT; IBM_TDB	OR	ON	2007/11/26 18:30

S98	0	(((multimedia or mp3 or music or media adj player or audio adj file) with (receiv\$3 or receiver or radio or stereo or sound adj system) with (broadcast\$3 or transmit \$4)) with ((text\$3 adj information or metadata or title or associated adj information or artist) with (display\$3)) and (mp3 or digital adj audio adj file) and ((text\$3 adj information or metadata or title or artist or song or associated adj information) with display \$3) and ((gui or graphical adj user adj interface or menu) with ((soft adj (key or button)) or touch adj screen or touchscreen))).clm.	US-PGPUB; USPAT; USOCR; FPRS; EPO; JPO; DERWENT; IBM_TDB	OR	ON	2007/11/26 18:26
S99	0	(((multimedia or mp3 or music or media adj player or audio adj file) with (receiv\$3 or receiver or radio or stereo or sound adj system) with (broadcast\$3 or transmit \$4)) with ((text\$3 adj information or metadata or title or associated adj information or artist) with (display\$3)) and (mp3 or digital adj audio adj file) and ((text\$3 adj information or metadata or title or artist or song or associated adj information) with display \$3) and ((gui or graphical adj user adj interface or menu))).clm.	US-PGPUB; USPAT; USOCR; FPRS; EPO; JPO; DERWENT; IBM_TDB	OR	ON	2007/11/26 18:31

S100	14	(((multimedia or mp3 or music or media adj player or audio adj file) with (receiv\$3 or receiver or radio or stereo or sound adj system) with (broadcast\$3 or transmit \$4)) with ((text\$3 adj information or metadata or title or associated adj information or artist) with (display\$3)) and (mp3 or digital adj audio adj file) and ((text\$3 adj information or metadata or title or artist or song or associated adj information) with display \$3) and ((gui or graphical adj user adj interface or menu)))	US-PGPUB; USPAT; USOCR; FPRS; EPO; JPO; DERWENT; IBM_TDB	OR	ON	2007/11/26 18:27
S101	10	(((multimedia or mp3 or music or media adj player or audio adj file) with (receiv\$3 or receiver or radio or stereo or sound adj system) with (broadcast\$3 or transmit \$4)) with ((text\$3 adj information or metadata or title or associated adj information or artist) with (display\$3)) and (mp3 or digital adj audio adj file) and ((text\$3 adj information or metadata or title or artist or song or associated adj information) with display \$3) and ((gui or graphical adj user adj interface)))	US-PGPUB; USPAT; USOCR; FPRS; EPO; JPO; DERWENT; IBM_TDB	OR	ON	2007/11/26 18:28
S102	4	S100 not S101	US-PGPUB; USPAT; USOCR; FPRS; EPO; JPO; DERWENT; IBM_TDB	OR	ON	2007/11/26 18:28

S103	0	((multimedia or mp3 or music or media adj player or audio adj file) with (receiv\$3 or receiver or radio or stereo or sound adj system) with (broadcast\$3 or transmit \$4)) with ((text\$3 adj information or metadata or title or associated adj information or artist) with (display\$3)) and (mp3 or audio adj file) and ((text\$3 adj information or metadata or title or artist or song or associated adj information) with display \$3) and ((gui or graphical adj user adj interface or menu) with ((soft adj (key or button)) or touch adj screen or touchscreen))	US-PGPUB; USPAT; USOCR; FPRS; EPO; JPO; DERWENT; IBM_TDB	OR	ON	2007/11/26 18:30
S104	16	((multimedia or mp3 or music or media adj player or audio adj file) with (receiv\$3 or receiver or radio or stereo or sound adj system) with (broadcast\$3 or transmit \$4)) with ((text\$3 adj information or metadata or title or associated adj information or artist) with (display\$3)) and (mp3 or audio adj file) and ((text\$3 adj information or metadata or title or artist or song or associated adj information) with display \$3) and ((gui or graphical adj user adj interface or menu)))	US-PGPUB; USPAT; USOCR; FPRS; EPO; JPO; DERWENT; IBM_TDB	OR	ON	2007/11/26 18:33
S105	2	S104 not S100	US-PGPUB; USPAT; USOCR; FPRS; EPO; JPO; DERWENT; IBM_TDB	OR	ON	2007/11/26 18:31

S106	11	((((multimedia or mp3 or music or media adj player or audio adj file) with (receiv\$3 or receiver or radio or stereo or sound adj system) with (broadcast\$3 or transmit \$4)) with ((text\$3 adj information or metadata or title or associated adj information or artist) with (display\$3)) and (mp3 or audio adj file) and ((text\$3 adj information or metadata or title or artist or song or associated adj information) with display \$3) and ((gui or graphical adj user adj interface))	US-PGPUB; USPAT; USOCR; FPRS; EPO; JPO; DERWENT; IBM_TDB	OR	ON	2007/11/26 18:36
S107	0	S106 not S104	US-PGPUB; USPAT; USOCR; FPRS; EPO; JPO; DERWENT; IBM_TDB	OR	ON	2007/11/26 18:33
S108	0	((((multimedia or mp3 or music or media adj player or audio adj file) with (receiv\$3 or receiver or radio or stereo or sound adj system) with (broadcast\$3 or transmit \$4)) with ((text\$3 adj information or metadata or title or associated adj information or artist) with (display\$3)) and (mp3 or audio adj file) and ((text\$3 adj information or metadata or title or artist or song or associated adj information) with display \$3) and ((gui or graphical adj user adj interface))). clm.	US-PGPUB; USPAT; USOCR; FPRS; EPO; JPO; DERWENT; IBM_TDB	OR	ON	2007/11/26 18:36

S109	0	((multimedia or mp3 or music or media adj player or audio adj file) with (receiv\$3 or receiver or radio or stereo or sound adj system) with (broadcast\$3 or transmit \$4)) with ((text\$3 adj information or metadata or title or associated adj information or artist) with (display\$3)) and ((text\$3 adj information or metadata or title or artist or song or associated adj information) with display \$3) and ((gui or graphical adj user adj interface) with ((soft adj (key or button)) or touch adj screen or touchscreen))	US-PGPUB; USPAT; USOCR; FPRS; EPO; JPO; DERWENT; IBM_TDB	OR	ON	2007/11/26 18:37
S110	16	((multimedia or mp3 or music or media adj player or audio adj file) with (receiv\$3 or receiver or radio or stereo or sound adj system) with (broadcast\$3 or transmit \$4)) with ((text\$3 adj information or metadata or title or associated adj information or artist) with (display\$3)) and ((text\$3 adj information or metadata or title or artist or song or associated adj information) with display \$3) and ((gui or graphical adj user adj interface))	US-PGPUB; USPAT; USOCR; FPRS; EPO; JPO; DERWENT; IBM_TDB	OR	ON	2007/11/26 18:41
S111	5	S110 not S104	US-PGPUB; USPAT; USOCR; FPRS; EPO; JPO; DERWENT; IBM_TDB	OR	ON	2007/11/26 18:37

S112	4	((multimedia or mp3 or music or media adj player or audio adj file) with (receiv\$3 or receiver or radio or stereo or sound adj system) with (broadcast\$3 or transmit \$4)) with ((text\$3 adj information or metadata or title or associated adj information or artist) with (display\$3)) and ((text\$3 adj information or metadata or title or artist or song or associated adj information) with display \$3) and ((gui or graphical adj user adj interface)). clm.	US-PGPUB; USPAT; USOCR; FPRS; EPO; JPO; DERWENT; IBM_TDB	OR	ON	2007/11/26 18:42
S113	0	((multimedia or mp3 or music or media adj player or audio adj file) with (receiv\$3 or receiver or radio or stereo or sound adj system) with (broadcast\$3 or transmit \$4)) with ((text\$3 adj information or metadata or title or associated adj information or artist) with (display\$3)) and ((text\$3 adj information or metadata or title or artist or song or associated adj information) with display \$3) and ((gui or graphical adj user adj interface) with ((soft adj (key or button)) or touchscreen or touch adj screen)). clm.	US-PGPUB; USPAT; USOCR; FPRS; EPO; JPO; DERWENT; IBM_TDB	OR	ON	2007/11/26 18:42
S114	0	((multimedia or mp3 or music or media adj player or audio adj file) with (receiv\$3 or receiver or radio or stereo or sound adj system) with (broadcast\$3 or transmit \$4)) with ((text\$3 adj information or metadata or title or associated adj information or artist) with (display\$3)) and ((text\$3 adj information or metadata or title or artist or song or associated adj	US-PGPUB; USPAT; USOCR; FPRS; EPO; JPO; DERWENT; IBM_TDB	OR	ON	2007/11/26 18:42

		information) with display \$3) and ((gui or graphical adj user adj interface) with ((soft adj (key or button)) or touchscreen or touch adj screen))				
S115	3	((("7324833") or ("7187947") or ("7440772")).PN.	USPAT	OR	OFF	2009/01/30 13:23
S116	0	S115 and (digital adj satellite adj receiver)	USPAT	OR	ON	2009/01/30 13:25
S117	0	S115 and (digital adj satellite adj receiv\$3)	USPAT	OR	ON	2009/01/30 13:26
S118	0	S115 and (account with streaming adj audio)	USPAT	OR	ON	2009/01/30 13:26
S119	0	S115 and (account with streaming)	USPAT	OR	ON	2009/01/30 13:26
S120	0	S115 and (account with satellite)	USPAT	OR	ON	2009/01/30 13:26
S121	3	S115 and (streaming adj audio)	USPAT	OR	ON	2009/01/30 13:27
S122	0	S115 and (streaming adj audio with satellite)	USPAT	OR	ON	2009/01/30 13:27
S123	3	S115 and (streaming adj audio with internet)	USPAT	OR	ON	2009/01/30 13:27
S124	0	S115 and ((subscription or account) with streaming adj audio)	USPAT	OR	ON	2009/01/30 13:28
S125	0	S115 and ((subscription or account or subscrib\$3) with streaming adj audio)	USPAT	OR	ON	2009/01/30 13:28
S126	0	S115 and ((subscription or account or subscrib\$3) with satellite)	USPAT	OR	ON	2009/01/30 13:28
S127	3	((("6396164") or ("6255961") or ("6282464")).PN.	USPAT	OR	OFF	2009/01/30 13:38
S128	6	((("6622083") or ("6396164") or ("6255961") or ("6282464") or ("6148261") or ("6526355")).PN.	USPAT	OR	OFF	2009/11/07 17:48
S129	3	((("20040117442") or ("20010028717") or ("20030215102")).PN.	US-PGPUB; USPAT	OR	OFF	2009/11/07 18:00
S130	3	((("7321783") or ("6681120") or ("6278884")).PN.	US-PGPUB; USPAT	OR	OFF	2009/11/07 18:08

S131	1	pubsey.in. and information adj distribution.ti.	USPAT; EPO	OR	ON	2009/11/07 18:45
S132	12	S128 or S129 or S130 or S131	US-PGPUB; USPAT	OR	ON	2009/11/07 18:53
S133	6	S132 and (charg\$3 or recharg\$)	US-PGPUB; USPAT	OR	ON	2009/11/07 18:53
S134	3	((("4807292") or ("6232539") or ("6230322")).PN.	USPAT	OR	OFF	2009/11/07 19:09
S135	2	S134 and (charg\$3 or recharg\$)	US-PGPUB; USPAT	OR	ON	2009/11/07 19:13
S136	0	S134 and soft adj button	US-PGPUB; USPAT	OR	ON	2009/11/07 19:16
S137	0	S132 and soft adj button	US-PGPUB; USPAT	OR	ON	2009/11/07 19:16
S138	4	S132 and (gui or graphical adj2 interface)	US-PGPUB; USPAT	OR	ON	2009/11/07 19:17
S139	5	S132 and (gui or graphical adj2 interface or icon or soft adj button or soft adj key)	US-PGPUB; USPAT	OR	ON	2009/11/07 19:17
S140	4	S139 and (vehicle or automobile)	US-PGPUB; USPAT	OR	ON	2009/11/07 19:18
S141	1	((("6202060")).PN.	USPAT	OR	OFF	2009/11/07 19:25
S142	474	((multimedia or mp3 or music or media adj player or audio adj file or audio aj stream) with (receiv\$3 or receiver or radio or stereo or sound adj system) with (broadcast\$3 or transmit\$4)) and (recharg\$5) and (local adj broadcast or radio adj station)	US-PGPUB; USPAT; USOCR; FPRS; EPO; JPO; DERWENT; IBM_TDB	OR	ON	2010/04/29 14:41
S143	187	((multimedia or mp3 or music or media adj player or audio adj file or audio aj stream) with (receiv\$3 or receiver or radio or stereo or sound adj system) with (broadcast\$3 or transmit\$4)) and (recharg\$5) and (local adj broadcast or radio adj station) and ((telephone or phone or incoming) adj call)	US-PGPUB; USPAT; USOCR; FPRS; EPO; JPO; DERWENT; IBM_TDB	OR	ON	2010/04/29 14:42

S144	6	((multimedia or mp3 or music or media adj player or audio adj file or audio aj stream) with (receiv\$3 or receiver or radio or stereo or sound adj system) with (broadcast\$3 or transmit\$4)) and (recharg\$5) and (local adj broadcast or radio adj station) and ((telephone or phone or incoming) adj call) and physical adj interface	US-PGPUB; USPAT; USOCR; FPRS; EPO; JPO; DERWENT; IBM_TDB	OR	ON	2010/04/29 14:42
S145	0	((multimedia or mp3 or music or media adj player or audio adj file or audio aj stream) with (receiv\$3 or receiver or radio or stereo or sound adj system) with (broadcast\$3 or transmit\$4)) and (recharg\$5) and (local adj broadcast or radio adj station) and ((telephone or phone or incoming) adj call) and physical adj interface).clm.	US-PGPUB; USPAT; USOCR; FPRS; EPO; JPO; DERWENT; IBM_TDB	OR	ON	2010/04/29 14:44
S146	151	((multimedia or mp3 or music or media adj player or audio adj file or audio aj stream) with (receiv\$3 or receiver or radio or stereo or sound adj system) with (broadcast\$3 or transmit\$4)) and (recharg\$5) and (local adj broadcast or radio adj station) and ((telephone or phone or incoming) adj call) and interface	US-PGPUB; USPAT; USOCR; FPRS; EPO; JPO; DERWENT; IBM_TDB	OR	ON	2010/04/29 14:45
S147	0	((multimedia or mp3 or music or media adj player or audio adj file or audio aj stream) with (receiv\$3 or receiver or radio or stereo or sound adj system) with (broadcast\$3 or transmit\$4)) and (recharg\$5) and (local adj broadcast or radio adj station) and ((telephone or phone or incoming) adj call)).ab. and interface	US-PGPUB; USPAT; USOCR; FPRS; EPO; JPO; DERWENT; IBM_TDB	OR	ON	2010/04/29 14:45

S148	12	((multimedia or mp3 or music or media adj player or audio adj file or audio aj stream) with (receiv\$3 or receiver or radio or stereo or sound adj system) with (broadcast\$3 or transmit\$4)).ab. and (recharg\$5) and (local adj broadcast or radio adj station) and ((telephone or phone or incoming) adj call) and interface	US-PGPUB; USPAT; USOCR; FPRS; EPO; JPO; DERWENT; IBM_TDB	OR	ON	2010/04/29 14:45
S149	12	S148 not S144	US-PGPUB; USPAT; USOCR; FPRS; EPO; JPO; DERWENT; IBM_TDB	OR	ON	2010/04/29 14:45
S150	41	((multimedia or mp3 or music or media adj player or audio adj file or audio aj stream) with (receiv\$3 or receiver or radio or stereo or sound adj system)).ab. and (broadcast\$3 or transmit \$4) and (recharg\$5) and (local adj broadcast or radio adj station) and ((telephone or phone or incoming) adj call) and interface	US-PGPUB; USPAT; USOCR; FPRS; EPO; JPO; DERWENT; IBM_TDB	OR	ON	2010/04/29 14:48
S151	29	S150 not S149	US-PGPUB; USPAT; USOCR; FPRS; EPO; JPO; DERWENT; IBM_TDB	OR	ON	2010/04/29 14:48
S152	50	((multimedia or mp3 or music or media adj player or audio adj file or audio aj stream) with (receiv\$3 or receiver or radio or stereo or sound adj system)).ab. and (broadcast\$3 or transmit \$4) and (recharg\$5) and (local adj broadcast or radio adj station) and ((telephone or phone or incoming) adj call) and interface	US-PGPUB; USPAT; USOCR; FPRS; EPO; JPO; DERWENT; IBM_TDB	OR	ON	2010/04/29 14:51

S153	9	S152 not S150	US-PGPUB; USPAT; USOCR; FPRS; EPO; JPO; DERWENT; IBM_TDB	OR	ON	2010/04/29 14:51
S154	17	(((multimedia or mp3 or music or media adj player or audio adj file or audio aj stream) with (receiv\$3 or receiver or radio or stereo or sound adj system) with (broadcast\$3 or transmit\$4))) .ab. and (recharg\$5) and (local adj broadcast or radio adj station) and ((telephone or phone or incoming) adj call) and interface	US-PGPUB; USPAT; USOCR; FPRS; EPO; JPO; DERWENT; IBM_TDB	OR	ON	2010/04/29 14:52
S155	5	S154 not S148	US-PGPUB; USPAT; USOCR; FPRS; EPO; JPO; DERWENT; IBM_TDB	OR	ON	2010/04/29 14:52
S156	6	(((multimedia or mp3 or music or media adj player or audio adj file or audio aj stream) with (receiv\$3 or receiver or radio or stereo or sound adj system) with (broadcast\$3 or transmit\$4)) and (recharg\$5) and (local adj broadcast or radio adj station) and ((telephone or phone or incoming) adj call) and physical adj interface	US-PGPUB; USPAT; USOCR; FPRS; EPO; JPO; DERWENT; IBM_TDB	OR	ON	2010/04/29 14:53
S157	0	(((multimedia or mp3 or music or media adj player or audio adj file or audio aj stream) with (receiv\$3 or receiver or radio or stereo or sound adj system) with (broadcast\$3 or transmit\$4)) and (recharg\$5) and (local adj broadcast or radio adj station) and ((telephone or phone or incoming) adj call) and physical adj interface).clm.	US-PGPUB; USPAT; USOCR; FPRS; EPO; JPO; DERWENT; IBM_TDB	OR	ON	2010/04/29 14:53

S165	1	"7778595"	USPAT	ADJ	ON	2010/08/25 10:59
S166	1	S165 and regional adj broadcasting adj channel	USPAT	ADJ	ON	2010/08/25 10:59
S167	1	S165 and local adj broadcast\$3	USPAT	ADJ	ON	2010/08/25 11:03
S168	10	((region\$4 or local\$2) adj2 broadcast\$3) with (phone or telephone or pda or wireless or mobile or ms or radiotelephone) with (outside with (region\$2 or local or area))	US-PGPUB; USPAT; USOCR; EPO; JPO; DERWENT; IBM_TDB	OR	OFF	2010/08/25 12:05
S169	10	((region\$4 or local\$2) adj2 (radio adj station or broadcast\$3)) with (phone or telephone or pda or wireless or mobile or ms or radiotelephone) with (outside with (region\$2 or local or area))	US-PGPUB; USPAT; USOCR; EPO; JPO; DERWENT; IBM_TDB	OR	OFF	2010/08/25 12:10
S170	152	((radio adj station or broadcast\$3)) with (phone or telephone or pda or wireless or mobile or ms or radiotelephone) with (outside with (region\$2 or local or area))	US-PGPUB; USPAT; USOCR; EPO; JPO; DERWENT; IBM_TDB	OR	OFF	2010/08/25 12:17
S171	27	((radio adj station or broadcast\$3)) with (phone or telephone or pda or ms or radiotelephone) with (outside with (region\$2 or local or area))	US-PGPUB; USPAT; USOCR; EPO; JPO; DERWENT; IBM_TDB	OR	OFF	2010/08/25 12:18
S172	24	S171 not S169	US-PGPUB; USPAT; USOCR; EPO; JPO; DERWENT; IBM_TDB	OR	OFF	2010/08/25 12:18
S173	0	S165 and computer adj readable adj medium	USPAT	ADJ	ON	2010/08/25 12:27
S174	139	"6587127"	USPAT	ADJ	ON	2010/08/25 14:10
S175	1	("6587127").PN.	USPAT	OR	OFF	2010/08/25 14:10
S176	1	S175 and (advertisement with demographic)	USPAT	ADJ	ON	2010/08/25 14:11
S177	1	("7778595").PN.	USPAT	OR	OFF	2010/09/13 17:11
S178	1	S177 and software adj upgrade	USPAT	ADJ	ON	2010/09/13 17:11

S179	0	S177 and 100kbps	USPAT	ADJ	ON	2010/09/13 17:15
S180	0	S177 and "100" adj kbps	USPAT	ADJ	ON	2010/09/13 17:15
S181	1	S177 and instructions	USPAT	ADJ	ON	2010/09/13 17:15
S182	0	(content or streaming or media or audio or music or video) with (gui or graphical adj user adj interface or display\$3) with icon with data adj rate	US-PGPUB; USPAT; USOCR; FPRS; EPO; JPO; DERWENT; IBM_TDB	ADJ	ON	2010/09/13 17:21
S183	895	(content or streaming or media or audio or music or video) with (gui or graphical adj user adj interface or display\$3) with data adj rate	US-PGPUB; USPAT; USOCR; FPRS; EPO; JPO; DERWENT; IBM_TDB	ADJ	ON	2010/09/13 17:21
S184	30	S183 and first adj data adj rate and second adj data adj rate	US-PGPUB; USPAT; USOCR; FPRS; EPO; JPO; DERWENT; IBM_TDB	ADJ	ON	2010/09/13 17:22
S185	1	S184 and icon	US-PGPUB; USPAT; USOCR; FPRS; EPO; JPO; DERWENT; IBM_TDB	ADJ	ON	2010/09/13 17:22
S186	29	S184 not S185	US-PGPUB; USPAT; USOCR; FPRS; EPO; JPO; DERWENT; IBM_TDB	ADJ	ON	2010/09/13 17:23
S187	0	(content or streaming or media or audio or music or video or multimedia) with (gui or graphical adj user adj interface or display\$3) with data adj rate with icon	US-PGPUB; USPAT; USOCR; FPRS; EPO; JPO; DERWENT; IBM_TDB	ADJ	ON	2010/09/13 17:28
S188	7	((content or streaming or media or audio or music or video or multimedia) with data adj rate with icon) and (gui or graphical adj user adj interface or display\$3)	US-PGPUB; USPAT; USOCR; FPRS; EPO; JPO; DERWENT; IBM_TDB	ADJ	ON	2010/09/13 17:29

S189	7	S188 not S186	US-PGPUB; USPAT; USOCR; FPRS; EPO; JPO; DERWENT; IBM_TDB	ADJ	ON	2010/09/13 17:29
S190	1	("6587127").PN.	USPAT	OR	OFF	2010/09/13 17:35
S191	0	S190 and data adj rate	USPAT	ADJ	ON	2010/09/13 17:36
S192	0	S190 and transmission adj rate	USPAT	ADJ	ON	2010/09/13 17:36
S193	1	S190 and rate	USPAT	ADJ	ON	2010/09/13 17:36
S194	1	S190 and speed	USPAT	ADJ	ON	2010/09/13 17:37
S195	0	(streaming adj media with first adj data adj rate) and (streaming adj media with second adj data adj rate)	US-PGPUB; USPAT; USOCR; FPRS; EPO; JPO; DERWENT; IBM_TDB	ADJ	ON	2010/09/13 17:40
S196	1439	(content or streaming or media or audio or music or video or multimedia) with (streaming or download \$3) with data adj rate	US-PGPUB; USPAT; USOCR; FPRS; EPO; JPO; DERWENT; IBM_TDB	ADJ	ON	2010/09/13 17:41
S197	33	S196 and first adj data adj rate and second adj data adj rate	US-PGPUB; USPAT; USOCR; FPRS; EPO; JPO; DERWENT; IBM_TDB	ADJ	ON	2010/09/13 17:41
S198	0	S196 and (switch\$3 with first adj data adj rate with second adj data adj rate)	US-PGPUB; USPAT; USOCR; FPRS; EPO; JPO; DERWENT; IBM_TDB	ADJ	ON	2010/09/13 17:41
S199	0	S196 and (switch\$3 with first adj data adj rate with another adj data adj rate)	US-PGPUB; USPAT; USOCR; FPRS; EPO; JPO; DERWENT; IBM_TDB	ADJ	ON	2010/09/13 17:42

S200	0	S196 and (switch\$3 with first adj data adj rate with slower adj data adj rate)	US-PGPUB; USPAT; USOCR; FPRS; EPO; JPO; DERWENT; IBM_TDB	ADJ	ON	2010/09/13 17:42
S201	0	S196 and (switch\$3 with data adj rate with slower adj data adj rate)	US-PGPUB; USPAT; USOCR; FPRS; EPO; JPO; DERWENT; IBM_TDB	ADJ	ON	2010/09/13 17:42
S202	27	S196 and (switch\$3 with data adj rate with (faster or slower or second or another))	US-PGPUB; USPAT; USOCR; FPRS; EPO; JPO; DERWENT; IBM_TDB	ADJ	ON	2010/09/13 17:43
S203	127	S196 and ((content or streaming) with data adj rate with (faster or slower or second or another))	US-PGPUB; USPAT; USOCR; FPRS; EPO; JPO; DERWENT; IBM_TDB	ADJ	ON	2010/09/13 17:49
S204	10	S196 and ((content or streaming) with first adj data adj rate with second adj data adj rate)	US-PGPUB; USPAT; USOCR; FPRS; EPO; JPO; DERWENT; IBM_TDB	ADJ	ON	2010/09/13 17:50
S205	82	S196 and ((receiv\$3 or download\$3) with data adj rate with (faster or slower or second or another))	US-PGPUB; USPAT; USOCR; FPRS; EPO; JPO; DERWENT; IBM_TDB	ADJ	ON	2010/09/13 17:55
S206	8	S196 and ((receiv\$3 or download\$3) with data adj rate with (faster or slower or second or another) with (portion or segment))	US-PGPUB; USPAT; USOCR; FPRS; EPO; JPO; DERWENT; IBM_TDB	ADJ	ON	2010/09/13 17:55
S207	0	S190 and software adj upgrade	USPAT	ADJ	ON	2010/09/13 18:04
S208	0	S190 and (software with upgrad\$3)	USPAT	ADJ	ON	2010/09/13 18:05
S209	0	S177 and (copy with instructions)	USPAT	ADJ	ON	2010/09/13 18:07
S210	0	S177 and (content with (segment\$3 or portion))	USPAT	ADJ	ON	2010/09/13 18:07

S211	1	S177 and ((streaming or media or content) with (segment\$3 or portion))	USPAT	ADJ	ON	2010/09/13 18:08
------	---	-------------------------------------------------------------------------	-------	-----	----	---------------------

EAST Search History (I nterference)

Ref #	Hits	Search Query	DBs	Default Operator	Plurals	Time Stamp
S158	0	((multimedia or mp3 or music or media adj player or audio adj file or audio aj stream) with (receiv\$3 or receiver or radio or stereo or sound adj system) with (broadcast\$3 or transmit \$4)) and (recharg\$5) and (local adj broadcast or radio adj station) and ((telephone or phone or incoming) adj call) and physical adj interface).clm.	USPAT; UPAD	OR	ON	2010/04/29 14:44
S159	0	((multimedia or mp3 or music or media adj player or audio adj file or audio aj stream) with (receiv\$3 or receiver or radio or stereo or sound adj system) with (broadcast\$3 or transmit \$4)) and (recharg\$5) and (local adj broadcast or radio adj station) and ((telephone or phone or incoming) adj call) and interface).clm.	USPAT; UPAD	OR	ON	2010/04/29 14:44
S160	0	((multimedia or mp3 or music or media adj player or audio adj file or audio aj stream) with (receiv\$3 or receiver or radio or stereo or sound adj system) with (broadcast\$3 or transmit \$4)) and (recharg\$5) and (local adj broadcast or radio adj station) and ((telephone or phone or incoming) adj call) and interface).clm.	USPAT; UPAD	OR	ON	2010/04/29 14:51

S161	0	(((multimedia or mp3 or music or media adj player or audio adj file or audio aj stream) with (receiv\$3 or receiver or radio or stereo or sound adj system) with (broadcast\$3 or transmit \$4)) and (recharg\$5) and (local adj broadcast or radio adj station) and ((telephone or phone or incoming) adj call) and (port or interface or jack)).clm.	USPAT; UPAD	OR	ON	2010/04/29 14:53
S162	0	(((multimedia or mp3 or music or media adj player or audio adj file or audio aj stream) with (broadcast\$3 or transmit \$4)) and (recharg\$5) and (local adj broadcast or radio adj station) and ((telephone or phone or incoming) adj call) and (port or interface or jack)).clm.	USPAT; UPAD	OR	ON	2010/04/29 14:56
S163	0	(((multimedia or mp3 or music or media adj player or audio adj file or audio aj stream) with (broadcast\$3 or transmit \$4)) and (local adj broadcast or radio adj station) and ((telephone or phone or incoming) adj call) and (port or interface or jack)).clm.	USPAT; UPAD	OR	ON	2010/04/29 14:57
S164	0	(((multimedia or mp3 or music or media adj player or audio adj file or audio aj stream) with (broadcast\$3 or transmit \$4)) and (local adj broadcast or radio adj station) and ((telephone or phone or incoming) adj2 call) and (port or interface or jack)).clm.	USPAT; UPAD	OR	ON	2010/04/29 14:57

9/ 15/ 10 11:28:46 AM

C:\ Documents and Settings\ egary\ My Documents\ EAST\ Workspaces\ 12495190.wsp

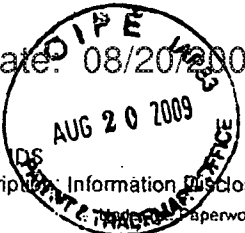

Doc code: DS
 Doc description: Information Disclosure Statement (IDS) Filed

PTO/SB/08a (05-09)
 Approved for use through 06/30/2009. OMB 0651-0031
 U.S. Patent and Trademark Office; U.S. DEPARTMENT OF COMMERCE
 Paperwork Reduction Act of 1995, no persons are required to respond to a collection of information unless it contains a valid OMB control number.

INFORMATION DISCLOSURE STATEMENT BY APPLICANT (Not for submission under 37 CFR 1.99)	Application Number	12015320
	Filing Date	2008-01-16
	First Named Inventor	Russell W. White, et al.
	Art Unit	2617
	Examiner Name	Erika A. Gary
	Attorney Docket Number	AFF.004C5US

U.S. PATENTS						
Examiner Initial*	Cite No	Patent Number	Kind Code ¹	Issue Date	Name of Patentee or Applicant of cited Document	Pages, Columns, Lines where Relevant Passages or Relevant Figures Appear
	1					

If you wish to add additional U.S. Patent citation information please click the Add button.

U.S. PATENT APPLICATION PUBLICATIONS						
Examiner Initial*	Cite No	Publication Number	Kind Code ¹	Publication Date	Name of Patentee or Applicant of cited Document	Pages, Columns, Lines where Relevant Passages or Relevant Figures Appear
	1					

If you wish to add additional U.S. Published Application citation information please click the Add button.

FOREIGN PATENT DOCUMENTS								
Examiner Initial*	Cite No	Foreign Document Number ³	Country Code ²	Kind Code ⁴	Publication Date	Name of Patentee or Applicant of cited Document	Pages, Columns, Lines where Relevant Passages or Relevant Figures Appear	T ⁵
	1							<input type="checkbox"/>

If you wish to add additional Foreign Patent Document citation information please click the Add button

NON-PATENT LITERATURE DOCUMENTS			
Examiner Initials*	Cite No	Include name of the author (in CAPITAL LETTERS), title of the article (when appropriate), title of the item (book, magazine, journal, serial, symposium, catalog, etc), date, pages(s), volume-issue number(s), publisher, city and/or country where published.	T ⁵

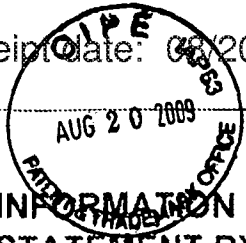

**INFORMATION DISCLOSURE
STATEMENT BY APPLICANT**
(Not for submission under 37 CFR 1.99)

Application Number		12015320
Filing Date		2008-01-16
First Named Inventor	Russell W. White, et al.	
Art Unit	2617	
Examiner Name	Erika A. Gary	
Attorney Docket Number	AFF.004C5US	

1	Affinity Labs of Texas, LLC, Plaintiff, v. Apple, Inc., Defendant, C.A. No. 9:09-cv-00047-RC (Eastern District of Texas), Complaint (pages 1-7), with Exhibits A, B and C, Filed March 24, 2009. 76 pages in total.	<input type="checkbox"/>
---	---------------------------------------------------------------------------------------------------------------------------------------------------------------------------------------------------------------------	--------------------------

If you wish to add additional non-patent literature document citation information please click the Add button

EXAMINER SIGNATURE

Examiner Signature	/Erika Gary/ (09/15/2010)	Date Considered	09/15/2010
--------------------	---------------------------	-----------------	------------

*EXAMINER: Initial if reference considered, whether or not citation is in conformance with MPEP 609. Draw line through a citation if not in conformance and not considered. Include copy of this form with next communication to applicant.

¹ See Kind Codes of USPTO Patent Documents at www.USPTO.GOV or MPEP 901.04. ² Enter office that issued the document; by the two-letter code (WIPO Standard ST.3). ³ For Japanese patent documents, the indication of the year of the reign of the Emperor must precede the serial number of the patent document. ⁴ Kind of document by the appropriate symbols as indicated on the document under WIPO Standard ST.16 if possible. ⁵ Applicant is to place a check mark here if English language translation is attached.

Doc code: IDS

Doc description: Information Disclosure Statement (IDS) Filed

PTO/SB/08a (04-09)

Approved for use through 05/31/2009. OMB 0651-0031
U.S. Patent and Trademark Office; U.S. DEPARTMENT OF COMMERCE

Under the Paperwork Reduction Act of 1995, no persons are required to respond to a collection of information unless it contains a valid OMB control number.

<p>INFORMATION DISCLOSURE STATEMENT BY APPLICANT (Not for submission under 37 CFR 1.99)</p>	Application Number		12015320	
	Filing Date		2008-01-16	
	First Named Inventor	Russell W. White, et al.		
	Art Unit	2617		
	Examiner Name	Erika A. Gary		
	Attorney Docket Number	AFF.004C5US		

U.S.PATENTS						
Examiner Initial*	Cite No	Patent Number	Kind Code ¹	Issue Date	Name of Patentee or Applicant of cited Document	Pages, Columns, Lines where Relevant Passages or Relevant Figures Appear
	1					

If you wish to add additional U.S. Patent citation information please click the Add button.

U.S.PATENT APPLICATION PUBLICATIONS						
Examiner Initial*	Cite No	Publication Number	Kind Code ¹	Publication Date	Name of Patentee or Applicant of cited Document	Pages, Columns, Lines where Relevant Passages or Relevant Figures Appear
	1					

If you wish to add additional U.S. Published Application citation information please click the Add button.

FOREIGN PATENT DOCUMENTS								
Examiner Initial*	Cite No	Foreign Document Number ³	Country Code ^{2j}	Kind Code ⁴	Publication Date	Name of Patentee or Applicant of cited Document	Pages, Columns, Lines where Relevant Passages or Relevant Figures Appear	T ⁵
	1	2000-66974	JP		2000-03-03			<input type="checkbox"/>
	2	11-68685	JP		1999-03-09			<input type="checkbox"/>
	3	CN 1218258A	CN		1999-06-02			<input type="checkbox"/>

**INFORMATION DISCLOSURE
STATEMENT BY APPLICANT**
(Not for submission under 37 CFR 1.99)

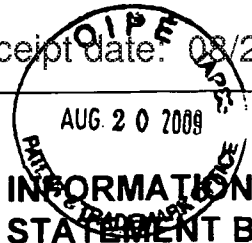

Application Number		12015320
Filing Date		2008-01-16
First Named Inventor	Russell W. White, et al.	
Art Unit	2617	
Examiner Name	Erika A. Gary	
Attorney Docket Number	AFF.004C5US	

4	H11-242686	JP		1999-09-07	Sony Corporation	<input type="checkbox"/>
5	DE 44 31 070 B4	DE		2004-07-22	DaimlerChrysler AG	<input type="checkbox"/>
6	0 569 343 A1	EP		1993-10-11	Pioneer Electronic Corporation	<input type="checkbox"/>
7	0 675 341 A1	EP		1995-04-10	Honda Giken-Kogyo	<input type="checkbox"/>
8	0 771 686 A2	EP		1997-07-05	Toyota Jidosha Kabushiki Kaisha Toyota-shi, Aichi-	<input type="checkbox"/>
9	H4-261576	JP		1992-09-17	Mitsubishi Electric Corporation	<input type="checkbox"/>
10	2-301330	JP		1990-12-13		<input type="checkbox"/>
11	5-294250	JP		1993-11-09		<input type="checkbox"/>
12	6-187597	JP		1994-07-08		<input type="checkbox"/>
13	JP6289118	JP		1994-10-18	Sega Enterprises KK	<input type="checkbox"/>
14	JP6294659	JP		1994-10-21	Dainippon Printing Co. LTD.	<input type="checkbox"/>

INFORMATION DISCLOSURE STATEMENT BY APPLICANT (Not for submission under 37 CFR 1.99)	Application Number		12015320	
	Filing Date		2008-01-16	
	First Named Inventor	Russell W. White, et al.		
	Art Unit	2617		
	Examiner Name	Erika A. Gary		
	Attorney Docket Number	AFF.004C5US		

	15	07-129895	JP		1995-05-19	Honda Motor Co Ltd		<input type="checkbox"/>
	16	07-146155	JP		1995-06-06	Honda Motor Co Ltd		<input type="checkbox"/>
	17	7-262493	JP		1995-10-13	CSK Corporation		<input type="checkbox"/>
	18	7-262493	JP		1995-10-13			<input type="checkbox"/>
	19	JP7270171	JP		1995-10-20	Sumitomo Electronic Industries		<input type="checkbox"/>
	20	JP7036382	JP		1995-02-07	Mitsubishi Electric Corp.		<input type="checkbox"/>
	21	8-110231	JP		1996-04-30			<input type="checkbox"/>
	22	9-61514	JP		1997-03-07			<input type="checkbox"/>
	23	10-103966	JP		1998-04-24			<input type="checkbox"/>
	24	10-143349	JP		1998-05-29	Compaq Computer Corporation		<input type="checkbox"/>
	25	JP1018712	JP		1989-01-23	Mazda Motor		<input type="checkbox"/>

INFORMATION DISCLOSURE STATEMENT BY APPLICANT (Not for submission under 37 CFR 1.99)	Application Number		12015320	
	Filing Date		2008-01-16	
	First Named Inventor	Russell W. White, et al.		
	Art Unit	2617		
	Examiner Name	Erika A. Gary		
	Attorney Docket Number	AFF.004C5US		

	26	JP5077679	JP		1993-03-30	Nissan Motor		<input type="checkbox"/>
	27	JP59085599	JP		1984-05-17	Nissan Motor		<input type="checkbox"/>
	28	JP63136828	JP		1988-06-09	Pioneer Electronic Corp.		<input type="checkbox"/>
	29	63-136828	JP		1988-06-09			<input type="checkbox"/>
	30	WO 96/04724	WO		1996-02-15	Emerson, Harry		<input type="checkbox"/>
	31	WO 96/07110	WO		1996-03-07	British Telecommunications Public Limited Company		<input type="checkbox"/>
	32	WO 97/13657	WO		1997-04-17	United Technologies Automotive, Inc.		<input type="checkbox"/>
	33	H11-317061	JP		1999-11-16	Victor Company of Japan, LTD.		<input checked="" type="checkbox"/>
	34	2901445	JP		1999-03-19	Kenwood Corporation		<input checked="" type="checkbox"/>
	35	WO 99/35009	WO		1999-07-15	Microsoft Corporation		<input type="checkbox"/>
	36	11-219580	JP		1999-08-10			<input type="checkbox"/>

INFORMATION DISCLOSURE STATEMENT BY APPLICANT (Not for submission under 37 CFR 1.99)	Application Number		12015320	
	Filing Date		2008-01-16	
	First Named Inventor	Russell W. White, et al.		
	Art Unit	2617		
	Examiner Name	Erika A. Gary		
	Attorney Docket Number	AFF.004C5US		

	37	11219580 A	JP		1999-10-08	Sony Corp		<input type="checkbox"/>
	38	1168685	JP		1999-03-09			<input type="checkbox"/>
	39	11-068685	JP		1999-09-03	Sony Corp		<input type="checkbox"/>
	40	1998-052033	JP		1998-09-25			<input type="checkbox"/>
	41	1999-0042565	JP		1999-06-15			<input type="checkbox"/>
	42	1999-0073234	KR		1999-10-05	Young-Man Lee		<input type="checkbox"/>
	43	1999-0048723	KR		1999-07-05			<input type="checkbox"/>
	44	KR2019990022030U	KR		1999-06-25	Young-Shik Cheon		<input type="checkbox"/>
	45	2000-0001465	KR		2000-01-25	Samsung Motors		<input type="checkbox"/>
	46	0142256	KR		1998-03-30			<input type="checkbox"/>
	47	WO 98/21672	WO		1998-05-22	Inergy Online, Inc.		<input type="checkbox"/>

INFORMATION DISCLOSURE STATEMENT BY APPLICANT (Not for submission under 37 CFR 1.99)	Application Number		12015320	
	Filing Date		2008-01-16	
	First Named Inventor	Russell W. White, et al.		
	Art Unit	2617		
	Examiner Name	Erika A. Gary		
	Attorney Docket Number	AFF.004C5US		

48	WO 98/47252	WO		1998-10-22	Stern, Geoffrey	<input type="checkbox"/>
49	WO 00/54187	WO		2000-09-14	Rock.Com, Inc.	<input type="checkbox"/>
50	WO 00/60450	WO		2000-10-12	Khyber Technologies Corporation	<input type="checkbox"/>

If you wish to add additional Foreign Patent Document citation information please click the Add button

NON-PATENT LITERATURE DOCUMENTS

Examiner Initials*	Cite No	Include name of the author (in CAPITAL LETTERS), title of the article (when appropriate), title of the item (book, magazine, journal, serial, symposium, catalog, etc), date, pages(s), volume-issue number(s), publisher, city and/or country where published.	T ⁵
	1	MARK MOELLER, Computing Unplugged Magazine, "Product Preview, A Survey of Auto PC 2.0 for software developers," 1999-2009, Zatz Publishing, pages 1-7.	<input type="checkbox"/>
	2	MARK MOELLER, Computing Unplugged Magazine, "AutoPC Update, Auto PC/Windows CE for Automotive news bites," 1999-2009, Zatz Publishing, pages 1-4.	<input type="checkbox"/>
	3	Claim Chart for KR19990033393, Claim 17 of U.S. Patent No. 7,324,833, pages 1-3.	<input type="checkbox"/>
	4	RIO500, Getting Started Guide for Windows 98 and Macintosh OS 8.6, pages 1-2.	<input type="checkbox"/>
	5	NORBERT A. STREITZ, et al., "DOLPHIN: Integrated Meeting Support Across Local And Remote Desktop Environments And LiveBoards," Integrated Publication and Information Systems Institute, 1994, pages 345-358.	<input type="checkbox"/>
	6	LEO DEGEN, et al., "Working with Audio: Integrating Personal Tape Recorders and Desktop Computers," May 3-7, 1992, pages 413-418.	<input type="checkbox"/>

INFORMATION DISCLOSURE STATEMENT BY APPLICANT (Not for submission under 37 CFR 1.99)	Application Number		12015320
	Filing Date		2008-01-16
	First Named Inventor	Russell W. White, et al.	
	Art Unit		2617
	Examiner Name	Erika A. Gary	
	Attorney Docket Number		AFF.004C5US

7	H.S. JUN GIBEE, "A Virtual Information Desk On The Internet," University of Ulsan, September 1999, pages 265-268.	<input type="checkbox"/>
8	STEVE WHITTAKER, et al., "TeleNotes: Managing Lightweight Interactions in the Desktop," Lotus Development Corporation, June 1997, pages 137-168.	<input type="checkbox"/>
9	R.M. CROWDER, et al., "Integration of Manufacturing Information Using Open Hypermedia," Computer in Industry, 1999, pages 31-42.	<input type="checkbox"/>
10	TOMAS BOSTROM, et al., "Mobile Audio Distribution," Royal Institute of Technology, 1999, pages 166-172.	<input type="checkbox"/>
11	ALEX POON, et al., Xerox Disclosure Journal, Vol. 19, No. 2, "Gestural User Interface Technique for Controlling the Playback of Sequential Media," March/April 1994, pages 187-190.	<input type="checkbox"/>
12	DEB KUMAR ROY, "NewsComm: A Hand-Held Device For Interactive Access to Structured Audio," Massachusetts Institute of Technology, June 1995, pages 1-12.	<input type="checkbox"/>
13	VICTORIA BELLOTTI, et al., "Walking Away from the Desktop Computer: Distributed Collaboration and Mobility in a Product Design Team," 1996, pages 209-218.	<input type="checkbox"/>
14	UPUL OBEYSEKARE, et al., "The Visual Interactive Desktop Laboratory," January-March 1997, pages 63-71.	<input type="checkbox"/>
15	ASIM SMAILAGIC, et al., "MoCCA: A Mobile Communication and Computing Architecture," Institute for Complex Engineered Systems, pages 1-8.	<input type="checkbox"/>
16	SUI-MENG POON, et al., "Integration of Value-Added Audio Playback Capacity Into Computer Network," Nanyang Technological University, 1995, pages 632-636.	<input type="checkbox"/>
17	ERDAL PAKSOY, et al., "A variable-rate celp coder for fast remote voicemail retrieval using a notebook computer," DSPS R&D Center, Texas Instruments, 1997, pages 119-124.	<input type="checkbox"/>

INFORMATION DISCLOSURE STATEMENT BY APPLICANT (Not for submission under 37 CFR 1.99)	Application Number	12015320
	Filing Date	2008-01-16
	First Named Inventor	Russell W. White, et al.
	Art Unit	2617
	Examiner Name	Erika A. Gary
	Attorney Docket Number	AFF.004C5US

18	JEFFREY A. DAVIS, "Use of Personal Computers in Satellite Command and Control Systems," Raytheon Systems Company, October 24, 1999, pages 283-291.	<input type="checkbox"/>
19	NIKI DAVIS, "Remote Teaching Via ISDN2 And Desktop Conferencing," Exeter University School of Education, pages 1-3.	<input type="checkbox"/>
20	A CHAN, et al., "The PEP-II Project-Wide Database," Stanford University, 1996, pages 840-842.	<input type="checkbox"/>
21	KRISHNA BHARAT, et al., "Migratory Applications," Springer Berlin, Vol. 1222, 1997, pages 1-21.	<input type="checkbox"/>
22	EMPEG CAR, "MP3 in your dash," Digital Audio Player User Guide, pages 1-50.	<input type="checkbox"/>
23	MICROSOFT, "Getting Started Microsoft. Windows. 98" Second Edition, 1998, pages 1-138.	<input type="checkbox"/>
24	SAUL GREENBERG, "PDAs and Shared Public Displays: Making Personal Information Public, and Public Information Personal," University of Calgary, March 1999, pages 1-11.	<input type="checkbox"/>
25	NAOHIKO KOHTAKE, et al., "InfoStick: an interaction device for Inter-Appliance Computing," Keio University, pages 1-15.	<input type="checkbox"/>
26	HEWLETT PACKARD, User's Guide, HP Jornada 420, Palm-Size PC, pages 1-75	<input type="checkbox"/>
27	MICROSOFT, "Introducing Microsoft Windows 95 - Certificate of Authenticity," 1995, pages 1-117.	<input type="checkbox"/>
28	SONY, "New Technical Theory For Servicing, MZ-R5ST Operation Manual," pages 1-44.	<input type="checkbox"/>

INFORMATION DISCLOSURE STATEMENT BY APPLICANT (Not for submission under 37 CFR 1.99)	Application Number		12015320
	Filing Date		2008-01-16
	First Named Inventor	Russell W. White, et al.	
	Art Unit		2617
	Examiner Name	Erika A. Gary	
	Attorney Docket Number		AFF.004C5US

29	RICHARD C. DAVIS, et al., "A Framework for Sharing Handwritten Notes," 1998, pages 119-120.	<input type="checkbox"/>
30	KRISHNA A. BHARAT, et al., "Migratory Applications," UIST '95, November 14-17, 1995, pages 133-142.	<input type="checkbox"/>
31	BRAD A. MYERS, "Collaboration Using Multiple PDAs Connected To A PC," Carnegie Mellon University, 1998, pages 385-294.	<input type="checkbox"/>
32	RICHARD C. DAVIS, et al., "NotePals: Lightweight Note Sharing by the Group, for the Group," May 15-20, 1999, pages 338-345.	<input type="checkbox"/>
33	JUN REKIMOTO, et al., "Augmented Surfaces: A Spatially Continuous Work Space for Hybrid Computing Environments," May 15-20, 1999, pages 378-385.	<input type="checkbox"/>
34	DAN R. OLSEN, JR., "Interacting with Chaos," September and October 1999, pages 42-54.	<input type="checkbox"/>
35	SCOTT ROBERTSON, et al., "Dual Device User Interface Design: PDAs and Interactive Television," April 13-18, 1996, pages 79-86.	<input type="checkbox"/>
36	SYMANTEC CORPORATION, "pcANYWHERE32 User's Guide," 1993-1997, pages 1-216.	<input type="checkbox"/>
37	KRISHNA BHARAT, et al., Migratory Applications, "Mobile Object Systems Towards the Programmable Internet," Springer Berlin/Heidelberg, Volume 1222/11997, 1997, pages 1-134.	<input type="checkbox"/>
38	DIAMOND MULTIMEDIA SYSTEMS, INC., "Rio PMP300, User's Guide," 1998, pages 1-27.	<input type="checkbox"/>
39	SONY, "Portable MiniDisc Recorder, Operating Instructions, MZ-R55," 1998, pages 1-42.	<input type="checkbox"/>

INFORMATION DISCLOSURE STATEMENT BY APPLICANT (Not for submission under 37 CFR 1.99)	Application Number		12015320
	Filing Date		2008-01-16
	First Named Inventor	Russell W. White, et al.	
	Art Unit		2617
	Examiner Name	Erika A. Gary	
	Attorney Docket Number		AFF.004C5US

40	NORBERT A. STREITZ, et al., "i-Land: An Interactive Landscape for Creativity and Innovation," Proceedings of the ACM Conference on Human Factors in Computing Systems, May 15-20, 1999, pages 120-127.	<input type="checkbox"/>
41	NORBERT A. STREITZ, et al., "Roomware for Cooperative Buildings: Integrated Design of Architectural Spaces and Information Spaces," pages 1-20	<input type="checkbox"/>
42	Direct Cable Connection screen shot, "B1U6U4," 10 pages total.	<input type="checkbox"/>
43	Direct Cable Connection screen shot, 10 pages total.	<input type="checkbox"/>
44	IBM, "WordPad z50 Cradle Option - User's Guide," 1990, pages 1-18.	<input type="checkbox"/>
45	IBM MOBILE SYSTEMS, "WorkPad z50 Mobile Companion (2608-1Ax), Hardware Maintenance Manual," March 1999, pages 1-77.	<input type="checkbox"/>
46	KEVIN JOST, Automotive Engineering International, "The car as a mobile-media platform," May 1998, pages 49-53.	<input type="checkbox"/>
47	MICROSOFT CORPORATION, "Windows CE 2.1 Technical Articles, Developing Applications for an Auto PC," June 1999, pages 1-13.	<input type="checkbox"/>
48	INFOGATION CORPORATION, "InfoGation Corp. Introduces Software Applications for Next-Generation Smart Car Systems," January 8, 1998, pages 1-2.	<input type="checkbox"/>
49	BUSINESS WIRE, "ORA Electronics Announces USB-Compatible TelCar Mark VII Begins Shipping First Quarter of 1999," January 6, 1999, pages 1-2.	<input type="checkbox"/>
50	ORA USA, "ORA Electronics Patents Telcar Cellular Telephone Interface," July 6, 1998, pages 1-2.	<input type="checkbox"/>

INFORMATION DISCLOSURE STATEMENT BY APPLICANT (Not for submission under 37 CFR 1.99)	Application Number	12015320
	Filing Date	2008-01-16
	First Named Inventor	Russell W. White, et al.
	Art Unit	2617
	Examiner Name	Erika A. Gary
	Attorney Docket Number	AFF.004C5US

If you wish to add additional non-patent literature document citation information please click the Add button			
EXAMINER SIGNATURE			
Examiner Signature	/Erika Gary/ (09/15/2010)	Date Considered	09/15/2010
*EXAMINER: Initial if reference considered, whether or not citation is in conformance with MPEP 609. Draw line through a citation if not in conformance and not considered. Include copy of this form with next communication to applicant.			
<small> ¹ See Kind Codes of USPTO Patent Documents at www.USPTO.GOV or MPEP 901.04. ² Enter office that issued the document, by the two-letter code (WIPO Standard ST.3). ³ For Japanese patent documents, the indication of the year of the reign of the Emperor must precede the serial number of the patent document. ⁴ Kind of document by the appropriate symbols as indicated on the document under WIPO Standard ST.16 if possible. ⁵ Applicant is to place a check mark here if English language translation is attached. </small>			

Doc code: IDS
 Doc Description: Information Disclosure Statement (IDS) Filed

PTO/SB/08a (04-09)
 Approved for use through 05/31/2009. OMB 0651-0031
 U.S. Patent and Trademark Office, U.S. DEPARTMENT OF COMMERCE
 Under the Paperwork Reduction Act of 1995, no persons are required to respond to a collection of information unless it contains a valid OMB control number.

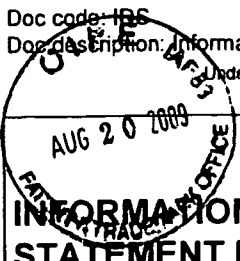

INFORMATION DISCLOSURE STATEMENT BY APPLICANT
 (Not for submission under 37 CFR 1.99)

Application Number	12015320
Filing Date	2008-01-16
First Named Inventor	Russell W. White, et al.
Art Unit	2617
Examiner Name	Erika A. Gary
Attorney Docket Number	AFF.004C5US

U.S. PATENTS

Examiner Initial*	Cite No	Patent Number	Kind Code ¹	Issue Date	Name of Patentee or Applicant of cited Document	Pages, Columns, Lines where Relevant Passages or Relevant Figures Appear
	1					

If you wish to add additional U.S. Patent citation information please click the Add button.

U.S. PATENT APPLICATION PUBLICATIONS

Examiner Initial*	Cite No	Publication Number	Kind Code ¹	Publication Date	Name of Patentee or Applicant of cited Document	Pages, Columns, Lines where Relevant Passages or Relevant Figures Appear
	1					

If you wish to add additional U.S. Published Application citation information please click the Add button.

FOREIGN PATENT DOCUMENTS

Examiner Initial*	Cite No	Foreign Document Number ³	Country Code ²ⁱ	Kind Code ⁴	Publication Date	Name of Patentee or Applicant of cited Document	Pages, Columns, Lines where Relevant Passages or Relevant Figures Appear	T ⁵
	1	WO 00/79372 A1	WO		2000-12-28	Colvin, David S.		<input type="checkbox"/>

If you wish to add additional Foreign Patent Document citation information please click the Add button

NON-PATENT LITERATURE DOCUMENTS

Examiner Initials*	Cite No	Include name of the author (in CAPITAL LETTERS), title of the article (when appropriate), title of the item (book, magazine, journal, serial, symposium, catalog, etc), date, pages(s), volume-issue number(s), publisher, city and/or country where published.	T ⁵

INFORMATION DISCLOSURE STATEMENT BY APPLICANT (Not for submission under 37 CFR 1.99)	Application Number	12015320
	Filing Date	2008-01-16
	First Named Inventor	Russell W. White, et al.
	Art Unit	2617
	Examiner Name	Erika A. Gary
	Attorney Docket Number	AFF.004C5US

1	HEWLETT PACKARD, "HP Jomada 430/430se Palm-Size PC, User's Guide," Edition 1, 1999, pages 1-151.	<input type="checkbox"/>
2	NEC, "NEC MobilePro 750C, User's Guide," 1998, pages 1-83.	<input type="checkbox"/>
3	MICROSOFT, "Palm PC User's Guide," Microsoft Windows CE, pages 1-39.	<input type="checkbox"/>
4	PALM PC USER'S GUIDE, "Chapter 6, Information Backup and Exchange," pages 69-148	<input type="checkbox"/>
5	MPMan, "User's Guide, The Portable MP 3player using the flash memory and SmartMedia card," 1997, pages 1-35.	<input type="checkbox"/>
6	Cover Sheet, www.mpman.com, 1 page.	<input type="checkbox"/>
7	Smart Media Card Slot Diagram, 1 page.	<input type="checkbox"/>
8	MP Man F20 Logo, 1 page.	<input type="checkbox"/>
9	MPMan, "User's Guide, The portable MP3 player using the flash memory with variety features including the voice recording, phone/memo browsing, etc.," 1997, pages 1-47.	<input type="checkbox"/>
10	Smart Media card diagram and install instructions, pages 1-4.	<input type="checkbox"/>
11	ANAND LAL SHIMPI, Empeg, Ltd., "MP3 meets Car Audio: Empeg Mark II in-dash Car MP3 Player," September 18, 2000, pages 1-17.	<input type="checkbox"/>

INFORMATION DISCLOSURE STATEMENT BY APPLICANT (Not for submission under 37 CFR 1.99)	Application Number	12015320
	Filing Date	2008-01-16
	First Named Inventor	Russell W. White, et al.
	Art Unit	2617
	Examiner Name	Erika A. Gary
	Attorney Docket Number	AFF.004C5US

12	PETER CLARKE, EE Times, "Engineers drive craze for MP3 audio players," February 5, 1999, pages 1-4.	<input type="checkbox"/>
13	RIO CAR DOT ORG GEEK GUIDE, "empeg car Mk. 1," February 21, pages 1-4.	<input type="checkbox"/>
14	HUGO FIENNES, RIO CAR DOT ORG GEEK GUIDE, "MP3 Mobile," February 21, pages 1-4.	<input type="checkbox"/>
15	RIO CAR DOT ORG, "Frequently Asked Questions," pages 1-16.	<input type="checkbox"/>
16	DIAMOND MULTIMEDIA SYSTEMS, INC., "Rio PMP300 User's Guide," 1998, pages 1-27.	<input type="checkbox"/>
17	STEPHEN J. BUCKLEY, et al., "The Car as a Peripheral, Adapting a Portable Computer to a Vehicle Intranet," SAE Technical Paper Series, 98C030, October 19-21, 1998, pages 1-14.	<input type="checkbox"/>
18	"The MP3 Mobile," April 8, 1998, pages 1-13.	<input type="checkbox"/>
19	12-Volt Business & Technology Solutions, AutoMedia, "How the Intelligent Data Bus will impact the way you do business," November 1998, pages 1-2.	<input type="checkbox"/>
20	Press Release, "Creative Labs Launches Nomad Portable MP3 Players," April 15, 1999, pages 1-5.	<input type="checkbox"/>
21	BMW, "Betriebsanleitung Bordmonitor mit Navigation und TV," 1995, pages 1-82.	<input type="checkbox"/>
22	BMW, "Owner's Manual, On-board monitor with navigation system," 1996, pages 1-81.	<input type="checkbox"/>

INFORMATION DISCLOSURE STATEMENT BY APPLICANT (Not for submission under 37 CFR 1.99)	Application Number	12015320
	Filing Date	2008-01-16
	First Named Inventor	Russell W. White, et al.
	Art Unit	2617
	Examiner Name	Erika A. Gary
	Attorney Docket Number	AFF.004C5US

23	TRANSPERFECT/TRANSLATIONS, "True and accurate translation of the 1995 BMW Manual, from German into English," August 16, 2005, pages 1-80.	<input type="checkbox"/>
24	HEINZ SODEIKAT, "EURO-SCOUT is facing the German 1994 Market," 1994, pages 551-556.	<input type="checkbox"/>
25	Pictures of car navigation systems in a car dashboard, pages 1-11.	<input type="checkbox"/>
26	BMW, "The BMW On-Board Navigation System - Technology Takes a Remarkable Turn," 2005, pages 1-9.	<input type="checkbox"/>
27	OLDSMOBILE, "1991 Toronado/Trofeo User's Guide," 1991, pages 1-41.	<input type="checkbox"/>
28	YEPP, "Digital Sounds - yepp - YP-E32/E64102-291," October 23, 1999, pages 1-46	<input type="checkbox"/>
29		<input type="checkbox"/>
30	U.S. Provisional Application No. 60/167179, entitled "System, Method, And Device for Playing Recorded Music on a Wireless Communications Device," by Devon A. Rolf, filed November 23, 1999, pages 1-48.	<input type="checkbox"/>
31	MICROSOFT, "Getting Started, Microsoft Windows 98, For distribution with a new PC only," 1998, pages 1-145.	<input type="checkbox"/>
32	PR NEWSWIRE, "Alpine Announces Fall Release of Interface Adapter That Enables iPod Control and Playback from In-Vehicle Sound Systems," July 7, 2004, pages 1-2..	<input type="checkbox"/>
33	HA-YOUNG PARK, The Customer Times, "Portable Computer Music, MP3 File and MP3 Player rise as the Next Generation Audio Format," May 1999, pages 1-2.	<input type="checkbox"/>

INFORMATION DISCLOSURE STATEMENT BY APPLICANT (Not for submission under 37 CFR 1.99)	Application Number		12015320
	Filing Date		2008-01-16
	First Named Inventor	Russell W. White, et al.	
	Art Unit	2617	
	Examiner Name	Erika A. Gary	
	Attorney Docket Number	AFF.004C5US	

34	"MP3 Players Introduced in the Korean IT Magazines," 1998-1999, pages 1-15.	<input type="checkbox"/>
35	MpMan, "MP-F20, User's Guide, Portable MP3 player using the flash memory and a Memory card," [ages 1-16.	<input type="checkbox"/>
36	PR NEWSWIRE ASSOCIATION, INC., "Delphi's Communiport(R) Technology for Tomorrow, Today Demonstrated at Frankfurt Auto Show," September 15, 1999, pages 1-8.	<input type="checkbox"/>
37	CRAIN COMMUNIATIONS, INC., "Products," Agilent Technologies Press Release, February 21, 2000, pages 1-6.	<input type="checkbox"/>
38	THE WASHINGTON TIMES, LLC, John Hanan, Dallas Morning News, "Cars add computer, audiovisual gear," January 14, 2000, pages 1-3.	<input type="checkbox"/>

If you wish to add additional non-patent literature document citation information please click the Add button

EXAMINER SIGNATURE

Examiner Signature	/Erika Gary/ (09/15/2010)	Date Considered	09/15/2010
--------------------	---------------------------	-----------------	------------

***EXAMINER:** Initial if reference considered, whether or not citation is in conformance with MPEP 609. Draw line through a citation if not in conformance and not considered. Include copy of this form with next communication to applicant.

¹ See Kind Codes of USPTO Patent Documents at www.USPTO.GOV or MPEP 901.04. ² Enter office that issued the document, by the two-letter code (WIPO Standard ST.3). ³ For Japanese patent documents, the indication of the year of the reign of the Emperor must precede the serial number of the patent document. ⁴ Kind of document by the appropriate symbols as indicated on the document under WIPO Standard ST.16 if possible. ⁵ Applicant is to place a check mark here if English language translation is attached.

Doc code: IDS

Doc description: Information Disclosure Statement (IDS) Filed

PTO/SB/08a (04-09)

Approved for use through 05/31/2009. OMB 0651-0031

U.S. Patent and Trademark Office; U.S. DEPARTMENT OF COMMERCE

Under the Paperwork Reduction Act of 1995, no persons are required to respond to a collection of information unless it contains a valid OMB control number.

INFORMATION DISCLOSURE STATEMENT BY APPLICANT (Not for submission under 37 CFR 1.99)	Application Number		12015320	
	Filing Date		2008-01-16	
	First Named Inventor	Russell W. White, et al.		
	Art Unit	2617		
	Examiner Name	Erika A. Gary		
	Attorney Docket Number	AFF.004C5US		

U.S.PATENTS						
Examiner Initial*	Cite No	Patent Number	Kind Code ¹	Issue Date	Name of Patentee or Applicant of cited Document	Pages, Columns, Lines where Relevant Passages or Relevant Figures Appear
	1					

If you wish to add additional U.S. Patent citation information please click the Add button.

U.S.PATENT APPLICATION PUBLICATIONS						
Examiner Initial*	Cite No	Publication Number	Kind Code ¹	Publication Date	Name of Patentee or Applicant of cited Document	Pages, Columns, Lines where Relevant Passages or Relevant Figures Appear
	1					

If you wish to add additional U.S. Published Application citation information please click the Add button.

FOREIGN PATENT DOCUMENTS								
Examiner Initial*	Cite No	Foreign Document Number ³	Country Code ²ⁱ	Kind Code ⁴	Publication Date	Name of Patentee or Applicant of cited Document	Pages, Columns, Lines where Relevant Passages or Relevant Figures Appear	T ⁵
	1	2000-66974	JP		2000-03-03			<input type="checkbox"/>
	2	11-68685	JP		1999-03-09			<input type="checkbox"/>
	3	CN 1218258A	CN		1999-06-02			<input type="checkbox"/>

INFORMATION DISCLOSURE STATEMENT BY APPLICANT (Not for submission under 37 CFR 1.99)	Application Number		12015320	
	Filing Date		2008-01-16	
	First Named Inventor	Russell W. White, et al.		
	Art Unit	2617		
	Examiner Name	Erika A. Gary		
	Attorney Docket Number	AFF.004C5US		

	4	H11-242686	JP		1999-09-07	Sony Corporation		<input type="checkbox"/>
	5	DE 44 31 070 B4	DE		2004-07-22	DaimlerChrysler AG		<input type="checkbox"/>
	6	0 569 343 A1	EP		1993-10-11	Pioneer Electronic Corporation		<input type="checkbox"/>
	7	0 675 341 A1	EP		1995-04-10	Honda Giken Kogyo		<input type="checkbox"/>
	8	0 771 686 A2	EP		1997-07-05	Toyota Jidosha Kabushiki Kaisha Toyota-shi, Aichi-		<input type="checkbox"/>
	9	H4-261576	JP		1992-09-17	Mitsubishi Electric Corporation		<input type="checkbox"/>
	10	2-301330	JP		1990-12-13			<input type="checkbox"/>
	11	5-294250	JP		1993-11-09			<input type="checkbox"/>
	12	6-187597	JP		1994-07-08			<input type="checkbox"/>
	13	JP6289118	JP		1994-10-18	Sega Enterprises KK		<input type="checkbox"/>
	14	JP6294659	JP		1994-10-21	Dainippon Printing Co. LTD.		<input type="checkbox"/>

INFORMATION DISCLOSURE STATEMENT BY APPLICANT (Not for submission under 37 CFR 1.99)	Application Number		12015320	
	Filing Date		2008-01-16	
	First Named Inventor	Russell W. White, et al.		
	Art Unit	2617		
	Examiner Name	Erika A. Gary		
	Attorney Docket Number	AFF.004C5US		

	15	07-129895	JP		1995-05-19	Honda Motor Co Ltd		<input type="checkbox"/>
	16	07-146155	JP		1995-06-06	Honda Motor Co Ltd		<input type="checkbox"/>
	17	7-262493	JP		1995-10-13	CSK Corporation		<input type="checkbox"/>
	18	7-262493	JP		1995-10-13			<input type="checkbox"/>
	19	JP7270171	JP		1995-10-20	Sumitomo Electronic Industries		<input type="checkbox"/>
	20	JP7036382	JP		1995-02-07	Mitsubishi Electric Corp.		<input type="checkbox"/>
	21	8-110231	JP		1996-04-30			<input type="checkbox"/>
	22	9-61514	JP		1997-03-07			<input type="checkbox"/>
	23	10-103966	JP		1998-04-24			<input type="checkbox"/>
	24	10-143349	JP		1998-05-29	Compaq Computer Corporation		<input type="checkbox"/>
	25	JP1018712	JP		1989-01-23	Mazda Motor		<input type="checkbox"/>

INFORMATION DISCLOSURE STATEMENT BY APPLICANT (Not for submission under 37 CFR 1.99)	Application Number		12015320	
	Filing Date		2008-01-16	
	First Named Inventor	Russell W. White, et al.		
	Art Unit	2617		
	Examiner Name	Erika A. Gary		
	Attorney Docket Number	AFF.004C5US		

	26	JP5077679	JP		1993-03-30	Nissan Motor		<input type="checkbox"/>
	27	JP59085599	JP		1984-05-17	Nissan Motor		<input type="checkbox"/>
	28	JP63136828	JP		1988-06-09	Pioneer Electronic Corp.		<input type="checkbox"/>
	29	63-136828	JP		1988-06-09			<input type="checkbox"/>
	30	WO 96/04724	WO		1996-02-15	Emerson, Harry		<input type="checkbox"/>
	31	WO 96/07110	WO		1996-03-07	British Telecommunications Public Limited Company		<input type="checkbox"/>
	32	WO 97/13657	WO		1997-04-17	United Technologies Automotive, Inc.		<input type="checkbox"/>
	33	H11-317061	JP		1999-11-16	Victor Company of Japan, LTD.		<input checked="" type="checkbox"/>
	34	2901445	JP		1999-03-19	Kenwood Corporation		<input checked="" type="checkbox"/>
	35	WO 99/35009	WO		1999-07-15	Microsoft Corporation		<input type="checkbox"/>
	36	11-219580	JP		1999-08-10			<input type="checkbox"/>

INFORMATION DISCLOSURE STATEMENT BY APPLICANT (Not for submission under 37 CFR 1.99)	Application Number		12015320	
	Filing Date		2008-01-16	
	First Named Inventor	Russell W. White, et al.		
	Art Unit	2617		
	Examiner Name	Erika A. Gary		
	Attorney Docket Number	AFF.004C5US		

	37	11219580 A	JP		1999-10-08	Sony Corp		<input type="checkbox"/>
	38	1168685	JP		1999-03-09			<input type="checkbox"/>
	39	11-068685	JP		1999-09-03	Sony Corp		<input type="checkbox"/>
	40	1998-052033	JP		1998-09-25			<input type="checkbox"/>
	41	1999-0042565	JP		1999-06-15			<input type="checkbox"/>
	42	1999-0073234	KR		1999-10-05	Young-Man Lee		<input type="checkbox"/>
	43	1999-0048723	KR		1999-07-05			<input type="checkbox"/>
	44	KR2019990022030U	KR		1999-06-25	Young-Shik Cheon		<input type="checkbox"/>
	45	2000-0001465	KR		2000-01-25	Samsung Motors		<input type="checkbox"/>
	46	0142256	KR		1998-03-30			<input type="checkbox"/>
	47	WO 98/21672	WO		1998-05-22	Inergy Online, Inc.		<input type="checkbox"/>

INFORMATION DISCLOSURE STATEMENT BY APPLICANT (Not for submission under 37 CFR 1.99)	Application Number	12015320
	Filing Date	2008-01-16
	First Named Inventor	Russell W. White, et al.
	Art Unit	2617
	Examiner Name	Erika A. Gary
	Attorney Docket Number	AFF.004C5US

48	WO 98/47252	WO		1998-10-22	Stern, Geoffrey	<input type="checkbox"/>
49	WO 00/54187	WO		2000-09-14	Rock.Com, Inc.	<input type="checkbox"/>
50	WO 00/60450	WO		2000-10-12	Khyber Technologies Corporation	<input type="checkbox"/>

If you wish to add additional Foreign Patent Document citation information please click the Add button

NON-PATENT LITERATURE DOCUMENTS

Examiner Initials*	Cite No	Include name of the author (in CAPITAL LETTERS), title of the article (when appropriate), title of the item (book, magazine, journal, serial, symposium, catalog, etc), date, pages(s), volume-issue number(s), publisher, city and/or country where published.	T ⁵
	1	MARK MOELLER, Computing Unplugged Magazine, "Product Preview, A Survey of Auto PC 2.0 for software developers," 1999-2009, Zatz Publishing, pages 1-7.	<input type="checkbox"/>
	2	MARK MOELLER, Computing Unplugged Magazine, "AutoPC Update, Auto PC/Windows CE for Automotive news bites," 1999-2009, Zatz Publishing, pages 1-4.	<input type="checkbox"/>
	3	Claim Chart for KR19990033393, Claim 17 of U.S. Patent No. 7,324,833, pages 1-3.	<input type="checkbox"/>
	4	RIO500, Getting Started Guide for Windows 98 and Macintosh OS 8.6, pages 1-2.	<input type="checkbox"/>
	5	NORBERT A. STREITZ, et al., "DOLPHIN: Integrated Meeting Support Across Local And Remote Desktop Environments And LiveBoards," Integrated Publication and Information Systems Institute, 1994, pages 345-358.	<input type="checkbox"/>
	6	LEO DEGEN, et al., "Working with Audio: Integrating Personal Tape Recorders and Desktop Computers," May 3-7, 1992, pages 413-418.	<input type="checkbox"/>

INFORMATION DISCLOSURE STATEMENT BY APPLICANT (Not for submission under 37 CFR 1.99)	Application Number		12015320
	Filing Date		2008-01-16
	First Named Inventor	Russell W. White, et al.	
	Art Unit		2617
	Examiner Name	Erika A. Gary	
	Attorney Docket Number		AFF.004C5US

7	H.S. JUN GIBEE, "A Virtual Information Desk On The Internet," University of Ulsan, September 1999, pages 265-268.	<input type="checkbox"/>
8	STEVE WHITTAKER, et al., "TeleNotes: Managing Lightweight Interactions in the Desktop," Lotus Development Corporation, June 1997, pages 137-168.	<input type="checkbox"/>
9	R.M. CROWDER, et al., "Integration of Manufacturing Information Using Open Hypermedia," Computer in Industry, 1999, pages 31-42.	<input type="checkbox"/>
10	TOMAS BOSTROM, et al., "Mobile Audio Distribution," Royal Institute of Technology, 1999, pages 166-172.	<input type="checkbox"/>
11	ALEX POON, et al., Xerox Disclosure Journal, Vol. 19, No. 2, "Gestural User Interface Technique for Controlling the Playback of Sequential Media," March/April 1994, pages 187-190.	<input type="checkbox"/>
12	DEB KUMAR ROY, "NewsComm: A Hand-Held Device For Interactive Access to Structured Audio," Massachusetts Institute of Technology, June 1995, pages 1-12.	<input type="checkbox"/>
13	VICTORIA BELLOTTI, et al., "Walking Away from the Desktop Computer: Distributed Collaboration and Mobility in a Product Design Team," 1996, pages 209-218.	<input type="checkbox"/>
14	UPUL OBEYSEKARE, et al., "The Visual Interactive Desktop Laboratory," January-March 1997, pages 63-71.	<input type="checkbox"/>
15	ASIM SMAILAGIC, et al., "MoCCA: A Mobile Communication and Computing Architecture," Institute for Complex Engineered Systems, pages 1-8.	<input type="checkbox"/>
16	SUI-MENG POON, et al., "Integration of Value-Added Audio Playback Capacity Into Computer Network," Nanyang Technological University, 1995, pages 632-636.	<input type="checkbox"/>
17	ERDAL PAKSOY, et al., "A variable-rate celp coder for fast remote voicemail retrieval using a notebook computer," DSPS R&D Center, Texas Instruments, 1997, pages 119-124.	<input type="checkbox"/>

INFORMATION DISCLOSURE STATEMENT BY APPLICANT (Not for submission under 37 CFR 1.99)	Application Number	12015320
	Filing Date	2008-01-16
	First Named Inventor	Russell W. White, et al.
	Art Unit	2617
	Examiner Name	Erika A. Gary
	Attorney Docket Number	AFF.004C5US

18	JEFFREY A. DAVIS, "Use of Personal Computers in Satellite Command and Control Systems," Raytheon Systems Company, October 24, 1999, pages 283-291.	<input type="checkbox"/>
19	NIKI DAVIS, "Remote Teaching Via ISDN2 And Desktop Conferencing," Exeter University School of Education, pages 1-3.	<input type="checkbox"/>
20	A CHAN, et al., "The PEP-II Project-Wide Database," Stanford University, 1996, pages 840-842.	<input type="checkbox"/>
21	KRISHNA BHARAT, et al., "Migratory Applications," Springer Berlin, Vol. 1222, 1997, pages 1-21.	<input type="checkbox"/>
22	EMPEG CAR, "MP3 in your dash," Digital Audio Player User Guide, pages 1-50.	<input type="checkbox"/>
23	MICROSOFT, "Getting Started Microsoft Windows 98" Second Edition, 1998, pages 1-138.	<input type="checkbox"/>
24	SAUL GREENBERG, "PDAs and Shared Public Displays: Making Personal Information Public, and Public Information Personal," University of Calgary, March 1999, pages 1-11.	<input type="checkbox"/>
25	NAOHIKO KOHTAKE, et al., "InfoStick: an interaction device for Inter-Appliance Computing," Keio University, pages 1-15.	<input type="checkbox"/>
26	HEWLETT PACKARD, User's Guide, HP Jomada 420, Palm-Size PC, pages 1-75	<input type="checkbox"/>
27	MICROSOFT, "Introducing Microsoft Windows 95 - Certificate of Authenticity," 1995, pages 1-117.	<input type="checkbox"/>
28	SONY, "New Technical Theory For Servicing, MZ-R5ST Operation Manual," pages 1-44.	<input type="checkbox"/>

INFORMATION DISCLOSURE STATEMENT BY APPLICANT (Not for submission under 37 CFR 1.99)	Application Number	12015320
	Filing Date	2008-01-16
	First Named Inventor	Russell W. White, et al.
	Art Unit	2617
	Examiner Name	Erika A. Gary
	Attorney Docket Number	AFF.004C5US

29	RICHARD C. DAVIS, et al., "A Framework for Sharing Handwritten Notes," 1998, pages 119-120.	<input type="checkbox"/>
30	KRISHNA A. BHARAT, et al., "Migratory Applications," UIST '95, November 14-17, 1995, pages 133-142.	<input type="checkbox"/>
31	BRAD A. MYERS, "Collaboration Using Multiple PDAs Connected To A PC," Carnegie Mellon University, 1998, pages 385-294.	<input type="checkbox"/>
32	RICHARD C. DAVIS, et al., "NotePals: Lightweight Note Sharing by the Group, for the Group," May 15-20, 1999, pages 338-345.	<input type="checkbox"/>
33	JUN REKIMOTO, et al., "Augmented Surfaces: A Spatially Continuous Work Space for Hybrid Computing Environments," May 15-20, 1999, pages 378-385.	<input type="checkbox"/>
34	DAN R. OLSEN, JR., "Interacting with Chaos," September and October 1999, pages 42-54.	<input type="checkbox"/>
35	SCOTT ROBERTSON, et al., "Dual Device User Interface Design: PDAs and Interactive Television," April 13-18, 1996, pages 79-86.	<input type="checkbox"/>
36	SYMANTEC CORPORATION, "pcANYWHERE32 User's Guide," 1993-1997, pages 1-216.	<input type="checkbox"/>
37	KRISHNA BHARAT, et al., Migratory Applications, "Mobile Object Systems Towards the Programmable Internet," Springer Berlin/Heidelberg, Volume 1222/11997, 1997, pages 1-134.	<input type="checkbox"/>
38	DIAMOND MULTIMEDIA SYSTEMS, INC., "Rio PMP300, User's Guide," 1998, pages 1-27.	<input type="checkbox"/>
39	SONY, "Portable MiniDisc Recorder, Operating Instructions, MZ-R55," 1998, pages 1-42.	<input type="checkbox"/>

INFORMATION DISCLOSURE STATEMENT BY APPLICANT (Not for submission under 37 CFR 1.99)	Application Number		12015320
	Filing Date		2008-01-16
	First Named Inventor	Russell W. White, et al.	
	Art Unit	2617	
	Examiner Name	Erika A. Gary	
	Attorney Docket Number	AFF.004C5US	

40	NORBERT A. STREITZ, et al., "i-Land: An Interactive Landscape for Creativity and Innovation," Proceedings of the ACM Conference on Human Factors in Computing Systems, May 15-20, 1999, pages 120-127.	<input type="checkbox"/>
41	NORBERT A. STREITZ, et al., "Roomware for Cooperative Buildings: Integrated Design of Architectural Spaces and Information Spaces," pages 1-20	<input type="checkbox"/>
42	Direct Cable Connection screen shot, "B1U6U4," 10 pages total.	<input type="checkbox"/>
43	Direct Cable Connection screen shot, 10 pages total.	<input type="checkbox"/>
44	IBM, "WordPad z50 Cradle Option - User's Guide," 1990, pages 1-18.	<input type="checkbox"/>
45	IBM MOBILE SYSTEMS, "WorkPad z50 Mobile Companion (2608-1Ax), Hardware Maintenance Manual," March 1999, pages 1-77.	<input type="checkbox"/>
46	KEVIN JOST, Automotive Engineering International, "The car as a mobile-media platform," May 1998, pages 49-53.	<input type="checkbox"/>
47	MICROSOFT CORPORATION, "Windows CE 2.1 Technical Articles, Developing Applications for an Auto PC," June 1999, pages 1-13.	<input type="checkbox"/>
48	INFOGATION CORPORATION, "InfoGation Corp. Introduces Software Applications for Next-Generation Smart Car Systems," January 8, 1998, pages 1-2.	<input type="checkbox"/>
49	BUSINESS WIRE, "ORA Electronics Announces USB-Compatible TelCar Mark VII Begins Shipping First Quarter of 1999," January 6, 1999, pages 1-2.	<input type="checkbox"/>
50	ORA USA, "ORA Electronics Patents Telcar Cellular Telephone Interface," July 6, 1998, pages 1-2.	<input type="checkbox"/>

INFORMATION DISCLOSURE STATEMENT BY APPLICANT (Not for submission under 37 CFR 1.99)	Application Number	12015320
	Filing Date	2008-01-16
	First Named Inventor	Russell W. White, et al.
	Art Unit	2617
	Examiner Name	Erika A. Gary
	Attorney Docket Number	AFF.004C5US

If you wish to add additional non-patent literature document citation information please click the Add button			
EXAMINER SIGNATURE			
Examiner Signature	/Erika Gary/ (09/15/2010)	Date Considered	09/15/2010
*EXAMINER: Initial if reference considered, whether or not citation is in conformance with MPEP 609. Draw line through a citation if not in conformance and not considered. Include copy of this form with next communication to applicant.			
<small> ¹ See Kind Codes of USPTO Patent Documents at www.USPTO.GOV or MPEP 901.04. ² Enter office that issued the document, by the two-letter code (WIPO Standard ST.3). ³ For Japanese patent documents, the indication of the year of the reign of the Emperor must precede the serial number of the patent document. ⁴ Kind of document by the appropriate symbols as indicated on the document under WIPO Standard ST.16 if possible. ⁵ Applicant is to place a check mark here if English language translation is attached. </small>			

Doc code: IDS

Doc description: Information Disclosure Statement (IDS) Filed

PTO/SB/08a (04-09)

Approved for use through 05/31/2009. OMB 0651-0031

U.S. Patent and Trademark Office; U.S. DEPARTMENT OF COMMERCE

Under the Paperwork Reduction Act of 1995, no persons are required to respond to a collection of information unless it contains a valid OMB control number.

INFORMATION DISCLOSURE STATEMENT BY APPLICANT (Not for submission under 37 CFR 1.99)	Application Number		12015320	
	Filing Date		2008-01-16	
	First Named Inventor	Russell W. White, et al.		
	Art Unit	2617		
	Examiner Name	Erika A. Gary		
	Attorney Docket Number	AFF.004C5US		

U.S.PATENTS

Examiner Initial*	Cite No	Patent Number	Kind Code ¹	Issue Date	Name of Patentee or Applicant of cited Document	Pages, Columns, Lines where Relevant Passages or Relevant Figures Appear
	1					

If you wish to add additional U.S. Patent citation information please click the Add button.

U.S.PATENT APPLICATION PUBLICATIONS

Examiner Initial*	Cite No	Publication Number	Kind Code ¹	Publication Date	Name of Patentee or Applicant of cited Document	Pages, Columns, Lines where Relevant Passages or Relevant Figures Appear
	1					

If you wish to add additional U.S. Published Application citation information please click the Add button.

FOREIGN PATENT DOCUMENTS

Examiner Initial*	Cite No	Foreign Document Number ³	Country Code ²	Kind Code ⁴	Publication Date	Name of Patentee or Applicant of cited Document	Pages, Columns, Lines where Relevant Passages or Relevant Figures Appear	T ⁵
	1	WO 00/79372 A1	WO		2000-12-28	Colvin, David S.		<input type="checkbox"/>

If you wish to add additional Foreign Patent Document citation information please click the Add button

NON-PATENT LITERATURE DOCUMENTS

Examiner Initials*	Cite No	Include name of the author (in CAPITAL LETTERS), title of the article (when appropriate), title of the item (book, magazine, journal, serial, symposium, catalog, etc), date, pages(s), volume-issue number(s), publisher, city and/or country where published.	T ⁵

INFORMATION DISCLOSURE STATEMENT BY APPLICANT (Not for submission under 37 CFR 1.99)	Application Number	12015320
	Filing Date	2008-01-16
	First Named Inventor	Russell W. White, et al.
	Art Unit	2617
	Examiner Name	Erika A. Gary
	Attorney Docket Number	AFF.004C5US

1	HEWLETT PACKARD, "HP Jomada 430/430se Palm-Size PC, User's Guide," Edition 1, 1999, pages 1-151.	<input type="checkbox"/>
2	NEC, "NEC MobilePro 750C, User's Guide," 1998, pages 1-83.	<input type="checkbox"/>
3	MICROSOFT, "Palm PC User's Guide," Microsoft Windows CE, pages 1-39.	<input type="checkbox"/>
4	PALM PC USER'S GUIDE, "Chapter 6, Information Backup and Exchange," pages 69-148	<input type="checkbox"/>
5	MPMan, "User's Guide, The Portable MP 3player using the flash memory and SmartMedia card," 1997, pages 1-35.	<input type="checkbox"/>
6	Cover Sheet, www.mpman.com, 1 page.	<input type="checkbox"/>
7	Smart Media Card Slot Diagram, 1 page.	<input type="checkbox"/>
8	MP Man F20 Logo, 1 page.	<input type="checkbox"/>
9	MPMan, "User's Guide, The portable MP3 player using the flash memory with variety features including the voice recording, phone/memo browsing, etc.," 1997, pages 1-47.	<input type="checkbox"/>
10	Smart Media card diagram and install instructions, pages 1-4.	<input type="checkbox"/>
11	ANAND LAL SHIMPI, Empeg, Ltd., "MP3 meets Car Audio: Empeg Mark II in-dash Car MP3 Player," September 18, 2000, pages 1-17.	<input type="checkbox"/>

INFORMATION DISCLOSURE STATEMENT BY APPLICANT (Not for submission under 37 CFR 1.99)	Application Number		12015320
	Filing Date		2008-01-16
	First Named Inventor	Russell W. White, et al.	
	Art Unit	2617	
	Examiner Name	Erika A. Gary	
	Attorney Docket Number	AFF.004C5US	

12	PETER CLARKE, EE Times, "Engineers drive craze for MP3 audio players," February 5, 1999, pages 1-4.	<input type="checkbox"/>
13	RIO CAR DOT ORG GEEK GUIDE, "empeg car Mk. 1," February 21, pages 1-4.	<input type="checkbox"/>
14	HUGO FIENNES, RIO CAR DOT ORG GEEK GUIDE, "MP3 Mobile," February 21, pages 1-4.	<input type="checkbox"/>
15	RIO CAR DOT ORG, "Frequently Asked Questions," pages 1-16.	<input type="checkbox"/>
16	DIAMOND MULTIMEDIA SYSTEMS, INC., "Rio PMP300 User's Guide," 1998, pages 1-27.	<input type="checkbox"/>
17	STEPHEN J. BUCKLEY, et al., "The Car as a Peripheral, Adapting a Portable Computer to a Vehicle Intranet," SAE Technical Paper Series, 98C030, October 19-21, 1998, pages 1-14.	<input type="checkbox"/>
18	"The MP3 Mobile," April 8, 1998, pages 1-13.	<input type="checkbox"/>
19	12-Volt Business & Technology Solutions, AutoMedia, "How the Intelligent Data Bus will impact the way you do business," November 1998, pages 1-2.	<input type="checkbox"/>
20	Press Release, "Creative Labs Launches Nomad Portable MP3 Players," April 15, 1999, pages 1-5.	<input type="checkbox"/>
21	BMW, "Betriebsanleitung Bordmonitor mit Navigation und TV," 1995, pages 1-82.	<input type="checkbox"/>
22	BMW, "Owner's Manual, On-board monitor with navigation system," 1996, pages 1-81.	<input type="checkbox"/>

INFORMATION DISCLOSURE STATEMENT BY APPLICANT (Not for submission under 37 CFR 1.99)	Application Number		12015320
	Filing Date		2008-01-16
	First Named Inventor	Russell W. White, et al.	
	Art Unit	2617	
	Examiner Name	Erika A. Gary	
	Attorney Docket Number	AFF.004C5US	

23	TRANSPERFECT/TRANSLATIONS, "True and accurate translation of the 1995 BMW Manual, from German into English," August 16, 2005, pages 1-80.	<input type="checkbox"/>
24	HEINZ SODEIKAT, "EURO-SCOUT is facing the German 1994 Market," 1994, pages 551-556.	<input type="checkbox"/>
25	Pictures of car navigation systems in a car dashboard, pages 1-11.	<input type="checkbox"/>
26	BMW, "The BMW On-Board Navigation System - Technology Takes a Remarkable Turn," 2005, pages 1-9.	<input type="checkbox"/>
27	OLDSMOBILE, "1991 Toronado/Trofeo User's Guide," 1991, pages 1-41.	<input type="checkbox"/>
28	YEPP, "Digital Sounds - yepp - YP-E32/E64102-291," October 23, 1999, pages 1-46	<input type="checkbox"/>
29		<input type="checkbox"/>
30	U.S. Provisional Application No. 60/167179, entitled "System, Method, And Device for Playing Recorded Music on a Wireless Communications Device," by Devon A. Rolf, filed November 23, 1999, pages 1-48.	<input type="checkbox"/>
31	MICROSOFT, "Getting Started, Microsoft Windows 98, For distribution with a new PC only," 1998, pages 1-145.	<input type="checkbox"/>
32	PR NEWSWIRE, "Alpine Announces Fall Release of Interface Adapter That Enables iPod Control and Playback from In-Vehicle Sound Systems," July 7, 2004, pages 1-2..	<input type="checkbox"/>
33	HA-YOUNG PARK, The Customer Times, "Portable Computer Music, MP3 File and MP3 Player rise as the Next Generation Audio Format," May 1999, pages 1-2.	<input type="checkbox"/>

INFORMATION DISCLOSURE STATEMENT BY APPLICANT (Not for submission under 37 CFR 1.99)	Application Number		12015320
	Filing Date		2008-01-16
	First Named Inventor	Russell W. White, et al.	
	Art Unit	2617	
	Examiner Name	Erika A. Gary	
	Attorney Docket Number	AFF.004C5US	

34	"MP3 Players Introduced in the Korean IT Magazines," 1998-1999, pages 1-15.	<input type="checkbox"/>
35	MpMan, "MP-F20, User's Guide, Portable MP3 player using the flash memory and a Memory card," [ages 1-16.	<input type="checkbox"/>
36	PR NEWSWIRE ASSOCIATION, INC., "Delphi's Communiport(R) Technology for Tomorrow, Today Demonstrated at Frankfurt Auto Show," September 15, 1999, pages 1-8.	<input type="checkbox"/>
37	CRAIN COMMUNIATIONS, INC., "Products," Agilent Technologies Press Release, February 21, 2000, pages 1-6.	<input type="checkbox"/>
38	THE WASHINGTON TIMES, LLC, John Hanan, Dallas Morning News, "Cars add computer, audiovisual gear," January 14, 2000, pages 1-3.	<input type="checkbox"/>

If you wish to add additional non-patent literature document citation information please click the Add button

EXAMINER SIGNATURE

Examiner Signature	/Erika Gary/ (09/15/2010)	Date Considered	09/15/2010
--------------------	---------------------------	-----------------	------------

*EXAMINER: Initial if reference considered, whether or not citation is in conformance with MPEP 609. Draw line through a citation if not in conformance and not considered. Include copy of this form with next communication to applicant.

¹ See Kind Codes of USPTO Patent Documents at www.USPTO.GOV or MPEP 901.04. ² Enter office that issued the document, by the two-letter code (WIPO Standard ST.3). ³ For Japanese patent documents, the indication of the year of the reign of the Emperor must precede the serial number of the patent document. ⁴ Kind of document by the appropriate symbols as indicated on the document under WIPO Standard ST.16 if possible. ⁵ Applicant is to place a check mark here if English language translation is attached.

Doc code: IDS
 Doc description: Information Disclosure Statement (IDS) Filed

PTO/SB/08a (04-09)
 Approved for use through 05/31/2009. OMB 0851-0031
 U.S. Patent and Trademark Office; U.S. DEPARTMENT OF COMMERCE
 Under the Paperwork Reduction Act of 1995, no persons are required to respond to a collection of information unless it contains a valid OMB control number.

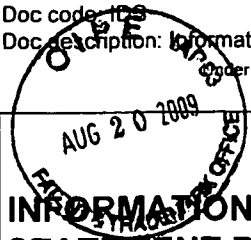

INFORMATION DISCLOSURE STATEMENT BY APPLICANT
 (Not for submission under 37 CFR 1.99)

Application Number		12015320
Filing Date		2008-01-16
First Named Inventor	Russell W. White, et al.	
Art Unit	2617	
Examiner Name	Erika A. Gary	
Attorney Docket Number	AFF.004C5US	

U.S. PATENTS

Examiner Initial*	Cite No	Patent Number	Kind Code ¹	Issue Date	Name of Patentee or Applicant of cited Document	Pages, Columns, Lines where Relevant Passages or Relevant Figures Appear
	1					

If you wish to add additional U.S. Patent citation information please click the Add button.

U.S. PATENT APPLICATION PUBLICATIONS

Examiner Initial*	Cite No	Publication Number	Kind Code ¹	Publication Date	Name of Patentee or Applicant of cited Document	Pages, Columns, Lines where Relevant Passages or Relevant Figures Appear
	1					

If you wish to add additional U.S. Published Application citation information please click the Add button.

FOREIGN PATENT DOCUMENTS

Examiner Initial*	Cite No	Foreign Document Number ³	Country Code ^{2j}	Kind Code ⁴	Publication Date	Name of Patentee or Applicant of cited Document	Pages, Columns, Lines where Relevant Passages or Relevant Figures Appear	T ⁵
	1	2000-66974	JP		2000-03-03			<input type="checkbox"/>
	2	11-68685	JP		1999-03-09			<input type="checkbox"/>
	3	CN 1218258A	CN		1999-06-02			<input type="checkbox"/>

INFORMATION DISCLOSURE STATEMENT BY APPLICANT (Not for submission under 37 CFR 1.99)	Application Number		12015320	
	Filing Date		2008-01-16	
	First Named Inventor	Russell W. White, et al.		
	Art Unit	2617		
	Examiner Name	Erika A. Gary		
	Attorney Docket Number	AFF.004C5US		

	4	H11-242686	JP		1999-09-07	Sony Corporation		<input type="checkbox"/>
	5	DE 44 31 070 B4	DE		2004-07-22	DaimlerChrysler AG		<input type="checkbox"/>
	6	0 569 343 A1	EP		1993-10-11	Pioneer Electronic Corporation		<input type="checkbox"/>
	7	0 675 341 A1	EP		1995-04-10	Honda Giken-Kogyo		<input type="checkbox"/>
	8	0 771 686 A2	EP		1997-07-05	Toyota Jidosha Kabushiki Kaisha Toyota-shi, Aichi-		<input type="checkbox"/>
	9	H4-261576	JP		1992-09-17	Mitsubishi Electric Corporation		<input type="checkbox"/>
	10	2-301330	JP		1990-12-13			<input type="checkbox"/>
	11	5-294250	JP		1993-11-09			<input type="checkbox"/>
	12	6-187597	JP		1994-07-08			<input type="checkbox"/>
	13	JP6289118	JP		1994-10-18	Sega Enterprises KK		<input type="checkbox"/>
	14	JP6294659	JP		1994-10-21	Dainippon Printing Co. LTD.		<input type="checkbox"/>

INFORMATION DISCLOSURE STATEMENT BY APPLICANT (Not for submission under 37 CFR 1.99)	Application Number		12015320	
	Filing Date		2008-01-16	
	First Named Inventor	Russell W. White, et al.		
	Art Unit	2617		
	Examiner Name	Erika A. Gary		
	Attorney Docket Number	AFF.004C5US		

	15	07-129895	JP		1995-05-19	Honda Motor Co Ltd		<input type="checkbox"/>
	16	07-146155	JP		1995-06-06	Honda Motor Co Ltd		<input type="checkbox"/>
	17	7-262493	JP		1995-10-13	CSK Corporation		<input type="checkbox"/>
	18	7-262493	JP		1995-10-13			<input type="checkbox"/>
	19	JP7270171	JP		1995-10-20	Sumitomo Electronic Industries		<input type="checkbox"/>
	20	JP7036382	JP		1995-02-07	Mitsubishi Electric Corp.		<input type="checkbox"/>
	21	8-110231	JP		1996-04-30			<input type="checkbox"/>
	22	9-61514	JP		1997-03-07			<input type="checkbox"/>
	23	10-103966	JP		1998-04-24			<input type="checkbox"/>
	24	10-143349	JP		1998-05-29	Compaq Computer Corporation		<input type="checkbox"/>
	25	JP1018712	JP		1989-01-23	Mazda Motor		<input type="checkbox"/>

INFORMATION DISCLOSURE STATEMENT BY APPLICANT (Not for submission under 37 CFR 1.99)	Application Number		12015320	
	Filing Date		2008-01-16	
	First Named Inventor	Russell W. White, et al.		
	Art Unit	2617		
	Examiner Name	Erika A. Gary		
	Attorney Docket Number	AFF.004C5US		

	26	JP5077679	JP		1993-03-30	Nissan Motor		<input type="checkbox"/>
	27	JP59085599	JP		1984-05-17	Nissan Motor		<input type="checkbox"/>
	28	JP63136828	JP		1988-06-09	Pioneer Electronic Corp.		<input type="checkbox"/>
	29	63-136828	JP		1988-06-09			<input type="checkbox"/>
	30	WO 96/04724	WO		1996-02-15	Emerson, Harry		<input type="checkbox"/>
	31	WO 96/07110	WO		1996-03-07	British Telecommunications Public Limited Company		<input type="checkbox"/>
	32	WO 97/13657	WO		1997-04-17	United Technologies Automotive, Inc.		<input type="checkbox"/>
	33	H11-317061	JP		1999-11-16	Victor Company of Japan, LTD.		<input checked="" type="checkbox"/>
	34	2901445	JP		1999-03-19	Kenwood Corporation		<input checked="" type="checkbox"/>
	35	WO 99/35009	WO		1999-07-15	Microsoft Corporation		<input type="checkbox"/>
	36	11-219580	JP		1999-08-10			<input type="checkbox"/>

INFORMATION DISCLOSURE STATEMENT BY APPLICANT (Not for submission under 37 CFR 1.99)	Application Number		12015320	
	Filing Date		2008-01-16	
	First Named Inventor	Russell W. White, et al.		
	Art Unit	2617		
	Examiner Name	Erika A. Gary		
	Attorney Docket Number	AFF.004C5US		

37	11219580 A	JP		1999-10-08	Sony Corp	<input type="checkbox"/>
38	1168685	JP		1999-03-09		<input type="checkbox"/>
39	11-068685	JP		1999-09-03	Sony Corp	<input type="checkbox"/>
40	1998-052033	JP		1998-09-25		<input type="checkbox"/>
41	1999-0042565	JP		1999-06-15		<input type="checkbox"/>
42	1999-0073234	KR		1999-10-05	Young-Man Lee	<input type="checkbox"/>
43	1999-0048723	KR		1999-07-05		<input type="checkbox"/>
44	KR2019990022030U	KR		1999-06-25	Young-Shik Cheon	<input type="checkbox"/>
45	2000-0001465	KR		2000-01-25	Samsung Motors	<input type="checkbox"/>
46	0142256	KR		1998-03-30		<input type="checkbox"/>
47	WO 98/21672	WO		1998-05-22	Inergy Online, Inc.	<input type="checkbox"/>

INFORMATION DISCLOSURE STATEMENT BY APPLICANT (Not for submission under 37 CFR 1.99)	Application Number		12015320	
	Filing Date		2008-01-16	
	First Named Inventor	Russell W. White, et al.		
	Art Unit	2617		
	Examiner Name	Erika A. Gary		
	Attorney Docket Number	AFF.004C5US		

48	WO 98/47252	WO		1998-10-22	Stern, Geoffrey	<input type="checkbox"/>
49	WO 00/54187	WO		2000-09-14	Rock.Com, Inc.	<input type="checkbox"/>
50	WO 00/60450	WO		2000-10-12	Khyber Technologies Corporation	<input type="checkbox"/>

If you wish to add additional Foreign Patent Document citation information please click the Add button

NON-PATENT LITERATURE DOCUMENTS

Examiner Initials*	Cite No	Include name of the author (in CAPITAL LETTERS), title of the article (when appropriate), title of the item (book, magazine, journal, serial, symposium, catalog, etc), date, pages(s), volume-issue number(s), publisher, city and/or country where published.	T ⁵
	1	MARK MOELLER, Computing Unplugged Magazine, "Product Preview, A Survey of Auto PC 2.0 for software developers," 1999-2009, Zatz Publishing, pages 1-7.	<input type="checkbox"/>
	2	MARK MOELLER, Computing Unplugged Magazine, "AutoPC Update, Auto PC/Windows CE for Automotive news bites," 1999-2009, Zatz Publishing, pages 1-4.	<input type="checkbox"/>
	3	Claim Chart for KR19990033393, Claim 17 of U.S. Patent No. 7,324,833, pages 1-3.	<input type="checkbox"/>
	4	RIO500, Getting Started Guide for Windows 98 and Macintosh OS 8.6, pages 1-2.	<input type="checkbox"/>
	5	NORBERT A. STREITZ, et al., "DOLPHIN: Integrated Meeting Support Across Local And Remote Desktop Environments And LiveBoards," Integrated Publication and Information Systems Institute, 1994, pages 345-358.	<input type="checkbox"/>
	6	LEO DEGEN, et al., "Working with Audio: Integrating Personal Tape Recorders and Desktop Computers," May 3-7, 1992, pages 413-418.	<input type="checkbox"/>

INFORMATION DISCLOSURE STATEMENT BY APPLICANT (Not for submission under 37 CFR 1.99)	Application Number	12015320
	Filing Date	2008-01-16
	First Named Inventor	Russell W. White, et al.
	Art Unit	2617
	Examiner Name	Erika A. Gary
	Attorney Docket Number	AFF.004C5US

7	H.S. JUN GIBEE, "A Virtual Information Desk On The Internet," University of Ulsan, September 1999, pages 265-268.	<input type="checkbox"/>
8	STEVE WHITTAKER, et al., "TeleNotes: Managing Lightweight Interactions in the Desktop," Lotus Development Corporation, June 1997, pages 137-168.	<input type="checkbox"/>
9	R.M. CROWDER, et al., "Integration of Manufacturing Information Using Open Hypermedia," Computer in Industry, 1999, pages 31-42.	<input type="checkbox"/>
10	TOMAS BOSTROM, et al., "Mobile Audio Distribution," Royal Institute of Technology, 1999, pages 166-172.	<input type="checkbox"/>
11	ALEX POON, et al., Xerox Disclosure Journal, Vol. 19, No. 2, "Gestural User Interface Technique for Controlling the Playback of Sequential Media," March/April 1994, pages 187-190.	<input type="checkbox"/>
12	DEB KUMAR ROY, "NewsComm: A Hand-Held Device For Interactive Access to Structured Audio," Massachusetts Institute of Technology, June 1995, pages 1-12.	<input type="checkbox"/>
13	VICTORIA BELLOTTI, et al., "Walking Away from the Desktop Computer: Distributed Collaboration and Mobility in a Product Design Team," 1996, pages 209-218.	<input type="checkbox"/>
14	UPUL OBEYSEKARE, et al., "The Visual Interactive Desktop Laboratory," January-March 1997, pages 63-71.	<input type="checkbox"/>
15	ASIM SMAILAGIC, et al., "MoCCA: A Mobile Communication and Computing Architecture," Institute for Complex Engineered Systems, pages 1-8.	<input type="checkbox"/>
16	SUI-MENG POON, et al., "Integration of Value-Added Audio Playback Capacity Into Computer Network," Nanyang Technological University, 1995, pages 632-636.	<input type="checkbox"/>
17	ERDAL PAKSOY, et al., "A variable-rate celp coder for fast remote voicemail retrieval using a notebook computer," DSPS R&D Center, Texas Instruments, 1997, pages 119-124.	<input type="checkbox"/>

INFORMATION DISCLOSURE STATEMENT BY APPLICANT (Not for submission under 37 CFR 1.99)	Application Number		12015320
	Filing Date		2008-01-16
	First Named Inventor	Russell W. White, et al.	
	Art Unit	2617	
	Examiner Name	Erika A. Gary	
	Attorney Docket Number	AFF.004C5US	

18	JEFFREY A. DAVIS, "Use of Personal Computers in Satellite Command and Control Systems," Raytheon Systems Company, October 24, 1999, pages 283-291.	<input type="checkbox"/>
19	NIKI DAVIS, "Remote Teaching Via ISDN2 And Desktop Conferencing," Exeter University School of Education, pages 1-3.	<input type="checkbox"/>
20	A CHAN, et al., "The PEP-II Project-Wide Database," Stanford University, 1996, pages 840-842.	<input type="checkbox"/>
21	KRISHNA BHARAT, et al., "Migratory Applications," Springer Berlin, Vol. 1222, 1997, pages 1-21.	<input type="checkbox"/>
22	EMPEG CAR, "MP3 in your dash," Digital Audio Player User Guide, pages 1-50.	<input type="checkbox"/>
23	MICROSOFT, "Getting Started Microsoft Windows. 98" Second Edition, 1998, pages 1-138.	<input type="checkbox"/>
24	SAUL GREENBERG, "PDAs and Shared Public Displays: Making Personal Information Public, and Public Information Personal," University of Calgary, March 1999, pages 1-11.	<input type="checkbox"/>
25	NAOHIKO KOHTAKE, et al., "InfoStick: an interaction device for Inter-Appliance Computing," Keio University, pages 1-15.	<input type="checkbox"/>
26	HEWLETT PACKARD, User's Guide, HP Jornada 420, Palm-Size PC, pages 1-75	<input type="checkbox"/>
27	MICROSOFT, "Introducing Microsoft Windows 95 - Certificate of Authenticity," 1995, pages 1-117.	<input type="checkbox"/>
28	SONY, "New Technical Theory For Servicing, MZ-R5ST Operation Manual," pages 1-44.	<input type="checkbox"/>

INFORMATION DISCLOSURE STATEMENT BY APPLICANT (Not for submission under 37 CFR 1.99)	Application Number		12015320
	Filing Date		2008-01-16
	First Named Inventor	Russell W. White, et al.	
	Art Unit		2617
	Examiner Name	Erika A. Gary	
	Attorney Docket Number		AFF.004C5US

29	RICHARD C. DAVIS, et al., "A Framework for Sharing Handwritten Notes," 1998, pages 119-120.	<input type="checkbox"/>
30	KRISHNA A. BHARAT, et al., "Migratory Applications," UIST '95, November 14-17, 1995, pages 133-142.	<input type="checkbox"/>
31	BRAD A. MYERS, "Collaboration Using Multiple PDAs Connected To A PC," Carnegie Mellon University, 1998, pages 385-294.	<input type="checkbox"/>
32	RICHARD C. DAVIS, et al., "NotePals: Lightweight Note Sharing by the Group, for the Group," May 15-20, 1999, pages 338-345.	<input type="checkbox"/>
33	JUN REKIMOTO, et al., "Augmented Surfaces: A Spatially Continuous Work Space for Hybrid Computing Environments," May 15-20, 1999, pages 378-385.	<input type="checkbox"/>
34	DAN R. OLSEN, JR., "Interacting with Chaos," September and October 1999, pages 42-54.	<input type="checkbox"/>
35	SCOTT ROBERTSON, et al., "Dual Device User Interface Design: PDAs and Interactive Television," April 13-18, 1996, pages 79-86.	<input type="checkbox"/>
36	SYMANTEC CORPORATION, "pcANYWHERE32 User's Guide," 1993-1997, pages 1-216.	<input type="checkbox"/>
37	KRISHNA BHARAT, et al., Migratory Applications, "Mobile Object Systems Towards the Programmable Internet," Springer Berlin/Heidelberg, Volume 1222/11997, 1997, pages 1-134.	<input type="checkbox"/>
38	DIAMOND MULTIMEDIA SYSTEMS, INC., "Rio PMP300, User's Guide," 1998, pages 1-27.	<input type="checkbox"/>
39	SONY, "Portable MiniDisc Recorder, Operating Instructions, MZ-R55," 1998, pages 1-42.	<input type="checkbox"/>

INFORMATION DISCLOSURE STATEMENT BY APPLICANT (Not for submission under 37 CFR 1.99)	Application Number		12015320
	Filing Date		2008-01-16
	First Named Inventor	Russell W. White, et al.	
	Art Unit	2617	
	Examiner Name	Erika A. Gary	
	Attorney Docket Number	AFF.004C5US	

40	NORBERT A. STREITZ, et al., "i-Land: An Interactive Landscape for Creativity and Innovation," Proceedings of the ACM Conference on Human Factors in Computing Systems, May 15-20, 1999, pages 120-127.	<input type="checkbox"/>
41	NORBERT A. STREITZ, et al., "Roomware for Cooperative Buildings: Integrated Design of Architectural Spaces and Information Spaces," pages 1-20	<input type="checkbox"/>
42	Direct Cable Connection screen shot, "B1U6U4," 10 pages total.	<input type="checkbox"/>
43	Direct Cable Connection screen shot, 10 pages total.	<input type="checkbox"/>
44	IBM, "WordPad z50 Cradle Option - User's Guide," 1990, pages 1-18.	<input type="checkbox"/>
45	IBM MOBILE SYSTEMS, "WorkPad z50 Mobile Companion (2608-1Ax), Hardware Maintenance Manual," March 1999, pages 1-77.	<input type="checkbox"/>
46	KEVIN JOST, Automotive Engineering International, "The car as a mobile-media platform," May 1998, pages 49-53.	<input type="checkbox"/>
47	MICROSOFT CORPORATION, "Windows CE 2.1 Technical Articles, Developing Applications for an Auto PC," June 1999, pages 1-13.	<input type="checkbox"/>
48	INFOGATION CORPORATION, "InfoGation Corp. Introduces Software Applications for Next-Generation Smart Car Systems," January 8, 1998, pages 1-2.	<input type="checkbox"/>
49	BUSINESS WIRE, "ORA Electronics Announces USB-Compatible TelCar Mark VII Begins Shipping First Quarter of 1999," January 6, 1999, pages 1-2.	<input type="checkbox"/>
50	ORA USA, "ORA Electronics Patents Telcar Cellular Telephone Interface," July 6, 1998, pages 1-2.	<input type="checkbox"/>

INFORMATION DISCLOSURE STATEMENT BY APPLICANT (Not for submission under 37 CFR 1.99)	Application Number	12015320
	Filing Date	2008-01-16
	First Named Inventor	Russell W. White, et al.
	Art Unit	2617
	Examiner Name	Erika A. Gary
	Attorney Docket Number	AFF.004C5US

If you wish to add additional non-patent literature document citation information please click the Add button			
EXAMINER SIGNATURE			
Examiner Signature	/Erika Gary/ (09/15/2010)	Date Considered	09/15/2010
*EXAMINER: Initial if reference considered, whether or not citation is in conformance with MPEP 609. Draw line through a citation if not in conformance and not considered. Include copy of this form with next communication to applicant.			
<small> ¹ See Kind Codes of USPTO Patent Documents at www.USPTO.GOV or MPEP 901.04. ² Enter office that issued the document, by the two-letter code (WIPO Standard ST.3). ³ For Japanese patent documents, the indication of the year of the reign of the Emperor must precede the serial number of the patent document. ⁴ Kind of document by the appropriate symbols as indicated on the document under WIPO Standard ST.16 if possible. ⁵ Applicant is to place a check mark here if English language translation is attached. </small>			

Doc code: IDS

Doc description: Information Disclosure Statement (IDS) Filed

PTO/SB/08a (04-09)

Approved for use through 05/31/2009. OMB 0651-0031

U.S. Patent and Trademark Office, U.S. DEPARTMENT OF COMMERCE

Under the Paperwork Reduction Act of 1995, no persons are required to respond to a collection of information unless it contains a valid OMB control number.

<p>INFORMATION DISCLOSURE STATEMENT BY APPLICANT (Not for submission under 37 CFR 1.99)</p>	Application Number		12015320	
	Filing Date		2008-01-16	
	First Named Inventor	Russell W. White, et al.		
	Art Unit	2617		
	Examiner Name	Erika A. Gary		
	Attorney Docket Number	AFF.004C5US		

U.S. PATENTS						
Examiner Initial*	Cite No	Patent Number	Kind Code ¹	Issue Date	Name of Patentee or Applicant of cited Document	Pages, Columns, Lines where Relevant Passages or Relevant Figures Appear
	1					

If you wish to add additional U.S. Patent citation information please click the Add button.

U.S. PATENT APPLICATION PUBLICATIONS						
Examiner Initial*	Cite No	Publication Number	Kind Code ¹	Publication Date	Name of Patentee or Applicant of cited Document	Pages, Columns, Lines where Relevant Passages or Relevant Figures Appear
	1					

If you wish to add additional U.S. Published Application citation information please click the Add button.

FOREIGN PATENT DOCUMENTS								
Examiner Initial*	Cite No	Foreign Document Number ³	Country Code ²ⁱ	Kind Code ⁴	Publication Date	Name of Patentee or Applicant of cited Document	Pages, Columns, Lines where Relevant Passages or Relevant Figures Appear	T ⁵
	1	WO 00/79372 A1	WO		2000-12-28	Colvin, David S.		<input type="checkbox"/>

If you wish to add additional Foreign Patent Document citation information please click the Add button

NON-PATENT LITERATURE DOCUMENTS			
Examiner Initials*	Cite No	Include name of the author (in CAPITAL LETTERS), title of the article (when appropriate), title of the item (book, magazine, journal, serial, symposium, catalog, etc), date, pages(s), volume-issue number(s), publisher, city and/or country where published.	T ⁵

INFORMATION DISCLOSURE STATEMENT BY APPLICANT (Not for submission under 37 CFR 1.99)	Application Number	12015320
	Filing Date	2008-01-16
	First Named Inventor	Russell W. White, et al.
	Art Unit	2617
	Examiner Name	Erika A. Gary
	Attorney Docket Number	AFF.004C5US

1	HEWLETT PACKARD, "HP Jomada 430/430se Palm-Size PC, User's Guide," Edition 1, 1999, pages 1-151.	<input type="checkbox"/>
2	NEC, "NEC MobilePro 750C, User's Guide," 1998, pages 1-83.	<input type="checkbox"/>
3	MICROSOFT, "Palm PC User's Guide," Microsoft Windows CE, pages 1-39.	<input type="checkbox"/>
4	PALM PC USER'S GUIDE, "Chapter 6, Information Backup and Exchange," pages 69-148	<input type="checkbox"/>
5	MPMan, "User's Guide, The Portable MP 3player using the flash memory and SmartMedia card," 1997, pages 1-35.	<input type="checkbox"/>
6	Cover Sheet, www.mpman.com, 1 page.	<input type="checkbox"/>
7	Smart Media Card Slot Diagram, 1 page.	<input type="checkbox"/>
8	MP Man F20 Logo, 1 page.	<input type="checkbox"/>
9	MPMan, "User's Guide, The portable MP3 player using the flash memory with variety features including the voice recording, phone/memo browsing, etc.," 1997, pages 1-47.	<input type="checkbox"/>
10	Smart Media card diagram and install instructions, pages 1-4.	<input type="checkbox"/>
11	ANAND LAL SHIMPI, Empeg, Ltd., "MP3 meets Car Audio: Empeg Mark II in-dash Car MP3 Player," September 18, 2000, pages 1-17.	<input type="checkbox"/>

INFORMATION DISCLOSURE STATEMENT BY APPLICANT (Not for submission under 37 CFR 1.99)	Application Number	12015320
	Filing Date	2008-01-16
	First Named Inventor	Russell W. White, et al.
	Art Unit	2617
	Examiner Name	Erika A. Gary
	Attorney Docket Number	AFF.004C5US

12	PETER CLARKE, EE Times, "Engineers drive craze for MP3 audio players," February 5, 1999, pages 1-4.	<input type="checkbox"/>
13	RIO CAR DOT ORG GEEK GUIDE, "empeg car Mk. 1," February 21, pages 1-4.	<input type="checkbox"/>
14	HUGO FIENNES, RIO CAR DOT ORG GEEK GUIDE, "MP3 Mobile," February 21, pages 1-4.	<input type="checkbox"/>
15	RIO CAR DOT ORG, "Frequently Asked Questions," pages 1-16.	<input type="checkbox"/>
16	DIAMOND MULTIMEDIA SYSTEMS, INC., "Rio PMP300 User's Guide," 1998, pages 1-27.	<input type="checkbox"/>
17	STEPHEN J. BUCKLEY, et al., "The Car as a Peripheral, Adapting a Portable Computer to a Vehicle Intranet," SAE Technical Paper Series, 98C030, October 19-21, 1998, pages 1-14.	<input type="checkbox"/>
18	"The MP3 Mobile," April 8, 1998, pages 1-13.	<input type="checkbox"/>
19	12-Volt Business & Technology Solutions, AutoMedia, "How the Intelligent Data Bus will impact the way you do business," November 1998, pages 1-2.	<input type="checkbox"/>
20	Press Release, "Creative Labs Launches Nomad Portable MP3 Players," April 15, 1999, pages 1-5.	<input type="checkbox"/>
21	BMW, "Betriebsanleitung Bordmonitor mit Navigation und TV," 1995, pages 1-82.	<input type="checkbox"/>
22	BMW, "Owner's Manual, On-board monitor with navigation system," 1996, pages 1-81.	<input type="checkbox"/>

INFORMATION DISCLOSURE STATEMENT BY APPLICANT (Not for submission under 37 CFR 1.99)	Application Number	12015320
	Filing Date	2008-01-16
	First Named Inventor	Russell W. White, et al.
	Art Unit	2617
	Examiner Name	Erika A. Gary
	Attorney Docket Number	AFF.004C5US

23	TRANSPERFECT/TRANSLATIONS, "True and accurate translation of the 1995 BMW Manual, from German into English," August 16, 2005, pages 1-80.	<input type="checkbox"/>
24	HEINZ SODEIKAT, "EURO-SCOUT is facing the German 1994 Market," 1994, pages 551-556.	<input type="checkbox"/>
25	Pictures of car navigation systems in a car dashboard, pages 1-11.	<input type="checkbox"/>
26	BMW, "The BMW On-Board Navigation System - Technology Takes a Remarkable Turn," 2005, pages 1-9.	<input type="checkbox"/>
27	OLDSMOBILE, "1991 Toronado/Trofeo User's Guide," 1991, pages 1-41.	<input type="checkbox"/>
28	YEPP, "Digital Sounds - yepp - YP-E32/E64102-291," October 23, 1999, pages 1-46	<input type="checkbox"/>
29		<input type="checkbox"/>
30	U.S. Provisional Application No. 60/167179, entitled "System, Method, And Device for Playing Recorded Music on a Wireless Communications Device," by Devon A. Rolf, filed November 23, 1999, pages 1-48.	<input type="checkbox"/>
31	MICROSOFT, "Getting Started, Microsoft Windows 98, For distribution with a new PC only," 1998, pages 1-145.	<input type="checkbox"/>
32	PR NEWSWIRE, "Alpine Announces Fall Release of Interface Adapter That Enables iPod Control and Playback from In-Vehicle Sound Systems," July 7, 2004, pages 1-2..	<input type="checkbox"/>
33	HA-YOUNG PARK, The Customer Times, "Portable Computer Music, MP3 File and MP3 Player rise as the Next Generation Audio Format," May 1999, pages 1-2.	<input type="checkbox"/>

INFORMATION DISCLOSURE STATEMENT BY APPLICANT (Not for submission under 37 CFR 1.99)	Application Number	12015320
	Filing Date	2008-01-16
	First Named Inventor	Russell W. White, et al.
	Art Unit	2617
	Examiner Name	Erika A. Gary
	Attorney Docket Number	AFF.004C5US

34	"MP3 Players Introduced in the Korean IT Magazines," 1998-1999, pages 1-15.	<input type="checkbox"/>
35	MpMan, "MP-F20, User's Guide, Portable MP3 player using the flash memory and a Memory card," [ages 1-16.	<input type="checkbox"/>
36	PR NEWSWIRE ASSOCIATION, INC., "Delphi's Communiport(R) Technology for Tomorrow, Today Demonstrated at Frankfurt Auto Show," September 15, 1999, pages 1-8.	<input type="checkbox"/>
37	CRAIN COMMUNIATIONS, INC., "Products," Agilent Technologies Press Release, February 21, 2000, pages 1-6.	<input type="checkbox"/>
38	THE WASHINGTON TIMES, LLC, John Hanan, Dallas Morning News, "Cars add computer, audiovisual gear," January 14, 2000, pages 1-3.	<input type="checkbox"/>

If you wish to add additional non-patent literature document citation information please click the Add button

EXAMINER SIGNATURE

Examiner Signature	/Erika Gary/ (09/15/2010)	Date Considered	09/15/2010
--------------------	---------------------------	-----------------	------------

***EXAMINER:** Initial if reference considered, whether or not citation is in conformance with MPEP 609. Draw line through a citation if not in conformance and not considered. Include copy of this form with next communication to applicant.

¹ See Kind Codes of USPTO Patent Documents at www.USPTO.GOV or MPEP 901.04. ² Enter office that issued the document, by the two-letter code (WIPO Standard ST.3). ³ For Japanese patent documents, the indication of the year of the reign of the Emperor must precede the serial number of the patent document. ⁴ Kind of document by the appropriate symbols as indicated on the document under WIPO Standard ST.16 if possible. ⁵ Applicant is to place a check mark here if English language translation is attached.

Doc. Code: EDS
 Description: Information Disclosure Statement (IDS) Filed

PTO/SB/08a (04-09)
 Approved for use through 05/31/2009. OMB 0651-0031
 U.S. Patent and Trademark Office; U.S. DEPARTMENT OF COMMERCE
 Under the Paperwork Reduction Act of 1995, no persons are required to respond to a collection of information unless it contains a valid OMB control number.

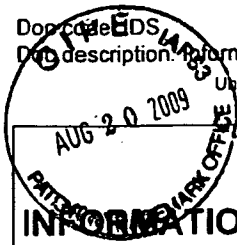

INFORMATION DISCLOSURE STATEMENT BY APPLICANT
 (Not for submission under 37 CFR 1.99)

Application Number	12015320
Filing Date	2008-01-16
First Named Inventor	Russell W. White, et al.
Art Unit	2617
Examiner Name	Erika A. Gary
Attorney Docket Number	AFF.004C5US

U.S. PATENTS

Examiner Initial*	Cite No	Patent Number	Kind Code ¹	Issue Date	Name of Patentee or Applicant of cited Document	Pages, Columns, Lines where Relevant Passages or Relevant Figures Appear
	1					

If you wish to add additional U.S. Patent citation information please click the Add button.

U.S. PATENT APPLICATION PUBLICATIONS

Examiner Initial*	Cite No	Publication Number	Kind Code ¹	Publication Date	Name of Patentee or Applicant of cited Document	Pages, Columns, Lines where Relevant Passages or Relevant Figures Appear
	1					

If you wish to add additional U.S. Published Application citation information please click the Add button.

FOREIGN PATENT DOCUMENTS

Examiner Initial*	Cite No	Foreign Document Number ³	Country Code ²ⁱ	Kind Code ⁴	Publication Date	Name of Patentee or Applicant of cited Document	Pages, Columns, Lines where Relevant Passages or Relevant Figures Appear	T ⁵
	1	2000-66974	JP		2000-03-03			<input type="checkbox"/>
	2	11-68685	JP		1999-03-09			<input type="checkbox"/>
	3	CN 1218258A	CN		1999-06-02			<input type="checkbox"/>

INFORMATION DISCLOSURE STATEMENT BY APPLICANT (Not for submission under 37 CFR 1.99)	Application Number		12015320	
	Filing Date		2008-01-16	
	First Named Inventor	Russell W. White, et al.		
	Art Unit	2617		
	Examiner Name	Erika A. Gary		
	Attorney Docket Number	AFF.004C5US		

4	H11-242686	JP		1999-09-07	Sony Corporation	<input type="checkbox"/>
5	DE 44 31 070 B4	DE		2004-07-22	DaimlerChrysler AG	<input type="checkbox"/>
6	0 569 343 A1	EP		1993-10-11	Pioneer Electronic Corporation	<input type="checkbox"/>
7	0 675 341 A1	EP		1995-04-10	Honda Giken Kogyo	<input type="checkbox"/>
8	0 771 686 A2	EP		1997-07-05	Toyota Jidosha Kabushiki Kaisha Toyota-shi, Aichi-	<input type="checkbox"/>
9	H4-261576	JP		1992-09-17	Mitsubishi Electric Corporation	<input type="checkbox"/>
10	2-301330	JP		1990-12-13		<input type="checkbox"/>
11	5-294250	JP		1993-11-09		<input type="checkbox"/>
12	6-187597	JP		1994-07-08		<input type="checkbox"/>
13	JP6289118	JP		1994-10-18	Sega Enterprises KK	<input type="checkbox"/>
14	JP6294659	JP		1994-10-21	Dainippon Printing Co. LTD.	<input type="checkbox"/>

INFORMATION DISCLOSURE STATEMENT BY APPLICANT (Not for submission under 37 CFR 1.99)	Application Number		12015320	
	Filing Date		2008-01-16	
	First Named Inventor	Russell W. White, et al.		
	Art Unit	2617		
	Examiner Name	Erika A. Gary		
	Attorney Docket Number	AFF.004C5US		

	15	07-129895	JP		1995-05-19	Honda Motor Co Ltd		<input type="checkbox"/>
	16	07-146155	JP		1995-06-06	Honda Motor Co Ltd		<input type="checkbox"/>
	17	7-262493	JP		1995-10-13	CSK Corporation		<input type="checkbox"/>
	18	7-262493	JP		1995-10-13			<input type="checkbox"/>
	19	JP7270171	JP		1995-10-20	Sumitomo Electronic Industries		<input type="checkbox"/>
	20	JP7036382	JP		1995-02-07	Mitsubishi Electric Corp.		<input type="checkbox"/>
	21	8-110231	JP		1996-04-30			<input type="checkbox"/>
	22	9-61514	JP		1997-03-07			<input type="checkbox"/>
	23	10-103966	JP		1998-04-24			<input type="checkbox"/>
	24	10-143349	JP		1998-05-29	Compaq Computer Corporation		<input type="checkbox"/>
	25	JP1018712	JP		1989-01-23	Mazda Motor		<input type="checkbox"/>

INFORMATION DISCLOSURE STATEMENT BY APPLICANT (Not for submission under 37 CFR 1.99)	Application Number		12015320	
	Filing Date		2008-01-16	
	First Named Inventor	Russell W. White, et al.		
	Art Unit	2617		
	Examiner Name	Erika A. Gary		
	Attorney Docket Number	AFF.004C5US		

26	JP5077679	JP		1993-03-30	Nissan Motor		<input type="checkbox"/>
27	JP59085599	JP		1984-05-17	Nissan Motor		<input type="checkbox"/>
28	JP63136828	JP		1988-06-09	Pioneer Electronic Corp.		<input type="checkbox"/>
29	63-136828	JP		1988-06-09			<input type="checkbox"/>
30	WO 96/04724	WO		1996-02-15	Emerson, Harry		<input type="checkbox"/>
31	WO 96/07110	WO		1996-03-07	British Telecommunications Public Limited Company		<input type="checkbox"/>
32	WO 97/13657	WO		1997-04-17	United Technologies Automotive, Inc.		<input type="checkbox"/>
33	H11-317061	JP		1999-11-16	Victor Company of Japan, LTD.		<input checked="" type="checkbox"/>
34	2901445	JP		1999-03-19	Kenwood Corporation		<input checked="" type="checkbox"/>
35	WO 99/35009	WO		1999-07-15	Microsoft Corporation		<input type="checkbox"/>
36	11-219580	JP		1999-08-10			<input type="checkbox"/>

INFORMATION DISCLOSURE STATEMENT BY APPLICANT (Not for submission under 37 CFR 1.99)	Application Number		12015320	
	Filing Date		2008-01-16	
	First Named Inventor	Russell W. White, et al.		
	Art Unit	2617		
	Examiner Name	Erika A. Gary		
	Attorney Docket Number	AFF.004C5US		

	37	11219580 A	JP		1999-10-08	Sony Corp		<input type="checkbox"/>
	38	1168685	JP		1999-03-09			<input type="checkbox"/>
	39	11-068685	JP		1999-09-03	Sony Corp		<input type="checkbox"/>
	40	1998-052033	JP		1998-09-25			<input type="checkbox"/>
	41	1999-0042565	JP		1999-06-15			<input type="checkbox"/>
	42	1999-0073234	KR		1999-10-05	Young-Man Lee		<input type="checkbox"/>
	43	1999-0048723	KR		1999-07-05			<input type="checkbox"/>
	44	KR2019990022030U	KR		1999-06-25	Young-Shik Cheon		<input type="checkbox"/>
	45	2000-0001465	KR		2000-01-25	Samsung Motors		<input type="checkbox"/>
	46	0142256	KR		1998-03-30			<input type="checkbox"/>
	47	WO 98/21672	WO		1998-05-22	Inergy Online, Inc.		<input type="checkbox"/>

INFORMATION DISCLOSURE STATEMENT BY APPLICANT (Not for submission under 37 CFR 1.99)	Application Number		12015320	
	Filing Date		2008-01-16	
	First Named Inventor	Russell W. White, et al.		
	Art Unit	2617		
	Examiner Name	Erika A. Gary		
	Attorney Docket Number	AFF.004C5US		

	48	WO 98/47252	WO		1998-10-22	Stem, Geoffrey		<input type="checkbox"/>
	49	WO 00/54187	WO		2000-09-14	Rock.Com, Inc.		<input type="checkbox"/>
	50	WO 00/60450	WO		2000-10-12	Khyber Technologies Corporation		<input type="checkbox"/>

If you wish to add additional Foreign Patent Document citation information please click the Add button

NON-PATENT LITERATURE DOCUMENTS

Examiner Initials*	Cite No	Include name of the author (in CAPITAL LETTERS), title of the article (when appropriate), title of the item (book, magazine, journal, serial, symposium, catalog, etc), date, pages(s), volume-issue number(s), publisher, city and/or country where published.	T ⁵
	1	MARK MOELLER, Computing Unplugged Magazine, "Product Preview, A Survey of Auto PC 2.0 for software developers," 1999-2009, Zatz Publishing, pages 1-7.	<input type="checkbox"/>
	2	MARK MOELLER, Computing Unplugged Magazine, "AutoPC Update, Auto PC/Windows CE for Automotive news bites," 1999-2009, Zatz Publishing, pages 1-4.	<input type="checkbox"/>
	3	Claim Chart for KR19990033393, Claim 17 of U.S. Patent No. 7,324,833, pages 1-3.	<input type="checkbox"/>
	4	RIO500, Getting Started Guide for Windows 98 and Macintosh OS 8.6, pages 1-2.	<input type="checkbox"/>
	5	NORBERT A. STREITZ, et al., "DOLPHIN: Integrated Meeting Support Across Local And Remote Desktop Environments And LiveBoards," Integrated Publication and Information Systems Institute, 1994, pages 345-358.	<input type="checkbox"/>
	6	LEO DEGEN, et al., "Working with Audio: Integrating Personal Tape Recorders and Desktop Computers," May 3-7, 1992, pages 413-418.	<input type="checkbox"/>

INFORMATION DISCLOSURE STATEMENT BY APPLICANT (Not for submission under 37 CFR 1.99)	Application Number		12015320
	Filing Date		2008-01-16
	First Named Inventor	Russell W. White, et al.	
	Art Unit	2617	
	Examiner Name	Erika A. Gary	
	Attorney Docket Number	AFF.004C5US	

7	H.S. JUN GIBEE, "A Virtual Information Desk On The Internet," University of Ulsan, September 1999, pages 265-268.	<input type="checkbox"/>
8	STEVE WHITTAKER, et al., "TeleNotes: Managing Lightweight Interactions in the Desktop," Lotus Development Corporation, June 1997, pages 137-168.	<input type="checkbox"/>
9	R.M. CROWDER, et al., "Integration of Manufacturing Information Using Open Hypermedia," Computer in Industry, 1999, pages 31-42.	<input type="checkbox"/>
10	TOMAS BOSTROM, et al., "Mobile Audio Distribution," Royal Institute of Technology, 1999, pages 166-172.	<input type="checkbox"/>
11	ALEX POON, et al., Xerox Disclosure Journal, Vol. 19, No. 2, "Gestural User Interface Technique for Controlling the Playback of Sequential Media," March/April 1994, pages 187-190.	<input type="checkbox"/>
12	DEB KUMAR ROY, "NewsComm: A Hand-Held Device For Interactive Access to Structured Audio," Massachusetts Institute of Technology, June 1995, pages 1-12.	<input type="checkbox"/>
13	VICTORIA BELLOTTI, et al., "Walking Away from the Desktop Computer: Distributed Collaboration and Mobility in a Product Design Team," 1996, pages 209-218.	<input type="checkbox"/>
14	UPUL OBEYSEKARE, et al., "The Visual Interactive Desktop Laboratory," January-March 1997, pages 63-71.	<input type="checkbox"/>
15	ASIM SMAILAGIC, et al., "MoCCA: A Mobile Communication and Computing Architecture," Institute for Complex Engineered Systems, pages 1-8.	<input type="checkbox"/>
16	SUI-MENG POON, et al., "Integration of Value-Added Audio Playback Capacity Into Computer Network," Nanyang Technological University, 1995, pages 632-636.	<input type="checkbox"/>
17	ERDAL PAKSOY, et al., "A variable-rate celp coder for fast remote voicemail retrieval using a notebook computer," DSPS R&D Center, Texas Instruments, 1997, pages 119-124.	<input type="checkbox"/>

INFORMATION DISCLOSURE STATEMENT BY APPLICANT (Not for submission under 37 CFR 1.99)	Application Number		12015320
	Filing Date		2008-01-16
	First Named Inventor	Russell W. White, et al.	
	Art Unit	2617	
	Examiner Name	Erika A. Gary	
	Attorney Docket Number	AFF.004C5US	

18	JEFFREY A. DAVIS, "Use of Personal Computers in Satellite Command and Control Systems," Raytheon Systems Company, October 24, 1999, pages 283-291.	<input type="checkbox"/>
19	NIKI DAVIS, "Remote Teaching Via ISDN2 And Desktop Conferencing," Exeter University School of Education, pages 1-3.	<input type="checkbox"/>
20	A CHAN, et al., "The PEP-II Project-Wide Database," Stanford University, 1996, pages 840-842.	<input type="checkbox"/>
21	KRISHNA BHARAT, et al., "Migratory Applications," Springer Berlin, Vol. 1222, 1997, pages 1-21.	<input type="checkbox"/>
22	EMPEG CAR, "MP3 in your dash," Digital Audio Player User Guide, pages 1-50.	<input type="checkbox"/>
23	MICROSOFT, "Getting Started Microsoft. Windows. 98" Second Edition, 1998, pages 1-138.	<input type="checkbox"/>
24	SAUL GREENBERG, "PDAs and Shared Public Displays: Making Personal Information Public, and Public Information Personal," University of Calgary, March 1999, pages 1-11.	<input type="checkbox"/>
25	NAOHIKO KOHTAKE, et al., "InfoStick: an interaction device for Inter-Appliance Computing," Keio University, pages 1-15.	<input type="checkbox"/>
26	HEWLETT PACKARD, User's Guide, HP Jornada 420, Palm-Size PC, pages 1-75	<input type="checkbox"/>
27	MICROSOFT, "Introducing Microsoft Windows 95 - Certificate of Authenticity," 1995, pages 1-117.	<input type="checkbox"/>
28	SONY, "New Technical Theory For Servicing, MZ-R5ST Operation Manual," pages 1-44.	<input type="checkbox"/>

INFORMATION DISCLOSURE STATEMENT BY APPLICANT (Not for submission under 37 CFR 1.99)	Application Number	12015320
	Filing Date	2008-01-16
	First Named Inventor	Russell W. White, et al.
	Art Unit	2617
	Examiner Name	Erika A. Gary
	Attorney Docket Number	AFF.004C5US

29	RICHARD C. DAVIS, et al., "A Framework for Sharing Handwritten Notes," 1998, pages 119-120.	<input type="checkbox"/>
30	KRISHNA A. BHARAT, et al., "Migratory Applications," UIST '95, November 14-17, 1995, pages 133-142.	<input type="checkbox"/>
31	BRAD A. MYERS, "Collaboration Using Multiple PDAs Connected To A PC," Carnegie Mellon University, 1998, pages 385-294.	<input type="checkbox"/>
32	RICHARD C. DAVIS, et al., "NotePals: Lightweight Note Sharing by the Group, for the Group," May 15-20, 1999, pages 338-345.	<input type="checkbox"/>
33	JUN REKIMOTO, et al., "Augmented Surfaces: A Spatially Continuous Work Space for Hybrid Computing Environments," May 15-20, 1999, pages 378-385.	<input type="checkbox"/>
34	DAN R. OLSEN, JR., "Interacting with Chaos," September and October 1999, pages 42-54.	<input type="checkbox"/>
35	SCOTT ROBERTSON, et al., "Dual Device User Interface Design: PDAs and Interactive Television," April 13-18, 1996, pages 79-86.	<input type="checkbox"/>
36	SYMANTEC CORPORATION, "pcANYWHERE32 User's Guide," 1993-1997, pages 1-216.	<input type="checkbox"/>
37	KRISHNA BHARAT, et al., Migratory Applications, "Mobile Object Systems Towards the Programmable Internet," Springer Berlin/Heidelberg, Volume 1222/11997, 1997, pages 1-134.	<input type="checkbox"/>
38	DIAMOND MULTIMEDIA SYSTEMS, INC., "Rio PMP300, User's Guide," 1998, pages 1-27.	<input type="checkbox"/>
39	SONY, "Portable MiniDisc Recorder, Operating Instructions, MZ-R55," 1998, pages 1-42.	<input type="checkbox"/>

INFORMATION DISCLOSURE STATEMENT BY APPLICANT (Not for submission under 37 CFR 1.99)	Application Number	12015320
	Filing Date	2008-01-16
	First Named Inventor	Russell W. White, et al.
	Art Unit	2617
	Examiner Name	Erika A. Gary
	Attorney Docket Number	AFF.004C5US

40	NORBERT A. STREITZ, et al., "i-Land: An Interactive Landscape for Creativity and Innovation," Proceedings of the ACM Conference on Human Factors in Computing Systems, May 15-20, 1999, pages 120-127.	<input type="checkbox"/>
41	NORBERT A. STREITZ, et al., "Roomware for Cooperative Buildings: Integrated Design of Architectural Spaces and Information Spaces," pages 1-20	<input type="checkbox"/>
42	Direct Cable Connection screen shot, "B1U6U4," 10 pages total.	<input type="checkbox"/>
43	Direct Cable Connection screen shot, 10 pages total.	<input type="checkbox"/>
44	IBM, "WordPad z50 Cradle Option - User's Guide," 1990, pages 1-18.	<input type="checkbox"/>
45	IBM MOBILE SYSTEMS, "WorkPad z50 Mobile Companion (2608-1Ax), Hardware Maintenance Manual," March 1999, pages 1-77.	<input type="checkbox"/>
46	KEVIN JOST, Automotive Engineering International, "The car as a mobile-media platform," May 1998, pages 49-53.	<input type="checkbox"/>
47	MICROSOFT CORPORATION, "Windows CE 2.1 Technical Articles, Developing Applications for an Auto PC," June 1999, pages 1-13.	<input type="checkbox"/>
48	INFOGATION CORPORATION, "InfoGation Corp. Introduces Software Applications for Next-Generation Smart Car Systems," January 8, 1998, pages 1-2.	<input type="checkbox"/>
49	BUSINESS WIRE, "ORA Electronics Announces USB-Compatible TelCar Mark VII Begins Shipping First Quarter of 1999," January 6, 1999, pages 1-2.	<input type="checkbox"/>
50	ORA USA, "ORA Electronics Patents Telcar Cellular Telephone Interface," July 6, 1998, pages 1-2.	<input type="checkbox"/>

INFORMATION DISCLOSURE STATEMENT BY APPLICANT (Not for submission under 37 CFR 1.99)	Application Number		12015320	
	Filing Date		2008-01-16	
	First Named Inventor	Russell W. White, et al.		
	Art Unit	2617		
	Examiner Name	Erika A. Gary		
	Attorney Docket Number	AFF.004C5US		

If you wish to add additional non-patent literature document citation information please click the Add button			
EXAMINER SIGNATURE			
Examiner Signature	/Erika Gary/ (09/15/2010)		Date Considered
09/15/2010			
<p>*EXAMINER: Initial if reference considered, whether or not citation is in conformance with MPEP 609. Draw line through a citation if not in conformance and not considered. Include copy of this form with next communication to applicant.</p>			
<p><small>¹ See Kind Codes of USPTO Patent Documents at www.USPTO.GOV or MPEP 901.04. ² Enter office that issued the document, by the two-letter code (WIPO Standard ST.3). ³ For Japanese patent documents, the indication of the year of the reign of the Emperor must precede the serial number of the patent document. ⁴ Kind of document by the appropriate symbols as indicated on the document under WIPO Standard ST.16 if possible. ⁵ Applicant is to place a check mark here if English language translation is attached.</small></p>			

Doc page: 265
 Description: Information Disclosure Statement (IDS) Filed

PTO/SB/08a (04-09)
 Approved for use through 05/31/2009. OMB 0651-0031
 U.S. Patent and Trademark Office; U.S. DEPARTMENT OF COMMERCE
 Under the Paperwork Reduction Act of 1995, no persons are required to respond to a collection of information unless it contains a valid OMB control number.

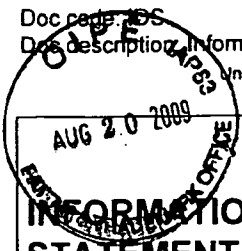

INFORMATION DISCLOSURE STATEMENT BY APPLICANT
 (Not for submission under 37 CFR 1.99)

Application Number		12015320
Filing Date		2008-01-16
First Named Inventor	Russell W. White, et al.	
Art Unit	2617	
Examiner Name	Erika A. Gary	
Attorney Docket Number	AFF.004C5US	

U.S. PATENTS

Examiner Initial*	Cite No	Patent Number	Kind Code ¹	Issue Date	Name of Patentee or Applicant of cited Document	Pages, Columns, Lines where Relevant Passages or Relevant Figures Appear
	1					

If you wish to add additional U.S. Patent citation information please click the Add button.

U.S. PATENT APPLICATION PUBLICATIONS

Examiner Initial*	Cite No	Publication Number	Kind Code ¹	Publication Date	Name of Patentee or Applicant of cited Document	Pages, Columns, Lines where Relevant Passages or Relevant Figures Appear
	1					

If you wish to add additional U.S. Published Application citation information please click the Add button.

FOREIGN PATENT DOCUMENTS

Examiner Initial*	Cite No	Foreign Document Number ³	Country Code ²	Kind Code ⁴	Publication Date	Name of Patentee or Applicant of cited Document	Pages, Columns, Lines where Relevant Passages or Relevant Figures Appear	T ⁵
	1	WO 00/79372 A1	WO		2000-12-28	Colvin, David S.		<input type="checkbox"/>

If you wish to add additional Foreign Patent Document citation information please click the Add button

NON-PATENT LITERATURE DOCUMENTS

Examiner Initials*	Cite No	Include name of the author (in CAPITAL LETTERS), title of the article (when appropriate), title of the item (book, magazine, journal, serial, symposium, catalog, etc), date, pages(s), volume-issue number(s), publisher, city and/or country where published.	T ⁵

INFORMATION DISCLOSURE STATEMENT BY APPLICANT (Not for submission under 37 CFR 1.99)	Application Number		12015320
	Filing Date		2008-01-16
	First Named Inventor	Russell W. White, et al.	
	Art Unit	2617	
	Examiner Name	Erika A. Gary	
	Attorney Docket Number	AFF.004C5US	

1	HEWLETT PACKARD, "HP Jomada 430/430se Palm-Size PC, User's Guide," Edition 1, 1999, pages 1-151.	<input type="checkbox"/>
2	NEC, "NEC MobilePro 750C, User's Guide," 1998, pages 1-83.	<input type="checkbox"/>
3	MICROSOFT, "Palm PC User's Guide," Microsoft Windows CE, pages 1-39.	<input type="checkbox"/>
4	PALM PC USER'S GUIDE, "Chapter 6, Information Backup and Exchange," pages 69-148	<input type="checkbox"/>
5	MPMan, "User's Guide, The Portable MP 3player using the flash memory and SmartMedia card," 1997, pages 1-35.	<input type="checkbox"/>
6	Cover Sheet, www.mpman.com, 1 page.	<input type="checkbox"/>
7	Smart Media Card Slot Diagram, 1 page.	<input type="checkbox"/>
8	MP Man F20 Logo, 1 page.	<input type="checkbox"/>
9	MPMan, "User's Guide, The portable MP3 player using the flash memory with variety features including the voice recording, phone/memo browsing, etc.," 1997, pages 1-47.	<input type="checkbox"/>
10	Smart Media card diagram and install instructions, pages 1-4.	<input type="checkbox"/>
11	ANAND LAL SHIMPI, Empeg, Ltd., "MP3 meets Car Audio: Empeg Mark II in-dash Car MP3 Player," September 18, 2000, pages 1-17.	<input type="checkbox"/>

INFORMATION DISCLOSURE STATEMENT BY APPLICANT (Not for submission under 37 CFR 1.99)	Application Number	12015320
	Filing Date	2008-01-16
	First Named Inventor	Russell W. White, et al.
	Art Unit	2617
	Examiner Name	Erika A. Gary
	Attorney Docket Number	AFF.004C5US

12	PETER CLARKE, EE Times, "Engineers drive craze for MP3 audio players," February 5, 1999, pages 1-4.	<input type="checkbox"/>
13	RIO CAR DOT ORG GEEK GUIDE, "empeg car Mk. 1," February 21, pages 1-4.	<input type="checkbox"/>
14	HUGO FIENNES, RIO CAR DOT ORG GEEK GUIDE, "MP3 Mobile," February 21, pages 1-4.	<input type="checkbox"/>
15	RIO CAR DOT ORG, "Frequently Asked Questions," pages 1-16.	<input type="checkbox"/>
16	DIAMOND MULTIMEDIA SYSTEMS, INC., "Rio PMP300 User's Guide," 1998, pages 1-27.	<input type="checkbox"/>
17	STEPHEN J. BUCKLEY, et al., "The Car as a Peripheral, Adapting a Portable Computer to a Vehicle Intranet," SAE Technical Paper Series, 98C030, October 19-21, 1998, pages 1-14.	<input type="checkbox"/>
18	"The MP3 Mobile," April 8, 1998, pages 1-13.	<input type="checkbox"/>
19	12-Volt Business & Technology Solutions, AutoMedia, "How the Intelligent Data Bus will impact the way you do business," November 1998, pages 1-2.	<input type="checkbox"/>
20	Press Release, "Creative Labs Launches Nomad Portable MP3 Players," April 15, 1999, pages 1-5.	<input type="checkbox"/>
21	BMW, "Betriebsanleitung Bordmonitor mit Navigation und TV," 1995, pages 1-82.	<input type="checkbox"/>
22	BMW, "Owner's Manual, On-board monitor with navigation system," 1996, pages 1-81.	<input type="checkbox"/>

INFORMATION DISCLOSURE STATEMENT BY APPLICANT (Not for submission under 37 CFR 1.99)	Application Number		12015320
	Filing Date		2008-01-16
	First Named Inventor	Russell W. White, et al.	
	Art Unit	2617	
	Examiner Name	Erika A. Gary	
	Attorney Docket Number	AFF.004C5US	

23	TRANSPERFECT/TRANSLATIONS, "True and accurate translation of the 1995 BMW Manual, from German into English," August 16, 2005, pages 1-80.	<input type="checkbox"/>
24	HEINZ SODEIKAT, "EURO-SCOUT is facing the German 1994 Market," 1994, pages 551-556.	<input type="checkbox"/>
25	Pictures of car navigation systems in a car dashboard, pages 1-11.	<input type="checkbox"/>
26	BMW, "The BMW On-Board Navigation System - Technology Takes a Remarkable Turn," 2005, pages 1-9.	<input type="checkbox"/>
27	OLDSMOBILE, "1991 Toronado/Trofeo User's Guide," 1991, pages 1-41.	<input type="checkbox"/>
28	YEPP, "Digital Sounds - yepp - YP-E32/E64102-291," October 23, 1999, pages 1-46	<input type="checkbox"/>
29		<input type="checkbox"/>
30	U.S. Provisional Application No. 60/167179, entitled "System, Method, And Device for Playing Recorded Music on a Wireless Communications Device," by Devon A. Rolf, filed November 23, 1999, pages 1-48.	<input type="checkbox"/>
31	MICROSOFT, "Getting Started, Microsoft Windows 98, For distribution with a new PC only," 1998, pages 1-145.	<input type="checkbox"/>
32	PR NEWSWIRE, "Alpine Announces Fall Release of Interface Adapter That Enables iPod Control and Playback from In-Vehicle Sound Systems," July 7, 2004, pages 1-2..	<input type="checkbox"/>
33	HA-YOUNG PARK, The Customer Times, "Portable Computer Music, MP3 File and MP3 Player rise as the Next Generation Audio Format," May 1999, pages 1-2.	<input type="checkbox"/>

INFORMATION DISCLOSURE STATEMENT BY APPLICANT (Not for submission under 37 CFR 1.99)	Application Number	12015320
	Filing Date	2008-01-16
	First Named Inventor	Russell W. White, et al.
	Art Unit	2617
	Examiner Name	Erika A. Gary
	Attorney Docket Number	AFF.004C5US

34	"MP3 Players Introduced in the Korean IT Magazines," 1998-1999, pages 1-15.	<input type="checkbox"/>
35	MpMan, "MP-F20, User's Guide, Portable MP3 player using the flash memory and a Memory card," [ages 1-16.	<input type="checkbox"/>
36	PR NEWSWIRE ASSOCIATION, INC., "Delphi's Communiport(R) Technology for Tomorrow, Today Demonstrated at Frankfurt Auto Show," September 15, 1999, pages 1-8.	<input type="checkbox"/>
37	CRAIN COMMUNIATIONS, INC., "Products," Agilent Technologies Press Release, February 21, 2000, pages 1-6.	<input type="checkbox"/>
38	THE WASHINGTON TIMES, LLC, John Hanan, Dallas Morning News, "Cars add computer, audiovisual gear," January 14, 2000, pages 1-3.	<input type="checkbox"/>

If you wish to add additional non-patent literature document citation information please click the Add button

EXAMINER SIGNATURE

Examiner Signature	/Erika Gary/ (09/15/2010)	Date Considered	09/15/2010
--------------------	---------------------------	-----------------	------------

***EXAMINER:** Initial if reference considered, whether or not citation is in conformance with MPEP 609. Draw line through a citation if not in conformance and not considered. Include copy of this form with next communication to applicant.

¹ See Kind Codes of USPTO Patent Documents at www.USPTO.GOV or MPEP 901.04. ² Enter office that issued the document, by the two-letter code (WIPO Standard ST.3). ³ For Japanese patent documents, the indication of the year of the reign of the Emperor must precede the serial number of the patent document. ⁴ Kind of document by the appropriate symbols as indicated on the document under WIPO Standard ST.16 if possible. ⁵ Applicant is to place a check mark here if English language translation is attached.

Doc code: IDS

Doc description: Information Disclosure Statement (IDS) Filed

PTO/SB/08a (04-09)

Approved for use through 05/31/2009. OMB 0651-0031

U.S. Patent and Trademark Office; U.S. DEPARTMENT OF COMMERCE

Under the Paperwork Reduction Act of 1995, no persons are required to respond to a collection of information unless it contains a valid OMB control number.

<p>INFORMATION DISCLOSURE STATEMENT BY APPLICANT (Not for submission under 37 CFR 1.99)</p>	Application Number		12015320	
	Filing Date		2008-01-16	
	First Named Inventor	Russell W. White, et al.		
	Art Unit	2617		
	Examiner Name	Erika A. Gary		
	Attorney Docket Number	AFF.004C5US		

U.S. PATENTS						
Examiner Initial*	Cite No	Patent Number	Kind Code ¹	Issue Date	Name of Patentee or Applicant of cited Document	Pages, Columns, Lines where Relevant Passages or Relevant Figures Appear
	1					

If you wish to add additional U.S. Patent citation information please click the Add button.

U.S. PATENT APPLICATION PUBLICATIONS						
Examiner Initial*	Cite No	Publication Number	Kind Code ¹	Publication Date	Name of Patentee or Applicant of cited Document	Pages, Columns, Lines where Relevant Passages or Relevant Figures Appear
	1					

If you wish to add additional U.S. Published Application citation information please click the Add button.

FOREIGN PATENT DOCUMENTS								
Examiner Initial*	Cite No	Foreign Document Number ³	Country Code ²ⁱ	Kind Code ⁴	Publication Date	Name of Patentee or Applicant of cited Document	Pages, Columns, Lines where Relevant Passages or Relevant Figures Appear	T ⁵
	1	2000-66974	JP		2000-03-03			<input type="checkbox"/>
	2	11-68685	JP		1999-03-09			<input type="checkbox"/>
	3	CN 1218258A	CN		1999-06-02			<input type="checkbox"/>

INFORMATION DISCLOSURE STATEMENT BY APPLICANT (Not for submission under 37 CFR 1.99)	Application Number		12015320	
	Filing Date		2008-01-16	
	First Named Inventor	Russell W. White, et al.		
	Art Unit	2617		
	Examiner Name	Erika A. Gary		
	Attorney Docket Number	AFF.004C5US		

4	H11-242686	JP		1999-09-07	Sony Corporation	<input type="checkbox"/>
5	DE 44 31 070 B4	DE		2004-07-22	DaimlerChrysler AG	<input type="checkbox"/>
6	0 569 343 A1	EP		1993-10-11	Pioneer Electronic Corporation	<input type="checkbox"/>
7	0 675 341 A1	EP		1995-04-10	Honda Giken-Kogyo	<input type="checkbox"/>
8	0 771 686 A2	EP		1997-07-05	Toyota Jidosha Kabushiki Kaisha Toyota-shi, Aichi-	<input type="checkbox"/>
9	H4-261576	JP		1992-09-17	Mitsubishi Electric Corporation	<input type="checkbox"/>
10	2-301330	JP		1990-12-13		<input type="checkbox"/>
11	5-294250	JP		1993-11-09		<input type="checkbox"/>
12	6-187597	JP		1994-07-08		<input type="checkbox"/>
13	JP6289118	JP		1994-10-18	Sega Enterprises KK	<input type="checkbox"/>
14	JP6294659	JP		1994-10-21	Dainippon Printing Co. LTD.	<input type="checkbox"/>

INFORMATION DISCLOSURE STATEMENT BY APPLICANT (Not for submission under 37 CFR 1.99)	Application Number		12015320	
	Filing Date		2008-01-16	
	First Named Inventor	Russell W. White, et al.		
	Art Unit	2617		
	Examiner Name	Erika A. Gary		
	Attorney Docket Number	AFF.004C5US		

	15	07-129895	JP		1995-05-19	Honda Motor Co Ltd		<input type="checkbox"/>
	16	07-146155	JP		1995-06-06	Honda Motor Co Ltd		<input type="checkbox"/>
	17	7-262493	JP		1995-10-13	CSK Corporation		<input type="checkbox"/>
	18	7-262493	JP		1995-10-13			<input type="checkbox"/>
	19	JP7270171	JP		1995-10-20	Sumitomo Electronic Industries		<input type="checkbox"/>
	20	JP7036382	JP		1995-02-07	Mitsubishi Electric Corp.		<input type="checkbox"/>
	21	8-110231	JP		1996-04-30			<input type="checkbox"/>
	22	9-61514	JP		1997-03-07			<input type="checkbox"/>
	23	10-103966	JP		1998-04-24			<input type="checkbox"/>
	24	10-143349	JP		1998-05-29	Compaq Computer Corporation		<input type="checkbox"/>
	25	JP1018712	JP		1989-01-23	Mazda Motor		<input type="checkbox"/>

INFORMATION DISCLOSURE STATEMENT BY APPLICANT (Not for submission under 37 CFR 1.99)	Application Number		12015320	
	Filing Date		2008-01-16	
	First Named Inventor	Russell W. White, et al.		
	Art Unit	2617		
	Examiner Name	Erika A. Gary		
	Attorney Docket Number	AFF.004C5US		

	26	JP5077679	JP		1993-03-30	Nissan Motor		<input type="checkbox"/>
	27	JP59085599	JP		1984-05-17	Nissan Motor		<input type="checkbox"/>
	28	JP63136828	JP		1988-06-09	Pioneer Electronic Corp.		<input type="checkbox"/>
	29	63-136828	JP		1988-06-09			<input type="checkbox"/>
	30	WO 96/04724	WO		1996-02-15	Emerson, Harry		<input type="checkbox"/>
	31	WO 96/07110	WO		1996-03-07	British Telecommunications Public Limited Company		<input type="checkbox"/>
	32	WO 97/13657	WO		1997-04-17	United Technologies Automotive, Inc.		<input type="checkbox"/>
	33	H11-317061	JP		1999-11-16	Victor Company of Japan, LTD.		<input checked="" type="checkbox"/>
	34	2901445	JP		1999-03-19	Kenwood Corporation		<input checked="" type="checkbox"/>
	35	WO 99/35009	WO		1999-07-15	Microsoft Corporation		<input type="checkbox"/>
	36	11-219580	JP		1999-08-10			<input type="checkbox"/>

INFORMATION DISCLOSURE STATEMENT BY APPLICANT (Not for submission under 37 CFR 1.99)	Application Number		12015320	
	Filing Date		2008-01-16	
	First Named Inventor	Russell W. White, et al.		
	Art Unit	2617		
	Examiner Name	Erika A. Gary		
	Attorney Docket Number	AFF.004C5US		

	37	11219580 A	JP		1999-10-08	Sony Corp		<input type="checkbox"/>
	38	1168685	JP		1999-03-09			<input type="checkbox"/>
	39	11-068685	JP		1999-09-03	Sony Corp		<input type="checkbox"/>
	40	1998-052033	JP		1998-09-25			<input type="checkbox"/>
	41	1999-0042565	JP		1999-06-15			<input type="checkbox"/>
	42	1999-0073234	KR		1999-10-05	Young-Man Lee		<input type="checkbox"/>
	43	1999-0048723	KR		1999-07-05			<input type="checkbox"/>
	44	KR2019990022030U	KR		1999-06-25	Young-Shik Cheon		<input type="checkbox"/>
	45	2000-0001465	KR		2000-01-25	Samsung Motors		<input type="checkbox"/>
	46	0142256	KR		1998-03-30			<input type="checkbox"/>
	47	WO 98/21672	WO		1998-05-22	Inergy Online, Inc.		<input type="checkbox"/>

INFORMATION DISCLOSURE STATEMENT BY APPLICANT (Not for submission under 37 CFR 1.99)	Application Number		12015320	
	Filing Date		2008-01-16	
	First Named Inventor	Russell W. White, et al.		
	Art Unit	2617		
	Examiner Name	Erika A. Gary		
	Attorney Docket Number	AFF.004C5US		

	48	WO 98/47252	WO		1998-10-22	Stern, Geoffrey		<input type="checkbox"/>
	49	WO 00/54187	WO		2000-09-14	Rock.Com, Inc.		<input type="checkbox"/>
	50	WO 00/60450	WO		2000-10-12	Khyber Technologies Corporation		<input type="checkbox"/>

If you wish to add additional Foreign Patent Document citation information please click the Add button

NON-PATENT LITERATURE DOCUMENTS

Examiner Initials*	Cite No	Include name of the author (in CAPITAL LETTERS), title of the article (when appropriate), title of the item (book, magazine, journal, serial, symposium, catalog, etc), date, pages(s), volume-issue number(s), publisher, city and/or country where published.	T5
	1	MARK MOELLER, Computing Unplugged Magazine, "Product Preview, A Survey of Auto PC 2.0 for software developers," 1999-2009, Zatz Publishing, pages 1-7.	<input type="checkbox"/>
	2	MARK MOELLER, Computing Unplugged Magazine, "AutoPC Update, Auto PC/Windows CE for Automotive news bites," 1999-2009, Zatz Publishing, pages 1-4.	<input type="checkbox"/>
	3	Claim Chart for KR19990033393, Claim 17 of U.S. Patent No. 7,324,833, pages 1-3.	<input type="checkbox"/>
	4	RIO500, Getting Started Guide for Windows 98 and Macintosh OS 8.6, pages 1-2.	<input type="checkbox"/>
	5	NORBERT A. STREITZ, et al., "DOLPHIN: Integrated Meeting Support Across Local And Remote Desktop Environments And LiveBoards," Integrated Publication and Information Systems Institute, 1994, pages 345-358.	<input type="checkbox"/>
	6	LEO DEGEN, et al., "Working with Audio: Integrating Personal Tape Recorders and Desktop Computers," May 3-7, 1992, pages 413-418.	<input type="checkbox"/>

INFORMATION DISCLOSURE STATEMENT BY APPLICANT (Not for submission under 37 CFR 1.99)	Application Number		12015320
	Filing Date		2008-01-16
	First Named Inventor	Russell W. White, et al.	
	Art Unit		2617
	Examiner Name	Erika A. Gary	
	Attorney Docket Number		AFF.004C5US

7	H.S. JUN GIBEE, "A Virtual Information Desk On The Internet," University of Ulsan, September 1999, pages 265-268.	<input type="checkbox"/>
8	STEVE WHITTAKER, et al., "TeleNotes: Managing Lightweight Interactions in the Desktop," Lotus Development Corporation, June 1997, pages 137-168.	<input type="checkbox"/>
9	R.M. CROWDER, et al., "Integration of Manufacturing Information Using Open Hypermedia," Computer in Industry, 1999, pages 31-42.	<input type="checkbox"/>
10	TOMAS BOSTROM, et al., "Mobile Audio Distribution," Royal Institute of Technology, 1999, pages 166-172.	<input type="checkbox"/>
11	ALEX POON, et al., Xerox Disclosure Journal, Vol. 19, No. 2, "Gestural User Interface Technique for Controlling the Playback of Sequential Media," March/April 1994, pages 187-190.	<input type="checkbox"/>
12	DEB KUMAR ROY, "NewsComm: A Hand-Held Device For Interactive Access to Structured Audio," Massachusetts Institute of Technology, June 1995, pages 1-12.	<input type="checkbox"/>
13	VICTORIA BELLOTTI, et al., "Walking Away from the Desktop Computer: Distributed Collaboration and Mobility in a Product Design Team," 1996, pages 209-218.	<input type="checkbox"/>
14	UPUL OBEYSEKARE, et al., "The Visual Interactive Desktop Laboratory," January-March 1997, pages 63-71.	<input type="checkbox"/>
15	ASIM SMAILAGIC, et al., "MoCCA: A Mobile Communication and Computing Architecture," Institute for Complex Engineered Systems, pages 1-8.	<input type="checkbox"/>
16	SUI-MENG POON, et al., "Integration of Value-Added Audio Playback Capacity Into Computer Network," Nanyang Technological University, 1995, pages 632-636.	<input type="checkbox"/>
17	ERDAL PAKSOY, et al., "A variable-rate celp coder for fast remote voicemail retrieval using a notebook computer," DSPS R&D Center, Texas Instruments, 1997, pages 119-124.	<input type="checkbox"/>

INFORMATION DISCLOSURE STATEMENT BY APPLICANT (Not for submission under 37 CFR 1.99)	Application Number	12015320
	Filing Date	2008-01-16
	First Named Inventor	Russell W. White, et al.
	Art Unit	2617
	Examiner Name	Erika A. Gary
	Attorney Docket Number	AFF.004C5US

18	JEFFREY A. DAVIS, "Use of Personal Computers in Satellite Command and Control Systems," Raytheon Systems Company, October 24, 1999, pages 283-291.	<input type="checkbox"/>
19	NIKI DAVIS, "Remote Teaching Via ISDN2 And Desktop Conferencing," Exeter University School of Education, pages 1-3.	<input type="checkbox"/>
20	A CHAN, et al., "The PEP-II Project-Wide Database," Stanford University, 1996, pages 840-842.	<input type="checkbox"/>
21	KRISHNA BHARAT, et al., "Migratory Applications," Springer Berlin, Vol. 1222, 1997, pages 1-21.	<input type="checkbox"/>
22	EMPEG CAR, "MP3 in your dash," Digital Audio Player User Guide, pages 1-50.	<input type="checkbox"/>
23	MICROSOFT, "Getting Started Microsoft. Windows. 98" Second Edition, 1998, pages 1-138.	<input type="checkbox"/>
24	SAUL GREENBERG, "PDAs and Shared Public Displays: Making Personal Information Public, and Public Information Personal," University of Calgary, March 1999, pages 1-11.	<input type="checkbox"/>
25	NAOHIKO KOHTAKE, et al., "InfoStick: an interaction device for Inter-Appliance Computing," Keio University, pages 1-15.	<input type="checkbox"/>
26	HEWLETT PACKARD, User's Guide, HP Jomada 420, Palm-Size PC, pages 1-75	<input type="checkbox"/>
27	MICROSOFT, "Introducing Microsoft Windows 95 - Certificate of Authenticity," 1995, pages 1-117.	<input type="checkbox"/>
28	SONY, "New Technical Theory For Servicing, MZ-R5ST Operation Manual," pages 1-44.	<input type="checkbox"/>

INFORMATION DISCLOSURE STATEMENT BY APPLICANT (Not for submission under 37 CFR 1.99)	Application Number	12015320
	Filing Date	2008-01-16
	First Named Inventor	Russell W. White, et al.
	Art Unit	2617
	Examiner Name	Erika A. Gary
	Attorney Docket Number	AFF.004C5US

29	RICHARD C. DAVIS, et al., "A Framework for Sharing Handwritten Notes," 1998, pages 119-120.	<input type="checkbox"/>
30	KRISHNA A. BHARAT, et al., "Migratory Applications," UIST '95, November 14-17, 1995, pages 133-142.	<input type="checkbox"/>
31	BRAD A. MYERS, "Collaboration Using Multiple PDAs Connected To A PC," Carnegie Mellon University, 1998, pages 385-294.	<input type="checkbox"/>
32	RICHARD C. DAVIS, et al., "NotePals: Lightweight Note Sharing by the Group, for the Group," May 15-20, 1999, pages 338-345.	<input type="checkbox"/>
33	JUN REKIMOTO, et al., "Augmented Surfaces: A Spatially Continuous Work Space for Hybrid Computing Environments," May 15-20, 1999, pages 378-385.	<input type="checkbox"/>
34	DAN R. OLSEN, JR., "Interacting with Chaos," September and October 1999, pages 42-54.	<input type="checkbox"/>
35	SCOTT ROBERTSON, et al., "Dual Device User Interface Design: PDAs and Interactive Television," April 13-18, 1996, pages 79-86.	<input type="checkbox"/>
36	SYMANTEC CORPORATION, "pcANYWHERE32 User's Guide," 1993-1997, pages 1-216.	<input type="checkbox"/>
37	KRISHNA BHARAT, et al., Migratory Applications, "Mobile Object Systems Towards the Programmable Internet," Springer Berlin/Heidelberg, Volume 1222/11997, 1997, pages 1-134.	<input type="checkbox"/>
38	DIAMOND MULTIMEDIA SYSTEMS, INC., "Rio PMP300, User's Guide," 1998, pages 1-27.	<input type="checkbox"/>
39	SONY, "Portable MiniDisc Recorder, Operating Instructions, MZ-R55," 1998, pages 1-42.	<input type="checkbox"/>

INFORMATION DISCLOSURE STATEMENT BY APPLICANT (Not for submission under 37 CFR 1.99)	Application Number		12015320
	Filing Date		2008-01-16
	First Named Inventor	Russell W. White, et al.	
	Art Unit	2617	
	Examiner Name	Erika A. Gary	
	Attorney Docket Number	AFF.004C5US	

40	NORBERT A. STREITZ, et al., "i-Land: An Interactive Landscape for Creativity and Innovation," Proceedings of the ACM Conference on Human Factors in Computing Systems, May 15-20, 1999, pages 120-127.	<input type="checkbox"/>
41	NORBERT A. STREITZ, et al., "Roomware for Cooperative Buildings: Integrated Design of Architectural Spaces and Information Spaces," pages 1-20	<input type="checkbox"/>
42	Direct Cable Connection screen shot, "B1U6U4," 10 pages total.	<input type="checkbox"/>
43	Direct Cable Connection screen shot, 10 pages total.	<input type="checkbox"/>
44	IBM, "WordPad z50 Cradle Option - User's Guide," 1990, pages 1-18.	<input type="checkbox"/>
45	IBM MOBILE SYSTEMS, "WorkPad z50 Mobile Companion (2608-1Ax), Hardware Maintenance Manual," March 1999, pages 1-77.	<input type="checkbox"/>
46	KEVIN JOST, Automotive Engineering International, "The car as a mobile-media platform," May 1998, pages 49-53.	<input type="checkbox"/>
47	MICROSOFT CORPORATION, "Windows CE 2.1 Technical Articles, Developing Applications for an Auto PC," June 1999, pages 1-13.	<input type="checkbox"/>
48	INFOGATION CORPORATION, "InfoGation Corp. Introduces Software Applications for Next-Generation Smart Car Systems," January 8, 1998, pages 1-2.	<input type="checkbox"/>
49	BUSINESS WIRE, "ORA Electronics Announces USB-Compatible TelCar Mark VII Begins Shipping First Quarter of 1999," January 6, 1999, pages 1-2.	<input type="checkbox"/>
50	ORA USA, "ORA Electronics Patents Telcar Cellular Telephone Interface," July 6, 1998, pages 1-2.	<input type="checkbox"/>

INFORMATION DISCLOSURE STATEMENT BY APPLICANT (Not for submission under 37 CFR 1.99)	Application Number	12015320
	Filing Date	2008-01-16
	First Named Inventor	Russell W. White, et al.
	Art Unit	2617
	Examiner Name	Erika A. Gary
	Attorney Docket Number	AFF.004C5US

If you wish to add additional non-patent literature document citation information please click the Add button			
EXAMINER SIGNATURE			
Examiner Signature	/Erika Gary/ (09/15/2010)	Date Considered	09/15/2010
*EXAMINER: Initial if reference considered, whether or not citation is in conformance with MPEP 809. Draw line through a citation if not in conformance and not considered. Include copy of this form with next communication to applicant.			
<small> ¹ See Kind Codes of USPTO Patent Documents at www.USPTO.GOV or MPEP 901.04. ² Enter office that issued the document, by the two-letter code (WIPO Standard ST.3). ³ For Japanese patent documents, the indication of the year of the reign of the Emperor must precede the serial number of the patent document. ⁴ Kind of document by the appropriate symbols as indicated on the document under WIPO Standard ST.16 if possible. ⁵ Applicant is to place a check mark here if English language translation is attached. </small>			

Doc code: IDS

Doc description: Information Disclosure Statement (IDS) Filed

PTO/SB/08a (04-09)

Approved for use through 05/31/2009. OMB 0651-0031

U.S. Patent and Trademark Office; U.S. DEPARTMENT OF COMMERCE

Under the Paperwork Reduction Act of 1995, no persons are required to respond to a collection of information unless it contains a valid OMB control number.

INFORMATION DISCLOSURE STATEMENT BY APPLICANT (Not for submission under 37 CFR 1.99)	Application Number		12015320	
	Filing Date		2008-01-16	
	First Named Inventor	Russell W. White, et al.		
	Art Unit	2617		
	Examiner Name	Erika A. Gary		
	Attorney Docket Number	AFF.004C5US		

U.S. PATENTS						
Examiner Initial*	Cite No	Patent Number	Kind Code ¹	Issue Date	Name of Patentee or Applicant of cited Document	Pages, Columns, Lines where Relevant Passages or Relevant Figures Appear
	1					

If you wish to add additional U.S. Patent citation information please click the Add button.

U.S. PATENT APPLICATION PUBLICATIONS						
Examiner Initial*	Cite No	Publication Number	Kind Code ¹	Publication Date	Name of Patentee or Applicant of cited Document	Pages, Columns, Lines where Relevant Passages or Relevant Figures Appear
	1					

If you wish to add additional U.S. Published Application citation information please click the Add button.

FOREIGN PATENT DOCUMENTS								
Examiner Initial*	Cite No	Foreign Document Number ³	Country Code ²	Kind Code ⁴	Publication Date	Name of Patentee or Applicant of cited Document	Pages, Columns, Lines where Relevant Passages or Relevant Figures Appear	T ⁵
	1	WO 00/79372 A1	WO		2000-12-28	Colvin, David S.		<input type="checkbox"/>

If you wish to add additional Foreign Patent Document citation information please click the Add button

NON-PATENT LITERATURE DOCUMENTS			
Examiner Initials*	Cite No	Include name of the author (in CAPITAL LETTERS), title of the article (when appropriate), title of the item (book, magazine, journal, serial, symposium, catalog, etc), date, pages(s), volume-issue number(s), publisher, city and/or country where published.	T ⁵

<p>INFORMATION DISCLOSURE STATEMENT BY APPLICANT (Not for submission under 37 CFR 1.99)</p>	Application Number	12015320
	Filing Date	2008-01-16
	First Named Inventor	Russell W. White, et al.
	Art Unit	2617
	Examiner Name	Erika A. Gary
	Attorney Docket Number	AFF.004C5US

1	HEWLETT PACKARD, "HP Jornada 430/430se Palm-Size PC, User's Guide," Edition 1, 1999, pages 1-151.	<input type="checkbox"/>
2	NEC, "NEC MobilePro 750C, User's Guide," 1998, pages 1-83.	<input type="checkbox"/>
3	MICROSOFT, "Palm PC User's Guide," Microsoft Windows CE, pages 1-39.	<input type="checkbox"/>
4	PALM PC USER'S GUIDE, "Chapter 6, Information Backup and Exchange," pages 69-148	<input type="checkbox"/>
5	MPMan, "User's Guide, The Portable MP 3player using the flash memory and SmartMedia card," 1997, pages 1-35.	<input type="checkbox"/>
6	Cover Sheet, www.mpman.com, 1 page.	<input type="checkbox"/>
7	Smart Media Card Slot Diagram, 1 page.	<input type="checkbox"/>
8	MP Man F20 Logo, 1 page.	<input type="checkbox"/>
9	MPMan, "User's Guide, The portable MP3 player using the flash memory with variety features including the voice recording, phone/memo browsing, etc.," 1997, pages 1-47.	<input type="checkbox"/>
10	Smart Media card diagram and install instructions, pages 1-4.	<input type="checkbox"/>
11	ANAND LAL SHIMPI, Empeg, Ltd., "MP3 meets Car Audio: Empeg Mark II in-dash Car MP3 Player," September 18, 2000, pages 1-17.	<input type="checkbox"/>

INFORMATION DISCLOSURE STATEMENT BY APPLICANT (Not for submission under 37 CFR 1.99)	Application Number	12015320
	Filing Date	2008-01-16
	First Named Inventor	Russell W. White, et al.
	Art Unit	2617
	Examiner Name	Erika A. Gary
	Attorney Docket Number	AFF.004C5US

12	PETER CLARKE, EE Times, "Engineers drive craze for MP3 audio players," February 5, 1999, pages 1-4.	<input type="checkbox"/>
13	RIO CAR DOT ORG GEEK GUIDE, "empeg car Mk. 1," February 21, pages 1-4.	<input type="checkbox"/>
14	HUGO FIENNES, RIO CAR DOT ORG GEEK GUIDE, "MP3 Mobile," February 21, pages 1-4.	<input type="checkbox"/>
15	RIO CAR DOT ORG, "Frequently Asked Questions," pages 1-16.	<input type="checkbox"/>
16	DIAMOND MULTIMEDIA SYSTEMS, INC., "Rio PMP300 User's Guide," 1998, pages 1-27.	<input type="checkbox"/>
17	STEPHEN J. BUCKLEY, et al., "The Car as a Peripheral, Adapting a Portable Computer to a Vehicle Intranet," SAE Technical Paper Series, 98C030, October 19-21, 1998, pages 1-14.	<input type="checkbox"/>
18	"The MP3 Mobile," April 8, 1998, pages 1-13.	<input type="checkbox"/>
19	12-Volt Business & Technology Solutions, AutoMedia, "How the Intelligent Data Bus will impact the way you do business," November 1998, pages 1-2.	<input type="checkbox"/>
20	Press Release, "Creative Labs Launches Nomad Portable MP3 Players," April 15, 1999, pages 1-5.	<input type="checkbox"/>
21	BMW, "Betriebsanleitung Bordmonitor mit Navigation und TV," 1995, pages 1-82.	<input type="checkbox"/>
22	BMW, "Owner's Manual, On-board monitor with navigation system," 1996, pages 1-81.	<input type="checkbox"/>

INFORMATION DISCLOSURE STATEMENT BY APPLICANT (Not for submission under 37 CFR 1.99)	Application Number	12015320
	Filing Date	2008-01-16
	First Named Inventor	Russell W. White, et al.
	Art Unit	2617
	Examiner Name	Erika A. Gary
	Attorney Docket Number	AFF.004C5US

23	TRANSPERFECT/TRANSLATIONS, "True and accurate translation of the 1995 BMW Manual, from German into English," August 16, 2005, pages 1-80.	<input type="checkbox"/>
24	HEINZ SODEIKAT, "EURO-SCOUT is facing the German 1994 Market," 1994, pages 551-556.	<input type="checkbox"/>
25	Pictures of car navigation systems in a car dashboard, pages 1-11.	<input type="checkbox"/>
26	BMW, "The BMW On-Board Navigation System - Technology Takes a Remarkable Turn," 2005, pages 1-9.	<input type="checkbox"/>
27	OLDSMOBILE, "1991 Toronado/Trofeo User's Guide," 1991, pages 1-41.	<input type="checkbox"/>
28	YEPP, "Digital Sounds - yepp - YP-E32/E64102-291," October 23, 1999, pages 1-46	<input type="checkbox"/>
29		<input type="checkbox"/>
30	U.S. Provisional Application No. 60/167179, entitled "System, Method, And Device for Playing Recorded Music on a Wireless Communications Device," by Devon A. Rolf, filed November 23, 1999, pages 1-48.	<input type="checkbox"/>
31	MICROSOFT, "Getting Started, Microsoft Windows 98, For distribution with a new PC only," 1998, pages 1-145.	<input type="checkbox"/>
32	PR NEWSWIRE, "Alpine Announces Fall Release of Interface Adapter That Enables iPod Control and Playback from In-Vehicle Sound Systems," July 7, 2004, pages 1-2..	<input type="checkbox"/>
33	HA-YOUNG PARK, The Customer Times, "Portable Computer Music, MP3 File and MP3 Player rise as the Next Generation Audio Format," May 1999, pages 1-2.	<input type="checkbox"/>

INFORMATION DISCLOSURE STATEMENT BY APPLICANT (Not for submission under 37 CFR 1.99)	Application Number	12015320
	Filing Date	2008-01-16
	First Named Inventor	Russell W. White, et al.
	Art Unit	2617
	Examiner Name	Erika A. Gary
	Attorney Docket Number	AFF.004C5US

34	"MP3 Players Introduced in the Korean IT Magazines," 1998-1999, pages 1-15.	<input type="checkbox"/>
35	MpMan, "MP-F20, User's Guide, Portable MP3 player using the flash memory and a Memory card," (ages 1-16.	<input type="checkbox"/>
36	PR NEWSWIRE ASSOCIATION, INC., "Delphi's Communiport(R) Technology for Tomorrow, Today Demonstrated at Frankfurt Auto Show," September 15, 1999, pages 1-8.	<input type="checkbox"/>
37	CRAIN COMMUNIATIONS, INC., "Products," Agilent Technologies Press Release, February 21, 2000, pages 1-6.	<input type="checkbox"/>
38	THE WASHINGTON TIMES, LLC, John Hanan, Dallas Morning News, "Cars add computer, audiovisual gear," January 14, 2000, pages 1-3.	<input type="checkbox"/>

If you wish to add additional non-patent literature document citation information please click the Add button

EXAMINER SIGNATURE

Examiner Signature	/Erika Gary/ (09/15/2010)	Date Considered	09/15/2010
--------------------	---------------------------	-----------------	------------

***EXAMINER:** Initial if reference considered, whether or not citation is in conformance with MPEP 609. Draw line through a citation if not in conformance and not considered. Include copy of this form with next communication to applicant.

¹ See Kind Codes of USPTO Patent Documents at www.USPTO.GOV or MPEP 901.04. ² Enter office that issued the document, by the two-letter code (WIPO Standard ST.3). ³ For Japanese patent documents, the indication of the year of the reign of the Emperor must precede the serial number of the patent document. ⁴ Kind of document by the appropriate symbols as indicated on the document under WIPO Standard ST.16 if possible. ⁵ Applicant is to place a check mark here if English language translation is attached.

Doc code: IDS

Doc description: Information Disclosure Statement (IDS) Filed

PTO/SB/08a (04-09)

Approved for use through 05/31/2009. OMB 0851-0031
U.S. Patent and Trademark Office; U.S. DEPARTMENT OF COMMERCE

Under the Paperwork Reduction Act of 1995, no persons are required to respond to a collection of information unless it contains a valid OMB control number.

INFORMATION DISCLOSURE STATEMENT BY APPLICANT (Not for submission under 37 CFR 1.99)	Application Number		12015320	
	Filing Date		2008-01-16	
	First Named Inventor	Russell W. White, et al.		
	Art Unit	2617		
	Examiner Name	Erika A. Gary		
	Attorney Docket Number	AFF.004C5US		

U.S.PATENTS						
Examiner Initial*	Cite No	Patent Number	Kind Code ¹	Issue Date	Name of Patentee or Applicant of cited Document	Pages, Columns, Lines where Relevant Passages or Relevant Figures Appear
	1					

If you wish to add additional U.S. Patent citation information please click the Add button.

U.S.PATENT APPLICATION PUBLICATIONS						
Examiner Initial*	Cite No	Publication Number	Kind Code ¹	Publication Date	Name of Patentee or Applicant of cited Document	Pages, Columns, Lines where Relevant Passages or Relevant Figures Appear
	1					

If you wish to add additional U.S. Published Application citation information please click the Add button.

FOREIGN PATENT DOCUMENTS								
Examiner Initial*	Cite No	Foreign Document Number ³	Country Code ² i	Kind Code ⁴	Publication Date	Name of Patentee or Applicant of cited Document	Pages, Columns, Lines where Relevant Passages or Relevant Figures Appear	T ⁵
	1	2000-66974	JP		2000-03-03			<input type="checkbox"/>
	2	11-68685	JP		1999-03-09			<input type="checkbox"/>
	3	CN 1218258A	CN		1999-06-02			<input type="checkbox"/>

INFORMATION DISCLOSURE STATEMENT BY APPLICANT (Not for submission under 37 CFR 1.99)	Application Number		12015320	
	Filing Date		2008-01-16	
	First Named Inventor	Russell W. White, et al.		
	Art Unit		2617	
	Examiner Name	Erika A. Gary		
	Attorney Docket Number		AFF.004C5US	

4	H11-242686	JP		1999-09-07	Sony Corporation		<input type="checkbox"/>
5	DE 44 31 070 B4	DE		2004-07-22	DaimlerChrysler AG		<input type="checkbox"/>
6	0 569 343 A1	EP		1993-10-11	Pioneer Electronic Corporation		<input type="checkbox"/>
7	0 675 341 A1	EP		1995-04-10	Honda Giken Kogyo		<input type="checkbox"/>
8	0 771 686 A2	EP		1997-07-05	Toyota Jidosha Kabushiki Kaisha Toyota-shi, Aichi-		<input type="checkbox"/>
9	H4-261576	JP		1992-09-17	Mitsubishi Electric Corporation		<input type="checkbox"/>
10	2-301330	JP		1990-12-13			<input type="checkbox"/>
11	5-294250	JP		1993-11-09			<input type="checkbox"/>
12	6-187597	JP		1994-07-08			<input type="checkbox"/>
13	JP6289118	JP		1994-10-18	Sega Enterprises KK		<input type="checkbox"/>
14	JP6294659	JP		1994-10-21	Dainippon Printing Co. LTD.		<input type="checkbox"/>

INFORMATION DISCLOSURE STATEMENT BY APPLICANT (Not for submission under 37 CFR 1.99)	Application Number		12015320	
	Filing Date		2008-01-16	
	First Named Inventor	Russell W. White, et al.		
	Art Unit	2617		
	Examiner Name	Erika A. Gary		
	Attorney Docket Number	AFF.004C5US		

	15	07-129895	JP		1995-05-19	Honda Motor Co Ltd		<input type="checkbox"/>
	16	07-146155	JP		1995-06-06	Honda Motor Co Ltd		<input type="checkbox"/>
	17	7-262493	JP		1995-10-13	CSK Corporation		<input type="checkbox"/>
	18	7-262493	JP		1995-10-13			<input type="checkbox"/>
	19	JP7270171	JP		1995-10-20	Sumitomo Electronic Industries		<input type="checkbox"/>
	20	JP7036382	JP		1995-02-07	Mitsubishi Electric Corp.		<input type="checkbox"/>
	21	8-110231	JP		1996-04-30			<input type="checkbox"/>
	22	9-61514	JP		1997-03-07			<input type="checkbox"/>
	23	10-103966	JP		1998-04-24			<input type="checkbox"/>
	24	10-143349	JP		1998-05-29	Compaq Computer Corporation		<input type="checkbox"/>
	25	JP1018712	JP		1989-01-23	Mazda Motor		<input type="checkbox"/>

INFORMATION DISCLOSURE STATEMENT BY APPLICANT (Not for submission under 37 CFR 1.99)	Application Number		12015320	
	Filing Date		2008-01-16	
	First Named Inventor	Russell W. White, et al.		
	Art Unit		2617	
	Examiner Name	Erika A. Gary		
	Attorney Docket Number		AFF.004C5US	

	26	JP5077679	JP		1993-03-30	Nissan Motor	<input type="checkbox"/>
	27	JP59085599	JP		1984-05-17	Nissan Motor	<input type="checkbox"/>
	28	JP63136828	JP		1988-06-09	Pioneer Electronic Corp.	<input type="checkbox"/>
	29	63-136828	JP		1988-06-09		<input type="checkbox"/>
	30	WO 96/04724	WO		1996-02-15	Emerson, Harry	<input type="checkbox"/>
	31	WO 96/07110	WO		1996-03-07	British Telecommunications Public Limited Company	<input type="checkbox"/>
	32	WO 97/13657	WO		1997-04-17	United Technologies Automotive, Inc.	<input type="checkbox"/>
	33	H11-317061	JP		1999-11-16	Victor Company of Japan, LTD.	<input checked="" type="checkbox"/>
	34	2901445	JP		1999-03-19	Kenwood Corporation	<input checked="" type="checkbox"/>
	35	WO 99/35009	WO		1999-07-15	Microsoft Corporation	<input type="checkbox"/>
	36	11-219580	JP		1999-08-10		<input type="checkbox"/>

INFORMATION DISCLOSURE STATEMENT BY APPLICANT (Not for submission under 37 CFR 1.99)	Application Number		12015320	
	Filing Date		2008-01-16	
	First Named Inventor	Russell W. White, et al.		
	Art Unit	2617		
	Examiner Name	Erika A. Gary		
	Attorney Docket Number	AFF.004C5US		

	37	11219580 A	JP		1999-10-08	Sony Corp		<input type="checkbox"/>
	38	1168685	JP		1999-03-09			<input type="checkbox"/>
	39	11-068685	JP		1999-09-03	Sony Corp		<input type="checkbox"/>
	40	1998-052033	JP		1998-09-25			<input type="checkbox"/>
	41	1999-0042565	JP		1999-06-15			<input type="checkbox"/>
	42	1999-0073234	KR		1999-10-05	Young-Man Lee		<input type="checkbox"/>
	43	1999-0048723	KR		1999-07-05			<input type="checkbox"/>
	44	KR2019990022030U	KR		1999-06-25	Young-Shik Cheon		<input type="checkbox"/>
	45	2000-0001465	KR		2000-01-25	Samsung Motors		<input type="checkbox"/>
	46	0142256	KR		1998-03-30			<input type="checkbox"/>
	47	WO 98/21672	WO		1998-05-22	Inergy Online, Inc.		<input type="checkbox"/>

INFORMATION DISCLOSURE STATEMENT BY APPLICANT (Not for submission under 37 CFR 1.99)	Application Number		12015320	
	Filing Date		2008-01-16	
	First Named Inventor	Russell W. White, et al.		
	Art Unit	2617		
	Examiner Name	Erika A. Gary		
	Attorney Docket Number	AFF.004C5US		

48	WO 98/47252	WO		1998-10-22	Stern, Geoffrey	<input type="checkbox"/>
49	WO 00/54187	WO		2000-09-14	Rock.Com, Inc.	<input type="checkbox"/>
50	WO 00/60450	WO		2000-10-12	Khyber Technologies Corporation	<input type="checkbox"/>

If you wish to add additional Foreign Patent Document citation information please click the Add button

NON-PATENT LITERATURE DOCUMENTS

Examiner Initials*	Cite No	Include name of the author (in CAPITAL LETTERS), title of the article (when appropriate), title of the item (book, magazine, journal, serial, symposium, catalog, etc), date, pages(s), volume-issue number(s), publisher, city and/or country where published.	T ^s
	1	MARK MOELLER, Computing Unplugged Magazine, "Product Preview, A Survey of Auto PC 2.0 for software developers," 1999-2009, Zatz Publishing, pages 1-7.	<input type="checkbox"/>
	2	MARK MOELLER, Computing Unplugged Magazine, "AutoPC Update, Auto PC/Windows CE for Automotive news bites," 1999-2009, Zatz Publishing, pages 1-4.	<input type="checkbox"/>
	3	Claim Chart for KR19990033393, Claim 17 of U.S. Patent No. 7,324,833, pages 1-3.	<input type="checkbox"/>
	4	RIO500, Getting Started Guide for Windows 98 and Macintosh OS 8.6, pages 1-2.	<input type="checkbox"/>
	5	NORBERT A. STREITZ, et al., "DOLPHIN: Integrated Meeting Support Across Local And Remote Desktop Environments And LiveBoards," Integrated Publication and Information Systems Institute, 1994, pages 345-358.	<input type="checkbox"/>
	6	LEO DEGEN, et al., "Working with Audio: Integrating Personal Tape Recorders and Desktop Computers," May 3-7, 1992, pages 413-418.	<input type="checkbox"/>

INFORMATION DISCLOSURE STATEMENT BY APPLICANT (Not for submission under 37 CFR 1.99)	Application Number	12015320
	Filing Date	2008-01-16
	First Named Inventor	Russell W. White, et al.
	Art Unit	2617
	Examiner Name	Erika A. Gary
	Attorney Docket Number	AFF.004C5US

7	H.S. JUN GIBEE, "A Virtual Information Desk On The Internet," University of Ulsan, September 1999, pages 265-268.	<input type="checkbox"/>
8	STEVE WHITTAKER, et al., "TeleNotes: Managing Lightweight Interactions in the Desktop," Lotus Development Corporation, June 1997, pages 137-168.	<input type="checkbox"/>
9	R.M. CROWDER, et al., "Integration of Manufacturing Information Using Open Hypermedia," Computer in Industry, 1999, pages 31-42.	<input type="checkbox"/>
10	TOMAS BOSTROM, et al., "Mobile Audio Distribution," Royal Institute of Technology, 1999, pages 166-172.	<input type="checkbox"/>
11	ALEX POON, et al., Xerox Disclosure Journal, Vol. 19, No. 2, "Gestural User Interface Technique for Controlling the Playback of Sequential Media," March/April 1994, pages 187-190.	<input type="checkbox"/>
12	DEB KUMAR ROY, "NewsComm: A Hand-Held Device For Interactive Access to Structured Audio," Massachusetts Institute of Technology, June 1995, pages 1-12.	<input type="checkbox"/>
13	VICTORIA BELLOTTI, et al., "Walking Away from the Desktop Computer: Distributed Collaboration and Mobility in a Product Design Team," 1996, pages 209-218.	<input type="checkbox"/>
14	UPUL OBEYSEKARE, et al., "The Visual Interactive Desktop Laboratory," January-March 1997, pages 63-71.	<input type="checkbox"/>
15	ASIM SMAILAGIC, et al., "MoCCA: A Mobile Communication and Computing Architecture," Institute for Complex Engineered Systems, pages 1-8.	<input type="checkbox"/>
16	SUI-MENG POON, et al., "Integration of Value-Added Audio Playback Capacity Into Computer Network," Nanyang Technological University, 1995, pages 632-636.	<input type="checkbox"/>
17	ERDAL PAKSOY, et al., "A variable-rate celp coder for fast remote voicemail retrieval using a notebook computer," DSPS R&D Center, Texas Instruments, 1997, pages 119-124.	<input type="checkbox"/>

INFORMATION DISCLOSURE STATEMENT BY APPLICANT (Not for submission under 37 CFR 1.99)	Application Number	12015320
	Filing Date	2008-01-16
	First Named Inventor	Russell W. White, et al.
	Art Unit	2617
	Examiner Name	Erika A. Gary
	Attorney Docket Number	AFF.004C5US

18	JEFFREY A. DAVIS, "Use of Personal Computers in Satellite Command and Control Systems," Raytheon Systems Company, October 24, 1999, pages 283-291.	<input type="checkbox"/>
19	NIKI DAVIS, "Remote Teaching Via ISDN2 And Desktop Conferencing," Exeter University School of Education, pages 1-3.	<input type="checkbox"/>
20	A CHAN, et al., "The PEP-II Project-Wide Database," Stanford University, 1996, pages 840-842.	<input type="checkbox"/>
21	KRISHNA BHARAT, et al., "Migratory Applications," Springer Berlin, Vol. 1222, 1997, pages 1-21.	<input type="checkbox"/>
22	EMPEG CAR, "MP3 in your dash," Digital Audio Player User Guide, pages 1-50.	<input type="checkbox"/>
23	MICROSOFT, "Getting Started Microsoft Windows 98" Second Edition, 1998, pages 1-138.	<input type="checkbox"/>
24	SAUL GREENBERG, "PDAs and Shared Public Displays: Making Personal Information Public, and Public Information Personal," University of Calgary, March 1999, pages 1-11.	<input type="checkbox"/>
25	NAOHIKO KOHTAKE, et al., "InfoStick: an interaction device for Inter-Appliance Computing," Keio University, pages 1-15.	<input type="checkbox"/>
26	HEWLETT PACKARD, User's Guide, HP Jornada 420, Palm-Size PC, pages 1-75	<input type="checkbox"/>
27	MICROSOFT, "Introducing Microsoft Windows 95 - Certificate of Authenticity," 1995, pages 1-117.	<input type="checkbox"/>
28	SONY, "New Technical Theory For Servicing, MZ-R5ST Operation Manual," pages 1-44.	<input type="checkbox"/>

INFORMATION DISCLOSURE STATEMENT BY APPLICANT (Not for submission under 37 CFR 1.99)	Application Number	12015320
	Filing Date	2008-01-16
	First Named Inventor	Russell W. White, et al.
	Art Unit	2617
	Examiner Name	Erika A. Gary
	Attorney Docket Number	AFF.004C5US

29	RICHARD C. DAVIS, et al., "A Framework for Sharing Handwritten Notes," 1998, pages 119-120.	<input type="checkbox"/>
30	KRISHNA A. BHARAT, et al., "Migratory Applications," UIST '95, November 14-17, 1995, pages 133-142.	<input type="checkbox"/>
31	BRAD A. MYERS, "Collaboration Using Multiple PDAs Connected To A PC," Carnegie Mellon University, 1998, pages 385-294.	<input type="checkbox"/>
32	RICHARD C. DAVIS, et al., "NotePals: Lightweight Note Sharing by the Group, for the Group," May 15-20, 1999, pages 338-345.	<input type="checkbox"/>
33	JUN REKIMOTO, et al., "Augmented Surfaces: A Spatially Continuous Work Space for Hybrid Computing Environments," May 15-20, 1999, pages 378-385.	<input type="checkbox"/>
34	DAN R. OLSEN, JR., "Interacting with Chaos," September and October 1999, pages 42-54.	<input type="checkbox"/>
35	SCOTT ROBERTSON, et al., "Dual Device User Interface Design: PDAs and Interactive Television," April 13-18, 1996, pages 79-86.	<input type="checkbox"/>
36	SYMANTEC CORPORATION, "pcANYWHERE32 User's Guide," 1993-1997, pages 1-216.	<input type="checkbox"/>
37	KRISHNA BHARAT, et al., Migratory Applications, "Mobile Object Systems Towards the Programmable Internet," Springer Berlin/Heidelberg, Volume 1222/11997, 1997, pages 1-134.	<input type="checkbox"/>
38	DIAMOND MULTIMEDIA SYSTEMS, INC., "Rio PMP300, User's Guide," 1998, pages 1-27.	<input type="checkbox"/>
39	SONY, "Portable MiniDisc Recorder, Operating Instructions, MZ-R55," 1998, pages 1-42.	<input type="checkbox"/>

INFORMATION DISCLOSURE STATEMENT BY APPLICANT (Not for submission under 37 CFR 1.99)	Application Number		12015320
	Filing Date		2008-01-16
	First Named Inventor	Russell W. White, et al.	
	Art Unit	2617	
	Examiner Name	Erika A. Gary	
	Attorney Docket Number	AFF.004C5US	

40	NORBERT A. STREITZ, et al., "i-Land: An Interactive Landscape for Creativity and Innovation," Proceedings of the ACM Conference on Human Factors in Computing Systems, May 15-20, 1999, pages 120-127.	<input type="checkbox"/>
41	NORBERT A. STREITZ, et al., "Roomware for Cooperative Buildings: Integrated Design of Architectural Spaces and Information Spaces," pages 1-20	<input type="checkbox"/>
42	Direct Cable Connection screen shot, "B1U6U4," 10 pages total.	<input type="checkbox"/>
43	Direct Cable Connection screen shot, 10 pages total.	<input type="checkbox"/>
44	IBM, "WordPad z50 Cradle Option - User's Guide," 1990, pages 1-18.	<input type="checkbox"/>
45	IBM MOBILE SYSTEMS, "WorkPad z50 Mobile Companion (2608-1Ax), Hardware Maintenance Manual," March 1999, pages 1-77.	<input type="checkbox"/>
46	KEVIN JOST, Automotive Engineering International, "The car as a mobile-media platform," May 1998, pages 49-53.	<input type="checkbox"/>
47	MICROSOFT CORPORATION, "Windows CE 2.1 Technical Articles, Developing Applications for an Auto PC," June 1999, pages 1-13.	<input type="checkbox"/>
48	INFOGATION CORPORATION, "InfoGation Corp. Introduces Software Applications for Next-Generation Smart Car Systems," January 8, 1998, pages 1-2.	<input type="checkbox"/>
49	BUSINESS WIRE, "ORA Electronics Announces USB-Compatible TelCar Mark VII Begins Shipping First Quarter of 1999," January 6, 1999, pages 1-2.	<input type="checkbox"/>
50	ORA USA, "ORA Electronics Patents Telcar Cellular Telephone Interface," July 6, 1998, pages 1-2.	<input type="checkbox"/>

INFORMATION DISCLOSURE STATEMENT BY APPLICANT (Not for submission under 37 CFR 1.99)	Application Number	12015320
	Filing Date	2008-01-16
	First Named Inventor	Russell W. White, et al.
	Art Unit	2617
	Examiner Name	Erika A. Gary
	Attorney Docket Number	AFF.004C5US

If you wish to add additional non-patent literature document citation information please click the Add button			
EXAMINER SIGNATURE			
Examiner Signature	/Erika Gary/ (09/15/2010)	Date Considered	09/15/2010
*EXAMINER: Initial if reference considered, whether or not citation is in conformance with MPEP 609. Draw line through a citation if not in conformance and not considered. Include copy of this form with next communication to applicant.			
<small> ¹ See Kind Codes of USPTO Patent Documents at www.USPTO.GOV or MPEP 901.04. ² Enter office that issued the document, by the two-letter code (WIPO Standard ST.3). ³ For Japanese patent documents, the indication of the year of the reign of the Emperor must precede the serial number of the patent document. ⁴ Kind of document by the appropriate symbols as indicated on the document under WIPO Standard ST.16 if possible. ⁵ Applicant is to place a check mark here if English language translation is attached. </small>			

Doc code: IDS

Doc description: Information Disclosure Statement (IDS) Filed

PTO/SB/08a (04-09)

Approved for use through 05/31/2009. OMB 0651-0031

U.S. Patent and Trademark Office; U.S. DEPARTMENT OF COMMERCE

Under the Paperwork Reduction Act of 1995, no persons are required to respond to a collection of information unless it contains a valid OMB control number.

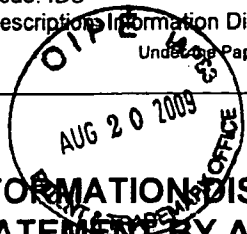

INFORMATION DISCLOSURE STATEMENT BY APPLICANT
(Not for submission under 37 CFR 1.99)

Application Number	12015320
Filing Date	2008-01-16
First Named Inventor	Russell W. White, et al.
Art Unit	2617
Examiner Name	Erika A. Gary
Attorney Docket Number	AFF.004C5US

U.S. PATENTS

Examiner Initial*	Cite No	Patent Number	Kind Code ¹	Issue Date	Name of Patentee or Applicant of cited Document	Pages, Columns, Lines where Relevant Passages or Relevant Figures Appear
	1					

If you wish to add additional U.S. Patent citation information please click the Add button.

U.S. PATENT APPLICATION PUBLICATIONS

Examiner Initial*	Cite No	Publication Number	Kind Code ¹	Publication Date	Name of Patentee or Applicant of cited Document	Pages, Columns, Lines where Relevant Passages or Relevant Figures Appear
	1					

If you wish to add additional U.S. Published Application citation information please click the Add button.

FOREIGN PATENT DOCUMENTS

Examiner Initial*	Cite No	Foreign Document Number ³	Country Code ²	Kind Code ⁴	Publication Date	Name of Patentee or Applicant of cited Document	Pages, Columns, Lines where Relevant Passages or Relevant Figures Appear	T ⁵
	1	WO 00/79372 A1	WO		2000-12-28	Colvin, David S.		<input type="checkbox"/>

If you wish to add additional Foreign Patent Document citation information please click the Add button

NON-PATENT LITERATURE DOCUMENTS

Examiner Initials*	Cite No	Include name of the author (in CAPITAL LETTERS), title of the article (when appropriate), title of the item (book, magazine, journal, serial, symposium, catalog, etc), date, pages(s), volume-issue number(s), publisher, city and/or country where published.	T ⁵

INFORMATION DISCLOSURE STATEMENT BY APPLICANT (Not for submission under 37 CFR 1.99)	Application Number	12015320
	Filing Date	2008-01-16
	First Named Inventor	Russell W. White, et al.
	Art Unit	2617
	Examiner Name	Erika A. Gary
	Attorney Docket Number	AFF.004C5US

1	HEWLETT PACKARD, "HP Jornada 430/430se Palm-Size PC, User's Guide," Edition 1, 1999, pages 1-151.	<input type="checkbox"/>
2	NEC, "NEC MobilePro 750C, User's Guide," 1998, pages 1-83.	<input type="checkbox"/>
3	MICROSOFT, "Palm PC User's Guide," Microsoft Windows CE, pages 1-39.	<input type="checkbox"/>
4	PALM PC USER'S GUIDE, "Chapter 6, Information Backup and Exchange," pages 69-148	<input type="checkbox"/>
5	MPMan, "User's Guide, The Portable MP 3player using the flash memory and SmartMedia card," 1997, pages 1-35.	<input type="checkbox"/>
6	Cover Sheet, www.mpman.com, 1 page.	<input type="checkbox"/>
7	Smart Media Card Slot Diagram, 1 page.	<input type="checkbox"/>
8	MP Man F20 Logo, 1 page.	<input type="checkbox"/>
9	MPMan, "User's Guide, The portable MP3 player using the flash memory with variety features including the voice recording, phone/memo browsing, etc.," 1997, pages 1-47.	<input type="checkbox"/>
10	Smart Media card diagram and install instructions, pages 1-4.	<input type="checkbox"/>
11	ANAND LAL SHIMPI, Empeg, Ltd., "MP3 meets Car Audio: Empeg Mark II in-dash Car MP3 Player," September 18, 2000, pages 1-17.	<input type="checkbox"/>

INFORMATION DISCLOSURE STATEMENT BY APPLICANT (Not for submission under 37 CFR 1.99)	Application Number	12015320
	Filing Date	2008-01-16
	First Named Inventor	Russell W. White, et al.
	Art Unit	2617
	Examiner Name	Erika A. Gary
	Attorney Docket Number	AFF.004C5US

12	PETER CLARKE, EE Times, "Engineers drive craze for MP3 audio players," February 5, 1999, pages 1-4.	<input type="checkbox"/>
13	RIO CAR DOT ORG GEEK GUIDE, "empeg car Mk. 1," February 21, pages 1-4.	<input type="checkbox"/>
14	HUGO FIENNES, RIO CAR DOT ORG GEEK GUIDE, "MP3 Mobile," February 21, pages 1-4.	<input type="checkbox"/>
15	RIO CAR DOT ORG, "Frequently Asked Questions," pages 1-16.	<input type="checkbox"/>
16	DIAMOND MULTIMEDIA SYSTEMS, INC., "Rio PMP300 User's Guide," 1998, pages 1-27.	<input type="checkbox"/>
17	STEPHEN J. BUCKLEY, et al., "The Car as a Peripheral, Adapting a Portable Computer to a Vehicle Intranet," SAE Technical Paper Series, 98C030, October 19-21, 1998, pages 1-14.	<input type="checkbox"/>
18	"The MP3 Mobile," April 8, 1998, pages 1-13.	<input type="checkbox"/>
19	12-Volt Business & Technology Solutions, AutoMedia, "How the Intelligent Data Bus will impact the way you do business," November 1998, pages 1-2.	<input type="checkbox"/>
20	Press Release, "Creative Labs Launches Nomad Portable MP3 Players," April 15, 1999, pages 1-5.	<input type="checkbox"/>
21	BMW, "Betriebsanleitung Bordmonitor mit Navigation und TV," 1995, pages 1-82.	<input type="checkbox"/>
22	BMW, "Owner's Manual, On-board monitor with navigation system," 1996, pages 1-81.	<input type="checkbox"/>

INFORMATION DISCLOSURE STATEMENT BY APPLICANT (Not for submission under 37 CFR 1.99)	Application Number	12015320
	Filing Date	2008-01-16
	First Named Inventor	Russell W. White, et al.
	Art Unit	2617
	Examiner Name	Erika A. Gary
	Attorney Docket Number	AFF.004C5US

23	TRANSPERFECT/TRANSLATIONS, "True and accurate translation of the 1995 BMW Manual, from German into English," August 16, 2005, pages 1-80.	<input type="checkbox"/>
24	HEINZ SODEIKAT, "EURO-SCOUT is facing the German 1994 Market," 1994, pages 551-556.	<input type="checkbox"/>
25	Pictures of car navigation systems in a car dashboard, pages 1-11.	<input type="checkbox"/>
26	BMW, "The BMW On-Board Navigation System - Technology Takes a Remarkable Turn," 2005, pages 1-9.	<input type="checkbox"/>
27	OLDSMOBILE, "1991 Toronado/Trofeo User's Guide," 1991, pages 1-41.	<input type="checkbox"/>
28	YEPP, "Digital Sounds - yepp - YP-E32/E64102-291," October 23, 1999, pages 1-.46	<input type="checkbox"/>
29		<input type="checkbox"/>
30	U.S. Provisional Application No. 60/167179, entitled "System, Method, And Device for Playing Recorded Music on a Wireless Communications Device," by Devon A. Rolf, filed November 23, 1999, pages 1-48.	<input type="checkbox"/>
31	MICROSOFT, "Getting Started, Microsoft Windows 98, For distribution with a new PC only," 1998, pages 1-145.	<input type="checkbox"/>
32	PR NEWSWIRE, "Alpine Announces Fall Release of Interface Adapter That Enables iPod Control and Playback from In-Vehicle Sound Systems," July 7, 2004, pages 1-2..	<input type="checkbox"/>
33	HA-YOUNG PARK, The Customer Times, "Portable Computer Music, MP3 File and MP3 Player rise as the Next Generation Audio Format," May 1999, pages 1-2.	<input type="checkbox"/>

INFORMATION DISCLOSURE STATEMENT BY APPLICANT (Not for submission under 37 CFR 1.99)	Application Number	12015320
	Filing Date	2008-01-16
	First Named Inventor	Russell W. White, et al.
	Art Unit	2617
	Examiner Name	Erika A. Gary
	Attorney Docket Number	AFF.004C5US

34	"MP3 Players Introduced in the Korean IT Magazines," 1998-1999, pages 1-15.	<input type="checkbox"/>
35	MPMan, "MP-F20, User's Guide, Portable MP3 player using the flash memory and a Memory card," [ages 1-16.	<input type="checkbox"/>
36	PR NEWSWIRE ASSOCIATION, INC., "Delphi's Communiport(R) Technology for Tomorrow, Today Demonstrated at Frankfurt Auto Show," September 15, 1999, pages 1-8.	<input type="checkbox"/>
37	CRAIN COMMUNIATIONS, INC., "Products," Agilent Technologies Press Release, February 21, 2000, pages 1-6.	<input type="checkbox"/>
38	THE WASHINGTON TIMES, LLC, John Hanan, Dallas Morning News, "Cars add computer, audiovisual gear," January 14, 2000, pages 1-3.	<input type="checkbox"/>

If you wish to add additional non-patent literature document citation information please click the Add button

EXAMINER SIGNATURE

Examiner Signature	Erika Gary/ (09/15/2010)	Date Considered	09/15/2010
--------------------	--------------------------	-----------------	------------

*EXAMINER: Initial if reference considered, whether or not citation is in conformance with MPEP 609. Draw line through a citation if not in conformance and not considered. Include copy of this form with next communication to applicant.

¹ See Kind Codes of USPTO Patent Documents at www.USPTO.GOV or MPEP 901.04. ² Enter office that issued the document, by the two-letter code (WIPO Standard ST.3). ³ For Japanese patent documents, the indication of the year of the reign of the Emperor must precede the serial number of the patent document. ⁴ Kind of document by the appropriate symbols as indicated on the document under WIPO Standard ST.16 if possible. ⁵ Applicant is to place a check mark here if English language translation is attached.

Doc code: IDS

Doc description: Information Disclosure Statement (IDS) Filed

PTO/SB/08a (04-09)

Approved for use through 05/31/2009. OMB 0651-0031

U.S. Patent and Trademark Office; U.S. DEPARTMENT OF COMMERCE

Under the Paperwork Reduction Act of 1995, no persons are required to respond to a collection of information unless it contains a valid OMB control number.

<p>INFORMATION DISCLOSURE STATEMENT BY APPLICANT (Not for submission under 37 CFR 1.99)</p>	Application Number		12015320	
	Filing Date		2008-01-16	
	First Named Inventor	Russell W. White, et al.		
	Art Unit	2617		
	Examiner Name	Erika A. Gary		
	Attorney Docket Number	AFF.004C5US		

U.S. PATENTS						
Examiner Initial*	Cite No	Patent Number	Kind Code ¹	Issue Date	Name of Patentee or Applicant of cited Document	Pages, Columns, Lines where Relevant Passages or Relevant Figures Appear
	1					

If you wish to add additional U.S. Patent citation information please click the Add button.

U.S. PATENT APPLICATION PUBLICATIONS						
Examiner Initial*	Cite No	Publication Number	Kind Code ¹	Publication Date	Name of Patentee or Applicant of cited Document	Pages, Columns, Lines where Relevant Passages or Relevant Figures Appear
	1					

If you wish to add additional U.S. Published Application citation information please click the Add button.

FOREIGN PATENT DOCUMENTS								
Examiner Initial*	Cite No	Foreign Document Number ³	Country Code ^{2j}	Kind Code ⁴	Publication Date	Name of Patentee or Applicant of cited Document	Pages, Columns, Lines where Relevant Passages or Relevant Figures Appear	T ⁵
	1	2000-66974	JP		2000-03-03			<input type="checkbox"/>
	2	11-68685	JP		1999-03-09			<input type="checkbox"/>
	3	CN 1218258A	CN		1999-06-02			<input type="checkbox"/>

INFORMATION DISCLOSURE STATEMENT BY APPLICANT (Not for submission under 37 CFR 1.99)	Application Number		12015320	
	Filing Date		2008-01-16	
	First Named Inventor	Russell W. White, et al.		
	Art Unit	2617		
	Examiner Name	Erika A. Gary		
	Attorney Docket Number	AFF.004C5US		

4	H11-242686	JP		1999-09-07	Sony Corporation	<input type="checkbox"/>
5	DE 44 31 070 B4	DE		2004-07-22	DaimlerChrysler AG	<input type="checkbox"/>
6	0 569 343 A1	EP		1993-10-11	Pioneer Electronic Corporation	<input type="checkbox"/>
7	0 675 341 A1	EP		1995-04-10	Honda Giken Kogyo	<input type="checkbox"/>
8	0 771 686 A2	EP		1997-07-05	Toyota Jidosha Kabushiki Kaisha Toyota-shi, Aichi-	<input type="checkbox"/>
9	H4-261576	JP		1992-09-17	Mitsubishi Electric Corporation	<input type="checkbox"/>
10	2-301330	JP		1990-12-13		<input type="checkbox"/>
11	5-294250	JP		1993-11-09		<input type="checkbox"/>
12	6-187597	JP		1994-07-08		<input type="checkbox"/>
13	JP6289118	JP		1994-10-18	Sega Enterprises KK	<input type="checkbox"/>
14	JP6294659	JP		1994-10-21	Dainippon Printing Co. LTD.	<input type="checkbox"/>

INFORMATION DISCLOSURE STATEMENT BY APPLICANT (Not for submission under 37 CFR 1.99)	Application Number		12015320	
	Filing Date		2008-01-16	
	First Named Inventor	Russell W. White, et al.		
	Art Unit	2617		
	Examiner Name	Erika A. Gary		
	Attorney Docket Number	AFF.004C5US		

15	07-129895	JP		1995-05-19	Honda Motor Co Ltd	<input type="checkbox"/>
16	07-146155	JP		1995-06-06	Honda Motor Co Ltd	<input type="checkbox"/>
17	7-262493	JP		1995-10-13	CSK Corporation	<input type="checkbox"/>
18	7-262493	JP		1995-10-13		<input type="checkbox"/>
19	JP7270171	JP		1995-10-20	Sumitomo Electronic Industries	<input type="checkbox"/>
20	JP7036382	JP		1995-02-07	Mitsubishi Electric Corp.	<input type="checkbox"/>
21	8-110231	JP		1996-04-30		<input type="checkbox"/>
22	9-61514	JP		1997-03-07		<input type="checkbox"/>
23	10-103966	JP		1998-04-24		<input type="checkbox"/>
24	10-143349	JP		1998-05-29	Compaq Computer Corporation	<input type="checkbox"/>
25	JP1018712	JP		1989-01-23	Mazda Motor	<input type="checkbox"/>

INFORMATION DISCLOSURE STATEMENT BY APPLICANT (Not for submission under 37 CFR 1.99)	Application Number		12015320	
	Filing Date		2008-01-16	
	First Named Inventor	Russell W. White, et al.		
	Art Unit	2617		
	Examiner Name	Erika A. Gary		
	Attorney Docket Number	AFF.004C5US		

26	JP5077679	JP		1993-03-30	Nissan Motor		<input type="checkbox"/>
27	JP59085599	JP		1984-05-17	Nissan Motor		<input type="checkbox"/>
28	JP63136828	JP		1988-06-09	Pioneer Electronic Corp.		<input type="checkbox"/>
29	63-136828	JP		1988-06-09			<input type="checkbox"/>
30	WO 96/04724	WO		1996-02-15	Emerson, Harry		<input type="checkbox"/>
31	WO 96/07110	WO		1996-03-07	British Telecommunications Public Limited Company		<input type="checkbox"/>
32	WO 97/13657	WO		1997-04-17	United Technologies Automotive, Inc.		<input type="checkbox"/>
33	H11-317061	JP		1999-11-16	Victor Company of Japan, LTD.		<input checked="" type="checkbox"/>
34	2901445	JP		1999-03-19	Kenwood Corporation		<input checked="" type="checkbox"/>
35	WO 99/35009	WO		1999-07-15	Microsoft Corporation		<input type="checkbox"/>
36	11-219580	JP		1999-08-10			<input type="checkbox"/>

INFORMATION DISCLOSURE STATEMENT BY APPLICANT (Not for submission under 37 CFR 1.99)	Application Number		12015320	
	Filing Date		2008-01-16	
	First Named Inventor	Russell W. White, et al.		
	Art Unit	2617		
	Examiner Name	Erika A. Gary		
	Attorney Docket Number	AFF.004C5US		

	37	11219580 A	JP		1999-10-08	Sony Corp		<input type="checkbox"/>
	38	1168685	JP		1999-03-09			<input type="checkbox"/>
	39	11-068685	JP		1999-09-03	Sony Corp		<input type="checkbox"/>
	40	1998-052033	JP		1998-09-25			<input type="checkbox"/>
	41	1999-0042565	JP		1999-06-15			<input type="checkbox"/>
	42	1999-0073234	KR		1999-10-05	Young-Man Lee		<input type="checkbox"/>
	43	1999-0048723	KR		1999-07-05			<input type="checkbox"/>
	44	KR2019990022030U	KR		1999-06-25	Young-Shik Cheon		<input type="checkbox"/>
	45	2000-0001465	KR		2000-01-25	Samsung Motors		<input type="checkbox"/>
	46	0142256	KR		1998-03-30			<input type="checkbox"/>
	47	WO 98/21672	WO		1998-05-22	Inergy Online, Inc.		<input type="checkbox"/>

INFORMATION DISCLOSURE STATEMENT BY APPLICANT (Not for submission under 37 CFR 1.99)	Application Number		12015320	
	Filing Date		2008-01-16	
	First Named Inventor	Russell W. White, et al.		
	Art Unit		2617	
	Examiner Name	Erika A. Gary		
	Attorney Docket Number		AFF.004C5US	

48	WO 98/47252	WO		1998-10-22	Stern, Geoffrey	<input type="checkbox"/>
49	WO 00/54187	WO		2000-09-14	Rock.Com, Inc.	<input type="checkbox"/>
50	WO 00/60450	WO		2000-10-12	Khyber Technologies Corporation	<input type="checkbox"/>

If you wish to add additional Foreign Patent Document citation information please click the Add button

NON-PATENT LITERATURE DOCUMENTS

Examiner Initials*	Cite No	Include name of the author (in CAPITAL LETTERS), title of the article (when appropriate), title of the item (book, magazine, journal, serial, symposium, catalog, etc), date, pages(s), volume-issue number(s), publisher, city and/or country where published.	T ⁵
	1	MARK MOELLER, Computing Unplugged Magazine, "Product Preview, A Survey of Auto PC 2.0 for software developers," 1999-2009, Zatz Publishing, pages 1-7.	<input type="checkbox"/>
	2	MARK MOELLER, Computing Unplugged Magazine, "AutoPC Update, Auto PC/Windows CE for Automotive news bites," 1999-2009, Zatz Publishing, pages 1-4.	<input type="checkbox"/>
	3	Claim Chart for KR19990033393, Claim 17 of U.S. Patent No. 7,324,833, pages 1-3.	<input type="checkbox"/>
	4	RIO500, Getting Started Guide for Windows 98 and Macintosh OS 8.6, pages 1-2.	<input type="checkbox"/>
	5	NORBERT A. STREITZ, et al., "DOLPHIN: Integrated Meeting Support Across Local And Remote Desktop Environments And LiveBoards," Integrated Publication and Information Systems Institute, 1994, pages 345-358.	<input type="checkbox"/>
	6	LEO DEGEN, et al., "Working with Audio: Integrating Personal Tape Recorders and Desktop Computers," May 3-7, 1992, pages 413-418.	<input type="checkbox"/>

INFORMATION DISCLOSURE STATEMENT BY APPLICANT (Not for submission under 37 CFR 1.99)	Application Number	12015320
	Filing Date	2008-01-16
	First Named Inventor	Russell W. White, et al.
	Art Unit	2617
	Examiner Name	Erika A. Gary
	Attorney Docket Number	AFF.004C5US

7	H.S. JUN GIBEE, "A Virtual Information Desk On The Internet," University of Ulsan, September 1999, pages 265-268.	<input type="checkbox"/>
8	STEVE WHITTAKER, et al., "TeleNotes: Managing Lightweight Interactions in the Desktop," Lotus Development Corporation, June 1997, pages 137-168.	<input type="checkbox"/>
9	R.M. CROWDER, et al., "Integration of Manufacturing Information Using Open Hypermedia," Computer in Industry, 1999, pages 31-42.	<input type="checkbox"/>
10	TOMAS BOSTROM, et al., "Mobile Audio Distribution," Royal Institute of Technology, 1999, pages 166-172.	<input type="checkbox"/>
11	ALEX POON, et al., Xerox Disclosure Journal, Vol. 19, No. 2, "Gestural User Interface Technique for Controlling the Playback of Sequential Media," March/April 1994, pages 187-190.	<input type="checkbox"/>
12	DEB KUMAR ROY, "NewsComm: A Hand-Held Device For Interactive Access to Structured Audio," Massachusetts Institute of Technology, June 1995, pages 1-12.	<input type="checkbox"/>
13	VICTORIA BELLOTTI, et al., "Walking Away from the Desktop Computer: Distributed Collaboration and Mobility in a Product Design Team," 1996, pages 209-218.	<input type="checkbox"/>
14	UPUL OBEYSEKARE, et al., "The Visual Interactive Desktop Laboratory," January-March 1997, pages 63-71.	<input type="checkbox"/>
15	ASIM SMAILAGIC, et al., "MoCCA: A Mobile Communication and Computing Architecture," Institute for Complex Engineered Systems, pages 1-8.	<input type="checkbox"/>
16	SUI-MENG POON, et al., "Integration of Value-Added Audio Playback Capacity Into Computer Network," Nanyang Technological University, 1995, pages 632-636.	<input type="checkbox"/>
17	ERDAL PAKSOY, et al., "A variable-rate celp coder for fast remote voicemail retrieval using a notebook computer," DSPS R&D Center, Texas Instruments, 1997, pages 119-124.	<input type="checkbox"/>

INFORMATION DISCLOSURE STATEMENT BY APPLICANT (Not for submission under 37 CFR 1.99)	Application Number		12015320
	Filing Date		2008-01-16
	First Named Inventor	Russell W. White, et al.	
	Art Unit	2617	
	Examiner Name	Erika A. Gary	
	Attorney Docket Number	AFF.004C5US	

18	JEFFREY A. DAVIS, "Use of Personal Computers in Satellite Command and Control Systems," Raytheon Systems Company, October 24, 1999, pages 283-291.	<input type="checkbox"/>
19	NIKI DAVIS, "Remote Teaching Via ISDN2 And Desktop Conferencing," Exeter University School of Education, pages 1-3.	<input type="checkbox"/>
20	A CHAN, et al., "The PEP-II Project-Wide Database," Stanford University, 1996, pages 840-842.	<input type="checkbox"/>
21	KRISHNA BHARAT, et al., "Migratory Applications," Springer Berlin, Vol. 1222, 1997, pages 1-21.	<input type="checkbox"/>
22	EMPEG CAR, "MP3 in your dash," Digital Audio Player User Guide, pages 1-50.	<input type="checkbox"/>
23	MICROSOFT, "Getting Started Microsoft. Windows. 98" Second Edition, 1998, pages 1-138.	<input type="checkbox"/>
24	SAUL GREENBERG, "PDAs and Shared Public Displays: Making Personal Information Public, and Public Information Personal," University of Calgary, March 1999, pages 1-11.	<input type="checkbox"/>
25	NAOHIKO KOHTAKE, et al., "InfoStick: an interaction device for Inter-Appliance Computing," Keio University, pages 1-15.	<input type="checkbox"/>
26	HEWLETT PACKARD, User's Guide, HP Jornada 420, Palm-Size PC, pages 1-75	<input type="checkbox"/>
27	MICROSOFT, "Introducing Microsoft Windows 95 - Certificate of Authenticity," 1995, pages 1-117.	<input type="checkbox"/>
28	SONY, "New Technical Theory For Servicing, MZ-R5ST Operation Manual," pages 1-44.	<input type="checkbox"/>

INFORMATION DISCLOSURE STATEMENT BY APPLICANT (Not for submission under 37 CFR 1.99)	Application Number	12015320
	Filing Date	2008-01-16
	First Named Inventor	Russell W. White, et al.
	Art Unit	2617
	Examiner Name	Erika A. Gary
	Attorney Docket Number	AFF.004C5US

29	RICHARD C. DAVIS, et al., "A Framework for Sharing Handwritten Notes," 1998, pages 119-120.	<input type="checkbox"/>
30	KRISHNA A. BHARAT, et al., "Migratory Applications," UIST '95, November 14-17, 1995, pages 133-142.	<input type="checkbox"/>
31	BRAD A. MYERS, "Collaboration Using Multiple PDAs Connected To A PC," Carnegie Mellon University, 1998, pages 385-294.	<input type="checkbox"/>
32	RICHARD C. DAVIS, et al., "NotePals: Lightweight Note Sharing by the Group, for the Group," May 15-20, 1999, pages 338-345.	<input type="checkbox"/>
33	JUN REKIMOTO, et al., "Augmented Surfaces: A Spatially Continuous Work Space for Hybrid Computing Environments," May 15-20, 1999, pages 378-385.	<input type="checkbox"/>
34	DAN R. OLSEN, JR., "Interacting with Chaos," September and October 1999, pages 42-54.	<input type="checkbox"/>
35	SCOTT ROBERTSON, et al., "Dual Device User Interface Design: PDAs and Interactive Television," April 13-18, 1996, pages 79-86.	<input type="checkbox"/>
36	SYMANTEC CORPORATION, "pcANYWHERE32 User's Guide," 1993-1997, pages 1-216.	<input type="checkbox"/>
37	KRISHNA BHARAT, et al., Migratory Applications, "Mobile Object Systems Towards the Programmable Internet," Springer Berlin/Heidelberg, Volume 1222/11997, 1997, pages 1-134.	<input type="checkbox"/>
38	DIAMOND MULTIMEDIA SYSTEMS, INC., "Rio PMP300, User's Guide," 1998, pages 1-27.	<input type="checkbox"/>
39	SONY, "Portable MiniDisc Recorder, Operating Instructions, MZ-R55," 1998, pages 1-42.	<input type="checkbox"/>

INFORMATION DISCLOSURE STATEMENT BY APPLICANT (Not for submission under 37 CFR 1.99)	Application Number		12015320
	Filing Date		2008-01-16
	First Named Inventor	Russell W. White, et al.	
	Art Unit		2617
	Examiner Name	Erika A. Gary	
	Attorney Docket Number		AFF.004C5US

40	NORBERT A. STREITZ, et al., "i-Land: An Interactive Landscape for Creativity and Innovation," Proceedings of the ACM Conference on Human Factors in Computing Systems, May 15-20, 1999, pages 120-127.	<input type="checkbox"/>
41	NORBERT A. STREITZ, et al., "Roomware for Cooperative Buildings: Integrated Design of Architectural Spaces and Information Spaces," pages 1-20	<input type="checkbox"/>
42	Direct Cable Connection screen shot, "B1U6U4," 10 pages total.	<input type="checkbox"/>
43	Direct Cable Connection screen shot, 10 pages total.	<input type="checkbox"/>
44	IBM, "WordPad z50 Cradle Option - User's Guide," 1990, pages 1-18.	<input type="checkbox"/>
45	IBM MOBILE SYSTEMS, "WorkPad z50 Mobile Companion (2608-1Ax), Hardware Maintenance Manual," March 1999, pages 1-77.	<input type="checkbox"/>
46	KEVIN JOST, Automotive Engineering International, "The car as a mobile-media platform," May 1998, pages 49-53.	<input type="checkbox"/>
47	MICROSOFT CORPORATION, "Windows CE 2.1 Technical Articles, Developing Applications for an Auto PC," June 1999, pages 1-13.	<input type="checkbox"/>
48	INFOGATION CORPORATION, "InfoGation Corp. Introduces Software Applications for Next-Generation Smart Car Systems," January 8, 1998, pages 1-2.	<input type="checkbox"/>
49	BUSINESS WIRE, "ORA Electronics Announces USB-Compatible TelCar Mark VII Begins Shipping First Quarter of 1999," January 6, 1999, pages 1-2.	<input type="checkbox"/>
50	ORA USA, "ORA Electronics Patents Telcar Cellular Telephone Interface," July 6, 1998, pages 1-2.	<input type="checkbox"/>

INFORMATION DISCLOSURE STATEMENT BY APPLICANT (Not for submission under 37 CFR 1.99)	Application Number	12015320
	Filing Date	2008-01-16
	First Named Inventor	Russell W. White, et al.
	Art Unit	2617
	Examiner Name	Erika A. Gary
	Attorney Docket Number	AFF.004C5US

If you wish to add additional non-patent literature document citation information please click the Add button			
EXAMINER SIGNATURE			
Examiner Signature	/Erika Gary/ (09/15/2010)	Date Considered	09/15/2010
*EXAMINER: Initial if reference considered, whether or not citation is in conformance with MPEP 609. Draw line through a citation if not in conformance and not considered. Include copy of this form with next communication to applicant.			
<small> ¹ See Kind Codes of USPTO Patent Documents at www.USPTO.GOV or MPEP 901.04. ² Enter office that issued the document, by the two-letter code (WIPO Standard ST.3). ³ For Japanese patent documents, the indication of the year of the reign of the Emperor must precede the serial number of the patent document. ⁴ Kind of document by the appropriate symbols as indicated on the document under WIPO Standard ST.16 if possible. ⁵ Applicant is to place a check mark here if English language translation is attached. </small>			

Doc code: IDS
 Doc description: Information Disclosure Statement (IDS) Filed

PTO/SB/08a (04-09)
 Approved for use through 05/31/2009. OMB 0651-0031
 U.S. Patent and Trademark Office; U.S. DEPARTMENT OF COMMERCE
 Under the Paperwork Reduction Act of 1995, no persons are required to respond to a collection of information unless it contains a valid OMB control number.

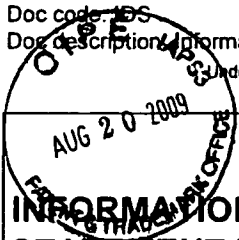

**INFORMATION DISCLOSURE
 STATEMENT BY APPLICANT**
 (Not for submission under 37 CFR 1.99)

Application Number		12015320
Filing Date		2008-01-16
First Named Inventor	Russell W. White, et al.	
Art Unit	2617	
Examiner Name	Erika A. Gary	
Attorney Docket Number	AFF.004C5US	

U.S.PATENTS

Examiner Initial*	Cite No	Patent Number	Kind Code ¹	Issue Date	Name of Patentee or Applicant of cited Document	Pages, Columns, Lines where Relevant Passages or Relevant Figures Appear
	1	6349352		2002-02-19	Lea	
	2	6697944		2004-02-24	Jones, et al.	
	3	6760916		2004-07-06	Holtz, et al.	
	4	6225984		2001-05-01	Crawford	
	5	5327558		1994-07-05	Burke, et al.	
	6	5715474		1998-02-03	Burke, et al.	

If you wish to add additional U.S. Patent citation information please click the Add button.

U.S.PATENT APPLICATION PUBLICATIONS

Examiner Initial*	Cite No	Publication Number	Kind Code ¹	Publication Date	Name of Patentee or Applicant of cited Document	Pages, Columns, Lines where Relevant Passages or Relevant Figures Appear
-------------------	---------	--------------------	------------------------	------------------	-------------------------------------------------	--------------------------------------------------------------------------

INFORMATION DISCLOSURE STATEMENT BY APPLICANT (Not for submission under 37 CFR 1.99)	Application Number		12015320	
	Filing Date		2008-01-16	
	First Named Inventor	Russell W. White, et al.		
	Art Unit	2617		
	Examiner Name	Erika A. Gary		
	Attorney Docket Number	AFF.004C5US		

1					
---	--	--	--	--	--

If you wish to add additional U.S. Published Application citation information please click the Add button.

FOREIGN PATENT DOCUMENTS

Examiner Initial*	Cite No	Foreign Document Number ³	Country Code ² i	Kind Code ⁴	Publication Date	Name of Patentee or Applicant of cited Document	Pages, Columns, Lines where Relevant Passages or Relevant Figures Appear	T ⁵
	1	WO 00/38340	WO		2000-06-29	Kim, Joehan		<input type="checkbox"/>
	2	WO 98/19480	WO		1998-07-05	Ericsson, Inc.		<input type="checkbox"/>
	3	WO 99/43136	WO		1999-08-26	Ericsson, Inc.		<input type="checkbox"/>
	4	8-79814	JP		1996-03-22			<input type="checkbox"/>
	5	9-74580	JP		1997-03-18			<input type="checkbox"/>
	6	10-149182	FP		1998-06-02			<input type="checkbox"/>
	7	3056721	FP		1998-12-02			<input type="checkbox"/>
	8	WO 99/06910	WO		1999-02-11	Ludtke, Harold A.		<input type="checkbox"/>

INFORMATION DISCLOSURE STATEMENT BY APPLICANT (Not for submission under 37 CFR 1.99)	Application Number		12015320	
	Filing Date		2008-01-16	
	First Named Inventor	Russell W. White, et al.		
	Art Unit	2617		
	Examiner Name	Erika A. Gary		
	Attorney Docket Number	AFF.004C5US		

9	11-73192	JP		1999-03-16			<input type="checkbox"/>
10	3890692	JP		2006-12-15			<input type="checkbox"/>
11	WO 99/12152	WO		1999-11-03	Sony Corporation		<input type="checkbox"/>
12	EP 0 920 016 A2	EP		1999-02-06	Sony Corporation		<input type="checkbox"/>
13	11-219580	JP		1999-08-10			<input type="checkbox"/>
14	EP 0 918 408 A2	EP		1999-05-26	Sony Corporation		<input type="checkbox"/>
15	11-143791	JP		1999-05-28			<input type="checkbox"/>
16	2007-207257	JP		2007-08-16			<input type="checkbox"/>
17	DE 20 2004 013 65	DE		2004-12-23	Boll, Nobert		<input type="checkbox"/>
18	WO 99/35009	WO		1999-07-15	Microsoft Corporation		<input type="checkbox"/>
19	2001-128280	JP		2001-05-11			<input type="checkbox"/>

INFORMATION DISCLOSURE STATEMENT BY APPLICANT (Not for submission under 37 CFR 1.99)	Application Number		12015320	
	Filing Date		2008-01-16	
	First Named Inventor	Russell W. White, et al.		
	Art Unit	2617		
	Examiner Name	Erika A. Gary		
	Attorney Docket Number	AFF.004C5US		

	20	KR20000036680	KR		2000-07-05	Kee Kang Choon		<input type="checkbox"/>
	21	10-1997-0016743	KR		1997-04-30			<input type="checkbox"/>
	22	20-1997-0012254	KR		1997-05-28			<input type="checkbox"/>
	23	WO 99/23856	WO		1999-05-14	Mershon, Stuart		<input type="checkbox"/>
	24	WO 99/28897	WO		1999-06-10	Voquette Networks, LTD.		<input type="checkbox"/>
	25	1999-0055970	KR		1999-07-15			<input type="checkbox"/>
	26	100242563 B1	KR		1999-10-11	Kim, Joon Sung		<input type="checkbox"/>
	27	EP 0 982 732 A1	EP		2000-01-03	Saehan Information Systems, Inc.		<input type="checkbox"/>
	28	10-0356742	KR		2002-10-18	Hyundai Autonet, Co. Ltd.		<input type="checkbox"/>
	29	10-356742	JP		2002-10-02			<input type="checkbox"/>
	30	WO 00/38340	WO		2000-06-29	Kim, Jaehan		<input type="checkbox"/>

INFORMATION DISCLOSURE STATEMENT BY APPLICANT (Not for submission under 37 CFR 1.99)	Application Number		12015320	
	Filing Date		2008-01-16	
	First Named Inventor	Russell W. White, et al.		
	Art Unit	2617		
	Examiner Name	Erika A. Gary		
	Attorney Docket Number	AFF.004C5US		

	31	2000-0001465	JP		2000-01-25			<input type="checkbox"/>
	32	2001-0009302	JP		2001-02-05			<input type="checkbox"/>
	33	2001-0028354	JP		2001-04-06			<input type="checkbox"/>
	34	1999-0033393	JP		1999-05-15			<input type="checkbox"/>
	35	11-317061	JP		1999-11-16			<input type="checkbox"/>
	36	2225910	CA		1997-12-24	Lussier, Luc.		<input type="checkbox"/>
	37	0 661 676 A1	EP		1994-12-21	AT&T Global Information Solutions International		<input type="checkbox"/>
	38	0 982 732 A1	EP		2000-01-03	Saehan Information Systems, Inc.		<input type="checkbox"/>
	39	2901445	JP		1999-03-19			<input type="checkbox"/>
	40	9-50282	JP		1997-02-18			<input type="checkbox"/>
	41	10-173737	JP		1998-06-26			<input type="checkbox"/>

INFORMATION DISCLOSURE STATEMENT BY APPLICANT (Not for submission under 37 CFR 1.99)	Application Number		12015320	
	Filing Date		2008-01-16	
	First Named Inventor	Russell W. White, et al.		
	Art Unit	2617		
	Examiner Name	Erika A. Gary		
	Attorney Docket Number	AFF.004C5US		

42	11-96735	JP		1999-04-09			<input type="checkbox"/>
43	11-242686	JP		1999-09-07			<input type="checkbox"/>
44	WO 94/18763	WO		1994-08-18	Gutle, Hubert		<input type="checkbox"/>
45	WO 98/21672	WO		1998-05-22	Inergy Online, Inc.		<input type="checkbox"/>
46	WO 98/33102	WO		1998-07-30	Guimaraes Teixeira		<input type="checkbox"/>
47	WO 99/18518	WO		1999-04-15	Polash, Peter		<input type="checkbox"/>
48	WO 00/07849	WO		2000-02-17	Microsoft Corporation		<input type="checkbox"/>
49	11-317061	WO		1999-11-16			<input type="checkbox"/>
50	2901445	JP		1999-03-19			<input type="checkbox"/>

If you wish to add additional Foreign Patent Document citation information please click the Add button

NON-PATENT LITERATURE DOCUMENTS

Examiner Initials*	Cite No	Include name of the author (in CAPITAL LETTERS), title of the article (when appropriate), title of the item (book, magazine, journal, serial, symposium, catalog, etc), date, pages(s), volume-issue number(s), publisher, city and/or country where published.	T5
--------------------	---------	-----------------------------------------------------------------------------------------------------------------------------------------------------------------------------------------------------------------------------------------------------------------	----

INFORMATION DISCLOSURE STATEMENT BY APPLICANT (Not for submission under 37 CFR 1.99)	Application Number		12015320
	Filing Date		2008-01-16
	First Named Inventor	Russell W. White, et al.	
	Art Unit	2617	
	Examiner Name	Erika A. Gary	
	Attorney Docket Number	AFF.004C5US	

1	DANIEL KUMIN, Stereo Review, "Jukebox Heaven," January 1999, pages 64-71.	<input type="checkbox"/>
2	AUDIO, "Anthem Five-Channel Amp," July/August 1999, page 15.	<input type="checkbox"/>
3	Sony webpages in Japanese, "Portable Mini Disc Player MD Recorder," July 21, 1996, pages 1-5.	<input type="checkbox"/>
4	Sony, "MD Walkman Operating Instructions - MZ-R4ST," 1996, pages 1-64.	<input type="checkbox"/>
5	Sony, "MD Walkman Operating Instructions - MZ-R5ST," 1997, pages 1-79.	<input type="checkbox"/>
6	STEREO REVIEW, "New Products," June 1998, 1 page.	<input type="checkbox"/>
7	FACTIVA, Hardware Review, "Lost in the Supermarket," 2009, pages 1-3.	<input type="checkbox"/>
8	Sony webpages in Japanese, "Portable Mini Disc Player MD Recorder," October 21, 1999, pages 1-63.	<input type="checkbox"/>
9	JAMIE SORCHER, Stereo Review, "New for the Road," May 1998, 2 pages.	<input type="checkbox"/>
10	Sony, "MD Walkman Operating Instructions - MZ-R55," 1998, pages 1-42.	<input type="checkbox"/>
11	JOHN WHITTERS, The Advertiser, "Is the cassette doomed?" July 16, 1998, pages 1-2.	<input type="checkbox"/>

INFORMATION DISCLOSURE STATEMENT BY APPLICANT (Not for submission under 37 CFR 1.99)	Application Number	12015320
	Filing Date	2008-01-16
	First Named Inventor	Russell W. White, et al.
	Art Unit	2617
	Examiner Name	Erika A. Gary
	Attorney Docket Number	AFF.004C5US

12	GEORGE COLE, Financial Times, "Listen with your eyes: A new music CD format supplies textual information," October 23, 1997, pages 1-2.	<input type="checkbox"/>
13	DANA J. PARKER, Standard Deviations, "CD-TEXTra! Read all about it!", October 1996, pages 1-2.	<input type="checkbox"/>
14	MOBILE ELECTRONICS, "Down the Road," July 2004, pages 1-2.	<input type="checkbox"/>
15	ALPINE, "Interface Adapter for iPod KCA-420i - Owner's Manual," 44 pages total.	<input type="checkbox"/>
16	PR Newswire, "Alpine Announces Fall Release of Interface Adapter That Enables iPod Control and Playback From In-Vehicle Sound Systems," July 7, 2004, 2 pages total.	<input type="checkbox"/>
17	AMY GILBOY, Mobile Electronics, "Apple's iPod Seen Transforming Car Audio Business," 1 page.	<input type="checkbox"/>
18	GREG BORROWMAN, The Sydney Morning Herald, "Philips Releases Its Latest DVD," 1999, 2 pages total.	<input type="checkbox"/>
19	JVC, "Audio/Video Control Receiver, RX-668VBK, Instructions," pages 1-43.	<input type="checkbox"/>
20	Sony webpages in Japanese, "Portable MD Recorder," October 1997, 5 pages total.	<input type="checkbox"/>
21	Sony, "Walkman MZ-R50 Recorder," October 1997 7 pages total.	<input type="checkbox"/>
22	Sony, "MD Walkman MZ-R55," October 10, 1998, 6 pages total.	<input type="checkbox"/>

INFORMATION DISCLOSURE STATEMENT BY APPLICANT (Not for submission under 37 CFR 1.99)	Application Number		12015320
	Filing Date		2008-01-16
	First Named Inventor	Russell W. White, et al.	
	Art Unit		2617
	Examiner Name	Erika A. Gary	
	Attorney Docket Number		AFF.004C5US

23	VON HERBERT PAULER, Funkschau, "Kopierschutz fur MP3-Audio," 1999, 9 pages total.	<input type="checkbox"/>
24	English Summary, "A device for remotely controlling a car device for playing mp3 files is disclosed....", 1 page.	<input type="checkbox"/>
25	FRANKLIN N. TESSLER, MACWORLD, "Mobile MAC, Highway Fidelity," June 2004, pages 1-3.	<input type="checkbox"/>
26	BARRY COLLINS, The Sunday Times, "High-class high-tech - Buyer's guide," 2001, 2 pages total.	<input type="checkbox"/>
27	PETER FAMILARI, Herald-Sun, "Clever Deck - CD and mini-disc combination," 1998, 1 page.	<input type="checkbox"/>
28	JVC, "MD-CD Combination Deck, XU-301BK, Instructions," pages 1-59.	<input type="checkbox"/>
29	AMY GILROY, Mobile Electronics, "OEM Integrators Embrace iPod's Success," 1 page.	<input type="checkbox"/>
30	JVC, "Portable Minidisc Recorder, XM-R700SL, Instructions," pages 1-24.	<input type="checkbox"/>
31	Rio Car, "Car Toy Sole Retailer For Rio Car," May 28, 2001, 1 page.	<input type="checkbox"/>
32	AMY GILROY, Twice, "Panasonic Ships First SD MP3," December 4, 2000, 1 page.	<input type="checkbox"/>
33	Twice, "PhatNoise Readies MP3," November 5, 2001, 1 page.	<input type="checkbox"/>

INFORMATION DISCLOSURE STATEMENT BY APPLICANT (Not for submission under 37 CFR 1.99)	Application Number	12015320
	Filing Date	2008-01-16
	First Named Inventor	Russell W. White, et al.
	Art Unit	2617
	Examiner Name	Erika A. Gary
	Attorney Docket Number	AFF.004C5US

34	KEVIN SAVETZ, The Washington Post, "Putting Your MP3 Collection in Drive (Final Edition)," August 10, 2001, pages 1-3.	<input type="checkbox"/>
35	Twice, "Study Sees Retail Opportunities For Mobile Multimedia," Volume 14, Issue 15, June 28, 1999, pages 1-2.	<input type="checkbox"/>
36	Japanese Webpage, www.kcalgo.kr/jsp/main.jsp, 1 page.	<input type="checkbox"/>
37	Japanese Webpage, www.kca.go.kr - Brochure Free - Microsoft Internet Explorer, 1 page.	<input type="checkbox"/>
38	Japanese Webpage, www.kca.go.kr - Brochure Free - Microsoft Internet Explorer, 1 page.	<input type="checkbox"/>
39	STEPHEN KEMPAINEN, EDN Access For Design, By Design "In-car computing gets personal," August 17, 1998, pages 1-7.	<input type="checkbox"/>
40	Japanese Website, MM MPMANIA.com, http://mpmania, x-y.net/bbs/zboard.php?id=products&keyword=1998, 1 page.	<input type="checkbox"/>
41	Japanese document regarding MP3, May 1999, 1 page.	<input type="checkbox"/>
42	MPMan, "The portable MP3 player using the Flash Memory and Memory card - MP-F20," in Japanese, pages 1-34.	<input type="checkbox"/>
43	Japanese Website, MM MPMANIA.com, http://mpmania, x-y.net/bbs/view.php?id=products&page=1&sn1=&divpage, 1 page.	<input type="checkbox"/>
44	www.mpman.com, "MP-F30, User's Guide," pages 2-47.	<input type="checkbox"/>

INFORMATION DISCLOSURE STATEMENT BY APPLICANT (Not for submission under 37 CFR 1.99)	Application Number		12015320
	Filing Date		2008-01-16
	First Named Inventor	Russell W. White, et al.	
	Art Unit	2617	
	Examiner Name	Erika A. Gary	
	Attorney Docket Number	AFF.004C5US	

45	MARK MOELLER, Computing Unplugged Magazine, "Software Review, New software products for the Auto PC," 1999-2009, Zatz Publishing, pages 1-4	<input type="checkbox"/>
46	MARK MOELLER, Computing Unplugged Magazine, "Auto PC Power, A survey of resources for Auto PC owners," 1999-2009, Zatz Publishing, pages 1-5.	<input type="checkbox"/>
47	MARK MOELLER, Computing Unplugged Magazine, "Auto PC Power, A look at the first year of the Auto PC with Microsoft," 1999-2009, Zatz Publishing, pages 1-5.	<input type="checkbox"/>
48	MARK MOELLER, Computing Unplugged Magazine, "Auto PC Power, Next generation AutoPCs make a big debut at CES," 1999-2009, Zatz Publishing, pages 1-6.	<input type="checkbox"/>
49	MARK MOELLER, Computing Unplugged Magazine, "Programming Power, Getting started developing software for the Auto PC," 1999-2009, Zatz Publishing, pages 1-5	<input type="checkbox"/>
50	MARK MOELLER, Computing Unplugged Magazine, "Behind the Scenes, The AutoPC: Vision vs. Reality," 1999-2009, Zatz Publishing, pages 1-7.	<input type="checkbox"/>

If you wish to add additional non-patent literature document citation information please click the Add button

EXAMINER SIGNATURE

Examiner Signature	/Erika Gary/ (09/15/2010)	Date Considered	09/15/2010
--------------------	---------------------------	-----------------	------------

*EXAMINER: Initial if reference considered, whether or not citation is in conformance with MPEP 609. Draw line through a citation if not in conformance and not considered. Include copy of this form with next communication to applicant.

¹ See Kind Codes of USPTO Patent Documents at www.USPTO.GOV or MPEP 901.04. ² Enter office that issued the document, by the two-letter code (WIPO Standard ST.3). ³ For Japanese patent documents, the indication of the year of the reign of the Emperor must precede the serial number of the patent document. ⁴ Kind of document by the appropriate symbols as indicated on the document under WIPO Standard ST.16 if possible. ⁵ Applicant is to place a check mark here if English language translation is attached.

Doc code: IDS

Doc description: Information Disclosure Statement (IDS) Filed

PTO/SB/08a (04-09)

Approved for use through 05/31/2009. OMB 0651-0031

U.S. Patent and Trademark Office, U.S. DEPARTMENT OF COMMERCE

Under the Paperwork Reduction Act of 1995, no persons are required to respond to a collection of information unless it contains a valid OMB control number.

INFORMATION DISCLOSURE STATEMENT BY APPLICANT (Not for submission under 37 CFR 1.99)	Application Number		12015320	
	Filing Date		2008-01-16	
	First Named Inventor	Russell W. White, et al.		
	Art Unit	2617		
	Examiner Name	Erika A. Gary		
	Attorney Docket Number	AFF.004C5US		

U.S.PATENTS						
Examiner Initial*	Cite No	Patent Number	Kind Code ¹	Issue Date	Name of Patentee or Applicant of cited Document	Pages, Columns, Lines where Relevant Passages or Relevant Figures Appear
	1	6349352		2002-02-19	Lea	
	2	6697944		2004-02-24	Jones, et al.	
	3	6760916		2004-07-06	Holtz, et al.	
	4	6225984		2001-05-01	Crawford	
	5	5327558		1994-07-05	Burke, et al.	
	6	5715474		1998-02-03	Burke, et al.	

If you wish to add additional U.S. Patent citation information please click the Add button.

U.S.PATENT APPLICATION PUBLICATIONS						
Examiner Initial*	Cite No	Publication Number	Kind Code ¹	Publication Date	Name of Patentee or Applicant of cited Document	Pages, Columns, Lines where Relevant Passages or Relevant Figures Appear

INFORMATION DISCLOSURE STATEMENT BY APPLICANT (Not for submission under 37 CFR 1.99)	Application Number		12015320	
	Filing Date		2008-01-16	
	First Named Inventor		Russell W. White, et al.	
	Art Unit		2617	
	Examiner Name		Erika A. Gary	
	Attorney Docket Number		AFF.004C5US	

1						
---	--	--	--	--	--	--

If you wish to add additional U.S. Published Application citation information please click the Add button.

FOREIGN PATENT DOCUMENTS								
Examiner Initial*	Cite No	Foreign Document Number ³	Country Code ² i	Kind Code ⁴	Publication Date	Name of Patentee or Applicant of cited Document	Pages, Columns, Lines where Relevant Passages or Relevant Figures Appear	T ⁵
	1	WO 00/38340	WO		2000-06-29	Kim, Joehan		<input type="checkbox"/>
	2	WO 98/19480	WO		1998-07-05	Ericsson, Inc.		<input type="checkbox"/>
	3	WO 99/43136	WO		1999-08-26	Ericsson, Inc.		<input type="checkbox"/>
	4	8-79814	JP		1996-03-22			<input type="checkbox"/>
	5	9-74580	JP		1997-03-18			<input type="checkbox"/>
	6	10-149182	FP		1998-06-02			<input type="checkbox"/>
	7	3056721	FP		1998-12-02			<input type="checkbox"/>
	8	WO 99/06910	WO		1999-02-11	Ludtke, Harold A.		<input type="checkbox"/>

INFORMATION DISCLOSURE STATEMENT BY APPLICANT (Not for submission under 37 CFR 1.99)	Application Number		12015320	
	Filing Date		2008-01-16	
	First Named Inventor	Russell W. White, et al.		
	Art Unit	2617		
	Examiner Name	Erika A. Gary		
	Attorney Docket Number	AFF.004C5US		

9	11-73192	JP		1999-03-16			<input type="checkbox"/>
10	3890692	JP		2006-12-15			<input type="checkbox"/>
11	WO 99/12152	WO		1999-11-03	Sony Corporation		<input type="checkbox"/>
12	EP 0 920 016 A2	EP		1999-02-06	Sony Corporation		<input type="checkbox"/>
13	11-219580	JP		1999-08-10			<input type="checkbox"/>
14	EP 0 918 408 A2	EP		1999-05-26	Sony Corporation		<input type="checkbox"/>
15	11-143791	JP		1999-05-28			<input type="checkbox"/>
16	2007-207257	JP		2007-08-16			<input type="checkbox"/>
17	DE 20 2004 013 65	DE		2004-12-23	Boll, Nobert		<input type="checkbox"/>
18	WO 99/35009	WO		1999-07-15	Microsoft Corporation		<input type="checkbox"/>
19	2001-128280	JP		2001-05-11			<input type="checkbox"/>

INFORMATION DISCLOSURE STATEMENT BY APPLICANT (Not for submission under 37 CFR 1.99)	Application Number		12015320	
	Filing Date		2008-01-16	
	First Named Inventor	Russell W. White, et al.		
	Art Unit	2617		
	Examiner Name	Erika A. Gary		
	Attorney Docket Number	AFF.004C5US		

	20	KR20000036680	KR		2000-07-05	Kee Kang Choon		<input type="checkbox"/>
	21	10-1997-0016743	KR		1997-04-30			<input type="checkbox"/>
	22	20-1997-0012254	KR		1997-05-28			<input type="checkbox"/>
	23	WO 99/23856	WO		1999-05-14	Mershon, Stuart		<input type="checkbox"/>
	24	WO 99/28897	WO		1999-06-10	Voquette Networks, LTD.		<input type="checkbox"/>
	25	1999-0055970	KR		1999-07-15			<input type="checkbox"/>
	26	100242563 B1	KR		1999-10-11	Kim, Joon Sung		<input type="checkbox"/>
	27	EP 0 982 732 A1	EP		2000-01-03	Saehan Information Systems, Inc.		<input type="checkbox"/>
	28	10-0356742	KR		2002-10-18	Hyundai Autonet, Co. Ltd.		<input type="checkbox"/>
	29	10-356742	JP		2002-10-02			<input type="checkbox"/>
	30	WO 00/38340	WO		2000-06-29	Kim, Jaehan		<input type="checkbox"/>

INFORMATION DISCLOSURE STATEMENT BY APPLICANT (Not for submission under 37 CFR 1.99)	Application Number		12015320	
	Filing Date		2008-01-16	
	First Named Inventor	Russell W. White, et al.		
	Art Unit	2617		
	Examiner Name	Erika A. Gary		
	Attorney Docket Number	AFF.004C5US		

	31	2000-0001465	JP		2000-01-25			<input type="checkbox"/>
	32	2001-0009302	JP		2001-02-05			<input type="checkbox"/>
	33	2001-0028354	JP		2001-04-06			<input type="checkbox"/>
	34	1999-0033393	JP		1999-05-15			<input type="checkbox"/>
	35	11-317061	JP		1999-11-16			<input type="checkbox"/>
	36	2225910	CA		1997-12-24	Lussier, Luc.		<input type="checkbox"/>
	37	0 661 676 A1	EP		1994-12-21	AT&T Global Information Solutions International		<input type="checkbox"/>
	38	0 982 732 A1	EP		2000-01-03	Saeahan Information Systems, Inc.		<input type="checkbox"/>
	39	2901445	JP		1999-03-19			<input type="checkbox"/>
	40	9-50282	JP		1997-02-18			<input type="checkbox"/>
	41	10-173737	JP		1998-06-26			<input type="checkbox"/>

INFORMATION DISCLOSURE STATEMENT BY APPLICANT (Not for submission under 37 CFR 1.99)	Application Number		12015320	
	Filing Date		2008-01-16	
	First Named Inventor	Russell W. White, et al.		
	Art Unit		2617	
	Examiner Name	Erika A. Gary		
	Attorney Docket Number		AFF.004C5US	

42	11-96735	JP		1999-04-09			<input type="checkbox"/>
43	11-242686	JP		1999-09-07			<input type="checkbox"/>
44	WO 94/18763	WO		1994-08-18	Gutle, Hubert		<input type="checkbox"/>
45	WO 98/21672	WO		1998-05-22	Inergy Online, Inc.		<input type="checkbox"/>
46	WO 98/33102	WO		1998-07-30	Guimaraes Teixeira		<input type="checkbox"/>
47	WO 99/18518	WO		1999-04-15	Polash, Peter		<input type="checkbox"/>
48	WO 00/07849	WO		2000-02-17	Microsoft Corporation		<input type="checkbox"/>
49	11-317061	WO		1999-11-16			<input type="checkbox"/>
50	2901445	JP		1999-03-19			<input type="checkbox"/>

If you wish to add additional Foreign Patent Document citation information please click the Add button

NON-PATENT LITERATURE DOCUMENTS

Examiner Initials*	Cite No	Include name of the author (in CAPITAL LETTERS), title of the article (when appropriate), title of the item (book, magazine, journal, serial, symposium, catalog, etc), date, pages(s), volume-issue number(s), publisher, city and/or country where published.	T ⁵
--------------------	---------	-----------------------------------------------------------------------------------------------------------------------------------------------------------------------------------------------------------------------------------------------------------------	----------------

INFORMATION DISCLOSURE STATEMENT BY APPLICANT (Not for submission under 37 CFR 1.99)	Application Number	12015320
	Filing Date	2008-01-16
	First Named Inventor	Russell W. White, et al.
	Art Unit	2617
	Examiner Name	Erika A. Gary
	Attorney Docket Number	AFF.004C5US

1	DANIEL KUMIN, Stereo Review, "Jukebox Heaven," January 1999, pages 64-71.	<input type="checkbox"/>
2	AUDIO, "Anthem Five-Channel Amp," July/August 1999, page 15.	<input type="checkbox"/>
3	Sony webpages in Japanese, "Portable Mini Disc Player MD Recorder," July 21, 1996, pages 1-5.	<input type="checkbox"/>
4	Sony, "MD Walkman Operating Instructions - MZ-R4ST," 1996, pages 1-64.	<input type="checkbox"/>
5	Sony, "MD Walkman Operating Instructions - MZ-R5ST," 1997, pages 1-79.	<input type="checkbox"/>
6	STEREO REVIEW, "New Products," June 1998, 1 page.	<input type="checkbox"/>
7	FACTIVA, Hardware Review, "Lost in the Supermarket," 2009, pages 1-3.	<input type="checkbox"/>
8	Sony webpages in Japanese, "Portable Mini Disc Player MD Recorder," October 21, 1999, pages 1-63.	<input type="checkbox"/>
9	JAMIE SORCHER, Stereo Review, "New for the Road," May 1998, 2 pages.	<input type="checkbox"/>
10	Sony, "MD Walkman Operating Instructions - MZ-R55," 1998, pages 1-42.	<input type="checkbox"/>
11	JOHN WHITTERS, The Advertiser, "Is the cassette doomed?" July 16, 1998, pages 1-2.	<input type="checkbox"/>

INFORMATION DISCLOSURE STATEMENT BY APPLICANT (Not for submission under 37 CFR 1.99)	Application Number	12015320
	Filing Date	2008-01-16
	First Named Inventor	Russell W. White, et al.
	Art Unit	2617
	Examiner Name	Erika A. Gary
	Attorney Docket Number	AFF.004C5US

12	GEORGE COLE, Financial Times, "Listen with your eyes: A new music CD format supplies textual information," October 23, 1997, pages 1-2.	<input type="checkbox"/>
13	DANA J. PARKER, Standard Deviations, "CD-TEXTral Read all about it!", October 1996, pages 1-2.	<input type="checkbox"/>
14	MOBILE ELECTRONICS, "Down the Road," July 2004, pages 1-2.	<input type="checkbox"/>
15	ALPINE, "Interface Adapter for iPod KCA-420i - Owner's Manual," 44 pages total.	<input type="checkbox"/>
16	PR Newswire, "Alpine Announces Fall Release of Interface Adapter That Enables iPod Control and Playback From In-Vehicle Sound Systems," July 7, 2004, 2 pages total.	<input type="checkbox"/>
17	AMY GILBOY, Mobile Electronics, "Apple's iPod Seen Transforming Car Audio Business," 1 page.	<input type="checkbox"/>
18	GREG BORROWMAN, The Sydney Morning Herald, "Philips Releases Its Latest DVD," 1999, 2 pages total.	<input type="checkbox"/>
19	JVC, "Audio/Video Control Receiver, RX-668VBK, Instructions," pages 1-43.	<input type="checkbox"/>
20	Sony webpages in Japanese, "Portable MD Recorder," October 1997, 5 pages total.	<input type="checkbox"/>
21	Sony, "Walkman MZ-R50 Recorder," October 1997 7 pages total.	<input type="checkbox"/>
22	Sony, "MD Walkman MZ-R55," October 10, 1998, 6 pages total.	<input type="checkbox"/>

INFORMATION DISCLOSURE STATEMENT BY APPLICANT (Not for submission under 37 CFR 1.99)	Application Number	12015320
	Filing Date	2008-01-16
	First Named Inventor	Russell W. White, et al.
	Art Unit	2617
	Examiner Name	Erika A. Gary
	Attorney Docket Number	AFF.004C5US

23	VON HERBERT PAULER, Funkschau, "Kopierschutz fur MP3-Audio," 1999, 9 pages total.	<input type="checkbox"/>
24	English Summary, "A device for remotely controlling a car device for playing mp3 files is disclosed....", 1 page.	<input type="checkbox"/>
25	FRANKLIN N. TESSLER, MACWORLD, "Mobile MAC, Highway Fidelity," June 2004, pages 1-3.	<input type="checkbox"/>
26	BARRY COLLINS, The Sunday Times, "High-class high-tech - Buyer's guide," 2001, 2 pages total.	<input type="checkbox"/>
27	PETER FAMILARI, Herald-Sun, "Clever Deck - CD and mini-disc combination," 1998, 1 page.	<input type="checkbox"/>
28	JVC, "MD-CD Combination Deck, XU-301BK, Instructions," pages 1-59.	<input type="checkbox"/>
29	AMY GILROY, Mobile Electronics, "OEM Integrators Embrace iPod's Success," 1 page.	<input type="checkbox"/>
30	JVC, "Portable Minidisc Recorder, XM-R700SL, Instructions," pages 1-24.	<input type="checkbox"/>
31	Rio Car, "Car Toy Sole Retailer For Rio Car," May 28, 2001, 1 page.	<input type="checkbox"/>
32	AMY GILROY, Twice, "Panasonic Ships First SD MP3," December 4, 2000, 1 page.	<input type="checkbox"/>
33	Twice, "PhatNoise Readies MP3," November 5, 2001, 1 page.	<input type="checkbox"/>

INFORMATION DISCLOSURE STATEMENT BY APPLICANT (Not for submission under 37 CFR 1.99)	Application Number		12015320
	Filing Date		2008-01-16
	First Named Inventor	Russell W. White, et al.	
	Art Unit		2617
	Examiner Name	Erika A. Gary	
	Attorney Docket Number		AFF.004C5US

34	KEVIN SAVETZ, The Washington Post, "Putting Your MP3 Collection in Drive (Final Edition)," August 10, 2001, pages 1-3.	<input type="checkbox"/>
35	Twice, "Study Sees Retail Opportunities For Mobile Multimedia," Volume 14, Issue 15, June 28, 1999, pages 1-2.	<input type="checkbox"/>
36	Japanese Webpage, www.kcalgo.kr/jsp/main.jsp, 1 page.	<input type="checkbox"/>
37	Japanese Webpage, www.kca.go.kr - Brochure Free - Microsoft Internet Explorer, 1 page.	<input type="checkbox"/>
38	Japanese Webpage, www.kca.go.kr - Brochure Free - Microsoft Internet Explorer, 1 page.	<input type="checkbox"/>
39	STEPHEN KEMPAINEN, EDN Access For Design, By Design "In-car computing gets personal," August 17, 1998, pages 1-7.	<input type="checkbox"/>
40	Japanese Website, MM MPMANIA.com, http://mpmania, x-y.net/bbs/zboard.php?id=products&keyword=1998, 1 page.	<input type="checkbox"/>
41	Japanese document regarding MP3, May 1999, 1 page.	<input type="checkbox"/>
42	MPMan, "The portable MP3 player using the Flash Memory and Memory card - MP-F20," in Japanese, pages 1-34.	<input type="checkbox"/>
43	Japanese Website, MM MPMANIA.com, http://mpmania, x-y.net/bbs/view.php?id=products&page=1&sn1=&divpage, 1 page.	<input type="checkbox"/>
44	www.mpman.com, "MP-F30, User's Guide," pages 2-47.	<input type="checkbox"/>

INFORMATION DISCLOSURE STATEMENT BY APPLICANT (Not for submission under 37 CFR 1.99)	Application Number		12015320
	Filing Date		2008-01-16
	First Named Inventor	Russell W. White, et al.	
	Art Unit	2617	
	Examiner Name	Erika A. Gary	
	Attorney Docket Number	AFF.004C5US	

45	MARK MOELLER, Computing Unplugged Magazine, "Software Review, New software products for the Auto PC," 1999-2009, Zatz Publishing, pages 1-4	<input type="checkbox"/>
46	MARK MOELLER, Computing Unplugged Magazine, "Auto PC Power, A survey of resources for Auto PC owners," 1999-2009, Zatz Publishing, pages 1-5.	<input type="checkbox"/>
47	MARK MOELLER, Computing Unplugged Magazine, "Auto PC Power, A look at the first year of the Auto PC with Microsoft," 1999-2009, Zatz Publishing, pages 1-5.	<input type="checkbox"/>
48	MARK MOELLER, Computing Unplugged Magazine, "Auto PC Power, Next generation AutoPCs make a big debut at CES," 1999-2009, Zatz Publishing, pages 1-6.	<input type="checkbox"/>
49	MARK MOELLER, Computing Unplugged Magazine, "Programming Power, Getting started developing software for the Auto PC," 1999-2009, Zatz Publishing, pages 1-5	<input type="checkbox"/>
50	MARK MOELLER, Computing Unplugged Magazine, "Behind the Scenes, The AutoPC: Vision vs. Reality," 1999-2009, Zatz Publishing, pages 1-7.	<input type="checkbox"/>

If you wish to add additional non-patent literature document citation information please click the Add button

EXAMINER SIGNATURE

Examiner Signature	/Erika Gary/ (09/15/2010)	Date Considered	09/15/2010
--------------------	---------------------------	-----------------	------------

*EXAMINER: Initial if reference considered, whether or not citation is in conformance with MPEP 609. Draw line through a citation if not in conformance and not considered. Include copy of this form with next communication to applicant.

¹ See Kind Codes of USPTO Patent Documents at www.USPTO.GOV or MPEP 901.04. ² Enter office that issued the document, by the two-letter code (WIPO Standard ST.3). ³ For Japanese patent documents, the indication of the year of the reign of the Emperor must precede the serial number of the patent document. ⁴ Kind of document by the appropriate symbols as indicated on the document under WIPO Standard ST.16 if possible. ⁵ Applicant is to place a check mark here if English language translation is attached.

Doc code: IDS

Doc description: Information Disclosure Statement (IDS) Filed

PTO/SB/08a (04-09)

Approved for use through 05/31/2009. OMB 0651-0031
U.S. Patent and Trademark Office, U.S. DEPARTMENT OF COMMERCE

Under the Paperwork Reduction Act of 1995, no persons are required to respond to a collection of information unless it contains a valid OMB control number.

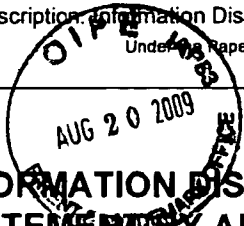

INFORMATION DISCLOSURE STATEMENT BY APPLICANT
(Not for submission under 37 CFR 1.99)

Application Number		12015320
Filing Date		2008-01-16
First Named Inventor	Russell W. White, et al.	
Art Unit	2617	
Examiner Name	Erika A. Gary	
Attorney Docket Number	AFF.004C5US	

U.S.PATENTS

Examiner Initial*	Cite No	Patent Number	Kind Code ¹	Issue Date	Name of Patentee or Applicant of cited Document	Pages, Columns, Lines where Relevant Passages or Relevant Figures Appear
	1	6349352		2002-02-19	Lea	
	2	6697944		2004-02-24	Jones, et al.	
	3	6760916		2004-07-06	Holtz, et al.	
	4	6225984		2001-05-01	Crawford	
	5	5327558		1994-07-05	Burke, et al.	
	6	5715474		1998-02-03	Burke, et al.	

If you wish to add additional U.S. Patent citation information please click the Add button.

U.S.PATENT APPLICATION PUBLICATIONS

Examiner Initial*	Cite No	Publication Number	Kind Code ¹	Publication Date	Name of Patentee or Applicant of cited Document	Pages, Columns, Lines where Relevant Passages or Relevant Figures Appear
-------------------	---------	--------------------	------------------------	------------------	-------------------------------------------------	--------------------------------------------------------------------------

INFORMATION DISCLOSURE STATEMENT BY APPLICANT (Not for submission under 37 CFR 1.99)	Application Number		12015320	
	Filing Date		2008-01-16	
	First Named Inventor	Russell W. White, et al.		
	Art Unit	2617		
	Examiner Name	Erika A. Gary		
	Attorney Docket Number	AFF.004C5US		

1					
---	--	--	--	--	--

If you wish to add additional U.S. Published Application citation information please click the Add button.

FOREIGN PATENT DOCUMENTS								
Examiner Initial*	Cite No	Foreign Document Number ³	Country Code ² i	Kind Code ⁴	Publication Date	Name of Patentee or Applicant of cited Document	Pages, Columns, Lines where Relevant Passages or Relevant Figures Appear	T ⁵
	1	WO 00/38340	WO		2000-06-29	Kim, Joehan		<input type="checkbox"/>
	2	WO 98/19480	WO		1998-07-05	Ericsson, Inc.		<input type="checkbox"/>
	3	WO 99/43136	WO		1999-08-26	Ericsson, Inc.		<input type="checkbox"/>
	4	8-79814	JP		1996-03-22			<input type="checkbox"/>
	5	9-74580	JP		1997-03-18			<input type="checkbox"/>
	6	10-149182	FP		1998-06-02			<input type="checkbox"/>
	7	3056721	FP		1998-12-02			<input type="checkbox"/>
	8	WO 99/06910	WO		1999-02-11	Ludtke, Harold A.		<input type="checkbox"/>

INFORMATION DISCLOSURE STATEMENT BY APPLICANT (Not for submission under 37 CFR 1.99)	Application Number		12015320	
	Filing Date		2008-01-16	
	First Named Inventor	Russell W. White, et al.		
	Art Unit	2617		
	Examiner Name	Erika A. Gary		
	Attorney Docket Number	AFF.004C5US		

9	11-73192	JP		1999-03-16			<input type="checkbox"/>
10	3890692	JP		2006-12-15			<input type="checkbox"/>
11	WO 99/12152	WO		1999-11-03	Sony Corporation		<input type="checkbox"/>
12	EP 0 920 016 A2	EP		1999-02-06	Sony Corporation		<input type="checkbox"/>
13	11-219580	JP		1999-08-10			<input type="checkbox"/>
14	EP 0 918 408 A2	EP		1999-05-26	Sony Corporation		<input type="checkbox"/>
15	11-143791	JP		1999-05-28			<input type="checkbox"/>
16	2007-207257	JP		2007-08-16			<input type="checkbox"/>
17	DE 20 2004 013 65	DE		2004-12-23	Boll, Nobert		<input type="checkbox"/>
18	WO 99/35009	WO		1999-07-15	Microsoft Corporation		<input type="checkbox"/>
19	2001-128280	JP		2001-05-11			<input type="checkbox"/>

INFORMATION DISCLOSURE STATEMENT BY APPLICANT (Not for submission under 37 CFR 1.99)	Application Number		12015320	
	Filing Date		2008-01-16	
	First Named Inventor	Russell W. White, et al.		
	Art Unit	2617		
	Examiner Name	Erika A. Gary		
	Attorney Docket Number	AFF.004C5US		

	20	KR20000036680	KR		2000-07-05	Kee Kang Choon		<input type="checkbox"/>
	21	10-1997-0016743	KR		1997-04-30			<input type="checkbox"/>
	22	20-1997-0012254	KR		1997-05-28			<input type="checkbox"/>
	23	WO 99/23856	WO		1999-05-14	Mershon, Stuart		<input type="checkbox"/>
	24	WO 99/28897	WO		1999-06-10	Voquette Networks, LTD.		<input type="checkbox"/>
	25	1999-0055970	KR		1999-07-15			<input type="checkbox"/>
	26	100242563 B1	KR		1999-10-11	Kim, Joon Sung		<input type="checkbox"/>
	27	EP 0 982 732 A1	EP		2000-01-03	Saehan Information Systems, Inc.		<input type="checkbox"/>
	28	10-0356742	KR		2002-10-18	Hyundai Autonet, Co. Ltd.		<input type="checkbox"/>
	29	10-356742	JP		2002-10-02			<input type="checkbox"/>
	30	WO 00/38340	WO		2000-06-29	Kim, Jaehan		<input type="checkbox"/>

INFORMATION DISCLOSURE STATEMENT BY APPLICANT (Not for submission under 37 CFR 1.99)	Application Number		12015320	
	Filing Date		2008-01-16	
	First Named Inventor	Russell W. White, et al.		
	Art Unit	2617		
	Examiner Name	Erika A. Gary		
	Attorney Docket Number	AFF.004C5US		

	31	2000-0001465	JP		2000-01-25			<input type="checkbox"/>
	32	2001-0009302	JP		2001-02-05			<input type="checkbox"/>
	33	2001-0028354	JP		2001-04-06			<input type="checkbox"/>
	34	1999-0033393	JP		1999-05-15			<input type="checkbox"/>
	35	11-317061	JP		1999-11-16			<input type="checkbox"/>
	36	2225910	CA		1997-12-24	Lussier, Luc.		<input type="checkbox"/>
	37	0 661 676 A1	EP		1994-12-21	AT&T Global Information Solutions International		<input type="checkbox"/>
	38	0 982 732 A1	EP		2000-01-03	Saeahan Information Systems, Inc.		<input type="checkbox"/>
	39	2901445	JP		1999-03-19			<input type="checkbox"/>
	40	9-50282	JP		1997-02-18			<input type="checkbox"/>
	41	10-173737	JP		1998-06-26			<input type="checkbox"/>

INFORMATION DISCLOSURE STATEMENT BY APPLICANT (Not for submission under 37 CFR 1.99)	Application Number		12015320	
	Filing Date		2008-01-16	
	First Named Inventor	Russell W. White, et al.		
	Art Unit	2617		
	Examiner Name	Erika A. Gary		
	Attorney Docket Number	AFF.004C5US		

42	11-96735	JP		1999-04-09			<input type="checkbox"/>
43	11-242686	JP		1999-09-07			<input type="checkbox"/>
44	WO 94/18763	WO		1994-08-18	Gutte, Hubert		<input type="checkbox"/>
45	WO 98/21672	WO		1998-05-22	Inergy Online, Inc.		<input type="checkbox"/>
46	WO 98/33102	WO		1998-07-30	Guimaraes Teixeira		<input type="checkbox"/>
47	WO 99/18518	WO		1999-04-15	Polash, Peter		<input type="checkbox"/>
48	WO 00/07849	WO		2000-02-17	Microsoft Corporation		<input type="checkbox"/>
49	11-317061	WO		1999-11-16			<input type="checkbox"/>
50	2901445	JP		1999-03-19			<input type="checkbox"/>

If you wish to add additional Foreign Patent Document citation information please click the Add button

NON-PATENT LITERATURE DOCUMENTS

Examiner Initials*	Cite No	Include name of the author (in CAPITAL LETTERS), title of the article (when appropriate), title of the item (book, magazine, journal, serial, symposium, catalog, etc), date, pages(s), volume-issue number(s), publisher, city and/or country where published.	T5
--------------------	---------	-----------------------------------------------------------------------------------------------------------------------------------------------------------------------------------------------------------------------------------------------------------------	----

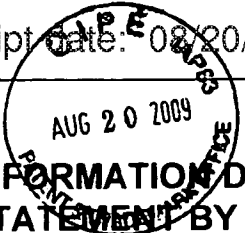

INFORMATION DISCLOSURE STATEMENT BY APPLICANT
 (Not for submission under 37 CFR 1.99)

Application Number		12015320
Filing Date		2008-01-16
First Named Inventor	Russell W. White, et al.	
Art Unit	2617	
Examiner Name	Erika A. Gary	
Attorney Docket Number	AFF.004C5US	

1	DANIEL KUMIN, Stereo Review, "Jukebox Heaven," January 1999, pages 64-71.	<input type="checkbox"/>
2	AUDIO, "Anthem Five-Channel Amp," July/August 1999, page 15.	<input type="checkbox"/>
3	Sony webpages in Japanese, "Portable Mini Disc Player MD Recorder," July 21, 1996, pages 1-5.	<input type="checkbox"/>
4	Sony, "MD Walkman Operating Instructions - MZ-R4ST," 1996, pages 1-64.	<input type="checkbox"/>
5	Sony, "MD Walkman Operating Instructions - MZ-R5ST," 1997, pages 1-79.	<input type="checkbox"/>
6	STEREO REVIEW, "New Products," June 1998, 1 page.	<input type="checkbox"/>
7	FACTIVA, Hardware Review, "Lost in the Supermarket," 2009, pages 1-3.	<input type="checkbox"/>
8	Sony webpages in Japanese, "Portable Mini Disc Player MD Recorder," October 21, 1999, pages 1-63.	<input type="checkbox"/>
9	JAMIE SORCHER, Stereo Review, "New for the Road," May 1998, 2 pages.	<input type="checkbox"/>
10	Sony, "MD Walkman Operating Instructions - MZ-R55," 1998, pages 1-42.	<input type="checkbox"/>
11	JOHN WHITTERS, The Advertiser, "Is the cassette doomed?" July 16, 1998, pages 1-2.	<input type="checkbox"/>

INFORMATION DISCLOSURE STATEMENT BY APPLICANT (Not for submission under 37 CFR 1.99)	Application Number		12015320
	Filing Date		2008-01-16
	First Named Inventor	Russell W. White, et al.	
	Art Unit		2617
	Examiner Name	Erika A. Gary	
	Attorney Docket Number		AFF.004C5US

12	GEORGE COLE, Financial Times, "Listen with your eyes: A new music CD format supplies textual information," October 23, 1997, pages 1-2.	<input type="checkbox"/>
13	DANA J. PARKER, Standard Deviations, "CD-TEXTral Read all about it!", October 1996, pages 1-2.	<input type="checkbox"/>
14	MOBILE ELECTRONICS, "Down the Road," July 2004, pages 1-2.	<input type="checkbox"/>
15	ALPINE, "Interface Adapter for iPod KCA-420i - Owner's Manual," 44 pages total.	<input type="checkbox"/>
16	PR Newswire, "Alpine Announces Fall Release of Interface Adapter That Enables iPod Control and Playback From In-Vehicle Sound Systems," July 7, 2004, 2 pages total.	<input type="checkbox"/>
17	AMY GILBOY, Mobile Electronics, "Apple's iPod Seen Transforming Car Audio Business," 1 page.	<input type="checkbox"/>
18	GREG BORROWMAN, The Sydney Morning Herald, "Philips Releases Its Latest DVD," 1999, 2 pages total.	<input type="checkbox"/>
19	JVC, "Audio/Video Control Receiver, RX-668VBK, Instructions," pages 1-43.	<input type="checkbox"/>
20	Sony webpages in Japanese, "Portable MD Recorder," October 1997, 5 pages total.	<input type="checkbox"/>
21	Sony, "Walkman MZ-R50 Recorder," October 1997 7 pages total.	<input type="checkbox"/>
22	Sony, "MD Walkman MZ-R55," October 10, 1998, 6 pages total.	<input type="checkbox"/>

INFORMATION DISCLOSURE STATEMENT BY APPLICANT (Not for submission under 37 CFR 1.99)	Application Number	12015320
	Filing Date	2008-01-16
	First Named Inventor	Russell W. White, et al.
	Art Unit	2617
	Examiner Name	Erika A. Gary
	Attorney Docket Number	AFF.004C5US

23	VON HERBERT PAULER, Funkschau, "Kopierschutz fur MP3-Audio," 1999, 9 pages total.	<input type="checkbox"/>
24	English Summary, "A device for remotely controlling a car device for playing mp3 files is disclosed....", 1 page.	<input type="checkbox"/>
25	FRANKLIN N. TESSLER, MACWORLD, "Mobile MAC, Highway Fidelity," June 2004, pages 1-3.	<input type="checkbox"/>
26	BARRY COLLINS, The Sunday Times, "High-class high-tech - Buyer's guide," 2001, 2 pages total.	<input type="checkbox"/>
27	PETER FAMILARI, Herald-Sun, "Clever Deck - CD and mini-disc combination," 1998, 1 page.	<input type="checkbox"/>
28	JVC, "MD-CD Combination Deck, XU-301BK, Instructions," pages 1-59.	<input type="checkbox"/>
29	AMY GILROY, Mobile Electronics, "OEM Integrators Embrace iPod's Success," 1 page.	<input type="checkbox"/>
30	JVC, "Portable Minidisc Recorder, XM-R700SL, Instructions," pages 1-24.	<input type="checkbox"/>
31	Rio Car, "Car Toy Sole Retailer For Rio Car," May 28, 2001, 1 page.	<input type="checkbox"/>
32	AMY GILROY, Twice, "Panasonic Ships First SD MP3," December 4, 2000, 1 page.	<input type="checkbox"/>
33	Twice, "PhatNoise Readies MP3," November 5, 2001, 1 page.	<input type="checkbox"/>

INFORMATION DISCLOSURE STATEMENT BY APPLICANT (Not for submission under 37 CFR 1.99)	Application Number		12015320
	Filing Date		2008-01-16
	First Named Inventor	Russell W. White, et al.	
	Art Unit	2617	
	Examiner Name	Erika A. Gary	
	Attorney Docket Number	AFF.004C5US	

34	KEVIN SAVETZ, The Washington Post, "Putting Your MP3 Collection in Drive (Final Edition)," August 10, 2001, pages 1-3.	<input type="checkbox"/>
35	Twice, "Study Sees Retail Opportunities For Mobile Multimedia," Volume 14, Issue 15, June 28, 1999, pages 1-2.	<input type="checkbox"/>
36	Japanese Webpage, www.kcalgo.kr/jsp/main.jsp, 1 page.	<input type="checkbox"/>
37	Japanese Webpage, www.kca.go.kr - Brochure Free - Microsoft Internet Explorer, 1 page.	<input type="checkbox"/>
38	Japanese Webpage, www.kca.go.kr - Brochure Free - Microsoft Internet Explorer, 1 page.	<input type="checkbox"/>
39	STEPHEN KEMPAINEN, EDN Access For Design, By Design "In-car computing gets personal," August 17, 1998, pages 1-7.	<input type="checkbox"/>
40	Japanese Website, MM MPMANIA.com, http://mpmania, x-y.net/bbs/zboard.php?id=products&keyword=1998, 1 page.	<input type="checkbox"/>
41	Japanese document regarding MP3, May 1999, 1 page.	<input type="checkbox"/>
42	MPMan, "The portable MP3 player using the Flash Memory and Memory card - MP-F20," in Japanese, pages 1-34.	<input type="checkbox"/>
43	Japanese Website, MM MPMANIA.com, http://mpmania, x-y.net/bbs/view.php?id=products&page=1&sn1=&divpage, 1 page.	<input type="checkbox"/>
44	www.mpman.com, "MP-F30, User's Guide," pages 2-47.	<input type="checkbox"/>

INFORMATION DISCLOSURE STATEMENT BY APPLICANT (Not for submission under 37 CFR 1.99)	Application Number	12015320
	Filing Date	2008-01-16
	First Named Inventor	Russell W. White, et al.
	Art Unit	2617
	Examiner Name	Erika A. Gary
	Attorney Docket Number	AFF.004C5US

45	MARK MOELLER, Computing Unplugged Magazine, "Software Review, New software products for the Auto PC," 1999-2009, Zatz Publishing, pages 1-4	<input type="checkbox"/>
46	MARK MOELLER, Computing Unplugged Magazine, "Auto PC Power, A survey of resources for Auto PC owners," 1999-2009, Zatz Publishing, pages 1-5.	<input type="checkbox"/>
47	MARK MOELLER, Computing Unplugged Magazine, "Auto PC Power, A look at the first year of the Auto PC with Microsoft," 1999-2009, Zatz Publishing, pages 1-5.	<input type="checkbox"/>
48	MARK MOELLER, Computing Unplugged Magazine, "Auto PC Power, Next generation AutoPCs make a big debut at CES," 1999-2009, Zatz Publishing, pages 1-6.	<input type="checkbox"/>
49	MARK MOELLER, Computing Unplugged Magazine, "Programming Power, Getting started developing software for the Auto PC," 1999-2009, Zatz Publishing, pages 1-5	<input type="checkbox"/>
50	MARK MOELLER, Computing Unplugged Magazine, "Behind the Scenes, The AutoPC: Vision vs. Reality," 1999-2009, Zatz Publishing, pages 1-7.	<input type="checkbox"/>

If you wish to add additional non-patent literature document citation information please click the Add button

EXAMINER SIGNATURE

Examiner Signature	/Erika Gary/ (09/15/2010)	Date Considered	09/15/2010
--------------------	---------------------------	-----------------	------------

*EXAMINER: Initial if reference considered, whether or not citation is in conformance with MPEP 609. Draw line through a citation if not in conformance and not considered. Include copy of this form with next communication to applicant.

¹ See Kind Codes of USPTO Patent Documents at www.USPTO.GOV or MPEP 901.04. ² Enter office that issued the document, by the two-letter code (WIPO Standard ST.3). ³ For Japanese patent documents, the indication of the year of the reign of the Emperor must precede the serial number of the patent document. ⁴ Kind of document by the appropriate symbols as indicated on the document under WIPO Standard ST.16 if possible. ⁵ Applicant is to place a check mark here if English language translation is attached.

Doc code: IDS

Doc description: Information Disclosure Statement (IDS) Filed

PTO/SB/08a (04-09)

Approved for use through 05/31/2009. OMB 0651-0031

U.S. Patent and Trademark Office; U.S. DEPARTMENT OF COMMERCE

Under the Paperwork Reduction Act of 1995, no persons are required to respond to a collection of information unless it contains a valid OMB control number.

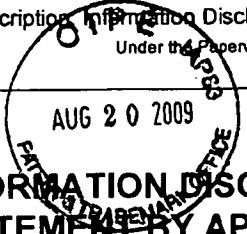

INFORMATION DISCLOSURE STATEMENT BY APPLICANT (Not for submission under 37 CFR 1.99)	Application Number		12015320	
	Filing Date		2008-01-16	
	First Named Inventor	Russell W. White, et al.		
	Art Unit	2617		
	Examiner Name	Erika A. Gary		
	Attorney Docket Number	AFF.004C5US		

U.S. PATENTS

Examiner Initial*	Cite No	Patent Number	Kind Code ¹	Issue Date	Name of Patentee or Applicant of cited Document	Pages, Columns, Lines where Relevant Passages or Relevant Figures Appear
	1					

If you wish to add additional U.S. Patent citation information please click the Add button.

U.S. PATENT APPLICATION PUBLICATIONS

Examiner Initial*	Cite No	Publication Number	Kind Code ¹	Publication Date	Name of Patentee or Applicant of cited Document	Pages, Columns, Lines where Relevant Passages or Relevant Figures Appear
	1					

If you wish to add additional U.S. Published Application citation information please click the Add button.

FOREIGN PATENT DOCUMENTS

Examiner Initial*	Cite No	Foreign Document Number ³	Country Code ²	Kind Code ⁴	Publication Date	Name of Patentee or Applicant of cited Document	Pages, Columns, Lines where Relevant Passages or Relevant Figures Appear	T ⁵
	1	2000-66974	JP		2000-03-03			<input type="checkbox"/>
	2	11-68685	JP		1999-03-09			<input type="checkbox"/>
	3	CN 1218258A	CN		1999-06-02			<input type="checkbox"/>

INFORMATION DISCLOSURE STATEMENT BY APPLICANT (Not for submission under 37 CFR 1.99)	Application Number		12015320	
	Filing Date		2008-01-16	
	First Named Inventor	Russell W. White, et al.		
	Art Unit	2617		
	Examiner Name	Erika A. Gary		
	Attorney Docket Number	AFF.004C5US		

4	H11-242686	JP		1999-09-07	Sony Corporation	<input type="checkbox"/>
5	DE 44 31 070 B4	DE		2004-07-22	DaimlerChrysler AG	<input type="checkbox"/>
6	0 569 343 A1	EP		1993-10-11	Pioneer Electronic Corporation	<input type="checkbox"/>
7	0 675 341 A1	EP		1995-04-10	Honda Giken-Kogyo	<input type="checkbox"/>
8	0 771 686 A2	EP		1997-07-05	Toyota Jidosha Kabushiki Kaisha Toyota-shi, Aichi-	<input type="checkbox"/>
9	H4-261576	JP		1992-09-17	Mitsubishi Electric Corporation	<input type="checkbox"/>
10	2-301330	JP		1990-12-13		<input type="checkbox"/>
11	5-294250	JP		1993-11-09		<input type="checkbox"/>
12	6-187597	JP		1994-07-08		<input type="checkbox"/>
13	JP6289118	JP		1994-10-18	Sega Enterprises KK	<input type="checkbox"/>
14	JP6294659	JP		1994-10-21	Dainippon Printing Co. LTD.	<input type="checkbox"/>

INFORMATION DISCLOSURE STATEMENT BY APPLICANT (Not for submission under 37 CFR 1.99)	Application Number		12015320	
	Filing Date		2008-01-16	
	First Named Inventor	Russell W. White, et al.		
	Art Unit	2617		
	Examiner Name	Erika A. Gary		
	Attorney Docket Number	AFF.004C5US		

	15	07-129895	JP		1995-05-19	Honda Motor Co Ltd		<input type="checkbox"/>
	16	07-146155	JP		1995-06-06	Honda Motor Co Ltd		<input type="checkbox"/>
	17	7-262493	JP		1995-10-13	CSK Corporation		<input type="checkbox"/>
	18	7-262493	JP		1995-10-13			<input type="checkbox"/>
	19	JP7270171	JP		1995-10-20	Sumitomo Electronic Industries		<input type="checkbox"/>
	20	JP7036382	JP		1995-02-07	Mitsubishi Electric Corp.		<input type="checkbox"/>
	21	8-110231	JP		1996-04-30			<input type="checkbox"/>
	22	9-61514	JP		1997-03-07			<input type="checkbox"/>
	23	10-103966	JP		1998-04-24			<input type="checkbox"/>
	24	10-143349	JP		1998-05-29	Compaq Computer Corporation		<input type="checkbox"/>
	25	JP1018712	JP		1989-01-23	Mazda Motor		<input type="checkbox"/>

INFORMATION DISCLOSURE STATEMENT BY APPLICANT (Not for submission under 37 CFR 1.99)	Application Number		12015320	
	Filing Date		2008-01-16	
	First Named Inventor	Russell W. White, et al.		
	Art Unit	2617		
	Examiner Name	Erika A. Gary		
	Attorney Docket Number	AFF.004C5US		

26	JP5077679	JP		1993-03-30	Nissan Motor	<input type="checkbox"/>
27	JP59085599	JP		1984-05-17	Nissan Motor	<input type="checkbox"/>
28	JP63136828	JP		1988-06-09	Pioneer Electronic Corp.	<input type="checkbox"/>
29	63-136828	JP		1988-06-09		<input type="checkbox"/>
30	WO 96/04724	WO		1996-02-15	Emerson, Harry	<input type="checkbox"/>
31	WO 96/07110	WO		1996-03-07	British Telecommunications Public Limited Company	<input type="checkbox"/>
32	WO 97/13657	WO		1997-04-17	United Technologies Automotive, Inc.	<input type="checkbox"/>
33	H11-317061	JP		1999-11-16	Victor Company of Japan, LTD.	<input checked="" type="checkbox"/>
34	2901445	JP		1999-03-19	Kenwood Corporation	<input checked="" type="checkbox"/>
35	WO 99/35009	WO		1999-07-15	Microsoft Corporation	<input type="checkbox"/>
36	11-219580	JP		1999-08-10		<input type="checkbox"/>

INFORMATION DISCLOSURE STATEMENT BY APPLICANT (Not for submission under 37 CFR 1.99)	Application Number		12015320	
	Filing Date		2008-01-16	
	First Named Inventor	Russell W. White, et al.		
	Art Unit	2617		
	Examiner Name	Erika A. Gary		
	Attorney Docket Number	AFF.004C5US		

	37	11219580 A	JP		1999-10-08	Sony Corp		<input type="checkbox"/>
	38	1168685	JP		1999-03-09			<input type="checkbox"/>
	39	11-068685	JP		1999-09-03	Sony Corp		<input type="checkbox"/>
	40	1998-052033	JP		1998-09-25			<input type="checkbox"/>
	41	1999-0042565	JP		1999-06-15			<input type="checkbox"/>
	42	1999-0073234	KR		1999-10-05	Young-Man Lee		<input type="checkbox"/>
	43	1999-0048723	KR		1999-07-05			<input type="checkbox"/>
	44	KR2019990022030U	KR		1999-06-25	Young-Shik Cheon		<input type="checkbox"/>
	45	2000-0001465	KR		2000-01-25	Samsung Motors		<input type="checkbox"/>
	46	0142256	KR		1998-03-30			<input type="checkbox"/>
	47	WO 98/21672	WO		1998-05-22	Inergy Online, Inc.		<input type="checkbox"/>

INFORMATION DISCLOSURE STATEMENT BY APPLICANT (Not for submission under 37 CFR 1.99)	Application Number	12015320
	Filing Date	2008-01-16
	First Named Inventor	Russell W. White, et al.
	Art Unit	2617
	Examiner Name	Erika A. Gary
	Attorney Docket Number	AFF.004C5US

48	WO 98/47252	WO		1998-10-22	Stern, Geoffrey	<input type="checkbox"/>
49	WO 00/54187	WO		2000-09-14	Rock.Com, Inc.	<input type="checkbox"/>
50	WO 00/60450	WO		2000-10-12	Khyber Technologies Corporation	<input type="checkbox"/>

If you wish to add additional Foreign Patent Document citation information please click the Add button

NON-PATENT LITERATURE DOCUMENTS

Examiner Initials*	Cite No	Include name of the author (in CAPITAL LETTERS), title of the article (when appropriate), title of the item (book, magazine, journal, serial, symposium, catalog, etc), date, pages(s), volume-issue number(s), publisher, city and/or country where published.	T ⁵
	1	MARK MOELLER, Computing Unplugged Magazine, "Product Preview, A Survey of Auto PC 2.0 for software developers," 1999-2009, Zatz Publishing, pages 1-7.	<input type="checkbox"/>
	2	MARK MOELLER, Computing Unplugged Magazine, "AutoPC Update, Auto PC/Windows CE for Automotive news bites," 1999-2009, Zatz Publishing, pages 1-4.	<input type="checkbox"/>
	3	Claim Chart for KR19990033393, Claim 17 of U.S. Patent No. 7,324,833, pages 1-3.	<input type="checkbox"/>
	4	RIO500, Getting Started Guide for Windows 98 and Macintosh OS 8.6, pages 1-2.	<input type="checkbox"/>
	5	NORBERT A. STREITZ, et al., "DOLPHIN: Integrated Meeting Support Across Local And Remote Desktop Environments And LiveBoards," Integrated Publication and Information Systems Institute, 1994, pages 345-358.	<input type="checkbox"/>
	6	LEO DEGEN, et al., "Working with Audio: Integrating Personal Tape Recorders and Desktop Computers," May 3-7, 1992, pages 413-418.	<input type="checkbox"/>

INFORMATION DISCLOSURE STATEMENT BY APPLICANT (Not for submission under 37 CFR 1.99)	Application Number	12015320
	Filing Date	2008-01-16
	First Named Inventor	Russell W. White, et al.
	Art Unit	2617
	Examiner Name	Erika A. Gary
	Attorney Docket Number	AFF.004C5US

7	H.S. JUN GIBEE, "A Virtual Information Desk On The Internet," University of Ulsan, September 1999, pages 265-268.	<input type="checkbox"/>
8	STEVE WHITTAKER, et al., "TeleNotes: Managing Lightweight Interactions in the Desktop," Lotus Development Corporation, June 1997, pages 137-168.	<input type="checkbox"/>
9	R.M. CROWDER, et al., "Integration of Manufacturing Information Using Open Hypermedia," Computer in Industry, 1999, pages 31-42.	<input type="checkbox"/>
10	TOMAS BOSTROM, et al., "Mobile Audio Distribution," Royal Institute of Technology, 1999, pages 166-172.	<input type="checkbox"/>
11	ALEX POON, et al., Xerox Disclosure Journal, Vol. 19, No. 2, "Gestural User Interface Technique for Controlling the Playback of Sequential Media," March/April 1994, pages 187-190.	<input type="checkbox"/>
12	DEB KUMAR ROY, "NewsComm: A Hand-Held Device For Interactive Access to Structured Audio," Massachusetts Institute of Technology, June 1995, pages 1-12.	<input type="checkbox"/>
13	VICTORIA BELLOTTI, et al., "Walking Away from the Desktop Computer: Distributed Collaboration and Mobility in a Product Design Team," 1996, pages 209-218.	<input type="checkbox"/>
14	UPUL OBEYSEKARE, et al., "The Visual Interactive Desktop Laboratory," January-March 1997, pages 63-71.	<input type="checkbox"/>
15	ASIM SMAILAGIC, et al., "MoCCA: A Mobile Communication and Computing Architecture," Institute for Complex Engineered Systems, pages 1-8.	<input type="checkbox"/>
16	SUI-MENG POON, et al., "Integration of Value-Added Audio Playback Capacity Into Computer Network," Nanyang Technological University, 1995, pages 632-636.	<input type="checkbox"/>
17	ERDAL PAKSOY, et al., "A variable-rate celp coder for fast remote voicemail retrieval using a notebook computer," DSPS R&D Center, Texas Instruments, 1997, pages 119-124.	<input type="checkbox"/>

INFORMATION DISCLOSURE STATEMENT BY APPLICANT (Not for submission under 37 CFR 1.99)	Application Number	12015320
	Filing Date	2008-01-16
	First Named Inventor	Russell W. White, et al.
	Art Unit	2617
	Examiner Name	Erika A. Gary
	Attorney Docket Number	AFF.004C5US

18	JEFFREY A. DAVIS, "Use of Personal Computers in Satellite Command and Control Systems," Raytheon Systems Company, October 24, 1999, pages 283-291.	<input type="checkbox"/>
19	NIKI DAVIS, "Remote Teaching Via ISDN2 And Desktop Conferencing," Exeter University School of Education, pages 1-3.	<input type="checkbox"/>
20	A CHAN, et al., "The PEP-II Project-Wide Database," Stanford University, 1996, pages 840-842.	<input type="checkbox"/>
21	KRISHNA BHARAT, et al., "Migratory Applications," Springer Berlin, Vol. 1222, 1997, pages 1-21.	<input type="checkbox"/>
22	EMPEG CAR, "MP3 in your dash," Digital Audio Player User Guide, pages 1-50.	<input type="checkbox"/>
23	MICROSOFT, "Getting Started Microsoft Windows 98" Second Edition, 1998, pages 1-138.	<input type="checkbox"/>
24	SAUL GREENBERG, "PDAs and Shared Public Displays: Making Personal Information Public, and Public Information Personal," University of Calgary, March 1999, pages 1-11.	<input type="checkbox"/>
25	NAOHIKO KOHTAKE, et al., "InfoStick: an interaction device for Inter-Appliance Computing," Keio University, pages 1-15.	<input type="checkbox"/>
26	HEWLETT PACKARD, User's Guide, HP Jornada 420, Palm-Size PC, pages 1-75	<input type="checkbox"/>
27	MICROSOFT, "Introducing Microsoft Windows 95 - Certificate of Authenticity," 1995, pages 1-117.	<input type="checkbox"/>
28	SONY, "New Technical Theory For Servicing, MZ-R5ST Operation Manual," pages 1-44.	<input type="checkbox"/>

INFORMATION DISCLOSURE STATEMENT BY APPLICANT (Not for submission under 37 CFR 1.99)	Application Number		12015320
	Filing Date		2008-01-16
	First Named Inventor	Russell W. White, et al.	
	Art Unit		2617
	Examiner Name	Erika A. Gary	
	Attorney Docket Number		AFF.004C5US

29	RICHARD C. DAVIS, et al., "A Framework for Sharing Handwritten Notes," 1998, pages 119-120.	<input type="checkbox"/>
30	KRISHNA A. BHARAT, et al., "Migratory Applications," UIST '95, November 14-17, 1995, pages 133-142.	<input type="checkbox"/>
31	BRAD A. MYERS, "Collaboration Using Multiple PDAs Connected To A PC," Carnegie Mellon University, 1998, pages 385-294.	<input type="checkbox"/>
32	RICHARD C. DAVIS, et al., "NotePals: Lightweight Note Sharing by the Group, for the Group," May 15-20, 1999, pages 338-345.	<input type="checkbox"/>
33	JUN REKIMOTO, et al., "Augmented Surfaces: A Spatially Continuous Work Space for Hybrid Computing Environments," May 15-20, 1999, pages 378-385.	<input type="checkbox"/>
34	DAN R. OLSEN, JR., "Interacting with Chaos," September and October 1999, pages 42-54.	<input type="checkbox"/>
35	SCOTT ROBERTSON, et al., "Dual Device User Interface Design: PDAs and Interactive Television," April 13-18, 1996, pages 79-86.	<input type="checkbox"/>
36	SYMANTEC CORPORATION, "pcANYWHERE32 User's Guide," 1993-1997, pages 1-216.	<input type="checkbox"/>
37	KRISHNA BHARAT, et al., Migratory Applications, "Mobile Object Systems Towards the Programmable Internet," Springer Berlin/Heidelberg, Volume 1222/11997, 1997, pages 1-134.	<input type="checkbox"/>
38	DIAMOND MULTIMEDIA SYSTEMS, INC., "Rio PMP300, User's Guide," 1998, pages 1-27.	<input type="checkbox"/>
39	SONY, "Portable MiniDisc Recorder, Operating Instructions, MZ-R55," 1998, pages 1-42.	<input type="checkbox"/>

INFORMATION DISCLOSURE STATEMENT BY APPLICANT (Not for submission under 37 CFR 1.99)	Application Number	12015320
	Filing Date	2008-01-16
	First Named Inventor	Russell W. White, et al.
	Art Unit	2617
	Examiner Name	Erika A. Gary
	Attorney Docket Number	AFF.004C5US

40	NORBERT A. STREITZ, et al., "i-Land: An Interactive Landscape for Creativity and Innovation," Proceedings of the ACM Conference on Human Factors in Computing Systems, May 15-20, 1999, pages 120-127.	<input type="checkbox"/>
41	NORBERT A. STREITZ, et al., "Roomware for Cooperative Buildings: Integrated Design of Architectural Spaces and Information Spaces," pages 1-20	<input type="checkbox"/>
42	Direct Cable Connection screen shot, "B1U6U4," 10 pages total.	<input type="checkbox"/>
43	Direct Cable Connection screen shot, 10 pages total.	<input type="checkbox"/>
44	IBM, "WordPad z50 Cradle Option - User's Guide," 1990, pages 1-18.	<input type="checkbox"/>
45	IBM MOBILE SYSTEMS, "WorkPad z50 Mobile Companion (2608-1Ax), Hardware Maintenance Manual," March 1999, pages 1-77.	<input type="checkbox"/>
46	KEVIN JOST, Automotive Engineering International, "The car as a mobile-media platform," May 1998, pages 49-53.	<input type="checkbox"/>
47	MICROSOFT CORPORATION, "Windows CE 2.1 Technical Articles, Developing Applications for an Auto PC," June 1999, pages 1-13.	<input type="checkbox"/>
48	INFOGATION CORPORATION, "InfoGation Corp. Introduces Software Applications for Next-Generation Smart Car Systems," January 8, 1998, pages 1-2.	<input type="checkbox"/>
49	BUSINESS WIRE, "ORA Electronics Announces USB-Compatible TelCar Mark VII Begins Shipping First Quarter of 1999," January 6, 1999, pages 1-2.	<input type="checkbox"/>
50	ORA USA, "ORA Electronics Patents Telcar Cellular Telephone Interface," July 6, 1998, pages 1-2.	<input type="checkbox"/>

INFORMATION DISCLOSURE STATEMENT BY APPLICANT (Not for submission under 37 CFR 1.99)	Application Number	12015320
	Filing Date	2008-01-16
	First Named Inventor	Russell W. White, et al.
	Art Unit	2617
	Examiner Name	Erika A. Gary
	Attorney Docket Number	AFF.004C5US

If you wish to add additional non-patent literature document citation information please click the Add button

EXAMINER SIGNATURE

Examiner Signature	/Erika Gary/ (09/15/2010)	Date Considered	09/15/2010
--------------------	---------------------------	-----------------	------------

*EXAMINER: Initial if reference considered, whether or not citation is in conformance with MPEP 609. Draw line through a citation if not in conformance and not considered. Include copy of this form with next communication to applicant.

¹ See Kind Codes of USPTO Patent Documents at www.USPTO.GOV or MPEP 901.04. ² Enter office that issued the document, by the two-letter code (WIPO Standard ST.3). ³ For Japanese patent documents, the indication of the year of the reign of the Emperor must precede the serial number of the patent document. ⁴ Kind of document by the appropriate symbols as indicated on the document under WIPO Standard ST.16 if possible. ⁵ Applicant is to place a check mark here if English language translation is attached.

Doc code: IDS

Doc description: Information Disclosure Statement (IDS) Filed

PTO/SB/08a (04-09)

Approved for use through 05/31/2009. OMB 0651-0031
U.S. Patent and Trademark Office, U.S. DEPARTMENT OF COMMERCE

Under the Paperwork Reduction Act of 1995, no persons are required to respond to a collection of information unless it contains a valid OMB control number.

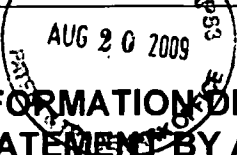
 <p>INFORMATION DISCLOSURE STATEMENT BY APPLICANT (Not for submission under 37 CFR 1.99)</p>	Application Number		12015320	
	Filing Date		2008-01-16	
	First Named Inventor	Russell W. White, et al.		
	Art Unit	2617		
	Examiner Name	Erika A. Gary		
	Attorney Docket Number	AFF.004C5US		

U.S.PATENTS						
Examiner Initial*	Cite No	Patent Number	Kind Code ¹	Issue Date	Name of Patentee or Applicant of cited Document	Pages, Columns, Lines where Relevant Passages or Relevant Figures Appear
	1	6349352		2002-02-19	Lea	
	2	6697944		2004-02-24	Jones, et al.	
	3	6760916		2004-07-06	Holtz, et al.	
	4	6225984		2001-05-01	Crawford	
	5	5327558		1994-07-05	Burke, et al.	
	6	5715474		1998-02-03	Burke, et al.	

If you wish to add additional U.S. Patent citation information please click the Add button.

U.S.PATENT APPLICATION PUBLICATIONS						
Examiner Initial*	Cite No	Publication Number	Kind Code ¹	Publication Date	Name of Patentee or Applicant of cited Document	Pages, Columns, Lines where Relevant Passages or Relevant Figures Appear

Receipt date: 08/26/2009

12495190 - GAU: 2617

INFORMATION DISCLOSURE STATEMENT BY APPLICANT (Not for submission under 37 CFR 1.99)	Application Number		12015320	
	Filing Date		2008-01-16	
	First Named Inventor	Russell W. White, et al.		
	Art Unit	2617		
	Examiner Name	Erika A. Gary		
	Attorney Docket Number	AFF.004C5US		

1					
---	--	--	--	--	--

If you wish to add additional U.S. Published Application citation information please click the Add button.

FOREIGN PATENT DOCUMENTS

Examiner Initial*	Cite No	Foreign Document Number ³	Country Code ^{2j}	Kind Code ⁴	Publication Date	Name of Patentee or Applicant of cited Document	Pages, Columns, Lines where Relevant Passages or Relevant Figures Appear	T ⁵
	1	WO 00/38340	WO		2000-06-29	Kim, Joehan		<input type="checkbox"/>
	2	WO 98/19480	WO		1998-07-05	Ericsson, Inc.		<input type="checkbox"/>
	3	WO 99/43136	WO		1999-08-26	Ericsson, Inc.		<input type="checkbox"/>
	4	8-79814	JP		1996-03-22			<input type="checkbox"/>
	5	9-74580	JP		1997-03-18			<input type="checkbox"/>
	6	10-149182	FP		1998-06-02			<input type="checkbox"/>
	7	3056721	FP		1998-12-02			<input type="checkbox"/>
	8	WO 99/06910	WO		1999-02-11	Ludtke, Harold A.		<input type="checkbox"/>

INFORMATION DISCLOSURE STATEMENT BY APPLICANT (Not for submission under 37 CFR 1.99)	Application Number		12015320	
	Filing Date		2008-01-16	
	First Named Inventor	Russell W. White, et al.		
	Art Unit	2617		
	Examiner Name	Erika A. Gary		
	Attorney Docket Number	AFF.004C5US		

9	11-73192	JP		1999-03-16			<input type="checkbox"/>
10	3890692	JP		2006-12-15			<input type="checkbox"/>
11	WO 99/12152	WO		1999-11-03	Sony Corporation		<input type="checkbox"/>
12	EP 0 920 016 A2	EP		1999-02-06	Sony Corporation		<input type="checkbox"/>
13	11-219580	JP		1999-08-10			<input type="checkbox"/>
14	EP 0 918 408 A2	EP		1999-05-26	Sony Corporation		<input type="checkbox"/>
15	11-143791	JP		1999-05-28			<input type="checkbox"/>
16	2007-207257	JP		2007-08-16			<input type="checkbox"/>
17	DE 20 2004 013 65	DE		2004-12-23	Boll, Nobert		<input type="checkbox"/>
18	WO 99/35009	WO		1999-07-15	Microsoft Corporation		<input type="checkbox"/>
19	2001-128280	JP		2001-05-11			<input type="checkbox"/>

INFORMATION DISCLOSURE STATEMENT BY APPLICANT (Not for submission under 37 CFR 1.99)	Application Number		12015320	
	Filing Date		2008-01-16	
	First Named Inventor	Russell W. White, et al.		
	Art Unit	2617		
	Examiner Name	Erika A. Gary		
	Attorney Docket Number	AFF.004C5US		

	20	KR20000036680	KR		2000-07-05	Kee Kang Choon		<input type="checkbox"/>
	21	10-1997-0016743	KR		1997-04-30			<input type="checkbox"/>
	22	20-1997-0012254	KR		1997-05-28			<input type="checkbox"/>
	23	WO 99/23856	WO		1999-05-14	Mershon, Stuart		<input type="checkbox"/>
	24	WO 99/28897	WO		1999-06-10	Voquette Networks, LTD.		<input type="checkbox"/>
	25	1999-0055970	KR		1999-07-15			<input type="checkbox"/>
	26	100242563 B1	KR		1999-10-11	Kim, Joon Sung		<input type="checkbox"/>
	27	EP 0 982 732 A1	EP		2000-01-03	Saehan Information Systems, Inc.		<input type="checkbox"/>
	28	10-0356742	KR		2002-10-18	Hyundai Autonet, Co. Ltd.		<input type="checkbox"/>
	29	10-356742	JP		2002-10-02			<input type="checkbox"/>
	30	WO 00/38340	WO		2000-06-29	Kim, Jaehan		<input type="checkbox"/>

INFORMATION DISCLOSURE STATEMENT BY APPLICANT (Not for submission under 37 CFR 1.99)	Application Number		12015320	
	Filing Date		2008-01-16	
	First Named Inventor	Russell W. White, et al.		
	Art Unit	2617		
	Examiner Name	Erika A. Gary		
	Attorney Docket Number	AFF.004C5US		

	31	2000-0001465	JP		2000-01-25			<input type="checkbox"/>
	32	2001-0009302	JP		2001-02-05			<input type="checkbox"/>
	33	2001-0028354	JP		2001-04-06			<input type="checkbox"/>
	34	1999-0033393	JP		1999-05-15			<input type="checkbox"/>
	35	11-317061	JP		1999-11-16			<input type="checkbox"/>
	36	2225910	CA		1997-12-24	Lussier, Luc.		<input type="checkbox"/>
	37	0 661 676 A1	EP		1994-12-21	AT&T Global Information Solutions International		<input type="checkbox"/>
	38	0 982 732 A1	EP		2000-01-03	Saeahan Information Systems, Inc.		<input type="checkbox"/>
	39	2901445	JP		1999-03-19			<input type="checkbox"/>
	40	9-50282	JP		1997-02-18			<input type="checkbox"/>
	41	10-173737	JP		1998-06-26			<input type="checkbox"/>

INFORMATION DISCLOSURE STATEMENT BY APPLICANT (Not for submission under 37 CFR 1.99)	Application Number		12015320	
	Filing Date		2008-01-16	
	First Named Inventor	Russell W. White, et al.		
	Art Unit	2617		
	Examiner Name	Erika A. Gary		
	Attorney Docket Number	AFF.004C5US		

42	11-96735	JP		1999-04-09			<input type="checkbox"/>
43	11-242686	JP		1999-09-07			<input type="checkbox"/>
44	WO 94/18763	WO		1994-08-18	Gutle, Hubert		<input type="checkbox"/>
45	WO 98/21672	WO		1998-05-22	Inergy Online, Inc.		<input type="checkbox"/>
46	WO 98/33102	WO		1998-07-30	Guimaraes Teixeira		<input type="checkbox"/>
47	WO 99/18518	WO		1999-04-15	Polash, Peter		<input type="checkbox"/>
48	WO 00/07849	WO		2000-02-17	Microsoft Corporation		<input type="checkbox"/>
49	11-317061	WO		1999-11-16			<input type="checkbox"/>
50	2901445	JP		1999-03-19			<input type="checkbox"/>

If you wish to add additional Foreign Patent Document citation information please click the Add button

NON-PATENT LITERATURE DOCUMENTS

Examiner Initials*	Cite No	Include name of the author (in CAPITAL LETTERS), title of the article (when appropriate), title of the item (book, magazine, journal, serial, symposium, catalog, etc), date, pages(s), volume-issue number(s), publisher, city and/or country where published.	T5
--------------------	---------	-----------------------------------------------------------------------------------------------------------------------------------------------------------------------------------------------------------------------------------------------------------------	----

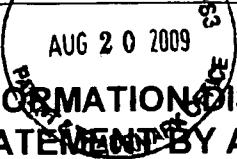
<p style="text-align: center;">  INFORMATION DISCLOSURE STATEMENT BY APPLICANT (Not for submission under 37 CFR 1.99) </p>	Application Number		12015320
	Filing Date		2008-01-16
	First Named Inventor	Russell W. White, et al.	
	Art Unit		2617
	Examiner Name	Erika A. Gary	
	Attorney Docket Number		AFF.004C5US

1	DANIEL KUMIN, Stereo Review, "Jukebox Heaven," January 1999, pages 64-71.	<input type="checkbox"/>
2	AUDIO, "Anthem Five-Channel Amp," July/August 1999, page 15.	<input type="checkbox"/>
3	Sony webpages in Japanese, "Portable Mini Disc Player MD Recorder," July 21, 1996, pages 1-5.	<input type="checkbox"/>
4	Sony, "MD Walkman Operating Instructions - MZ-R4ST," 1996, pages 1-64.	<input type="checkbox"/>
5	Sony, "MD Walkman Operating Instructions - MZ-R5ST," 1997, pages 1-79.	<input type="checkbox"/>
6	STEREO REVIEW, "New Products," June 1998, 1 page.	<input type="checkbox"/>
7	FACTIVA, Hardware Review, "Lost in the Supermarket," 2009, pages 1-3.	<input type="checkbox"/>
8	Sony webpages in Japanese, "Portable Mini Disc Player MD Recorder," October 21, 1999, pages 1-63.	<input type="checkbox"/>
9	JAMIE SORCHER, Stereo Review, "New for the Road," May 1998, 2 pages.	<input type="checkbox"/>
10	Sony, "MD Walkman Operating Instructions - MZ-R55," 1998, pages 1-42.	<input type="checkbox"/>
11	JOHN WHITTERS, The Advertiser, "Is the cassette doomed?" July 16, 1998, pages 1-2.	<input type="checkbox"/>

INFORMATION DISCLOSURE STATEMENT BY APPLICANT (Not for submission under 37 CFR 1.99)	Application Number	12015320
	Filing Date	2008-01-16
	First Named Inventor	Russell W. White, et al.
	Art Unit	2617
	Examiner Name	Erika A. Gary
	Attorney Docket Number	AFF.004C5US

12	GEORGE COLE, Financial Times, "Listen with your eyes: A new music CD format supplies textual information," October 23, 1997, pages 1-2.	<input type="checkbox"/>
13	DANA J. PARKER, Standard Deviations, "CD-TEXTra! Read all about it!", October 1996, pages 1-2.	<input type="checkbox"/>
14	MOBILE ELECTRONICS, "Down the Road," July 2004, pages 1-2.	<input type="checkbox"/>
15	ALPINE, "Interface Adapter for iPod KCA-420i - Owner's Manual," 44 pages total.	<input type="checkbox"/>
16	PR Newswire, "Alpine Announces Fall Release of Interface Adapter That Enables iPod Control and Playback From In-Vehicle Sound Systems," July 7, 2004, 2 pages total.	<input type="checkbox"/>
17	AMY GILBOY, Mobile Electronics, "Apple's iPod Seen Transforming Car Audio Business," 1 page.	<input type="checkbox"/>
18	GREG BORROWMAN, The Sydney Morning Herald, "Philips Releases Its Latest DVD," 1999, 2 pages total.	<input type="checkbox"/>
19	JVC, "Audio/Video Control Receiver, RX-668VBK, Instructions," pages 1-43.	<input type="checkbox"/>
20	Sony webpages in Japanese, "Portable MD Recorder," October 1997, 5 pages total.	<input type="checkbox"/>
21	Sony, "Walkman MZ-R50 Recorder," October 1997 7 pages total.	<input type="checkbox"/>
22	Sony, "MD Walkman MZ-R55," October 10, 1998, 6 pages total.	<input type="checkbox"/>

INFORMATION DISCLOSURE STATEMENT BY APPLICANT (Not for submission under 37 CFR 1.99)	Application Number	12015320
	Filing Date	2008-01-16
	First Named Inventor	Russell W. White, et al.
	Art Unit	2617
	Examiner Name	Erika A. Gary
	Attorney Docket Number	AFF.004C5US

23	VON HERBERT PAULER, Funkschau, "Kopierschutz für MP3-Audio," 1999, 9 pages total.	<input type="checkbox"/>
24	English Summary, "A device for remotely controlling a car device for playing mp3 files is disclosed....", 1 page.	<input type="checkbox"/>
25	FRANKLIN N. TESSLER, MACWORLD, "Mobile MAC, Highway Fidelity," June 2004, pages 1-3.	<input type="checkbox"/>
26	BARRY COLLINS, The Sunday Times, "High-class high-tech - Buyer's guide," 2001, 2 pages total.	<input type="checkbox"/>
27	PETER FAMILARI, Herald-Sun, "Clever Deck - CD and mini-disc combination," 1998, 1 page.	<input type="checkbox"/>
28	JVC, "MD-CD Combination Deck, XU-301BK, Instructions," pages 1-59.	<input type="checkbox"/>
29	AMY GILROY, Mobile Electronics, "OEM Integrators Embrace iPod's Success," 1 page.	<input type="checkbox"/>
30	JVC, "Portable Minidisc Recorder, XM-R700SL, Instructions," pages 1-24.	<input type="checkbox"/>
31	Rio Car, "Car Toy Sole Retailer For Rio Car," May 28, 2001, 1 page.	<input type="checkbox"/>
32	AMY GILROY, Twice, "Panasonic Ships First SD MP3," December 4, 2000, 1 page.	<input type="checkbox"/>
33	Twice, "PhatNoise Readies MP3," November 5, 2001, 1 page.	<input type="checkbox"/>

INFORMATION DISCLOSURE STATEMENT BY APPLICANT (Not for submission under 37 CFR 1.99)	Application Number	12015320
	Filing Date	2008-01-16
	First Named Inventor	Russell W. White, et al.
	Art Unit	2617
	Examiner Name	Erika A. Gary
	Attorney Docket Number	AFF.004C5US

34	KEVIN SAVETZ, The Washington Post, "Putting Your MP3 Collection in Drive (Final Edition)," August 10, 2001, pages 1-3.	<input type="checkbox"/>
35	Twice, "Study Sees Retail Opportunities For Mobile Multimedia," Volume 14, Issue 15, June 28, 1999, pages 1-2.	<input type="checkbox"/>
36	Japanese Webpage, www.kcalgo.kr/jsp/main.jsp, 1 page.	<input type="checkbox"/>
37	Japanese Webpage, www.kca.go.kr - Brochure Free - Microsoft Internet Explorer, 1 page.	<input type="checkbox"/>
38	Japanese Webpage, www.kca.go.kr - Brochure Free - Microsoft Internet Explorer, 1 page.	<input type="checkbox"/>
39	STEPHEN KEMPAINEN, EDN Access For Design, By Design "In-car computing gets personal," August 17, 1998, pages 1-7.	<input type="checkbox"/>
40	Japanese Website, MM MPMANIA.com, http://mpmania, x-y.net/bbs/zboard.php?id=products&keyword=1998, 1 page.	<input type="checkbox"/>
41	Japanese document regarding MP3, May 1999, 1 page.	<input type="checkbox"/>
42	MPMan, "The portable MP3 player using the Flash Memory and Memory card - MP-F20," in Japanese, pages 1-34.	<input type="checkbox"/>
43	Japanese Website, MM MPMANIA.com, http://mpmania, x-y.net/bbs/view.php?id=products&page=1&sn1=&divpage, 1 page.	<input type="checkbox"/>
44	www.mpman.com, "MP-F30, User's Guide," pages 2-47.	<input type="checkbox"/>

INFORMATION DISCLOSURE STATEMENT BY APPLICANT (Not for submission under 37 CFR 1.99)	Application Number		12015320
	Filing Date		2008-01-16
	First Named Inventor	Russell W. White, et al.	
	Art Unit		2617
	Examiner Name	Erika A. Gary	
	Attorney Docket Number		AFF.004C5US

45	MARK MOELLER, Computing Unplugged Magazine, "Software Review, New software products for the Auto PC," 1999-2009, Zatz Publishing, pages 1-4	<input type="checkbox"/>
46	MARK MOELLER, Computing Unplugged Magazine, "Auto PC Power, A survey of resources for Auto PC owners," 1999-2009, Zatz Publishing, pages 1-5.	<input type="checkbox"/>
47	MARK MOELLER, Computing Unplugged Magazine, "Auto PC Power, A look at the first year of the Auto PC with Microsoft," 1999-2009, Zatz Publishing, pages 1-5.	<input type="checkbox"/>
48	MARK MOELLER, Computing Unplugged Magazine, "Auto PC Power, Next generation AutoPCs make a big debut at CES," 1999-2009, Zatz Publishing, pages 1-6.	<input type="checkbox"/>
49	MARK MOELLER, Computing Unplugged Magazine, "Programming Power, Getting started developing software for the Auto PC," 1999-2009, Zatz Publishing, pages 1-5	<input type="checkbox"/>
50	MARK MOELLER, Computing Unplugged Magazine, "Behind the Scenes, The AutoPC: Vision vs. Reality," 1999-2009, Zatz Publishing, pages 1-7.	<input type="checkbox"/>

If you wish to add additional non-patent literature document citation information please click the Add button

EXAMINER SIGNATURE

Examiner Signature	/Erika Gary/ (09/15/2010)	Date Considered	09/15/2010
--------------------	---------------------------	-----------------	------------

*EXAMINER: Initial if reference considered, whether or not citation is in conformance with MPEP 609. Draw line through a citation if not in conformance and not considered. Include copy of this form with next communication to applicant.

¹ See Kind Codes of USPTO Patent Documents at www.USPTO.GOV or MPEP 901.04. ² Enter office that issued the document, by the two-letter code (WIPO Standard ST.3). ³ For Japanese patent documents, the indication of the year of the reign of the Emperor must precede the serial number of the patent document. ⁴ Kind of document by the appropriate symbols as indicated on the document under WIPO Standard ST.16 if possible. ⁵ Applicant is to place a check mark here if English language translation is attached.

Doc code: IDS

Doc description: Information Disclosure Statement (IDS) Filed

PTO/SB/08a (04-09)

Approved for use through 05/31/2009. OMB 0651-0031

U.S. Patent and Trademark Office; U.S. DEPARTMENT OF COMMERCE

Under the Paperwork Reduction Act of 1995, no persons are required to respond to a collection of information unless it contains a valid OMB control number.

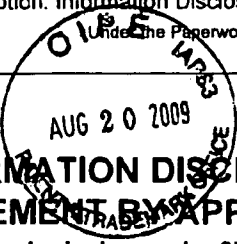

INFORMATION DISCLOSURE STATEMENT BY APPLICANT
(Not for submission under 37 CFR 1.99)

Application Number		12015320
Filing Date		2008-01-16
First Named Inventor	Russell W. White, et al.	
Art Unit	2617	
Examiner Name	Erika A. Gary	
Attorney Docket Number	AFF.004C5US	

U.S.PATENTS

Examiner Initial*	Cite No	Patent Number	Kind Code ¹	Issue Date	Name of Patentee or Applicant of cited Document	Pages, Columns, Lines where Relevant Passages or Relevant Figures Appear
	1	6349352		2002-02-19	Lea	
	2	6697944		2004-02-24	Jones, et al.	
	3	6760916		2004-07-06	Holtz, et al.	
	4	6225984		2001-05-01	Crawford	
	5	5327558		1994-07-05	Burke, et al.	
	6	5715474		1998-02-03	Burke, et al.	

If you wish to add additional U.S. Patent citation information please click the Add button.

U.S.PATENT APPLICATION PUBLICATIONS

Examiner Initial*	Cite No	Publication Number	Kind Code ¹	Publication Date	Name of Patentee or Applicant of cited Document	Pages, Columns, Lines where Relevant Passages or Relevant Figures Appear
-------------------	---------	--------------------	------------------------	------------------	-------------------------------------------------	--------------------------------------------------------------------------

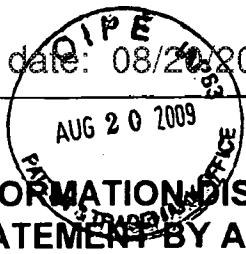

**INFORMATION DISCLOSURE
STATEMENT BY APPLICANT**
(Not for submission under 37 CFR 1.99)

Application Number		12015320
Filing Date		2008-01-16
First Named Inventor	Russell W. White, et al.	
Art Unit	2617	
Examiner Name	Erika A. Gary	
Attorney Docket Number	AFF.004C5US	

1						
---	--	--	--	--	--	--

If you wish to add additional U.S. Published Application citation information please click the Add button.

FOREIGN PATENT DOCUMENTS

Examiner Initial*	Cite No	Foreign Document Number ³	Country Code ^{2j}	Kind Code ⁴	Publication Date	Name of Patentee or Applicant of cited Document	Pages, Columns, Lines where Relevant Passages or Relevant Figures Appear	T ⁵
	1	WO 00/38340	WO		2000-06-29	Kim, Joehan		<input type="checkbox"/>
	2	WO 98/19480	WO		1998-07-05	Ericsson, Inc.		<input type="checkbox"/>
	3	WO 99/43136	WO		1999-08-26	Ericsson, Inc.		<input type="checkbox"/>
	4	8-79814	JP		1996-03-22			<input type="checkbox"/>
	5	9-74580	JP		1997-03-18			<input type="checkbox"/>
	6	10-149182	FP		1998-06-02			<input type="checkbox"/>
	7	3056721	FP		1998-12-02			<input type="checkbox"/>
	8	WO 99/06910	WO		1999-02-11	Ludtke, Harold A.		<input type="checkbox"/>

INFORMATION DISCLOSURE STATEMENT BY APPLICANT (Not for submission under 37 CFR 1.99)	Application Number		12015320	
	Filing Date		2008-01-16	
	First Named Inventor	Russell W. White, et al.		
	Art Unit	2617		
	Examiner Name	Erika A. Gary		
	Attorney Docket Number	AFF.004C5US		

9	11-73192	JP		1999-03-16			<input type="checkbox"/>
10	3890692	JP		2006-12-15			<input type="checkbox"/>
11	WO 99/12152	WO		1999-11-03	Sony Corporation		<input type="checkbox"/>
12	EP 0 920 016 A2	EP		1999-02-06	Sony Corporation		<input type="checkbox"/>
13	11-219580	JP		1999-08-10			<input type="checkbox"/>
14	EP 0 918 408 A2	EP		1999-05-26	Sony Corporation		<input type="checkbox"/>
15	11-143791	JP		1999-05-28			<input type="checkbox"/>
16	2007-207257	JP		2007-08-16			<input type="checkbox"/>
17	DE 20 2004 013 65	DE		2004-12-23	Boll, Nobert		<input type="checkbox"/>
18	WO 99/35009	WO		1999-07-15	Microsoft Corporation		<input type="checkbox"/>
19	2001-128280	JP		2001-05-11			<input type="checkbox"/>

INFORMATION DISCLOSURE STATEMENT BY APPLICANT (Not for submission under 37 CFR 1.99)	Application Number		12015320	
	Filing Date		2008-01-16	
	First Named Inventor	Russell W. White, et al.		
	Art Unit	2617		
	Examiner Name	Erika A. Gary		
	Attorney Docket Number	AFF.004C5US		

	20	KR20000036680	KR		2000-07-05	Kee Kang Choon		<input type="checkbox"/>
	21	10-1997-0016743	KR		1997-04-30			<input type="checkbox"/>
	22	20-1997-0012254	KR		1997-05-28			<input type="checkbox"/>
	23	WO 99/23856	WO		1999-05-14	Mershon, Stuart		<input type="checkbox"/>
	24	WO 99/28897	WO		1999-06-10	Voquette Networks, LTD.		<input type="checkbox"/>
	25	1999-0055970	KR		1999-07-15			<input type="checkbox"/>
	26	100242563 B1	KR		1999-10-11	Kim, Joon Sung		<input type="checkbox"/>
	27	EP 0 982 732 A1	EP		2000-01-03	Saehan Information Systems, Inc.		<input type="checkbox"/>
	28	10-0356742	KR		2002-10-18	Hyundai Autonet, Co. Ltd.		<input type="checkbox"/>
	29	10-356742	JP		2002-10-02			<input type="checkbox"/>
	30	WO 00/38340	WO		2000-06-29	Kim, Jaehan		<input type="checkbox"/>

INFORMATION DISCLOSURE STATEMENT BY APPLICANT (Not for submission under 37 CFR 1.99)	Application Number		12015320	
	Filing Date		2008-01-16	
	First Named Inventor	Russell W. White, et al.		
	Art Unit	2617		
	Examiner Name	Erika A. Gary		
	Attorney Docket Number	AFF.004C5US		

	31	2000-0001465	JP		2000-01-25			<input type="checkbox"/>
	32	2001-0009302	JP		2001-02-05			<input type="checkbox"/>
	33	2001-0028354	JP		2001-04-06			<input type="checkbox"/>
	34	1999-0033393	JP		1999-05-15			<input type="checkbox"/>
	35	11-317061	JP		1999-11-16			<input type="checkbox"/>
	36	2225910	CA		1997-12-24	Lussier, Luc.		<input type="checkbox"/>
	37	0 661 676 A1	EP		1994-12-21	AT&T Global Information Solutions International		<input type="checkbox"/>
	38	0 982 732 A1	EP		2000-01-03	Saeahan Information Systems, Inc.		<input type="checkbox"/>
	39	2901445	JP		1999-03-19			<input type="checkbox"/>
	40	9-50282	JP		1997-02-18			<input type="checkbox"/>
	41	10-173737	JP		1998-06-26			<input type="checkbox"/>

INFORMATION DISCLOSURE STATEMENT BY APPLICANT (Not for submission under 37 CFR 1.99)	Application Number		12015320	
	Filing Date		2008-01-16	
	First Named Inventor	Russell W. White, et al.		
	Art Unit	2617		
	Examiner Name	Erika A. Gary		
	Attorney Docket Number	AFF.004C5US		

42	11-96735	JP		1999-04-09			<input type="checkbox"/>
43	11-242686	JP		1999-09-07			<input type="checkbox"/>
44	WO 94/18763	WO		1994-08-18	Gutle, Hubert		<input type="checkbox"/>
45	WO 98/21672	WO		1998-05-22	Inergy Online, Inc.		<input type="checkbox"/>
46	WO 98/33102	WO		1998-07-30	Guimaraes Teixeira		<input type="checkbox"/>
47	WO 99/18518	WO		1999-04-15	Polash, Peter		<input type="checkbox"/>
48	WO 00/07849	WO		2000-02-17	Microsoft Corporation		<input type="checkbox"/>
49	11-317061	WO		1999-11-16			<input type="checkbox"/>
50	2901445	JP		1999-03-19			<input type="checkbox"/>

If you wish to add additional Foreign Patent Document citation information please click the Add button

NON-PATENT LITERATURE DOCUMENTS

Examiner Initials*	Cite No	Include name of the author (in CAPITAL LETTERS), title of the article (when appropriate), title of the item (book, magazine, journal, serial, symposium, catalog, etc), date, pages(s), volume-issue number(s), publisher, city and/or country where published.	T ⁵
--------------------	---------	-----------------------------------------------------------------------------------------------------------------------------------------------------------------------------------------------------------------------------------------------------------------	----------------

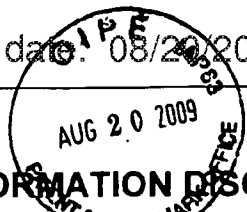

INFORMATION DISCLOSURE STATEMENTS BY APPLICANT
(Not for submission under 37 CFR 1.99)

Application Number		12015320
Filing Date		2008-01-16
First Named Inventor	Russell W. White, et al.	
Art Unit	2617	
Examiner Name	Erika A. Gary	
Attorney Docket Number	AFF.004C5US	

1	DANIEL KUMIN, Stereo Review, "Jukebox Heaven," January 1999, pages 64-71.	<input type="checkbox"/>
2	AUDIO, "Anthem Five-Channel Amp," July/August 1999, page 15.	<input type="checkbox"/>
3	Sony webpages in Japanese, "Portable Mini Disc Player MD Recorder," July 21, 1996, pages 1-5.	<input type="checkbox"/>
4	Sony, "MD Walkman Operating Instructions - MZ-R4ST," 1996, pages 1-64.	<input type="checkbox"/>
5	Sony, "MD Walkman Operating Instructions - MZ-R5ST," 1997, pages 1-79.	<input type="checkbox"/>
6	STEREO REVIEW, "New Products," June 1998, 1 page.	<input type="checkbox"/>
7	FACTIVA, Hardware Review, "Lost in the Supermarket," 2009, pages 1-3.	<input type="checkbox"/>
8	Sony webpages in Japanese, "Portable Mini Disc Player MD Recorder," October 21, 1999, pages 1-63.	<input type="checkbox"/>
9	JAMIE SORCHER, Stereo Review, "New for the Road," May 1998, 2 pages.	<input type="checkbox"/>
10	Sony, "MD Walkman Operating Instructions - MZ-R55," 1998, pages 1-42.	<input type="checkbox"/>
11	JOHN WHITTERS, The Advertiser, "Is the cassette doomed?" July 16, 1998, pages 1-2.	<input type="checkbox"/>

INFORMATION DISCLOSURE STATEMENT BY APPLICANT (Not for submission under 37 CFR 1.99)	Application Number	12015320
	Filing Date	2008-01-16
	First Named Inventor	Russell W. White, et al.
	Art Unit	2617
	Examiner Name	Erika A. Gary
	Attorney Docket Number	AFF.004C5US

12	GEORGE COLE, Financial Times, "Listen with your eyes: A new music CD format supplies textual information," October 23, 1997, pages 1-2.	<input type="checkbox"/>
13	DANA J. PARKER, Standard Deviations, "CD-TEXTra! Read all about it!", October 1996, pages 1-2.	<input type="checkbox"/>
14	MOBILE ELECTRONICS, "Down the Road," July 2004, pages 1-2.	<input type="checkbox"/>
15	ALPINE, "Interface Adapter for iPod KCA-420i - Owner's Manual," 44 pages total.	<input type="checkbox"/>
16	PR Newswire, "Alpine Announces Fall Release of Interface Adapter That Enables iPod Control and Playback From In-Vehicle Sound Systems," July 7, 2004, 2 pages total.	<input type="checkbox"/>
17	AMY GILBOY, Mobile Electronics, "Apple's iPod Seen Transforming Car Audio Business," 1 page.	<input type="checkbox"/>
18	GREG BORROWMAN, The Sydney Morning Herald, "Philips Releases Its Latest DVD," 1999, 2 pages total.	<input type="checkbox"/>
19	JVC, "Audio/Video Control Receiver, RX-668VBK, Instructions," pages 1-43.	<input type="checkbox"/>
20	Sony webpages in Japanese, "Portable MD Recorder," October 1997, 5 pages total.	<input type="checkbox"/>
21	Sony, "Walkman MZ-R50 Recorder," October 1997 7 pages total.	<input type="checkbox"/>
22	Sony, "MD Walkman MZ-R55," October 10, 1998, 6 pages total.	<input type="checkbox"/>

INFORMATION DISCLOSURE STATEMENT BY APPLICANT (Not for submission under 37 CFR 1.99)	Application Number	12015320
	Filing Date	2008-01-16
	First Named Inventor	Russell W. White, et al.
	Art Unit	2617
	Examiner Name	Erika A. Gary
	Attorney Docket Number	AFF.004C5US

23	VON HERBERT PAULER, Funkschau, "Kopierschutz für MP3-Audio," 1999, 9 pages total.	<input type="checkbox"/>
24	English Summary, "A device for remotely controlling a car device for playing mp3 files is disclosed....", 1 page.	<input type="checkbox"/>
25	FRANKLIN N. TESSLER, MACWORLD, "Mobile MAC, Highway Fidelity," June 2004, pages 1-3.	<input type="checkbox"/>
26	BARRY COLLINS, The Sunday Times, "High-class high-tech - Buyer's guide," 2001, 2 pages total.	<input type="checkbox"/>
27	PETER FAMILARI, Herald-Sun, "Clever Deck - CD and mini-disc combination," 1998, 1 page.	<input type="checkbox"/>
28	JVC, "MD-CD Combination Deck, XU-301BK, Instructions," pages 1-59.	<input type="checkbox"/>
29	AMY GILROY, Mobile Electronics, "OEM Integrators Embrace iPod's Success," 1 page.	<input type="checkbox"/>
30	JVC, "Portable Minidisc Recorder, XM-R700SL, Instructions," pages 1-24.	<input type="checkbox"/>
31	Rio Car, "Car Toy Sole Retailer For Rio Car," May 28, 2001, 1 page.	<input type="checkbox"/>
32	AMY GILROY, Twice, "Panasonic Ships First SD MP3," December 4, 2000, 1 page.	<input type="checkbox"/>
33	Twice, "PhatNoise Readies MP3," November 5, 2001, 1 page.	<input type="checkbox"/>

INFORMATION DISCLOSURE STATEMENT BY APPLICANT (Not for submission under 37 CFR 1.99)	Application Number	12015320
	Filing Date	2008-01-16
	First Named Inventor	Russell W. White, et al.
	Art Unit	2617
	Examiner Name	Erika A. Gary
	Attorney Docket Number	AFF.004C5US

34	KEVIN SAVETZ, The Washington Post, "Putting Your MP3 Collection in Drive (Final Edition)," August 10, 2001, pages 1-3.	<input type="checkbox"/>
35	Twice, "Study Sees Retail Opportunities For Mobile Multimedia," Volume 14, Issue 15, June 28, 1999, pages 1-2.	<input type="checkbox"/>
36	Japanese Webpage, www.kcalgo.kr/jsp/main.jsp, 1 page.	<input type="checkbox"/>
37	Japanese Webpage, www.kca.go.kr - Brochure Free - Microsoft Internet Explorer, 1 page.	<input type="checkbox"/>
38	Japanese Webpage, www.kca.go.kr - Brochure Free - Microsoft Internet Explorer, 1 page.	<input type="checkbox"/>
39	STEPHEN KEMPAINEN, EDN Access For Design, By Design "In-car computing gets personal," August 17, 1998, pages 1-7.	<input type="checkbox"/>
40	Japanese Website, MM MPMANIA.com, http://mpmania, x-y.net/bbs/zboard.php?id=products&keyword=1998, 1 page.	<input type="checkbox"/>
41	Japanese document regarding MP3, May 1999, 1 page.	<input type="checkbox"/>
42	MPMan, "The portable MP3 player using the Flash Memory and Memory card - MP-F20," in Japanese, pages 1-34.	<input type="checkbox"/>
43	Japanese Website, MM MPMANIA.com, http://mpmania, x-y.net/bbs/view.php?id=products&page=1&sn1=&divpage, 1 page.	<input type="checkbox"/>
44	www.mpman.com, "MP-F30, User's Guide," pages 2-47.	<input type="checkbox"/>

INFORMATION DISCLOSURE STATEMENT BY APPLICANT (Not for submission under 37 CFR 1.99)	Application Number		12015320
	Filing Date		2008-01-16
	First Named Inventor	Russell W. White, et al.	
	Art Unit	2617	
	Examiner Name	Erika A. Gary	
	Attorney Docket Number	AFF.004C5US	

45	MARK MOELLER, Computing Unplugged Magazine, "Software Review, New software products for the Auto PC," 1999-2009, Zatz Publishing, pages 1-4	<input type="checkbox"/>
46	MARK MOELLER, Computing Unplugged Magazine, "Auto PC Power, A survey of resources for Auto PC owners," 1999-2009, Zatz Publishing, pages 1-5.	<input type="checkbox"/>
47	MARK MOELLER, Computing Unplugged Magazine, "Auto PC Power, A look at the first year of the Auto PC with Microsoft," 1999-2009, Zatz Publishing, pages 1-5.	<input type="checkbox"/>
48	MARK MOELLER, Computing Unplugged Magazine, "Auto PC Power, Next generation AutoPCs make a big debut at CES," 1999-2009, Zatz Publishing, pages 1-6.	<input type="checkbox"/>
49	MARK MOELLER, Computing Unplugged Magazine, "Programming Power, Getting started developing software for the Auto PC," 1999-2009, Zatz Publishing, pages 1-5	<input type="checkbox"/>
50	MARK MOELLER, Computing Unplugged Magazine, "Behind the Scenes, The AutoPC: Vision vs. Reality," 1999-2009, Zatz Publishing, pages 1-7.	<input type="checkbox"/>

If you wish to add additional non-patent literature document citation information please click the Add button

EXAMINER SIGNATURE

Examiner Signature	/Erika Gary/ (09/15/2010)	Date Considered	09/15/2010
--------------------	---------------------------	-----------------	------------

*EXAMINER: Initial if reference considered, whether or not citation is in conformance with MPEP 609. Draw line through a citation if not in conformance and not considered. Include copy of this form with next communication to applicant.

¹ See Kind Codes of USPTO Patent Documents at www.USPTO.GOV or MPEP 901.04. ² Enter office that issued the document, by the two-letter code (WIPO Standard ST.3). ³ For Japanese patent documents, the indication of the year of the reign of the Emperor must precede the serial number of the patent document. ⁴ Kind of document by the appropriate symbols as indicated on the document under WIPO Standard ST.16 if possible. ⁵ Applicant is to place a check mark here if English language translation is attached.

Doc code: IDS

Doc description: Information Disclosure Statement (IDS) Filed

PTO/SB/08a (04-09)

Approved for use through 05/31/2009. OMB 0651-0031

U.S. Patent and Trademark Office; U.S. DEPARTMENT OF COMMERCE

Under the Paperwork Reduction Act of 1995, no persons are required to respond to a collection of information unless it contains a valid OMB control number.

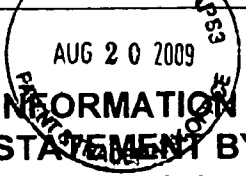
 <p>INFORMATION DISCLOSURE STATEMENT BY APPLICANT (Not for submission under 37 CFR 1.99)</p>	Application Number		12015320	
	Filing Date		2008-01-16	
	First Named Inventor	Russell W. White, et al.		
	Art Unit	2617		
	Examiner Name	Erika A. Gary		
	Attorney Docket Number	AFF.004C5US		

U.S.PATENTS						
Examiner Initial*	Cite No	Patent Number	Kind Code ¹	Issue Date	Name of Patentee or Applicant of cited Document	Pages, Columns, Lines where Relevant Passages or Relevant Figures Appear
	1					

If you wish to add additional U.S. Patent citation information please click the Add button.

U.S.PATENT APPLICATION PUBLICATIONS						
Examiner Initial*	Cite No	Publication Number	Kind Code ¹	Publication Date	Name of Patentee or Applicant of cited Document	Pages, Columns, Lines where Relevant Passages or Relevant Figures Appear
	1					

If you wish to add additional U.S. Published Application citation information please click the Add button.

FOREIGN PATENT DOCUMENTS								
Examiner Initial*	Cite No	Foreign Document Number ³	Country Code ²	Kind Code ⁴	Publication Date	Name of Patentee or Applicant of cited Document	Pages, Columns, Lines where Relevant Passages or Relevant Figures Appear	T ⁵
	1	2000-66974	JP		2000-03-03			<input type="checkbox"/>
	2	11-68685	JP		1999-03-09			<input type="checkbox"/>
	3	CN 1218258A	CN		1999-06-02			<input type="checkbox"/>

INFORMATION DISCLOSURE STATEMENT BY APPLICANT (Not for submission under 37 CFR 1.99)	Application Number		12015320	
	Filing Date		2008-01-16	
	First Named Inventor	Russell W. White, et al.		
	Art Unit	2617		
	Examiner Name	Erika A. Gary		
	Attorney Docket Number	AFF.004C5US		

4	H11-242686	JP		1999-09-07	Sony Corporation		<input type="checkbox"/>
5	DE 44 31 070 B4	DE		2004-07-22	DaimlerChrysler AG		<input type="checkbox"/>
6	0 569 343 A1	EP		1993-10-11	Pioneer Electronic Corporation		<input type="checkbox"/>
7	0 675 341 A1	EP		1995-04-10	Honda Giken Kogyo		<input type="checkbox"/>
8	0 771 686 A2	EP		1997-07-05	Toyota Jidosha Kabushiki Kaisha Toyota-shi, Aichi-		<input type="checkbox"/>
9	H4-261576	JP		1992-09-17	Mitsubishi Electric Corporation		<input type="checkbox"/>
10	2-301330	JP		1990-12-13			<input type="checkbox"/>
11	5-294250	JP		1993-11-09			<input type="checkbox"/>
12	6-187597	JP		1994-07-08			<input type="checkbox"/>
13	JP6289118	JP		1994-10-18	Sega Enterprises KK		<input type="checkbox"/>
14	JP6294659	JP		1994-10-21	Dainippon Printing Co. LTD.		<input type="checkbox"/>

INFORMATION DISCLOSURE STATEMENT BY APPLICANT (Not for submission under 37 CFR 1.99)	Application Number		12015320	
	Filing Date		2008-01-16	
	First Named Inventor	Russell W. White, et al.		
	Art Unit	2617		
	Examiner Name	Erika A. Gary		
	Attorney Docket Number	AFF.004C5US		

	15	07-129895	JP		1995-05-19	Honda Motor Co Ltd		<input type="checkbox"/>
	16	07-146155	JP		1995-06-06	Honda Motor Co Ltd		<input type="checkbox"/>
	17	7-262493	JP		1995-10-13	CSK Corporation		<input type="checkbox"/>
	18	7-262493	JP		1995-10-13			<input type="checkbox"/>
	19	JP7270171	JP		1995-10-20	Sumitomo Electronic Industries		<input type="checkbox"/>
	20	JP7036382	JP		1995-02-07	Mitsubishi Electric Corp.		<input type="checkbox"/>
	21	8-110231	JP		1996-04-30			<input type="checkbox"/>
	22	9-61514	JP		1997-03-07			<input type="checkbox"/>
	23	10-103966	JP		1998-04-24			<input type="checkbox"/>
	24	10-143349	JP		1998-05-29	Compaq Computer Corporation		<input type="checkbox"/>
	25	JP1018712	JP		1989-01-23	Mazda Motor		<input type="checkbox"/>

INFORMATION DISCLOSURE STATEMENT BY APPLICANT (Not for submission under 37 CFR 1.99)	Application Number		12015320	
	Filing Date		2008-01-16	
	First Named Inventor	Russell W. White, et al.		
	Art Unit	2617		
	Examiner Name	Erika A. Gary		
	Attorney Docket Number	AFF.004C5US		

	26	JP5077679	JP		1993-03-30	Nissan Motor		<input type="checkbox"/>
	27	JP59085599	JP		1984-05-17	Nissan Motor		<input type="checkbox"/>
	28	JP63136828	JP		1988-06-09	Pioneer Electronic Corp.		<input type="checkbox"/>
	29	63-136828	JP		1988-06-09			<input type="checkbox"/>
	30	WO 96/04724	WO		1996-02-15	Emerson, Harry		<input type="checkbox"/>
	31	WO 96/07110	WO		1996-03-07	British Telecommunications Public Limited Company		<input type="checkbox"/>
	32	WO 97/13657	WO		1997-04-17	United Technologies Automotive, Inc.		<input type="checkbox"/>
	33	H11-317061	JP		1999-11-16	Victor Company of Japan, LTD.		<input checked="" type="checkbox"/>
	34	2901445	JP		1999-03-19	Kenwood Corporation		<input checked="" type="checkbox"/>
	35	WO 99/35009	WO		1999-07-15	Microsoft Corporation		<input type="checkbox"/>
	36	11-219580	JP		1999-08-10			<input type="checkbox"/>

INFORMATION DISCLOSURE STATEMENT BY APPLICANT (Not for submission under 37 CFR 1.99)	Application Number		12015320	
	Filing Date		2008-01-16	
	First Named Inventor	Russell W. White, et al.		
	Art Unit	2617		
	Examiner Name	Erika A. Gary		
	Attorney Docket Number	AFF.004C5US		

	37	11219580 A	JP		1999-10-08	Sony Corp		<input type="checkbox"/>
	38	1168685	JP		1999-03-09			<input type="checkbox"/>
	39	11-068685	JP		1999-09-03	Sony Corp		<input type="checkbox"/>
	40	1998-052033	JP		1998-09-25			<input type="checkbox"/>
	41	1999-0042565	JP		1999-06-15			<input type="checkbox"/>
	42	1999-0073234	KR		1999-10-05	Young-Man Lee		<input type="checkbox"/>
	43	1999-0048723	KR		1999-07-05			<input type="checkbox"/>
	44	KR2019990022030U	KR		1999-06-25	Young-Shik Cheon		<input type="checkbox"/>
	45	2000-0001465	KR		2000-01-25	Samsung Motors		<input type="checkbox"/>
	46	0142256	KR		1998-03-30			<input type="checkbox"/>
	47	WO 98/21672	WO		1998-05-22	Inergy Online, Inc.		<input type="checkbox"/>

INFORMATION DISCLOSURE STATEMENT BY APPLICANT (Not for submission under 37 CFR 1.99)	Application Number	12015320
	Filing Date	2008-01-16
	First Named Inventor	Russell W. White, et al.
	Art Unit	2617
	Examiner Name	Erika A. Gary
	Attorney Docket Number	AFF.004C5US

48	WO 98/47252	WO		1998-10-22	Stern, Geoffrey	<input type="checkbox"/>
49	WO 00/54187	WO		2000-09-14	Rock.Com, Inc.	<input type="checkbox"/>
50	WO 00/60450	WO		2000-10-12	Khyber Technologies Corporation	<input type="checkbox"/>

If you wish to add additional Foreign Patent Document citation information please click the Add button

NON-PATENT LITERATURE DOCUMENTS

Examiner Initials*	Cite No	Include name of the author (in CAPITAL LETTERS), title of the article (when appropriate), title of the item (book, magazine, journal, serial, symposium, catalog, etc), date, pages(s), volume-issue number(s), publisher, city and/or country where published.	T ⁵
	1	MARK MOELLER, Computing Unplugged Magazine, "Product Preview, A Survey of Auto PC 2.0 for software developers," 1999-2009, Zatz Publishing, pages 1-7.	<input type="checkbox"/>
	2	MARK MOELLER, Computing Unplugged Magazine, "AutoPC Update, Auto PC/Windows CE for Automotive news bites," 1999-2009, Zatz Publishing, pages 1-4.	<input type="checkbox"/>
	3	Claim Chart for KR19990033393, Claim 17 of U.S. Patent No. 7,324,833, pages 1-3.	<input type="checkbox"/>
	4	RIO500, Getting Started Guide for Windows 98 and Macintosh OS 8.6, pages 1-2.	<input type="checkbox"/>
	5	NORBERT A. STREITZ, et al., "DOLPHIN: Integrated Meeting Support Across Local And Remote Desktop Environments And LiveBoards," Integrated Publication and Information Systems Institute, 1994, pages 345-358.	<input type="checkbox"/>
	6	LEO DEGEN, et al., "Working with Audio: Integrating Personal Tape Recorders and Desktop Computers," May 3-7, 1992, pages 413-418.	<input type="checkbox"/>

INFORMATION DISCLOSURE STATEMENT BY APPLICANT (Not for submission under 37 CFR 1.99)	Application Number	12015320
	Filing Date	2008-01-16
	First Named Inventor	Russell W. White, et al.
	Art Unit	2617
	Examiner Name	Erika A. Gary
	Attorney Docket Number	AFF.004C5US

7	H.S. JUN GIBEE, "A Virtual Information Desk On The Internet," University of Ulsan, September 1999, pages 265-268.	<input type="checkbox"/>
8	STEVE WHITTAKER, et al., "TeleNotes: Managing Lightweight Interactions in the Desktop," Lotus Development Corporation, June 1997, pages 137-168.	<input type="checkbox"/>
9	R.M. CROWDER, et al., "Integration of Manufacturing Information Using Open Hypermedia," Computer in Industry, 1999, pages 31-42.	<input type="checkbox"/>
10	TOMAS BOSTROM, et al., "Mobile Audio Distribution," Royal Institute of Technology, 1999, pages 166-172.	<input type="checkbox"/>
11	ALEX POON, et al., Xerox Disclosure Journal, Vol. 19, No. 2, "Gestural User Interface Technique for Controlling the Playback of Sequential Media," March/April 1994, pages 187-190.	<input type="checkbox"/>
12	DEB KUMAR ROY, "NewsComm: A Hand-Held Device For Interactive Access to Structured Audio," Massachusetts Institute of Technology, June 1995, pages 1-12.	<input type="checkbox"/>
13	VICTORIA BELLOTTI, et al., "Walking Away from the Desktop Computer: Distributed Collaboration and Mobility in a Product Design Team," 1996, pages 209-218.	<input type="checkbox"/>
14	UPUL OBEYSEKARE, et al., "The Visual Interactive Desktop Laboratory," January-March 1997, pages 63-71.	<input type="checkbox"/>
15	ASIM SMIALAGIC, et al., "MoCCA: A Mobile Communication and Computing Architecture," Institute for Complex Engineered Systems, pages 1-8.	<input type="checkbox"/>
16	SUI-MENG POON, et al., "Integration of Value-Added Audio Playback Capacity Into Computer Network," Nanyang Technological University, 1995, pages 632-636.	<input type="checkbox"/>
17	ERDAL PAKSOY, et al., "A variable-rate celp coder for fast remote voicemail retrieval using a notebook computer," DSPS R&D Center, Texas Instruments, 1997, pages 119-124.	<input type="checkbox"/>

INFORMATION DISCLOSURE STATEMENT BY APPLICANT (Not for submission under 37 CFR 1.99)	Application Number		12015320
	Filing Date		2008-01-16
	First Named Inventor	Russell W. White, et al.	
	Art Unit	2617	
	Examiner Name	Erika A. Gary	
	Attorney Docket Number	AFF.004C5US	

18	JEFFREY A. DAVIS, "Use of Personal Computers in Satellite Command and Control Systems," Raytheon Systems Company, October 24, 1999, pages 283-291.	<input type="checkbox"/>
19	NIKI DAVIS, "Remote Teaching Via ISDN2 And Desktop Conferencing," Exeter University School of Education, pages 1-3.	<input type="checkbox"/>
20	A CHAN, et al., "The PEP-II Project-Wide Database," Stanford University, 1996, pages 840-842.	<input type="checkbox"/>
21	KRISHNA BHARAT, et al., "Migratory Applications," Springer Berlin, Vol. 1222, 1997, pages 1-21.	<input type="checkbox"/>
22	EMPEG CAR, "MP3 in your dash," Digital Audio Player User Guide, pages 1-50.	<input type="checkbox"/>
23	MICROSOFT, "Getting Started Microsoft Windows. 98" Second Edition, 1998, pages 1-138.	<input type="checkbox"/>
24	SAUL GREENBERG, "PDAs and Shared Public Displays: Making Personal Information Public, and Public Information Personal," University of Calgary, March 1999, pages 1-11.	<input type="checkbox"/>
25	NAOHIKO KOHTAKE, et al., "InfoStick: an interaction device for Inter-Appliance Computing," Keio University, pages 1-15.	<input type="checkbox"/>
26	HEWLETT PACKARD, User's Guide, HP Jornada 420, Palm-Size PC, pages 1-75	<input type="checkbox"/>
27	MICROSOFT, "Introducing Microsoft Windows 95 - Certificate of Authenticity," 1995, pages 1-117.	<input type="checkbox"/>
28	SONY, "New Technical Theory For Servicing, MZ-R5ST Operation Manual," pages 1-44.	<input type="checkbox"/>

INFORMATION DISCLOSURE STATEMENT BY APPLICANT (Not for submission under 37 CFR 1.99)	Application Number	12015320
	Filing Date	2008-01-16
	First Named Inventor	Russell W. White, et al.
	Art Unit	2617
	Examiner Name	Erika A. Gary
	Attorney Docket Number	AFF.004C5US

29	RICHARD C. DAVIS, et al., "A Framework for Sharing Handwritten Notes," 1998, pages 119-120.	<input type="checkbox"/>
30	KRISHNA A. BHARAT, et al., "Migratory Applications," UIST '95, November 14-17, 1995, pages 133-142.	<input type="checkbox"/>
31	BRAD A. MYERS, "Collaboration Using Multiple PDAs Connected To A PC," Carnegie Mellon University, 1998, pages 385-294.	<input type="checkbox"/>
32	RICHARD C. DAVIS, et al., "NotePals: Lightweight Note Sharing by the Group, for the Group," May 15-20, 1999, pages 338-345.	<input type="checkbox"/>
33	JUN REKIMOTO, et al., "Augmented Surfaces: A Spatially Continuous Work Space for Hybrid Computing Environments," May 15-20, 1999, pages 378-385.	<input type="checkbox"/>
34	DAN R. OLSEN, JR., "Interacting with Chaos," September and October 1999, pages 42-54.	<input type="checkbox"/>
35	SCOTT ROBERTSON, et al., "Dual Device User Interface Design: PDAs and Interactive Television," April 13-18, 1996, pages 79-86.	<input type="checkbox"/>
36	SYMANTEC CORPORATION, "pcANYWHERE32 User's Guide," 1993-1997, pages 1-216.	<input type="checkbox"/>
37	KRISHNA BHARAT, et al., Migratory Applications, "Mobile Object Systems Towards the Programmable Internet," Springer Berlin/Heidelberg, Volume 1222/11997, 1997, pages 1-134.	<input type="checkbox"/>
38	DIAMOND MULTIMEDIA SYSTEMS, INC., "Rio PMP300, User's Guide," 1998, pages 1-27.	<input type="checkbox"/>
39	SONY, "Portable MiniDisc Recorder, Operating Instructions, MZ-R55," 1998, pages 1-42.	<input type="checkbox"/>

INFORMATION DISCLOSURE STATEMENT BY APPLICANT (Not for submission under 37 CFR 1.99)	Application Number	12015320
	Filing Date	2008-01-16
	First Named Inventor	Russell W. White, et al.
	Art Unit	2617
	Examiner Name	Erika A. Gary
	Attorney Docket Number	AFF.004C5US

40	NORBERT A. STREITZ, et al., "i-Land: An Interactive Landscape for Creativity and Innovation," Proceedings of the ACM Conference on Human Factors in Computing Systems, May 15-20, 1999, pages 120-127.	<input type="checkbox"/>
41	NORBERT A. STREITZ, et al., "Roomware for Cooperative Buildings: Integrated Design of Architectural Spaces and Information Spaces," pages 1-20	<input type="checkbox"/>
42	Direct Cable Connection screen shot, "B1U6U4," 10 pages total.	<input type="checkbox"/>
43	Direct Cable Connection screen shot, 10 pages total.	<input type="checkbox"/>
44	IBM, "WordPad z50 Cradle Option - User's Guide," 1990, pages 1-18.	<input type="checkbox"/>
45	IBM MOBILE SYSTEMS, "WorkPad z50 Mobile Companion (2608-1Ax), Hardware Maintenance Manual," March 1999, pages 1-77.	<input type="checkbox"/>
46	KEVIN JOST, Automotive Engineering International, "The car as a mobile-media platform," May 1998, pages 49-53.	<input type="checkbox"/>
47	MICROSOFT CORPORATION, "Windows CE 2.1 Technical Articles, Developing Applications for an Auto PC," June 1999, pages 1-13.	<input type="checkbox"/>
48	INFOGATION CORPORATION, "InfoGation Corp. Introduces Software Applications for Next-Generation Smart Car Systems," January 8, 1998, pages 1-2.	<input type="checkbox"/>
49	BUSINESS WIRE, "ORA Electronics Announces USB-Compatible TelCar Mark VII Begins Shipping First Quarter of 1999," January 6, 1999, pages 1-2.	<input type="checkbox"/>
50	ORA USA, "ORA Electronics Patents Telcar Cellular Telephone Interface," July 6, 1998, pages 1-2.	<input type="checkbox"/>

INFORMATION DISCLOSURE STATEMENT BY APPLICANT (Not for submission under 37 CFR 1.99)	Application Number		12015320
	Filing Date		2008-01-16
	First Named Inventor	Russell W. White, et al.	
	Art Unit	2617	
	Examiner Name	Erika A. Gary	
	Attorney Docket Number	AFF.004C5US	

If you wish to add additional non-patent literature document citation information please click the Add button			
EXAMINER SIGNATURE			
Examiner Signature	/Erika Gary/ (09/15/2010)	Date Considered	09/15/2010
*EXAMINER: Initial if reference considered, whether or not citation is in conformance with MPEP 609. Draw line through a citation if not in conformance and not considered. Include copy of this form with next communication to applicant.			
<small> ¹ See Kind Codes of USPTO Patent Documents at www.USPTO.GOV or MPEP 901.04. ² Enter office that issued the document, by the two-letter code (WIPO Standard ST.3). ³ For Japanese patent documents, the indication of the year of the reign of the Emperor must precede the serial number of the patent document. ⁴ Kind of document by the appropriate symbols as indicated on the document under WIPO Standard ST.16 if possible. ⁵ Applicant is to place a check mark here if English language translation is attached. </small>			

Receipt date:

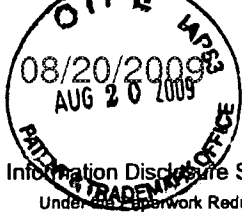

12495190 - GAU;2617

Doc code: IDS

Doc description: Information Disclosure Statement (IDS) Filed

Approved for use through 05/31/2009. OMB 0651-0031
 U.S. Patent and Trademark Office, U.S. DEPARTMENT OF COMMERCE

Under the Paperwork Reduction Act of 1995, no persons are required to respond to a collection of information unless it contains a valid OMB control number.

INFORMATION DISCLOSURE STATEMENT BY APPLICANT (Not for submission under 37 CFR 1.99)	Application Number		12015320	
	Filing Date		2008-01-16	
	First Named Inventor	Russell W. White, et al.		
	Art Unit	2617		
	Examiner Name	Erika A. Gary		
	Attorney Docket Number	AFF.004C5US		

U.S.PATENTS						
Examiner Initial*	Cite No	Patent Number	Kind Code ¹	Issue Date	Name of Patentee or Applicant of cited Document	Pages, Columns, Lines where Relevant Passages or Relevant Figures Appear
	1	6349352		2002-02-19	Lea	
	2	6697944		2004-02-24	Jones, et al.	
	3	6760916		2004-07-06	Holtz, et al.	
	4	6225984		2001-05-01	Crawford	
	5	5327558		1994-07-05	Burke, et al.	
	6	5715474		1998-02-03	Burke, et al.	

If you wish to add additional U.S. Patent citation information please click the Add button.

U.S.PATENT APPLICATION PUBLICATIONS						
Examiner Initial*	Cite No	Publication Number	Kind Code ¹	Publication Date	Name of Patentee or Applicant of cited Document	Pages, Columns, Lines where Relevant Passages or Relevant Figures Appear

<p>INFORMATION DISCLOSURE STATEMENT BY APPLICANT (Not for submission under 37 CFR 1.99)</p>	Application Number		12015320	
	Filing Date		2008-01-16	
	First Named Inventor	Russell W. White, et al.		
	Art Unit	2617		
	Examiner Name	Erika A. Gary		
	Attorney Docket Number	AFF.004C5US		

1					
---	--	--	--	--	--

If you wish to add additional U.S. Published Application citation information please click the Add button.

FOREIGN PATENT DOCUMENTS								
Examiner Initial*	Cite No	Foreign Document Number ³	Country Code ^{2j}	Kind Code ⁴	Publication Date	Name of Patentee or Applicant of cited Document	Pages, Columns, Lines where Relevant Passages or Relevant Figures Appear	T ⁵
	1	WO 00/38340	WO		2000-06-29	Kim, Joehan		<input type="checkbox"/>
	2	WO 98/19480	WO		1998-07-05	Ericsson, Inc.		<input type="checkbox"/>
	3	WO 99/43136	WO		1999-08-26	Ericsson, Inc.		<input type="checkbox"/>
	4	8-79814	JP		1996-03-22			<input type="checkbox"/>
	5	9-74580	JP		1997-03-18			<input type="checkbox"/>
	6	10-149182	FP		1998-06-02			<input type="checkbox"/>
	7	3056721	FP		1998-12-02			<input type="checkbox"/>
	8	WO 99/06910	WO		1999-02-11	Ludtke, Harold A.		<input type="checkbox"/>

INFORMATION DISCLOSURE STATEMENT BY APPLICANT (Not for submission under 37 CFR 1.99)	Application Number		12015320	
	Filing Date		2008-01-16	
	First Named Inventor	Russell W. White, et al.		
	Art Unit	2617		
	Examiner Name	Erika A. Gary		
	Attorney Docket Number	AFF.004C5US		

9	11-73192	JP		1999-03-16			<input type="checkbox"/>
10	3890692	JP		2006-12-15			<input type="checkbox"/>
11	WO 99/12152	WO		1999-11-03	Sony Corporation		<input type="checkbox"/>
12	EP 0 920 016 A2	EP		1999-02-06	Sony Corporation		<input type="checkbox"/>
13	11-219580	JP		1999-08-10			<input type="checkbox"/>
14	EP 0 918 408 A2	EP		1999-05-26	Sony Corporation		<input type="checkbox"/>
15	11-143791	JP		1999-05-28			<input type="checkbox"/>
16	2007-207257	JP		2007-08-16			<input type="checkbox"/>
17	DE 20 2004 013 65	DE		2004-12-23	Boll, Nobert		<input type="checkbox"/>
18	WO 99/35009	WO		1999-07-15	Microsoft Corporation		<input type="checkbox"/>
19	2001-128280	JP		2001-05-11			<input type="checkbox"/>

INFORMATION DISCLOSURE STATEMENT BY APPLICANT (Not for submission under 37 CFR 1.99)	Application Number		12015320	
	Filing Date		2008-01-16	
	First Named Inventor	Russell W. White, et al.		
	Art Unit	2617		
	Examiner Name	Erika A. Gary		
	Attorney Docket Number	AFF.004C5US		

20	KR20000036680	KR		2000-07-05	Kee Kang Choon		<input type="checkbox"/>
21	10-1997-0016743	KR		1997-04-30			<input type="checkbox"/>
22	20-1997-0012254	KR		1997-05-28			<input type="checkbox"/>
23	WO 99/23856	WO		1999-05-14	Mershon, Stuart		<input type="checkbox"/>
24	WO 99/28897	WO		1999-06-10	Voquette Networks, LTD.		<input type="checkbox"/>
25	1999-0055970	KR		1999-07-15			<input type="checkbox"/>
26	100242563 B1	KR		1999-10-11	Kim, Joon Sung		<input type="checkbox"/>
27	EP 0 982 732 A1	EP		2000-01-03	Saehan Information Systems, Inc.		<input type="checkbox"/>
28	10-0356742	KR		2002-10-18	Hyundai Autonet, Co. Ltd.		<input type="checkbox"/>
29	10-356742	JP		2002-10-02			<input type="checkbox"/>
30	WO 00/38340	WO		2000-06-29	Kim, Jaehan		<input type="checkbox"/>

INFORMATION DISCLOSURE STATEMENT BY APPLICANT (Not for submission under 37 CFR 1.99)	Application Number		12015320	
	Filing Date		2008-01-16	
	First Named Inventor	Russell W. White, et al.		
	Art Unit	2617		
	Examiner Name	Erika A. Gary		
	Attorney Docket Number	AFF.004C5US		

	31	2000-0001465	JP		2000-01-25			<input type="checkbox"/>
	32	2001-0009302	JP		2001-02-05			<input type="checkbox"/>
	33	2001-0028354	JP		2001-04-06			<input type="checkbox"/>
	34	1999-0033393	JP		1999-05-15			<input type="checkbox"/>
	35	11-317061	JP		1999-11-16			<input type="checkbox"/>
	36	2225910	CA		1997-12-24	Lussier, Luc.		<input type="checkbox"/>
	37	0 661 676 A1	EP		1994-12-21	AT&T Global Information Solutions International		<input type="checkbox"/>
	38	0 982 732 A1	EP		2000-01-03	Saeahan Information Systems, Inc.		<input type="checkbox"/>
	39	2901445	JP		1999-03-19			<input type="checkbox"/>
	40	9-50282	JP		1997-02-18			<input type="checkbox"/>
	41	10-173737	JP		1998-06-26			<input type="checkbox"/>

INFORMATION DISCLOSURE STATEMENT BY APPLICANT (Not for submission under 37 CFR 1.99)	Application Number		12015320	
	Filing Date		2008-01-16	
	First Named Inventor	Russell W. White, et al.		
	Art Unit	2617		
	Examiner Name	Erika A. Gary		
	Attorney Docket Number	AFF.004C5US		

42	11-96735	JP		1999-04-09			<input type="checkbox"/>
43	11-242686	JP		1999-09-07			<input type="checkbox"/>
44	WO 94/18763	WO		1994-08-18	Gutle, Hubert		<input type="checkbox"/>
45	WO 98/21672	WO		1998-05-22	Inergy Online, Inc.		<input type="checkbox"/>
46	WO 98/33102	WO		1998-07-30	Guimaraes Teixeira		<input type="checkbox"/>
47	WO 99/18518	WO		1999-04-15	Polash, Peter		<input type="checkbox"/>
48	WO 00/07849	WO		2000-02-17	Microsoft Corporation		<input type="checkbox"/>
49	11-317061	WO		1999-11-16			<input type="checkbox"/>
50	2901445	JP		1999-03-19			<input type="checkbox"/>

If you wish to add additional Foreign Patent Document citation information please click the Add button

NON-PATENT LITERATURE DOCUMENTS

Examiner Initials*	Cite No	Include name of the author (in CAPITAL LETTERS), title of the article (when appropriate), title of the item (book, magazine, journal, serial, symposium, catalog, etc), date, pages(s), volume-issue number(s), publisher, city and/or country where published.	T ⁵
--------------------	---------	-----------------------------------------------------------------------------------------------------------------------------------------------------------------------------------------------------------------------------------------------------------------	----------------

<p>INFORMATION DISCLOSURE STATEMENT BY APPLICANT (Not for submission under 37 CFR 1.99)</p>	Application Number		12015320
	Filing Date		2008-01-16
	First Named Inventor	Russell W. White, et al.	
	Art Unit		2617
	Examiner Name	Erika A. Gary	
	Attorney Docket Number		AFF.004C5US

1	DANIEL KUMIN, Stereo Review, "Jukebox Heaven," January 1999, pages 64-71.	<input type="checkbox"/>
2	AUDIO, "Anthem Five-Channel Amp," July/August 1999, page 15.	<input type="checkbox"/>
3	Sony webpages in Japanese, "Portable Mini Disc Player MD Recorder," July 21, 1996, pages 1-5.	<input type="checkbox"/>
4	Sony, "MD Walkman Operating Instructions - MZ-R4ST," 1996, pages 1-64.	<input type="checkbox"/>
5	Sony, "MD Walkman Operating Instructions - MZ-R5ST," 1997, pages 1-79.	<input type="checkbox"/>
6	STEREO REVIEW, "New Products," June 1998, 1 page.	<input type="checkbox"/>
7	FACTIVA, Hardware Review, "Lost in the Supermarket," 2009, pages 1-3.	<input type="checkbox"/>
8	Sony webpages in Japanese, "Portable Mini Disc Player MD Recorder," October 21, 1999, pages 1-63.	<input type="checkbox"/>
9	JAMIE SORCHER, Stereo Review, "New for the Road," May 1998, 2 pages.	<input type="checkbox"/>
10	Sony, "MD Walkman Operating Instructions - MZ-R55," 1998, pages 1-42.	<input type="checkbox"/>
11	JOHN WHITTERS, The Advertiser, "Is the cassette doomed?" July 16, 1998, pages 1-2.	<input type="checkbox"/>

INFORMATION DISCLOSURE STATEMENT BY APPLICANT (Not for submission under 37 CFR 1.99)	Application Number	12015320
	Filing Date	2008-01-16
	First Named Inventor	Russell W. White, et al.
	Art Unit	2617
	Examiner Name	Erika A. Gary
	Attorney Docket Number	AFF.004C5US

12	GEORGE COLE, Financial Times, "Listen with your eyes: A new music CD format supplies textual information," October 23, 1997, pages 1-2.	<input type="checkbox"/>
13	DANA J. PARKER, Standard Deviations, "CD-TEXTra! Read all about it!", October 1996, pages 1-2.	<input type="checkbox"/>
14	MOBILE ELECTRONICS, "Down the Road," July 2004, pages 1-2.	<input type="checkbox"/>
15	ALPINE, "Interface Adapter for iPod KCA-420i - Owner's Manual," 44 pages total.	<input type="checkbox"/>
16	PR Newswire, "Alpine Announces Fall Release of Interface Adapter That Enables iPod Control and Playback From In-Vehicle Sound Systems," July 7, 2004, 2 pages total.	<input type="checkbox"/>
17	AMY GILBOY, Mobile Electronics, "Apple's iPod Seen Transforming Car Audio Business," 1 page.	<input type="checkbox"/>
18	GREG BORROWMAN, The Sydney Morning Herald, "Philips Releases Its Latest DVD," 1999, 2 pages total.	<input type="checkbox"/>
19	JVC, "Audio/Video Control Receiver, RX-668VBK, Instructions," pages 1-43.	<input type="checkbox"/>
20	Sony webpages in Japanese, "Portable MD Recorder," October 1997, 5 pages total.	<input type="checkbox"/>
21	Sony, "Walkman MZ-R50 Recorder," October 1997 7 pages total.	<input type="checkbox"/>
22	Sony, "MD Walkman MZ-R55," October 10, 1998, 6 pages total.	<input type="checkbox"/>

INFORMATION DISCLOSURE STATEMENT BY APPLICANT (Not for submission under 37 CFR 1.99)	Application Number	12015320
	Filing Date	2008-01-16
	First Named Inventor	Russell W. White, et al.
	Art Unit	2617
	Examiner Name	Erika A. Gary
	Attorney Docket Number	AFF.004C5US

23	VON HERBERT PAULER, Funkschau, "Kopierschutz fur MP3-Audio," 1999, 9 pages total.	<input type="checkbox"/>
24	English Summary, "A device for remotely controlling a car device for playing mp3 files is disclosed....", 1 page.	<input type="checkbox"/>
25	FRANKLIN N. TESSLER, MACWORLD, "Mobile MAC, Highway Fidelity," June 2004, pages 1-3.	<input type="checkbox"/>
26	BARRY COLLINS, The Sunday Times, "High-class high-tech - Buyer's guide," 2001, 2 pages total.	<input type="checkbox"/>
27	PETER FAMILARI, Herald-Sun, "Clever Deck - CD and mini-disc combination," 1998, 1 page.	<input type="checkbox"/>
28	JVC, "MD-CD Combination Deck, XU-301BK, Instructions," pages 1-59.	<input type="checkbox"/>
29	AMY GILROY, Mobile Electronics, "OEM Integrators Embrace iPod's Success," 1 page.	<input type="checkbox"/>
30	JVC, "Portable Minidisc Recorder, XM-R700SL, Instructions," pages 1-24.	<input type="checkbox"/>
31	Rio Car, "Car Toy Sole Retailer For Rio Car," May 28, 2001, 1 page.	<input type="checkbox"/>
32	AMY GILROY, Twice, "Panasonic Ships First SD MP3," December 4, 2000, 1 page.	<input type="checkbox"/>
33	Twice, "PhatNoise Readies MP3," November 5, 2001, 1 page.	<input type="checkbox"/>

INFORMATION DISCLOSURE STATEMENT BY APPLICANT (Not for submission under 37 CFR 1.99)	Application Number	12015320
	Filing Date	2008-01-16
	First Named Inventor	Russell W. White, et al.
	Art Unit	2617
	Examiner Name	Erika A. Gary
	Attorney Docket Number	AFF.004C5US

34	KEVIN SAVETZ, The Washington Post, "Putting Your MP3 Collection in Drive (Final Edition)," August 10, 2001, pages 1-3.	<input type="checkbox"/>
35	Twice, "Study Sees Retail Opportunities For Mobile Multimedia," Volume 14, Issue 15, June 28, 1999, pages 1-2.	<input type="checkbox"/>
36	Japanese Webpage, www.kcalgo.kr/jsp/main.jsp, 1 page.	<input type="checkbox"/>
37	Japanese Webpage, www.kca.go.kr - Brochure Free - Microsoft Internet Explorer, 1 page.	<input type="checkbox"/>
38	Japanese Webpage, www.kca.go.kr - Brochure Free - Microsoft Internet Explorer, 1 page.	<input type="checkbox"/>
39	STEPHEN KEMPAINEN, EDN Access For Design, By Design "In-car computing gets personal," August 17, 1998, pages 1-7.	<input type="checkbox"/>
40	Japanese Website, MM MPMANIA.com, http://mpmania.x-y.net/bbs/zboard.php?id=products&keyword=1998, 1 page.	<input type="checkbox"/>
41	Japanese document regarding MP3, May 1999, 1 page.	<input type="checkbox"/>
42	MPMan, "The portable MP3 player using the Flash Memory and Memory card - MP-F20," in Japanese, pages 1-34.	<input type="checkbox"/>
43	Japanese Website, MM MPMANIA.com, http://mpmania.x-y.net/bbs/view.php?id=products&page=1&sn1=&divpage, 1 page.	<input type="checkbox"/>
44	www.mpman.com, "MP-F30, User's Guide," pages 2-47.	<input type="checkbox"/>

INFORMATION DISCLOSURE STATEMENT BY APPLICANT (Not for submission under 37 CFR 1.99)	Application Number		12015320
	Filing Date		2008-01-16
	First Named Inventor	Russell W. White, et al.	
	Art Unit	2617	
	Examiner Name	Erika A. Gary	
	Attorney Docket Number	AFF.004C5US	

45	MARK MOELLER, Computing Unplugged Magazine, "Software Review, New software products for the Auto PC," 1999-2009, Zatz Publishing, pages 1-4	<input type="checkbox"/>
46	MARK MOELLER, Computing Unplugged Magazine, "Auto PC Power, A survey of resources for Auto PC owners," 1999-2009, Zatz Publishing, pages 1-5.	<input type="checkbox"/>
47	MARK MOELLER, Computing Unplugged Magazine, "Auto PC Power, A look at the first year of the Auto PC with Microsoft," 1999-2009, Zatz Publishing, pages 1-5.	<input type="checkbox"/>
48	MARK MOELLER, Computing Unplugged Magazine, "Auto PC Power, Next generation AutoPCs make a big debut at CES," 1999-2009, Zatz Publishing, pages 1-6.	<input type="checkbox"/>
49	MARK MOELLER, Computing Unplugged Magazine, "Programming Power, Getting started developing software for the Auto PC," 1999-2009, Zatz Publishing, pages 1-5	<input type="checkbox"/>
50	MARK MOELLER, Computing Unplugged Magazine, "Behind the Scenes, The AutoPC: Vision vs. Reality," 1999-2009, Zatz Publishing, pages 1-7.	<input type="checkbox"/>

If you wish to add additional non-patent literature document citation information please click the Add button

EXAMINER SIGNATURE

Examiner Signature	/Erika Gary/ (09/15/2010)	Date Considered	09/15/2010
--------------------	---------------------------	-----------------	------------

*EXAMINER: Initial if reference considered, whether or not citation is in conformance with MPEP 609. Draw line through a citation if not in conformance and not considered. Include copy of this form with next communication to applicant.

¹ See Kind Codes of USPTO Patent Documents at www.USPTO.GOV or MPEP 901.04. ² Enter office that issued the document, by the two-letter code (WIPO Standard ST.3). ³ For Japanese patent documents, the indication of the year of the reign of the Emperor must precede the serial number of the patent document. ⁴ Kind of document by the appropriate symbols as indicated on the document under WIPO Standard ST.16 if possible. ⁵ Applicant is to place a check mark here if English language translation is attached.

Receipt date: 08/20/2009

12495190 - GAU: 2617

Doc code: IDS
 Doc description: Information Disclosure Statement (IDS) Filed

PTO/SB/08a (04-09)
 Approved for use through 05/31/2009. OMB 0651-0031
 U.S. Patent and Trademark Office; U.S. DEPARTMENT OF COMMERCE

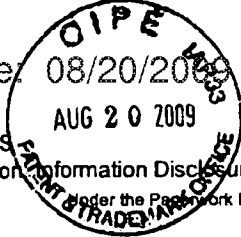

Under the Paperwork Reduction Act of 1995, no persons are required to respond to a collection of information unless it contains a valid OMB control number.

INFORMATION DISCLOSURE STATEMENT BY APPLICANT (Not for submission under 37 CFR 1.99)	Application Number		12015320	
	Filing Date		2008-01-16	
	First Named Inventor	Russell W. White, et al.		
	Art Unit	2617		
	Examiner Name	Erika A. Gary		
	Attorney Docket Number	AFF.004C5US		

U.S.PATENTS						
Examiner Initial*	Cite No	Patent Number	Kind Code ¹	Issue Date	Name of Patentee or Applicant of cited Document	Pages, Columns, Lines where Relevant Passages or Relevant Figures Appear
	1					

If you wish to add additional U.S. Patent citation information please click the Add button.

U.S.PATENT APPLICATION PUBLICATIONS						
Examiner Initial*	Cite No	Publication Number	Kind Code ¹	Publication Date	Name of Patentee or Applicant of cited Document	Pages, Columns, Lines where Relevant Passages or Relevant Figures Appear
	1					

If you wish to add additional U.S. Published Application citation information please click the Add button.

FOREIGN PATENT DOCUMENTS								
Examiner Initial*	Cite No	Foreign Document Number ³	Country Code ²	Kind Code ⁴	Publication Date	Name of Patentee or Applicant of cited Document	Pages, Columns, Lines where Relevant Passages or Relevant Figures Appear	T ⁵
	1	2000-66974	JP		2000-03-03			<input type="checkbox"/>
	2	11-68685	JP		1999-03-09			<input type="checkbox"/>
	3	CN 1218258A	CN		1999-06-02			<input type="checkbox"/>

INFORMATION DISCLOSURE STATEMENT BY APPLICANT (Not for submission under 37 CFR 1.99)	Application Number	12015320
	Filing Date	2008-01-16
	First Named Inventor	Russell W. White, et al.
	Art Unit	2617
	Examiner Name	Erika A. Gary
	Attorney Docket Number	AFF.004C5US

4	H11-242686	JP		1999-09-07	Sony Corporation	<input type="checkbox"/>
5	DE 44 31 070 B4	DE		2004-07-22	DaimlerChrysler AG	<input type="checkbox"/>
6	0 569 343 A1	EP		1993-10-11	Pioneer Electronic Corporation	<input type="checkbox"/>
7	0 675 341 A1	EP		1995-04-10	Honda Giken-Kogyo	<input type="checkbox"/>
8	0 771 686 A2	EP		1997-07-05	Toyota Jidosha Kabushiki Kaisha Toyota-shi, Aichi-	<input type="checkbox"/>
9	H4-261576	JP		1992-09-17	Mitsubishi Electric Corporation	<input type="checkbox"/>
10	2-301330	JP		1990-12-13		<input type="checkbox"/>
11	5-294250	JP		1993-11-09		<input type="checkbox"/>
12	6-187597	JP		1994-07-08		<input type="checkbox"/>
13	JP6289118	JP		1994-10-18	Sega Enterprises KK	<input type="checkbox"/>
14	JP6294659	JP		1994-10-21	Dainippon Printing Co. LTD.	<input type="checkbox"/>

INFORMATION DISCLOSURE STATEMENT BY APPLICANT (Not for submission under 37 CFR 1.99)	Application Number		12015320	
	Filing Date		2008-01-16	
	First Named Inventor	Russell W. White, et al.		
	Art Unit	2617		
	Examiner Name	Erika A. Gary		
	Attorney Docket Number	AFF.004C5US		

15	07-129895	JP		1995-05-19	Honda Motor Co Ltd		<input type="checkbox"/>
16	07-146155	JP		1995-06-06	Honda Motor Co Ltd		<input type="checkbox"/>
17	7-262493	JP		1995-10-13	CSK Corporation		<input type="checkbox"/>
18	7-262493	JP		1995-10-13			<input type="checkbox"/>
19	JP7270171	JP		1995-10-20	Sumitomo Electronic Industries		<input type="checkbox"/>
20	JP7036382	JP		1995-02-07	Mitsubishi Electric Corp.		<input type="checkbox"/>
21	8-110231	JP		1996-04-30			<input type="checkbox"/>
22	9-61514	JP		1997-03-07			<input type="checkbox"/>
23	10-103966	JP		1998-04-24			<input type="checkbox"/>
24	10-143349	JP		1998-05-29	Compaq Computer Corporation		<input type="checkbox"/>
25	JP1018712	JP		1989-01-23	Mazda Motor		<input type="checkbox"/>

INFORMATION DISCLOSURE STATEMENT BY APPLICANT (Not for submission under 37 CFR 1.99)	Application Number		12015320	
	Filing Date		2008-01-16	
	First Named Inventor	Russell W. White, et al.		
	Art Unit	2617		
	Examiner Name	Erika A. Gary		
	Attorney Docket Number	AFF.004C5US		

26	JP5077679	JP		1993-03-30	Nissan Motor		<input type="checkbox"/>
27	JP59085599	JP		1984-05-17	Nissan Motor		<input type="checkbox"/>
28	JP63136828	JP		1988-06-09	Pioneer Electronic Corp.		<input type="checkbox"/>
29	63-136828	JP		1988-06-09			<input type="checkbox"/>
30	WO 96/04724	WO		1996-02-15	Emerson, Harry		<input type="checkbox"/>
31	WO 96/07110	WO		1996-03-07	British Telecommunications Public Limited Company		<input type="checkbox"/>
32	WO 97/13657	WO		1997-04-17	United Technologies Automotive, Inc.		<input type="checkbox"/>
33	H11-317061	JP		1999-11-16	Victor Company of Japan, LTD.		<input checked="" type="checkbox"/>
34	2901445	JP		1999-03-19	Kenwood Corporation		<input checked="" type="checkbox"/>
35	WO 99/35009	WO		1999-07-15	Microsoft Corporation		<input type="checkbox"/>
36	11-219580	JP		1999-08-10			<input type="checkbox"/>

INFORMATION DISCLOSURE STATEMENT BY APPLICANT (Not for submission under 37 CFR 1.99)	Application Number		12015320	
	Filing Date		2008-01-16	
	First Named Inventor	Russell W. White, et al.		
	Art Unit	2617		
	Examiner Name	Erika A. Gary		
	Attorney Docket Number	AFF.004C5US		

37	11219580 A	JP		1999-10-08	Sony Corp		<input type="checkbox"/>
38	1168685	JP		1999-03-09			<input type="checkbox"/>
39	11-068685	JP		1999-09-03	Sony Corp		<input type="checkbox"/>
40	1998-052033	JP		1998-09-25			<input type="checkbox"/>
41	1999-0042565	JP		1999-06-15			<input type="checkbox"/>
42	1999-0073234	KR		1999-10-05	Young-Man Lee		<input type="checkbox"/>
43	1999-0048723	KR		1999-07-05			<input type="checkbox"/>
44	KR2019990022030U	KR		1999-06-25	Young-Shik Cheon		<input type="checkbox"/>
45	2000-0001465	KR		2000-01-25	Samsung Motors		<input type="checkbox"/>
46	0142256	KR		1998-03-30			<input type="checkbox"/>
47	WO 98/21672	WO		1998-05-22	Inergy Online, Inc.		<input type="checkbox"/>

INFORMATION DISCLOSURE STATEMENT BY APPLICANT (Not for submission under 37 CFR 1.99)	Application Number	12015320
	Filing Date	2008-01-16
	First Named Inventor	Russell W. White, et al.
	Art Unit	2617
	Examiner Name	Erika A. Gary
	Attorney Docket Number	AFF.004C5US

48	WO 98/47252	WO		1998-10-22	Stern, Geoffrey	<input type="checkbox"/>
49	WO 00/54187	WO		2000-09-14	Rock.Com, Inc.	<input type="checkbox"/>
50	WO 00/60450	WO		2000-10-12	Khyber Technologies Corporation	<input type="checkbox"/>

If you wish to add additional Foreign Patent Document citation information please click the Add button

NON-PATENT LITERATURE DOCUMENTS

Examiner Initials*	Cite No	Include name of the author (in CAPITAL LETTERS), title of the article (when appropriate), title of the item (book, magazine, journal, serial, symposium, catalog, etc), date, pages(s), volume-issue number(s), publisher, city and/or country where published.	T ⁵
	1	MARK MOELLER, Computing Unplugged Magazine, "Product Preview, A Survey of Auto PC 2.0 for software developers," 1999-2009, Zatz Publishing, pages 1-7.	<input type="checkbox"/>
	2	MARK MOELLER, Computing Unplugged Magazine, "AutoPC Update, Auto PC/Windows CE for Automotive news bites," 1999-2009, Zatz Publishing, pages 1-4.	<input type="checkbox"/>
	3	Claim Chart for KR19990033393, Claim 17 of U.S. Patent No. 7,324,833, pages 1-3.	<input type="checkbox"/>
	4	RIO500, Getting Started Guide for Windows 98 and Macintosh OS 8.6, pages 1-2.	<input type="checkbox"/>
	5	NORBERT A. STREITZ, et al., "DOLPHIN: Integrated Meeting Support Across Local And Remote Desktop Environments And LiveBoards," Integrated Publication and Information Systems Institute, 1994, pages 345-358.	<input type="checkbox"/>
	6	LEO DEGEN, et al., "Working with Audio: Integrating Personal Tape Recorders and Desktop Computers," May 3-7, 1992, pages 413-418.	<input type="checkbox"/>

INFORMATION DISCLOSURE STATEMENT BY APPLICANT (Not for submission under 37 CFR 1.99)	Application Number	12015320
	Filing Date	2008-01-16
	First Named Inventor	Russell W. White, et al.
	Art Unit	2617
	Examiner Name	Erika A. Gary
	Attorney Docket Number	AFF.004C5US

7	H.S. JUN GIBEE, "A Virtual Information Desk On The Internet," University of Ulsan, September 1999, pages 265-268.	<input type="checkbox"/>
8	STEVE WHITTAKER, et al., "TeleNotes: Managing Lightweight Interactions in the Desktop," Lotus Development Corporation, June 1997, pages 137-168.	<input type="checkbox"/>
9	R.M. CROWDER, et al., "Integration of Manufacturing Information Using Open Hypertext," Computer in Industry, 1999, pages 31-42.	<input type="checkbox"/>
10	TOMAS BOSTROM, et al., "Mobile Audio Distribution," Royal Institute of Technology, 1999, pages 166-172.	<input type="checkbox"/>
11	ALEX POON, et al., Xerox Disclosure Journal, Vol. 19, No. 2, "Gestural User Interface Technique for Controlling the Playback of Sequential Media," March/April 1994, pages 187-190.	<input type="checkbox"/>
12	DEB KUMAR ROY, "NewsComm: A Hand-Held Device For Interactive Access to Structured Audio," Massachusetts Institute of Technology, June 1995, pages 1-12.	<input type="checkbox"/>
13	VICTORIA BELLOTTI, et al., "Walking Away from the Desktop Computer: Distributed Collaboration and Mobility in a Product Design Team," 1996, pages 209-218.	<input type="checkbox"/>
14	UPUL OBEYSEKARE, et al., "The Visual Interactive Desktop Laboratory," January-March 1997, pages 63-71.	<input type="checkbox"/>
15	ASIM SMAILAGIC, et al., "MoCCA: A Mobile Communication and Computing Architecture," Institute for Complex Engineered Systems, pages 1-8.	<input type="checkbox"/>
16	SUI-MENG POON, et al., "Integration of Value-Added Audio Playback Capacity Into Computer Network," Nanyang Technological University, 1995, pages 632-636.	<input type="checkbox"/>
17	ERDAL PAKSOY, et al., "A variable-rate celp coder for fast remote voicemail retrieval using a notebook computer," DSPS R&D Center, Texas Instruments, 1997, pages 119-124.	<input type="checkbox"/>

INFORMATION DISCLOSURE STATEMENT BY APPLICANT (Not for submission under 37 CFR 1.99)	Application Number		12015320
	Filing Date		2008-01-16
	First Named Inventor	Russell W. White, et al.	
	Art Unit	2617	
	Examiner Name	Erika A. Gary	
	Attorney Docket Number	AFF.004C5US	

18	JEFFREY A. DAVIS, "Use of Personal Computers in Satellite Command and Control Systems," Raytheon Systems Company, October 24, 1999, pages 283-291.	<input type="checkbox"/>
19	NIKI DAVIS, "Remote Teaching Via ISDN2 And Desktop Conferencing," Exeter University School of Education, pages 1-3.	<input type="checkbox"/>
20	A CHAN, et al., "The PEP-II Project-Wide Database," Stanford University, 1996, pages 840-842.	<input type="checkbox"/>
21	KRISHNA BHARAT, et al., "Migratory Applications," Springer Berlin, Vol. 1222, 1997, pages 1-21.	<input type="checkbox"/>
22	EMPEG CAR, "MP3 in your dash," Digital Audio Player User Guide, pages 1-50.	<input type="checkbox"/>
23	MICROSOFT, "Getting Started Microsoft Windows 98" Second Edition, 1998, pages 1-138.	<input type="checkbox"/>
24	SAUL GREENBERG, "PDAs and Shared Public Displays: Making Personal Information Public, and Public Information Personal," University of Calgary, March 1999, pages 1-11.	<input type="checkbox"/>
25	NAOHIKO KOHTAKE, et al., "InfoStick: an interaction device for Inter-Appliance Computing," Keio University, pages 1-15.	<input type="checkbox"/>
26	HEWLETT PACKARD, User's Guide, HP Jornada 420, Palm-Size PC, pages 1-75	<input type="checkbox"/>
27	MICROSOFT, "Introducing Microsoft Windows 95 - Certificate of Authenticity," 1995, pages 1-117.	<input type="checkbox"/>
28	SONY, "New Technical Theory For Servicing, MZ-R5ST Operation Manual," pages 1-44.	<input type="checkbox"/>

INFORMATION DISCLOSURE STATEMENT BY APPLICANT (Not for submission under 37 CFR 1.99)	Application Number	12015320
	Filing Date	2008-01-16
	First Named Inventor	Russell W. White, et al.
	Art Unit	2617
	Examiner Name	Erika A. Gary
	Attorney Docket Number	AFF.004C5US

29	RICHARD C. DAVIS, et al., "A Framework for Sharing Handwritten Notes," 1998, pages 119-120.	<input type="checkbox"/>
30	KRISHNA A. BHARAT, et al., "Migratory Applications," UIST '95, November 14-17, 1995, pages 133-142.	<input type="checkbox"/>
31	BRAD A. MYERS, "Collaboration Using Multiple PDAs Connected To A PC," Carnegie Mellon University, 1998, pages 385-294.	<input type="checkbox"/>
32	RICHARD C. DAVIS, et al., "NotePals: Lightweight Note Sharing by the Group, for the Group," May 15-20, 1999, pages 338-345.	<input type="checkbox"/>
33	JUN REKIMOTO, et al., "Augmented Surfaces: A Spatially Continuous Work Space for Hybrid Computing Environments," May 15-20, 1999, pages 378-385.	<input type="checkbox"/>
34	DAN R. OLSEN, JR., "Interacting with Chaos," September and October 1999, pages 42-54.	<input type="checkbox"/>
35	SCOTT ROBERTSON, et al., "Dual Device User Interface Design: PDAs and Interactive Television," April 13-18, 1996, pages 79-86.	<input type="checkbox"/>
36	SYMANTEC CORPORATION, "pcANYWHERE32 User's Guide," 1993-1997, pages 1-216.	<input type="checkbox"/>
37	KRISHNA BHARAT, et al., Migratory Applications, "Mobile Object Systems Towards the Programmable Internet," Springer Berlin/Heidelberg, Volume 1222/11997, 1997, pages 1-134.	<input type="checkbox"/>
38	DIAMOND MULTIMEDIA SYSTEMS, INC., "Rio PMP300, User's Guide," 1998, pages 1-27.	<input type="checkbox"/>
39	SONY, "Portable MiniDisc Recorder, Operating Instructions, MZ-R55," 1998, pages 1-42.	<input type="checkbox"/>

INFORMATION DISCLOSURE STATEMENT BY APPLICANT (Not for submission under 37 CFR 1.99)	Application Number		12015320
	Filing Date		2008-01-16
	First Named Inventor	Russell W. White, et al.	
	Art Unit	2617	
	Examiner Name	Erika A. Gary	
	Attorney Docket Number	AFF.004C5US	

40	NORBERT A. STREITZ, et al., "i-Land: An Interactive Landscape for Creativity and Innovation," Proceedings of the ACM Conference on Human Factors in Computing Systems, May 15-20, 1999, pages 120-127.	<input type="checkbox"/>
41	NORBERT A. STREITZ, et al., "Roomware for Cooperative Buildings: Integrated Design of Architectural Spaces and Information Spaces," pages 1-20	<input type="checkbox"/>
42	Direct Cable Connection screen shot, "B1U6U4," 10 pages total.	<input type="checkbox"/>
43	Direct Cable Connection screen shot, 10 pages total.	<input type="checkbox"/>
44	IBM, "WordPad z50 Cradle Option - User's Guide," 1990, pages 1-18.	<input type="checkbox"/>
45	IBM MOBILE SYSTEMS, "WorkPad z50 Mobile Companion (2608-1Ax), Hardware Maintenance Manual," March 1999, pages 1-77.	<input type="checkbox"/>
46	KEVIN JOST, Automotive Engineering International, "The car as a mobile-media platform," May 1998, pages 49-53.	<input type="checkbox"/>
47	MICROSOFT CORPORATION, "Windows CE 2.1 Technical Articles, Developing Applications for an Auto PC," June 1999, pages 1-13.	<input type="checkbox"/>
48	INFOGATION CORPORATION, "InfoGation Corp. Introduces Software Applications for Next-Generation Smart Car Systems," January 8, 1998, pages 1-2.	<input type="checkbox"/>
49	BUSINESS WIRE, "ORA Electronics Announces USB-Compatible TelCar Mark VII Begins Shipping First Quarter of 1999," January 6, 1999, pages 1-2.	<input type="checkbox"/>
50	ORA USA, "ORA Electronics Patents Telcar Cellular Telephone Interface," July 6, 1998, pages 1-2.	<input type="checkbox"/>

INFORMATION DISCLOSURE STATEMENT BY APPLICANT (Not for submission under 37 CFR 1.99)	Application Number		12015320
	Filing Date		2008-01-16
	First Named Inventor	Russell W. White, et al.	
	Art Unit	2617	
	Examiner Name	Erika A. Gary	
	Attorney Docket Number	AFF.004C5US	

If you wish to add additional non-patent literature document citation information please click the Add button			
EXAMINER SIGNATURE			
Examiner Signature	/Erika Gary/ (09/15/2010)	Date Considered	09/15/2010
*EXAMINER: Initial if reference considered, whether or not citation is in conformance with MPEP 609. Draw line through a citation if not in conformance and not considered. Include copy of this form with next communication to applicant.			
<small> ¹ See Kind Codes of USPTO Patent Documents at www.USPTO.GOV or MPEP 901.04. ² Enter office that issued the document, by the two-letter code (WIPO Standard ST.3). ³ For Japanese patent documents, the indication of the year of the reign of the Emperor must precede the serial number of the patent document. ⁴ Kind of document by the appropriate symbols as indicated on the document under WIPO Standard ST.16 if possible. ⁵ Applicant is to place a check mark here if English language translation is attached. </small>			

Doc code: ICS E
 Doc description: Information Disclosure Statement (IDS) Filed

PTO/SB/08a (04-09)
 Approved for use through 05/31/2009. OMB 0651-0031
 U.S. Patent and Trademark Office; U.S. DEPARTMENT OF COMMERCE

Under the Paperwork Reduction Act of 1995, no persons are required to respond to a collection of information unless it contains a valid OMB control number.

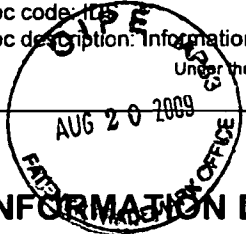

INFORMATION DISCLOSURE STATEMENT BY APPLICANT
 (Not for submission under 37 CFR 1.99)

Application Number		12015320
Filing Date		2008-01-16
First Named Inventor	Russell W. White, et al.	
Art Unit	2617	
Examiner Name	Erika A. Gary	
Attorney Docket Number	AFF.004C5US	

U.S.PATENTS

Examiner Initial*	Cite No	Patent Number	Kind Code ¹	Issue Date	Name of Patentee or Applicant of cited Document	Pages, Columns, Lines where Relevant Passages or Relevant Figures Appear
	1	6349352		2002-02-19	Lea	
	2	6697944		2004-02-24	Jones, et al.	
	3	6760916		2004-07-06	Holtz, et al.	
	4	6225984		2001-05-01	Crawford	
	5	5327558		1994-07-05	Burke, et al.	
	6	5715474		1998-02-03	Burke, et al.	

If you wish to add additional U.S. Patent citation information please click the Add button.

U.S.PATENT APPLICATION PUBLICATIONS

Examiner Initial*	Cite No	Publication Number	Kind Code ¹	Publication Date	Name of Patentee or Applicant of cited Document	Pages, Columns, Lines where Relevant Passages or Relevant Figures Appear
-------------------	---------	--------------------	------------------------	------------------	-------------------------------------------------	--------------------------------------------------------------------------

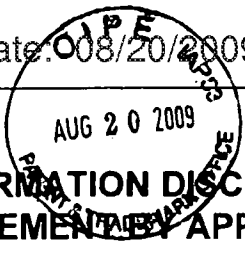

INFORMATION DISCLOSURE STATEMENT BY APPLICANT
(Not for submission under 37 CFR 1.99)

Application Number		12015320
Filing Date		2008-01-16
First Named Inventor	Russell W. White, et al.	
Art Unit	2617	
Examiner Name	Erika A. Gary	
Attorney Docket Number	AFF.004C5US	

1					
---	--	--	--	--	--

If you wish to add additional U.S. Published Application citation information please click the Add button.

FOREIGN PATENT DOCUMENTS

Examiner Initial*	Cite No	Foreign Document Number ³	Country Code ²ⁱ	Kind Code ⁴	Publication Date	Name of Patentee or Applicant of cited Document	Pages, Columns, Lines where Relevant Passages or Relevant Figures Appear	T ⁵
	1	WO 00/38340	WO		2000-06-29	Kim, Joehan		<input type="checkbox"/>
	2	WO 98/19480	WO		1998-07-05	Ericsson, Inc.		<input type="checkbox"/>
	3	WO 99/43136	WO		1999-08-26	Ericsson, Inc.		<input type="checkbox"/>
	4	8-79814	JP		1996-03-22			<input type="checkbox"/>
	5	9-74580	JP		1997-03-18			<input type="checkbox"/>
	6	10-149182	FP		1998-06-02			<input type="checkbox"/>
	7	3056721	FP		1998-12-02			<input type="checkbox"/>
	8	WO 99/06910	WO		1999-02-11	Ludtke, Harold A.		<input type="checkbox"/>

**INFORMATION DISCLOSURE
STATEMENT BY APPLICANT**
(Not for submission under 37 CFR 1.99)

Application Number		12015320
Filing Date		2008-01-16
First Named Inventor	Russell W. White, et al.	
Art Unit	2617	
Examiner Name	Erika A. Gary	
Attorney Docket Number	AFF.004C5US	

9	11-73192	JP		1999-03-16			<input type="checkbox"/>
10	3890692	JP		2006-12-15			<input type="checkbox"/>
11	WO 99/12152	WO		1999-11-03	Sony Corporation		<input type="checkbox"/>
12	EP 0 920 016 A2	EP		1999-02-06	Sony Corporation		<input type="checkbox"/>
13	11-219580	JP		1999-08-10			<input type="checkbox"/>
14	EP 0 918 408 A2	EP		1999-05-26	Sony Corporation		<input type="checkbox"/>
15	11-143791	JP		1999-05-28			<input type="checkbox"/>
16	2007-207257	JP		2007-08-16			<input type="checkbox"/>
17	DE 20 2004 013 65	DE		2004-12-23	Boll, Nobert		<input type="checkbox"/>
18	WO 99/35009	WO		1999-07-15	Microsoft Corporation		<input type="checkbox"/>
19	2001-128280	JP		2001-05-11			<input type="checkbox"/>

INFORMATION DISCLOSURE STATEMENT BY APPLICANT (Not for submission under 37 CFR 1.99)	Application Number		12015320	
	Filing Date		2008-01-16	
	First Named Inventor	Russell W. White, et al.		
	Art Unit	2617		
	Examiner Name	Erika A. Gary		
	Attorney Docket Number	AFF.004C5US		

20	KR20000036680	KR		2000-07-05	Kee Kang Choon		<input type="checkbox"/>
21	10-1997-0016743	KR		1997-04-30			<input type="checkbox"/>
22	20-1997-0012254	KR		1997-05-28			<input type="checkbox"/>
23	WO 99/23856	WO		1999-05-14	Mershon, Stuart		<input type="checkbox"/>
24	WO 99/28897	WO		1999-06-10	Voquette Networks, LTD.		<input type="checkbox"/>
25	1999-0055970	KR		1999-07-15			<input type="checkbox"/>
26	100242563 B1	KR		1999-10-11	Kim, Joon Sung		<input type="checkbox"/>
27	EP 0 982 732 A1	EP		2000-01-03	Saehan Information Systems, Inc.		<input type="checkbox"/>
28	10-0356742	KR		2002-10-18	Hyundai Autonet, Co. Ltd.		<input type="checkbox"/>
29	10-356742	JP		2002-10-02			<input type="checkbox"/>
30	WO 00/38340	WO		2000-06-29	Kim, Jaehan		<input type="checkbox"/>

INFORMATION DISCLOSURE STATEMENT BY APPLICANT (Not for submission under 37 CFR 1.99)	Application Number		12015320	
	Filing Date		2008-01-16	
	First Named Inventor	Russell W. White, et al.		
	Art Unit	2617		
	Examiner Name	Erika A. Gary		
	Attorney Docket Number	AFF.004C5US		

	31	2000-0001465	JP		2000-01-25			<input type="checkbox"/>
	32	2001-0009302	JP		2001-02-05			<input type="checkbox"/>
	33	2001-0028354	JP		2001-04-06			<input type="checkbox"/>
	34	1999-0033393	JP		1999-05-15			<input type="checkbox"/>
	35	11-317061	JP		1999-11-16			<input type="checkbox"/>
	36	2225910	CA		1997-12-24	Lussier, Luc.		<input type="checkbox"/>
	37	0 661 676 A1	EP		1994-12-21	AT&T Global Information Solutions International		<input type="checkbox"/>
	38	0 982 732 A1	EP		2000-01-03	Saeahan Information Systems, Inc.		<input type="checkbox"/>
	39	2901445	JP		1999-03-19			<input type="checkbox"/>
	40	9-50282	JP		1997-02-18			<input type="checkbox"/>
	41	10-173737	JP		1998-06-26			<input type="checkbox"/>

INFORMATION DISCLOSURE STATEMENT BY APPLICANT (Not for submission under 37 CFR 1.99)	Application Number		12015320	
	Filing Date		2008-01-16	
	First Named Inventor	Russell W. White, et al.		
	Art Unit	2617		
	Examiner Name	Erika A. Gary		
	Attorney Docket Number	AFF.004C5US		

42	11-96735	JP		1999-04-09			<input type="checkbox"/>
43	11-242686	JP		1999-09-07			<input type="checkbox"/>
44	WO 94/18763	WO		1994-08-18	Gutle, Hubert		<input type="checkbox"/>
45	WO 98/21672	WO		1998-05-22	Inergy Online, Inc.		<input type="checkbox"/>
46	WO 98/33102	WO		1998-07-30	Guimaraes Teixeira		<input type="checkbox"/>
47	WO 99/18518	WO		1999-04-15	Polash, Peter		<input type="checkbox"/>
48	WO 00/07849	WO		2000-02-17	Microsoft Corporation		<input type="checkbox"/>
49	11-317061	WO		1999-11-16			<input type="checkbox"/>
50	2901445	JP		1999-03-19			<input type="checkbox"/>

If you wish to add additional Foreign Patent Document citation information please click the Add button

NON-PATENT LITERATURE DOCUMENTS

Examiner Initials*	Cite No	Include name of the author (in CAPITAL LETTERS), title of the article (when appropriate), title of the item (book, magazine, journal, serial, symposium, catalog, etc), date, pages(s), volume-issue number(s), publisher, city and/or country where published.	T5
--------------------	---------	-----------------------------------------------------------------------------------------------------------------------------------------------------------------------------------------------------------------------------------------------------------------	----

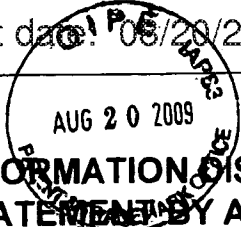

INFORMATION DISCLOSURE STATEMENT BY APPLICANT
 (Not for submission under 37 CFR 1.99)

Application Number		12015320
Filing Date		2008-01-16
First Named Inventor	Russell W. White, et al.	
Art Unit	2617	
Examiner Name	Erika A. Gary	
Attorney Docket Number	AFF.004C5US	

1	DANIEL KUMIN, Stereo Review, "Jukebox Heaven," January 1999, pages 64-71.	<input type="checkbox"/>
2	AUDIO, "Anthem Five-Channel Amp," July/August 1999, page 15.	<input type="checkbox"/>
3	Sony webpages in Japanese, "Portable Mini Disc Player MD Recorder," July 21, 1996, pages 1-5.	<input type="checkbox"/>
4	Sony, "MD Walkman Operating Instructions - MZ-R4ST," 1996, pages 1-64.	<input type="checkbox"/>
5	Sony, "MD Walkman Operating Instructions - MZ-R5ST," 1997, pages 1-79.	<input type="checkbox"/>
6	STEREO REVIEW, "New Products," June 1998, 1 page.	<input type="checkbox"/>
7	FACTIVA, Hardware Review, "Lost in the Supermarket," 2009, pages 1-3.	<input type="checkbox"/>
8	Sony webpages in Japanese, "Portable Mini Disc Player MD Recorder," October 21, 1999, pages 1-63.	<input type="checkbox"/>
9	JAMIE SORCHER, Stereo Review, "New for the Road," May 1998, 2 pages.	<input type="checkbox"/>
10	Sony, "MD Walkman Operating Instructions - MZ-R55," 1998, pages 1-42.	<input type="checkbox"/>
11	JOHN WHITTERS, The Advertiser, "Is the cassette doomed?" July 16, 1998, pages 1-2.	<input type="checkbox"/>

INFORMATION DISCLOSURE STATEMENT BY APPLICANT (Not for submission under 37 CFR 1.99)	Application Number	12015320
	Filing Date	2008-01-16
	First Named Inventor	Russell W. White, et al.
	Art Unit	2617
	Examiner Name	Erika A. Gary
	Attorney Docket Number	AFF.004C5US

12	GEORGE COLE, Financial Times, "Listen with your eyes: A new music CD format supplies textual information," October 23, 1997, pages 1-2.	<input type="checkbox"/>
13	DANA J. PARKER, Standard Deviations, "CD-TEXTra! Read all about it!", October 1996, pages 1-2.	<input type="checkbox"/>
14	MOBILE ELECTRONICS, "Down the Road," July 2004, pages 1-2.	<input type="checkbox"/>
15	ALPINE, "Interface Adapter for iPod KCA-420i - Owner's Manual," 44 pages total.	<input type="checkbox"/>
16	PR Newswire, "Alpine Announces Fall Release of Interface Adapter That Enables iPod Control and Playback From In-Vehicle Sound Systems," July 7, 2004, 2 pages total.	<input type="checkbox"/>
17	AMY GILBOY, Mobile Electronics, "Apple's iPod Seen Transforming Car Audio Business," 1 page.	<input type="checkbox"/>
18	GREG BORROWMAN, The Sydney Morning Herald, "Philips Releases Its Latest DVD," 1999, 2 pages total.	<input type="checkbox"/>
19	JVC, "Audio/Video Control Receiver, RX-668VBK, Instructions," pages 1-43.	<input type="checkbox"/>
20	Sony webpages in Japanese, "Portable MD Recorder," October 1997, 5 pages total.	<input type="checkbox"/>
21	Sony, "Walkman MZ-R50 Recorder," October 1997 7 pages total.	<input type="checkbox"/>
22	Sony, "MD Walkman MZ-R55," October 10, 1998, 6 pages total.	<input type="checkbox"/>

INFORMATION DISCLOSURE STATEMENT BY APPLICANT (Not for submission under 37 CFR 1.99)	Application Number	12015320
	Filing Date	2008-01-16
	First Named Inventor	Russell W. White, et al.
	Art Unit	2617
	Examiner Name	Erika A. Gary
	Attorney Docket Number	AFF.004C5US

23	VON HERBERT PAULER, Funkschau, "Kopierschutz für MP3-Audio," 1999, 9 pages total.	<input type="checkbox"/>
24	English Summary, "A device for remotely controlling a car device for playing mp3 files is disclosed....", 1 page.	<input type="checkbox"/>
25	FRANKLIN N. TESSLER, MACWORLD, "Mobile MAC, Highway Fidelity," June 2004, pages 1-3.	<input type="checkbox"/>
26	BARRY COLLINS, The Sunday Times, "High-class high-tech - Buyer's guide," 2001, 2 pages total.	<input type="checkbox"/>
27	PETER FAMILARI, Herald-Sun, "Clever Deck - CD and mini-disc combination," 1998, 1 page.	<input type="checkbox"/>
28	JVC, "MD-CD Combination Deck, XU-301BK, Instructions," pages 1-59.	<input type="checkbox"/>
29	AMY GILROY, Mobile Electronics, "OEM Integrators Embrace iPod's Success," 1 page.	<input type="checkbox"/>
30	JVC, "Portable Minidisc Recorder, XM-R700SL, Instructions," pages 1-24.	<input type="checkbox"/>
31	Rio Car, "Car Toy Sole Retailer For Rio Car," May 28, 2001, 1 page.	<input type="checkbox"/>
32	AMY GILROY, Twice, "Panasonic Ships First SD MP3," December 4, 2000, 1 page.	<input type="checkbox"/>
33	Twice, "PhatNoise Readies MP3," November 5, 2001, 1 page.	<input type="checkbox"/>

INFORMATION DISCLOSURE STATEMENT BY APPLICANT (Not for submission under 37 CFR 1.99)	Application Number		12015320
	Filing Date		2008-01-16
	First Named Inventor	Russell W. White, et al.	
	Art Unit		2617
	Examiner Name	Erika A. Gary	
	Attorney Docket Number		AFF.004C5US

34	KEVIN SAVETZ, The Washington Post, "Putting Your MP3 Collection in Drive (Final Edition)," August 10, 2001, pages 1-3.	<input type="checkbox"/>
35	Twice, "Study Sees Retail Opportunities For Mobile Multimedia," Volume 14, Issue 15, June 28, 1999, pages 1-2.	<input type="checkbox"/>
36	Japanese Webpage, www.kcalgo.kr/jsp/main.jsp, 1 page.	<input type="checkbox"/>
37	Japanese Webpage, www.kca.go.kr - Brochure Free - Microsoft Internet Explorer, 1 page.	<input type="checkbox"/>
38	Japanese Webpage, www.kca.go.kr - Brochure Free - Microsoft Internet Explorer, 1 page.	<input type="checkbox"/>
39	STEPHEN KEMPAINEN, EDN Access For Design, By Design "In-car computing gets personal," August 17, 1998, pages 1-7.	<input type="checkbox"/>
40	Japanese Website, MM MPMANIA.com, http://mpmania, x-y.net/bbs/zboard.php?id=products&keyword=1998, 1 page.	<input type="checkbox"/>
41	Japanese document regarding MP3, May 1999, 1 page.	<input type="checkbox"/>
42	MPMan, "The portable MP3 player using the Flash Memory and Memory card - MP-F20," in Japanese, pages 1-34.	<input type="checkbox"/>
43	Japanese Website, MM MPMANIA.com, http://mpmania, x-y.net/bbs/view.php?id=products&page=1&sn1=&divpage, 1 page.	<input type="checkbox"/>
44	www.mpman.com, "MP-F30, User's Guide," pages 2-47.	<input type="checkbox"/>

INFORMATION DISCLOSURE STATEMENT BY APPLICANT (Not for submission under 37 CFR 1.99)	Application Number		12015320
	Filing Date		2008-01-16
	First Named Inventor	Russell W. White, et al.	
	Art Unit	2617	
	Examiner Name	Erika A. Gary	
	Attorney Docket Number	AFF.004C5US	

45	MARK MOELLER, Computing Unplugged Magazine, "Software Review, New software products for the Auto PC," 1999-2009, Zatz Publishing, pages 1-4	<input type="checkbox"/>
46	MARK MOELLER, Computing Unplugged Magazine, "Auto PC Power, A survey of resources for Auto PC owners," 1999-2009, Zatz Publishing, pages 1-5.	<input type="checkbox"/>
47	MARK MOELLER, Computing Unplugged Magazine, "Auto PC Power, A look at the first year of the Auto PC with Microsoft," 1999-2009, Zatz Publishing, pages 1-5.	<input type="checkbox"/>
48	MARK MOELLER, Computing Unplugged Magazine, "Auto PC Power, Next generation AutoPCs make a big debut at CES," 1999-2009, Zatz Publishing, pages 1-6.	<input type="checkbox"/>
49	MARK MOELLER, Computing Unplugged Magazine, "Programming Power, Getting started developing software for the Auto PC," 1999-2009, Zatz Publishing, pages 1-5	<input type="checkbox"/>
50	MARK MOELLER, Computing Unplugged Magazine, "Behind the Scenes, The AutoPC: Vision vs. Reality," 1999-2009, Zatz Publishing, pages 1-7.	<input type="checkbox"/>

If you wish to add additional non-patent literature document citation information please click the Add button

EXAMINER SIGNATURE

Examiner Signature	/Erika Gary/ (09/15/2010)	Date Considered	09/15/2010
--------------------	---------------------------	-----------------	------------

*EXAMINER: Initial if reference considered, whether or not citation is in conformance with MPEP 609. Draw line through a citation if not in conformance and not considered. Include copy of this form with next communication to applicant.

¹ See Kind Codes of USPTO Patent Documents at www.USPTO.GOV or MPEP 901.04. ² Enter office that issued the document, by the two-letter code (WIPO Standard ST.3). ³ For Japanese patent documents, the indication of the year of the reign of the Emperor must precede the serial number of the patent document. ⁴ Kind of document by the appropriate symbols as indicated on the document under WIPO Standard ST.16 if possible. ⁵ Applicant is to place a check mark here if English language translation is attached.

Doc code: IDS
 Doc description: Information Disclosure Statement (IDS) Filed

PTO/SB/08a (04-09)
 Approved for use through 05/31/2009. OMB 0651-0031
 U.S. Patent and Trademark Office; U.S. DEPARTMENT OF COMMERCE

Under the Paperwork Reduction Act of 1995, no persons are required to respond to a collection of information unless it contains a valid OMB control number.

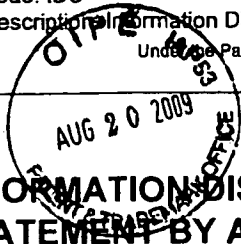

INFORMATION DISCLOSURE STATEMENT BY APPLICANT
 (Not for submission under 37 CFR 1.99)

Application Number		12015320
Filing Date		2008-01-16
First Named Inventor	Russell W. White, et al.	
Art Unit	2617	
Examiner Name	Erika A. Gary	
Attorney Docket Number	AFF.004C5US	

U.S.PATENTS

Examiner Initial*	Cite No	Patent Number	Kind Code ¹	Issue Date	Name of Patentee or Applicant of cited Document	Pages, Columns, Lines where Relevant Passages or Relevant Figures Appear
	1					

If you wish to add additional U.S. Patent citation information please click the Add button.

U.S.PATENT APPLICATION PUBLICATIONS

Examiner Initial*	Cite No	Publication Number	Kind Code ¹	Publication Date	Name of Patentee or Applicant of cited Document	Pages, Columns, Lines where Relevant Passages or Relevant Figures Appear
	1					

If you wish to add additional U.S. Published Application citation information please click the Add button.

FOREIGN PATENT DOCUMENTS

Examiner Initial*	Cite No	Foreign Document Number ³	Country Code ²	Kind Code ⁴	Publication Date	Name of Patentee or Applicant of cited Document	Pages, Columns, Lines where Relevant Passages or Relevant Figures Appear	T ⁵
	1	2000-66974	JP		2000-03-03			<input type="checkbox"/>
	2	11-68685	JP		1999-03-09			<input type="checkbox"/>
	3	CN 1218258A	CN		1999-06-02			<input type="checkbox"/>

INFORMATION DISCLOSURE STATEMENT BY APPLICANT (Not for submission under 37 CFR 1.99)	Application Number		12015320	
	Filing Date		2008-01-16	
	First Named Inventor	Russell W. White, et al.		
	Art Unit	2617		
	Examiner Name	Erika A. Gary		
	Attorney Docket Number	AFF.004C5US		

4	H11-242686	JP		1999-09-07	Sony Corporation	<input type="checkbox"/>
5	DE 44 31 070 B4	DE		2004-07-22	DaimlerChrysler AG	<input type="checkbox"/>
6	0 569 343 A1	EP		1993-10-11	Pioneer Electronic Corporation	<input type="checkbox"/>
7	0 675 341 A1	EP		1995-04-10	Honda Giken-Kogyo	<input type="checkbox"/>
8	0 771 686 A2	EP		1997-07-05	Toyota Jidosha Kabushiki Kaisha Toyota-shi, Aichi-	<input type="checkbox"/>
9	H4-261576	JP		1992-09-17	Mitsubishi Electric Corporation	<input type="checkbox"/>
10	2-301330	JP		1990-12-13		<input type="checkbox"/>
11	5-294250	JP		1993-11-09		<input type="checkbox"/>
12	6-187597	JP		1994-07-08		<input type="checkbox"/>
13	JP6289118	JP		1994-10-18	Sega Enterprises KK	<input type="checkbox"/>
14	JP6294659	JP		1994-10-21	Dainippon Printing Co. LTD.	<input type="checkbox"/>

INFORMATION DISCLOSURE STATEMENT BY APPLICANT (Not for submission under 37 CFR 1.99)	Application Number		12015320	
	Filing Date		2008-01-16	
	First Named Inventor	Russell W. White, et al.		
	Art Unit	2617		
	Examiner Name	Erika A. Gary		
	Attorney Docket Number	AFF.004C5US		

15	07-129895	JP		1995-05-19	Honda Motor Co Ltd		<input type="checkbox"/>
16	07-146155	JP		1995-06-06	Honda Motor Co Ltd		<input type="checkbox"/>
17	7-262493	JP		1995-10-13	CSK Corporation		<input type="checkbox"/>
18	7-262493	JP		1995-10-13			<input type="checkbox"/>
19	JP7270171	JP		1995-10-20	Sumitomo Electronic Industries		<input type="checkbox"/>
20	JP7036382	JP		1995-02-07	Mitsubishi Electric Corp.		<input type="checkbox"/>
21	8-110231	JP		1996-04-30			<input type="checkbox"/>
22	9-61514	JP		1997-03-07			<input type="checkbox"/>
23	10-103966	JP		1998-04-24			<input type="checkbox"/>
24	10-143349	JP		1998-05-29	Compaq Computer Corporation		<input type="checkbox"/>
25	JP1018712	JP		1989-01-23	Mazda Motor		<input type="checkbox"/>

INFORMATION DISCLOSURE STATEMENT BY APPLICANT (Not for submission under 37 CFR 1.99)	Application Number		12015320	
	Filing Date		2008-01-16	
	First Named Inventor	Russell W. White, et al.		
	Art Unit	2617		
	Examiner Name	Erika A. Gary		
	Attorney Docket Number	AFF.004C5US		

	26	JP5077679	JP		1993-03-30	Nissan Motor		<input type="checkbox"/>
	27	JP59085599	JP		1984-05-17	Nissan Motor		<input type="checkbox"/>
	28	JP63136828	JP		1988-06-09	Pioneer Electronic Corp.		<input type="checkbox"/>
	29	63-136828	JP		1988-06-09			<input type="checkbox"/>
	30	WO 96/04724	WO		1996-02-15	Emerson, Harry		<input type="checkbox"/>
	31	WO 96/07110	WO		1996-03-07	British Telecommunications Public Limited Company		<input type="checkbox"/>
	32	WO 97/13657	WO		1997-04-17	United Technologies Automotive, Inc.		<input type="checkbox"/>
	33	H11-317061	JP		1999-11-16	Victor Company of Japan, LTD.		<input checked="" type="checkbox"/>
	34	2901445	JP		1999-03-19	Kenwood Corporation		<input checked="" type="checkbox"/>
	35	WO 99/35009	WO		1999-07-15	Microsoft Corporation		<input type="checkbox"/>
	36	11-219580	JP		1999-08-10			<input type="checkbox"/>

INFORMATION DISCLOSURE STATEMENT BY APPLICANT (Not for submission under 37 CFR 1.99)	Application Number		12015320	
	Filing Date		2008-01-16	
	First Named Inventor		Russell W. White, et al.	
	Art Unit		2617	
	Examiner Name		Erika A. Gary	
	Attorney Docket Number		AFF.004C5US	

	37	11219580 A	JP		1999-10-08	Sony Corp		<input type="checkbox"/>
	38	1168685	JP		1999-03-09			<input type="checkbox"/>
	39	11-068685	JP		1999-09-03	Sony Corp		<input type="checkbox"/>
	40	1998-052033	JP		1998-09-25			<input type="checkbox"/>
	41	1999-0042565	JP		1999-06-15			<input type="checkbox"/>
	42	1999-0073234	KR		1999-10-05	Young-Man Lee		<input type="checkbox"/>
	43	1999-0048723	KR		1999-07-05			<input type="checkbox"/>
	44	KR2019990022030U	KR		1999-06-25	Young-Shik Cheon		<input type="checkbox"/>
	45	2000-0001465	KR		2000-01-25	Samsung Motors		<input type="checkbox"/>
	46	0142256	KR		1998-03-30			<input type="checkbox"/>
	47	WO 98/21672	WO		1998-05-22	Inergy Online, Inc.		<input type="checkbox"/>

INFORMATION DISCLOSURE STATEMENT BY APPLICANT (Not for submission under 37 CFR 1.99)	Application Number		12015320	
	Filing Date		2008-01-16	
	First Named Inventor	Russell W. White, et al.		
	Art Unit	2617		
	Examiner Name	Erika A. Gary		
	Attorney Docket Number	AFF.004C5US		

48	WO 98/47252	WO		1998-10-22	Stern, Geoffrey	<input type="checkbox"/>
49	WO 00/54187	WO		2000-09-14	Rock.Com, Inc.	<input type="checkbox"/>
50	WO 00/60450	WO		2000-10-12	Khyber Technologies Corporation	<input type="checkbox"/>

If you wish to add additional Foreign Patent Document citation information please click the Add button

NON-PATENT LITERATURE DOCUMENTS

Examiner Initials*	Cite No	Include name of the author (in CAPITAL LETTERS), title of the article (when appropriate), title of the item (book, magazine, journal, serial, symposium, catalog, etc), date, pages(s), volume-issue number(s), publisher, city and/or country where published.	T ⁵
	1	MARK MOELLER, Computing Unplugged Magazine, "Product Preview, A Survey of Auto PC 2.0 for software developers," 1999-2009, Zatz Publishing, pages 1-7.	<input type="checkbox"/>
	2	MARK MOELLER, Computing Unplugged Magazine, "AutoPC Update, Auto PC/Windows CE for Automotive news bites," 1999-2009, Zatz Publishing, pages 1-4.	<input type="checkbox"/>
	3	Claim Chart for KR19990033393, Claim 17 of U.S. Patent No. 7,324,833, pages 1-3.	<input type="checkbox"/>
	4	RIO500, Getting Started Guide for Windows 98 and Macintosh OS 8.6, pages 1-2.	<input type="checkbox"/>
	5	NORBERT A. STREITZ, et al., "DOLPHIN: Integrated Meeting Support Across Local And Remote Desktop Environments And LiveBoards," Integrated Publication and Information Systems Institute, 1994, pages 345-358.	<input type="checkbox"/>
	6	LEO DEGEN, et al., "Working with Audio: Integrating Personal Tape Recorders and Desktop Computers," May 3-7, 1992, pages 413-418.	<input type="checkbox"/>

INFORMATION DISCLOSURE STATEMENT BY APPLICANT (Not for submission under 37 CFR 1.99)	Application Number	12015320
	Filing Date	2008-01-16
	First Named Inventor	Russell W. White, et al.
	Art Unit	2617
	Examiner Name	Erika A. Gary
	Attorney Docket Number	AFF.004C5US

7	H.S. JUN GIBEE, "A Virtual Information Desk On The Internet," University of Ulsan, September 1999, pages 265-268.	<input type="checkbox"/>
8	STEVE WHITTAKER, et al., "TeleNotes: Managing Lightweight Interactions in the Desktop," Lotus Development Corporation, June 1997, pages 137-168.	<input type="checkbox"/>
9	R.M. CROWDER, et al., "Integration of Manufacturing Information Using Open Hypermedia," Computer in Industry, 1999, pages 31-42.	<input type="checkbox"/>
10	TOMAS BOSTROM, et al., "Mobile Audio Distribution," Royal Institute of Technology, 1999, pages 166-172.	<input type="checkbox"/>
11	ALEX POON, et al., Xerox Disclosure Journal, Vol. 19, No. 2, "Gestural User Interface Technique for Controlling the Playback of Sequential Media," March/April 1994, pages 187-190.	<input type="checkbox"/>
12	DEB KUMAR ROY, "NewsComm: A Hand-Held Device For Interactive Access to Structured Audio," Massachusetts Institute of Technology, June 1995, pages 1-12.	<input type="checkbox"/>
13	VICTORIA BELLOTTI, et al., "Walking Away from the Desktop Computer: Distributed Collaboration and Mobility in a Product Design Team," 1996, pages 209-218.	<input type="checkbox"/>
14	UPUL OBEYSEKARE, et al., "The Visual Interactive Desktop Laboratory," January-March 1997, pages 63-71.	<input type="checkbox"/>
15	ASIM SMAILAGIC, et al., "MoCCA: A Mobile Communication and Computing Architecture," Institute for Complex Engineered Systems, pages 1-8.	<input type="checkbox"/>
16	SUI-MENG POON, et al., "Integration of Value-Added Audio Playback Capacity Into Computer Network," Nanyang Technological University, 1995, pages 632-636.	<input type="checkbox"/>
17	ERDAL PAKSOY, et al., "A variable-rate celp coder for fast remote voicemail retrieval using a notebook computer," DSPS R&D Center, Texas Instruments, 1997, pages 119-124.	<input type="checkbox"/>

INFORMATION DISCLOSURE STATEMENT BY APPLICANT (Not for submission under 37 CFR 1.99)	Application Number		12015320
	Filing Date		2008-01-16
	First Named Inventor	Russell W. White, et al.	
	Art Unit		2617
	Examiner Name	Erika A. Gary	
	Attorney Docket Number		AFF.004C5US

18	JEFFREY A. DAVIS, "Use of Personal Computers in Satellite Command and Control Systems," Raytheon Systems Company, October 24, 1999, pages 283-291.	<input type="checkbox"/>
19	NIKI DAVIS, "Remote Teaching Via ISDN2 And Desktop Conferencing," Exeter University School of Education, pages 1-3.	<input type="checkbox"/>
20	A CHAN, et al., "The PEP-II Project-Wide Database," Stanford University, 1996, pages 840-842.	<input type="checkbox"/>
21	KRISHNA BHARAT, et al., "Migratory Applications," Springer Berlin, Vol. 1222, 1997, pages 1-21.	<input type="checkbox"/>
22	EMPEG CAR, "MP3 in your dash," Digital Audio Player User Guide, pages 1-50.	<input type="checkbox"/>
23	MICROSOFT, "Getting Started Microsoft Windows 98" Second Edition, 1998, pages 1-138.	<input type="checkbox"/>
24	SAUL GREENBERG, "PDAs and Shared Public Displays: Making Personal Information Public, and Public Information Personal," University of Calgary, March 1999, pages 1-11.	<input type="checkbox"/>
25	NAOHIKO KOHTAKE, et al., "InfoStick: an interaction device for Inter-Appliance Computing," Keio University, pages 1-15.	<input type="checkbox"/>
26	HEWLETT PACKARD, User's Guide, HP Jornada 420, Palm-Size PC, pages 1-75	<input type="checkbox"/>
27	MICROSOFT, "Introducing Microsoft Windows 95 - Certificate of Authenticity," 1995, pages 1-117.	<input type="checkbox"/>
28	SONY, "New Technical Theory For Servicing, MZ-R5ST Operation Manual," pages 1-44.	<input type="checkbox"/>

INFORMATION DISCLOSURE STATEMENT BY APPLICANT (Not for submission under 37 CFR 1.99)	Application Number		12015320
	Filing Date		2008-01-16
	First Named Inventor	Russell W. White, et al.	
	Art Unit		2617
	Examiner Name	Erika A. Gary	
	Attorney Docket Number		AFF.004C5US

29	RICHARD C. DAVIS, et al., "A Framework for Sharing Handwritten Notes," 1998, pages 119-120.	<input type="checkbox"/>
30	KRISHNA A. BHARAT, et al., "Migratory Applications," UIST '95, November 14-17, 1995, pages 133-142.	<input type="checkbox"/>
31	BRAD A. MYERS, "Collaboration Using Multiple PDAs Connected To A PC," Carnegie Mellon University, 1998, pages 385-294.	<input type="checkbox"/>
32	RICHARD C. DAVIS, et al., "NotePals: Lightweight Note Sharing by the Group, for the Group," May 15-20, 1999, pages 338-345.	<input type="checkbox"/>
33	JUN REKIMOTO, et al., "Augmented Surfaces: A Spatially Continuous Work Space for Hybrid Computing Environments," May 15-20, 1999, pages 378-385.	<input type="checkbox"/>
34	DAN R. OLSEN, JR., "Interacting with Chaos," September and October 1999, pages 42-54.	<input type="checkbox"/>
35	SCOTT ROBERTSON, et al., "Dual Device User Interface Design: PDAs and Interactive Television," April 13-18, 1996, pages 79-86.	<input type="checkbox"/>
36	SYMANTEC CORPORATION, "pcANYWHERE32 User's Guide," 1993-1997, pages 1-216.	<input type="checkbox"/>
37	KRISHNA BHARAT, et al., Migratory Applications, "Mobile Object Systems Towards the Programmable Internet," Springer Berlin/Heidelberg, Volume 1222/11997, 1997, pages 1-134.	<input type="checkbox"/>
38	DIAMOND MULTIMEDIA SYSTEMS, INC., "Rio PMP300, User's Guide," 1998, pages 1-27.	<input type="checkbox"/>
39	SONY, "Portable MiniDisc Recorder, Operating Instructions, MZ-R55," 1998, pages 1-42.	<input type="checkbox"/>

INFORMATION DISCLOSURE STATEMENT BY APPLICANT (Not for submission under 37 CFR 1.99)	Application Number		12015320
	Filing Date		2008-01-16
	First Named Inventor	Russell W. White, et al.	
	Art Unit		2617
	Examiner Name	Erika A. Gary	
	Attorney Docket Number		AFF.004C5US

40	NORBERT A. STREITZ, et al., "i-Land: An Interactive Landscape for Creativity and Innovation," Proceedings of the ACM Conference on Human Factors in Computing Systems, May 15-20, 1999, pages 120-127.	<input type="checkbox"/>
41	NORBERT A. STREITZ, et al., "Roomware for Cooperative Buildings: Integrated Design of Architectural Spaces and Information Spaces," pages 1-20	<input type="checkbox"/>
42	Direct Cable Connection screen shot, "B1U6U4," 10 pages total.	<input type="checkbox"/>
43	Direct Cable Connection screen shot, 10 pages total.	<input type="checkbox"/>
44	IBM, "WordPad z50 Cradle Option - User's Guide," 1990, pages 1-18.	<input type="checkbox"/>
45	IBM MOBILE SYSTEMS, "WorkPad z50 Mobile Companion (2608-1Ax), Hardware Maintenance Manual," March 1999, pages 1-77.	<input type="checkbox"/>
46	KEVIN JOST, Automotive Engineering International, "The car as a mobile-media platform," May 1998, pages 49-53.	<input type="checkbox"/>
47	MICROSOFT CORPORATION, "Windows CE 2.1 Technical Articles, Developing Applications for an Auto PC," June 1999, pages 1-13.	<input type="checkbox"/>
48	INFOGATION CORPORATION, "InfoGation Corp. Introduces Software Applications for Next-Generation Smart Car Systems," January 8, 1998, pages 1-2.	<input type="checkbox"/>
49	BUSINESS WIRE, "ORA Electronics Announces USB-Compatible TelCar Mark VII Begins Shipping First Quarter of 1999," January 6, 1999, pages 1-2.	<input type="checkbox"/>
50	ORA USA, "ORA Electronics Patents Telcar Cellular Telephone Interface," July 6, 1998, pages 1-2.	<input type="checkbox"/>

INFORMATION DISCLOSURE STATEMENT BY APPLICANT (Not for submission under 37 CFR 1.99)	Application Number	12015320
	Filing Date	2008-01-16
	First Named Inventor	Russell W. White, et al.
	Art Unit	2617
	Examiner Name	Erika A. Gary
	Attorney Docket Number	AFF.004C5US

If you wish to add additional non-patent literature document citation information please click the Add button

EXAMINER SIGNATURE			
Examiner Signature	/Erika Gary/ (09/15/2010)	Date Considered	09/15/2010

*EXAMINER: Initial if reference considered, whether or not citation is in conformance with MPEP 609. Draw line through a citation if not in conformance and not considered. Include copy of this form with next communication to applicant.

¹ See Kind Codes of USPTO Patent Documents at www.USPTO.GOV or MPEP 901.04. ² Enter office that issued the document, by the two-letter code (WIPO Standard ST.3). ³ For Japanese patent documents, the indication of the year of the reign of the Emperor must precede the serial number of the patent document. ⁴ Kind of document by the appropriate symbols as indicated on the document under WIPO Standard ST.16 if possible. ⁵ Applicant is to place a check mark here if English language translation is attached.

Doc code: IDS

Doc description: Information Disclosure Statement (IDS) Filed

PTO/SB/08a (04-09)

Approved for use through 05/31/2009. OMB 0851-0031

U.S. Patent and Trademark Office; U.S. DEPARTMENT OF COMMERCE

Under the Paperwork Reduction Act of 1995, no persons are required to respond to a collection of information unless it contains a valid OMB control number.

<p>INFORMATION DISCLOSURE STATEMENT BY APPLICANT (Not for submission under 37 CFR 1.99)</p>	Application Number		12015320	
	Filing Date		2008-01-16	
	First Named Inventor	Russell W. White, et al.		
	Art Unit	2617		
	Examiner Name	Erika A. Gary		
	Attorney Docket Number	AFF.004C5US		

U.S.PATENTS						
Examiner Initial*	Cite No	Patent Number	Kind Code ¹	Issue Date	Name of Patentee or Applicant of cited Document	Pages, Columns, Lines where Relevant Passages or Relevant Figures Appear
	1					

If you wish to add additional U.S. Patent citation information please click the Add button.

U.S.PATENT APPLICATION PUBLICATIONS						
Examiner Initial*	Cite No	Publication Number	Kind Code ¹	Publication Date	Name of Patentee or Applicant of cited Document	Pages, Columns, Lines where Relevant Passages or Relevant Figures Appear
	1					

If you wish to add additional U.S. Published Application citation information please click the Add button.

FOREIGN PATENT DOCUMENTS								
Examiner Initial*	Cite No	Foreign Document Number ³	Country Code ² i	Kind Code ⁴	Publication Date	Name of Patentee or Applicant of cited Document	Pages, Columns, Lines where Relevant Passages or Relevant Figures Appear	T ⁵
	1	2000-66974	JP		2000-03-03			<input type="checkbox"/>
	2	11-68685	JP		1999-03-09			<input type="checkbox"/>
	3	CN 1218258A	CN		1999-06-02			<input type="checkbox"/>

INFORMATION DISCLOSURE STATEMENT BY APPLICANT (Not for submission under 37 CFR 1.99)	Application Number		12015320	
	Filing Date		2008-01-16	
	First Named Inventor	Russell W. White, et al.		
	Art Unit	2617		
	Examiner Name	Erika A. Gary		
	Attorney Docket Number	AFF.004C5US		

4	H11-242686	JP		1999-09-07	Sony Corporation	<input type="checkbox"/>
5	DE 44 31 070 B4	DE		2004-07-22	DaimlerChrysler AG	<input type="checkbox"/>
6	0 569 343 A1	EP		1993-10-11	Pioneer Electronic Corporation	<input type="checkbox"/>
7	0 675 341 A1	EP		1995-04-10	Honda Giken Kogyo	<input type="checkbox"/>
8	0 771 686 A2	EP		1997-07-05	Toyota Jidosha Kabushiki Kaisha Toyota-shi, Aichi-	<input type="checkbox"/>
9	H4-261576	JP		1992-09-17	Mitsubishi Electric Corporation	<input type="checkbox"/>
10	2-301330	JP		1990-12-13		<input type="checkbox"/>
11	5-294250	JP		1993-11-09		<input type="checkbox"/>
12	6-187597	JP		1994-07-08		<input type="checkbox"/>
13	JP6289118	JP		1994-10-18	Sega Enterprises KK	<input type="checkbox"/>
14	JP6294659	JP		1994-10-21	Dainippon Printing Co. LTD.	<input type="checkbox"/>

INFORMATION DISCLOSURE STATEMENT BY APPLICANT (Not for submission under 37 CFR 1.99)	Application Number		12015320	
	Filing Date		2008-01-16	
	First Named Inventor	Russell W. White, et al.		
	Art Unit	2617		
	Examiner Name	Erika A. Gary		
	Attorney Docket Number	AFF.004C5US		

	15	07-129895	JP		1995-05-19	Honda Motor Co Ltd		<input type="checkbox"/>
	16	07-146155	JP		1995-06-06	Honda Motor Co Ltd		<input type="checkbox"/>
	17	7-262493	JP		1995-10-13	CSK Corporation		<input type="checkbox"/>
	18	7-262493	JP		1995-10-13			<input type="checkbox"/>
	19	JP7270171	JP		1995-10-20	Sumitomo Electronic Industries		<input type="checkbox"/>
	20	JP7036382	JP		1995-02-07	Mitsubishi Electric Corp.		<input type="checkbox"/>
	21	8-110231	JP		1996-04-30			<input type="checkbox"/>
	22	9-61514	JP		1997-03-07			<input type="checkbox"/>
	23	10-103966	JP		1998-04-24			<input type="checkbox"/>
	24	10-143349	JP		1998-05-29	Compaq Computer Corporation		<input type="checkbox"/>
	25	JP1018712	JP		1989-01-23	Mazda Motor		<input type="checkbox"/>

INFORMATION DISCLOSURE STATEMENT BY APPLICANT (Not for submission under 37 CFR 1.99)	Application Number		12015320	
	Filing Date		2008-01-16	
	First Named Inventor	Russell W. White, et al.		
	Art Unit	2617		
	Examiner Name	Erika A. Gary		
	Attorney Docket Number	AFF.004C5US		

	26	JP5077679	JP		1993-03-30	Nissan Motor	<input type="checkbox"/>
	27	JP59085599	JP		1984-05-17	Nissan Motor	<input type="checkbox"/>
	28	JP63136828	JP		1988-06-09	Pioneer Electronic Corp.	<input type="checkbox"/>
	29	63-136828	JP		1988-06-09		<input type="checkbox"/>
	30	WO 96/04724	WO		1996-02-15	Emerson, Harry	<input type="checkbox"/>
	31	WO 96/07110	WO		1996-03-07	British Telecommunications Public Limited Company	<input type="checkbox"/>
	32	WO 97/13657	WO		1997-04-17	United Technologies Automotive, Inc.	<input type="checkbox"/>
	33	H11-317061	JP		1999-11-16	Victor Company of Japan, LTD.	<input checked="" type="checkbox"/>
	34	2901445	JP		1999-03-19	Kenwood Corporation	<input checked="" type="checkbox"/>
	35	WO 99/35009	WO		1999-07-15	Microsoft Corporation	<input type="checkbox"/>
	36	11-219580	JP		1999-08-10		<input type="checkbox"/>

INFORMATION DISCLOSURE STATEMENT BY APPLICANT (Not for submission under 37 CFR 1.99)	Application Number		12015320	
	Filing Date		2008-01-16	
	First Named Inventor	Russell W. White, et al.		
	Art Unit		2617	
	Examiner Name	Erika A. Gary		
	Attorney Docket Number		AFF.004C5US	

	37	11219580 A	JP		1999-10-08	Sony Corp		<input type="checkbox"/>
	38	1168685	JP		1999-03-09			<input type="checkbox"/>
	39	11-068685	JP		1999-09-03	Sony Corp		<input type="checkbox"/>
	40	1998-052033	JP		1998-09-25			<input type="checkbox"/>
	41	1999-0042565	JP		1999-06-15			<input type="checkbox"/>
	42	1999-0073234	KR		1999-10-05	Young-Man Lee		<input type="checkbox"/>
	43	1999-0048723	KR		1999-07-05			<input type="checkbox"/>
	44	KR2019990022030U	KR		1999-06-25	Young-Shik Cheon		<input type="checkbox"/>
	45	2000-0001465	KR		2000-01-25	Samsung Motors		<input type="checkbox"/>
	46	0142256	KR		1998-03-30			<input type="checkbox"/>
	47	WO 98/21672	WO		1998-05-22	Inergy Online, Inc.		<input type="checkbox"/>

INFORMATION DISCLOSURE STATEMENT BY APPLICANT (Not for submission under 37 CFR 1.99)	Application Number	12015320
	Filing Date	2008-01-16
	First Named Inventor	Russell W. White, et al.
	Art Unit	2617
	Examiner Name	Erika A. Gary
	Attorney Docket Number	AFF.004C5US

48	WO 98/47252	WO		1998-10-22	Stern, Geoffrey	<input type="checkbox"/>
49	WO 00/54187	WO		2000-09-14	Rock.Com, Inc.	<input type="checkbox"/>
50	WO 00/60450	WO		2000-10-12	Khyber Technologies Corporation	<input type="checkbox"/>

If you wish to add additional Foreign Patent Document citation information please click the Add button

NON-PATENT LITERATURE DOCUMENTS

Examiner Initials*	Cite No	Include name of the author (in CAPITAL LETTERS), title of the article (when appropriate), title of the item (book, magazine, journal, serial, symposium, catalog, etc), date, pages(s), volume-issue number(s), publisher, city and/or country where published.	T ⁵
	1	MARK MOELLER, Computing Unplugged Magazine, "Product Preview, A Survey of Auto PC 2.0 for software developers," 1999-2009, Zatz Publishing, pages 1-7.	<input type="checkbox"/>
	2	MARK MOELLER, Computing Unplugged Magazine, "AutoPC Update, Auto PC/Windows CE for Automotive news bites," 1999-2009, Zatz Publishing, pages 1-4.	<input type="checkbox"/>
	3	Claim Chart for KR19990033393, Claim 17 of U.S. Patent No. 7,324,833, pages 1-3.	<input type="checkbox"/>
	4	RIO500, Getting Started Guide for Windows 98 and Macintosh OS 8.6, pages 1-2.	<input type="checkbox"/>
	5	NORBERT A. STREITZ, et al., "DOLPHIN: Integrated Meeting Support Across Local And Remote Desktop Environments And LiveBoards," Integrated Publication and Information Systems Institute, 1994, pages 345-358.	<input type="checkbox"/>
	6	LEO DEGEN, et al., "Working with Audio: Integrating Personal Tape Recorders and Desktop Computers," May 3-7, 1992, pages 413-418.	<input type="checkbox"/>

INFORMATION DISCLOSURE STATEMENT BY APPLICANT (Not for submission under 37 CFR 1.99)	Application Number		12015320
	Filing Date		2008-01-16
	First Named Inventor	Russell W. White, et al.	
	Art Unit	2617	
	Examiner Name	Erika A. Gary	
	Attorney Docket Number	AFF.004C5US	

7	H.S. JUN GIBEE, "A Virtual Information Desk On The Internet," University of Ulsan, September 1999, pages 265-268.	<input type="checkbox"/>
8	STEVE WHITTAKER, et al., "TeleNotes: Managing Lightweight Interactions in the Desktop," Lotus Development Corporation, June 1997, pages 137-168.	<input type="checkbox"/>
9	R.M. CROWDER, et al., "Integration of Manufacturing Information Using Open Hypermedia," Computer in Industry, 1999, pages 31-42.	<input type="checkbox"/>
10	TOMAS BOSTROM, et al., "Mobile Audio Distribution," Royal Institute of Technology, 1999, pages 166-172.	<input type="checkbox"/>
11	ALEX POON, et al., Xerox Disclosure Journal, Vol. 19, No. 2, "Gestural User Interface Technique for Controlling the Playback of Sequential Media," March/April 1994, pages 187-190.	<input type="checkbox"/>
12	DEB KUMAR ROY, "NewsComm: A Hand-Held Device For Interactive Access to Structured Audio," Massachusetts Institute of Technology, June 1995, pages 1-12.	<input type="checkbox"/>
13	VICTORIA BELLOTTI, et al., "Walking Away from the Desktop Computer: Distributed Collaboration and Mobility in a Product Design Team," 1996, pages 209-218.	<input type="checkbox"/>
14	UPUL OBEYSEKARE, et al., "The Visual Interactive Desktop Laboratory," January-March 1997, pages 63-71.	<input type="checkbox"/>
15	ASIM SMAILAGIC, et al., "MoCCA: A Mobile Communication and Computing Architecture," Institute for Complex Engineered Systems, pages 1-8.	<input type="checkbox"/>
16	SUI-MENG POON, et al., "Integration of Value-Added Audio Playback Capacity Into Computer Network," Nanyang Technological University, 1995, pages 632-636.	<input type="checkbox"/>
17	ERDAL PAKSOY, et al., "A variable-rate celp coder for fast remote voicemail retrieval using a notebook computer," DSPS R&D Center, Texas Instruments, 1997, pages 119-124.	<input type="checkbox"/>

INFORMATION DISCLOSURE STATEMENT BY APPLICANT (Not for submission under 37 CFR 1.99)	Application Number		12015320
	Filing Date		2008-01-16
	First Named Inventor	Russell W. White, et al.	
	Art Unit		2617
	Examiner Name	Erika A. Gary	
	Attorney Docket Number		AFF.004C5US

18	JEFFREY A. DAVIS, "Use of Personal Computers in Satellite Command and Control Systems," Raytheon Systems Company, October 24, 1999, pages 283-291.	<input type="checkbox"/>
19	NIKI DAVIS, "Remote Teaching Via ISDN2 And Desktop Conferencing," Exeter University School of Education, pages 1-3.	<input type="checkbox"/>
20	A CHAN, et al., "The PEP-II Project-Wide Database," Stanford University, 1996, pages 840-842.	<input type="checkbox"/>
21	KRISHNA BHARAT, et al., "Migratory Applications," Springer Berlin, Vol. 1222, 1997, pages 1-21.	<input type="checkbox"/>
22	EMPEG CAR, "MP3 in your dash," Digital Audio Player User Guide, pages 1-50.	<input type="checkbox"/>
23	MICROSOFT, "Getting Started Microsoft Windows 98" Second Edition, 1998, pages 1-138.	<input type="checkbox"/>
24	SAUL GREENBERG, "PDAs and Shared Public Displays: Making Personal Information Public, and Public Information Personal," University of Calgary, March 1999, pages 1-11.	<input type="checkbox"/>
25	NAOHIKO KOHTAKE, et al., "InfoStick: an interaction device for Inter-Appliance Computing," Keio University, pages 1-15.	<input type="checkbox"/>
26	HEWLETT PACKARD, User's Guide, HP Jornada 420, Palm-Size PC, pages 1-75	<input type="checkbox"/>
27	MICROSOFT, "Introducing Microsoft Windows 95 - Certificate of Authenticity," 1995, pages 1-117.	<input type="checkbox"/>
28	SONY, "New Technical Theory For Servicing, MZ-R5ST Operation Manual," pages 1-44.	<input type="checkbox"/>

INFORMATION DISCLOSURE STATEMENT BY APPLICANT (Not for submission under 37 CFR 1.99)	Application Number	12015320
	Filing Date	2008-01-16
	First Named Inventor	Russell W. White, et al.
	Art Unit	2617
	Examiner Name	Erka A. Gary
	Attorney Docket Number	AFF.004C5US

29	RICHARD C. DAVIS, et al., "A Framework for Sharing Handwritten Notes," 1998, pages 119-120.	<input type="checkbox"/>
30	KRISHNA A. BHARAT, et al., "Migratory Applications," UIST '95, November 14-17, 1995, pages 133-142.	<input type="checkbox"/>
31	BRAD A. MYERS, "Collaboration Using Multiple PDAs Connected To A PC," Carnegie Mellon University, 1998, pages 385-294.	<input type="checkbox"/>
32	RICHARD C. DAVIS, et al., "NotePals: Lightweight Note Sharing by the Group, for the Group," May 15-20, 1999, pages 338-345.	<input type="checkbox"/>
33	JUN REKIMOTO, et al., "Augmented Surfaces: A Spatially Continuous Work Space for Hybrid Computing Environments," May 15-20, 1999, pages 378-385.	<input type="checkbox"/>
34	DAN R. OLSEN, JR., "Interacting with Chaos," September and October 1999, pages 42-54.	<input type="checkbox"/>
35	SCOTT ROBERTSON, et al., "Dual Device User Interface Design: PDAs and Interactive Television," April 13-18, 1996, pages 79-86.	<input type="checkbox"/>
36	SYMANTEC CORPORATION, "pcANYWHERE32 User's Guide," 1993-1997, pages 1-216.	<input type="checkbox"/>
37	KRISHNA BHARAT, et al., Migratory Applications, "Mobile Object Systems Towards the Programmable Internet," Springer Berlin/Heidelberg, Volume 1222/11997, 1997, pages 1-134.	<input type="checkbox"/>
38	DIAMOND MULTIMEDIA SYSTEMS, INC., "Rio PMP300, User's Guide," 1998, pages 1-27.	<input type="checkbox"/>
39	SONY, "Portable MiniDisc Recorder, Operating Instructions, MZ-R55," 1998, pages 1-42.	<input type="checkbox"/>

INFORMATION DISCLOSURE STATEMENT BY APPLICANT (Not for submission under 37 CFR 1.99)	Application Number		12015320
	Filing Date		2008-01-16
	First Named Inventor	Russell W. White, et al.	
	Art Unit	2617	
	Examiner Name	Erika A. Gary	
	Attorney Docket Number	AFF.004C5US	

40	NORBERT A. STREITZ, et al., "i-Land: An Interactive Landscape for Creativity and Innovation," Proceedings of the ACM Conference on Human Factors in Computing Systems, May 15-20, 1999, pages 120-127.	<input type="checkbox"/>
41	NORBERT A. STREITZ, et al., "Roomware for Cooperative Buildings: Integrated Design of Architectural Spaces and Information Spaces," pages 1-20	<input type="checkbox"/>
42	Direct Cable Connection screen shot, "B1U6U4," 10 pages total.	<input type="checkbox"/>
43	Direct Cable Connection screen shot, 10 pages total.	<input type="checkbox"/>
44	IBM, "WordPad z50 Cradle Option - User's Guide," 1990, pages 1-18.	<input type="checkbox"/>
45	IBM MOBILE SYSTEMS, "WorkPad z50 Mobile Companion (2608-1Ax), Hardware Maintenance Manual," March 1999, pages 1-77.	<input type="checkbox"/>
46	KEVIN JOST, Automotive Engineering International, "The car as a mobile-media platform," May 1998, pages 49-53.	<input type="checkbox"/>
47	MICROSOFT CORPORATION, "Windows CE 2.1 Technical Articles, Developing Applications for an Auto PC," June 1999, pages 1-13.	<input type="checkbox"/>
48	INFOGATION CORPORATION, "InfoGation Corp. Introduces Software Applications for Next-Generation Smart Car Systems," January 8, 1998, pages 1-2.	<input type="checkbox"/>
49	BUSINESS WIRE, "ORA Electronics Announces USB-Compatible TelCar Mark VII Begins Shipping First Quarter of 1999," January 6, 1999, pages 1-2.	<input type="checkbox"/>
50	ORA USA, "ORA Electronics Patents Telcar Cellular Telephone Interface," July 6, 1998, pages 1-2.	<input type="checkbox"/>

INFORMATION DISCLOSURE STATEMENT BY APPLICANT (Not for submission under 37 CFR 1.99)	Application Number		12015320
	Filing Date		2008-01-16
	First Named Inventor	Russell W. White, et al.	
	Art Unit	2617	
	Examiner Name	Erika A. Gary	
	Attorney Docket Number	AFF.004C5US	

If you wish to add additional non-patent literature document citation information please click the Add button			
EXAMINER SIGNATURE			
Examiner Signature	/Erika Gary/ (09/15/2010)	Date Considered	09/15/2010
*EXAMINER: Initial if reference considered, whether or not citation is in conformance with MPEP 609. Draw line through a citation if not in conformance and not considered. Include copy of this form with next communication to applicant.			
<small> ¹ See Kind Codes of USPTO Patent Documents at www.USPTO.GOV or MPEP 901.04. ² Enter office that issued the document, by the two-letter code (WIPO Standard ST.3). ³ For Japanese patent documents, the indication of the year of the reign of the Emperor must precede the serial number of the patent document. ⁴ Kind of document by the appropriate symbols as indicated on the document under WIPO Standard ST.16 if possible. ⁵ Applicant is to place a check mark here if English language translation is attached. </small>			

Doc code: IDS

Doc description: Information Disclosure Statement (IDS) Filed

PTO/SB/08a (04-09)

Approved for use through 05/31/2009. OMB 0651-0031

U.S. Patent and Trademark Office; U.S. DEPARTMENT OF COMMERCE

Under the Paperwork Reduction Act of 1995, no persons are required to respond to a collection of information unless it contains a valid OMB control number.

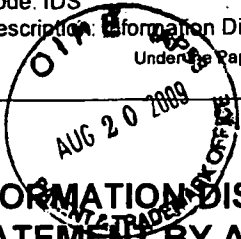

INFORMATION DISCLOSURE STATEMENT BY APPLICANT
(Not for submission under 37 CFR 1.99)

Application Number	12015320
Filing Date	2008-01-16
First Named Inventor	Russell W. White, et al.
Art Unit	2617
Examiner Name	Erika A. Gary
Attorney Docket Number	AFF.004C5US

U.S. PATENTS

Examiner Initial*	Cite No	Patent Number	Kind Code ¹	Issue Date	Name of Patentee or Applicant of cited Document	Pages, Columns, Lines where Relevant Passages or Relevant Figures Appear
	1					

If you wish to add additional U.S. Patent citation information please click the Add button.

U.S. PATENT APPLICATION PUBLICATIONS

Examiner Initial*	Cite No	Publication Number	Kind Code ¹	Publication Date	Name of Patentee or Applicant of cited Document	Pages, Columns, Lines where Relevant Passages or Relevant Figures Appear
	1					

If you wish to add additional U.S. Published Application citation information please click the Add button.

FOREIGN PATENT DOCUMENTS

Examiner Initial*	Cite No	Foreign Document Number ³	Country Code ²	Kind Code ⁴	Publication Date	Name of Patentee or Applicant of cited Document	Pages, Columns, Lines where Relevant Passages or Relevant Figures Appear	T ⁵
	1	WO 00/79372 A1	WO		2000-12-28	Colvin, David S.		<input type="checkbox"/>

If you wish to add additional Foreign Patent Document citation information please click the Add button

NON-PATENT LITERATURE DOCUMENTS

Examiner Initials*	Cite No	Include name of the author (in CAPITAL LETTERS), title of the article (when appropriate), title of the item (book, magazine, journal, serial, symposium, catalog, etc), date, pages(s), volume-issue number(s), publisher, city and/or country where published.	T ⁵

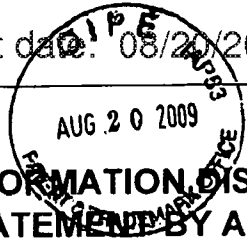

INFORMATION DISCLOSURE STATEMENT BY APPLICANT
 (Not for submission under 37 CFR 1.99)

Application Number	12015320
Filing Date	2008-01-16
First Named Inventor	Russell W. White, et al.
Art Unit	2617
Examiner Name	Erika A. Gary
Attorney Docket Number	AFF.004C5US

1	HEWLETT PACKARD, "HP Jornada 430/430se Palm-Size PC, User's Guide," Edition 1, 1999, pages 1-151.	<input type="checkbox"/>
2	NEC, "NEC MobilePro 750C, User's Guide," 1998, pages 1-83.	<input type="checkbox"/>
3	MICROSOFT, "Palm PC User's Guide," Microsoft Windows CE, pages 1-39.	<input type="checkbox"/>
4	PALM PC USER'S GUIDE, "Chapter 6, Information Backup and Exchange," pages 69-148	<input type="checkbox"/>
5	MPMan, "User's Guide, The Portable MP 3player using the flash memory and SmartMedia card," 1997, pages 1-35.	<input type="checkbox"/>
6	Cover Sheet, www.mpman.com, 1 page.	<input type="checkbox"/>
7	Smart Media Card Slot Diagram, 1 page.	<input type="checkbox"/>
8	MP Man F20 Logo, 1 page.	<input type="checkbox"/>
9	MPMan, "User's Guide, The portable MP3 player using the flash memory with variety features including the voice recording, phone/memo browsing, etc.," 1997, pages 1-47.	<input type="checkbox"/>
10	Smart Media card diagram and install instructions, pages 1-4.	<input type="checkbox"/>
11	ANAND LAL SHIMPI, Empeg, Ltd., "MP3 meets Car Audio: Empeg Mark II in-dash Car MP3 Player," September 18, 2000, pages 1-17.	<input type="checkbox"/>

INFORMATION DISCLOSURE STATEMENT BY APPLICANT (Not for submission under 37 CFR 1.99)	Application Number	12015320
	Filing Date	2008-01-16
	First Named Inventor	Russell W. White, et al.
	Art Unit	2617
	Examiner Name	Erika A. Gary
	Attorney Docket Number	AFF.004C5US

12	PETER CLARKE, EE Times, "Engineers drive craze for MP3 audio players," February 5, 1999, pages 1-4.	<input type="checkbox"/>
13	RIO CAR DOT ORG GEEK GUIDE, "empeg car Mk. 1," February 21, pages 1-4.	<input type="checkbox"/>
14	HUGO FIENNES, RIO CAR DOT ORG GEEK GUIDE, "MP3 Mobile," February 21, pages 1-4.	<input type="checkbox"/>
15	RIO CAR DOT ORG, "Frequently Asked Questions," pages 1-16.	<input type="checkbox"/>
16	DIAMOND MULTIMEDIA SYSTEMS, INC., "Rio PMP300 User's Guide," 1998, pages 1-27.	<input type="checkbox"/>
17	STEPHEN J. BUCKLEY, et al., "The Car as a Peripheral, Adapting a Portable Computer to a Vehicle Intranet," SAE Technical Paper Series, 98C030, October 19-21, 1998, pages 1-14.	<input type="checkbox"/>
18	"The MP3 Mobile," April 8, 1998, pages 1-13.	<input type="checkbox"/>
19	12-Volt Business & Technology Solutions, AutoMedia, "How the Intelligent Data Bus will impact the way you do business," November 1998, pages 1-2.	<input type="checkbox"/>
20	Press Release, "Creative Labs Launches Nomad Portable MP3 Players," April 15, 1999, pages 1-5.	<input type="checkbox"/>
21	BMW, "Betriebsanleitung Bordmonitor mit Navigation und TV," 1995, pages 1-82.	<input type="checkbox"/>
22	BMW, "Owner's Manual, On-board monitor with navigation system," 1996, pages 1-81.	<input type="checkbox"/>

INFORMATION DISCLOSURE STATEMENT BY APPLICANT (Not for submission under 37 CFR 1.99)	Application Number		12015320
	Filing Date		2008-01-16
	First Named Inventor	Russell W. White, et al.	
	Art Unit	2617	
	Examiner Name	Erika A. Gary	
	Attorney Docket Number	AFF.004C5US	

23	TRANSPERFECT/TRANSLATIONS, "True and accurate translation of the 1995 BMW Manual, from German into English," August 16, 2005, pages 1-80.	<input type="checkbox"/>
24	HEINZ SODEIKAT, "EURO-SCOUT is facing the German 1994 Market," 1994, pages 551-556.	<input type="checkbox"/>
25	Pictures of car navigation systems in a car dashboard, pages 1-11.	<input type="checkbox"/>
26	BMW, "The BMW On-Board Navigation System - Technology Takes a Remarkable Turn," 2005, pages 1-9.	<input type="checkbox"/>
27	OLDSMOBILE, "1991 Toronado/Trofeo User's Guide," 1991, pages 1-41.	<input type="checkbox"/>
28	YEPP, "Digital Sounds - yepp - YP-E32/E64102-291," October 23, 1999, pages 1-46	<input type="checkbox"/>
29		<input type="checkbox"/>
30	U.S. Provisional Application No. 60/167179, entitled "System, Method, And Device for Playing Recorded Music on a Wireless Communications Device," by Devon A. Rolf, filed November 23, 1999, pages 1-48.	<input type="checkbox"/>
31	MICROSOFT, "Getting Started, Microsoft Windows 98, For distribution with a new PC only," 1998, pages 1-145.	<input type="checkbox"/>
32	PR NEWSWIRE, "Alpine Announces Fall Release of Interface Adapter That Enables iPod Control and Playback from In-Vehicle Sound Systems," July 7, 2004, pages 1-2..	<input type="checkbox"/>
33	HA-YOUNG PARK, The Customer Times, "Portable Computer Music, MP3 File and MP3 Player rise as the Next Generation Audio Format," May 1999, pages 1-2.	<input type="checkbox"/>

INFORMATION DISCLOSURE STATEMENT BY APPLICANT (Not for submission under 37 CFR 1.99)	Application Number		12015320
	Filing Date		2008-01-16
	First Named Inventor	Russell W. White, et al.	
	Art Unit	2617	
	Examiner Name	Erika A. Gary	
	Attorney Docket Number	AFF.004C5US	

34	"MP3 Players Introduced in the Korean IT Magazines," 1998-1999, pages 1-15.	<input type="checkbox"/>
35	MPMan, "MP-F20, User's Guide, Portable MP3 player using the flash memory and a Memory card," [ages 1-16.	<input type="checkbox"/>
36	PR NEWSWIRE ASSOCIATION, INC., "Delphi's Communiport(R) Technology for Tomorrow, Today Demonstrated at Frankfurt Auto Show," September 15, 1999, pages 1-8.	<input type="checkbox"/>
37	CRAIN COMMUNIATIONS, INC., "Products," Agilent Technologies Press Release, February 21, 2000, pages 1-6.	<input type="checkbox"/>
38	THE WASHINGTON TIMES, LLC, John Hanan, Dallas Morning News, "Cars add computer, audiovisual gear," January 14, 2000, pages 1-3.	<input type="checkbox"/>

If you wish to add additional non-patent literature document citation information please click the Add button

EXAMINER SIGNATURE

Examiner Signature	/Erika Gary/ (09/15/2010)	Date Considered	09/15/2010
--------------------	---------------------------	-----------------	------------

*EXAMINER: Initial if reference considered, whether or not citation is in conformance with MPEP 609. Draw line through a citation if not in conformance and not considered. Include copy of this form with next communication to applicant.

¹ See Kind Codes of USPTO Patent Documents at www.USPTO.GOV or MPEP 901.04. ² Enter office that issued the document, by the two-letter code (WIPO Standard ST.3). ³ For Japanese patent documents, the indication of the year of the reign of the Emperor must precede the serial number of the patent document. ⁴ Kind of document by the appropriate symbols as indicated on the document under WIPO Standard ST.16 if possible. ⁵ Applicant is to place a check mark here if English language translation is attached.

Receipt date: 08/20/2009

12495190 - GAU: 2617

Doc code: IDS

Doc description: Information Disclosure Statement (IDS) Filed

PTO/SB/08a (04-09)

Approved for use through 05/31/2009. OMB 0651-0031

U.S. Patent and Trademark Office; U.S. DEPARTMENT OF COMMERCE

Under the Paperwork Reduction Act of 1995, no persons are required to respond to a collection of information unless it contains a valid OMB control number.

INFORMATION DISCLOSURE STATEMENT BY APPLICANT
 (Not for submission under 37 CFR 1.99)

Application Number	12015320
Filing Date	2008-01-16
First Named Inventor	Russell W. White, et al.
Art Unit	2617
Examiner Name	Erika A. Gary
Attorney Docket Number	AFF.004C5US

U.S. PATENTS						Remove
Examiner Initial*	Cite No	Patent Number	Kind Code ¹	Issue Date	Name of Patentee or Applicant of cited Document	Pages, Columns, Lines where Relevant Passages or Relevant Figures Appear
	1	5969283		1999-10-19	Looney , et al.	
	2	6147938		2000-11-14	Ogawa , et al.	
	3	6157725		2000-12-05	Becker	
	4	6425018		2002-07-23	Kaganas , et al.	
	5	5812870		1998-09-22	Kikinis , et al.	
	6	6862357		2005-03-01	Albus , et al.	
	7	6493546		2002-12-10	Patsiokas	
	8	6721489		2004-04-13	Benyamin , et al.	

INFORMATION DISCLOSURE STATEMENT BY APPLICANT (Not for submission under 37 CFR 1.99)	Application Number		12015320
	Filing Date		2008-01-16
	First Named Inventor	Russell W. White, et al.	
	Art Unit	2617	
	Examiner Name	Erika A. Gary	
	Attorney Docket Number	AFF.004C5US	

	9	5878282		1999-03-02	Mital	
	10	6349352		2002-02-19	Lea	
	11	6446080		2002-09-03	Van Ryzin , et al.	
	12	6963784		2005-11-08	Gibbs	
	13	5657221		1997-08-12	Warman , et al.	
	14	5798759		1998-08-25	Dahl	
	15	6084584		2000-07-04	Nahi , et al.	
	16	5956029		1999-09-21	Okada , et al.	
	17	6100884		2000-08-08	Tomita , et al.	
	18	6243725		2001-06-05	Hempleman , et al.	
	19	6456892		2002-09-24	Dara-Abrams , et al.	

INFORMATION DISCLOSURE STATEMENT BY APPLICANT (Not for submission under 37 CFR 1.99)	Application Number		12015320
	Filing Date		2008-01-16
	First Named Inventor	Russell W. White, et al.	
	Art Unit		2617
	Examiner-Name	Erika A. Gary	
	Attorney Docket Number		AFF.004C5US

	20	6760916		2004-07-06	Holtz , et al.	
	21	7200357		2007-04-03	Janik , et al.	
	22	7321923		2008-01-22	Rosenberg , et al.	
	23	7346687		2008-03-18	Lipscomb , et al.	
	24	6314326		2001-11-06	Fuchu	
	25	6344861		2002-02-05	Naughton , et al.	
	26	6163711		2000-12-19	Juntunen , et al.	
	27	5616876		1997-04-01	Cluts	
	28	6892067		2005-05-10	Sharma , et al.	
	29	5475835		1995-12-12	Hickey	
	30	5388248		1995-02-07	Robinson , et al.	

INFORMATION DISCLOSURE STATEMENT BY APPLICANT (Not for submission under 37 CFR 1.99)	Application Number		12015320	
	Filing Date		2008-01-16	
	First Named Inventor	Russell W. White, et al.		
	Art Unit		2617	
	Examiner Name	Erika A. Gary		
	Attorney Docket Number		AFF.004C5US	

	31	5839108		1998-11-17	Daberko , et al.	
	32	6121282		2000-09-19	Dominianni , et al.	
	33	6422941		2002-07-23	Thomer , et al.	
	34	6476825		2002-11-05	Croy ; Clemens	
	35	6832316		2004-12-14	Sibert	
	36	5557541		1996-09-17	Schulhof , et al.	

If you wish to add additional U.S. Patent citation information please click the Add button.

U.S.PATENT APPLICATION PUBLICATIONS

Examiner Initial*	Cite No	Publication Number	Kind Code ¹	Publication Date	Name of Patentee or Applicant of cited Document	Pages, Columns, Lines where Relevant Passages or Relevant Figures Appear
	1	20050282600		2005-12-22	Paradice	
	2	20060094349		2006-05-04	Slesak; Christian H. ; et al.	
	3	20020058475		2002-05-16	PATSIOKAS, STELIOS	

INFORMATION DISCLOSURE STATEMENT BY APPLICANT (Not for submission under 37 CFR 1.99)	Application Number	12015320
	Filing Date	2008-01-16
	First Named Inventor	Russell W. White, et al.
	Art Unit	2617
	Examiner Name	Erika A. Gary
	Attorney Docket Number	AFF.004C5US

4	20020026442		2002-02-28	Lipscomb, Kenneth O. ; et al.	
5	20050282600		2005-12-22	Paradice, William L. III	
6	20060039263		2006-02-23	Trotabas, Remy	
7	20020072818		2002-06-13	Moon, Kwang-Su ; et al.	
8	20030105718		2003-06-05	HURTADO, MARCO M. ; et al.	
9	20030163486		2003-08-28	Van Der Meulen, Pieter	
10	20040210765		2004-10-21	Erickson, John S.	
11	20060080741		2006-04-13	Nair, Mark	
12	20060105804		2006-05-18	Kumar, Rajendra	
13	20060206493		2006-09-14	Lipscomb, Kenneth O. ; et al.	
14	20070150963		2007-06-28	Lee, Charles C. ; et al.	

INFORMATION DISCLOSURE STATEMENT BY APPLICANT (Not for submission under 37 CFR 1.99)	Application Number		12015320	
	Filing Date		2008-01-16	
	First Named Inventor		Russell W. White, et al.	
	Art Unit		2617	
	Examiner Name		Erika A. Gary	
	Attorney Docket Number		AFF.004C5US	

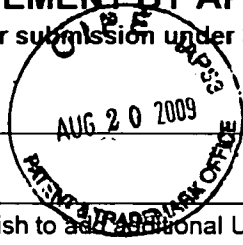

If you wish to add additional U.S. Published Application citation information please click the Add button

FOREIGN PATENT DOCUMENTS <input type="button" value="Remove"/>								
Examiner Initial*	Cite No	Foreign Document Number ³	Country Code ² j	Kind Code ⁴	Publication Date	Name of Patentee or Applicant of cited Document	Pages, Columns, Lines where Relevant Passages or Relevant Figures Appear	T ⁵
	1							<input type="checkbox"/>

If you wish to add additional Foreign Patent Document citation information please click the Add button

NON-PATENT LITERATURE DOCUMENTS <input type="button" value="Remove"/>			
Examiner Initials*	Cite No	Include name of the author (in CAPITAL LETTERS), title of the article (when appropriate), title of the item (book, magazine, journal, serial, symposium, catalog, etc), date, pages(s), volume-issue number(s), publisher, city and/or country where published.	T ⁵
	1		<input type="checkbox"/>

If you wish to add additional non-patent literature document citation information please click the Add button

EXAMINER SIGNATURE			
Examiner Signature	/Erika Gary/ (09/15/2010)		Date Considered 09/15/2010

*EXAMINER: Initial if reference considered, whether or not citation is in conformance with MPEP 609. Draw line through a citation if not in conformance and not considered. Include copy of this form with next communication to applicant.

¹ See Kind Codes of USPTO Patent Documents at www.USPTO.GOV or MPEP 901.04. ² Enter office that issued the document, by the two-letter code (WIPO Standard ST.3). ³ For Japanese patent documents, the indication of the year of the reign of the Emperor must precede the serial number of the patent document. ⁴ Kind of document by the appropriate symbols as indicated on the document under WIPO Standard ST.16 if possible. ⁵ Applicant is to place a check mark here if English language translation is attached.

Receipt date: 08/20/2009

12495190 - GAU: 2617

Doc code: IDS

Doc description: Information Disclosure Statement (IDS) Filed

PTO/SB/08a (04-09)

Approved for use through 05/31/2009. OMB 0651-0031

U.S. Patent and Trademark Office; U.S. DEPARTMENT OF COMMERCE

Under the Paperwork Reduction Act of 1995, no persons are required to respond to a collection of information unless it contains a valid OMB control number.

INFORMATION DISCLOSURE STATEMENT BY APPLICANT (Not for submission under 37 CFR 1.99)	Application Number		12015320
	Filing Date		2008-01-16
	First Named Inventor	Russell W. White, et al.	
	Art Unit	2617	
	Examiner Name	Erika A. Gary	
	Attorney Docket Number	AFF.004C5US	

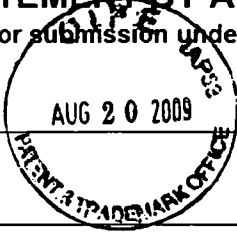

U.S. PATENTS

Remove

Examiner Initial*	Cite No	Patent Number	Kind Code ¹	Issue Date	Name of Patentee or Applicant of cited Document	Pages, Columns, Lines where Relevant Passages or Relevant Figures Appear
	1	6055478		2000-04-25	Heron	
	2	6377825		2002-04-23	Kennedy , et al.	
	3	6041023		2000-03-21	Lakhansingh	
	4	6148261		2000-11-14	Obradovich , et al.	
	5	6275231		2001-08-14	Obradovich	
	6	5524051		1996-06-04	Ryan	
	7	4291749		1981-09-29	Ootsuka , et al.	
	8	4337821		1982-07-06	Saito	

**INFORMATION DISCLOSURE
STATEMENT BY APPLICANT**
(Not for submission under 37 CFR 1.99)

Application Number		12015320
Filing Date		2008-01-16
First Named Inventor	Russell W. White, et al.	
Art Unit	2617	
Examiner Name	Erika A. Gary	
Attorney Docket Number	AFF.004C5US	

9	4441405		1984-04-10	Takeuchi	
10	4481584		1984-11-06	Holland	
11	4716458		1987-12-29	Heitzman , et al.	
12	4740779		1988-04-26	Cleary , et al.	
13	4740780		1988-04-26	Brown , et al.	
14	4752824		1988-06-21	Moore	
15	4795223		1989-01-03	Moss	
16	4809177		1989-02-28	Windle , et al.	
17	4812843		1989-03-14	Champion, III , et al.	
18	4818048		1989-04-04	Moss	
19	4827520		1989-05-02	Zeinstra	

INFORMATION DISCLOSURE STATEMENT BY APPLICANT (Not for submission under 37 CFR 1.99)	Application Number		12015320
	Filing Date		2008-01-16
	First Named Inventor	Russell W. White, et al.	
	Art Unit		2617
	Examiner Name	Erika A. Gary	
	Attorney Docket Number		AFF.004C5US

	20	4837551		1989-06-06	lino	
	21	4876594		1989-10-24	Schiffman	
	22	4914705		1990-04-03	Nigawara	
	23	4977509		1990-12-11	Pitchford , et al.	
	24	4988976		1991-01-29	Lu	
	25	4995258		1991-02-26	Frank	
	26	4996959		1991-03-05	Akimoto	
	27	5006829		1991-04-09	Miyamoto , et al.	
	28	5051735		1991-09-24	Furukawa	
	29	5070323		1991-12-03	lino , et al.	
	30	5124915		1992-06-23	Krenzel	

**INFORMATION DISCLOSURE
STATEMENT BY APPLICANT**
(Not for submission under 37 CFR 1.99)

Application Number		12015320
Filing Date		2008-01-16
First Named Inventor	Russell W. White, et al.	
Art Unit	2617	
Examiner Name	Erika A. Gary	
Attorney Docket Number	AFF.004C5US	

	31	5164904		1992-11-17	Sumner	
	32	5179385		1993-01-12	O'Loughlin , et al.	
	33	5198797		1993-03-30	Daidoji	
	34	5203499		1993-04-20	Knittel	
	35	5214413		1993-05-25	Okabayashi , et al.	
	36	5214707		1993-05-25	Fujimoto , et al.	
	37	5214793		1993-05-25	Conway , et al.	
	38	5239700		1993-08-24	Guenther , et al.	
	39	5257190		1993-10-26	Crane	
	40	5270689		1993-12-14	Hermann	
	41	5274560		1993-12-28	LaRue	

INFORMATION DISCLOSURE STATEMENT BY APPLICANT (Not for submission under 37 CFR 1.99)	Application Number		12015320	
	Filing Date		2008-01-16	
	First Named Inventor	Russell W. White, et al.		
	Art Unit	2617		
	Examiner Name	Erika A. Gary		
	Attorney Docket Number	AFF.004C5US		

	42	5278532		1994-01-11	Hegg , et al.	
	43	5293115		1994-03-08	Swanson	
	44	5299132		1994-03-29	Wortham	
	45	5335743		1994-08-09	Gillbrand , et al.	
	46	5345817		1994-09-13	Grenn , et al.	
	47	5351041		1994-09-27	Ikata , et al.	
	48	5361165		1994-11-01	Stringfellow , et al.	
	49	5371510		1994-12-06	Miyauchi , et al.	
	50	5400045		1995-03-21	Aoki	

If you wish to add additional U.S. Patent citation information please click the Add button.

U.S. PATENT APPLICATION PUBLICATIONS

Examiner Initial*	Cite No	Publication Number	Kind Code ¹	Publication Date	Name of Patentee or Applicant of cited Document	Pages, Columns, Lines where Relevant Passages or Relevant Figures Appear
-------------------	---------	--------------------	------------------------	------------------	-------------------------------------------------	--------------------------------------------------------------------------

Receipt date: 08/20/2009

12495190 - GAU: 2617

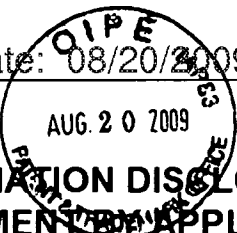

INFORMATION DISCLOSURE STATEMENT BY APPLICANT
(Not for submission under 37 CFR 1.99)

Application Number		12015320	
Filing Date		2008-01-16	
First Named Inventor	Russell W. White, et al.		
Art Unit	2617		
Examiner Name	Erika A. Gary		
Attorney Docket Number	AFF.004C5US		

1						
---	--	--	--	--	--	--

If you wish to add additional U.S. Published Application citation information please click the Add button

FOREIGN PATENT DOCUMENTS

Examiner Initial*	Cite No	Foreign Document Number ³	Country Code ² i	Kind Code ⁴	Publication Date	Name of Patentee or Applicant of cited Document	Pages, Columns, Lines where Relevant Passages or Relevant Figures Appear	T ⁵
	1							<input type="checkbox"/>

If you wish to add additional Foreign Patent Document citation information please click the Add button

NON-PATENT LITERATURE DOCUMENTS

Examiner Initials*	Cite No	Include name of the author (in CAPITAL LETTERS), title of the article (when appropriate), title of the item (book, magazine, journal, serial, symposium, catalog, etc), date, pages(s), volume-issue number(s), publisher, city and/or country where published.	T ⁵
	1		<input type="checkbox"/>

If you wish to add additional non-patent literature document citation information please click the Add button

EXAMINER SIGNATURE

Examiner Signature	/Erika Gary/ (09/15/2010)	Date Considered	09/15/2010
--------------------	---------------------------	-----------------	------------

*EXAMINER: Initial if reference considered, whether or not citation is in conformance with MPEP 609. Draw line through a citation if not in conformance and not considered. Include copy of this form with next communication to applicant.

¹ See Kind Codes of USPTO Patent Documents at www.USPTO.GOV or MPEP 901.04. ² Enter office that issued the document, by the two-letter code (WIPO Standard ST.3). ³ For Japanese patent documents, the indication of the year of the reign of the Emperor must precede the serial number of the patent document. ⁴ Kind of document by the appropriate symbols as indicated on the document under WIPO Standard ST.16 if possible. ⁵ Applicant is to place a check mark here if English language translation is attached.

Receipt date: 08/20/2009

12495190 - GAU: 2617

Doc code: IDS

Doc description: Information Disclosure Statement (IDS) Filed

PTO/SB/08a (04-09)

Approved for use through 05/31/2009. OMB 0651-0031

U.S. Patent and Trademark Office; U.S. DEPARTMENT OF COMMERCE

Under the Paperwork Reduction Act of 1995, no persons are required to respond to a collection of information unless it contains a valid OMB control number.

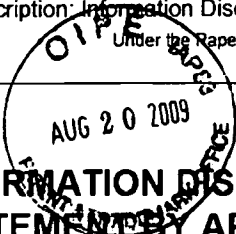

INFORMATION DISCLOSURE STATEMENT BY APPLICANT
(Not for submission under 37 CFR 1.99)

Application Number	12015320
Filing Date	2008-01-16
First Named Inventor	Russell W. White, et al.
Art Unit	2617
Examiner Name	Erika A. Gary
Attorney Docket Number	AFF.004C5US

U.S. PATENTS

[Remove](#)

Examiner Initial*	Cite No	Patent Number	Kind Code ¹	Issue Date	Name of Patentee or Applicant of cited Document	Pages, Columns, Lines where Relevant Passages or Relevant Figures Appear
	1	5666102		1997-09-09	Lahiff	
	2	5670953		1997-09-23	Satoh , et al.	
	3	5677837		1997-10-14	Reynolds	
	4	5682525		1997-10-28	Bouve , et al.	
	5	5684490		1997-11-04	Young , et al.	
	6	5691695		1997-11-25	Lahiff	
	7	5699056		1997-12-16	Yoshida	
	8	5699255		1997-12-16	Ellis , et al.	

INFORMATION DISCLOSURE STATEMENT BY APPLICANT (Not for submission under 37 CFR 1.99)	Application Number		12015320
	Filing Date		2008-01-16
	First Named Inventor	Russell W. White, et al.	
	Art Unit		2617
	Examiner Name	Erika A. Gary	
	Attorney Docket Number		AFF.004C5US

	9	5702165		1997-12-30	Koibuchi	
	10	5712640		1998-01-27	Andou , et al.	
	11	5734973		1998-03-31	Honda	
	12	5752754		1998-05-19	Amitani , et al.	
	13	5754774		1998-05-19	Bittinger , et al.	
	14	5754775		1998-05-19	Adamson , et al.	
	15	5757359		1998-05-26	Morimoto , et al.	
	16	5758311		1998-05-26	Tsuji , et al.	
	17	5760742		1998-06-02	Branch , et al.	
	18	5772534		1998-06-30	Dudley	
	19	5774070		1998-06-30	Rendon	

INFORMATION DISCLOSURE STATEMENT BY APPLICANT (Not for submission under 37 CFR 1.99)	Application Number		12015320
	Filing Date		2008-01-16
	First Named Inventor	Russell W. White, et al.	
	Art Unit		2617
	Examiner Name	Erika A. Gary	
	Attorney Docket Number		AFF.004C5US

	20	5774827		1998-06-30	Smith, Jr. , et al.	
	21	5777394		1998-07-07	Arold	
	22	5790973		1998-08-04	Blaker , et al.	
	23	5790974		1998-08-04	Tognazzini	
	24	5802492		1989-02-07	Grunstein	
	25	5806018		1998-09-08	Smith , et al.	
	26	5808566		1998-09-15	Behr , et al.	
	27	5864305		1999-01-26	Rosenquist	
	28	5875412		1999-02-23	Sulich , et al.	
	29	5908464		1999-06-01	Kishigami , et al.	
	30	5917405		1999-06-29	Joao	

INFORMATION DISCLOSURE STATEMENT BY APPLICANT (Not for submission under 37 CFR 1.99)	Application Number		12015320
	Filing Date		2008-01-16
	First Named Inventor	Russell W. White, et al.	
	Art Unit		2617
	Examiner Name	Erika A. Gary	
	Attorney Docket Number		AFF.004C5US

	31	5919239		1999-07-06	Fraker , et al.	
	32	5919246		1999-07-06	Waizmann , et al.	
	33	5982298		1999-11-09	Lappenbusch , et al.	
	34	5987381		1999-11-16	Oshizawa	
	35	5987394		1999-11-16	Takakura , et al.	
	36	5999877		1999-12-07	Takahashi , et al.	
	37	6006161		1999-12-21	Katou	
	38	6009355		1999-12-28	Obradovich , et al.	
	39	6047234		2000-04-04	Chervený , et al.	
	40	6047327		2000-04-04	Tso , et al.	
	41	6115669		2000-09-05	Watanabe , et al.	

INFORMATION DISCLOSURE STATEMENT BY APPLICANT (Not for submission under 37 CFR 1.99)	Application Number		12015320	
	Filing Date		2008-01-16	
	First Named Inventor	Russell W. White, et al.		
	Art Unit		2617	
	Examiner Name	Erika A. Gary		
	Attorney Docket Number		AFF.004C5US	

	42	6128559		2000-10-03	Saitou , et al.	
	43	6131060		2000-10-10	Obradovich , et al.	
	44	6133853		2000-10-17	Obradovich , et al.	
	45	6148261		2000-11-14	Obradovich , et al.	
	46	6161071		2000-12-12	Shuman , et al.	
	47	6169515		2001-01-02	Mannings , et al.	
	48	5175782		2001-01-16	Obradovich , et al.	
	49	6584403		2003-06-24	Bunn	

If you wish to add additional U.S. Patent citation information please click the Add button.

U.S.PATENT APPLICATION PUBLICATIONS

Examiner Initial*	Cite No	Publication Number	Kind Code ¹	Publication Date	Name of Patentee or Applicant of cited Document	Pages,Columns,Lines where Relevant Passages or Relevant Figures Appear
	1	20020144271		2002-10-03	BEHAGEN, MICHAEL ; et al.	

If you wish to add additional U.S. Published Application citation information please click the Add button.

INFORMATION DISCLOSURE STATEMENT BY APPLICANT (Not for submission under 37 CFR 1.99)	Application Number	12015320
	Filing Date	2008-01-16
	First Named Inventor	Russell W. White, et al.
	Art Unit	2617
	Examiner Name	Erika A. Gary
	Attorney Docket Number	AFF.004C5US

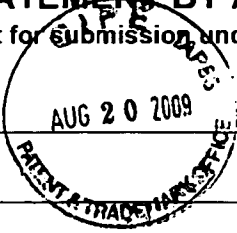

FOREIGN PATENT DOCUMENTS

Examiner Initial*	Cite No	Foreign Document Number ³	Country Code ²	Kind Code ⁴	Publication Date	Name of Patentee or Applicant of cited Document	Pages, Columns, Lines where Relevant Passages or Relevant Figures Appear	T ⁵
	1							<input type="checkbox"/>

If you wish to add additional Foreign Patent Document citation information please click the Add button

NON-PATENT LITERATURE DOCUMENTS

Examiner Initials*	Cite No	Include name of the author (in CAPITAL LETTERS), title of the article (when appropriate), title of the item (book, magazine, journal, serial, symposium, catalog, etc), date, pages(s), volume-issue number(s), publisher, city and/or country where published.	T ⁵
	1		<input type="checkbox"/>

If you wish to add additional non-patent literature document citation information please click the Add button

EXAMINER SIGNATURE

Examiner Signature	/Erika Gary/ (09/15/2010)	Date Considered	09/15/2010
--------------------	---------------------------	-----------------	------------

*EXAMINER: Initial if reference considered, whether or not citation is in conformance with MPEP 609. Draw line through a citation if not in conformance and not considered. Include copy of this form with next communication to applicant.

¹ See Kind Codes of USPTO Patent Documents at www.USPTO.GOV or MPEP 901.04. ² Enter office that issued the document, by the two-letter code (WIPO Standard ST.3). ³ For Japanese patent documents, the indication of the year of the reign of the Emperor must precede the serial number of the patent document. ⁴ Kind of document by the appropriate symbols as indicated on the document under WIPO Standard ST.16 if possible. ⁵ Applicant is to place a check mark here if English language translation is attached.

Receipt date: 08/20/2009

12495190 - GAU: 2617

Doc code: IDS

PTO/SB/08a (04-09)

Doc description: Information Disclosure Statement (IDS) Filed

Approved for use through 05/31/2009. OMB 0851-0031

U.S. Patent and Trademark Office; U.S. DEPARTMENT OF COMMERCE

Under the Paperwork Reduction Act of 1995, no persons are required to respond to a collection of information unless it contains a valid OMB control number.

<p>INFORMATION DISCLOSURE STATEMENT BY APPLICANT (Not for submission under 37 CFR 1.99)</p>	Application Number		12015320
	Filing Date		2008-01-16
	First Named Inventor	Russell W. White, et al.	
	Art Unit		2617
	Examiner Name	Erika A. Gary	
	Attorney Docket Number		AFF.0004C5US

U.S. PATENTS						Remove
Examiner Initial*	Cite No	Patent Number	Kind Code ¹	Issue Date	Name of Patentee or Applicant of cited Document	Pages, Columns, Lines where Relevant Passages or Relevant Figures Appear
	1	5819160		1998-10-06	Foladare , et al.	
	2	5926624		1999-07-20	Katz , et al.	
	3	6014689		2000-01-11	Budge , et al.	
	4	6018571		2000-01-25	Langlois , et al.	
	5	6104334		2000-08-15	Allport	
	6	6178403		2001-01-23	Detlef	
	7	6182006		2001-01-30	Meek	
	8	6196846		2001-03-06	Berger , et al.	

INFORMATION DISCLOSURE STATEMENT BY APPLICANT (Not for submission under 37 CFR 1.99)	Application Number		12015320
	Filing Date		2008-01-16
	First Named Inventor	Russell W. White, et al.	
	Art Unit		2617
	Examiner Name	Erika A. Gary	
	Attorney Docket Number		AFF.0004C5US

	9	6246935		2001-06-12	Buckley	
	10	6262724		2001-07-17	Crow , et al.	
	11	6418421		2002-07-09	Hurtado , et al.	
	12	6446080		2002-09-03	Van Ryzin , et al.	
	13	6507762		2003-01-14	Amro , et al.	
	14	6549942		2003-04-15	Janky , et al.	
	15	6594740		2003-07-15	Fukuda	
	16	6618039		2003-09-09	Grant , et al.	
	17	6639584		2003-10-28	Li	
	18	6640306		2003-10-28	Tone , et al.	
	19	6671567		2003-12-30	Dwyer , et al.	

INFORMATION DISCLOSURE STATEMENT BY APPLICANT (Not for submission under 37 CFR 1.99)	Application Number		12015320
	Filing Date		2008-01-16
	First Named Inventor	Russell W. White, et al.	
	Art Unit		2617
	Examiner Name	Erika A. Gary	
	Attorney Docket Number		AFF.0004C5US

	20	6697944		2004-02-24	Jones , et al.	
	21	6704394		2004-03-09	Kambhatla , et al.	
	22	6725022		2004-04-20	Clayton , et al.	
	23	6791907		2004-09-14	Berhan	
	24	6888927		2005-05-03	Cruickshank , et al.	
	25	6963783		2005-11-08	Bi , et al.	
	26	6990208		2006-01-24	Lau , et al.	
	27	7058376		2006-06-06	Logan , et al.	
	28	7209943		2007-04-24	Ching , et al.	
	29	7219123		2007-05-15	Fiechter , et al.	
	30	7379541		2008-05-27	Iggulden , et al.	

INFORMATION DISCLOSURE STATEMENT BY APPLICANT (Not for submission under 37 CFR 1.99)	Application Number		12015320
	Filing Date		2008-01-16
	First Named Inventor	Russell W. White, et al.	
	Art Unit		2617
	Examiner Name	Erika A. Gary	
	Attorney Docket Number		AFF.0004C5US

	31	7437485		2008-10-14	Kruglikov , et al.	
	32	6150925		2000-11-21	Casazza	
	33	6292743		2001-09-18	Pu , et al.	
	34	6671745		2003-12-30	Mathur , et al.	
	35	7085710		2006-08-01	Beckert , et al.	
	36	5657221		1997-08-12	Warman , et al.	
	37	5798759		1998-08-25	Dahl	
	38	5956029		1999-09-21	Okada , et al.	
	39	6084584		2000-07-04	Nahi , et al.	
	40	6100884		2000-08-08	Tomita , et al.	
	41	6243725		2001-06-05	Hempleman , et al.	

INFORMATION DISCLOSURE STATEMENT BY APPLICANT (Not for submission under 37 CFR 1.99)	Application Number	12015320
	Filing Date	2008-01-16
	First Named Inventor	Russell W. White, et al.
	Art Unit	2617
	Examiner Name	Erika A. Gary
	Attorney Docket Number	AFF.0004C5US

42	6456892		2002-09-24	Dara-Abrams , et al.	
43	7200357		2007-04-03	Janik , et al.	
44	7321923		2008-01-22	Rosenberg , et al.	
45	7346687		2008-03-18	Lipscomb , et al.	
46	4570217		1986-02-11	Allen , et al.	
47	5969826		1999-10-19	Dash , et al.	
48	5742893		1998-04-21	Frank	

If you wish to add additional U.S. Patent citation information please click the Add button.

U.S.PATENT APPLICATION PUBLICATIONS

Examiner Initial*	Cite No	Publication Number	Kind Code ¹	Publication Date	Name of Patentee or Applicant of cited Document	Pages,Columns,Lines where Relevant Passages or Relevant Figures Appear
	1	20020060701		2002-05-23	Naughton, Patrick J. ; et al.	
	2	20020026442		2002-02-28	Lipscomb, Kenneth O. ; et al.	

If you wish to add additional U.S. Published Application citation information please click the Add button.

INFORMATION DISCLOSURE STATEMENT BY APPLICANT (Not for submission under 37 CFR 1.99)	Application Number		12015320	
	Filing Date		2008-01-16	
	First Named Inventor		Russell W. White, et al.	
	Art Unit		2617	
	Examiner Name		Erika A. Gary	
	Attorney Docket Number		AFF.0004C5US	

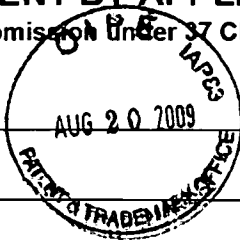

FOREIGN PATENT DOCUMENTS								Remove
Examiner Initial*	Cite No	Foreign Document Number ³	Country Code ²	Kind Code ⁴	Publication Date	Name of Patentee or Applicant of cited Document	Pages, Columns, Lines where Relevant Passages or Relevant Figures Appear	T ⁵
	1							<input type="checkbox"/>

If you wish to add additional Foreign Patent Document citation information please click the Add button

NON-PATENT LITERATURE DOCUMENTS				Remove
Examiner Initials*	Cite No	Include name of the author (in CAPITAL LETTERS), title of the article (when appropriate), title of the item (book, magazine, journal, serial, symposium, catalog, etc), date, pages(s), volume-issue number(s), publisher, city and/or country where published.		T ⁵
	1			<input type="checkbox"/>

If you wish to add additional non-patent literature document citation information please click the Add button

EXAMINER SIGNATURE			
Examiner Signature	/Erika Gary/ (09/15/2010)		Date Considered 09/15/2010

*EXAMINER: Initial if reference considered, whether or not citation is in conformance with MPEP 609. Draw line through a citation if not in conformance and not considered. Include copy of this form with next communication to applicant.

¹ See Kind Codes of USPTO Patent Documents at www.USPTO.GOV or MPEP 901.04. ² Enter office that issued the document, by the two-letter code (WIPO Standard ST.3). ³ For Japanese patent documents, the indication of the year of the reign of the Emperor must precede the serial number of the patent document. ⁴ Kind of document by the appropriate symbols as indicated on the document under WIPO Standard ST.16 if possible. ⁵ Applicant is to place a check mark here if English language translation is attached.

Receipt date: 08/20/2009

12495190 - GAU: 2617

Doc code: IDS

Doc description: Information Disclosure Statement (IDS) Filed

PTO/SB/08a (04-09)

Approved for use through 05/31/2009. OMB 0851-0031

U.S. Patent and Trademark Office; U.S. DEPARTMENT OF COMMERCE

Under the Paperwork Reduction Act of 1995, no persons are required to respond to a collection of information unless it contains a valid OMB control number.

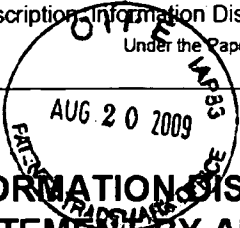

INFORMATION DISCLOSURE STATEMENT BY APPLICANT
(Not for submission under 37 CFR 1.99)

Application Number	12015320
Filing Date	2008-01-16
First Named Inventor	Russell W. White, et al.
Art Unit	2617
Examiner Name	Erika A. Gary
Attorney Docket Number	AFF.004C5US

U.S. PATENTS

[Remove](#)

Examiner Initial*	Cite No	Patent Number	Kind Code ¹	Issue Date	Name of Patentee or Applicant of cited Document	Pages, Columns, Lines where Relevant Passages or Relevant Figures Appear
	1	5400246		1995-03-21	Wilson , et al.	
	2	5404443		1995-04-04	Hirata	
	3	5408686		1995-04-18	Mankovitz	
	4	5414439		1995-05-09	Groves , et al.	
	5	5416318		1995-05-16	Hegy	
	6	5422565		1995-06-06	Swanson	
	7	5432904		1995-07-11	Wong	
	8	5440428		1995-08-08	Hegg , et al.	

INFORMATION DISCLOSURE STATEMENT BY APPLICANT (Not for submission under 37 CFR 1.99)	Application Number		12015320
	Filing Date		2008-01-16
	First Named Inventor	Russell W. White, et al.	
	Art Unit		2617
	Examiner Name	Erika A. Gary	
	Attorney Docket Number		AFF.004C5US

	9	5442553		1995-08-15	Parrillo	
	10	5442557		1995-08-15	Kaneko	
	11	5450321		1995-09-12	Crane	
	12	5450613		1995-19-12	Takahara , et al.	
	13	5475399		1995-12-12	Borsuk	
	14	5479157		1995-12-26	Suman , et al.	
	15	5483632		1996-01-09	Kuwamoto , et al.	
	16	5486840		1996-01-23	Borrego , et al.	
	17	5493658		1996-02-20	Chiang , et al.	
	18	5497271		1996-03-05	Mulvanny , et al.	
	19	5504482		1996-04-02	Schreder	

INFORMATION DISCLOSURE STATEMENT BY APPLICANT (Not for submission under 37 CFR 1.99)	Application Number	12015320
	Filing Date	2008-01-16
	First Named Inventor	Russell W. White, et al.
	Art Unit	2617
	Examiner Name	Erika A. Gary
	Attorney Docket Number	AFF.004C5US

	20	5504622		1996-04-02	Oikawa , et al.	
	21	5506595		1996-04-09	Fukano , et al.	
	22	5511724		1996-04-30	Freiberger , et al.	
	23	5519410		1996-05-21	Smalanskas , et al.	
	24	5523559		1996-06-04	Swanson	
	25	5525977		1996-06-11	Suman	
	26	5528248		1996-06-18	Steiner , et al.	
	27	5528496		1996-06-18	Brauer , et al.	
	28	5534888		1996-07-09	Lebby , et al.	
	29	5539645		1996-07-23	Mandhyan , et al.	
	30	5539869		1996-07-23	Spoto , et al.	