



US005598280A

United States Patent [19]

[11] Patent Number: **5,598,280**

Nishio et al.

[45] Date of Patent: **Jan. 28, 1997**

- [54] **FILM LENS AND A SURFACE LIGHT SOURCE USING THE SAME**
- [75] Inventors: **Toshikazu Nishio; Michiko Takeuchi; Nobu Masubuchi**, all of Tokyo-to, Japan

- 1-241590 9/1989 Japan .
- 2-257188 10/1990 Japan .
- 4-91905 3/1992 Japan .
- 5-232466 9/1993 Japan .
- 5-45474 11/1993 Japan .
- 5-313004 11/1993 Japan .

[73] Assignee: **Dai Nippon Printing Co., Ltd.**, Japan

Primary Examiner—David C. Nelms
Assistant Examiner—F. Nirranjan
Attorney, Agent, or Firm—Parkhurst, Wendel & Burr, L.L.P.

[21] Appl. No.: **215,789**

[22] Filed: **Mar. 22, 1994**

[30] Foreign Application Priority Data

Mar. 23, 1993 [JP] Japan 5-086954
 Nov. 29, 1993 [JP] Japan 5-323214

[51] Int. Cl.⁶ **G02F 1/13**

[52] U.S. Cl. **349/57; 362/31; 362/32; 385/147; 349/62**

[58] Field of Search 359/261, 263,
 359/291, 572, 589, 366, 642, 36, 40, 49,
 69, 51, 619; 362/31, 32, 26, 27, 330, 329;
 385/147

[56] References Cited

U.S. PATENT DOCUMENTS

4,729,067 3/1988 Ohe .
 4,924,356 5/1990 French et al. 362/31
 5,394,255 2/1995 Yokota et al. 362/31

FOREIGN PATENT DOCUMENTS

57-44365 9/1982 Japan .

[57] ABSTRACT

A film lens comprises a light transmitting base having one side and an opposite side, a plurality of concave or convex unit lenses formed on the one side of the light transmitting base, and a plurality of projections formed on the opposite side of the light transmitting base and having a profile height not smaller than the wavelength of a source light and not greater than 100 μm. In this arrangement, when the film lens is placed on a smooth surface of a light guide plate of a surface light source of the edge-light type, the projections on the reverse side of the light transmitting base can secure a gap with a width not smaller than the wavelength of the source light between the film lens and the light guide plate. Thus, the source light can be uniformly distributed without hindrance throughout the light guide plate as it is totally reflected by the surface of the guide plate. In the surface light source using the film lens, moreover, the lens can provide a uniform luminance in a desired angular range, and a uniform luminance distribution can be obtained for the whole surface without concentration in the vicinity of the light source.

6 Claims, 11 Drawing Sheets

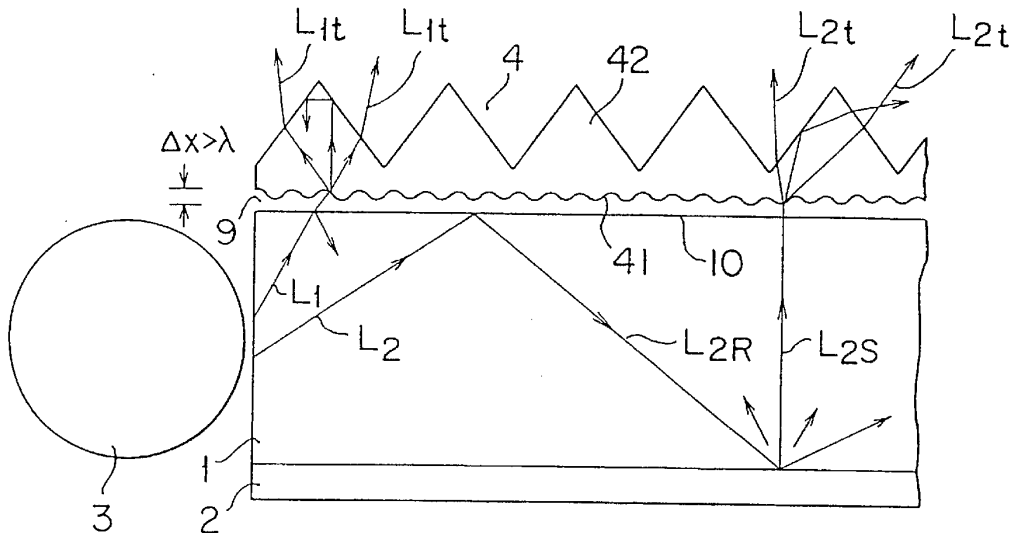

LG Display Ex. 1012

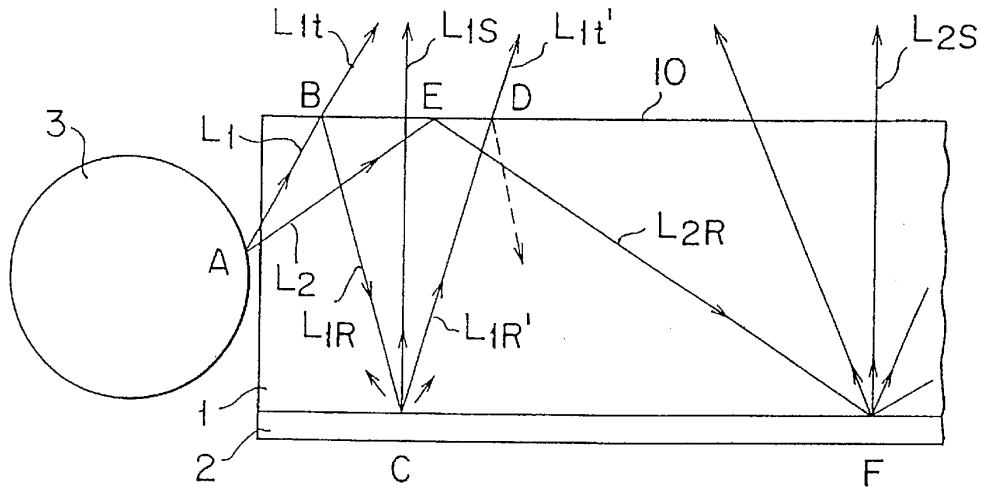

FIG. 1 PRIOR ART

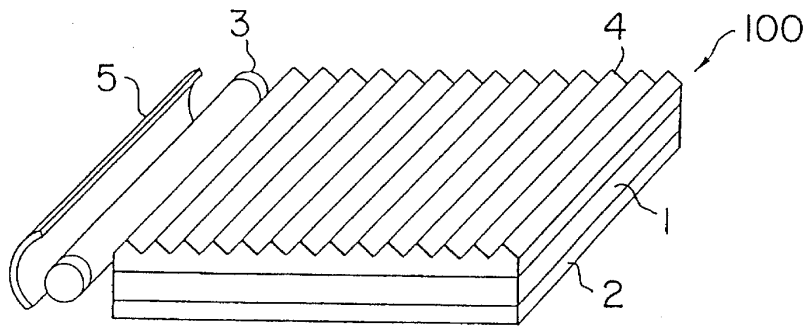

FIG. 2 PRIOR ART

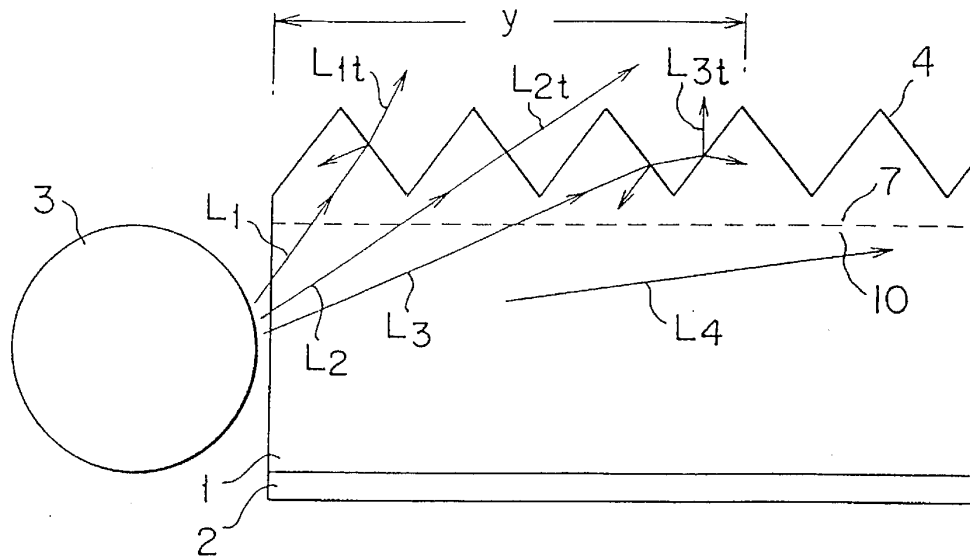

FIG. 3 PRIOR ART

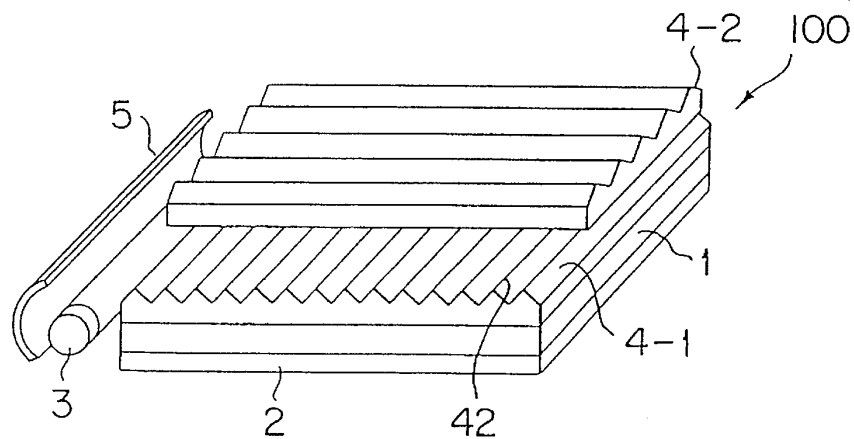

FIG. 4 PRIOR ART

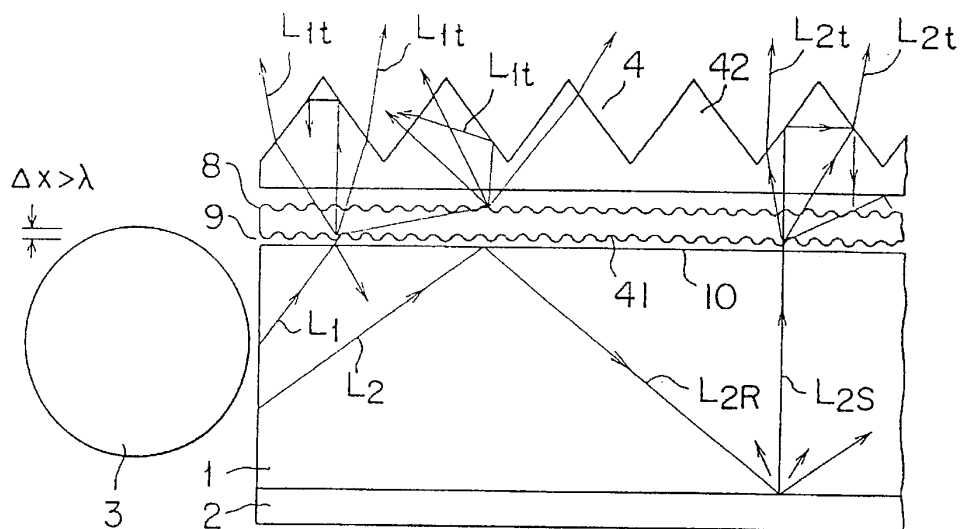

FIG. 5

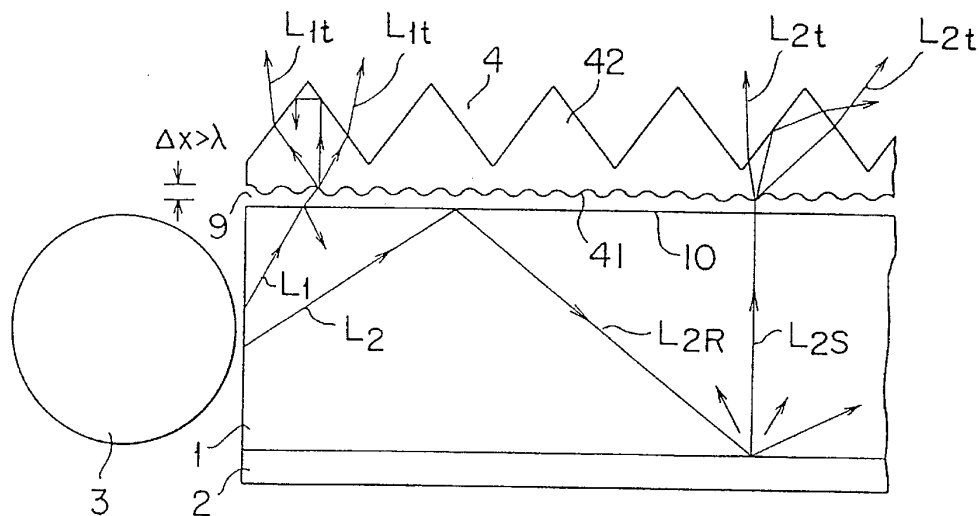

FIG. 6

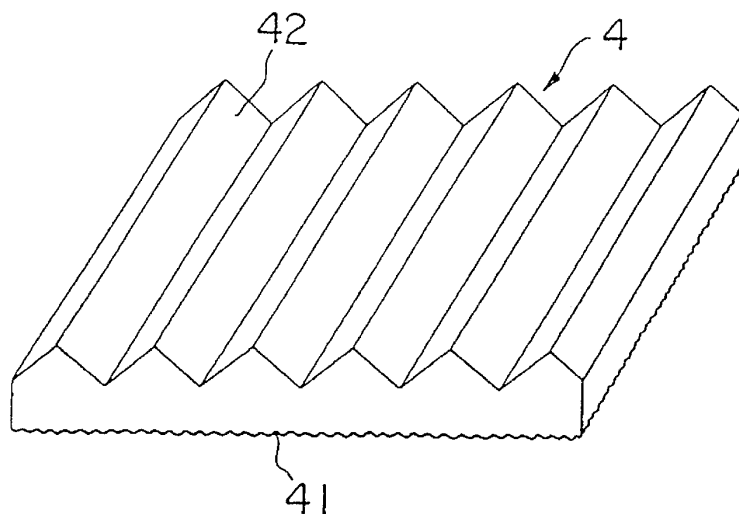

FIG. 7

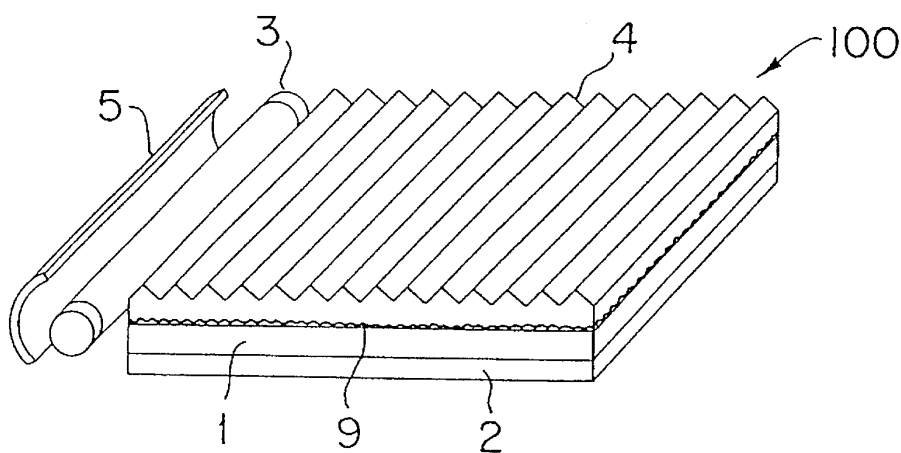

FIG. 8

Explore Litigation Insights

Docket Alarm provides insights to develop a more informed litigation strategy and the peace of mind of knowing you're on top of things.

Real-Time Litigation Alerts



Keep your litigation team up-to-date with **real-time alerts** and advanced team management tools built for the enterprise, all while greatly reducing PACER spend.

Our comprehensive service means we can handle Federal, State, and Administrative courts across the country.

Advanced Docket Research



With over 230 million records, Docket Alarm's cloud-native docket research platform finds what other services can't. Coverage includes Federal, State, plus PTAB, TTAB, ITC and NLRB decisions, all in one place.

Identify arguments that have been successful in the past with full text, pinpoint searching. Link to case law cited within any court document via Fastcase.

Analytics At Your Fingertips



Learn what happened the last time a particular judge, opposing counsel or company faced cases similar to yours.

Advanced out-of-the-box PTAB and TTAB analytics are always at your fingertips.

API

Docket Alarm offers a powerful API (application programming interface) to developers that want to integrate case filings into their apps.

LAW FIRMS

Build custom dashboards for your attorneys and clients with live data direct from the court.

Automate many repetitive legal tasks like conflict checks, document management, and marketing.

FINANCIAL INSTITUTIONS

Litigation and bankruptcy checks for companies and debtors.

E-DISCOVERY AND LEGAL VENDORS

Sync your system to PACER to automate legal marketing.