

EXHIBIT A.01
U.S. Patent No. 7,147,759

References cited herein:

- U.S. Patent No. 7,147,759 (“759 Patent”)
- D.V. Mozgrin, *et al*, High-Current Low-Pressure Quasi-Stationary Discharge in a Magnetic Field: Experimental Research, Plasma Physics Reports, Vol. 21, No. 5, 1995 (“Mozgrin”)
- A. A. Kudryavtsev, *et al*, Ionization relaxation in a plasma produced by a pulsed inert-gas discharge, Sov. Phys. Tech. Phys. 28(1), January 1983 (“Kudryavtsev”)

Claims 1-3, 5-10, 13-16, 18-20, 22-34, 37, 40-43 and 45-46, 48, 50	Mozgrin in view of Kudryavtsev
<p>[1pre.] A magnetically enhanced sputtering source comprising:</p>	<p>The combination of Mozgrin with Kudryavtsev discloses a magnetically enhanced sputtering source.</p> <p>Mozgrin 403, right col, ¶4 (“Regime 2 was characterized by intense cathode sputtering...”)</p> <p>Mozgrin at Fig. 1</p>  <p>Fig. 1. Discharge device configurations: (a) planar magnetron; (b) shaped-electrode configuration. (1) Cathode; (2) anode; (3) magnetic system.</p>
<p>[1a.] an anode;</p>	<p>The combination of Mozgrin with Kudryavtsev discloses an anode.</p>

EXHIBIT A.01
U.S. Patent No. 7,147,759

<p>Claims 1-3, 5-10, 13-16, 18-20, 22-34, 37, 40-43 and 45-46, 48, 50</p>	<p align="center">Mozgrin in view of Kudryavtsev</p>
	<p>‘759 Patent at Fig. 1</p> <p align="center">PRIOR ART FIG. 1</p> <p>‘759 Patent at Fig. 1 (“FIG. 1 illustrates a cross-sectional view of a known magnetron sputtering apparatus having a pulsed power source.”)</p> <p>‘759 Patent at 3:40-41 (“an anode 130 is positioned in the vacuum chamber 104 proximate to the cathode assembly.”)</p> <p>Mozgrin at Fig. 1</p> <p align="center">(a)</p>

EXHIBIT A.01
U.S. Patent No. 7,147,759

<p>Claims 1-3, 5-10, 13-16, 18-20, 22-34, 37, 40-43 and 45-46, 48, 50</p>	<p align="center">Mozgrin in view of Kudryavtsev</p>
	 <p>Fig. 1. Discharge device configurations: (a) planar magnetron; (b) shaped-electrode configuration. (1) Cathode; (2) anode; (3) magnetic system.</p>
<p>[1b.] a cathode assembly that is positioned adjacent to the anode, the cathode assembly including a sputtering target;</p>	<p>The combination of Mozgrin with Kudryavtsev discloses a cathode assembly that is positioned adjacent to the anode, the cathode assembly including a sputtering target.</p> <p>‘759 Patent at Fig. 1</p>  <p>‘759 Patent at 3:10-12 (“FIG. 1 illustrates a cross-sectional view of a known magnetron sputtering apparatus having a pulsed power source.”)</p>

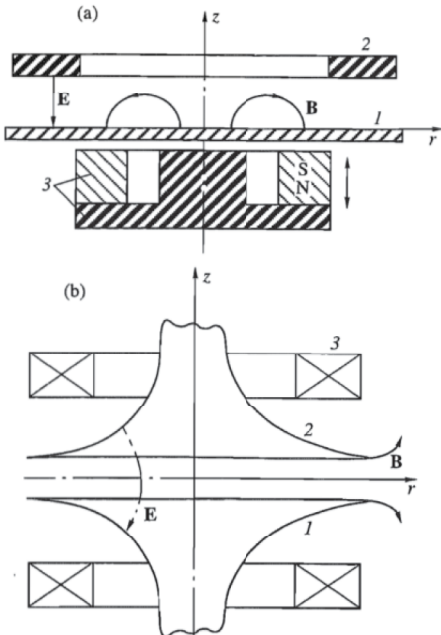
EXHIBIT A.01
U.S. Patent No. 7,147,759

<p>Claims 1-3, 5-10, 13-16, 18-20, 22-34, 37, 40-43 and 45-46, 48, 50</p>	<p align="center">Mozgrin in view of Kudryavtsev</p>
	<p>‘759 Patent at 3:23-24 (“magnetron sputtering apparatus 100 also includes a cathode assembly 114 having a target material 116.”)</p> <p>Mozgrin at 403, right col, ¶ 4 (“Regime 2 was characterized by intense cathode sputtering...”).</p> <p>Mozgrin at 403, right col, ¶ 4 (“...The pulsed deposition rate of the cathode material...”).</p> <p>Mozgrin at Fig. 1</p>  <p>Fig. 1. Discharge device configurations: (a) planar magnetron; (b) shaped-electrode configuration. (1) Cathode; (2) anode; (3) magnetic system.</p>
<p>[1c.] an ionization source that generates a weakly-ionized plasma proximate to the anode and the cathode assembly;</p>	<p>The combination of Mozgrin with Kudryavtsev discloses an ionization source that generates a weakly-ionized plasma proximate to the anode and the cathode assembly.</p> <p>‘759 Patent at 6:30-32 (“The weakly-ionized plasma is also referred to as a pre-ionized plasma.”)</p> <p>‘759 Patent at claim 32 (“wherein the peak plasma density of the weakly-ionized plasma is less than about 10^{12} cm^{-3}”).</p> <p>Mozgrin at 401, right col, ¶ 2 (“For pre-ionization, we used a stationary magnetron discharge; the discharge current ranged up to 300 mA.... We found out that only the regimes with magnetic</p>

EXHIBIT A.01
U.S. Patent No. 7,147,759

<p>Claims 1-3, 5-10, 13-16, 18-20, 22-34, 37, 40-43 and 45-46, 48, 50</p>	<p style="text-align: center;">Mozgrin in view of Kudryavtsev</p>
	<p>field strength not lower than 400 G provided the initial plasma density in the $10^9 - 10^{11} \text{ cm}^{-3}$ range.”). (emphasis added).</p> <p>Mozgrin at 401, left col, ¶ 1 (“The [plasma] discharge had an annular shape and was adjacent to the cathode.”). (emphasis added)</p> <p>Mozgrin at 402, right col, ¶ 2 (“Figure 3 shows typical voltage and current oscillograms.... Part I in the voltage oscillogram represents the voltage of the stationary discharge (pre-ionization stage).”).</p> <p>Mozgrin at Fig. 6</p>  <p>Fig. 6. High-current quasi-stationary discharge regimes. (a) planar magnetron: (1) high-current magnetron regime ($p = 5 \times 10^{-3}$ torr, Ar, $I_d = 70 \text{ A}$, $U_d = 900 \text{ V}$); (2) high-current diffuse regime ($p = 10^{-1}$ torr, Ar, $I_d = 700 \text{ A}$, $U_d = 80 \text{ V}$); (3) arc regime ($p = 10^{-1}$ torr, Ar, $I_d = 1000 \text{ A}$, $U_d = 45 \text{ V}$). (b) Shaped-electrode system: (1) high-current diffuse regime ($p = 10^{-1}$ torr, Ar, $I_d = 1000 \text{ A}$, $U_d = 90 \text{ V}$); (2) contracted arc regime ($p = 10^{-1}$ torr, Ar, $I_d = 1500 \text{ A}$, $U_d = 50 \text{ V}$).</p>
<p>[1d.] a magnet that is positioned to generate a magnetic field proximate to the weakly-ionized plasma, the magnetic field substantially</p>	<p>The combination of Mozgrin with Kudryavtsev discloses a magnet that is positioned to generate a magnetic field proximate to the weakly-ionized plasma, the magnetic field substantially trapping electrons in the weakly-ionized plasma proximate to the sputtering target.</p> <p>‘759 Patent at 3:10-12 (“FIG. 1 shows a cross-sectional view of a</p>

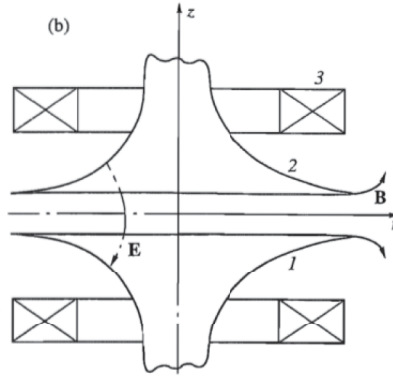
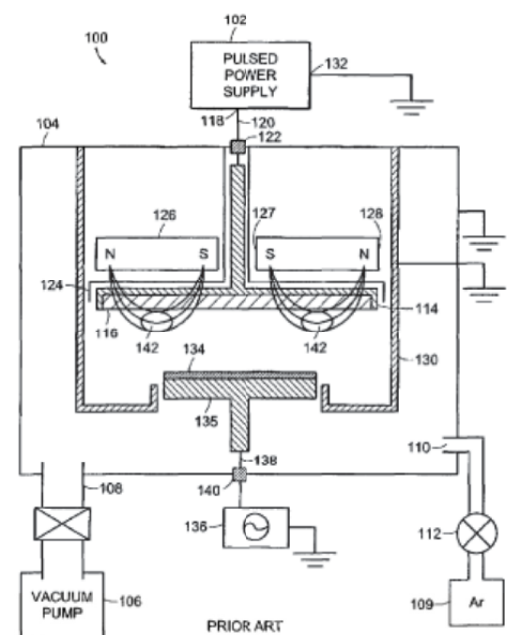
EXHIBIT A.01
U.S. Patent No. 7,147,759

<p>Claims 1-3, 5-10, 13-16, 18-20, 22-34, 37, 40-43 and 45-46, 48, 50</p>	<p align="center">Mozgrin in view of Kudryavtsev</p>
<p>trapping electrons in the weakly-ionized plasma proximate to the sputtering target; and</p>	<p>known magnetron sputtering apparatus 100...” that has a magnet 126.”)</p> <p>‘759 Patent at 4:4-10 [<i>describing the prior art Fig. 1</i>] (“The electrons, which cause ionization, are generally confined by the magnetic fields produced by the magnet 126. The magnetic confinement is strongest in a confinement region 142....”)</p> <p>Mozgrin at 401, left col, ¶ 1 (“The electrodes were immersed in a magnetic field of annular permanent magnets.”).</p> <p>Mozgrin at 401, right col, ¶2 (“We found out that only the regimes with magnetic field strength not lower than 400 G provided the initial plasma density in the 10^9-10^{11} cm⁻³ range.”).</p> <p>Mozgrin at 407, left col, ¶ 3 (“The action of the magnetic field serves only to limit the electron thermal conductivity and to provide collisions sufficient for efficient energy transfer from electrons to heavy particles.”).</p> <p>Mozgrin at Fig. 1</p>  <p>Fig. 1. Discharge device configurations: (a) planar magnetron; (b) shaped-electrode configuration. (1) Cathode; (2) anode; (3) magnetic system.</p>
<p>[1e.] a power supply</p>	<p>The combination of Mozgrin with Kudryavtsev discloses a power</p>

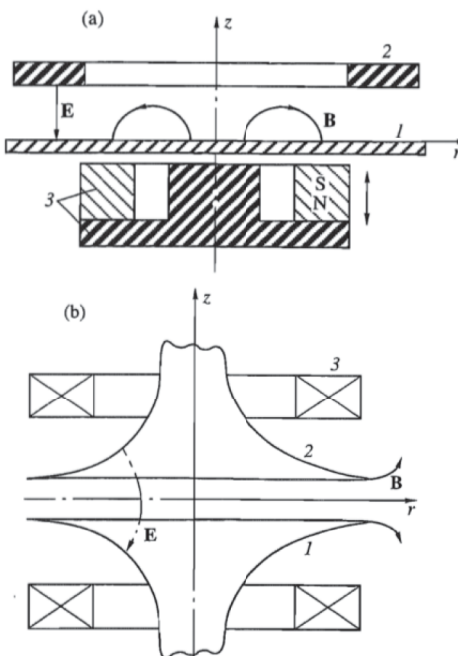
EXHIBIT A.01
U.S. Patent No. 7,147,759

<p>Claims 1-3, 5-10, 13-16, 18-20, 22-34, 37, 40-43 and 45-46, 48, 50</p>	<p style="text-align: center;">Mozgrin in view of Kudryavtsev</p>
<p>generating a voltage pulse that produces an electric field between the cathode assembly and the anode, the power supply being configured to generate the voltage pulse with an amplitude and a rise time that increases an excitation rate of ground state atoms that are present in the weakly-ionized plasma to create a multi-step ionization process that generates a strongly-ionized plasma, which comprises ions that sputter target material, from the weakly-ionized plasma, the multi-step ionization process comprising exciting the ground state atoms to generate excited atoms, and then ionizing the excited atoms within the weakly-ionized plasma without forming an arc discharge.</p>	<p>supply generating a voltage pulse that produces an electric field between the cathode assembly and the anode, the power supply being configured to generate the voltage pulse with an amplitude and a rise time that increases an excitation rate of ground state atoms that are present in the weakly-ionized plasma to create a multi-step ionization process that generates a strongly-ionized plasma, which comprises ions that sputter target material, from the weakly-ionized plasma, the multi-step ionization process comprising exciting the ground state atoms to generate excited atoms, and then ionizing the excited atoms within the weakly-ionized plasma without forming an arc discharge.</p> <p>‘759 Patent, claim 33 (“wherein the peak plasma density of the strongly-ionized plasma is greater than about 10^{12} cm^{-3}”)</p> <p>Mozgrin at Fig. 1</p>  <p>Fig. 1. Discharge device configurations: (a) planar magnetron; (b) shaped-electrode configuration. (1) Cathode; (2) anode; (3) magnetic system.</p> <p>Mozgrin at Fig. 2</p>

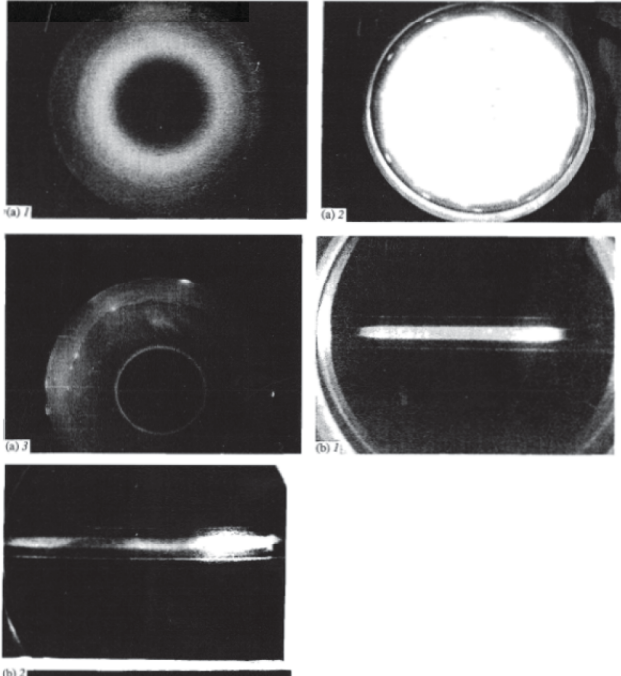
EXHIBIT A.01
U.S. Patent No. 7,147,759

**Claims 1-3, 5-10, 13-16,
 18-20, 22-34, 37, 40-43
 and 45-46, 48, 50**

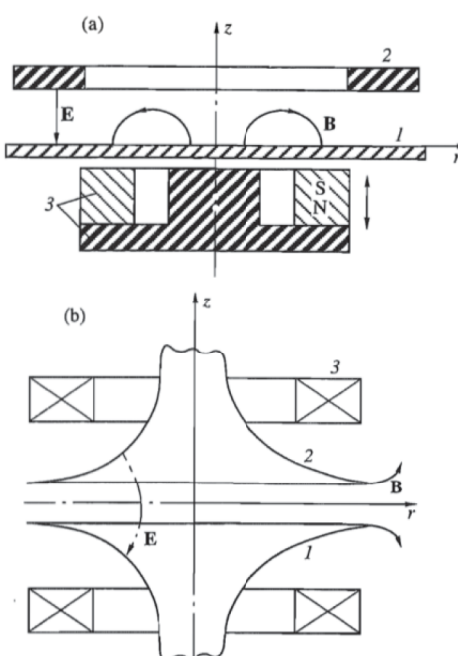
Mozgrin in view of Kudryavtsev

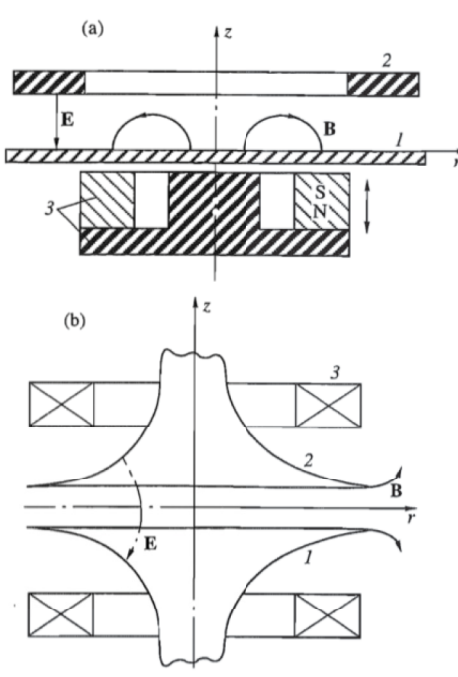
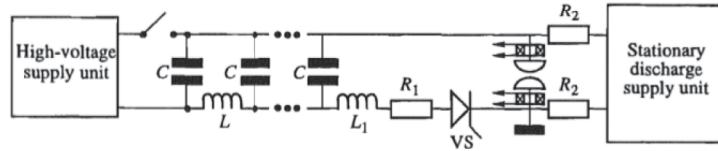

Fig. 2. Discharge supply unit.

Mozgrin at Fig. 3

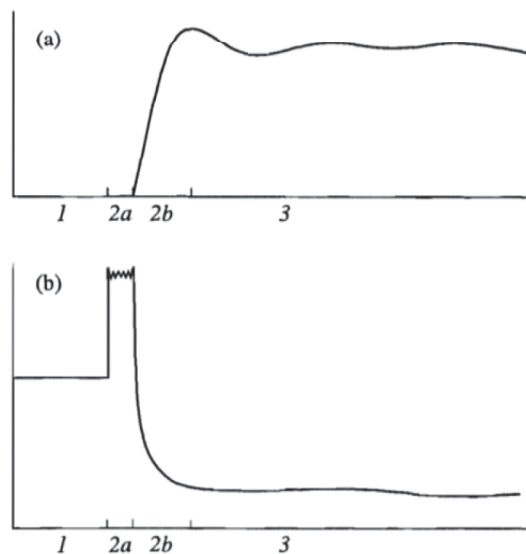

Fig. 3. Oscillograms of (a) current and (b) voltage of the quasi-stationary discharge (50 μ s per div., 180 A per div., 180 V per div.).

Mozgrin at 402, right col, ¶ 2 (“Part 1 in the voltage oscillogram represents the voltage of the stationary discharge (pre-ionization stage).”)

Mozgrin at 401, right col, ¶ 1 (“Thus, the supply unit was made providing square voltage and current pulses with [rise] times (leading edge) of 5 – 60 μ s...”).

Mozgrin 403, right col, ¶4 (“Regime 2 was characterized by intense cathode sputtering...” (emphasis added).

Mozgrin at 409, left col, ¶5 (“The high-current diffuse discharge (regime 3) is useful for producing large-volume uniform dense plasmas $n_i \cong 1.5 \times 10^{15} \text{ cm}^{-3}$...”)

Mozgrin at 401, ¶ spanning left and right columns (“Designing the [pulsed supply] unit, we took into account the dependences which had been obtained in [Kudryavtsev] of ionization relaxation on

EXHIBIT A.01
U.S. Patent No. 7,147,759

Claims 1-3, 5-10, 13-16, 18-20, 22-34, 37, 40-43 and 45-46, 48, 50	Mozgrin in view of Kudryavtsev
	<p>pre-ionization parameters, pressure, and pulse voltage amplitude.”)</p> <p>Mozgrin at 400, left col, ¶ 3 (“Some experiments on magnetron systems of various geometry showed that discharge regimes which do not transit to arcs can be obtained even at high currents.”)</p> <p>Mozgrin at 400, right col, ¶ 1 (“A further increase in the discharge currents caused the discharges to transit to the arc regimes...”).</p> <p>Mozgrin at 401, right col, ¶ 2 (“For pre-ionization ... the initial plasma density in the $10^9 - 10^{11} \text{ cm}^{-3}$ range.”)</p> <p>Mozgrin at 404, left col, ¶ 3 (“The parameters of the shaped-electrode discharge...transit to arc regime 4, could be well determined... The point of the planar-magnetron discharge transit to the arc regime was determined by discharge voltage and structure changes...”).</p> <p>Mozgrin at 404, left col, ¶ 4 (“If the current was raised above 1.8 kA or the pulse duration was increase to 2 – 10 ms, an instability development and discharge contraction was observed.”).</p> <p>Mozgrin at 409, left col, ¶ 4 (“The implementation of the high-current magnetron discharge (regime 2) in sputtering ... plasma density (exceeding $2 \times 10^{13} \text{ cm}^{-3}$).”).</p> <p>Mozgrin at Fig. 4</p> <p>Fig. 4. Current-voltage characteristic of the quasi-stationary discharge with shaped electrodes in argon, $p = 0.1$ torr; $B = 0.4$ kG.</p> <p>Mozgrin at Fig. 7</p>

EXHIBIT A.01
U.S. Patent No. 7,147,759

<p>Claims 1-3, 5-10, 13-16, 18-20, 22-34, 37, 40-43 and 45-46, 48, 50</p>	<p align="center">Mozgrin in view of Kudryavtsev</p>
	<div data-bbox="568 378 1153 724" data-label="Figure"> </div> <p>Fig. 7. Generalized ampere-voltaic characteristic CVC of quasi-stationary discharge.</p> <p>Kudryavtsev at 34, right col, ¶ 4 (“Since the effects studied in this work are characteristic of ionization whenever a field is suddenly applied to a weakly ionized gas, they must be allowed for when studying emission mechanisms in pulsed gas lasers, gas breakdown, laser sparks, etc.”)</p> <p>Kudryavtsev at Fig. 1</p> <div data-bbox="568 1123 1136 1354" data-label="Diagram"> </div> <p>FIG. 1. Diagram showing the relative sizes of the fluxes in terms of the atomic energy levels for and fast (b) stages. The width of the arrows indicates magnitude of the electron flux. The horizontal arrows indicate the diffusion fluxes of electrons and excited atoms at the walls of the discharge tube.</p> <p>Kudryavtsev at Fig. 6</p>

EXHIBIT A.01
U.S. Patent No. 7,147,759

<p>Claims 1-3, 5-10, 13-16, 18-20, 22-34, 37, 40-43 and 45-46, 48, 50</p>	<p align="center">Mozgrin in view of Kudryavtsev</p>
	<div data-bbox="576 388 1144 829" data-label="Figure"> </div> <div data-bbox="568 840 1356 955" data-label="Caption"> <p>FIG. 6. The behavior of n_e in the bulk of an argon discharge. 1) $n_{e0}/n_1 = 10^{-8}$; 2) 10^{-7}. Stepwise ionization predominates in region I, direct ionization processes predominate in region II, and n_e does not increase in region III.</p> </div> <div data-bbox="560 976 1404 1197" data-label="Text"> <p>Kudryavtsev at 31, right col, ¶ 7 (“The behavior of the increase in n_e with time thus enables us to arbitrarily divide the ionization process into two stages, which we will call the slow and fast growth stages. Fig. 1 illustrates the relationships between the main electron currents in terms of the atomic energy levels during the slow and fast stages.”).</p> </div> <div data-bbox="560 1207 1421 1428" data-label="Text"> <p>Kudryavtsev at 31, right col, ¶ 6 (“For nearly stationary n_2 [excited atom density] values ... there is an explosive increase in n_e [plasma density]. The subsequent increase in n_e then reaches its maximum value, equal to the rate of excitation [equation omitted], which is several orders of magnitude greater than the ionization rate during the initial stage.”)</p> </div> <div data-bbox="560 1438 1421 1596" data-label="Text"> <p>Kudryavtsev at Abstract (“[I]n a pulsed inert-gas discharge plasma at moderate pressures... [i]t is shown that the electron density increases explosively in time due to accumulation of atoms in the lowest excited states.”)</p> </div> <div data-bbox="560 1606 1421 1869" data-label="Text"> <p>One of ordinary skill would have been motivated to use Kudryavtsev’s fast stage of ionization in Mozgrin so as to increase plasma density and thereby increase the sputtering rate. Further, use of Kudryavtsev’s fast stage in Mozgrin would have been a combination of old elements that in which each element performed as expected to yield predictable results of increasing plasma density and multi-step ionization.</p> </div>

EXHIBIT A.01
U.S. Patent No. 7,147,759

<p>Claims 1-3, 5-10, 13-16, 18-20, 22-34, 37, 40-43 and 45-46, 48, 50</p>	<p align="center">Mozgrin in view of Kudryavtsev</p>
<p>2. The sputtering source of claim 1 wherein the power supply generates a constant power.</p>	<p>The combination of Mozgrin with Kudryavtsev discloses the power supply generates a constant power.</p> <p><i>See evidence cited in claim 1.</i></p> <p>'759 Patent at Fig. 5</p> <p>'759 Patent, 11:48-50 (“Between time t_1 and time t_2, the voltage 326, the current 328, and the power 326 remain constant...”).</p> <p>Mozgrin Fig. 3 shows constant power in region 3</p>  <p>Fig. 3. Oscillograms of (a) current and (b) voltage of the quasi-stationary discharge (50 μs per div., 180 A per div., 180 V per div.).</p>
<p>3. The sputtering source of claim 1 wherein the power supply generates a constant voltage.</p>	<p>The combination of Mozgrin with Kudryavtsev discloses the power supply generates a constant voltage.</p> <p><i>See evidence cited in claim 1.</i></p> <p>Mozgrin at Fig. 3</p>  <p>Fig. 3. Oscillograms of (a) current and (b) voltage of the quasi-stationary discharge (50 μs per div., 180 A per div., 180 V per div.).</p>

EXHIBIT A.01
U.S. Patent No. 7,147,759

<p>Claims 1-3, 5-10, 13-16, 18-20, 22-34, 37, 40-43 and 45-46, 48, 50</p>	<p align="center">Mozgrin in view of Kudryavtsev</p>
<p>5. The sputtering source of claim 1 wherein the electric field comprises a pulsed electric field.</p>	<p>The combination of Mozgrin with Kudryavtsev discloses the electric field comprises a pulsed electric field.</p> <p><i>See evidence cited in claim 1.</i></p> <p>Mozgrin at Fig. 1</p>  <p>Fig. 1. Discharge device configurations: (a) planar magnetron; (b) shaped-electrode configuration. (1) Cathode; (2) anode; (3) magnetic system.</p> <p>Mozgrin, at 403-404, right col, last paragraph of 403, left col, first paragraph of 404 (“...The current pulse ... repetition frequency was 10 Hz...”).</p> <p>Mozgrin at Fig. 3</p>  <p>Fig. 3. Oscillograms of (a) current and (b) voltage of the quasi-stationary discharge (50 μs per div., 180 A per div., 180 V per div.).</p>
<p>6. The sputtering source of claim 1 wherein the rise time of the voltage</p>	<p>The combination of Mozgrin with Kudryavtsev discloses the rise time of the voltage pulse is chosen to increase the ionization rate of the excited atoms in the weakly-ionized plasma.</p>

EXHIBIT A.01
U.S. Patent No. 7,147,759

<p>Claims 1-3, 5-10, 13-16, 18-20, 22-34, 37, 40-43 and 45-46, 48, 50</p>	<p align="center">Mozgrin in view of Kudryavtsev</p>
<p>pulse is chosen to increase the ionization rate of the excited atoms in the weakly-ionized plasma.</p>	<p><i>See</i> evidence cited in claim 1.</p> <p>Mozgrin at 401, right col, ¶ 1 (“[t]he power supply was able to deliver square voltage and current pulses with [rise] times (leading edge) of 5 – 60 μs ...”).</p> <p>Kudryavtsev at Fig. 1</p> <p align="right">FIG. 1. Diagram showing the relative sizes of fluxes in terms of the atomic energy levels for slow (a) and fast (b) stages. The width of the arrows is magnitude of the electron flux. The horizontal arrows show the diffusion fluxes of electrons and excited atoms at the walls of the discharge tube.</p>
<p>7. The sputtering source of claim 1 wherein the weakly-ionized plasma reduces the probability of developing an electrical breakdown condition between the anode and the cathode assembly.</p>	<p>The combination of Mozgrin with Kudryavtsev discloses the weakly-ionized plasma reduces the probability of developing an electrical breakdown condition between the anode and the cathode assembly.</p> <p><i>See</i> evidence cited in claim 1.</p> <p>Mozgrin at 406, right col, ¶ 3 (“pre-ionization was not necessary; however, in this case, the probability of discharge transferring to arc mode increased.”)</p>
<p>8. The sputtering source of claim 1 wherein the ions in the strongly-ionized plasma impact the surface of the sputtering target in a manner that causes substantially uniform erosion of the sputtering target.</p>	<p>The combination of Mozgrin with Kudryavtsev discloses the ions in the strongly-ionized plasma impact the surface of the sputtering target in a manner that causes substantially uniform erosion of the sputtering target.</p> <p><i>See</i> evidence cited in claim 1.</p> <p>Mozgrin at Fig. 1</p> <p>Mozgrin, at 403, left col, last ¶ (“...being transferred to the high-current regime, the discharge expands over a considerably larger area of the cathode surface than it occupied in the stationary pre-ionization regime.”).</p> <p>Mozgrin at 404, left col, ¶ 4 (“...the discharge plasma and current area were seen to expand and cover the whole cathode surface (Fig. 6).”)</p> <p>One of ordinary skill would understand that expanding the plasma increases its uniformity. One of ordinary skill in the art would understand that the plasma discharge covering a larger area of the</p>

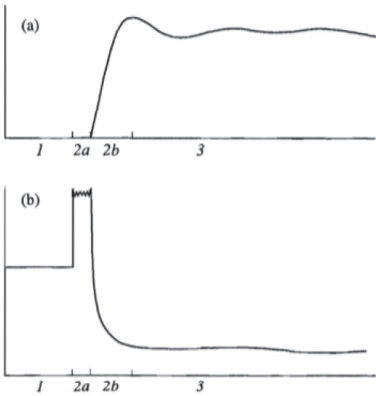
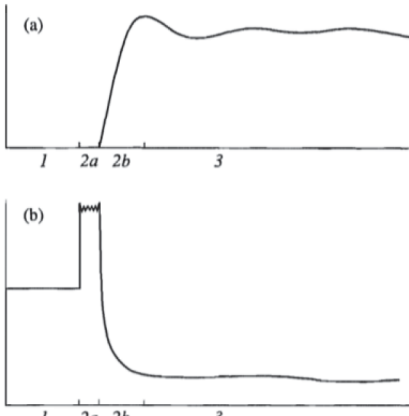
EXHIBIT A.01
U.S. Patent No. 7,147,759

<p>Claims 1-3, 5-10, 13-16, 18-20, 22-34, 37, 40-43 and 45-46, 48, 50</p>	<p style="text-align: center;">Mozgrin in view of Kudryavtsev</p>
	<p>cathode surface during sputtering would impact the surface of the sputtering target in a substantially uniform manner and lead to a substantially more uniform erosion of the sputtering target</p>
<p>9. The sputtering source of claim 1 wherein the strongly-ionized plasma is substantially uniform proximate to the sputtering target.</p>	<p>Mozgrin at Fig. 1</p> <p>Mozgrin, at 403, left col, last ¶ (“...being transferred to the high-current regime, the discharge expands over a considerably larger area of the cathode surface than it occupied in the stationary pre-ionization regime.”).</p> <p>Mozgrin at 404, left col, ¶ 4 (“...the discharge plasma and current area were seen to expand and cover the whole cathode surface (Fig. 6).”)</p> <p>One of ordinary skill would understand that expanding the plasma increases its uniformity. One of ordinary skill in the art would understand that the plasma discharge covering a larger area of the cathode surface during sputtering would impact the surface of the sputtering target in a substantially uniform manner and lead to a substantially more uniform erosion of the sputtering target</p>
<p>10. The sputtering source of claim 1 further comprising a substrate support that is positioned in a path of the sputtering flux.</p>	<p>The combination of Mozgrin with Kudryavtsev discloses a substrate support that is positioned in a path of the sputtering flux.</p> <p><i>See evidence cited in claim 1.</i></p> <p>‘759 Patent at 3:10-12 (“FIG. 1 shows a cross-sectional view of a known magnetron sputtering apparatus 100...”)</p> <p>‘759 Patent at 3:44-46 (“substrate 134 is positioned in the vacuum chamber 104 on a substrate support 135 to receive the sputtered target material 116.”)</p> <p>Mozgrin, at 403, right col, ¶ 4 (“To study sputtering, we used a probecollector placed 120 mm from the cathode. The pulsed deposition rate of cathode material (copper was used) turned out to be about 80 μm/min...”).</p>
<p>13. The sputtering source of claim 1 wherein a volume between the anode and the cathode assembly is chosen to increase the ionization rate of the excited atoms in the weakly-ionized</p>	<p>The combination of Mozgrin with Kudryavtsev discloses a volume between the anode and the cathode assembly is chosen to increase the ionization rate of the excited atoms in the weakly-ionized plasma.</p> <p><i>See evidence cited in claim 1.</i></p> <p><i>See evidence cited in claim 6.</i></p> <p>Mozgrin’s experiments were conducted in actual magnetrons with</p>

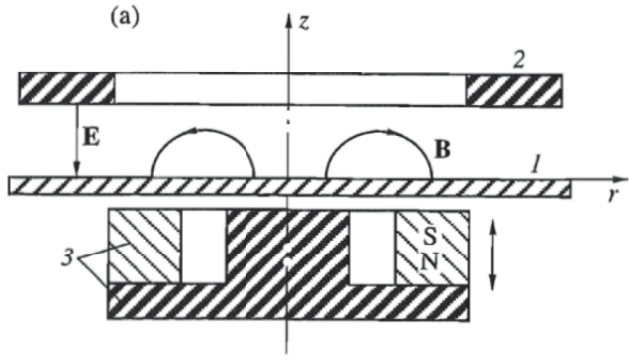
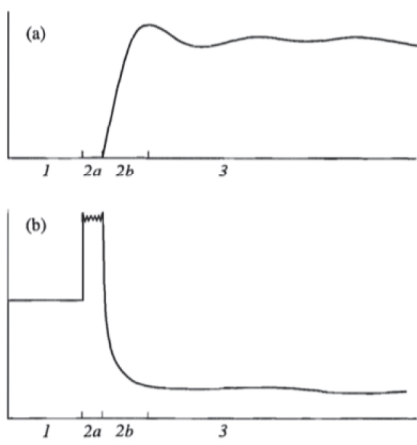
EXHIBIT A.01
U.S. Patent No. 7,147,759

<p>Claims 1-3, 5-10, 13-16, 18-20, 22-34, 37, 40-43 and 45-46, 48, 50</p>	<p>Mozgrin in view of Kudryavtsev</p>
<p>plasma.</p>	<p>an actual volume between the anode and the cathode. Mozgrin's ionization rate of excited atoms increased within that volume. Moreover, if one of ordinary skill building a system according to Mozgrin did not experience Kudryavtsev's "explosive increase" in plasma density, it would have been obvious to incorporate Kudryavtsev's fast stage into Mozgrin so as to increase plasma density and thereby increase the sputtering rate. Further, use of Kudryavtsev's fast stage in Mozgrin would have been a combination of old elements that yielded predictable results to increase plasma density and multi-step ionization.</p>
<p>14. The sputtering source of claim 1 wherein the ionization source comprises an electrode.</p>	<p>The combination of Mozgrin with Kudryavtsev discloses the ionization source comprises an electrode.</p> <p><i>See evidence cited in claim 1.</i></p> <p>Mozgrin at Fig. 1</p>  <p>Fig. 1. Discharge device configurations: (a) planar magnetron; (b) shaped-electrode configuration. (1) Cathode; (2) anode; (3) magnetic system.</p>
<p>15. The sputtering source of claim 1 wherein the ionization source comprises a DC power</p>	<p>The combination of Mozgrin with Kudryavtsev discloses the ionization source comprises a DC power supply that generates an electric field proximate to the anode and the cathode assembly.</p>

EXHIBIT A.01
U.S. Patent No. 7,147,759

<p>Claims 1-3, 5-10, 13-16, 18-20, 22-34, 37, 40-43 and 45-46, 48, 50</p>	<p align="center">Mozgrin in view of Kudryavtsev</p>
<p>supply that generates an electric field proximate to the anode and the cathode assembly.</p>	<p>See evidence cited in claim 1.</p> <p>Mozgrin at Fig. 2</p>  <p align="center">Fig. 2. Discharge supply unit.</p> <p>Mozgrin at 401, left col, ¶ 5 (“... The pre-ionization system provided direct current up to 0.3A and voltage up to 3 kV.”)</p> <p>Mozgrin at Fig. 1</p>  <p>Fig. 1. Discharge device configurations: (a) planar magnetron; (b) shaped-electrode configuration. (1) Cathode; (2) anode; (3) magnetic system.</p> <p>Mozgrin at Fig. 3</p>

EXHIBIT A.01
U.S. Patent No. 7,147,759

<p>Claims 1-3, 5-10, 13-16, 18-20, 22-34, 37, 40-43 and 45-46, 48, 50</p>	<p style="text-align: center;">Mozgrin in view of Kudryavtsev</p>
	 <p>Fig. 3. Oscillograms of (a) current and (b) voltage of the quasi-stationary discharge (50 μs per div., 180 A per div., 180 V per div.).</p>
<p>16. The sputtering source of claim 1 wherein the ionization source comprises an AC power supply that generates an electric field proximate to the anode and the cathode assembly.</p>	<p>The combination of Mozgrin with Kudryavtsev discloses the ionization source comprises an AC power supply that generates an electric field proximate to the anode and the cathode assembly.</p> <p><i>See evidence cited in claim 1.</i></p> <p>'759 Patent at 4:52-54 (“In one embodiment, the bias voltage source 214 is an alternating current (AC) power source, such as a radio frequency (RF) power source.”)</p> <p>Mozgrin at 401, left col, ¶ 4 (“The pre-ionization could be provided by RF discharge...”).</p> <p>Mozgrin at Fig. 1</p> 

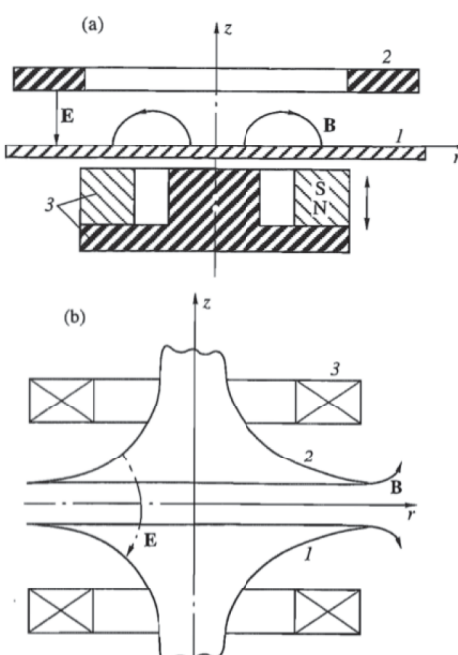
EXHIBIT A.01
U.S. Patent No. 7,147,759

<p>Claims 1-3, 5-10, 13-16, 18-20, 22-34, 37, 40-43 and 45-46, 48, 50</p>	<p>Mozgrin in view of Kudryavtsev</p>
	 <p>Fig. 1. Discharge device configurations: (a) planar magnetron; (b) shaped-electrode configuration. (1) Cathode; (2) anode; (3) magnetic system.</p>
<p>18. The sputtering source of claim 1 wherein the magnet comprises an electro-magnet.</p>	<p>The combination of Mozgrin with Kudryavtsev discloses the magnet comprises an electro-magnet.</p> <p><i>See evidence cited in claim 1.</i></p> <p>Mozgrin at 401, left col, ¶ 2 (“The system with shaped electrodes involved two axisymmetrical electrodes 120 mm in diameter separated by about 10 mm, and immersed in a cusp-shaped magnetic field produced by oppositely directed multilayer coils. The values of B_{max} were controlled by coil current variation to range from 0 to 1000 G.”).</p> <p>Mozgrin at Fig. 1</p> 

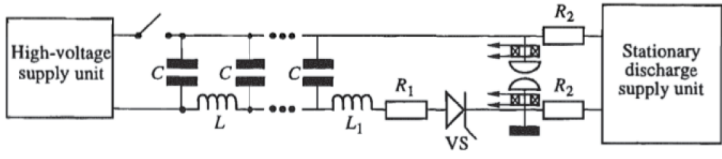
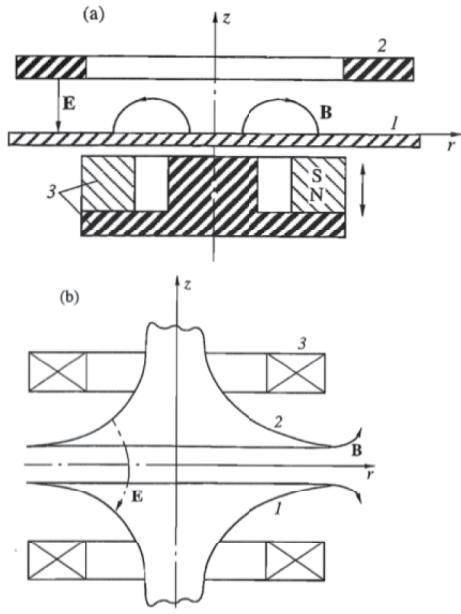
EXHIBIT A.01
U.S. Patent No. 7,147,759

<p>Claims 1-3, 5-10, 13-16, 18-20, 22-34, 37, 40-43 and 45-46, 48, 50</p>	<p style="text-align: center;">Mozgrin in view of Kudryavtsev</p>
	<p>Fig. 1. Discharge device configurations: (a) planar magnetron; (b) shaped-electrode configuration. (1) Cathode; (2) anode; (3) magnetic system.</p>
<p>19. The sputtering source of claim 1 wherein the sputtering target is formed of a material chosen from the group comprising a metallic material, a polymer material, a superconductive material, a magnetic material, a non-magnetic material, a conductive material, a non-conductive material, a composite material, a reactive material, and a refractory material.</p>	<p>The combination of Mozgrin with Kudryavtsev discloses the sputtering target is formed of a material chosen from the group comprising a metallic material, a polymer material, a superconductive material, a magnetic material, a non-magnetic material, a conductive material, a non-conductive material, a composite material, a reactive material, and a refractory material.</p> <p><i>See evidence cited in claim 1.</i></p> <p>Mozgrin at 401, left col, ¶ 1, (“The cathodes we used were made of Cu, Mo, Ti, Al, or stainless steel.”).</p>
<p>[20pre.] A method of generating sputtering flux, the method comprising:</p>	<p>The combination of Mozgrin with Kudryavtsev discloses a method of generating sputtering flux.</p> <p><i>See evidence cited in limitation [1pre] of claim 1.</i></p> <p>Mozgrin at 403, right col, ¶ 4 (“Regime 2 was characterized by intense cathode sputtering...”).</p>
<p>[20a.] ionizing a feed gas to generate a weakly-ionized plasma proximate to a sputtering target;</p>	<p>The combination of Mozgrin with Kudryavtsev discloses ionizing a feed gas to generate a weakly-ionized plasma proximate to a sputtering target.</p> <p><i>See evidence cited in limitation [1c] of claim 1.</i></p> <p>‘759 Patent at 6:30-32 (“The weakly-ionized plasma is also referred to as a pre-ionized plasma.”)</p> <p>‘759 Patent at claim 32 (“wherein the peak plasma density of the weakly-ionized plasma is less than about 10^{12} cm⁻³”)</p> <p>Mozgrin at Fig. 2</p> <p>Mozgrin at 402, right col, ¶2 (“Figure 3 shows typical voltage and</p>

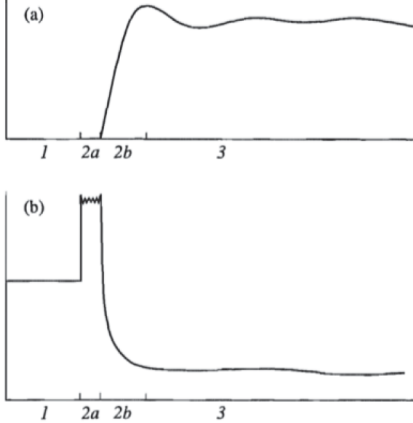
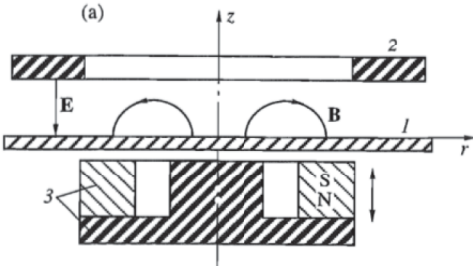
EXHIBIT A.01
U.S. Patent No. 7,147,759

Claims 1-3, 5-10, 13-16, 18-20, 22-34, 37, 40-43 and 45-46, 48, 50	Mozgrin in view of Kudryavtsev
	<p>current oscillograms.... Part I in the voltage oscillogram represents the voltage of the stationary discharge (pre-ionization stage).”)</p> <p>Mozgrin at 401, right col, ¶2 (“[f]or pre-ionization, we used a stationary magnetron discharge; ... provided the initial plasma density in the $10^9 - 10^{11} \text{ cm}^{-3}$ range.”)</p> <p>Mozgrin at 400, right col, ¶ 3 (“We investigated the discharge regimes in various gas mixtures at $10^{-3} - 10$ torr...”)</p> <p>Mozgrin at 402, ¶ spanning left and right cols (“We studied the high-current discharge in wide ranges of discharge current...and operating pressure...using various gases (Ar, N₂, SF₆, and H₂) or their mixtures of various composition...”)</p> <p>Mozgrin at 403, right col, ¶ 4 (“Regime 2 was characterized by intense cathode sputtering...”).</p>
<p>[20b.] generating a magnetic field proximate to the weakly-ionized plasma, the magnetic field substantially trapping electrons in the weakly-ionized plasma proximate to the sputtering target; and</p>	<p>The combination of Mozgrin with Kudryavtsev discloses generating a magnetic field proximate to the weakly-ionized plasma, the magnetic field substantially trapping electrons in the weakly-ionized plasma proximate to the sputtering target.</p> <p>‘759 Patent at 3:10-12 (“Fig. 1 shows a cross-sectional view of a known magnetron sputtering apparatus 100...”)</p> <p>‘759 Patent at 4:4-10 (“The electrons, which cause ionization, are generally confined by the magnetic fields produced by the magnet 126. The magnetic confinement is strongest in a confinement region 142....”)</p> <p>Mozgrin at 401, left col, ¶ 1 (“The electrodes were immersed in a magnetic field of annular permanent magnets.”)</p> <p>Mozgrin at 401, right col, ¶2 (“We found out that only the regimes with magnetic field strength not lower than 400 G provided the initial plasma density in the 10^9-10^{11} cm^{-3} range.”)</p> <p>Mozgrin at 407, left col, ¶ 3 (“The action of the magnetic field serves only to limit the electron thermal conductivity and to provide collisions sufficient for efficient energy transfer from electrons to heavy particles.”)</p>
<p>[20c.] applying a voltage pulse to the weakly-ionized plasma, an amplitude and a rise time</p>	<p>The combination of Mozgrin with Kudryavtsev discloses applying a voltage pulse to the weakly-ionized plasma, an amplitude and a rise time of the voltage pulse being chosen to increase an excitation rate of ground state atoms that are present in the</p>

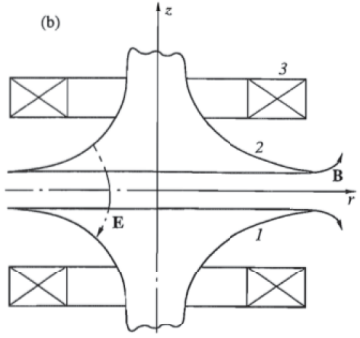
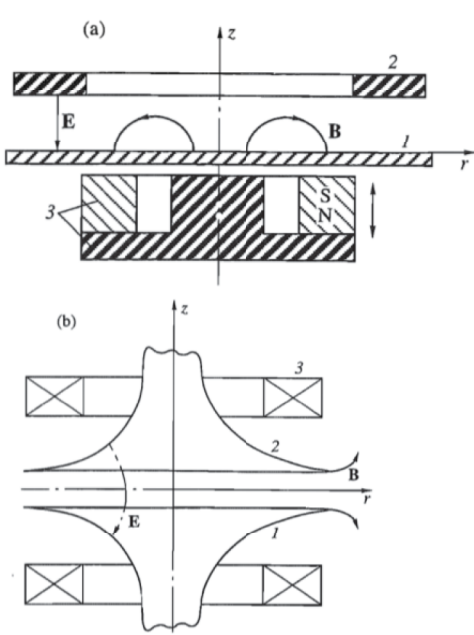
EXHIBIT A.01
U.S. Patent No. 7,147,759

<p>Claims 1-3, 5-10, 13-16, 18-20, 22-34, 37, 40-43 and 45-46, 48, 50</p>	<p style="text-align: center;">Mozgrin in view of Kudryavtsev</p>
<p>of the voltage pulse being chosen to increase an excitation rate of ground state atoms that are present in the weakly-ionized plasma to create a multi-step ionization process that generates a strongly-ionized plasma, which comprises ions that sputter target material, from the weakly-ionized plasma, the multi-step ionization process comprising exciting the ground state atoms to generate excited atoms, and then ionizing the excited atoms within the weakly-ionized plasma without forming an arc discharge.</p>	<p>weakly-ionized plasma to create a multi-step ionization process that generates a strongly-ionized plasma, which comprises ions that sputter target material, from the weakly-ionized plasma, the multi-step ionization process comprising exciting the ground state atoms to generate excited atoms, and then ionizing the excited atoms within the weakly-ionized plasma without forming an arc discharge.</p> <p>‘759 Patent, claim 33 (“wherein the peak plasma density of the strongly-ionized plasma is greater than about 10^{12} cm⁻³”)</p> <p>Mozgrin at Figs. 1, 2, 3</p> <p>Mozgrin at 402, right col, ¶ 2 (“Part 1 in the voltage oscillogram represents the voltage of the stationary discharge (pre-ionization stage).”)</p> <p>Mozgrin at 401, right col, ¶ 1 (“Thus, the supply unit was made providing square voltage and current pulses with [rise] times (leading edge) of 5 – 60 μs...”)</p> <p>Mozgrin at 401, right col, ¶2 (“For pre-ionization ... the initial plasma density in the 10^9 – 10^{11} cm⁻³ range.”)</p> <p>Mozgrin at 409, left col, ¶ 4 (“The implementation of the high-current magnetron discharge (regime 2) in sputtering ... plasma density (exceeding 2×10^{13} cm⁻³).”)</p> <p>Mozgrin at 403, right col, ¶4 (“Regime 2 was characterized by intense cathode sputtering...”)</p> <p>Mozgrin at 401, ¶ spanning left and right columns (“Designing the [pulsed supply] unit, we took into account the dependences which had been obtained in [Kudryavtsev] of ionization relaxation on pre-ionization parameters, pressure, and pulse voltage amplitude.”)</p> <p>Mozgrin at 400, left col, ¶ 3 (“Some experiments on magnetron systems of various geometry showed that discharge regimes which do not transit to arcs can be obtained even at high currents.”)</p> <p>Mozgrin at 404, left col, ¶ 3 (“The parameters of the shaped-electrode discharge...transit to arc regime 4, could be well determined... The point of the planar-magnetron discharge transit to the arc regime was determined by discharge voltage and structure changes...”)</p>

EXHIBIT A.01
U.S. Patent No. 7,147,759

Claims 1-3, 5-10, 13-16, 18-20, 22-34, 37, 40-43 and 45-46, 48, 50	Mozgrin in view of Kudryavtsev
	<p>Kudryavtsev at Figs. 1, 6</p> <p>Kudryavtsev at 34, right col, ¶ 4 (“Since the effects studied in this work are characteristic of ionization whenever a field is suddenly applied to a weakly ionized gas, they must be allowed for when studying emission mechanisms in pulsed gas lasers, gas breakdown, laser sparks, etc.”)</p> <p>Kudryavtsev at 31, right col, ¶ 7 (“The behavior of the increase in n_e with time thus enables us to arbitrarily divide the ionization process into two stages, which we will call the slow and fast growth stages. Fig. 1 illustrates the relationships between the main electron currents in terms of the atomic energy levels during the slow and fast stages.”)</p> <p>Kudryavtsev at 31, right col, ¶ 6 (“For nearly stationary n_2 [excited atom density] values ... there is an explosive increase in n_e [plasma density]. The subsequent increase in n_e then reaches its maximum value, equal to the rate of excitation [equation omitted], which is several orders of magnitude greater than the ionization rate during the initial stage.”)</p> <p>Because Mozgrin applies voltage pulses that “suddenly generate an electric field,” one of ordinary skill reading Mozgrin would have been motivated to consider Kudryavtsev to better understand the effects of applying Mozgrin’s pulse.</p> <p>If one of ordinary skill building a system according to Mozgrin did not experience Kudryavtsev’s “explosive increase” in plasma density, it would have been obvious to adjust the operating parameters, e.g., increase the pulse length and/or pressure, so as to trigger Kudryavtsev’s fast stage of ionization. One of ordinary skill would have been motivated to use Kudryavtsev’s fast stage of ionization in Mozgrin so as to increase plasma density and thereby increase the sputtering rate. Further, use of Kudryavtsev’s fast stage in Mozgrin would have been a combination of old elements that in which each element performed as expected to yield predictable results of increasing plasma density and multi-step ionization. Finally, because Mozgrin’s pulse, or the pulse used in the combination of Mozgrin and Kudryavtsev, produced Kudryavtsev’s fast stage of ionization, the rise time and amplitude of the pulse result in increasing the ionization rate of excited atoms and creation of a multi-step ionization process.</p>
22. The method of claim	The combination of Mozgrin with Kudryavtsev discloses the

EXHIBIT A.01
U.S. Patent No. 7,147,759

<p>Claims 1-3, 5-10, 13-16, 18-20, 22-34, 37, 40-43 and 45-46, 48, 50</p>	<p align="center">Mozgrin in view of Kudryavtsev</p>
<p>20 wherein the applying the electric field comprises applying a substantially uniform electric field.</p>	<p>applying the electric field comprises applying a substantially uniform electric field.</p> <p><i>See evidence cited in claim 20.</i></p> <p>Mozgrin at Fig. 1.</p>  <p>Fig. 1. Discharge device configurations: (a) planar magnetron; (b) shaped-electrode configuration. (1) Cathode; (2) anode; (3) magnetic system.</p>
<p>23. The method of claim 20 wherein the applying the electric field comprises applying an electrical pulse across the weakly-ionized plasma.</p>	<p>The combination of Mozgrin with Kudryavtsev discloses the applying the electric field comprises applying an electrical pulse across the weakly-ionized plasma.</p> <p><i>See evidence cited in claim 20.</i></p> <p>Mozgrin at Fig. 1.</p>  <p>Fig. 1. Discharge device configurations: (a) planar magnetron; (b) shaped-electrode configuration. (1) Cathode; (2) anode; (3) magnetic system.</p> <p>Mozgrin at Fig. 3.</p>

EXHIBIT A.01
U.S. Patent No. 7,147,759

<p>Claims 1-3, 5-10, 13-16, 18-20, 22-34, 37, 40-43 and 45-46, 48, 50</p>	<p style="text-align: center;">Mozgrin in view of Kudryavtsev</p>
	 <p>Fig. 3. Oscillograms of (a) current and (b) voltage of the quasi-stationary discharge (50 μs per div., 180 A per div., 180 V per div.).</p>
<p>24. The method of claim 23 further comprising selecting at least one of a pulse amplitude and a pulse width of the electrical pulse that increases an ionization rate of the strongly-ionized plasma.</p>	<p>The combination of Mozgrin with Kudryavtsev discloses selecting at least one of a pulse amplitude and a pulse width of the electrical pulse that increases an ionization rate of the strongly-ionized plasma.</p> <p><i>See evidence cited in claim 23.</i></p> <p><i>See evidence cited in claim 20.</i></p> <p>Mozgrin at 409, left col, ¶¶ 4-5 (“The implementation of the high-current magnetron discharge (regime 2)...provides an enhancement in...plasma density (exceeding $2 \times 10^{13} \text{ cm}^{-3}$)... The high-current diffuse discharge (regime 3) is useful for producing large-volume uniform dense plasmas $n_i \cong 1.5 \times 10^{15} \text{ cm}^{-3}$...”).</p>
<p>25. The method of claim 23 further comprising selecting at least one of a pulse amplitude and a pulse width of the electrical pulse that reduces a probability of developing an electrical breakdown condition proximate to the sputtering target.</p>	<p>The combination of Mozgrin with Kudryavtsev discloses selecting at least one of a pulse amplitude and a pulse width of the electrical pulse that reduces a probability of developing an electrical breakdown condition proximate to the sputtering target.</p> <p><i>See evidence cited in claim 23.</i></p> <p>Mozgrin at 404, left col, ¶ 4 (“The parameters of the shaped-electrode discharge transit to regime 3, as well as the conditions of its transit to arc regime 4, could be well determined for every given set of the discharge parameters. The point of the planar-magnetron discharge transit to the arc regime was determined by discharge voltage...If the discharge current or pulse duration were increased, the instability development accompanied by the plasma column contraction and the occurrence of one of several cathode</p>

EXHIBIT A.01
U.S. Patent No. 7,147,759

<p>Claims 1-3, 5-10, 13-16, 18-20, 22-34, 37, 40-43 and 45-46, 48, 50</p>	<p>Mozgrin in view of Kudryavtsev</p>
	<p>spots were also observed in the planar magnetron.”).</p> <p>Mozgrin at 403, left col, ¶ 2 (“We studied regimes 2 and 3 [which do not arc] separately to determine the boundary parameters of their occurrence, such as current, voltage, pressure, and magnetic field.”).</p>
<p>26. The method of claim 23 further comprising selecting at least one of a pulse amplitude and a pulse width of the electrical pulse that causes the strongly-ionized plasma to be substantially uniform in an area adjacent to a surface of the sputtering target.</p>	<p>The combination of Mozgrin with Kudryavtsev discloses selecting at least one of a pulse amplitude and a pulse width of the electrical pulse that causes the strongly-ionized plasma to be substantially uniform in an area adjacent to a surface of the sputtering target.</p> <p><i>See evidence cited in 9.</i></p> <p><i>See evidence cited in claim 23.</i></p> <p><i>See evidence cited in claim 20.</i></p> <p>Mozgrin, at 403, left col, last ¶ (“...being transferred to the high-current regime, the discharge expands over a considerably larger area of the cathode surface than it occupied in the stationary pre-ionization regime.”).</p> <p>Mozgrin at 404, left col, ¶ 4 (“...the discharge plasma and current area were seen to expand and cover the whole cathode surface (Fig. 6).”).</p> <p>Mozgrin at Fig. 3</p>  <p style="font-size: small;">Fig. 3. Oscillograms of (a) current and (b) voltage of the quasi-stationary discharge (50 μs per div., 180 A per div., 180 V per div.).</p> <p>One of ordinary skill in the art would understand that the plasma discharge covering a larger area of the cathode surface during</p>

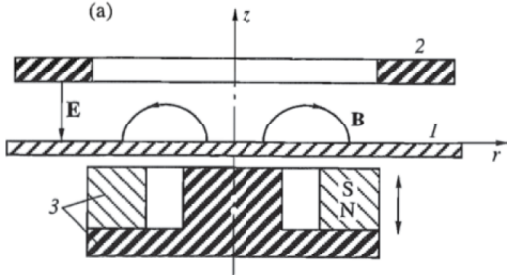
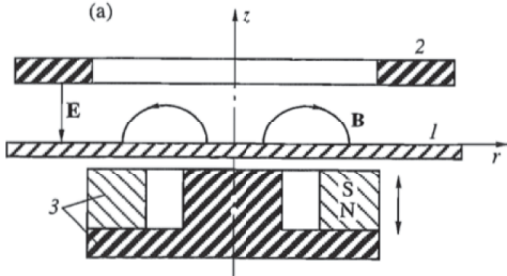
EXHIBIT A.01
U.S. Patent No. 7,147,759

Claims 1-3, 5-10, 13-16, 18-20, 22-34, 37, 40-43 and 45-46, 48, 50	Mozgrin in view of Kudryavtsev
	sputtering would impact the surface of the sputtering target in a substantially uniform manner and lead to a substantially more uniform erosion of the sputtering target.
27. The method of claim 23 wherein the electrical pulse comprises a pulse having a current density that is greater than 1 A/cm ² .	<p>The combination of Mozgrin with Kudryavtsev discloses the electrical pulse comprises a pulse having a current density that is greater than 1 A/cm².</p> <p><i>See evidence cited in claim 23.</i></p> <p>Mozgrin at 403, left col, ¶ 4 (“Figure 5a exhibits representative CVC of the high-current magnetron discharge [region 2]... Then the discharge transferred to region 3 or the arc regime... the current of transition amounted to 250 A, which corresponded to 25 A/cm² cathode current density <i>j</i>.”).</p>
28. The method of claim 23 wherein the electrical pulse comprises a pulse having a pulse width that is greater than 1.0 microseconds.	<p>The combination of Mozgrin with Kudryavtsev discloses the electrical pulse comprises a pulse having a pulse width that is greater than 1.0 microseconds.</p> <p><i>See evidence cited in claim 23.</i></p> <p>Mozgrin at 400, right col, ¶ 3 (“We investigated...pulse durations exceeding 1 ms.”)</p> <p>Mozgrin at 401, right col, ¶ 1 (“the supply unit was made providing square voltage and current pulses with...durations of as much as 1.5 ms.”)</p>
29. The method of claim 23 wherein the electrical pulse comprises a pulse train having a repetition rate that is substantially between 0.1 Hz and 1 kHz.	<p>The combination of Mozgrin with Kudryavtsev discloses the electrical pulse comprises a pulse train having a repetition rate that is substantially between 0.1 Hz and 1 kHz.</p> <p><i>See evidence cited in claim 23.</i></p> <p>Mozgrin at ¶ spanning 403-404 (“The current pulse repetition frequency ...was 10Hz.”)</p>
30. The method of claim 20 wherein the ions in the strongly-ionized	The combination of Mozgrin with Kudryavtsev discloses the ions in the strongly-ionized plasma impact the surface of the sputtering target in a substantially uniform manner.

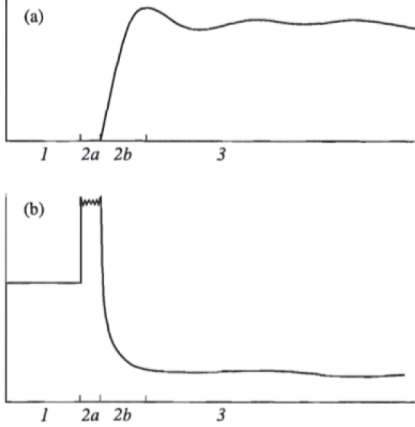
EXHIBIT A.01
U.S. Patent No. 7,147,759

Claims 1-3, 5-10, 13-16, 18-20, 22-34, 37, 40-43 and 45-46, 48, 50	Mozgrin in view of Kudryavtsev
plasma impact the surface of the sputtering target in a substantially uniform manner.	<p><i>See</i> evidence cited in claim 8.</p> <p><i>See</i> evidence cited in claim 20.</p> <p><i>See</i> evidence cited in claim 26.</p>
31. The method of claim 20 wherein the strongly-ionized plasma is substantially uniform proximate to the sputtering target.	<p>The combination of Mozgrin with Kudryavtsev discloses the strongly-ionized plasma is substantially uniform proximate to the sputtering target.</p> <p><i>See</i> evidence cited in claim 20.</p> <p><i>See</i> evidence cited in claim 26.</p> <p><i>See</i> evidence cited in claim 9.</p>
32. The method of claim 20 wherein the peak plasma density of the weakly-ionized plasma is less than about 10^{12} cm^{-3} .	<p>The combination of Mozgrin with Kudryavtsev discloses the peak plasma density of the weakly-ionized plasma is less than about 10^{12} cm^{-3}.</p> <p><i>See</i> evidence cited in claim 20.</p> <p>Mozgrin at 401, right col. ¶ 2 (“For pre-ionization, ... the initial plasma density [is] in the $10^9 - 10^{11} \text{ cm}^{-3}$ range....”).</p>
33. The method of claim 20 wherein the peak plasma density of the strongly-ionized plasma is greater than about 10^{12} cm^{-3} .	<p>The combination of Mozgrin with Kudryavtsev discloses the peak plasma density of the strongly-ionized plasma is greater than about 10^{12} cm^{-3}.</p> <p><i>See</i> evidence cited in claim 20.</p> <p>Mozgrin at 409, left col, ¶ 4 (emphasis added) (“The implementation of the high-current magnetron discharge (regime 2) in sputtering ... plasma density (exceeding $2 \times 10^{13} \text{ cm}^{-3}$).”)</p> <p>Mozgrin at 409, left col, ¶ 5 (“The high-current diffuse discharge (regime 3) is useful for producing large-volume uniform dense plasmas $n_i \cong 1.5 \times 10^{15} \text{ cm}^{-3}$...”)</p>
34. The method of claim 20 further comprising forming a film on a surface of a substrate	<p>The combination of Mozgrin with Kudryavtsev discloses forming a film on a surface of a substrate from the material sputtered from the sputtering target.</p>

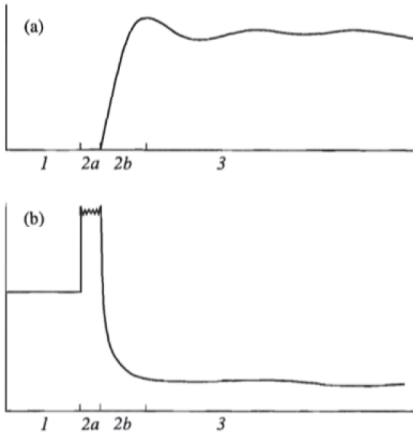
EXHIBIT A.01
U.S. Patent No. 7,147,759

<p>Claims 1-3, 5-10, 13-16, 18-20, 22-34, 37, 40-43 and 45-46, 48, 50</p>	<p>Mozgrin in view of Kudryavtsev</p>
<p>from the material sputtered from the sputtering target.</p>	<p><i>See evidence cited in claim 20.</i></p> <p>‘759 Patent at 3:10-12 (“FIG. 1 shows a cross-sectional view of a known magnetron sputtering apparatus 100...”)</p> <p>‘759 Patent at 3:44-46 (“substrate 134 is positioned in the vacuum chamber 104 on a substrate support 135 to receive the sputtered target material 116.”)</p> <p>Mozgrin, at 403, right col, ¶ 4 (“To study sputtering, we used a probecollector placed 120 mm from the cathode.”).</p>
<p>37. The method of claim 20 wherein the ionizing the feed gas comprises exposing the feed gas to an electric field.</p>	<p>The combination of Mozgrin with Kudryavtsev discloses the ionizing the feed gas comprises exposing the feed gas to an electric field.</p> <p><i>See evidence cited in claim 20.</i></p> <p>Mozgrin at 401, left col, ¶ 4 (“... applying a square voltage pulse to the discharge gap which was filled up with either neutral or pre-ionized gas.”)</p> <p>Mozgrin at Fig. 1</p>  <p>Fig. 1. Discharge device configurations: (a) planar magnetron; (b) shaped-electrode configuration. (1) Cathode; (2) anode; (3) magnetic system.</p>
<p>[40pre.] A magnetically enhanced sputtering source comprising:</p>	<p>The combination of Mozgrin with Kudryavtsev discloses a magnetically enhanced sputtering source.</p> <p><i>See evidence cited in limitation [1pre] of claim 1.</i></p> <p>Mozgrin at 403, right col, ¶ 4 (“Regime 2 was characterized by intense cathode sputtering...”).</p>
<p>[40a.] means for ionizing a feed gas to generate a weakly-ionized plasma</p>	<p>The combination of Mozgrin with Kudryavtsev discloses means for ionizing a feed gas to generate a weakly-ionized plasma</p>

EXHIBIT A.01
U.S. Patent No. 7,147,759

Claims 1-3, 5-10, 13-16, 18-20, 22-34, 37, 40-43 and 45-46, 48, 50	Mozgrin in view of Kudryavtsev
<p>proximate to a sputtering target;</p>	<p>proximate to a sputtering target.</p> <p><u>Claimed function</u></p> <p>Claim 40 recites “means for ionizing a feed gas to generate a weakly-ionized plasma proximate to a sputtering target.”</p> <p>The combination of Mozgrin and Kudryavtsev teach the function corresponding to the “means for ionizing...” limitation.</p> <p>‘759 Patent at 6:30-32 (“The weakly-ionized plasma is also referred to as a pre-ionized plasma.”)</p> <p>‘759 Patent at claim 32 (“wherein the peak plasma density of the weakly-ionized plasma is less than about 10^{12} cm⁻³”)</p> <p>Mozgrin at 401, right col, ¶2 (“[f]or pre-ionization, we used a stationary magnetron discharge; ... provided the initial plasma density in the $10^9 - 10^{11}$ cm⁻³ range.”)</p> <p>Mozgrin at 400, right col, ¶ 3 (“We investigated the discharge regimes in various gas mixtures at $10^{-3} - 10$ torr...”)</p> <p>Mozgrin at 403, right col, ¶ 4 (“Regime 2 was characterized by intense cathode sputtering...”).</p> <p>Mozgrin at 402, ¶ spanning left and right cols (“We studied the high-current discharge in wide ranges of discharge current...and operating pressure...using various gases (Ar, N₂, SF₆, and H₂) or their mixtures of various composition...”)</p> <p>Mozgrin at 402, right col, ¶2 (“Figure 3 shows typical voltage and current oscillograms.... Part I in the voltage oscillogram represents the voltage of the stationary discharge (pre-ionization stage).”)</p> <p><u>Corresponding structure</u></p> <p>The ‘759 Patent discloses the following structure that corresponds to the “means for ionizing...” limitation:</p> <p>a power supply (e.g., 456), generating the voltage, current and power values shown in Fig. 5 (e.g., between $t_1 - t_2$ and $t_6 - t_7$), that is electrically coupled to an anode (e.g., 238), a cathode assembly (e.g., 216), and/or an electrode (e.g., 452, 452’, 452”) wherein the anode, cathode assembly, and/or electrode are arranged relative to a sputtering target as shown in Figs. 2, 3, 7, 9A-9C, 10 and 11 and as described in the text of the ‘759 Patent at 4:57-65, 6:53-7:8, 8:40-46, 11:39-12:6, 12:39-46, 15:7-15, 15:35-44, 17:19-18:15,</p>

EXHIBIT A.01
U.S. Patent No. 7,147,759

<p>Claims 1-3, 5-10, 13-16, 18-20, 22-34, 37, 40-43 and 45-46, 48, 50</p>	<p align="center">Mozgrin in view of Kudryavtsev</p>
	<p>18:35-49, and 18:58-19:30</p> <p>The combination of Mozgrin and Kudryavstev discloses the structure corresponding to the “means for ionizing...” limitation. For example:</p> <p>Mozgrin at Fig. 2</p>  <p align="center">Fig. 2. Discharge supply unit.</p>  <p align="center">Fig. 3(b) of Mozgrin</p>  <p align="center">Fig. 5 of '759 Patent</p>

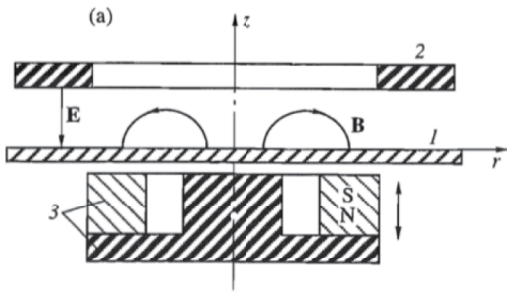
EXHIBIT A.01
U.S. Patent No. 7,147,759

<p>Claims 1-3, 5-10, 13-16, 18-20, 22-34, 37, 40-43 and 45-46, 48, 50</p>	<p align="center">Mozgrin in view of Kudryavtsev</p>
	<div style="display: flex; justify-content: space-around; align-items: flex-start;"> <div style="text-align: center;">  <p>Fig. 1 of Mozgrin</p> </div> <div style="text-align: center;">  <p>Fig. 3 of '759 Patent</p> </div> </div> <p>Any difference between Mozgrin's and the '759 Patent's mechanical arrangement of the anode and cathode is nothing more than the mechanical rearrangement of well-known components. Rearranging Mozgrin's components to match that of the '759 Patent would be obvious to one of ordinary skill</p>
<p>[40b.] means for generating a magnetic field proximate to the weakly-ionized plasma, the magnetic field substantially trapping electrons in the weakly-ionized plasma proximate to the sputtering target; and</p>	<p>The combination of Mozgrin with Kudryavtsev discloses means for generating a magnetic field proximate to the weakly-ionized plasma, the magnetic field substantially trapping electrons in the weakly-ionized plasma proximate to the sputtering target.</p> <p><u>Claimed function</u></p> <p>Claim 40 recites “means for generating a magnetic field proximate to the weakly-ionized plasma, the magnetic field substantially trapping electrons in the weakly-ionized plasma proximate to the sputtering target.”</p> <p>The combination of Mozgrin and Kudryavtsev teach the function corresponding to the “means for generating...” limitation.</p> <p>'759 Patent at 3:10-12 (“FIG. 1 shows a cross-sectional view of a known magnetron sputtering apparatus 100...” that has a magnet 126.)</p> <p>'759 Patent at 4:4-10 (“The electrons, which cause ionization, are generally confined by the magnetic fields produced by the magnet 126. The magnetic confinement is strongest in a confinement region 142....”)</p> <p>Mozgrin at Fig. 1</p> <p>Mozgrin at 401, left col, ¶ 1 (“The electrodes were immersed in a magnetic field of annular permanent magnets.”)</p> <p>Mozgrin at 401, right col, ¶ 2 (“We found out that only the regimes</p>

EXHIBIT A.01
U.S. Patent No. 7,147,759

<p>Claims 1-3, 5-10, 13-16, 18-20, 22-34, 37, 40-43 and 45-46, 48, 50</p>	<p align="center">Mozgrin in view of Kudryavtsev</p>
	<p>with magnetic field strength not lower than 400 G provided the initial plasma density in the 10^9-10^{11} cm⁻³ range.”)</p> <p>Mozgrin at 407, left col, ¶ 3 (“The action of the magnetic field serves only to limit the electron thermal conductivity and to provide collisions sufficient for efficient energy transfer from electrons to heavy particles.”)</p> <p><u>Corresponding structure</u></p> <p>The ‘759 Patent discloses the following structure that corresponds to the “means for generating...”</p> <p>magnet assembly 252 arranged as shown in Figs. 2, 3, 6A-6D, 7, 10 and 11 and as described in the text of the ‘759 Patent at 5:58-6:21, 8:46-50, 12:62-14:65, and 15:29-33</p> <p>‘759 Patent at 12:62-66 (“FIG. 6A through FIG. 6D illustrate various simulated magnetic field distributions ... in the magnetron sputtering apparatus 200 of FIG. 2.”)</p> <p>The combination of Mozgrin and Kudryavstev discloses the structure corresponding to the “means for generating...” limitation. For example:</p> <p>Mozgrin at Fig. 1</p>  <p>Fig. 1 of Mozgrin</p>  <p align="center">FIG. 6A</p> <p>Fig. 6A of ‘759 Patent</p>

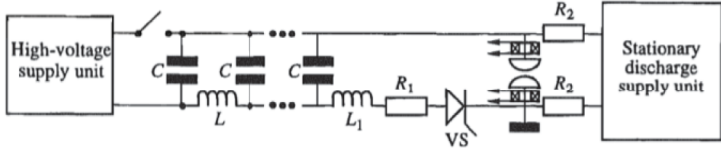
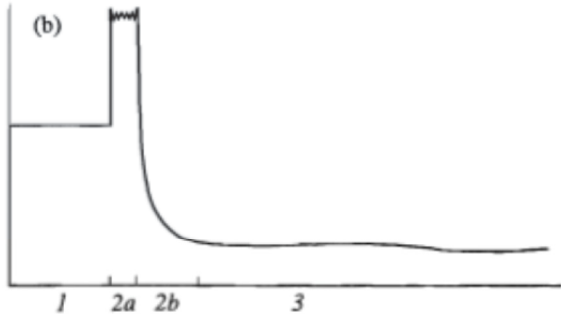
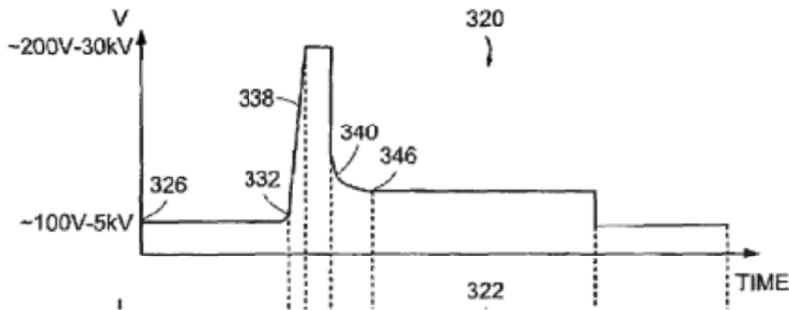
EXHIBIT A.01
U.S. Patent No. 7,147,759

<p>Claims 1-3, 5-10, 13-16, 18-20, 22-34, 37, 40-43 and 45-46, 48, 50</p>	<p style="text-align: center;">Mozgrin in view of Kudryavtsev</p>
<p>[40c.] means for applying a voltage pulse to the weakly-ionized plasma, an amplitude and a rise time of the voltage pulse being chosen to increase an excitation rate of ground state atoms that are present in the weakly-ionized plasma to create a multi-step ionization process that generates a strongly-ionized plasma from the weakly-ionized plasma, the multi-step ionization process comprising exciting the ground state atoms to generate excited atoms, and then ionizing the excited atoms within the weakly-ionized plasma, without forming an arc discharge, to ions that sputter target material from the sputtering target.</p>	<p>The combination of Mozgrin with Kudryavtsev discloses means for applying a voltage pulse to the weakly-ionized plasma, an amplitude and a rise time of the voltage pulse being chosen to increase an excitation rate of ground state atoms that are present in the weakly-ionized plasma to create a multi-step ionization process that generates a strongly-ionized plasma from the weakly-ionized plasma, the multi-step ionization process comprising exciting the ground state atoms to generate excited atoms, and then ionizing the excited atoms within the weakly-ionized plasma, without forming an arc discharge, to ions that sputter target material from the sputtering target.</p> <p><u>Claimed function</u></p> <p>Claim 40 recites “means for applying a voltage pulse to the weakly-ionized plasma, an amplitude and a rise time of the voltage pulse being chosen to increase an excitation rate of ground state atoms that are present in the weakly-ionized plasma to create a multi-step ionization process that generates a strongly-ionized plasma from the weakly-ionized plasma, the multi-step ionization process comprising exciting the ground state atoms to generate excited atoms, and then ionizing the excited atoms within the weakly-ionized plasma, without forming an arc discharge, to ions that sputter target material from the sputtering target.”</p> <p>The combination of Mozgrin and Kudryavtsev teach the function corresponding to the “means for applying...” limitation.</p> <p>‘759 Patent, claim 33 (“wherein the peak plasma density of the strongly-ionized plasma is greater than about 10^{12} cm^{-3}”)</p> <p>Mozgrin at Figs. 1, 2, 3</p> <p>Mozgrin at 402, right col, ¶ 2 (“Part 1 in the voltage oscillogram represents the voltage of the stationary discharge (pre-ionization stage).”)</p> <p>Mozgrin at 401, right col, ¶ 1 (“Thus, the supply unit was made providing square voltage and current pulses with [rise] times (leading edge) of 5 – 60 μs...”)</p> <p>Mozgrin at 401, right col, ¶2 (“For pre-ionization ... the initial plasma density in the $10^9 - 10^{11} \text{ cm}^{-3}$ range.”)</p> <p>Mozgrin at 409, left col, ¶ 4 (“The implementation of the high-current magnetron discharge (regime 2) in sputtering ... plasma</p>

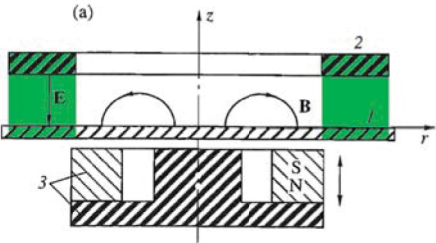
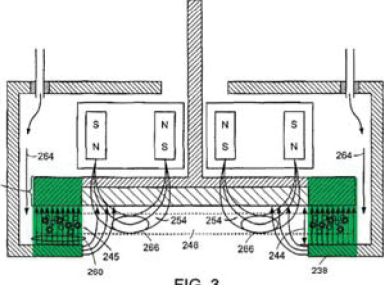
EXHIBIT A.01
U.S. Patent No. 7,147,759

Claims 1-3, 5-10, 13-16, 18-20, 22-34, 37, 40-43 and 45-46, 48, 50	Mozgrin in view of Kudryavtsev
	<p>density (exceeding $2 \times 10^{13} \text{ cm}^{-3}$).”)</p> <p>Mozgrin at 403, right col, ¶4 (“Regime 2 was characterized by intense cathode sputtering...”)</p> <p>Mozgrin at 401, ¶ spanning left and right columns (“Designing the [pulsed supply] unit, we took into account the dependences which had been obtained in [Kudryavtsev] of ionization relaxation on pre-ionization parameters, pressure, and pulse voltage amplitude.”)</p> <p>Mozgrin at 400, left col, ¶ 3 (“Some experiments on magnetron systems of various geometry showed that discharge regimes which do not transit to arcs can be obtained even at high currents.”)</p> <p>Mozgrin at 404, left col, ¶ 3 (“The parameters of the shaped-electrode discharge...transit to arc regime 4, could be well determined... The point of the planar-magnetron discharge transit to the arc regime was determined by discharge voltage and structure changes...”)</p> <p>Kudryavtsev at Figs. 1, 6</p> <p>Kudryavtsev at 34, right col, ¶ 4 (“Since the effects studied in this work are characteristic of ionization whenever a field is suddenly applied to a weakly ionized gas, they must be allowed for when studying emission mechanisms in pulsed gas lasers, gas breakdown, laser sparks, etc.”)</p> <p>Kudryavtsev at 31, right col, ¶ 7 (“The behavior of the increase in n_e with time thus enables us to arbitrarily divide the ionization process into two stages, which we will call the slow and fast growth stages. Fig. 1 illustrates the relationships between the main electron currents in terms of the atomic energy levels during the slow and fast stages.”)</p> <p>Kudryavtsev at 31, right col, ¶ 6 (“For nearly stationary n_2 [excited atom density] values ... there is an explosive increase in n_e [plasma density]. The subsequent increase in n_e then reaches its maximum value, equal to the rate of excitation [equation omitted], which is several orders of magnitude greater than the ionization rate during the initial stage.”)</p> <p>Kudryavtsev at Abstract (“in a pulsed inert-gas discharge plasma at moderate pressures... [i]t is shown that the electron density increases explosively in time due to accumulation of atoms in the</p>

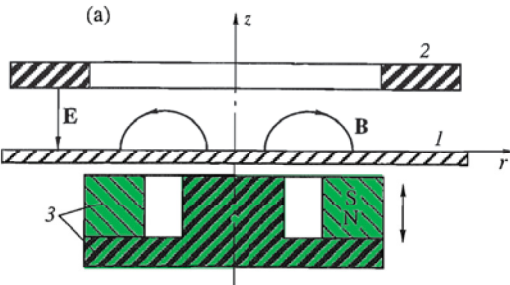
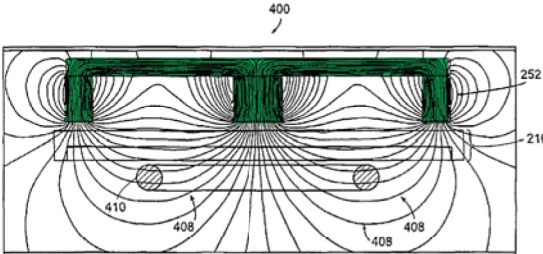
EXHIBIT A.01
U.S. Patent No. 7,147,759

<p>Claims 1-3, 5-10, 13-16, 18-20, 22-34, 37, 40-43 and 45-46, 48, 50</p>	<p style="text-align: center;">Mozgrin in view of Kudryavtsev</p>
	<p>lowest excited states.”)</p> <p>Because Mozgrin applies voltage pulses that “suddenly generate an electric field,” one of ordinary skill reading Mozgrin would have been motivated to consider Kudryavtsev to better understand the effects of applying Mozgrin’s pulse.</p> <p>If one of ordinary skill building a system according to Mozgrin did not experience Kudryavtsev’s “explosive increase” in plasma density, it would have been obvious to adjust the operating parameters, e.g., increase the pulse length and/or pressure, so as to trigger Kudryavtsev’s fast stage of ionization. One of ordinary skill would have been motivated to use Kudryavtsev’s fast stage of ionization in Mozgrin so as to increase plasma density and thereby increase the sputtering rate. Further, use of Kudryavtsev’s fast stage in Mozgrin would have been a combination of old elements that in which each element performed as expected of increasing plasma density and multi-step ionization. Finally, because Mozgrin’s pulse, or the pulse used in the combination of Mozgrin and Kudryavtsev, produced Kudryavtsev’s fast stage of ionization, the rise time and amplitude of the pulse result in increasing the ionization rate of excited atoms and creation of a multi-step ionization process.</p> <p><u>Corresponding structure</u></p> <p>The ‘759 Patent discloses the following structure that corresponds to the “means for applying...”</p> <p>a pulsed DC power supply (e.g., 234), generating the voltage, current and power values shown in Fig. 5 (e.g., between $t_2 - t_4$), electrically coupled to an anode (e.g., 238) and cathode assembly (e.g., 216), wherein the anode and cathode assembly are arranged as shown in Figs. 2, 3, 7, 10, and 11 and as described in the text of the ‘759 Patent at 5:6-49, 8:51-10:6, 12:7-38, 12:47-54, 15:54-16:12 and 19:31-38</p> <p>The combination of Mozgrin and Kudryavstev discloses the structure corresponding to the “means for applying...” limitation. For example:</p> <p>Mozgrin at Figs. 2, 3</p> <p>Any difference between Mozgrin’s and the ‘759 Patent’s mechanical arrangement of the anode and cathode is nothing more than the mechanical rearrangement of well-known components.</p>

EXHIBIT A.01
U.S. Patent No. 7,147,759

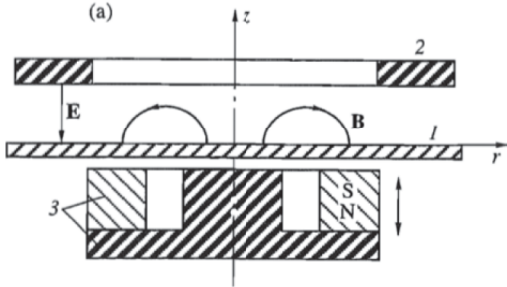
<p>Claims 1-3, 5-10, 13-16, 18-20, 22-34, 37, 40-43 and 45-46, 48, 50</p>	<p>Mozgrin in view of Kudryavtsev</p>
	<p>Rearranging Mozgrin's components to match that of the '759 Patent would be obvious to one of ordinary skill.</p>
<p>41. The sputtering source of claim 1 wherein the cathode assembly and the anode are positioned so as to form a gap there between.</p>	<p>The combination of Mozgrin with Kudryavtsev discloses the cathode assembly and the anode are positioned so as to form a gap there between.</p> <p><i>See evidence cited in claim 1.</i></p> <p>Mozgrin at Fig. 1</p>  <p>Fig. 1. Discharge device configurations: (a) planar magnetron; (b) shaped-electrode configuration. (1) Cathode; (2) anode; (3) magnetic system.</p> <p>Mozgrin at 401, left col, ¶ 4 (“...applying a square voltage pulse to the discharge gap...”).</p> <p>Mozgrin at 401, right col, ¶ 2 (“...square voltage was applied to the gap.”).</p>
<p>42. The sputtering source of claim 1 wherein the weakly-ionized plasma is generated from a feed gas that comprises the ground state atoms.</p>	<p>The combination of Mozgrin with Kudryavtsev discloses the weakly-ionized plasma is generated from a feed gas that comprises the ground state atoms.</p> <p><i>See evidence cited in claim 1.</i></p> <p>Mozgrin at 401, left col, ¶ 4 (“It was possible to form the high-current quasi-stationary regime by applying a square voltage pulse to the discharge gap which was filled up with either neutral or pre-ionized gas.”)</p>
<p>43. The sputtering source of claim 1 wherein the excited atoms within the weakly-ionized plasma are ionized by electrons to create the ions that</p>	<p>The combination of Mozgrin with Kudryavtsev discloses the excited atoms within the weakly-ionized plasma are ionized by electrons to create the ions that sputter material from the sputtering target.</p> <p><i>See evidence cited in 1.</i></p>

EXHIBIT A.01
U.S. Patent No. 7,147,759

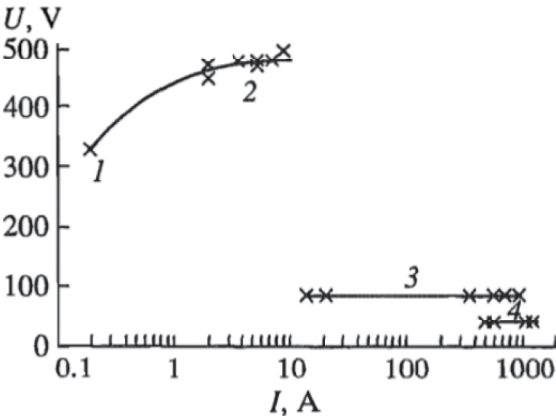
Claims 1-3, 5-10, 13-16, 18-20, 22-34, 37, 40-43 and 45-46, 48, 50	Mozgrin in view of Kudryavtsev
sputter material from the sputtering target.	<p>'759 Patent at 1:32-35 (“The plasma is replenished by electron-ion pairs formed by the collision of neutral molecules with secondary electrons generated at the target surface.”)</p> <p>Kudryavtsev at Equation (1):</p> $\frac{\partial n_e}{\partial t} = n_1 n_e \beta_{1e} + n_2 n_e \beta_{2e} + n_2 n_e \beta_{st} - \nabla \Gamma_e,$ <p>Kudryavtsev at 30, right col, last ¶ (“...n₂, and n_e are the atomic densities in the ...first excited states and the electron density, respectively;... β_{2e} [is] the rate coefficient[.]...”).</p>
45. The sputtering source of claim 1 wherein the amplitude of the voltage pulse is approximately between 100V and 30 kV.	<p>The combination of Mozgrin with Kudryavtsev discloses the amplitude of the voltage pulse is approximately between 100V and 30 kV.</p> <p>See evidence cited in 1.</p> <p>Mozgrin at Fig. 4</p>  <p>Fig. 4. Current-voltage characteristic of the quasi-stationary discharge with shaped electrodes in argon, p = 0.1 torr; B = 0.4 kG.</p>
46. The method of claim 20 wherein the weakly-ionized plasma is generated from a feed gas that comprises the ground state atoms.	<p>The combination of Mozgrin with Kudryavtsev discloses the weakly-ionized plasma is generated from a feed gas that comprises the ground state atoms.</p> <p>See evidence cited in claim 26.</p> <p>See evidence cited in claim 42.</p> <p>Mozgrin at 401, left col, ¶ 4 (“It was possible to form the high-current quasi-stationary regime by applying a square voltage pulse</p>

EXHIBIT A.01
U.S. Patent No. 7,147,759

Claims 1-3, 5-10, 13-16, 18-20, 22-34, 37, 40-43 and 45-46, 48, 50	Mozgrin in view of Kudryavtsev
	to the discharge gap which was filled up with either neutral or pre-ionized gas.”)
48. The method of claim 20 wherein the ionizing the excited atoms within the weakly-ionized plasma to create ions that sputter material from the sputtering target comprises ionizing the excited atoms with electrons.	<p>The combination of Mozgrin with Kudryavtsev discloses the ionizing the excited atoms within the weakly-ionized plasma to create ions that sputter material from the sputtering target comprises ionizing the excited atoms with electrons.</p> <p><i>See</i> evidence cited in claim 20.</p> <p><i>See</i> evidence cited in claim 43.</p> <p>‘759 Patent at 1:32-35 (“The plasma is replenished by electron-ion pairs formed by the collision of neutral molecules with secondary electrons generated at the target surface.”)</p> <p>Kudryavtsev at 30, right col, Eq. 1.</p> <p>Kudryavtsev at 30, right col, last ¶ (“...n_2, and n_e are the atomic densities in the ...first excited states and the electron density, respectively;... β_{2e} [is] the rate coefficient[]...”)</p>
50. The method of claim 20 wherein the amplitude of the voltage pulse is approximately between 100V and 30 kV.	<p>The combination of Mozgrin with Kudryavtsev discloses the amplitude of the voltage pulse is approximately between 100V and 30 kV.</p> <p><i>See</i> evidence cited in claim 20.</p> <p><i>See</i> evidence cited in claim 45.</p> <p>Mozgrin at Fig. 4</p>