



US005784001A

United States Patent [19]

[11] Patent Number: **5,784,001**

Deluca et al.

[45] Date of Patent: **Jul. 21, 1998**

[54] METHOD AND APPARATUS FOR PRESENTING GRAPHIC MESSAGES IN A DATA COMMUNICATION RECEIVER

[75] Inventors: **Joan Deluca**, Boca Raton; **Douglas Kraul**, Parkland; **Charles Edward Batey, Jr.**, Lake Worth, all of Fla.

[73] Assignee: **Motorola, Inc.**, Schaumburg, Ill.

[21] Appl. No.: **898,640**

[22] Filed: **Jul. 21, 1997**

Related U.S. Application Data

[63] Continuation of Ser. No. 560,604, Nov. 20, 1995, abandoned.

[51] Int. Cl.⁶ **G08B 5/22**

[52] U.S. Cl. **340/825.44; 345/133**

[58] Field of Search **340/825.44; 345/133. 345/122**

References Cited

U.S. PATENT DOCUMENTS

4,330,780	5/1982	Masaki	340/825.44
4,336,524	6/1982	Levine	340/825.44
4,429,306	1/1984	Macauley et al.	345/195
4,704,608	11/1987	Sato et al.	340/825.44
4,713,808	12/1987	Gaskill et al.	340/825.44
4,860,005	8/1989	De Luca et al.	340/825.44
4,870,402	9/1989	Deluca et al.	340/825.44
4,951,039	8/1990	Schwendeman	340/825.44

5,157,391	10/1992	Weitzen	340/825.44
5,182,553	1/1993	Kung	340/825.44
5,212,721	5/1993	Deluca et al.	379/57
5,223,831	6/1993	Kung et al.	340/825.44
5,257,307	10/1993	Ise	340/825.44
5,347,269	9/1994	Vanden Heuvel et al.	340/825.44
5,452,356	9/1995	Albert	340/825.44
5,512,916	4/1996	Merchant et al.	340/825.44
5,561,702	10/1996	Lipp et al.	340/825.44
5,574,439	11/1996	Miyashita	340/825.44

FOREIGN PATENT DOCUMENTS

0 393 794 A1	4/1990	European Pat. Off.	G08B 5/22
55-34710 (A)	3/1980	Japan	
2 197 103	5/1988	United Kingdom	H04B 5/04
2 206 718	1/1989	United Kingdom	H04B 5/04
9103885	3/1991	WIPO	455/154

Primary Examiner—Brian Zimmerman

Assistant Examiner—Edward Merz

[57] ABSTRACT

A data communication receiver (100) includes a receiver (110) for receiving a message including at least one code, a database (155) for storing codes and image data associated with the codes, and a presentation element (150) for locating the at least one code in the database (155). The presentation element (150) then retrieves the image data associated with the at least one code. The image data associated with the at least one code is representative of at least one image. The data communication receiver (100) also includes a display (130) coupled to the presentation element (150) for presenting the at least one image as a graphic message.

6 Claims, 8 Drawing Sheets

CODE	IMAGE
#01	TELEPHONE
#02	HOUSE
#03	OFFICE
#04	FAMILY
#05	TRAIN
#06	PERSON RUNNING
#07	COFFEE MUG
#08	CLOCK FOLLOWED BY TIME
#09	FOOD PLATTER

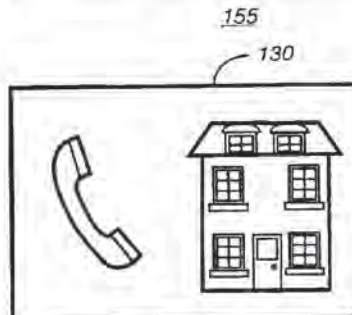

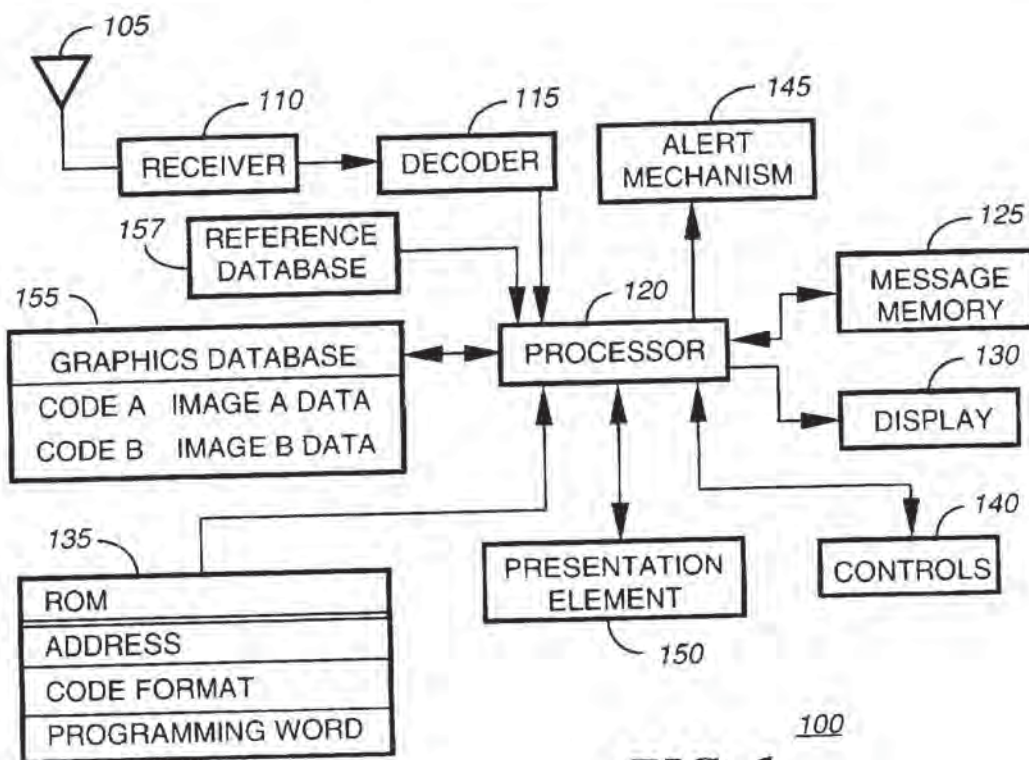

FIG. 1

CODE	IMAGE
#01	TELEPHONE
#02	HOUSE
#03	OFFICE
#04	FAMILY
#05	TRAIN
#06	PERSON RUNNING
#07	COFFEE MUG
#08	CLOCK FOLLOWED BY TIME
#09	FOOD PLATTER

FIG. 2

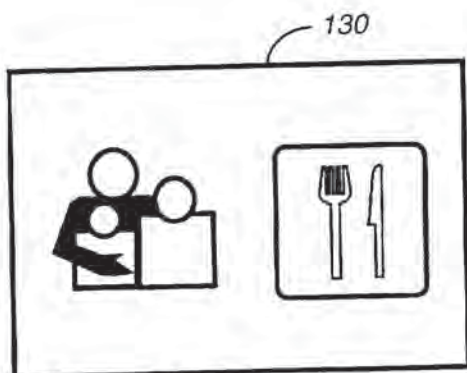

FIG. 3

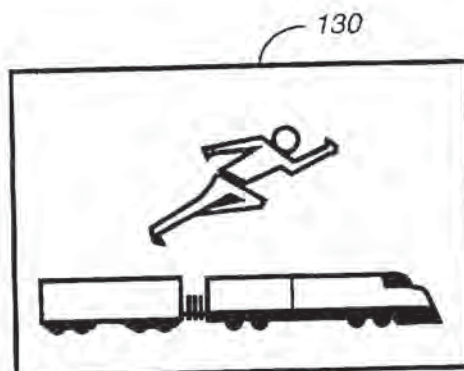

FIG. 6

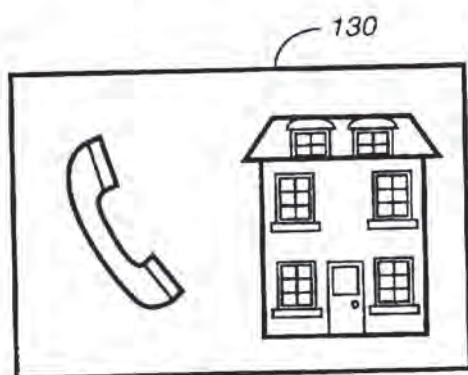

FIG. 4

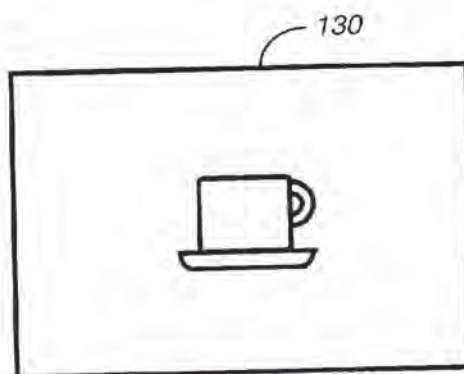

FIG. 7

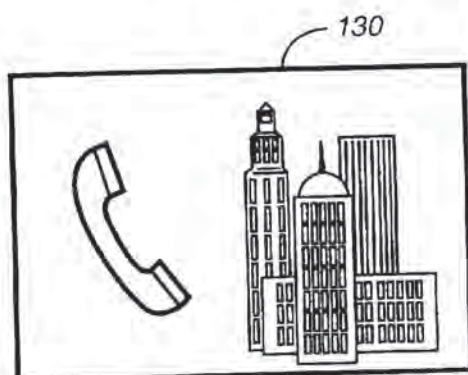

FIG. 5

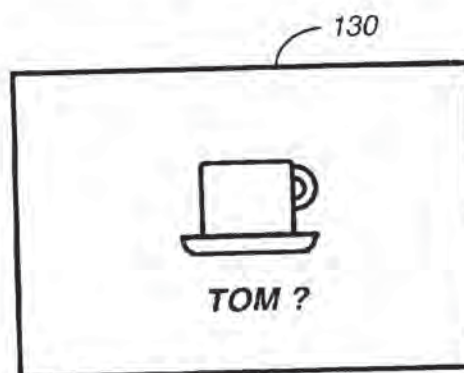
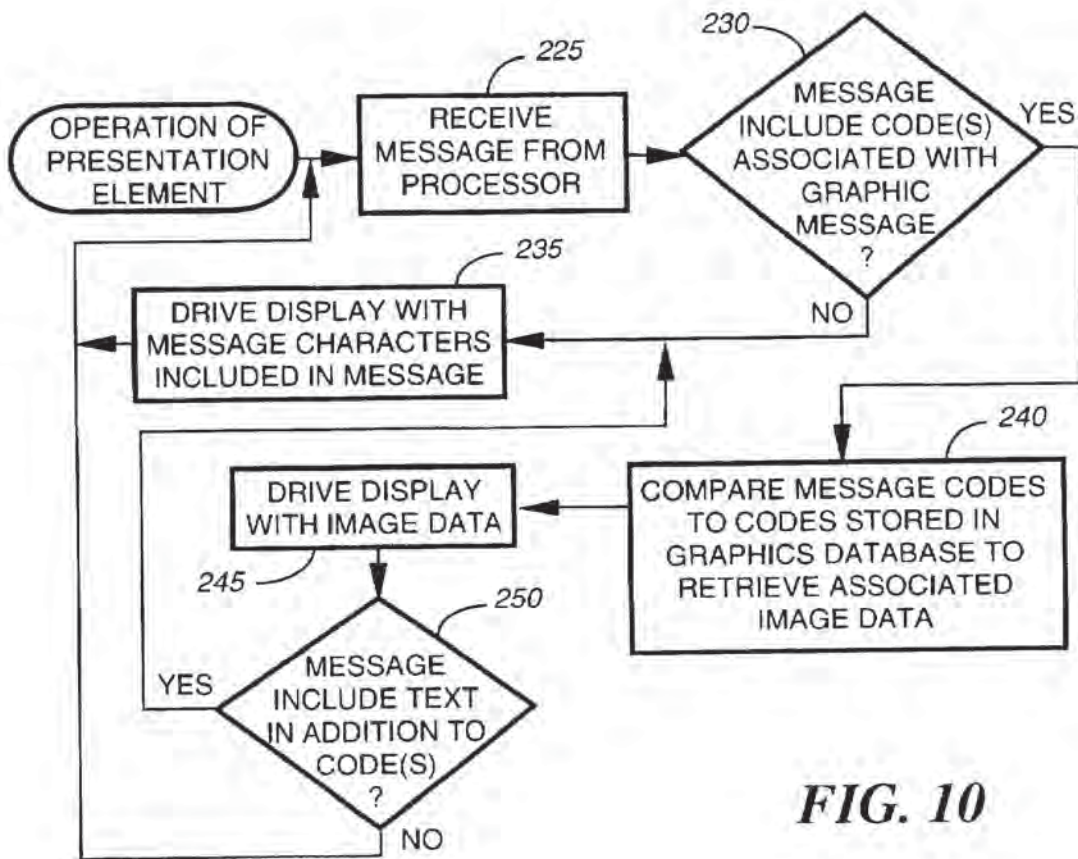
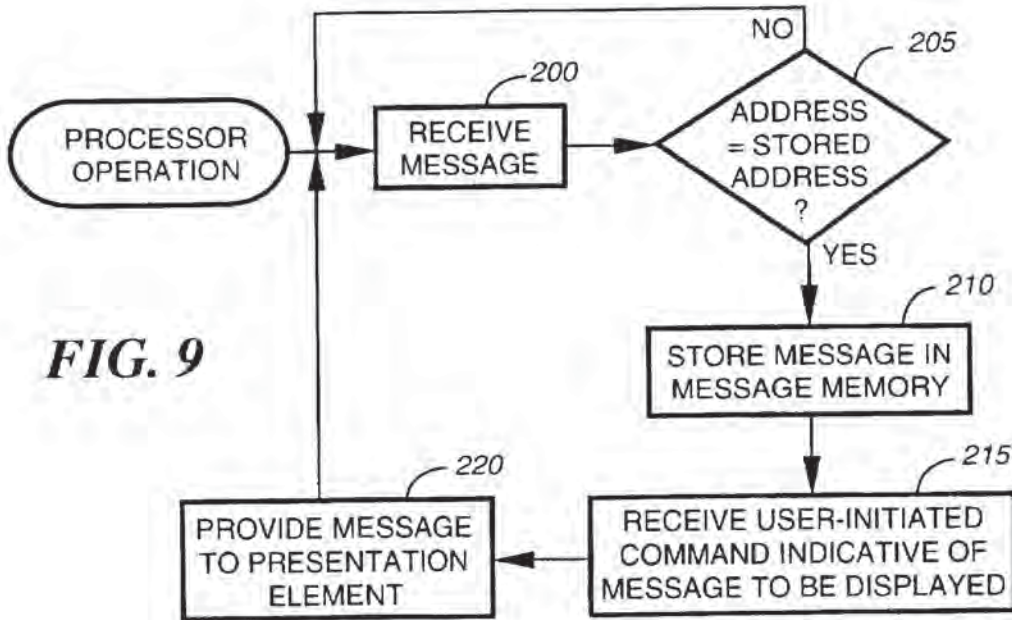
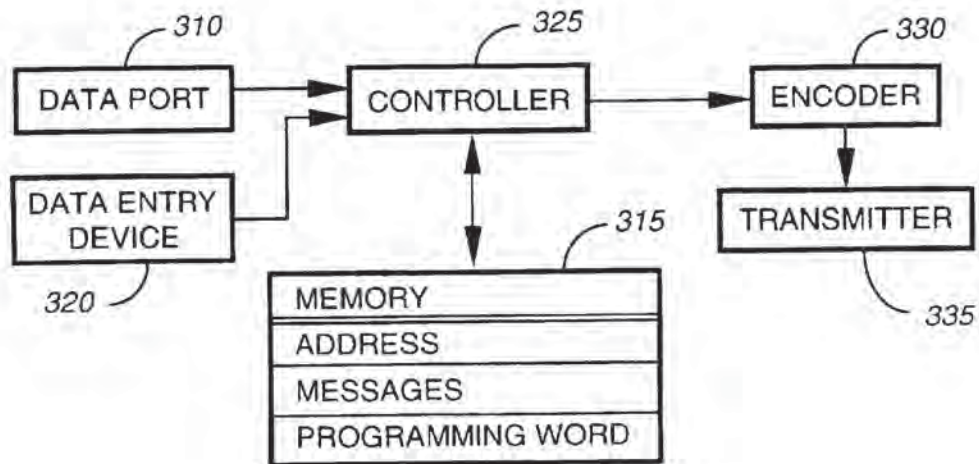

FIG. 8





³⁰⁵
FIG. 11

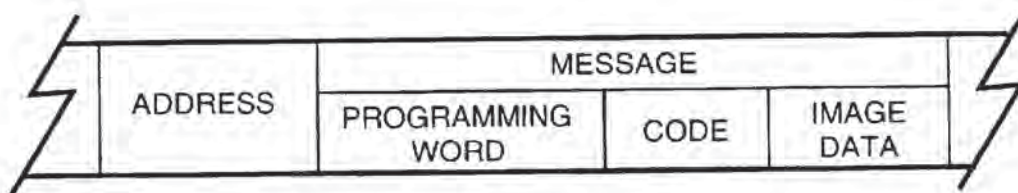

FIG. 12

Explore Litigation Insights

Docket Alarm provides insights to develop a more informed litigation strategy and the peace of mind of knowing you're on top of things.

Real-Time Litigation Alerts



Keep your litigation team up-to-date with **real-time alerts** and advanced team management tools built for the enterprise, all while greatly reducing PACER spend.

Our comprehensive service means we can handle Federal, State, and Administrative courts across the country.

Advanced Docket Research



With over 230 million records, Docket Alarm's cloud-native docket research platform finds what other services can't. Coverage includes Federal, State, plus PTAB, TTAB, ITC and NLRB decisions, all in one place.

Identify arguments that have been successful in the past with full text, pinpoint searching. Link to case law cited within any court document via Fastcase.

Analytics At Your Fingertips



Learn what happened the last time a particular judge, opposing counsel or company faced cases similar to yours.

Advanced out-of-the-box PTAB and TTAB analytics are always at your fingertips.

API

Docket Alarm offers a powerful API (application programming interface) to developers that want to integrate case filings into their apps.

LAW FIRMS

Build custom dashboards for your attorneys and clients with live data direct from the court.

Automate many repetitive legal tasks like conflict checks, document management, and marketing.

FINANCIAL INSTITUTIONS

Litigation and bankruptcy checks for companies and debtors.

E-DISCOVERY AND LEGAL VENDORS

Sync your system to PACER to automate legal marketing.