

THIN-FILM DEPOSITION

PRINCIPLES & PRACTICE

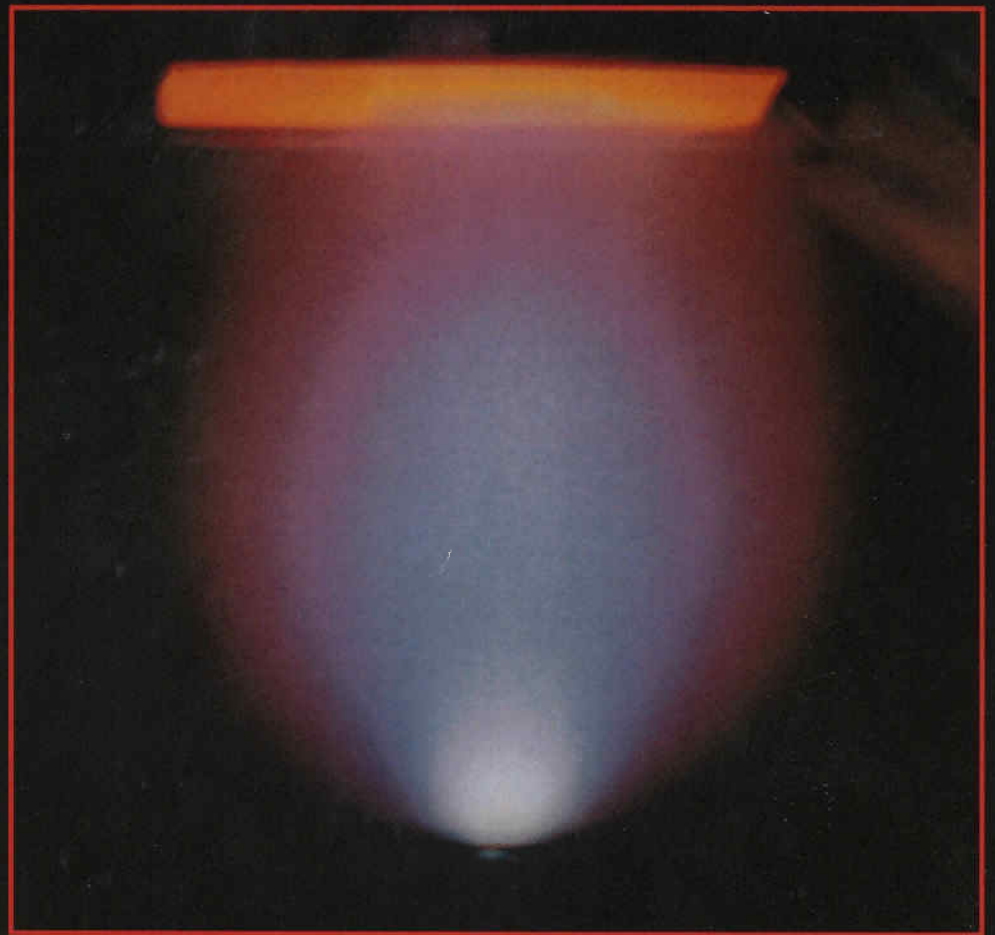

DONALD L. SMITH

GILLETTE 1115

Thin-Film Deposition

Principles and Practice

Donald L. Smith



Boston, Massachusetts Burr Ridge, Illinois
Dubuque, Iowa Madison, Wisconsin New York, New York
San Francisco, California St. Louis, Missouri

Library of Congress Cataloging-in-Publication Data

Smith, Donald L. (Donald Leonard), date.

Thin-film deposition: principles and practice / Donald L. Smith.

p. cm.

Includes index.

ISBN 0-07-058502-4

1. Thin films. 2. Vapor-plating. 3. Thin film devices.

I. Includes index. II. Title

TA418.9.T45S65 1995

621.3815'2—dc20

94-47002

CIP

Copyright © 1995 by McGraw-Hill, Inc. All rights reserved. Printed in the United States of America. Except as permitted under the United States Copyright Act of 1976, no part of this publication may be reproduced or distributed in any form or by any means, or stored in a data base or retrieval system, without the prior written permission of the publisher.

11 12 13 14 15 16 IBT/IBT 1 9 8 7 6 5 4 3 2

ISBN-13: 978-0-07-058502-7

ISBN-10: 0-07-058502-4

The sponsoring editor for this book was Stephen S. Chapman and the production supervisor was Suzanne W. B. Rapcavage. It was set in New Century Schoolbook by J. K. Eckert & Company, Inc.

INTERNATIONAL EDITION

Copyright © 1995. Exclusive rights by McGraw-Hill, Inc. for manufacture and export. This book cannot be re-exported from the country to which it is consigned by McGraw-Hill. The International Edition is not available in North America.

When ordering this title, use ISBN 0-07-113913-3.

Cover photo: A thin film of the high-temperature superconductor $\text{YBa}_2\text{Cu}_3\text{O}_7$ is being deposited from a pulsed-laser vaporization source onto a $\sim 750^\circ\text{C}$ MgO substrate shown glowing orange at the top of the picture. Pulses from a UV (248 nm) KrF excimer laser enter the vacuum chamber from the right and impinge at 45° upon a sintered pellet of $\text{YBa}_2\text{Cu}_3\text{O}_7$ situated near the bottom where the white glow originates. Energy from the pulses electronically excites and partially ionizes both the vaporizing material and the 4 Pa of O_2 ambient gas, resulting in a spectacular plume of glowing plasma. The pulsed-laser deposition process is discussed in Sec. 8.4. This photo of Douglas Chrisey's apparatus was taken by M.A. Savell at the U.S. Naval Research Laboratories, Washington, D.C., and appeared on the cover of the *MRS Bulletin*, February 1992. (Used by permission of MRS and NRL.)

Information contained in this work has been obtained by McGraw-Hill, Inc., from sources believed to be reliable. However, neither McGraw-Hill nor its authors guarantee the accuracy or completeness of any information published herein and neither McGraw-Hill nor its authors shall be responsible for any errors, omissions, or damages arising out of use of this information. This work is published with the understanding that McGraw-Hill and its authors are supplying information but are not attempting to render engineering or other professional services. If such services are required, the assistance of an appropriate professional should be sought.

Vacuum Technology

Most of the film deposition processes to be discussed in this book operate under some degree of vacuum. Only atmospheric-pressure CVD does not, but the same vacuum techniques of contamination reduction and process control still apply to it. Vacuum technology is a large topic which is well treated in textbooks such as those in the recommended readings list at the end of this chapter. Our purposes here are more specific: first, to become oriented to the general topic and, second, to examine certain aspects of vacuum technology that are particularly relevant to film deposition and deserve special emphasis. As we know, "Nature abhors a vacuum," so good equipment and techniques are needed to create one.

Figure 3.1 is a schematic diagram of a typical vacuum system for thin-film deposition. The purpose and functioning of the components shown will be elaborated upon in the subheadings below. Sometimes not all of these components will be required for a particular process. As shown, the substrate is introduced through a "load-lock" chamber to allow the main process chamber to remain under vacuum, because this reduces contamination and shortens substrate turnaround time. The roughing pump evacuates the load-lock chamber from atmospheric pressure after the substrate has been loaded into it and before the valve is opened into the process chamber. Once the substrate is in the process chamber, it is heated and controlled at the film deposition temperature. Process gases and vapors are metered into the chamber through mass flow-controlled supply lines, which are discussed more in Sec. 7.1.2. Process pressure is measured by a vacuum gauge that can be coupled to a motor-driven throttle valve in the pump throat for

ration." In *Handbook of Thin Film Technology*,
York: McGraw-Hill.
ermodynamics, the Kinetic Theory of Gases, and
Ambridge, Mass.: Addison-Wesley.

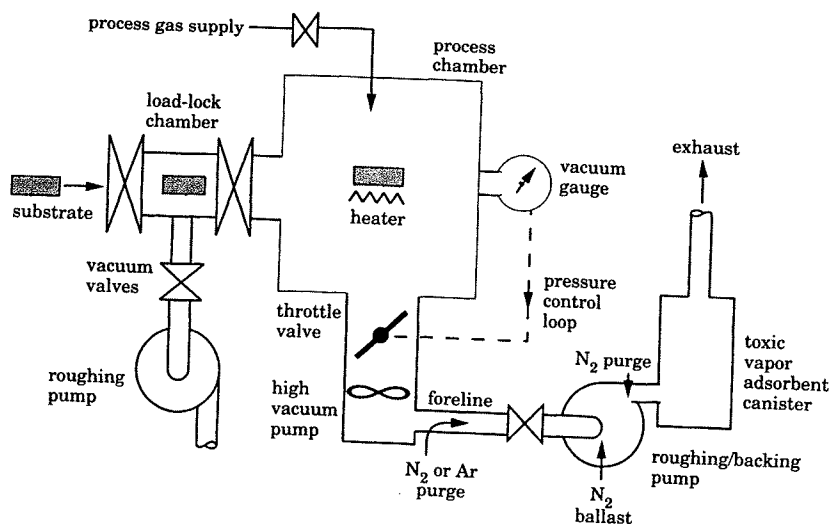

Figure 3.1 Typical vacuum-system components for thin-film deposition.

pling the vacuum gauge to the gas-supply metering valve, but that technique does not allow independent control of gas flow rate and pressure. Finally, process and impurity gases are evacuated through a high-vacuum pump followed by a "backing" pump which often serves to rough out the process chamber from atmosphere as well. For process vacuums above 10 Pa, only one stage of pumping is needed. The foreline and "ballast" nitrogen/argon purges which are shown are often required for reducing process and pump contamination, respectively. The exhaust nitrogen purge and the vapor-adsorbent canister provide safe disposal of flammable and toxic process vapors, respectively.

3.1 Pump Selection and Exhaust Handling

The principal types of vacuum pumps are listed in Table 3.1, along with their key characteristics. The choice of pumps will depend on the process vacuum level and on the properties of the vapors to be handled. Pumps fall into two categories by pumping principle: those that *displace* gas from the vacuum chamber and exhaust it to atmosphere, and those that *trap* it within the pump itself. Displacement pumps are often oil lubricated, which means that great care must be taken to avoid contaminating the process chamber with oil. On the other hand, they can pump large gas flows continuously without becoming saturated like trapping-type pumps do. Trapping pumps of the cryogenic variety are not recommended when pumping flammable vapors,

Explore Litigation Insights

Docket Alarm provides insights to develop a more informed litigation strategy and the peace of mind of knowing you're on top of things.

Real-Time Litigation Alerts



Keep your litigation team up-to-date with **real-time alerts** and advanced team management tools built for the enterprise, all while greatly reducing PACER spend.

Our comprehensive service means we can handle Federal, State, and Administrative courts across the country.

Advanced Docket Research



With over 230 million records, Docket Alarm's cloud-native docket research platform finds what other services can't. Coverage includes Federal, State, plus PTAB, TTAB, ITC and NLRB decisions, all in one place.

Identify arguments that have been successful in the past with full text, pinpoint searching. Link to case law cited within any court document via Fastcase.

Analytics At Your Fingertips



Learn what happened the last time a particular judge, opposing counsel or company faced cases similar to yours.

Advanced out-of-the-box PTAB and TTAB analytics are always at your fingertips.

API

Docket Alarm offers a powerful API (application programming interface) to developers that want to integrate case filings into their apps.

LAW FIRMS

Build custom dashboards for your attorneys and clients with live data direct from the court.

Automate many repetitive legal tasks like conflict checks, document management, and marketing.

FINANCIAL INSTITUTIONS

Litigation and bankruptcy checks for companies and debtors.

E-DISCOVERY AND LEGAL VENDORS

Sync your system to PACER to automate legal marketing.