



US007147759B2

(12) **United States Patent**
Chistyakov

(10) **Patent No.:** **US 7,147,759 B2**
(45) **Date of Patent:** ***Dec. 12, 2006**

(54) **HIGH-POWER PULSED MAGNETRON SPUTTERING**

(75) Inventor: **Roman Chistyakov**, Andover, MA (US)

(73) Assignee: **Zond, Inc.**, Mansfield, MA (US)

(*) Notice: Subject to any disclaimer, the term of this patent is extended or adjusted under 35 U.S.C. 154(b) by 0 days.

This patent is subject to a terminal disclaimer.

(21) Appl. No.: **10/065,277**

(22) Filed: **Sep. 30, 2002**

(65) **Prior Publication Data**

US 2004/0060813 A1 Apr. 1, 2004

(51) **Int. Cl.**
C23C 14/35 (2006.01)

(52) **U.S. Cl.** **204/192.12**; 204/192.13;
204/298.03; 204/298.06; 204/298.08; 204/298.14;
204/298.19

(58) **Field of Classification Search** 204/192.12,
204/192.13, 298.03, 298.06, 298.08, 298.14,
204/298.19, 298.26

See application file for complete search history.

(56) **References Cited**

U.S. PATENT DOCUMENTS

3,516,920 A	6/1970	Muly, Jr. et al.	
4,953,174 A	8/1990	Eldridge et al.	372/87
4,965,248 A	10/1990	Poppe et al.	505/1
5,015,493 A	5/1991	Gruen	427/38
5,616,224 A	4/1997	Boling	
5,875,207 A	2/1999	Osmanow	372/86
5,942,089 A	8/1999	Sproul et al.	
6,083,361 A	7/2000	Kobayashi et al.	
6,296,742 B1	10/2001	Kouznetsov	204/192.12
6,342,132 B1	1/2002	Rossnagel	

6,398,929 B1*	6/2002	Chiang et al.	204/298.11
6,413,382 B1	7/2002	Wang et al.	204/192.12
6,436,251 B1	8/2002	Gopalraja et al.	204/298.12
6,440,280 B1	8/2002	Burton et al.	
6,456,642 B1	9/2002	Hilliard	
2002/0033480 A1	3/2002	Kawamata et al.	
2005/0252763 A1*	11/2005	Chistyakov	204/192.12

FOREIGN PATENT DOCUMENTS

DE 3210351 A1 9/1983

(Continued)

OTHER PUBLICATIONS

Booth, et al., The Transition From Symmetric To Asymmetric Discharges In Pulsed 13.56 MHz Capacity Coupled Plasmas, J. Appl. Phys., Jul. 15, 1997, pp. 552-560, vol. 82 (2), American Institute of Physics.

(Continued)

Primary Examiner—Rodney G. McDonald

(74) Attorney, Agent, or Firm—Kurt Rauschenbach; Rauschenbach Patent Law Group, LLC

(57) **ABSTRACT**

Magnetically enhanced sputtering methods and apparatus are described. A magnetically enhanced sputtering source according to the present invention includes an anode and a cathode assembly having a target that is positioned adjacent to the anode. An ionization source generates a weakly-ionized plasma proximate to the anode and the cathode assembly. A magnet is positioned to generate a magnetic field proximate to the weakly-ionized plasma. The magnetic field substantially traps electrons in the weakly-ionized plasma proximate to the sputtering target. A power supply produces an electric field in a gap between the anode and the cathode assembly. The electric field generates excited atoms in the weakly ionized plasma and generates secondary electrons from the sputtering target. The secondary electrons ionize the excited atoms, thereby creating a strongly-ionized plasma having ions that impact a surface of the sputtering target to generate sputtering flux.

50 Claims, 18 Drawing Sheets

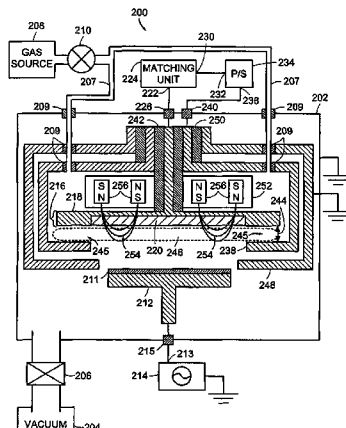

GILLETTE 1207

FOREIGN PATENT DOCUMENTS

EP	0 788 139 A1	8/1997
GB	1339910	12/1973
JP	57194254	11/1982
JP	10204633	8/1998
WO	WO9504368	* 2/1995
WO	WO 98/40532	9/1998
WO	WO 01/98553 A1	12/2001

OTHER PUBLICATIONS

Bunshah, et al., Deposition Technologies For Films And Coatings, Materials Science Series, pp. 176-183, Noyes Publications, Park Ridge, New Jersey.

Daugherty, et al., Attachment-Dominated Electron-Beam-Ionized Discharges, Applied Science Letters, May 15, 1976, vol. 28, No. 10, American Institute of Physics.

Goto, et al., Dual Excitation Reactive Ion Etcher for Low Energy Plasma Processing, J. Vac. Sci. Technol. A, Sep./Oct. 1992, pp. 3048-3054, vol. 10, No. 5, American Vacuum Society.

Kouznetsov, et al., A Novel Pulsed Magnetron Sputter Technique Utilizing Very High Target Power Densities, Surface & Coatings Technology, pp. 290-293, Elsevier Sciences S.A.

Lindquist, et al., High Selectivity Plasma Etching Of Silicon Dioxide With A Dual Frequency 27/2 MHz Capacitive RF Discharge.

Macak, Reactive Sputter Deposition Process of Al₂O₃ and Characterization Of A Novel High Plasma Density Pulsed Magnetron Discharge, Linkoping Studies in Science And Technology, 1999, pp. 1-2, Sweden.

Macak, et al., Ionized Sputter Deposition Using An Extremely High Plasma Density Pulsed Magnetron Discharge, J. Vac. Sci. Technol. A., Jul./Aug. 2000, pp. 1533-1537, vol. 18, No. 4, American Vacuum Society.

Mozgrin, et al., High-Current Low-Pressure Quasi -Stationary Discharge In A Magnetic Field: Experimental Research, Plasma Physics Reports, 1995, pp. 400-409, vol. 21, No. 5, Mozgrin, Feitsov, Khodachenko.

Rosnagel, et al., Induced Drift Currents In Circular Planar Magnetrons, J. Vac. Sci. Technol. A., Jan./Feb. 1987, pp. 88-91, vol. 5, No. 1, American Vacuum Society.

Sheridan, et al., Electron Velocity Distribution Functions In A Sputtering Magnetron Discharge For The EXB Direction, J. Vac. Sci. Technol. A., Jul./Aug. 1998, pp. 2173-2176, vol. 16, No. 4, American Vacuum Society.

Steinbruchel, A Simple Formula For Low-Energy Sputtering Yields, Applied Physics A., 1985, pp. 37-42, vol. 36, Springer-Verlag.

Turenko, et al., Magnetron Discharge In The Vapor Of The Cathode Material, Soviet Technical Physics Letters, Jul. 1989, pp. 519-520; vol. 15, No. 7, New York, US.

Encyclopedia Of Low Temperature Plasma, p. 119, vol. 3.

Encyclopedia Of Low Temperature Plasma, p. 123, vol. 3.

Sugimoto, et al; Magnetic Condensation Of A Photoexcited Plasma During Fluoropolymer Sputtering; J. Appl. Phys.; Feb. 15, 1990; pp. 2093-2099; vol. 67, No. 4; American Institute of Physics; New York, US.

Yamaya, et al; Use Of A Helicon-Wave Excited Plasma For Aluminum-Doped ZnO Thin-Film Sputtering; Appl. Phys. Lett.; Jan. 12, 1998; pp. 235-237; vol. 72; No. 2; American Institute of Physics; New York US.

* cited by examiner

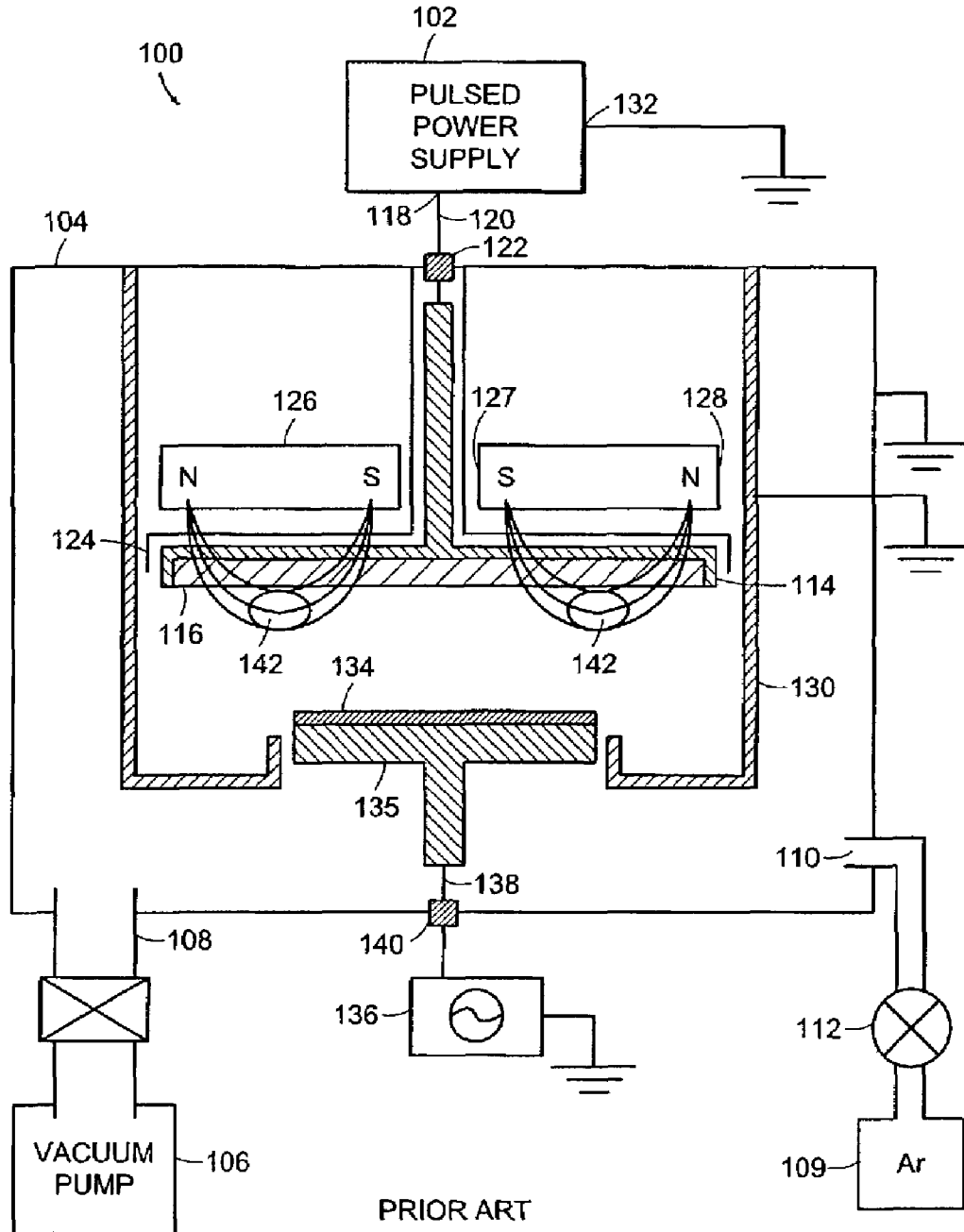

PRIOR ART
FIG. 1

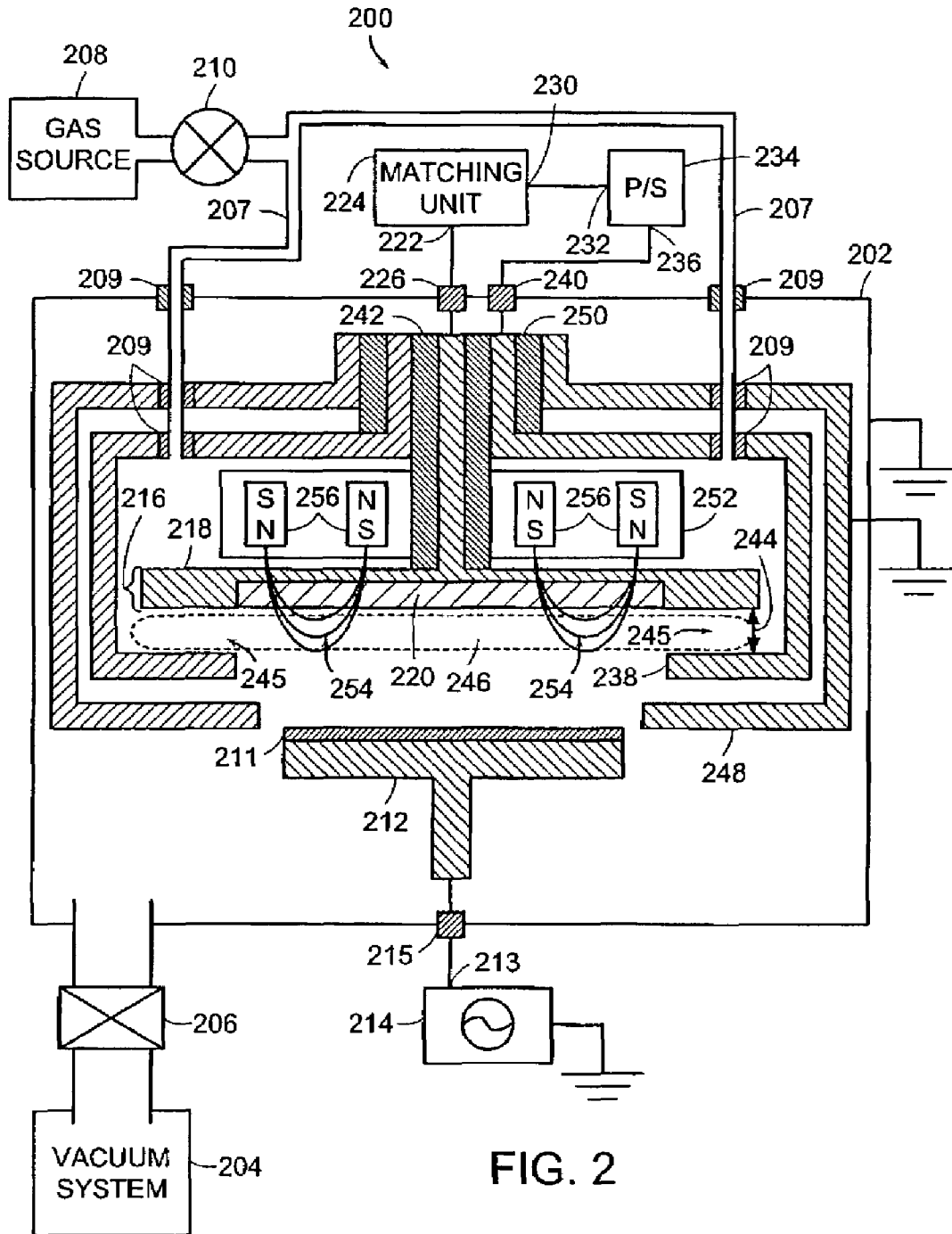

FIG. 2

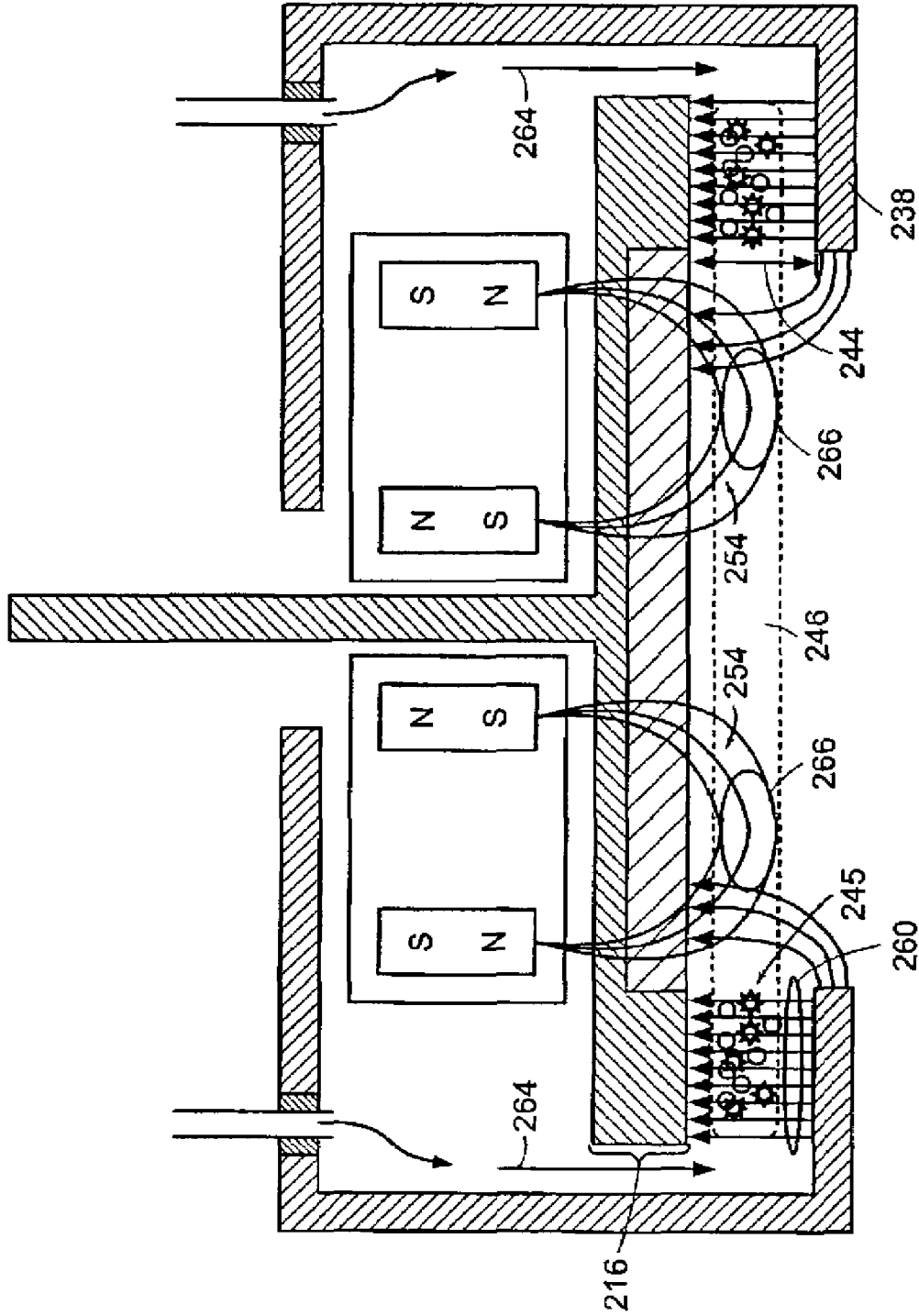

FIG. 3

Explore Litigation Insights

Docket Alarm provides insights to develop a more informed litigation strategy and the peace of mind of knowing you're on top of things.

Real-Time Litigation Alerts



Keep your litigation team up-to-date with **real-time alerts** and advanced team management tools built for the enterprise, all while greatly reducing PACER spend.

Our comprehensive service means we can handle Federal, State, and Administrative courts across the country.

Advanced Docket Research



With over 230 million records, Docket Alarm's cloud-native docket research platform finds what other services can't. Coverage includes Federal, State, plus PTAB, TTAB, ITC and NLRB decisions, all in one place.

Identify arguments that have been successful in the past with full text, pinpoint searching. Link to case law cited within any court document via Fastcase.

Analytics At Your Fingertips



Learn what happened the last time a particular judge, opposing counsel or company faced cases similar to yours.

Advanced out-of-the-box PTAB and TTAB analytics are always at your fingertips.

API

Docket Alarm offers a powerful API (application programming interface) to developers that want to integrate case filings into their apps.

LAW FIRMS

Build custom dashboards for your attorneys and clients with live data direct from the court.

Automate many repetitive legal tasks like conflict checks, document management, and marketing.

FINANCIAL INSTITUTIONS

Litigation and bankruptcy checks for companies and debtors.

E-DISCOVERY AND LEGAL VENDORS

Sync your system to PACER to automate legal marketing.