

# HIGH ELECTRON DENSITY, ATMOSPHERIC PRESSURE AIR GLOW DISCHARGES

Frank Leipold, Abdel-Aleam H. Mohamed, and Karl H. Schoenbach

Physical Electronics Research Institute, Old Dominion University, Norfolk, VA 23529

## Abstract

The pulsed electron heating effect has been studied on an atmospheric pressure air glow discharge. Application of a high voltage pulse causes a shift in the electron energy distribution function to higher energies. This causes a temporary increase of the ionization rate and consequently an increase of the electron density. The electron density after a 10 ns pulse application to a direct current glow discharge increased from its dc value of  $2 \times 10^{13} \text{ cm}^{-3}$  to  $2.8 \times 10^{15} \text{ cm}^{-3}$ . The average power density, required for sustaining the high pressure plasma with a given minimum electron density, was found to be lowered when the discharge was operated in a repetitive pulsed mode compared to a dc mode. For an atmospheric pressure air plasma, an average power density of  $1.5 \text{ kW/cm}^3$  and  $50 \text{ W/cm}^3$  is required for an average electron density of  $10^{13} \text{ cm}^{-3}$  and  $10^{12} \text{ cm}^{-3}$ , respectively. This value is less by a factor of three than that required to sustain a dc plasma with the same base electron density.

## I. INTRODUCTION

Weakly ionized plasmas, generated in high pressure air glow discharges, reflect or absorb electromagnetic radiation in the microwave range and consequently act as temporally controllable barriers for this radiation: as plasma ramparts. Direct current microhollow cathode sustained glow discharges (MCSG) have been shown to provide plasmas with an electron density of  $10^{13} \text{ cm}^{-3}$ ,

required for reflection of microwave radiation of up to 30 GHz [1]. The MCSG plasma was found to be scalable in size by extending the electrode gap and by placing the discharges in parallel [2]. However, at equilibrium conditions, the power density required to sustain an atmospheric pressure air plasma of  $10^{13} \text{ cm}^{-3}$  electron density is approximately  $5 \text{ kW/cm}^3$  [3], a value which makes these equilibrium plasmas difficult to scale to large volumes.

Pulsed electron heating has been shown to allow reduction of the electrical power, while keeping the average electron density at the required level for microwave reflection [4]. In order to explore the effect of pulsed electron heating on the temporal development of single discharges and discharge arrays we have measured the electrical and the optical response to pulsed electron heating with a temporal resolution on the order of 10 ns. Laser interferometry, electrical conductivity and optical spectroscopy was used to determine the temporal development of electron density, and gas temperature.

## II. EXPERIMENTAL SETUP

The experimental setup is shown in Fig. 1. The atmospheric pressure air discharge(s) were operated in a direct current mode, with a 10 ns to 12 ns voltage pulse superimposed. The gap was set at 0.6 cm, the distance between discharge axes, for a three discharge arrangement, was 0.4 cm (Fig. 2).

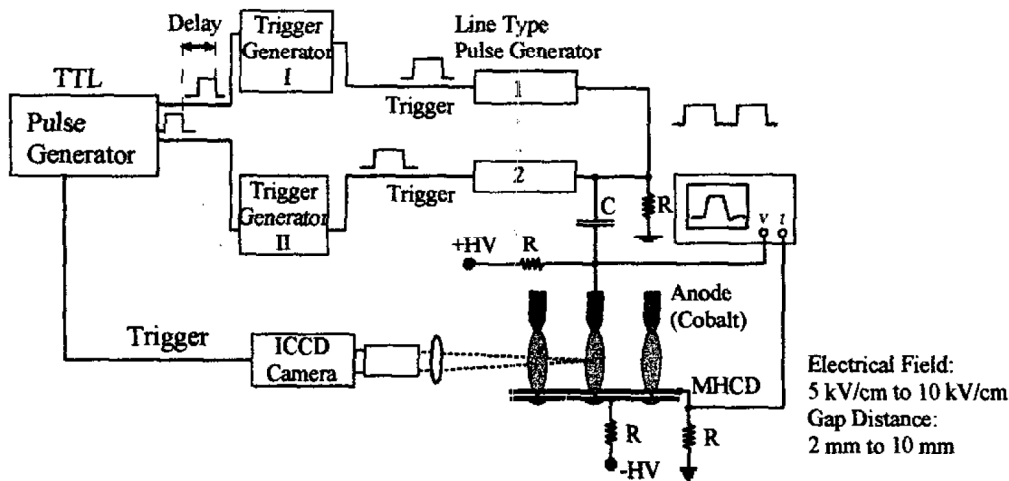

Figure 1. Experimental setup

Microhollow cathode discharges (MHCD) serve as plasma cathodes. In order to increase the size of the

plasma, three discharges were operated in parallel [2]. The discharges can be operated either in DC with

superimposed pulses or in pulsed mode only. Two independent triggerable line type pulse generators provided 10 ns pulses. The applied diagnostics are emission spectroscopy for gas temperature measurements, interferometry [1], and conductivity measurements for electron density measurements. High-speed photography was used to obtain the spatial plasma distribution.

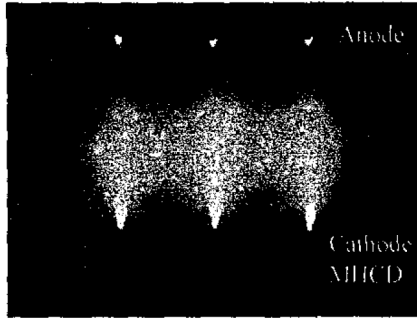

Figure 2. Three MCSGs operated in parallel at atmospheric pressure in air. Electrode gap: 6 mm, distance between two discharges: 4 mm.

### III. EXPERIMENTAL RESULTS

#### A. Gas temperature

The gas temperature is obtained by comparison of a measured and a simulated spectrum of the 2<sup>nd</sup> positive system of nitrogen. For a DC glow discharge, the gas temperature was found to be 2200 K close to the cathode. The temperature in the plasma column reaches with increasing gap length a constant level of 2000 K (Fig. 3).

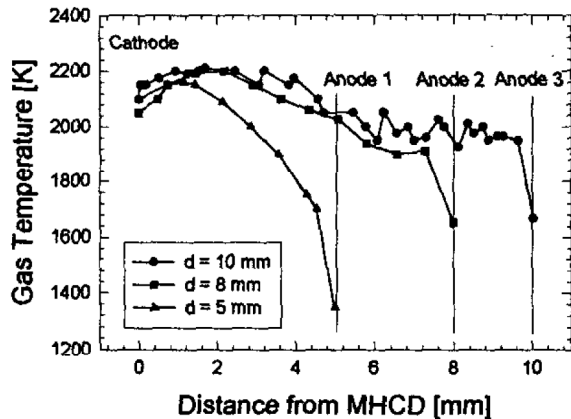

Figure 3. Gas temperature on the axis of a DC MCSG for various electrode distances. The discharge current was 13 mA.

For a DC operated MCSG with a superimposed pulse, an increase of the gas temperature by 300 K was measured 10 ns after pulse application (Fig. 4). Due to the low light intensity 25 ns after pulse application, information on the

decay of the temperature could not be obtained with this method.

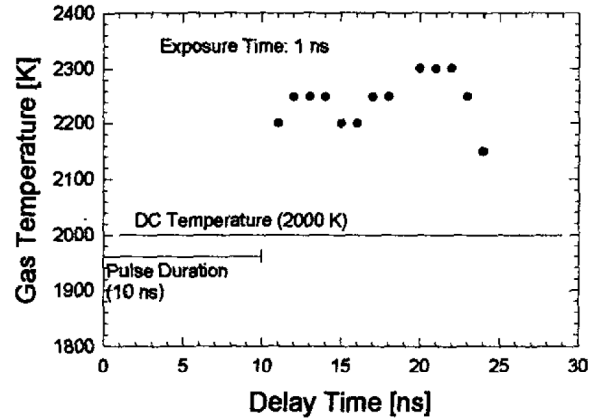

Figure 4. Temporal Development of the gas temperature in the center of a MCSG discharge operated DC with superimposed pulse. Electrode distance: 2 mm,  $I_{\text{MCSG DC}} = 10$  mA.

#### B. Electron density

The electron density was measured spatially and temporally resolved by means of infrared heterodyne interferometry. The radial profile was found to be time independent. It can be fit by a gaussian profile with a width of  $\sigma = 0.056$  mm. Due to the limited temporal resolution, the electron density cannot be measured during the pulse. However, a measurement at 22 ns after pulse application provides an electron density of  $2.8 \cdot 10^{15} \text{ cm}^{-3}$  for a discharge with a gap distance of 2 mm and an applied pulsed electrical field of 8 kV/cm. This indicates, that the electron density during the pulse is at least  $2.8 \cdot 10^{15} \text{ cm}^{-3}$ . The radial electron density distribution in the center plane of the discharge for different times after pulse application is shown in Fig. 5.

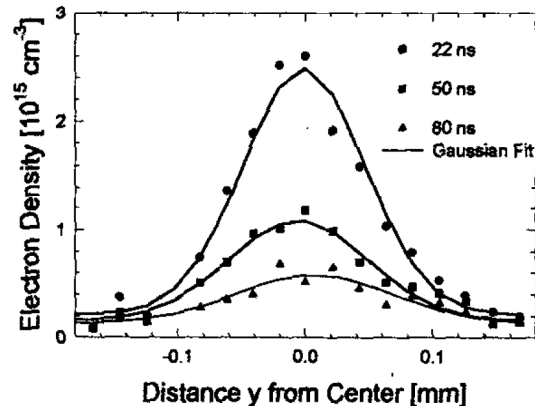

Figure 5. Radially resolved electron density in the center plane of the discharge for different times after pulse application. Electrode Distance: 2 mm, applied electrical field: 8 kV/cm.

The electron density after pulse application can also be obtained from measurements of the electrical field and current density. The relation between current density, electron density and electrical field is given by the equation:

$$J = n_e e v(E/n) \quad (1)$$

The electron density was calculated using average values of electric field ( $E = V/d$ ) and current density  $J$ . The current density is given by the measured current and the spatial distribution profile of the electron density, which is assumed to be represented by the optical emission profile. Photographs of the discharge plasma for different times after pulse application are shown in Fig. 6. The exposure time is 5 ns. The drift velocity  $v$ , which depends on the reduced electrical field, varies between  $2 \cdot 10^4$  m/s and  $10^7$  m/s for reduced electrical fields between 10 Td and 200 Td [5].

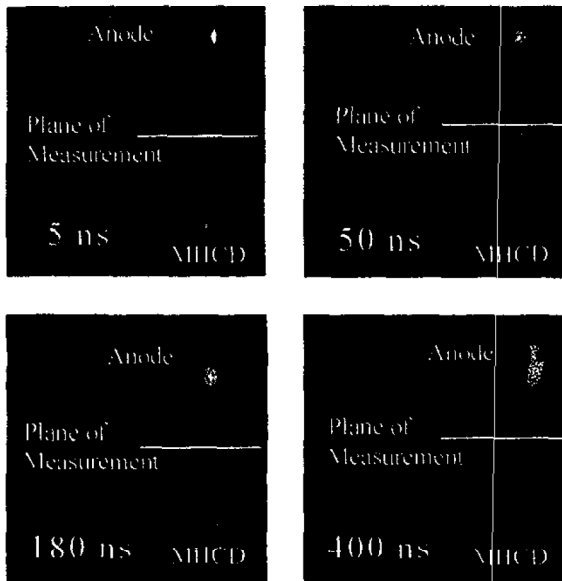

Figure 6. Photographs of the MCSG for different times after pulse application. Electrode gap: 2mm, applied electrical field: 10 kV/cm [6].

For an applied electrical field of 10 kV/cm and an electrode distance of 2 mm, the FWHM of the radial profile was found to be 0.16 mm. The profile is time independent. The electron density after pulse application versus the reduced electrical field is shown in Fig. 7.

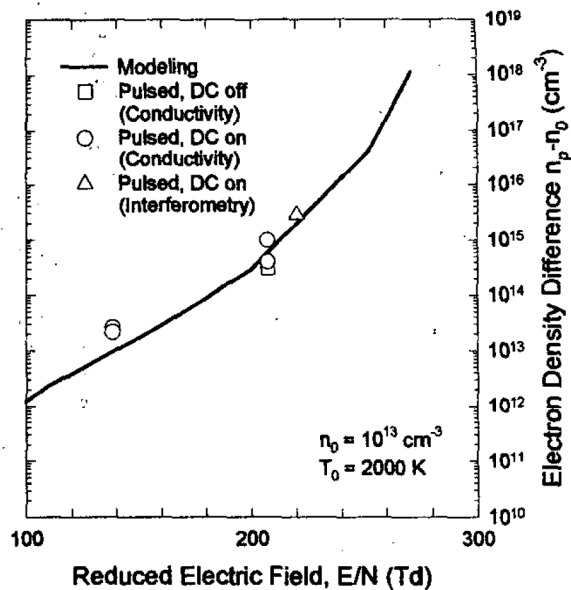

Figure 7. Electron density difference after a 10 ns pulse application versus the applied electrical field. The solid line represents modeling results [4].

For high pulsed electrical field, the dc contribution to the electron density can be neglected. For investigation of the electron heating effect for low applied electrical fields, the current of the discharge has to be turned off before the pulse is applied. A typical temporal development of the current is shown in Fig. 8.

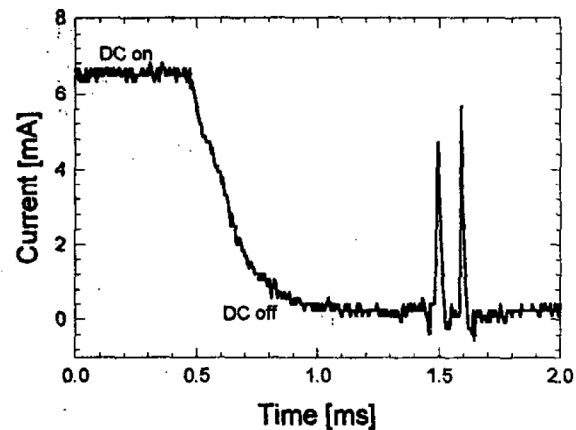

Figure 8. Temporal development of the discharge current. Before the two voltage pulses were applied, the direct current was turned off.

### C. Power Density

The power density,  $P$ , for repetitive pulsed mode is:

$$P = E J t_{\text{pulse}} / t_{\text{rep}} \quad (2)$$

All factors in this equation can be expressed in terms of the electrical field intensity. The expression for the current density is given in equ. 1. The drift velocity in this equation depends on the reduced electrical field [5]. The repetition time,  $t_{\text{rep}}$ , is the time, required for the electron density to decay from the peak value to a minimum value. In our case, the major electron loss process is dissociative recombination. Attachment can be neglected in atmospheric pressure air plasmas with a gas temperature exceeding 1500 K [7]. The repetition time  $t_{\text{rep}}$  is therefore given by

$$t_{\text{rep}} = (n_p - n_0) / (n_p * n_0 \beta) \quad (3)$$

where  $n_p$  is the peak electron density after pulse application,  $n_0$  is the minimum electron density, and  $\beta$  is the recombination coefficient. As shown in Fig. 7, the peak electron density is a function of the applied reduced electrical field.

The total power consumption for atmospheric pressure plasmas with minimum electron densities versus the applied electrical field is shown in Fig. 9. The solid lines represents the modeling results and the squares and circles the experimental results. If the applied electrical field is too low, a high repetition rate is required, a mode of operation which approaches direct current operation. Consequently the power increases towards the dc value. With increasing electrical field, most of the energy is used to generate electron densities far exceeding the desired minimum value. This density decreases rapidly due to recombination and as shown in equ. 3, contributes only minimally to the repetition time. Consequently, there is an optimum electrical field for minimum power consumption, as shown in Fig. 9.

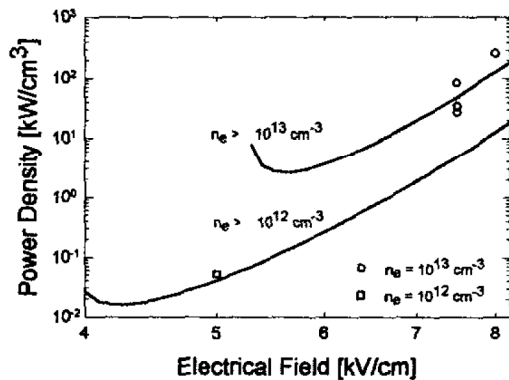

Figure 9. Power density versus the applied electrical field for different electron densities. The solid lines represent the modeling results, circles and squares represent measured values.

For an electron density of  $10^{13} \text{ cm}^{-3}$ , the minimum power density is  $0.85 \text{ kW/cm}^3$ . For an electron density of  $10^{12} \text{ cm}^{-3}$ , the power consumption can be reduced to  $18 \text{ W/cm}^3$ . The theoretical values are confirmed by the experimental results.

### IV. SUMMARY

Atmospheric pressure air plasmas could be generated with characteristic dimensions of centimeters at gas temperatures of 2000 K. A reduction in the power consumption compared to the DC glow discharge could be achieved by operating the discharges in pulsed mode. Minimum power densities required to sustain atmospheric pressure air plasmas with electron densities of  $10^{13} \text{ cm}^{-3}$  and  $10^{12} \text{ cm}^{-3}$  are  $850 \text{ W/cm}^3$  and  $18 \text{ W/cm}^3$ , respectively.

### V. ACKNOWLEDGEMENT

This work was supported by the US Air Force Office of Scientific Research, and the National Science Foundation (Award # INT-0001438).

### VI. REFERENCES

- [1] Frank Leipold, Robert H. Stark, Ahmed El-Habachi, and Karl H. Schoenbach, "Electron Density Measurements in an Atmospheric Pressure Air Plasma by Means of IR Heterodyne Interferometry" *J. Phys. D: Appl. Phys.* **33**, 2268 (2000).
- [2] Abdel-Aleam H. Mohamed, Rolf Block, and Karl H. Schoenbach "Direct Current Glow Discharges in Atmospheric Air," *IEEE Trans. Plasma Science.* **30**, 182 (2002).
- [3] Robert H. Stark and Karl H. Schoenbach, "Direct Current Glow Discharges in Atmospheric Air," *Appl. Phys. Lett.* **74**, 3770 (1999).
- [4] Robert H. Stark and Karl H. Schoenbach, "Electron Heating in Pulsed Atmospheric Pressure Glow Discharges," *J. Appl. Phys.* **89**, 3568 (2001).
- [5] A. V. Phelps, "Excitation and Ionisation Coefficients", in *Gaseous Dielectrics V*, L. G. Christophourou, and D. W. Boudin, eds., Pergamon Press, 1987, p. 1
- [6] Hisham Merhi, Masters Thesis, Old Dominion University, Norfolk, VA, August 2001.
- [7] Laux, C.O., Yu, L., Packan, D.M., Gessman, R.J., Pierrot, L., Kruger, C.H., and Zare, R.N., 30th AIAA Plasmadynamics and Lasers Conference, Norfolk, VA, June 28-July 1, 1999