

(12) **United States Patent**
Slup et al.

(10) **Patent No.:** **US 6,708,768 B2**
(45) **Date of Patent:** **Mar. 23, 2004**

- (54) **DRILLABLE BRIDGE PLUG**
- (75) Inventors: **Gabriel Slup**, Spring, TX (US);
Douglas J. Lehr, The Woodlands, TX (US)
- (73) Assignee: **BJ Services Company**, Houston, TX (US)
- (*) Notice: Subject to any disclaimer, the term of this patent is extended or adjusted under 35 U.S.C. 154(b) by 37 days.

3,828,852 A	8/1974	Delano	166/78
3,971,436 A	7/1976	Lee	166/70
4,151,875 A	5/1979	Sullaway	166/126
4,190,111 A	2/1980	Davis	166/291
4,258,788 A	3/1981	Patton et al.	166/185
4,266,620 A	5/1981	Wolgamott et al.	173/215
4,349,071 A	9/1982	Fish	166/124
4,427,065 A	1/1984	Watson	166/250
4,479,548 A	* 10/1984	Gilbert	166/387
4,520,879 A	6/1985	MacElvain	173/57
4,708,202 A	11/1987	Sukup et al.	166/123
4,722,389 A	2/1988	Arnold	166/70
5,224,540 A	7/1993	Streich et al.	166/118
5,271,468 A	12/1993	Streich et al.	166/387
5,390,737 A	2/1995	Jacobi et al.	166/184
5,413,172 A	5/1995	Laurel	166/153

(21) Appl. No.: **10/146,491**

(22) Filed: **May 15, 2002**

(65) **Prior Publication Data**

US 2002/0189820 A1 Dec. 19, 2002

Related U.S. Application Data

(63) Continuation-in-part of application No. 09/844,512, filed on Apr. 27, 2001, which is a continuation-in-part of application No. 09/608,052, filed on Jun. 30, 2000.

(51) **Int. Cl.**⁷ **E21B 33/129**

(52) **U.S. Cl.** **166/382; 166/387; 166/123; 166/134; 166/212**

(58) **Field of Search** 166/387, 382, 166/118, 134, 135, 192, 217, 123, 124, 125

(56) **References Cited**

U.S. PATENT DOCUMENTS

1,684,266 A	9/1928	Fisher et al.	
RE21,677 E	12/1940	Tremolada	255/19
3,076,509 A	2/1963	Burns et al.	166/70
3,299,955 A	1/1967	Page, Jr.	166/48
3,479,829 A	11/1969	Goodman	61/53.6
3,687,196 A	8/1972	Mullins	166/217
3,720,264 A	3/1973	Hutchinson	166/311
3,727,691 A	4/1973	Muecke et al.	166/295
3,750,749 A	8/1973	Giroux	166/95

(List continued on next page.)

OTHER PUBLICATIONS

Baker Service Tools Catalog, p. 26, [date unknown] "Compact Bridge Plug Model P-1."

(List continued on next page.)

Primary Examiner—William Neuder

(57) **ABSTRACT**

A method and apparatus for use in a subterranean well is described. The apparatus typically includes a subterranean plug including a mandrel having an outer surface and a non-circular cross-section and a packing element arranged about the mandrel, the packing element having a non-circular inner surface matching the mandrel outer surface such that concentric rotation between the mandrel and the packing element is precluded. The apparatus may include slips having cavities to facilitate quick drill-out of the plug. The apparatus may include a valve for controlling fluid flow through a hollow mandrel. The apparatus may include a composite mandrel having radial vents that establish fluid communication from within to without the mandrel. Also, the apparatus may include a wire line adapter kit for running the apparatus in a well bore.

38 Claims, 9 Drawing Sheets

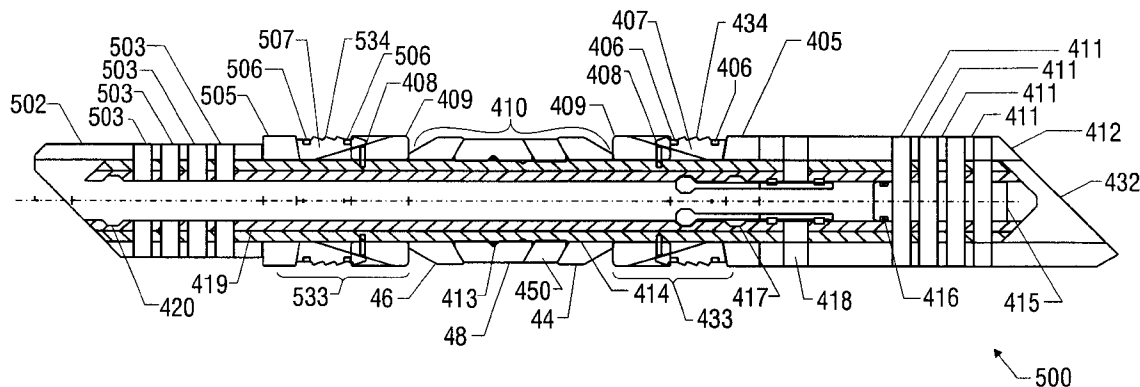

U.S. PATENT DOCUMENTS

5,449,040	A	*	9/1995	Milner et al.	166/382
5,451,084	A		9/1995	Jansch	294/1.1
5,540,279	A		7/1996	Branch et al.	166/118
5,669,448	A		9/1997	Minthorn et al.	166/308
5,701,959	A		12/1997	Hushbeck et al.	166/387
5,839,515	A		11/1998	Yuan et al.	166/387
5,865,251	A		2/1999	Rebardi et al.	166/278
5,984,007	A		11/1999	Yuan et al.	166/134
6,167,963	B1		1/2001	McMahan et al.	166/179
6,220,349	B1		4/2001	Vargus et al.	166/138
6,491,108	B1	*	12/2002	Slup et al.	166/387
6,578,633	B2	*	6/2003	Slup et al.	166/118

OTHER PUBLICATIONS

Baker Service Tools Catalog, p. 6, Unit No. 4180, Apr. 26, 1985, "E-4 Wireline Pressure Setting Assembly."

Baker Oil Tools Catalog, 1998, "Quik Drill Composite Bridge Plug."

Baker Service Tools Catalog, p. 26, [date unknown] "Model T Compact Wireline Bridge Plug."

Baker Service Tools Catalog, p. 24, [date unknown] "Model S, N-1, and NC-1 Wireline Bridge Plugs."

Society of Petroleum Engineers Article SPE 23741; ©1992. Baker Sand Control Catalog for Gravel Pack Systems; ©1988.

Offshore Technology Conference papers OTC 7022, "Horizontal Well Completing, Oseberg Gamma North," Bjorkeset et al.; ©1992.

"Water-packing Techniques Successful in Gravel Packing High-Angle Wells," Douglas J. Wilson and Mark F. Barrilleaux, Oil and Gas Journal ©1991.

Baker Prime Fiberglass Packer Prod. 739-09 data sheet.

Jun. 1968 World Oil Advertisement, p. 135 for Baker All-Fiberglass Packer.

Society of Plastics, www.socplas.org.

"Tape-laying precision industrial shafts", by Debbie Stover, Senior Editor; High-Performance Composites Jul./Aug. 1994.

Halliburton's "FAS Drill" product sheets (FAS Drill® Frac Plug, ©1999 Halliburton Energy Services, Inc.; FAS Drill® Squeeze Packers and Sliding-Valve Packers, ©1997 Halliburton Energy Services, Inc.; FAS Drill® Bridge Plugs, ©1997 Halliburton Energy Services, Inc.).

Baker, "A Primer of Oilwell Drilling", Sixth Edition, published by Petroleum Extension Service in cooperation with International Association of Drilling Contractors, 2001; first published 1951.

Long, Improved Completion Method for Mesaverde-Meeteetse Wells in the Wind River Basin, SPE 60312, Copyright 1999.

Savage, "Taking New Materials Downhole—The Composite Bridge Plug", PNEC 662,935 (1994).

Guoynes, "New Composite Fracturing Plug Improves Efficiency in Coalbed Methane Completions" SPE 40052, Copyright 1998.

Baker Hughes' web page for "QUIK Drill™ Composite Bridge Plug" (Jul. 16, 2002).

* cited by examiner

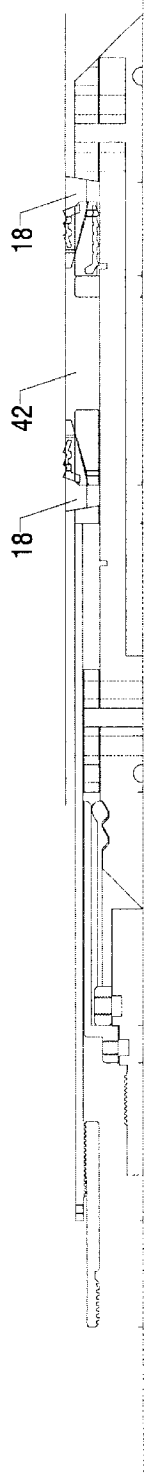

FIG. 6

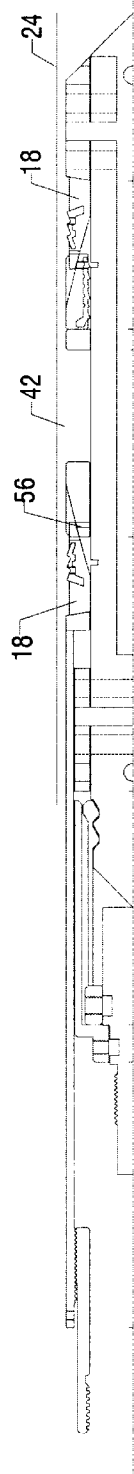

FIG. 5

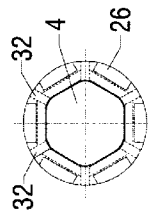

FIG. 2

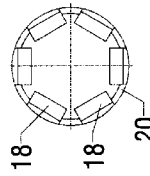

FIG. 3

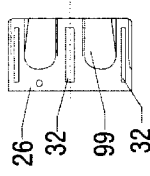

FIG. 4

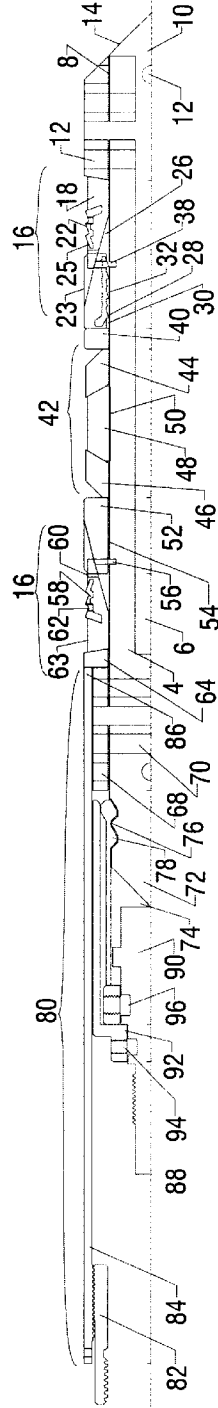

FIG. 1

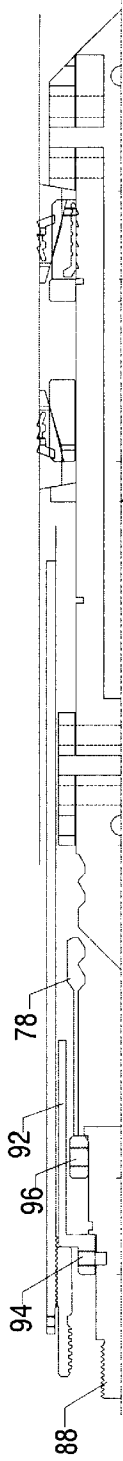

FIG. 10

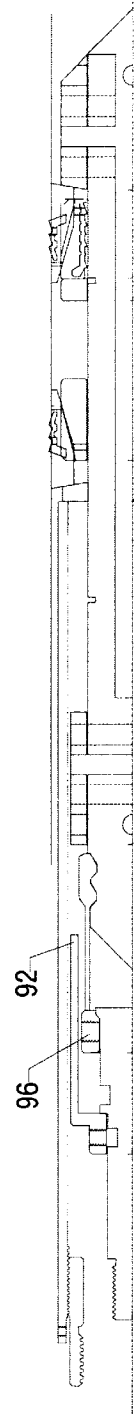

FIG. 9

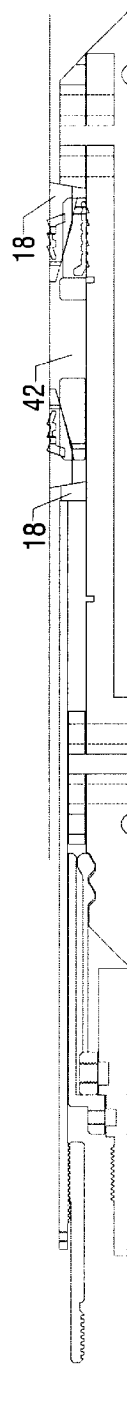

FIG. 8



FIG. 7

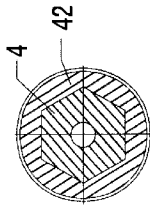

FIG. 13A

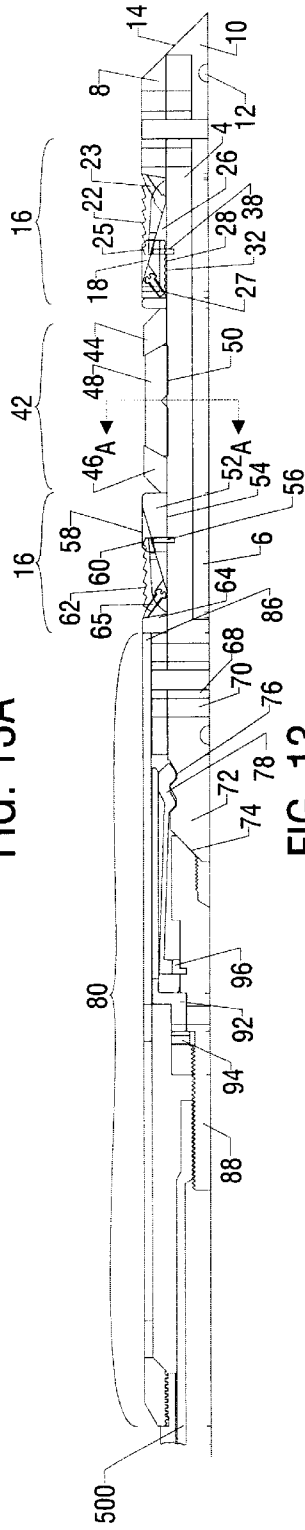

FIG. 13

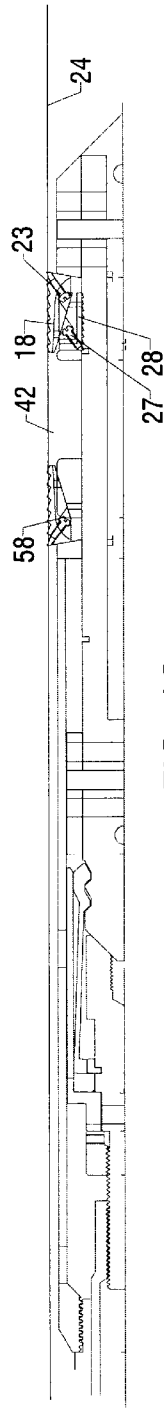

FIG. 12

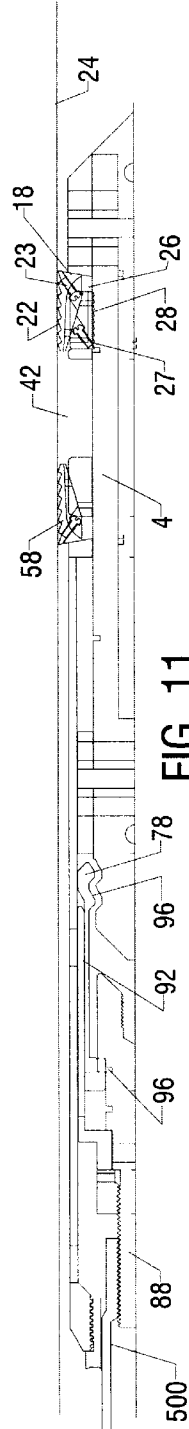

FIG. 11

Explore Litigation Insights

Docket Alarm provides insights to develop a more informed litigation strategy and the peace of mind of knowing you're on top of things.

Real-Time Litigation Alerts



Keep your litigation team up-to-date with **real-time alerts** and advanced team management tools built for the enterprise, all while greatly reducing PACER spend.

Our comprehensive service means we can handle Federal, State, and Administrative courts across the country.

Advanced Docket Research



With over 230 million records, Docket Alarm's cloud-native docket research platform finds what other services can't. Coverage includes Federal, State, plus PTAB, TTAB, ITC and NLRB decisions, all in one place.

Identify arguments that have been successful in the past with full text, pinpoint searching. Link to case law cited within any court document via Fastcase.

Analytics At Your Fingertips



Learn what happened the last time a particular judge, opposing counsel or company faced cases similar to yours.

Advanced out-of-the-box PTAB and TTAB analytics are always at your fingertips.

API

Docket Alarm offers a powerful API (application programming interface) to developers that want to integrate case filings into their apps.

LAW FIRMS

Build custom dashboards for your attorneys and clients with live data direct from the court.

Automate many repetitive legal tasks like conflict checks, document management, and marketing.

FINANCIAL INSTITUTIONS

Litigation and bankruptcy checks for companies and debtors.

E-DISCOVERY AND LEGAL VENDORS

Sync your system to PACER to automate legal marketing.