



United States Patent [19]
McNelly et al.

[11] **Patent Number:** **5,550,754**
[45] **Date of Patent:** **Aug. 27, 1996**

- [54] **TELECONFERENCING CAMCORDER**
- [75] Inventors: **Steve McNelly**, Capistrano; **Eric Williams**, Altadena, both of Calif.
- [73] Assignee: **Videoptic Research**, San Juan Capistrano, Calif.
- [21] Appl. No.: **242,131**
- [22] Filed: **May 13, 1994**
- [51] Int. Cl.⁶ **H05K 11/00**
- [52] U.S. Cl. **364/514 A; 348/13**
- [58] Field of Search **364/514 A; 348/14, 348/15, 13, 19**

5,157,512	10/1992	Inada et al. .	
5,159,445	10/1992	Gitlin et al. .	
5,162,915	11/1992	Idera et al. .	
5,170,427	12/1992	Guichard et al.	348/14
5,189,691	2/1993	Dunpal .	
5,206,731	4/1993	Takaiwa et al. .	
5,243,413	9/1993	Gitlin et al. .	
5,249,053	9/1993	Jain .	
5,253,286	10/1993	Sano et al.	348/14
5,278,681	1/1994	Gitlin et al. .	

Primary Examiner—Emanuel T. Voeltz
Assistant Examiner—Thomas Peeso
Attorney, Agent, or Firm—Price, Gess & Ubell

[57] **ABSTRACT**

A combination portable recording video camera and video-conferencing terminal is described, wherein a video camera and lens is adjustable so that it can either produce images of an operator's surroundings for recording on a medium such as video tape, as in normal recording video cameras, or of the operator as in video conferencing terminals. The device is preferably provided with a video display screen that functions as a viewfinder in video-graphing the surroundings. The device is equipped with communication electronics that establish a connection over a network, and then transmits video and audio signals from the device while displaying video signals and reproducing audio signals that arrive over the network. Attempts by the network to establish a connection with the device result in the device automatically establishing the connection. Then the device activates its internal recording systems to play the pre-recorded video message and transmit it over the network. The operator is later able to play the recorded signals and view them on the device's built-in display.

65 Claims, 12 Drawing Sheets

[56] **References Cited**

U.S. PATENT DOCUMENTS

4,400,725	8/1983	Tanigaki .	
4,485,400	11/1984	Lemelson et al. .	
4,604,668	8/1986	Lemelson .	
4,819,101	4/1989	Lemelson .	
4,829,555	5/1989	Hashimoto .	
4,875,107	10/1989	Heidt et al. .	
4,894,715	1/1990	Uchikubo et al. .	
4,899,231	2/1990	Maeda et al. .	
4,928,300	5/1990	Ogawa et al.	348/14
4,928,301	5/1990	Smoot .	
4,996,592	2/1991	Yoshida .	
5,032,820	7/1991	Tanikawa et al.	348/14
5,046,079	9/1991	Hashimoto .	
5,061,992	10/1991	Ueno	348/14
5,111,498	5/1992	Guichard et al.	348/14
5,117,285	5/1992	Nelson et al. .	
5,142,562	8/1992	Guichard et al.	348/14
5,151,727	9/1992	Sasaki .	

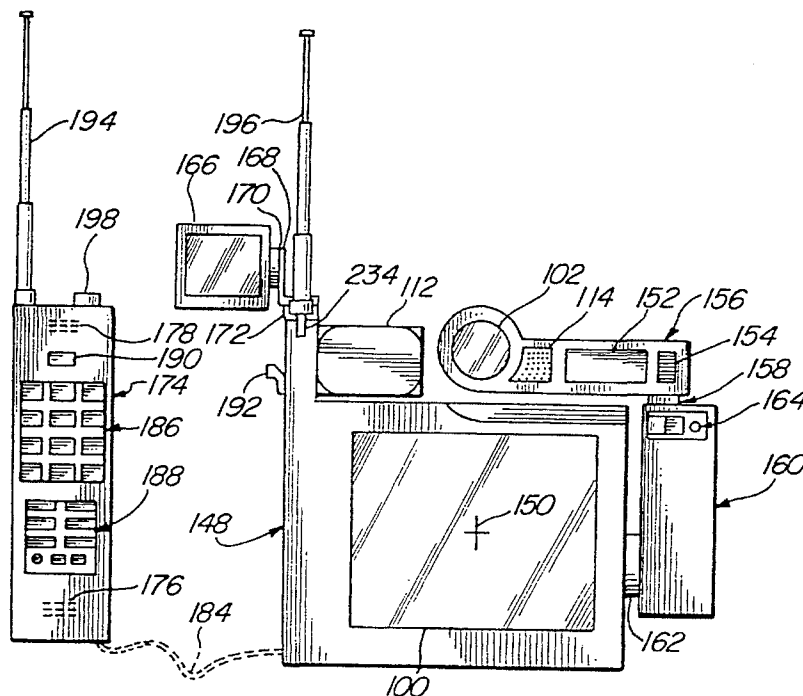

PRIOR ART
FIG. 2

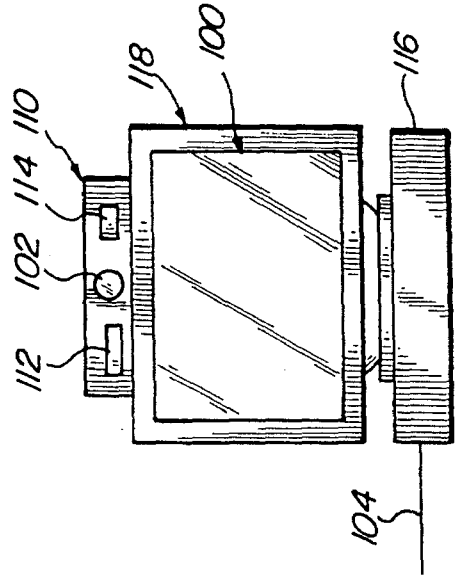

PRIOR ART

FIG. 4

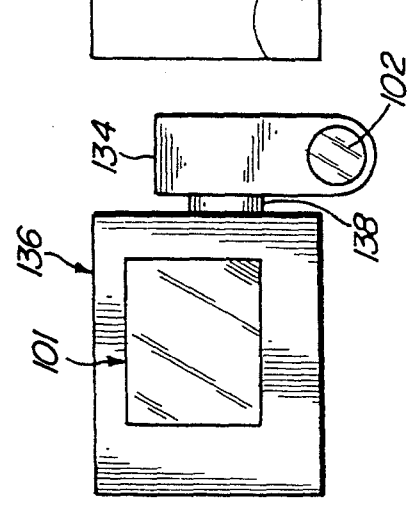

PRIOR ART

FIG. 1

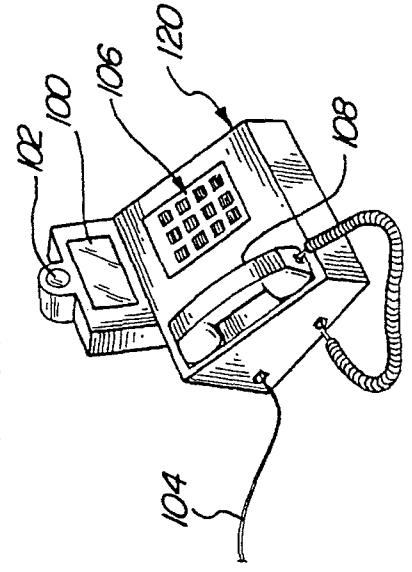

PRIOR ART

FIG. 3

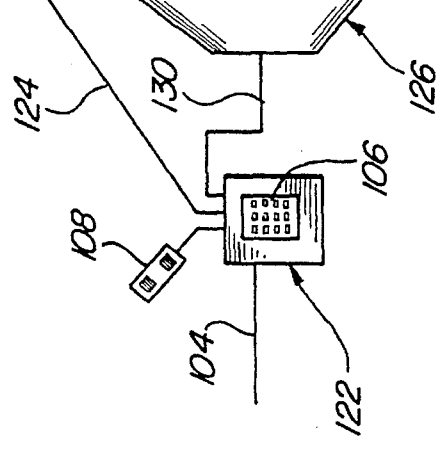

FIG. 8

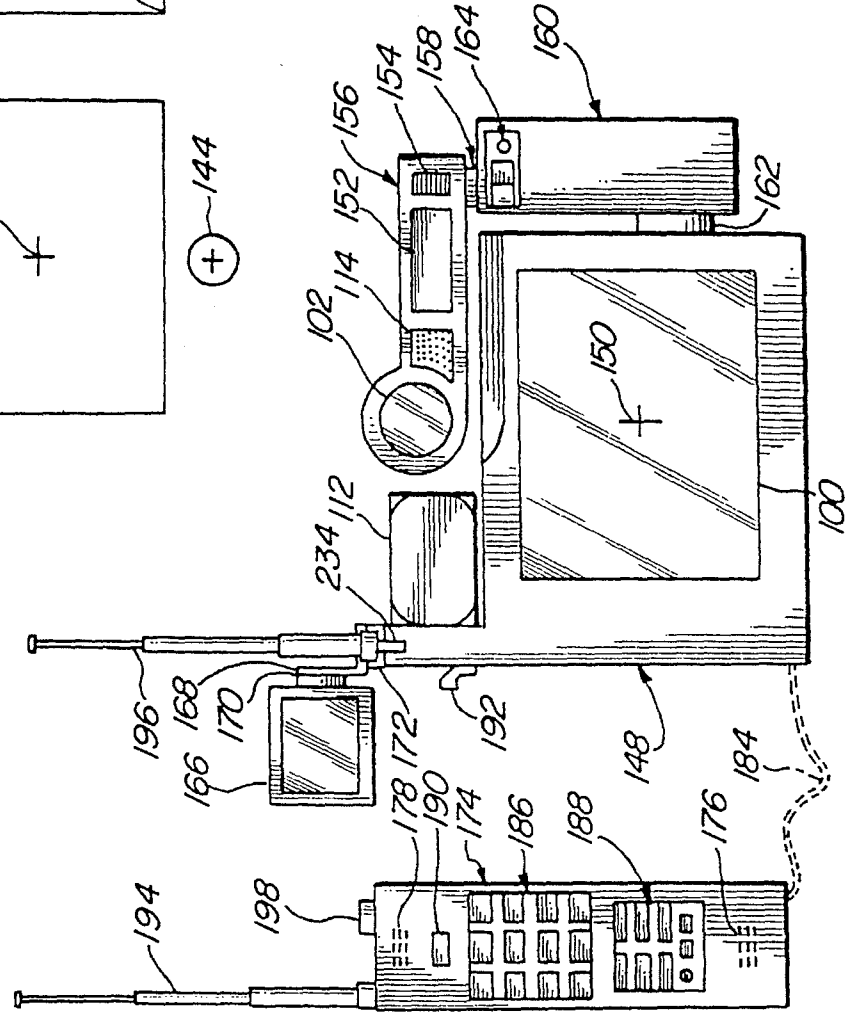

FIG. 6

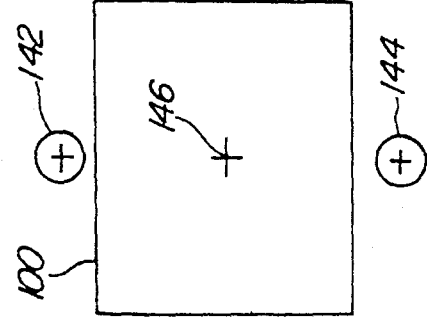

FIG. 7

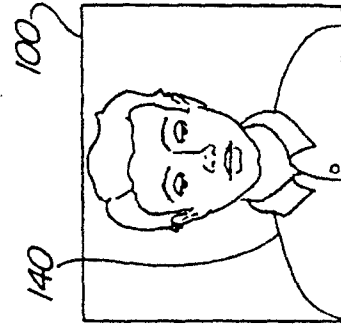

FIG. 10

FIG. 11

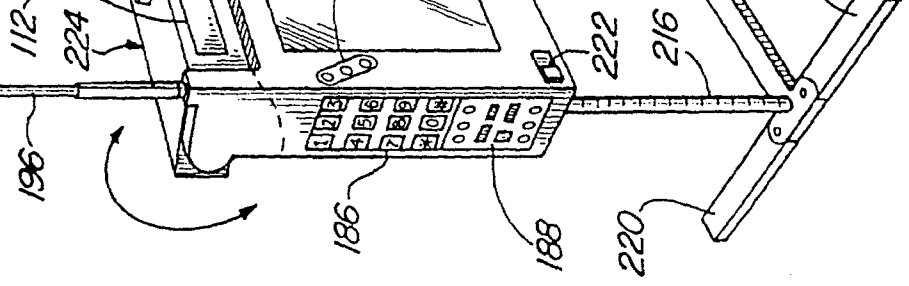
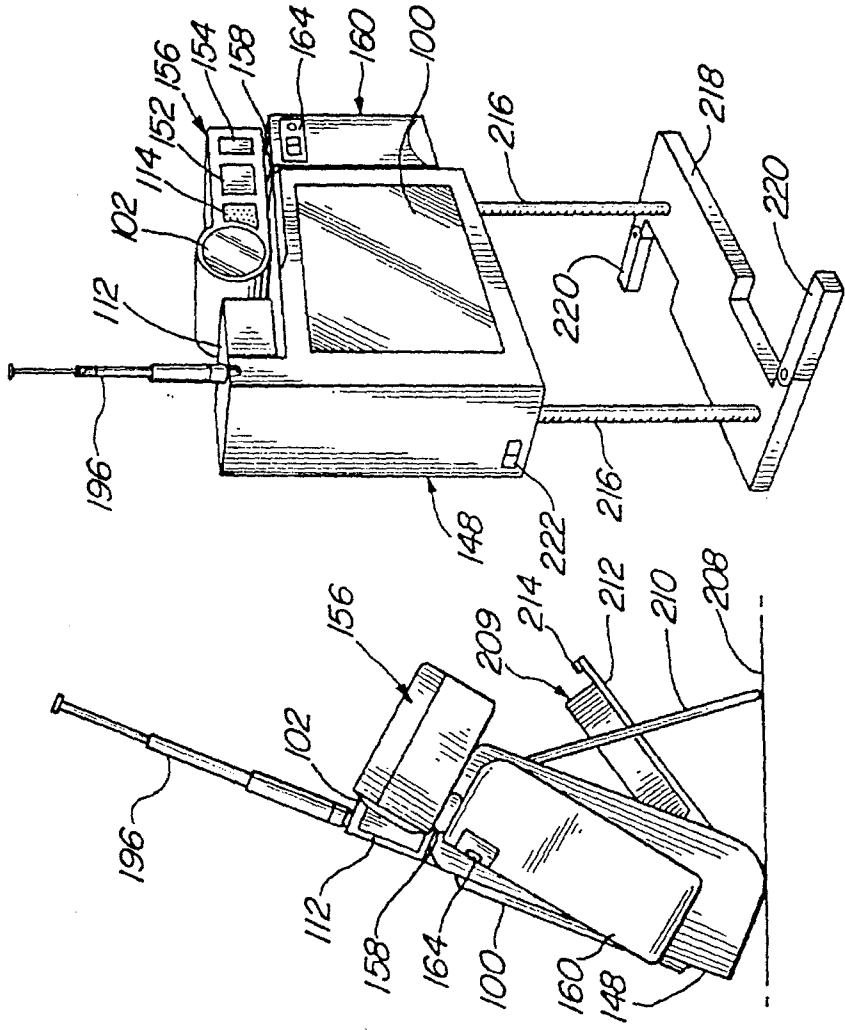

FIG. 13

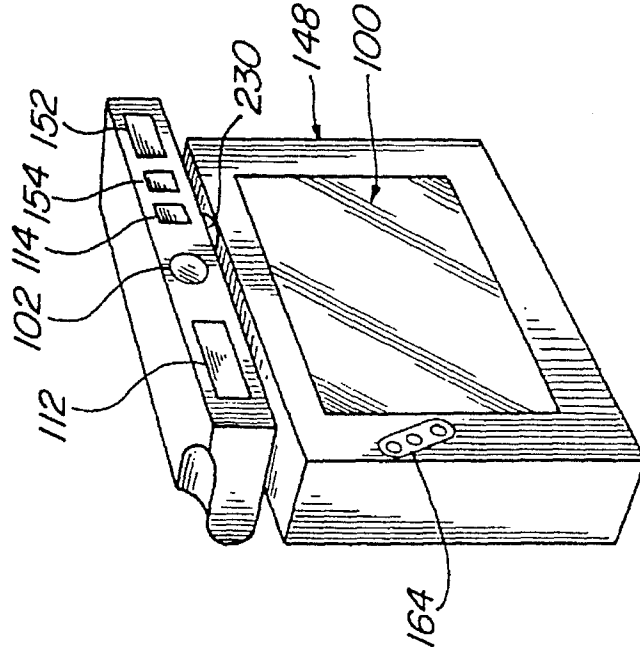
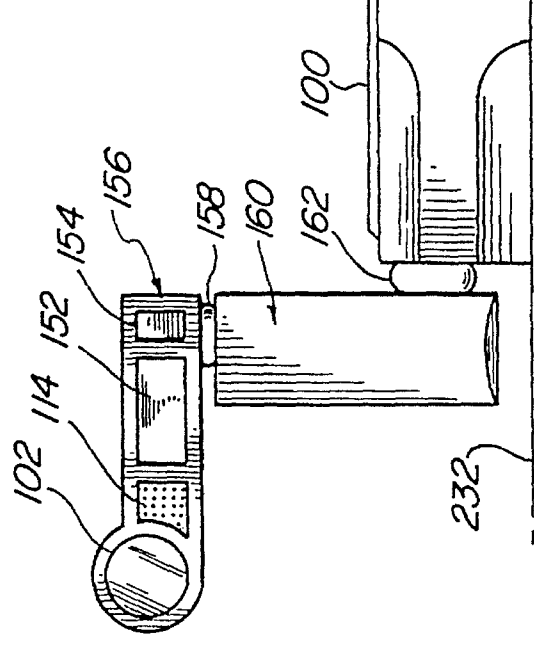

FIG. 14



Explore Litigation Insights

Docket Alarm provides insights to develop a more informed litigation strategy and the peace of mind of knowing you're on top of things.

Real-Time Litigation Alerts



Keep your litigation team up-to-date with **real-time alerts** and advanced team management tools built for the enterprise, all while greatly reducing PACER spend.

Our comprehensive service means we can handle Federal, State, and Administrative courts across the country.

Advanced Docket Research



With over 230 million records, Docket Alarm's cloud-native docket research platform finds what other services can't. Coverage includes Federal, State, plus PTAB, TTAB, ITC and NLRB decisions, all in one place.

Identify arguments that have been successful in the past with full text, pinpoint searching. Link to case law cited within any court document via Fastcase.

Analytics At Your Fingertips



Learn what happened the last time a particular judge, opposing counsel or company faced cases similar to yours.

Advanced out-of-the-box PTAB and TTAB analytics are always at your fingertips.

API

Docket Alarm offers a powerful API (application programming interface) to developers that want to integrate case filings into their apps.

LAW FIRMS

Build custom dashboards for your attorneys and clients with live data direct from the court.

Automate many repetitive legal tasks like conflict checks, document management, and marketing.

FINANCIAL INSTITUTIONS

Litigation and bankruptcy checks for companies and debtors.

E-DISCOVERY AND LEGAL VENDORS

Sync your system to PACER to automate legal marketing.