

High flux beam source of thermal rare-gas metastable atoms

This content has been downloaded from IOPscience. Please scroll down to see the full text.

View [the table of contents for this issue](#), or go to the [journal homepage](#) for more

Download details:

IP Address: 216.185.156.28

This content was downloaded on 02/10/2013 at 22:04

Please note that [terms and conditions apply](#).

INTEL 1005

minimises shock overloads. This simple technique ensures rapid application of an accurate load. The rate of penetration of the indenter is thus essentially material-dependent and therefore enables comparisons to be made with results from other hardness tests, e.g. Brinell and Vickers to British Standards specification. The load is maintained for a known time (e.g. 15 s) prior to removal; recovery is allowed for a second fixed period. The transducer readings corresponding to the undeformed sample surface, the depth of penetration under load and the recovered depth of indentation are fed into a computer which calculates the hardness and elastic modulus of the material, as well as parameters such as the diameter and volume of the indentation and the radius of the recovered surface. The tester can also be used to obtain data on time-dependent properties such as creep compliance: the load is maintained for the desired period and data are collected continuously.

5 Conclusions

This indentation tester has already been used successfully in the investigation of pharmaceutical tablets (Aulton *et al* 1974, Aulton and Tebby 1976). The versatility of the tester can be considerably increased by changes in indentation load, type and size of indenter tip, and transducer characteristics. However, we consider the realistic applications of this instrument to be limited to materials with hardness values between 5 and 1000 MPa.

We suggest that this indenter could find wide use in the characterisation and routine quality control of materials such as polymer films and plastics, foodstuffs (e.g. fruit, chocolate, ice-cream), pharmaceuticals, and soft metals such as lead.

References

- Aulton M E and Tebby H G 1976 Time-dependent deformations of tablets during indentation testing *J. Pharm. Pharmac.* **28** Suppl. 66P
- Aulton M E, Tebby H G and White P J P 1974 Indentation hardness testing of tablets *J. Pharm. Pharmac.* **26** Suppl. 59P

High flux beam source of thermal rare-gas metastable atoms

D W Fahey, W F Parks and L D Schearer

Physics Department, University of Missouri, Rolla, Missouri 65401

Received 9 April 1979, in final form 5 October 1979

Abstract A high-flux beam source has been constructed for the production of helium, neon and argon metastable atoms. The source is a DC electric discharge maintained in an expanding gas. A metastable flux of 3.5×10^{14} , and 7.2×10^{13} atoms $s^{-1} sr^{-1}$ has been achieved with most probable energies of 66, 72 and 74 meV for the helium, neon and argon sources, respectively. Time-of-flight measurements showed the widths of the respective velocity distributions to be 45%, 27% and 27%.

1 Introduction

A novel metastable beam source was recently described by Leasure *et al* (1975), whose design employed a weak, high-voltage corona discharge between a sharp needle and a cone-shaped anode. The discharge was maintained across a substantial pressure gradient. This source provided up to 10^{14} metastable helium and argon atoms $s^{-1} sr^{-1}$ with beam energies between 5 eV (helium) and 74 eV (argon). The attractive features of this source were its relative simplicity and high flux.

We report here modifications to the Leasure *et al* design which result in a further simplification, enhanced beam flux, species-independent energies, and importantly, beam energies only slightly in excess of thermal energies. The source is capable of providing very stable thermal energy beams of helium, neon, and argon metastable atoms with flux values near 10^{14} metastable atoms $s^{-1} sr^{-1}$.

2 Source design and operation

The source is essentially a low-voltage discharge between a sharp needle and cone-shaped skimmer electrode. The discharge is maintained across a pressure gradient created by differentially pumping a gas nozzle. The source design is shown in figure 1. A vacuum fitting is mounted in a vacuum

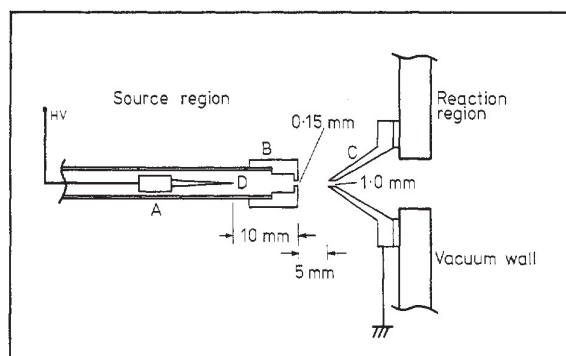

Figure 1 Beam source schematic showing Pyrex tube (A), boron nitride nozzle (B), skimmer (C), and needle or needle array (D).

wall and seals around a 7 mm OD Pyrex glass tube (A) that extends into the vacuum chamber. A machined piece of boron nitride (B) is attached with epoxy to form a cap for the end of the glass tube. A small hole drilled in this cap serves as the nozzle opening. The skimmer is a cone-shaped piece of stainless steel (C) with a small hole at the apex. Inside the glass tube behind the nozzle, several steel hypodermic needles are supported to lie near the axis of the tube. The skimmer piece is attached with an aluminium gasket to a vacuum wall to allow differential pumping of the source. Gas is admitted to the glass tube by a micrometer leak valve mounted outside of the vacuum chamber. The source region is contained inside a 10 cm Corning Pyrex glass cross which is evacuated by a 300 l s^{-1} oil diffusion pump. The reaction region is a 97 l stainless-steel chamber in which the pressure is maintained below $1.3 \times 10^{-4} \text{ Pa}$ (10^{-6} Torr).

The needles behind the nozzle are the cathode of the electric discharge and hence are maintained at a negative potential with respect to the skimmer which is kept at ground potential. Since the needle electrode is a cold-cathode type, the application of the voltage necessary to sustain the discharge is not generally sufficient to initiate a discharge. It is therefore necessary to apply an initiating high-voltage pulse simultaneously with a negative DC sustaining voltage in order to turn on the source. The DC source discharge after initiation by the high voltage pulse is maintained at 3 mA and 400 V.

The optimum nozzle pressures for the three source gases used were measured with a Wallace and Tiernan dial gauge to be 6.7 kPa (50 Torr) for He, 11.3 kPa (85 Torr) for Ne, and 6.0 kPa (45 Torr) for Ar. The background pressure in the source region at these operating pressures was measured with an ionisation gauge at low emission current to be between 0.13 and 0.20 Pa (1.0 and 1.5 mTorr). At 0.13 Pa helium background pressure the mass flow rate was determined to be 66 Pa l s^{-1} . The beam flux is a slowly varying function of operating nozzle pressure. At 2.7–6.7 kPa (20–50 Torr) below optimum pressure the source discharge cannot be sustained, and at 6.7–13.3 kPa above optimum pressure the beam flux is reduced to zero after slowly decreasing from the optimum value.

The stability of the source output at 3 mA emission was very good. Degradation in source yield from use results primarily from wearing of the nozzle opening. After a run period of a month at several hours a day, the nozzle diameter is virtually unchanged as measured with a travelling microscope.

3 Beam diagnostics

The beam was characterised using two very different detection methods. The first method of detecting the beam made use of particle detectors. The second method used the detection of optical emission resulting from the interaction of the beam components with a strontium vapour target. Two types of particle detectors were used to observe all beam components and to estimate the absolute flux and energy of the components. For all diagnostic measurements, the beam was kept free of charged species by maintaining an adequate voltage on a set of parallel sweep plates mounted after the skimmer.

3.1 Particle detection

For direct particle detection, both a copper–beryllium particle multiplier and a specially designed metastable detector were used. Copper–beryllium dynodes have shown better than 50% efficiency for secondary electron ejection by slow metastables and up to 20% efficiency for photons below 200 nm (Dunning *et al* 1975, Smith 1972). The surface is also sensitive to fast neutral ground state particles and ions of sufficient kinetic energy. The particle multiplier was used with a chopper wheel

to analyse the time of flight (TOF) spectrum for different component species and their respective velocities. The multiplier was mounted in the chamber such that it could undergo displacements of up to 60 cm in order to allow accurate measurements.

The TOF spectrum for the helium, neon and argon beams as observed with the particle multiplier revealed only two peaks. The first is identified as the detection of resonant photons from the source discharge and the second as the detection of the respective metastable species of the source gas. A sample TOF spectrum is shown in figure 2 for the helium source. The photon peak is established by the fact that its shape matches the aperture function, as it must for photons, and by the fact that the position of the peak in time with respect to the chopper wheel reference signal and the shape of the peak remain unchanged for multiplier displacements. The velocity of the slower peak is established equally by its separation in time from the photon peak and from its displacement in time resulting from a spatial displacement of the multiplier.

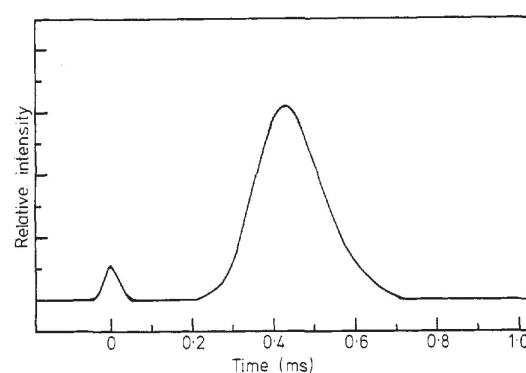

Figure 2 TOF spectrum for the helium source for a detector-to-chopper wheel separation of 85 cm.

The most probable velocity and velocity distribution of the metastable species were obtained by assuming a weighted Gaussian for the distribution (Anderson and Fenn 1965). It was determined by numerical integration that, for these measurements, the detector current was well approximated by the ideal case in which the chopper wheel aperture was open for a time negligible compared to the time of flight. In this ideal case the velocity distribution, $f(v)$, is proportional to the time-of-flight spectrum, $I(t)$, multiplied by t^2 , where vt is the detector-to-chopper wheel separation. The most probable velocities of the calculated distribution for the three metastable species were $1.8 \times 10^3 \text{ m s}^{-1}$, $8.3 \times 10^2 \text{ m s}^{-1}$ and $6.0 \times 10^2 \text{ m s}^{-1}$ for helium, neon and argon, respectively, for source conditions of 3 mA discharge current and optimum nozzle pressures. These velocities correspond to energies of 66 meV, 72 meV and 74 meV, respectively. The half-widths of the velocity distributions were 45% for helium and 27% for neon and argon.

The specially designed metastable detector incorporates the principal features of a gas cell used by Dunning and Smith (1971) to measure secondary emission coefficients. With this detector absolute flux measurements of the metastable component of the beam were obtained. The sensitive surface was a disc of chemically cleaned stainless steel or copper from which secondary electrons ejected by the beam were measured. The secondary electron ejection coefficients for the target surface for the three metastable species lie very close to unity (Dunning and Smith 1971). The flux at 3 mA emission and optimum pressure for the helium, neon and argon metastables

was 3.5×10^{14} , 1.5×10^{14} , and 7.2×10^{13} atoms $\text{s}^{-1} \text{sr}^{-1}$, respectively. The flux values obtained for the different target surfaces agreed within the coefficient uncertainty. The photon flux was shown to contribute much less than 1% of the total secondary current.

3.2 Strontium optical emission

The metastable character of each beam was established independently of particle detectors by observing the optical excitation produced in strontium vapour titrated into the beam path. The metastable beam components react with strontium in Penning ionising collisions which can leave the strontium ion in an excited state. The resultant excited state emission is monitored as evidence of the metastable beam component. A spectrum of the strontium emission for each metastable beam revealed the SrII $5^2\text{P}_{3/2} - 5^2\text{S}_{1/2}$ emission line as the most intense in the visible region. This result agrees with flowing-afterglow emission studies that have been performed in our laboratory. Thus, with the added information that the beam energies are near thermal energy, the observed strontium emission is sufficient evidence of the metastable character of the beam.

4 Source performance

The beam source of metastable helium, neon and argon atoms has proved to be highly reliable and very stable, operating many hours per day over several months without attention. The high beam flux and the high stability have permitted us to observe the formation of coherently excited ions in Penning ionisation (Fahey *et al* 1978).

We have also successfully extended the operation of this source to include molecular systems such as nitrogen. In this system a significant flux of $\text{A}^3\Sigma$ metastable nitrogen molecules is obtained. Nozzle seeding techniques to increase the beam velocity have also been successful. In argon, for example, the velocity is enhanced by a factor of 2 by the addition of hydrogen. In the neon source the addition of helium results in a 20% velocity enhancement.

Acknowledgment

This research is supported by the Office of Naval Research.

References

- Anderson J B and Fenn J B 1965 Velocity distributions in molecular beams from nozzle sources
Phys. Fluids **8** 780-7
- Dunning F B and Smith A C 1971 Secondary electron ejection from metal surfaces by metastable atoms. II Measurements of secondary emission coefficients using a gas cell method
J. Phys. B: Atom. Molec. Phys. **4** 1696-710
- Dunning F B, Rundel R D and Stebbings R F 1975 Determination of secondary electron ejection coefficients for rare gas metastable atoms
Rev. Sci. Instrum. **46** 697-701
- Fahey D W, Parks W F and Schearer L D 1978 Aligned, excited ions from Penning ionization
Bull. Am. Phys. Soc. **23** 1088
- Leasure E L, Mueller C R and Ridley T Y 1975 'Hot' metastable atom, molecular beam source
Rev. Sci. Instrum. **46** 635-7
- Smith A B 1972 Notes on the performance and application of EMI windowless particle detectors
EMI Electronics Ltd Document R/P034

An apparatus for the measurement of initial magnetic permeability as a function of temperature

E Cedillo,† J Ocampo,† V Rivera‡ and R Valenzuela‡

† Departamento de Ciencia de Materiales, Escuela Superior de Física y Matemáticas, Instituto Politécnico Nacional, México

‡ Centro de Investigación de Materiales, Universidad Nacional Autónoma de México, México Apartado Postal 70-360, México 20, DF

Received 29 May 1979, in final form 31 October 1979

Abstract A simple apparatus for the study of the quasi-static initial magnetic permeability as a function of temperature is presented. It is based on the Faraday law of electromagnetic induction and is especially suited for toroidal samples of ferrimagnetic compounds. The measurements can be performed at frequencies from 1 to 100 kHz, and temperatures from 80 to 900 K. In addition to the initial permeability and the Curie temperature, this apparatus provides a qualitative determination of the chemical homogeneity of the samples.

1 Introduction

The initial magnetic permeability is a very microstructure-sensitive property. The study of the thermal variations of initial permeability of polycrystalline ferrites has contributed to significant improvements in our knowledge of the magnetisation mechanisms (Globus and Duplex 1966). It can also be used as a quality test (Globus and Valenzuela 1975) in the preparation of ferrite samples.

Measurement of initial permeability as a function of temperature is generally performed by measuring the inductance of a toroidal sample on an impedance bridge at different temperatures. However, this technique can be tedious if the temperature intervals are very narrow and an interesting phenomenon can be missed if they are very widely spaced. At the Curie point the initial permeability falls from a high value (generally its maximum) to near 1. The verticality of this drop provides an evaluation of the sample's chemical homogeneity. Clearly, it is difficult to estimate the homogeneity using this technique.

In this paper we describe a simple apparatus for recording continuously the initial permeability as a function of the temperature, from 80 to 900 K. This apparatus is especially suited for toroidal samples of ferrimagnetic oxides.

2 Basis of the apparatus

The toroidal sample is used as a transformer core, and a sinusoidal current i_p is established in the primary coil. As a consequence of the induction a voltage V_s appears at the secondary coil:

$$V_s = n_s d\phi/dt \quad (1)$$

where n_s is the number of turns in the secondary coil.

As

$$i_p = i_0 e^{-j\omega t},$$