



US006190512B1

(12) **United States Patent**  
**Lantsman**

(10) **Patent No.:** **US 6,190,512 B1**  
(45) **Date of Patent:** **Feb. 20, 2001**

(54) **SOFT PLASMA IGNITION IN PLASMA PROCESSING CHAMBERS**

(75) **Inventor:** Alexander D. Lantsman, Middletown, NY (US)

(73) **Assignee:** Tokyo Electron Arizona Inc., Tokyo (JP)

(\* ) **Notice:** Under 35 U.S.C. 154(b), the term of this patent shall be extended for 0 days.

(21) **Appl. No.:** 08/117,443

(22) **Filed:** Sep. 7, 1993

(51) **Int. Cl.<sup>7</sup>** ..... C23C 14/34

(52) **U.S. Cl.** ..... 204/192.12; 204/192.13

(58) **Field of Search** ..... 156/643, 646, 156/626, 627, 345; 204/192.12, 192.13, 298.08, 298.06, 298.34, 298.32, 192.33; 219/121.57; 118/723 R, 723 E

(56) **References Cited**

**U.S. PATENT DOCUMENTS**

- 4,557,819 \* 12/1985 Meacham et al. .... 204/298
- 4,888,088 \* 12/1989 Slomowitz ..... 156/643
- 5,288,971 \* 2/1994 Knipp ..... 204/298.08 X

**FOREIGN PATENT DOCUMENTS**

59-222580 12/1984 (JP) ..... C23C/15/00

**OTHER PUBLICATIONS**

Mashiro Kazuhiko, "Discharge Triggering Method of Sputtering Device" Abstracts of Japanese Patent Application No. 59-222580, Published December 14, 1984.

Jeff Rowland, "Equipment Profile—Coherence One Series II Preamp and Model 7 Mono Amp" Audio Magazine, Apr., 1990.

Audio Research Corporation, Product Brochure D70/D115/D250 and M100 Power Amplifiers.

"Gaseous Conductors Theory and Engineering Applications" James Dillon Cobine, Ph.D. (1941, 1958).

"The Advanced Energy MDX Magnetron Drive" Sales Brochure of Advanced Energy Industries, Inc. (Jun., 1991).

\* cited by examiner

*Primary Examiner*—Nam Nguyen

(74) *Attorney, Agent, or Firm*—Wood, Herron & Evans, L.L.P.

(57) **ABSTRACT**

The specification discloses a power supply circuit which reduces oscillations generated upon ignition of a plasma within a processing chamber. A secondary power supply pre-ignites the plasma by driving the cathode to a process initiation voltage. Thereafter, a primary power supply electrically drives the cathode to generate plasma current and deposition on a wafer.

**7 Claims, 3 Drawing Sheets**

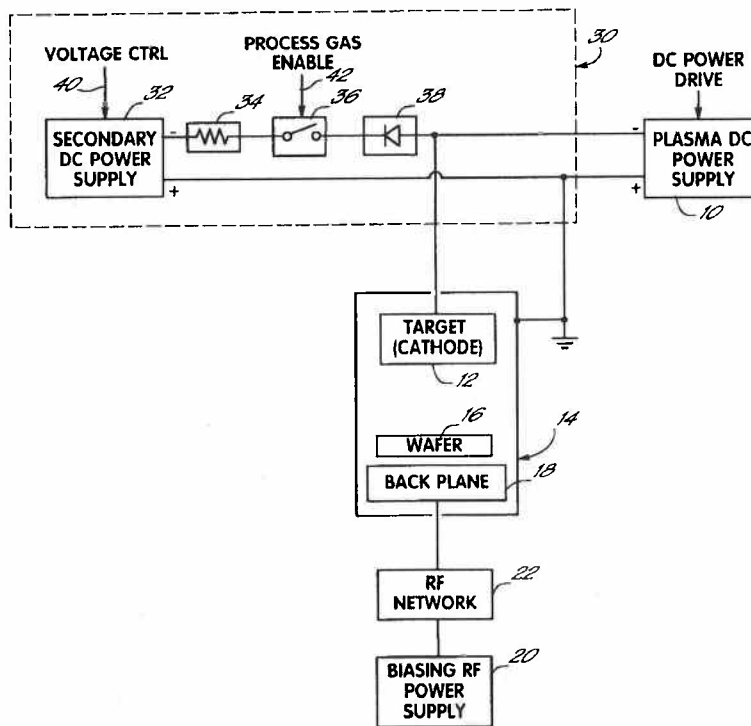

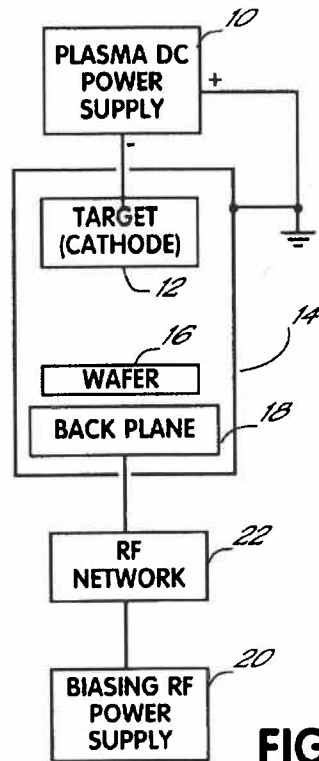

FIG. 1

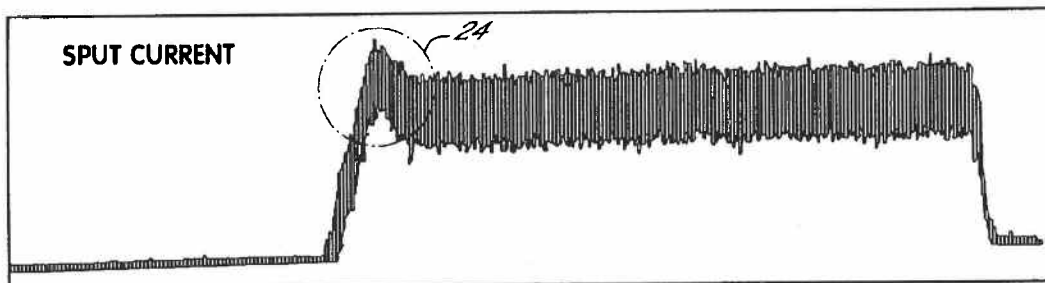

FIG. 2

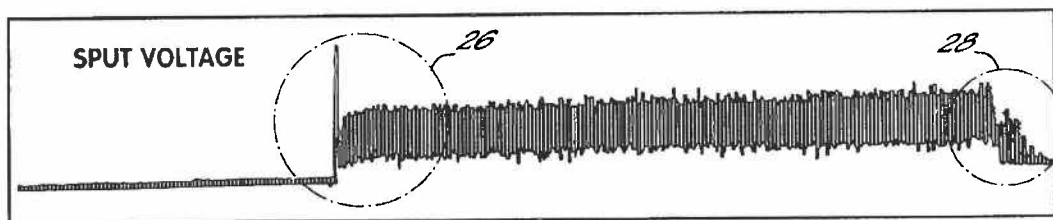

FIG. 3

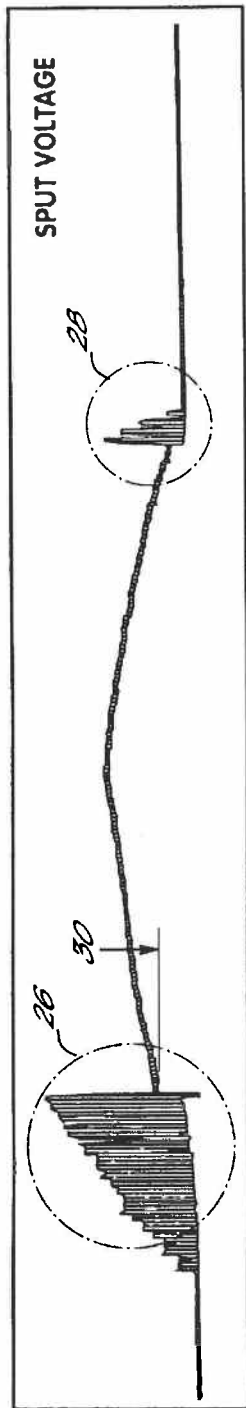

FIG. 4

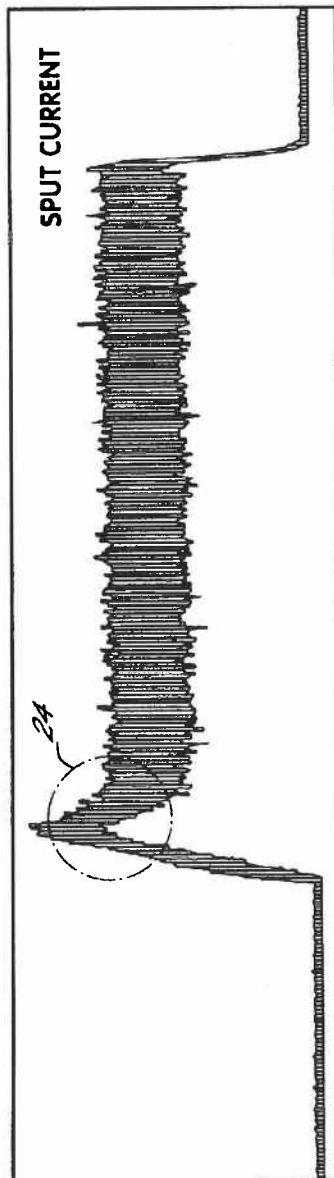

FIG. 7

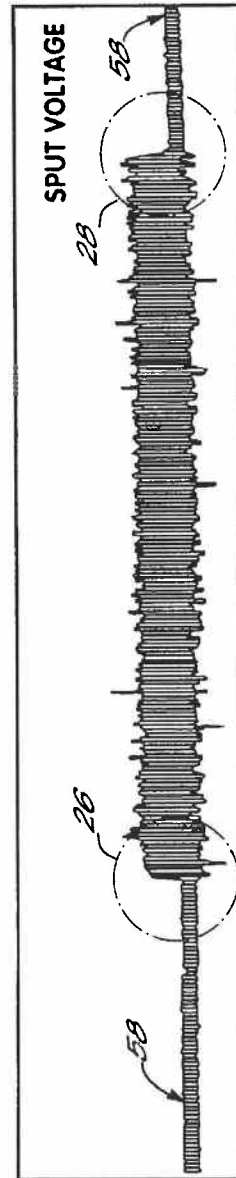

FIG. 8

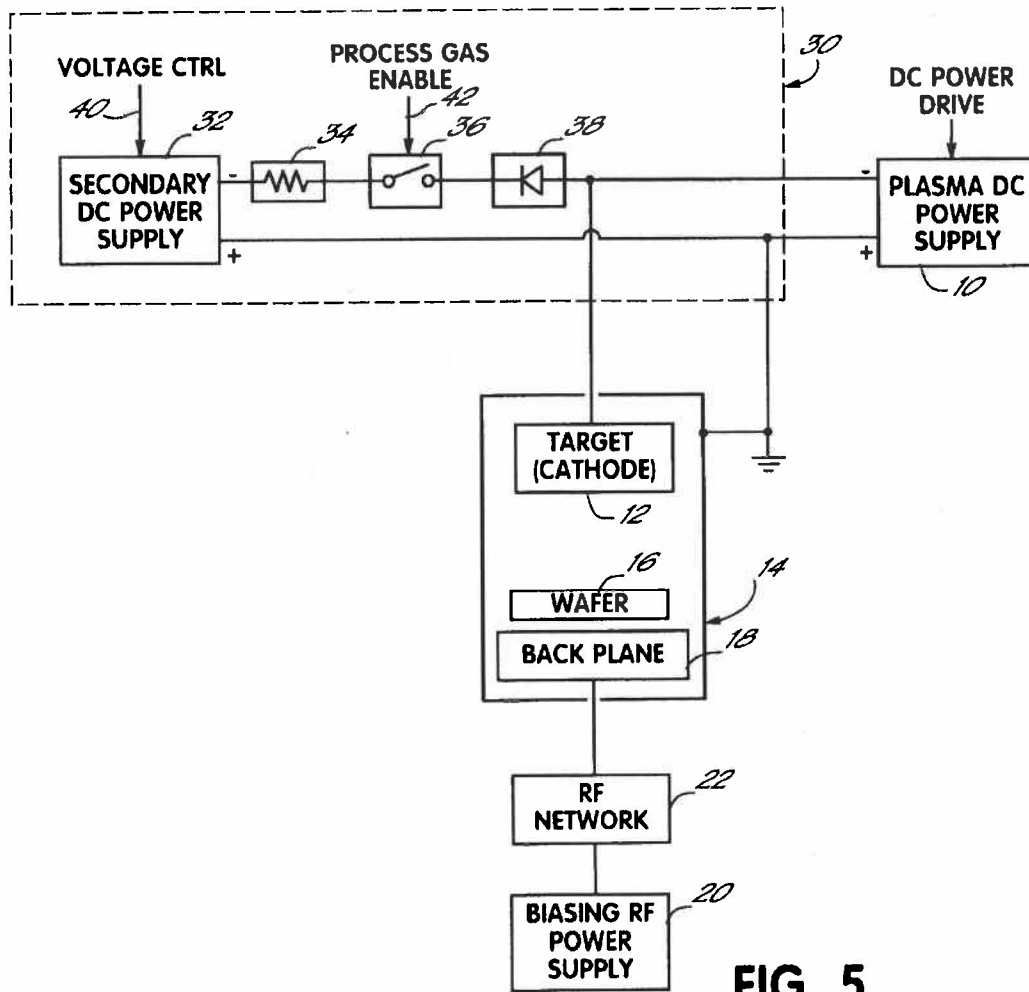

FIG. 5

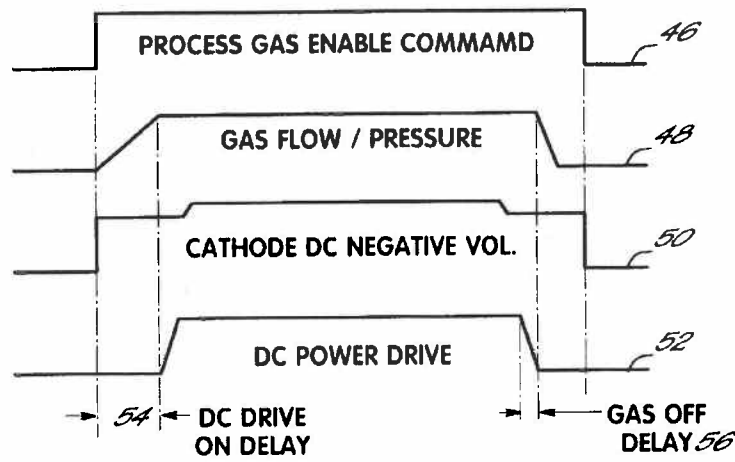

FIG. 6

## SOFT PLASMA IGNITION IN PLASMA PROCESSING CHAMBERS

### BACKGROUND OF THE INVENTION

This invention relates to reduction of device damage in plasma processes, including DC (magnetron or non-magnetron) sputtering, and RF sputtering.

A typical plasma processing apparatus is shown in FIG. 1. The apparatus includes a plasma power supply 10, which drives a cathode or target 12 to a large DC voltage (e.g., -400 Volts) relative to the walls of vacuum chamber 14. The semiconductor substrate 16 (also known as the wafer) rests on a back plane 18 inside the chamber. The back plane may be driven by radio frequency (RF) AC voltage signals, produced by an RF power supply 20, which drives the back plane through a compensating network 22.

The AC and/or DC power supplies generate a plasma in the area above the wafer and between the wafer and the target, and cause material from the target to deposit on the wafer surface.

A typical DC power supply 10 includes a relatively sophisticated control system, designed to permit operation in constant power, constant voltage, or constant current modes. This control circuitry includes a damped control loop which, when the supply is engaged, produces a controlled ramping toward the desired output level. For example, as shown in FIG. 2, upon engagement of a typical DC power supply in an apparatus as shown in FIG. 1, the supply current (which represents the density of ionic transfer from the target due to sputter deposition on the wafer) ramps up to a constant value in a controlled manner with a small overshoot 24.

Despite the otherwise carefully regulated output produced by typical power supplies, it is normal to observe a spike in the target voltage during process initiation. As shown in FIG. 3, the magnitude of the spike 26 at process initiation may exceed the normal DC voltage level by a factor of 2 or more (e.g., those shown in FIG. 3 reach -1100 Volts). This phenomenon, known as the "break down" spike, is typically viewed as a necessary, isolated event associated with the creation of a plasma in the chamber 14 (otherwise known as "plasma ignition"). Furthermore, a large magnitude break down spike has been seen as necessary to improve process quality.

### SUMMARY OF THE INVENTION

Overvoltage in the processing chamber deteriorates the quality of sputtered films in several ways: High voltage events electrically damage layers and/or devices on the processing substrate (wafer). Furthermore, arcing which can be produced by overvoltages can cause local overheating of the target, leading to evaporation or flaking of target material into the processing chamber and causing substrate particle contamination and device damage. These sources of wafer damage become increasingly significant as integrated circuits reach higher densities and become more complex. Thus, it is advantageous to avoid voltage spikes during processing wherever possible.

With this in mind, careful analysis has revealed that the so-called break down spike is not, in fact, an isolated event necessarily associated with the creation of a plasma in the chamber. The spike is not caused by the creation of a plasma per se, but rather by harmonic oscillations within the chamber.

As shown in FIG. 4, a gas-filled chamber generates sizable oscillations when driven by a DC voltage within a

given voltage range. These oscillations are evident in regions 26 and 28. Notably, however, the oscillations cease when the driving voltage exceeds a threshold voltage represented by line 30. One explanation of this phenomenon is that complete plasma ignition occurs above threshold voltage 30. When the power supply voltage is near to, but below this threshold voltage, unstable gas discharges, as well as related transitions between gas and plasma phases, occur in chamber 14. (Similar effects have been observed in gaseous-discharge tubes.) As a result, the gas-plasma system begins unstable oscillation, producing brief, but very large magnitude voltage perturbations. This oscillation continues until the threshold voltage 30 is achieved, at which point the gas/plasma mixture fully transitions to a plasma, and oscillations cease.

Voltage 30 will be referred to as the "oscillation threshold voltage". The value of the oscillation threshold voltage will depend on the target (cathode) material, process gas and pressure, chamber geometry, electrical characteristics of the external power wiring, and possibly the volt-ampere curve of the sputtering chamber.

Based on the preceding observations, the spike observed in region 26 of FIG. 3 is now understood to be an oscillation caused when the output voltage of primary supply 10 lingers at a voltage just below the oscillation threshold. Furthermore, careful inspection of region 28 of FIG. 3 also reveals oscillatory behaviors analogous to those which appear in region 28 of FIG. 4. (The oscillations in region 28 have smaller magnitudes, in part because when the power supply is disabled, its output voltage drops relatively rapidly, whereas when the power supply is enabled its output voltage increases relatively slowly.)

It has been found that the oscillation spike observed in FIG. 3 can be eliminated by elevating the target/cathode voltage above the oscillation threshold voltage before initiating gas flow into the chamber, and maintaining the cathode voltage above the oscillation threshold until processing is completed, gas flow is halted, and vacuum is restored. This technique prevents overvoltage during processing, and therefore can reduce device damage and particulate contamination.

In brief summary, this technique is implemented by a power supply circuit comprising two power supply sections: an essentially conventional primary power supply, which provides the primary power to electrically drive the cathode during the plasma process, and a secondary power supply which supplies an initial plasma ignition voltage sufficiently in excess of the oscillation threshold voltage. This secondary power supply "pre-ignites" the plasma so that when the primary power supply is applied, the system smoothly transitions to final plasma development and deposition. This design thereby avoids oscillations when the primary power supply is engaged and disengaged, and any corresponding device damage.

In preferred embodiments, a current limiting resistor, switch, and diode are connected in series between the secondary power supply and the cathode.

The current limiting resistor limits the current flowing from the secondary power supply into the cathode. Only a minimal current is needed to elevate the cathode voltage above the oscillation threshold and pre-ignite the plasma; by interposing a current-limiting resistor, the secondary power supply current is held at this minimum level, thus avoiding the need for a high power secondary supply, and also limiting the plasma current and deposition while the secondary power supply is enabled and the primary supply is disabled.



# Explore Litigation Insights

Docket Alarm provides insights to develop a more informed litigation strategy and the peace of mind of knowing you're on top of things.

## Real-Time Litigation Alerts



Keep your litigation team up-to-date with **real-time alerts** and advanced team management tools built for the enterprise, all while greatly reducing PACER spend.

Our comprehensive service means we can handle Federal, State, and Administrative courts across the country.

## Advanced Docket Research



With over 230 million records, Docket Alarm's cloud-native docket research platform finds what other services can't. Coverage includes Federal, State, plus PTAB, TTAB, ITC and NLRB decisions, all in one place.

Identify arguments that have been successful in the past with full text, pinpoint searching. Link to case law cited within any court document via Fastcase.

## Analytics At Your Fingertips



Learn what happened the last time a particular judge, opposing counsel or company faced cases similar to yours.

Advanced out-of-the-box PTAB and TTAB analytics are always at your fingertips.

## API

Docket Alarm offers a powerful API (application programming interface) to developers that want to integrate case filings into their apps.

## LAW FIRMS

Build custom dashboards for your attorneys and clients with live data direct from the court.

Automate many repetitive legal tasks like conflict checks, document management, and marketing.

## FINANCIAL INSTITUTIONS

Litigation and bankruptcy checks for companies and debtors.

## E-DISCOVERY AND LEGAL VENDORS

Sync your system to PACER to automate legal marketing.