



(12) **United States Patent**
Wang et al.

(10) **Patent No.:** **US 6,413,382 B1**
(45) **Date of Patent:** **Jul. 2, 2002**

(54) **PULSED SPUTTERING WITH A SMALL ROTATING MAGNETRON**

5,976,327 A 11/1999 Tanaka 204/192.15

FOREIGN PATENT DOCUMENTS

(75) Inventors: **Wei Wang**, Santa Clara; **Praburam Gopalraja**, Sunnyvale; **Jianming Fu**, San Jose; **Zheng Xu**, Foster City, all of CA (US)

WO WO 00/48226 A1 8/2000 H01J/37/34

OTHER PUBLICATIONS

(73) Assignee: **Applied Materials, Inc.**, Santa Clara, CA (US)

Kouznetsov et al., "A novel pulsed magnetron sputter technique utilizing very high target power densities", *Surface and Coatings Technology*, vol. 122, 1999, pp. 290-293.

(*) Notice: Subject to any disclaimer, the term of this patent is extended or adjusted under 35 U.S.C. 154(b) by 0 days.

Primary Examiner—Steven H. VerSteeg
(74) *Attorney, Agent, or Firm*—Charles S. Guenzer

(57) **ABSTRACT**

(21) Appl. No.: **09/705,324**

A magnetron sputter reactor having a target that is pulsed with a duty cycle of less than 10% and preferably less than 1% and further having a small magnetron of area less than 20% of the target area rotating about the target center, whereby a very high plasma density is produced during the pulse adjacent to the area of the magnetron. The power pulsing frequency needs to be desynchronized from the rotation frequency so that the magnetron does not overlie the same area of the magnetron during different pulses. Advantageously, the power pulses are delivered above a DC background level sufficient to continue to excite the plasma so that no ignition is required for each pulse.

(22) Filed: **Nov. 3, 2000**

(51) **Int. Cl.**⁷ **C23C 14/35**

(52) **U.S. Cl.** **204/192.12; 204/298.08; 204/298.17; 204/298.2; 204/298.22**

(58) **Field of Search** **204/192.12, 298.08, 204/298.17, 298.2, 298.22**

(56) **References Cited**

U.S. PATENT DOCUMENTS

5,789,071 A 8/1998 Sproul et al. 428/216
5,810,982 A 9/1998 Sellers 204/298.08

27 Claims, 4 Drawing Sheets

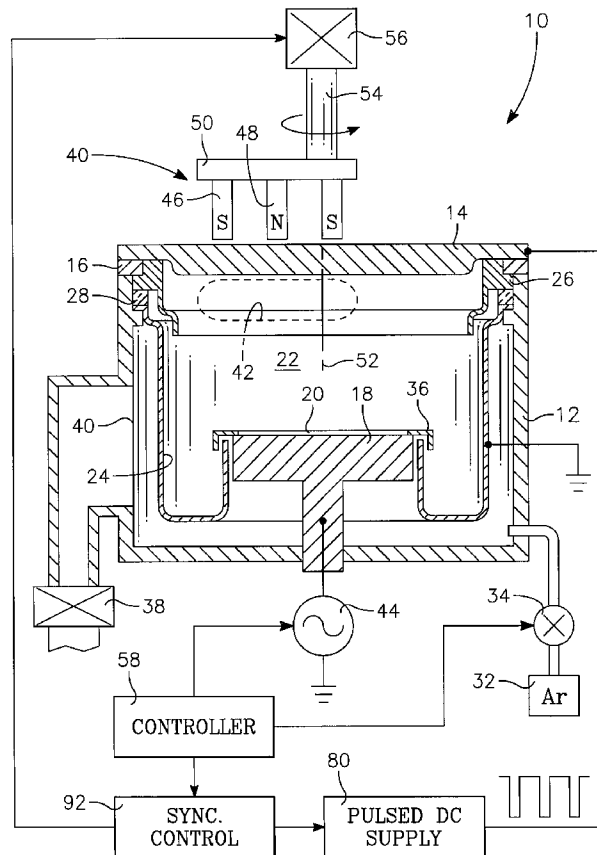

INTEL 1104

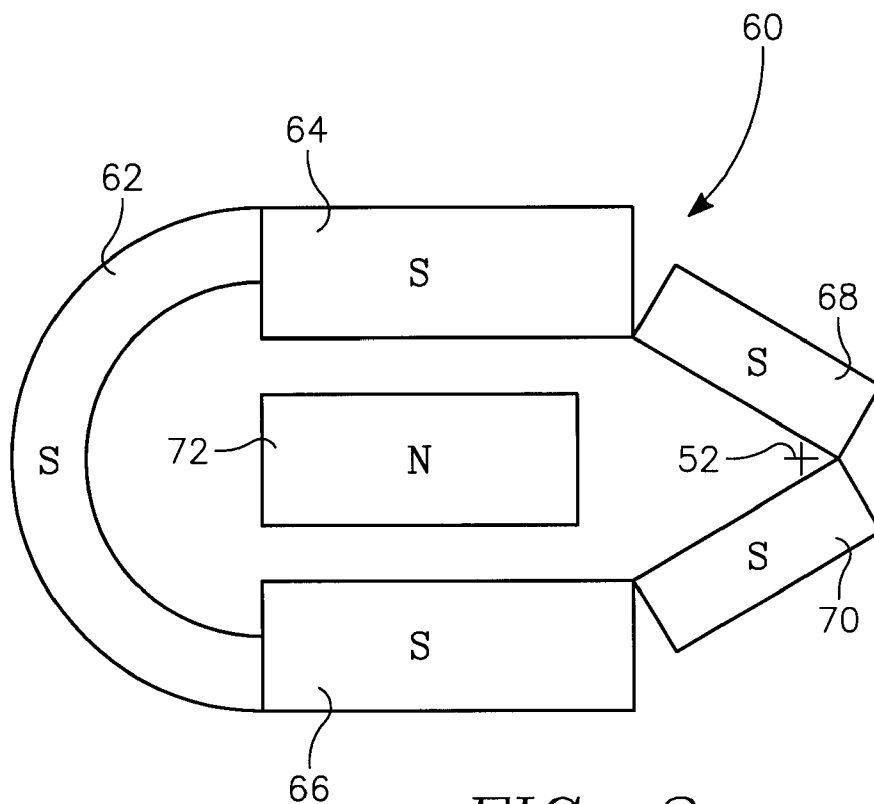

FIG. 2

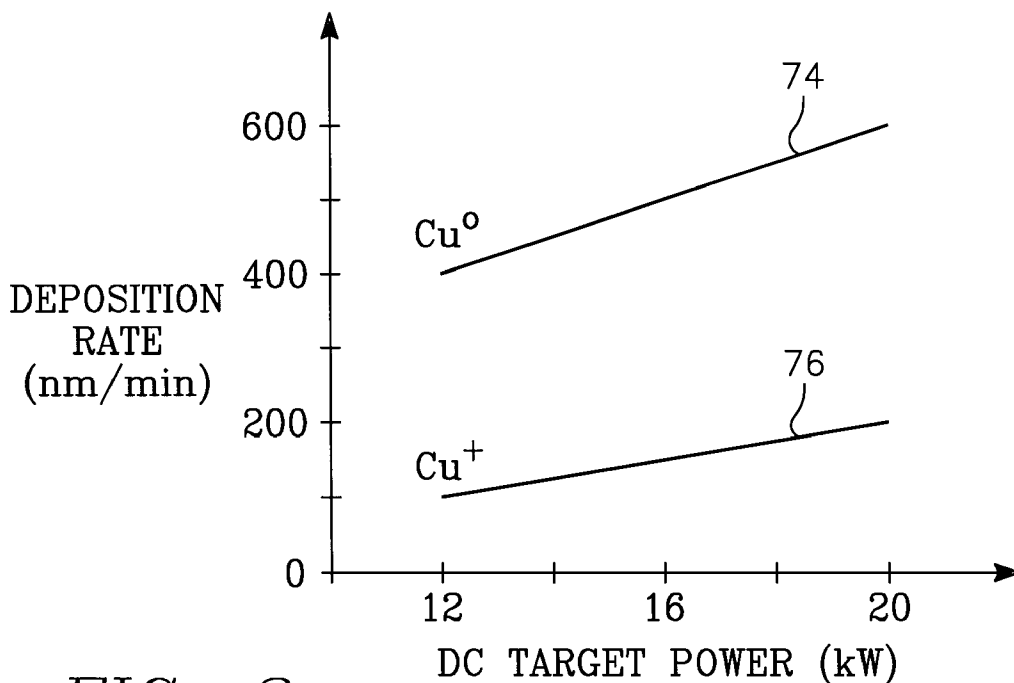

FIG. 3

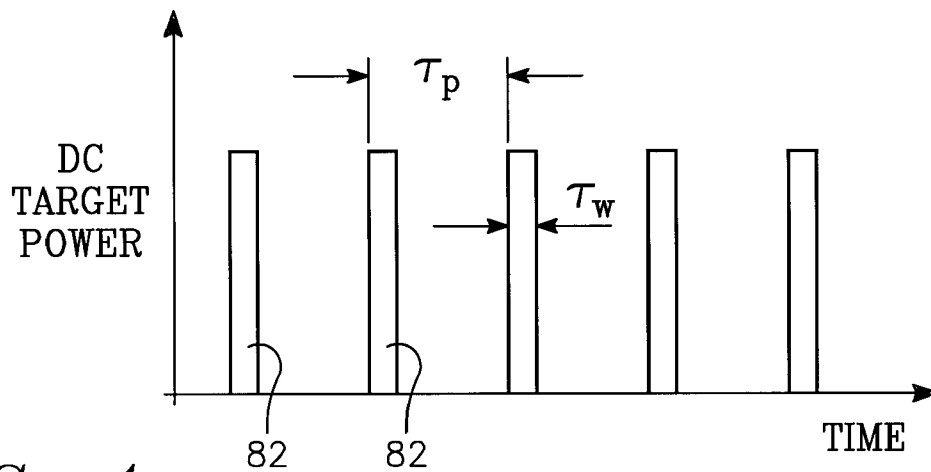

FIG. 4

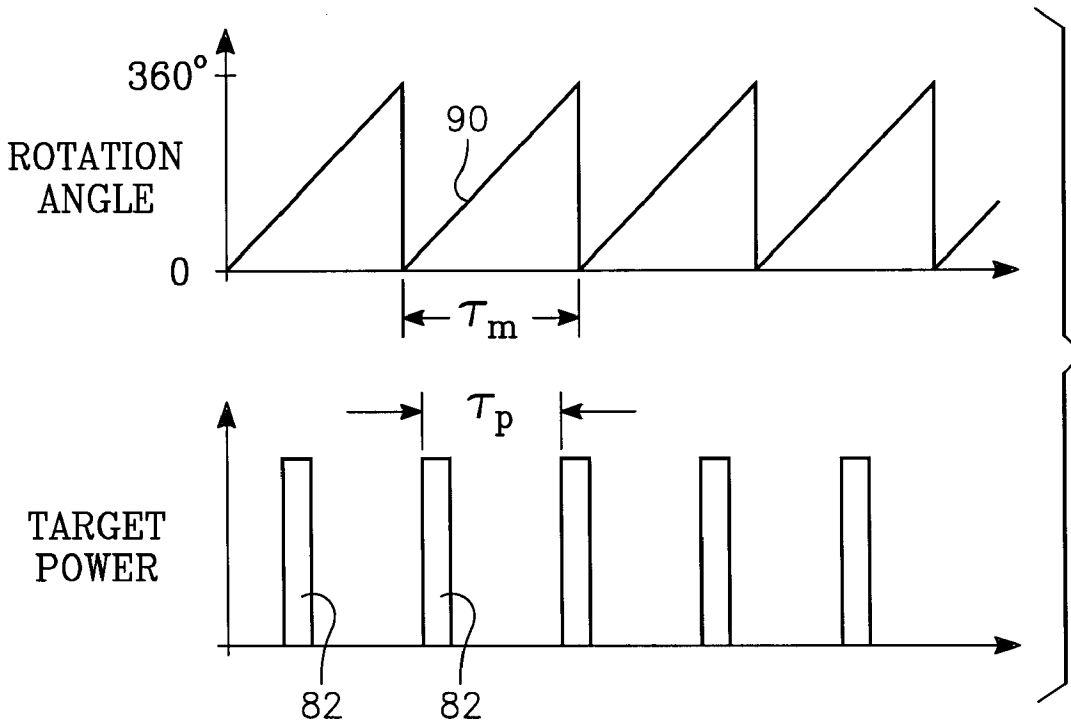

FIG. 5

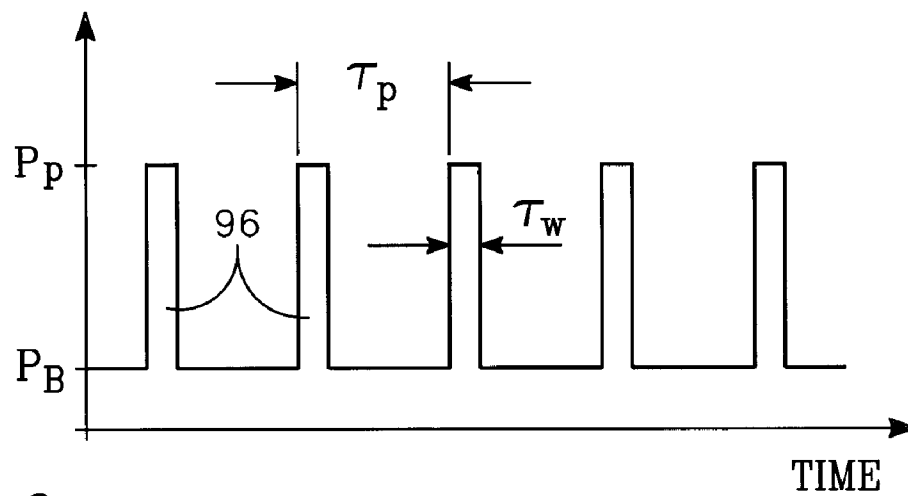

FIG. 6

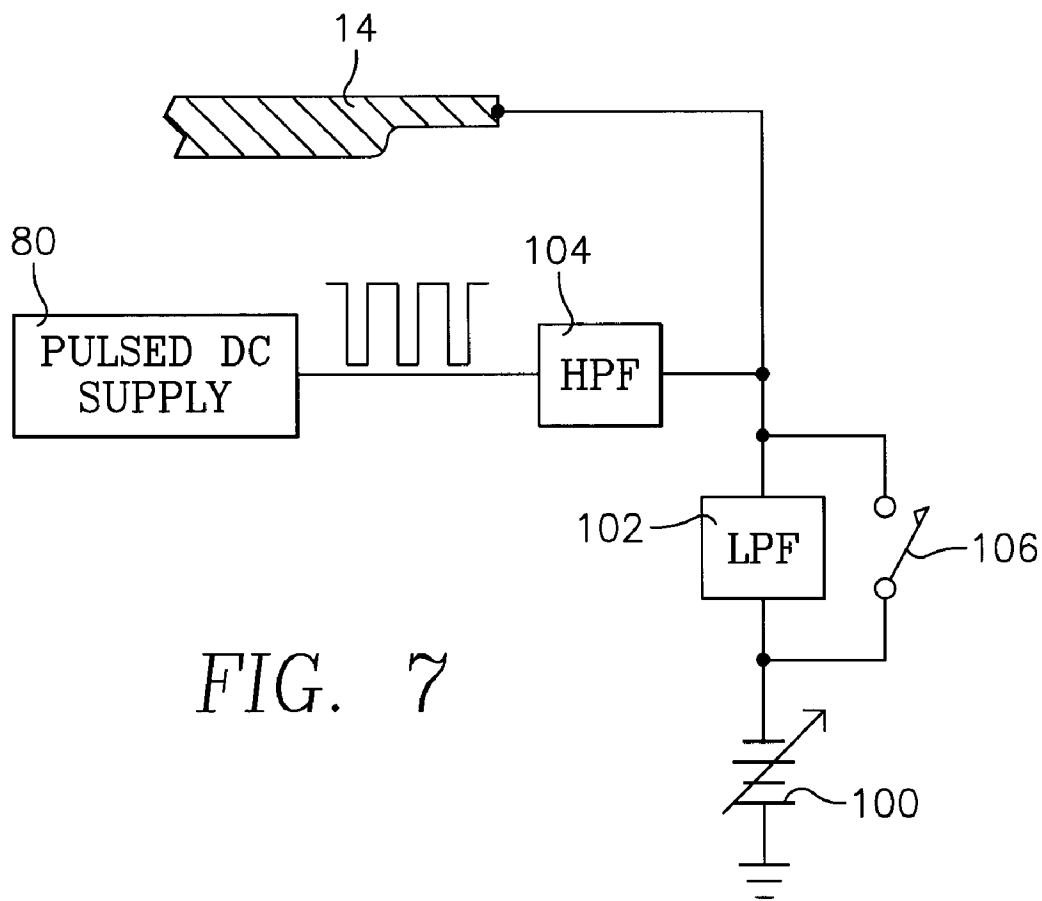

FIG. 7

Explore Litigation Insights

Docket Alarm provides insights to develop a more informed litigation strategy and the peace of mind of knowing you're on top of things.

Real-Time Litigation Alerts



Keep your litigation team up-to-date with **real-time alerts** and advanced team management tools built for the enterprise, all while greatly reducing PACER spend.

Our comprehensive service means we can handle Federal, State, and Administrative courts across the country.

Advanced Docket Research



With over 230 million records, Docket Alarm's cloud-native docket research platform finds what other services can't. Coverage includes Federal, State, plus PTAB, TTAB, ITC and NLRB decisions, all in one place.

Identify arguments that have been successful in the past with full text, pinpoint searching. Link to case law cited within any court document via Fastcase.

Analytics At Your Fingertips



Learn what happened the last time a particular judge, opposing counsel or company faced cases similar to yours.

Advanced out-of-the-box PTAB and TTAB analytics are always at your fingertips.

API

Docket Alarm offers a powerful API (application programming interface) to developers that want to integrate case filings into their apps.

LAW FIRMS

Build custom dashboards for your attorneys and clients with live data direct from the court.

Automate many repetitive legal tasks like conflict checks, document management, and marketing.

FINANCIAL INSTITUTIONS

Litigation and bankruptcy checks for companies and debtors.

E-DISCOVERY AND LEGAL VENDORS

Sync your system to PACER to automate legal marketing.