

(12) United States Patent
Hermann et al.

(10) Patent No.: US 6,338,725 B1
(45) Date of Patent: *Jan. 15, 2002

(54) LARGE-DIAMETER INTRODUCER SHEATH HAVING HEMOSTASIS VALVE AND REMOVABLE STEERING MECHANISM

(75) Inventors: **George D. Hermann**, Los Gatos; **Kirsten Freislinger**, Menlo Park; **Steven W. Kim**, Cupertino; **Jay A. Lenker**, Laguna Beach; **Michael A. Evans**, Palo Alto, all of CA (US)

(73) Assignee: **Medtronic AVE, Inc.**, Santa Rosa, CA (US)

(*) Notice: Subject to any disclaimer, the term of this patent is extended or adjusted under 35 U.S.C. 154(b) by 0 days.

This patent is subject to a terminal disclaimer.

(21) Appl. No.: **09/158,777**

(22) Filed: **Sep. 23, 1998**

Related U.S. Application Data

(60) Continuation of application No. 08/735,401, filed on Oct. 21, 1996, now Pat. No. 5,843,031, which is a division of application No. 08/330,140, filed on Oct. 24, 1994, now Pat. No. 5,599,305.

(51) Int. Cl.⁷ A61M 37/00

(52) U.S. Cl. 604/95.04; 604/96.01; 604/164.01; 604/167.01; 604/523; 604/537; 604/912

(58) Field of Search 604/95, 164, 167, 604/53, 200, 169, 170, 264, 256, 96, 101, 912, 919, 523, 527, 526, 537, 164.01, 164.09, 164.12, 164.13, 528; 251/149.2, 149.6, 149.1, 149.4, 149.5, 149.11; 137/844

(56) References Cited

U.S. PATENT DOCUMENTS

3,941,119 A 3/1976 Corrales 128/2 M

4,066,070 A	1/1978	Utsugi	128/4
4,129,129 A *	12/1978	Amrine	604/95
4,177,814 A	12/1979	Knepshield et al.	128/348
4,411,655 A	10/1983	Schreck	604/165
4,475,548 A *	10/1984	Muto	128/207.14
4,586,923 A	5/1986	Gould et al.	604/95

(List continued on next page.)

FOREIGN PATENT DOCUMENTS

DE	3920-707 A3	1/1991	A61M/25/01
EP	0 442 194 A2	10/1990	A61M/25/01
EP	0 488 322 A1	6/1992	A61M/25/00
EP	0 596 172 A2	12/1992	A61M/25/01
EP	0 567 141	10/1993	

(List continued on next page.)

OTHER PUBLICATIONS

Product label; Arrow International, Inc., Reading, Pennsylvania 19605; super Arrow Flex™.

Primary Examiner—John G. Weiss

Assistant Examiner—Joseph F. Weiss, Jr.

(74) Attorney, Agent, or Firm—Sterne, Kessler, Goldstein & Fox P.L.L.C.

(57) ABSTRACT

A catheter introducing system includes an introducer catheter comprising a flexible sheath having a hemostasis valve and an obturator having a steering mechanism operated by a proximal actuator handle. The catheter introducer system will usually be introduced with the obturator inside of the flexible sheath so that the obturator can effect steering by laterally deflecting the distal end of the combined sheath and obturator. Such catheter introducing systems are particularly useful for large diameter sheaths which are not readily introduced over guide wires. A first exemplary hemostasis valve comprises a compressed foam insert having an axial lumen therein. A second exemplary hemostasis valve comprises an elastomeric insert which receives and seals over the catheter.

10 Claims, 13 Drawing Sheets

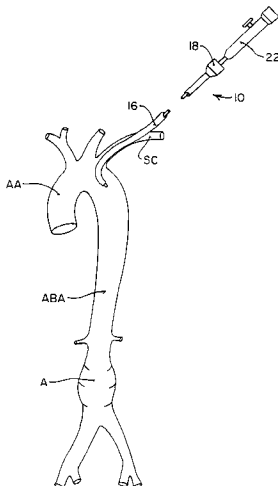

U.S. PATENT DOCUMENTS

4,589,868	A *	5/1986	Dretler	604/96	5,284,474	A	2/1994	Adair	604/164
4,610,674	A *	9/1986	Suzuki et al.	604/282	5,300,033	A *	4/1994	Miller	604/167
4,634,432	A	1/1987	Kocak	604/167	5,300,034	A	4/1994	Behnke et al.	604/167
4,643,194	A	2/1987	Fogarty et al.	128/668	5,300,048	A *	4/1994	Drewes, Jr. et al.	604/280
4,673,393	A *	6/1987	Suzuki et al.	604/167	5,324,262	A *	6/1994	Fischell et al.	604/96
4,715,360	A *	12/1987	Akui et al.	604/256	5,325,850	A *	7/1994	Ulrich et al.	128/200.26
4,723,936	A *	2/1988	Buchbinden et al.	604/95	5,334,185	A	8/1994	Giesy et al.	604/164
4,815,478	A *	3/1989	Buchbinder et al.	604/170	5,338,313	A	8/1994	Mollenauer et al.	604/209
4,946,133	A *	8/1990	Johnson et al.	251/149.1	5,364,357	A *	11/1994	Aase	604/96
4,960,410	A *	10/1990	Pinchuk	604/96	5,380,304	A	1/1995	Parker	604/282
4,976,688	A	12/1990	Rosenblum	604/95	5,383,852	A	1/1995	Stevens-Wright	604/95
4,983,165	A	1/1991	Loiterman	604/95	5,403,292	A *	4/1995	Ju	604/282
4,985,022	A	1/1991	Fearnot et al.	604/282	5,456,665	A *	10/1995	Postell et al.	604/96
5,019,040	A	5/1991	Itaoka et al.	604/95	5,460,608	A *	10/1995	Lodin et al.	604/96
5,055,101	A *	10/1991	McCoy	604/95	5,462,527	A	10/1995	Stevens-Wright et al.	604/95
5,057,084	A *	10/1991	Ensminger et al.	604/167	5,467,763	A *	11/1995	McMahon et al.	600/201
5,066,285	A	11/1991	Hillstead	604/164	5,484,425	A	1/1996	Fischell et al.	604/282
5,069,217	A	12/1991	Fleischhacker, Jr.	128/657	5,496,294	A *	3/1996	Hergenrother et al.	604/282
5,098,412	A	3/1992	Shiu	604/280	5,513,628	A *	5/1996	Coles et al.	128/200.26
5,104,389	A	4/1992	Deem et al.	604/264	5,514,236	A *	5/1996	Avellanet et al.	156/154
5,109,830	A	5/1992	Cho	128/4	5,520,644	A *	5/1996	Imran	604/95
5,125,893	A *	6/1992	Dryden	604/56	5,569,200	A *	10/1996	Umeno et al.	604/96
5,127,626	A	7/1992	Hilal et al.	251/149.1	5,584,821	A *	12/1996	Hobbs et al.	604/280
5,147,315	A *	9/1992	Weber	604/164	5,599,325	A *	2/1997	Ju et al.	604/282
5,167,636	A	12/1992	Clement	604/167	5,630,806	A *	5/1997	Inagaki et al.	604/282
5,180,376	A	1/1993	Fischell	604/282	5,676,659	A *	10/1997	McGurk	604/282
5,205,325	A *	4/1993	Piper	137/844	5,725,513	A *	3/1998	Ju et al.	604/280
5,207,656	A	5/1993	Kranys	604/256	5,782,817	A *	7/1998	Franzel et al.	604/256
5,215,537	A	6/1993	Lynn et al.	604/244	5,807,328	A *	9/1998	Briscoe	604/96
5,221,255	A	6/1993	Mahurkar et al.	604/43	5,865,800	A *	2/1999	Mirarchi et al.	604/95
5,221,270	A *	6/1993	Parker	604/282	5,895,377	A *	4/1999	Smith et al.	604/256
5,222,948	A	6/1993	Austin et al.	604/213					
5,226,899	A	7/1993	Lee et al.	604/282					
5,242,425	A	9/1993	White et al.	604/256					
5,273,546	A	12/1993	McLaughlin et al.	604/167					
5,275,152	A	1/1994	Krauter et al.	128/4					
5,279,596	A	1/1994	Castaneda et al.	604/282					
5,279,597	A	1/1994	Dassa et al.	604/283					

FOREIGN PATENT DOCUMENTS

WO	WO 94/01169	1/1994	A61M/39/00
WO	WO 94/11057	5/1994	A61M/37/00
WO	WO 94/21165	9/1994	A61B/5/04
WO	WO 96/13228	5/1996	A61F/2/06

* cited by examiner

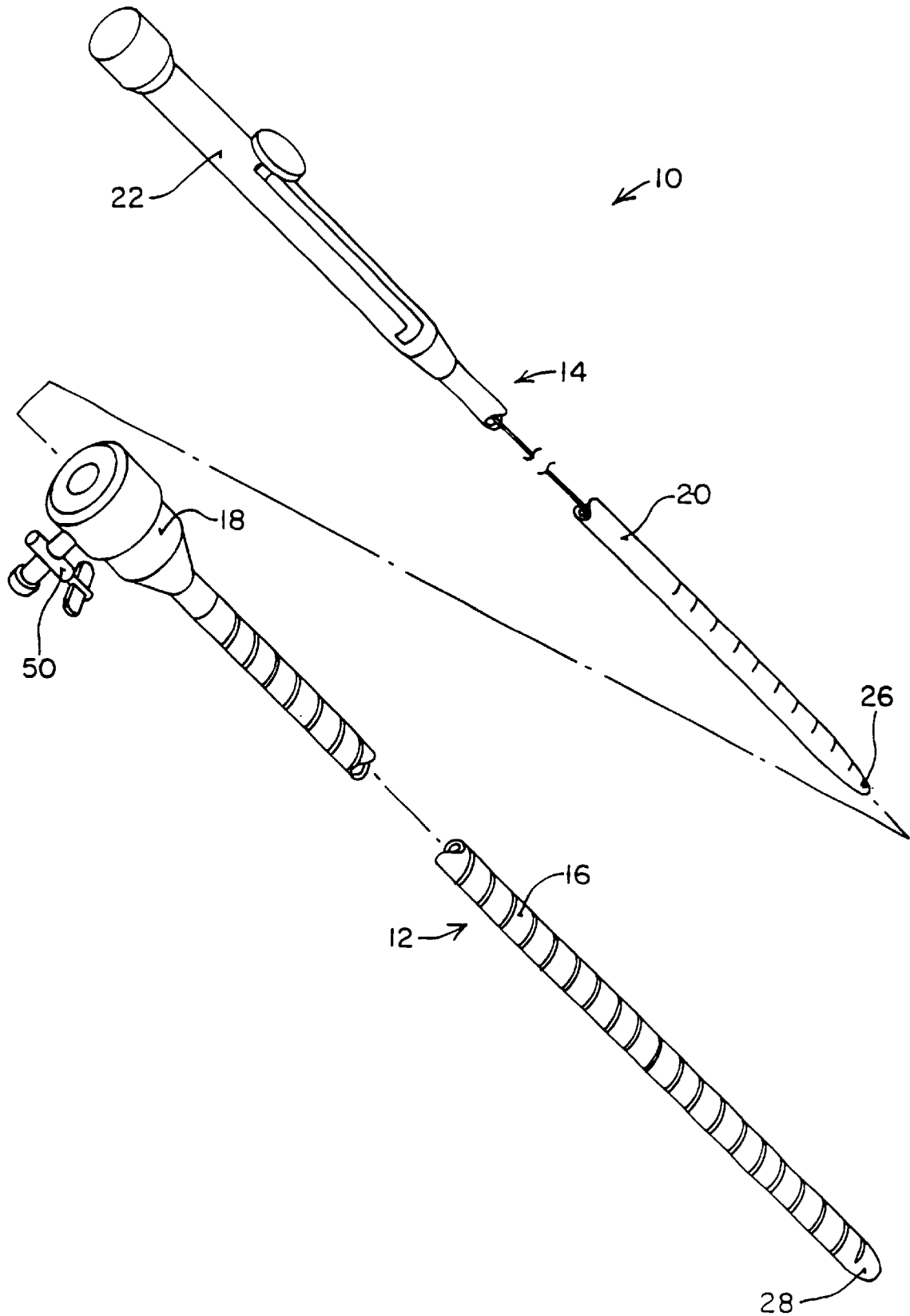

FIG. 1

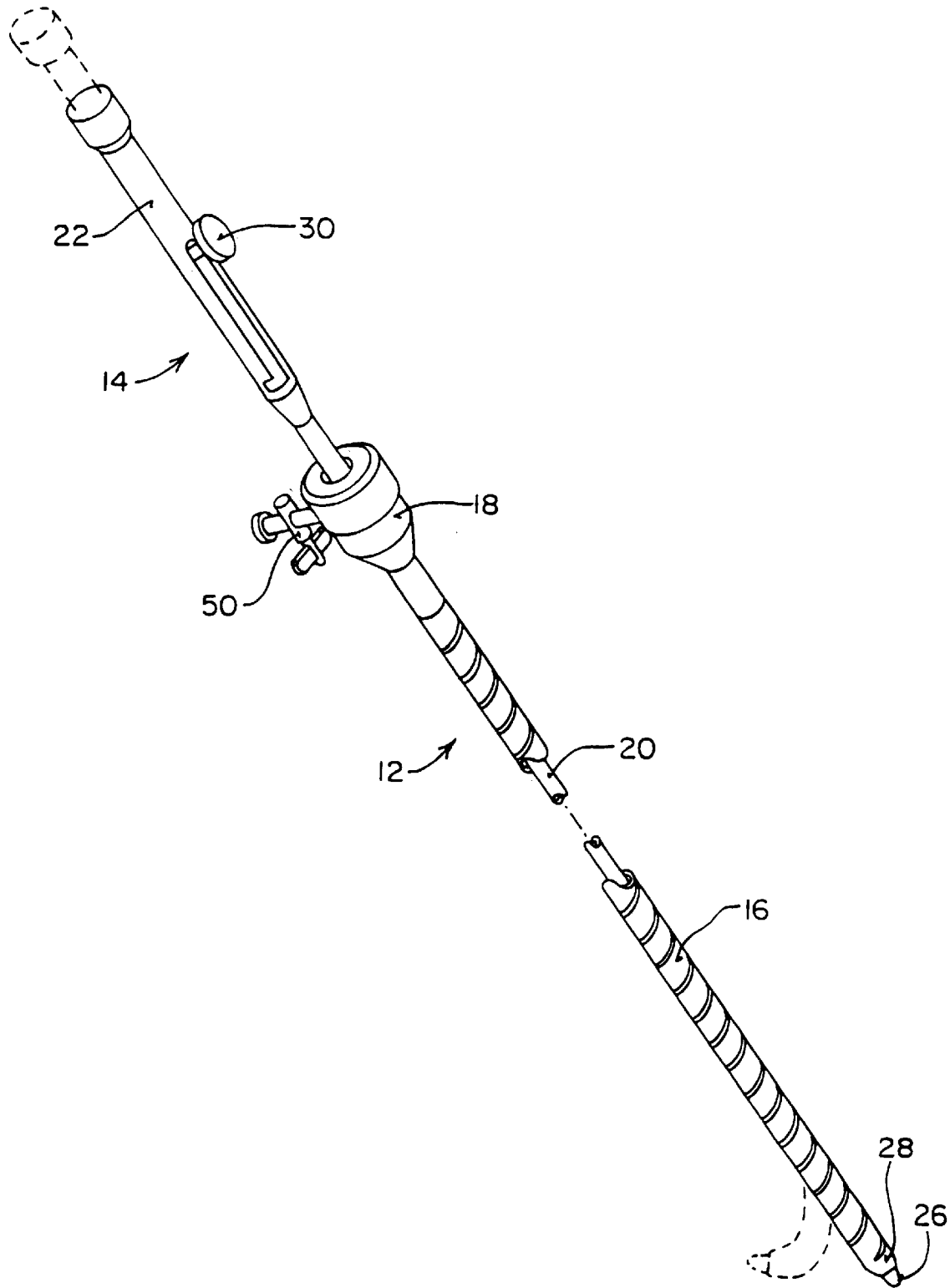

FIG. 2

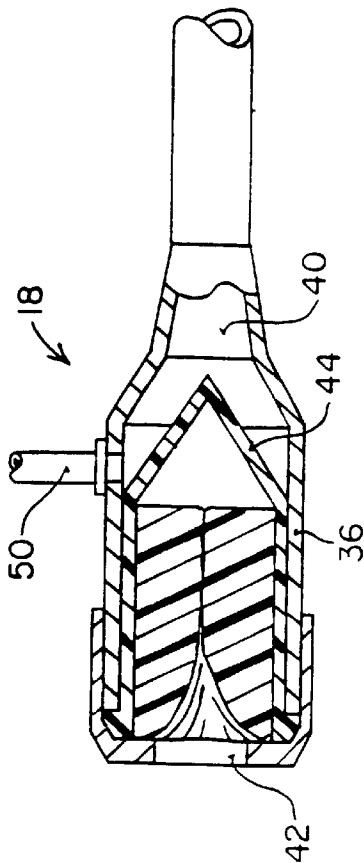

FIG. 3

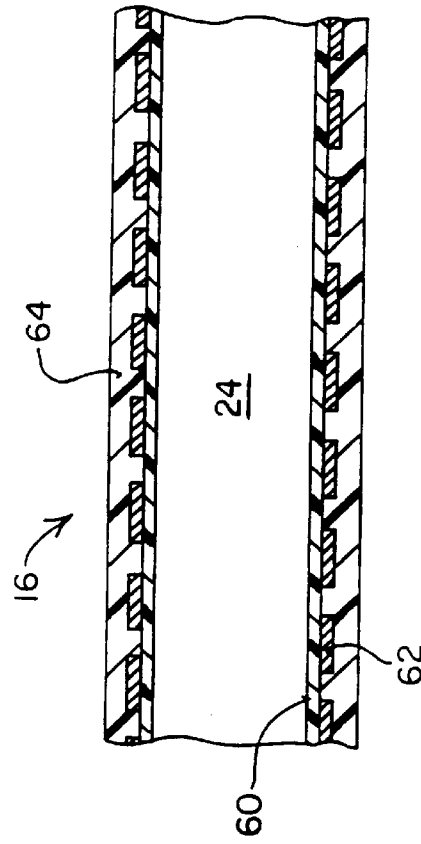

FIG. 5

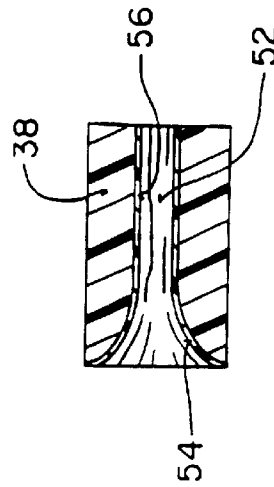

FIG. 4

Explore Litigation Insights

Docket Alarm provides insights to develop a more informed litigation strategy and the peace of mind of knowing you're on top of things.

Real-Time Litigation Alerts



Keep your litigation team up-to-date with **real-time alerts** and advanced team management tools built for the enterprise, all while greatly reducing PACER spend.

Our comprehensive service means we can handle Federal, State, and Administrative courts across the country.

Advanced Docket Research



With over 230 million records, Docket Alarm's cloud-native docket research platform finds what other services can't. Coverage includes Federal, State, plus PTAB, TTAB, ITC and NLRB decisions, all in one place.

Identify arguments that have been successful in the past with full text, pinpoint searching. Link to case law cited within any court document via Fastcase.

Analytics At Your Fingertips



Learn what happened the last time a particular judge, opposing counsel or company faced cases similar to yours.

Advanced out-of-the-box PTAB and TTAB analytics are always at your fingertips.

API

Docket Alarm offers a powerful API (application programming interface) to developers that want to integrate case filings into their apps.

LAW FIRMS

Build custom dashboards for your attorneys and clients with live data direct from the court.

Automate many repetitive legal tasks like conflict checks, document management, and marketing.

FINANCIAL INSTITUTIONS

Litigation and bankruptcy checks for companies and debtors.

E-DISCOVERY AND LEGAL VENDORS

Sync your system to PACER to automate legal marketing.