



US005594726A

United States Patent [19]

[11] Patent Number: **5,594,726**

Thompson et al.

[45] Date of Patent: **Jan. 14, 1997**

[54] **FREQUENCY AGILE BROADBAND COMMUNICATIONS SYSTEM**

4,912,552	3/1990	Allison, III et al.	358/84
4,926,255	5/1990	Von Kohorn	358/84
4,955,048	8/1990	Iwamura et al.	379/53
4,961,109	10/1990	Tanaka	358/84

[75] Inventors: **Leo J. Thompson**, Lilburn; **Gregory T. Dubberly**, Atlanta; **John A. Ritchie, Jr.**, Duluth, all of Ga.

(List continued on next page.)

[73] Assignee: **Scientific-Atlanta, Inc.**, Atlanta, Ga.

FOREIGN PATENT DOCUMENTS

WO90/13956 11/1990 WIPO .

[21] Appl. No.: **219,848**

OTHER PUBLICATIONS

[22] Filed: **Mar. 30, 1994**

A Passive Optical/Coax Hybrid Network Architecture for Delivery of CATV, Telephony and Data Services; 1993. by M. Mesiya, pp. 358-364.

Related U.S. Application Data

[63] Continuation-in-part of Ser. No. 123,363, Sep. 17, 1993, Pat. No. 5,499,241.

Primary Examiner—Benedict V. Safourek
Assistant Examiner—Ajit Patel
Attorney, Agent, or Firm—Jones & Askew

[51] Int. Cl.⁶ **H04J 1/00**
[52] U.S. Cl. **370/485; 370/524; 455/5.1; 455/6.1; 348/12**

[57] ABSTRACT

[58] **Field of Search** 348/12, 11, 14, 348/15; 370/69.1, 71, 73, 110.1, 112; 375/219, 222, 202; 455/5.1, 6.10, 4.1, 6.3, 6.2, 3.1

A broadband communications system for coupling telephony or other digital networks to a CATV network. The system transmits a multiplex of telephony signals in the forward band of the CATV network. Each forward channel is QPR modulated on a carrier and contains multiple subscriber telephony signals. The forward telephony channels are demodulated and demultiplexed by a plurality of subscriber terminals into the individual telephony signals directed to an addressed subscriber. Audio and control signals returning from the subscriber are digitized into standard telephony signals and QPSK modulated on a carrier onto the reverse band of the CATV network. The multiplicity of reverse band telephony channels are demodulated and multiplexed into a standard telephony signal which is directly interfaced to the telephony network. The reverse band modulators are frequency agile and modulate telephony signals from a subscriber in a selected one or more frequency subbands in the reverse band of the subscription network, so as to provide selectably changeable frequencies and selectably variable bandwidth in the reverse band commensurate with a selected subscriber communication feature. e.g. a single voice line, multiple voice lines, ISDN service, data communications services, security monitoring services, etc.

[56] References Cited

U.S. PATENT DOCUMENTS

2,236,501	4/1941	Goldsmith .	
3,275,746	9/1966	Beltrami .	
3,529,088	9/1970	Hauer	370/76
3,992,589	11/1976	Kuegler	370/120
4,099,202	7/1978	Cavanaugh	358/85
4,367,548	1/1983	Cotten, Jr. et al.	358/86
4,485,400	11/1984	Lemelson et al.	358/85
4,633,462	12/1986	Shitle et al.	370/95.1
4,709,418	11/1987	Fox et al.	455/612
4,742,512	5/1988	Akashi et al.	370/104.1
4,748,618	5/1988	Brown et al.	370/94.1
4,761,684	8/1988	Clark et al.	358/84
4,763,317	8/1988	Lehman et al.	370/58.1
4,849,811	7/1989	Kleierman	358/133
4,887,158	12/1989	Guichard et al.	358/143
4,888,638	12/1989	Bohn	358/84
4,888,795	12/1989	Ando et al.	379/53
4,891,694	1/1990	Way	358/86
4,905,080	2/1990	Watanabe et al.	358/84
4,907,079	3/1990	Turner et al.	358/84

113 Claims, 15 Drawing Sheets

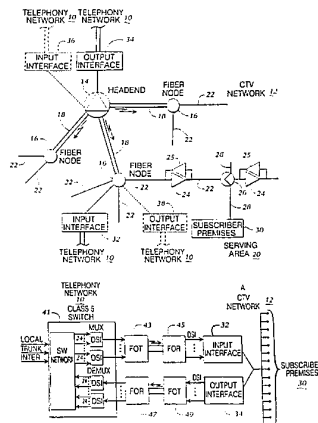

Petitioner ARRIS Group, Inc.'s



U.S. PATENT DOCUMENTS

4,974,252	11/1990	Osborne	379/92	5,063,587	11/1991	Semasa et al.	379/53
4,975,902	12/1990	Damany	370/62	5,075,771	12/1991	Hashimoto	358/84
4,995,071	2/1991	Weber et al.	379/53	5,084,903	1/1992	McNamara et al.	375/18
5,003,384	3/1991	Durden et al.	358/84	5,088,111	2/1992	McNamara et al.	375/18
5,008,926	4/1991	Misholi	379/54	5,124,980	6/1992	Maki	370/77
5,014,125	5/1991	Pocock et al.	358/86	5,351,234	9/1994	Beierle et al.	370/50
5,029,333	7/1991	Graves et al.	370/58.1	5,440,335	8/1995	Beveridge	348/13
				5,469,495	11/1995	Beveridge	379/56

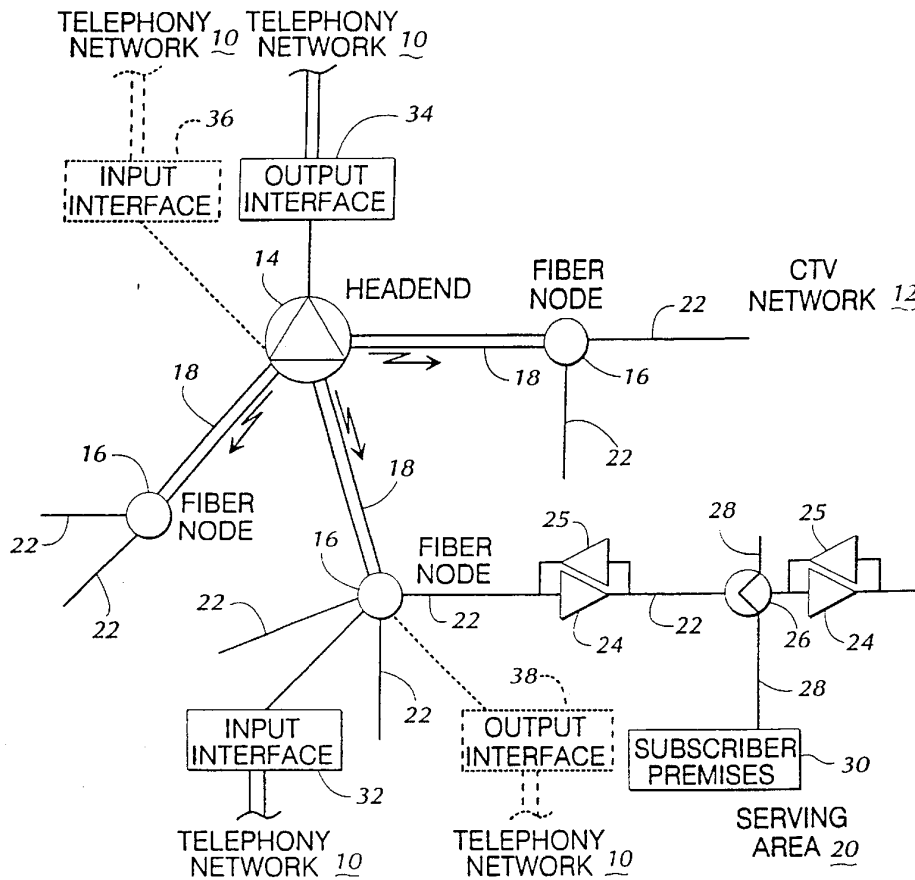

FIG. 1

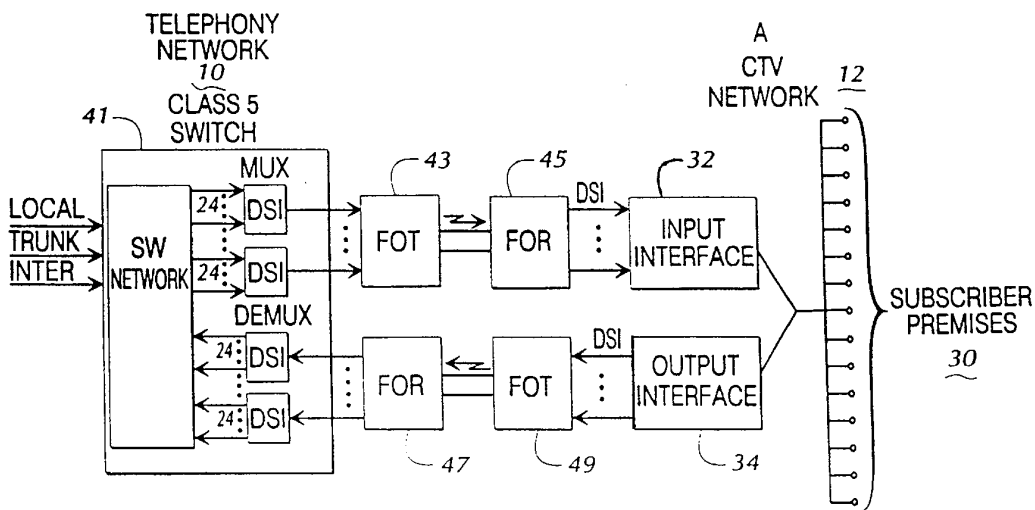

FIG. 2

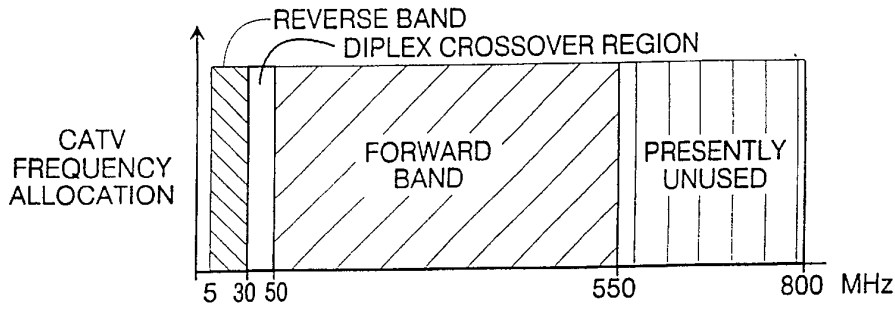

FIG. 3A

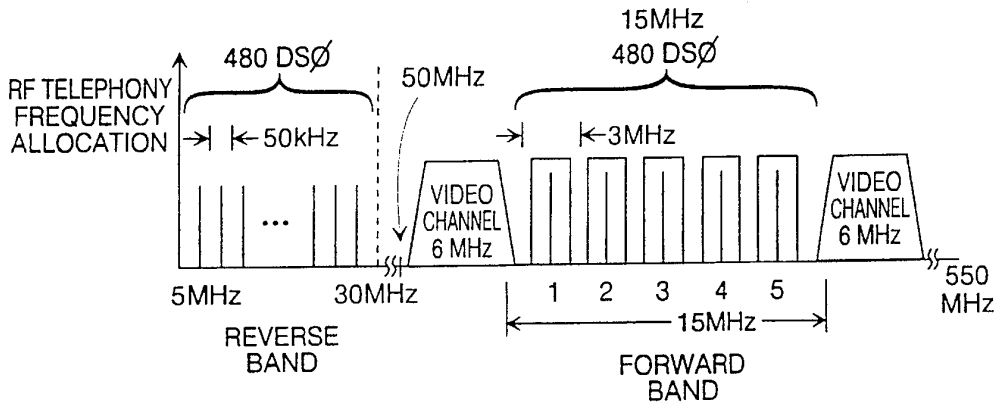

FIG. 3B

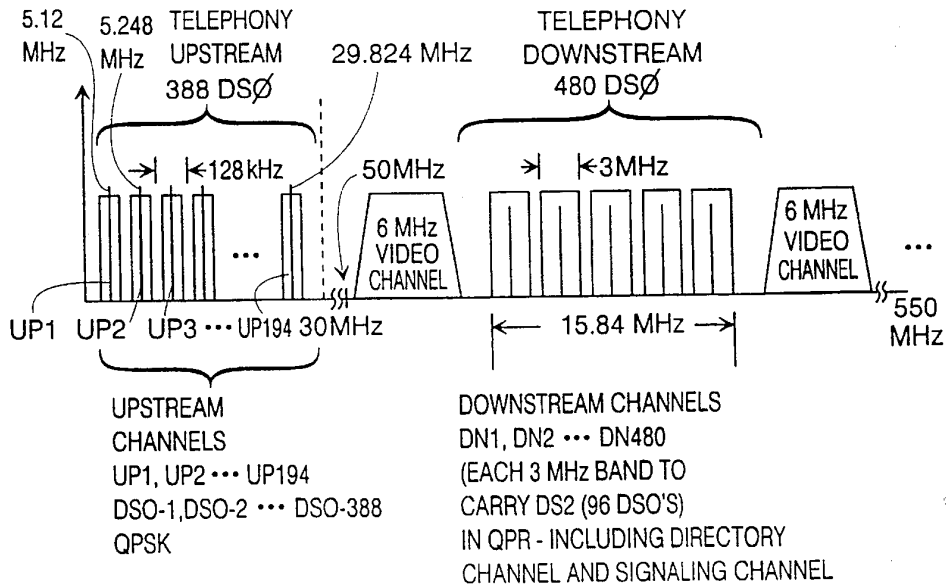

FIG. 3C

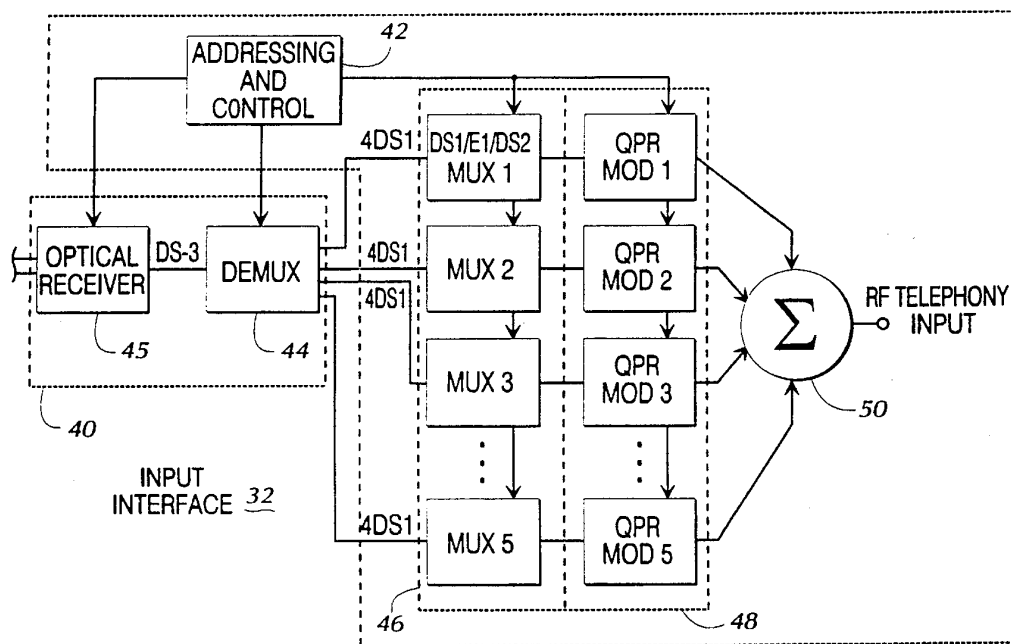

FIG. 4

Explore Litigation Insights

Docket Alarm provides insights to develop a more informed litigation strategy and the peace of mind of knowing you're on top of things.

Real-Time Litigation Alerts



Keep your litigation team up-to-date with **real-time alerts** and advanced team management tools built for the enterprise, all while greatly reducing PACER spend.

Our comprehensive service means we can handle Federal, State, and Administrative courts across the country.

Advanced Docket Research



With over 230 million records, Docket Alarm's cloud-native docket research platform finds what other services can't. Coverage includes Federal, State, plus PTAB, TTAB, ITC and NLRB decisions, all in one place.

Identify arguments that have been successful in the past with full text, pinpoint searching. Link to case law cited within any court document via Fastcase.

Analytics At Your Fingertips



Learn what happened the last time a particular judge, opposing counsel or company faced cases similar to yours.

Advanced out-of-the-box PTAB and TTAB analytics are always at your fingertips.

API

Docket Alarm offers a powerful API (application programming interface) to developers that want to integrate case filings into their apps.

LAW FIRMS

Build custom dashboards for your attorneys and clients with live data direct from the court.

Automate many repetitive legal tasks like conflict checks, document management, and marketing.

FINANCIAL INSTITUTIONS

Litigation and bankruptcy checks for companies and debtors.

E-DISCOVERY AND LEGAL VENDORS

Sync your system to PACER to automate legal marketing.