

Appendix B. Error Return Codes

Symbolic Name	Value	Definition
EEXIST	17	File exists
EXDEV	18	Cross-device link (link to another device)
ENODEV	19	No such device (or inappropriate call)
ENOTDIR	20	Not a directory (e.g., in a path prefix)
EISDIR	21	Is a directory (cannot write to a directory)
EINVAL	22	Invalid argument
ENFILE	23	File table overflow (no more OPENS allowed)
EMFILE	24	Too many open files (process limit is 60)
ENOTTY	25	Not a typewriter
ETXTBSY	26	Text file busy (cannot EXEC an open file)
EFBIG	27	File too large (exceeds system maximum)
ENOSPC	28	No space left on device (write error)
ESPIPE	29	Illegal seek (cannot lseek to a pipe)
EROFS	30	Read-only file system (device is read only)
EMLINK	31	Too many links (to a file)
EPIPE	32	Broken pipe
EDOM	33	Math argument out of domain of function
ERANGE	34	Math result not representable

Error Return Names Listed Alphabetically

<u>Symbolic Name</u>	<u>Value</u>	<u>Definition</u>
E2BIG	7	Argument list too long: EXEC list > 5120 bytes
EACCES	13	Access denied by file protection system
EAGAIN	11	No more processes (FORK failure)
EBADF	9	Bad file number (not open, write only, etc.)
EBUSY	16	Device busy (MOUNT if already mounted,.....)
ECHILD	10	No child processes (for WAIT)
EDOM	33	Math arg out of domain of function
EEXIST	17	File exists
EFAULT	14	Bad address: hardware fault using argument
EFBIG	27	File too large (exceeds system maximum)
EINTR	4	Interrupted system call
EINVAL	22	Invalid argument
EIO	5	I/O error (physical)
EISDIR	21	Is a directory (cannot write to a directory)
EMFILE	24	Too many open files (process limit is 60)
EMLINK	31	Too many links (to a file)

Appendix B. Error Return Codes

Symbolic Name	Value	Definition
ENFILE	23	File table overflow (no more OPENS allowed)
ENODEV	19	No such device (or inappropriate call)
ENOENT	2	No such file or directory
ENOEXEC	8	EXEC format error (file has no "magic" number)
ENOMEM	12	Insufficient memory (EXEC or SBRK or FORK or...)
ENOSPC	28	No space left on device (write error)
ENOTBLK	15	Block device required: e.g., for MOUNT
ENOTDIR	20	Not a directory (e.g., in a path prefix)
ENOTTY	25	Not a typewriter
ENXIO	6	No such device or address (or beyond limit)
EPERM	1	Not owner (caller does not own file)
EPIPE	32	Broken pipe
ERANGE	34	Math result not representable
EROFS	30	Read-only file system (device is read only)
ESPIPE	29	Illegal seek (cannot lseek to a pipe)
ESRCH	3	No such process
ETXTBSY	26	Text file busy (cannot EXEC an open file)
EXDEV	18	Cross-device link (link to another device)



C

Model Specifications

Each model of the OMNI 300 Series terminals offers different options, including different communication devices:

Table C-1. OMNI 300 Series Communication Devices

OMNI Model	Serial Async Port*	Serial Sync/ Async Port	PIN Pad/ Bar Code Port	Internal Modem	LAN Port
380 Dial	DTR	—	Yes	Yes	—
385 Dial	No DTR	Async only	Yes	Yes	—
385 LAN	No DTR	Async only	Yes	—	Yes
390 Dial	DTR	—	Yes	Yes	—
395 LAN	No DTR	Yes	Yes	—	Yes
395 Dial	No DTR	Yes	Yes	Yes	—
460 Dial	DTR	—	Yes	Yes	—

* Note that the Serial Async Port differs between models. Some models support the DTR signal required for full Hayes-compatible support of external modems, while others do not.

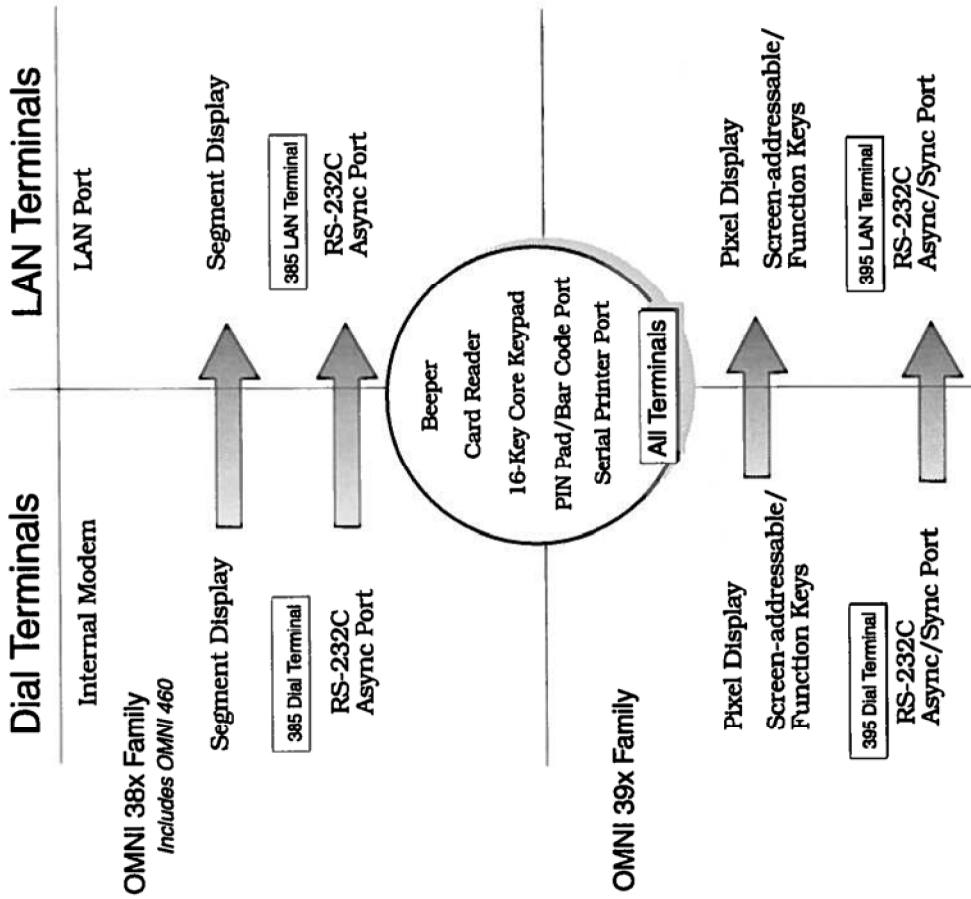
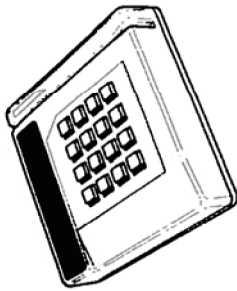

Figure C-1. OMNI 300 Series Terminal Family Features

OMNI 38x Dial Terminal



The OMNI 380 and OMNI 385 dial terminals are powerful, compact electronic transaction terminals capable of gathering and transferring information at high speed. Their versatility makes them ideal for a multitude of applications, including point-of-sale (POS), electronic payment transfer and authorization, time and attendance tracking, order entry, inventory and process tracking.

OMNI terminals simplify transactions and provide users more flexibility, improved speed and greater accuracy.

Keypad
The keypad has 16 keys for entering alphabetical and numeric data. The actual functions of each key will vary depending on your application. The OMNI 38x terminal is available in two keypad models: one with a telco-style keypad and the other with a calculator-style keypad.

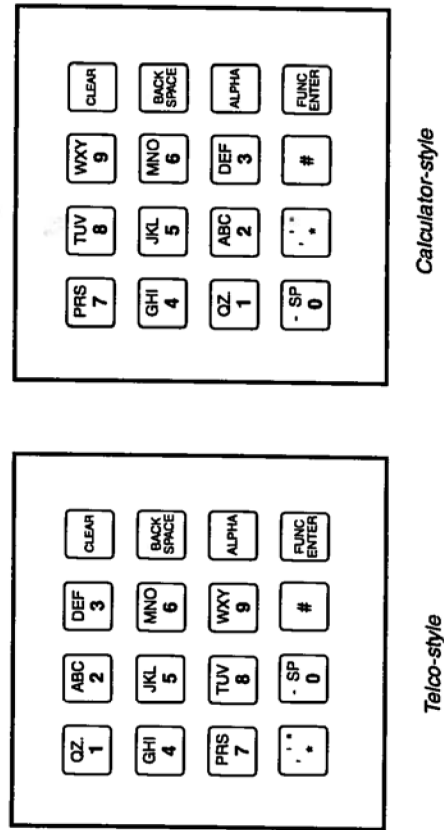

Figure C-2. OMNI 38x Terminal Keypads

The 16-character alphanumeric display panel provides the visual prompts and information needed to operate the OMNI 38x terminal. This bright blue, vacuum-fluorescent display is easy to read, even under poor lighting conditions. It displays fully-formed numerals, letters and punctuation symbols.

All OMNI 300 Series terminals feature an integrated magnetic stripe cardreader (slot on the right side of the terminal) for reading the data of most major credit, debit and private cards. Specifically, the cardreader comprises IATA Track 1, ABA Track 2 and ATM Track 3. It is possible to simultaneously read Tracks 1 and 2, or Tracks 2 and 3. It is also possible to read only a single track at a time, thus facilitating VISA fraud control features when software is written for either Track 1 or 2.

The OMNI 380 dial terminal includes two modular telephone jacks. The user can connect a telephone line to either jack. The second jack allows a standard telephone or another dial terminal to share the same telephone line.

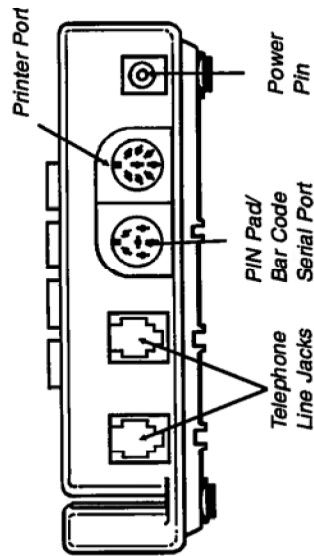

Figure C-3. OMNI 380 Terminal Rear Panel

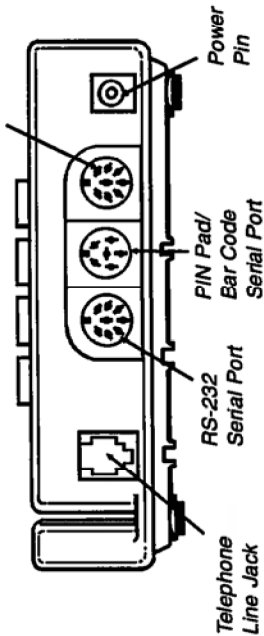
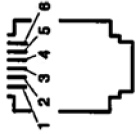

Figure C-4. OMNI 385 Terminal Rear Panel

Appendix C. Model Specifications

The serial telephone line interface employs a USOC RJ-11 modular telephone jack and has a default modem data format of 7 data bits, even parity and 1 stop bit.

Pin	Signal
1	(not used)
2	A
3	Ring
4	Tip
5	A1
6	(not used)



Note: Not all versions of OMNI 380 terminals support A/A1 activation.

Viewed looking into the RJ-11 jack

PIN Pad/Bar Code Wand Serial Port
A serial port is provided for a PIN (personal identification number) Pad or a Bar Code Wand. These devices connect to the 6-pin DIN connector on the terminal's rear panel.

Pin	Signal/Function
1	+5 Volts (through 4.7 ohm resistor)
2	Bar Code Wand Receive Data
3	PIN Pad Receive Data
4	PIN Pad Transmit Data
5	Ground
6	+9 Volts Unregulated PIN Pad/Bar Code Wand Power

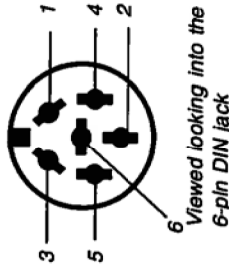

Viewed looking into the 6-pin DIN jack

RS-232 Serial Port
The OMNI 38x terminal uses a serial port to communicate with other devices, such as a printer, an IBM PC-compatible computer, or another OMNI terminal. These devices connect to the 8-pin DIN connector on the terminal's rear panel.

❖ This port is normally used for direct downloading during application development.

Pin	Signal/Function
1	GND - Signal Ground
2	DCD - Data Carrier Detect
3	RTS - Request To Send
4	CTS - Clear To Send
5	RXD - Receive Data
6	TXD - Transmit Data
7	(no connection)
8	(no connection)

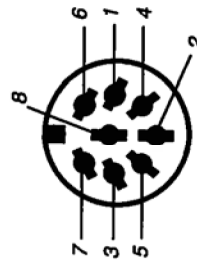

Viewed looking into the 8-pin DIN jack

385 RS-232C Async Port

OMNI 385 Dial and LAN terminals include a second 8-pin RS-232 port (defined as COM3) for asynchronous device communication. This port includes two clock signals.

Pin Signal/Function

Pin	Signal/Function
1	GND - Signal Ground
2	DCD - Data Carrier Detect
3	RTS - Request To Send
4	CTS - Clear To Send
5	RXD - Receive Data
6	TXD - Transmit Data
7	TXC - Transmit Clock Data
8	RXC - Receive Clock Data

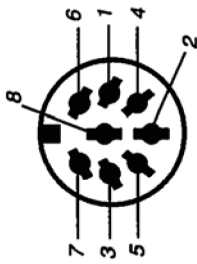

Viewed looking into the 8-pin DIN Jack

Power Pack

Each terminal has a power pack that plugs into a standard outlet. The cord from the power pack plugs into the power pin on the terminal's rear panel. Each terminal comes with the power pack appropriate for its country's power specifications.

Internal Modem

Dial terminals feature an integrated modem offering Bell 103/212A and CCITT V.21/V.22 compatibility for communications with the host computer. The modem supports both asynchronous communication and Synchronous Data Link Control (SDLC) for synchronous communication, and can communicate over public dial telephone lines at two different speeds: 300 and 1200 baud.

❖ **Note:** *Not all versions of OMNI terminals support CCITT communications.*

Appendix C. Model Specifications

- Features**
- ◆ Z180 CPU operating at 6 MHz
 - ◆ 128K RAM or 256K RAM
 - ◆ Built-in calendar/clock chip for maintaining accurate date and time. Can be used with a VeriFone printer for date and time stamping of transactions, reports and receipts.
 - ◆ Internal lithium battery backup power source for RAM in the event of a power failure
 - ◆ Display panel and keypad accepts alphanumeric characters including letters A - Z, numerals 0 - 9, and special characters *, ' " - . # ; : @ (space)
 - ◆ Asynchronous and Synchronous (SDLC) communication mode
 - ◆ Auto answer
 - ◆ Bi-directional local communications via RS-232 port
 - ◆ Multiple terminals can share the same telephone line
 - ◆ Terminal dials either touch tone or pulse (rotary mode) and accepts 38-digit telephone numbers
 - ◆ Automatically dials host telephone and call center numbers
 - ◆ The user-programmable password locks memory to prevent unauthorized use of the terminal
 - ◆ Memory can be locked by the application and/or password protected to prevent accidental erasure, tampering and unauthorized reading of data
 - ◆ Height: 1.5 in (38.10 mm)
 - ◆ Width: 5.6 in (143.10 mm)
 - ◆ Depth: 6.0 in (152.40 mm)
 - ◆ Shipping Weight: 2.3 lbs (1.04 kg)

OMNI 385 LAN Terminal



The OMNI 385 LAN terminal's versatility makes it ideal for a multitude of applications, including point-of-sale (POS), electronic payment transfer and authorization, time and attendance tracking, order entry, inventory and process tracking. The terminal can be loaded with an application which will automatically communicate over the LAN with a gateway terminal, such as an OMNI 480 unit, to obtain credit authorizations and perform other transactions on a remote host computer via telephone lines.

The OMNI 385 LAN terminal simplifies transactions and provides more flexibility, improved speed and greater accuracy. Because the terminal uses standard telephone-style cables for LAN connections, you can easily install and use the terminal at any retail counter or desk. The OMNI 385 LAN terminal also saves the cost of multiple telephone service connections since only one such service drop is needed for the LAN host gateway terminal, which can serve up to 31 additional terminals.

OMNI 385 Family Features The OMNI 385 LAN terminal shares the following features with the OMNI 38x family Dial terminal:

- ◆ Z180 CPU @ 6 MHz
- ◆ 128K or 256K RAM
- ◆ 16-key keypad (telco or calculator style)
- ◆ 16-character alphanumeric display panel (segment type)
- ◆ Integrated cardreader
- ◆ Serial Printer Port
- ◆ 8-pin RS-232 port (Async only with TXC/RXC)

Appendix C. Model Specifications

LAN Port

The terminal has a modular telephone-style jack on its rear panel serving as the LAN port. Thus, OMNI 385 LAN terminals may be connected with standard telephone-style cables, one of which is supplied with each terminal, to one of the RJ-11 ports of a LAN trunk cable.

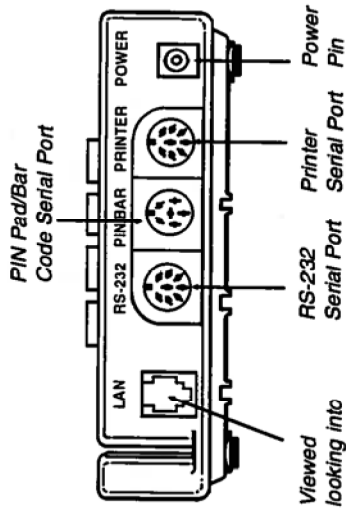

Figure C-5. OMNI 385 LAN Terminal Rear Panel

The LAN port employs a USOC RJ-11 modular telephone-style jack and has a LAN data format of 8 data bits, no parity, 1 stop bit and serial interface.

Pin	Signal
1	(not used)
2	Data/Receive (-) <i>bi-directional</i>
3	Isolated Ground
4	Isolated Ground
5	Data/Receive (+) <i>bi-directional</i>
6	(not used)

Viewed looking into the RJ-11 jack

The diagram shows a top-down view of the RJ-11 jack with pins numbered 1 through 6 from left to right.

OMNI 39x Dial Terminal

OMNI 39x Dial terminals are powerful, compact electronic transaction devices capable of gathering and transferring information at high speed. The versatility of these terminals makes them ideal for a multitude of applications, including point-of-sale (POS), electronic payment transfer and authorization, time and attendance tracking, order entry, inventory and process tracking. OMNI terminals simplify transactions and provide users more flexibility, improved speed and greater accuracy.

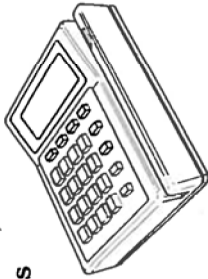

Keypad As Figure C-6 illustrates, the keypad has 16 keys for entering alphabetical and numeric data and 8 half-size function keys. The actual function of each of these 24 keys will vary depending on your application.

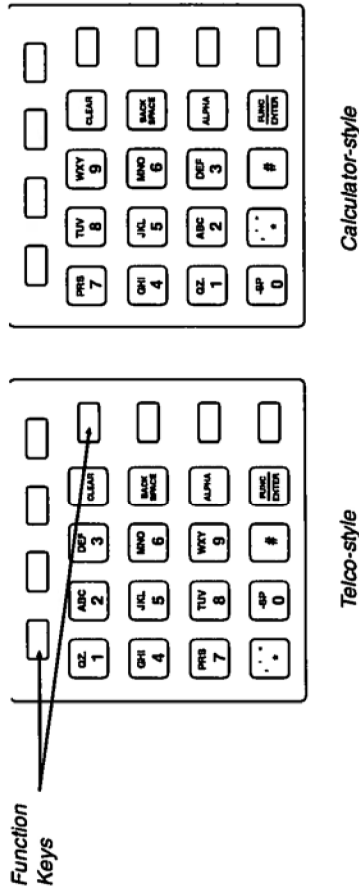

Figure C-6. OMNI 395 Terminal Keypad

Display Panel OMNI 39x terminals use Liquid Crystal Display (LCD) technology to provide the user with a complete set of visual prompts and information needed to operate the terminal. In addition, the LCD is backlit, allowing readability even in dark environments. The OMNI 39x terminal uses a graphic-type display, offering flexibility in the sizes and shapes of characters on

Appendix C. Model Specifications

the display. This graphic display supports 32 dots by 150 dots, arranged into the following modes:

- ◆ 4 lines of 25 characters, each character cell containing 6 x 8 dots
- ◆ 3 lines of 18 characters, each character cell containing 8 x 10 dots
- ◆ 2 lines of 18 characters, each character cell containing 8 x 16 dots
- ◆ 2 lines of 9 characters, each character cell containing 16 x 16 dots
- ◆ Dot graphic mode

Cardreader

All OMNI 300 Series terminals feature an integrated magnetic stripe cardreader (slot on the right side of the terminal) for reading the data of most major credit, debit and private cards. Specifically, the cardreader comprises IATA Track 1, ABA Track 2 and ATM Track 3. It is possible to simultaneously read Tracks 1 and 2, or read Tracks 2 and 3. When software is written to read only Track 1 or Track 2, VISA fraud control features are enabled.

Telephone Jacks

The OMNI 390 Dial terminal includes two modular telephone jacks. The user can connect a telephone line to either jack. The second jack allows a standard telephone or another OMNI terminal to share the same telephone line. The OMNI 395 dial terminal includes only one telephone jack.

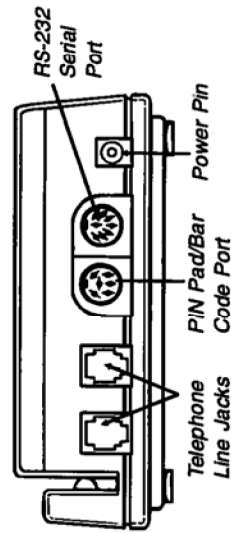

Figure C-7. OMNI 390 Terminal Rear Panel

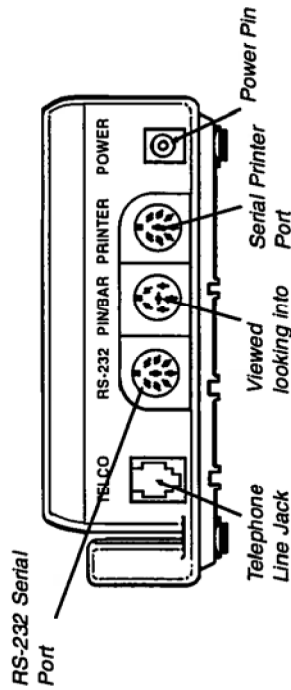

Figure C-8. OMNI 395 Dial Terminal Rear Panel

The serial telephone line interface employs a USOC RJ-11 modular telephone jack and has a default modem data format of 7 data bits, even parity and 1 stop bit.

Pin	Signal
1	(not used)
2	A
3	Ring
4	Tip
5	A1
6	(not used)

Viewed looking into the RJ-11 jack

Not all versions of OMNI 390 terminals support A/A1 activation.

A serial port is provided for a PIN (personal identification number) Pad or a Bar Code Wand. These devices connect to the 6-pin DIN connector on the terminal's rear panel.

PIN Pad/
Bar Code Wand
Serial Port

Pin	Signal/Function
1	+5 Volts (through 4.7 ohm resistor)
2	Bar Code Wand Receive Data
3	PIN Pad Receive Data (input port)
4	PIN Pad Transmit Data (output port)
5	Ground
6	+9 Volts Unregulated PIN Pad/Bar Code Wand Power

Viewed looking into the 6-pin DIN jack

Appendix C. Model Specifications

RS-232 Serial Port

The terminal uses a serial port to communicate with other devices, such as a printer, an IBM PC-compatible computer, or another OMNI 390 terminal. These devices connect to the 8-pin DIN connector on the terminal's rear panel.

❖ *This port is normally used for direct downloading during application development.*

Pin	Signal/Function
1	GND - Signal Ground
2	DCD - Data Carrier Detect
3	RTS - Request To Send
4	CTS - Clear To Send
5	RXD - Receive Data
6	TXD - Transmit Data
7	(no connection)
8	(no connection)

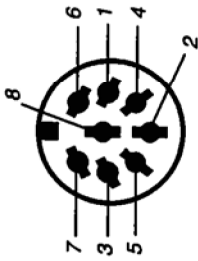

Viewed looking into the 8-pin DIN jack

395 RS-232C Async/Sync Port

OMNI 385 Dial and LAN terminals include a second 8-pin RS-232 port (defined as COM3) for asynchronous and synchronous (SDLC) device communication. This port includes two clock signals.

Pin	Signal/Function
1	GND - Signal Ground
2	DCD - Data Carrier Detect
3	RTS - Request To Send
4	CTS - Clear To Send
5	RXD - Receive Data
6	TXD - Transmit Data
7	TXC - Transmit Clock Data
8	RXC - Receive Clock Data

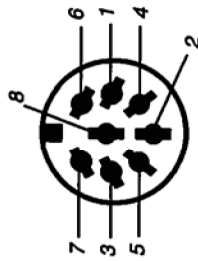

Viewed looking into the 8-pin DIN jack

Power Pack

Each terminal has a power pack that plugs into a standard outlet. The cord from the power pack plugs into the power pin on the terminal's rear panel. The OMNI 390 terminal comes with the power pack appropriate for its country's power specifications.

Internal Modem

The OMNI 39x dial terminal features an integrated modem offering Bell 103/212A and CCITT V.21/V.22 compatibility for communications with the host computer. The modem supports both asynchronous communication and Synchronous Data Link Control

(SDLC) for synchronous communication, and can communicate over public dial telephone lines at two different speeds: 300 and 1200 baud.

❖ *Note: Not all versions of OMNI terminals support CCITT communications.*

- Features**
- ◆ Z180 CPU operating at 6 MHz
 - ◆ 128K RAM or 256K RAM
 - ◆ Built-in calendar/clock chip for maintaining accurate date and time. Used with a VeriFone printer for date and time stamping of transactions, reports and receipts
 - ◆ Internal lithium battery backup power source for RAM in the event of a power failure
 - ◆ Display panel and keypad accepts alphanumeric characters including letters A - Z, numerals 0 - 9, and special characters *, " - . # ; ; @ (space)
 - ◆ Asynchronous and Synchronous (SDLC) communication mode
 - ◆ Auto answer
 - ◆ Bi-directional local communications via RS-232 port
 - ◆ Multiple terminals can share the same telephone line
 - ◆ Terminal dials either touch tone or pulse (rotary mode) and accepts 38-digit telephone numbers
 - ◆ Automatically dials host and call center telephone numbers
 - ◆ The user-programmable password locks memory to prevent unauthorized use of the terminal
 - ◆ Memory can be locked by the application and/or password protected to prevent accidental erasure, tampering and unauthorized reading of data
 - ◆ Height: 1.5 in (38.10 mm), 2.0 in (50.80 mm) height at rear
 - ◆ Width: 5.6 in (143.10 mm)
 - ◆ Depth: 6.0 in (152.40 mm)
 - ◆ Shipping Weight: 2.3 lbs (1.04 kg)

OMNI 395 LAN Terminal

The OMNI 395 LAN terminal's versatility makes it ideal for a multitude of applications, including point-of-sale (POS), electronic payment transfer and authorization, time and attendance tracking, order entry, inventory and process tracking.

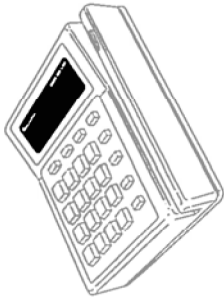

The terminal can be loaded with an application which will automatically communicate over the LAN with a gateway terminal, such as an OMNI 480 unit, to obtain credit authorizations and perform other transactions on a remote host computer via telephone lines.

The OMNI 395 LAN terminal simplifies transactions and provides more flexibility, improved speed and greater accuracy. Because the terminal uses standard telephone-style cables for LAN connections, you can easily install and use the terminal at any retail counter or desk. The OMNI 395 LAN terminal also saves the cost of multiple telephone service connections since only one such service drop is needed for the LAN host gateway terminal, which can serve up to 31 additional terminals.

OMNI 39x Family Features
The OMNI 395 LAN terminal shares the following features with the OMNI 39x family Dial terminal:

- ◆ Z180 CPU @ 6 MHz
- ◆ 128K or 256K RAM
- ◆ 16-key keypad (telco or calculator style)
- ◆ 8 half-size function keys
- ◆ LCD graphics display
- ◆ Integrated cardreader
- ◆ Serial Printer Port
- ◆ 8-pin RS-232 printer port (Async/Sync with TXC/RXC)

LAN Port

The OMNI 395 LAN terminal uses a modular telephone-style jack as its LAN port. OMNI LAN terminals may be connected with standard telephone-style cables, one of which is supplied with each terminal, to one of the RJ-11 ports of a LAN trunk cable.

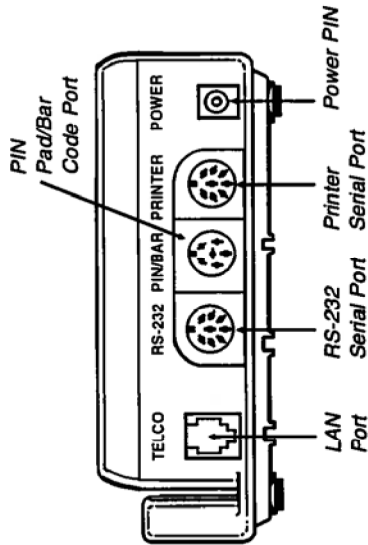
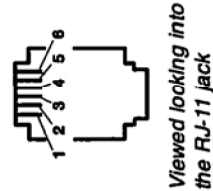

Figure C-9. OMNI 395 LAN Terminal Rear Panel

The LAN port employs a USOC RJ-11 modular telephone-style jack and has a LAN data format of 8 data bits, no parity, 1 stop bit and serial interface.

Pin	Signal
1	(not used)
2	Data/Receive (-) <i>bi-directional</i>
3	Isolated Ground
4	Isolated Ground
5	Data/Receive (+) <i>bi-directional</i>
6	(not used)



OMNI 460 Dial Terminal/Printer

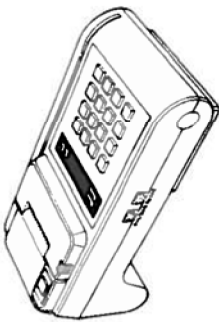

The OMNI 460 is a desktop transaction terminal with an integrated printer for credit, debit, and proprietary card payment and other value-added applications. It is an extension of the OMNI 300 Series of terminals, and is most similar in hardware and features to the OMNI 380, with the inclusion of its integrated printer. The OMNI 460 hardware is the migration from the TRANZ 460 Product Line. The terminal is marketed as a fully dedicated for desktop applications. Its applications are not intended to be portable to other OMNI platforms.

OMNI 38x Family Features The OMNI 460 terminal shares the following features with the OMNI 38x family Dial terminal:

- ◆ Z180 CPU @ 6 MHz
- ◆ 128K or 256K RAM
- ◆ 16-key keypad (telco or calculator style)
- ◆ 16-character alphanumeric display panel (segment type)
- ◆ Integrated cardreader
- ◆ 8-pin RS-232 port (Async only with TXC/RXC)

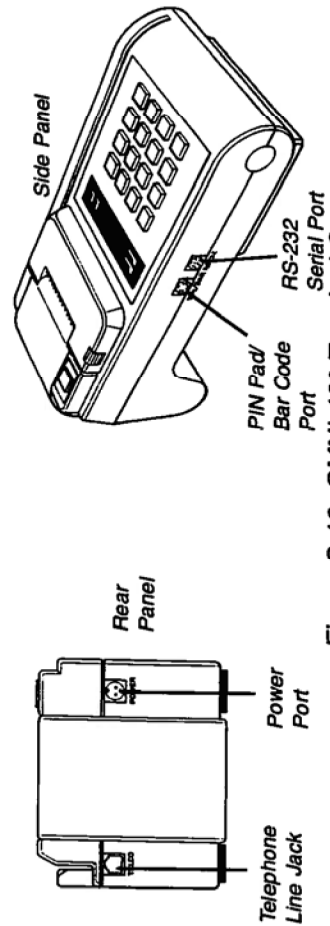
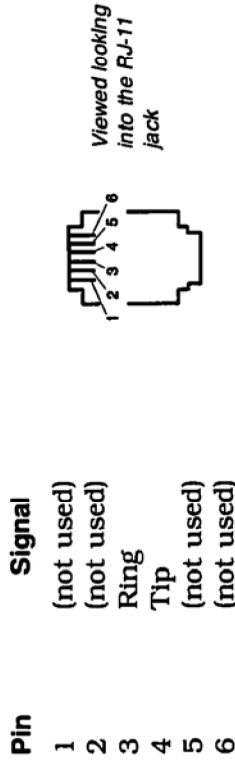

Figure C-10. OMNI 460 Terminal Connectors

Telephone Jack The terminal has one 6-position modular telephone jack on its rear panel. (No A/A1 support.)

The serial telephone line interface employs a USOC RJ-11 modular telephone jack and has a default modem data format of 7 data bits, even parity and 1 stop bit.



PIN Pad/ Bar Code Wand Serial Port A serial port is provided for a PIN (personal identification number) Pad or a Bar Code Wand. These devices connect to the 6-pin mini-DIN connector on the terminal's side panel.

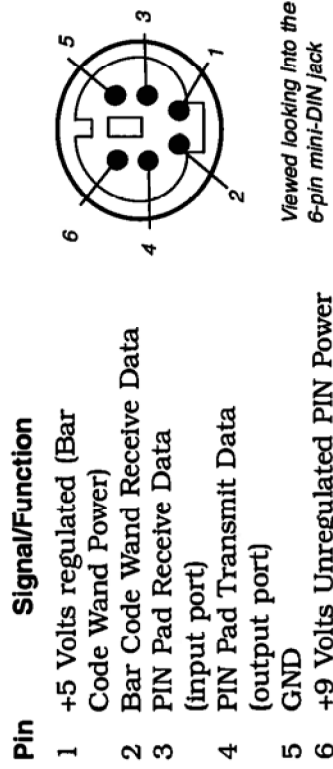

RS-232 Serial Port The terminal uses a serial port to communicate with other devices, such as a printer, an IBM PC-compatible computer, or another OMNI 380 terminal. These devices connect to the 8-pin DIN connector on the terminal's rear panel.

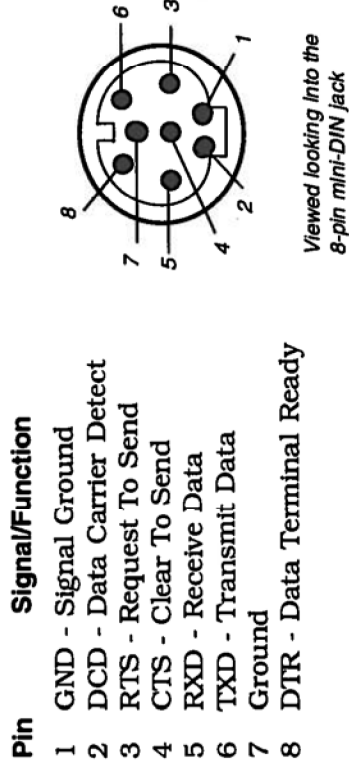

Appendix C. Model Specifications

- Power Pack** Each terminal has a power pack that plugs into a standard outlet. The cord from the power pack plugs into the power pin on the terminal's rear panel. The OMNI 460 terminal comes with the power pack appropriate for its country's power specifications.
- Internal Modem** Dial terminals feature an integrated modem offering Bell 103/212A and CCITT V.21/V.22 compatibility for communications with the host computer. The modem supports both asynchronous communication and Synchronous Data Link Control (SDLC) for synchronous communication, and can communicate over public dial telephone lines at two different speeds: 300 and 1200 baud.
- ❖ *Note: Not all versions of OMNI terminals support CCITT communications.*
- Features**
- ◆ Z180 CPU operating at 6 MHz
 - ◆ 128K, 256K or 512K RAM
 - ◆ Integral impact dot matrix printer
 - ◆ Built-in calendar/clock chip
 - ◆ Internal lithium battery backup power source for RAM in the event of a power failure
 - ◆ Display panel and keypad accepts alphanumeric characters including letters A through Z, numerals 0 through 9, and special characters *, ' , " - . # ; ; @ (space)
 - ◆ Asynchronous and Synchronous (SDLC) communication mode
 - ◆ Auto answer
 - ◆ Multiple terminals can share the same telephone line
 - ◆ Terminal dials either touch tone or pulse (rotary mode) and accepts 38-digit telephone numbers
 - ◆ Automatically dials host telephone and call center numbers
 - ◆ The user-programmable password locks memory to prevent unauthorized use of the terminal
 - ◆ Memory can be locked by the application and/or password protected to prevent accidental erasure, tampering and unauthorized reading of data

OMNI 300 Series Programmer's Manual

- ◆ Height: 4.6 in (116 mm)
- ◆ Width: 5.8 in (148 mm)
- ◆ Depth: 11.85 in (301 mm)
- ◆ Shipping Weight: 3.3 lbs (1.54 kg)



D

OMNI 460 Printer Programming

The OMNI 460 operating system consists of two major parts: the main processor (terminal controller) and the printer controller. Each part is controlled by a micro-processor and communicates over a serial communication link.

A unique feature of the OMNI 460 terminal is its integral, low-powered Epson Model 180 roll printer that produces credit card receipts and transaction records. The printer controller not only controls the Epson printer, but also provides system status information and initiates system shutdown.

The printer controller font sets are stored in the micro-processor ROM. The active font set is software selectable. The font details and supported countries are described under the section titled Printable Character Set.

Serial TTL Interface

The printer controller communicates with the main processor over an internal TTL serial line. An internal multiplexor determines the TTL serial line path. Data direction is controlled by the RTS line from the main processor. Communication is set at 19,200 bps using 1 start bit, 1 stop bit, 8 data bits per character and no parity.

The printer controller double buffers its data. One buffer is used by the printer driver while the other is used by the receiver. The printer controller is able to simultaneously print the data to one buffer and accept transmitted data in the other.

When data is sent in packets it is followed by a 2-byte CRC (Cyclic Redundancy Check). This only occurs when the main processor board requests status of the printer controller. Data for the printer is always sent in a non-validated bit stream.

Printer Mechanism

The Model 180 printer mechanism is a dot matrix printer featuring six print solenoids (pins). Each pin is capable of printing, in a single pass, the horizontal row of dots that form one dot row of four consecutive characters. A character is defined as being a matrix of five horizontal dots by seven vertical dots (in a default "frame" of six by eight to give the white space around the characters); thus seven consecutive pin passes will build four complete characters (a one-dot deep "line-feed" is performed before the start of printing).

Each pin is horizontally separated from its neighbor by approximately four characters that all move together. Thus, by driving all six solenoids together, a line of 24 characters can be printed. The printer mechanism has connections for the six solenoids, the carriage motor, a fast-feed solenoid, and two timing outputs. All buffering and data manipulation must be done by the controller.

Printable Character Set

The roll printer is capable of printing the full set of printable ASCII characters. In addition, it is capable of supporting a number of special printing enhancements, 11 country character sets and a number of useful graphics.

Fonts

The standard (default) font set is the United States country character set, consisting of the 96 printable characters from 0x20 to 0x7F (i.e., the 7-bit ASCII set). Character sets are included for the following countries:

- ◆ U.S.A. (default)
- ◆ France
- ◆ Germany
- ◆ United Kingdom
- ◆ Denmark I
- ◆ Sweden
- ◆ Italy
- ◆ Spain
- ◆ Japan
- ◆ Norway

An incoming ASCII character to be printed is used as an offset into an index table that is stored in memory locations 0x800 to 0x8FF. Each printable character is converted to an index into the font tables, which are arrays of bit patterns corresponding to the dots that form the character to be printed. The font tables are stored in locations 0x900 to 0xF00.

The font bitmapping commits a page of 256 bytes for each row of dots, giving the possibility of 256 different printable characters. That is, locations 0x900 to 0x9FF contain 256 bytes whose bits correspond to the dot patterns for the first row of dots for each of the

OMNI 300 Series Programmer's Manual

maximum 256 printable characters; locations 0xA00 to 0xAF7 have the second row definitions, and so on. The active printer character set contains 96 characters, 12 of which are subject to variation for the 11 country character sets. The 132 (12 * 11) variable characters are stored in the second half of each page corresponding to indices greater than 0x7F. Hence, the MSB of each index may be used as a flag to indicate a character is subject to country character set variation; the country code is used as an offset to the character bitmaps. Refer to the table below for the character fonts for each country code.

Table D-1: Country Specific Character Map

Country	0x23	0x24	0x40	0x5B	0x5C	0x5D	0x5E	0x60	0x7B	0x7C	0x7D	0x7E
U.S.A.	#	\$	@	[\]	^	'	{		}	~
France	#	\$	à	°	ç	§	^	'	é	ú	è	..
Germany	#	\$	§	À	Ö	Ü	^	'	ä	ö	ü	ß
U.K.	£	\$	@	[\]	^	'	{		}	~
Denmark I	#	\$	@	Æ	Ø	À	^	'	æ	ø	á	~
Sweden	#	□	É	Ä	Ö	À	Ü	é	ä	ö	á	ü
Italy	#	\$	@	°	\	é	^	ù	à	ò	è	ì
Spain	℞	\$	@	ı	Ñ	¿	^	'	..	ñ	}	~
Japan	#	\$	@	[¥]	^	'	{		}	~
Norway	#	□	É	Æ	Ø	À	Ü	é	æ	ø	á	ü

Appendix D. OMNI 460 Printer Programming

Enhancements

There are two enhancements available to modify and emphasize the printed characters: Double Wide and Double Height.

- ◆ Double Wide is used to produce double-width characters. Each character occupies twice the normal space width on the paper, reducing the number of characters per line from 24 to 12.
- ◆ Double Height is used to produce double-height characters. Each line of characters occupies twice the normal height of the paper, reducing the number of lines per inch by approximately half.

Printer Controller Functions

The printer controller has the following functional responsibilities:

- ◆ Communicate with the OMNI 460 microprocessor
- ◆ Turn power on and off to the printer
- ◆ Monitor the printer's paper-out detection circuit
- ◆ Monitor the printer's print motor speed
- ◆ Monitor the system battery
- ◆ Find and interpret printer commands

Paper Detection Circuit

To avoid the possibility of printing a transaction without producing a printed receipt, the printer controller continuously monitors the paper detection circuit. When the paper sensor detects the lack of paper, the printer will complete the line it is currently printing and stop any additional printing.

Printer Commands

The printer controller is designed to find and interpret all recognized printer commands. Any other nonprintable (i.e., less than ASCII 0x20) commands will be ignored and discarded; however, any printable characters following these will be added to the print buffer.

These commands are discussed in detail later in this appendix.

Printer Power-Up Test

At every system power-up, or when instructed by the terminal controller, the printer controller performs a timing test on the printer mechanism. This involves driving the motor and verifying that the mechanism is operating within its specifications. If the mechanism is operating normally, the printer controller enters into the idle state, waiting for the next print command or data from the terminal controller. If the mechanism is not operating within specification, the printer controller waits for the terminal controller to send a status request, and reports the error as part of the status response packet (i.e., bit 2 of the status byte is set). All commands or data that preceded the status request are discarded. Upon successful transmission of the status response, the printer controller enters into the idle state.

Controller Commands

The terminal controller, a Z180-based transaction device, communicates directly with the printer controller. This processor interrogates the status and sets the state of various system parameters by issuing Status Requests. Apart from this, all other commands are directed to the printer, either controlling text printing or setting printer parameters.

Appendix D. OMNI 460 Printer Programming

Status Request

Periodically, the terminal controller will request the printer controller to report the system status. Assuming there are no errors, the communication procedure is as follows:

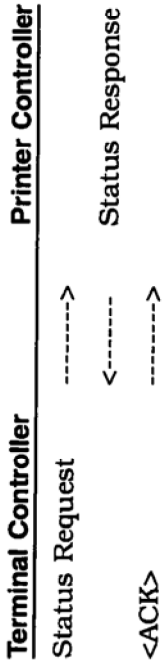

Status Request Packet Structure

The following is the packet structure used to request a status report from the printer controller:

<u>Value</u>	<u>Size</u>	<u>Description</u>
0x16	1 byte	Status request prefix byte
VAR	1 byte	Command byte
VAR	1 byte	1st byte of CRC
VAR	1 byte	2nd byte of CRC

<u>Bit</u>	<u>Usage</u>
0-4	Don't care (reserved for status response)
5	Not used
6	Not used
7	0 = Disable system power 1 = Enable system power

Bits 0 through 4 are reserved as status bits that are set by the printer controller in the Status Response mode; in the Status Request mode they contain no useful information and are ignored by the printer controller.

Status Response Packet Structure

Upon receiving a valid Status Request, the printer controller generates a Status Response. The following is the packet structure of the response packet:

Value	Size	Description
0x21	1 byte	Fixed constant
0x00	2 bytes	Fixed constant
0x15	1 byte	Fixed constant
0x24	1 byte	Fixed constant
0xFF	1 byte	Fixed constant
0x29	1 byte	Fixed constant
VAR	1 byte	Status byte
0x00	12 bytes	Fixed constant
VAR	1 byte	1st byte of CRC
VAR	1 byte	2nd byte of CRC

The bit assignments for the status byte are as follows:

Bit	Usage
0	Not used
1	0 = paper loaded; 1 = paper out
2	0 = printer OK; 1 = printer error
3	Not used
4	0 = printer active; 1 = printer idle
5	Not used
6	Not used
7	Same value found in command byte

Abnormal Condition Handling

The following sections list possible abnormal conditions the printer controller may encounter and the suggested method of handling them.

Appendix D. OMNI 460 Printer Programming

Power Failure

The printer controller continuously monitors the system power supply, reporting its instantaneous status as a parameter of the status response. A failing power supply will normally be detected by the hardware monitor circuit before it becomes a time-critical event. This information is accurately reported to the host, and the printer controller continues to execute its normal tasks until instructed to do otherwise. No specific action is invoked.

Paper Out

The printer controller continuously monitors the paper-out detect circuit, reporting its instantaneous status as a parameter of the status response. The printer controller suspends printing until the paper supply is refilled. As a convenience to the operator, the Line Feed button on the top of the terminal is monitored to cause the paper feed action to take place.

When paper out is detected (i.e., after every line of printing is complete, at the first print command after an idle period or after servicing a status request, or a <FS> J or a <FS> T), the printer controller will continue to discard print commands except for the status request command. The printer remains dormant until paper is replaced.

Timing Failure

The printer controller continuously monitors the printer motor speed. If the speed falls below an amount dictated by the Epson printer specification, the motor is shut down, all solenoids are turned off and the controller enters an error state. In this state all printer activity is suspended, and the only serial input acted upon is the status request message. The error code is reported as

part of the reply to the request. This also clears the error condition and re-enables printing.

Communication Failure

Data corruption during packet transmission is detected by the CRC algorithm, resulting in a <NAK> and retransmission of the packet.

The packet protocol is as follows:

Printer Controller	Host	Printer Action
<-----	Status Request	
NAK ----->		If CRC does not match
or, <-----	Status Request	
Status Reply ----->	ACK	Printer expects ACK Printer goes to idle (OK)
or, <-----	Status Request	
Status Reply ----->		Printer expects ACK
<-----	Nothing	Printer times out and resends up to three times then goes idle (OK)
Status Reply ----->		Printer expects ACK
<-----	Status Request	
Status Reply ----->	NAK	Printer expects ACK
Status Reply ----->		Printer resends . . .

No data validation is performed on the print data received.

Appendix D. OMNI 460 Printer Programming

Unrecognized Characters

The printer controller command parser is designed to find and interpret all recognized commands. Any other nonprintable (i.e., less than 0x20 or greater than 0x7F) characters are ignored and discarded; however, any printable characters following will be added to the print buffer.

Memory/Programming Error

On power-up, the printer controller executes an internal check on the operation of the controller and ROM memory. If this test fails, the printer controller will idle, rejecting all communication with the host. The host will display a message that it is unable to communicate with the printer controller. There is no recovery from this condition as it indicates that the controller has failed. The terminal should be returned for service.

Printer Commands

The following commands may be used with the OMNI 460 terminal.

CAN Cancel

<i>Format</i>	ASCII value: CAN
	HEX value: 18
<i>Description</i>	Empties the print buffer and cancels character attributes.

FF **Form Feed**

Format ASCII value: FF
HEX value: 0A
Description Advances the paper approximately one inch.

LF **Print and Line Feed**

Format ASCII value: LF
HEX value: 0A
Description This command prints the contents of the print buffer on the current line and advances the paper one line.

RS **Double-wide Characters**

Format ASCII value: RS
HEX value: 1E
Description Prints characters twice as wide as normal; therefore, only 12 characters, instead of 24 characters, fit on one line.

US **Reset Character Width to Normal Width**

Format ASCII value: US
HEX value: 1F
Description Cancels double-width character printing and resets the printer to normal character width.

ESC a (n) **Set Line Height to "n" Dots**

Format ASCII value: ESC a n ;
HEX value: 1B 61 n 3B

Appendix D. OMNI 460 Printer Programming

Description Sets the line height—measured in dots—from the top of one line to the bottom of the same line, including any "shoulder" space. (Spacing is set to *n* dots, where *n* = modula 64.)

The default setting is 7, which leaves a shoulder space of one dot between lines and fits 8.6 lines vertically per inch. For the default of 7, one dot of line spacing occurs between lines, as the default character "frame" is 6 dots high, thus leaving one dot as a "shoulder" space.

ESC b (n) Eject Paper "n" Lines

Format ASCII value: ESC b n ;
HEX value: 1B 62 n 3B

Description Ejects the paper 0 to 9 lines, where *n* = number of lines (0x30 – 0x39).

ESC c Reset Printer

Format ASCII value: ESC c
HEX value: 1B 63

Description Resets the printer to its power-up state.

ESC d Return Printer Status Byte

Format ASCII value: ESC d
HEX value: 1B 64

Description: Returns printer status byte in the following format:
Px1xxL, where:
P = parity
x = reserved
1 = always high
L = paper out status