



# ABANDONE

Class	Subclass
ISSUE CLASSIFICATION	

UTILITY SERIAL NUMBER <b>105304</b>	PATENT DATE	PATENT NUMBER
--	-------------	---------------

SERIAL NUMBER 8/105,304	FILING DATE 08/11/93	CLASS <del>340</del> 34Y	SUBCLASS 149	GROUP PART UNIT <del>2617</del> 2615	EXAMINER Au
----------------------------	-------------------------	-----------------------------	-----------------	--	----------------

PERONE, J. LEMELSON, INCLINE VILLAGE, NV; ROBERT D. PEDERSEN, DALLAS, TX.

\*CONTINUING DATA\*\*\*\*\*  
VERIFIED

\*FOREIGN/PCT APPLICATIONS\*\*\*\*\*  
VERIFIED

FOREIGN FILING LICENSE GRANTED 09/14/93 \*\*\*\*\* SMALL ENTITY \*\*\*\*\*

Foreign priority claimed 35 USC 119 conditions met	<input type="checkbox"/> yes <input type="checkbox"/> no <input type="checkbox"/> yes <input type="checkbox"/> no	AS FILED	STATE OR COUNTRY NV	SHEETS DRWGS. 13	TOTAL CLAIMS 99	INDEP. CLAIMS 11	FILING FEE RECEIVED \$1,520.00	ATTORNEY'S DOCKET NO.
---	--	----------	------------------------	---------------------	--------------------	---------------------	-----------------------------------	-----------------------

Verified and Acknowledged Examiner's Initials →

~~JEROME H. LEMELSON~~  
~~SUITE 206~~  
~~1938 FANGE BLVD.~~  
~~SUITE 202~~  
~~INCLINE VILLAGE, NV 89451-9406~~

*Louis J. Woffman*  
*15150 North Hayden Road*  
*Suite 202*  
*Scottsdale, AZ 85260*

TITLE: MOTOR VEHICLE WARNING AND CONTROL SYSTEM AND METHOD

U.S. DEPT. of COMM. Pat. & TM Office - PTO-436L (rev. 10/78)

PARTS OF APPLICATION FILED SEPARATELY		Applications Examiner	
NOTICE OF ALLOWANCE MAILED		CLAIMS ALLOWED	
Assistant Examiner		Total Claims	Print Claim
ISSUE FEE		DRAWING	
Amount Due	Date Paid	Sheets Drwg.	Figs. Drwg.
Label Area		Print Fig.	
		ISSUE BATCH NUMBER	
PREPARED FOR ISSUE			
<p><b>WARNING:</b> The information disclosed herein may be restricted. Unauthorized disclosure may be prohibited by the United States Code Title 35, Sections 122, 181 and 368. Possession outside the U.S. Patent &amp; Trademark Office is restricted to authorized employees and contractors only.</p>			

Form PTO-436A Rev. 8/92

(FACE)

08 105304

PATENT APPLICATION SERIAL NO. \_\_\_\_\_

U.S. DEPARTMENT OF COMMERCE  
PATENT AND TRADEMARK OFFICE  
FEE RECORD SHEET

140 KM 09/02/93 08105304

1 101 1.520.00 CK

PTO-1556  
(5/87)

BAR CODE LABEL		<b>U.S. PATENT APPLICATION</b>			
					
SERIAL NUMBER		FILING DATE	CLASS	GROUP ART UNIT	
08/105,304		08/11/93	340	2617	
APPLICANT	JEROME H. LEMELSON, INCLINE VILLAGE, NV; ROBERT D. PEDERSEN, DALLAS, TX.				
	**CONTINUING DATA***** VERIFIED   **FOREIGN/PCT APPLICATIONS***** VERIFIED   				
FOREIGN FILING LICENSE GRANTED 09/14/93			***** SMALL ENTITY *****		
STATE OR COUNTRY	SHEETS DRAWING	TOTAL CLAIMS	INDEPENDENT CLAIMS	FILING FEE RECEIVED	ATTORNEY DOCKET NO.
NV	13	99	11	\$1,520.00	
ADDRESS	JEROME H. LEMELSON SUITE 286 930 TAHOE BLVD. UNIT 802 INCLINE VILLAGE, NV 89451-9436				
	MOTOR VEHICLE WARNING AND CONTROL SYSTEM AND METHOD				
TITLE	MOTOR VEHICLE WARNING AND CONTROL SYSTEM AND METHOD				
	This is to certify that annexed hereto is a true copy from the records of the United States Patent and Trademark Office of the application which is identified above. By authority of the COMMISSIONER OF PATENTS AND TRADEMARKS  Date _____ Certifying Officer _____				



Applicant: Jerome H. Lemelson

Application Branch

Serial No: \_\_\_\_\_

August 11, 1993

Filed: August 11, 1993

For: MOTOR VEHICLE WARNING AND CONTROL SYSTEM AND METHOD

APPLICATION TRANSMITTAL

Commissioner of Patents and Trademarks Washington, D.C. 20231

Sir:

I hereby certify that the above identified patent application enclosed herewith is being deposited in the U.S. Postal Service as Express Mail No: HB 242939400 on August 11, 1993 addressed to the Commissioner of Patents and Trademarks, Washington, D.C. 20231.

A check covering the filing of 99 claims including 8 independent claims over three (total of 11 independent claims) is enclosed herewith together with a Small Entity Declaration; a Declaration and Power of Attorney; a 31 page specification and claims 1-99 and 13 pages showing FIGS. 1-15 of drawings. Calculation of Total Filing Fee amount:

1. Basic Filing Fee.....	\$ 355.00
2. Claims in Excess of 20 = 79....( 79 x \$11=	869.00
3. Independent Claims (in excess of 3) = 8x \$37) =	296.00
Total Filing Fee=\$1520.00	

A check in the amount of \$1522 is enclosed as is a postcard listing the above enclosed items to be mailed to applicant.

Respectfully submitted, Jerome H. Lemelson

Suite 286 - Unit 802 930 Tahoe Blvd. Incline Village, NV. 89451-9436





1,520-101 A

Jerome Lemelson  
Suite 286  
930 Tahoe Blvd., Unit 802  
Incline Village, NV 89451-9436

08 105304

MOTOR VEHICLE WARNING AND CONTROL SYSTEM AND METHOD

Abstract of the Disclosure

A system and method for assisting <sup>S</sup>the driver of a motor vehicle in preventing accidents or minimizing the effects of same. In one form, a television camera is mounted on a vehicle and scans the roadway ahead of the vehicle as the vehicle travels. Continuously generated video picture signals output by the camera are electronically processed and analyzed by an image analyzing computer, which generates codes <sup>that</sup> which serve to identify obstacles ~~on the road ahead of the vehicle.~~ Using such identifying information and comparing it with information on the shapes and sizes of various objects such as rear and front profiles of all production vehicles and the like and their relative sizes or select dimensions thereof, indications of distances to such objects may be computed and indicated as further codes. A decision computer mounted in the controlled vehicle receives such code signals along with code signals generated by the speedometer or one or more ~~speed and direction~~ sensors sensing steering mechanism operation and generates control signals ~~for driving a display, such as a heads up display on the windshield and/or dashboard to display such information as images of the controlled vehicle and other vehicles in and adjacent its path of travel and relative distances thereto as well as groups of characters defining same, colored and flashing warning lights and the like for pre-warning and warning purposes.~~ Such code signals <sup>may be</sup> and ~~displayed, and display(s) as well as synthetic speech and/or special sound generating and warning means may be~~ <sup>used</sup> employed, to warn the driver of the vehicle of approaching and existing hazards, ~~and, in certain~~ <sup>and</sup> detected instances, to control the operation of the brakes <sup>A1</sup> and/or steering mechanism of the vehicle <sup>A2</sup> to avoid or lessen the effects of a collision. In a particular form, the television camera and/or auxiliary radiation scanning means may scan a wide angle in front of the vehicle and areas to the sides of the vehicle to sense other vehicles traveling in the same direction and provide information in the form of codes to the decision computer to permit it to analyze same in effecting automatic

IN-A1)  
A1  
A2

~~control of the vehicle to avoid a collision with a vehicle directly ahead and to either or both sides and the rear of the controlled vehicle. While manual override means is provided, the decision computer may override or prevent the operation of same if it determines that a collision may occur if such override means is permitted to be operated. In a modified form, video scanning and radar or lidar scanning may be jointly employed to identify and indicate distances between the controlled vehicle and objects ahead to the side(s) and rear of the controlled vehicle.~~

Field  
Summary of the Invention

B  
INS (B1) } This invention relates to a system and method for operating a motor vehicle, such as an automobile, truck, aircraft or other vehicle, wherein a computer or computerized system is employed to assist and/or supplement the driver in the movement of the vehicle along a path of travel, such as a street or roadway and may be used to avoid obstacles and accidents. In a preferred form of the invention, a video scanning system, such as a television camera and/or one or more laser scanners mounted on the vehicle scan the road in front of the vehicle and generate image information which is computer analyzed per se or in combination with a range sensing system to warn the driver of hazardous conditions during driving by operating a display, such as a heads-up display, and/or a synthetic speech generating means which generates sounds or words of speech to verbally indicate such road conditions ahead of the vehicle.

The preferred form of the invention provides audible and/or visual display means to cooperate in indicating to the driver of a motor vehicle both normal and hazardous road conditions ahead as well as driving variables such as distances to stationary objects, and other vehicles; the identification, direction of travel and speed of such other vehicles, and the identification of and distances to stationary or slowly moving objects such as barriers, center islands, pedestrians, parked cars poles, sharp turns in the road, and other conditions. In addition, the image analyzing computer of the vehicle may be operated to scan and decode coded and/or character containing signs or signals generated by indicia or code generating other devices within or at the side of the road and indicating select road and driving conditions ahead.

The computer is operable to analyze video and/or other forms of image information generated as the vehicle travels to identify obstacles ahead of the vehicle and, in certain instances, quantify the distance between the vehicle containing same on the basis of the size of the identified

NSA3

vehicle or object and/or by processing received pulse-echo signals. <sup>DR</sup> When the closing distance becomes hazardous, select vehicle subsystems may be automatically controlled by the computer as it continues to analyze image signals generated by the television camera. A first subsystem generates a first select code or codes which controls an electronic display, such as a heads-up display to cause it to display a warning indication, such as one or more flashing red light portions of the display or other lighted effect. <sup>AB</sup> A second subsystem generates a code or series of codes which control a sound generating means which generates a select sound such as a horn, buzzing sound and/or select synthetic speech warning of the hazardous condition detected and, in certain instances, generating sounds of select words of speech which may warn of same and/or suggest corrective action <sup>A4</sup> (s) by the vehicle operator or driver to avoid an accident.

NSA7

A third subsystem comes on-line and generates one or more codes which are applied to at least partly effect a corrective action such as by pulsing one or more motors or solenoids to apply the brakes of the vehicle to cause it to slow down. If necessary to avoid or lessen the effects of an accident, the third subsystem stops the forward travel of the vehicle in a controlled manner depending on the relative speeds of the two vehicles, and/or the controlled vehicle and a stationery object or structure and the distance therebetween.

A fourth subsystem, which may be part of or separate from the third subsystem may generate one or more codes which are applied to either effect partial and/or complete control of the steering mechanism for the vehicle to avoid an obstacle and/or lessen the effect of an accident. Either or both the third or fourth subsystem may also be operable to control one or more safety devices by controlling motors, solenoids or valves, to operate a restraining device or devices for the driver and passenger(s) of the vehicle, such as a safety belt tightening means, an air bag inflation means or other device designed to protect human beings in the vehicle.

The second, and/or third and fourth subsystems may also be operable to effect or control the operations~~(s)~~ of additional warning means such as the horn, headlights and/or other warning lights on the vehicle or other warning means which operates to alert, flag or warn the driver of the approaching or approached vehicle or a pedestrian of the approaching hazardous condition. One or more of these subsystems may also be operable to generate and transmit one or more codes to be received and used by the approaching or approached vehicle or a roadside device to effect additional on-line warning(s) of the hazardous condition, and/or may be recorded on a disc or RAM (random access memory) for future analysis, if necessary.

In a modified form of the invention, the vehicle warning system may also include a short wave receiving means to receive code signals from other vehicles and/or short wave transmitters at the side of or within the road for controlling the visual, audio and/or brake and steering means of the vehicle to avoid or <sup>lessen</sup> ~~lessen~~ the effects of an accident and/or to maintain the vehicle in-lane and in proper operating condition as it travels.

The systems and methods of this invention preferably employ computerized image analyzing techniques of the types disclosed and defined in such patents of mine as 4,969,038 and 4,979,029 and references cited in the file wrappers thereof as well as other more recent patents and include the use of known artificial intelligence, neural networking and fuzzy logic computing electronic circuits.

Accordingly it is a primary object of this invention to provide a new and improved system and method for controlling the operation of a <sup>powered vehicle</sup> ~~motor vehicle, boat, train or aircraft~~.

Another object is provide a system and method for assisting the driver of a ~~motor vehicle;~~ <sup>powered vehicle</sup> ~~train, boat or aircraft~~ in controlling its operation to avoid an accident or hazardous driving condition.

Another object is to provide a system and method employing computerized image analysis to control or assist the driver of a motor vehicle in controlling its operation to avoid hazardous conditions such as collisions with other vehicles, stationery objects or pedestrians.

Another object is to provide a computerized system and method for controlling the speed of travel of a motor vehicle to lessen the chances of an accident while being driven by a person.

Another object is to provide a system and method employing a television scanning camera mounted on a vehicle for scanning the field ahead, such as the image of the road ahead of the vehicle and a computer for analyzing the image signals generated wherein automatic image intensifying, or infra-red scanning and detection means is utilized to permit scanning operations to be effected during driving at night and in low light, snowing or fog conditions.

Another object is to provide a system and method employing a television camera or other video scanning means mounted on a moving motor vehicle for scanning, detecting and identifying obstacles such as other vehicles ahead of such moving vehicle wherein the video image signals are analyzed to determine distances to such objects.

Another object is to provide a computer controlled safety system for a motor vehicle which employs a television camera and an auxiliary scanning means to both identify obstacles in the path of the vehicle and determine distance therefrom on a real time and continuous basis for use in warning the operator of same and/or in controlling the operation of the vehicle to avoid a collision.

#### **BRIEF DESCRIPTION OF DRAWINGS**

The various hardware and software elements used to carry out the invention described herein are illustrated in the form of block diagrams, flow charts, and depictions of neural network

and fuzzy logic algorithms and structures. The preferred embodiment is illustrated in the following figures:

Fig. 1 is a block diagram of the overall Motor Vehicle Warning and Control System illustrating system sensors, computers, displays, input/output devices and other key elements.

Fig. 2 is a block diagram of an Image Analysis Computer 19 of the type that can be used in the Vehicle Hazard Avoidance System herein of Fig. 1.

Fig. 3 illustrates a neural network of the type useful in the Image Analysis Computer of Fig. 4.

Fig. 4 illustrates the structure of a Processing Element (PE) in the neural network of Fig. 3.

Fig. 5 is an alternate embodiment of a neural network image processor useful in the system of Fig. 1.

Fig. 6 is a Flow Diagram illustrating the overall operation of the Motor Vehicle Warning and Control System of Fig. 1.

Fig. 7 illustrates typical input signal membership functions for Fuzzy Logic Algorithms useful in the Motor Vehicle Warning and Control System of Figure 1.

Fig. 8 illustrates typical output signal membership functions for Fuzzy Logic Algorithms useful in the Motor Vehicle Warning and Control System of Fig. 1.

Fig. 9 illustrates typical Fuzzy Associative Memory (FAM) maps for the Fuzzy Logic Algorithms useful in the Motor Vehicle Warning and Control System of Fig. 1.

Fig. 10 is a Hazard/Object State Vector useful in implementing the Fuzzy Logic Vehicle Warning and Control System.

Fig. 11 is a Hazard Collision Control Vector useful in implementing the Fuzzy Logic Vehicle Warning and Control System.

Fig. 12 is a table of Hazard/Object state vectors indicating possible combinations of hazards and objects useful in the Fuzzy Associative Memory access system used herein.

Fig. 13 is a more detailed Logic Flow Diagram for the analysis of detection signals prior to accessing Fuzzy Logic control structures in the Motor Vehicle Warning and Control System.

Fig. 14 is a more detailed Logic Flow Diagram for the Fuzzy Associative Memory (FAM) selection processing.

Fig. 15 is an example system flow illustrating the operation of the Motor Vehicle Warning and Control System.

### Detailed Description SYSTEM DESCRIPTION

In Fig. 1 is shown a computerized control system 10 for controlling the operation of a motor vehicle to prevent or lessen the effects of accidents such as collisions with stationary and/or moving objects such as other vehicles. The system 10 employs a control computer or microprocessor 11 mounted on the vehicle and operable to receive and gate digital signals, such as codes and control signals from various sensors, to one or more specialized computers and from such computers to a number of servos such as electric motors and lineal actuators or solenoids, switches and the like, speakers and display drivers to perform either or both the functions of audibly and/or visually informing or warning the driver of the vehicle of a hazardous road condition ahead and/or to effect controlled braking and steering actions of the vehicle.

ARAM 12 and ROM 13 are connected to processor 11 to effect and facilitate its operation. A television camera(s) 16 having a wide angle lens 16L is mounted at the front of the vehicle such as the front end of the roof, bumper or end of the hood to scan the road ahead of the vehicle at an angle encompassing the sides of the road and intersecting roads. The analog signal output of



camera 16 is digitized in an A/D convertor 18 and passed directly to or through a video preprocessor 51 to microprocessor 11, to an image field analyzing computer 19 which is provided, implemented and programmed using neural networks and artificial intelligence as well as fuzzy logic algorithms to (a) identify objects on the road ahead such as other vehicles, pedestrians, barriers and dividers, turns in the road, signs and symbols, etc. and generate identification codes, and (b) detect distances from such objects by their size (and shape) and provide codes indicating same for use by a decision computer, 23, which generates coded control signals which are applied through the computer 11 or are directly passed to various warning and vehicle operating devices such as a braking computer or drive, 35, which operates a brake servo 33, a steering computer or drive(s) 39 and 40 which operate steering servos 36; a synthetic speech signal generator 27 which sends trains of indicating and warning digital speech signals to a digital-analog converter 29 connected to a speaker 30; a display driver 31 which drives a (heads-up or dashboard) display 32; a head light controller 41 for flashing the head lights, a warning light control 42 for flashing external and/or internal warning lights; a horn control 43, etc.

A digital speedometer 44 and accelerometer(s) 45 provide information signals for use by the decision computer, 23, in issuing its commands. Accelerometer(s) 45 are connected to control computer microprocessor 11 through analog-to-digital converter 46. The accelerometer(s) 45 may pass data continuously to control computer microprocessor 11, or, alternatively, respond to query signals from said control computer 11. An auxiliary range detection means comprises a range computer 21 which accepts digital code signals from a radar or lidar computer 14 which interprets radar and/or laser range signals from respective reflected radiation receiving means on the vehicle.

NSAS  
The image analyzing computer 19 with associated memory 20 may be implemented in several different ways. Of particular concern is the requirement for high speed image processing with the capability to detect various hazards in dynamic image fields with changing scenes, moving

objects and multiple objects, more than one of which maybe a potential hazard. Requirements for wide angle vision and the ability to analyze both right and left side image fields also exist. The imaging system not only detects hazards, but also estimates distance based on image data for input to the range computer 21 implemented with the associated memory unit 22.

High speed image processing can be implemented employing known special purpose computer architectures including various parallel system structures and systems based on neural networks. <sup>Fig.</sup> Figure 2 shows a high speed parallel processor system embodiment with dedicated image processing hardware. The system of <sup>Fig.</sup> Figure 2 has a dedicated image data bus 50 for high speed image data transfer. The video camera 16 transfers full-frame video picture signal/data to the image bus 50 via analog/digital converter 18 and video preprocessor 51. The video camera 16 is preferably a CCD array camera generating successive picture frames with individual pixels being digitized for processing by the video preprocessor 51. The video camera 16 may also be implemented with other technologies including known image intensifying electron gun and infra-red imaging methods. Multiple cameras may be used for front, side and rear viewing and for stereo imaging capabilities suitable for generation of <sup>three</sup> ~~3~~-Dimensional image information including capabilities for depth perception and placing multiple objects in three dimensional image fields to further improve hazard detection capabilities.

As shown in Fig. 2, the video preprocessor 51 performs necessary video image frame management and data manipulation in preparation for image analysis. The preprocessor 51 may also be used in some embodiments for digital prefiltering and image enhancement. Actual image data can be displayed in real time using video display 55 via analog-to-digital converter 54. The image display may include highlighting of hazards, special warning images such as flashing lights, alpha-numeric messages, distance values, speed indicators and other hazard and safety related

13 (23) messages. Simulated as well as actual video displays may also be used to enhance driver recognition of dangerous situations.

2 The Image Analysis Computer 19 operates under the control of control processor 56 with random-access-memory (RAM) 57 and program and reference data stored in ~~read~~<sup>read</sup>-only memory (ROM) 58. The control processor 56 communicates with the motor vehicle warning and control system micro-processor controller 11 through the Bus Interface Unit 59. Results of the image analysis are passed in real-time to microprocessor controller 11 for integration with other sensory, computing, warning and control signals as depicted in Figure 1.

1 The Image Analysis Computer 19 of ~~Figure~~<sup>Fig.</sup> 2 uses high speed dedicated co-processor 53 for actual image analysis under control of the control processor 56. Typical operations performed using co-processors 53 include multidimensional filtering for operations such as feature extraction and motion detection. The co-processors 53 are used for multidimensional discrete transforms and other digital filtering operations used in image analysis. Multiple image memories 52 with parallel access to successive image data frames via image bus 50 permit concurrent processing with high speed data access by respective co-processing elements 53. The co-processor elements 53 may be high speed programmable processors or special purpose hardware processors specifically constructed for image analysis operations. SIMD (single instruction, multiple data) architectures provide high speed operation with multiple identical processing elements under control of a control unit that broadcasts instructions to all processing elements. The same instruction is executed simultaneously on different data elements making this approach particularly well suited for matrix and vector operations commonly employed in image analysis operations. Parallel operations of this type are particularly important with high pixel counts. A 1000 x 1000 pixel image has one million data points. Tightly coupled Multiple Instruction, Multiple Data (MIMD) architectures also are used in image processing applications. MIMD systems execute independent but related

programs concurrently on multiple processing elements. Various array processor and massively parallel architectures known to those skilled in the art may also be used for real-time image analysis.

15  
39

The calculation of the distance of certain recognizable objects from the vehicle is facilitated by having standard images stored in memory and recalling and comparing such image data with image data representing the object detected by the vehicle scanning mechanisms. For example, virtually all automobiles, trucks, and other standard vehicles have known widths. It follows that the distance to ~~another vehicle~~ can be determined by calculating its width in the scanned image. If a CCD camera is used, for example, the width can be ascertained in pixels in the image field. The distance to the vehicle can then be easily calculated using a simple relationship wherein the distance will be directly proportional to the object image width in pixels. The relative velocities and accelerations can also be easily calculated from respective first and second derivatives of the image width with respect to time. These image measurements and calculations can be used in addition to radar/lidar signal measurements or they may be used alone depending on system requirements.

In another embodiment, the image analyzing computer 19 is implemented as a neural computing network with networked processing elements performing successive computations on input image structure as shown in <sup>Fig.</sup> ~~Figure~~ 3 where signal inputs 61 are connected to multiple processing elements 63, 65 and 67 through the network connections 62, 64 and 66. The processing elements (PE's) 63, 65 and 67 map input signal vectors to the output decision layer, performing such tasks as image recognition and image parameter analysis.

a

A typical neural network processing element known to those skilled in the art is shown in Fig. 4 where input vectors,  $(X_1, X_2, \dots, X_n)$  are connected via weighing elements  $(W_1, W_2, \dots, W_n)$  to a summing node 70. The output of node 70 is passed through a nonlinear processing element 72 to produce an output signal, U. Offset or bias inputs can be added to the

inputs through weighing circuit  $W_0$ . The output signal from summing node 70 is passed through the nonlinear element 72. The nonlinear function is preferably a continuous, differentiable function such as a sigmoid which is typically used in neural network processing element nodes. Neural networks used in the vehicle warning system are trained to recognize roadway hazards which the vehicle is approaching including automobiles, trucks, and pedestrians. Training involves providing known inputs to the network resulting in desired output responses. The weights are automatically adjusted based on error signal measurements until the desired outputs are generated. Various learning algorithms may be applied. Adaptive operation is also possible with on-line adjustment of network weights to meet imaging requirements. The neural network embodiment of the image analysis computer 19 provides a highly parallel image processing structure with rapid, real-time image recognition necessary for the Motor Vehicle Warning and Control System. Very Large Scale Integrated (VLSI) Circuit implementation of the neural processing elements permits low-cost, low-weight implementation. Also, a neural network has certain reliability advantages important in a safety warning system. Loss of one processing element does not necessarily result in a processing system failure.

In an alternate embodiment, the neural network computing network of <sup>Fig</sup> Figure 3 can be implemented using multiple virtual processing elements 73 interconnected via an image data bus 75 with an image processor 74 as shown in <sup>Fig</sup> Figure 5. Image data presented to the Image Processor 74 is routed to selected virtual processing elements 73 which implement the neural network computing functions. The virtual PE's may be pipelined processors to increase speed and computational efficiency.

a The <sup>Fig</sup> Decision Computer 23 of <sup>Fig</sup> Figure 1 integrates the inputs from the image analysis computer 19, range computer 21, digital accelerometer 45, and the radar or lidar computer 14 to generate output warning and control signals. Warning signals alert the driver of impending

hazards and, depending on the situation, actual vehicle control signals may be generated to operate the vehicle in a manner that will avoid the hazard or minimize the danger to the vehicle and passengers. Control signals will be generated to operate brake servos 33 and steering servos 36. Manual overrides are provided to ensure driver vehicle control if necessary.

A particularly attractive embodiment of the decision computer 23 makes use of <sup>f</sup>Fuzzy <sup>l</sup>Logic Algorithmic structures to implement the automated control and warning signal generation. Fuzzy Logic is particularly well suited to the vehicle control problem wherein it is necessary to deal with a multiplicity of image, motion, and environmental parameters, each of which may extend over ranges of values and in different combinations which require different responses.

<sup>f</sup>Figure 6 illustrates a <sup>f</sup>Flow <sup>d</sup>Diagram for implementing a Fuzzy Logic Vehicle Control and Warning signal generation system suitable for the decision computer 23. The system of Fig. 6 receives inputs via the <sup>c</sup>Control <sup>c</sup>Computer <sup>m</sup>Microprocessor 11 of <sup>f</sup>Figure 1. Inputs include image analysis outputs, motion sensor outputs, distance measurements from radar/lidar systems, and environmental parameters which may indicate adverse driving conditions including rain or ice. The input signals are analyzed in a preprocessing step for hazardous conditions in the processing block 74. When a hazard is detected, the Fuzzy Associative Memory (FAM) ~~Section~~ block 76 described in more detail below is activated via decision element 75. If no hazard is present, the system continues to analyze scanning signals until a hazardous situation is encountered.

The Fuzzy Associative Memory (FAM) <sup>b</sup>Block 76 also receives a parameter input file from the Detection Signal Analysis <sup>b</sup>Block 74. This file contains necessary information to make control decision including, for example, hazard location (front, back, left side, right side), hazard distance, relative velocity, steering angle, braking pressure, weather data, and the presence or absence of obstructions or objects to the front, rear, or to either side of the vehicle.

Control signals are derived using FAM's 77, 78, 79 and 80. In practice, a large number of FAM's may be used to reflect different possible driving conditions and hazard scenarios. Each Fuzzy Associative Memory maps input control parameter combinations to appropriate output control signals. The output signals are defuzzified in the control signal generator 81 for input to the microprocessor controller 11 of <sup>Fig.</sup> Figure 1. This controller in turn generates control signals for steering servos, braking servos, and display and warning signals.

The FAM's operate with input signals measuring, for example, distance to the hazard, relative velocity of the vehicle relative to the hazard and relative acceleration between the vehicle and the hazard. Membership functions for these three variables are shown in <sup>Fig.</sup> Figure 7. The distance variable is classified as being Very Close (VC), Close (C), Medium (M), Far (F) or Very Far (VF). Overlap between membership in the various grades is indicated by the overlapping trapezoids of <sup>Fig.</sup> Figure 7. Certain distances are in more than one membership grade, being, for example, on the high end of being very close and the low end of being close.

Similarly, the membership functions for relative velocity grades inputs as Very Low (VL), Low (L), Medium (M), High (H) and Very High (VH) with overlap of membership grades indicated by the intersection of membership grade trapezoids. Relative acceleration is graded as being either positive or negative. Deceleration of the vehicle's velocity relative to the hazard is classified as negative acceleration. Both positive and negative acceleration are classified as being Low (L), Medium (M) or High (H). Overlapping "fuzzy" membership is indicated with the overlapping trapezoids, permitting possible membership in multiple grades. For example, a particular velocity might have a degree of membership in grade "Low" of 0.2 and a degree of membership in grade "Medium" of 0.6.

Three outputs are generated from the Fuzzy Associative Memory or FAM bank: (1) Warning Level; (2) Braking Pressure and (3) Steering Angle. The <sup>f</sup> Fuzzy output membership

functions for these signals are shown in <sup>Fig</sup> ~~Figure~~ 8. Three trapezoidal membership functions used for Braking Pressure: (1) Low Brake (LB), (2) Medium Brake (MB), and (3) High Brake (HB). Similarly, the Steering Angle is graded as Low Angle (LØ), Medium Angle (MØ), or High Angle (HØ). Steering will be right or left depending on side obstructions, vehicles, or other conditions as indicated by the detection signal analysis block, 74, of Fig. 6. The warning level is indicated as being green, yellow, or red, depending on the danger level presented by the detected hazard. Continuous or discrete warnings can be generated on the output. Possibilities include visual light indicators of different intensity, continuously variable audible alarms, continuously variable color indicators, or other arrangements with possible combinations of visible and audible alarms. Warning indicators can be combined with actual video displays of vehicle situations including hazards and nearby objects. The synthetic speech signal generator, 27, of Fig. 1 may be used to generate synthetic speech signals defining spoken alarm warnings.

<sup>Fig</sup> ~~Figure~~ 9 depicts typical FAM's for generating the output control signals from the input signals. Each FAM is segmented in six sections depending on the membership grade of the acceleration variable. Interpretation of the FAM logic rules is straight forward. For example, if the relative acceleration is High Positive (HP), the distance is Close (C), and the relative velocity is Medium (M), then the rule stated in the FAM requires grading the warning as Red (R), the Brakes as Medium (MB), and the steering as Small <sup>Angle (SØ)</sup> ~~Angle (SØ)~~. As a logic statement or premise, this becomes:

If Acceleration is High Positive (HP), Distance is Close (C), and Velocity is Medium (M), then Warning equals Red (R), Braking equals Medium (M) and Steering Angle equals Small Angle (SØ).

As another example:

If Acceleration is Low Negative (LN), Distance is Medium (M) and Velocity is Very High (VH), then Warning equals Red, Braking equals Medium (MB), and Steering Angle equals Small Angle (SØ).



Each premise has multiple control variables, each with possibly different degrees of membership. Using Fuzzy Logic principles, the minimum of the truth expression for each variable can be taken as the truth level of the premise. For example, if the membership grade for accelerator High Positive (HP) is 0.6, for Distance Close (C) is 0.45, and for velocity medium (M) is 0.8, then the truth level for the Warning Red (R), Braking Medium (M) and Steering Angle Small (SØ) will be 0.45

With overlapping Fuzzy Membership grades, more than one FAM will typically fire in response to a given set of values for the input control variables. Each FAM that fires will yield a particular set of truth value premises for each output variable. The result may include multiple output memberships with different truth values. For example, it may happen that two braking memberships result, such as Low Braking with a truth value of 0.2 and Medium Braking with a truth value of 0.6. The corresponding overlapping membership functions can be defuzzified using these values by known techniques such as the centroid method.

The FAM's of Figure 9 specify 150 such logic rules. Warning Levels, Braking Pressure, and Steering Angle become higher as the danger from the impending hazard increases. Additional FAM entries, not shown, are used to compensate for different driving conditions. For example, a different set of rules is used for inclement weather such as encountered with rain, ice or snow. Also, if side obstructions prevent steering adjustments, different braking scenarios are necessary. Another set of FAM logic rules is also necessary in the event of a hazard to the rear of the vehicle, simultaneous front and rear hazards, or hazards approaching from the right or left side. Such extensions to the teachings presented herein are described below and expand the situations for which the warning system offers protection in avoiding or minimizing the effect of a collision.

The Control Signal Generator 81 of Figure 6 serves to defuzzify the outputs from the Fuzzy Associative Memory. The defuzzification process converts the output fuzzy sets into

particular values that can be used to exercise appropriate control. Various algorithms can be used to defuzzify the output including using the maximum indicated output value in the selected membership class or the centroid method which provides output signals based on center of gravity calculations depending on the range of outputs indicated by the different input variables.

An important attribute of the system is the driver override feature indicated by the override input to the detection signal analysis. The Driver Override permits the driver to take control at any time by manually braking or steering the vehicle. In practice, then, the automated system will first warn the driver and then provide immediate automatic corrective action if necessary. <sup>NSB5</sup> ~~Having~~ <sup>if the warning is</sup> ~~gained the driver's~~ <sup>driver's</sup> attention, the driver may then regain control <sup>with the override feature</sup> and operate the vehicle to avoid the hazard. Thus the automatic system will normally only apply initial corrective action with the driver then taking control. Of course, if the driver fails to take over, the automated system will continue to operate the vehicle to avoid or minimize the danger presented by the hazard. <sup>NSA6</sup> ~~NSA6~~

Fig. 10 shows a Hazard/Object State vector used in control of the Motor Vehicle Warning and Control System herein described. Each state vector has eight bits and represents a particular row of the possible state vectors of Fig. 12. Hazards and obstacles may occur to the front (HF), back (HB), left side (HL) or right side (HR) of the vehicle. For purpose of this discussion, a hazard is a potentially dangerous object such as another vehicle, post, pedestrian or other obstacle when the relative motion of the vehicle under control and the hazard could lead to a collision. An obstacle is an object to the front, rear, right side or left side of the vehicle that might become a hazard depending <sup>on the</sup> evasive action taken by the vehicle control system to avoid a hazard. <sup>zero(0)</sup> ~~A zero~~ indicates no hazard or obstacle, a one ("1") indicates the presence of a hazard or obstacle. As indicated in the state vector, multiple hazards and/or obstacles may be present.

Fig. 11 is a Hazard Collision Vector. This vector has three fields indicating respectively distance between the vehicle and a particular hazard, relative velocity between the vehicle and a

particular hazard, and relative acceleration between the vehicle and a particular hazard. This vector is calculated for hazards detected by the image analysis computer 19 of Fig. 1 and various other sensors including radar/lidar sensors 14 in Fig. 1. The data in the Hazard Collision Vector is used to rank hazard dangers when more than one hazard is simultaneously detected, and also as input to the Fuzzy Logic decision system implemented in decision computer 23 and described below.

Fig. 12 is a table listing various possible combinations of hazards and obstacles that may be encountered by the Motor Vehicle Warning and Control System herein described. Each row is a possible state vector of type shown in Fig. 10. For example, state vector <sup>number</sup>44 corresponds to a situation where there is a hazard in front of the vehicle and obstacles to the left and right of the vehicle. Thus, in this situation, it is dangerous to steer the car to the left or right to avoid the hazard. Appropriate avoidance action in this case is to slow the car to minimize the possibility of a collision with the vehicle directly in front of the controlled vehicle.

As another example from the table of Fig. 12, in state vector <sup>number</sup>11, the hazard is to the left of the controlled vehicle. In this case, the hazard may be an approaching vehicle from the side wherein the relative motion of the two vehicles will, if not corrected, result in a collision. The controlled vehicle is clear of obstacles to the front and back but may not turn to the right because of a potentially hazardous obstacle located there.

The state vectors of Fig. 12 are determined by the Detection Signal Analysis block 74 of Fig. 6. The state vectors of Fig. 12 become part of the data file passed to the Fuzzy Associative Memory (FAM) selection block 76 of Fig. 6 and to the Control Signal Generator Defuzzifier 81 of Fig. 6.

Fig. 13 is more detailed drawing of the Detection Signal Analysis Block 74 of the Flow Diagram shown in Fig. 6. The more detailed Flow Diagram of Fig. 13 is used to set the variables in the State Vector of Fig. 10 and to enter parameter values in Hazard Collision Vector of Fig. 11. As

shown in Fig. 6 and 13, the Detection Signal Analysis Block, 74, receives a Sensor Input Data File from the multiple image, motion and environment sensors of Fig. 1. This data file is used to evaluate potential hazards and set the various control parameters needed in the Hazard/Object State Vector, 82, and in the Hazard Collision Vector, 83, of Figs. 10 and 11 respectively.

The process flow diagram of Fig. 13 first initializes the Hazard/Object State Vector, 82, and the Hazard Collision Vector, 83, in block 84, placing zeros in all control fields. Initial calculations are also made in this block using data from the sensor input data file to evaluate potential hazards and identify objects or obstacles to the control system for alerting the driver and, if necessary, exercising direct control over the operation of the vehicle.

Using this information, successive bits are set in the Hazard/Object State Vector as indicated in Fig. 13. Decision element 85 will cause the "HF" bit of the Hazard/Object State Vector to be set to "1" in Block 86 if a hazard is found in the front of the vehicle. Block 87 then calculates the Hazard Collision Vector corresponding to the frontal hazard, for entering into the Hazard Collision Vector 83 of Fig. 11. Block 11 formats <sup>those</sup> ~~this~~ data for use in the Fuzzy Logic vehicle control algorithm herein above described providing numerical values for distance, relative velocity, and relative acceleration between the controlled vehicle and the frontal hazard. These numerical values are used later in the control algorithm to rank collision hazards in the event multiple, simultaneous hazards are detected and the control system is called upon to alert the driver and possibly control the vehicle to minimize collision impacts while dealing with multiple dangerous situations.

If no frontal hazard is detected, the flow diagram of Fig. 13 branches around the frontal Hazard/Object State Vector Operation 86 and frontal Hazard Collision Vector Operation 87. Whether or not a frontal hazard is present, the flow continues to the rear hazard decision element 88 in Fig. 13. The operation here is basically identical to that described above <sup>for</sup> ~~from~~ the frontal

hazard calculation. If a hazard exists in back of the vehicle, the "HB" bit is set to logic "1" in Block 89 and the corresponding Hazard Collision Vector is calculated and formatted as described above for the frontal hazard situation in Block 90. If no hazard exists to the rear, the Blocks 89 and 90 are branched around as indicated in Fig. 13.

The same procedure is followed for hazards to the left and right of vehicle in Blocks 91 through 96 of Fig. 13. In this way, the flow from Block 85 through Block 96 of Fig. 13 will set all of the hazard control bits of the State Vector 82 of Fig. 10 and provide necessary control parameters for the Hazard Collision Vector 83 of Fig. 11 for each hazard detected by the system.

If more than one of the bits, HF, HB, HL or HR are set in the blocks 85 to 96 of Fig. 13, multiple hazards exist representing a very dangerous situation for the vehicle. The existence of multiple hazards is indicated by decision element 97 based on the values of HF, HB, HL and HR in blocks 85 to 96 of Fig. 13. If multiple hazards do exist, it is necessary to evaluate and rank each detected hazard so that the most effective avoidance strategy can be adopted. The detailed collision hazards are analyzed and ranked in Block 98 of Fig. 13. Hazard ranking is achieved from the respective collision vectors of the indicated hazards as calculated in Blocks 87, 90, 93 or 96. As discussed above, the parameter values in these blocks indicate numerical values for distance, relative velocities and relative accelerations. Using these parameters, the time to collision can be calculated for each detected hazard using well known kinematic equations. The most dangerous hazard then can be determined and control signals generated accordingly.

While time to collision is an important control parameter for multiple hazards, other factors may be considered and programmed into the Motor Vehicle Warning and Control System. This is especially possible with advanced image analysis such as the neural network implementation of the image analysis computer 19 herein before described. Using such advanced, high speed image recognition techniques will allow identifying pedestrians, animals, particular vehicle types such as

trucks or other large and potentially very destructive collision objects. Special algorithmic sensitivity to avoid certain obstacles based on their respective identifications may also be programmed into processing Block 98 of Fig. 13.

Having ranked the collision hazards in Block 98, the Hazard/Collision State Vector 82 can be modified in Block 99. This operation permits indicating to the FAM selection Block 78 of Fig. 6 which of the multiple detected hazards is currently the most dangerous. One approach is to downgrade all hazards except the most dangerous from a hazard to an obstacle in the Hazard/Collision state 82 of Fig. 10. This would ensure that the Fuzzy Associative Memory Selection Block 76 of Fig. 6 would direct the system to the particular FAM most responsive to the highest ranking hazard as determined in processing Block 98 of Fig. 13 while still instructing the system to avoid the other hazards.

It is also possible to set threshold levels for differences in parameter values as calculated and compared in the Ranking of Collision Hazards in Block 98 of Fig. 13. It may occur that multiple hazards are essentially of equal danger making it unwise to rank one higher than the other. In this case, Block 99 of Fig. 13 would not upgrade one hazard over another, but rather would use an input in the form of the Hazard/Object State Vector 82 that ranks both as hazards permitting selection of a Fuzzy Associative Memory element in Block 76 of Fig. 6 that is best responsive to the multiple hazards.

Having evaluated front, back, right side and left side hazards, the flow diagram of Fig. 13 proceeds to set the object or obstacle bits OF, OB, OL and OR in the vector 82. Recall that front, back, left and right side obstacles are herein defined as objects which are not currently hazards but may become a hazard if the wrong evasive action is taken. Examples include vehicles approaching in adjacent lanes that are not on a collision course, automobiles safely behind the controlled vehicle, a tree by the side of the road, and so forth. Blocks 100 through 107 set bits OF, OB, OL,

and OR depending on the presence or absence of front, back, left or right objects to be avoided in controlling the vehicle.

Fig. 14 shows a more detailed flow diagram for the Fuzzy Associative Memory (FAM) Selection Block 76 of Fig. 6. The collision vector inputs contain numerical values for relative distance, velocity, and acceleration of the vehicle and the impending hazard. Block 76 uses this information as indicated in Fig. 13 to decide the respective fuzzy membership grades. Fuzzy distance membership is decided in block 109; fuzzy velocity membership is decided in block 110; and fuzzy acceleration membership is decided in block 111. Once decided, these membership grades serve as indices for addressing the Fuzzy Associative Memories (FAM's) as illustrated in Fig. 9. Membership is determined in the respective cases by limits as indicated in Fig. 7.

The Hazard/Object State Vector also serves as an index into the total FAM. A simple address translation provides the actual address of the FAM locations appropriate for the detected hazard/object combination indicated in the vector. Control signals are then directly read from the FAM ensuring rapid overall system response. Signals are immediately generated to control braking, steering and warning systems as shown in Fig. 6. These output signals are likewise treated as fuzzy variables with membership classes as shown in Fig. 7. Defuzzification takes place in processing block 81 of Fig. 6 as herein above described.

The Motor Vehicle Warning and Control System herein above described is capable of dealing with hundreds, or even thousands, of different combinations of variables representing image analysis data and vehicle motion parameters. Indeed, given the continuous nature of the variables, in the limit the number of situations is infinite. Control signal generation is implemented using the above described parallel image processing, fuzzy logic, and fuzzy associative memories (FAM's). While a complete logic flow diagram describing all possible flow scenarios is not practical, it is instructive to consider the system operation for a particular example situation. To

this end, Fig. 15 illustrates the logical system flow based on the herein above described embodiment for the situation wherein the image analysis system detects a hazard in front of the controlled vehicle.

The operation of the system with this scenario is as outlined in Fig. 15. The sensor input file is used to evaluate respective hazards. The result is the indication that a frontal hazard exists but no other hazards are present. The hazard collision vector is prepared with numerical values for relative distance, velocity and acceleration as indicated in Fig. 15. The system flow continues with an analysis of the presence of objects that might become hazards depending on the evasive action taken by the system. There is, of course, an object in the front of the vehicle, which is in fact the hazard of concern. An object is also detected to the right side of the vehicle, limiting evasive action in that direction. Using this information, the Hazard/Object vector becomes  $[10001001]$ .

Using the collision vector for the hazard in front of the controlled vehicle, the Fuzzy Membership Grades for distance, velocity and acceleration are evaluated. Overlapping membership is possible depending on the values for the control variables. Using the combination of the Hazard/Object vector and Fuzzy Membership Grades, the FAM is accessed to determine the "expert" driving response control signals. The FAM entries indicate that the warning, braking, and angle steering to avoid the hazard or minimize danger to the vehicle. Defuzzification is used to determine exact output control variable values. The steering swerve, if any, will be to the left because of the object detected on the right side of the vehicle. With this information, appropriate warnings and displays are activated and control action is taken. Even if the driver does not respond to the warnings, the evasive control steps will tend to reduce the danger.

In the system of <sup>Fig.</sup> Figure 6, a different FAM is used for each state vector of Fig. 12. Furthermore, as indicated in Fig. 9, different FAM's are used for different relative accelerations of the controlled vehicle and the impending hazard. There are a total of 68 state vectors in Fig. 12



and 6 different relative acceleration FAM's in Fig. 9 yielding a total of 408 different FAM's. The particular set of six FAM's of Fig. 9 correspond to state vectors with a hazard in front of the vehicle only and no obstacles in the rear nor on at least one side. Thus this set of FAM's may be used with state vectors 41, 42, and 43. It can be seen that a given set of FAM's may be used with multiple state vectors, thereby reducing the number of actual required Fuzzy Associative Memories or FAM's.

It is important to understand that the Motor Vehicle Warning and Control System and Method herein described is based on the real time feedback control with Fuzzy Logic algorithms providing corrective action, the results of which are immediately analyzed by the warning control system using high speed image processing based on advanced parallel computing structures and/or neural network image analysis. The near instantaneous control response required to avoid or minimize the effects of a collision are not possible without adopting these techniques. Fuzzy Logic permits incremental control when necessary with continuous real-time feedback. The results of this control are immediately sensed and further control action activated as necessary to minimize the danger presented by the hazard. This continuous closed loop operation closely emulates the response of a human driver with immediate visual feedback, rapid evaluation of alternatives, and reflexive response in handling a vehicle in a hazardous situation.

It is also important to note that the response rules programmed in the FAM's are "expert" driving rules for the specified conditions. These rules are defined by expert drivers and represent the best possible driving responses. Computer simulations and studies may also be used in defining these rules. This "Expert System" is designed to minimize driving mistakes in hazardous situations. Note that even verbal warnings corresponding to the driving hazard/obstacle states are derived based on FAM defined expert driving responses. These warnings are delivered as described above via synthetic speech system 27 of Fig. 1. Thus the driver has the assistance of an

on-board, real-time expert speaking to him or her and advising on the optimum driving response to a given roadway condition.

A further extension of the described system is responsive to visually or electronic detectable road markers such as lane markers, safe speed markers, curve warnings, or other hazard indicating devices installed along or in the roadway. The same system herein above described can be responsive to signals detected from such warnings and integrate this information into the overall vehicle control system.

In a modified form of the invention, it is noted that system 10 may also perform as a navigational computer informing the driver of the motor vehicle containing same of the location of the vehicle by controlling the display 32 to cause it to display characters describing such location and/or a map showing the road or street along which the vehicle is travelling and its location and direction of travel there along by means of an indicia such as an arrow. The map may graphically or by means of characters include auxiliary information such as towns and cities along the route of travel, distances thereto, alternate routes of travel, road conditions, information on traffic density, hazardous conditions, weather ahead, sightseeing information and other information derived via short wave or other receiving or input means which outputs digital codes to RAM memory 12 and/or other computer or microprocessor 11. Such information may be derived via earth satellite short wave transmission and/or local or roadside radio transmitters as the vehicle approaches and passes same and/or may be input via wire or short wave to a short wave receiver of the vehicle, such as its audio radio, receiver or an auxiliary receiver connected (via an analog-to-digital converter) to computer 11 via an input bus (not shown).

The memories 12 and 13 or other memories may also be programmed with trip or travel data derived via short wave, telephone line, microwave satellite or other communication system connected to a remote computer or by a select pluggable memory or recorder output. Vehicle

instant location data codes may be received via satellite location or electronic triangulation and the codes generated may be employed to properly access map defining graphics data and to effect the display of the proper map graphics on the heads-up or video display 32.

A keyboard 82 and/or microphone (located, for example, in the steering wheel or steering wheel hub) of the vehicle and a speech recognition computer such as computer 25 may be employed by the driver to generate command control signals for controlling the trip or navigational computer and effecting the display and/or playback of synthetic speech of select information on the location, direction of travel, distances to select locations, towns or cities, map information or other information as defined above.

In yet another form of the invention, the memory 20 of the image analyzing computer 19 and/or an auxiliary memory therefor may contain image data derived from the output of a television camera on a vehicle travelling the same road, roads or route travelled by the driven vehicle containing system 10. Such image data may be derived from archival memory once the expected route or routes of travel is known, which archived memory data was generated by computer processing the output of TV camera 16 of system 10 during previous travel of the vehicle along the same route and/or from TV scannings of other vehicles. Such previously generated image signal data may be utilized to improve or effect proper operation of system 10 by providing data on ~~stationary~~ stationary objects and background, or road images along the route of travel.

Thus computer 11 may have (a) a microphone and analog to digital converter of speech signals connected thereto as well as (b) a short wave receiver of data and (c) an input keyboard as described.

Another form of the invention involves short wave (for example, microwave or infra-red) communication between two or more vehicles containing respective systems 10 to effect cooperative control functions to be performed by the computers of both vehicles. A short wave

radio transmitter 86 is shown in <sup>Fig</sup> ~~Figure~~ 1 connected to microprocessor 11 to receive digital codes from the decision computer 23 which codes are generated when a hazardous driving or road condition is detected as described and may involve a collision with a vehicle travelling in the same or opposite direction as the vehicle containing system 10 which detects such condition. Such code signals sent by short wave microwave, radar or infra-red transmitter-receivers of either or both vehicles and/or other vehicles in the vicinity of the developing hazard may be employed on receipt to warn the driver of the other vehicle(s) of the hazardous condition with suddenly generated synthetic speech, flashing lights, tones, etc. and/or effect an automatic vehicle control operation such as an automatic braking and/or steering operation, as described, to avoid or reduce the effects of a collision. The infra-red communication system may involve code pulsed infra-red diodes or lasers and solid state receivers of infra-red light mounted on the front and rear bumpers of the vehicles.

It is also noted that system 10 may be employed with suitable software as described above, or with additional sensors or sensing systems added to the system to sense traffic lane times along roads and highways, active and/or passive signal or code generators and short-wave transmitters buried in the highway and/or at the side of the road travelled and/or supported by other vehicles, to automatically operate the vehicle containing such computerized system during the normal travel of such vehicle between two locations and/or destinations. For example, select highways or select sections of a highway may be designed and operable to accommodate (only) vehicles which are equipped with system 10 which is operable to steer and control the speed of the vehicle in accordance with control signals generated by the decision computer 23 when it is specially programmed to guide and control the speed of the vehicle in its travel along the select highway or road. To supplement the signals generated by the image analyzing computer 19, or as a replacement therefor, an auxiliary computer 19A, not shown, may be provided connected to the

control computer 11 and operable to receive and analyze information signals or codes generated as a result of digitizing the output(s) of one or more sensors on the vehicle sensing (a) highway marker or lane delineating lines, (b) curb and/or divider markings, (c) embedded or roadside code generators, <sup>or</sup> (d) electro-optically scannable <sup>indicia</sup> ~~indicia~~ or reflectors along and/or at the side of the road or a combination thereof. The short wave receiver 84 may receive radio-frequency codes generated locally as the vehicle passes while one or more electro-optical scanning systems employing solid state lasers and photodetectors of the reflected laser light may be employed to provide such coded information which is processed by <sup>computer 19 or the auxiliary computer</sup> ~~the computer(s) 19 and/or 19a~~ to provide vehicle control or operational signals which may be used per se or by the decision computer 23 to control and maintain control of the vehicle to keep it travelling in a select lane and at a select speed in accordance with the set speed for the highway or the select lane thereof along which the vehicle is travelling and/or the speed of other vehicles ahead of the computer controlled vehicle containing system 10.

A further enhancement of the herein defined automated vehicle warning system makes use of a separate driver monitoring computer to constantly monitor driver actions and reactions while operating the vehicle. This type of monitoring is especially helpful in determining driver fatigue or detecting erratic driving patterns caused for example, from driving while intoxicated or under the influence of drugs. Erratic driving patterns may include swerving in steering of the vehicle, uneven or unnatural acceleration or deceleration, combinations of unusual or unnatural driving patterns, driving much slower or faster than other vehicles around the automobile being monitored, unnatural sequences of exercising control over the vehicle such as alternate braking and acceleration, braking or stopping in a flowing traffic stream, or excessive acceleration. Also, driving patterns inconsistent with surrounding vehicle motion can be detected such as any action by the driver that increases rather than decreases the possibility of a collision in a dangerous or

hazardous situation. A separate driver monitoring system can detect all of these situations and respond by warning the driver or, if necessary, activating the automated vehicle control system.

The motor vehicle warning and control system can warn other vehicles of an impending or detected possible collision by flashing exterior warning lights and/or sounding audible alarms including the horn. The system may also warn other vehicles via radio transmission which activates warnings in adjacent vehicles of dangerous situations. Drivers of other vehicles can then be warned by audible or visual warning devices and/or displays and can take necessary evasive action. The radio signal can also alert police or highway patrolmen of dangerous driving patterns by identifying the vehicle. As a further extension, the vehicle may have an electronic location system such as satellite Global Position System (GPS) electronics permitting precision vehicle location, which information can be transmitted with the hazard warning signals, permitting law enforcement and roadway safety personnel to precisely locate the vehicle detected as being in a hazardous situation caused by the driver or other conditions.

A further enhancement of the vehicle warning and control system and method disclosed herein makes use of a recorder to record the last several minutes of driving action for future analysis. Such recordings permit reconstruction of events leading up to collision permitting more accurate determination of causes including fault.

In yet another form of the invention which may supplement or replace the motor vehicle warning and control system described above, it is noted that vehicle sensing devices such as fixed or computer controlled panning television cameras may be located on poles adjacent the roadway as may motion sensing devices within or adjacent the roadway which communicate their sensing signals to one or more roadside or remote computers of the types described wherein the image and/or motion or detection signals are automatically analyzed to detect and calculate distances and closing speeds between vehicles travelling respective sections of the road and generate code signals indicative thereof. Such code signals may be applied to (a) control the operation of roadside displays to visually warn the driver(s) of the motor vehicles detected of their speeds and/or hazardous driving conditions together with suitable instructions to avoid accidents and/or (b) to drive one or more displays in the vehicle(s) when the code signals are short wave transmitted to and received by the short wave receiver 84 of the vehicle. The received code signals may also be transmitted to the decision computer 23 for use thereby as described in controlling the operation of the vehicle if necessary. Such an auxiliary warning system may be applicable to prevent accidents between vehicles wherein one or both vehicles are not provided with on-board system 10 or such system is not properly functioning. It may also be useful in controlling traffic by visually and audibly warning the drivers of a plurality of vehicle travelling the same direction to slow down in the event of an accident or hazardous driving condition ahead, to maintain a select driving speed or detour to optimize traffic flow.

What is claimed is:

SUBA7

1. A method for controlling the travel of a motor vehicle comprising:
  - a) scanning the roadway along which a motor vehicle is traveling with a video scanning means supported by said motor vehicle and generating a train of video signals as the vehicle travels said roadway,
  - b) computer processing and analyzing each video signal as it is generated and generating a first train of first code signals which first code signals define information relating to the identification of objects ahead of said motor vehicle, such as at least one other vehicle traveling in the same direction as said motor vehicle,
  - c) employing said first code signals to control the operation of a first intelligible indicating means to cause it to indicate to the driver of said motor vehicle the identification and distance to the object directly ahead of said vehicle.
2. A method in accordance with claim 1 wherein step (c) includes computer processing the information defined by said first video signals in a manner to generate second code signals indicative of distances between said motor vehicle and an the object directly ahead of said vehicle.
3. A method in accordance with claim 2 wherein the object directly in front of said motor vehicle is a motor vehicle traveling in the same direction as the vehicle there behind containing said video scanning means, said method including computer identifying said motor vehicle by its image shape and computer detecting the distant to said vehicle by intermittently scanning the image of the rear view of said vehicle and computer processing the video signals generated to determine the size of the vehicle scanned.



4. A method in accordance with claim 1 wherein step (a) is effected by means of a television camera which scans a field in front of said motor vehicle, including said roadway, at a constant scanning rate.

5. A method in accordance with claim 4 wherein said television camera is operable to generate full-frame video picture signals on its output.

6. A method in accordance with claim 5 wherein selected of said first code signals define at least a portion of the rear view shape of a motor vehicle directly ahead of said vehicle, further comprising computer processing said selected first code signals to calculate and indicate the distance between the two motor vehicles.

7. A method in accordance with claim 6 wherein second code signals are generated and employed to control said intelligible indicating means to intelligibly indicate the distance between said two motor vehicles on a continuous basis.

8. A method in accordance with claim 7 wherein said second code signals are generated by computer processing and analyzing said first code signals, and said second code signals are employed to control a braking means to slow the forward travel of said motor vehicle when said second code signals indicate that a select distance between said two vehicles has been exceeded.

9. A method in accordance with claim 8 further including a sensing means to sense the speed of said motor vehicle and generating third code signals indicative of said speed and employing said

second and third code signals to generate fourth code signals to control said braking means when the closing speed and distance between the two vehicles is such as to cause a collision between the two vehicles if the brakes of said motor vehicle are not properly applied.

10. A method in accordance with claim 9 which includes employing said fourth code signals to operate a warning means selected from a group including a warning light, a flashing light, a sound generating means, an intermittent sound generating means, a speech signal generating and select speech generating means to intermittently warn the driver of said vehicle to immediately slow the forward travel of his vehicle to avoid a collision of the two vehicles.

11. A method in accordance with claim 1 which includes operating said intelligible indicating means to generate a warning to the driver of said motor vehicle when an unsafe driving condition develops on said roadway.

12. A method in accordance with claim 1 wherein said intelligible indicating means is controlled in its operation in response to a computerized expert system employing information generated by an electro-optical image scanning means scanning ahead of said motor vehicle.

13. A method in accordance with claim 12 wherein scanning is effected of an image field ahead of said vehicle which image field includes both vehicles traveling the roadway ahead of said vehicle and objects to both sides of said roadway and said expert system is operable to discriminate between moving and stationary objects on and adjacent said roadway and to detect and respond to objects in the path of said vehicle in a manner to effect the avoidance of collisions between said vehicle and the objects detected.

14. A method in accordance with claim 12 wherein said intelligible indicating means is controlled in its operation in response to a computing means employing neural networks.

15. A method in accordance with claim 1 employing a computer having neural network means and an expert system operable to control said braking means to slow or stop the travel of said motor vehicle to avoid or lessen the effects of an accident involving said motor vehicle.

16. A method in accordance with claim 1 which includes employing a computing means employing fuzzy logic circuit means to effect the computer processing and analyzing of the video signals generated by said video scanning means.

17. A method in accordance with claim 1 which includes employing a computing means employing a plurality of software systems selected from the group including an expert system based on safe driving conditions, neural network means and fuzzy logic means for controlling the operation of said motor vehicle to avoid accidents.

18. A method in accordance with claim 17 wherein said computing means is operable to control the speed of travel of said motor vehicle to avoid hazardous driving conditions such as collisions with other motor vehicles ahead of said motor vehicle.

19. A method in accordance with claim 17 wherein said computing means is operable to control the steering mechanism of said motor vehicle to avoid hazardous driving conditions such as collisions with other vehicles and stationary objects.

20. A method in accordance with claim 17 wherein said computing means is operable to control both the speed and steering mechanism of said motor vehicle to avoid hazardous traveling conditions of said vehicle such as collisions with other vehicles and stationary objects.

21. A method in accordance with claim 17 which includes sensing the slowing down of said motor vehicle when the brakes thereof are applied by the driver of said vehicle or under the control of the computing means of said vehicle or both and generating further code signals, and applying said further code signals to modify the control of said braking means to properly slow down or stop said vehicle to avoid a collision with an object in the path of travel of said vehicle.

22. A method in accordance with claim 21 which also includes sensing the steering of said vehicle and generating still further code signals and employing the latter code signals to control the steering means of the vehicle and the braking means to avoid an accident.

23. A method in accordance with claim 17 which includes operating a restraining means for a person in said motor vehicle to restrain the movement of said person in the event of an accident in response to certain of said code signals.

24. A method in accordance with claim 23 which includes programming a decision computing means to receive feedback signals as streams of data as said motor vehicle is driven which streams of data include data codes defining distances between said motor vehicle and a vehicle in its path of travel and also the closing speed between said motor vehicle and said vehicle in its path and at least one or a plurality of codes indicative that a collision between the two vehicles will occur if the

speed of said motor vehicle is not slowed or the motor vehicle is not stopped, and operating said decision computer to cause it to control a means for power operating the brakes of said motor vehicle in a manner to controllably slow down or stop said motor vehicle.

25. A method for operating a motor vehicle comprising:

a) driver controlling the operation of a motor vehicle to cause it to travel in traffic along a roadway having other vehicles traveling in the same direction as said motor vehicle and approaching said motor vehicle in an adjacent lane,

b) scanning the images of both vehicles traveling in the same and opposite directions ahead of said motor vehicle with a video scanning means supported by said vehicle to continuously generate full-frame video picture signals on the output of said scanning means,

c) computer processing said video picture signals and generating trains of first digital code signals,

d) computer analyzing said first digital code signals by comparing said first code signals with codes recorded in a memory and identifying the objects scanned ahead of said vehicle including at least one object in the path of travel of said vehicle,

e) detecting the distance between said motor vehicle and an object immediately ahead of said vehicle and generating a train of second code signals each of which indicates said distance at a different time,

f) computer analyzing said first and second code signals and generating third code signals, and

g) employing said third code signals to control a warning device to intelligibly indicate to the driver of said vehicle to take a corrective action, such as effect deceleration or apply the brakes of the vehicle to avoid a collision with the object ahead of his vehicle.

26. A method in accordance with claim 25 wherein step (g) is effected by means of intermittently operating a warning device such as a sound generator, a flashing light or both.

27. A method in accordance with claim 25 wherein step (g) is effected by controlling the operation of a synthetic speech generating computer to cause it to generate speech signals defining sounds of select words of speech and to warn the driver of the motor vehicle with such speech sounds of a developing hazardous condition and, when the circumstance requires it, to generate further speech signals and corresponding sounds and speech which suggest a corrective action by the driver to avoid or reduce the possibility of an accident.

28. A method in accordance with claim 27 which includes employing selected of said third code signals to controllably operate decelerating or braking means for said vehicle and, if necessary, a steering means for said vehicle if a collision with an object ahead of said vehicle is imminent.

29. A method in accordance with claim 27 which includes employing selected of said third code signals to operate a means for overriding the accelerator of the vehicle if the closing distance between said vehicle and another vehicle in the path of said vehicle and traveling in the same direction as said vehicle becomes hazardous.

SUBA 8

30. A system for operating a motor vehicle comprising:

a) a motor vehicle having a vehicle body, motor means and driver operated means including an accelerator for said motor means, braking and steering means,

b) first means supported by said vehicle for scanning ahead of said vehicle as it travels a roadway and generating first image signals modulated with information relating to objects and obstacles such as other vehicles, pedestrians, animals, road dividers, and other obstacles with which said vehicle may collide,

c) means for generating scanning signals on the output of said scanning means which scanning signals are modulated with image information relating to the identification of obstacles in or approaching the path of travel of said vehicle,

d) first computer means for receiving and analyzing said scanning signals as the vehicle travels and generating first code signals,

e) means for generating second code signals indicative of the distances between said vehicle and obstacles ahead of said vehicle which are in the path of said vehicle,

f) second computer means for analyzing said first and second code signals and generating third code signals,

g) means for receiving and utilizing said third code signals to control the operation of said vehicle to avoid collisions between said vehicle and objects in its path of travel.

31. A system in accordance with claim 30 wherein said latter means comprises a visual display means for the driver of said vehicle controllably operated by said third code signals to intelligibly indicate road conditions ahead of said vehicle as it is driven.

32. A system in accordance with claim 31 wherein said visual display means comprises a heads-up display means operable to project images of intelligible information on the windshield of said vehicle within the direct line of vision of said driver of said vehicle.

33. A system in accordance with claim 30 wherein said later means comprises a synthetic speech generating computer operable to generate sounds of select words of speech which may be heard by the driver of said vehicle and which inform or warn the driver of hazardous driving conditions, such as objects in the path of travel or about to intersect the path of travel of said vehicle.

34. A system in accordance with claim 30 wherein said latter means comprises a synthetic speech generating computer and a visual display means both of which are simultaneously controllable by selected of said third code signals to warn the driver of said vehicle of hazardous conditions ahead of said vehicle.

35. A system in accordance with claim 30 wherein said latter means is a vehicle travel control means controlled in its operation by selected of said third code signals to effect the braking of said vehicle to avoid collision with an obstacle ahead of said vehicle.

36. A system in accordance with claim 35 including a decision computing means operable to analyze said first, second and third control signals and generate fourth code signals for use in effecting the braking of said motor vehicle.

37. A system in accordance with claim 30 wherein said latter means is a directional control means including the steering mechanism for said vehicle, said steering mechanism being controlled in operation by selected of said third code signals to avoid collision with an obstacle in the path of said vehicle.



SUBA9

38. A system in accordance with claim 30 including object identification means responsive to said first code signals for identifying and intelligibly indicating to the driver of said vehicle the identification of said vehicle, and further means for generating fourth code signals and employing said fourth code signals in intelligibly indicating distances between said vehicle and objects in the path of said vehicle.

39. A system in accordance with claim 38 wherein said object identification means is operable to identify objects, such as other vehicles traveling at an angle to the roadway said vehicle is traveling and pedestrians in movement in the road ahead and to the side of said vehicle.

40. A system in accordance with claim 39 including means operable in response to selected of said third code signals for controlling the operation of said vehicle to avoid or lessen the effects of collision with any obstacle in the path of said vehicle if the driver of said vehicle does not properly or quickly enough respond to indication by said intelligible indicating means that obstacles are in the path of travel of said vehicle.

41. A system in accordance with claim 40 including a decision computing means for analyzing said third code signals and generating control signals, when necessary, to avoid or lessen the effects of a collision, to override or cooperate with the driver of said motor vehicle in controlling the operation of said vehicle.

42. A system in accordance with claim 41 wherein said decision computing means is operable to control the operation of the braking means for said motor vehicle when necessary to avoid or lessen the effects of an accident.

SUBAM

43. A system in accordance with claim 41 wherein said decision computing means is operable to control the operation of the steering means or said vehicle.

44. A method for controlling the operation of a motor vehicle.

a) scanning the area in front of a driven, moving motor vehicle with a forwardly directed scanning means, and generating first image signals,

b) computer processing and analyzing said first image signals and generating first code signals,

c) employing said first code signals to intelligibly indicate and define the condition of the road in front of said vehicle including the presence, direction and speed of travel of obstacles of such as other moving vehicles and stationery obstacles in front of said vehicle,

d) scanning the area on front of said vehicle and detecting distance between said vehicle and said objects such as moving vehicles travelling in the direction of said vehicle and approaching the path of travel of said vehicle from a side road and generating second code signals indicative of said distances,

e) computer processing and analyzing said first and second code signals and generating third code signals and

f) employing selected said third code signals to intelligibly indicate to the driver of said vehicle information relating to the approach of another motor vehicle along a roadway angulated to the road along which said vehicle is travelling.

45. A method in accordance with Claim 44 wherein said third code signals are employed to indicate the direction said other motor vehicle is approaching the path of travel of said motor vehicle.

46. A method for controlling the operation of a motor vehicle.

a) scanning the area in front of a driven, moving motor vehicle with a forwardly directed scanning means, and generating first image signals,

b) computer processing and analyzing said first image signals and generating first code signals,

c) employing said first code signals to intelligibly indicate and define the condition of the road in front of said vehicle including the presence, direction and speed of travel of obstacles of such as other moving vehicles and stationery obstacles in front of said vehicle,

d) scanning the area on front of said vehicle and detecting distance between said vehicle and said objects such as pedestrians or bicyclists in the path of travel of said vehicle and approaching the path of travel of said vehicle from a side road and generating second code signals indicative of said distances,

e) computer processing and analyzing said first and second code signals and generating third code signals and

f) employing selected said third code signals to intelligibly indicate to the driver of said vehicle information relating to the approach of said objects from said side road.

47. The method of claim 46 wherein said method includes a warning device such as a light or horn to warn said pedestrian or bicyclist of the approaching vehicle.

SUB B13 48. A method for controlling the operation of a motor vehicle comprising:

a) operating a first motor vehicle by driving said vehicle along a road,

b) scanning with a first scanning means an area in front of said first motor vehicle as it travels said road and generating first information signals modulated with first information relating to objects such as other vehicles travel ahead of said motor vehicle in the same direction said motor vehicle is traveling,

c) computer processing said first information signals and generating first code signals,

d) employing said first code signals to generate second code signals indicative of the distance between said first motor vehicle and a second motor vehicle traveling in the same direction as said first motor vehicle on said road and the closing speed between said first motor vehicle and said second motor vehicle,

e) scanning with a second scanning means an area behind said first motor vehicle as it travels said road and generating second scanning signals modulated with information relating to a third vehicle traveling behind said first motor vehicle in the same direction as the direction of travel of said first motor vehicle,

f) computer processing said second information signals and generating third code signals,

g) employing said third code signals to generate fourth code signals indicative of the closing speed and distance between said first and third motor vehicles,

h) computer analyzing said second and fourth code signals and generating fifth code signals, and

i) employing said fifth code signals to control the operation of an intelligible indicating means in said first motor vehicle to intelligibly indicate to the driver of said first motor vehicle to slow the speed of said first motor vehicle to avoid a hazardous driving condition with respect second motor vehicle.

49. A method in accordance with claim 48, further including employing said fifth code signals to control a further indicating means to intelligibly indicate to the driver of said third motor vehicle that said first motor has been warned to slow down.

50. A method in accordance with claim 49 including generating sixth code signals when the computer processing in steps (c) and (f) indicate that a collision between said first and second motor vehicles may take place and employing said sixth code signals to control the operation of a braking means for said first motor vehicle to slow the speed and controllably stop said first motor vehicle if necessary to avoid collision with said second motor vehicle.

51. A method in accordance with claim 50 which includes also employing said sixth code signals to operate a warning means on said vehicle to warn the driver of said third motor vehicle that said first motor vehicle is being braked to stop.

52. A method in accordance with claim 50 wherein said sixth code signals are operable to effect braking of said first motor vehicle in an anti-locking mode.

SUBPAIN

53. A method for controlling the operation of a motor vehicle comprising:

a) operating a first motor vehicle by employing a human operator to drive said first motor vehicle along a multiple lane roadway,

b) scanning with a first scanning means an area in front of said first motor vehicle as it travels said roadway and generating first information signals modulated with information relating to objects ahead of said first motor vehicle such as a second vehicle traveling said roadway ahead of said vehicle,

- c) computer processing said first information signals and generating a first chain of digital signals,
- d) computer analyzing said first chain of digital signals and generating first code signals indicative of the distance between said first and second motor vehicles and the closing speed therebetween,
- e) scanning areas to the left and right sides of said first motor vehicle with a second scanning means as it travels said roadway and generating respective second and third chains of digital signals,
- f) computer analyzing said second and third chains of digital signals and generating second and third code signals when vehicles to the left and right sides of said first motor vehicle are detected by the scanning of step (e),
- g) computer analyzing said first, second and third code signals as they are generated and generating fourth code signals indicative that a collision may occur between said first motor vehicle and one of said vehicles ahead of or to one of the sides of said first motor vehicle is imminent, and
- h) employing said fourth code signals to effect control of the operation of said first motor vehicle to prevent such collision.

54. A method in accordance with claim 53 wherein step (h) is effected by employing said fourth code signals to operate an intelligible indicating means within said first motor vehicle to warn the driver thereof to control the operation of said first motor vehicle in a manner to avoid a collision.

55. A method in accordance with claim 54 wherein the intelligible indicating means operates to visually indicate to the driver of said first motor vehicle the hazardous condition.

56. A method in accordance with claim 54 wherein the intelligible indicating means operates to visually indicate by lighted display to the driver of said first motor vehicle the hazardous condition.

57. A method in accordance with claim 54 wherein the intelligible indicating means operates to visually indicate by heads-up display on the windshield of said first motor vehicle to the driver of said first motor vehicle the hazardous condition.

58. A method in accordance with claim 54 wherein the intelligible indicating means operates to visually indicate to the driver of said first motor vehicle the relative positions between said first motor vehicle, one or more vehicles ahead of and, if present, to either or both sides of said first motor vehicle.

59. A method in accordance with claim 54 wherein the intelligible indicating means operates to visually indicate to the driver of said first motor vehicle the relative closing speeds between at least two of said motor vehicles.

60. A method in accordance with claim 54 wherein the intelligible indicating means operates to indicate by generating sounds of select speech which may be heard by the driver of said first motor vehicle, which speech provides details of the hazardous condition.

61. A method in accordance with claim 54 wherein the intelligible indicating means operates to indicate by generating sounds of select speech which may be heard by the driver of said first motor vehicle, which speech provides details of the hazardous condition and informs said driver of corrective actions to take to avoid an accident.

62. A method in accordance with claim 54 wherein the intelligible indicating means operates to indicate by generating sounds of select speech which may be heard by the driver of said first motor vehicle, which speech provides details of the hazardous condition and informs said driver of corrective actions to take to avoid an accident using such words as "slow down", "slow down and stop", "swerve left", "swerve right", etc.

63. A method in accordance with claim 53 wherein step (h) is effected by employing said fourth code signals to control the operation of the brakes of said first motor vehicle to avoid collision with the vehicle ahead of said first motor vehicle.

64. A method in accordance with claim 53 wherein step (h) is effected by employing said fourth code signals to control the operation of the steering mechanism of said first motor vehicle to avoid collision with the vehicle ahead of said first motor vehicle.

UP AB 65. A method in accordance with claim 53 wherein step (h) is effected by employing said fourth code signals to control the operation of both the brakes and the steering mechanism of said first motor vehicle to avoid collision with the vehicle ahead of said first motor vehicle.



66. A method in accordance with claim 53 wherein step (h) is effected by employing said fourth code signals to control the operation of the steering mechanism of said first motor vehicle to avoid collision between said first motor vehicle and a vehicle at one side of said first motor vehicle when the steering mechanism of said first motor vehicle is so controlled.

67. A method for controlling the operation of a motor vehicle comprising:

- a) operating a motor vehicle by employing a human operator to drive said motor vehicle along a multiple lane roadway,
- b) scanning with scanning means selected areas around said motor vehicle and generating first information signals modulated with information relating to objects detected in the said vehicle vicinity,
- c) computer processing said first information signals and generating second information signals containing characteristic information defining objects in said scanning areas,
- d) computer analyzing said second information signals and generating third information signals defining the presence of hazards and objects in the vicinity of said motor vehicle,
- e) Further analyzing said second information signals and generating fourth information signals indicative of relative motion of said motor vehicle and detected hazards,
- f) computer processing third and fourth information signals to generate fifth information signals used to warn the driver of hazardous conditions

68. The method of claim 67 wherein said fifth information signals of step (f) are used to control the operation of said motor vehicle.

69. The method of claim 67 wherein said fifth information signals are used to both warn the driver of hazardous conditions and to control the operation of said motor vehicle.
70. The method of claim 67 wherein said scanning means of step (b) includes video scanning means.
71. The method of claim 67 wherein said scanning means includes radar/lidar scanning means.
72. The method of claim 67 wherein the vicinity scanned includes the front, back, and right and left sides of the vehicle.
73. The method of claim 67 wherein the computer processing includes the use of neural networks for image analysis.
74. The method of claim 67 wherein the derivation of control signals for warning the driver and controlling the operation of the motor vehicle includes the use of fuzzy logic algorithms with defined membership grades for fuzzy variables.
75. The method of claim 74 wherein the fuzzy logic algorithms make use of fuzzy associative memories (FAM's) to define expert system driving control responses to control the operation of the motor vehicle for different encountered hazards.
76. The method of claim 75 wherein the expert system control responses include control signals for braking the motion of the vehicle.
77. The method of claim 75 wherein the expert system control responses include control signals for steering the vehicle.
78. A motor vehicle control system for a self propelled motor vehicle having a driver operable accelerator, brake and steering means for said vehicle, comprising in combination:
- a) motor means for operating said accelerator, brake and steering means,
  - b) control means for said motor means,

- c) master computing means for controlling the operation of said control means to variably control the operation of said accelerator, brake and steering means,
  - d) first means for operating said master computing means to cause it to control said accelerator and steering means to cause said vehicle to travel a select lane of a highway,
  - e) second means for operating said master computing means to cause it to control said brake to slow said vehicle, if necessary, to prevent collisions between said vehicle and other vehicles travelling said highway,
  - f) first override control means for allowing the driver of said motor vehicle to override said first means,
  - g) second override control means for allowing the driver of said motor vehicle to override said second means.
79. A motor vehicle control system in accordance with claim 78 wherein said first override control means is operative when the driver of said motor vehicle operates either the accelerator or the steering means of said motor vehicle.
80. A motor vehicle control system in accordance with claim 78 wherein said second override control means is operative when the driver of said motor vehicle operates the brakes of said motor vehicle.
81. A motor vehicle control system in accordance with claim 78 including means for sensing hazardous driving conditions of said motor vehicle as it travels a roadway and generating code signals indicative of such hazardous conditions, and means for employing said code signals to permit said master computing means to operate said control means to control said motor means to operate said brake and steering mean to avoid collisions between said

motor vehicle and obstacles such as moving vehicles and stationary objects in the path of travel of said motor vehicle.

82. A motor vehicle control system in accordance with claim 81 wherein said master computing means is operable to also control said motor means to operate said accelerator to in driving conditions where it is necessary to controllably accelerate to prevent a collision.
83. A motor vehicle control system in accordance with claim 78 including an electronic display means supported within said motor vehicle for displaying information to the driver of said vehicle, said display means being operable in response to signals generated by said master computing means to display information relating to the travel of said vehicle.
84. A motor vehicle control system in accordance with claim 83 wherein said master computing means is operable to control said display means to graphically display a map which includes the road along which said vehicle is travelling and said vehicle thereon.
85. A method for operating a motor vehicle comprising:
  - a) operating a motor vehicle in a first mode which includes driver controlling the movement of said vehicle along a first section of roadway,
  - b) monitoring the travel of said vehicle and other vehicles with a first computer means and generating first control signals,
  - c) employing said first control signals to intelligibly indicate to the driver of said motor vehicle driving conditions with respect to other vehicles,
  - d) generating second control signals when a hazardous condition develops during the movement of said vehicle and employing said second control signals to effect the temporary control of said vehicle to prevent or lessen the effects of an accident involving said vehicle and another vehicle or obstacle in the path of said vehicle.

SUBB16 86. A method for operating a motor vehicle comprising:

- a) operating a motor vehicle in a first mode which includes driver controlling the movement of said vehicle along a first section of roadway,
  - b) monitoring the travel of said vehicle and other vehicles with a first computer means and generating first control signals,
  - c) employing said first control signals to intelligibly indicate to the driver of said motor vehicle driving conditions with respect to other vehicles and stationary obstacles,
  - d) generating second control signals when a hazardous condition develops during the movement of said vehicle and employing said second control signals to effect the temporary control of said vehicle to prevent or lessen the effects of an accident involving said vehicle and another vehicle or obstacle in the path of said vehicle.
87. A method in accordance with claim 85 including operating said motor vehicle in a second mode wherein said first computing means includes means for automatically controlling the operation of said motor vehicle in normally driving said vehicle along a second section of roadway without driver control of said vehicle.
88. A method in accordance with claim 87 which includes overriding the computer control of the operation of said motor vehicle during said second mode of operation to permit the driver of said vehicle to take control of its operation reverting to control of the operation of said motor vehicle by said computing means when the driver thereof ceases to manually control said vehicle.
89. A method in accordance with claim 87 which includes overriding the computer control of the operation of said motor vehicle during said second mode of operation to permit the driver of said vehicle to take control of its operation and automatically

reverting to control of the operation of said motor vehicle by said computing means when the driver thereof ceases to manually control said vehicle.

90. A method in accordance with claim 87 which includes overriding the computer control of the operation of said motor vehicle during said second mode of operation to permit the driver of said vehicle to take control of its operation reverting to control of the operation of said motor vehicle by said computing means when the driver thereof fails to control said vehicle to avoid an accident.

SUB (317)

91. A method in accordance with claim 85 which includes employing selected of said first control signals to control a display means to display indicia to the driver of said motor vehicle indicative of the relative positions of said motor vehicle and at least one other motor vehicle which is in movement along the route of travel of said motor vehicle.

92. A method in accordance with claim 85 which includes employing selected of said first control signals to control a heads-up windshield display means to display indicia to the driver of said motor vehicle indicative of the relative positions of said motor vehicle and at least one other motor vehicle which is in movement along the route of travel of said motor vehicle.

93. A method in accordance with claim 85 which includes employing selected of said first control signals to control a display means to display indicia to the driver of said motor vehicle indicative of the relative positions of said motor vehicle and at least one other motor vehicle which is in movement ahead of the route of travel of said motor vehicle.

94. A method in accordance with claim 85 which includes employing selected of said first control signals to control a display means to display indicia to the driver of said

motor vehicle indicative of the relative positions of said motor vehicle and at least one other motor vehicle which is in movement along the route of travel of said motor vehicle and providing on said display means an indication of the distance between the two vehicles.

95. A method in accordance with claim 85 which includes employing selected of said first control signals to control a display means to display a graphical indication of the distance at any instant to the driver of said motor vehicle indicative of the relative positions of said motor vehicle and at least one other motor vehicle which is in movement along the route of travel of said motor vehicle.

96. A method in accordance with claim 85 which includes employing selected of said first control signals to control a display means to display a numerical indication of the distance between said motor vehicle and at least one other motor vehicle which is in movement along the route of travel of said motor vehicle.

97. A method in accordance with claim 85 which includes employing selected of said first control signals to control a display means to display a colored indication of the distance between said motor vehicle and at least one other motor vehicle which is in movement along the route of travel of said motor vehicle.

98. A method in accordance with claim 85 which includes employing selected of said first control signals to control a display means to display a flashing light indication of the distance between said motor vehicle and at least one other motor vehicle which is in movement along the route of travel of said motor vehicle.

SUB(B18) 99. A method in accordance with claim 85 which includes employing selected of said first control signals to control a verbal indication in synthetic speech of the distance

ADD(A13)

between said motor vehicle and at least one other motor vehicle which is in movement along the route of travel of said motor vehicle.

### References

1. Carpenter, G. A. and Grossberg, S., "Neural Networks for Vision and Image Processing," MIT Press, Cambridge, Massachusetts, 1992.
2. Soucek, B and Soucek, M., "Neural and Massively Parallel Computers," John Wiley & Sons, New York, 1988.
3. Kittler, J. and Duff, M., "Image Processing System Architectures," Research Studies Press LTD., Letachworth, England, 1985.
4. Pearson, D., "Image Processing," McGraw-Hill Book Company, New York, 1991.
5. Suaya, R. and Birtwistle, G., "VLSI AND Parallel Computation," Morgan Kaufmann Publishers, Inc., San Mateo, California, 1990.
6. Wasserman, P. D., "Neural Computing Theory and Practice," Van Nostrand Reinhold, New York, 1989.
7. Teuber, J., "Digital Image Processing," Prentice Hall, New York, 1993.
8. Lisboa, P. G. J., "Neural Networks," Chapman & Hall, New York, 1992.
9. Jurgen, R. K., "Smart Cars and Highways Go Global," IEEE Spectrum, pp.-26-36, May, 1991.
10. Hammerstrom, D., "Neural Networks at Work," IEEE Spectrum, pp.-26-32, June, 1993.
11. Schwartz, D. G. and Klir, G. J., "Fuzzy Logic Flowers in Japan", IEEE Spectrum, pp.-32-35, July, 1992.
12. Cox, E., "Fuzzy Fundamentals," IEEE Spectrum, pp.-58-61, October, 1992.
13. Hush, D. R. and Horne, B. G., "Progress in Supervised Neural Networks," IEEE Signal Processing Magazine, pp.-8-39, January, 1993.
14. Lippmann, R. P., "An Introduction to Computing with Neural Nets," IEEE ASSP Magazine, pp.-4-22, April, 1987.



15. Abu-Mostafa, Y.S., "Information Theory, Complexity, and Neural Networks," IEEE Communications Magazine, pp. 25-28, November, 1989.
16. Alspector, J., "Neural-Style Microsystems that Learn," IEEE Communications Magazine, pp.-29-36, November, 1989.
17. Psaltis, D., et. al, "Optoelectronic Implementations of Neural Networks," IEEE Communications Magazine, pp.-37-40, November, 1989.
18. Lippmann, R. P., "Pattern Classification Using Neural Networks", IEEE Communications Magazine, pp.- 47-64, November, 1989.
19. Yuhas, B. P., et. al, "Integration of Acoustic and Visual Speech Signals Using Neural Networks", IEEE Communications Magazine, pp.-65-71, November, 1989.
20. Lupo, J. C., "Defense Applications of Neural Networks," IEEE Communications Magazine, pp.- 82-88, November, 1989.
21. Roth, M. W., "Neural Networks for Extraction of Weak Targets in High Clutter Environments," IEEE Transactions on Systems, Man, and Cybernetics, pp. 1210-1217, September/October, 1989.
22. Aggarwal, J. K. and Nandhakumar, N., "On the Computation of Motion from Sequences of Images-A Review," Proceedings of the IEEE, pp. -917-935, August, 1988.
23. Maresca, M., et. al, "Parallel Architectures for Vision," Proceedings of the IEEE, pp. 970-981, August, 1988.
24. Kosko B. and Isaka, S., Fuzzy Logic, Scientific American, pp. 76-81, July 1993.
25. Lee C. C., Fuzzy Logic in Control Systems: Fuzzy Logic Controller, Parts I and II, IEEE Transactions on Systems Man and Cybernetics, pp. 419 - 435, March/April, 1990.

**COMBINED DECLARATION AND POWER OF ATTORNEY  
IN ORIGINAL APPLICATION**

ATTORNEY DOCKET NO.

As a below named inventor, I hereby declare that:  
my residence, post office address and citizenship are as stated below next to my name; that  
I verily believe that I am the original, first and sole inventor (if only one name is listed below) or a joint  
inventor (if plural inventors are named below) of the invention entitled: MOTOR VEHICLE  
WARNING AND CONTROL SYSTEM AND METHOD

described and claimed in the attached specification, that I understand the content of the attached specification,  
that I do not know and do not believe the same was ever known or used in the United States of America be-  
fore my or our invention thereof, or patented or described in any printed publication in any country before  
my or our invention thereof or more than one year prior to this application, that the same was not in public  
use or on sale in the United States of America more than one year prior to this application, that the invention  
has not been patented or made the subject of an inventor's certificate issued before the date of this applica-  
tion in any country foreign to the United States of America on an application filed by me or my legal repre-  
sentatives or assigns more than twelve months prior to this application, that I acknowledge my duty to dis-  
close information of which I am aware which is material to the examination of this application, and that no  
application for patent or inventor's certificate on this invention has been filed in any country foreign to the  
United States of America prior to this application by me or my legal representatives or assigns,  
and I further declare that I have read and

understand the specification attached hereto.

I hereby appoint the following attorney(s) and/or agent(s) to prosecute this application and to transact  
all business in the Patent and Trademark Office connected therewith: myself

Address all telephone calls to Jerome H. Lemelson at telephone no 702-832-0250

Address all correspondence to Suite 286, 930 Tahoe Blvd, Unit 802, Incline Village, NV. 89451-9436

I hereby declare that all statements made herein of my own knowledge are true and that all statements  
made on information and belief are believed to be true; and further that these statements were made with  
the knowledge that willful false statements and the like so made are punishable by fine or imprisonment, or  
both, under Section 1001 of Title 18 of the United States Code and that such willful false statements may  
jeopardize the validity of the application or any patent issued thereon.

1-00

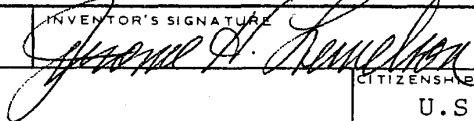
FULL NAME OF SOLE OR FIRST INVENTOR <u>Jerome H. Lemelson</u>	INVENTOR'S SIGNATURE 	DATE <u>7/22/93</u>
RESIDENCE <u>868 Tyner Way</u>	CITIZENSHIP <u>U.S.A.</u>	
POST OFFICE ADDRESS <u>Incline Village, Nevada 89450</u> <u>NY</u>		

2-00

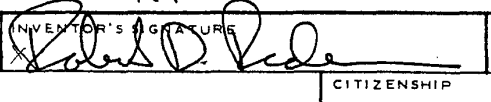
FULL NAME OF SECOND JOINT INVENTOR, IF ANY <u>Robert Pedersen</u>	INVENTOR'S SIGNATURE 	DATE <u>7/26/93</u>
RESIDENCE <u>7808 GlenEagle</u>	CITIZENSHIP <u>U.S.A.</u>	
POST OFFICE ADDRESS <u>Dallas, Texas 75248</u> <u>TX</u>		

FULL NAME OF THIRD JOINT INVENTOR, IF ANY	INVENTOR'S SIGNATURE	DATE
RESIDENCE	CITIZENSHIP	
POST OFFICE ADDRESS		

FORM PTO-298T (10-77)

Patent & TM Office - U.S. COMM-D.C.

Applicant or Patentee: Jerome H. Lemelson et al Attorney's  
 Serial or Patent No.: \_\_\_\_\_ Docket No.: \_\_\_\_\_  
 Filed or Issued: \_\_\_\_\_  
 For: MOTOR VEHICLE WARNING AND CONTROL SYSTEM AND METHOD

VERIFIED STATEMENT (DECLARATION) CLAIMING SMALL ENTITY  
 STATUS (37 CFR 1.9(f) and 1.47(b)) - INDEPENDENT INVENTOR

As a below named inventor, I hereby declare that I qualify as an independent inventor as defined in 37 CFR 1.9(c) for purposes of paying reduced fees under section 41(a) and (b) of Title 35, United States Code, to the Patent and Trademark Office with regard to the invention entitled MOTOR VEHICLE WARNING & CONTROL SYSTEM & METHOD described in

- the specification filed herewith
- application serial no. \_\_\_\_\_, filed \_\_\_\_\_
- patent no. \_\_\_\_\_, issued \_\_\_\_\_

I have not assigned, granted, conveyed or licensed and am under no obligation under contract or law to assign, grant, convey or license, any rights in the invention to any person who could not be classified as an independent inventor under 37 CFR 1.9(c) if that person had made the invention, or to any concern which would not qualify as a small business concern under 37 CFR 1.9(d) or a nonprofit organization under 37 CFR 1.9(e).

Each person, concern or organization to which I have assigned, granted, conveyed, or licensed or am under an obligation under contract or law to assign, grant, convey, or license any rights in the invention is listed below:

- no such person, concern, or organization
- persons, concerns or organizations listed below\*

\*NOTE: Separate verified statements are required from each named person, concern or organization having rights to the invention averring to their status as small entities. (37 CFR 1.27)

FULL NAME \_\_\_\_\_  
 ADDRESS \_\_\_\_\_  
 INDIVIDUAL  SMALL BUSINESS CONCERN  NONPROFIT ORGANIZATION

FULL NAME \_\_\_\_\_  
 ADDRESS \_\_\_\_\_  
 INDIVIDUAL  SMALL BUSINESS CONCERN  NONPROFIT ORGANIZATION

FULL NAME \_\_\_\_\_  
 ADDRESS \_\_\_\_\_  
 INDIVIDUAL  SMALL BUSINESS CONCERN  NONPROFIT ORGANIZATION

I acknowledge the duty to file, in this application or patent, notification of any change in status resulting in loss of entitlement to small entity status prior to paying, or at the time of paying, the earliest of the issue fee or any maintenance fee due after the date on which status as a small entity is no longer appropriate. (37 CFR 1.28(b))

I hereby declare that all statements made herein of my own knowledge are true and that all statements made on information and belief are believed to be true; and further that these statements were made with the knowledge that willful false statements and the like so made are punishable by fine or imprisonment, or both, under section 1001 of Title 18 of the United States Code, and that such willful false statements may jeopardize the validity of the application, any patent issuing thereon, or any patent to which this verified statement is directed.

Jerome H. Lemelson

Robert Pedersen

NAME OF INVENTOR	NAME OF INVENTOR	NAME OF INVENTOR
<u>Jerome H. Lemelson</u>	<u>Robert D. Pedersen</u>	
Signature of Inventor	Signature of Inventor	Signature of Inventor
<u>July 22, 1993</u>	<u>July 26, 1992</u>	
Date	Date	Date

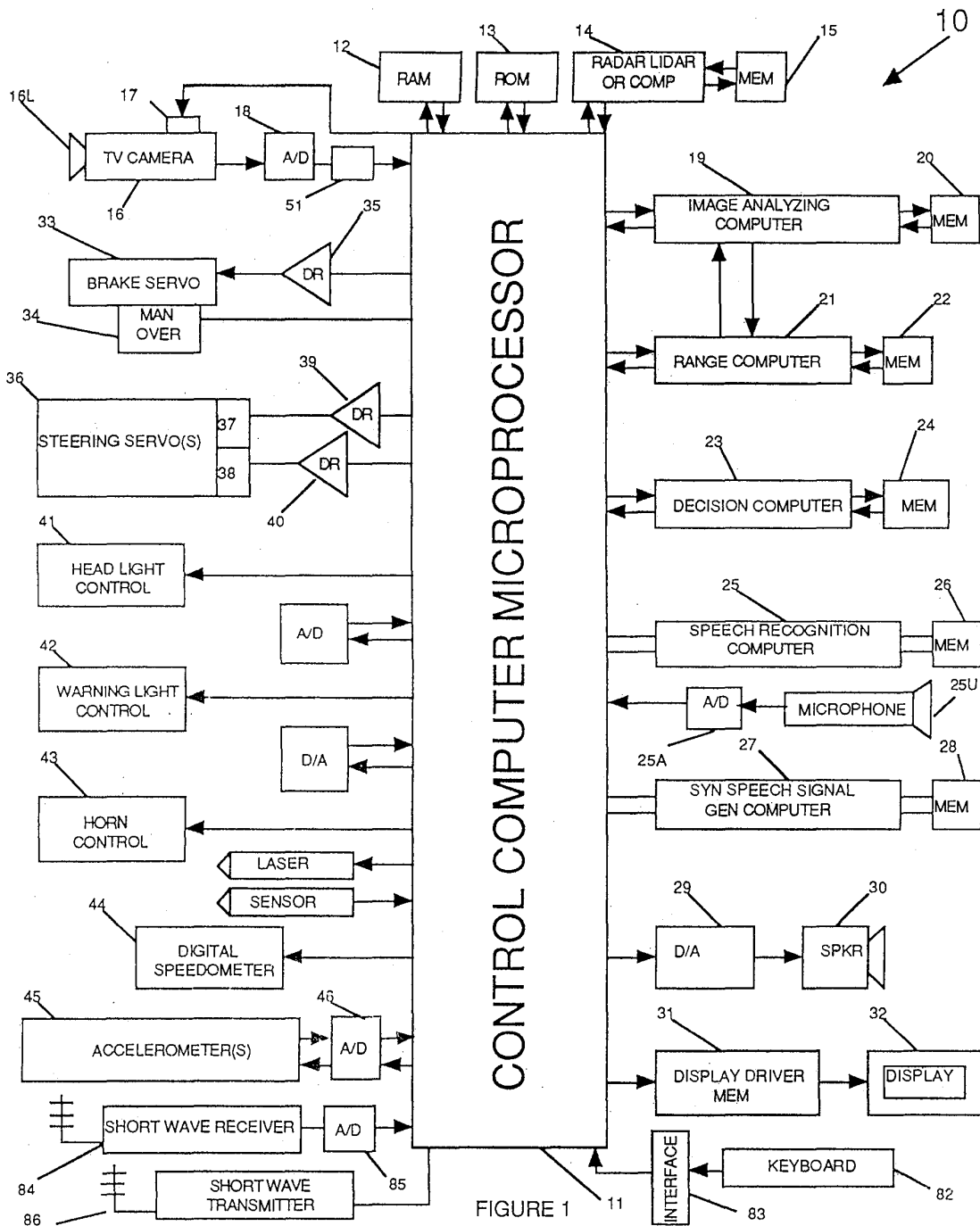

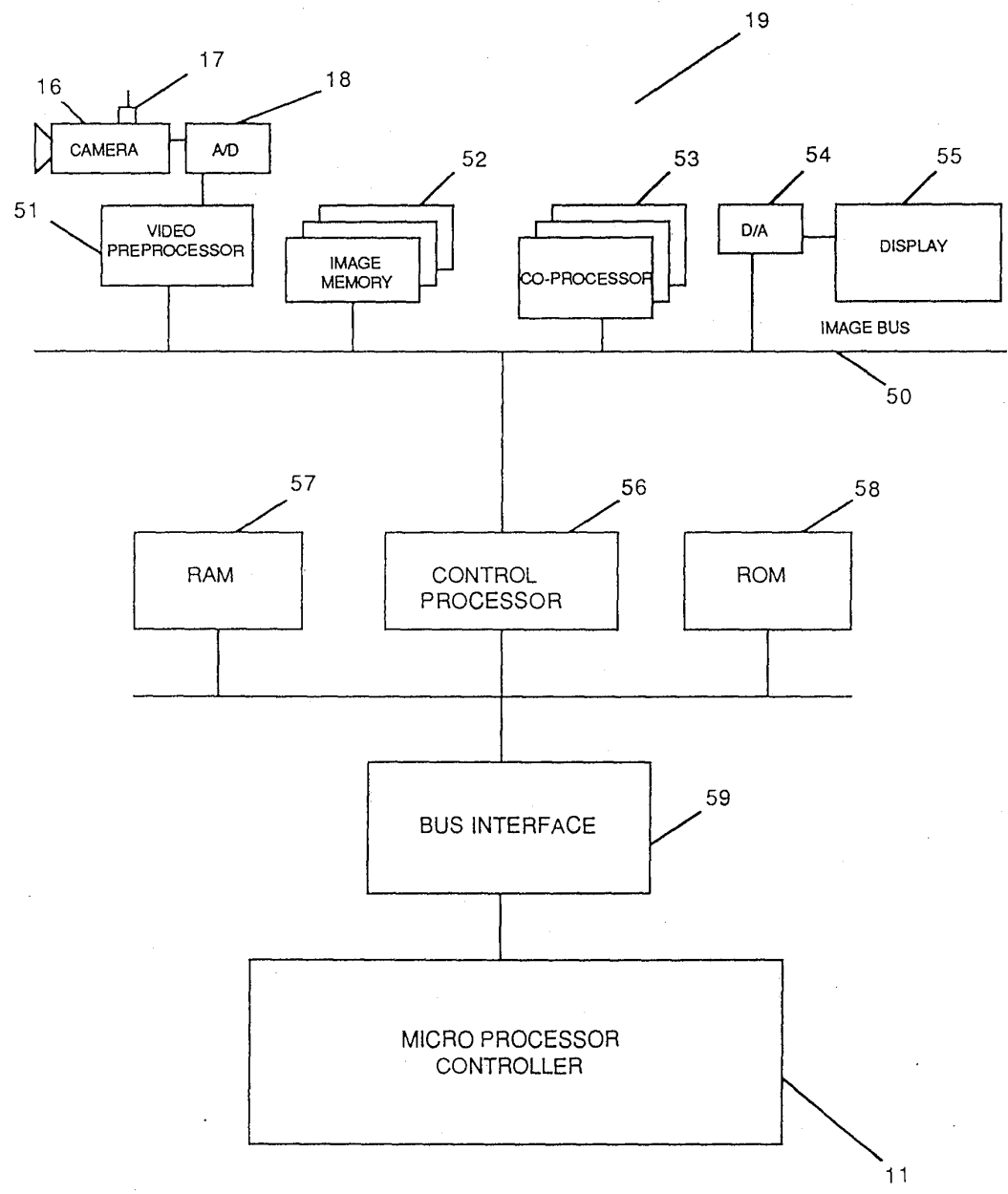

FIGURE 2

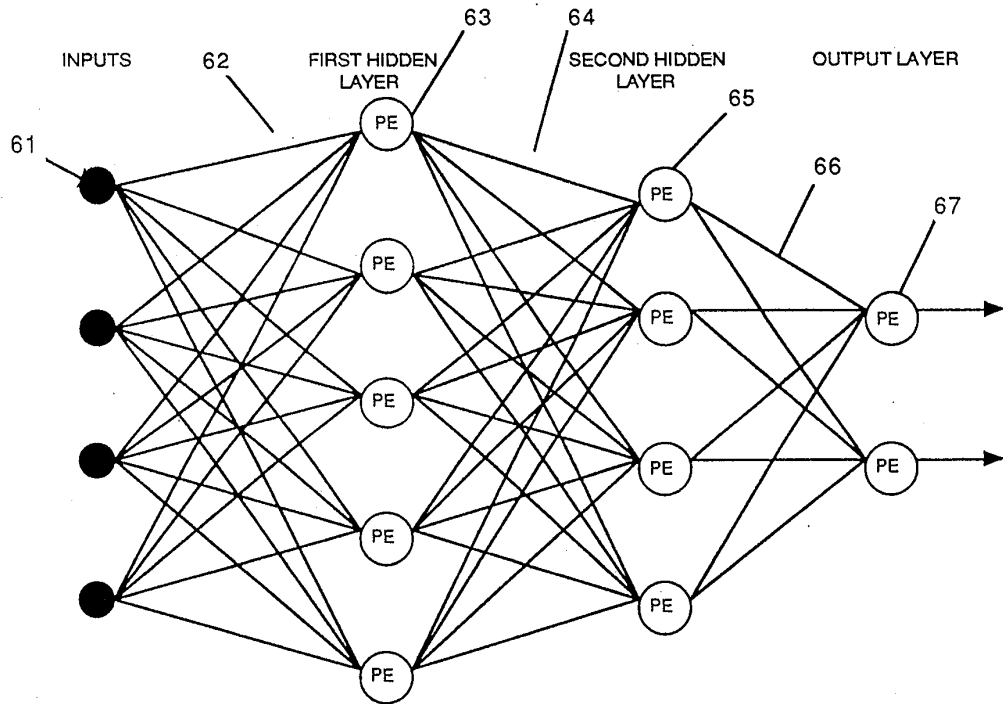

FIGURE 3

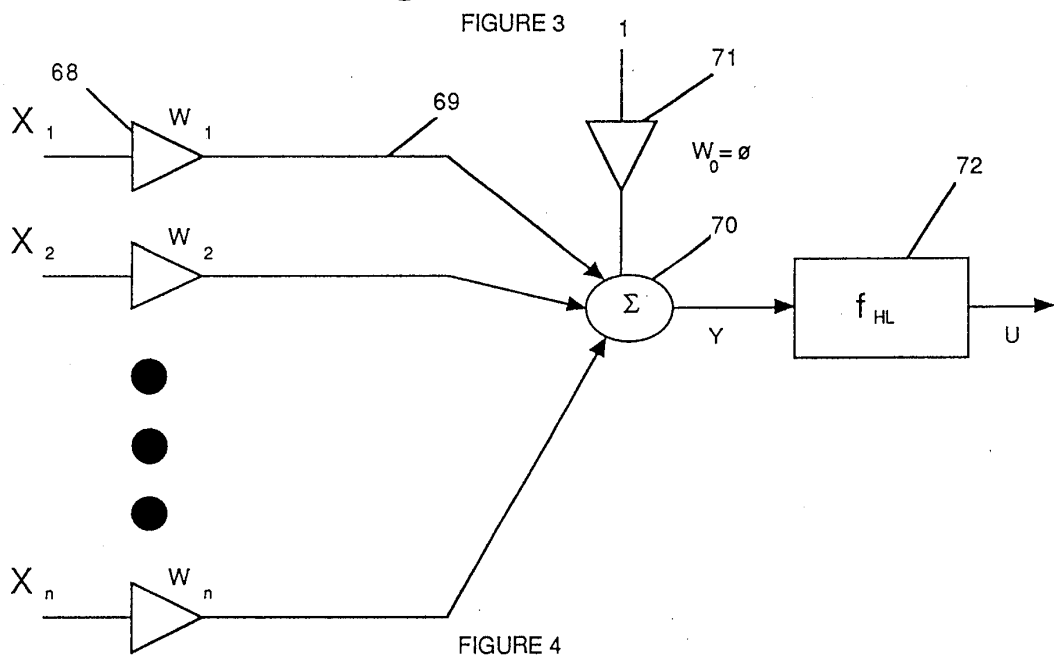

FIGURE 4

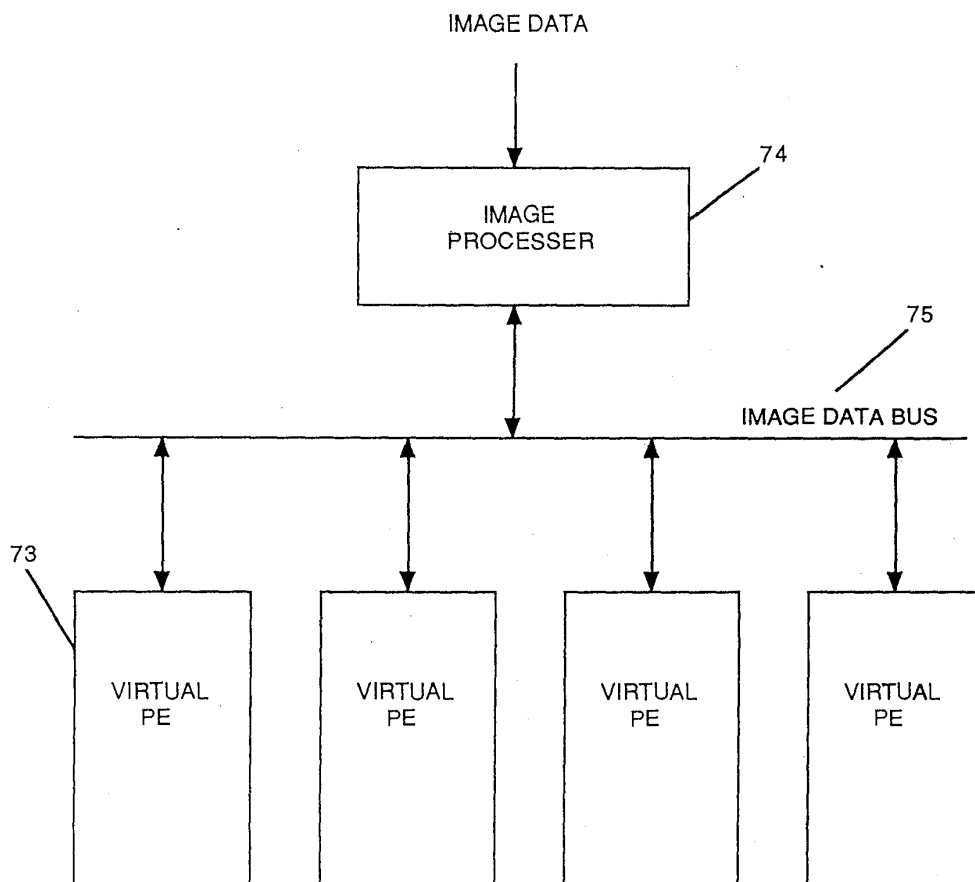

FIGURE 5

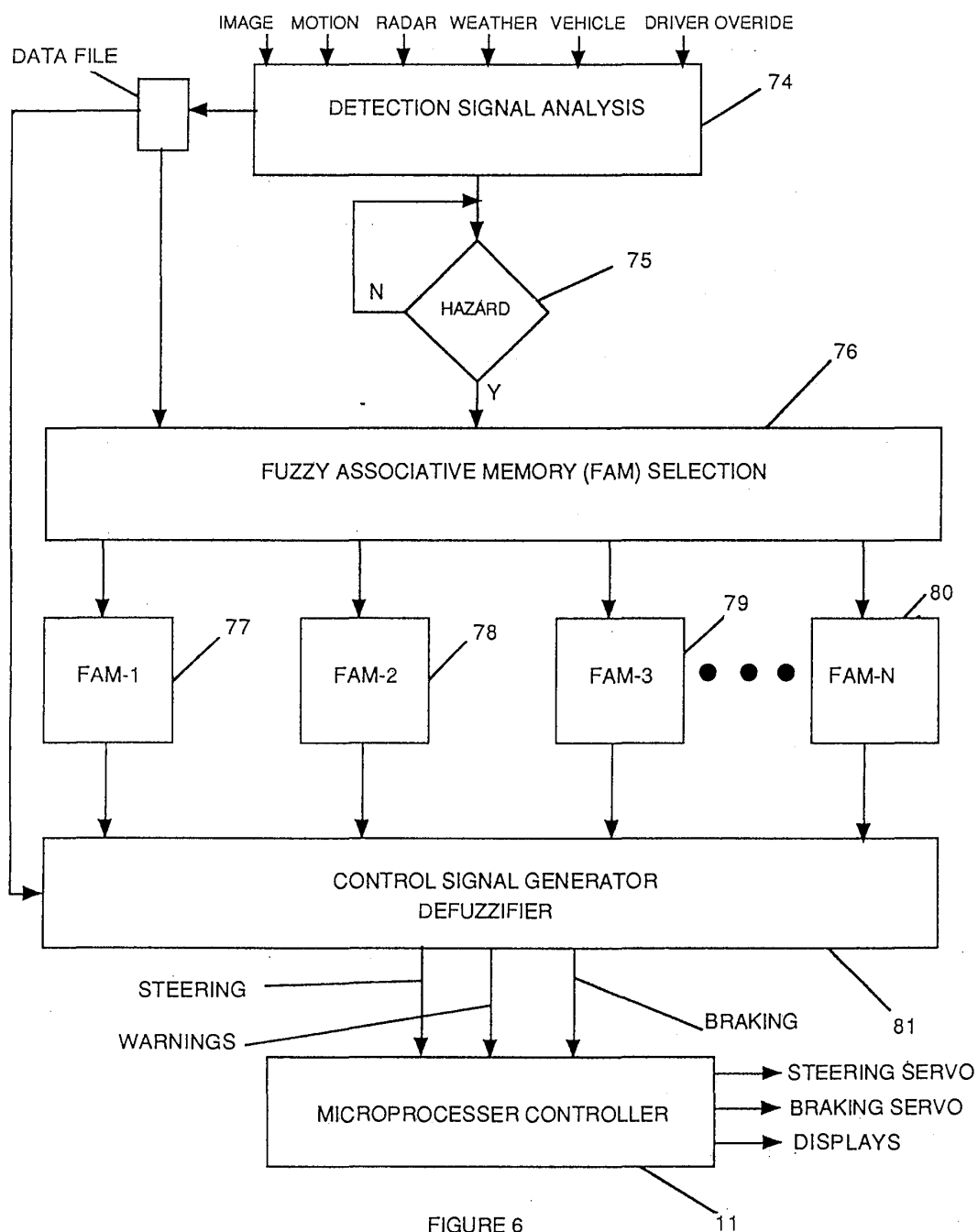

FIGURE 6



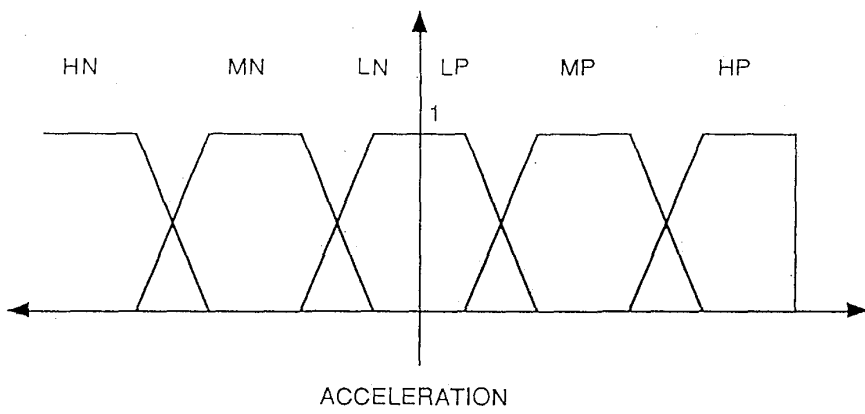
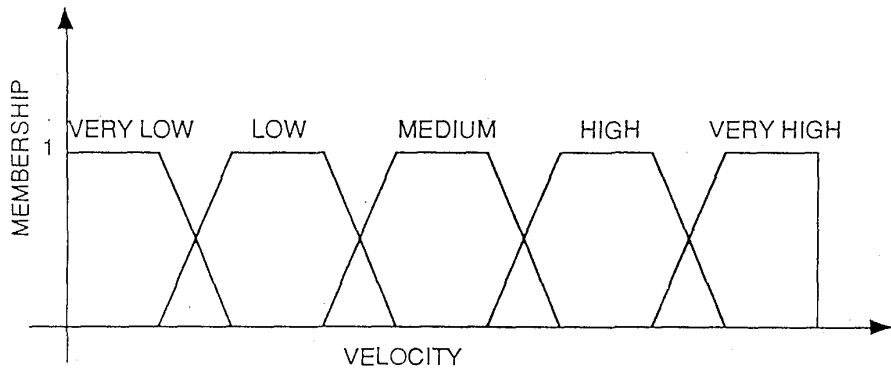
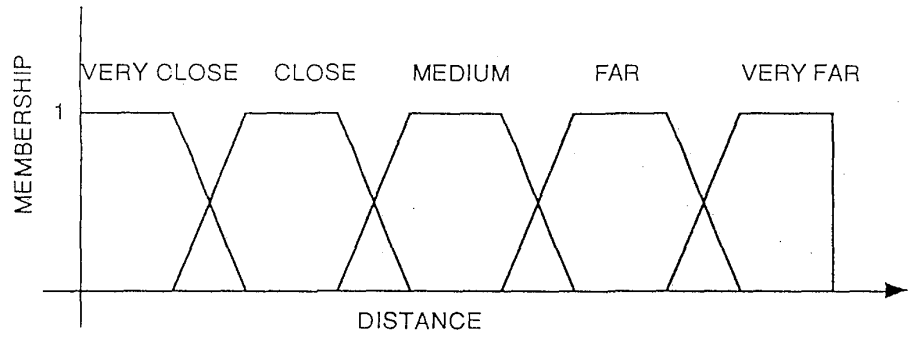

FIGURE 7

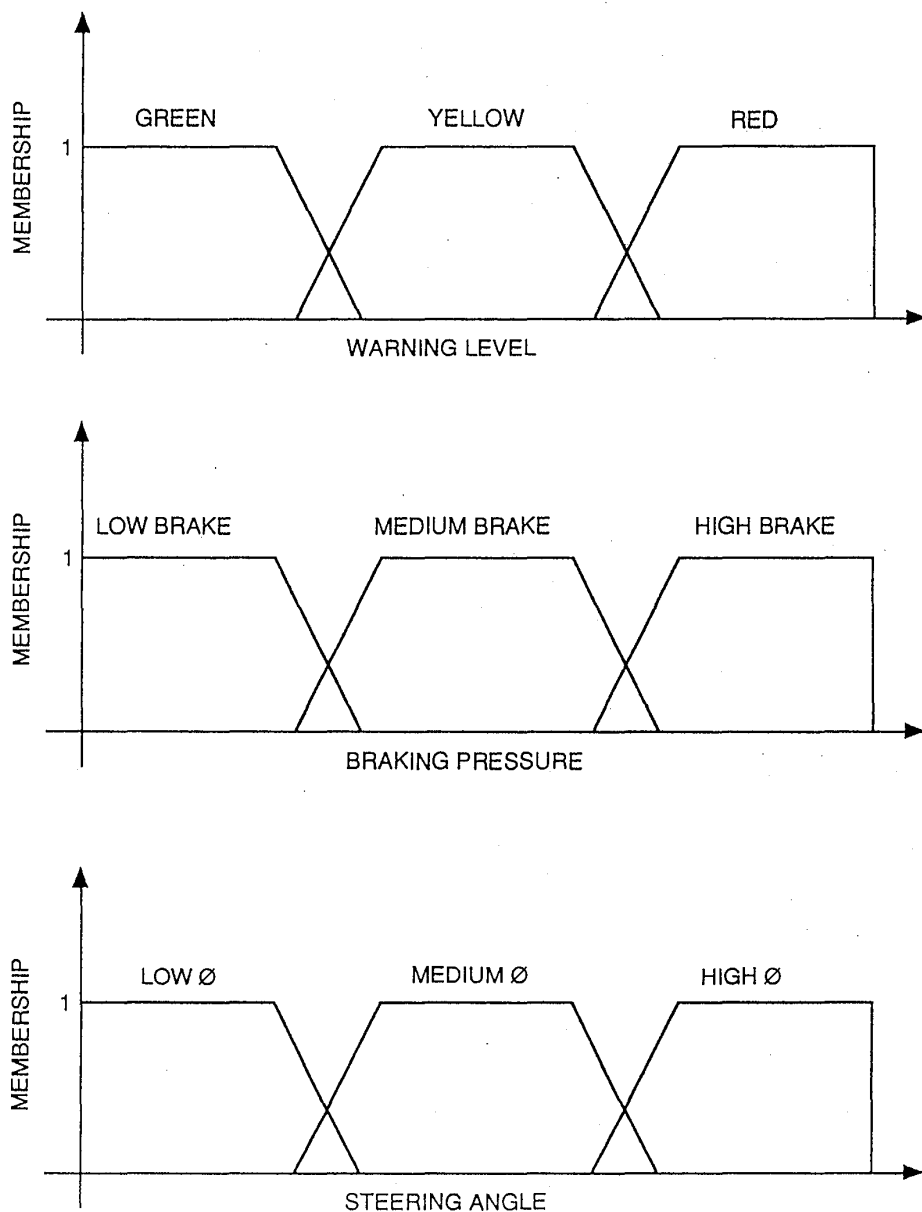

FIGURE 8

D \ V	VL	L	M	H	VH
VC	Y-LB-NØ	R-LB-SØ	R-MB-SØ	R-HB-MØ	R-HB-MØ
C	Y-NB-NØ	Y-LB-NØ	R-MB-SØ	R-HB-SØ	R-HB-MØ
M	G-NB-NØ	Y-NB-NØ	Y-LB-NØ	R-MB-NØ	R-HB-SØ
F	G-NB-NØ	G-NB-NØ	G-NB-NØ	Y-LB-NØ	Y-LB-NØ
VF	G-NB-NØ	G-NB-NØ	G-NB-NØ	Y-LB-NØ	Y-LB-NØ

ACCELERATION =LP

D \ V	VL	L	M	H	VH
VC	R-MB-NØ	R-MB-SØ	R-HB-MØ	R-HB-HØ	R-HB-HØ
C	Y-LB-NØ	R-MB-NØ	R-MB-SØ	R-HB-MØ	R-HB-HØ
M	Y-NB-NØ	Y-LB-NØ	R-MB-NØ	R-HB-NØ	R-HB-SØ
F	G-NB-NØ	G-NB-NØ	Y-NB-NØ	Y-LB-NØ	R-LB-NØ
VF	G-NB-NØ	G-NB-NØ	Y-NB-NØ	Y-LB-NØ	Y-LB-NØ

ACCELERATION =MP

D \ V	VL	L	M	H	VH
VC	R-MB-NØ	R-HB-NØ	R-HB-SØ	R-HB-HØ	R-HB-HØ
C	R-MB-NØ	R-MB-NØ	R-MB-SØ	R-HB-MØ	R-HB-HØ
M	Y-LB-NØ	R-MB-NØ	R-MB-SØ	R-HB-MØ	R-HB-MØ
F	Y-NB-NØ	Y-NB-NØ	Y-NB-NØ	R-LB-NØ	R-LB-NØ
VF	G-NB-NØ	G-NB-NØ	Y-NB-NØ	Y-NB-NØ	R-MB-NØ

ACCELERATION =HP

D \ V	VL	L	M	H	VH
VC	Y-LB-NØ	Y-LB-NØ	R-MB-NØ	R-HB-SØ	R-HB-MØ
C	Y-NB-NØ	Y-MB-NØ	Y-MB-NØ	R-HB-NØ	R-HB-SØ
M	G-NB-NØ	G-NB-NØ	Y-SB-NØ	R-MB-SØ	R-MB-SØ
F	G-NB-NØ	G-NB-NØ	G-NB-NØ	Y-NB-NØ	Y-NB-NØ
VF	G-NB-NØ	G-NB-NØ	G-NB-NØ	G-NB-NØ	Y-NB-NØ

ACCELERATION =LN

D \ V	VL	L	M	H	VH
VC	Y-LB-NØ	Y-LB-NØ	Y-MB-NØ	R-HB-SØ	R-HB-MØ
C	Y-NB-NØ	Y-NB-NØ	Y-LB-NØ	Y-LB-SØ	R-MB-SØ
M	G-NB-NØ	G-NB-NØ	Y-MB-NØ	Y-MB-SØ	R-MB-SØ
F	G-NB-NØ	G-NB-NØ	G-NB-NØ	G-NB-NØ	Y-NB-NØ
VF	G-NB-NØ	G-NB-NØ	G-NB-NØ	G-NB-NØ	Y-NB-NØ

ACCELERATION =MN

D \ V	VL	L	M	H	VH
VC	Y-NB-NØ	Y-LB-NØ	Y-LB-NØ	Y-MB-SØ	R-MB-MØ
C	G-NB-NØ	G-NB-NØ	G-NB-NØ	Y-LB-NØ	Y-LB-NØ
M	G-NB-NØ	G-NB-NØ	G-NB-NØ	Y-LB-NØ	Y-LB-NØ
F	G-NB-NØ	G-NB-NØ	G-NB-NØ	G-NB-NØ	G-NB-NØ
VF	G-NB-NØ	G-NB-NØ	G-NB-NØ	G-NB-NØ	G-NB-NØ

ACCELERATION =HN

FIGURE 9

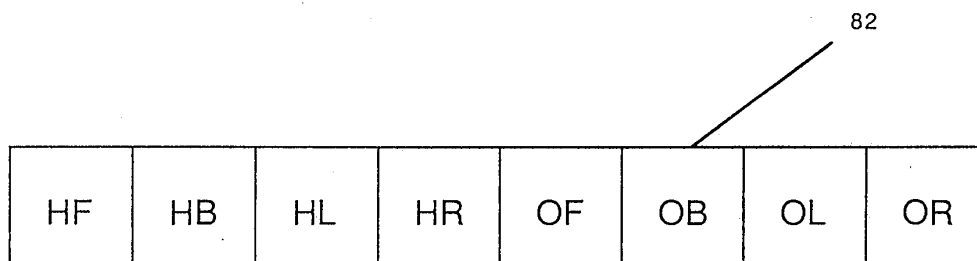

FIGURE 10

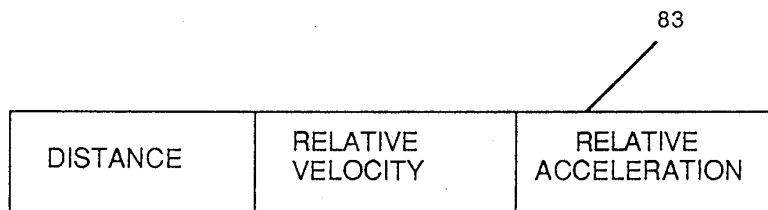

FIGURE 11

08 105304

STATE VECTOR	HAZZARD				OBSTACLE			
	HF	HB	HL	HR	CF	CB	CL	CR
1	0	0	0	0				
2	0	0	0	1	0	0	0	
3	0	0	0	1	0	0	1	
4	0	0	0	1	0	1	0	
5	0	0	0	1	0	1	1	
6	0	0	0	1	1	0	0	
7	0	0	0	1	1	0	1	
8	0	0	0	1	1	1	0	
9	0	0	0	1	1	1	1	
10	0	0	1	0	0	0		0
11	0	0	1	0	0	0		1
12	0	0	1	0	0	1		0
13	0	0	1	0	0	1		1
14	0	0	1	0	1	0		0
15	0	0	1	0	1	0		1
16	0	0	1	0	1	1		0
17	0	0	1	0	1	1		1
18	0	0	1	1	0	0		
19	0	0	1	1	0	1		
20	0	0	1	1	1	0		
21	0	0	1	1	1	1		
22	0	1	0	0	0		0	0
23	0	1	0	0	0		0	1
24	0	1	0	0	0		1	0
25	0	1	0	0	0		1	1
26	0	1	0	0	1		0	0
27	0	1	0	0	1		0	1
28	0	1	0	0	1		1	0
29	0	1	0	0	1		1	1
30								
31	0	1	0	1	0		0	
32	0	1	0	1	0		1	
33	0	1	0	1	1		0	
34	0	1	0	1	1		1	
35	0	1	1	0	0			0
36	0	1	1	0	0			1
37	0	1	1	0	1			0
38	0	1	1	0	1			1
39	0	1	1	1	0			
40	0	1	1	1	1			
41	1	0	0	0		0	0	0
42	1	0	0	0		0	0	1
43	1	0	0	0		0	1	0
44	1	0	0	0		0	1	1
45	1	0	0	0		0	0	0
46	1	0	0	0		1	0	1
47	1	0	0	0		1	1	0
48	1	0	0	0		1	1	1
49	1	0	0	1		0	0	
50	1	0	0	1		0	1	
51	1	0	0	1			0	
52	1	0	0	1		1	1	
53						1		
54	1	0	1	0		0		0
55	1	0	1	0		0		1
56	1	0	1	0		1		0
57	1	0	1	0		1		1
58	1	0	1	1		0		
59	1	0	1	1		1		
60	1	1	0	0			0	0
61	1	1	0	0			0	1
62	1	1	0	0			1	0
63	1	1	0	0			1	1
64	1	1	0	1			0	
65	1	1	0	1			1	
66	1	1	1	0				0
67	1	1	1	0				1
68	1	1	1	1				

FIGURE 12

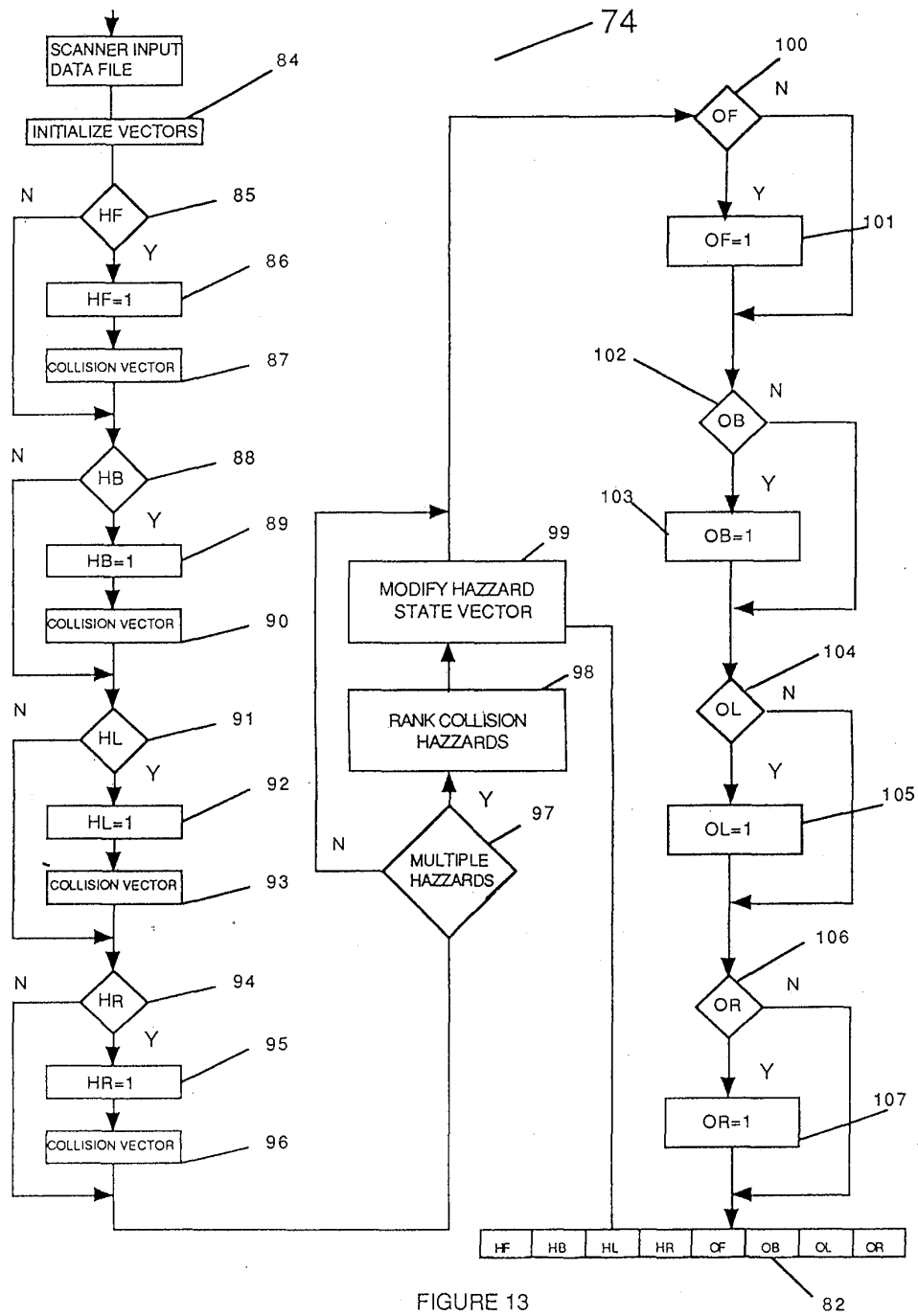

FIGURE 13

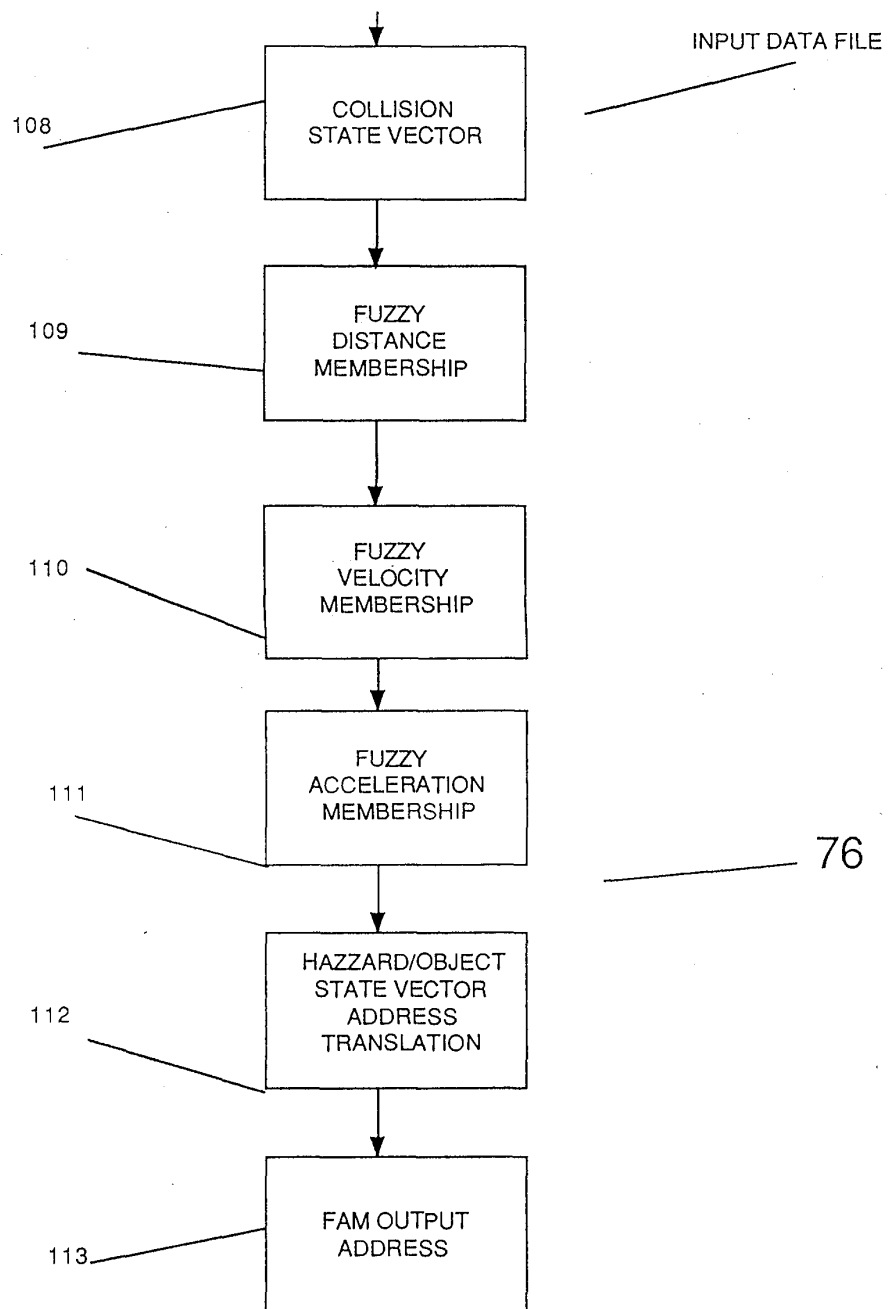

FIGURE 14

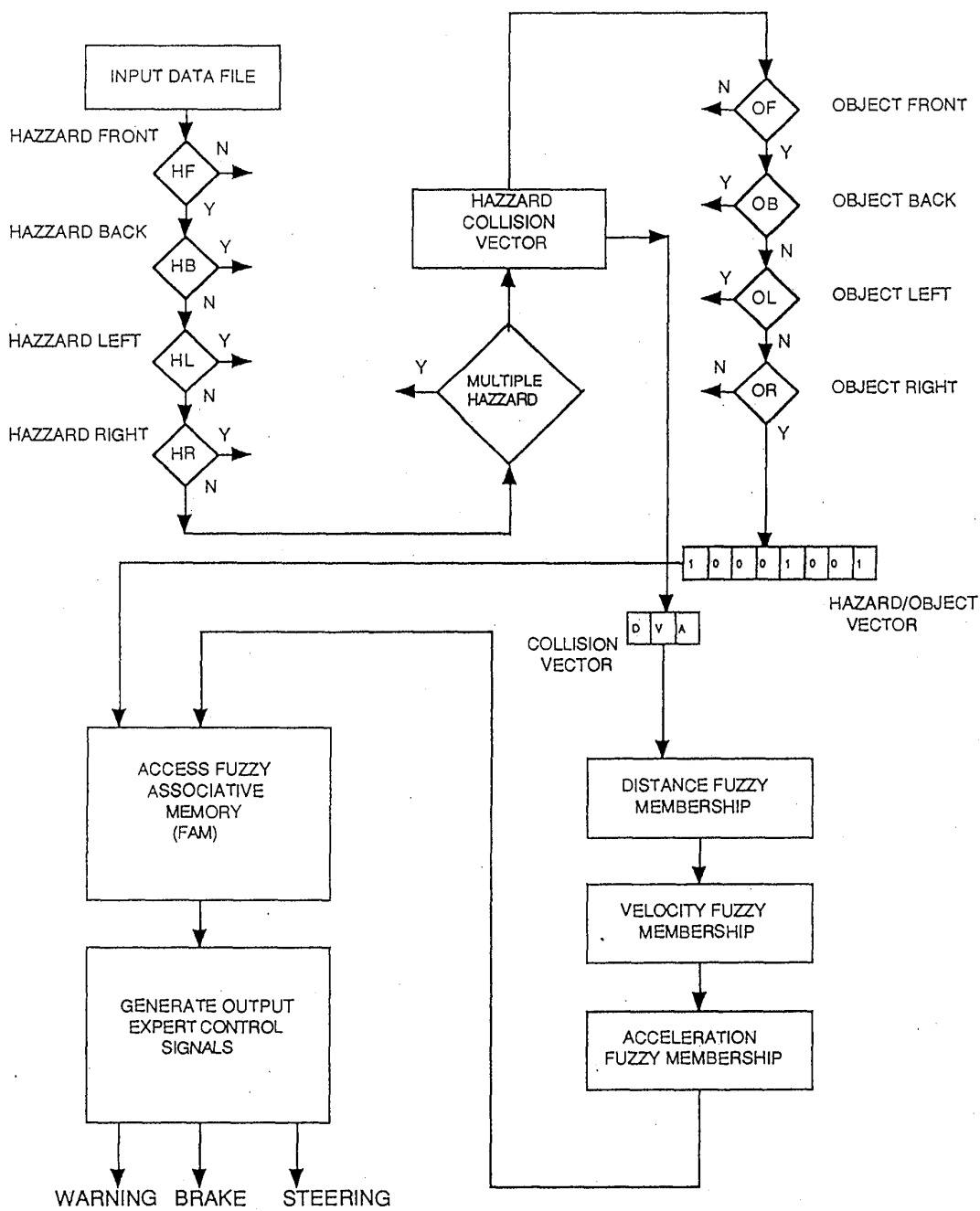

FIGURE 15



340/903  
Lefkowitz

Jerome Lemelson  
Suite 286  
930 Tahoe Blvd., Unit 802  
Incline Village, NV 89451-9436  
DB 105304

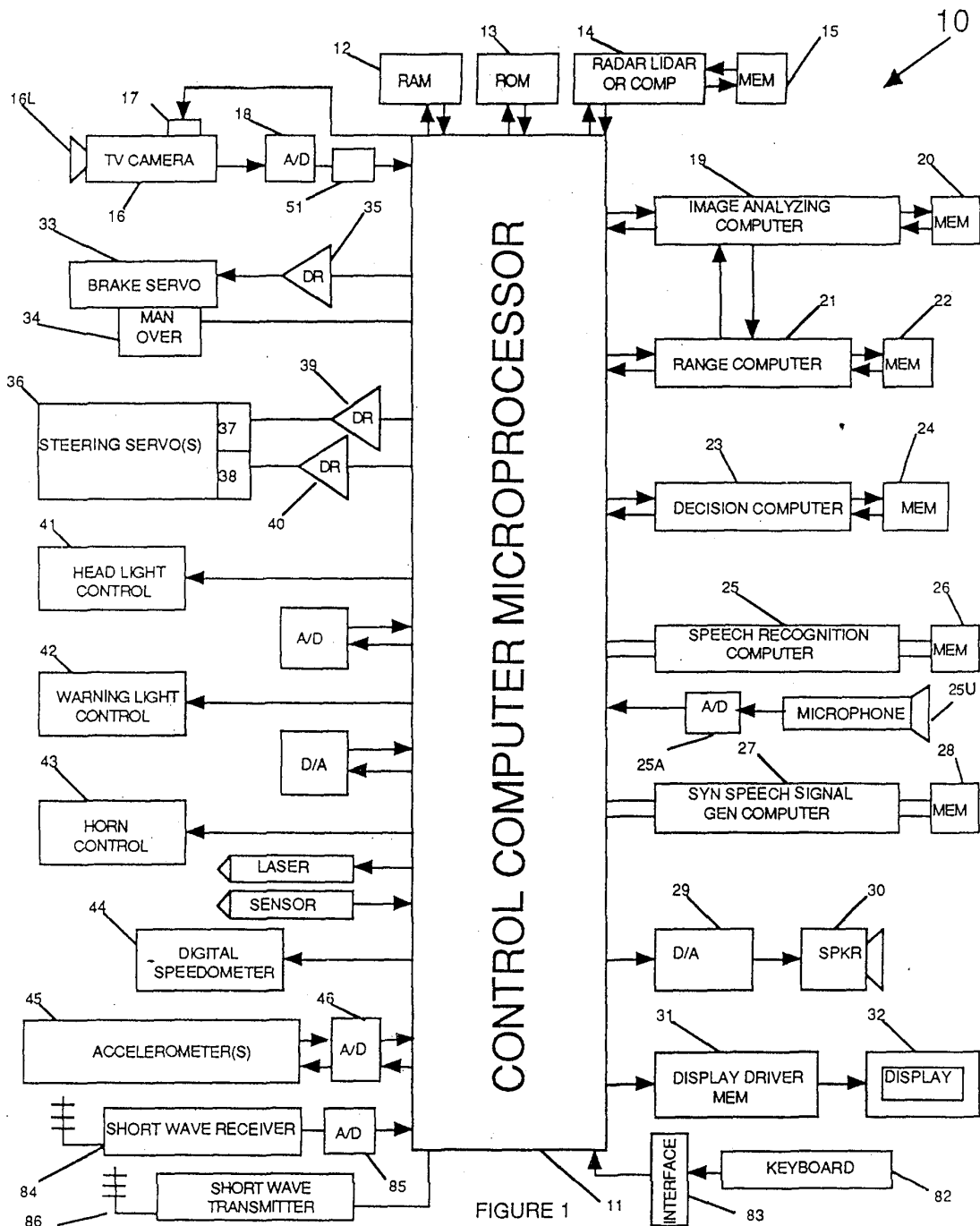

FIGURE 1

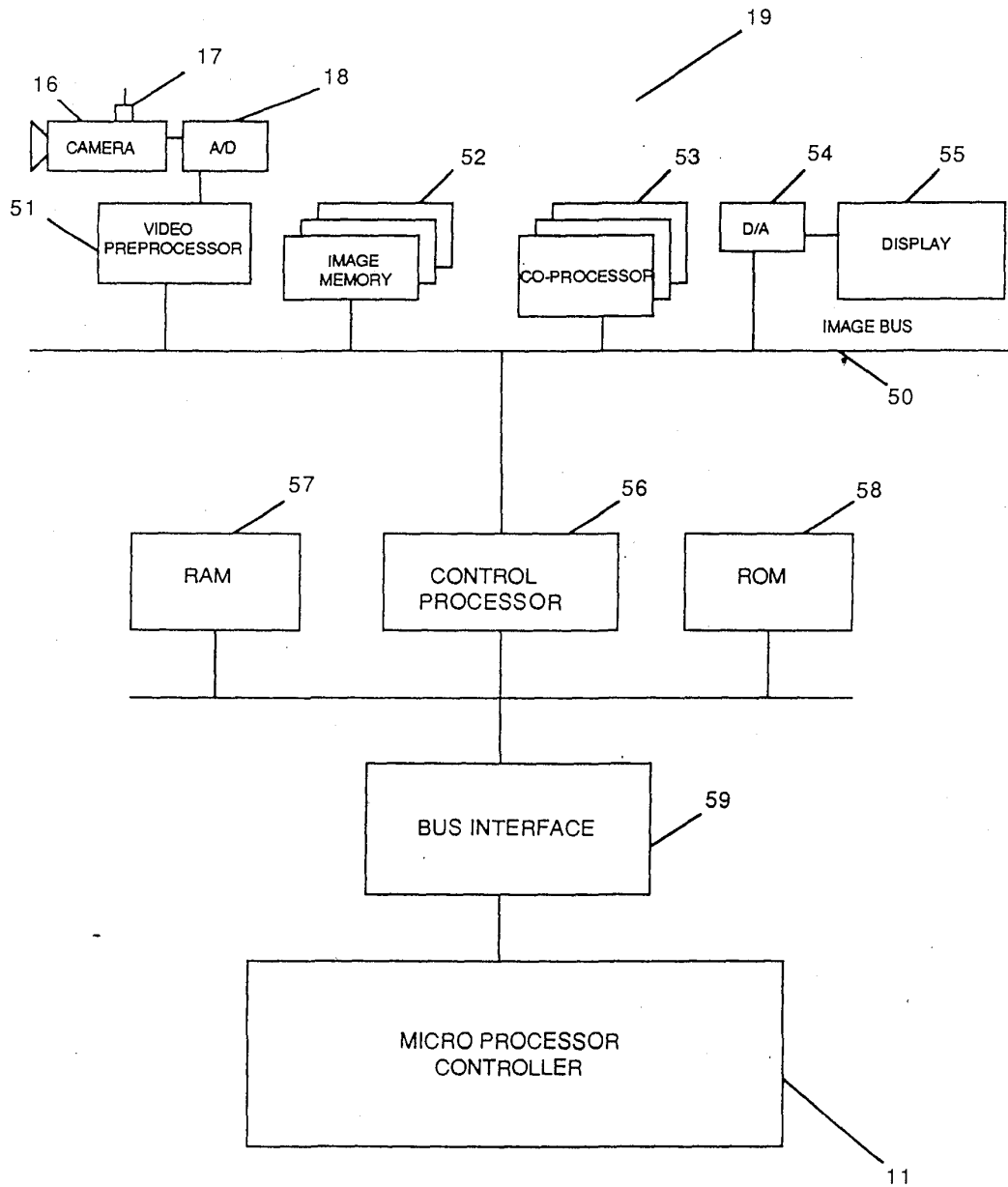

FIGURE 2

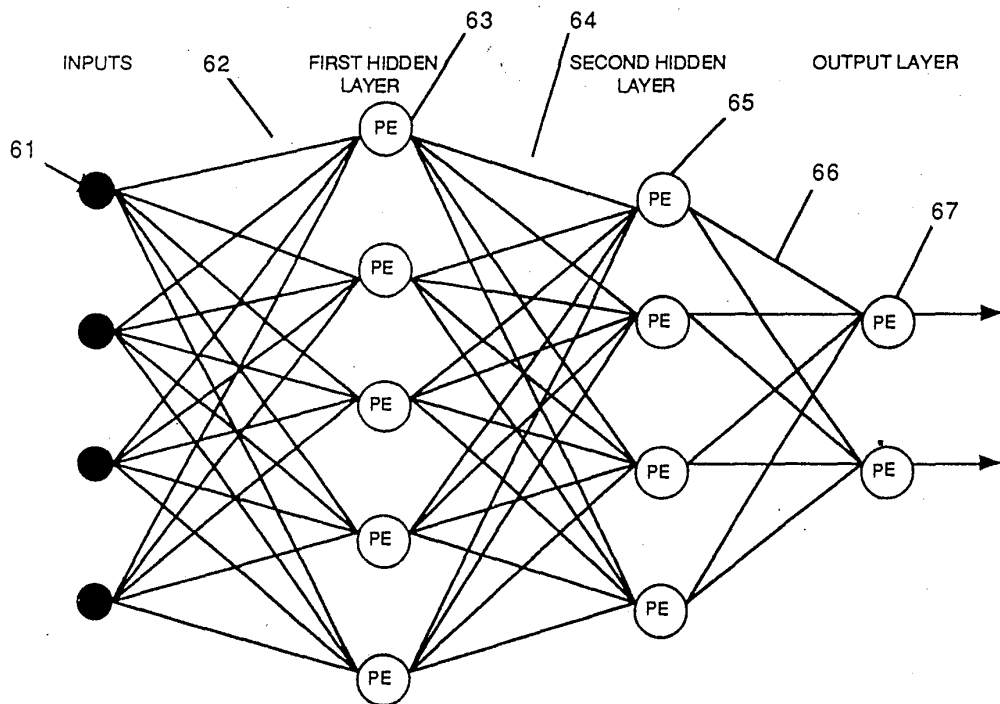

FIGURE 3

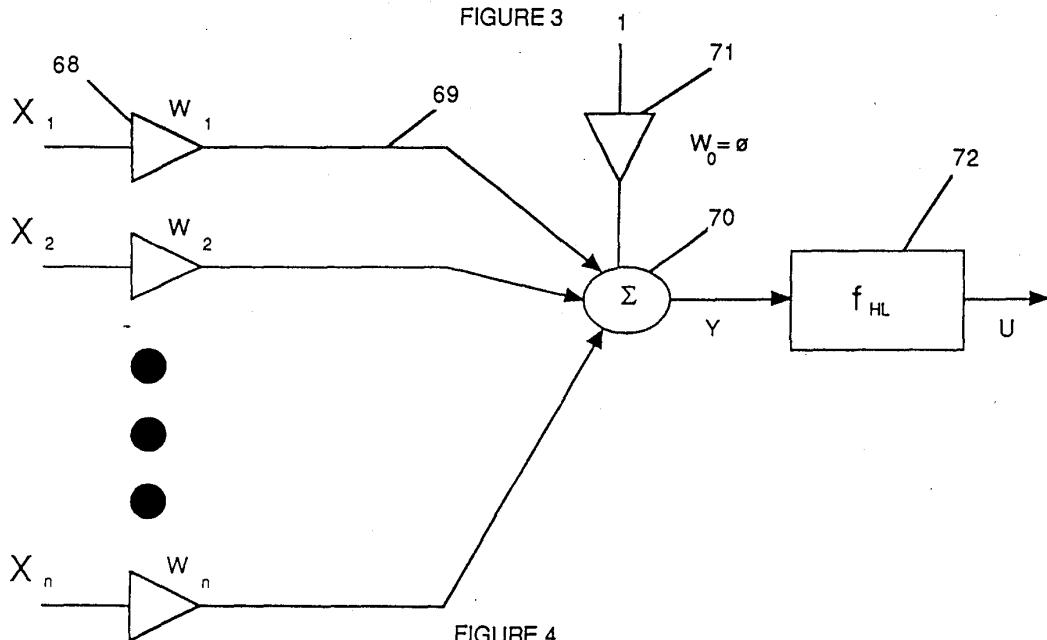

FIGURE 4

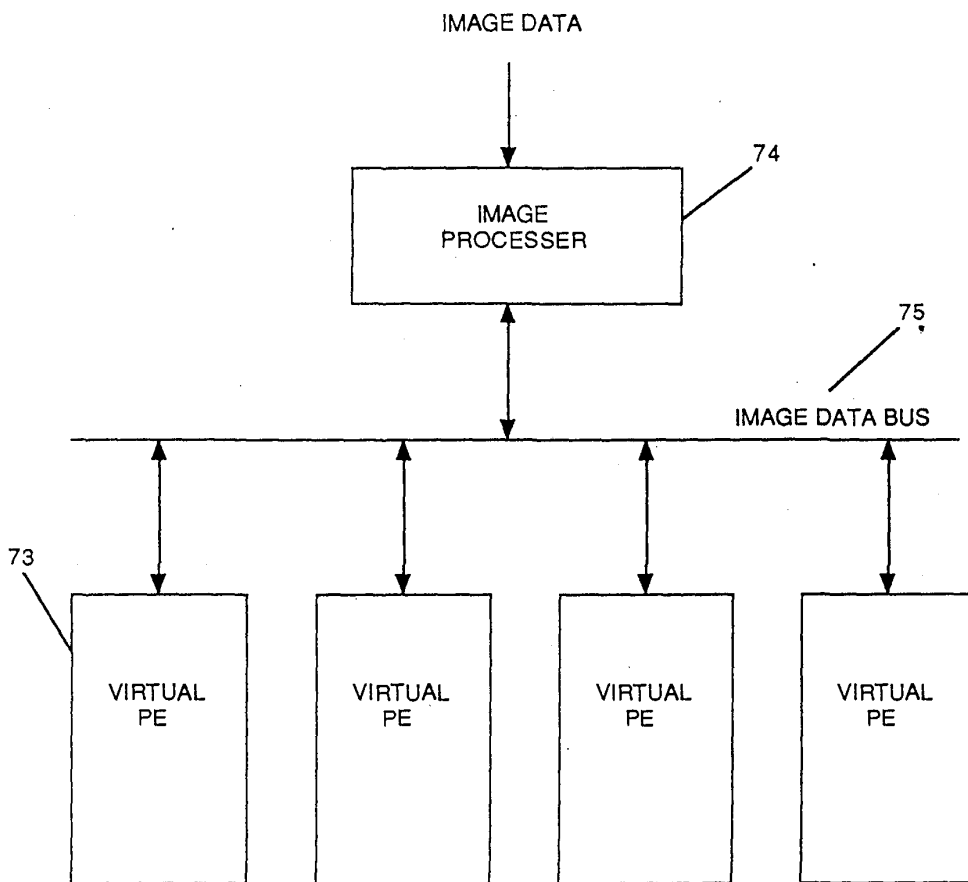

FIGURE 5

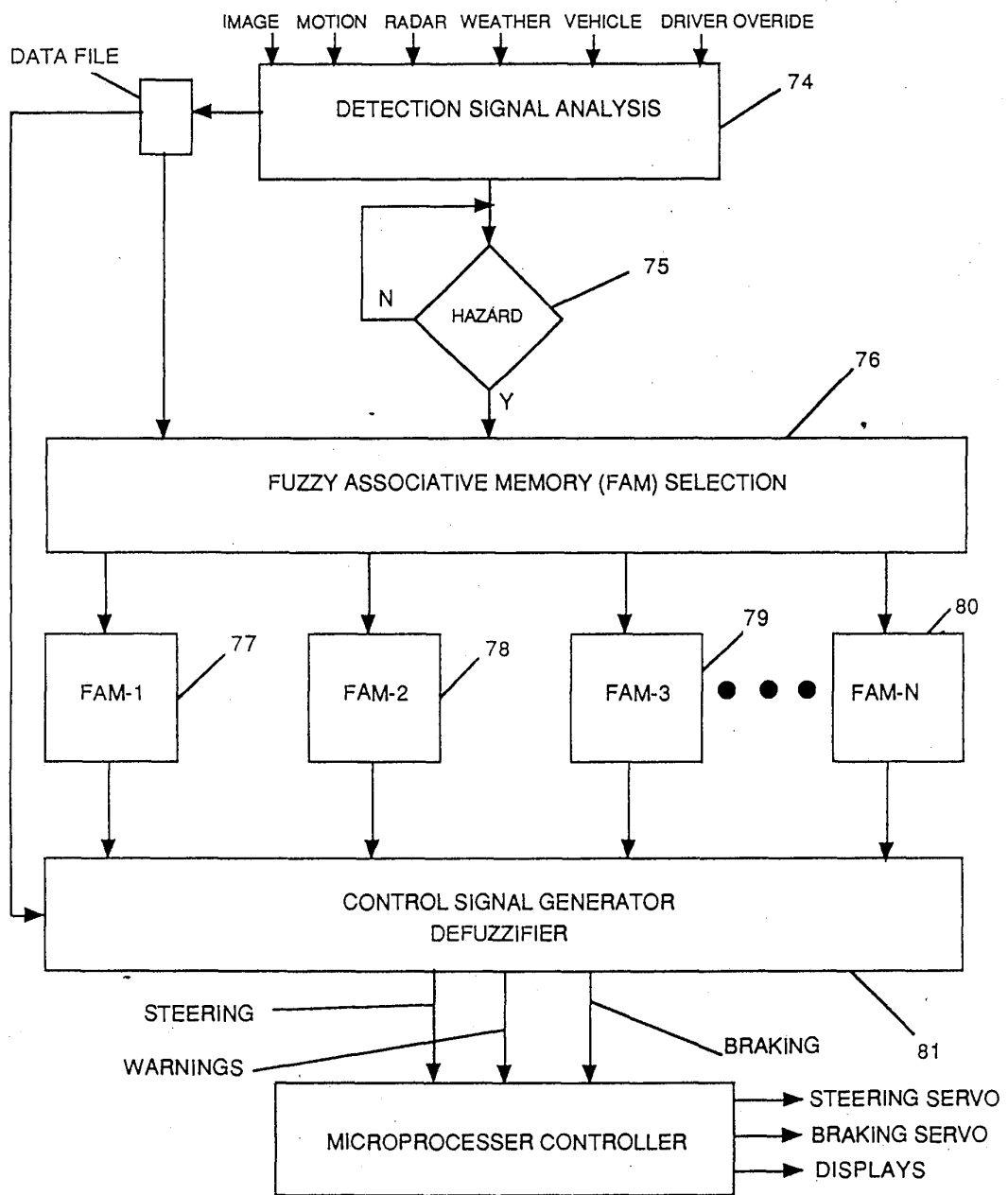

FIGURE 6

11

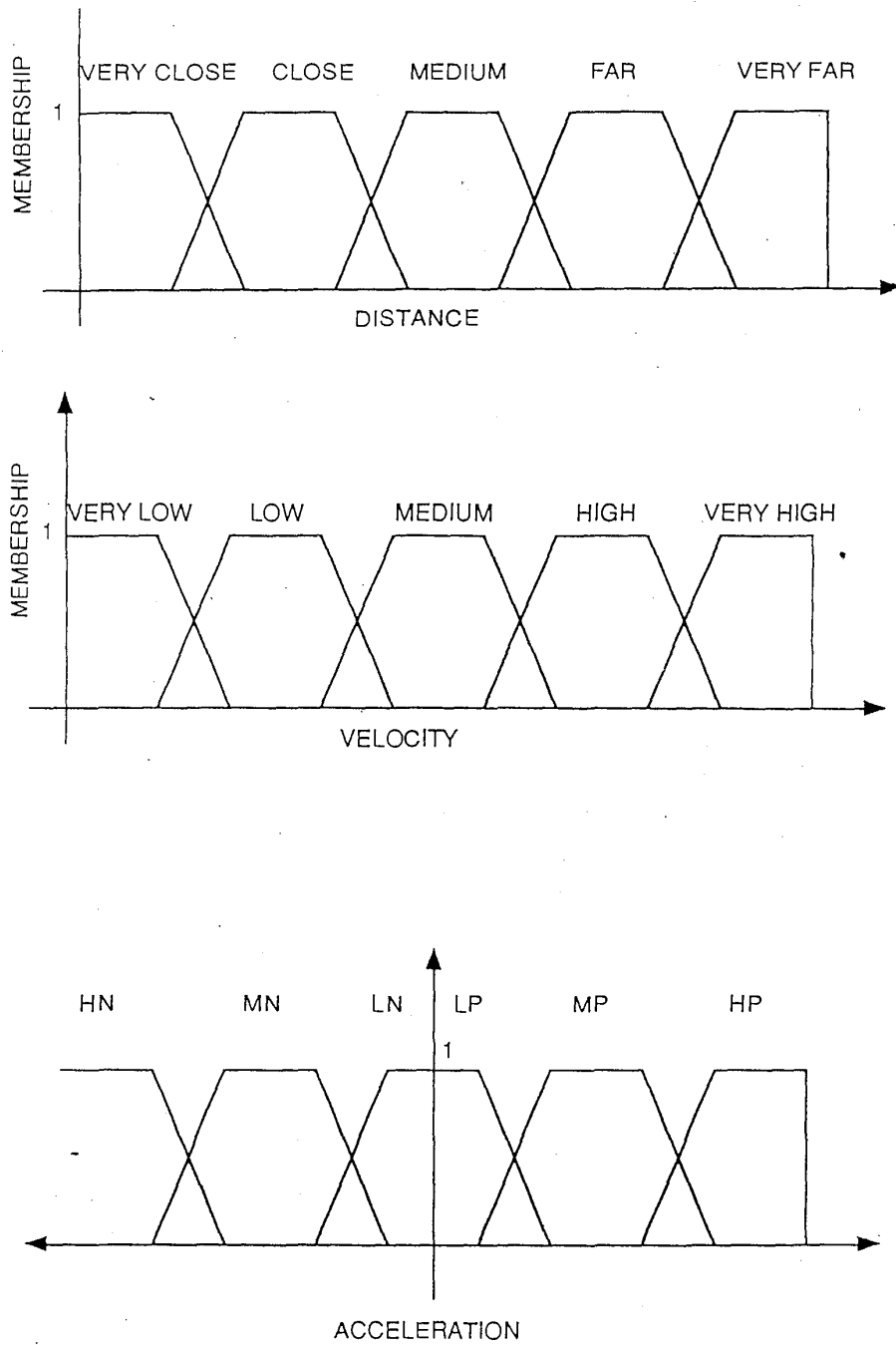

FIGURE 7

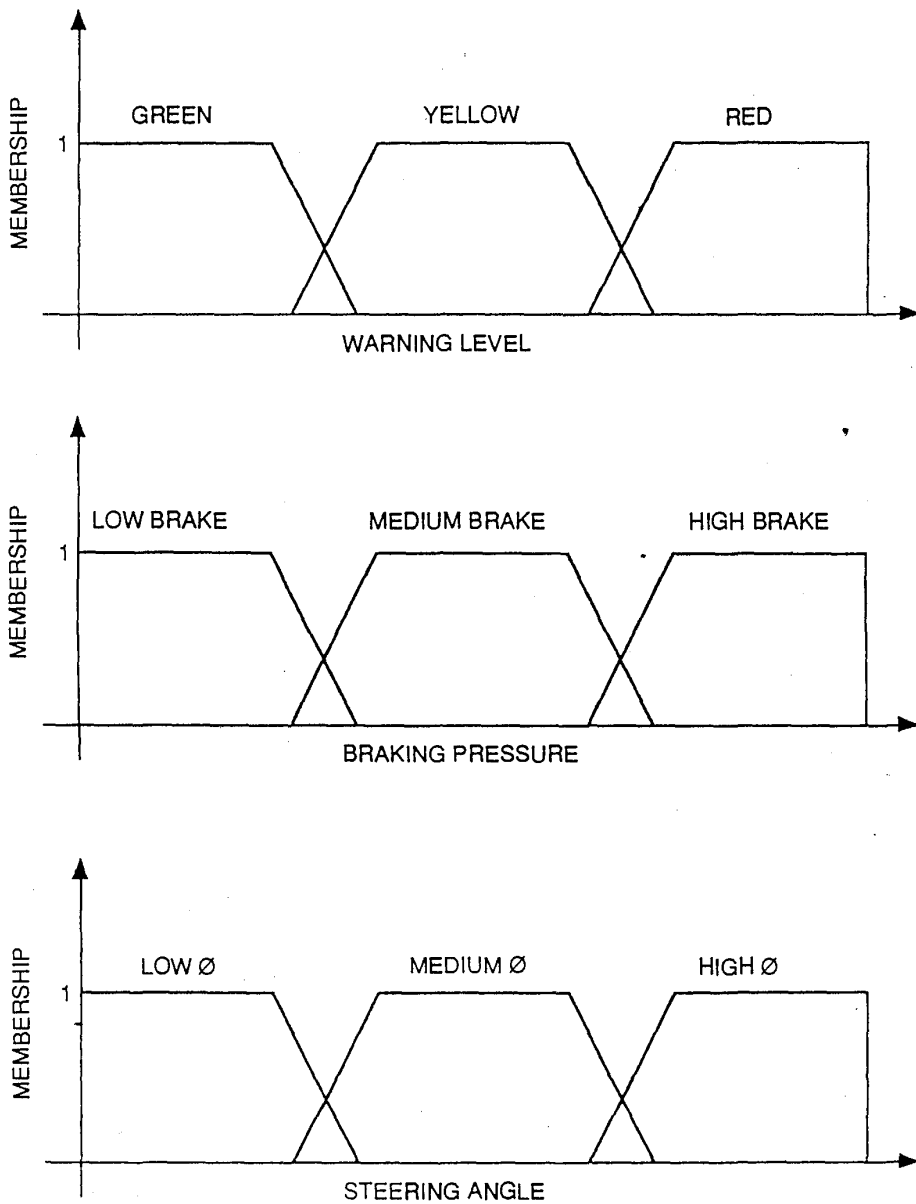

FIGURE 8

D \ V	VL	L	M	H	VH
VC	Y-LB-NØ	R-LB-SØ	R-MB-SØ	R-HB-MØ	R-HB-MØ
C	Y-NB-NØ	Y-LB-NØ	R-MB-SØ	R-HB-SØ	R-HB-MØ
M	G-NB-NØ	Y-NB-NØ	Y-LB-NØ	R-MB-NØ	R-HB-SØ
F	G-NB-NØ	G-NB-NØ	G-NB-NØ	Y-LB-NØ	Y-LB-NØ
VF	G-NB-NØ	G-NB-NØ	G-NB-NØ	Y-LB-NØ	Y-LB-NØ

ACCELERATION =LP

D \ V	VL	L	M	H	VH
VC	R-MB-NØ	R-MB-SØ	R-HB-MØ	R-HB-HØ	R-HB-HØ
C	Y-LB-NØ	R-MB-NØ	R-MB-SØ	R-HB-MØ	R-HB-HØ
M	Y-NB-NØ	Y-LB-NØ	R-MB-NØ	R-HB-NØ	R-HB-SØ
F	G-NB-NØ	G-NB-NØ	Y-NB-NØ	Y-LB-NØ	R-LB-NØ
VF	G-NB-NØ	G-NB-NØ	Y-NB-NØ	Y-LB-NØ	Y-LB-NØ

ACCELERATION =MP

D \ V	VL	L	M	H	VH
VC	R-MB-NØ	R-HB-NØ	R-HB-SØ	R-HB-HØ	R-HB-HØ
C	R-MB-NØ	R-MB-NØ	R-MB-SØ	R-HB-MØ	R-HB-HØ
M	Y-LB-NØ	R-MB-NØ	R-MB-SØ	R-HB-MØ	R-HB-MØ
F	Y-NB-NØ	Y-NB-NØ	Y-NB-NØ	R-LB-NØ	R-LB-NØ
VF	G-NB-NØ	G-NB-NØ	Y-NB-NØ	Y-NB-NØ	R-MB-NØ

ACCELERATION =HP

D \ V	VL	L	M	H	VH
VC	Y-LB-NØ	Y-LB-NØ	R-MB-NØ	R-HB-SØ	R-HB-MØ
C	Y-NB-NØ	Y-MB-NØ	Y-MB-NØ	R-HB-NØ	R-HB-SØ
M	G-NB-NØ	G-NB-NØ	Y-SB-NØ	R-MB-SØ	R-MB-SØ
F	G-NB-NØ	G-NB-NØ	G-NB-NØ	Y-NB-NØ	Y-NB-NØ
VF	G-NB-NØ	G-NB-NØ	G-NB-NØ	G-NB-NØ	Y-NB-NØ

ACCELERATION =LN

D \ V	VL	L	M	H	VH
VC	Y-LB-NØ	Y-LB-NØ	Y-MB-NØ	R-HB-SØ	R-HB-MØ
C	Y-NB-NØ	Y-NB-NØ	Y-LB-NØ	Y-LB-SØ	R-MB-SØ
M	G-NB-NØ	G-NB-NØ	Y-MB-NØ	Y-MB-SØ	R-MB-SØ
F	G-NB-NØ	G-NB-NØ	G-NB-NØ	G-NB-NØ	Y-NB-NØ
VF	G-NB-NØ	G-NB-NØ	G-NB-NØ	G-NB-NØ	Y-NB-NØ

ACCELERATION =MN

D \ V	VL	L	M	H	VH
VC	Y-NB-NØ	Y-LB-NØ	Y-LB-NØ	Y-MB-SØ	R-MB-MØ
C	G-NB-NØ	G-NB-NØ	G-NB-NØ	Y-LB-NØ	Y-LB-NØ
M	G-NB-NØ	G-NB-NØ	G-NB-NØ	Y-LB-NØ	Y-LB-NØ
F	G-NB-NØ	G-NB-NØ	G-NB-NØ	G-NB-NØ	G-NB-NØ
VF	G-NB-NØ	G-NB-NØ	G-NB-NØ	G-NB-NØ	G-NB-NØ

ACCELERATION =HN

FIGURE 9



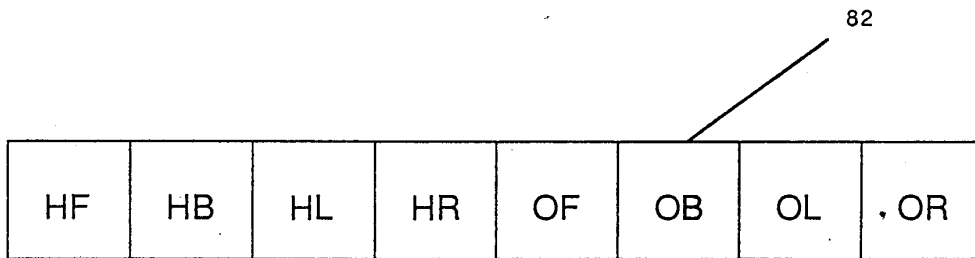

FIGURE 10

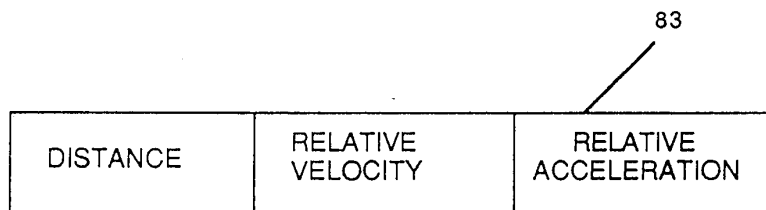

FIGURE 11

STATE VECTOR	HAZZARD				OBSTACLE			
	HF	HB	HL	HR	CF	CB	CL	CR
1	0	0	0	0				
2	0	0	0	1	0	0	0	
3	0	0	0	1	0	0	1	
4	0	0	0	1	0	1	0	
5	0	0	0	1	0	1	1	
6	0	0	0	1	1	0	0	
7	0	0	0	1	1	0	1	
8	0	0	0	1	1	1	0	
9	0	0	0	1	1	1	1	
10	0	0	1	0	0	0		0
11	0	0	1	0	0	0		1
12	0	0	1	0	0	1		0
13	0	0	1	0	0	1		1
14	0	0	1	0	1	0		0
15	0	0	1	0	1	0		1
16	0	0	1	0	1	1		0
17	0	0	1	0	1	1		1
18	0	0	1	1	0	0		1
19	0	0	1	1	0	1		
20	0	0	1	1	1	0		
21	0	0	1	1	1	1		
22	0	1	0	0	0		0	0
23	0	1	0	0	0		0	1
24	0	1	0	0	0		1	0
25	0	1	0	0	0		1	1
26	0	1	0	0	1		0	0
27	0	1	0	0	1		0	1
28	0	1	0	0	1		1	0
29	0	1	0	0	1		1	1
30								
31	0	1	0	1	0		0	
32	0	1	0	1	0		1	
33	0	1	0	1	1		0	
34	0	1	0	1	1		1	
35	0	1	1	0	0			0
36	0	1	1	0	0			1
37	0	1	1	0	1			0
38	0	1	1	0	1			1
39	0	1	1	1	0			
40	0	1	1	1	1			
41	1	0	0	0		0		0
42	1	0	0	0		0	0	1
43	1	0	0	0		0	1	0
44	1	0	0	0		0	1	1
45	1	0	0	0			0	0
46	1	0	0	0		1	0	1
47	1	0	0	0		1	1	0
48	1	0	0	0		1	1	1
49	1	0	0	1		0	0	
50	1	0	0	1		0	1	
51	1	0	0	1			0	
52	1	0	0	1		1	1	
53						1		
54	1	0	1	0		0		0
55	1	0	1	0		0		1
56	1	0	1	0		1		0
57	1	0	1	0		1		1
58	1	0	1	1		0		
59	1	0	1	1		1		
60	1	1	0	0			0	0
61	1	1	0	0			0	1
62	1	1	0	0			1	0
63	1	1	0	0			1	1
64	1	1	0	1			0	
65	1	1	0	1			1	
66	1	1	1	0				0
67	1	1	1	0				1
68	1	1	1	1				

FIGURE 12

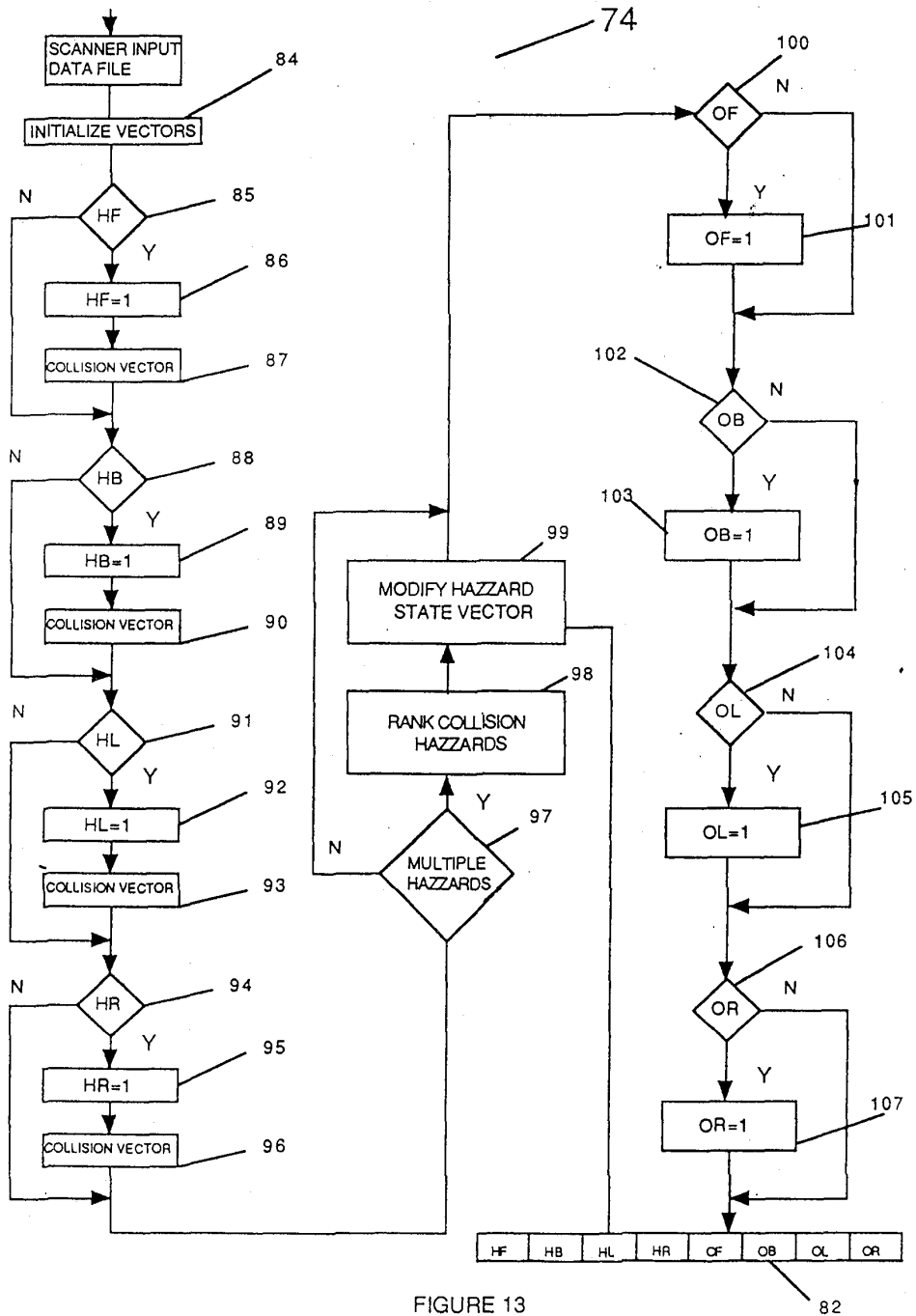

FIGURE 13

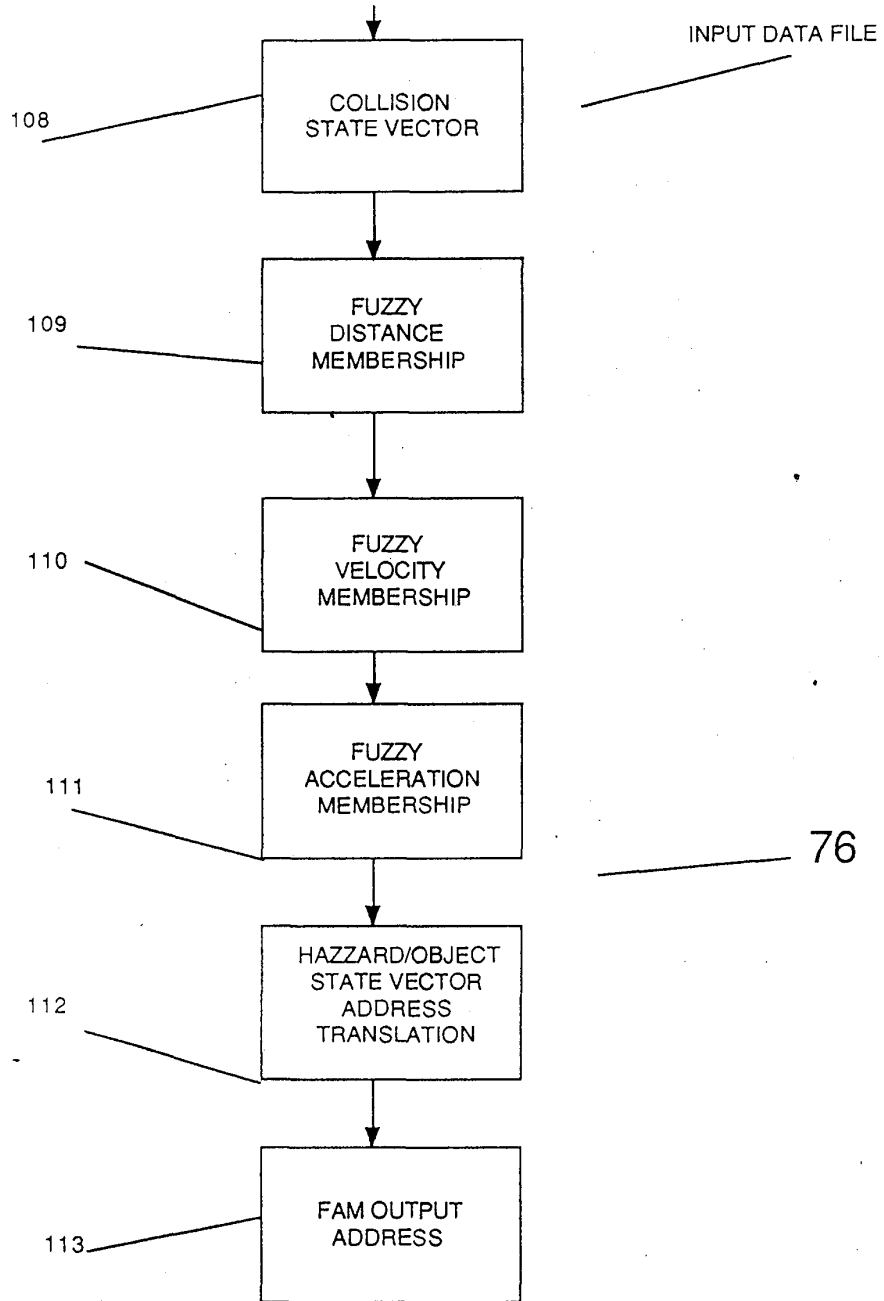

FIGURE 14

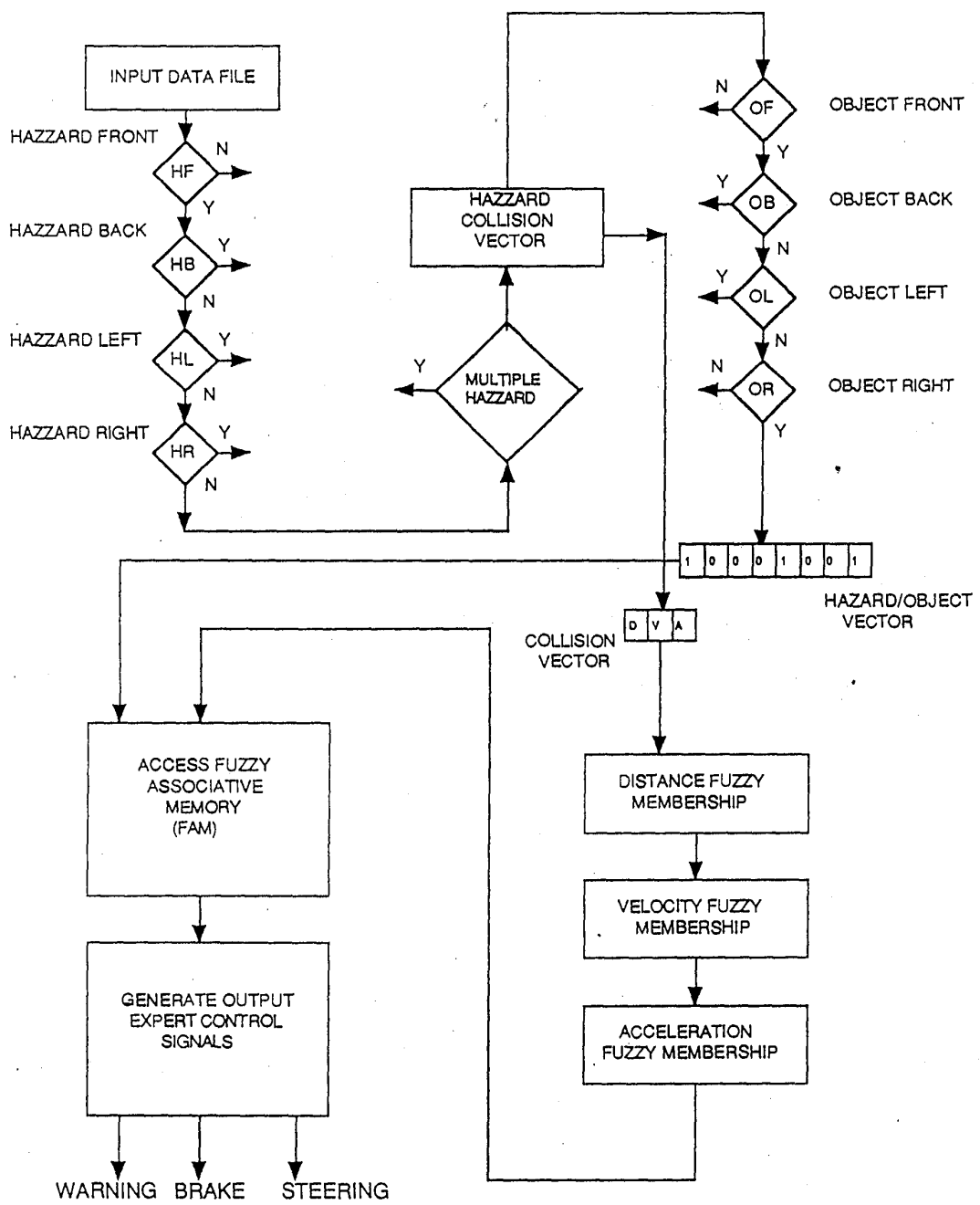

FIGURE 15



**UNITED STATES DEPARTMENT OF COMMERCE  
Patent and Trademark Office**

Address: COMMISSIONER OF PATENTS AND TRADEMARKS  
Washington, D.C. 20231

SERIAL NUMBER	FILING DATE	FIRST NAMED INVENTOR	ATTORNEY DOCKET NO.
---------------	-------------	----------------------	---------------------

08/105,304    08/11/93    LEMELSON

J

AU, A	EXAMINER
-------	----------

26M2/0907

ART UNIT	PAPER NUMBER
----------	--------------

JEROME H. LEMELSON  
SUITE 286  
930 TAHOE BLVD.  
UNIT 802  
INCLINE VILLAGE, NV 89451-9436

2615

2

DATE MAILED: 09/07/94

This is a communication from the examiner in charge of your application.  
COMMISSIONER OF PATENTS AND TRADEMARKS

This application has been examined     Responsive to communication filed on \_\_\_\_\_     This action is made final.

A shortened statutory period for response to this action is set to expire \_\_\_\_\_ month(s), 30 days from the date of this letter.  
Failure to respond within the period for response will cause the application to become abandoned. 35 U.S.C. 133

**Part I THE FOLLOWING ATTACHMENT(S) ARE PART OF THIS ACTION:**

- |   |   |
|---|---|
| 1. <input type="checkbox"/> Notice of References Cited by Examiner, PTO-892.        | 2. <input type="checkbox"/> Notice of Draftsman's Patent Drawing Review, PTO-948. |
| 3. <input type="checkbox"/> Notice of Art Cited by Applicant, PTO-1449.             | 4. <input type="checkbox"/> Notice of Informal Patent Application, PTO-152.       |
| 5. <input type="checkbox"/> Information on How to Effect Drawing Changes, PTO-1474. | 6. <input type="checkbox"/> _____   |

**Part II SUMMARY OF ACTION**

1.  Claims 1-99 are pending in the application.

Of the above, claims \_\_\_\_\_ are withdrawn from consideration.

2.  Claims \_\_\_\_\_ have been cancelled.
3.  Claims \_\_\_\_\_ are allowed.
4.  Claims \_\_\_\_\_ are rejected.
5.  Claims \_\_\_\_\_ are objected to.
6.  Claims 1-99 are subject to restriction or election requirement.
7.  This application has been filed with informal drawings under 37 C.F.R. 1.85 which are acceptable for examination purposes.
8.  Formal drawings are required in response to this Office action.
9.  The corrected or substitute drawings have been received on \_\_\_\_\_. Under 37 C.F.R. 1.84 these drawings are  acceptable;  not acceptable (see explanation or Notice of Draftsman's Patent Drawing Review, PTO-948).
10.  The proposed additional or substitute sheet(s) of drawings, filed on \_\_\_\_\_, has (have) been  approved by the examiner;  disapproved by the examiner (see explanation).
11.  The proposed drawing correction, filed \_\_\_\_\_, has been  approved;  disapproved (see explanation).
12.  Acknowledgement is made of the claim for priority under 35 U.S.C. 119. The certified copy has  been received  not been received  been filed in parent application, serial no. \_\_\_\_\_; filed on \_\_\_\_\_.
13.  Since this application appears to be in condition for allowance except for formal matters, prosecution as to the merits is closed in accordance with the practice under Ex parte Quayle, 1935 C.D. 11; 453 O.G. 213.
14.  Other

**EXAMINER'S ACTION**

Art Unit: 2615

1. This application contains claims directed to the following patentably distinct species of the claimed invention:

- a. claims 1-23, 30-43 relate to a species which monitors the roadway for another vehicle directly ahead of a motor vehicle;
- b. claims 25-29 relate to a species which monitors the roadway for two vehicles traveling in the same and opposite directions ahead of a motor vehicle;
- c. claims 30-43 relate to a species which monitors the roadway for other vehicles, pedestrians, animals, road dividers and other obstacles ahead of a motor vehicle;
- d. claims 44-45 and 46-47 relate to a species which monitors the roadway for other vehicles and stationary obstacles ahead of and approaching from a side road of a motor vehicle;
- e. claims 48-52 relate to a species which monitors the roadway for a second vehicle ahead of a first motor vehicle and for a third vehicle behind the first motor vehicle;
- f. claim 53-66 relate to a species which monitors the roadway for a second vehicle ahead of and to the left and right sides of a motor vehicle;
- g. claim 67-77 relate to a species which monitors only selected areas around a motor vehicle; and
- h. claim 78-84, 85, 86, and 87-99 relate to a species which monitors a motor vehicle and other vehicles;

Serial Number: 08/105,304

-3-

Art Unit: 2615

Applicant is required under 35 U.S.C. § 121 to elect a single disclosed species for prosecution on the merits to which the claims shall be restricted if no generic claim is finally held to be allowable. Currently, no claims are generic.

Applicant is advised that a response to this requirement must include an identification of the species that is elected consonant with this requirement, and a listing of all claims readable thereon, including any claims subsequently added. An argument that a claim is allowable or that all claims are generic is considered nonresponsive unless accompanied by an election.

Upon the allowance of a generic claim, applicant will be entitled to consideration of claims to additional species which are written in dependent form or otherwise include all the limitations of an allowed generic claim as provided by 37 C.F.R. § 1.141. If claims are added after the election, applicant must indicate which are readable upon the elected species. M.P.E.P. § 809.02(a).

Should applicant traverse on the ground that the species are not patentably distinct, applicant should submit evidence or identify such evidence now of record showing the species to be obvious variants or clearly admit on the record that this is the case. In either instance, if the examiner finds one of the inventions unpatentable over the prior art, the evidence or admission may be used in a rejection under 35 U.S.C. § 103 of the other invention.

2. Any inquiry concerning this communication or earlier communications from the examiner should be directed to Amelia Au whose telephone number is (703) 308-6604. The examiner can normally be reached on Monday, Tuesday, Thursday, and Friday from 6:30 am - 4:00 pm EST. The examiner can also be reached on alternate Wednesdays.

If attempts to reach the examiner by telephone are unsuccessful, the examiner's supervisor, Tommy Chin, can be reached on (703) 305-4715. The fax phone number for this Group is (703) 305-9508.

Any inquiry of a general nature or relating to the status of this application should be directed to the Group receptionist whose telephone number is (703) 305-4700.

W  
aa

August 11, 1994

  
TOMMY P. CHIN  
SUPERVISORY PATENT EXAMINER  
GROUP 2600



#13  
TLR  
9/29/94

RECEIVED  
IN THE UNITED STATES PATENT AND TRADEMARK OFFICE

Applicant: Jerome H. Lemelson Art Unit: 2615  
Serial No: 08/105,304 Examiner: Au  
Filed: 8/11/93  
Title: Motor Vehicle Warning and Control System and Method

Honorable Commissioner of  
Patents and Trademarks  
Washington, D.C. 20231

NEW POWER OF ATTORNEY

Dear Sir

Revoking all previous powers of attorney, applicant hereby appoints the following attorneys to transact all business with the Patent and Trademark Office in connection with the above-captioned application.

Steven G. Lisa  
Reg. No. 30,771  
STEVEN G. LISA, LTD.  
15150 North Hayden Road, Suite 202  
Scottsdale, Arizona 85260  
(602) 948-3295

Peter C. Warner  
Reg. No. 36,994  
PETER C. WARNER, P.C.  
15150 North Hayden Road, Suite 202  
Scottsdale, Arizona 85260  
(602) 948-3295

J. Kevin Parker  
Reg. No. 33,024  
551 Greenbay Road  
Highland Park, Illinois 60035  
(708) 432-7302

Dated: September 23, 1994.

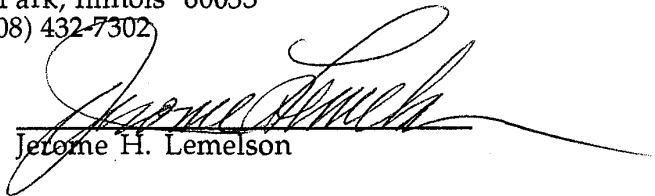
  
Jerome H. Lemelson

RECEIVED

IN THE UNITED STATES PATENT AND TRADEMARK OFFICE

94 SEP 26 PM 3: 55  
 APPLICANT: Jerome H. Lemelson ART UNIT: 2615  
 GROUP 260  
 SERIAL NO. : 08/105,304 EXAMINER: Au  
 FILED : 8/11/93  
 TITLE : Motor Vehicle Warning and Control System and Method

#4  
 EG

Honorable Commissioner of  
 Patents and Trademarks  
 Washington, D.C. 20231

POWER TO INSPECT

Dear Sir:

Please permit Ms. Terry Kannofsky or her representative\* to inspect the above-captioned application and to make copies of any of the papers in it that she may desire.

\*Cindy Pearsall or  
 Kathy VanAsperen

Respectfully submitted,

JEROME H. LEMELSON  
 by his attorney



Peter C. Warner  
 Reg. No. 36,994

Dated: September 23, 1994

PETER C. WARNER, P.C.  
 15150 North Hayden Road  
 Suite 202  
 Scottsdale, Arizona 85260  
 (602) 948-3295

APPROVED  
 EG  
 10-4-94



# 110/1.5

2615  
261  
11-6-94

IN THE UNITED STATES PATENT AND TRADEMARK OFFICE

Applicant : Jerome H. Lemelson Art Unit : 2615  
 Robert D. Pedersen

Serial No. : 08/105,304 Examiner : Au

Filed : 8/11/93

Title : Motor Vehicle Warning and Control System and Method

#5/A  
Rose  
12-6-94

Honorable Commissioner of  
Patents and Trademarks  
Washington, D.C. 20231

Certification Under 37 C.F.R. § 1.8  
 I hereby certify that this paper is being sent this  
 7 day of November, 1994 by first-class  
 mail addressed to "Commissioner of Patents and  
 Trademarks, Washington, D.C. 20231."  
 By: Lynnea J. Hart

RESPONSE TO SPECIES ELECTION REQUIREMENT

Dear Sir:

In response to the species election requirement dated September 7, 1994, applicant has taken efforts to advance the prosecution of this case significantly. Besides responding to the restriction requirement, applicants' attorneys looked at the art located by the Examiner in the file, checked for art in an additional classification, substantially amended the claims, checked the specification for typographic errors, and in every way attempted to place this case in condition for prompt allowance. An Information Disclosure Statement will be delivered promptly, including copies of references not already present in the case file.

Applicants respectfully request a one-month extension of time, and a check for \$110.00 is enclosed for the extension fee. Applicants no longer qualify as a small entity by virtue of recently signed licensing agreements that would cover this application, should it issue as a patent.

In response to the election requirement, applicants elect species (a), with traverse, as explained in the remarks below.

Please enter the following amendments before further examination:

12/90

090 MC 11/25/94 08105304

1 115

110.00 OK

### Amendments

#### IN THE ABSTRACT:

Please move the abstract as originally submitted to a separate page at the end of the specification.

Please amend the text of the abstract as follows:

On the first line after the header "Abstract of the Disclosure," change "for assisting" to --assists--.

On the fifth line after the header "Abstract of the Disclosure," after "computer" add a comma.

On the same line, change "codes which" to --codes that--.

On the fifth through sixth lines after the header "Abstract of the Disclosure," delete "on the road ahead of the vehicle".

Delete the sentence bridging the sixth to ninth lines after the header "Abstract of the Disclosure."

On the eleventh line after the header "Abstract of the Disclosure," delete the words "speed and direction".

On the same line, replace the word "for" at the end of the line with a period.

Please delete the twelfth to fourteenth lines after the header "Abstract of the Disclosure" and the portion of the fifteenth line through the period.

On the fifteenth line after the header "Abstract of the Disclosure," change "and" at the end of the line to --may be--.

On the sixteenth line after the header "Abstract of the Disclosure," change "display(s) as well as" to --displayed, and--.

On the same line, change "and/or" to --or--.

On the same line, delete "may be".

On the seventeenth line after the header "Abstract of the Disclosure," change "employed" to --used--.

On the same line, after "employed" add a comma.

On the same line, after "hazards" add a period.

On the same line, delete "and, in certain".

On the eighteenth line after the header "Abstract of the Disclosure," change "detected instances," to --The system may also use the control signals, particularly through application of fuzzy logic,--.

A1

On the same line, change "and/or" to --and--.

Delete the last three full sentences of the abstract and replace them with the following sentence: --In a particular form, the decision computer may select the evasive action taken from a number of choices, depending on whether and where the detection device senses other vehicles or obstacles.--

A2

#### IN THE SPECIFICATION:

Please amend the specification as follows:

On page 3, line 15, delete the comma after "vehicles".

On page 3, line 17, change "an" to --and--.

On page 3, line 21, change "forms(s)" to --forms--.

On page 4, line 1, after the period, insert the following: --Using such identifying information and comparing it with information on the shapes and sizes of various objects such as rear and front profiles of all production vehicles and the like and their relative sizes or select dimensions thereof, indications of distances to such objects may be computed and indicated as further codes.--

A3  
encl

On page 4, line 1, begin a new paragraph after the insert just above.

On page 4, line 6, after the period, insert the following: --For example, the display may project on the windshield or dashboard such information as images of the controlled vehicle and other vehicles in and adjacent its path of travel and relative distances thereto as well as groups of characters defining same, colored and flashing warning lights and the like for pre-warning and warning purposes.--

A4  
encl

On page 4, line 10, delete the space before "(s)".

On the last line of page 4, add a period at the end of the line.

On page 5, line 2, change "operations(s)" to --operation--.

On the same line, add a comma after "horn".

On page 5, line 12, change "lessens" to --lessen--.

On page 7, lines 5 and 7, change "Image Analysis Computer" to --image analysis computer--.

On page 7, line 13, change "Flow Diagram" to --flow diagram--.

On page 7, lines 15, and 17, change "Fuzzy Logic Algorithms" to --fuzzy logic algorithms--.

On page 7, lines 19-20, change "the Fuzzy Logic Algorithms" to --fuzzy logic algorithms--.

On page 7, line 21, change "State Vector" to --state vector--.

On page 7, second to last line, change "Vector" to --vector--.

On page 8, lines 3 and 5, change "Logic Flow Diagram" to --logic flow diagram--.

On page 8, line 4, change "Fuzzy Logic" to --fuzzy logic--.

On page 9, line 5, change "etc" to --etc--.

On page 9, line 13, delete the space after both occurrences of "head".

---

75 11 On page 9, at the end of the last full paragraph, insert: ~~In a modified form,~~  
video scanning and radar or lidar scanning may be jointly employed to identify and  
indicate distances between the controlled vehicle and objects ahead of, to the side(s) of,  
and to the rear of the controlled vehicle.--

---

On page 10, line 2, change "exists" to --exist--.

On page 10, lines 7 and 8, change "Figure" to --Fig--.

On page 10, line 15, change "3-Dimensional" to --three-dimensional--.

On page 11, line 4, change "ready" to --read--.

On page 11, lines 3 and 9, change "Image Analysis Computer" to --image analysis computer--.

On page 11, line 9, change "Figure" to --Fig--.

- On page 11, line 13, delete the comma.
- On page 11, line 14, change "permits" to --permit--.
- On page 12, line 17, change "Figure" to --Fig--.
- On page 12, the third to last line, delete the comma after "vectors".
- On page 13, lines 16, 18, and 22, change "Figure" to --Fig--.
- On page 13, line 22, change "Decision Computer" to --decision computer--.
- On page 14, line 5, change "Fuzzy Logic" to --fuzzy logic--.
- On page 14, line 6, change "Algorithmic" to --algorithmic--.
- On page 14, line 7, change "Logic" to --logic--.
- On page 14, line 10, change "Figure" to --Fig--.
- On page 14, line 10, change "Flow Diagram" to --flow diagram--.
- On page 14, line 12, change "Control Computer Microprocessor" to --control computer microprocessor--.
- On the same line, change "Figure" to --Fig--.
- On page 14, line 16, delete "Section".
- On page 14, lines 19 and 20, change "Block" to --block--.
- On page 15, line 1, delete the first comma.
- On the same line, delete the space after "practice".
- On page 15, lines 5, 9, and 12, change "Figure" to --Fig--.
- On page 15, last line, change "Fuzzy" to --fuzzy--.
- On page 16, line 1, change "Figure" to --Fig--.
- On page 16, line 5, delete both commas.
- On page 16, line 11, delete both commas.
- On page 16, line 13, change "Figure" to --Fig--.
- On page 16, line 15, delete the space after "straight".
- On page 16, line 18, change "Angle(SØ)" to --Angle(SØ)--.
- On page 17, line 2, change "Fuzzy Logic" to --fuzzy logic--.
- On page 17, at the end of each of the first two paragraphs, add a period.
- On page 17, line 7, change "Fuzzy Membership" to --fuzzy membership--.

On page 17, line 11, add a comma after "result".

On page 17, line 14 and the second to last line, change "Figure" to --Fig.--.

On page 17, second to last line, change "Control Signal Generator" to --control signal generator--.

On page 18, line 6, change "Driver Override" to --driver override--.

On page 18, line 9, change "drivers" to --driver's--.

---

196 On page 18, at the end of line 12, insert: --While manual override is provided, the decision computer may be set to prevent the operation of same if it determines that a collision may occur if the driver operates the manual override.--

---

On page 18, line 13, change "State" to --state--.

On page 18, line 20, after "depending", insert --on the--.

On page 18, lines 20-21, change "zero, "0", " to --zero ("0")--.

On page 18, line 21, change "one "1", " to --one ("1")--.

On page 18, second to last line, change "Vector" to --vector--.

On page 19, line 8, before "44" insert --number--.

On page 19, line 10, delete the space before "void".

On page 19, line 13, add a comma after "12".

On the same line, before "11" insert --number--.

On page 19, line 19, at two occurrences, change "Figure" to --Fig.--.

On page 19, second to last line, change "Flow Diagram" to --flow diagram--.

On page 19, last line, change "State Vector" to --state vector--.

On the same line, before "Fig. 10" insert --of--.

On the same line, change "Collision Vector" to --Collision vector--.

On page 20, line 1, change "Fig." to --Figs.--.

On the same line, delete the commas before and after "74".

On page 20, lines 3-4, change "State Vector" to --state vector--.

On page 20, line 4, change "Collision Vector" to --Collision vector--.

On the same line, delete the commas before and after "82".

On the same line, delete the commas before and after "83".



On page 20, line 5, change "State Vector" to --state vector--.  
On the same line, delete the commas before and after "82".  
On page 20, line 6, change "Collision Vector" to --Collision vector--.  
On the same line, delete the commas before and after "83".  
On page 20, line 10, change "State Vector" to --state vector--.  
On page 20, lines 11-12, change "State Vector" to --state vector--.  
On page 20, line 12, change "Block 86" to --block 86--.  
On page 20, line 13, add a comma after "hazard".  
On page 20, line 14, change "Collision Vector" to --Collision vector--.  
On the same line, change "this" to --those--.  
On the same line, change "Fuzzy Logic" to --fuzzy logic--.  
On page 20, line 15, delete the space after "herein".  
On page 20, third to last line, change "State Vector Operation" to --state vector operation--.  
On the same line, change "Vector Operation" to --vector operation--.  
On page 20, last line, change "from" to --for--.  
On page 21, line 2, change "Block" to --block--.  
On the same line, change "Collision Vector" to --Collision vector--.  
On page 21, line 3, change "Block" to --block--.  
On the same line, change "Blocks" to --blocks--.  
On page 21, line 5, change "Blocks" to --blocks--.  
On page 21, line 6, change "Block" to --blocks--.  
On the same line, change "to" to --through--.  
On page 21, line 7, change "State Vector" to --state vector--.  
On page 21, line 8, change "Collision Vector" to --Collision vector--.  
On page 21, line 14, change "Block" to --block--.  
On page 21, line 15, change "Blocks" to --blocks--.  
On page 22, lines 3 and 4, change "Block" to --block--.  
On page 22, line 4, change "State Vector" to --state vector--.

On page 22, line 5, change two occurrences of "Block" to --block--.

On page 22, lines 9 and 10, change "Block" to --block--.

On page 22, line 13, change "Ranking of Collision Hazards in Block" to --ranking of collision hazards in block--.

On page 22, line 15, change "Block" to --block--.

On page 22, line 16, change "State Vector" to --state vector--.

On the same line, add a comma after "hazards".

On page 22, line 17, change "Block" to --block--.

On page 23, line 4, change "Block" to --block--.

On page 23, at the end of the first full paragraph, add a period.

On page 23, line 11, change "State Vector" to --state vector--.

On page 24, line 1, delete the space after "herein".

On page 24, line 9, add a comma after "vehicle".

On page 24, line 11, change "Vector" to --vector--.

On the same line, change "become" to --becomes--.

On page 24, line 15, change "Vector" to --vector--.

On page 24, line 19, delete one of the two commas.

On page 24, third to last line, change "Figure" to --Fig.--.

On page 25, line 8, change "Fuzzy Logic" to --fuzzy logic--.

On page 25, line 12, change "Logic" to --logic--.

On page 26, at the end of the second full paragraph, add a period.

On page 27, line 18, change "stationery" to --stationary--.

On page 28, line 1, change "Figure" to --Fig.--.

On page 28, last line, delete "19A".

On page 29, line 4, after the comma, insert --or--.

On the same line, change "indica" to --indicia--.

On page 29, line 8, change "the computer(s) 19 and/or 19a" to --computer 19 or the auxiliary computer--.

IN THE DRAWINGS:

Please amend the text in the drawings as follows. Applicants will present substitute drawings sheets containing these changes, together with changes to overcome the objections noted on form PTO-948, when claims are allowed. Applicants respectfully request the Examiner to advise if any of the following proposed changes are unacceptable.

- In Figure 5, block 74, change "processer" to --processor--.
- In Figure 6, on an input line to block 74, change "override" to --override--.
- In Figure 6, block 11, change "microprocesser" to --microprocessor--.
- In Figure 12, at the top of the left column, change "hazzard" to --hazard--.
- In Figure 13, block 99, change "hazzard" to --hazard--.
- In Figure 13, blocks 97 and 98, change "hazzards" to --hazards--.
- In Figure 14, block 112, change "hazzard" to --hazard--.
- In Figure 15, at each of six occurrences, change "hazzard" to --hazard--.

IN THE CLAIMS:

Please cancel claims 15-24, 35, 36, 37, 41, 42, 63, 64, and 66.

Please amend the following claims:

SUBB6

A7  
cont

1. (Once Amended) A method for controlling the travel of a [motor] powered vehicle comprising:
  - (a) as a powered vehicle travels a roadway, scanning the roadway [along which a motor vehicle is traveling] with a video [scanning means] scanner supported by said [motor] vehicle and generating a train of video picture signals [as the vehicle travels said roadway,];
  - (b) computer processing and analyzing each video picture signal as it is generated [and generating a first train of first code signals which first code signals define information relating to the identification of] to detect objects

[ahead] in the vicinity of said [motor] vehicle[, such as at least one other vehicle traveling in the same direction as said motor vehicle,];

(c) measuring the distance from the vehicle to one of the detected objects;

(d) calculating the relative velocity between the one of the detected objects and the vehicle;

[(c)] (e) [employing said first code signals to control the operation of a first] intelligibl[e]y indicating [means to cause it to indicate to the driver of said motor vehicle the identification and distance to the] when one of the objects is in the path [directly ahead] of said vehicle; and

(f) using fuzzy logic to control the acceleration and steering of the vehicle based on the distance and relative velocity between the detected object and the vehicle.

77  
out

2. (Once Amended) A method in accordance with claim 1 wherein [step (c)] measuring the distance between the vehicle and one of the detected objects includes computer processing the [information defined by said first] video picture signals in a manner to [generate second code signals indicative of distances between said motor vehicle and an the object] measure the size of the object in the image defined by said video picture signals [directly ahead of said vehicle].

3. (Once Amended) A method in accordance with claim 2 wherein the object is directly in front of said [motor] vehicle and is a [motor] second powered vehicle traveling in the same direction as the vehicle [there behind] containing said video [scanning means] scanner, [said method including] and wherein measuring the size of the object in the image defined by said video picture signals comprises computer identifying said [motor] second vehicle by its image shape [and computer detecting the distant to said vehicle by intermittently scanning the image of the rear view of said

vehicle and computer processing the video signals generated to determine the size of the vehicle scanned].

4. (Once Amended) A method in accordance with claim 1 wherein [step] act (a) is effected by means of a television camera which scans a field in front of said motor vehicle, including said roadway, at a constant scanning rate.

5. (Once Amended) A method in accordance with claim 4 wherein said television camera is operable to generate full-frame video picture signals on its output.

SUBB7  
A7  
30X

6. (Once Amended) A method in accordance with claim [5] 1 wherein [selected of said first code signals define] one of the detected objects is directly in front of said vehicle and is a second powered vehicle traveling in the same direction as the vehicle containing said scanner, and wherein measuring the size of the object in the image defined by said video picture signals comprises computer identifying said second vehicle by at least a portion of the rear view shape of [a motor vehicle directly ahead of said] the second vehicle[, further comprising computer processing said selected first code signals to calculate and indicate the distance between the two motor vehicles].

7. (Once Amended) A method in accordance with claim 6 [wherein second code signals are generated and employed to control said intelligible indicating means to] further comprising intelligibly indicat[e]ing the distance between said two [motor] vehicles on a continuous basis.

SUBB8

8. (Once Amended) A method in accordance with claim [7] 1 wherein [said second code signals are generated by computer processing and analyzing said first code signals, and said second code signals are employed to] using fuzzy logic to control the acceleration of the vehicle comprises controlling a brak[ing]e [means] to slow the

[foreword] forward travel of said motor vehicle [when said second code signals indicate that a select distance between said two vehicles has been exceeded].

9. (Once Amended) A method in accordance with claim 8 further [including a sensing means to sense] comprising calculating the [speed of] change of relative velocity between said [motor] vehicle [and generating third code signals indicative of said speed] and said object and employing said [second and third code signals to generate fourth code signals to control said braking means when the closing speed and distance between the two vehicles is such as to cause a collision between the two vehicles if the brakes of said motor vehicle are not properly applied] calculated change in relative velocity as an input to said fuzzy logic function.

17  
10/11

10. (Once Amended) A method in accordance with claim [9] 1 [which includes employing said fourth code signals to] wherein intelligibly indicating when one of said objects is in the path of the vehicle comprises operat[e]ing a warning [means] device selected from a group including a warning light, a flashing light, a sound generat[ing means] or, [an intermittent sound generating means,] and a speech [signal generating and select speech generating means] generator [to intermittently warn the driver of said vehicle to immediately slow the forward travel of his vehicle to avoid a collision of the two vehicles].

11. (Once Amended) A method in accordance with claim [1] 10 which includes operating said [intelligible indicating means to generate a] warning device [to the driver of said motor vehicle] when [an unsafe driving condition develops on said roadway] the closing speed and distance between the vehicle and the object is such that a collision between the two will result if the brakes of said vehicle are not applied.

12. (Once Amended) A method in accordance with claim 1 wherein [said intelligible indicating means is controlled in its operation in response to a computerized

expert system employing information generated by an] scanning the roadway  
comprises electro-optically [image scanning means] scanning both ahead of and to both  
sides of said [motor] vehicle.

SUBB9] 13. (Once Amended) A method in accordance with claim 12 wherein  
[scanning is effected of an image field ahead of said vehicle which image field includes  
both vehicles traveling the roadway ahead of said vehicle and objects to both sides of  
said roadway and said expert system is operable to discriminate between moving and  
stationary objects on and adjacent said roadway and to detect and] act (f) comprises  
altering the steering of the vehicle in respon[d]se to an object[s] in the path of said  
vehicle in a manner to [effect the] avoid[ance of] a collision[s] between said vehicle and  
[the] other objects detected at the sides of the vehicle.

A7  
cancel

14. (Once Amended) A method in accordance with claim [12] 13 [wherein  
said] further comprising intelligibl[e]y indicating [means is controlled in its operation in  
response to a computing means employing neural networks] the distance between the  
vehicle and an object comprising a second powered vehicle moving in the same  
direction as the first vehicle and further indicating objects detected at the sides of the  
first vehicle.

UBB10] 30. (Once Amended) A system for operating and controlling a motor  
vehicle comprising:

(a) a motor vehicle having a vehicle body, [motor means] a powered  
drive, and driver-operated [means] controls including an accelerator [for said  
motor means], a brak[ing]e, and a steering [means,] system;

(b) [first means] a first scanning device supported by said vehicle [for  
scanning ahead], directed toward the front of said vehicle [as it travels a  
roadway], and [generating] configured to generate first [image] signals  
modulated with information relating to objects [and obstacles such as other

A7  
cancel

vehicles, pedestrians, animals, road dividers, and other obstacles with which said vehicle may collide,) in the field of said scanning device;

15 [(c) means for generating scanning signals on the output of said scanning means which scanning signals are modulated with image information relating to the identification of obstacles in or approaching the path of travel of said vehicle,]

16 [(d)] (c) a first computer [means for receiving and] coupled to said first scanning device and configured to [analyzing said scanning signals] analyze said first signals as the vehicle travels and [generating] to produce first code signals on an output of said first computer,

20 [(e) means for generating second] which first code signals are indicative of [the] distances between said vehicle and [obstacles] objects ahead of said vehicle [which are] and in the path of said vehicle[.]; and

AD  
21 [(f)] (d) [second] a second fuzzy logic-based computer [means for] coupled to said first computer and configured to analyz[ing]e said first [and second] code signals and to generat[ing]e [third code] command signals[,] on an output of said second computer;

22 [(g)] (e) [means for receiving and utilizing said third code signals] wherein the output of said second computer is electrically coupled to said driver-operated controls such that the command signals are applied to control the operation of said vehicle to avoid collisions between said vehicle and objects in its path of travel.

31. (Once Amended) A system in accordance with claim 30 [wherein said latter means] further compris[es]ing a visual display [means for the driver of] inside said vehicle body [controllably operated by said third code signals to intelligibly indicate road conditions ahead of said vehicle as it is driven] coupled to the output of said first computer and driven by said first code signals to generate symbols representative of objects in the path of the vehicle.



32. (Once Amended) A system in accordance with claim 31 wherein said visual display [means] comprises a heads-up display [means operable] aimed to project images of intelligible information on [the] a front windshield of said vehicle body [within the direct line of vision of said driver of said vehicle].

33. (Once Amended) A system in accordance with claim 30 [wherein said later means] further compris[es]ing a synthetic speech generating [computer operable] system coupled to the output of said first computer and driven by said first code signals to generate sounds of select words of speech [which may be heard by the driver of said vehicle and which inform or warn the driver of hazardous driving conditions, such as objects in the path of travel or about to intersect the path of travel of said vehicle].

34. (Once Amended) A system in accordance with claim [30] 33 [wherein said latter means] further compris[es]ing [a synthetic speech generating computer and] a visual display [means both of which are] coupled to the output of said first computer and simultaneously controll[able]ed by [selected of] said [third] first code signals [to warn the driver of said vehicle of hazardous conditions ahead of said vehicle].

38. (Once Amended) A system in accordance with claim 30 [including object identification means responsive to said first code signals for] wherein the first computer is configured to identify[ing and intelligibly indicating to the driver of said vehicle the identification of said vehicle,] said object by comparing the shape of part of the object to a set of standard shapes and generating a second code signal indicating a match, and [further means for generating fourth] wherein said second code signal[s and employing said fourth code signals in intelligibly indicating] and a measurement of the image of the object is used to determine the distance[s] between said vehicle and the object[s in the path of said vehicle].

SUBC8

39. (Once Amended) A system in accordance with claim 38 wherein said [object identification means] is operable to identify objects, such as] standards represent other vehicles [traveling at an angle to the roadway said vehicle is traveling] and pedestrians moving in [movement in the road ahead and to the side] the field of view of the first scanning device of said vehicle.

A9  
once

40. (Once Amended) A system in accordance with claim [39] 30 further comprising a warning device to the output of said first computer and driven by said first code signals to generate a warning signal perceptible to a human when one of the detected objects is in the path of the vehicle, [including means operable in response to selected of said third code signals for controlling] and wherein the second computer is timed to control the operation of said vehicle to avoid or lessen the effects of collision with an[y] obstacle in the path of said vehicle only if the driver of said vehicle does not [properly or quickly enough respond] alter the driver-operated controls of the vehicle sufficiently to avoid a collision with the object in response to indication by said [intelligible indicating means] warning device that an obstacle[s are] is in the path of travel of said vehicle.

SUBB12  
A10  
once

43. (Once Amended) A system in accordance with claim [41] 40 wherein said [decision computing means] second computer is [operable] coupled to control the [operation of the] speed and steering [means or] of said vehicle.

SUBB14

A11  
cont

53. (Once Amended) A method for controlling the operation of a [motor] vehicle driven by a human being comprising:  
[(a) operating a first motor vehicle by employing a human operator to drive said first motor vehicle along a multiple lane roadway,]  
[(b)] (a) scanning [with a first scanning means] an area in front of [said] a first [motor] vehicle as it travels [said] along a roadway and generating first information signals modulated with image information relating to objects

ahead of said first [motor] vehicle such as a second vehicle traveling said roadway ahead of said vehicle[.];

10  
[(c)] (b) computer processing said first information signals and generating a [first chain] time-varying sequence of digital signals[.];

[(d) computer analyzing said first chain of digital signals and generating first code signals] indicative of the distance between said first and second [motor] vehicles and the closing speed therebetween[.];

14  
[(e)] (c) scanning areas to the left and right sides of said first [motor] vehicle [with a second scanning means as it travels said roadway] and generating [respective] second [and third chains of digital signals,] information signals modulated with image information relating to objects to the sides of said first vehicle;

18  
A11  
CON  
[(f)] (d) computer analyzing said second [and third chains of digital] information signals and generating a second [and third code] time-varying sequence of digital signals when [vehicles] an object to the [left and right] side[s] of said first [motor] vehicle [are] is detected [by the scanning of step (e),];

22  
[(g)] (e) using fuzzy logic to [computer] analyz[ing]e said first[, second and third code] sequence of digital signals as they are generated and [generating fourth code signals indicative] to determine that a collision [may occur] is imminent between said first [motor] vehicle and [one of said vehicles] an object ahead of [or to one of the sides of] said first [motor] vehicle; [is imminent, and]

26  
[(h)] (f) employing said [fourth code] second sequence of digital signals to [effect] select one of several kinds of evasive action, each requiring a different alteration in the control of the operation of said first [motor] vehicle; and

30  
35  
(g) when said fuzzy logic determines that a collision is imminent, automatically altering control of the operation of the first vehicle in the selected fashion to prevent [such] a collision with an object ahead of said first vehicle

without causing the vehicle to collide with objects to the sides of said first vehicle.

54. (Once Amended) A method in accordance with claim 53 [wherein step (h) is effected by employing said fourth code signals to operate an] further comprising the act of first intelligibl[e]y indicating [means] a warning within said first [motor] vehicle [to warn the driver thereof to control the operation of said first motor vehicle in a manner to avoid a collision] and altering control of the operation of the first vehicle only if a collision remains imminent.

55. (Once Amended) A method in accordance with claim 54 wherein the act of intelligibl[e]y indicating [means operates to] comprises visually indicat[e]ing [to the driver of said first motor vehicle] the existence of a hazardous condition.

RH  
1/20/07

56. (Once Amended) A method in accordance with claim 54 wherein the act of intelligibl[e]y indicating [means operates to visually indicate by lighted display to the driver of said first motor vehicle the hazardous condition] further comprises indicating the recommended kind of evasive action selected in act (f).

57. (Once Amended) A method in accordance with claim 54 wherein the act of intelligibl[e]y indicating [means operates to] comprises displaying a visually [indicate by heads-up display] perceptible symbol on [the] a windshield of said first [motor] vehicle [to the driver of said first motor vehicle the hazardous condition].

58. (Once Amended) A method in accordance with claim [54] 55 wherein the act of intelligibl[e]y indicating [means operates to] further comprises visually indicat[e]ing [to the driver of said first motor vehicle] the relative positions between said first [motor] vehicle[, one or more vehicles ahead of and, if present, to either or

both sides of said first motor vehicle] and any obstacles detected in front of and to the side of said first vehicle.

59. (Once Amended) A method in accordance with claim [54] 58 wherein the act of intelligibl[e]y indicating [means operates to] further comprises visually indicat[e]ing [to the driver of said first motor vehicle] the relative closing speeds between at least two of said motor vehicles.

60. (Once Amended) A method in accordance with claim 54 wherein the act of intelligibl[e]y indicating [means operates to indicate by] comprises generating sounds of select speech [which may be heard by the driver of said first motor vehicle, which speech provides details] warning of [the] a hazardous condition.

A 11  
2008

61. (Once Amended) A method in accordance with claim [54] 60 wherein the act of intelligibl[e]y indicating [means operates to indicate by] further comprises generating sounds of select speech [which may be heard by the driver of said first motor vehicle, which speech provides details of the hazardous condition and informs said driver of] recommending a corrective action[s] to take to avoid [an accident] a collision.

62. (Once Amended) A method in accordance with claim [54] 61 wherein [the intelligible indicating means operates to indicate by] generating sounds of select speech [which may be heard by the driver of said first motor vehicle, which speech provides details of the hazardous condition and informs said driver of] recommending a corrective action[s] to take to avoid [an accident using such] a collision comprises synthetically generating one of the following words [as] of speech depending on the kind of evasive action determined by the fuzzy logic controller: "slow down", "[slow down and] stop", "swerve left", and "swerve right"[, etc].

SUB B15

~~A12  
cont~~

65. (Once Amended) A method in accordance with claim 53 wherein [step (h) is effected by employing said fourth code signals to] act (g) comprises selecting between various combinations of alteration of control of the operation of [both the brakes] a speed-altering mechanism and [the] a steering mechanism of said first [motor] vehicle [to avoid collision with the vehicle ahead of said first motor vehicle].

Please add the following dependent claims. The same number of dependent claims have been added as have been canceled, so no fee is due for additional claims.

SUB B19

~~A13  
cont~~

--100. A method in accordance with claim 1 further comprising determining whether several of the detected objects are in the path of the vehicle, and if so, ranking each object that is in the path of the vehicle in ascending order of calculated time to collision, and wherein act (f) is performed with regard to the highest-ranking object.--

--101. A method in accordance with claim 1 further comprising scanning the vicinity of the motor vehicle with at least one other video scanner supported by said vehicle.--

--102. A method in accordance with claim 101 wherein video scanners are positioned to scan in front of the vehicle and behind the vehicle.--

--103. A method in accordance with claim 102 further comprising measuring the distance and relative velocity between the vehicle and a second vehicle detected by the video scanners that is behind the first vehicle.--

--104. A method in accordance with claim 103 wherein act (f) comprises altering the acceleration of the vehicle in response to an object in the path of the vehicle in a manner also to avoid a collision between said vehicle and the second vehicle.--

--105. A method in accordance with claim 101 wherein video scanners are positioned to scan areas in front of the vehicle and on the sides of the vehicle.--

--106. A method in accordance with claim 101 wherein video scanners are positioned to scan areas all around the vehicle.--

--107. A method in accordance with claim 106 further comprising measuring the distance and relative velocity between the vehicle and all of the objects detected by the video scanners.--

A13  
cont

--108. A method in accordance with claim 107 wherein act (f) comprises altering the acceleration and steering of the vehicle in response to an object in the path of the vehicle in a manner also to avoid a collision between said vehicle and all other objects detected by the video scanners.--

--109. A method in accordance with claim 101 further comprising measuring the distance and relative velocity between the vehicle and all of the objects detected by the video scanners.--

--110. A method in accordance with claim 109 wherein act (f) comprises altering the acceleration and steering of the vehicle in response to an object in the path of the vehicle in a manner also to avoid a collision between said vehicle and all other objects detected by the video scanners.--

--111. A method in accordance with claim 110 wherein said act of avoiding a collision with all other detected objects comprises selecting one of a plurality of state vectors controlling the acceleration and steering of the vehicle depending on which sides of the vehicle objects are detected.--

--112. A method in accordance with claim 111 wherein selecting one of a plurality of state vectors comprises selecting one of the state vectors stored in a fuzzy associative memory.--

--113. A system in accordance with claim 1 further comprising determining whether several of the detected objects are in the path of the vehicle, and if so, ranking each object that is in the path of the vehicle in ascending order of calculated time to collision, and wherein acts (c), (d), and (f) are performed with regard to the highest-ranking object.--

A13  
cont  
--114. A system in accordance with claim 30 wherein the first scanning device comprises an image-generating camera.--

--115. A system in accordance with claim 30 wherein the first scanning device comprises a radar-based ranging system.--

SUBB20 }  
--116. A system in accordance with claim 30 further comprising:  
(a) a second scanning device supported by said vehicle, directed away from said vehicle in a direction other than the front of the vehicle, and configured to generate second signals modulated with information relating to objects in the field of said second scanning device; and  
(b) a third computer coupled to said second scanning device and configured to analyze said second signals as the vehicle travels and to produce second code signals on an output of said third computer, which code signals are indicative of distances between said vehicle and objects in the field of said second scanning device.

--117. A system in accordance with claim 116 wherein said second, fuzzy logic-based computer is also coupled to said third computer and configured to analyze said



Q (3)  
agency

second code signals and apply the results of the analysis to select command signals that are applied to control the operation of said vehicle to avoid collisions both with objects in the path of travel of the vehicle and objects in the field of said second scanning device.--

#### Remarks

Applicants have further amended the specification and the abstract to cure certain informalities. Certain portions of the abstract have been copied into the specification, so that the length of the abstract may be reduced.

The claims have been changed to better define the invention. Also, applicants have made amendments to clarify that the method claims refer to specific acts (or their equivalents) and the apparatus claims formerly in means-plus-function language refer to specific structure, so that none of the amended claims are within the scope of Section 112, paragraph 6. Also, the claims have been amended to make some of the claims generic to a number of the species designated by the Examiner.

In response to the species election requirement, applicants elect species (a), with traverse. Applicants respectfully request that the Examiner reconsider the election requirement in view of the amendments to the claims submitted concurrently. Applicants specifically request that the Examiner advise regarding the following questions:

(1) Claims 30-43 are listed both in paragraph 1(a) and paragraph 1(c) of the Examiner's species election requirement. Are applicants correct in assuming that the election of species (a) covers those claims as well?

(2) Claim 24 is not listed in any of the paragraphs of the species election requirement. Are applicants correct in assuming that the material of (now-canceled) claim 24 is included in species (a)?

(3) In view of the amendments submitted here, can some of the claims now be considered generic to at least certain of the species? In particular, applicants note that species (f), (g) and (h) may now be species of a generic claim

1. Applicants have amended the claims of species (f) to further highlight the point, and applicants respectfully request that the Examiner indicate either that species (f) is now part of the same species as the claims of group (a) or at least that claim 1 of group (a) is generic to the claims, as amended, of species (f).

Applicants have added new claims 100-117 dependent on the claims of group (a), and it is respectfully submitted that those claims should properly be considered part of species (a) or at least examined therewith.

The amendments should clarify that applicants intend to claim a fuzzy-logic system that can automatically control a powered vehicle, such as an automobile, to avoid a collision, as specifically set forth in the claim language. In some of the claims, there is specific language to the effect that the evasive maneuver taken by the system to avoid a collision with a vehicle or obstacle in the path of the powered vehicle will depend on whether obstacles are detected to the sides of or behind the vehicle and where those objects are located. The broadest claims contain no such selection of evasive maneuvers.

Although the relationship between the "species" may have been obscured by the original claim language and the large number of independent claims presented, applicants hope that the Examiner would agree to examine—in this application—both the broadest claims and any claims that add the feature of selection of from among many evasive maneuvers depending on the detection of other obstacles. One advantage of the inventive system is that the fuzzy logic mechanism can be set to recommend a change in vehicle operation that, while avoiding a primary collision, will not cause the vehicle to collide with another obstacle.

The prior art of record does not show a system for automatic obstacle avoidance that depends on fuzzy logic, that uses as inputs speed and direction as well as change in speed (acceleration), that uses image analysis in combination with the above to identify objects, that can identify objects from among a plurality of standard images, and that can select the most appropriate evasive maneuver. Various combinations of those

features are presented in the pending, elected claims, and applicants respectfully submits that some or all of those claims are in condition for allowance.

**Conclusion**

If the Examiner has any questions, please feel free to contact applicants' undersigned attorney.

Respectfully submitted,

JEROME H. LEMELSON  
ROBERT D. PEDERSEN  
by their attorney



Dated: November 7, 1994

---

Steven G. Lisa  
Reg. No. 30,771

STEVEN G. LISA, LTD.  
15150 North Hayden Road  
Suite 202  
Scottsdale, Arizona 85260  
(602) 948-3295



**UNITED STATES DEPARTMENT OF COMMERCE  
Patent and Trademark Office**

Address: COMMISSIONER OF PATENTS AND TRADEMARKS  
Washington, D.C. 20231

SERIAL NUMBER	FILING DATE	FIRST NAMED INVENTOR	ATTORNEY DOCKET NO.
---------------	-------------	----------------------	---------------------

08/105,304 08/11/93 LEMELSON

J

EXAMINER

AU, A

26M2/0126

ART UNIT PAPER NUMBER

JEROME H. LEMELSON  
SUITE 286  
930 TAHOE BLVD.  
UNIT 802  
INCLINE VILLAGE, NV 89451-9436

2615

6

DATE MAILED: 01/26/95

This is a communication from the examiner in charge of your application.  
COMMISSIONER OF PATENTS AND TRADEMARKS

This application has been examined  Responsive to communication filed on 11.14.95 *amendment*  This action is made final.

A shortened statutory period for response to this action is set to expire 3 month(s),      days from the date of this letter.  
Failure to respond within the period for response will cause the application to become abandoned. 35 U.S.C. 133

**Part I THE FOLLOWING ATTACHMENT(S) ARE PART OF THIS ACTION:**

- Notice of References Cited by Examiner, PTO-892.
- Notice of Draftsman's Patent Drawing Review, PTO-948.
- Notice of Art Cited by Applicant, PTO-1449.
- Notice of Informal Patent Application, PTO-152.
- Information on How to Effect Drawing Changes, PTO-1474.
- \_\_\_\_\_

**Part II SUMMARY OF ACTION**

- Claims 1-14, 25-34, 38-40, 43-62, 65, 67-117 are pending in the application.  
Of the above, claims \_\_\_\_\_ are withdrawn from consideration.
- Claims 15-24, 35-37, 41-42, 63-64, 66 have been cancelled.
- Claims \_\_\_\_\_ are allowed.
- Claims 1-14, 25-34, 38-40, 43-62, 65, 67-117 are rejected.
- Claims \_\_\_\_\_ are objected to.
- Claims \_\_\_\_\_ are subject to restriction or election requirement.
- This application has been filed with informal drawings under 37 C.F.R. 1.85 which are acceptable for examination purposes.
- Formal drawings are required in response to this Office action.
- The corrected or substitute drawings have been received on \_\_\_\_\_. Under 37 C.F.R. 1.84 these drawings are  acceptable;  not acceptable (see explanation or Notice of Draftsman's Patent Drawing Review, PTO-948).
- The proposed additional or substitute sheet(s) of drawings, filed on \_\_\_\_\_, has (have) been  approved by the examiner;  disapproved by the examiner (see explanation).
- The proposed drawing correction, filed \_\_\_\_\_, has been  approved;  disapproved (see explanation).
- Acknowledgement is made of the claim for priority under 35 U.S.C. 119. The certified copy has  been received  not been received  been filed in parent application, serial no. \_\_\_\_\_; filed on \_\_\_\_\_.
- Since this application appears to be in condition for allowance except for formal matters, prosecution as to the merits is closed in accordance with the practice under Ex parte Quayle, 1935 C.D. 11; 453 O.G. 213.
- Other

**EXAMINER'S ACTION**

Serial Number: 08/105,304

-2-

Art Unit: 2615

### Part III DETAILED ACTION

1. Applicant is reminded that a claim may be amended by rewriting such claim with underlining below the word or words added and brackets around the word or words deleted. "Word(s)" are supposed to be underlined or bracketed, not individual letters within the word, which was what applicant has done to the amended claims filed 11-14-94. Future amendments should comply with the requirement. See 37 CFR 1.121.

#### *Election/Restriction*

2. Applicant's election with traverse of species "a" is acknowledged. However, under further consideration and in view of applicant's amendment of the claims, the restriction requirement set forth in the previous office action has been withdrawn.

#### *Oath/Declaration*

3. Any interlineation or alteration of the application papers filed should be made before the signing of any accompanying oath or declaration pursuant to §1.63 referring to those application papers and should be dated and initialed or signed by the applicant on the same sheet of paper. Application papers containing alternations made after the signing of an oath or declaration referring to those application papers must be supported by a supplemental oath or declaration under §1.67(c).

Serial Number: 08/105,304

-3-

Art Unit: 2615

Page 30a of the specification which is in a different type style has not been dated or initialed or signed by the applicant on the same sheet of paper, therefore a supplemental oath or declaration is required. See 37 CFR 1.52(c).

#### *Information Disclosure Statement*

4. The information disclosure statement filed 8-11-93 along with the specification fails to comply with 37 CFR § 1.98(a)(2), which requires a legible copy of each U.S. and foreign patent; each publication or that portion which caused it to be listed; and all other information or that portion which caused it to be listed. It has been placed in the application file, but the information referred to therein has not been considered as to the merits.

The references listed on pages 55-56 of the disclosure are considered to be the information disclosure statement. Applicant failed to provide a legible copy of each document listed or a PTO-1449 form.

Applicant should also provide a concise explanation of relevance for each disclosure because it is unclear how some of the items listed would be pertinent to this application beyond providing the most basic and general information, for example an entire book entitled "Image Processing."

#### *Drawings*

Art Unit: 2615

5. The proposed drawing correction and/or the proposed substitute sheets of drawings, filed on 11-14-94 have been **disapproved** because any proposal by the applicant for amendment of the drawing to cure defects must be embodied in a separate letter. Otherwise the case, unless in other respects ready for issue, cannot be corrected. MPEP § 608.02(r). Correction is required.

6. The proposed drawing correction and/or the proposed substitute sheets of drawings, filed on 11-14-94 have been **disapproved** because any proposal by the applicant for changes to the drawing to cure defects must be filed as a print or pen-and-ink sketch showing such changes in red ink. MPEP § 608.02(v). Correction is required.

#### *Specification*

7. Applicant is reminded of the proper language and format of an Abstract of the Disclosure.

The abstract should be in narrative form and generally limited to a single paragraph on a separate sheet within the range of 50 to 250 words. It is important that the abstract not exceed 250 words in length since the space provided for the abstract on the computer tape used by the printer is limited. The form and legal phraseology often used in patent claims, such as "means" and "said", should be avoided. The abstract should describe the disclosure sufficiently to assist readers in deciding whether there is a need for consulting the full patent text for details.

The language should be clear and concise and should not repeat information given in the title. It should avoid using phrases which can be implied, such as, "The disclosure concerns," "The disclosure defined by this invention," "The disclosure describes," *etc.*

Art Unit: 2615

8. The Abstract of the Disclosure is objected to because the abstract contains more than 250 words. Correction is required. See M.P.E.P. § 608.01(b).

9. This application is informal in the arrangement of the specification.

The following guidelines illustrate the preferred layout and content for patent applications. These guidelines are suggested for the applicant's use.

#### **Arrangement of Specification**

The following order or arrangement is preferred in framing the specification and, except for the title of the invention, each of the lettered items should be preceded by the headings indicated below.

- (a) Title of the Invention.
- (b) Cross-References to Related Applications (if any).
- (c) Statement as to rights to inventions made under Federally-sponsored research and development (if any).
- (d) Background of the Invention.
  1. Field of the Invention
  2. Description of the Prior Art.
- (e) Summary of the Invention.
- (f) Brief Description of the Drawing.
- (g) Description of the Preferred Embodiment(s).
- (h) Claim(s).
- (i) Abstract of the Disclosure.

10. The disclosure is objected to because of the following informalities:

The disclosure does not have a "Background of the Invention" section. Appropriate correction is required.



Art Unit: 2615

11. The specification is objected to as failing to provide proper antecedent basis for the claimed subject matter. See 37 C.F.R. § 1.75(d)(1) and M.P.E.P. § 608.01(l). Correction of the following is required:

a. from claim 1, the terminology "powered vehicle" has no antecedent basis in the specification.

b. from claims 3 and 14, a second "powered vehicle" has no antecedent basis in the specification.

c. from claim 31, line 5-6, and claim 57, line 3, the term "symbols" of objects has no antecedent basis in the specification.

*Response to Amendment*

12. The amendment filed 11-14-94 is objected to under 35 U.S.C. § 132 because it introduces new matter into the specification. 35 U.S.C. § 132 states that no amendment shall introduce new matter into the disclosure of the invention. The added material which is not supported by the original disclosure is as follows:

a. the insertion to page 4, line 1:

Using such identifying information and comparing it with information on the shapes and sizes of various objects such as rear and front profiles of all production vehicles and the like and their relative sizes or select dimensions therefore, indications of distances to such objects may be computed and indicated as further codes.

Serial Number: 08/105,304

-7-

Art Unit: 2615

There was no previous disclosure of identifying information and information on the shapes and sizes of various object such as rear and front profiles of all production vehicles and the like and their relative sizes or select dimensions to provide further codes.

- b. the insertion to page 4, line 6:

For example, the display may project on the windshield or dashboard such information as images of the controlled vehicle and other vehicles in and adjacent its path of travel and relative distances thereto as well as groups of characters defining same, colored and flashing warning lights and the like for pre-warning and warning purposes.

There was no previous disclosure of being used for pre-warning or warning purposes.

- c. the insertion to page 9, at the end of the last paragraph:

In a modified form, video scanning and radar or lidar scanning may be jointly employed to identify and indicate distances between the controlled vehicle and objects ahead of, to the side(s) of, and to the rear of the controlled vehicle.

There was no previous disclosure of a video scanning and radar or lidar scanning "jointly employed" to identify and indicate distances to the side(s) of and to the rear of the controlled vehicle.

- d. insertion to page 18, at the end of line 12:

While manual override is provided, the decision computer may be set to prevent the operation of same if it determines that a collision may occur if the driver operates the manual override" is new matter.

Serial Number: 08/105,304

-8-

Art Unit: 2615

There was no previous disclosure of a decision computer which may be set to prevent the operation of the manual override if it determines that a collision may occur if the driver operates the manual override.

Applicant is required to cancel the new matter in the response to this Office action.

*Claim Rejections - 35 USC § 112*

13. The following is a quotation of the first paragraph of 35 U.S.C. § 112:

The specification shall contain a written description of the invention, and of the manner and process of making and using it, in such full, clear, concise, and exact terms as to enable any person skilled in the art to which it pertains, or with which it is most nearly connected, to make and use the same and shall set forth the best mode contemplated by the inventor of carrying out his invention.

The specification is objected to under 35 U.S.C. § 112, first paragraph, as failing to adequately teach how to make and/or use the invention, i.e. failing to provide an enabling disclosure.

a. From claim 1, lines 14-15; claim 9, lines 2-3; claim 103, lines 1-2; claim 107, lines 1-2; and claim 109, lines 1-2; "calculating the relative velocity between the one of the detected objects and the vehicle" has no enabling disclosure. The statement in the specification on page 12 reciting: "The relative velocities and accelerations can also be easily calculated from respective first and second derivatives of the image width with respect to time" is a mathematical truth, but there is no disclosure of a device which determines

Art Unit: 2615

what the derivatives are from the image with respect to time because there is no disclosed device which determines the time factor.

b. From claim 2, line 4; claim 3, lines 6; claim 6; claim 38; and claim 39, dealing with "measuring the size of the object in the image" and "identifying a second vehicle by its shape" to calculate distance has no enabling disclosure. The specification only discloses determining a width to calculate distance, not a size or a shape.

c. From claims 13, 14, 25, 30, 44, 45, 46, 48, 53, 58, 67, 78, 81, 85, 86, 100, 107, 108, 109, 110, 111, and 117 claim tracking and/or identifying all objects to prevent multiple collisions from any and all directions. However, there is no disclosure which would enable the claimed invention to work. Multiple tracking of all vehicles, objects, etc. surrounding a vehicle as it travels in real life situations and in real time and its corresponding collision computations and control operations require numerous complex and error free computations within a specific time frame. Such computations are unrealistic and unacceptable for real-time multiple collision avoidance. The article "Intelligent Road Transit: The Next Generation," AI Expert April 1994, pages 16-24, by Denny Rock, et al discusses this issue. The present specification has failed to provide any evidence or support of an enabling disclosure which would enable the claimed invention to be implemented and operate as claimed without the problems and deficiencies cited in the Rock reference.

d. Claims 53 and 117 claim avoiding collision with an object ahead of a vehicle without causing the vehicle to collide with objects to the sides of the first vehicle. It is not

Art Unit: 2615

enabling because it would not work in situations where collision with objects on the side is unavoidable. The claims presume that it would always avoid collisions with front objects and side objects, but there is no enabling disclosure supporting that it works in all situations, or in cases where collisions are unavoidable. Further the disclosure only discloses lessening the collision rather than completely avoiding all collisions.

14. The following is a quotation of the first paragraph of 35 U.S.C. § 112:

The specification shall contain a written description of the invention, and of the manner and process of making and using it, in such full, clear, concise, and exact terms as to enable any person skilled in the art to which it pertains, or with which it is most nearly connected, to make and use the same and shall set forth the best mode contemplated by the inventor of carrying out his invention.

The specification is objected to under 35 U.S.C. § 112, first paragraph, as the specification, as originally filed, does not provide support for the invention as is now claimed.

a. Claim 1, line 14-15, "calculating the relative velocity between the one of the detected objects and the vehicle" has no support in the specification because there is no disclosure of any device which calculates the velocity.

b. Claims 2, 3, and 6 claim "measuring the size of the object defined by the video signals" has no original support in the disclosure.

c. Claim 30, line 3, "a powered drive" has no support.

Art Unit: 2615

d. Claim 38, line 4-5, "comparing the shape of part of the object to a set of standard shapes and generating a second code signal indicating a match" has no support. There is no original disclosure of storing set of standard shapes, and comparing the shape of part of the objects for a match. The disclosure only supports storing and comparing "widths" which is not a shape.

e. Claim 39, lines 2-3, "said standards represent other vehicles" has no support.

f. Claim 40, lines 5-6, "the second computer is timed to control the operation of said vehicle to avoid or lessen the effects of collision with an obstacle in the path of said vehicle only if the driver of said vehicle does not alter the driver-operated controls of the vehicle sufficiently to avoid a collision with the object" has no original support in the specification. There is no disclosure in which the computer controls the vehicle if the driver does not sufficiently control the vehicle to avoid a collision.

g. Claim 53, line 36, "prevent a collision with an object ahead of said first vehicle without causing the vehicle to collide with objects to the sides of said first vehicle" has no support in the specification. There is no disclosure of avoiding collisions to both the front and the sides, only the lessening of the collision.

h. Claims 100 and 113 claim "ranking each object that is in the path of the vehicle in ascending order of calculated time to collision". There is no disclosure of ranking in ascending order of calculated time in the specification.

Art Unit: 2615

i. Claim 117, line 4-5, "apply the results of the analysis to select command signals that are applied to control the operation of said vehicle to avoid collisions both with object in the path of the vehicle and objects in the field of said second scanning device" has no support. There is no disclosure supporting that collisions can be avoided in "both" the path of the vehicle and the objects in the second scanning field. There is no disclosure supporting that all possible collision will be avoided, only reducing the collisions. The same applies to claim 13.

15. Claims 1-14, 25-34, 38-40, 43-62, 65, and 67-117 rejected under 35 U.S.C. § 112, first paragraph, for the reasons set forth in the objection to the specification.

16. Claims 1-14, 25-34, 38-40, 43-62, 65, and 67-117 rejected under 35 U.S.C. § 112, second paragraph, as being indefinite for failing to particularly point out and distinctly claim the subject matter which applicant regards as the invention.

a. Re claim 1, line 3, "a powered vehicle" should be "the powered vehicle" because it refers to the same on line 2.

b. Re claim 3, line 5, "comprises computer comprising" reads awkwardly, "a" should be added before "computer". The same applies to claim 6.

c. Re claim 4, line 2, "act (a)" is improper, a method claim comprises a series of steps, not acts. It should be changed back to "step (a)".

Art Unit: 2615

- d. Re claim 4, lines 2-3, "said motor vehicle" has no antecedent basis.
- e. Re claim 8, line 6, "said motor vehicle" has no antecedent basis.
- f. Re claim 9, line 8, "said fuzzy logic function" has no antecedent basis.
- g. Re claim 10, lines 2-3, "wherein intelligibly indicating when one of said objects is in the path of the vehicle" has no antecedent basis.
- h. Re claim 13, line 5, "act (f)" is improper, a method claim comprises a series of steps, not acts. It should be changed back to "step (f)".
- i. Re claim 13, lines 5-8, "altering the steering of the vehicles in response to an object in the path of said vehicle in a manner to avoid a collision between said vehicle and other objects at the sides of the vehicle" is confusing because it reads as, if an object is detected in front of the vehicle it is okay to collide with it as long as it avoids a collision with objects at the side of the vehicle.
- j. Re claim 14, line 4, "an object" is indefinite because it is unclear if it is the same object or one of the objects recited in claim 1.
- k. Re claim 25, line 5, "both vehicles" is indefinite because it has no clear antecedent basis.
- l. Re claim 25, line 6, "said vehicle" is indefinite because it is unclear which vehicle it is referring to, the motor vehicle, other vehicles in the same direction or approaching, or one of the both vehicles.



Art Unit: 2615

m. Re claim 25, lines 10-11, "said first code signals" should be --said first digital code signals-- for clear antecedent basis.

n. Re claim 25, line 11, "the objects" has no antecedent basis.

o. Re claim 25, line 12, "said vehicle" is indefinite because it has multiple antecedent basis, it is unclear which vehicle it is referring to.

p. Re claim 25, line 13, "an object immediately ahead of said vehicle" is indefinite because it is unclear if this is the "at least one object in the path of said vehicle" recited on line 12.

q. Re claim 28, line 2 and line 3 (both occurrences) "said vehicle" has multiple antecedent basis, it is unclear which vehicle it is referring to.

r. Re claim 29, lines 2-4, all occurrences of "said vehicle" and "another vehicle" have multiple antecedent basis, it is therefore unclear which vehicle it is referring to.

s. Re claim 30, line 11, "said scanning device" should be --said first scanning device--.

t. Re claim 38, line 4, "said object" should be --said objects--.

u. Re claim 44, line 10, "said objects" has no antecedent basis.

v. Re claim 44, lines 6-12 and lines 16-17, all occurrences of "said vehicle" has multiple antecedent basis, it is unclear which vehicle it is referring to.

w. Re claim 46, line 10, "said objects" has no antecedent basis.

Art Unit: 2615

- x. Re claim 46, lines 8-16, all occurrences of "said vehicles" has multiple antecedent basis.
- y. Re claim 53, line 9, "said vehicle" should be --said first vehicle--.
- z. Re claim 53, lines 24-25, "said first sequence of digital signals" has no proper antecedent basis.
  - aa. Re claim 54, line 3, "the act" should be --the step--.
  - ab. Re claim 55, line 2, "the act" should be --the step--.
  - ac. Re claim 56, line 2, "the act" should be --the step--.
  - ad. Re claim 56, line 4, "act (f) should be --step (f)--.
  - ae. Re claim 57, line 2; claim 58, line 2; claim 59, line 2; claim 60, line 2; and claim 61, line 2; "the act" should be --the step--.
  - af. Re claim 62, line 7, "the fuzzy logic controller" has no antecedent basis.
  - ag. Re claim 67, line 13, "Further" should be --further--.
  - ah. Re claim 85, lines 9-11, all occurrences of "said vehicle" has multiple antecedent basis.
  - ai. Re claim 86, lines 4-12, all occurrences of "said vehicle" has multiple antecedent basis. The same problem applies to claims 87-90.
  - aj. Re claim 100, line 4, "act (f)" is improper, a method claim comprises a series of steps, not acts. It should be changed to "step (f)".
  - ak. Re claim 101, line 2, "said motor vehicle" has no antecedent basis.

Art Unit: 2615

al. Re claim 102, before "video scanners" add --the-- since it has been previously recited.

am. Re claim 102, line 2 and claim 103, line 3, "behind" the vehicle is indefinite because it is unclear if it means at the back of the same vehicle or behind as in physically separate.

an. Re claim 103, "the first vehicle" is indefinite it has no clear antecedent basis.

ao. Re claim 103, line 3, it is unclear what is "behind the first vehicle", is it the video scanners or the second vehicle?

ap. Re claim 104, line 1, "act (f)" should be "step (f)".

aq. Re claim 104, line 2, "in response to an object in the path of the vehicle in a manner also to avoid collision between said vehicle and the second vehicle" is indefinite because it is unclear if "in response to an object" is actually "the second vehicle" or something else. It implies that if there is an object in the path of the vehicle, run over it, but don't collide with the second vehicle.

ar. Re claim 105, line 1, before "video scanners" insert --the--.

as. Re claim 106, line 1, before "video scanners" insert --the--.

at. Re claim 108, line 1, "act (f)" should be --step (f)--.

*Claim Rejections - 35 USC § 103*

17. The following is a quotation of 35 U.S.C. § 103 which forms the basis for all obviousness rejections set forth in this Office action:

Art Unit: 2615

A patent may not be obtained though the invention is not identically disclosed or described as set forth in section 102 of this title, if the differences between the subject matter sought to be patented and the prior art are such that the subject matter as a whole would have been obvious at the time the invention was made to a person having ordinary skill in the art to which said subject matter pertains. Patentability shall not be negated by the manner in which the invention was made.

Subject matter developed by another person, which qualifies as prior art only under subsection (f) or (g) of section 102 of this title, shall not preclude patentability under this section where the subject matter and the claimed invention were, at the time the invention was made, owned by the same person or subject to an obligation of assignment to the same person.

This application currently names joint inventors. In considering patentability of the claims under 35 U.S.C. § 103, the examiner presumes that the subject matter of the various claims was commonly owned at the time any inventions covered therein were made absent any evidence to the contrary. Applicant is advised of the obligation under 37 C.F.R. § 1.56 to point out the inventor and invention dates of each claim that was not commonly owned at the time a later invention was made in order for the examiner to consider the applicability of potential 35 U.S.C. § 102(f) or (g) prior art under 35 U.S.C. § 103.

18. Claims 1-10, 12-14, 53, 65, 101-112 rejected under 35 U.S.C. § 103 as being unpatentable over Adachi et al (P.N. 5,189,619) in view of Dye (P.N. 4,872,051).

a. Re claim 1, Adachi discloses controlling a vehicle on a roadway by measuring the distance and calculating the relative acceleration between the vehicle and a detected object; intelligibly indicating when the object is in the path of the vehicle; and using fuzzy logic to control the acceleration and steering of a vehicle based on distance and relative velocity between a detected object and a vehicle (col. 2, lines 55-64).

Adachi discloses using relative acceleration instead of relative velocity in determining the fuzzy controlled acceleration and steering. However, acceleration is a rate of change of

Art Unit: 2615

the velocity. Therefore, in order to determine acceleration, the velocity must also be calculated. It would also have been obvious to determine velocity because a traveling vehicle may have velocity and acceleration.

Adachi discloses using a laser scanner for scanning the roadway to detect objects in the vicinity of the vehicle, but does not disclose the laser scanner generates a video picture signal.

Dye teaches using a television camera (12) which generates a video picture signal to detect objects in the vicinity of a vehicle.

Therefore it would have been obvious to one skilled in the art that the laser scanner of Adachi and the television camera of Dye are alternative devices which perform the same function of detecting an object in the vicinity of a vehicle.

b. Re claim 2, Dye as applied above discloses measuring the size of the object (col. 2, lines 6-7).

c. Re claims 3 and 6, the device of Adachi as modified by Dye would disclose the object is a second vehicle and located in front of the vehicle carrying the scanner.

d. Re claim 4, Dye as applied to Adachi discloses a television camera. The view of the camera can be adjusted as desired.

e. Re claim 5, conventional television cameras output full-frame video picture signals.

Art Unit: 2615

f. Re claim 7, Adachi discloses intelligibly indicating the distance between the two vehicles on a continuous basis (col. 2, lines 65-68).

g. Re claim 8, Adachi discloses using fuzzy logic control the brakes (col. 6, lines 7-9).

h. Re claim 9, Adachi uses relative speed to input to the fuzzy logic function. A traveling vehicle may have both acceleration and velocity, therefore one skilled in the art may use either one to input to the fuzzy logic function depending upon the status of the vehicle since a vehicle can travel at a constant velocity with no acceleration.

i. Re claim 10, Dye teaches operating a warning device (alarm 20) can be visible or audible (col. 4, lines 20-24) to indicate a detected object. Therefore it would have been obvious to one skilled in the art that any type of visible or audible alarm including a warning light, flashing light, a sound generator, or a speech generator can be employed.

j. Re claims 12, 105, and 106, Adachi as modified by Dye does not disclose scanning both ahead and to both sides of the vehicle. However, it would have been obvious to one skilled in the art to scan in all directions in order to avoid collisions from other directions instead of just one direction.

k. Re claims 13, Adachi discloses altering the steering of the vehicle (col. 8, lines 63-68). Therefore it would have been obvious to one skilled in the art steer away from possible collision.

Art Unit: 2615

l. Re claim 14, Adachi as modified to detect objects in all directions for possible collision would be able to detect a second vehicle ahead and objects to the sides.

m. Re claim 101, Adachi does not disclose scanning the vicinity of the vehicle with at least another video scanner. However, it would have been obvious to one skilled in the art to use another scanner in order help scan the vicinity of the vehicle because most scanners have a limited field of view.

n. Re claim 102, positioning a scanners in the front and behind the vehicle would be an obvious choice since it would cover the areas where most collisions occur.

o. Re claims 103 and 107, Adachi as modified to locate a scanner behind the vehicle would measure the distance and relative velocity between the first vehicle and a second vehicle behind the first vehicle in order to prevent an collision behind the first vehicle.

p. Re claims 104 and 108, Adachi as modified would alter the acceleration and/or steering of the vehicle to avoid a collision as discussed above.

q. Re claims 65 and 109-112, Adachi as modified to detect all areas would discloses determine the distance and relative velocity, altering the acceleration and steering, and using the fuzzy logic for all areas.

r. Re claim 53, this claim differs from claim 1 in that it claims scanning the front and also scanning the left and right sides of the vehicle to determine and prevent collisions from the sides of the vehicle. It would have been obvious to one skilled in the art ~~that if the~~

Art Unit: 2615

that if the front of the vehicle can be scanned and to prevent collisions, then it would be advantageous to scan the left and right sides of the vehicle to determine and prevent collisions from those directions also since collisions can come from all directions.

19. Claims 11 and 54-57 rejected under 35 U.S.C. § 103 as being unpatentable over Adachi in view of Dye as applied to claims 10 and 53 above, and further in view of Taylor (P.N. 5,249,157).

a. Re claim 11, Adachi does not disclose operating a warning device if a collision would result if the brakes of the vehicle were not applied.

Taylor discloses generating a warning signal when the separation distance between vehicles is insufficient (col. 26, lines 25-30) and would cause a collision. Therefore it would have been obvious to one skilled in the art to use a warning signal as suggest by Taylor in the device of Adachi so to inform the driver of any possible collisions.

b. Re claims 54 and 55, this claim is similar to claim 11.

c. Re claim 56, Adachi discloses employing an evasive action of controlling the steering and/or brakes which reads on indicating the recommended kind of evasive action.

d. Re claim 57, Taylor discloses a warning signal, it would have been obvious to one skilled in the art that the display location would have been an obvious design choice base upon which location would best attract the driver's attention since displaying an image on a windshield is well known in the art.



Art Unit: 2615

20. Claims 58-59 rejected under 35 U.S.C. § 103 as being unpatentable over Adachi in view of Dye and Taylor as applied to claim 55 above, and further in view of Morioka (JP 4-219900 A).

Re claims 58 and 59, Adachi as modified discloses detecting objects, but does not disclose visually indicating the relative positions between the vehicle and any objects detected. Hancock teaches detected objects can be displayed to provide a visual indication of relative locations. Therefore it would have been obvious to one skilled in the art to modify the device of Adachi to visually display the locations of the detected objects to inform the user where the objects are located so the driver would know where to control the vehicle to avoid the object.

21. Claims 60-62 rejected under 35 U.S.C. § 103 as being unpatentable over Adachi in view of Dye and Taylor as applied to claim 54 above, and further in view of Zechnall (P.N. 5,146,219).

Re claims 60, 61, and 62, Adachi as modified by Taylor discloses a warning signal or evasive maneuver instructions (abstract, lines 9-10), but does not disclose speech which suggests a corrective action. Zechnall teaches corrective instructions to a driver (col. 2, lines 37-39). Therefore it would have been obvious to one skilled in the art to modify Taylor to issue a vocal corrective action to the driver along with his warning signal to inform the

Art Unit: 2615

driver of what action should be taken so the driver would not be distracted from viewing the road.

22. Claims 100 and 113 rejected under 35 U.S.C. § 103 as being unpatentable over Adachi in view of Dye as applied to claim 1 above, and further in view of Kohsaka (P.N. 5,327,117).

Re claims 100 and 113, Adachi as modified to detect objects in all directions would result in determining collision in various locations, but does not mention ranking each object.

Kohsaka teaches that in situation involving monitoring phenomena, priority ranking would be necessary to determine the optimum message to be outputted (col. 1, lines 48 to col. 2, lines 12).

Therefore it would have been obvious to one skilled in the art that if several collisions are possible, one would priority rank the most and least imminent, and then act upon the worst case.

23. Claims 25-26 and 44-47 rejected under 35 U.S.C. § 103 as being unpatentable over Taylor (P.N. 5,249,157) in view of Dye (P.N. 4,872,051).

a. Re claim 25, Taylor discloses detecting the distance between a motor vehicle and an object ahead of the vehicle; and controlling a warning device to intelligibly indicate to the driver of the vehicle to take corrective action, such as effect deceleration or apply the

Art Unit: 2615

brakes of the vehicle to avoid a collision with the object ahead of the vehicle (col. 26, lines 17-33).

Taylor discloses a driver controlling a motor vehicle and scanning the images of the vehicles traveling the roadway, but does not disclose that its scanner is a video scanning means which generates full-frame picture signals.

Dye teaches a scanning means which is a video scanning means which generates full-frame video picture signals (television camera 12); computer processing the video picture signals and generating trains of first digital code signals (logic processing unit 18); computer analyzing the first digital code signals by comparing said first code signals with codes recorded in a memory (16) and identifying the objects scanned ahead of the vehicle including at least one object in the path of the vehicle (col. 3, line 66 to col. 4, line 11).

Therefore it would have been obvious to one skilled in the art to use the scanning device of Dye to detect objects in the path of vehicle of Taylor as another method of determining possible collisions.

b. Re claim 26, Taylor discloses a warning device via the vehicle console display (col. 26, lines 28-30). A sound generator and/or a flashing light are conventional warning devices.

c. Re claims 44, 45, and 46, these claims are similar to claims 25 and 26. However, Taylor as modified does not mention other vehicles traveling from a road angled to the road the vehicle is traveling or a side road. However, it would ave been obvious to one

Art Unit: 2615

skilled in the art to monitor the area surrounding the vehicle for any possible collisions with any type of objects.

d. Re claim 47, a horn to warn pedestrians or bicyclists of an approaching vehicle is standard in all motor vehicles.

24. Claims 27-29 rejected under 35 U.S.C. § 103 as being unpatentable over Taylor in view of Dye as applied to claim 25 above, and further in view of Zechnall (P.N. 5,146,219).

a. Re claim 27, Taylor further discloses issuing a warning signal or evasive maneuver instructions (abstract, lines 9-10), but does not disclose speech which suggest a corrective action. Zechnall teaches corrective instructions to a driver (col. 2, lines 37-39). Therefore it would have been obvious to one skilled in the art to modify Taylor to issue a corrective action to the driver along with his warning signal to inform the driver of what action should be taken.

b. Re claims 28 and 29, Taylor discloses braking the vehicle and controlling the steering of the vehicle if a collision is imminent (col. 26, lines 29-32).

25. Claims 30 and 115-117 rejected under 35 U.S.C. § 103 as being unpatentable over Adachi et al (P.N. 5,189,619).

a. Re claim 30, Adachi discloses a motor vehicle having a vehicle body, a powered drive, a driver-operated controls including an accelerator, a brake, and a steering

Art Unit: 2615

system (col. 3, line 65), a first scanning device (laser radar apparatus 30), a first computer to generate codes which indicate distance between the vehicle and an object (distance calculating means 36), and a second fuzzy logic-based computer (danger index calculating means 34) to output signals which control the operation of the vehicle to avoid collisions.

Adachi does not disclose two distinct computers. However, it would have been obvious to one skilled in the art that the various calculating means in Adachi can be utilized by separate computers, since computers can be programmed to perform as calculating means of Adachi.

b. Re claim 115, Adachi discloses a radar-based ranging system (30).

c. Re claims 116 and 117, Adachi does not disclose a second scanning device and a third computer to analyze the signals from the second scanning device. However, it would have been obvious to one skilled in the art to have another scanning device to detect and prevent collisions from another direction to ensure that all possible areas are monitored.

26. Claim 31 rejected under 35 U.S.C. § 103 as being unpatentable over Adachi as applied to claim 30 above, and further in view of Hancock (P.N. 5,179,377).

Re claim 31, Adachi does not disclose a visual display of objects in the path of the vehicle. However, Hancock teaches displaying a visual display of objects in the path of a vehicle. Therefore, it would have been obvious to one skilled in the art to modify Adachi to

Art Unit: 2615

have a visual display to indicate objects in its path so the driver would be informed of objects in its path in order to prevent and/or avoid accidents.

27. Claim 32 rejected under 35 U.S.C. § 103 as being unpatentable over Adachi in view of Hancock as applied to claim 31 above, and further in view of "Design and Validation of Headup Displays for Navigation in IVHS," Vehicle Navigation & Information Systems Conference Proceedings, Oct. 1991, pages 537-542 by S. Shekhar, et al (hereinafter Shekhar).

Re claim 32, Adachi as modified does not disclose using a head-up display. Shekhar teaches using a heads-up display in an intelligent vehicle. Therefore it would have been obvious to one skilled in the art for the modified invention of Adachi to employ a heads-up display instead of conventional display because Shekhar discloses it has a faster response time than dashboard displays in automobiles (8th paragraph on page 538).

28. Claims 33-34 rejected under 35 U.S.C. § 103 as being unpatentable over Adachi as applied to claim 30 above, and further in view of Zechnall (P.N. 5,146,219).

Re claims 33 and 34, Adachi does not disclose a synthetic speech generating system or a visual display means. Zechnall teaches a synthetic speech generating system (col. 2, lines 30-42) as claimed in claim 33, and a visual display (col. 2, lines 14-21) as claimed in claim 34 to provide information to a driver concerning hazards, etc. Therefore it would

Art Unit: 2615

have been obvious to one skilled in the art to provide a speech system and a visual display in the device of Adachi to provide safety information to the driver.

29. Claims 38-39 and 114 rejected under 35 U.S.C. § 103 as being unpatentable over Adachi as applied to claim 30 above, and further in view of Dye (P.N. 4,872,051).

a. Re claims 38 and 39, Adachi does not disclose determining the distance between the vehicle and an object by its measurement of the image of the object. However, Dye teaches distance between objects can be determined by measuring the image of the object (col. 2, lines 34-38). Therefore it would have been obvious to one skilled in the art to modify Adachi to determine the distance between the vehicle and the object by measuring the image of the object because it is an alternative method of determining distance.

b. Re claim 114, Adachi does not disclose a first scanning device comprises an image-generating camera. However, Dye discloses a camera (12) is used to determine distance. Therefore it would have been obvious to one skilled in the art to modify Adachi to use a camera instead of the laser to determine distance since it is an alternative method of determining distance.

30. Claims 40 and 43 rejected under 35 U.S.C. § 103 as being unpatentable over Adachi as applied to claim 30 above, and further in view of Taylor (P.N. 5,249,157).

Art Unit: 2615

a. Re claim 40, Adachi discloses controlling the vehicle to avoid a collision, but does not disclose a warning device. Taylor teaches the combination of a warning device along with controlling the vehicle to avoid a collision (col. 26, lines 20-35). Therefore it would have been obvious to one skilled in the art to modify Adachi to also provide a warning device as taught by Taylor.

b. Re claim 43, Adachi discloses controlling the speed and steering of the vehicle (col. 26, lines 20-35).

31. Claims 48-52, 67-69, 71-72, 78-83, and 85-86 rejected under 35 U.S.C. § 103 as being unpatentable over Taylor (P.N. 5,249,157).

a. Re claim 48, Taylor discloses scanning the area in front of a first motor vehicle, and determining the distance between the first motor vehicle and a second motor vehicle, but does not disclose scanning the area behind the first motor vehicle for a third motor vehicle. However, it would have been obvious to one skilled in the art to modify Taylor to also scan the area behind the first motor vehicle for the purpose of preventing collisions from behind the first motor vehicle.

b. Re claim 49, Taylor does not disclose an indicating means to indicate to the driver of the third motor vehicle that the first motor vehicle has been warned to slow down. However, it would have been obvious to one skilled in the art to provide warnings to other vehicles so the other vehicle can respond appropriately to avoid any possible collisions.



Art Unit: 2615

- c. Re claim 50, Taylor discloses controlling the operation of the braking means.
- d. Re claim 51, brake lights are a warning means to warn the driver of the third vehicle that the first vehicle is being braked to a stop.
- e. Re claim 52, anti-lock brakes are well known in the art as a safety feature.
- f. Re claim 67, this claim is similar to claim 48, but does not claim the selected areas was in front and behind the vehicle.
- g. Re claim 68, Taylor discloses controlling the operation of the vehicle (col. 26 lines 27-29).
- h. Re claim 69, Taylor discloses warning the driver of hazardous conditions and to control the operation of the vehicle (col. 26, lines 20-35).
- i. Re claim 71, Taylor discloses a radar scanning means (12).
- j. Re claim 72, it would have been obvious to one skilled in the art to scan the front, back, and right and left sides of the vehicle to prevent collisions from those directions.
- k. Re claims 78-82, Taylor discloses the claimed invention as discussed previously, but does not disclose a first and second override control means. However, it would have been obvious to one skilled in the art to provide a first and second override means, so the driver take control of the vehicle and operate the vehicle as he desires.
- l. Re claim 83, electronic display means to display information relating to the travel of the vehicle reads on a vehicle dashboard.

Art Unit: 2615

m. Re claims 85 and 86, Taylor discloses monitoring the travel of a vehicle and another vehicle and effecting temporary control of a vehicle when a hazardous condition develops, but does not mention monitoring more than one vehicle. However, it would have been obvious to one skilled in the art that any number of vehicles or obstacles can be monitored in order to prevent possible collisions.

32. Claim 70 rejected under 35 U.S.C. § 103 as being unpatentable over Taylor as applied to claim 67 above, and further in view of Dye (P.N. 4,872,051).

Re claim 70, Taylor does not disclose a video scanning means as the scanning means. However, Dye teaches that a video scanning means can be used to detect distance of obstacles. Therefore it would have been obvious to one skilled in the art to use a video scanning means to detect distance since it is an alternative method of determining the distance of objects.

33. Claims 73-77 rejected under 35 U.S.C. § 103 as being unpatentable over Taylor as applied to claim 67 above, and further in view of Adachi (P.N. 5,189,619).

Re claims 73, 74, 75, 76, and 77, Taylor discloses controlling the brakes and the steering to avoid collisions, but does not disclose using neural networks, fuzzy logic algorithms, or fuzzy associative memories. However, Adachi teaches using fuzzy logic to control the vehicle's steering and braking to avoid collisions. Therefore it would have been

Art Unit: 2615

obvious to one skilled in the art to modify Taylor to use the fuzzy principles to control the vehicle as taught by Adachi.

34. Claim 84 rejected under 35 U.S.C. § 103 as being unpatentable over Taylor as applied to claim 83 above, and further in view of Yasuki (JP 4-15799).

Re claim 84, Taylor does not disclose the display means to graphically display a map which includes the road the vehicle is traveling. However, Yasuki teaches displaying a map of the road the vehicle is traveling. Therefore it would have been obvious to one skilled in the art to modify Taylor to provide a visual display of a map of the road the vehicle is traveling for the purpose of indicating to the driver road information.

35. Claims 87-90 rejected under 35 U.S.C. § 103 as being unpatentable over Taylor (P.N. 5,249,157) as applied to claim 85 above, and further in view of NHTSA IVHS Plan by the National Highway Traffic Safety Administration U.S. Department of Transportation June 12, 1992 (hereinafter NHTSA).

Re claims 87-90, Taylor does not disclose a second mode of operation wherein means for automatically controlling the operation of the vehicle in normally driving the vehicle along a second section of roadway without driver control of the vehicle. However, NHTSA discloses the concept of an automatic highway. Therefore, it would have been obvious to

Art Unit: 2615

one skilled in the art for the vehicle of Taylor to have a second mode which would operate the vehicle in normal driving on the automatic highway.

36. Claims 91-95 rejected under 35 U.S.C. § 103 as being unpatentable over Taylor (P.N. 5,249,157) as applied to claim 85 above, and further in view of Hancock (P.N. 5,179,377).

a. Re claims 91, 93, 94, and 95 Taylor does not disclose a display means to display indicia of the relative positions of the vehicle and another vehicle. However, Hancock teaches a display means to display relative positions of a vehicle and other vehicles. Therefore it would have been obvious to one skilled in the art to modify Taylor to have a display means to visually display relative distances so the driver would be able to determine the positions of other vehicles to avoid collisions.

b. Re claim 92, headup displays are well known display devices commonly found in automobiles, therefore it would have been obvious to one skilled in the art to use a headup display to display information on the relative positions of the vehicles to inform the driver where other vehicles are located in order to avoid collisions.

37. Claims 96-99 rejected under 35 U.S.C. § 103 as being unpatentable over Taylor (P.N. 5,249,157) as applied to claim 85 above, and further in view of Morioka (JP 4-219900).

Art Unit: 2615

a. Re claim 96, Taylor does not disclose a numerical indication of the distance between the vehicle and another vehicle. However, Morioka teaches display a numerical indication of distance to inform the driver of distance between the vehicles. Therefore it would have been obvious to one skilled in the art to modify Taylor to display a numerical indication of distance to provide information to the driver.

b. Re claims 97 and 98, it would have been obvious to one skilled in the art that a colored indication or flashing light indication are well known warning indicators which would warn the driver of when the distance is too close.

c. Re claim 99, it would have been obvious to one skilled in the art to use a verbal warning so the driver would not need to take his eyes from the road.

#### *Conclusion*

38. The prior art made of record and not relied upon is considered pertinent to applicant's disclosure.

Mayeaux et al (P.N. 5,161,107), Broxmeyer (P.N. 5,369,591), Sumner (P.N. 5,164,904), Saneyoshi (P.N. 5,307,136), Lemelson (P.N. 4,933,852), Davidian (P.N. 5,357,438), Kajiwara (P.N. 5,177,462), Maekawa (P.N. 5,304,980), Yasunobu et al (P.N. 5,018,689), Tanaka (JP 5-143897), and "Fuzzy Logic Technology & the Intelligent Highway System (IHS)" by Bosacchi et al disclose related information.

Serial Number: 08/105,304

-35-

Art Unit: 2615

39. Any inquiry concerning this communication or earlier communications from the examiner should be directed to Amelia Au whose telephone number is (703) 308-6604. The examiner can normally be reached on Monday - Thursday from 7:30 am - 5:00 pm EST. The examiner can also be reached on alternate Fridays.

If attempts to reach the examiner by telephone are unsuccessful, the examiner's supervisor, Tommy Chin, can be reached on (703) 305-4715. The fax phone number for this Group is (703) 305-9508.

Any inquiry of a general nature or relating to the status of this application should be directed to the Group receptionist whose telephone number is (703) 305-4700.



maa

January 20, 1995

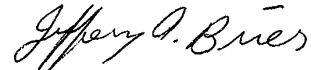

JEFFERY BRIER  
PRIMARY EXAMINER  
GROUP 2600

ATTACHMENT TO PAPER NUMBER <u>6</u>
APPLICATION NUMBER <u>105304</u>

GROUP                     

## NOTICE OF DRAFTSPERSON'S PATENT DRAWING REVIEW

**THE PTO DRAFTSMEN REVIEW ALL ORIGINALLY FILED DRAWINGS REGARDLESS OF WHETHER THEY WERE DESIGNATED AS INFORMAL OR FORMAL. ADDITIONALLY, THE PATENT EXAMINER WILL ALSO REVIEW THE DRAWINGS FOR COMPLIANCE WITH THE REGULATIONS.**

The drawings filed 8/11/93

- A.  are approved by the draftsman.
- B.  are objected to by the draftsman under 37 CFR 1.84 for the reason(s) checked below. The examiner will require submission of new, corrected drawings at the appropriate time. Corrected drawings must be submitted according to the instructions listed on the back of this Notice.

1. Paper and ink. 37 CFR 1.84(a)

Sheet(s) \_\_\_\_\_ Poor.

2. Size of Sheet and Margins. 37 CFR 1.84(b)

Acceptable Paper Sizes and Margins

Margin	Paper Size		
	8 1/2 by 14 inches	8 1/2 by 13 inches	DIN size A4 21 by 29.7 cm.
Top	2 inches	1 inch	2.5 cm.
Left	1/4 inch	1/4 inch	2.5 cm.
Right	1/4 inch	1/4 inch	1.5 cm.
Bottom	1/4 inch	1/4 inch	1.0 cm.

Proper Size Paper Required.  
All Sheets Must be Same Size.  
Sheet(s) \_\_\_\_\_

Proper Margins Required.  
Sheet(s) \_\_\_\_\_

- TOP       RIGHT  
 LEFT       BOTTOM

3. Character of Lines. 37 CFR 1.84(c)

Lines Pale or Rough and Blurred.  
Fig(s) 12, 13

Solid Black Shading Not Allowed.  
Fig(s) \_\_\_\_\_

4.  Photographs Not Approved.

Comments;

5. Hatching and Shading. 37 CFR 1.84(d)

Shade Lines are Required.  
Fig(s) \_\_\_\_\_

Criss-Cross Hatching Not Allowed.  
Fig(s) \_\_\_\_\_

Double Line Hatching Not Allowed.  
Fig(s) \_\_\_\_\_

Parts in Section Must be Hatched.  
Fig(s) \_\_\_\_\_

6. Reference Characters. 37 CFR 1.84(f)

Reference Characters Poor or Incorrectly Sized.  
Fig(s) 1-4, 9, 12, 13

Reference Characters Placed Incorrectly.  
Fig(s) \_\_\_\_\_

7. Views. 37 CFR 1.84(i) & (j)

Figures Must be Numbered Properly, separately  
 Figures Must Not be Connected. Fig. 7-9

8.  Identification of Drawings. 37 CFR 1.84(1)  
Extraneous Matter or Copy Machine Marks Not Allowed. Fig(s) \_\_\_\_\_

9.  Changes Not Completed from Prior PTO-948 dated \_\_\_\_\_

Telephone inquiries concerning this review should be directed to the Chief Draftsman at telephone number (703) 305-8404.

AD  
\_\_\_\_\_  
Reviewing Draftsman

9/15/93  
\_\_\_\_\_  
Date

Note: Any objection to the drawings made by the examiner will be communicated separately in an office action.

## INFORMATION ON HOW TO EFFECT DRAWING CHANGES

### 1. **Correction of Informalities—37 CFR 1.85**

File new drawing with the changes incorporated therein. The art unit number, serial number and number of drawing sheets should be written on the drawing in accordance with 37 CFR 1.84(l). Applicant may delay filing of the new drawings until receipt "Notice of Allowability" (PTOL-37). If delayed, the new drawings **MUST** be Filed within the **THREE MONTH** shortened statutory period set for response in the "Notice of Allowability" (PTOL-37). Extensions of time may be obtained under the provisions of 37 CFR 1.136. The drawing should be filed as a separate paper with a transmittal letter addressed to the Official Draftsperson.

#### **Timing of Corrections**

Applicant is required to submit **acceptable** corrected drawings within the three month shortened statutory period set in the "Notice of Allowability" (PTOL-37). Within the three month period, two weeks should be allowed for review by the Office of the correction. If a correction is determined to be unacceptable by the Office, applicant must arrange to have acceptable correction re-submitted within the original three month period to avoid the necessity of obtaining an extension of time and paying the extension fee. Therefore, applicant should file corrected drawings as soon as possible.

Failure to take corrective action within set (or extended) period will result in **ABANDONMENT** of the Application.

### 2. **Corrections other than Informalities Noted by the Draftsperson on the PTO-948**

All changes to the drawings, other than informalities noted by the Draftsperson, **Must** be made in the same manner as above except that, normally, a red ink sketch of the changes to be incorporated into the new drawings **MUST** be approved by the examiner before the application will be allowed. No changes will be permitted to be made, other than correction of informalities, unless the examiner has approved the proposed changes.



FORM PTO-892 (REV. 2-92)	U.S. DEPARTMENT OF COMMERCE PATENT AND TRADEMARK OFFICE	SERIAL NO. 08/105,304	GROUP/ART UNIT 2615	ATTACHMENT TO PAPER NUMBER 6
NOTICE OF REFERENCES CITED		APPLICANT(S) Lemelson et al		

U.S. PATENT DOCUMENTS

*	DOCUMENT NO.	DATE	NAME	CLASS	SUB-CLASS	FILING DATE IF APPROPRIATE
A	4872051	10.1989	Dye	340	903	
B	4933852	6.1990	Lemelson	340	439	
C	5018689	5.1991	Yasunobu et al	395	905	
D	5146219	9.1992	Zechall	340	905	
E	5161107	11.1992	Mayeaux et al	340	937	
F	5164904	11.1992	Sumner	340	905	
G	5177462	1.1993	Kajiwara	340	903	
H	5179 <sup>3</sup> 77	1.1993	Hancock	340	961	
I	5189619	2.1993	Adachi et al	395	905	
J	<del>5247439</del>	<del>9.1993</del>	<del>Gu...</del>			
K	5249157	9.1993	Taylor	340	903	8.1990

FOREIGN PATENT DOCUMENTS

*	DOCUMENT NO.	DATE	COUNTRY	NAME	CLASS	SUB-CLASS	PERTINENT SHTS. DWG.	PP. SPEC.
L	4-15799	1.1992	JP	Yasuki	340	905	—	—
M	4219900	8.1992	JP	Morioka	340	903	—	—
N	5143897	6.1993	JP	Tanaka	340	903	—	—
O								
P								
Q								

OTHER REFERENCES (Including Author, Title, Date, Pertinent Pages, Etc.)

R	Shekhar. et al, "Design and Validation of Head up Displays for Navigation in IVHS, VNIS '91, Oct 1991, pp 537-542
S	"NHTSA IVHS Plan," National Highway Safety Administration U.S. Dept. of Transportation, June 12, 1992
T	Bosacchi et al, "Fuzzy Logic Technology & the Intelligent Highway System (IHS); IEEE, 1993, pp. 65-70.
U	Rock et al, "Intelligent Road Transit: The Next Generation," AI EXPERT, April 1994, pp. 16-24.

EXAMINER AU	DATE 1-2095
----------------	----------------

\* A copy of this reference is not being furnished with this office action.  
(See Manual of Patent Examining Procedure, section 707.05 (a).)

FORM PTO-892 (REV. 2-92)	U.S. DEPARTMENT OF COMMERCE PATENT AND TRADEMARK OFFICE	SERIAL NO. 08/105,304	GROUPART UNIT 2615	ATTACHMENT TO PAPER NUMBER 6
NOTICE OF REFERENCES CITED		APPLICANT(S) Lemelson et al		

U.S. PATENT DOCUMENTS											
*	DOCUMENT NO.						DATE	NAME	CLASS	SUB-CLASS	FILING DATE IF APPROPRIATE
A	5	3	0	4	9	80	4-1994	Maekawa	340	903	1-1992
B	5	3	0	7	1	36	4-1994	Saneyoshi	380	167	10-1992
C	5	3	2	7	1	17	7-1994	Kohsaka	340	459	3-1992
D	5	3	5	7	4	38	10-1994	Davidian	180	169	6-1993
E	5	3	6	9	5	91	11-1994	Broxmeyer	340	903	3-1993
F											
G											
H											
I											
J											
K											

FOREIGN PATENT DOCUMENTS													
*	DOCUMENT NO.						DATE	COUNTRY	NAME	CLASS	SUB-CLASS	PERTINENT SHTS. PP. DWG. SPEC.	
L													
M													
N													
O													
P													
Q													

OTHER REFERENCES (Including Author, Title, Date, Pertinent Pages, Etc.)									
R									
S									
T									
U									

EXAMINER AU	DATE 1-20-95	
----------------	-----------------	--

\* A copy of this reference is not being furnished with this office action.  
(See Manual of Patent Examining Procedure, section 707.05 (a).)

210-26

2615

IN THE UNITED STATES PATENT AND TRADEMARK OFFICE

Applicant : Jerome H. Lemelson Art Unit : 2615  
 Robert D. Pedersen

Serial No. : 08/105,304 Examiner : Au

Filed : 8/11/93

Title : Motor Vehicle Warning and Control System and Method

#7  
ROSE  
6-29-95



Honorable Commissioner of  
 Patents and Trademarks  
 Washington, D.C. 20231

95 JUN 25 AM 11:15  
 RECEIVED  
 GROUP 260

INFORMATION DISCLOSURE STATEMENT

Dear Sir:

Applicants cite the references listed on the attached forms PTO-1449 and attach a copy of each reference to this Information Disclosure Statement. A check in the amount of \$210.00 is enclosed.

If the Examiner has any questions, please call applicants' undersigned attorney.

Respectfully submitted,

JEROME H. LEMELSON  
 ROBERT D. PEDERSEN  
 by their attorney

Dated: June 23, 1995

Louis J. Hoffman  
 Reg. No. 38,918

LOUIS J. HOFFMAN, P.C.  
 15150 North Hayden Road  
 Suite 202  
 Scottsdale, Arizona 85260  
 (602) 948-3295

060 BA 06/27/95 08105304

1 126 210.00 CK



Form PTO-1449 (Modified)

Page 1 of 5

List of Patents and Publications For Applicant's Information Disclosure Statement

Serial No.: 08/105,304

Applicant(s): Jerome H. Lemelson  
Robert D. Pedersen

Filing Date: 8/11/93 Group: 2615

U.S. PATENT DOCUMENTS

Examiner Initials	Document Number	Date	Name	Class	Subclass	Filing Date (if appropriate)	
M	A	4,257,703	3/24/81	Goodrich	356	4	
	B	4,626,850	12/2/86	Chey	340	903	
	C	4,825,211	4/25/89	Park	340	901	
	D	4,926,170	5/15/90	Beggs et al.	340	904	
	E	4,969,038	11/6/90	Lemelson	358	107	
	F	4,979,029	12/18/90	Lemelson	358	93	
	G	5,039,217	8/13/91	Maekawa et al.	356	1	
	H	5,081,585	1/14/92	Kurami et al.	364	424.02	
	I	5,091,726	2/25/92	Shyu	340	904	
	J	5,122,796	6/16/92	Beggs et al.	340	904	
	K	5,230,400	7/27/93	Kakinami et al.	180	169	
	L	5,276,620	1/4/94	Bottesch	364	424.05	3/25/91
	M	5,278,764	1/11/94	Iizuka et al.	364	461	1/28/91
	N	5,298,882	3/29/94	Tsai	340	468	2/22/93
	O	5,314,037	5/24/94	Shaw et al.	180	169	1/22/93
	P	5,332,057	7/26/94	Butsuen et al.	180	169	8/25/92
	Q	5,339,075	8/16/94	Abst et al.	340	903	11/24/92
	R	5,341,344	8/23/94	O'Brien et al.	367	96	10/14/92

FOREIGN PATENT DOCUMENTS

Document Number	Date	Country	Class	Subclass	Translation Yes/No
M S 5-124529	5/21/93	Japan			No (Abstract)

OTHER ART (Including Author, Title, Date, Pertinent Pages, Etc.)

M T Abu-Mostafa, "Information Theory, Complexity, and Neural Networks," IEEE Communications, pp. 25-28 (November 1989).

Examiner: Au Date Considered: 8.28.95

EXAMINER: Initial if reference considered, whether or not citation is in conformance with MPEP 609. Draw line through citation if not in conformance and not considered. Include copy of this form with next communication to applicant.



List of Patents and Publications For Applicant's Information Disclosure Statement

Serial No.: 08/105,304

Applicant(s): Jerome H. Lemelson  
Robert D. Pedersen

Filing Date: 8/11/93 Group: 2615

U.S. PATENT DOCUMENTS

Examiner Initials	Document Number	Date	Name	Class	Subclass	Filing Date (if appropriate)
-------------------	-----------------	------	------	-------	----------	------------------------------

A

FOREIGN PATENT DOCUMENTS

Document Number	Date	Country	Class	Subclass	Translation Yes / No
-----------------	------	---------	-------	----------	----------------------

B

OTHER ART (Including Author, Title, Date, Pertinent Pages, Etc.)

- m* C Aggarwal et al., "On the Computation of Motion from Sequences of Images—A Review," Proceedings of the IEEE, pp. 917-35 (August 1988).
- D Alspector, "Neural-Style Microsystems that Learn," IEEE Communications, pp. 29-36 (November 1989).
- E Casasent, "Optics and Neural Nets," Chapter 16 in Carpenter et al., eds., Neural Networks for Vision and Image Processing, pp. 437-48 (MIT Press 1992).
- F Cox, "Fuzzy Fundamentals," IEEE Spectrum, pp. 58-61 (October 1992).
- G Hammerstrom, "Neural Networks at Work," IEEE Spectrum, pp. 26-32 (June 1993).
- H Hush et al., "Progress in Supervised Neural Networks," IEEE Signal Processing, pp. 8-39 (January 1993).
- I Jurgen, "Smart Cars and Highways Go Global," IEEE Spectrum, pp. 26-36 (May 1991).
- m* J Kittler et al., eds., Image Processing System Architectures, Chapter 4, pp. 49-81, and Chapter 5, pp. 85-101 (John Wiley & Sons 1985).

Examiner:     *KV*    

Date Considered:     8.28.95    

EXAMINER: Initial if reference considered, whether or not citation is in conformance with MPEP 609. Draw line through citation if not in conformance and not considered. Include copy of this form with next communication to applicant.

Form PTO-1449 (Modified)



Page 3 of 5

List of Patents and Publications for Applicant's Information Disclosure Statement

Serial No.: 08/105,304

Applicant(s): Jerome H. Lemelson  
Robert D. Pedersen

Filing Date: 8/11/93 Group: 2615

U.S. PATENT DOCUMENTS

Examiner Initials	Document Number	Date	Name	Class	Subclass	Filing Date (if appropriate)
A						

FOREIGN PATENT DOCUMENTS

Document Number	Date	Country	Class	Subclass	Translation Yes/No
B					

OTHER ART (Including Author, Title, Date, Pertinent Pages, Etc.)

- M* C Kosko et al., "Fuzzy Logic," Scientific American, pp. 76-81 (July 1993).
- D Lee, "Fuzzy Logic in Control Systems: Fuzzy Logic Controller, Part II," IEEE Transaction on Systems, Man, and Cybernetics, pp. 419-35 (vol. 20, No. 2, March/April 1990).
- E Lippmann, "An Introduction to Computing with Neural Nets," IEEE ASSP, pp. 4-22 (April 1987).
- F Lippmann, "Pattern Classification Using Neural Networks," IEEE Communications, pp. 47-50, 59-64 (November 1989).
- G Lisboa, ed., Neural Networks—Current Applications, Chapter 1, pp. 1-34, Chapter 2, pp. 35-48, Chapter 7, pp. 123-47 (Chapman & Hall 1992).
- H Lupo, "Defense Applications of Neural Networks," IEEE Communications, pp. 82-88 (November 1989).
- M* I Maresca et al., "Parallel Architectures for Vision," Proceedings of the IEEE, pp. 970-81 (vol. 76, No. 8, August 1988).

Examiner: AV

Date Considered: 8.28.95

EXAMINER: Initial if reference considered, whether or not citation is in conformance with MPEP 609. Draw line through citation if not in conformance and not considered. Include copy of this form with next communication to applicant.

Form PTO-1449 (Modified)



Page 4 of 5

List of Patents and Publications For Applicant's Information Disclosure Statement

Serial No.: 08/105,304

Applicant(s): Jerome H. Lemelson  
Robert D. Pedersen

Filing Date: 8/11/93 Group: 2615

U.S. PATENT DOCUMENTS

Examiner Initials	Document Number	Date	Name	Class	Subclass	Filing Date (if appropriate)
-------------------	-----------------	------	------	-------	----------	------------------------------

A

FOREIGN PATENT DOCUMENTS

Document Number	Date	Country	Class	Subclass	Translation Yes / No
-----------------	------	---------	-------	----------	----------------------

B

OTHER ART (Including Author, Title, Date, Pertinent Pages, Etc.)

- C Nijhuis et al., "Evaluation of Fuzzy and Neural Vehicle Control," Institution of Electrical Engineers, pp. 447-52 (1992).
- D Pearson, ed., Image Processing, Chapter 8, pp. 141-55, and Chapter 10, pp. 169-89 (McGraw-Hill 1991).
- E Psaltis et al., "Optoelectronic Implementations of Neural Networks," IEEE Communications, pp. 37-40, 71 (November 1989).
- F Roth, "Neural Networks for Extraction of Weak Targets in High Clutter Environments," IEEE Transactions on Systems, Man, and Cybernetics, pp. 1210-17 (September/October 1989).
- G Schwartz et al., "Fuzzy Logic Flowers in Japan," IEEE Spectrum, pp. 32-35 (July 1992).
- H Soucek et al., Neural and Massively Parallel Computers, Chapter 12, pp. 245-76 (John Wiley & Sons 1988).
- I Suaya et al., eds., VLSI and Parallel Computation, Chapter 1, pp. 1-84, and Chapter 5, pp. 390-415 (Morgan Kaufmann 1990).

Examiner: AM Date Considered: 8.28.95

EXAMINER: Initial if reference considered, whether or not citation is in conformance with MPEP 609. Draw line through citation if not in conformance and not considered. Include copy of this form with next communication to applicant.

Form PTO-1449 (Modified)



Page 5 of 5

List of Patents and Publications For Applicant's Information Disclosure Statement

Serial No.: 08/105,304

Applicant(s): Jerome H. Lemelson  
Robert D. Pedersen

Filing Date: 8/11/93 Group: 2615

U.S. PATENT DOCUMENTS

Examiner Initials	Document Number	Date	Name	Class	Subclass	Filing Date (if appropriate)
-------------------	-----------------	------	------	-------	----------	------------------------------

A

FOREIGN PATENT DOCUMENTS

Document Number	Date	Country	Class	Subclass	Translation Yes / No
-----------------	------	---------	-------	----------	----------------------

B

OTHER ART (Including Author, Title, Date, Pertinent Pages, Etc.)

- C Teuber, Digital Image Processing, Chapter 1, pp. 1-30, Chapter 2, pp. 31-70, and Appendix D, pp. 254-55 (Prentice Hall 1993).
- D Wasserman, Neural Computing: Theory and Practice, Chapter 1, pp. 11-26, Chapter 2, pp. 27-42, Chapter 3, pp. 43-59, and Chapter 9, pp. 151-66 (Van Nostrand Reinhold 1989).
- E Yuhas et al., "Integration of Acoustic and Visual Speech Signals Using Neural Networks," IEEE Spectrum, pp. 65-71 (November 1989).

Examiner: AN

Date Considered: 8.28.95

EXAMINER: Initial if reference considered, whether or not citation is in conformance with MPEP 609. Draw line through citation if not in conformance and not considered. Include copy of this form with next communication to applicant.





370 116

2615

IN THE UNITED STATES PATENT AND TRADEMARK OFFICE

Applicant : Jerome H. Lemelson Art Unit : 2615  
 Robert D. Pedersen

Serial No. : 08/105,304 Examiner : Au

Filed : 8/11/93

Title : Motor Vehicle Warning and Control System and Method

#30  
Rose  
6-29-95

Honorable Commissioner of  
Patents and Trademarks  
Washington, D.C. 20231

RECEIVED  
GROUP 200

RESPONSE TO FIRST OFFICE ACTION

Dear Sir:

In response to the Office Action dated January 26, 1995, applicants enter the following amendments and remarks. An extension of two months is requested, and a check for \$370.00 for the extension fee is enclosed.

Amendments

IN THE SPECIFICATION:

Please amend the specification as follows:

On page 3, line 1, change "Summary" to --Field--.

On page 3, line 5, after the period, insert the following header and new paragraph:

--Background of the Invention

A major cause of human suffering is automobile accidents. Approximately 49,000 people die in traffic accidents each year in the United States, and another three million are injured. The costs of death and injury accidents are staggering. According to the United States National Highway Traffic Safety Administration, crash damage and medical bills total \$137 billion a year.

B /  
mt

280 TL 06/27/95 08105304

1 116 370.00 CK

Automobile designers offer many safety features, including passenger restraints, improved braking systems, and body designs, intended to better protect automobile crash victims. But very little has been done in the area of automatic vehicle control systems based on modern electronics, computer systems, and advanced real-time software. This is true despite rapidly increasing capabilities in these technologies and pervasive application in many other areas including, for example the business, entertainment, and medical fields. Vehicle guidance and control technology has, of course, been applied with great success in military defense systems, avionics systems and space exploration systems. But, this technology is costly and has not been commercialized.

The opportunity exists today to develop cost effective, commercial automated vehicle control systems. New advances in low-cost hardware and software technology make implementation feasible. High-speed, parallel computer architectures, specialized image-processing equipment, and advanced special computers such as math co-processors are available. Advanced expert system implementations based on concepts such as fuzzy logic and neural networks, and new, improved scanning systems for sensing environments around moving vehicles make it very timely, indeed, to pursue new approaches.

Work on these problems has begun. Intelligent vehicle/highway systems are being investigated with traffic control systems intended to minimize congestion. Vehicle location systems such as GPS (Global Positioning System) and route guidance systems are also being pursued. Certain systems for automated vehicle control have been proposed, including systems that scan the roadway directly ahead of a vehicle using radar/lidar or television and attempt to warn a driver of impending danger. Fuzzy logic expert systems for controlling vehicle speed (braking and throttle) based on scanning the roadway ahead of a vehicle have been described. Road tracking with electronic vehicle guidance is being pursued. Fuzzy logic has been applied to braking systems in subway and train systems.

10/10/81

While these developments are important, they fail to protect vehicles from many types of collisions or minimize the damage therefrom. More particularly, such systems fail to exercise simultaneous, coordinated control over vehicle steering and speed, fail to take full advantage of identification of different obstacle or hazard types using standard stored models of production vehicles and other commonly encountered roadway objects, fail to deal effectively with objects and hazards located simultaneously on different sides of the vehicle, and fail to capitalize fully on modern expert system decision and control technology, such as represented by fuzzy logic and neural network methods, to deal with more complex hazardous situations.

B1  
ended

Summary of the Invention -

---

On page 5, after line 18, insert the following paragraph:

---

While the invention is described herein principally in connection with an automobile on a roadway, it may be used in connection with controlling any powered vehicle, including a motor vehicle, a boat, a train, or an aircraft.

B2

---

On page 5, line 20, change "motor vehicle, boat, train or aircraft" to --powered vehicle--.

On page 5, lines 21-22, change "motor vehicle, train, boat or aircraft" to --powered vehicle--.

On page 8, line 9, change "SYSTEM DESCRIPTION" to --Detailed Description--.

---

On page 11, line 1, after "Simulated" insert --displays of symbols representing the hazard objects--.

B3

---

On page 12, line 8, change "another vehicle" to --a second powered vehicle such as an automobile or truck--.

B4

---

On page 18, line 8, after the period, insert the following: --The automatic system may operate to control the operation of the vehicle if the driver does not properly or quickly enough respond to indication by the warning/indicating device controlled by the system that obstacles are in the path of travel of the vehicle--.

B5

---

On page 18, lines 8-9, change "Having gained" to --If the warning gains--.

On page 18, line 9, after "control" insert --with the override feature--.

IN THE CLAIMS:

Please cancel claims 11, 25-29, 44-47, 49-52, 67-85, 87-90, and 93-98. Six independent claims and 43 total claims are being canceled.

Please amend the claims as follows. All claims remaining in this application are reproduced below, for the Examiner's convenience, whether or not here amended.

SUB (1)

1. (Twice Amended) A method for controlling the travel of a powered vehicle comprising:

- (a) as [a] the powered vehicle travels a roadway, scanning the roadway with a video scanner supported by said vehicle and generating a train of video picture signals;
- (b) computer processing and analyzing each video picture signal as it is generated to detect a plurality of objects in the vicinity of said vehicle;
- (c) measuring the distance from the vehicle to [one of] the detected objects;
- (d) calculating the relative velocity between [the] at least one of the detected objects and the vehicle;
- (e) [intelligibly indicating] when a collision is imminent between one of the objects [is in the path of said] and the vehicle, [; and
- (f) using fuzzy logic to take over control of the acceleration and steering of the vehicle from a driver based on (i) the distance and relative velocity between the [detected] indicated object and the vehicle and (ii) the location of the detected objects.

2. (Twice Amended) A method in accordance with claim 1 wherein measuring the distance between the vehicle and one of the detected objects includes computer processing the video picture signals in a manner to measure [the size] a selected dimension of the object in the image defined by said video picture signals.

Bl  
ence

3. (Twice Amended) A method in accordance with claim 2 wherein the object is directly in front of said vehicle and is a second powered vehicle traveling in the same direction as the controlled vehicle [containing said video scanner], and wherein measuring the [size of the object in the image defined by said video picture signals] distance between the controlled vehicle and the second vehicle comprises computer-identifying said second vehicle by its image shape.

4. (Twice Amended) A method in accordance with claim 1 wherein [act (a)] scanning is effected by [means of] a television camera which scans a field in front of said [motor] vehicle, including said roadway, at a constant scanning rate.

5. (Not Here Amended) A method in accordance with claim 4 wherein said television camera is operable to generate full-frame video picture signals on its output.

BCD

X  
D

6. (Twice Amended) A method in accordance with claim 1 wherein the one of the detected objects is directly in front of said vehicle and is a second powered vehicle traveling in the same direction as the controlled vehicle [containing said scanner], and wherein measuring the [size of the object in the image defined by said video picture signals] distance between the controlled vehicle and the second vehicle comprises computer-identifying said second vehicle by at least a portion of the rear view shape of the second vehicle.

7. (Not Here Amended) A method in accordance with claim 6 further comprising intelligibly indicating the distance between said two vehicles on a continuous basis.

---

8. (Twice Amended) A method in accordance with claim 1 wherein using fuzzy logic to control the acceleration of the vehicle comprises controlling a brake to slow the forward travel of said [motor] vehicle.

SUBC3

B9  
cont

9. (Twice Amended) A method in accordance with claim 8 further comprising calculating the change of relative velocity between said vehicle and [said] the one object and employing said calculated change in relative velocity as an input to [said] a fuzzy logic function.

10. (Twice Amended) A method in accordance with claim 1 [wherein] further comprising intelligibly indicating when a collision is imminent between one of said objects [is in the path of] and the vehicle [comprises] by operating a warning device selected from a group including a warning light, a flashing light, a sound generator, and a speech generator.

---

12. (Not Here Amended) A method in accordance with claim 1 wherein scanning the roadway comprises electro-optically scanning both ahead of and to both sides of said vehicle.

---

13. (Twice Amended) A method in accordance with claim 12 wherein [act (f)] using fuzzy logic to control the steering comprises altering the steering of the vehicle in response to an object in the path of said vehicle in a manner to attempt to avoid a collision between said vehicle and the object without causing the vehicle to collide with other objects detected at the sides of the vehicle.

B9  
cont

SUBC4 14. (Twice Amended) A method in accordance with claim 13 further comprising intelligibly indicating the distance between the vehicle and [an object] one of said detected objects comprising a second powered vehicle moving in the same

B9  
cond direction as the first vehicle and further indicating other of said detected objects  
[detected] at the sides of the first vehicle.

---

SUBCS

30. (Twice Amended) A system for operating and controlling a motor vehicle comprising:

(a) a [motor] vehicle having a [vehicle body, a powered] motor drive[,] and driver-operated controls including an accelerator, a brake, and a steering system;

(b) a first scanning device supported by said vehicle, directed toward the front of said vehicle, and configured to generate first signals modulated with information relating to objects in the field of view of said first scanning device;

(c) a first computer coupled to said first scanning device and configured to analyze said first signals as the vehicle travels and to produce first code signals on an output of said first computer, which first code signals are indicative of distances and relative motion between said vehicle and objects ahead of said vehicle and in the path of said vehicle; and

(d) a [second,] fuzzy logic-based second computer coupled to said first computer and configured to analyze said first code signals and to generate command signals on an output of said second computer;

(e) wherein the output of said second computer is electrically coupled to said driver-operated controls such that the command signals are applied to control the [operation] accelerator, brake, and steering system of said vehicle to attempt to avoid collisions between said vehicle and objects in its path of travel.

---

31. (Not Here Amended) A system in accordance with claim 30 further comprising a visual display inside said vehicle body coupled to the output of said first computer and driven by said first code signals to generate symbols representative of objects in the path of the vehicle.

32. (Not Here Amended) A system in accordance with claim 31 wherein said visual display comprises a heads-up display aimed to project images of intelligible information on a front windshield of said vehicle body.

33. (Not Here Amended) A system in accordance with claim 30 further comprising a synthetic speech generating system coupled to the output of said first computer and driven by said first code signals to generate sounds of select words of speech.

34. (Not Here Amended) A system in accordance with claim 33 further comprising a visual display coupled to the output of said first computer and simultaneously controlled by said first code signals.

BC7

38  
39  
40

~~38. (Twice Amended) A system in accordance with claim 30 wherein the first computer is configured to identify one of said [object] objects by comparing the shape of part of the object to a set of standard shapes and generating a second code signal indicating a match, and wherein said second code signal and a measurement of the image of the object is used to determine the distance between said vehicle and the object.~~

39. (Not Here Amended) A system in accordance with claim 38 wherein said standards represent other vehicles and pedestrians moving in the field of view of the first scanning device of said vehicle.

40. (Not Here Amended) A system in accordance with claim 30 further comprising a warning device to the output of said first computer and driven by said first code signals to generate a warning signal perceptible to a human when one of the detected objects is in the path of the vehicle, and wherein the second computer is timed to control the operation of said vehicle to avoid or lessen the effects of collision with an



obstacle in the path of said vehicle only if the driver of said vehicle does not alter the driver-operated controls of the vehicle sufficiently to avoid a collision with the object in response to indication by said warning device that an obstacle is in the path of travel of said vehicle.

---

B'2  
concl

43. (Twice Amended) A system in accordance with claim 40 wherein said second computer is coupled to control the speed and steering of said vehicle simultaneously.

---

48. (Once Amended) A method for controlling the operation of a motor vehicle comprising:

(a) [operating] driving a first [motor] vehicle [by driving said vehicle along a road],

(b) scanning [with a first scanning means] an area in front of said first [motor] vehicle [as it travels said road] and generating first information signals modulated with [first] information relating to objects [such as other vehicles travel] traveling ahead of said [motor] first vehicle [in the same direction said motor vehicle is traveling],

(c) computer processing said first information signals and generating first code signals[,

(d) employing said first code signals to generate second code signals] indicative of the distance between said first [motor] vehicle and a second [motor] vehicle traveling [in the same direction as] ahead of said first [motor] vehicle [on said road] and the closing speed between said first [motor] vehicle and said second [motor] vehicle,

(e) (d) scanning [with a second scanning means] an area behind said first [motor] vehicle [as it travels said road] and generating second [scanning] information signals modulated with information relating to [a third

vehicle] objects traveling behind said first [motor] vehicle [in the same direction as the direction of travel of said first motor vehicle],

[f]) (e) computer processing said second information signals and generating [third] second code signals[,

(g) employing said third code signals to generate fourth code signals] indicative of the [closing speed and] distance between said first [and third motor vehicles] vehicle and a third vehicle traveling behind said first vehicle and the closing speed between said first vehicle and said third vehicle,

[h]) (f) computer analyzing said [second and fourth] first and second code signals [and generating fifth code signals] using fuzzy logic analysis, and

[i]) (g) employing [said fifth code signals] the results of the analysis to control the [operation of an intelligible indicating means in said first motor vehicle to intelligibly indicate to the driver of said first motor vehicle to slow the] speed of said first [motor] vehicle to attempt to avoid a [hazardous driving condition with respect] collision with the second [motor] vehicle without thereby causing a collision with the third vehicle.

B13  
cancel

---

53. (Twice Amended) A method for controlling the operation of a vehicle driven by a human being comprising:

(a) scanning an area in front of a [first] vehicle as it travels along a roadway and generating first information signals modulated with image information relating to objects ahead of said [first] vehicle [such as a second vehicle traveling said roadway ahead of said vehicle];

(b) computer processing said first information signals and generating a first time-varying sequence of digital signals indicative of the distance between said [first and second vehicles] vehicle and one of said objects and the closing speed therebetween;

B14

(c) scanning areas to the left and right sides of said [first] vehicle and generating second information signals modulated with image information relating to other objects to the sides of said [first] vehicle;

(d) computer analyzing said second information signals and generating a second time-varying sequence of digital signals when an object to the side of said [first] vehicle is detected;

(e) [using fuzzy logic to analyze] analyzing said first sequence of digital signals as they are generated and to determine [that] whether a collision is imminent between said [first] vehicle and an object ahead of said [first] vehicle;

(f) [employing] using fuzzy logic to analyze said first and said second [sequence] sequences of digital signals to select one of several kinds of evasive action, each requiring a different alteration in [the] control of the operation of said [first] vehicle; and

(g) when said [fuzzy logic] analysis determines that a collision is imminent, automatically altering control of the operation of the [first] vehicle in accordance with the selected [fashion] evasive action to attempt to prevent a collision with an object ahead of said [first] vehicle without causing the vehicle to collide with other objects to the sides of said [first] vehicle.

B14  
cont

54. (Twice Amended) A method in accordance with claim 53 further comprising [the act of] first intelligibly indicating a warning within said [first] vehicle and altering control of the operation of the [first] vehicle only if a collision remains imminent.

55. (Twice Amended) A method in accordance with claim 54 wherein [the act of] intelligibly indicating comprises visually indicating the existence of a hazardous condition.

SUB C9 56. (Twice Amended) A method in accordance with claim 54 wherein [the act of] intelligibly indicating further comprises indicating the recommended kind of evasive action selected [in act (f)].

57. (Twice Amended) A method in accordance with claim [54] 56 wherein [the act of] intelligibly indicating comprises displaying a visually perceptible symbol on a windshield of said [first] vehicle.

58. (Twice Amended) A method in accordance with claim [55] 57 wherein [the act of] intelligibly indicating further comprises visually indicating the relative positions between said [first] vehicle and any obstacles detected in front of and to the side of said [first] vehicle.

B14  
cont 59. (Twice Amended) A method in accordance with claim 58 wherein [the act of] intelligibly indicating further comprises visually indicating the relative closing speeds between [at least two of said motor vehicles] said vehicle and one of the objects that is another motor vehicle.

60. (Twice Amended) A method in accordance with claim 54 wherein [the act of] intelligibly indicating comprises generating sounds of select speech warning of a hazardous condition.

61. (Twice Amended) A method in accordance with claim 60 wherein [the act of] intelligibly indicating further comprises generating sounds of select speech recommending a corrective action to take to avoid a collision.

SUB C10 62. (Twice Amended) A method in accordance with claim 61 wherein generating sounds of select speech recommending a corrective action to take to avoid a collision comprises synthetically generating one of the following words of speech

B14  
Once depending on the kind of evasive action determined by [the] fuzzy logic [controller]:  
"slow down", "stop", "swerve left", and "swerve right".

SUBC 11  
BKS  
Once  
65. (Twice Amended) A method in accordance with claim 53 wherein [act  
(g)] altering control of the operation of the vehicle comprises selecting between various  
combinations of alteration of control of the operation of a speed-altering mechanism  
and a steering mechanism of said first vehicle.

SUBC 12  
86. (Once Amended) A method [for] of operating a motor vehicle  
comprising:  
(a) operating a [motor] vehicle in a first mode [which includes]  
wherein a human driver [controlling] controls the movement of said vehicle  
along a [first section of] roadway,  
(b) [monitoring the travel of said vehicle and other vehicles with a first  
computer means and generating first control signals] scanning an image from the  
vehicle and computer-analyzing said image to detect the presence of other  
moving vehicles and stationary obstacles in all directions from the vehicle,  
(c) [employing said first control signals to] intelligibly [indicate]  
indicating to the driver of said driven motor vehicle [driving conditions with  
respect to other vehicles and] the presence of the detected moving vehicles and  
stationary obstacles, and  
(d) [generating second control signals when] if a predefined hazardous  
condition develops during the movement of said driven vehicle, [and employing  
said second control signals to effect the] switching operation of the driven vehicle  
to a second mode characterized by the automatic and temporary control of said  
vehicle, including controlling the vehicle in an evasive action selected from the  
group of braking the vehicle, altering the steering of the vehicle, and accelerating  
the vehicle, to attempt to prevent or lessen the effects of an accident [involving  
said vehicle and another vehicle or obstacle in the path of said vehicle].

Handwritten signature/initials on the left margin.

UBCLB

91. (Once Amended) A method in accordance with claim [85 which includes employing selected of said first control signals to control a display means to display indicia] ~~86~~ further comprising indicating to the driver of said motor vehicle [indicative of] the relative positions of said [motor] vehicle and at least one other [motor] vehicle [which is] in movement along the [route of travel of said motor vehicle] roadway.

R/17  
conco

92. (Once Amended) A method in accordance with claim [85 which includes employing selected of said first control signals to control] 91 wherein indicating comprises displaying symbols on a heads-up windshield display [means to display indicia to the driver of said motor vehicle indicative of the relative positions of said motor vehicle and at least one other motor vehicle which is in movement along the route of travel of said motor vehicle].

R/12  
conco

99. (Once Amended) A method in accordance with claim [85 which includes employing selected of said first control signals to control a] 91 wherein indicating comprises generating a verbal indication in synthetic speech [of the distance between said motor vehicle and at least one other motor vehicle which is in movement along the route of travel of said motor vehicle].

R/9  
conco

100. (Once Amended) A method in accordance with claim 1 further comprising determining whether a collision is imminent with several of the detected objects [are in the path of the vehicle], and if so, ranking each such object [that is in the path of the vehicle] in ascending order of calculated time to collision, and wherein [act (f)] using fuzzy logic to control the acceleration and steering of the vehicle is performed with regard to the highest-ranking object.

101. (Once Amended) A method in accordance with claim 1 further comprising scanning the vicinity of the [motor] vehicle with at least one other video scanner supported by said vehicle.

102. (Once Amended) A method in accordance with claim 101 wherein at least some of the video scanners are positioned to scan the roadway in front of the vehicle and the roadway behind the vehicle.

SUBC14 103. ~~(Once Amended)~~ A method in accordance with claim 102 further comprising measuring the distance and relative velocity between the vehicle and a second vehicle detected by the video scanners, which second vehicle [that] is behind the [first] controlled vehicle.

B19  
cont 104. (Once Amended) A method in accordance with claim 103 wherein [act (f)] using fuzzy logic to control the acceleration of the controlled vehicle comprises altering the acceleration of the controlled vehicle [in response to an ] so as to attempt to avoid a collision between the controlled vehicle and either of (i) said one detected object in the path of the controlled vehicle [in a manner also to avoid a collision between said vehicle] and (ii) the second vehicle.

105. (Once Amended) A method in accordance with claim 101 wherein at least some of the video scanners are positioned to scan areas in front of the vehicle and on the sides of the vehicle.

106. (Once Amended) A method in accordance with claim 101 wherein the video scanners are positioned to scan areas all around the vehicle.

107. (Not Here Amended) A method in accordance with claim 106 further comprising measuring the distance and relative velocity between the vehicle and all of the objects detected by the video scanners.

SUBC 15

108. (Once Amended) A method in accordance with claim 107 wherein [act (f)] using fuzzy logic to control the acceleration and steering of the controlled vehicle comprises altering the acceleration and steering of the vehicle [in response to an] so as to attempt to avoid a collision between the vehicle and either of (i) said one detected object in the path of the vehicle [in a manner also to avoid a collision between said vehicle] and (ii) all other objects detected by the video scanners.

B19  
cont

109. (Not Here Amended) A method in accordance with claim 101 further comprising measuring the distance and relative velocity between the vehicle and all of the objects detected by the video scanners.

SUBC 16

110. (Once Amended) A method in accordance with claim 109 wherein [act (f)] using fuzzy logic to control the acceleration and steering of the controlled vehicle comprises altering the acceleration and steering of the vehicle [in response to an] so as to attempt to avoid a collision between the vehicle and either of (i) said one detected object in the path of the vehicle [in a manner also to avoid a collision between said vehicle] and (ii) all other objects detected by the video scanners.

111. (Once Amended) A method in accordance with claim [110] 101 wherein [said act of avoiding] attempting to avoid a collision with all other detected objects comprises selecting one of a plurality of [state vectors] sets of fuzzy logic inference rules controlling the acceleration and steering of the vehicle depending on which [sides of] direction from the vehicle objects are detected.



112. (Once Amended) A method in accordance with claim 111 wherein selecting comprises reproducing one of a plurality of [state vectors comprises selecting one of the state vectors stored in a fuzzy] rule sets from an associative memory.

19

9/10/02

113. (Once Amended) A system in accordance with claim 1 further comprising determining whether a collision is imminent with several of the detected objects [are in the path of the vehicle], and if so, ranking each such object [that is in the path of the vehicle] in ascending order of calculated time to collision, and wherein [acts] parts (c), (d), and [(f)] (e) are performed with regard to the highest-ranking object.

---

114. (Not Here Amended) A system in accordance with claim 30 wherein the first scanning device comprises an image-generating camera.

115. (Not Here Amended) A system in accordance with claim 30 wherein the first scanning device comprises a radar-based ranging system.

---

uBc17

B330 cont

116. (Once Amended) A system in accordance with claim 30 further comprising:

- (a) a second scanning device supported by said vehicle, directed away from said vehicle in a direction other than the front of the vehicle, and configured to generate second signals modulated with information relating to objects in the field of view of said second scanning device; and
- (b) a third computer coupled to said second scanning device and configured to analyze said second signals as the vehicle travels and to produce second code signals on an output of said third computer, which code signals are indicative of distances and relative motion between said vehicle and each of the objects in the field of view of said second scanning device.

*B20  
cont*

~~117~~ (Once Amended) A system in accordance with claim 116 wherein said [second,] fuzzy logic-based second computer is also coupled to said third computer and configured to analyze said first and second code signals and [apply the results of the analysis] to [select] generate command signals therefrom that are applied to control [the] operation of said vehicle to attempt to avoid collisions both with objects in the path of travel of the vehicle and objects in the field of view of said second scanning device.

---

Please add the following new claims. No fee is due for additional claims, because the same number of independent and total claims are being canceled as are added below.

---

--118. A method for controlling the travel of a powered vehicle comprising:

*B21  
cont*

(a) as the powered vehicle travels a roadway, scanning the roadway with a video scanner supported by said vehicle and generating a train of video picture signals;

(b) computer processing and analyzing each video picture signal as it is generated to detect a plurality of objects in the vicinity of said vehicle;

(c) measuring the distances from the vehicle to the detected objects;

(d) calculating the relative velocities between the detected objects and the vehicle;

(e) intelligibly indicating when a collision is imminent between one of the objects and the vehicle; and

(f) using fuzzy logic to indicate a recommended alteration of the speed and direction of the vehicle based on (i) the distance and relative velocity between the indicated object and the vehicle and (ii) the location of the detected objects.--

--119. A method in accordance with claim 118 wherein measuring the distance between the vehicle and one of the detected objects includes computer processing the video picture signals in a manner to measure a selected dimension of the object in the image defined by said video picture signals.--

SUBC18

--120. A method in accordance with claim 119 wherein the object is directly in front of said vehicle and is a second powered vehicle traveling in the same direction as the controlled vehicle, and wherein measuring the distance between the controlled vehicle and the second vehicle comprises computer-identifying said second vehicle by its image shape.--

B21

--121. A method in accordance with claim 118 further comprising calculating the change of relative velocity between said vehicle and the one object and employing said calculated change in relative velocity as an input to a fuzzy logic function.--

301

--122. A method in accordance with claim 118 wherein intelligibly indicating when one of said objects is in the path of the vehicle comprises operating a warning device selected from a group including a warning light, a flashing light, a sound generator, and a speech generator.--

--123. A method in accordance with claim 118 wherein scanning the roadway comprises electro-optically scanning both ahead of and to both sides of said vehicle, and wherein using fuzzy logic to indicate a recommended alteration of control comprises making a suggestion for altering the steering of the vehicle in a manner to attempt to avoid a collision between said vehicle and the object with which the vehicle is about to collide without causing the vehicle to collide with other objects detected at the sides of the vehicle.--

--124. A method in accordance with claim 118 further comprising determining whether the vehicle is about to collide with several of the detected objects, and if so, ranking each such object in ascending order of calculated time to collision, and wherein using fuzzy logic to control the acceleration and steering of the vehicle is performed with regard to the highest-ranking object.--

--125. A method in accordance with claim 118 wherein scanning the roadway comprises electro-optically scanning both ahead of said vehicle and in at least one other direction with respect to said vehicle, and wherein using fuzzy logic to indicate a recommended alteration of control comprises making a suggestion for altering the steering of the vehicle in a manner to attempt to avoid a collision between said vehicle and the object with which the vehicle is about to collide without causing the vehicle to collide with other objects detected in the other direction.--

B2  
304  
--126. A method in accordance with claim 125 wherein scanning the roadway comprises electro-optically scanning both ahead of said vehicle and in a plurality of other directions with respect to said vehicle, and wherein using fuzzy logic to indicate a recommended alteration of control comprises making a suggestion for altering the steering of the vehicle in a manner to attempt to avoid a collision between said vehicle and the object with which the vehicle is about to collide without causing the vehicle to collide with other objects detected in the other directions.--

--127. A method in accordance with claim 126 wherein attempting to avoid a collision with other detected objects comprises selecting one of a plurality of sets of fuzzy logic rules recommending the acceleration and steering of the vehicle depending on in which of the other directions objects are detected.--

--128. A method in accordance with claim 127 wherein selecting one of a plurality of sets of fuzzy logic rules comprises reproducing the rules from an associative memory.--

--129. A method in accordance with claim 1 further comprising, upon receipt of an override command by the driver, ceasing alteration of the acceleration and steering of the vehicle.--

--130. A system in accordance with claim 30 further comprising an override controller coupled to the second computer so as, when activated by the driver, to prevent the command signals from controlling said driver-operated controls.--

--131. A method for controlling the operation of a vehicle driven by a human being comprising:

(a) scanning an area in front of a first vehicle as it travels along a roadway and generating first information signals modulated with image information relating to a second vehicle ahead of said first vehicle;

(b) computer processing said first information signals and generating a first time-varying sequence of digital signals indicative of the distance between said first and second vehicles and the closing speed therebetween;

(c) scanning areas to the left and right sides of said first vehicle and an area behind said first vehicle and generating second information signals modulated with image information relating to other objects detected in those directions;

(d) computer analyzing said second information signals and generating a second time-varying sequence of digital signals relating to the other objects;

B21  
cont

(e) analyzing said first sequence of digital signals as they are generated and to determine whether a collision is imminent between said first vehicle and said second vehicle;

(f) when a collision is imminent, employing fuzzy logic to select one of several kinds of evasive action, each requiring a different alteration in control of the operation of said first vehicle, based on the first and second sequences of digital signals; and

(g) automatically altering control of the operation of the first vehicle using the fuzzy logic selected evasive action to attempt to prevent a collision with said second vehicle without causing the first vehicle to collide with the other objects.--

SUBC 191  
B2  
cont

--132. A system for operating and controlling a vehicle comprising:

(a) a vehicle having a body, a motive system, and driver-operated controls including an accelerator, a brake, and a steering system;

(b) a first scanning device supported by said vehicle, directed toward the front of said vehicle, and configured to generate first signals modulated with information relating to first objects in the field of view of said first scanning device;

(c) a second scanning device supported by said vehicle, directed toward at least one side of said vehicle, and configured to generate second signals modulated with information relating to second objects in the field of view of said second scanning device;

(d) a first computer coupled to said first scanning device and configured to analyze said first signals as the vehicle travels and to produce first code signals on an output of said first computer, which first code signals are indicative of distances and relative motions between said vehicle and said first objects;

(e) a second computer coupled to said second scanning device and configured to analyze said second signals as the vehicle travels and to produce second code signals on an output of said second computer, which second code signals are indicative of the presence of said second objects; and

(f) a fuzzy logic-based control computer coupled to said first and second computers and configured to analyze said first and second code signals and to generate command signals on an output of said control computer;

(g) wherein the output of said control computer is electrically coupled to said driver-operated controls such that the command signals are applied to control the accelerator, brake, and steering system of said vehicle to attempt to avoid a collision between said vehicle and said first objects without causing the vehicle to collide with said second objects.--

--133. A system in accordance with claim 132:

(a) further comprising a third scanning device supported by said vehicle, directed so that the second and third scanning devices cover both the left and right sides of said vehicle, and configured to generate third signals modulated with information relating to third objects in the field of view of said third scanning device;

(b) further comprising a third computer coupled to said third scanning device and configured to analyze said third signals as the vehicle travels and to produce third code signals on an output of said first computer, which third code signals are indicative of the presence of said third objects;

(c) wherein said control computer is coupled to said third computer and configured to analyze said third code signals; and

(d) wherein said command signals are applied to attempt to avoid a collision between said vehicle and said first objects in its path of travel without causing the vehicle to collide with both of the second and the third objects.--

BJ  
cont

--134. A system in accordance with claim 132 wherein said second code signals are also indicative of the distance between said vehicle and said second objects.--

UBC 20

~~--135. A system in accordance with claim 132:~~

~~(a) further comprising a third scanning device supported by said vehicle, directed toward the rear of said vehicle, and configured to generate third signals modulated with information relating to third objects in the field of view of said third scanning device;~~

~~(b) further comprising a third computer coupled to said third scanning device and configured to analyze said third signals as the vehicle travels and to produce third code signals on an output of said first computer, which third code signals are indicative of the presence of said third objects;~~

~~(c) wherein said control computer is coupled to said third computer and configured to analyze said third code signals; and~~

~~(d) wherein said command signals are applied to attempt to avoid a collision between said vehicle and said first objects in its path of travel without causing the vehicle to collide with both of the second and the third objects.--~~

B21  
cont

--136. A system in accordance with claim 135 wherein said second control signals are also indicative of the distance between said vehicle and said second objects and said third control signals are also indicative of the distance between said vehicle and said third objects.--

--137. A system in accordance with claim 132 further comprising a visual display inside said vehicle body coupled to the output of said first and second computers and driven by said first and second code signals to generate symbols representative of said first and second objects.--



--138. A system in accordance with claim 132 further comprising a synthetic speech generating system coupled to the output of said control computer and driven by said command signals to generate sounds of select words of speech.--

--139. A system in accordance with claim 138 wherein said speech generating system generates a human-audible warning when a collision is imminent, and wherein the control computer is timed to control the operation of said vehicle to attempt to avoid a collision only if the driver-operated controls are not altered sufficiently to avoid a collision in response to the warning.--

UBC 21  
B2  
cont

--140. A system in accordance with claim 132 wherein the first computer is configured to identify one of said first objects by comparing the shape of part of the first object to a set of standard shapes and generating an output signal indicating a match, and wherein said output signal and a measurement of a dimension of the image of the one of the first objects is used to determine the distance between said vehicle and that object.--

--141. A system in accordance with claim 132 wherein said control computer is coupled to control the speed and steering of said vehicle simultaneously.--

--142. A method for enhancing safety of a moving vehicle comprising:

- (a) electronically scanning image areas in directions to the front, back, and both sides of the vehicle and generating video signals therefrom;
- (b) processing the video signals to detect objects located in the image areas;
- (c) further processing said video signals to determine, for each of the detected objects, distance and relative motion between the object and the vehicle;
- (d) using the distance and relative motion information to identify those of the objects that are collision hazards;

(e) assembling state information defining whether hazards and objects are located in each of the directions from the vehicle;

(f) using said state information to reproduce from a memory one of a plurality of fuzzy logic vehicle control rules;

(g) using the selected fuzzy logic control rules to generate output signals indicative of an evasive action for the vehicle; and

(h) employing the output signals to attempt to avoid collisions between the vehicle and the identified hazards while also avoiding a collision between the vehicle and the other objects detected on all sides of the vehicle.--

--143. A method in accordance with claim 142 wherein employing the output signals comprises automatically applying the output signals to control the motion of the vehicle in accordance with the evasive action.--

BJ  
cont

--144. A method in accordance with claim 143 wherein applying the output signals comprises controlling the motion of the vehicle by altering at least one of the speed and direction of travel of the vehicle in accordance with the evasive action defined by the fuzzy logic control rules.--

--145. A method in accordance with claim 144 wherein controlling the motion of the vehicle consists of altering the speed and steering of the vehicle simultaneously.--

--146. A method in accordance with claim 142 wherein employing the output signals comprises applying the output signals to warn a human operator of the vehicle.--

--147. A method in accordance with claim 146 wherein warning the human operator comprises displaying a visual warning.--

--148. A method in accordance with claim 146 wherein applying the output signals to warn a human operator comprises intelligibly indicating the recommended evasive action for the vehicle.--

--149. A method in accordance with claim 142 further comprising, if more than one hazard has been identified:

- (a) assembling the distance and relative motion information for each of the identified hazards;
- (b) priority ranking the hazards; and
- (c) wherein assembling said state information comprises first reclassifying as objects all of the hazards other than the hazard with the highest ranking priority.--

--150. A method in accordance with claim 142 wherein said relative motion information consists of relative velocity and relative acceleration data.--

--151. A method in accordance with claim 142 further comprising classifying each detected object into one of a plurality of object types.--

--152. A method in accordance with claim 151 wherein classifying includes using neural networks.--

*Subced* --153. A method in accordance with claim 151 wherein classifying includes comparing the image of the object with a plurality of reference images.--

--154. A method in accordance with claim 151 further comprising, if more than one hazard has been identified:

- (a) assembling the distance and relative motion information for each of the identified hazards;

(b) priority ranking the hazards based at least in part on the classification of hazards; and

(c) wherein assembling said state information comprises first reclassifying as objects all of the hazards other than the hazard with the highest ranking priority.--

--155. A method in accordance with claim 142 further comprising using road information, in addition to said state information, to reproduce from a memory one of a plurality of fuzzy logic vehicle control rules.--

--156. A method for enhancing safety of a moving vehicle comprising:

(a) electronically scanning image areas in directions to the front and back of the vehicle and generating video signals therefrom;

(b) processing the video signals to detect objects located in the image areas;

(c) further processing said video signals to determine, for each of the detected objects, distance and relative motion between the object and the vehicle;

(d) using the distance and relative motion information to identify those of the objects that are collision hazards;

(e) assembling state information defining whether hazards and objects are located in each of the directions from the vehicle;

(f) using said state information to reproduce from a memory one of a plurality of fuzzy logic vehicle control rules;

(g) using the selected fuzzy logic control rules to generate output signals indicative of an evasive action for the vehicle; and

(h) employing the output signals to attempt to avoid collisions between the vehicle and the identified hazards while also avoiding a collision between the vehicle and the other objects detected ahead of and behind the vehicle.--

3021  
cont

--157. A method for enhancing safety of a moving vehicle comprising:

- (a) electronically scanning image areas in directions to the front and both sides of the vehicle and generating video signals therefrom;
- (b) processing the video signals to detect objects located in the image areas;
- (c) further processing said video signals to determine, for each of the detected objects, distance and relative motion between the object and the vehicle;
- (d) using the distance and relative motion information to identify those of the objects that are collision hazards;
- (e) assembling state information defining whether hazards and objects are located in each of the directions from the vehicle;
- (f) using said state information to reproduce from a memory one of a plurality of fuzzy logic vehicle control rules;
- (g) using the selected fuzzy logic control rules to generate output signals indicative of an evasive action for the vehicle; and
- (h) employing the output signals to attempt to avoid collisions between the vehicle and the identified hazards while also avoiding a collision between the vehicle and the other objects detected in front and to the sides of the vehicle.--

B21  
cont

UBC23

--158. A system in accordance with claim 116:

- (a) further comprising a third scanning device supported by said vehicle, directed away from said vehicle in a direction other than the front of the vehicle and other than the direction of the second scanning device, and configured to generate third signals modulated with information relating to objects not in the field of view of either the first or second scanning devices;
- (b) further comprising a fourth computer coupled to said third scanning device and configured to analyze said third signals as the vehicle travels and to produce third code signals on an output of said fourth computer,

which code signals are indicative of distances and relative motion between said vehicle and each of the objects in the field of view of said third scanning device;

(c) wherein said scanning devices cover substantially all of an area surrounding the vehicle; and

(d) wherein said fuzzy logic-based second computer is also coupled to said third and fourth computers and configured to analyze said first, second, and third code signals and to generate command signals therefrom that are applied to control operation of said vehicle to attempt to avoid collisions both with objects in the path of travel of the vehicle and objects in the field of view of said second and third scanning devices.--

--159. A method in accordance with claim 53 further comprising

(a) scanning areas behind said vehicle and generating third information signals modulated with image information relating to other objects behind said vehicle;

(b) computer analyzing said third information signals and generating a third time-varying sequence of digital signals when an object behind said vehicle is detected;

(c) using fuzzy logic to analyze said first, second, and third sequences of digital signals to select one of several kinds of evasive action, each requiring a different alteration in control of the operation of said vehicle; and

(d) when said analysis determines that a collision is imminent, automatically altering control of the operation of the vehicle in accordance with the selected evasive action to attempt to prevent a collision with an object ahead of said vehicle without causing the vehicle to collide with other objects to the sides or to the rear of said vehicle.--

--160. A method in accordance with claim 53 wherein determining the distance between the vehicle and one of the objects in front of the vehicle comprises computer

B21  
cont

processing the first information signals in a manner to measure a selected dimension of the object in the image, thereby identifying the object. <sup>A</sup>

B21  
ConeQ

---

Remarks

The Office Action contains a large number of rejections and objections. They are treated in turn below.

**I. THE VARIOUS INFORMALITIES HAVE BEEN CURED.**

Regarding paragraph 1 of the Office Action, applicants acknowledge the Examiner's request that full words should be changed in any amendment and will comply in this and future amendments.

Regarding paragraph 2, applicants appreciate the Examiner's decision to withdraw the species election requirement, which should expedite prosecution.

Regarding paragraph 3, applicants acknowledge the request for a supplemental oath. A supplemental oath is being submitted separately.

Regarding paragraph 4, an Information Disclosure Statement with the accompanying fee accompanies this response. Copies of each of the references are enclosed with that document. Applicants have attempted to cite the most relevant portions of longer references. A concise explanation of relevance is not included because the requirement for such has been abolished by Office rule MPEP 609(A)(3), which states: "The requirement for a concise explanation of relevance is limited to information that is not in the English language." The only non-English-language reference is accompanied by an English abstract, which applicants submit in satisfaction of that requirement. If the Examiner has any specific questions concerning any particular references cited, applicants will be willing to assist upon request.

Regarding paragraphs 5 and 6, a separate document requesting drawings amendments with redlined versions of the figures is enclosed.

Regarding paragraph 7 and 8, applicants have reviewed the Abstract as amended by the paper filed November 7, 1994, and determined that the Abstract is 198 words long, well below the maximum.

Regarding paragraphs 9 and 10, the identified sections are added into the specification.

Regarding paragraph 11, the terms "powered vehicles" and "symbols" are added into appropriate places in the specification.

Regarding paragraph 12, the insertions objected to are not "new matter," as they were sentences moved from the abstract as originally filed (to shorten the abstract). Specifically, the insertion at paragraph 12(a) of the Office Action was moved from lines 6-9 of the original abstract. The insertion at paragraph 12(b) was moved from lines 12-15 of the original abstract (with slight modification to make it a complete sentence). The insertion at paragraph 12(c) was moved from the last three lines of the original abstract. The insertion at paragraph 12(d) was moved from the penultimate sentence of the original abstract. Applicants respectfully request the Examiner to withdraw the objection, in view of that showing.

Paragraphs 13-15 are discussed in part II, below. An amendment to claim 30 to evade the rejection in paragraph 14(c) has been made.

Regarding paragraph 16, applicants have submitted appropriate amendments to the claims to cure the antecedent basis and other problems or otherwise clarify the claims.

Regarding several of the subparagraphs or paragraph 16, although applicants understand the Examiner's concern that a method claim comprises a series of "steps," applicants' previous amendments were intended to ensure that the method claims are considered to contain specific acts. Thus, applicants have made amendments to reference the specific acts directly, rather than to use the claim parts. The amendments do not compromise applicants' point that Section 112(6) is not invoked, and applicants are entitled to their preferred choice of claim terminology, so long as the claims are definite. The claims as now amended quite clearly point out the antecedent references, thus, the Section 112(2) rejections of the claims have been overcome.

Regarding paragraph 16(g), the antecedent basis for "wherein intelligibly indicating..." is in part (e) of claim 1.



Power of attorney to the undersigned is contained in the Supplemental Declaration.

**II. THE SECTION 112(1) REJECTIONS HAVE BEEN OVERCOME.**

The Examiner has made various rejections based on Section 112(1). Applicants have made appropriate changes to the claims and the specification to overcome certain of those rejections, and present the following arguments based on the specification as filed to overcome the remainder.

**A. The Specification Enables Measuring Velocity.**

Paragraphs 13(a) and 14(a) of the Office Action question whether the disclosure contains any system for performing the stated function of calculating relative velocities and accelerations. The specific, stated concern is that "there is no disclosed device which determines the time factor." [Para. 13(a)]

As explained on page 9, lines 15-19, control processor 11 receives data concerning the speed of the controlled vehicle from digital speedometer 44 and accelerometer 45. (The arrow in Figure 1 from speedometer 44 to processor 11 has its head at the wrong end, which error is corrected in the accompanying request for corrected drawings, to conform it to the specification.) Thus, control processor 11 can determine the velocity and acceleration of the controlled vehicle.

The disclosed device must also determine the relative velocity and acceleration of the observed vehicle, as compared to those of the controlled vehicle. The specification discloses a range detector including "a range computer 21 which accepts digital code signals from a radar or lidar computer 14 which interprets radar and/or laser range signals from respective reflected radiation receiving means on the vehicle." [Page 9, lines 19-21] Both of those computers are directly connected to processor 11.

As the Examiner notes, the specification states that the function of the system is to calculate relative velocity and acceleration of the vehicle in the image, which can be done by image processing. That function requires a time factor, but it is well known in the art to provide a clock connected to and controlling a microprocessor, such as 11 (or for that matter, 14 and 21). The ordinarily skilled artisan at the time of the invention

would readily have understood that the digital clock typically used with such microprocessor controlled systems could be used for the stated purpose. Thus, the skilled artisan could implement the specified function without undue experimentation.

The enablement requirement is measured with respect to one of ordinary skill in the art as of the filing of the application, and not with respect to the general public. W.L. Gore & Assoc. v. Garlock, Inc., 721 F.2d 1540, 1556, 220 U.S.P.Q. 303, 315 (Fed. Cir. 1983). Accordingly, it is not required that applicant disclose every detail of the invention, as applicant's specification is written for the person of ordinary skill in the art. DeGeorge v. Bernier, 768 F.2d 1318, 1323, 226 U.S.P.Q. 758, 762 (Fed. Cir. 1985). That person of ordinary skill in the art is presumed to have knowledge of all art reasonably pertinent to the particular problem with which the inventor was involved, Custom Accessories, Inc. v. Jeffrey-Allen Indus., Inc., 807 F.2d 955, 962, 1 U.S.P.Q.2d 1196, 1201 (Fed. Cir. 1986). Thus, the person of ordinary skill in the art must be viewed as working in his shop with all of the reasonably pertinent and available references, which he is presumed to know, hanging on the walls around him. Union Carbide Corp. v. American Can Co., 724 F.2d 1567, 1576, 220 U.S.P.Q. 583, 591 (Fed. Cir. 1984).

It is for that reason that a patent need not teach, and in fact preferably should omit, what is well known in the art. Spectra-Physics, Inc. v. Coherent, Inc., 827 F.2d 1524, 3 U.S.P.Q.2d 1737 (Fed. Cir.), cert. denied, 484 U.S. 954 (1987). Because the use of a digital clock with the specified microprocessor is well known, the specification need not expressly recite that feature to enable the function of calculating relative velocity.

**B. The Specification Discloses Classifying Vehicle Shapes.**

In paragraphs 13(b) and 14(b), (d), and (e) of the Office Action, the Examiner questions whether the specification discloses identifying nearby vehicles by their shapes, and asserts that the original specification discussed no more than measuring the width of the vehicles in the image field. However, the original abstract stated that an image processor identifies the objects and:

“Using such identifying information and comparing it with information on the shapes and sizes of various objects such as the rear and front profiles of all

production vehicles and the like and their relative sizes or select dimensions thereof, indications of distances to such objects may be computed and indicated as further codes.”

That sentence was moved to page 4 of the specification, in the summary of the invention. In the Detailed Description, moreover, at page 12, applicants disclosed:

“The calculation of the distance of certain recognizable objects from the vehicle is facilitated by having standard images stored in memory and recalling and comparing such image data with image data representing the object detected by the vehicle scanning mechanisms. For example, virtually all automobiles, trucks, and other standard vehicles have known widths. It follows that the distance to another vehicle can be determined by calculating its width in the scanned image.”

Those portions of the disclosure in particular, as well as a number of claims as filed originally (such as claim 6 and others), provide ample support for the use of size or shape identification, and matching with standard images, to assist in determining distance.

**C. The Specification Enables Tracking of Multiple Vehicles.**

In paragraph 13(c), the Office Action refers to an article by Rock (which is not prior art) for the purpose of establishing that tracking all objects and vehicles around the controlled vehicle is computationally unrealistic. The Examiner lists a number of claims asserted to “claim tracking and/or identifying all objects to prevent multiple collisions from any and all directions.” First, applicants note that the listed claims, in general do not contain such limitations. Rather, the bulk of the listed claims refer to identifying objects within the field of view of one or a few cameras, such as “ahead only” (claim 25), “ahead and to the sides” (claim 13), “ahead and behind” (claim 48), etc. Only claims 107 and 108 refer to tracking “all objects” surrounding the car in “any and all directions.”

Second, even as to the claims that disclose tracking objects in several or all directions, the Examiner has not met the burden of demonstrating that the claimed

system is inoperable, as asserted. The Rock article relied on in the Office Action even admits, at page 22 of the paper, that "achieving real-time performance and reliability...is possible." The explanation of that statement is revealing:

"Some experts suggest that digital computer cannot solve practically the problem of multiple-target tracking assignments in real time. This point of view may be too pessimistic. At the Advanced Technology Laboratories of Martin Marietta (Moorestown, N.J.), an algorithm has been developed to provide a nearly optimal correlation in real time under conditions of very high target densities and with relatively few errors. This algorithm has been tested successfully on 172 targets maneuvering in close quarters with frequently intersecting paths and randomly, drastically changing velocities and directions. The error rates for the new algorithm are essentially zero. The new algorithm can undergo a very large speedup through parallel implementation, which is not possible for the JVC. This illustration shows that, despite prevailing pessimism, achieving real-time performance and reliability for IVHS is possible."

Thus, even Rock admits the work of Martin Marietta demonstrates the possibility of very advanced target recognition with essentially no errors. The claimed systems do not require the level of complexity of the Martin Marietta system; 172 targets would be unlikely in a typical automotive system, and targets are generally in the field of view for a relatively long time. Thus, the image processing problem is not so severe as that encountered in general target recognition systems.

Moreover, the Rock article points out the possibility of obtaining "a very large speedup through parallel implementation." Applicants disclose several possible "parallel processing" structures that may be used to achieve such a "very large speed-up." Beginning at page 10, line 5, applicants discuss the use of parallel image processors such as illustrated in Figure 2, with video preprocessing and multiple high-speed image co-processors. Applicants point out at page 11, beginning at line 9, that these co-processors may be high-speed, programmable processors or special purpose hardware processors specifically designed for image processing. Other possibilities are disclosed on pages 11 and 12. Highly parallel neural network computing elements specifically design for image processing are disclosed beginning at page 12, line 15 and in Figures 3 and 4. The possibility of implementing neural network image processors

using specialized VLSI circuits is disclosed at page 13, as is the possibility of using multiple virtual processing elements as shown in Figure 5. In addition, many of the references cited by applicants demonstrate that the required parallel processing and specialized image processing technology required for applicants' invention are known in the art, including, for example, References 1-8, 10, 14, 17, 21 and 23 in the list at the end of the specification.

Also, in applicants' specification, the claimed systems are implemented through the use of an additional computer associated with each imaging device. At page 10, line 7 of the specification, applicants identify the use of such parallelism associated with the image processors. The use of additional image processors associated with each camera (or the like) permits an arbitrary increase in the number of cameras, and consequently in the number of directions that can be covered. Thus, it simply does not reduce performance at all to increase the number of directions in which images are processed.

From the Examiner's inclusion of certain single-directional systems in the claims listed in the rejection, applicants infer that the Examiner also questions whether a particular image processing system can pick up and analyze all objects within a field of view. The reference in the Rock article to the Martin Marietta system suggests that such systems are workable. In addition, however, the specification discloses certain ways of simplifying the process of image identification and computation. As explained at page 12 of the specification, the calculation of distance, relative velocity, and relative acceleration is facilitated by having standard images of expected objects stored in memory, which permits rapid evaluation of those factors with reduced image processing.

Finally, a number of patents relied on by the Examiner, such as Adachi, Dye, Taylor, Maekawa, Kajwara, Seneyoshi, and Davidian, disclose relative motion calculations in the context of highway identification. The Examiner apparently believes that those references sufficiently disclose working ranging systems, as Section 103 rejections have been made.

Applicants' invention is not principally directed to a new way of acquiring and analyzing image data. Applicants' contribution in that area is directed to the disclosed way of simplifying calculations by comparing vehicle profiles to standards, which reduces the computational calculations, not increases them. Rather, applicants' contribution is principally in the area of using a parallel system of known imaging or ranging devices and handling the data through a fuzzy logic decision mechanism using state vectors to characterize hazards and objects surrounding the vehicle, ranking hazards if necessary, and determining an appropriate response to hazardous conditions.

Because the specification discloses an improved control system that relies on data provided by known imaging techniques (with the exception of the idea for simplification mentioned), the computational requirements discussed by Rock do not block implementation of the system. Indeed, the system provides a novel way of achieving vehicle control with known image processing methods, including, for example, systems like those of Martin Marietta cited by Rock.

To the extent that the Rock reference asserts that the computations are too difficult to implement a system of this sort, such assertions would be powerful evidence of non-obviousness. Expressions by knowledgeable persons of incredulity are one of the forms of extrinsic evidence that can be used to rebut a prima facie conclusion of obviousness.

**D. The Specification Discloses Accident Avoidance.**

Paragraphs 13(d) and 14(g) and (i) of the Office Action are related to the Examiner's point that the invention is directed to avoiding accidents, but that not every accident can be avoided, and the specification also discusses lessening the impact of unavoidable accidents. Applicants agree with some but not all of the Examiner's comments in this regard.

The specification discloses controlling the steering or braking of the vehicle to take the best evasive action. While in some instances an accident will occur anyway, in other instances the evasive action will be successful in avoiding the accident

completely. For example, if a car ahead suddenly brakes, and there is an obstacle behind and to the right, the control system will select an evasive action of steering to the left, which can evade an accident. If the car is hemmed in to the left, too, however, there may be no way of avoiding some sort of collision, but the ranked hazards will ensure that the least damaging course of action is taken. Thus, the system can avoid collisions completely in some cases.

Applicants have responded to the rejection by amending the identified claims to clarify that the system operates with the goal of avoiding the collision completely. Minimizing the damage from a collision is only a secondary consideration. Applicants have also amended other claims containing parallel language.

With those amendments and the above explanation, applicants respectfully submit that the rejections in those paragraphs have been overcome.

**E. The Specification Supports a "Warn First" Mode.**

The Examiner also questions whether the original specification supported a system "in which the computer controls the vehicle if the driver does not sufficiently control the vehicle to avoid a collision." [Office Action, para. 14(f)] That version of the invention was disclosed in particular at specification pages 18 and 24 and through original claim 40.

On page 18, lines 7-8, applicants wrote: "In practice, then, the automated system will first warn the driver and then provide immediate automatic corrective action if necessary." Applicants have added to that page of the specification the further description from original claim 40, which stated that the computerized system would operate the vehicle "if the driver of said vehicle does not properly or quickly enough respond to indication by said intelligible indicating means that obstacles are in the path of travel of said vehicle." Also, at page 24, lines 20-21, applicants wrote, "Even if the driver does not respond to the warnings, the evasive control steps will tend to reduce the danger."

Thus, the specification amply supports the questioned feature.

**F. The Specification Supports a Time-to-Collision Ordering.**

Paragraph 14(h) of the Office Action asserts, "There is no disclosure of ranking in ascending order of calculated time in the specification." However, page 21 of the specification discusses ranking the hazards, and at lines 17-19, applicants stated: "Using these parameters [distance, relative velocity, and relative acceleration], the time to collision can be calculated for each detected hazard using well known kinematic equations. The most dangerous hazard then can be determined and control signals generated accordingly." Thus, the specification clearly discloses a time-to-collision ordering of hazards.

**III. THE OBVIOUSNESS REJECTIONS HAVE BEEN OVERCOME.**

Applicants have substantially amended the claims and added revised versions of claims, to better define the invention. The Section 103 rejections are moot in view of the amendments, with some exceptions.

Applicants have carefully analyzed the rejections and references discussed by the Examiner, and wish to point out the following specific points of distinction, which may not have been amply appreciated by the Examiner to date.

**A. The Adachi Reference Does Not Disclose Steering Control.**

A principal reference used by the Examiner is the Adachi patent. In discussing Adachi, the Examiner states: "Adachi discloses...using fuzzy logic to control the acceleration and steering of a vehicle...(col. 2, lines 55-64)." [OA, para. 18(a); see also OA, para. 18(k) ("Adachi discloses altering the steering of the vehicle (col. 8, lines 63-68)"); OA para. 30(b) (referring to non-existent "col. 26")]

However, Adachi discloses only control of the throttle and braking of the vehicle. Steering is measured by the control system, but it is not controlled. Thus, steering is an input, not an output, of the control system. Figure 1 of Adachi shows the use of a speed sensor 32, but "manipulated variable control means 38" controls only throttle and brake actuators 40 and 42. Figure 9 of Adachi is to the same effect. Adachi's control rules in his Figure 13 confirm the point. The cited portions of text



from Adachi also state merely that speed is used as an input. Thus, the Office Action incorrectly states that speed is controlled by Adachi's fuzzy logic system.

In applicants' invention, the following claims specifically relate to a fuzzy logic system that can control both steering and speed: Claims 1-10, 12-14, 30-34, 38-40, 43, 65, 100-30, 132-41, 144-45, and 158. Those claims have been rejected *only* as obvious over Adachi, and as to certain other features, in combination with other references. (Of course, the newly presented claims have not been rejected at all.)

The control of steering as well as speed is quite important, in that it provides more flexibility in the types of response to a hazardous situation, and it permits avoidance of a greater number of accidents, providing substantial advantages over prior art systems. Adachi's system could not easily be modified to control steering as well as speed, because Adachi discloses a vehicle control system that adapts to the driving habits of the driver with respect to following distance and car speed. Adapting to a driver's steering habits would have little, if any meaning. Thus, Adachi's system could not easily be extended to steering, and conversely implementing a steering system would be difficult using an adaptive system such as Adachi's.

In view of the gaps in Adachi, the above-listed claims are patentable.

**B. No Reference Discloses Evading One Accident without Thereby Causing a Second Accident.**

A number of claims relate to the concept of selecting a response to a hazardous situation that does not cause the vehicle to strike another obstacle or vehicle. A significant problem with existing systems is that they will evade an impending accident, regardless of the cost. For example, Adachi's system will brake the car if it is about to hit the car in front of it, even if it will cause the car to be struck by the car behind. Such systems can get the car out of the frying pan, only to put it in the fire.

The inventive apparatus monitors not only the primary accident risk (such as the front of the vehicle), but also hazards from one or more other directions from the vehicle (such as to the sides or behind). The system can select between several evasive responses, depending on conditions around the vehicle. At least claims 13-14, 48, 53-62,

65, 104, 108, 110-12, 117, 123, 125-28, 131-57, and 159-60, relate to that aspect of the invention.

In the Office Action, the Examiner admits that the cited references do not disclose scanning in multiple directions from the vehicle. However, the Examiner nevertheless rejects those claims on the grounds that "it would have been obvious to one skilled in the art to scan in all directions in order to avoid collisions from other directions instead of just one direction." [OA, para. 18(j); see also, e.g., OA paras. 18(l), 18(r), 25(c), 31(a), 31(m)] But that is not the point of the invention as claimed. The invention does not consist merely of duplicative systems directed in different directions, it consists of a system that selects an evasive response to a danger depending on the presence of obstacles in other directions. Modification of the response to a particular danger is not obvious. To the extent that the Examiner means to assert that the element is well-known, applicants respectfully traverse the assertion.

**C. The Combination of Speed and Steering Control and Modification of the Evasive Action Based on Other Obstacles Is Particularly Powerful.**

The concept of modifying the response based on the observation of other obstacles adjacent to the vehicle is of particular importance where the fuzzy system controls not only vehicle speed but also steering. In that case, the system must elect between altering the speed and altering the steering, in either direction, in response to a hazard. Any one of those evasive responses can avoid the primary hazard, but not all of the responses are equally safe. The present invention provides a way of evaluating the best of several possible hazards.

At least claims 13, 14, 65, 104, 108, 110-12, 117, 123, 125-28, 132-41, and 144-45 specify fuzzy control of steering and braking, in combination with modification of the evasive action depending on the results of scanning and analysis in directions other than the direction of the primary danger.

**D. Taylor Does Not Enable Steering Control.**

Claims 86, 91, 92, and 99 do not expressly contain limitations related to fuzzy logic, and they stand rejected based principally on Taylor, rather than Adachi. Those

claims relate to the choice of evasive action, with omnidirectional scanning and indication of obstacles to the driver. Taylor does not fairly meet the claimed invention.

Taylor does not disclose omnidirectional scanning. Rather, Taylor is directed to a system of range-finding, that is, measuring a distance to an object. Taylor has essentially no disclosure of how to use that information, although he claims, at two places in the specification, that the information can be used to control braking and steering. However, Taylor says absolutely nothing about *how* that can be done or how the controller would select between multiple types of evasive actions. Thus, Taylor does not enable the concept of selecting between many evasive actions, even in a non-fuzzy system.

**E. Applicants' "Warn, Wait, then Control" System Is Novel.**

Certain of the claims relate to issuing a warning, waiting for the driver to respond in a way that would eliminate the hazard, and to take over control of the vehicle only if the hazard remains. Claims such as claims 40, 43, 54-56, and 139 relate to that distinction. None of the references cited by the Examiner fairly meet that distinction.

**F. Applicants' Visual System Is Distinct from Dye.**

The Office Action applies Dye to show visual scanning of an object adjacent to the vehicle. However, Dye does not disclose certain claimed elements.

First, Dye does not disclose *identification* of the object ahead of the vehicle. Claims 3, 6, 7, 38, 39, 120, 140, 151-54, and 160 here contain that limitation. Rather, Dye only discloses recognition of the existence of an object having a substantially constant bearing with respect to the direction of travel of the controlled vehicle.

Second, Dye does not disclose measuring a dimension of the image of the object, to determine its distance. Claims 2, 3, 119, 120, 140, and 160 here contain that limitation. Dye merely uses the fact that the image size increases to generate a warning.

Third, Dye does not disclose detecting an image shape. See claims 6, 7, 38, 39, 120, and 140 here.

**G. Applicants' Output Systems Are Novel.**

In paragraph 19(c), the Examiner asserts: "Adachi discloses employing an evasive action of controlling the steering and/or brakes which reads on indicating the recommended kind of evasive action." As noted above, Adachi does not control steering. Moreover, it is not understood why the Examiner suggests that taking an action that effects operation of the vehicle is considered to qualify as the act of "indicating." The word "indicating" in this context means pointing out something with a sign or symbol. If the Examiner believes that another word would more precisely connote that meaning, applicants respectfully request the Examiner to so advise.

Nothing in the prior art of record shows a system that indicates a recommendation of one of many types of possible evasive action. Claims 56-59, 61, 62, 118-28, and 148 include express limitations directed to that point.

In paragraph 20, the Examiner applies Morioka to meet the added limitations of claims 58 and 59 with respect to a windshield display. (At page 22, line 6 of the Office Action, the "Hancock" reference is identified, but applicants assume that this was an error.) Morioka discloses a heads up display with horizontal lines enabling the driver to estimate distance to another vehicle. However, there is no way that the Morioka display could be connected to the output of Adachi and Dye to meet those claims. Morioka does not disclose the information specified by those claims, or that of intermediate claims 56 and 57, and Adachi and Dye do not disclose outputting that information for display of any sort.

**H. Applicants' Fuzzy Ranking System Is Novel.**

In paragraph 22 of the Office Action, the Examiner applies Kohsaka to show the obviousness of the "priority rankings" added by dependent claims such as 100, 113, 149, and 154. However, Kohsaka discloses ranking messages, which are the *output* of the fuzzy logic system. In applicants' invention, the priority rankings are used to index into an associative memory to select an appropriate control response, that is, as an *input* to the fuzzy logic function. Kohsaka's fuzzy logic is not based on any sort of priority ranking.

Kohsaka's ranking would not be integrable with Adachi and Dye, and any melding of the three references would not be suited for vehicle control based on selection of several evasive actions. The inventive system provides significant advantages over the mere ranking of messages shown by Kohsaka.

Conclusion

If the Examiner has any questions, please contact applicants' undersigned attorney.

Respectfully submitted,

JEROME H. LEMELSON  
ROBERT D. PEDERSEN  
by their attorney

Dated: June 23, 1995

  
\_\_\_\_\_  
Louis J. Hoffman  
Reg. No. 38,918

LOUIS J. HOFFMAN, P.C.  
15150 North Hayden Road  
Suite 202  
Scottsdale, Arizona 85260  
(602) 948-3295

Certification

I hereby certify that this paper, together with the enclosures: (a) Combined Substitute Declaration and Power of Attorney, (b) Amendment to Drawings with seven sheets of redlined drawings, (c) Information Disclosure Statement with five pages of form PTO-1449, copies of all listed references, and a check for \$210.00, and (d) check for \$370.00, is being hand-delivered this 26th day of June, 1995, to the U.S. Patent and Trademark Office.

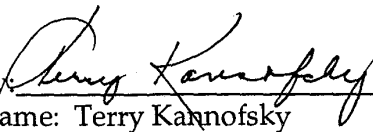
By:   
Name: Terry Kannofsky

RECEIPT IS ACKNOWLEDGED OF a document entitled Response to First Office Action, together with the enclosures: (a) Combined Substitute Declaration and Power of Attorney, (b) Amendment to Drawings with seven sheets of redlined drawings, (c) Information Disclosure Statement with five pages of form PTO-1449, copies of all listed references, and a check for \$210.00, and (d) check for \$370.00:



IN THE UNITED STATES PATENT AND TRADEMARK OFFICE

Applicant : Jerome H. Lemelson                      Art Unit : 2615  
              : Robert D. Pedersen  
Serial No. : 08/105,304                              Examiner : Au  
Filed : 8/11/93  
Title : Motor Vehicle Warning and Control System and Method

~~#9~~  
Rose  
7-3-95

Honorable Commissioner of  
Patents and Trademarks  
Washington, D.C. 20231

AMENDMENT TO DRAWINGS

Dear Sir:

Please amend the drawings as follows. Seven sheets of redlined drawings are enclosed, showing the proposed amendments.

IN THE DRAWINGS:

- In Figure 1, reverse the direction of the arrow connecting block 44 to block 11.
- In Figure 5, block 74, change "processer" to --processor--.
- In Figure 6, on an input line to block 74, change "override" to --override--.
- In Figure 6, block 11, change "microprocesser" to --microprocessor--.
- In Figure 12, at the top of the left column, change "hazzard" to --hazard--.
- In Figure 13, block 99, change "hazzard" to --hazard--.
- In Figure 13, blocks 97 and 98, change "hazzards" to --hazards--.
- In Figure 14, block 112, change "hazzard" to --hazard--.
- In Figure 15, at each of six occurrences, change "hazzard" to --hazard--.

If the Examiner has any questions, please feel free to call applicants' undersigned attorney.

Respectfully submitted,

JEROME H. LEMELSON  
ROBERT D. PEDERSEN  
by their attorney



---

Louis J. Hoffman  
Reg. No. 38,918

Dated: June 23, 1995

LOUIS J. HOFFMAN, P.C.  
15150 North Hayden Road  
Suite 202  
Scottsdale, Arizona 85260  
(602) 948-3295



340/903  
Lefkowitz

Jerome Lemelson  
Suite 286  
930 Tahoe Blvd., Unit 802  
Incline Village, NV 89451-9436  
08 105304

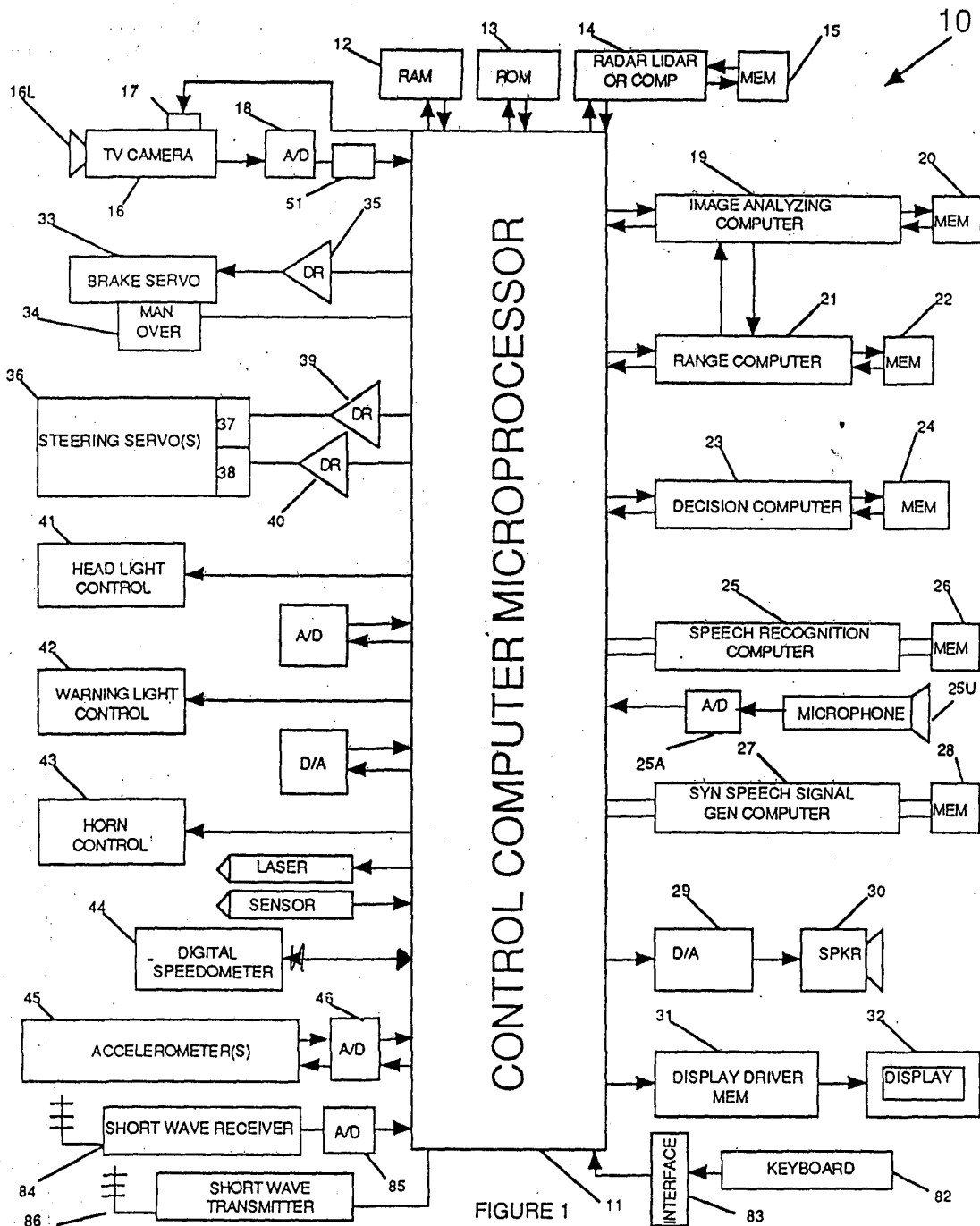

FIGURE 1

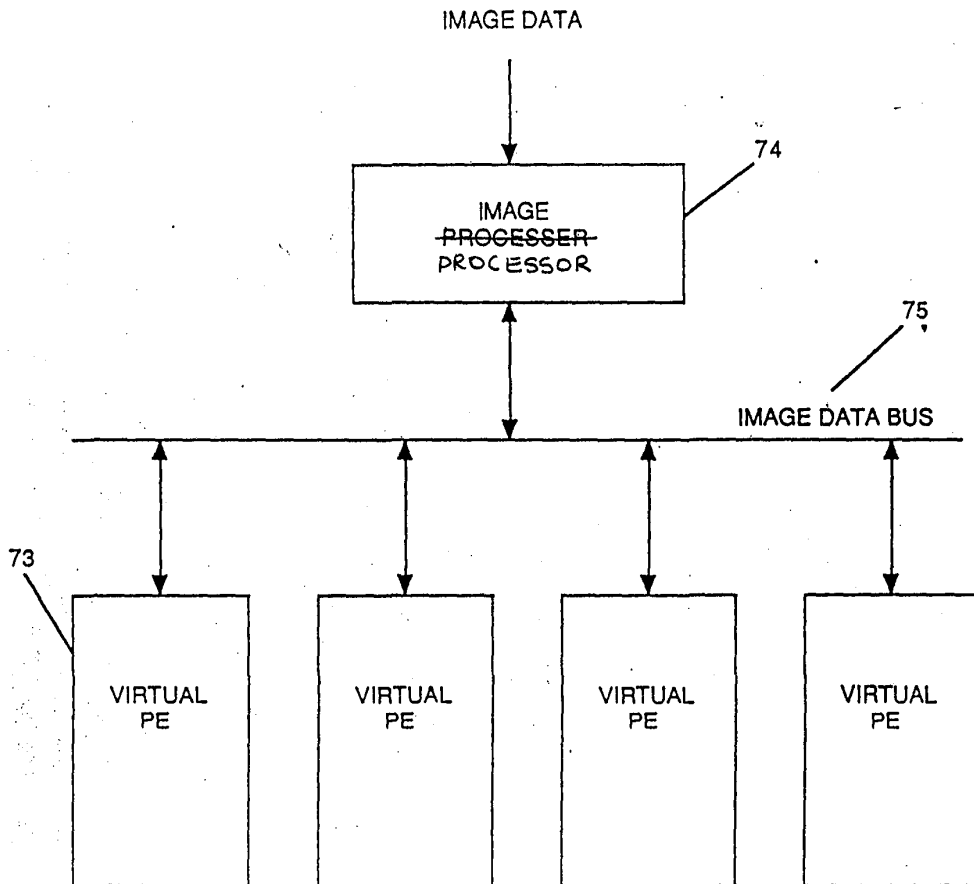

FIGURE 5

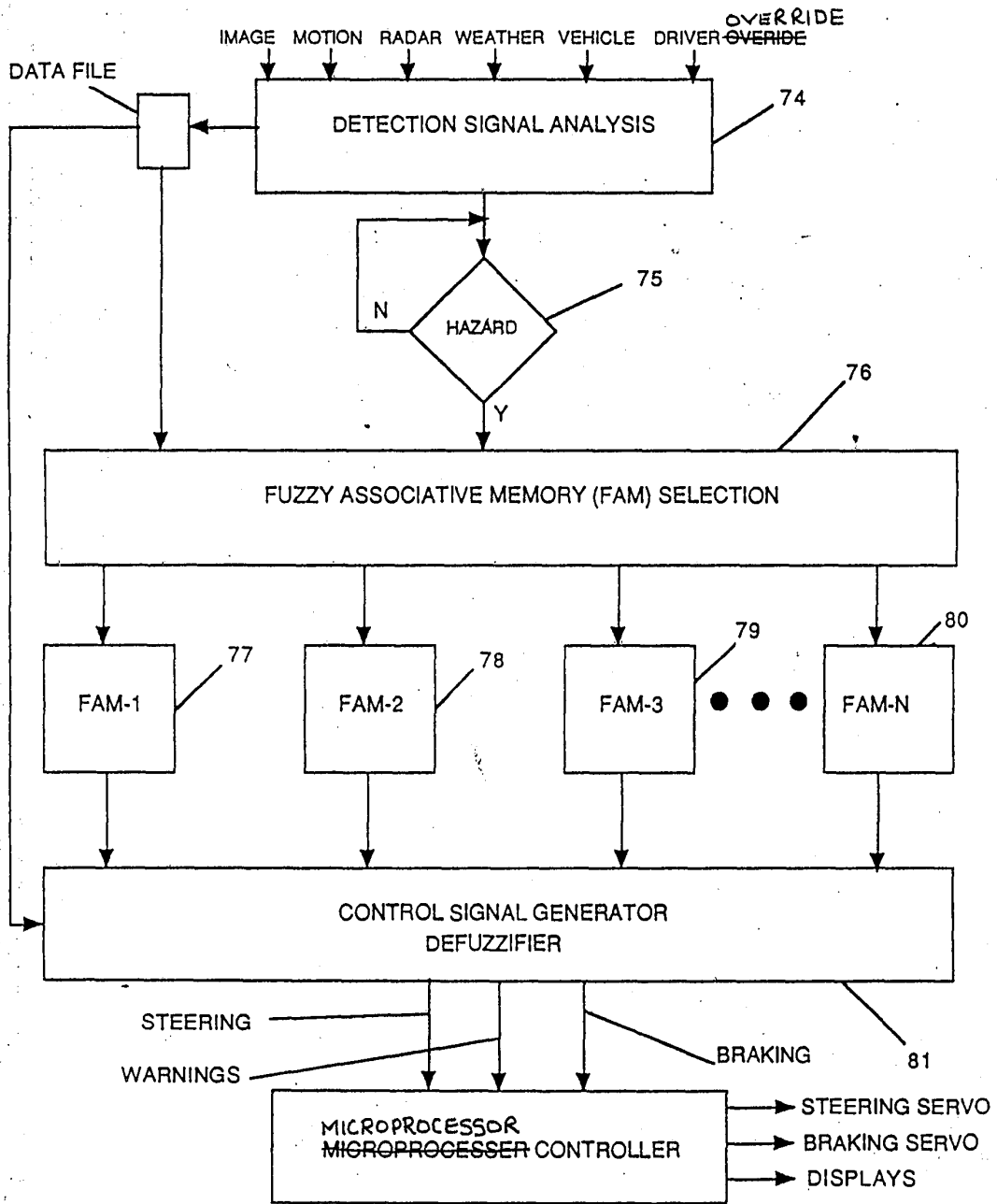

FIGURE 6

11

STATE VECTOR	HAZARD				OBSTACLE			
	HF	HB	HL	HR	OF	OB	OL	OR
1	0	0	0	0				
2	0	0	0	1	0	0	0	
3	0	0	0	1	0	0	1	
4	0	0	0	1	0	1	0	
5	0	0	0	1	0	1	1	
6	0	0	0	1	1	0	0	
7	0	0	0	1	1	0	1	
8	0	0	0	1	1	1	0	
9	0	0	0	1	1	1	1	
10	0	0	1	0	0	0		0
11	0	0	1	0	0	0		1
12	0	0	1	0	0	1		0
13	0	0	1	0	0	1		1
14	0	0	1	0	1	0		0
15	0	0	1	0	1	0		1
16	0	0	1	0	1	1		0
17	0	0	1	0	1	1		1
18	0	0	1	1	0	0		
19	0	0	1	1	0	1		
20	0	0	1	1	1	0		
21	0	0	1	1	1	1		
22	0	1	0	0	0		0	0
23	0	1	0	0	0		0	1
24	0	1	0	0	0		1	0
25	0	1	0	0	0		1	1
26	0	1	0	0	1		0	0
27	0	1	0	0	1		0	1
28	0	1	0	0	1		1	0
29	0	1	0	0	1		1	1
30								
31	0	1	0	1	0		0	
32	0	1	0	1	0		1	
33	0	1	0	1	1		0	
34	0	1	0	1	1		1	
35	0	1	1	0	0			0
36	0	1	1	0	0			1
37	0	1	1	0	1			0
38	0	1	1	0	1			1
39	0	1	1	1	0			
40	0	1	1	1	1			
41	1	0	0	0		0	0	0
42	1	0	0	0		0	0	1
43	1	0	0	0		0	1	0
44	1	0	0	0		0	1	1
45	1	0	0	0			0	0
46	1	0	0	0		1	0	1
47	1	0	0	0		1	1	0
48	1	0	0	0		1	1	1
49	1	0	0	1		0	0	
50	1	0	0	1		0	1	
51	1	0	0	1			0	
52	1	0	0	1			1	
53						1		
54	1	0	1	0		0		0
55	1	0	1	0		0		1
56	1	0	1	0		1		0
57	1	0	1	0		1		1
58	1	0	1	1		0		
59	1	0	1	1		1		
60	1	1	0	0			0	0
61	1	1	0	0			0	1
62	1	1	0	0			1	0
63	1	1	0	0			1	1
64	1	1	0	1			0	
65	1	1	0	1			1	
66	1	1	1	0				0
67	1	1	1	0				1
68	1	1	1	1				

FIGURE 12

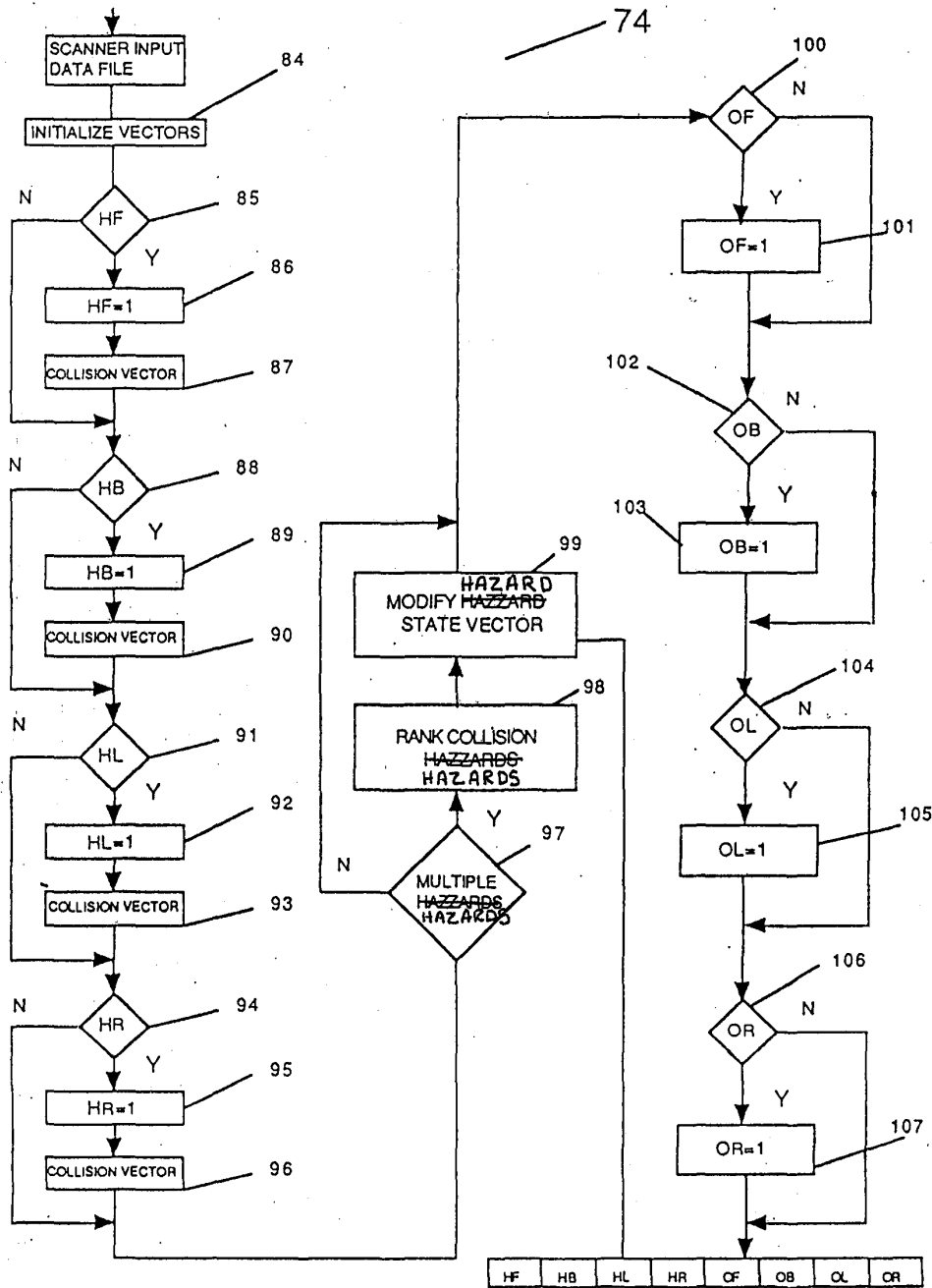

FIGURE 13

82

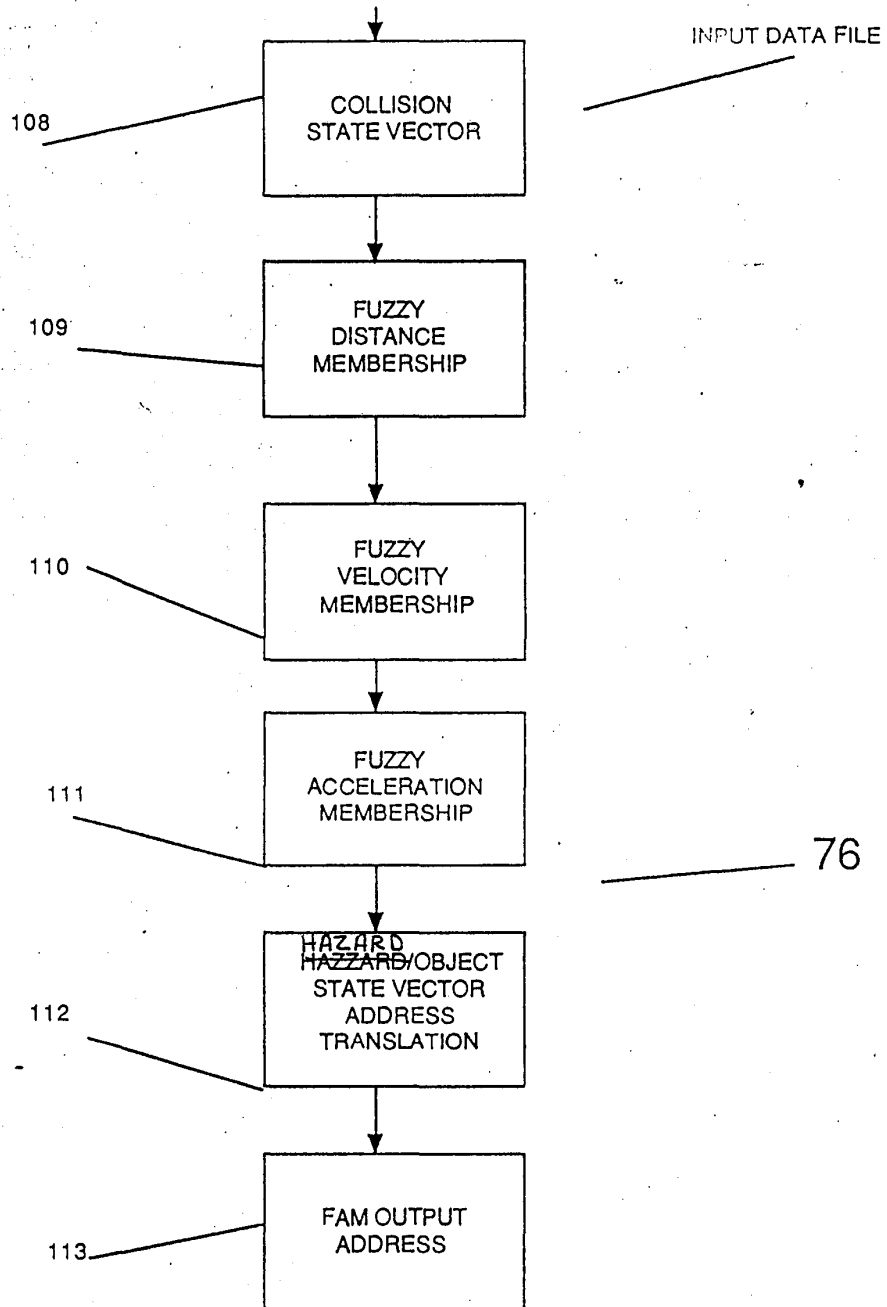

FIGURE 14

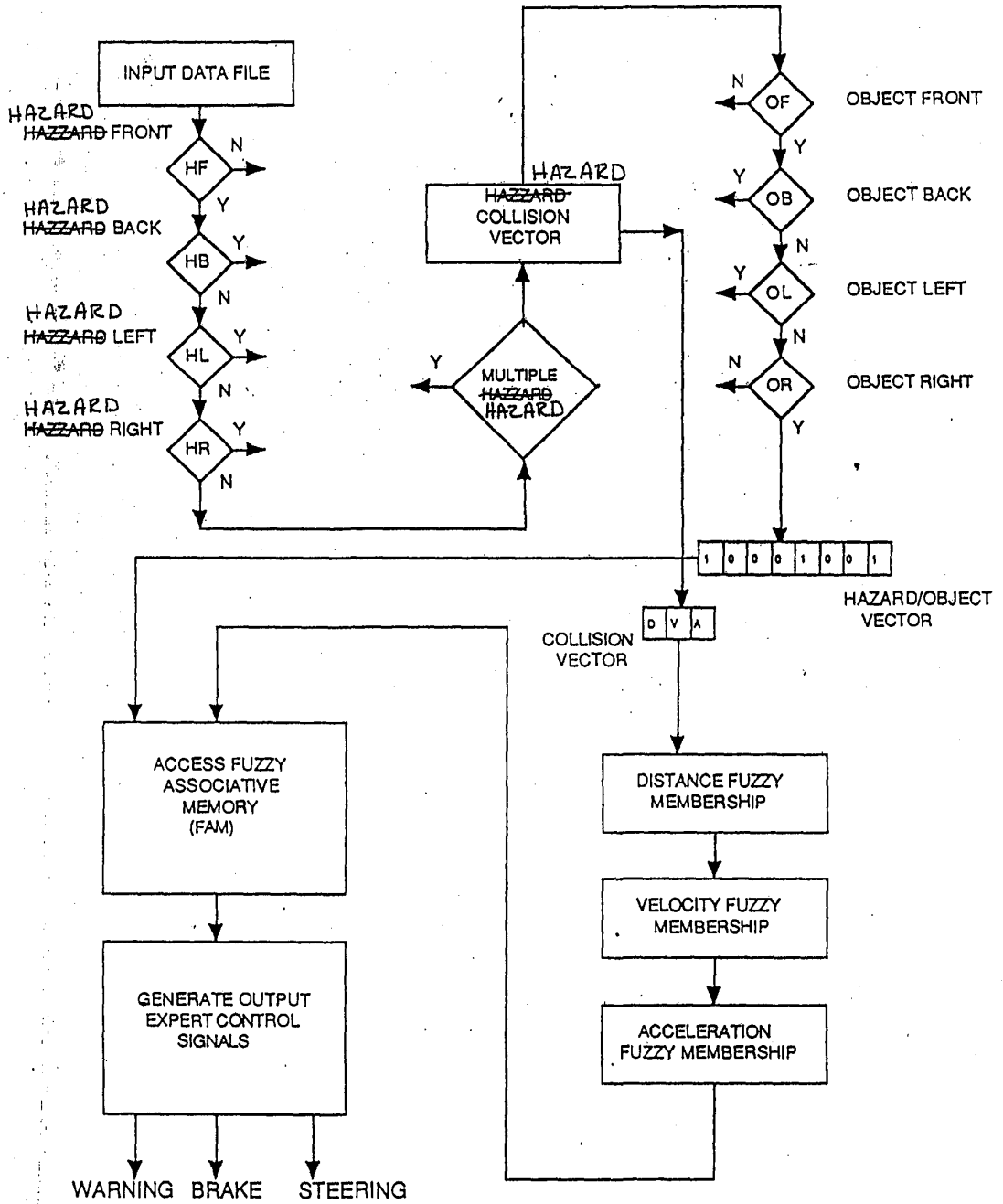

FIGURE 15



IN THE UNITED STATES PATENT AND TRADEMARK OFFICE

#110  
Rose  
7-3-95

Applicant : Jerome H. Lemelson Art Unit : 2615  
 Robert D. Pedersen

Serial No. : 08/105,304 Examiner : Au

Filed : 8/11/93

Title : Motor Vehicle Warning and Control System and Method

---

Honorable Commissioner of  
Patents and Trademarks  
Washington, D.C. 20231

**COMBINED SUBSTITUTE DECLARATION  
AND POWER OF ATTORNEY**

Dear Sir:

As the below-named inventors, we hereby declare that:

1. TYPE OF DECLARATION

This declaration is a substitute declaration for a new application.

2. INVENTORSHIP IDENTIFICATION

Our name, residence, post office address, and citizenship are as stated

below:

Name: Jerome H. Lemelson  
 Citizen of: United States  
 Resident of: Incline Village, Nevada  
 Post Office Address: Suite 286, Unit 802  
 930 Tahoe Boulevard  
 Incline Village, Nevada 89451-9436

Name: Robert D. Pedersen  
 Citizen of: United States  
 Resident of: Dallas, Texas  
 Post Office Address: 7808 Glen Eagle  
 Dallas, Texas 75248



We believe we are the original, first, and sole inventors of the subject matter which is claimed and for which a patent is sought on the invention entitled: "Motor Vehicle Warning and Control System and Method."

3. ACKNOWLEDGEMENT OF REVIEW OF PAPERS AND DUTY OF CANDOR

We hereby state that we have reviewed and understand the contents of the above-identified specification, including the claims, as amended.

We acknowledge the duty to disclose information that is material to the examination of this application in accordance with Title 37, Code of Federal Regulations § 1.56(a).

4. POWER OF ATTORNEY

As the named inventors, we hereby appoint Steven G. Lisa, Reg. No. 30,771; Peter C. Warner, Reg. No. 36,994; J. Kevin Parker, Reg. 33,024; and Louis J. Hoffman, Reg. No. 38,918 to prosecute this application and to transact all business in the Patent and Trademark Office connected with this application.

Send correspondence to:

LOUIS J. HOFFMAN, P.C.  
15150 North Hayden Road  
Suite 202  
Scottsdale, Arizona 85260

Direct telephone calls to:

Louis J. Hoffman  
(602) 948-3295

5. DECLARATION

We hereby declare that all statements made herein of our own knowledge are true and that all statements made on information and belief are believed to be true; and further that these statements were made with the knowledge that willful false statements and the like so made are punishable by fine or imprisonment or both under

Section 1001 of Title 18 of the United States Code and that such willful false statements may jeopardize the validity of the application or any patent issued thereon.

Dated: June 19 1995.

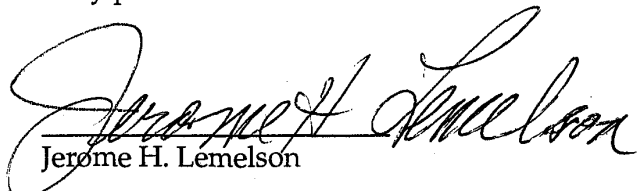

Jerome H. Lemelson

Dated: June 16 1995.



Robert D. Pedersen



UNITED STATES DEPARTMENT OF COMMERCE  
Patent and Trademark Office

Address: COMMISSIONER OF PATENTS AND TRADEMARKS  
Washington, D.C. 20231

08/105,304 08/11/93

LEMELSON

SERIAL NUMBER	FILING DATE	FIRST NAMED INVENTOR	A.U. A	ATTORNEY DOCKET NO.
---------------	-------------	----------------------	--------	---------------------

26M2/0906

JEROME H. LEMELSON  
SUITE 286  
930 TAHOE BLVD.  
UNIT 802  
INCLINE VILLAGE, NV 89451-9436

EXAMINER

2615

ART UNIT PAPER NUMBER

09/06/95

DATE MAILED:

This is a communication from the examiner in charge of your application.  
COMMISSIONER OF PATENTS AND TRADEMARKS

- This application has been examined  Responsive to communication filed on 6.26.95  This action is made final.

A shortened statutory period for response to this action is set to expire 3 month(s),        days from the date of this letter.  
Failure to respond within the period for response will cause the application to become abandoned. 35 U.S.C. 133

Part I THE FOLLOWING ATTACHMENT(S) ARE PART OF THIS ACTION:

- |   |   |
|---|---|
| 1. <input type="checkbox"/> Notice of References Cited by Examiner, PTO-892.        | 2. <input type="checkbox"/> Notice of Draftsman's Patent Drawing Review, PTO-948. |
| 3. <input checked="" type="checkbox"/> Notice of Art Cited by Applicant, PTO-1449.  | 4. <input type="checkbox"/> Notice of Informal Patent Application, PTO-152.       |
| 5. <input type="checkbox"/> Information on How to Effect Drawing Changes, PTO-1474. | 6. <input type="checkbox"/> _____   |

Part II SUMMARY OF ACTION

- Claims 1-10, 12-14, 30-34, 38-40, 43, 48, 53-62, 65, 86, 91-92, 99-160 are pending in the application.  
Of the above, claims \_\_\_\_\_ are withdrawn from consideration.
- Claims 11, 15-29, 35-37, 41-42, 44-47, 49-52, 63-64, 66-85, 87-90, 93-98 have been cancelled.
- Claims \_\_\_\_\_ are allowed.
- Claims 1-10, 12-14, 30-34, 38-40, 43, 48, 53-62, 65, 86, 91-92, 99-160 are rejected.
- Claims \_\_\_\_\_ are objected to.
- Claims \_\_\_\_\_ are subject to restriction or election requirement.
- This application has been filed with informal drawings under 37 C.F.R. 1.85 which are acceptable for examination purposes.
- Formal drawings are required in response to this Office action.
- The corrected or substitute drawings have been received on \_\_\_\_\_. Under 37 C.F.R. 1.84 these drawings are  acceptable;  not acceptable (see explanation or Notice of Draftsman's Patent Drawing Review, PTO-948).
- The proposed additional or substitute sheet(s) of drawings, filed on \_\_\_\_\_, has (have) been  approved by the examiner;  disapproved by the examiner (see explanation).
- The proposed drawing correction, filed 6.26.95, has been  approved;  disapproved (see explanation).
- Acknowledgement is made of the claim for priority under 35 U.S.C. 119. The certified copy has  been received  not been received  been filed in parent application, serial no. \_\_\_\_\_; filed on \_\_\_\_\_.
- Since this application appears to be in condition for allowance except for formal matters, prosecution as to the merits is closed in accordance with the practice under Ex parte Quayle, 1935 C.D. 11; 453 O.G. 213.
- Other

EXAMINER'S ACTION

PTOL-326 (Rev. 2/93)

Art Unit: 2615

### Part III DETAILED ACTION

#### *Claim Rejections - 35 USC § 112*

1. The following is a quotation of the first paragraph of 35 U.S.C. § 112:

The specification shall contain a written description of the invention, and of the manner and process of making and using it, in such full, clear, concise, and exact terms as to enable any person skilled in the art to which it pertains, or with which it is most nearly connected, to make and use the same and shall set forth the best mode contemplated by the inventor of carrying out his invention.

The specification is objected to under 35 U.S.C. § 112, first paragraph, as failing to adequately teach how to make and/or use the invention, i.e. failing to provide an enabling disclosure.

- a. Claims 38, 39, 120, 140, and 160 wherein in claims state identifying objects by comparing the shape to a set of standard shapes in order to determine distance are not enabling because there is no disclosure of how comparing a detected object with a standard shape or how computer-identifying an object by comparing it with a standard shape would be used to determine distance.

- b. Claims 13, 48, 53, 104, 108, 110, 111, 116, 123, 125, 126, 131, 132, 133, 135, 142, 156, 157, 158, and 159 wherein the claims state tracking, identifying, and controlling the vehicle to avoid all possible collisions from any and all directions and without causing other collisions are non-enabling. There is no disclosure which would enable the claimed invention to work. Controlling the vehicle to avoid all possible collisions in real life

Art Unit: 2615

situations and in real time requires numerous complex and error free computations and operating the vehicle within a specific time frame. Such computations and vehicle response are unrealistic and unacceptable for real-time multiple collision avoidance. The article "Intelligent Road Transit: The Next Generation," AI Expert April 1994, pages 16-24, by Denny Rock, et al discusses these issue. The present specification has failed to provide any evidence or support of an enabling disclosure which would enable the claimed invention to be implemented and operate as claimed without the problems and deficiencies well known in the art.

2. The following is a quotation of the first paragraph of 35 U.S.C. § 112:

The specification shall contain a written description of the invention, and of the manner and process of making and using it, in such full, clear, concise, and exact terms as to enable any person skilled in the art to which it pertains, or with which it is most nearly connected, to make and use the same and shall set forth the best mode contemplated by the inventor of carrying out his invention.

The specification is objected to under 35 U.S.C. § 112, first paragraph, as the specification, as originally filed, does not provide support for the invention as is now claimed.

There is no support in the specification for "classifying each detect objects into one of a plurality of object types" in claim 151 and wherein classifying includes using neural networks in claim 152.

Art Unit: 2615

3. Claims 13-14, 38-39, 48, 53, 62, 65, 104, 108, 110-112, 116-117, 120, 123, 125-128, and 131-160 are rejected under 35 U.S.C. § 112, first paragraph, for the reasons set forth in the objection to the specification.

4. Claims 1-10, 12-14, 30-34, 38-40, 43, 48, 53-62, 65, 86, 91-92, 99-160 are rejected under 35 U.S.C. § 112, second paragraph, as being indefinite for failing to particularly point out and distinctly claim the subject matter which applicant regards as the invention.

- a. Claim 1, line 16, "the indicated object" has no antecedent basis.
- b. Claim 2, line 4, "the image" should be "a image".
- c. Claim 3, line 3 and line 5, "the controlled vehicle" has no antecedent basis.
- d. Claim 4, line 2, before "scanning" insert "the" for proper antecedent.
- e. Claim 6, line 3 and line 5, "the controlled vehicle" has no antecedent basis.
- f. Claim 9, line 3, "the one object" should be changed to "one of said detected objects".
- g. Claim 14, line 4, "indicating other" is indefinite because it is unclear what "indicating other" is referring to, other what?
- h. Claim 14, line 4 and line 5, "said first vehicle" has no proper antecedent basis.
- i. Claim 31, line 2, "said vehicle body" has no antecedent basis.
- j. Claim 32, line 3, "said vehicle body" has no antecedent basis.
- k. Claim 38, line 5, "the image" should be "a image".

Art Unit: 2615

- l. Claim 39, line 2, "said standards" has no antecedent basis.
- m. Claim 56, line 2, "the recommended" should be "a recommended".
- n. Claim 56, line 3, "selected" has no antecedent basis.
- o. Claim 62, line 4, before "fuzzy" insert "the".
- p. Claim 65, line 4, "the first vehicle" has no antecedent basis.
- q. Claim 86, line 7-8, "scanning an image from the vehicle" is indefinite because the vehicle does not produce an image.
- r. Claim 86, lines 11, 15, 16 "said driven motor vehicle" has no antecedent basis.
- s. Claim 86, line 17, delete "the" in front of "automatic".
- t. Claim 86, line 18, the second occurrence of "the" should be change to "a".
- u. Claim 91, line 3, "motor" should be deleted.
- v. Claim 103, lines 3-4, "the controlled vehicle" has no antecedent basis.
- w. Claim 103, line 3, before "second" insert "the".
- x. Claim 104, lines 2, 3, and 4, "the controlled vehicle" has no antecedent basis.
- y. Claim 108, line 2, "the controlled vehicle" has no antecedent basis.
- z. Claim 110, line 2, "the controlled vehicle" has no antecedent basis.
- aa. Claim 111, line 5, before "objects" insert "the".
- ab. Claim 120, line 1, "the object" should be "one of the detected objects".
- ac. Claim 120, lines 2-3, both occurrences of "the controlled vehicle" has no antecedent basis.

Art Unit: 2615

- ad. Claim 121, line 2, "the one object" should be "one of the detected objects".
- ae. Claim 132, line 2, "motive" as best understood should be "motor".
- af. Claim 140, lines 2-3, "the first object" has no antecedent basis in the singular.
- ag. Claims 1-10, 12-14, 30-34, 38-40, 43, 48, 53-62, 65, 86, 91-92, 99-160,

applicant is requested in determining and correcting an problems not listed.

*Claim Rejections - 35 USC § 103*

5. The following is a quotation of 35 U.S.C. § 103 which forms the basis for all obviousness rejections set forth in this Office action:

A patent may not be obtained though the invention is not identically disclosed or described as set forth in section 102 of this title, if the differences between the subject matter sought to be patented and the prior art are such that the subject matter as a whole would have been obvious at the time the invention was made to a person having ordinary skill in the art to which said subject matter pertains. Patentability shall not be negated by the manner in which the invention was made.

Subject matter developed by another person, which qualifies as prior art only under subsection (f) or (g) of section 102 of this title, shall not preclude patentability under this section where the subject matter and the claimed invention were, at the time the invention was made, owned by the same person or subject to an obligation of assignment to the same person.

This application currently names joint inventors. In considering patentability of the claims under 35 U.S.C. § 103, the examiner presumes that the subject matter of the various claims was commonly owned at the time any inventions covered therein were made absent any evidence to the contrary. Applicant is advised of the obligation under 37 C.F.R. § 1.56 to point out the inventor and invention dates of each claim that was not commonly owned at the time a later invention was made in order for the examiner to consider the applicability of potential 35 U.S.C. § 102(f) or (g) prior art under 35 U.S.C. § 103.



Serial Number: 08/105,304

-7-

Art Unit: 2615

6. Claims 1, 4-5, 8-10, 12-14, 30, 48, 53, 54, 56-57, 65, 101-112, 114-118, 121-123, 125-136, 141-148, 150, 155-159 are rejected under 35 U.S.C. § 103 as being unpatentable over Kurami et al (P.N. 5,081,585) in view of Adachi et al (P.N. 5,189,619).

Regarding claims 1 and 118, Kurami discloses a method for controlling the travel of a powered vehicle comprising: as the powered vehicle travels a roadway, scanning the roadway with a video scanner supported by said vehicle and generating a train of video picture signals (video processing section 100; col. 3, lines 14-17; col. 3, lines 40-59); computer processing and analyzing each video picture signal as it is generated to detect a plurality of objects in the vicinity of said vehicle (col. 3, lines 52-54); when a collision is imminent between one of the objects and the vehicle, using fuzzy logic to take over control of the acceleration and steering of the vehicle from a driver (col. 4, lines 28-33, lines 57-65, col. 5, lines 64-68).

Kurami determines if collision is imminent (col. 4, lines 28-33), but does not disclose measuring the distance from the vehicle to the detected object and calculating the relative velocity between the detected objects and the vehicle.

Adachi teaches calculating distance and relative velocity between the vehicle and the object to determine if collision is imminent (col. 2, lines 55-64). Therefore it would have been obvious to one skilled in the art to modify Kurami to detect distance and relative velocity in order to determine if collision is imminent as taught by Adachi.

Serial Number: 08/105,304

-8-

Art Unit: 2615

Regarding claims 4 and 5, Kurami discloses a camera which scans a field in front of the vehicle including the roadway at a constant rate (col. 3, lines 40-53), but does not disclose the camera is a television camera. However, a television camera is commonly used for taking video images. Therefore it would have been obvious to one skilled in the art use a television camera because it is conventionally used.

Regarding claim 8, the combination of Kurami and Adachi discloses using fuzzy logic to control the acceleration of the vehicle comprises controlling the brake to slow the forward travel of the vehicle (Kurami, col. 6, lines 18-20).

Regarding claim 9 and 121, the combination of Kurami and Adachi would disclose calculating the change of relative velocity as an input to a fuzzy logic function (Adachi, fig. 3).

Regarding claims 10, 122, 146, and 147, the combination of Kurami and Adachi would disclose a warning device such as a sound generator (Kurami, col. 5, lines 3-7). When a collision is imminent the vehicle horn is actuated as needed. A visual warning is functionally equivalent to a audible warning.

Regarding claim 12, Kurami discloses scanning the roadway comprises electro-optically scanning both ahead of and to both sides of the vehicle (col. 3, lines 17-20).

Regarding claim 101, Kurami discloses using two video cameras (col. 3, lines 15-16).

Regarding claim 30, claim 30 is corresponds to the combination of limitations of claims 1 and 8, as meet by Kurami and Adachi, see the corresponding discussion above.

Art Unit: 2615

Regarding claims 13, 14, 48, 53, 102, 103, 104, 105, 106, 107, 108, 109, 110, 116, 117, 158, 159, 123, 125, 126, 131, 132, 133, 134, 135, 136, 142, 143, 150, 156, and 157, the combination of Kurami and Adachi discloses the claimed limitations as discussed above. Kurami disclose the angle of the camera may be changed (col. 3, lines 45-47), therefore it would have been obvious to one skilled in the art to scan the areas in the back, in the front and to the sides of the vehicle, and all around the vehicle in order to cover all possible locations where an obstacle may occur and to control the steering and acceleration of the vehicle, appropriately, to avoid collisions from any direction. Further, it would have been obvious to one skilled in the art to use more than one camera to cover all possible directions for the purpose of monitoring all directions simultaneously. The combination of Kurami and Adachi discloses controlling the vehicle to avoid a collision as discussed above, but does not mention avoiding a collision without causing another collision with another object at the sides of the vehicle, or any other direction. However, Kurami discloses that the actuator controls would replace the control normally provided by a human operator (col. 4, lines 57-61), and since a human operator would steer to avoid collisions not only in the front of the vehicle, but also any other possible collision from other directions, then it would have been obvious to one skilled in the art to modify Kurami and Adachi to avoid possible collisions from all directions as a human operator would because it is obvious to avoid a collision from one direction without causing a collision with something else in another direction.

Art Unit: 2615

Regarding claims 111, 112, 127, 128, and 155, Kurami discloses fuzzy logic inference rules (col. 5, lines 64-68). The rules would have to take into account which direction the objects are detected in order to avoid collisions. There have to be an associate memory to store the fuzzy data.

Regarding claim 129, Kurami and Adachi does not disclose an override command by the driver to ceasing alternation of the acceleration and steering of the vehicle. However, it would have been obvious to one skilled in the art to have an override command so the driver can take command of the vehicle if so desired so the driver may avoid the collision as he sees fit.

Regarding claims 114 and 115, Kurami as modified discloses an image generating camera (Kurami, col. 3, lines 15-16) as stated in claim 114, and a radar-based ranging system (Kurami, col. 4, line 5) as stated in claim 115.

Regarding claim 130, this claim corresponds to claim 128, see the discussion above.

Regarding claim 54, Kurami as modified discloses a warning (col. 5, lines 3-6), and it would have been obvious to control the operation of the vehicle only if the collision remains imminent because if the collision is not imminent there would be no reason for collision avoidance.

Regarding claims 56 and 148, Kurami as modified does not disclose indicating a recommended kind of evasive action. However, it is common in case of emergency situations to provide instructions on what to do. Therefore, it would have been obvious to one skilled

Art Unit: 2615

in the art to modify Kurami provide a recommended kind of evasive action to instruct the driver on what should be done such a situation.

Regarding claim 57, Kurami as modified does not disclose displaying a visually perceptible symbol on a windshield of the vehicle. However, projecting information of a windshield is well known in the art, therefore it would have been obvious to one skilled in the art to display symbols on the windshield because it is a location where drivers may take note of the information without taking his eyes from the roadway.

Regarding claim 65 and 144, all evasive action requires selecting various combinations of alteration of the speed-altering mechanism and steering mechanism based on what combination would best avoid a collision.

Regarding claim 141 and 145, it would have been obvious to one skilled in the art to control the speed and steering of a vehicle simultaneously because it provides a greater chance of avoid collisions if both the speed and steering were operated simultaneously.

7. Claims 2-3, 6-7, 38-39, 119, 120, 140, 151-153, and 160 are rejected under 35 U.S.C. § 103 as being unpatentable over Kurami in view of Adachi as applied to claims 1, 30, 53, 118, 132, and 142, above, and further in view of Kajiwara (P.N. 5,177,462).

Regarding claims 2, 3, 6, 7, 119, 140, and 160, the combination of Kurami and Adachi discloses measuring the distance between the vehicle and the detected objects and computer processing the video picture signals (col. 3, lines 52-54), but does not disclose that

Art Unit: 2615

the computer processing of the video pictures measures a selected dimension of the object defined by the video signals as stated in claim 2, or identifying the object by its image shape as stated in claim 3. Kajiwara teaches measuring a shape and size of the object defined by video signals to determine distance between a vehicle and an object and to track the object (col. 1, lines 58-60). Therefore it would have been obvious to one skilled in the art to modify Kurami and Adachi to measure the dimension of the object in the image and to identify the object by its image shape as a method of determining distance and tracking the object to avoid collision as taught by Kajiwara. As to the limitation that the object is directly in front of the vehicle and is a second vehicle, since a vehicle travels along the roadway, it is highly probable that the object in front of the vehicle would be a second vehicle.

Regarding claims 38, 39, 120, 151, 152, and 153, the combination of Kurami, Adachi, and Kajiwara discloses comparing the shape to determine distance, as discussed above with regard to claim 2, but does not disclose comparing the detected object with a standard shape. However, it would have been obvious to one skilled in the art to have an image recognition device to identify the object detected in order to automatically inform the driver of the type of danger involved, such a another vehicle or pedestrian.

8. Claims 40, 43, and 139 rejected under 35 U.S.C. § 103 as being unpatentable over Kurami and Adachi as applied to claims 30 and 132 above, and further in view of "Fuzzy Logic Technology & the Intelligent Highway System (IHS)" by Bosacchi et al.

Art Unit: 2615

Regarding claims 40 and 139, the combination of Kurami and Adachi discloses controlling the vehicle to avoid collisions and generating a warning signal, but does not disclose controlling the vehicle if the driver does not alter the driver operated controls sufficiently to avoid a collision. Bosacchi teaches the concept of providing automatic control in situations where the driver fails to perform the require action (page 68 last paragraph to page 69). Therefore it would have been obvious to one skilled in the art to modify Kurami and Adachi to automatically take control of the operation of the vehicle in case of collision if the driver does not control the vehicle sufficiently to avoid a collision as taught by Bosacchi so to ensure the correct measures were taken to prevent a collision.

Regarding claim 43, it would have been obvious to one skilled in the art to control the speed and steering of a vehicle simultaneously because it provides a greater chance of avoid collisions if both the speed and steering were operated simultaneously as performed in human control.

9. Claims 31, 55, 58-59, and 137 are rejected under 35 U.S.C. § 103 as being unpatentable over Kurami and Adachi as applied to claims 30, 54, 57, and 132 above, and further in view of Hancock (P.N. 5,179,377).

Re claims 31, 55, 58, and 137, the combination of Kurami and Adachi does not disclose a visual display of objects in the path of the vehicle. However, Hancock teaches displaying a visual display of objects in the path of a vehicle. Therefore, it would have been

Art Unit: 2615

obvious to one skilled in the art to modify Kurami and Adachi to have a visual display to indicate objects in its path so the driver would be informed of objects in its path in order to prevent and/or avoid accidents.

Re claim 59, it would have been obvious to one skilled in the art to indicate the relative closing speeds of the two vehicles for the purpose of informing the driver there relative speed until they may collide.

10. Claims 33-34, 60-62, and 138 are rejected under 35 U.S.C. § 103 as being unpatentable over Kurami and Adachi as applied to claims 30, 54, and 132 above, and further in view of Zechnall (P.N. 5,146,219).

Re claims 33, 34, 60, and 138, the combination of Kurami and Adachi does not disclose a synthetic speech generating system or a visual display means. Zechnall teaches a synthetic speech generating system (col. 2, lines 30-42) as claimed in claim 33, and a visual display (col. 2, lines 14-21) as claimed in claim 34 to provide information to a driver concerning hazards, etc. Therefore it would have been obvious to one skilled in the art to provide a speech system and a visual display in the device of Kurami and Adachi to provide safety information to the driver as it relates to the objected detected by the scanner.

Re claims 61 and 62, as discussed above with regard to claim 56 it would have been obvious to provide a recommended correction action to avoid a collision since it is well known in the art to do so. Generating words such as slow down, stop, swerve left, and



Art Unit: 2615

swerve right would be obvious because it informs the driver what action should be taken and provides more information than a alarm.

11. Claim 32 rejected under 35 U.S.C. § 103 as being unpatentable over Kurami in view of Adachi and Hancock as applied to claim 31 above, and further in view of "Design and Validation of Headup Displays for Navigation in IVHS," Vehicle Navigation & Information Systems Conference Proceedings, Oct. 1991, pages 537-542 by S. Shekhar, et al (hereinafter Shekhar).

Re claim 32, Kurami as modified does not disclose using a head-up display. Shekhar teaches using a heads-up display in an intelligent vehicle. Therefore it would have been obvious to one skilled in the art for the modified invention of Kurami to employ a heads-up display instead of conventional display because Shekhar discloses it has a faster response time than dashboard displays in automobiles (8th paragraph on page 538).

12. Claims 100, 113, 124, 149, and 154 are rejected under 35 U.S.C. § 103 as being unpatentable over Kurami and Adachi as applied to claims 1, 118, 142, 151 above, and further in view of Kohsaka (P.N. 5,327,117).

Regarding claims 100, 113, 124, 149, and 154, the combination of Kurami and Adachi discloses avoiding collisions, but does not disclose ranking in ascending order of calculated time to collision. However, Kohsaka teaches that in situations involving numerous

Art Unit: 2615

hazards are under consideration, priority ranking would be necessary to determine the most important warning or action to be outputted (col. 1, lines 48 col. 2, line 12). Therefore it would have been obvious to one skilled in the art to modify Kurami and Adachi to have priority ranking for situations when several collisions are possible as the most and least important for the purpose of acting upon the most important or worst case. Further it would have been obvious to continuously re-evaluate the rankings to provide up-to-date information.

13. Claims 86, 91, and 99 rejected under 35 U.S.C. § 103 as being unpatentable over Kurami (P.N. 5,081,585) in view of Hancock (P.N. 5,179,377).

Re claims 86 and 91, Kurami discloses monitoring the roadway and taking correction action to prevent accidents as discussed above. However, Kurami does not disclose indicating the presence of detected moving vehicles or objects. However, Hancock teaches a display to indicate objects in path of a vehicle. Therefore, it would have been obvious to one skilled in the art to modify Kurami to have a visual display to indicate objects in its path so the driver would be informed of objects in its path in order to prevent and/or avoid accidents. It would have been obvious to monitor all directions of the vehicle for the purpose cover all possible areas where collisions may occur.

Regarding claim 99, Kurami as modified by Hancock does not disclose indicating comprises a verbal indication in synthetic speech. However, synthetic verbal information is well known in the art. Therefore it would have been obvious to one skilled in the art to

Art Unit: 2615

replace visual information with verbal information because verbal information would not require the driver to take his eyes from the roadway.

14. Claim 92 rejected under 35 U.S.C. § 103 as being unpatentable over Kurami in view of Hancock as applied to claim 91 above, and further in view of "Design and Validation of Headup Displays for Navigation in IVHS," Vehicle Navigation & Information Systems Conference Proceedings, Oct. 1991, pages 537-542 by S. Shekhar, et al (hereinafter Shekhar).

Re claim 92, Kurami as modified does not disclose using a head-up display. Shekhar teaches using a heads-up display in an intelligent vehicle. Therefore it would have been obvious to one skilled in the art for the modified invention of Kurami to employ a heads-up display instead of conventional display because Shekhar discloses it has a faster response time than dashboard displays in automobiles (8th paragraph on page 538).

*Response to Amendment*

15. Applicant's arguments with respect to claims 1-10, 12-14, 30-34, 38-40, 43, 48, 53-62, 65, 86, 91-92, 99-160 have been considered but are deemed to be moot in view of the new grounds of rejection.

Applicant's response to the 35 USC 112 1st paragraph, non-enabling objection is not persuasive because even though the article to Rock demonstrates the *possibility* of operability,

Art Unit: 2615

applicant has not provided any positive proof or any showing that Applicant's present invention works as intended. There is no disclosure in the present invention to enable one skilled in the art to overcome all the problems and deficiencies known in the art for the intended operation in real time and in real life situations of controlling the vehicle to prevent all possible collisions. There are too many unknown variables that cannot be taken into account into the specific time frame for collision detection and avoidance. Even if the calculations are performed using high speed computers in parallel, the processing time for the calculations may exceed the time allow before a collision occurs. These and other problems are well known in the art as discussed in the article to Rock. Applicant has provided no showing that the present invention can overcome these deficiencies and operate as intended.

The reference to Martin Marietta is not persuasive because Martin Marietta discloses multiple tracking, not controlling a vehicle to prevent all possible collisions.

#### *Conclusion*

16. Applicant's amendment necessitated the new grounds of rejection. Accordingly, **THIS ACTION IS MADE FINAL**. See M.P.E.P. § 706.07(a). Applicant is reminded of the extension of time policy as set forth in 37 C.F.R. § 1.136(a).

**A SHORTENED STATUTORY PERIOD FOR RESPONSE TO THIS FINAL ACTION IS SET TO EXPIRE THREE MONTHS FROM THE DATE OF THIS ACTION. IN THE EVENT A FIRST RESPONSE IS FILED WITHIN TWO MONTHS OF THE MAILING DATE OF THIS FINAL ACTION AND THE ADVISORY ACTION IS NOT**

Serial Number: 08/105,304

-19-

Art Unit: 2615

MAILED UNTIL AFTER THE END OF THE THREE-MONTH SHORTENED STATUTORY PERIOD, THEN THE SHORTENED STATUTORY PERIOD WILL EXPIRE ON THE DATE THE ADVISORY ACTION IS MAILED, AND ANY EXTENSION FEE PURSUANT TO 37 C.F.R. § 1.136(a) WILL BE CALCULATED FROM THE MAILING DATE OF THE ADVISORY ACTION. IN NO EVENT WILL THE STATUTORY PERIOD FOR RESPONSE EXPIRE LATER THAN SIX MONTHS FROM THE DATE OF THIS FINAL ACTION.

17. Any inquiry concerning this communication or earlier communications from the examiner should be directed to Amelia Au whose telephone number is (703) 308-6604. The examiner can normally be reached on Monday - Thursday from 7:30 am - 5:00 pm EST. The examiner can also be reached on alternate Fridays.

If attempts to reach the examiner by telephone are unsuccessful, the examiner's supervisor, Tommy Chin, can be reached on (703) 305-4715. The fax phone number for this Group is (703) 305-9508.

Any inquiry of a general nature or relating to the status of this application should be directed to the Group receptionist whose telephone number is (703) 305-4700.

maa  
September 4, 1995

  
TOMMY P. CHIN  
SUPERVISORY PATENT EXAMINE  
GROUP 2800

Code 116 \$380.00

IN THE UNITED STATES PATENT AND TRADEMARK OFFICE

Applicant	:	Jerome H. Lemelson Robert D. Pedersen	<b>RESPONSE UNDER RULE 116</b>
			<b>EXPEDITED PROCEDURE.</b>
Serial No.	:	08/105,304	Art Unit : 2615
Filed	:	8/11/93	Examiner : Au
Title	:	Motor Vehicle Warning and Control System and Method	

5/11/96  
 #12C  
 ROSE  
 2-5-96

Assistant Commissioner for Patents  
Washington, D.C. 20231

**RESPONSE TO FINAL OFFICE ACTION**

Dear Sir:

In response to the Office Action dated September 6, 1995, applicants submit the following amendments and remarks. An extension of two months is requested, and a check for \$380.00 for the extension fee is enclosed.

wa  
x 2/6

**Amendments**

**IN THE CLAIMS:**

Please amend the following claims:

1. (Three Times Amended) A method for controlling the travel of a powered vehicle comprising:

(a) as the powered vehicle travels a roadway, scanning the roadway with a video scanner supported by said vehicle and generating a train of video picture signals;

(b) computer processing and analyzing each video picture signal as it is generated to detect a plurality of objects in the vicinity of said vehicle;

(c) measuring the distance from the vehicle to the detected objects;

(d) calculating the relative velocity between at least one of the detected objects and the vehicle;

C/ Cont

(e) when a collision is imminent between one of the objects and the vehicle, using fuzzy logic to take over control of the acceleration and steering of the vehicle from a driver based on (i) the distance and relative velocity between the [indicated] object with which a collision is imminent and the vehicle and (ii) the location of the detected objects.

2. (Three Times Amended) A method in accordance with claim 1 wherein measuring the distance between the vehicle and one of the detected objects includes computer processing the video picture signals in a manner to measure a selected dimension of the object in [the] an image defined by said video picture signals.

3. (Three Times Amended) A method in accordance with claim 2 wherein the object is directly in front of said vehicle and is a second powered vehicle traveling in the same direction as the [controlled] vehicle controlled by fuzzy logic, and wherein measuring the distance between the [controlled] vehicle controlled by fuzzy logic and the second vehicle comprises computer-identifying said second vehicle by its image shape.

4. (Three Times Amended) A method in accordance with claim 1 wherein the scanning is effected by a television camera [which] that scans a field in front of said vehicle, including said roadway, at a constant scanning rate.

---

6. (Three Times Amended) A method in accordance with claim 1 wherein the one of the detected objects is directly in front of said vehicle and is a second powered vehicle traveling in the same direction as the [controlled] vehicle controlled by fuzzy logic, and wherein measuring the distance between the [controlled] vehicle controlled by fuzzy logic and the second vehicle comprises computer-identifying said second vehicle by at least a portion of the rear view shape of the second vehicle.

---

---

9. (Three Times Amended) A method in accordance with claim 8 further comprising calculating the change of relative velocity between said vehicle and the [one] object with which a collision is imminent and employing said calculated change in relative velocity as an input to a fuzzy logic function.

10. (Three Times Amended) A method in accordance with claim 1 further comprising intelligibly indicating when a [collision] collision is imminent between one of said objects and the vehicle by operating a warning device selected from a group including a warning light, a flashing light, a sound generator, and a speech generator.

---

14. (Three Times Amended) A method in accordance with claim 13 further comprising intelligibly indicating the distance between the vehicle and one of said detected objects comprising a second powered vehicle moving in the same direction as the [first] vehicle controlled by fuzzy logic and further indicating [other] additional ones of said detected objects that are at the sides of the [first] vehicle controlled by fuzzy logic.

---

30. (Twice Amended) A system for operating and controlling a motor vehicle comprising:

(a) a vehicle having a motor drive and driver-operated controls including an accelerator, a brake, and a steering system;

(b) a first scanning device supported by said vehicle, directed toward the front of said vehicle, and [configured] structured to generate first signals modulated with information relating to objects in the field of view of said first scanning device;

(c) a first computer coupled to said first scanning device and [configured] structured to analyze said first signals as the vehicle travels and to produce first code signals on an output of said first computer, which first code



signals are indicative of distances and relative motion between said vehicle and objects ahead of said vehicle and in the path of said vehicle; and

(d) a fuzzy logic-based second computer coupled to said first computer and [configured] structured to analyze said first code signals and to generate command signals on an output of said second computer;

(e) wherein the output of said second computer is electrically coupled to said driver-operated controls such that the command signals are applied to control the accelerator, brake, and steering system of said vehicle to attempt to avoid collisions between said vehicle and objects in its path of travel.

---

35  
cancel

31. (Twice Amended) A system in accordance with claim 30 further comprising a visual display inside said vehicle [body] coupled to the output of said first computer and driven by said first code signals to generate symbols representative of objects in the path of the vehicle.

36  
cancel

32. (Twice Amended) A system in accordance with claim 31 wherein said visual display comprises a heads-up display aimed to project images of intelligible information on a front windshield of said vehicle [body].

---

38. (Three Times Amended) A system in accordance with claim 30 wherein the first computer is [configured] structured to identify one of said objects by comparing the shape of part of the object to a set of standard shapes and generating a second code signal indicating a match, and wherein said second code signal and a measurement of [the image of] the object from the first signals is used to determine the distance between said vehicle and the object.

---

37  
cancel

39. (Twice Amended) A system in accordance with claim 38 wherein said [standards] standard shapes represent other vehicles and pedestrians moving in the field of view of the first scanning device of said vehicle.

---

38  
cancel

19  
ence

56. (Three Times Amended) A method in accordance with claim 54 wherein intelligibly indicating further comprises indicating the [recommended kind of] selected evasive action [selected].

10  
ence

62. (Three Times Amended) A method in accordance with claim 61 wherein generating sounds of select speech recommending a corrective action to take to avoid a collision comprises synthetically generating one of the following words of speech depending on the kind of evasive action determined by the fuzzy logic: "slow down", "stop", "swerve left", and "swerve right".

11  
ence

65. (Three Times Amended) A method in accordance with claim 53 wherein altering control of the operation of the vehicle comprises selecting between various combinations of alteration of control of the operation of a speed-altering mechanism and a steering mechanism of said [first] vehicle.

C1/2  
cont

86. (Twice Amended) A method of operating a motor vehicle comprising:  
(a) operating a vehicle in a first mode wherein a human driver controls the movement of said vehicle along a roadway,  
(b) scanning an image [from] with a scanner supported by the vehicle and computer-analyzing said image to detect the presence of other moving vehicles and stationary obstacles in all directions from the vehicle,  
(c) intelligibly indicating to the driver of said [driven motor] vehicle being operated in said first mode the presence of the detected moving vehicles and stationary obstacles, and  
(d) if a predefined hazardous condition develops during the movement of said [driven] vehicle being operated in said first mode, switching operation of the [driven] vehicle being operated in said first mode to a second mode characterized by [the] automatic and temporary control of said vehicle,

212  
encl

including controlling the vehicle in an evasive action selected from the group of braking the vehicle, altering the steering of the vehicle, and accelerating the vehicle, to attempt to prevent or lessen the effects of an accident.

---

213  
encl

91. (Twice Amended) A method in accordance with claim 86 further comprising indicating to the driver of said [motor] vehicle the relative positions of said vehicle and at least one other vehicle in movement along the roadway.

---

103. (Twice Amended) A method in accordance with claim 102 further comprising measuring the distance and relative velocity between the vehicle and a second vehicle detected by the video scanners[, which second vehicle is] as being behind the [controlled] vehicle controlled by fuzzy logic.

214  
encl

104. (Twice Amended) A method in accordance with claim 103 wherein using fuzzy logic [to control the acceleration of the controlled vehicle] comprises altering the acceleration of the [controlled] vehicle controlled by fuzzy logic so as to attempt to avoid a collision between the [controlled] vehicle controlled by fuzzy logic and either of (i) [said one detected] the object with which a collision is imminent [in the path of the controlled vehicle] and (ii) the second vehicle.

---

215  
encl

108. (Twice Amended) A method in accordance with claim 107 wherein using fuzzy logic to control the acceleration and steering of the [controlled] vehicle controlled by fuzzy logic comprises altering the acceleration and steering of the vehicle so as to attempt to avoid a collision between the vehicle and either of (i) [said one detected] the object with which a collision is imminent [in the path of the vehicle] and (ii) all other objects detected by the video scanners.

---

216  
encl

110. (Twice Amended) A method in accordance with claim 109 wherein using fuzzy logic to control the acceleration and steering of the [controlled] vehicle

controlled by fuzzy logic comprises altering the acceleration and steering of the vehicle so as to attempt to avoid a collision between the vehicle and either of (i) [said one detected] the object with which a collision is imminent [in the path of the vehicle] and (ii) all other objects detected by the video scanners.

116  
mcp

111. (Twice Amended) A method in accordance with claim 101 wherein attempting to avoid a collision with all other detected objects comprises selecting one of a plurality of sets of fuzzy logic inference rules controlling the acceleration and steering of the vehicle depending on which direction from the vehicle the objects are detected.

---

116. (Twice Amended) A system in accordance with claim 30 further comprising:

(a) a second scanning device supported by said vehicle, directed away from said vehicle in a direction other than the front of the vehicle, and [configured] structured to generate second signals modulated with information relating to objects in the field of view of said second scanning device; and

(b) a third computer coupled to said second scanning device and [configured] structured to analyze said second signals as the vehicle travels and to produce second code signals on an output of said third computer, which code signals are indicative of distances and relative motion between said vehicle and each of the objects in the field of view of said second scanning device.

117  
mcp

117. (Twice Amended) A system in accordance with claim 116 wherein said fuzzy logic-based second computer is also coupled to said third computer and [configured] structured to analyze said first and second code signals and to generate command signals therefrom that are applied to control operation of said vehicle to attempt to avoid collisions both with objects in the path of travel of the vehicle and objects in the field of view of said second scanning device.

---

C/18

---

120. (Once Amended) A method in accordance with claim 119 wherein the object whose distance from the vehicle is measured is directly in front of said vehicle and is a second powered vehicle traveling in the same direction as the [controlled] vehicle using fuzzy logic, and wherein measuring the distance between the [controlled] vehicle and the second vehicle] two vehicles comprises computer-identifying said second vehicle by its image shape.

121. (Once Amended) A method in accordance with claim 118 further comprising calculating the change of relative velocity between said vehicle and the [one] object with which a collision is imminent and employing said calculated change in relative velocity as an input to a fuzzy logic function.

---

C/19

cont

132. (Once Amended) A system for operating and controlling a vehicle comprising:

- (a) a vehicle having a body, a motive system, and driver-operated controls including an accelerator, a brake, and a steering system;
- (b) a first scanning device supported by said vehicle, directed toward the front of said vehicle, and [configured] structured to generate first signals modulated with information relating to first objects in the field of view of said first scanning device;
- (c) a second scanning device supported by said vehicle, directed toward at least one side of said vehicle, and [configured] structured to generate second signals modulated with information relating to second objects in the field of view of said second scanning device;
- (d) a first computer coupled to said first scanning device and [configured] structured to analyze said first signals as the vehicle travels and to produce first code signals on an output of said first computer, which first code signals are indicative of distances and relative motions between said vehicle and said first objects;

(e) a second computer coupled to said second scanning device and [configured] structured to analyze said second signals as the vehicle travels and to produce second code signals on an output of said second computer, which second code signals are indicative of the presence of said second objects; and

(f) a fuzzy logic-based control computer coupled to said first and second computers and [configured] structured to analyze said first and second code signals and to generate command signals on an output of said control computer;

(g) wherein the output of said control computer is electrically coupled to said driver-operated controls such that the command signals are applied to control the accelerator, brake, and steering system of said vehicle to attempt to avoid a collision between said vehicle and said first objects without causing the vehicle to collide with said second objects.

2/9

133. (Once Amended) A system in accordance with claim 132:

(a) further comprising a third scanning device supported by said vehicle, directed so that the second and third scanning devices cover both the left and right sides of said vehicle, and [configured] structured to generate third signals modulated with information relating to third objects in the field of view of said third scanning device;

Done

(b) further comprising a third computer coupled to said third scanning device and [configured] structured to analyze said third signals as the vehicle travels and to produce third code signals on an output of said first computer, which third code signals are indicative of the presence of said third objects;

(c) wherein said control computer is coupled to said third computer and [configured] structured to analyze said third code signals; and

(d) wherein said command signals are applied to attempt to avoid a collision between said vehicle and said first objects in its path of travel without causing the vehicle to collide with both of the second and the third objects.

---

135. (Once Amended) A system in accordance with claim 132:

(a) further comprising a third scanning device supported by said vehicle, directed toward the rear of said vehicle, and [configured] structured to generate third signals modulated with information relating to third objects in the field of view of said third scanning device;

C22  
concl

(b) further comprising a third computer coupled to said third scanning device and [configured] structured to analyze said third signals as the vehicle travels and to produce third code signals on an output of said first computer, which third code signals are indicative of the presence of said third objects;

(c) wherein said control computer is coupled to said third computer and [configured] structured to analyze said third code signals; and

(d) wherein said command signals are applied to attempt to avoid a collision between said vehicle and said first objects in its path of travel without causing the vehicle to collide with both of the second and the third objects.

---

140. (Once Amended) A system in accordance with claim 132 wherein the first computer is [configured] structured to identify one of said first objects by comparing the shape of part of the first object being identified to a set of standard shapes and generating an output signal indicating a match, and wherein said output signal and a measurement of a dimension of [the image of the one of] the first [objects] object being identified from the first signals is used to determine the distance between said vehicle and that object.

C21  
concl

153. (Once Amended) A method in accordance with claim 151 wherein classifying includes comparing [the] an image of the object with a plurality of reference images.

---

C22  
concl

158. (Once Amended) A system in accordance with claim 116:

C23  
cont





One of those rejections, for the use of the word "motive" in claim 132, has not resulted in an amendment, because the word "motive," as defined in the dictionary, means "relating to the causing of motion," and may refer to a motor or any other system of causing the vehicle to move.

In addition, applicants have changed the word "configured" to "structured" in the claims, to ensure that the language following are viewed as structural limitations.

## **II. REQUEST FOR WITHDRAWAL OF FINALITY OF REJECTION.**

The Examiner has relied on an entirely new primary reference, Kurami, as compared to the first Office Action. Nevertheless, the Office Action is made final on the ground that "Applicant's amendment necessitated the new grounds of rejection." [Para. 16]

The assertion that the amendment necessitated switching grounds of rejection is simply untrue in this situation. Applicants respectfully request the Examiner to review claim 1 of the amendment (filed June 26, 1995), as an example of the nature of the changes presented. In that claim, applicants made only modest changes, exclusively designed to correct informalities and better define the invention. However, the scope of the claim was not altered in any material respect pertinent to the art rejections (except for narrowing to refer to taking over control from the driver, an issue that the Examiner did not cite the new reference to support).

The Office Action was made final prematurely, and applicants respectfully request that the Examiner withdraw the finality.

## **III. REMAINING SECTION 112(1) ISSUES.**

The Examiner has made or maintained three objections or rejections based on Section 112(1).

### **A. How to Determine Distance by Comparing Shapes.**

In paragraph 1(a) of the Office Action, the Examiner rejects claims 38, 39, 120, 140, and 160 on the ground that "there is no disclosure of how comparing a detected object with a standard shape...would be used to determine distance." This is clearly disclosed in the specification, for example at page 12, where applicants disclosed:

“The calculation of the distance of certain recognizable objects from the vehicle is facilitated by having standard images stored in memory and recalling and comparing such image data with image data representing the object detected by the vehicle scanning mechanisms. For example, virtually all automobiles, trucks, and other standard vehicles have known widths. It follows that the distance to another vehicle can be determined by calculating its width in the scanned image.”

**B. Disclosure of Classifying Objects.**

In paragraph 2 of the Office Action, the Examiner objects to the specification and apparently rejects claims 151 and 152, on the ground that there is no support in the specification for classifying each detected object into one of a plurality of object types, particularly using neural networks. This is very clearly disclosed in the specification, for example at page 9, lines 3-5; page 13, lines 4-12; and the paragraph bridging pages 21 and 22.

**C. Operability of the Specification.**

In paragraph 2(b), the Office Action rejects a number of claims based on the assertion, “There is no disclosure which would enable the claimed invention to work.” The Examiner is apparently concerned with the computational requirements as to those claims in which the vehicle is controlled to attempt to avoid possible collisions with objects in multiple directions. The Examiner supports the rejection with citation of the Rock article, which discusses some of these problems. Paragraph 15 of the Office Action further relates to this issue.

Applicants have a number of responses:

1. The Examiner bears the burden of proving non-operability. The Examiner has cited Rock, but that very article admits that it is possible to accomplish real-time tracking of multiple objects (the Martin Marietta work). The Office Action says that the reference to the Martin Marietta work is not persuasive because it relates to tracking objects, not controlling a vehicle. [Para. 15] But the computations that the Examiner is concerned might be difficult are exactly the computations of tracking the

objects in the field of view of the cameras. Indeed, the Office Action itself refers to the alleged computational difficulty in tracking at the second line of paragraph 1(b). If it is possible to figure out in real time where the objects are located and in which direction they are headed, then “controlling the vehicle” does not take very much additional computation (at least under applicants’ system). Indeed, applicants’ specification works by a simple table-lookup system, in which a “state vector” appropriate to the position of the objects is loaded from the table (Fig. 12) and used as the set of fuzzy inference rules (Fig. 9). This is not computationally difficult at all.

2. The Examiner has provided no response at all to applicants’ previous point that most of the claims do not refer to avoiding “all possible collisions from any and all directions and without causing other collisions,” as the Examiner characterizes them. [Para. 1(b)]

3. Applicants previously pointed out that their specification discloses several possible “parallel processing” structures, including the use of parallel image processors such as illustrated in Figure 2, with video preprocessing and multiple high-speed image co-processors. Applicants further pointed to certain prior art references disclosing parallel processing and specialized image processing technology. Applicants further noted that the specification discloses a separate computer for each camera or other scanner, and thus it takes no more time to analyze the view from many cameras pointing in different directions than it would to analyze the view from a single camera.

The only response in the Office Action to this point is the statement: ““Even if the calculations are performed using high speed computers in parallel, the processing time for the calculations *may* exceed the time allow[ed] before a collision occurs.” [Para. 15 (emphasis added)] The Examiner has no basis for this speculation. If the processing time would exceed the time to collision—and there is no reason for assuming that it would, in view of the points above—then one answer is to use a faster microprocessor. The Examiner simply has no basis for concluding that the fastest available microprocessors used for image processing available at the time of filing this application could not handle the computations needed to identify cars detected in a

single image field or collating the information from the image processors associated with a number of cameras and implement the look-up system disclosed.

In addition, the Examiner does not make a prima facie case of nonenablement or non-operability by merely stating that the processing time *may* exceed the requirements. Only if the Examiner could show that the processing time *would* exceed the requirements would the necessary showing be made. That is not the case here.

4. In the last response, applicants also noted that several patents relied on by the Examiner—such as Adachi, Dye, Taylor, Maekawa, Kajiwara, Saneyoshi, and Davidian, and now Kurami—disclose relative motion calculations in the context of highway identification, and that those were considered amply enabled. The Office Action provided absolutely no response to this point; thus, applicants provide further explanation below.

Each of those patents have earlier filing dates than applicants' application, yet they do not disclose any special systems for handling the computational problems identified by Rock. If those patents can do the necessary imaging computations without any special circuitry, then this application can do the computations too. There is no justification for determining that applicants' specification requires more intensive computations; to the contrary, applicants' disclosure of parallel image processors and table-lookup fuzzy logic systems disclose ways of *reducing* the computational requirements.

The fact that the Examiner has used those references in formulating Section 103 rejections constitutes a binding admission that it is possible to do the computations. If such were not possible, as the Office Action maintains, then each of the references cited above would be inoperative, too, and they could not be used as references under Section 103.

For example, Kurami discloses the use of multiple cameras, the images from which are handled "on the fly." The Examiner recognizes that point, as noted on the bottom of page 8 of the Office Action. Nevertheless, the Examiner rejects the claims

using Kurami, which means that the Examiner must believe that Kurami's disclosure is operative.

Kurami demonstrates that it is possible to derive the very control signals about which the Examiner expresses concern. Kurami characterizes his system in the abstract as follows: "An image processing section receives data from cameras mounted on the vehicle and produces an image or images from which a first set of so called 'local' data is derived and compiled." The imaging system used by Kurami is depicted in Figure 1, and comprises multiple cameras 101 and 103 connected to an image computing system 105. Outputs from the image computing system 105 are used as inputs to the obstacle avoidance control 501 and the local vehicle positioning determination unit 107. The signals are subsequently used to generate control signals for braking, throttle, and steering actuators. [Col. 3, lines 13-25] Multiple cameras are used to obtain stereo images. [Col. 3, lines 40-54] The use of ultrasonic and laser radar to scan behind and to the sides of the vehicle for obstacles is also disclosed. [Col. 4, lines 25-34]

If it is possible for Kurami to analyze the images from his two cameras in time, then why isn't it possible for these applicants to do the same analysis? Certainly, there is no different standard for Nissan's disclosures than for individual applicants' disclosures, or at least there should not be.

The Examiner also uses Adachi, which is assigned to Toyota. The Examiner admits that Adachi teaches calculating distance and relative velocity between the object and the vehicle to determine if a collision is imminent. But Adachi makes these calculations and generates his vehicle control signals based on the outputs of laser scanning. [Col. 3, line 64 to Col. 4, line 2] Thus, Adachi too demonstrates that the Patent Office has already decided that such scanning and control signal generation is possible.

The Saneyoshi patent (of record) confirms that video cameras may be used to determine the distance between automobiles for the purpose of generating warning signals and collision avoidance control. Saneyoshi permits recognizing an obstacle on a road, warns the driver, and performs automatic collision avoidance. [Col. 5, lines 45-50]

The method employs stereoscopic optical systems and stereoscopic picture processing to calculate three-dimensional distance data. [Col. 5, lines 51-62] Two pairs of CCD cameras are used to measure distances, between two and 100 meters. [Col. 6, lines 5-12] Again, the Patent Office has already decided the feasibility of such scanning and vehicle control signal generation for automotive collision avoidance.

In an earlier Office Action, the Examiner relied on the Dye patent, which also demonstrates the feasibility of deriving the required vehicle control signals based on scanning the areas around the controlled vehicle. Dye's abstract states: "An optical sensor (which may optionally be visible, infrared or ultraviolet) is disposed to provide a continuous raster scan of the scene within a wide angle of the direction of travel of the vehicle." The operation of the Dye system is shown in more detail in Figure 1, which illustrates the use of a TV camera 12, coupled to A/D converter 14, to memory unit 16 and logic processing unit 18. An alternative embodiment is shown in Figure 3 using an infrared scanning system 42.

The Examiner also applies Kajiwara, which is assigned to Mitsubishi, in certain rejections. That reference too proves the point that the required vehicle control signals can be derived from scanning the areas around the vehicle. Kajiwara controls brakes and throttle actuators to control the distance between cars. [Col. 5, lines 18-27] Kajiwara uses optical ranging and image sensing system to measure shape and size of an object and then to determine the distance to an object in front of a car using triangulation methods, and he uses a light beam to detect a intervening car into a lane in front and close to the driver's car by detecting light reflected by the intervening car. [Col. 4, lines 39-62]

The Maekawa patent, also assigned to Mitsubishi, has been cited and is similar in operation to Kajiwara. As shown in Figure 1, Maekawa uses two image signals generated by a pair of video cameras. Triangulation is used to determine distance to objects in the image field. [Col. 6, lines 16-22] Kajiwara's and Maekawa's calculations of vehicle warning and control signals based on optical scanning further demonstrate that

the Patent Office has already decided that such methods were within the skill of ordinarily skilled artisans at the relevant time.

Although none of the references accomplish the same things claimed here, there is very little additional processing power required to implement applicants' inventive system. Indeed, the existence of parallel processing as disclosed (as discussed above) establishes that there is no additional time to perform the necessary calculations for multiple cameras than the time needed to perform the calculations for a single camera. In all, there is no contradiction between the fact that the references can perform the computationally intensive calculations in real time, which demonstrates enablement, and the fact that the references do not perform the inventive system, which demonstrates nonobviousness.

If the disclosures of these references are sufficient to make possible "on the fly" image analysis—despite the problems identified by Rock—for the big Japanese car companies such as Nissan, Toyota, and Mitsubishi, then image analysis is equally possible for these applicants in this application. The standard under Section 112(1) is, or should be, no different for applications filed by big companies than those filed by individuals.

For any one or more of the above reasons, the enablement rejections must be withdrawn.

### III. THE OBVIOUSNESS REJECTIONS.

Applicants respectfully submit that the Kurami reference may not be read as broadly as the Examiner apparently believes, and that the claims thus contain a number of important distinctions that are patentable.

#### A. The Kurami Reference Does Not Disclose Fuzzy Control.

The principal reference used by the Examiner is the Kurami patent. The Office Action asserts that Kurami determines "when a collision is imminent between one of the objects and the vehicle" and uses "fuzzy logic to take over control of the acceleration and steering of the vehicle from a driver." [Para. 6]

However, a careful reading of Kurami reveals that Kurami's brief and unexplained reference to fuzzy logic is in connection with his "actuator control 309," which is simply designed to implement steering and braking commands issued by the central control 503 and steering control 505. Kurami states in this regard:

"The system includes...an actuator control section 300 which is arranged to control the operation of vehicle steering, engine power output, [and] the application of the vehicle brakes and the vehicle turn indicators..." [Col. 3, lines 14-24]

"The actuator section 300 contains a plurality of actuators which replace the control normally provided by a human operator. Viz., this section includes a steering actuator 301, a throttle valve actuator 303 which replaces the input normally provided through the accelerator pedal, a brake actuator 305 and a turn indicator actuator 307." [Col. 4, lines 57-63]

"With the instant invention *the actuator control* is adapted to be "fuzzy". That is to say, the control is adapted to follow an 'if...then...' production rule and to enable a control which is in essence similar to that provided by a human operator." [Col. 5, lines 64-68 (emphasis added)]

However, Kurami makes it quite clear that the steering and braking *commands* are issued to the actuator control by the "control section," and *not* the actuator control:

"In the instant system the [central control] section (500) functions to, based on a number of inputs, plan a course of action and subsequently derive a series of control commands and outputs the same to the above mentioned actuator control section 300..." [Col. 3, lines 27-32]

"[T]he control section produces a plan which results in commands which selectively determine if the vehicle should be steered to the left or right and by how much, if the speed should be increased, decreased or the vehicle brought to a halt. For example, if the vehicle is deemed to be approaching an intersection, the vehicle speed can be reduced to a level deemed safe for the instant situation." [Col. 5, lines 53-60]



Importantly, there is no disclosure in Kurami remotely suggesting that the "control section," which issues the commands to the actuator, be implemented with a fuzzy controller. Indeed, in Figs. 2 and 3 and the accompanying discussion on Col. 7, line 18 through Col. 8, line 8, Kurami discloses a *non-fuzzy* algorithm for determining how to control the steering, which is implemented by the control section.

Thus, the only possible interpretation of Kurami is that the (briefly mentioned) fuzzy controller simply controls the actuators to ensure that any commands to alter the braking, steering, and acceleration in specified ways are *implemented* in a smooth fashion, so as to mimic a human. For example, if Kurami's (non-fuzzy) control section issues a command to the actuator control to come to a stop, the fuzzy logic in the actuator control would ensure that the brakes are applied in a human-like way, so that the car would not jerk to a stop.

That is a far cry from applicants' invention, in which the fuzzy controller not only controls speed and steering, but also does so by selecting an appropriate evasive action, which might be either a speed or a course correction or a combination of the two, and which might be a severe or small correction of either sort. Thus, applicants' fuzzy controller selects appropriate combinations of speed corrections and course corrections and between levels of each of those sorts of corrections.

For example, in applicants' Figure 9, if the acceleration is high positive (HP), that is, the vehicle and the hazard are accelerating towards each other, and the distance to the hazard is medium (M), then the combination of warning, braking, and steering varies from Yellow, Low Brake, No Theta (Y, LB, NØ) to Red, High Brake, Medium Theta (R, HB, MØ), as the relative velocity variable varies from Very Low (VL) to Very High (VH). Thus, applicants disclose a coordinated determination of braking and steering using fuzzy logic, depending on the driving hazards. Applicants further disclose coordinated control based on the presence or absence of other obstacles or hazards in the vicinity of the controlled vehicle.

Kurami's failure to foreshadow applicants' invention is apparent also from the fact that the two systems can be used together. It might be a good idea to use Kurami's

fuzzy actuator control to implement the commands generated by applicants' fuzzy evasive-action selector. In that fashion, the changes in course or speed recommended to attempt to avoid an accident would be implemented as smoothly as possible under the circumstances. But this shows that the two systems are entirely distinct.

In any event, Kurami's patent is insufficiently enabled to obviate applicants' invention. Kurami shows no working embodiment of either his fuzzy logic actuator system or his non-fuzzy control system. And, while Kurami attempts to disclose (in connection with Figs. 2 and 3) a method (which contains inaccuracies) of controlling the steering of a car to cause it to track between the centerline and the edge of the road, he says nothing about how the control section selects between steering and braking to avoid an obstacle, or indeed if the control section makes such a selection at all.

Kurami's sketchy disclosure on these points contrasts sharply with applicants' detailed explanation of how a fuzzy system selects an appropriate evasive action.

The Examiner apparently concedes that Adachi lacks selection of an appropriate evasive action from among several options; thus, the supporting reference does not plug the holes in Kurami.

All of the claims here, with the exception of independent claim 86 and the three claims that depend thereon, relate to fuzzy logic control that can select an appropriate evasive action. Most of the claims (specifically independent claims 1, 30, 86, 118, and 132; dependent claims 65 and 144; and claims dependent thereon) expressly require that the evasive action be selected from a set including both course and speed changes.

In view of the gaps in the prior art, applicants respectfully submit that all of the claims are patentable.

**B. The References Do Not Disclose Evading One Accident without Thereby Causing a Different Accident.**

A large group of claims relates to the concept of selecting an evasive action that does not cause the vehicle to strike another obstacle or vehicle. As applicants previously noted, a significant problem with existing systems is that they will evade an impending accident, regardless of the cost. For example, Adachi's system will brake the

car if it is about to hit the car in front of it, even if it will cause the car to be struck by the car behind. Such systems can get the car out of the frying pan, only to put it in the fire.

The inventive apparatus monitors not only the primary accident risk (such as the front of the vehicle), but also hazards from one or more other directions from the vehicle (such as to the sides or behind). The system can select between several evasive responses, depending on conditions around the vehicle. At least independent claims 48, 53, 131, 132, 142, 156, and 157, dependent claims 13, 104, 108, 110, 111, 117, 123, 125, and 158, and claims dependent thereon relate to that aspect of the invention.

On page 9 of the Office Action, the Examiner discusses a list of claims that overlaps substantially (but not exactly) with this list. In that discussion, the Office Action admits, "The combination of Kurami and Adachi...does not mention avoiding a collision without causing another collision with another object at the sides of the vehicle, or any other direction." Thus, it is admitted that the references do not contain the claimed limitation. Nevertheless, the Office Action rejects the claims.

The Office Action's entire argument on this point is:

"However, Kurami discloses that the actuator controls would replace the control normally provided by a human operator (col. 4, lines 57-61), and since a human operator would steer to avoid collisions not only in the front of the vehicle, but also any other possible collision from other directions, then it would have been obvious to one skilled in the art to modify Kurami and Adachi to avoid possible collisions from all directions as a human operator would because it is obvious to avoid a collision from one direction without causing a collision with something else in another direction."

The Examiner cites no reference supporting the assertion that "it is obvious to avoid a collision from one direction without causing a collision with something else in another direction," at least not for a machine that does so, and applicants respectfully demand that the Examiner cite a reference supporting this point or else drop it.

By saying that "a human operator would steer to avoid collisions not only in the front of the vehicle, but also any other possible collision from other directions," it

appears that the Examiner means that it is obvious for a *human driver* to attempt to use evasive actions that do not cause another collisions. However, there is no disclosure in the prior art of which applicants are aware of an *automated system* that performs such control. The argument in the Office Action is akin to saying that automatic *handwriting* recognition is unpatentable over known optical character recognition (OCR) systems that recognize *typed* characters because humans know how to read handwriting.

It is entirely non-obvious to select an evasive response to a danger depending on the presence of obstacles in other directions. Such has not been done in prior systems, admittedly so in the case of Kurami and Adachi. At least these claims are in condition for prompt allowance.

**C. Additional Features of Applicants' Invention Are Novel.**

A number of other groups of claims contain features that are not fairly met by the cited references.

**1. Taking over from the driver.**

Certain claims include the limitation that the control system takes over control of the vehicle from the driver at a particular point, expressed with the claim language "when a collision is imminent." For example, claim 1 states: "when a collision is imminent between one of the objects and the vehicle, using fuzzy logic to take over control of the acceleration and steering of the vehicle from a driver...." [Part 1(e); *see also* parts 86(d) and 131(e), which are quite explicit on this point] Independent claims 1, 53, 86, 118, 131; dependent claims 40 and 139; and claims dependent therefrom contain limitations directed to this point.

The Office Action asserts without citation that Kurami takes over control from a driver when a collision is imminent [paras. 6, 13], but the reference does not discuss that feature. Rather, Kurami relates to an "autonomous control system for an automotive vehicle" [Col. 1, lines 7-8], which "enables an unmanned vehicle to be left to execute various tasks and or navigate a predetermined course without the need for human supervision" [Col. 1, lines 32-34].

2. **Selecting from among multiple fuzzy rule sets.**

Certain claims include the limitation that the control system selects from among a plurality of fuzzy logic rule sets. This is related to, but an important extension of, the point that the control system can elect different sorts of evasive action depending on the circumstances. Independent claims 142, 156, and 157; dependent claims 111 and 127; and claims dependent therefrom contain limitations directed to this point.

The first paragraph at the top of page 10 of the Office Action purports to deal with this subject, but it is not so that the fuzzy logic rules of Kurami “would have to take into account which direction the objects are detected in order to avoid collisions.” There is no requirement that Kurami select from among several rule sets, as opposed to the single set of fuzzy inference rules mentioned. And, recall that Kurami’s fuzzy rules are designed for a different function, namely implementing a command to alter speed or steering, so there is no requirement that the rules take into account direction of detected obstacles.

As to dependent claims 112 and 128, there is no reason why an associative memory would have to be used, as asserted.

Dependent claim 155 specifically refers to rule sets reflecting road conditions; this point is not treated by the Office Action at all.

3. **The driver override.**

Claims 129 and 130 relate to a driver override, in which the driver can block the proposed action of the automated system. The Office Action [second para. on page 10] admits that “Kurami and Adachi does not disclose an override command.” However, the Examiner states that “it would have been obvious” to include it. Applicants put the Examiner to strict proof of this bald assertion.

Respectfully, the Patent Office is not free to simply ignore claim limitations with mere *assertions* of obviousness. A prima facie case of obviousness is not established unless the Examiner can demonstrate that the limitations are suggested by or disclosed in the prior art and that there would have been some motivation to combine such features with the remainder of the claimed invention. If the Examiner believes that the

feature is "well known prior art," then *facts* supporting that assertion must be presented by the Examiner. [Rule 107(b); MPEP 706.02(a)]

4. **Applicants' "warn, wait, then control" feature.**

Certain of the claims relate to issuing a warning, waiting for the driver to respond in a way that would eliminate the hazard, and to take over control of the vehicle only if the driver does not react and the hazard remains. Dependent claims 40, 54, and 139 and claims dependent thereon relate to that distinction. The Office Action refers to claim 54 on page 10, stating that because Kurami discloses controlling a vehicle horn, it would have been obvious. However, Kurami discloses no control system that waits for a change in the situation and then alters the control of the vehicle only if a hazardous condition remains.

The Office Action refers to claims 40 and 139 at the top of page 13, alleging that "Bosacchi teaches the concept of providing automatic control in situations where the driver fails to perform the required action (page 68 last paragraph to page 69)." The Bosacchi reference fails to teach or suggest the claimed limitation. Bosacchi there discusses another article, which apparently relates to a speed-limit enforcement mechanism by the side of the road, which can transmit signals to an automobile warning the driver to slow down. There is no indication that the system can control the vehicle directly. At the cited place, Bosacchi makes a comment about "'dismissing' the driver" who does not cooperate. That apparently refers either to a company firing an employee-driver or a governmental agency de-licensing the driver, not to automatic vehicle control.

5. **Taking evasive action by altering both speed and steering.**

Certain claims relate to a system that makes a simultaneous alteration of both speed and direction of the vehicle. Dependent claims 43, 65, 141, and 145 relate to this aspect of the invention. The Examiner refers to this point on page 11 of the Office Action merely by stating that "all evasive action requires selecting various combinations of alteration of the speed-altering mechanism and steering mechanism based on what combination would best avoid a collision" and that "it would have been

obvious to one skilled in the art to control the speed and steering of a vehicle simultaneously because it provides a greater chance of avoiding collisions....”

These comments do not fairly meet the claimed invention. In addition, the absence of any supporting reference—as well as the admitted absence from the cited references of controlling steering and speed together—strongly suggests the nonobviousness of this invention. As above, applicants respectfully insist on proof of the existence of this feature in the prior art and respectfully submit that the fact that a human controls the car in this way does not make it obvious to automate the process.

**6. Ranging by classification of shapes.**

In the discussion of enablement above, applicants explained how they determine the distance to an object such as a car by recognizing it as a car and measuring its image from the image signals produced by the scanner. Dependent claims 38, 39, and 120 refer to this feature, and claims 151 and 153-154 refer to such recognition and classification as well. Claim 152 specifically refers to use of a neural net in such classification.

The Examiner discusses this feature on page 12, where the Office Action admits that the supporting reference applied to reject these claims, Kajiwara, “does not disclose comparing the detected object with a standard shape.” Again, the Office Action baldly asserts that adding the feature “would have been obvious.” Again, applicants insist on proof of the existence of the feature in the prior art and a motivation to use that feature in the ranging or identification systems as claimed.

**7. Display systems.**

In paragraphs 9, 11, 13, and 14 of the Office Action, the Examiner cites Shekar or Hancock for the features of a display system, which might be a heads-up one projected onto the windshield. The claims in question relate to displaying for the driver information concerning the location of obstacles such as other vehicles around the car being controlled. Claims 7, 14, 31, 86, and 137 and claims dependent thereon relate to displaying such information, while claims 32, 57, and 92 include windshield or heads-

up displays. Claims 7 and 59 display specifically identified information, which the Office Action does not discuss.

Neither of the cited references, however, disclose displaying the information discussed in these claims to the driver. Hancock shows a display terminal that is designed for a central-control person, namely an air-traffic controller. There is no discussion of having the information about obstacles or other planes displayed for the pilots. Shekar discloses a heads-up display of maps projected onto the windshield, not information about other moving vehicles in the vicinity of the driver.

The claimed display system is novel because it permits the driver to better control the car, without looking in rear-view mirrors or checking the "blind spot," which is particularly dangerous when a hazardous situation arises. Combining Shekar and Hancock with the primary references would not block the claims, and there is no motivation of placing known types of displays in cars for this purpose.

**8. The hazard priority system.**

In the first Office Action, the Examiner applied Kohsaka to show the obviousness of the "priority rankings" added by dependent claims 100, 113, 124, 149, and 154. In response, applicants noted that Kohsaka disclosed ranking messages, which are the *output* of the fuzzy logic system, while in applicants' invention, the priority rankings are used to index into an associative memory to select an appropriate control response, that is, as an *input* to the fuzzy logic function. Kohsaka's fuzzy logic is not based on any sort of priority ranking. Thus, Kohsaka's ranking could not be integrated for vehicle control based on selection of several evasive actions. The inventive system provides significant advantages over the mere ranking of messages shown by Kohsaka.

The final Office Action repeats the rejection of these claims using Kohsaka, without comment on applicants earlier distinction. [Para. 12] Applicants respectfully request an answer or an indication of allowability of these claims.

**Conclusion**

Applicants have amply disclosed a working vehicle control system that can more closely mimic the evasive response of a skilled driver. The inventive system can be



used to take over from the driver, to reduce driver error. The control or suggestions of the inventive system, unlike prior art systems, seek to avoid secondary accidents. These are significant advances over the prior art.

It is respectfully submitted that the Examiner cannot simply use hindsight to assert that each of the advances made by applicants are obvious. And, the Kurami and other references cited do not anticipate or obviate the claims.

Applicants respectfully request an in-person interview to discuss these points further, in the hope that an appeal can be avoided. The Examiner is respectfully requested to contact applicants' undersigned attorney regarding scheduling such a meeting at a convenient time after the Examiner has a chance to review this response.

Respectfully submitted,

JEROME H. LEMELSON  
ROBERT D. PEDERSEN  
by their attorney

Dated: January 29, 1996

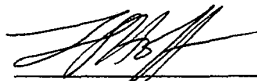

\_\_\_\_\_  
Louis J. Hoffman  
Reg. No. 38,918

LOUIS J. HOFFMAN, P.C.  
15150 North Hayden Road  
Suite 202  
Scottsdale, Arizona 85260  
(602) 948-3295

Certification

I hereby certify that this paper, together with the enclosed check for \$380.00, is being hand-delivered this 30<sup>th</sup> day of January, 1995, to the U.S. Patent and Trademark Office.

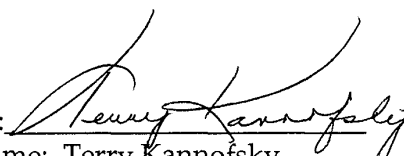
By:   
Name: Terry Kannoisky

RECEIPT IS ACKNOWLEDGED OF a document entitled Response to Final Office Action, together with the enclosed check for \$380.00:



UNITED STATES DEPARTMENT OF COMMERCE  
Patent and Trademark Office

Address: COMMISSIONER OF PATENTS AND TRADEMARKS  
Washington, D. C. 20231

08/105,304

SERIAL NUMBER	FILING DATE	FIRST NAMED APPLICANT	ATTORNEY DOCKET NO.

EXAMINER	
ART UNIT	PAPER NUMBER
	13

DATE MAILED:

EXAMINER INTERVIEW SUMMARY RECORD

All participants (applicant, applicant's representative, PTO personnel):

(1) A. Au PTO (3) Dr. Pedersen  
 (2) L. Hoffman (4) \_\_\_\_\_

Date of interview 2/8/96

Type:  Telephonic  Personal (copy is given to  applicant  applicant's representative).

Exhibit shown or demonstration conducted:  Yes  No. If yes, brief description: \_\_\_\_\_

Agreement  was reached with respect to some or all of the claims in question.  was not reached.

Claims discussed: 1, 142 as examples

Identification of prior art discussed: Kurami

Description of the general nature of what was agreed to if an agreement was reached, or any other comments: Applicants pointed out that detection and ranging aspects are known in the art, agreed that an affidavit will be filed for the § 112(1) rejection. The after final amendment would be ~~not~~ entered. Examiner will review the § 103 distinctions argued in the after final response filed 1.30.96

(A fuller description, if necessary, and a copy of the amendments, if available, which the examiner agreed would render the claims allowable must be attached. Also, where no copy of the amendments which would render the claims allowable is available, a summary thereof must be attached.)

Unless the paragraphs below have been checked to indicate to the contrary, A FORMAL WRITTEN RESPONSE TO THE LAST OFFICE ACTION IS NOT WAIVED AND MUST INCLUDE THE SUBSTANCE OF THE INTERVIEW (e.g., items 1-7 on the reverse side of this form). If a response to the last Office action has already been filed, then applicant is given one month from this interview date to provide a statement of the substance of the interview.

It is not necessary for applicant to provide a separate record of the substance of the interview.

Since the examiner's interview summary above (including any attachments) reflects a complete response to each of the objections, rejections and requirements that may be present in the last Office action, and since the claims are now allowable, this completed form is considered to fulfill the response requirements of the last Office action.

[Signature]  
Examiner's Signature

PTOL-413 (REV. 1-84)

ORIGINAL FOR INSERTION IN RIGHT HAND FLAP OF FILE WRAPPER



UNITED STATES DEPARTMENT OF COMMERCE  
 Patent and Trademark Office  
 Address: COMMISSIONER OF PATENTS AND TRADEMARKS  
 Washington, D.C. 20231

SERIAL NUMBER	FILING DATE	FIRST NAMED APPLICANT	ATTORNEY DOCKET NO.
08/105,304	08/11/93	LEMELSON	J

JEROME H. LEMELSON  
 SUITE 286  
 930 TAHOE BLVD.  
 UNIT 802  
 INCLINE VILLAGE, NV 89451-9436

26M2/0220

EXAMINER	
ART UNIT	PAPER NUMBER
2615	14

DATE MAILED:

02/20/96

Below is a communication from the EXAMINER in charge of this application

COMMISSIONER OF PATENTS AND TRADEMARKS

ADVISORY ACTION

THE PERIOD FOR RESPONSE:

- a)  is extended to run 5 months or continues to run \_\_\_\_\_ from the date of the final rejection
- b)  expires three months from the date of the final rejection or as of the mailing date of this Advisory Action, whichever is later. In no event however, will the statutory period for the response expire later than six months from the date of the final rejection.

Any extension of time must be obtained by filing a petition under 37 CFR 1.136(a), the proposed response and the appropriate fee. The date on which the response, the petition, and the fee have been filed is the date of the response and also the date for the purposes of determining the period of extension and the corresponding amount of the fee. Any extension fee pursuant to 37 CFR 1.17 will be calculated from the date of the originally set shortened statutory period for response or as set forth in b) above.

Appellant's Brief is due in accordance with 37 CFR 1.192(a).

Applicant's response to the final rejection, filed 1-30-96 has been considered with the following effect, but it is not deemed to place the application in condition for allowance:

1.  The proposed amendments to the claim and/or specification will not be entered and the final rejection stands because:
- a.  There is no convincing showing under 37 CFR 1.116(b) why the proposed amendment is necessary and was not earlier presented.
  - b.  They raise new issues that would require further consideration and/or search. (See Note).
  - c.  They raise the issue of new matter. (See Note).
  - d.  They are not deemed to place the application in better form for appeal by materially reducing or simplifying the issues for appeal.
  - e.  They present additional claims without cancelling a corresponding number of finally rejected claims.

NOTE:

2.  Newly proposed or amended claims \_\_\_\_\_ would be allowed if submitted in a separately filed amendment cancelling the non-allowable claims.

3.  Upon the filing an appeal, the proposed amendment  will be entered  will not be entered and the status of the claims will be as follows:

Claims allowed: none  
 Claims objected to: none  
 Claims rejected: 1-10, 12-14, 30-34, 38-40, 43, 48, 53-62, 65, 86, 91-92, 99-160

However;

Applicant's response has overcome the following rejection(s): \_\_\_\_\_

4.  The affidavit, exhibit or request for reconsideration has been considered but does not overcome the rejection because see attachment

5.  The affidavit or exhibit will not be considered because applicant has not shown good and sufficient reasons why it was not earlier presented.

The proposed drawing correction  has  has not been approved by the examiner.

Other

Art Unit: 2615

4. (con't) The request for reconsideration has been considered but does not overcome the rejection.

A. In response to applicant's arguments from pages 18-21 that Kurami does not disclose fuzzy control. The language claimed is "using fuzzy logic to take over control of the acceleration and steering of the vehicle" [claim 1, lines 12-13] which reads on Kurami's actuator control. The actuator control controls the acceleration and steering of the vehicle using fuzzy control as claimed.

B. In response to applicant's arguments from page 21-23 that the references do not disclose evading one accident without thereby causing a different accident. Kurami discloses in col. 4, lines 25-34, laser radar and ultrasonic sensors in addition to camera sensors for detecting "obstacles in the path of the vehicle and with which the vehicle is apt to collide" and "to induce the necessary steering, stoppage or speed reduction of the vehicle if required." Kurami detects and attempts to avoid possible collisions which "the vehicle is apt to collide" which may be in any direction. Therefore Kurami would attempt to avoid any and all collisions.

C. 1. In response to applicant's arguments regarding Taking over from the driver. Applicant argues that the control system does not take over control of the vehicle at a particular point. This is incorrect. Kurami discloses in col. 4, lines 32-33 of taking the necessary steps to avoid a collision. When obstacle avoidance is required it must take over control of the vehicle. Even though Kurami discloses an

Art Unit: 2615

autonomous control system and an unmanned vehicle, it does not mean that there is no driver controlling the vehicle. Kurami discloses a man-machine interface 600, col. 6, lines 1-12, which may be used to control the operation of the vehicle.

C. 2 In response to applicant's arguments regarding Selecting from among multiple fuzzy rule sets. Applicant is arguing limitations that are not specifically claimed. The claims does not specify selecting from among a plurality of fuzzy logic rule sets or a control system electing different sorts of evasive action depending upon the circumstances or taking into account direction of detected obstacles.

C. 3 In response to applicant's arguments regarding The driver override. Overrides of automated systems are standard practice in the art. For example, airplanes have auto-pilot, which may be override by the captain when automatic control is deemed unnecessary or undesirable, i.e. when it does not operate in the manner desired by the captain.

C. 4. In response to applicant's arguments regarding the Warn, wait, then control feature. Re Bosacchi reference, within the context of the article, the word "dismissing" would not refer to a company firing or de-licensing the driver.

C. 5 In response to Taking evasive action by altering both speed and steering. Kurami discloses in col. 4, lines 32-33, "to induce the necessary steering, stoppage or speed reduction of the vehicle if required."

Art Unit: 2615

C. 6. In response to Ranging by classification of shapes. Kajiwara discloses in col. 1, lines 57-60, "a picture image which most resembles the picture image in shape and size is determined from picture images." A present shape or size at an instant of time is required to be compared to a standard shape in order to determine distance. How the standard shape is generated is arbitrary.

C. 7 In response to Display systems. Hancock does disclose a display terminal showing obstacles and other planes, see figs 1-3.

C. 8 In response to Hazard priority system. Applicant is arguing limitations not in the claims. The claims do not recite that the priority rankings are used to index into an associated memory to select an appropriate control response. that is, as an input to the fuzzy logic function as argued by applicant.

Any inquiry concerning this communication or earlier communications from the examiner should be directed to Amelia Au whose telephone number is (703) 308-6604. The examiner can normally be reached on Monday - Thursday from 6:30 am - 4:00 pm EST. The examiner can also be reached on alternate Fridays.

If attempts to reach the examiner by telephone are unsuccessful, the examiner's supervisor, Tommy Chin, can be reached on (703) 305-4715. The fax phone number for this Group is (703) 308-5399.

Any inquiry of a general nature or relating to the status of this application should be directed to the Group receptionist whose telephone number is (703) 305-4700.



aa

February 14, 1996



**TOMMY P. CHIN**  
**SUPERVISORY PATENT EXAMINER**  
**GROUP 2600**

MM

IN THE UNITED STATES PATENT AND TRADEMARK OFFICE

Applicants : Jerome H. Lemelson      **RESPONSE UNDER RULE 116—**  
                        Robert D. Pedersen      **EXPEDITED PROCEDURE.**

Serial No. : 08/105,304      Art Unit : 2615

Filed : 8/11/93      Examiner : Au

Title : Motor Vehicle Warning and Control System and Method

#15  
ROSE  
2-28-96

Assistant Commissioner for Patents  
Washington, D.C. 20231

**DECLARATION OF DR. JOHN R. GRINDON**

Dear Sir:

I am a professional engineer, offering services in machine vision, electronic imaging, image processing, digital signal processing, and allied areas. I consult from my office in Hazelwood, Missouri. Applicants requested my professional opinion concerning certain aspects of the above-referenced patent application. In particular, I was asked to comment on the level of ordinary skill in the art as of August 1993 concerning analysis of video and image signals derived using video scanners, laser scanners, radar/lidar scanners, or ultrasonic scanners and the like to scan areas to the front, rear, and sides of a vehicle, as disclosed in this patent application, to derive the necessary system control signals to warn the driver and, if necessary, to control the vehicle. I have studied and considered this matter as outlined below, and I have personal knowledge of the facts set forth in this declaration .

**BACKGROUND**

1. I have received the following degrees, all in Electrical Engineering:
  - (a) Bachelor of Science, from what is now the University of Missouri at Rolla, 1961.
  - (b) Master of Science, from the Massachusetts Institute of Technology, 1962.
  - (c) Doctor of Science, from Washington University in St. Louis, 1970.

2. Honors that I have received include the Outstanding Electrical Engineering Senior award, the Westinghouse Achievement Scholarship, and election to Eta Kappa Nu, Tau Beta Pi, and Phi Kappa Phi honorary societies. I graduated with First Honors (first in Electrical Engineering and 99th percentile in class). I was granted

4/1/96  
JG



the Hughes Master's Fellowship to M.I.T. and was elected to the Sigma Xi research society there. I earned the doctorate from Washington University with straight A's. I am a Registered Professional Engineer and a member of the Institute of Electrical and Electronics Engineers (IEEE), and of the International Society for Optical Engineering (SPIE).

3. I have worked in industry as a practicing engineer throughout my professional career. I have been directly involved in advanced engineering design projects resulting in real-world developments with particular emphasis on machine vision and image-processing systems. Positions I have held include:

(a) Executive Vice President and Director of Research, Cencit, Inc., St. Louis, Missouri.

(b) Branch Chief - Electronics, McDonnell Douglas Corporation, St. Louis, Missouri.

(c) Scientist, McDonnell Douglas Electronics Company, a component of McDonnell Douglas Corporation, St. Charles, Missouri.

(d) Section Manager, Conductron Corporation, a component of McDonnell Douglas Corporation, St. Charles, Missouri.

(e) Engineer, Hughes Aircraft Company, Fullerton, California.

(f) Engineer, Westinghouse Electric Corporation, Baltimore, Maryland.

4. My employment with Cencit, Incorporated was from 1985 until 1990. My employment with companies of the McDonnell Douglas Corporation was from 1962 until 1987. For a time, I was employed with Cencit while serving part-time as manager of an image processing research and development team at McDonnell Douglas. My employment at Hughes Aircraft and Westinghouse Electric was between school years in 1961 and 1960, respectively.

5. My professional work experience centers on research and development relating to systems incorporating sensors, electronics, computers, and software algorithms for processing signals, images, and data. Applications have been to both defense and the private sector. Some of my accomplishments are summarized in the following paragraphs.

6. At Cencit, I developed a concept and led the design of a three-dimensional computer vision system and computer-controlled replicator. This equipment senses the surface of an object without physical contact and then machines a scaled

three-dimensional replica from the digitized shape data. It has found application in medical and military research. I received two U.S. Patents on this technology.

7. While employed at McDonnell Douglas, I led image processing R&D projects for Cruise Missile guidance applications and for automatic target recognition. I managed a software development and flight test program to statistically predict and verify guidance performance for the Tomahawk Cruise Missile. I also developed scene analysis algorithms for three-dimensional (3-D) imagery for advanced autonomous Cruise Missile guidance employing 3-D imaging laser radars. I conceived an approach and managed a program to develop automatic target classification and recognition algorithms for anti-ship missiles using infrared imaging sensors. I developed a new kind of processing algorithm for autonomous Cruise Missile guidance using infrared imaging sensors to automatically recognize scenes based on stored map data.

8. I invented a new system for detecting and more accurately locating ground-based communications transmitters through a method employing digital signal processing and statistical estimation, rather than through conventional direction-finding techniques. I also secured and led a series of research and development projects from the Department of Defense to analyze and develop algorithms and supporting electronics for this concept. I secured funding and developed a new correlation method to detect and locate spread-spectrum signals, which are used to hide covert communications beneath the frequency spectrum.

9. My doctoral research was in statistical estimation, with applications to digital signal processing and image processing. This work came into later use in the projects described above.

10. I also designed electronics for an aircraft collision-avoidance system, developed solutions for automatic instantaneous measurement of closing velocities between aircraft, and designed an interference-rejecting omnidirectional direction finding system. I was awarded a patent on this work. I did research on a multimode microwave direction-finding antenna, which led to a new system solution. I was awarded a U.S. Patent on a new method of generating single-sideband signals. I developed new techniques for designing receivers for pulsed signals to preserve radio frequency phase information, used in direction-finding and Doppler measurement systems. I developed a design methodology, computer-aided engineering software, and hardware for a wide dynamic range, multi-octave, intercept receiver for electronic warfare applications. I developed a unique and effective solution to the problem of

mutual electromagnetic interaction among multiple jamming transmitters on electronic warfare aircraft.

11. For my Master's Thesis, I performed research in microwave electronics design for radio astronomy and developed a multichannel waveguide filter for M.I.T.'s radio telescope, used in remote analysis of the Venusian atmosphere.

12. During early employment between school years, I performed electronic circuit design for radars and the system design for a radar simulator. I have had a strong interest in electronics from the early 1950's. I constructed my first amateur radio receiver and transmitter in 1953 and 1954 and was licensed as an amateur radio operator in 1954.

#### **Standards Applied**

13. I used the following guidelines as standards for evaluating the application disclosure and claims:

(a) It is for the invention as claimed, and not some other, that enablement must exist. Thus, it is sufficient if applicant discloses only the details of the claimed aspects of the invention without disclosing the details of all related, unclaimed aspects of the system with which the claimed invention might interface.

(b) Patent specifications were never intended to be production specifications.

(c) The enablement requirement is measured with respect to one of ordinary skill in the art as of the filing of the application and not with respect to the general public. Accordingly, it is not required that applicant disclose every detail of the invention, as applicant's specification is written for the person of ordinary skill in the art. That person of ordinary skill in the art is presumed to have knowledge of all references that are sufficiently related to one another and to the pertinent art, and to have knowledge of all art reasonably pertinent to the particular problem with which the inventor was involved. Thus, the person of ordinary skill in the art must be viewed as working in his shop with all of the reasonably pertinent and available references, which he is presumed to know, hanging on the walls around him. Thus, a patent need not teach, and in fact preferably should omit, what is well known in the art.

(d) That some experimentation may be required does not preclude finding an enabling disclosure. Only a finding that the amount of

experimentation is "unduly extensive" warrants a corresponding finding that the disclosure is not enabling. The key word is "undue," not "experimentation."

(e) As to what constitutes "undue" experimentation, certain fields, such as the mechanical and electrical environments, are more predictable than others, such as the chemical or physiological fields, and accordingly, can tolerate a lesser degree of disclosure or a greater degree of experimentation.

(f) Moreover, if an invention pertains to an art where the results are predictable, a broad claim can be enabled by disclosure of a single embodiment and is not invalid for lack of enablement simply because it also reads on another embodiment of the invention which is inadequately disclosed.

(g) Thus, the determination of what constitutes undue experimentation in a given case requires the application of a standard of reasonableness, having due regard for the nature of the invention and the state of the art. The test is not merely quantitative, since a considerable amount of experimentation is permissible, if it is merely routine or if the specification in question provides a reasonable amount of guidance with respect to the direction in which experimentation should proceed.

(f) In sum, the following factors should be considered in determining whether a disclosure would require undue experimentation: (1) the quantity of experimentation necessary, (2) the amount of direction or guidance presented in the disclosure, (3) the presence or absence of working examples, (4) the nature of the invention, (5) the state of the prior art, (6) the relative skill of those in the art, (7) the predictability or unpredictability of the art, and (8) the breadth of the claims.

14. In analyzing the question of enablement, I reviewed the following materials:

(a) Applicants' specification as filed and amended, including drawings;

(b) The claims as amended;

(c) U.S. Patent Office Action dated September 19, 1995, specifically the examiner's remarks at pages 2-3 at paragraph 1.b, and pages 17 and 18 at paragraph 15 concerning operability of the disclosed invention.

(d) The article: " Intelligent Road Transit: The Next Generation," *AI Expert*, April 1994, pages 16-24, by Denny Rock, et al.

(e) All listed Attachments to this Declaration.

15. I was instructed to assume the date of August 11, 1993, to measure the level of knowledge of the ordinarily skilled artisan. However, I do not believe that my conclusions would differ should that date vary a bit, as explained in more detail below.

16. As a further initial task, I considered the question of the background of one of ordinary skill in the art. Based on my experience and expertise, as described above, and my review of the specification, I concluded that the ordinarily skilled artisan would have a college degree in electrical engineering and at least four years' experience in computer vision and control system technology, or the equivalent. Because of my academic and industrial background in computer vision and applications of that technology to control systems, I am quite familiar with the capabilities of the ordinarily skilled artisan with knowledge in this field of endeavor.

17. My specific analysis and conclusions regarding enablement are provided in greater detail below.

#### Applicants' Disclosure

18. I reviewed the specification, drawings, and claims of the application, considering what was known in the art at the time of the filing of the patent application. My findings based on that review are summarized in the following paragraphs.

19. Applicants disclose an automatic system and method for assisting the driver of a motor vehicle in preventing or minimizing the effects of collisions. The driver is warned of impending danger. If the driver fails to respond, the disclosed system can take over control of the vehicle. The driver may override the automated control system.

20. In a preferred embodiment, as shown in Figure 1, a video scanning system, such as a one or more television camera or laser scanners, which may be used with a ranging system (P3/L4-7), are mounted on the vehicle and scan the roadway, generating electrical signals for computer analysis to detect hazards or obstacles and to automatically generate control signals to warn or advise the driver, and, if necessary, to automatically control the vehicle to avoid or to minimize the effects of collisions.

21. In addition to the use of television cameras and laser video scanners, applicants disclose the use of other radiation scanning means to scan to the front, rear, and sides of the controlled vehicle, including microwave and infrared radiation and radar.

22. Applicants disclose the use of modern video analysis techniques and methods, such as those made possible using modern high speed processors, parallel processors and neural networks to computer analyze signals generated from scanning, to detect obstacles and hazards in the vicinity of the motor vehicle, and to determine relative location, distances, velocities, and accelerations between the motor vehicle and the detected objects or hazards. Applicants do not claim in this application to have invented new video signal analysis methods, but rather claim the use of such methods as known in the existing art to implement the invention.

23. Applicants further disclose the use of fuzzy logic to exercise coordinated control over the motor vehicle braking, throttle, and steering to avoid or minimize the effects of a collisions. Fuzzy logic expert system response rules are used to determine the relative degree of braking, acceleration, or steering depending on the hazardous condition.

24. Applicants disclose the use of fuzzy logic to select the most appropriate combined degree of steering, braking, or acceleration, depending on the hazardous situation. For example, it may be better to brake less and steer to one side or the other rather than just brake hard to avoid a collision. The best choice depends on the presence of hazards or obstacles to the rear or to either side of the controlled vehicle and the distance to the vehicle to the front.

25. Applicants further disclose fuzzy logic methods for attempting to avoid causing secondary collisions while avoiding a first hazard, such as might be caused, for example, by steering into the path of another hazard or obstacle to avoid a first hazard or obstacle.

26. Applicants disclose several other capabilities related to motor vehicle control and collision avoidance not addressed in this declaration because they are considered of secondary importance to the capabilities of the modern signal processing and vehicle control techniques and methods necessary for the claimed invention.

27. Applicants disclose at pages 9 to 13 and in Figures 2, 3, 4, and 5 several possible image processing architectures for implementing image analysis functions. Applicants point out at page 9 that high speed image processing can be implemented employing known special-purpose computer architectures including various parallel processor structures and systems based on neural networks. Applicants disclose the use of video preprocessors and video co-processors used in modern systems to perform special image processing functions. SIMD (single instruction, multiple data)

architectures such as those employed in massively parallel computer architectures are disclosed and are capable of high speed image processing, wherein the same instruction sequences are executed in parallel on different data elements, such as is common in image processing. Comparisons to standard, known images in memory to further reduce image recognition processing times is also disclosed by applicants. The use of neural networks with highly parallel processing of image pixels to classify images and identify objects based on network training is also disclosed. Applicants also cite multiple technical references that further disclose the design and operation of such computer architecture systems and methods. All of these techniques were known and used in image processing systems at the time of the subject application.

**Discussion of References Demonstrating Enablement**

28. I have reviewed a large number of patents issued by the U.S. Patent Office and many published articles characterizing the state of the art in automotive guidance and collision avoidance systems, with particular attention to the use of video scanning, laser ranging, radar and ultrasonic scanning of the roadway in these systems for the purpose of guiding the vehicle and avoiding or minimizing the effects of collisions. I have found multiple disclosures of patented and experimental systems and methods that demonstrate the feasibility of generating the required scanning signals, including video scanning signals, necessary to generate, in real time, the control signals required in the automotive vehicle collision warning and control systems and methods that are the subject of this application.

29. With respect to the article by Denny Rock et al., the Examiner states at pages 17 and 18 of the September 19, 1995, Office Action that, while Rock confirms the "possibility" of performing the required image processing in applicants' application, he does not address the issues of vehicle control based on the results of that image processing. In this regard, applicants' proposed use of fuzzy logic with parallel associative memories that may be easily accessed based on the results of the image analysis greatly simplifies the required processing, and would permit real-time operation in the disclosed collision avoidance system. The disclosed control systems only require generation of hazard state vectors, execution of corresponding fuzzy inference rule identified by the hazard state vectors, and defuzzification to generate crisp control signal values.

30. In addition, the patents and articles reviewed below demonstrate that it is not only "possible" to implement the image processing required in the subject

application, but that it is also "possible" to implement the necessary real-time control signals for braking, acceleration, and steering. The various patents and articles discussed are attached. The summaries below and the corresponding attached references describe multiple systems where such control signals are generated to avoid or minimize the effects of such collisions. Indeed, the multiple cited U.S. Patents demonstrate that the Patent Office has already decided that such scanning, signal analysis, and control is possible.

31. K. Kurami, et al., U.S. Patent 5,081,585, "Control System For Autonomous Automotive Vehicle Or The Like," filed June 15, 1988, issued January 14, 1992, assigned to Nissan Motor Company, Ltd. (Attachment A).

This Nissan patent is cited by the Examiner in combination with the Adachi patent as obviating several claims of the pending application. The Nissan patent is characterized (in the first sentence of the abstract) as follows:

"An image processing section receives data from cameras mounted on the vehicle and produces an image or images from which a first set of so called 'local' data is derived and compiled."

The imaging system used in the Nissan patent is depicted in Figure 1 and comprises multiple cameras 101 and 103 connected to an image computing system 105. Outputs from the image computing system 105 are used as inputs to the obstacle avoidance control 501 and the local vehicle positioning determination unit 107. The signals are subsequently used to generate control signals for braking, throttle, and steering actuators.

The operation of the Nissan system is further characterized as follows (C1/L60 to C2/L5 and C2/L32-34):

" A second aspect of the present invention takes the form of the steps of producing an image of the road on which the vehicle is running and deriving the first set of positional data comprising: observing the road using first and second cameras; producing a stereo image using the inputs from the first and second cameras; producing an image of the road; identifying first, second and third road features from the image, the first second and third road features relating to the position of the vehicle on the road; establishing the distance of the vehicle from each of the first, second and third road features; and using the distances derived in the step of establishing to compile the first set of vehicle position data."

\*\*\*\*\*

"... the image processing section being arranged to observe the road, produce an image of the same, and derive distance related data from the image"

The Nissan patent provides the following further description of the operation of the cameras 101 and 103 and the image processing section 100 in Figure 1 (C3/L40-54):



"More specifically, the image processing section 100 includes a pair of cameras 101, 103 which are arranged at the front of the vehicle, for example at the front left and right corners of the same so as to enable the development of a stereo image. To increase the angle over which data can be collected, the cameras 101, 103 can be arranged to pivot and to sweep from side to side. The camera 101 and 103 in this instance are operatively connected with an image computing system 105 which is capable of converting the inputs therefrom into a planar image (or, and/or a three dimensional image or images). This image (or images) are used to determine the *presence or absence of an obstacle in the path of the vehicle.*" (emphasis added)

Thus, like this application, the Nissan system includes detection of the presence or absence of obstacles.

The Nissan patent further characterizes the operation of the automotive vehicle control system as including the use of ultrasonic and laser radar type sensors. These are shown in Figure 1 as part of sensor section 200 and include the ultrasonic sensors 201, 203, 205 and 207. The sensor section 200 also includes the laser radar 209 and the forward ultrasonic sensor 210. The ultrasonic sensors are used as input to the fail-safe local vehicle position detection section 215, and, subsequently, to the control section of the automotive vehicle. The laser radars and forward ultrasonic sensors are used as input to the fail-safe obstacle avoidance control 217 and likewise used to derive vehicle control signals.

The operation of these sensors is described as follows (C4/L4-13):

"In the instant system the sensor section 200 includes ultrasonic and laser radar type sensors. *These sensors are arranged to sense the presence of other vehicles, guard rails on the side of the road and the like obstacles.* In this instance these sensors are arranged so as to provide sufficient data as to enable the vehicle to proceed even in the absence of the data inputted via the image processing section and thus defines a back-up or failsafe arrangement which can compensate for the malfunction of the image processing section." (emphasis added)

The patent describes the ultrasonic sensors being arranged to sense conditions prevailing ahead of, behind, and on either side of the vehicle. (C4/L14-17)

The camera based video scanning methods, ultrasonic sensor methods, and laser radar sensing methods used in the Nissan patent would be entirely adequate to implement the motor vehicle warning and control system and method disclosed in the pending application. The Nissan patent uses signals derived from these various imaging sensors to control the throttle, braking, and steering of the vehicle both to

follow the road and to avoid obstacles in the path of the automobile. While the method and system used in the Nissan patent to generate the vehicle control signals is very different than the approach disclosed by the pending application, the video, ultrasonic, and laser scanning methods used can be the same.

32. **Robert H. Dye, U.S. Patent 4,872,051, "Collision Avoidance Alarm System," filed October 1, 1987, issued October 3, 1989, assigned to Environmental Research Institute of Michigan (Attachment B).**

The Dye patent is characterized (in its abstract) as follows:

"The following invention is passive collision avoidance alarm system. An optical sensor (which may optionally be visible, infrared or ultraviolet) is disposed to provide a continuous raster scan of the scene within a wide angle of the direction of travel of the vehicle. This sensor output is converted into digital data and stored. A computer system compares consecutive scenes to detect identifiable objects. For such identifiable objects the computer calculates the centroid of the object and its angle, and a measure of the size or extent of the object. Detection of an object having a constant angle and increasing measure of extent causes an alarm to be triggered."

The operation of the Dye system is shown in more detail in Figure 1, which illustrates the use of a TV camera 12, coupled to A/D converter 14, to memory unit 16, and to logic processing unit 18. An alternative embodiment is shown in Figure 3 using an infrared scanning system 42.

Dye explains that, while his system is described for watercraft application, it can be used for a collision avoidance alarm system for motor vehicles and, if three-dimensional space is considered, for aircraft (C2/L9-15). Dye further states that "such systems are further capable of triggering evasive action through an autopilot."

Dye characterizes his invention at (C2/L39-64) as follows:

"A collision avoidance alarm system in accordance with the present invention includes, in a preferred embodiment, a television system for viewing a scene and for providing a plurality of electrical signals corresponding to, and representing the spatial distribution of radiation, such as visible light emanating from the scene. The optical system associated with the television system has a sufficiently wide field of view, centered on the direction of travel of a platform or vehicle bearing the alarm system, so as to include all objects reasonably visible that may be on a collision course with the platform. The television system, through its raster scanning techniques, provides, as part of the electronic signals generated, angular correlation information with respect to the line of travel of the platform. The electrical signals may then be processed by a

neighborhood processing system that performs a correlation analysis between sequential views of the scene such that an object in the scene may be recognized from view to view despite changes in apparent size. When a correlation is found to be identifiable as an object maintaining a substantially constant bearing with respect to the direction of travel of the platform or vehicle carrying the alarm system, a concurrent apparent growth in the object can be used to generate a signal to an alarm circuit, thereby calling the attention of the user to a potential collision hazard."

The operation of the Dye logic processing unit 18 is further described beginning at C3/L48. The logic processing unit 18 compares successive frames of video information to determine either a "change" or "no change" and an indication of the directional change to greater or lesser magnitude. The logic processing unit 18 further provides grouping of digital values of similar magnitude to establish a geometric configuration of the image for which a spacial centroid may be computed. Using such computed image information, the Dye collision avoidance alarm system generates alarms when the object and the image scene is on an apparent collision course with the vehicle containing the collision avoidance alarm system.

The video and infrared scanning system and method of the Dye patent would be sufficient to implement a useful form of the motor vehicle warning and control system and method for collision avoidance of the pending application. While more sophisticated image processing techniques and methods are available, the Dye patent, already issued by the U.S. Patent Office, illustrates that the state of the art, even as early as October 1987, provided useful video scanning methods for implementing collision avoidance.

33. **Yasuya Kajiwara, U.S. Patent 5,177,462, "Car Interval Control Apparatus," filed March 13, 1991, issued January 5, 1993, assigned to Mitsubishi Denki K.K. (Attachment C).**

This Mitsubishi patent makes use of an optical ranging and image sensing system to measure the distance to an object in front of a car. The apparatus is described in the patent abstract as follows:

"A car control apparatus composed of a tracking type range finder having a pair of optical systems arranged in a parallel relation and an image sensor disposed in connection with each of said optical systems wherein a window is formed for a picture image of an object that is to be tracked and sensed by each of the image sensors. The distance to the object is measured in accordance with a triangular method, on the basis of a shift position of the picture image of the object displayed in the window.

A observing means which emits light and observes forcible entry of an intervening car into a lane in front and close to the driver's car by detecting light reflected by the intervening car. A control device controls the distance between the driver's car and the preceding car by using a signal produced from the tracking type range finder and generates an alarm when the forcibly entered car is detected by the observing means during the operation of the controlling of the distance of the cars."

The apparatus as disclosed in this Mitsubishi patent is illustrated in Figure 1 and includes a tracking type range finder type 21 used with control unit 4 to generate control signals for braking and throttle actuation as well as for generating alarms. The triangular imaging method of determining distance is shown in Figure 2. Figures 3 and 4 further illustrate the operation of the Mitsubishi apparatus.

Figure 5 illustrates a prior art system corresponding to a Japanese examined patent publication 3352/1985. (C1/L51-54) This 1985 system utilizes video scanning to measure the interval between cars by comparing picture images in specified image windows at successive time intervals. The Mitsubishi patent uses video scanning with triangulation to make such measurements. (C2/L26-48).

The Mitsubishi system captures images in windows, which are restored as digital values and are renewed in very short time intervals (e.g., every 1/32 second) (C3/L32). The window is designated by the driver, and triangulation is used to calculate the range to the automobile in the picture image. As explained in column 4, a light source emitting, for example, an infrared ray is used to detect the presence of an intervening vehicle in the path of the controlled automobile.

The video scanning and range detection apparatus and method disclosed in this Mitsubishi patent would be adequate to implement the motor vehicle warning and control system and method disclosed in the pending application. In this respect, it is important to understand that the video scanning methods disclosed in the pending application operate in a very structured environment looking primarily directly ahead and to the side of the control vehicle for other vehicle objects of known shape and size. Combining the video scanning and ranging methods disclosed by Kajiwara would permit automatic determination of the parameters required in the control method and apparatus of the pending application.

34. Dieter Zetsche, "The Automobile: Clean and Customized," *Scientific American*, pp. 102-06, September 1995 (Attachment D).

Although this article is not itself prior art, it describes (at pages 103 and 104) a German program called VITA, which was a collaboration among Daimler-Benz and

several German universities, beginning in 1985. In 1986, a vision-based lateral and longitudinal controlled public bus was developed. In 1991, the VITA I was introduced, which had two bifocal CCD cameras.

At some time later, the VITA II program was begun. That follow-on was characterized in the *Scientific American* article as follows:

"A Mercedes-Benz sedan was outfitted with 18 video cameras, which focused on the vehicle's surroundings. The car's position in its lane, traffic signs, obstacles and other traffic were all sensed and decoded, and a computer processed the information to drive the car in this realistic highway environment. During VITA II and its predecessor, VITA I, a total of about 5,000 kilometers were logged in test runs, mostly on German highways, at speeds of up to about 150 kilometers per hour. Developers are now considering ways of making the technology commercially viable."

The VITA II project is described in more detail in an article by Berthold Ulmer of Mercedes-Benz in a paper entitled "Autonomous Automated Driving In Real Traffic," presented in a conference entitled "Towards An Intelligent Transport System" on November 30 to December 3, 1994, in Paris, France. (Attachment E) According to this paper, "the environment detection is performed by two bifocal CCD cameras for the viewing direction in front of the vehicle. ... This test vehicle is capable of avoiding collisions even in those situations where the human driver's reaction would be too slow to react to warnings." The paper states that the video cameras are integrated in the vehicle to acquire environmental information around the vehicle. This paper includes a discussion of the vehicle computer and the perception modules of the VITA II system. The paper states, "this demonstrator vehicle senses the environment, interprets the situation, and derives appropriate maneuvers in order to avoid collisions."

Programs such as VITA clearly demonstrate the possibility of using video scanning and high-speed computer processing to guide automobiles and sense obstacles and other traffic as required in the pending application. The same methods used in German VITA program could clearly be used to provide the necessary image control signals for the inventive warning and collision avoidance system and methods.

Whether or not VITA II qualifies as prior art to this application, the earlier portion of the program demonstrates that real-time video analysis was quite possible.

35. **W. Taylor, U.S. Patent 5,249,157, "Collision Avoidance System," filed August 22, 1980, issued September 28, 1993, assigned to Kollmorgen Corporation (Attachment F).**

Although this patent was not available through issuance to the ordinarily skilled artisan on the filing date of the subject application, the basic techniques described in this patent were known to the ordinarily skilled artisan in August 1993, two months before issuance of the Taylor patent.

Taylor's patent makes use of an electro-optical range finder, which operates at a high scan rate with a wide field of view to identify potential collision targets and provide range and angle data as to each such target or obstacle. The range and angle information is processed by a computer to track potential collision targets and to determine and monitor the velocity and acceleration of such other vehicles. The invention is described (in the abstract) as follows:

"A collision avoidance system particularly suited for automotive applications includes an electro-optical rangefinder scanner, retroreflectors on target vehicles, and a processing unit. The rangefinder supplies data on the range and angle of target vehicles to the processor, which monitors each target vehicle's position, speed and acceleration and constantly determines and updates target range, angle, velocity, acceleration and predicted separation distances. A warning signal or evasive maneuver instructions are issued if the predicted separation at the time of intercept is below a minimum acceptable value."

The electro-optical rangefinder disclosed in the Taylor patent would be adequate and sufficient to implement the scanning required in the pending application.

36. W. Kelley, U.S. Patent 4,926,171, "Collision Prediction and Avoidance Device for Moving Vehicles," filed November 21, 1988, issued May 15, 1990 (Attachment G).

This patent describes the collision predicting and avoidance device for moving vehicles such as automobiles. The vehicle has a beam transmitting means for projecting a beam or multiple beams at individually scanned, limited sector areas around the vehicle. The patent states that the transmitter beams are the type capable of returning a detectable echo from a object. Beams of such type include centimeter microwaves, infrared beams, and beams of laser light. The invention provides an apparatus connected to the vehicle that repeatedly determines the distance and direction of an object relative to the vehicle and computes the probable point in time of impact. This system can generate braking, steering, and acceleration control signals based on the computer analysis of the ranging signals. An annunciator can speak a message or a message may be displayed to the vehicle operator to warn the operator of impending collisions.

The invention is characterized (in the abstract) as follows:

"Apparatus for avoiding collision between a vehicle and an object that moves in a trajectory relative to the vehicle. The apparatus includes at least one microwave pulsed transmitter and receiver for transmitting a scanning beam of pulsed energy which scans sector of space, at least forward of the vehicle, a check for producing timing pulses, a ranging device connected to the clock and the receiver for measuring the time difference between the transmitted pulses and any echoes received by the receiver. The antenna is pivotally coupled to the vehicle and a scanning motor serves to set the antenna in a scanning motion. A direction device is coupled to the scanning antenna for sensing the direction of the antenna. A computer is connected to ranging device, the clock, the direction device and computes continuously the last three coordinates for vector to the object, and is connected to an annunciator which can speak and/or display a message to the vehicle operator."

Kelley demonstrates that real-time, beam-based distance and direction measurements would have been known to the skilled artisan at the time.

37. G. Qualizza, U.S. Patent 5,235,316, "Vehicle Collision Avoidance System," filed December 20, 1991, issued August 10, 1993 (Attachment H).

This patent discloses a vehicle collision avoidance system based on the use of ultrasonic transmitting and receiving, which scans predetermine areas about the vehicle to detect the presence of an object and calculate its distance from the vehicle. The operation of the system is disclosed (in the abstract) as follows:

"The collision avoidance system includes structure mountable at the side mirror position of a vehicle. The system includes a rotatable mirror and an ultrasonic transmitting and receiving unit which is adaptable to scan a predetermined area about the vehicle to detect the presence of an object and to calculate its distance from the vehicle. If the distance and speed are determined to pose a threat, the distance and speed are placed on a display and an alarm is sounded. Two displays are provided, one for the forward end of the vehicle and another for the rear end of the vehicle. The system operates when the vehicle is moving forwardly and rearwardly. Also, when the vehicle is not moving, the presence of a potential intruder is also monitored and the system can actuate an anti-theft alarm of the vehicle. Further, the system can be programmed by a plurality of operators to particular distances, with the system discerning which operator is driving and automatically using the operator's input."

Thus, Qualizza confirms that real-time analysis of scanning could be performed.

38. K. I. Kim, et al., "An Autonomous Land Vehicle: Design Concept and Preliminary Results," POSTECH, Pohang, Republic of Korea, 1993 IEEE Intelligent Vehicle Symposium, July 1993, pp. 146-51 (Attachment I).

This reference discusses an autonomous land vehicle called the PRV I (Postech Road Vehicle I) developed in Korea. The system used a single camera to generate a 2-D road model. The vision module determined the velocity and the direction to guide the vehicle. The system used a preprocessor to extract a minimal set of image information for input to a neural network. Output data from a CCD camera was preprocessed for input to a neural network for the generation of control commands. A standard back-propagation, multi-layer, perceptron neural network was used with a single hidden layer. Training was done using real world data gathered while driving the vehicle. The article states:

"The validity and efficiency of using both computer vision and neural network based algorithms for an autonomous steering control of road vehicles has been demonstrated in a real experiment. Several neural nets cooperate to generate steering commands that carry out a planned driving path both indoors and outdoors. ... It is also emphasized here that the whole system consists of very inexpensive standard hardware/software components using only a IBM compatible PC486 as host and a 80C196 as the motor controller. It is concluded that neural nets possess an enormous potential for fast and accurate autonomous driving with great economy in development time and cost."

This paper, published one month before applicants' filing date, strongly demonstrates the feasibility of applicants proposed video scanning and image analysis system. The Korean PRV I worked—so would applicants' vision-processing design.

The PRV I does not use fuzzy logic and does not generate coordinated steering and speed warning and control signals to avoid or minimize the effects of collisions as taught and claimed by applicants. It does, however, demonstrate that those skilled in the art at the time of the application would have known to use the vision processing structures and methods discussed by applicants to implement applicants' system. These same techniques could have been applied to the object detection requirements of applicants' system, and the use of multiple cameras would permit dealing with hazards and obstacles to the front, rear, and sides of the vehicle.

39. Keiji Saneyoshi, U.S. Patent 5,307,136, "Distance Detection System For Vehicles," filed October 14, 1992, issued April 26, 1994, assigned to Fuji Jukogyo K.K. (Attachment J).



Like the Mitsubishi patent referenced above, this Fuji patent makes use of video cameras to determine the distance between automobiles for the purpose of generating warning signals and collision avoidance control. Although the U.S. version of the Fuji patent had not issued before the filing date of this application (and applicants assume but are not sure that there was a published version of the Japanese application), the reference provides further confirmation of the level of skill in the art in the approximate time frame of interest here.

The patent is characterized (in the abstract) as follows:

“An automobile distance detection system includes an image camera system which photographs an object which exists in a required range external to an automobile, from a plurality of different directions and obtains a plurality of pictures, and a picture processing unit which processes the plural number of pictures photographed by the camera system and outputs a distance distribution for an entire picture. The image processing unit includes a coincidence calculation element which performs high-speed calculation of a degree of coincidence for each required region, and corresponding to the plural number of pictures photographed by the camera system, and a discrepancy amount determination element determines discrepancy amounts corresponding to the plural number of pictures on the basis of a minimum value for the coincidence, as information relating to the distance distribution.”

The system permits recognizing an obstacle on a road, warns the driver, and performs automatic collision avoidance (C5/L45-50). Fuji employs stereoscopic optical systems and stereoscopic picture processing to calculate three-dimensional distance data. The apparatus recognizes obstacles on the road and inputs three-dimensional distance data, which are calculated by the picture processing apparatus. The system makes use of solid state imaging elements such as CCD (charged coupled devices) television cameras. Two pairs of CCD cameras are used to measure distances between two meters and 100 meters.

The methods and apparatus disclosed in the Fuji patent would be adequate and sufficient to implement the required video scanning for the motor vehicle warning and control system and methods disclosed in the pending application.

40. **Ichiro Masaki (Editor), “Vision-Based Vehicle Guidance,” Chapters 1, 4, and 5 (Springer-Verlag, 1992) (Attachment K).**

The preface of this book explains:

“This book is based on the IEEE round-table discussion held on July 2, 1990. The round-table discussion on vision-based vehicle guidance was

held as an activity of the Intelligent Vehicle Subcommittee in the IEEE Industrial Electronics Society."

The book consists of multiple chapters written by different authors on a number of projects related to vehicle guidance.

Chapter 4, by Hiroshi Kamada and Masumi Yoshida, is titled, "A Visual Control System Using Image Processing and Fuzzy Theory." The abstract to the chapter states:

"We developed a visual control system for an unmanned vehicle. The system consists of a dynamic image processor and a fuzzy logic control mechanism. It quickly recognizes markers lined along a road and thereby navigates a driverless vehicle. The markers are detected in real time by pipeline processing in the color identification processor and logical filter; the marker sequence is recognized by an improved Hough transform, then the fuzzy logic control mechanism decides the steering angle. To use the information on the movement of the vehicle, we constructed fuzzy inference rules on how position changes with time. We developed an LSI (large-scale integrated circuit) chip for the logical filter to realize a very compact and practical system (23 x 30 x 9.5 cm). We mounted this system on a vehicle, and it successfully drove around a test track."

41. In this chapter, Kamada and Yoshida describe a fuzzy logic control system that they successfully used to steer the vehicle. While the Kamada and Yoshida system is not a collision warning or avoidance system and does not involve coordinated steering and speed control like applicants' disclosed system and method, it does further validate the feasibility and practicality of using video scanning and fuzzy logic automated vehicle control. If it worked for these authors, it will work for the applicants' system.

42. Once programmed, very little processing power is needed to implement the inference engine of a fuzzy logic control system, and so control responses can be computed with little delay. This is borne out by Kamada and Yoshida, who make no mention of processing delays or other processing difficulties in the fuzzy logic control system.

43. Systems that process images to derive measurements for control will, in general, experience the greatest processing burden in deriving measurements (called "extracting features") from the images, not in generating control signals from the measurements. This is because the "raw" image data contains very many pixels, but the information of interest that is contained in the images, i.e., the feature descriptions, can be expressed with a relatively small amount of data. Processing starts with the images and extracts information, describing it in a much smaller number of data bits. The

"feature extraction" process may be multi-level, with lower-level features being extracted first, and from those, higher-level features are extracted, further reducing the amount of data. Thus subsequent processing and control functions need operate on only a relatively small amount of data.

44. Another way to consider the problem is to note that any mechanical devices that are controlled will in general have response times that are slow compared to the electronic data rates produced by imaging or other high-rate sensors, and so only a relatively low data rate is needed to maintain control of a mechanical device. Regarding the Kamada and Yoshida system, the authors state that the average processing time from image input to steering control was only 100 milliseconds, which confirms that the control function is not calculation intensive.

45. If the principal processing burden is up-front at the imaging (or other) sensor, then how did Kamada and Yoshida achieve their successful design with practical processors? The answer is that they took advantage of the structure of the problem, just as engineers generally do. The key is that vehicle control systems are not general purpose image (or other sensor) processing machines. Rather, they have a specific job to do, and require only specific kinds of inputs. This enables the system designer to simplify the algorithms, dramatically reducing processing requirements, while achieving the needed measurement speed, accuracy and reliability. This article is one from which the ordinarily skilled artisan in 1993 would have understood this point.

46. Kamada and Yoshida recognized that the sequence of road markers their system was to detect and follow could be detected using the Hough transform. Further, they found a satisfactory simplification of the Hough transform that performed adequately for the task while requiring much less computation than the textbook-general Hough transform. They then implemented their modified Hough transform algorithm in a specially designed integrated circuit as a preprocessor, and not in the central general purpose microprocessor. This is, and was, standard practice; that is, to design special purpose preprocessors or coprocessors to implement specially designed algorithms to handle the high speed data from sensors. The outputs of these preprocessors are then at a lower data rate and can be handled by slower, more general purpose processors.

47. This distribution of processing and the use of special purpose, or "application specific," processing devices is often the approach of choice, as opposed to simply adding more processing speed and power, although sometimes that is done too.

In the pending patent application, applicants amply disclosed the use of distributed and special processing such as this, as well as the use of coprocessors and parallel processing. For example, applicants' Figure 1 specifically discloses multiple dedicated computing devices, including one computing device associated directly with each of the sensors.

48. The Masaki book, in its other chapters, follows similar lines of thought, in a variety of contexts. The authors of Chapter 1, when designing a vision system they call BVV3 (as an improvement of the earlier BVV2) said:

"After having worked with the BVV2 for some time, it became clear that certain types of algorithms were particularly useful for feature extraction in dynamic scenes...and that the parallel processor spent a significant amount of time executing a fairly limited variety of operations....

"A standard microprocessor appeared to be well suited for the analysis and decision part, but it seemed likely that special hardware, similar to a signal processor, would be much more effective for the schematic part. It was, therefore, decided to develop the special hardware and implement it as a coprocessor, to be tightly coupled to an associated standard microprocessor.

"If such a coprocessor is used in combination with a microcomputer, a very powerful device for feature extraction results."

49. Similarly, in Chapter 5, the authors employ "local processing" to decrease the amount of computation required in the extraction of 3-D information from sequences of images. These are the ways engineers skilled in the art in 1993 would have designed practical real-time control systems that employ imaging or other high data rate sensors. The complexity of the task of automated vehicle guidance must not be underestimated, and normal experimentation would have been needed. But known systems were available to implement applicants' disclosed system.

**Why Implementing Applicants' System Is Not as Complex as It Might First Seem**

50. Applicants address the realistic goal of *assisting* the driver, not *replacing* him or her. Their disclosed system detects road hazards and obstacles and warns the driver. Of course, all of the driver's normal faculties remain in place to independently detect and act upon his or her assessment of the hazard to avoid a collision or minimize its effects. Consequently, unlike fully autonomous vehicle control systems, the driver achieves the combined benefits of his or her own control capabilities and those of the automated control system. Further, the automated system can act to control the vehicle if the driver does not respond to a detected threat. In this case, the vehicle is under no

control at all by the driver, so replacement of no control by a possibly imperfect automated control is still to the good. And even then, the driver can override the automated control if he or she regains his or her ability to do so. Thus perfect automated control is not necessary for the applicants' disclosed system to be useful in practice.

51. In my experience with automated targeting and guidance for missile systems, which not only have to distinguish a variety of targets and scenes from a highly variable background clutter but also from intentional deception, it was known that reliability was greatly increased by employing multiple sensor systems in combination. This is called "sensor fusion." Though any one sensor when taken alone may yield less than precise performance under certain conditions, the proper combination of results from multiple sensors will achieve performance requirements. Applicants have recognized this principle, and the pending application includes multiple sensory inputs and multiple feature measurements. Referring to Figure 1, applicants have incorporated, optionally as needed, TV cameras, radar, lidar, accelerometers, laser scanners, and other sensors, and provided for reception of external data inputs and cooperative communications and processing. These disclosed sensors will suffice to provide the information necessary to detect hazards and obstacles and compute warning and control signals for vehicle collision avoidance in a reliable way.

52. Applicants' system detects and identifies objects and extracts relative locations, distances, velocities, and accelerations. Applicants disclose the use of neural networks, video processors, coprocessors, and SIMD and MIMD parallel processing to perform the image processing for feature extraction. These tools would be the ones that would be useful to perform the desired functions.

53. As stated in the section of this Declaration above discussing the references, processing of the images and other sensor outputs to extract these measurements and features is computationally intensive but not as daunting as it might seem at first. As also explained above, processing algorithms such as those employed for target and obstacle detection, separation from clutter, identification, tracking, and measurements are normally developed by one skilled in the art to take advantage of the structure of the particular problem, to simplify it, and to minimize computational requirements. Then, each algorithm is examined for structure and computational requirements, and, if indicated, a special preprocessor or coprocessor is used or designed for efficient execution. As shown in Masaki's book on automated vehicle guidance, this approach is well known and allows the design of practical systems aimed at the task, without need

for massive computational power, as might be needed for a general-purpose image processing system without special-purpose processing devices.

54. Another observation of relevance to applicants' system is that target acquisition, identification and tracking can begin while the target or obstacle is still at a safe distance. Initial target acquisition requires more computation, with attendant computational delays, than does continued target tracking once it is acquired and identified. Response time becomes critical only when the minimum time for an evasive response nears, but by then the system has detected, identified and has been tracking the target for some time. Relatively little additional computation is needed to detect when the target becomes a hazard and warning or control signals must be generated.

55. In the section of this Declaration concerning my background, I discussed my participation in the successful design and quantity deployment of an aircraft collision avoidance system at an aerospace company where I worked. This system was used during flight testing of new supersonic fighter aircraft produced in volume, several of which would share the same airspace at the same time. These planes can approach one another unseen at over twice the speed of sound and thus demand a timely response from the collision avoidance system. We successfully used a "time to collision" criterion in warning the pilot, similar to that suggested by applicants. No aircraft carrying these systems ever collided.

56. Applicants disclosed use of stored information for comparison with sensed data is a valid and practical approach for incorporating a priori information that has been used successfully in machine vision as well as missile guidance systems. Algorithms for correlating stored and sensed image features are well developed and can be computed with reasonable processing power using devices available in 1993.

57. In addition, the system disclosed by applicants can have useful implementation in more structured or more controlled environments. For example, the system can be used to control motor vehicles such as an earthmover, roadgrader, or other specialized vehicle used in certain industries. These vehicles may travel much more slowly and in a more controlled environment than vehicles on open roadways. For those applications, applicants' system can be implemented in a less complex fashion, less processing may be required to achieve desired results, and that processing may be carried out at a lower speed than for the general, open road application. Thus, applicants' invention can be enabled by an embodiment that is within the scope of the

claims, even without high processing speeds that might be required for more complex embodiments.

58. Also, a system need not perform error-free to be useful. It need only achieve an improvement, not perfection. And it isn't intended to do the job alone. Its stated purpose is to assist the driver of a motor vehicle (for example a car, truck, boat, plane, or train) in preventing accidents or minimizing their effects. In my opinion, applicants' approach is sound and well thought out. All of the individual processing methodologies applicants disclose were in the state of the art as practiced at the time of their disclosure and would not unduly stress the capabilities of the technology available at that time. The most demanding aspect of the processing, I believe, is the multiple target tracking; but the cited paper by Denny Rock, et al. states that Martin Marietta had by that time developed a real time correlation algorithm that successfully tracks high target densities, and which is amenable to high-speed parallel processing. Applicants disclosed parallel processing.

#### Conclusion

59. In sum, the information presented in applicants' disclosure is sufficiently detailed and complete to enable one ordinarily skilled in the art at that time to successfully complete a design of the disclosed system. Based on my experience and knowledge of the level of skill of ordinarily skilled artisans in August 1993, I have concluded that the specification as a whole is amply enabled, particularly in respect to the question posed by the Examiner. I do not believe that a suitably trained engineer would need more than ordinary design time to create a working production device in accordance with the disclosure of the specification, and I believe that moving from the specification to a fully realized design would be a matter of design rather than requiring any inventive steps.

60. I hereby declare that all statements made herein of my own knowledge are true and that all statements made on information and belief are believed to be true; and further that these statements were made with the knowledge that willful false statements and the like so made are punishable by fine or imprisonment or both under Section 1001 of Title 18 of the United States Code and that such willful false statements may jeopardize the validity of the application or any patent issued thereon.

Signed this 23<sup>rd</sup> day of February, 1996, at Hazelwood, Missouri



Dr. John R. Grindon

Serial No. 08/105,304

Page 24

M.M.

SEP 23 11:16  
1996

Certification

I hereby certify that this paper, together with attachments A-K, is being hand-delivered this 26th day of February, 1996, to the U.S. Patent and Trademark Office.

By:   
Name: Myron Tereshchuk

RECEIPT IS ACKNOWLEDGED OF a document entitled "Declaration of Dr. John R. Grindon," together with attachments A-K:



#16

IN THE UNITED STATES PATENT AND TRADEMARK OFFICE

Applicant : Jerome H. Lemelson Art Unit : 2615  
 Robert D. Pedersen

Serial No. : 08/105,304 Examiner : Au

Filed : 8/11/93

Title : Motor Vehicle Warning and Control System and Method

Assistant Commissioner for Patents  
Washington, D.C. 20231

RECEIVED

APR - 3 1996

NOTICE OF APPEAL

OFFICE OF PATENT AND TRADEMARK APPEALS

Dear Sir:

Pursuant to Rule 191, applicants appeal from the Final Office Action dated September 6, 1995, rejecting all claims. Applicants calculate that the following fees are due:

Fee for Notice of Appeal	\$290.00
Fee for Three-Month Extension	900.00
<u>Credit for Two-Month Extension Paid Before</u>	<u>(380.00)</u>
<b>Total:</b>	<b>\$810.00</b>

A check for that amount is enclosed.

Respectfully submitted,

JEROME H. LEMELSON  
ROBERT D. PEDERSEN  
by their attorney

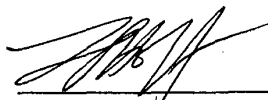

Louis J. Hoffman  
Reg. No. 38,918

Dated: March 11, 1996

LOUIS J. HOFFMAN, P.C.  
 15150 North Hayden Road, Suite 202  
 Scottsdale, Arizona 85260  
 (602) 948-3295  
 1 117

290.00 CK  
 520.00 CK

Certification

I hereby certify that this paper, together with the enclosed check for \$810.00, is being hand-delivered this ~~12th day of March, 1996~~, to the U.S. Patent and Trademark Office.

*3rd day of April*

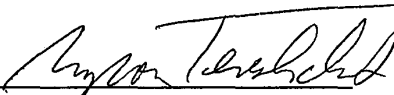
By:   
Name: Eric White

RECEIPT IS ACKNOWLEDGED OF a document entitled Notice of Appeal, together with the enclosed check for \$810.00:

ID	MCH	TPE	NAME OR ACCOUNT	C-NBR	MLEDTE	CURDTE	F-C	\$ AMOUNT
C	140	1	08105304	00078	930811	930902	101	1,520.00
C	080	1	08105304	00009	941110	941125	115	110.00
C	280	1	08105304	00072	950626	950627	116	370.00
C	060	1	08105304	00502	950626	950627	126	210.00
C	240	1	08105304	00036	960131	960201	116	380.00
C	240	1	08105304	00014	960329	960408	140	110.00
C	240	1	08105304	00015	960329	960408	117	810.00
C	070	1	08105304	00348	960506	960513	122	130.00

0 MORE TRANSACTIONS

PATENTPAGE  
2101 CRYSTAL PLAZA ARCADE  
SUITE 133  
ARLINGTON, VIRGINIA 22202

*file*  
140-110,00  
117-810,00  
#17

Pager: (703) 719-1001

Facsimile: (703) 415-0403  
Phone: (703) 213-9861

April 3, 1996

*2/6/96  
2-29-96*

Serial No. : 08/105,304

Title : Motor Vehicle Warning and Control System and Method

Honorable Commissioner of Patents  
and Trademarks  
Office of Petitions  
Washington, D.C. 20231

RECEIVED  
APR - 3 1996  
OFFICE OF PETITIONS  
AND TRADEMARKS

This letter is to explain that Applicant's Attorney, Louis Hoffman, sent to this office via overnight delivery, the accompanying documents for hand delivery to the Office of Petitions, which were received at my office on the 12th day of March, 1996. At that time, I was traveling in Ukraine to get married. Before leaving the United States, I made arrangements for a substitute to hand deliver all packages to the Patent Office and I so informed Mr. Hoffman. Upon my return, I discovered that the substitute had not delivered Mr. Hoffman's package. I apologize for the delay. If there are any questions, please feel free to call me.

Respectfully submitted,



Myron Tereshchuk

dba/PatentPage

*140-110-00  
117-810-00*

*140-110-00  
117-810-00*

IN THE UNITED STATES PATENT AND TRADEMARK OFFICE

Applicant : Jerome H. Lemelson Art Unit : 2615  
Robert D. Pedersen  
Serial No. : 08/105,304 Examiner : Au  
Filed : 8/11/93  
Title : Motor Vehicle Warning and Control System and Method

---

Honorable Commissioner of Patents  
and Trademarks  
Washington, D.C. 20231  
Via hand-delivery to:  
Office of Petitions

**RECEIVED**  
APR - 3 1996  
OFFICE OF PETITIONS  
A/C PATENTS

**PETITION TO REVIVE APPLICATION (UNAVOIDABLE)**

Dear Sir:

Pursuant to Rule 137, applicants hereby petition to revive this application, which as a matter of law went abandoned last Wednesday, March 6, 1996, by virtue of applicants' failure to timely lodge an appeal from the Final Office Action dated September 6, 1995. The delay of three business days between March 6 and today was based on an unavoidable error by counsel, the nature of which is described in the detailed affidavit of undersigned counsel, enclosed. Also enclosed is a check for the petition fee of \$110.00 under Rule 17(l). Also enclosed are the papers that applicants intended to file last Wednesday, namely a Notice of Appeal and a check for \$810.00, based on the fee calculation therein.

As reflected in the enclosed declaration, applicants' attorney took reasonable steps to docket the time deadline, but because of a combination of circumstances including a change of docketing paralegal and an unusually extensive travel schedule principally required for a litigation matter, the deadline was missed. The omission was discovered promptly, namely at the end of the second day past the deadline, and this petition is being drafted on the following business day. This is the only deadline that the attorney has missed in a four-year period.

Rule 137 exists for precisely this sort of circumstance, an unusual case where circumstances beyond the control of an attorney have caused a human error that results in a small delay, despite the existence of reasonable precautions. The delay here is truly minor, and granting this petition would not prejudice or harm the public or the Office in any way.

Applicants respectfully request that the Office grant this Petition to Revive promptly. It would also be appreciated if the decision granting petition would advise as to the date that the Notice of Appeal is considered entered, so that applicants can timely submit an appeal brief.

Respectfully submitted,

JEROME H. LEMELSON  
ROBERT D. PEDERSEN  
by their attorney



---

Louis J. Hoffman  
Reg. No. 38,918

Dated: March 11, 1996

LOUIS J. HOFFMAN, P.C.  
15150 North Hayden Road  
Suite 202  
Scottsdale, Arizona 85260  
(602) 948-3295

Certification

I hereby certify that this paper, together with the enclosed check for \$110.00, is being hand-delivered this ~~12th day of March, 1996,~~ to the U.S. Patent and Trademark Office.

*3rd day of April*

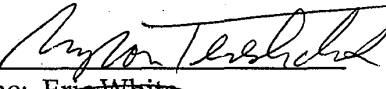
By:   
Name: ~~Eric White~~

RECEIPT IS ACKNOWLEDGED OF a document entitled "Petition to Revivie Application (Unavoidable)," together with the enclosed check for \$110.00:

IN THE UNITED STATES PATENT AND TRADEMARK OFFICE

Applicant : Jerome H. Lemelson Art Unit : 2615  
Robert D. Pedersen  
Serial No. : 08/105,304 Examiner : Au  
Filed : 8/11/93  
Title : Motor Vehicle Warning and Control System and Method

---

Honorable Commissioner of Patents  
and Trademarks  
Washington, D.C. 20231  
Via hand-delivery to:  
Office of Petitions

RECEIVED

APR - 3 1996

DECLARATION OF LOUIS J. HOFFMAN

OFFICE OF PETITIONS  
A/C PATENTS

Dear Sir:

Louis J. Hoffman declares that the following is true and correct of his own personal knowledge:

1. I am an attorney of record in the above-captioned patent application. I make this declaration in support of applicants' petition to revive this application pursuant to Rule 137.

2. In response to the Final Office Action dated September 6, 1995, we filed a Response to Final Office Action on January 30, 1996. Then, one of the inventors, Mr. Pedersen, and I visited Washington and participated in a lengthy and productive interview session with Examiner Amelia Au on February 8, 1996. At the interview session, it was agreed that the Examiner would reconsider the various Section 103 rejections based on the existing claim language, and that applicant would prepare a Declaration under Rule 132 explaining the enablement issues more fully and confirming what was described to the Examiner by the co-inventor at the interview on that subject. It was also agreed that applicant would file a continuation application with claims more clearly directed to the subject matter that the Examiner considered likely novel.

3. Following the interview, Mr. Pedersen and I worked with an expert engineer, Dr. John Grindon, and obtained and filed the planned declaration on



February 26, 1996. Meanwhile, the Examiner mailed an Advisory Action concerning the Section 103 rejections to the other co-inventor, in Nevada. (That Action was mailed to an incorrect address, because the Office had been requested to send correspondence to me.) I received the Advisory Action shortly after filing the Grindon Declaration.

4. Following the filing of the Grindon Declaration, we expected to receive another Advisory Action from the Examiner indicating that the enablement rejections were withdrawn. We wished to give the Examiner as long a time as possible to issue that notice, so we planned to file a Notice of Appeal on the last day possible, that is March 6, 1996, six months after the date of the Final Office Action.

5. My paralegal maintains a computerized docket report under my instructions. The computer program advises of the next "month" date, from the second through the sixth month after an Office Action, and it automatically updates the deadline to the next month, unless the agenda item is marked "done." In this case, the Final Office Action was properly docketed, and applicants' Response to Final was recorded but was not considered to stop the time for response, as is also proper.

6. In mid January 1996, my paralegal left to take a new job. Before then, she had worked for nearly three years in this job, and she was quite skilled in maintaining my docket. Just before she left, on January 16, 1996, she printed out a docket report. That report showed the "five-month response date" for this case as February 6, 1996.

7. I had some difficulty finding and hiring a suitable replacement paralegal, and the replacement began regular full-time employment on February 20, 1996. However, the replacement has not yet been trained on the docketing program.

8. In the month-long period while I had no paralegal, I maintained my docket by my usual system of jotting notes on the latest docket report printout, but no new printout was obtained from the computer. Thus, upon filing the Response to Office Action on January 30, 1996, I made a notation in the system, but I did not mark the entry "done." A true and correct copy of the page of the docket report containing the entry for this case, with information about all other cases blocked out, is attached.

9. I looked at the annotated docket report repeatedly between January 30 and March 6, 1996, specifically, at least once a week, and typically more often than that. I recall noticing several times that, as the five-month date had passed for this case, the response was due on the six-month date, that is, on March 6, 1996. I did not simply overlook the entry because it was recorded under "2/6/96" rather than "3/6/96." Indeed, the docket report is only four pages long, and I looked at each entry on all four pages on every occasion that I reviewed my docket. On each such occasion, I recalled our plan to file the Notice of Appeal on the final day, unless we heard from the Examiner sooner, and therefore I took no action at those times.

10. I am involved in a litigation that, at the beginning of this year, was placed on an extremely accelerated discovery track. In essence, discovery for the entire case is being condensed into about an eight-week period. In addition, I was forced to return to Washington suddenly for an interview with an Examiner in a pair of reexamination cases. As a result of these two events, I was called out of town repeatedly and with essentially no advance notice on several occasions in the two weeks including the March 6 deadline. In those cases, my flight plans changed considerably, virtually up to the last hours before departure.

11. As it turned out, I was out of town from February 27 through March 1, and again on the evening of March 5 through March 7. March 2 and 3 were the two days of the weekend. The schedule for the February 27-March 1 trip was particularly brutal. I took depositions in Los Angeles on Tuesday and Wednesday, departed L.A. at 6:00 p.m. on Wednesday evening, flew to Dallas and stayed in an airport hotel from midnight to seven in the morning, and then caught an 8:00 plane to Washington. I arrived at about noon on Thursday, and met with the Examiner in the reexamination cases from 2:00 to 5:30 on Thursday. I departed immediately for the airport and flew to Chicago, where I arrived in my hotel about 8:30 p.m. Thus, I was in four cities—one in the West, one in the South, one in the East, and one in the North—within twenty-four hours of elapsed time. On Friday, I met with two experts in the Chicago area and was at the airport to fly back to Phoenix by 6:00 p.m., arriving about 10:00 p.m. Friday night.

12. On Monday, March 4 and Tuesday March 5, I concentrated mostly on unpacking papers and files from the previous trip and planning the next one. I was also forced to spend a great deal of time training my new paralegal on how to handle the end-of-month accounting for the office, which she was handling for the first time. I also needed to prepare for the March 6-7 trip to L.A., to take depositions, and I spent time reviewing newly produced documents for possible use in the depositions during that interlude.

13. Even despite the great deal of tasks that I had to condense into those two days, I recall reviewing my docket list one final time. However, that review was a very quick one, checking only for non-extendable deadlines. I noticed a six-month deadline for March 15, and I recall concluding that March 15 was the next non-extendable deadline. I believe that I skipped over the entry for this case because of my handwritten notation that a response had been filed and my recollection that we were waiting for an action by the Examiner.

14. Obviously, I should have noticed that the March 6, 1996, deadline had arrived and prepared and sent the Notice of Appeal in the two days between my two trips. However, because of the flurry of activity and the limited amount of time that I was in my office, I failed to do so. In addition, my paralegal did not catch my mistake, which would have happened in the ordinary course of events, because of the recent change in personnel.

15. By virtue of the reasonable precautions that were taken, and the unusual combination of circumstances that conspired to cause the error, I believe that this error was unavoidable. This is the only deadline causing unintentional abandonment of a case that I have missed in a four-year period that I have been in charge of maintaining a patent docket. Although I have been a full-fledged patent attorney for only about one year, I acted as an apprentice for three years before becoming admitted, and I was responsible for maintaining a docket, consisting at any one time of about 50 pending patent applications, at all times through that entire four-year period.

16. Late in the afternoon of Friday, March 8, 1996, in response to an inquiry from both co-inventors, I checked my docket report again, and I noticed that I had missed the deadline in this case. I am filing this petition immediately.

I hereby declare that all statements made herein of my own knowledge are true and that all statements made on information and belief are believed to be true; and further that these statements were made with the knowledge that willful false statements and the like so made are punishable by fine or imprisonment or both under Section 1001 of Title 18 of the United States Code and that such willful false statements may jeopardize the validity of the application or any patent issued thereon.

Respectfully submitted,

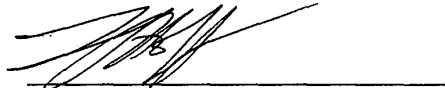

Louis J. Hoffman  
Reg. No. 38,918

Dated: March 11, 1996

LOUIS J. HOFFMAN, P.C.  
15150 North Hayden Road  
Suite 202  
Scottsdale, Arizona 85260  
(602) 948-3295

Certification

I hereby certify that this paper, together with a one-page attachment, is being hand-delivered this ~~12th day of March, 1996~~, to the U.S. Patent and Trademark Office.

*3rd day of April*

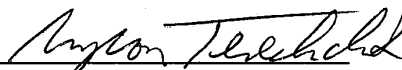
By:   
Name: ~~Eric White~~

RECEIPT IS ACKNOWLEDGED OF a document entitled "Declaration of Louis J. Hoffman," together with a one-page attachment:

1/30/96  
(Month 4)  
LJH

2/5/96  
(Month 4)  
LJH

2/5/96  
(Month 2)  
LJH

2/5/96  
(Month 3)  
LJH

2/6/96 Lemelson 105,304  
(Month 5) VEHICLE COLLISION - Respond to **FINAL** Office Action  
LJH dated 9/6/95. *(Response filed 1/30/96)*

2/9/96  
LJH

2/12/96  
(Month 4)  
LJH



THE UNITED STATES PATENT AND TRADEMARK OFFICE

#1718  
105-304-260

Applicant : Jerome H. Lemelson Art Unit : 2615  
 Robert D. Pedersen

Serial No. : 08/105,304 Examiner : Au

Filed : 8/11/93

Title : Motor Vehicle Warning and Control System and Method

Assistant Commissioner for Patents  
Washington, D.C. 20231

**PETITION FOR CONSIDERATION OF  
SUPPLEMENTAL INFORMATION DISCLOSURE STATEMENT**

Dear Sir:

Applicants respectfully request consideration of the enclosed references cited in the enclosed Supplemental IDS, pursuant to MPEP 609(B)(3).

No item contained in the Supplemental IDS was cited in a communication from a foreign patent office in a counterpart foreign application or, to the knowledge of the undersigned after making reasonable inquiry, was known to any individual designated in Rule 56(c) more than three months prior to filing of this statement. A check for the petition fee of \$130.00 under Rule 17(i)(1) is enclosed.

Respectfully submitted,

JEROME H. LEMELSON  
ROBERT D. PEDERSEN  
by their attorney

Louis J. Hoffman  
Reg. No. 38,918

Dated: April 22, 1996

Certification Under 37 C.F.R. § 1.8

I hereby certify that this paper is being sent this <sup>check</sup> 22<sup>nd</sup> day of April 1996 by first-class mail addressed to "Commissioner of Patents and Trademarks, Washington, D.C. 20231."

By: M. Frankenburg

LOUIS J. HOFFMAN, P.C.  
15150 North Hayden Road  
Suite 202  
Scottsdale, Arizona 85260  
(602) 948-3295

RECEIVED  
96 MAY 16 AM 8:17  
GROUP 260

130/122  
GP  
2615

IN THE UNITED STATES PATENT AND TRADEMARK OFFICE

Applicant	Jerome H. Lemelson Robert D. Pedersen	Art Unit	: 2615
Serial No.	08/105,304	Examiner	: Au
Filed	: 8/11/93		
Title	: Motor Vehicle Warning and Control System and Method		



Assistant Commissioner for Patents  
Washington, D.C. 20231

SUPPLEMENTAL INFORMATION DISCLOSURE STATEMENT

Dear Sir:

In this application, in which a petition to revive is pending, applicants cite a number of newly located references, copies of which are enclosed and which are listed on the enclosed forms PTO-1449.

Pursuant to 37 C.F.R. § 1.97(e), applicants' undersigned attorney certifies that none of the cited references were cited by a foreign patent office or, to his knowledge after making reasonable inquiry, was known to any person designated in 37 C.F.R. § 1.56(c), more than three months ago. A petition to consider those new references accompanies this Statement.

Respectfully submitted,

JEROME H. LEMELSON  
ROBERT D. PEDERSEN  
by their attorney

Louis J. Hoffman  
Reg. No. 38,918

LOUIS J. HOFFMAN, P.C.  
15150 North Hayden Road  
Suite 202  
Scottsdale, Arizona 85260  
(602) 948-3295

Dated: April 22, 1996

+ 6 pages of form PTO-1449  
and cited references,

Certification Under 37 C.F.R. § 1.8

I hereby certify that this paper is being sent this  
22<sup>nd</sup> day of April, 1996, by first-class  
mail addressed to the Commissioner of Patents and  
Trademarks, Washington, D.C.

By: M. Frankel

RECEIVED  
96 MAY 16 AM 8:17  
GROUP 260

130.00 EX



Form PTO 149 (Modified)

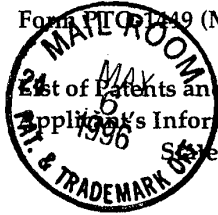

U.S. Department of Commerce  
 Patent and Trademark Office  
 Office of Patents and Publications For  
 Applicants Information Disclosure  
 Statement

Serial No.: 08/105,304

Applicants: Jerome H. Lemelson  
 Robert D. Pedersen

Filing Date: 8/11/93 Art Unit: 2615

U.S. PATENT DOCUMENTS

Examiner Initials	Document Number	Date	Name	Class	Subclass	Filing Date (if appropriate)
A	3,892,483	7/1/75	Saufferer	356	4	
B	4,549,181	10/22/85	Tachibana	340	904	
C	4,611,209	9/9/86	Lemelson	343	6.5 R	
D	4,621,705	11/11/86	Etoh	180	169	
E	4,673,937	6/16/87	Davis	342	72	
F	4,681,431	7/21/87	Sims	356	4	
G	4,703,429	10/27/87	Sakata	364	426	
H	4,786,164	11/22/88	Kawata	356	4	
I	4,849,731	7/18/89	Melocik	340	435	
J	4,926,171	5/15/90	Kelley	340	961	
K	4,965,583	10/23/90	Broxmeyer	342	42	
L	5,161,107	11/3/92	Mayeaux	364	436	
M	5,165,497	11/24/92	Chi	180	169	
N	5,189,619	2/23/93	Adachi	364	426.04	8/2/90
O	5,235,316	8/10/93	Qualizza	340	436	12/20/91

FOREIGN PATENT DOCUMENTS

Document Number	Date	Country	Class	Translation Subclass	Yes / No
--------------------	------	---------	-------	-------------------------	----------

OTHER ART (Including Author, Title, Date, Pertinent Pages, Etc.)

- A Fenton, Robert E., "On Future Traffic Control: Advanced Systems Hardware," IEEE Transactions on Vehicular Technology, pp. 200-207 (Vol. VT-29, NO. 2, May 1980)
- B MacAdam, "Application of an Optimal Preview Control for Simulation of Closed-Loop Automobile Driving," IEEE Transactions on Systems, Man, and Cybernetics, pp. 393-399 (Vol. SMC-11, No. 6, June 1981).

Examiner: \_\_\_\_\_ Date Considered: \_\_\_\_\_

EXAMINER: Initial if reference considered, whether or not citation is in conformance with MPEP 609. Draw line through citation if not in conformance and not considered. Include copy of this form with next communication to applicant.

Form PTO-1449 (Modified)

List of Patents and Publications For  
Applicant's Information Disclosure  
Statement



Serial No.: 08/105,304

Applicants: Jerome H. Lemelson  
Robert D. Pedersen

Filing Date: 8/11/93 Art Unit: 2615

- C Belohoubek, "Radar Control for Automotive Collision Mitigation and Headway Spacing," IEEE Transactions on Vehicular Technology, pp. 89-99 (Vol. VT-31, No. 2, May 1982).
- D Hatwal et al., "Some Inverse Solutions to an Automobile Path-Tracking Problem with Input Control of Steering and Brakes," IEEE Transactions on Vehicular Technology, Vol. VT-31, No. 2, May 1982).
- E Dickmanns et al., "Guiding Land Vehicles Along Roadways by Computer Vision," The Tools for Tomorrow, pp. 232-245 (October 1985).
- F Kuan et al., "Autonomous Robotic Vehicle Road Following," IEEE Transactions on Pattern Analysis and Machine Intelligence, pp. 648-658 (Vol. 10, No. 5, September 1988).
- G Moigne, "Domain-Dependent Reasoning for Visual Navigation of Roadways," IEEE Journal of Robotics and Automation, pp. 419-427 (Vol. 4, No. 4, August 1988).
- H Kuan et al., "Autonomous Robotic Vehicle Road Following," IEEE Transactions on Pattern Analysis and Machine Intelligence, pp. 648-658 (Vol. 10, No. 5, September 1988).
- I Bender, "An Overview of Systems Studies of Automated Highway Systems," IEEE Transactions on Vehicular Technology, pp. 82-99 (Vol. 40, No. 1, February 1991).
- J Aurrand-Lions, "Application of Fuzzy Control For ISIS Vehicle Braking" University of Aix-Marseille II and Neurinfo Research Dept., pp. 1-7 (Paper # 32 November 1991).
- K Carpenter et al., Neural Networks for Vision and Image Processing, Chapter 16, pp. 437-448 (MIT Press 1992).
- L Song et al., "Fuzzy Navigation of a Mobile Robot," Fuzzy Logic Technology and Applications, pp. 141-147 (Feb. 1992).
- M Sabharwal et al., "Design of a Rule-Based Fuzzy Controller for the Pitch Axis of an Unmanned Research Vehicle," Fuzzy Logic Technology and Applications, pp. 81-87 (March 1992).
- N Nijhuis et al., "Evaluation of Fuzzy and Neural Vehicle Control," Fuzzy Logic Technology and Applications, pp. 50-55 (March 1992).
- O Maeda et al., "Hierarchical Control for Autonomous Mobile Robots with Behavior-Decision Fuzzy Algorithm," Fuzzy Logic Technology and Applications, pp. 135-140 (April 1992).
- P Pin et al., "Autonomous Navigation of a Mobile Robot Using Custom-Designed Qualitative Reasoning VLSI chips and Boards," Fuzzy Logic Technology and Applications, pp. 319-324 (April 1992).

Examiner: \_\_\_\_\_

Date Considered: \_\_\_\_\_

EXAMINER: Initial if reference considered, whether or not citation is in conformance with MPEP 609. Draw line through citation if not in conformance *and* not considered. Include copy of this form with next communication to applicant.

Form PTO-1449 (Modified)

List of Patents and Publications For  
Applicant's Information Disclosure  
Statement

Serial No.: 08/105,304

Applicants: Jerome H. Lemelson  
Robert D. Pedersen

Filing Date: 8/11/93 Art Unit: 2615

- Q Altan et al., "Computer Architecture and Implementation of Vision-Based Real-Time Lane Sensing," IEEE Intelligent Vehicles Symposium, pp. 202-206 (July 1992).
- R Hassoun et al., "Reactive Motion Planning for an Intelligent Vehicle," IEEE Intelligent Vehicles Symposium, pp. 259-264 (July 1992)
- S Hatsopoulos et al., "Collision-Avoidance System Based on Optical Flow," IEEE Intelligent Vehicles Symposium, pp. 79-84 (July 1992).
- T Hattori et al., "Driving Control System for an Autonomous Vehicle Using Multiple Observed Point Information," IEEE Intelligent Vehicles Symposium, pp. 207-212 (July 1992).
- U Hashimoto et al., "An Image Processing Architecture and a Motion Control Method for an Autonomous Vehicle," IEEE Intelligent Vehicles Symposium, pp. 213-218 (July 1992).
- V Marko et al., "Application of Genetic Programming to Control of Vehicle Systems," IEEE Intelligent Vehicles Symposium, pp. 191-195 (July 1992).
- W Ito et al., "A Real Time distance Headway Measurement Method Using Stereo and Optical Flow," IEEE Intelligent Vehicles Symposium, pp. 230-235 (July 1992).
- X Nguyen et al., "Obstacle Detection Using Bi-Spectrum CCD Camera and Image Processing," IEEE Intelligent Vehicles Symposium, pp. 42-50 (July 1992).
- Y Bruyelle et al., "Disparity Analysis For Real Time Obstacle Detection By Linear Stereovision," IEEE Intelligent Vehicles Symposium, pp. 51-56 (July 1992).
- Z Efenberger et al., "Automatic Recognition of Vehicles Approaching from Behind," IEEE Intelligent Vehicles Symposium, pp. 57-62 (July 1992).
- AA Schwarzwinger et al., "Vision-Based Car -Following: Detection, Tracking, and Identification," IEEE Intelligent Vehicles Symposium, pp. 24-29 (July 1992).
- AB Sekine et al., "Design Method for an Automotive Laser Radar System and Future Prospects for Laser Radar," IEEE Intelligent Vehicles Symposium, pp. 120-125 (July 1992).
- AC Shigematu et al., "Development of Automatic Driving System on Rough Road - Automatic Steering Control by Fuzzy Algorithm -" IEEE Intelligent Vehicles Symposium, pp. 154-159 (July 1992).
- AD Siegle et al., "Autonomous Driving on a Road Network," IEEE Intelligent Vehicles Symposium, pp. 403-404 (July 1992).
- AE Lubin et al., "Lateral control of an Autonomous Road Vehicle in a Simulated Highway Environment Using Adaptive Resonance Neural Networks," IEEE Intelligent Vehicles Symposium, pp. 85-91 (July 1992).

Examiner: \_\_\_\_\_

Date Considered: \_\_\_\_\_

EXAMINER: Initial if reference considered, whether or not citation is in conformance with MPEP 609. Draw line through citation if not in conformance *and* not considered. Include copy of this form with next communication to applicant.

Form PTO-1449 (Modified)

List of Patents and Publications For  
Applicant's Information Disclosure  
Statement

Serial No.: 08/105,304

Applicants: Jerome H. Lemelson  
Robert D. Pedersen

Filing Date: 8/11/93 Art Unit: 2615

- AF Funka-Lea et al., "Vision for Vehicle Guidance Using Two Road Cues," IEEE Intelligent Vehicles Symposium, pp. 126-131 (July 1992).
- AG Hartmann et al., "A Hierarchical Vision System," IEEE Intelligent Vehicles Symposium, pp. 18-23 (July 1992).
- AH Pomerleau, "Progress in Neural Network-based Vision for Autonomous Robot Driving," IEEE Intelligent Vehicles Symposium, pp. 391-396 (July 1992).
- AI Riseman, "Visual Processing for Vehicle control Functions," IEEE Intelligent Vehicles Symposium, pp. 397-402 (July 1992).
- AJ Young et al., "Obstacle Detection for a Vehicle Using Optical Flow," IEEE Intelligent Vehicles Symposium, pp. 185-190 (July 1992).
- AK Yu et al., "Road Tracking, Lane Segmentation and Obstacle Recognition by Mathematical Morphology," IEEE Intelligent Vehicles Symposium, pp. 166-172 (July 1992).
- AL Ulmer, "VITA - An Autonomous Road Vehicle (ARV) for Collision Avoidance in Traffic," IEEE Intelligent Vehicles Symposium, pp. 36-41 (July 1992).
- AM Suzuki et al., "Lane Recognition System for Guiding of Autonomous Vehicle," IEEE Intelligent Vehicles Symposium, pp. 196-201 (July 1992).
- AN Ohnishi et al., "Development of Automatic Driving System on Rough Road - Realization of High Reliable Automatic Driving System -" IEEE Intelligent Vehicles Symposium, pp. 148-153 (July 1992).
- AO Ooka et al., "Development of Automatic Driving System on Rough Road - Fault Tolerant Structure for Electronic Controller," IEEE Intelligent Vehicles Symposium, pp. 160-165 (July 1992).
- AP Kim et al., "The Areawide Real-Time Traffic Control (ARTC) System: A New Traffic Control Concept," IEEE Transactions on Vehicular Technology, pp. 212-224 (Vol. 42, No. 2, May 1993).
- AQ Arain et al., "Action Planning for the Collision Avoidance System Using Neural Networks," IEEE Intelligent Vehicles Symposium, pp. 119-124 (July 1993).
- AR Braithwaite, "A Vehicle Steering Algorithm Based on Bearing Measurements," IEEE Intelligent Vehicles Symposium, pp. 287-292 (July 1993).
- AS Burie et al., "A New Edge Matching Procedure for Obstacle Detection by Linear Stereo Vision," IEEE Intelligent Vehicles Symposium, pp. 414-419 (July 1993).
- AT Campani et al., "Visual Routines for outdoor Navigation," IEEE Intelligent Vehicles Symposium, pp. 107-112 (July 1993).

Examiner: \_\_\_\_\_

Date Considered: \_\_\_\_\_

---

EXAMINER: Initial if reference considered, whether or not citation is in conformance with MPEP 609. Draw line through citation if not in conformance *and* not considered. Include copy of this form with next communication to applicant.

Form PTO-1449 (Modified)

List of Patents and Publications For  
Applicant's Information Disclosure  
Statement

Serial No.: 08/105,304

Applicants: Jerome H. Lemelson  
Robert D. Pedersen

Filing Date: 8/11/93 Art Unit: 2615

- AU Feldkamp, "Trainable Fuzzy and Neural-Fuzzy Systems for Idle-Speed Control," Fuzzy Logic Technology and Applications, pp. 43-49 (July 1993).
- AV Gomi et al., "Collision Avoidance Using Behavioral-Based AI Techniques," IEEE Intelligent Vehicles Symposium, pp. 141-145 (July 1993).
- AW Graefe, "Vision for Intelligent Road Vehicles," IEEE Intelligent Vehicles Symposium, pp. 135-140 (July 1993).
- AX Ito et al., "Preceding Vehicle Recognition Algorithm Using Fusion of Laser Radar and Image Processing," IEEE Intelligent Vehicles Symposium, pp. 420-425 (July 1993).
- AY Kamat et al., "Hough Transform for Vehicle Identification," IEEE Intelligent Vehicles Symposium, pp. 230-234 (July 1993).
- AZ Kim et al., "An Autonomous Land Vehicle: Design Concept and Preliminary Road Test Results," IEEE Intelligent Vehicles Symposium, pp. 146-151 (July 1993).
- BA Liu et al., "Real-time Neural Vision for Vehicle Navigation and Safety," IEEE Intelligent Vehicles Symposium, pp. 283-286 (July 1993).
- BB Madau et al., "Fuzzy Logic Anti-Lock Brake System for a Limited Range Coefficient of Friction Surface," Fuzzy Logic Technology and Applications, pp. 68-73 (July 1993).
- BC Mertsching et al., "Interpretation of Traffic Scenes Using a Hierarchical Data Structure," IEEE Intelligent Vehicles Symposium, pp. 163-168 (July 1993).
- BD Micheli et al., "Vehicle Guidance from One Dimensional Optical Flow," IEEE Intelligent Vehicles Symposium, pp. 183-188 (July 1993).
- BE Mori et al., "Recent Progress in Mobile Robot Harunobu (2) - Moving Obstacle Detection and Mobile Robot Application -," IEEE Intelligent Vehicles Symposium, pp. 169-176 (July 1993).
- BF Nashman et al., "Real-Time Visual Processing for Autonomous Driving," IEEE Proceedings of the Intelligent Vehicles '93 Symposium, pp. 373-378 (July 1993).
- BG Pomerleau, "Neural Networks for Intelligent Vehicles," IEEE Intelligent Vehicles Symposium, pp. 19-24 (July 1993).
- BH Romano et al., "A Real-time visual Reflex for Autonomous Navigation," IEEE Intelligent Vehicles Symposium, pp. 50-55 (July 1993).
- BI Saneyoshi et al., "3-D Image Recognition System for Drive Assist," IEEE Intelligent Vehicles Symposium, pp. 60-65 (July 1993).
- BJ Sukthankar et al., "A Real-time Autonomous Car Chaser Operating Optimally at Night," IEEE Intelligent Vehicles Symposium, pp. 37-42 (July 1993).
- BK Tomita et al., "Preview Lateral Control with Machine Vision for Intelligent

Examiner: \_\_\_\_\_

Date Considered: \_\_\_\_\_

EXAMINER: Initial if reference considered, whether or not citation is in conformance with MPEP 609. Draw line through citation if not in conformance and not considered. Include copy of this form with next communication to applicant.

Form PTO-1449 (Modified)

List of Patents and Publications For  
Applicant's Information Disclosure  
Statement

Serial No.: 08/105,304

Applicants: Jerome H. Lemelson  
Robert D. Pedersen

Filing Date: 8/11/93 Art Unit: 2615

- Vehicle," IEEE Intelligent Vehicles Symposium, pp. 467-472 (July 1993).
- BL Yokoi et al., "An Approach to the Avoiding Obstacle Problem by the Vibrating Potential Method," IEEE Intelligent Vehicles Symposium, pp. 235-245 (July 1993).
- BM Yokoyama et al., "Automated Vehicle System Using Both a Computer Vision and Magnetic Field Sensors," IEEE Intelligent Vehicles and Symposium, pp. 157-162 (July 1993).
- BN Zhao et al., "Obstacle Detection by Vision System for an Autonomous Vehicle," IEEE Intelligent Vehicles Symposium, pp. 31-36 (July 1993).
- BO Hughes, "Aerospace Electronics May Guide Smart Cars," Aviation Week & Space Technology, pp. 63-64 (November, 1993).

Examiner: \_\_\_\_\_

Date Considered: \_\_\_\_\_

---

EXAMINER: Initial if reference considered, whether or not citation is in conformance with MPEP 609. Draw line through citation if not in conformance *and* not considered. Include copy of this form with next communication to applicant.



UNITED STATES DEPARTMENT OF COMMERCE  
Patent and Trademark Office  
ASSISTANT SECRETARY AND COMMISSIONER OF  
PATENTS AND TRADEMARKS  
Washington, D.C. 20231

kdb/5

Paper No. 18

Louis J. Hoffman  
15150 North Hayden Road  
Suite 202  
Scottsdale, AZ 85260

**COPY MAILED**

**MAY 30 1996**

**OFFICE OF PETITIONS  
AND PATENTS**

In re Application of :  
Jerome H. Lemelson, et al. :  
Application No. 08/105,304 : ON PETITION  
Filed: August 11, 1993 :  
Attorney Docket No. n/a :

This is a decision on the petition under 37 CFR 1.137(a), filed April 3, 1996, to revive the above-identified application.

The petition is dismissed.

Any request for reconsideration of this decision must be submitted within TWO (2) MONTHS from the mail date of this decision. Extensions of time under 37 CFR 1.136(a) are permitted. The reconsideration request should include a cover letter entitled "Renewed Petition under 37 CFR 1.137(a)."

A grantable petition to revive an abandoned application under 37 CFR 1.137(a) must be accompanied by (1) a proposed response to continue prosecution of the abandoned application, or filing of a continuation application, unless either has been previously filed; (2) the petition fee required by 37 CFR 1.17(1); (3) an adequate verified showing of the cause of unavoidable delay; and (4) a terminal disclaimer and fee (if a grantable petition to revive was not filed within 6 months from the date of abandonment). This petition lacks items (3) above.

This application became abandoned on February 7, 1996 for failure to respond to the final Office action mailed September 6, 1995. The request for a third month extension of time is unacceptable because it was received outside the statutory period for response.

Petitioner asserts that he overlooked the due date because of a change in clerical personnel and his extensive travel schedule and preoccupation with litigation matters.

Petitioner's preoccupation with other matters which took precedence over responding to the Patent and Trademark Office in

this case within the set time period does not constitute unavoidable delay within the meaning of 37 CFR 1.137(a) and 35 USC 133. According to the statements presented, petitioner was aware that a response was due and chose to delay filing the response. In this regard, petitioner may delay a response until the end of the time period for taking action to avoid abandonment; however, any individual so delaying a response must assume the risk attendant to such delay. Ex parte Warren, 1901 Dec. Comm'r Pat. 137 (Comm'r Pat. 1901).

In view of the above, it does not appear that petitioner took any responsible steps to keep this application from become abandoned. The fact that petitioner was without trained clerical docketing assistance during the period in which the response was due should have made a reasonably prudent practitioner even more aware of the fact that special care needed to be taken to prevent the abandonment of this application. Additionally, since petitioner is not a sole practitioner, it would appear that during petitioner's absence arrangements could have been made for another attorney to review his docket and timely file the appropriate response.

If a grantable petition is not filed within 6 months after the date of abandonment, a disclaimer of a terminal portion of any patent which may issue on the above-identified application or on any application entitled to the benefit of the filing date of this application under 35 USC 120 is required. The period to be disclaimed will be a terminal part of the patent to be granted equivalent to the period of abandonment. The period of abandonment will be computed to be the number of months lapsed from the date of abandonment to the date of filing a grantable petition. A terminal disclaimer fee of \$55 is required. If the terminal disclaimer is signed by an assignee, the assignee must comply with the requirements of 37 CFR 3.73(b). A blank terminal disclaimer form is enclosed herewith.

Petitioner should consider filing a petition stating that the delay was unintentional. Public Law 97-247, which revised patent and trademark fees, provides for the revival of an "unintentionally" abandoned application without a showing that the delay in prosecution or in late payment of an issue fee was "unavoidable." Rules implementing these provisions have been promulgated; 37 CFR 1.137(b), 1.155(c), 1.316(c) and 1.317(c). In order to qualify, a petition must be filed within 1 year of the date of abandonment of the application or within 3 months of a first decision on a petition based on "unavoidable" delay which was filed within one year of the date of abandonment. An "unintentional" petition must be accompanied by the \$625 petition fee required by law.



Since this decision represents such a "first decision" on petition based on a showing of "unavoidable" delay, YOU HAVE THREE (3) MONTHS FROM THE DATE OF THIS DECISION OR ONE (1) YEAR FROM THE DATE OF ABANDONMENT, WHICHEVER IS LONGER, IN WHICH TO FILE AN "UNINTENTIONAL" PETITION or your right to do so will be lost.

The filing of a petition under the unintentional standard cannot be intentionally delayed and therefore should be filed promptly. A person seeking revival due to unintentional delay can not make a statement that the delay was unintentional unless the entire delay, including the delay from the date it was discovered that the application was abandoned until the filing of the petition to revive under 37 CFR 1.137(b), was unintentional. A statement that the delay was unintentional is not appropriate if petitioner intentionally delayed the filing of a petition for revival under 37 CFR 1.137(b).

Further correspondence with respect to this matter should be addressed as follows:

By mail: Assistant Commissioner for Patents  
Box DAC  
Washington, D.C. 20231

By FAX: (703) 308-6916  
Attn: Office of Petitions

Telephone inquiries should be directed to the Office of Petitions Staff at (703) 305-9282.

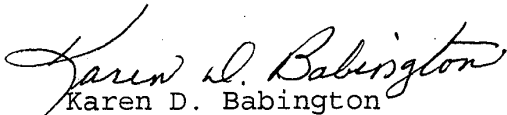

Karen D. Babington  
Petitions Examiner  
Office of Petitions  
Office of the Deputy Assistant Commissioner  
for Patent Policy and Programs

Enclosure: Terminal Disclaimer form

47FO (A/C For Patents Petitions)  
5-30-96  
082

IN THE UNITED STATES PATENT AND TRADEMARK OFFICE

Applicant : Jerome H. Lemelson Art Unit : 2615  
Robert D. Pedersen  
Serial No. : 08/105,304 Examiner : Au  
Filed : 8/11/93  
Title : Motor Vehicle Warning and Control System and Method

#19

Assistant Commissioner for Patents  
Washington, D.C. 20231  
Via hand-delivery to:  
Office of Petitions

96 JUN -5 PM 12:31  
GROUP 260  
RECEIVED

PETITION TO REVIVE APPLICATION (UNINTENTIONAL)

Dear Sir:

Pursuant to Rule 137(b), applicants hereby petition to revive this application, which as a matter of law went abandoned on March 6, 1996. This petition is being filed within one year of the date of abandonment. Applicants respectfully request that:

- The case be revived;
- The paper entitled "Notice of Appeal" dated March 11, 1996, and filed on April 3, 1996, at the same time as the recently dismissed "Petition to Revive Application (Unavoidable)" be entered;
- The "Petition for Consideration of Supplemental Information Disclosure Statement" filed April 22, 1996, by mail, be granted, the accompanying Statement be considered, and the initialed forms PTO-1449 be returned; and
- The "Declaration of Dr. John R. Grindon" filed February 26, 1996, be considered by the Examiner and an advisory action issued indicating that the enablement rejection has been overcome.

Revival is also requested to permit copendency with a planned continuation application.

The petition fee in the amount of \$1,250.00 (37 C.F.R. § 1.17(m)) is enclosed in support of this Petition.

The undersigned, who was involved with this application throughout the period of delay, states that the delay was unintentional.

It would also be appreciated if the decision granting this petition would advise as to the date that the Notice of Appeal is considered entered, so that applicants can timely submit an appeal brief.

If there are any questions, please contact applicants' undersigned attorney.

Respectfully submitted,

JEROME H. LEMELSON  
ROBERT D. PEDERSEN  
by their attorney

Dated: June 4, 1996



---

Louis J. Hoffman  
Reg. No. 38,918

LOUIS J. HOFFMAN, P.C.  
15150 North Hayden Road  
Suite 202  
Scottsdale, Arizona 85260  
(602) 948-3295

Certification

I hereby certify that this paper, together with the enclosed check for \$1,250.00, is being hand-delivered this 5<sup>th</sup> day of June, 1996, to the U.S. Patent and Trademark Office.

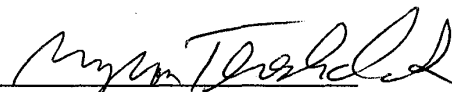
By:   
Name: Myron Tereshchuk

RECEIPT IS ACKNOWLEDGED OF a document entitled "Petition to Revive Application (Unintentional)," together with the enclosed check for \$1,250.00:

FAX RECEIVED  
AUG 29 1996  
PATENT OFFICE

LEONARD J. ROBERTSON  
A Professional Corporation

15150 North Hayden Road, Suite 202  
Scottsdale, Arizona 85260

Patents, Trademarks, Copyright  
& Trade Secrets

Registered  
Patent Attorney

Telephone: (602) 948-3295  
Facsimile: (602) 948-5557

TELECOPIER TRANSMITTAL SHEET

DATE : 8/29/96  
TO : Latrice Bond  
USPTO, Petition Office  
FAX NO. : 703/308-6916  
FROM : LJR  
NUMBER OF PAGES  
(including this transmittal sheet): 4  
SENT BY : Robertson

SPECIAL MESSAGE:

Please call me regarding this and  
a second case. I have left messages  
twice this week. Thank you!  
My tel. # 602/948-3295

The transmittal may be a confidential attorney-client communication or may otherwise be privileged and confidential. If the reader of this transmittal is not the intended recipient or an agent responsible for delivering it to the intended recipient, you are hereby notified that you have received this transmittal in error, and that any review, dissemination, distribution or copying of the transmittal is strictly prohibited. If you have received this in error, please notify us immediately by telephone (call us collect) at (602) 948-3295 and return the original transmittal to us by mail. Thank you.

Client : 10

IN THE UNITED STATES PATENT AND TRADEMARK OFFICE

Applicant : Jerome H. Lemelson                      Art Unit : 2615  
                       Robert D. Pedersen  
Serial No. : 08/105,304                              Examiner : Au  
Filed : 8/11/93  
Title : Motor Vehicle Warning and Control System and Method

---

Assistant Commissioner for Patents  
Washington, D.C. 20231  
Via hand-delivery to:  
Office of Petitions

PETITION TO REVIVE APPLICATION (UNINTENTIONAL)

Dear Sir:

Pursuant to Rule 137(b), applicants hereby petition to revive this application, which as a matter of law went abandoned on March 6, 1996. This petition is being filed within one year of the date of abandonment. Applicants respectfully request that:

- The case be revived;
- The paper entitled "Notice of Appeal" dated March 11, 1996, and filed on April 3, 1996, at the same time as the recently dismissed "Petition to Revive Application (Unavoidable)" be entered;
  - The "Petition for Consideration of Supplemental Information Disclosure Statement" filed April 22, 1996, by mail, be granted, the accompanying Statement be considered, and the initialed forms PTO-1449 be returned; and
  - The "Declaration of Dr. John R. Grindon" filed February 26, 1996, be considered by the Examiner and an advisory action issued indicating that the enablement rejection has been overcome.

Revival is also requested to permit copendency with a planned continuation application.

P.2

AUG 29 10 34AM '96

The petition fee in the amount of \$1,250.00 (37 C.F.R. § 1.17(m)) is enclosed in support of this Petition.

The undersigned, who was involved with this application throughout the period of delay, states that the delay was unintentional.

It would also be appreciated if the decision granting this petition would advise as to the date that the Notice of Appeal is considered entered, so that applicants can timely submit an appeal brief.

If there are any questions, please contact applicants' undersigned attorney.

Respectfully submitted,

JEROME H. LEMELSON  
ROBERT D. PEDERSEN  
by their attorney



Louis J. Hoffman  
Reg. No. 38,918

Dated: June 4, 1996

LOUIS J. HOFFMAN, P.C.  
15150 North Hayden Road  
Suite 202  
Scottsdale, Arizona 85260  
(602) 948-3295

Serial No. 08/105,304

Page 2

AUG 29 '96 10:34AM

P.3

FAX RECEIVED  
AUG 29 1996  
PETITIONS OFFICE

RECEIVED  
96 JUN -5 PM 12:34  
GROUP 260

Certification

I hereby certify that this paper, together with the enclosed check for \$1,250.00, is being hand-delivered this 5<sup>th</sup> day of June, 1996, to the U.S. Patent and Trademark Office.

By: Myron Tereshchuk  
Name: Myron Tereshchuk

RECEIPT IS ACKNOWLEDGED OF a document entitled "Petition to Revive Application (Unintentional)," together with the enclosed check for \$1,250.00:



141-1250.00  
Lem #19

IN THE UNITED STATES PATENT AND TRADEMARK OFFICE

Applicant : Jerome H. Lemelson Art Unit : 2615  
          : Robert D. Pedersen  
Serial No. : 08/105,304 Examiner : Au  
Filed : 8/11/93  
Title : Motor Vehicle Warning and Control System and Method

---

Assistant Commissioner for Patents  
Washington, D.C. 20231  
Via hand-delivery to:  
Office of Petitions

RECEIVED

SEP - 3 1996

PETITION TO REVIVE APPLICATION (UNINTENTIONAL)

Dear Sir:

Pursuant to Rule 137(b), applicants hereby petition to revive this application, which as a matter of law went abandoned on March 6, 1996. This petition is being filed within one year of the date of abandonment. Applicants respectfully request that:

- The case be revived;
- The paper entitled "Notice of Appeal" dated March 11, 1996, and filed on April 3, 1996, at the same time as the recently dismissed "Petition to Revive Application (Unavoidable)" be entered;
- The "Petition for Consideration of Supplemental Information Disclosure Statement" filed April 22, 1996, by mail, be granted, the accompanying Statement be considered, and the initialed forms PTO-1449 be returned; and
- The "Declaration of Dr. John R. Grindon" filed February 26, 1996, be considered by the Examiner and an advisory action issued indicating that the enablement rejection has been overcome.

Revival is also requested to permit copendency with a planned continuation application.

240 DD 09/05/96 08105304  
1 141 1,250.00 CK

1501

The petition fee in the amount of \$1,250.00 (37 C.F.R. § 1.17(m)) is enclosed in support of this Petition.

The undersigned, who was involved with this application throughout the period of delay, states that the delay was unintentional.

It would also be appreciated if the decision granting this petition would advise as to the date that the Notice of Appeal is considered entered, so that applicants can timely submit an appeal brief.

If there are any questions, please contact applicants' undersigned attorney.

Respectfully submitted,

JEROME H. LEMELSON  
ROBERT D. PEDERSEN  
by their attorney

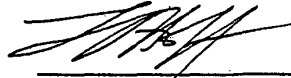

Dated: June 4, 1996

---

Louis J. Hoffman  
Reg. No. 38,918

LOUIS J. HOFFMAN, P.C.  
15150 North Hayden Road  
Suite 202  
Scottsdale, Arizona 85260  
(602) 948-3295

rels

RECEIVED  
96 JUN -5 PM 12:34  
GROUP 260

Certification

I hereby certify that this paper, together with the enclosed check for \$1,250.00, is being hand-delivered this 5<sup>th</sup> day of June, 1996, to the U.S. Patent and Trademark Office.

By:   
Name: Myron Tereshchuk

RECEIPT IS ACKNOWLEDGED OF a document entitled "Petition to Revive Application (Unintentional)," together with the enclosed check for \$1,250.00:

Serial No. 08/105,304

Page 3



UNITED STATES DEPARTMENT OF COMMERCE  
 Patent and Trademark Office  
 ASSISTANT SECRETARY AND COMMISSIONER OF  
 PATENTS AND TRADEMARKS  
 Washington, D.C. 20231

Paper No. 20

Louis J. Hoffman  
 15150 North Hayden Road  
 Suite 202  
 Scottsdale, AZ 85260

**COPY MAILED**

**SEP 13 1996**

**OFFICE OF PETITIONS  
 AND PATENTS  
 ON PETITION**

In re Application of  
 Jerome H. Lemelson, et al.  
 Application No. 08/105,304  
 Filed: August 11, 1993

:  
:  
:  
:

This is a decision on the petition under 37 CFR 1.137(b), filed June 5, 1996,<sup>1</sup> to revive the above-identified application.

The petition is granted.

This application became abandoned for failure to timely respond to the final Office action mailed September 6, 1995, which set a three month shortened statutory period for filing a response. A two month extension of time having been obtained pursuant to the provisions of 37 CFR 1.136(a), the date of abandonment of this application is February 7, 1996. Therefore, since this petition was filed within one year of the date of abandonment, the petition complies with the one year filing period requirement in 37 CFR 1.137(b).

**The 2-month period for filing the Appeal Brief, in triplicate, accompanied by the fee required by law, runs from the date of this decision.**

The application file is being forwarded to Group 2600.

*Handwritten initials*

<sup>1</sup>Facsimile received August 29, 1996.

Serial No. 08/209,108

Page 2

Telephone inquiries concerning this matter may be directed to the undersigned at (703) 305-8859.

*Karen Creasy*

Karen Creasy  
Legal Instruments Examiner  
Office of Petitions  
Office of the Deputy Assistant Commissioner  
for Patent Policy and Projects

*Karen D. Babington*  
Karen D. Babington  
Petitions Examiner



UNITED STATES DEPARTMENT OF COMMERCE  
Patent and Trademark Office

Address: COMMISSIONER OF PATENTS AND TRADEMARKS  
Washington, D.C. 20231

SERIAL NUMBER	FILING DATE	FIRST NAMED APPLICANT	ATTORNEY DOCKET NO.
08/105,304	08/11/93	LEMELSON	J

LOUIS J. HOFFMAN, P.C.  
15150 NORTH HAYDEN ROAD  
SUITE 202  
SCOTTSDALE, AZ 85260

26M2/1011

AUSA EXAMINER	
ART UNIT	PAPER NUMBER
2615	150 21

DATE MAILED:

10/11/96

Below is a communication from the EXAMINER in charge of this application

COMMISSIONER OF PATENTS AND TRADEMARKS

ADVISORY ACTION

THE PERIOD FOR RESPONSE:

a)  is extended to run 5 months or continues to run \_\_\_\_\_ from the date of the final rejection

b)  expires three months from the date of the final rejection or as of the mailing date of this Advisory Action, whichever is later. In no event however, will the statutory period for the response expire later than six months from the date of the final rejection.

Any extension of time must be obtained by filing a petition under 37 CFR 1.136(a), the proposed response and the appropriate fee. The date on which the response, the petition, and the fee have been filed is the date of the response and also the date for the purposes of determining the period of extension and the corresponding amount of the fee. Any extension fee pursuant to 37 CFR 1.17 will be calculated from the date of the originally set shortened statutory period for response or as set forth in b) above.

Appellant's Brief is due in accordance with 37 CFR 1.192(a).

Applicant's response to the final rejection, filed 2-26-96 has been considered with the following effect, but it is not deemed to place the application in condition for allowance:

1.  The proposed amendments to the claim and/or specification will not be entered and the final rejection stands because:

a.  There is no convincing showing under 37 CFR 1.116(b) why the proposed amendment is necessary and was not earlier presented.

b.  They raise new issues that would require further consideration and/or search. (See Note).

c.  They raise the issue of new matter. (See Note).

d.  They are not deemed to place the application in better form for appeal by materially reducing or simplifying the issues for appeal.

e.  They present additional claims without cancelling a corresponding number of finally rejected claims.

NOTE: \_\_\_\_\_  
\_\_\_\_\_  
\_\_\_\_\_

2.  Newly proposed or amended claims \_\_\_\_\_ would be allowed if submitted in a separately filed amendment cancelling the non-allowable claims.

3.  Upon the filing an appeal, the proposed amendment  will be entered  will not be entered and the status of the claims will be as follows:

Claims allowed: \_\_\_\_\_

Claims objected to: \_\_\_\_\_

Claims rejected: \_\_\_\_\_

However;

Applicant's response has overcome the following rejection(s): \_\_\_\_\_

4.  The affidavit, exhibit or request for reconsideration has been considered but does not overcome the rejection because \_\_\_\_\_

See attachment

5.  The affidavit or exhibit will not be considered because applicant has not shown good and sufficient reasons why it was not earlier presented.

The proposed drawing correction  has  has not been approved by the examiner.

Other

Art Unit: 2615

*Advisory Action (can't)*

1. The declaration under 37 C.F.R. § 1.132 filed 2-26-96 is insufficient to overcome the rejection of claims 13-14, 38-39, 48, 53, 62, 104, 108, 110-112, 116-117, 120, 123, 125-128, and 131-160 based upon insufficiency of disclosure under 35 USC 112, first paragraph as set forth in the last Office action because of the following reasons.

The declaration fails to provide suitable proof that one skilled in the art would have been able to make and use the claimed invention using the disclosure as a guide. Evidence to supplement a specification which on its face appears deficient under 35 USC 112 must establish that the information which must be read into the specification to make it complete would have been known to those of ordinary skill in the art.

Affidavits or declarations presented to show that the disclosure of an application is sufficient to one skilled in the art are not acceptable to establish facts which the specification itself should recite.

The declaration discusses various references to show that image processing, automotive control, collision avoidance, fuzzy technology, etc are well known in the art.

This is not persuasive because the present invention does not function or operate in the manner disclosed in the cited references. For example, the Kurami reference uses an image to detect the presence or absence of an obstacle in the path of the vehicle, however, Kurami does not identify an obstacle by comparison to a reference library and does not determine

Serial Number: 08/105,304

-3-

Art Unit: 2615

what type of object the obstacle is and what type of danger it signifies as in the present invention. The declaration further cites that a reference to Kamada and Yoshida describes fuzzy logic to successfully steer a vehicle. However, the technology used by Kamada and Yoshida employs markers, which are simple since markers have a standard shape and are stationary, while the present invention alleges it can identify all types of moving and non-moving object such as a person or a sign of any size and shape simultaneously and collectively and rank its danger potential.

The declaration has not provided any suitable proof that one skilled in the art would have been able to make an use the claimed invention using the disclosure as a guide. The disclosure lacks critical details of how the technology is applied beyond using advance processing computers to enable the present invention to operate. The operation of the present invention requires specially designed processing and algorithms that are not readily available. The declaration fails to provide any proof or facts that the technology is available without undue experimentation. The technology that is available and shown by the references cited in the declaration are accepted as valid, however, the technology disclosed in the references do not operate in the manner described in the disclosure.

2. Any inquiry concerning this communication or earlier communications from the examiner should be directed to Amelia Au whose telephone number is (703) 308-6604. The examiner can normally be reached on Monday - Thursday from 6:30 am - 4:00 pm EST. The examiner can also be reached on alternate Fridays.



Serial Number: 08/105,304

-4-

Art Unit: 2615

If attempts to reach the examiner by telephone are unsuccessful, the examiner's supervisor, Tommy Chin, can be reached on (703) 305-4715. The fax phone number for this Group is (703) 308-5399.

Any inquiry of a general nature or relating to the status of this application should be directed to the Group receptionist whose telephone number is (703) 305-4700.

  
aa  
April 14, 1996

  
TOMMY P. CHIN  
SUPERVISORY PATENT EXAMINER  
GROUP 2800



**UNITED STATES DEPARTMENT OF COMMERCE**  
**Patent and Trademark Office**  
Address: COMMISSIONER OF PATENTS AND TRADEMARKS  
Washington, D.C. 20231

SERIAL NUMBER	FILING DATE	FIRST NAMED APPLICANT	ATTORNEY DOCKET NO.
08/105,304	08/11/93	LEMELSON	J

LOUIS J. HOFFMAN, P.C.  
15150 NORTH HAYDEN ROAD  
SUITE 202  
SCOTTSDALE AZ 85260

26M1/0318

EXAMINER	
AU, A	
ART UNIT	PAPER NUMBER
2615	22

DATE MAILED: 03/18/97

Please find below a communication from the EXAMINER in charge of this application.

Commissioner of Patents



**UNITED STATES DEPARTMENT OF COMMERCE  
Patent and Trademark Office**  
Address: COMMISSIONER OF PATENTS AND TRADEMARKS  
Washington, D.C. 20231

SERIAL NUMBER	FILING DATE	FIRST NAMED APPLICANT	ATTORNEY DOCKET NO.
08/105,304	08/11/93	LEMELSON	J

26M1/0318  
LOUIS J. HOFFMAN, P.C.  
15150 NORTH HAYDEN ROAD  
SUITE 202  
SCOTTSDALE AZ 85260

EXAMINER	
AU, A	
ART UNIT	PAPER NUMBER
2615	22

DATE MAILED: 03/18/97

Please find below a communication from the EXAMINER in charge of this application.

Commissioner of Patents

**DECISION ON PETITION UNDER 37 C.F.R. §1.97 FOR CONSIDERATION OF  
INFORMATION DISCLOSURE STATEMENT**

The petition filed May 6, 1996 under 37 C.F.R. §1.97(d) for consideration of an information disclosure statement filed after final rejection has been:

GRANTED.

Since the information disclosure statement was not accompanied with an amendment it has been placed of record in the file but will not be considered by the examiner until the applicant responds to the office action mailed 9/6/95.

DENIED.

The petition lacks:

The required fee under 37 C.F.R. §§1.97(d) and 1.17(i)(1).

A proper certification as specified in 37 C.F.R. §§1.97(d) and 1.97(e).

The information disclosure statement has been placed of record in the file but will not be considered by the examiner.

  
**TOMMY P. CHIN**  
SUPERVISORY PATENT EXAMINER  
GROUP 2600

<b>Interview Summary</b>	Application No. <b>08/105,304</b>	Applicant(s) <b>Lemelson et al</b>	
	Examiner <b>A. Au</b>	Group Art Unit <b>2615</b>	

All participants (applicant, applicant's representative, PTO personnel):

(1) A. Au (PTO) (3) \_\_\_\_\_

(2) Louis J. Hoffman (4) \_\_\_\_\_

Date of Interview Mar 18, 1997

Type:  Telephonic  Personal (copy is given to  applicant  applicant's representative).

Exhibit shown or demonstration conducted:  Yes  No. If yes, brief description:  
 \_\_\_\_\_  
 \_\_\_\_\_

Agreement  was reached.  was not reached.

Claim(s) discussed: \_\_\_\_\_

Identification of prior art discussed:  
 \_\_\_\_\_  
 \_\_\_\_\_

Description of the general nature of what was agreed to if an agreement was reached, or any other comments:  
In response to examiner's earlier inquiry concerning the status of the application, applicant called to inform examiner that no response or appeal will be filed for the present application, and the case will be abandoned.  
 \_\_\_\_\_  
 \_\_\_\_\_  
 \_\_\_\_\_  
 \_\_\_\_\_  
 \_\_\_\_\_

(A fuller description, if necessary, and a copy of the amendments, if available, which the examiner agreed would render the claims allowable must be attached. Also, where no copy of the amendments which would render the claims allowable is available, a summary thereof must be attached.)

1.  It is not necessary for applicant to provide a separate record of the substance of the interview.

Unless the paragraph above has been checked to indicate to the contrary, A FORMAL WRITTEN RESPONSE TO THE LAST OFFICE ACTION IS NOT WAIVED AND MUST INCLUDE THE SUBSTANCE OF THE INTERVIEW. (See MPEP Section 713.04). If a response to the last Office action has already been filed, APPLICANT IS GIVEN ONE MONTH FROM THIS INTERVIEW DATE TO FILE A STATEMENT OF THE SUBSTANCE OF THE INTERVIEW.

2.  Since the Examiner's interview summary above (including any attachments) reflects a complete response to each of the objections, rejections and requirements that may be present in the last Office action, and since the claims are now allowable, this completed form is considered to fulfill the response requirements of the last Office action. Applicant is not relieved from providing a separate record of the interview unless box 1 above is also checked.

Examiner Note: You must sign and stamp this form unless it is an attachment to a signed Office action.



**UNITED STATES DEPARTMENT OF COMMERCE**  
**Patent and Trademark Office**  
 Address: COMMISSIONER OF PATENTS AND TRADEMARKS  
 Washington, D.C. 20231

087117/97	08/11/97	LEWELSON	J
APPLICATION NUMBER	FILING DATE	FIRST NAMED APPLICANT	ATTORNEY DOCKET NO.

E3M1/0331

LOUIS J. HOFFMAN, P.C.  
 15150 NORTH HAYDEN ROAD  
 SUITE 202  
 SCOTTSDALE AZ 85260

AU, A	EXAMINER
-------	----------

AFUNP	PAPER NUMBER
-------	--------------

03 <sup>24</sup> / 97

DATE MAILED:

**NOTICE OF ABANDONMENT**

This application is abandoned in view of:

- Applicant's failure to timely file a proper response to the Office letter mailed on \_\_\_\_\_.
- A response (with a Certificate of Mailing or Transmission of \_\_\_\_\_) was received on \_\_\_\_\_, which is after the expiration of the period for response (including a total extension of time of \_\_\_\_\_ month(s)) which expired on \_\_\_\_\_.
- A proposed response was received on \_\_\_\_\_, but it does not constitute a proper response to the final rejection.  
 (A proper response to a final rejection consists only of: a timely filed amendment which places the application in condition for allowance; a Notice of Appeal; or the filing of a continuing application under 37 CFR 1.62 (FWC).
- No response has been received.
- Applicant's failure to timely pay the required issue fee within the statutory period of three months from the mailing date of the Notice of Allowance.
  - The issue fee (with a Certificate of Mailing or Transmission of \_\_\_\_\_) was received on \_\_\_\_\_.
  - The submitted issue fee of \$ \_\_\_\_\_ is insufficient. The issue fee required by 37 CFR 1.18 is \$ \_\_\_\_\_.
  - The issue fee has not been received.
- Applicant's failure to timely file new formal drawings as required in the Notice of Allowability.
  - Proposed new formal drawings (with a Certificate of Mailing or Transmission of \_\_\_\_\_) were received on \_\_\_\_\_.
  - The proposed new formal drawings filed \_\_\_\_\_ are not acceptable.
  - No proposed new formal drawings have been received.
- The express abandonment under 37 CFR 1.62(g) in favor of the FWC application filed on \_\_\_\_\_.
- The letter of express abandonment which is signed by the attorney or agent of record, the assignee of the entire interest, or all of the applicants.
- The letter of express abandonment which is signed by an attorney or agent (acting in a representative capacity under 37 CFR 1.34(a) upon the filing of a continuing application.
- The decision by the Board of Patent Appeals and Interferences rendered on \_\_\_\_\_ and because the period for seeking court review of the decision has expired and there are no allowed claims.
- The reason(s) below: *As per telephone interview, applicant informed examiner that the application will be abandoned and no response will be filed.*

*Amelia Au*  
 AMELIA AU  
 PATENT EXAMINER  
 GROUP 2600

JUL 31 '97 03:57PM

P.2 ~~46~~  
#25

IN THE UNITED STATES PATENT AND TRADEMARK OFFICE

Applicant : Jerome H. Lemelson Art Unit : 2615  
Robert D. Pedersen  
Serial No. : 08/105,304 Examiner : Au  
Filed : 8/11/93  
Title : Motor Vehicle Warning and Control System and Method

---

Assistant Commissioner for Patents  
Washington, D.C. 20231

POWER TO INSPECT AND MAKE COPIES

Dear Sir:

Please permit Terry Kannofsky, Kathy VanAsperen, Cindy Pearsall, James M. Kannofsky, or any other representative of TK Associates to inspect and make copies in the above-captioned matter.

Respectfully submitted,

JEROME H. LEMELSON  
by his attorney



Dated: July 31, 1997

---

Louis J. Hoffman  
Reg. No. 38,918

LOUIS J. HOFFMAN, P.C.  
15150 North Hayden Road  
Suite 202  
Scottsdale, Arizona 85260  
(602) 948-3295

**PROCESSED BY**  
AUG 1 1997  
**FIU**

Under the Paperwork Reduction Act of 1995, no persons are required to respond to a collection of information unless it displays a valid OMB control number.

**REQUEST FOR ACCESS TO AN ABANDONED APPLICATION UNDER 37 CFR 1.14**

Bring completed form to: File Information Unit, Suite 3A20 2800 South Randolph Street Arlington, VA 22206  Telephone: (703) 756-1800	In re Application of	
	RECEIVED OCT 10 2012	Application Number 08/105,304
	Filed Aug. 11, 1993	Paper No. # 26

I hereby request access under 37 CFR 1.14(a)(1)(iv) to the application file record of the above-identified ABANDONED application, which is not within the file jacket of a pending Continued Prosecution Application (CPA) (37 CFR 1.53(d)) and which is identified in, or to which a benefit is claimed, in the following document (as shown in the attachment):

United States Patent Application Publication No. \_\_\_\_\_, page, \_\_\_\_\_ line \_\_\_\_\_  
 United States Patent Number 5983161, column \_\_\_\_\_, line \_\_\_\_\_  
 WIPO Pub. No. \_\_\_\_\_, page \_\_\_\_\_, line \_\_\_\_\_

**Related Information About Access to Applications Maintained in the Image File Wrapper System (IFW) and Access to Pending Applications in General**

A member of the public, acting without a power to inspect, cannot order applications maintained in the IFW system through the FIU. If the member of the public is entitled to a copy of the application file, then the file is made available through the Public Patent Application Information Retrieval system (Public PAIR) on the USPTO internet web site (www.uspto.gov). Terminals that allow access to Public PAIR are available in the Public Search Room. The member of the public may also be entitled to obtain a copy of all or part of the application file upon payment of the appropriate fee. Such copies must be purchased through the Office of Public Records upon payment of the appropriate fee (37 CFR 1.19(b)).

For published applications that are still pending, a member of the public may obtain a copy of:  
 the file contents; the pending application as originally filed; or any document in the file of the pending application.

For unpublished applications that are still pending:

- (1) If the benefit of the pending application is claimed under 35 U.S.C. 119(e), 120, 121, or 365 in another application that has: (a) issued as a U.S. patent, or (b) published as a statutory invention registration, a U.S. patent application publication, or an international patent application publication in accordance with PCT Article 21(2), a member of the public may obtain a copy of: the file contents; the pending application as originally filed; or any document in the file of the pending application.
- (2) If the application is incorporated by reference or otherwise identified in a U.S. patent, a statutory invention registration, a U.S. patent application publication, or an international patent application publication in accordance with PCT Article 21(2), a member of the public may obtain a copy of the pending application as originally filed.

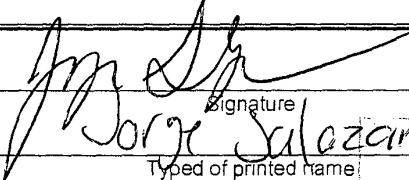
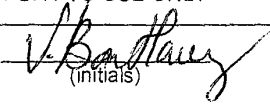
Signature 	Date 10-10-2012
Typed of printed name Jorge Salazar	FOR PTO USE ONLY Approved by:  (initials)
Registration Number, if applicable. (703) 553-0000	Unit: _____

This collection of information is required by 37 CFR 1.11 and 1.14. The information is required to obtain or retain a benefit by the public which is to file (and by the USPTO to process) an application. Confidentiality is governed by 35 U.S.C. 122 and 37 CFR 1.11 and 1.14. This collection is estimated to take 12 minutes to complete, including gathering, preparing, and submitting the completed application form to the USPTO. Time will vary depending upon the individual case. Any comments on the amount of time you require to complete this form and/or suggestions for reducing this burden, should be sent to the Chief Information Officer, U.S. Patent and Trademark Office, U.S. Department of Commerce, P.O. Box 1450, Alexandria, VA 22313-1450. DO NOT SEND FEES OR COMPLETED FORMS TO THIS ADDRESS. BRING TO: File Information Unit, Suite 3A20, 2800 South Randolph Street, Arlington, Virginia.

If you need assistance in completing the form, call 1-800-PTO-9199 and select option 2.



United States Patent [19]  
Lemelson et al.

[11] Patent Number: 5,983,161  
[45] Date of Patent: Nov. 9, 1999

- [54] GPS VEHICLE COLLISION AVOIDANCE WARNING AND CONTROL SYSTEM AND METHOD
- [76] Inventors: Jerome H. Lemelson, 930 Tahoe Blvd., Unit 802, Suite 286, Incline Village, Nev. 89451-9436; Robert D. Pedersen, 7808 Glenneagle, Dallas, Tex. 75248

[21] Appl. No.: 08/717,807  
[22] Filed: Sep. 24, 1996

Related U.S. Application Data

- [63] Continuation-in-part of application No. 08/105,304, Aug. 11, 1993, abandoned.
- [51] Int. Cl.<sup>6</sup> ..... G06F 165/00
- [52] U.S. Cl. .... 701/301; 701/27; 701/98; 701/214; 340/903; 340/436; 342/455
- [58] Field of Search ..... 701/23, 24, 27, 701/200, 213, 214, 93, 98, 300, 301; 340/903, 905, 435, 436; 342/29, 41, 454, 455; 180/167-170

[56] References Cited

U.S. PATENT DOCUMENTS

3,892,438	7/1975	Sauferer	356/4
4,257,703	3/1981	Goodrich	356/4

(List continued on next page.)

FOREIGN PATENT DOCUMENTS

4-15799	1/1992	Japan
4-219900	8/1992	Japan
5-124529	5/1993	Japan
5-143897	6/1993	Japan

OTHER PUBLICATIONS

Kitter, Josef, *Image Processing and System Architectures* (video). John Wiley & Sons, 1985.  
 Soucek, B. *Neural and Massively Parallel Computers*, John Wiley & Sons, pp. 245-273, New York, 1988.  
 Wasserman, Philip. *Neural Computing Theory and Practice*. Van Norstrand Reinhold, New York, 1989.

Teuber, Jan. *Digital Image Processing*. Prentice Hall, New York, 1993.  
 Suaya, Robert. *VLSI and Parallel Computation and Neural Networks*. Morgan Kaufmann Publishing, San Mateo, California, 1990.  
 Pearson, Don. *Image Processing*. McGraw-Hill, New York, 1991.  
 Carpenter, Gail. *Neural Networks for Vision and Image Processing*. MIT Press, Cambridge, Mass., 1992.

(List continued on next page.)

Primary Examiner—Gary Chin  
Attorney, Agent, or Firm—Steven G. Lisa

[57] ABSTRACT

GPS satellite (4) ranging signals (6) received (32) on comm1, and DGPS auxiliary range correction signals and pseudolite carrier phase ambiguity resolution signals (8) from a fixed known earth base station (10) received (34) on comm2, at one of a plurality of vehicles/aircraft/automobiles (2) are computer processed (36) to continuously determine the one's kinematic tracking position on a pathway (14) with centimeter accuracy. That GPS-based position is communicated with selected other status information to each other one of the plurality of vehicles (2), to the one station (10), and/or to one of a plurality of control centers (16), and the one vehicle receives therefrom each of the others' status information and kinematic tracking position. Objects (22) are detected from all directions (300) by multiple supplemental mechanisms, e.g., video (54), radar/lidar (56), laser and optical scanners. Data and information are computer processed and analyzed (50,52,200,452) in neural networks (132, FIGS. 6-8) in the one vehicle to identify, rank, and evaluate collision hazards/objects, an expert operating response to which is determined in a fuzzy logic associative memory (484) which generates control signals which actuate a plurality of control systems of the one vehicle in a coordinated manner to maneuver it laterally and longitudinally to avoid each collision hazard, or, for motor vehicles, when a collision is unavoidable, to minimize injury or damage therefrom. The operator is warned by a heads up display and other modes and may override. An automotive auto-pilot mode is provided.

44 Claims, 17 Drawing Sheets

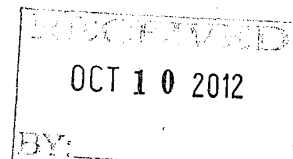
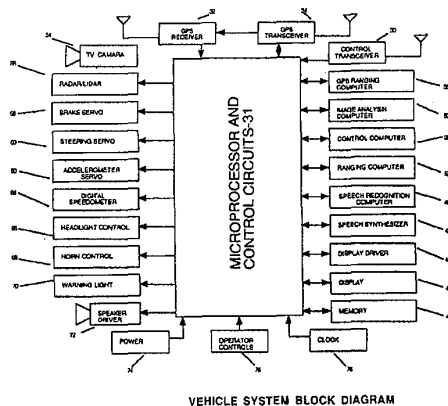



# APPLICATION TRANSFER REQUEST

4/7

**Section I. APPLICATION TRANSFER REQUEST** Date 5-19-94 S.N. 105,304

TO: Receiving A.U. Classification Class/sub \_\_\_\_\_ Examiner \_\_\_\_\_

FROM: Originating A.U. 2617 Class/sub 340/903 Examiner B. Quattrone

REASON: Claims pertain to computer processing, computer analyzing, fuzzy logic, neural network (cl. 17) and video scanning. Appears proper for 364-424.01, 424.02 or 436 or CL.348.

Request for Reconsideration (Return to Classification)

**Section II. DISPOSITION BY RECEIVING A.U.** Date \_\_\_\_\_ Ex'r \_\_\_\_\_

Accepted (keep in receiving A.U.)

Not Accepted  Forward to \_\_\_\_\_ Classification Group

Return to Originating A.U. \_\_\_\_\_ Nonclassification issue only:

REASON:

Restriction  
 Other

**Section III. DISPOSITION BY** C/E Classification Group. Date 6-13-94

Transfer Approved-Forward to A.U. 2615 Class/sub 348/113 Classifier Will Davis

Transfer Disapproved-Forward to Originating A.U. \_\_\_\_\_ Concurring J. Cranson

REASON:

Nonclassification issue raised:  Restriction  
 Other

*Accepted for Class 348.  
M 6/13/94*

## INDEX OF CLAIMS

Claim		Date			
Final	Original	1/20/95	2/1/95		
101		✓	✓		
102		✓	✓		
103		✓	✓		
104		✓	✓		
105		✓	✓		
106		✓	✓		
107		✓	✓		
108		✓	✓		
109		✓	✓		
110		✓	✓		
111		✓	✓		
112		✓	✓		
113		✓	✓		
114		✓	✓		
115		✓	✓		
115		✓	✓		
117		✓	✓		
(118)		✓	✓		
119			✓		
120			✓		
121			✓		
122			✓		
123			✓		
124			✓		
125			✓		
126			✓		
127			✓		
128			✓		
129			✓		
130			✓		
(131)			✓		
(132)			✓		
133			✓		
134			✓		
135			✓		
136			✓		
137			✓		
138			✓		
139			✓		
140			✓		
141			✓		
(142)			✓		
143			✓		
144			✓		
145			✓		
146			✓		
147			✓		
148			✓		
149			✓		
150			✓		

Claim		Date			
Final	Original	2/1/95			
151		✓			
152		✓			
153		✓			
154		✓			
155		✓			
(156)		✓			
(157)		✓			
158		✓			
159		✓			
160		✓			
161					
162					
163					
164					
165					
166					
167					
168					
169					
170					
171					
172					
173					
174					
175					
176					
177					
178					
179					
180					
181					
182					
183					
184					
185					
186					
187					
188					
189					
190					
191					
192					
193					
194					
195					
196					
197					
198					
199					
100					

- SYMBOLS
- ✓ ..... Rejected
  - = ..... Allowed
  - (Through numeral) ..... Canceled
  - + ..... Restricted
  - N ..... Non-elected
  - I ..... Interference
  - A ..... Appeal
  - O ..... Objected

(LEFT INSIDE)

<b>PATENT APPLICATION FEE DETERMINATION RECORD</b>						Application or Docket Number <b>105304</b>					
Effective October 1, 1992											
<b>CLAIMS AS FILED - PART I</b>						SMALL ENTITY		OR		OTHER THAN SMALL ENTITY	
		(Column 1)		(Column 2)							
FOR	NUMBER FILED		NUMBER EXTRA		RATE	FEE			RATE	FEE	
BASIC FEE						\$355.00	OR			\$710.00	
TOTAL CLAIMS	99	minus 20 = *	79		x\$11=	869	OR		x\$22=		
INDEPENDENT CLAIMS	11	minus 3 = *	8		x 37=	296	OR		x 74=		
MULTIPLE DEPENDENT CLAIM PRESENT						+115=	OR		+230=		
						TOTAL	1520	OR		TOTAL	
* If the difference in column 1 is less than zero, enter "0" in column 2											
<b>CLAIMS AS AMENDED - PART II</b>						SMALL ENTITY		OR		OTHER THAN SMALL ENTITY	
		(Column 1)		(Column 2)		(Column 3)					
<b>AMENDMENT A</b>		CLAIMS REMAINING AFTER AMENDMENT		HIGHEST NUMBER PREVIOUSLY PAID FOR	PRESENT EXTRA	RATE	ADDI-TIONAL FEE			RATE	ADDI-TIONAL FEE
	Total	* 99	Minus	** 99	=	x\$11=		OR		x\$22=	
	Independent	* 11	Minus	*** 11	=	x 37=		OR		x 74=	
	FIRST PRESENTATION OF MULTIPLE DEPENDENT CLAIM						+ 115=	OR		+ 230=	
						TOTAL		OR		TOTAL	
						ADDIT. FEE		OR		ADDIT. FEE	
<b>AMENDMENT B</b>		CLAIMS REMAINING AFTER AMENDMENT		HIGHEST NUMBER PREVIOUSLY PAID FOR	PRESENT EXTRA	RATE	ADDI-TIONAL FEE			RATE	ADDI-TIONAL FEE
	Total	*	Minus	**	=	x\$11=		OR		x\$22=	
	Independent	*	Minus	***	=	x 37=		OR		x 74=	
	FIRST PRESENTATION OF MULTIPLE DEPENDENT CLAIM						+ 115=	OR		+ 230=	
						TOTAL		OR		TOTAL	
						ADDIT. FEE		OR		ADDIT. FEE	
<b>AMENDMENT C</b>		CLAIMS REMAINING AFTER AMENDMENT		HIGHEST NUMBER PREVIOUSLY PAID FOR	PRESENT EXTRA	RATE	ADDI-TIONAL FEE			RATE	ADDI-TIONAL FEE
	Total	*	Minus	**	=	x\$11=		OR		x\$22=	
	Independent	*	Minus	***	=	x 37=		OR		x 74=	
	FIRST PRESENTATION OF MULTIPLE DEPENDENT CLAIM						+115=	OR		+230=	
						TOTAL		OR		TOTAL	
						ADDIT. FEE		OR		ADDIT. FEE	

PACE DATA ENTRY CODING SHEET

1ST EXAMINER *P. DAVALEY* DATE *9 8 93*

2ND EXAMINER \_\_\_\_\_ DATE \_\_\_\_\_

APPLICATION NUMBER **08 105304**

TYPE APPL  FILING DATE MONTH  DAY  YEAR  SPECIAL HANDLING  SHEETS OF DRAWING

GROUP ART UNIT CLASS

INDEPENDENT CLAIMS   SMALL ENTITY?  FILING FEE     FOREIGN LICENSE  ATTORNEY DOCKET NUMBER \_\_\_\_\_

CONTINUITY DATA

CONTINUITY CODE	STATUS CODE	PARENT APPLICATION SERIAL NUMBER	PARENT PATENT NUMBER	PARENT FILING DATE MONTH	PARENT FILING DATE DAY	PARENT FILING DATE YEAR
<input type="text"/>	<input type="text"/>	<input type="text"/>	<input type="text"/>	<input type="text"/>	<input type="text"/>	<input type="text"/>
<input type="text"/>	<input type="text"/>	<input type="text"/>	<input type="text"/>	<input type="text"/>	<input type="text"/>	<input type="text"/>
<input type="text"/>	<input type="text"/>	<input type="text"/>	<input type="text"/>	<input type="text"/>	<input type="text"/>	<input type="text"/>
<input type="text"/>	<input type="text"/>	<input type="text"/>	<input type="text"/>	<input type="text"/>	<input type="text"/>	<input type="text"/>

PCT/FOREIGN APPLICATION DATA

FOREIGN PRIORITY CLAIMED	COUNTRY CODE	PCT/FOREIGN APPLICATION SERIAL NUMBER	FOREIGN FILING DATE MONTH	FOREIGN FILING DATE DAY	FOREIGN FILING DATE YEAR
<input type="text"/>	<input type="text"/>	<input type="text"/>	<input type="text"/>	<input type="text"/>	<input type="text"/>
<input type="text"/>	<input type="text"/>	<input type="text"/>	<input type="text"/>	<input type="text"/>	<input type="text"/>
<input type="text"/>	<input type="text"/>	<input type="text"/>	<input type="text"/>	<input type="text"/>	<input type="text"/>
<input type="text"/>	<input type="text"/>	<input type="text"/>	<input type="text"/>	<input type="text"/>	<input type="text"/>

Staple Issue Slip Here

POSITION	ID NO.	DATE
CLASSIFIER	20	9/7/93
EXAMINER	340	9-8-93
TYPIST	18	9-14
VERIFIER	342	9-15
CORPS CORR.		
SPEC. HAND		
FILE MAINT.		
DRAFTING		

INDEX OF CLAIMS

Final	Claim		Date	
	Original			
	1	✓	8/20	8/25
	2	✓		
	3	✓		
	4	✓		
	5	✓		
	6	✓		
	7	✓		
	8	✓		
	9	✓		
	10	✓		
	11			
	12	✓		
	13	✓		
	14	✓		
	15			
	16			
	17			
	18			
	19			
	20	✓		
	31	✓		
	32	✓		
	33	✓		
	34	✓		
	35			
	36			
	37			
	38	✓		
	39	✓		
	40	✓		
	41			
	42			
	43	✓		
	44			
	45			
	46			
	47			
	48	✓		

Final	Claim		Date	
	Original			
	51			
	52			
	53	✓		
	54	✓		
	55	✓		
	56	✓		
	57	✓		
	58	✓		
	59	✓		
	60	✓		
	61	✓		
	62	✓		
	63			
	64			
	65	✓		
	66			
	67			
	68			
	69			
	70			
	71			
	72			
	73			
	74			
	75			
	76			
	77			
	78			
	79			
	80			
	81			
	82			
	83			
	84			
	85			
	86	✓		
	87			
	88			
	89			
	90			
	91	✓		
	92	✓		
	93			
	94			
	95			
	96			
	97			
	98			
	99	✓		
	100	✓		

SYMBOLS  
 ✓ ..... Rejected  
 = ..... Allowed  
 - (Through numeral) Canceled  
 + ..... Restricted  
 N ..... Non-elected  
 I ..... Interference  
 A ..... Appeal  
 O ..... Objected

(LEFT INSIDE)

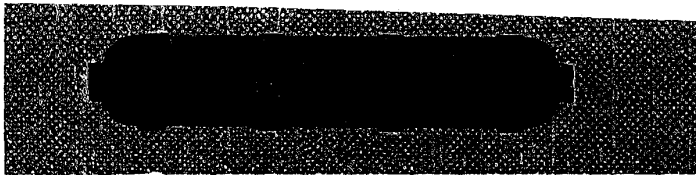

SEARCHED			
Class	Sub.	Date	Exmr.
348	148 149 113 118,119	1.9.95	APU
364	425.09 425.01 425.02 426.01		
340	903 435 692 937,905 436,961 460,		
395	905,913 900		
180	167,168 169,271 274,275		
364	436,437 443,460 461,		
382	update <del>300</del> 106,209	8.28.95	M

SEARCH NOTES		
	Date	Exmr.
Allen MacDonald 364/	1.9.95	APU
Thomas Black 364/		
Donnie Crossland 340/		
Andrew Johns Class 382	8.31.95	M

INTERFERENCE SEARCHED			
Class	Sub.	Date	Exmr.

(RIGHT OUTSIDE)

08 105304



APPROVED FOR LICENSE

INDEXED 080328

Date Entered or Counted

CONTENTS

Date Received or Mailed

ABANDONED

Date Entered or Counted	Description	Date Received or Mailed	Other
	1. Application <sup>RWM</sup> <u>Pnts</u> papers.		
	2. Restriction (30 days)	9-7-94	9/6
	3. Power of Attorney	9/20/94	
	4. Power to Inspect	9-26-94	
	5. Reg Ext time ① Ammt A	11-14-94	
1-23-95	6. Rej. (3mes)	1-26-95gm	
	7. PRIOR ART + Refs.	6-26-95	:
✓	8. Ammt B Reg Ext time ②	6-26-95	:
	9. Drawing Changes	6-26-95	
	10. Power of Attorney	6-26-95	
	11. Final Rej. 3 months.	9-6-95	9/5
	12. Reg Ext time ② Ammt C & 2	1-30-96	
	13. Interview Summary	2-8-96	
02-20-96	14. Advisory Action	2-20-96	
	15. Declaration	2-26-96	
4-15-96	16. <del>Letter</del> Noticing Appeal	4-3-96	
	17. Petition R. 137b	4-3-96	
	18. <sup>IDS + Refs.</sup> Petition dismissed	5-6-96	5-30-96
	19. Petition 1.137(b)	6-5-96	
	20. Pat granted 1.137(b) <sup>30</sup>	9-13-96	
10-9-96	21. Advisory Action	10-11-96	
	22. Letter	3-18-97	
	23. interview summary	3-18-97	
	24. Notice of abandonment	3-31-97 M.A.	
	25. Power to Inspect	8-4-97	
	26. Request For Access	10/10/12	
	27.		
	28.		
	29.		
	30.		
	31.		
	32.		

(FRONT)