

IPR2014-00579

Introduction

- **U.S. Patent No. 7,104,347**
- **Ground 1 (§ 103):**
 - **Challenged claims: 1, 7, 8, 18, 21, 23, 37**
 - **Asserted Art: Bumby I, II, III, IV, V (collectively, “the Bumby references”)**

Introduction to the '347 Patent

- '347 Patent (Ex. 1101) is directed to hybrid vehicles and control systems thereof
- The '347 patent recognized that the "vehicle operational mode in response to preferably be controlled in response to the vehicle's actual torque requirements, i.e., the road load."
- Use of "road load" according to the patent provides "superior performance, in terms of both vehicle response to operator commands and fuel efficiency, under the widely varying conditions encountered in 'real world' driving situations."



(10) Patent No.: **US 7,104,347 B2**
 (45) Date of Patent: **Sep. 12, 2006**

FOREIGN PATENT DOCUMENTS

DE	10 197 5
DE	198 744
DE	198 744
DE	198 146 2
DE	3 198
DE	193 88 5
EP	0 136 6 5
EP	3 198
EP	5 188
EP	10 192
EP	0 136 6 5
EP	5 196
EP	0 24 2 1
EP	0 76 94 3
EP	4 197

OTHER PUBLICATIONS

Simpkins, "Electric Vehicles", *Road & Track*, May 1992, pp. 126-129.

Kopylov, "AC Propulsion CRX", *Road & Track*, Oct. 1992, pp. 126-129.

Kubertsh, "Electric Hybrid Drive Systems . . .", SAE Paper No. 910247, 1991.

REFERENCES CITED

U.S. Pat. Nos. 5,188, 5,192, 5,196, 5,198, 5,200, 5,202, 5,204, 5,206, 5,208, 5,210, 5,212, 5,214, 5,216, 5,218, 5,220, 5,222, 5,224, 5,226, 5,228, 5,230, 5,232, 5,234, 5,236, 5,238, 5,240, 5,242, 5,244, 5,246, 5,248, 5,250, 5,252, 5,254, 5,256, 5,258, 5,260, 5,262, 5,264, 5,266, 5,268, 5,270, 5,272, 5,274, 5,276, 5,278, 5,280, 5,282, 5,284, 5,286, 5,288, 5,290, 5,292, 5,294, 5,296, 5,298, 5,300, 5,302, 5,304, 5,306, 5,308, 5,310, 5,312, 5,314, 5,316, 5,318, 5,320, 5,322, 5,324, 5,326, 5,328, 5,330, 5,332, 5,334, 5,336, 5,338, 5,340, 5,342, 5,344, 5,346, 5,348, 5,350, 5,352, 5,354, 5,356, 5,358, 5,360, 5,362, 5,364, 5,366, 5,368, 5,370, 5,372, 5,374, 5,376, 5,378, 5,380, 5,382, 5,384, 5,386, 5,388, 5,390, 5,392, 5,394, 5,396, 5,398, 5,400, 5,402, 5,404, 5,406, 5,408, 5,410, 5,412, 5,414, 5,416, 5,418, 5,420, 5,422, 5,424, 5,426, 5,428, 5,430, 5,432, 5,434, 5,436, 5,438, 5,440, 5,442, 5,444, 5,446, 5,448, 5,450, 5,452, 5,454, 5,456, 5,458, 5,460, 5,462, 5,464, 5,466, 5,468, 5,470, 5,472, 5,474, 5,476, 5,478, 5,480, 5,482, 5,484, 5,486, 5,488, 5,490, 5,492, 5,494, 5,496, 5,498, 5,500, 5,502, 5,504, 5,506, 5,508, 5,510, 5,512, 5,514, 5,516, 5,518, 5,520, 5,522, 5,524, 5,526, 5,528, 5,530, 5,532, 5,534, 5,536, 5,538, 5,540, 5,542, 5,544, 5,546, 5,548, 5,550, 5,552, 5,554, 5,556, 5,558, 5,560, 5,562, 5,564, 5,566, 5,568, 5,570, 5,572, 5,574, 5,576, 5,578, 5,580, 5,582, 5,584, 5,586, 5,588, 5,590, 5,592, 5,594, 5,596, 5,598, 5,600, 5,602, 5,604, 5,606, 5,608, 5,610, 5,612, 5,614, 5,616, 5,618, 5,620, 5,622, 5,624, 5,626, 5,628, 5,630, 5,632, 5,634, 5,636, 5,638, 5,640, 5,642, 5,644, 5,646, 5,648, 5,650, 5,652, 5,654, 5,656, 5,658, 5,660, 5,662, 5,664, 5,666, 5,668, 5,670, 5,672, 5,674, 5,676, 5,678, 5,680, 5,682, 5,684, 5,686, 5,688, 5,690, 5,692, 5,694, 5,696, 5,698, 5,700, 5,702, 5,704, 5,706, 5,708, 5,710, 5,712, 5,714, 5,716, 5,718, 5,720, 5,722, 5,724, 5,726, 5,728, 5,730, 5,732, 5,734, 5,736, 5,738, 5,740, 5,742, 5,744, 5,746, 5,748, 5,750, 5,752, 5,754, 5,756, 5,758, 5,760, 5,762, 5,764, 5,766, 5,768, 5,770, 5,772, 5,774, 5,776, 5,778, 5,780, 5,782, 5,784, 5,786, 5,788, 5,790, 5,792, 5,794, 5,796, 5,798, 5,800, 5,802, 5,804, 5,806, 5,808, 5,810, 5,812, 5,814, 5,816, 5,818, 5,820, 5,822, 5,824, 5,826, 5,828, 5,830, 5,832, 5,834, 5,836, 5,838, 5,840, 5,842, 5,844, 5,846, 5,848, 5,850, 5,852, 5,854, 5,856, 5,858, 5,860, 5,862, 5,864, 5,866, 5,868, 5,870, 5,872, 5,874, 5,876, 5,878, 5,880, 5,882, 5,884, 5,886, 5,888, 5,890, 5,892, 5,894, 5,896, 5,898, 5,900, 5,902, 5,904, 5,906, 5,908, 5,910, 5,912, 5,914, 5,916, 5,918, 5,920, 5,922, 5,924, 5,926, 5,928, 5,930, 5,932, 5,934, 5,936, 5,938, 5,940, 5,942, 5,944, 5,946, 5,948, 5,950, 5,952, 5,954, 5,956, 5,958, 5,960, 5,962, 5,964, 5,966, 5,968, 5,970, 5,972, 5,974, 5,976, 5,978, 5,980, 5,982, 5,984, 5,986, 5,988, 5,990, 5,992, 5,994, 5,996, 5,998, 6,000, 6,002, 6,004, 6,006, 6,008, 6,010, 6,012, 6,014, 6,016, 6,018, 6,020, 6,022, 6,024, 6,026, 6,028, 6,030, 6,032, 6,034, 6,036, 6,038, 6,040, 6,042, 6,044, 6,046, 6,048, 6,050, 6,052, 6,054, 6,056, 6,058, 6,060, 6,062, 6,064, 6,066, 6,068, 6,070, 6,072, 6,074, 6,076, 6,078, 6,080, 6,082, 6,084, 6,086, 6,088, 6,090, 6,092, 6,094, 6,096, 6,098, 6,100, 6,102, 6,104, 6,106, 6,108, 6,110, 6,112, 6,114, 6,116, 6,118, 6,120, 6,122, 6,124, 6,126, 6,128, 6,130, 6,132, 6,134, 6,136, 6,138, 6,140, 6,142, 6,144, 6,146, 6,148, 6,150, 6,152, 6,154, 6,156, 6,158, 6,160, 6,162, 6,164, 6,166, 6,168, 6,170, 6,172, 6,174, 6,176, 6,178, 6,180, 6,182, 6,184, 6,186, 6,188, 6,190, 6,192, 6,194, 6,196, 6,198, 6,200, 6,202, 6,204, 6,206, 6,208, 6,210, 6,212, 6,214, 6,216, 6,218, 6,220, 6,222, 6,224, 6,226, 6,228, 6,230, 6,232, 6,234, 6,236, 6,238, 6,240, 6,242, 6,244, 6,246, 6,248, 6,250, 6,252, 6,254, 6,256, 6,258, 6,260, 6,262, 6,264, 6,266, 6,268, 6,270, 6,272, 6,274, 6,276, 6,278, 6,280, 6,282, 6,284, 6,286, 6,288, 6,290, 6,292, 6,294, 6,296, 6,298, 6,300, 6,302, 6,304, 6,306, 6,308, 6,310, 6,312, 6,314, 6,316, 6,318, 6,320, 6,322, 6,324, 6,326, 6,328, 6,330, 6,332, 6,334, 6,336, 6,338, 6,340, 6,342, 6,344, 6,346, 6,348, 6,350, 6,352, 6,354, 6,356, 6,358, 6,360, 6,362, 6,364, 6,366, 6,368, 6,370, 6,372, 6,374, 6,376, 6,378, 6,380, 6,382, 6,384, 6,386, 6,388, 6,390, 6,392, 6,394, 6,396, 6,398, 6,400, 6,402, 6,404, 6,406, 6,408, 6,410, 6,412, 6,414, 6,416, 6,418, 6,420, 6,422, 6,424, 6,426, 6,428, 6,430, 6,432, 6,434, 6,436, 6,438, 6,440, 6,442, 6,444, 6,446, 6,448, 6,450, 6,452, 6,454, 6,456, 6,458, 6,460, 6,462, 6,464, 6,466, 6,468, 6,470, 6,472, 6,474, 6,476, 6,478, 6,480, 6,482, 6,484, 6,486, 6,488, 6,490, 6,492, 6,494, 6,496, 6,498, 6,500, 6,502, 6,504, 6,506, 6,508, 6,510, 6,512, 6,514, 6,516, 6,518, 6,520, 6,522, 6,524, 6,526, 6,528, 6,530, 6,532, 6,534, 6,536, 6,538, 6,540, 6,542, 6,544, 6,546, 6,548, 6,550, 6,552, 6,554, 6,556, 6,558, 6,560, 6,562, 6,564, 6,566, 6,568, 6,570, 6,572, 6,574, 6,576, 6,578, 6,580, 6,582, 6,584, 6,586, 6,588, 6,590, 6,592, 6,594, 6,596, 6,598, 6,600, 6,602, 6,604, 6,606, 6,608, 6,610, 6,612, 6,614, 6,616, 6,618, 6,620, 6,622, 6,624, 6,626, 6,628, 6,630, 6,632, 6,634, 6,636, 6,638, 6,640, 6,642, 6,644, 6,646, 6,648, 6,650, 6,652, 6,654, 6,656, 6,658, 6,660, 6,662, 6,664, 6,666, 6,668, 6,670, 6,672, 6,674, 6,676, 6,678, 6,680, 6,682, 6,684, 6,686, 6,688, 6,690, 6,692, 6,694, 6,696, 6,698, 6,700, 6,702, 6,704, 6,706, 6,708, 6,710, 6,712, 6,714, 6,716, 6,718, 6,720, 6,722, 6,724, 6,726, 6,728, 6,730, 6,732, 6,734, 6,736, 6,738, 6,740, 6,742, 6,744, 6,746, 6,748, 6,750, 6,752, 6,754, 6,756, 6,758, 6,760, 6,762, 6,764, 6,766, 6,768, 6,770, 6,772, 6,774, 6,776, 6,778, 6,780, 6,782, 6,784, 6,786, 6,788, 6,790, 6,792, 6,794, 6,796, 6,798, 6,800, 6,802, 6,804, 6,806, 6,808, 6,810, 6,812, 6,814, 6,816, 6,818, 6,820, 6,822, 6,824, 6,826, 6,828, 6,830, 6,832, 6,834, 6,836, 6,838, 6,840, 6,842, 6,844, 6,846, 6,848, 6,850, 6,852, 6,854, 6,856, 6,858, 6,860, 6,862, 6,864, 6,866, 6,868, 6,870, 6,872, 6,874, 6,876, 6,878, 6,880, 6,882, 6,884, 6,886, 6,888, 6,890, 6,892, 6,894, 6,896, 6,898, 6,900, 6,902, 6,904, 6,906, 6,908, 6,910, 6,912, 6,914, 6,916, 6,918, 6,920, 6,922, 6,924, 6,926, 6,928, 6,930, 6,932, 6,934, 6,936, 6,938, 6,940, 6,942, 6,944, 6,946, 6,948, 6,950, 6,952, 6,954, 6,956, 6,958, 6,960, 6,962, 6,964, 6,966, 6,968, 6,970, 6,972, 6,974, 6,976, 6,978, 6,980, 6,982, 6,984, 6,986, 6,988, 6,990, 6,992, 6,994, 6,996, 6,998, 7,000, 7,002, 7,004, 7,006, 7,008, 7,010, 7,012, 7,014, 7,016, 7,018, 7,020, 7,022, 7,024, 7,026, 7,028, 7,030, 7,032, 7,034, 7,036, 7,038, 7,040, 7,042, 7,044, 7,046, 7,048, 7,050, 7,052, 7,054, 7,056, 7,058, 7,060, 7,062, 7,064, 7,066, 7,068, 7,070, 7,072, 7,074, 7,076, 7,078, 7,080, 7,082, 7,084, 7,086, 7,088, 7,090, 7,092, 7,094, 7,096, 7,098, 7,100, 7,102, 7,104, 7,106, 7,108, 7,110, 7,112, 7,114, 7,116, 7,118, 7,120, 7,122, 7,124, 7,126, 7,128, 7,130, 7,132, 7,134, 7,136, 7,138, 7,140, 7,142, 7,144, 7,146, 7,148, 7,150, 7,152, 7,154, 7,156, 7,158, 7,160, 7,162, 7,164, 7,166, 7,168, 7,170, 7,172, 7,174, 7,176, 7,178, 7,180, 7,182, 7,184, 7,186, 7,188, 7,190, 7,192, 7,194, 7,196, 7,198, 7,200, 7,202, 7,204, 7,206, 7,208, 7,210, 7,212, 7,214, 7,216, 7,218, 7,220, 7,222, 7,224, 7,226, 7,228, 7,230, 7,232, 7,234, 7,236, 7,238, 7,240, 7,242, 7,244, 7,246, 7,248, 7,250, 7,252, 7,254, 7,256, 7,258, 7,260, 7,262, 7,264, 7,266, 7,268, 7,270, 7,272, 7,274, 7,276, 7,278, 7,280, 7,282, 7,284, 7,286, 7,288, 7,290, 7,292, 7,294, 7,296, 7,298, 7,300, 7,302, 7,304, 7,306, 7,308, 7,310, 7,312, 7,314, 7,316, 7,318, 7,320, 7,322, 7,324, 7,326, 7,328, 7,330, 7,332, 7,334, 7,336, 7,338, 7,340, 7,342, 7,344, 7,346, 7,348, 7,350, 7,352, 7,354, 7,356, 7,358, 7,360, 7,362, 7,364, 7,366, 7,368, 7,370, 7,372, 7,374, 7,376, 7,378, 7,380, 7,382, 7,384, 7,386, 7,388, 7,390, 7,392, 7,394, 7,396, 7,398, 7,400, 7,402, 7,404, 7,406, 7,408, 7,410, 7,412, 7,414, 7,416, 7,418, 7,420, 7,422, 7,424, 7,426, 7,428, 7,430, 7,432, 7,434, 7,436, 7,438, 7,440, 7,442, 7,444, 7,446, 7,448, 7,450, 7,452, 7,454, 7,456, 7,458, 7,460, 7,462, 7,464, 7,466, 7,468, 7,470, 7,472, 7,474, 7,476, 7,478, 7,480, 7,482, 7,484, 7,486, 7,488, 7,490, 7,492, 7,494, 7,496, 7,498, 7,500, 7,502, 7,504, 7,506, 7,508, 7,510, 7,512, 7,514, 7,516, 7,518, 7,520, 7,522, 7,524, 7,526, 7,528, 7,530, 7,532, 7,534, 7,536, 7,538, 7,540, 7,542, 7,544, 7,546, 7,548, 7,550, 7,552, 7,554, 7,556, 7,558, 7,560, 7,562, 7,564, 7,566, 7,568, 7,570, 7,572, 7,574, 7,576, 7,578, 7,580, 7,582, 7,584, 7,586, 7,588, 7,590, 7,592, 7,594, 7,596, 7,598, 7,600, 7,602, 7,604, 7,606, 7,608, 7,610, 7,612, 7,614, 7,616, 7,618, 7,620, 7,622, 7,624, 7,626, 7,628, 7,630, 7,632, 7,634, 7,636, 7,638, 7,640, 7,642, 7,644, 7,646, 7,648, 7,650, 7,652, 7,654, 7,656, 7,658, 7,660, 7,662, 7,664, 7,666, 7,668, 7,670, 7,672, 7,674, 7,676, 7,678, 7,680, 7,682, 7,684, 7,686, 7,688, 7,690, 7,692, 7,694, 7,696, 7,698, 7,700, 7,702, 7,704, 7,706, 7,708, 7,710, 7,712, 7,714, 7,716, 7,718, 7,720, 7,722, 7,724, 7,726, 7,728, 7,730, 7,732, 7,734, 7,736, 7,738, 7,740, 7,742, 7,744, 7,746, 7,748, 7,750, 7,752, 7,754, 7,756, 7,758, 7,760, 7,762, 7,764, 7,766, 7,768, 7,770, 7,772, 7,774, 7,776, 7,778, 7,780, 7,782, 7,784, 7,786, 7,788, 7,790, 7,792, 7,794, 7,796, 7,798, 7,800, 7,802, 7,804, 7,806, 7,808, 7,810, 7,812, 7,814, 7,816, 7,818, 7,820, 7,822, 7,824, 7,826, 7,828, 7,830, 7,832, 7,834, 7,836, 7,838, 7,840, 7,842, 7,844, 7,846, 7,848, 7,850, 7,852, 7,854, 7,856, 7,858, 7,860, 7,862, 7,864, 7,866, 7,868, 7,870, 7,872, 7,874, 7,876, 7,878, 7,880, 7,882, 7,884, 7,886, 7,888, 7,890, 7,892, 7,894, 7,896, 7,898, 7,900, 7,902, 7,904, 7,906, 7,908, 7,910, 7,912, 7,914, 7,916, 7,918, 7,920, 7,922, 7,924, 7,926, 7,928, 7,930, 7,932, 7,934, 7,936, 7,938, 7,940, 7,942, 7,944, 7,946, 7,948, 7,950, 7,952, 7,954, 7,956, 7,958, 7,960, 7,962, 7,964, 7,966, 7,968, 7,970, 7,972, 7,974, 7,976, 7,978, 7,980, 7,982, 7,984, 7,986, 7,988, 7,990, 7,992, 7,994, 7,996, 7,998, 8,000, 8,002, 8,004, 8,006, 8,008, 8,010, 8,012, 8,014, 8,016, 8,018, 8,020, 8,022, 8,024, 8,026, 8,028, 8,030, 8,032, 8,034, 8,036, 8,038, 8,040, 8,042, 8,044, 8,046, 8,048, 8,050, 8,052, 8,054, 8,056, 8,058, 8,060, 8,062, 8,064, 8,066, 8,068, 8,070, 8,072, 8,074, 8,076, 8,078, 8,080, 8,082, 8,084, 8,086, 8,088, 8,090, 8,092, 8,094, 8,096, 8,098, 8,100, 8,102, 8,104, 8,106, 8,108, 8,110, 8,112, 8,114, 8,116, 8,118, 8,120, 8,122, 8,124, 8,126, 8,128, 8,130, 8,132, 8,134, 8,136, 8,138, 8,140, 8,142, 8,144, 8,146, 8,148, 8,150, 8,152, 8,154, 8,156, 8,158, 8,160, 8,162, 8,164, 8,166, 8,168, 8,170, 8,172, 8,174, 8,176, 8,178, 8,180, 8,182, 8,184, 8,186, 8,188, 8,190, 8,192, 8,194, 8,196, 8,198, 8,200, 8,202, 8,204, 8,206, 8,208, 8,210, 8,212, 8,214, 8,216, 8,218, 8,220, 8,222, 8,224, 8,226, 8,228, 8,230, 8,232, 8,234, 8,236, 8,238, 8,240, 8,242, 8,244, 8,246, 8,248, 8,250, 8,252, 8,254, 8,256, 8,258, 8,260, 8,262, 8,264, 8,266, 8,268, 8,270, 8,272, 8,274, 8,276, 8,278, 8,280, 8,282, 8,284, 8,286, 8,288, 8,290, 8,292, 8,294, 8,296, 8,298, 8,300, 8,302, 8,304, 8,306, 8,308, 8,310, 8,312, 8,314, 8,316, 8,318, 8,320, 8,322, 8,324, 8,326, 8,328, 8,330, 8,332, 8,334, 8,336, 8,338, 8,340, 8,342, 8,344, 8,346, 8,348, 8,350, 8,352, 8,354, 8,356, 8,358, 8,360, 8,362, 8,364, 8,366, 8,368, 8,370, 8,372, 8,374, 8,376, 8,378, 8,380, 8,382, 8,384, 8,386, 8,388, 8,390, 8,392, 8,394, 8,396, 8,398, 8,400, 8,402, 8,404, 8,406, 8,408, 8,410, 8,412, 8,414, 8,416, 8,418, 8,420, 8,422, 8,424, 8,426, 8,428, 8,430, 8,432, 8,43

Introduction to the '347 Patent

- Independent claim 1 turns the engine on “when torque require[d] to be produced by said engine to propel the vehicle and/or to drive either one or both said electric motor(s) to charge said battery is at least equal to a setpoint (SP) .
- Dependent claim 7 recites a “vehicle [that] is operating in a plurality of operating modes responsive to the value for the road load (RL) and said setpoint SP.”
- Independent claim 23 similarly recites selecting various operating modes by comparing the “road load” to a “setpoint.”



US007104347B2
 (10) Patent No.: US 7,104,347 B2
 (45) Date of Patent: Sep. 12, 2006

(64) HYBRID VEHICLES
 (75) Inventors: Alex J. Severinsky, Washington, DC (US); Theodore Loncker, Holly, MI (US)
 (73) Assignee: Pace LLC, Boca Raton, FL (US)
 (*) Notice: Subject to any disclaimer, the term of this patent is extended or adjusted under 35 U.S.C. 154(b) by 265 days.

(21) Appl. No.: 10/982,577
 (22) Filed: Mar. 7, 2003
 (65) Prior Publication Data
 US 2003/021876 A1 Nov. 27, 2003

Related U.S. Application Data
 Division of application No. 09/822,866, filed on Apr. 2, 2001, which is a continuation-in-part of application No. 09/392,743, filed on Sep. 30, 1999, which is a continuation-in-part of application No. 09/254,817, filed on Mar. 9, 1999, now Pat. No. 6,329,672.
 Division of application No. 60/132,286, filed on Mar. 1, 1999, and provisional application No. 60/100,075, filed on Sep. 14, 1998.

(31) Int. Cl.
 B60K 6/02 (2006.01)
 (52) U.S. Cl.
 180/65.2; 180/65.4; 701/54
 (58) Field of Classification Search
 180/65.3; 65.4; 65.8; 165; 60/706; 711; 716; 60718; 20017; 40 R; 40 C; 32216; 4772.
 See application file for complete search history.

References Cited
 U.S. PATENT DOCUMENTS
 913,846 A 3/1959 Paper
 1,824,014 A 9/1931 Foshich
 2,666,692 A 1/1954 Sims et al.
 (Continued)

FOREIGN PATENT DOCUMENTS
 DE 10 097,519
 DE 1997,441
 DE 1981,462 3/1998
 DE 1933,853 8/1998
 EP 0136,655 3/1985
 EP 510,882 10/1992
 EP 0136,655 3/1985
 EP 024,211 5/1996
 EP 076,943 4/1977
 (Continued)

OTHER PUBLICATIONS
 Simonsick, “Electric Vehicles”, *Road & Track*, May 1992, pp. 126-129.
 Royakids, “AC Propulsion CRX”, *Road & Track*, Oct. 1992, pp. 126-129.
 Kubertsh, “Electric Hybrid Drive Systems . . .”, SAE Paper No. 910247, 1991.
 (Continued)

ABSTRACT
 (57) A hybrid vehicle comprises an internal combustion engine, a traction motor, a starter motor, and a battery bank, all controlled by a microprocessor in accordance with the vehicle's operating mode. The microprocessor is configured not only under conditions of high efficiency, typically only when the load is at least equal to 30% of the engine's maximum torque output. In some embodiments, a turbo-charger may be provided, activated only when the load is above a predetermined threshold. In some embodiments, an extended period, a two-speed transmission may further be provided, to further broaden the vehicle's load range. A hybrid brake system provides regenerative braking, with mechanical braking available in the event the battery bank is fully charged. In some embodiments, a brake system mechanism is provided to control the brake system to provide linear brake feel under varying circumstances.

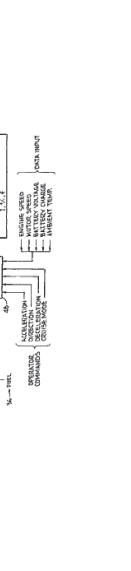

41 Claims, 17 Drawing Sheets

Introduction to the '347 Patent

employing said at least one electric motor to propel said vehicle when the torque RL required to do so is less than said lower level SP;

employing said engine to propel said vehicle when the torque RL required to do so is between said lower level SP and MTO;

'347 Patent, Claim 23

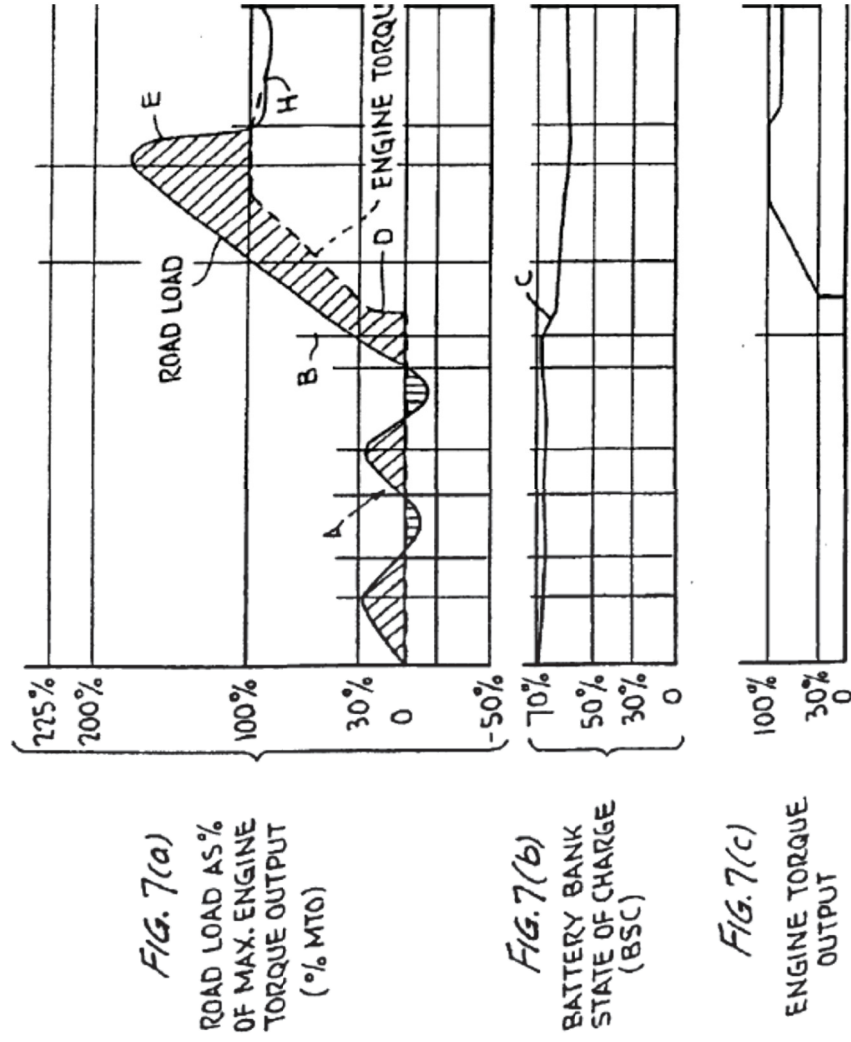
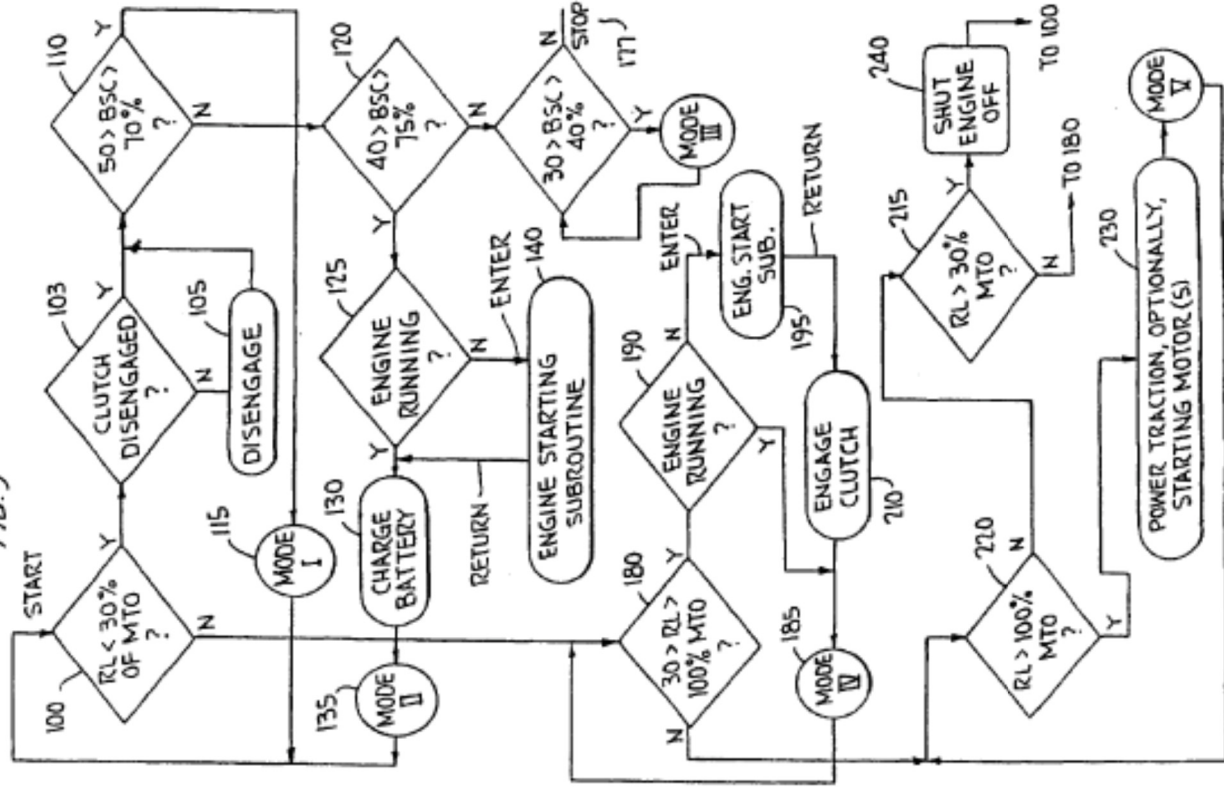

Fig. 9



'347 Patent, Fig. 7

'347 Patent, Fig. 9

Introduction to the Bumby references

- Ford relies on five different “Bumby references”: Bumby I, II, III, IV, and V (as Ford refers to them)
- Written by varying combinations of four different authors, with J.R. Bumby appearing as an author of each.
- Published over the course of five years in three different journals.

A hybrid internal combustion engine/battery electric passenger car for petroleum displacement

J. Kuster, MSc, PhD and J.R. Bumby, MSc, PhD, CHEM, MSEE
School of Engineering and Applied Science, University of Durham

This paper examines the potential of the hybrid electric vehicle in substituting petroleum fuel by fossil-based electrical energy. In particular a hybrid car is considered. The way in which the petroleum can be controlled and the effect component outputs have on achieving the petroleum displacement is discussed. It is shown that a hybrid vehicle can be controlled in a number of ways, but that of an environmentally sensitive area and yet be capable of a range at high and intermediate speeds that is limited only by the size of its fuel tank.

NOTATION

- E_c energy input to the i.c. engine (J)
- E_e energy input to the electric traction system (J)
- F objective function
- i_g gear ratio
- L_e energy weighting factor
- L_c electrical energy weighting factor
- x torque split ratio

1 INTRODUCTION

The disruption to the world's oil supplies that occurred in 1973 and 1978 helped focus international attention on the need to conserve energy. The oil crisis of 1973 also prompted the adoption of energy conservation policies and emphasized the need to transfer energy demands away from oil to other sources of energy, such as coal, gas, wind, solar, hydro, and nuclear power.

As a result of the oil crisis, many countries have implemented policies to reduce their dependence on petroleum products. In the United States, for example, the National Petroleum Council (NPC) has recommended that the total energy consumption be reduced by 50 to 60 per cent over the period 1973-85. Although such an energy transfer is feasible in many energy sectors, it is more difficult in the transport area, particularly in the case of passenger cars. The use of the rail system by the use of increased electrification but in the road sector such an energy transfer is more difficult. Consequently, the use of electric traction systems requires the energy source to be on-board the vehicle itself. Consequently, in the period 1973-85, the use of petroleum as the energy source for the road transport sector has increased from 12 to 39 per cent (1).

A transfer of energy from oil to electricity, with its associated advantages, is possible. The use of electric energy in the road transport sector is limited in extent in the road transport sector by the increased use of electric vehicles. However, such vehicles are limited in range due to the amount of energy that can be realistically stored in the battery. The range of such vehicles must be used in situations where daily use is well

defined, for example in urban delivery duty. Indeed, it is not clear that the use of electric energy in a passenger vehicle or milk float that relatively low performance electric traction drives have been traditionally applied with a great deal of success. Certainly the advantages of electric traction are likely to be realized with greater traffic compatibility in terms of speed and range. It is in such vehicles as the Freight Rover Sherpa and the Land Rover Defender that the advantages of electric performance electric drives have started to appear (2).

Although urban delivery vehicle applications will help to reduce the dependence of the road transport sector on petroleum, the use of electric energy in the passenger car market requires vehicles that are not limited in range and have a performance compatible with today's internal combustion (i.c.) engine vehicles. The use of electric energy in a passenger car is limited by the range limitation of electric vehicles is one possible solution. However, this would still result in a vehicle limited in range and may in itself create additional problems. The use of electric energy in a passenger car is limited by the energy, the charging time required will be greater than at present while the higher continuous rating of the electric traction system compared with today's vehicles will need careful attention.

The range limitations of the pure electric vehicle can be overcome by the use of a hybrid electric vehicle which incorporates both an i.c. engine and an electric traction system. Although such a vehicle can be designed to meet a number of end objectives, it has been suggested that the use of a hybrid electric vehicle to substitute a substantial amount of petroleum fuel by electrical energy in a passenger car would require the use of an all-electric mode under urban conditions and to use the electric mode for the majority of the driving cycle. The hybrid mode could then be used for extending urban range and/or improving vehicle acceleration performance on accelerator kick-downs.

The use of a hybrid electric vehicle capable of substituting petroleum fuel is not new. Bosch (4) and Volkswagen (5) having built vehicles in the 1970s. More

Proc Inst Mech Engrs Vol 202 No 10

0955-546X/88 \$2.00 + .00

© IMechE 1988

This MS received 17 April 1987 and was accepted for publication on 23 June 1987.

2338 © IMechE 1988

Introduction to the Bumby references

Bumby II (Ex. 1104)

Optimisation and control of a hybrid electric car

J.R. Bumby, BSc, PhD, CEng, MIEE
I. Forster, BSc, PhD

Indicating terms: Optimised control, Optimal

Abstract: The paper examines the potential of the hybrid electric vehicle in substituting petroleum fuel by broad-based electrical energy. In this paper, the authors describe the design of a hybrid electric passenger car. Two energy sources are identified, one for energy for substituting petroleum energy. The way in which the control system is designed and component rating are described. In the final part of the paper the optimised hybrid vehicle is described. The authors describe both IC engine and electric motor substitution design in further development.

1 Introduction

A hybrid vehicle can be defined as two or more energy storage devices connected to the road wheels through a transmission and a differential. In this paper, the hybrid is considered with energy being stored in an electric traction battery. The associated

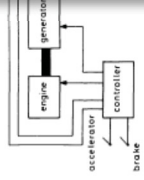

Fig. 1 Series hybrid electric vehicle

an internal combustion (IC) engine motor, respectively. To utilise the energy stored in the battery, it is necessary to convert it into a form suitable for driving the motor. In the series arrangement of Fig. 1, the energy is converted directly through an electric generator motor. Introducing a traction battery and motor buffers the engine

from the fluctuations of the road wheels. The authors are with the Department of Mechanical Engineering, South Devon, Science Laboratories, South Devon, Devon, UK.

IEE PROCEEDINGS, Vol. 114, Pt. D, No. 11, 1986

Bumby III (Ex. 1105)

31

A hybrid internal combustion engine/battery electric passenger car for petroleum displacement

I. Forster, BSc, PhD and J.R. Bumby, BSc, PhD, CEng, MIEE
School of Engineering and Applied Science, University of Durham

This paper examines the potential of the hybrid electric vehicle in substituting petroleum fuel by broad-based electrical energy. In this paper, the authors describe the design of a hybrid electric passenger car. Two energy sources are identified, one for energy for substituting petroleum energy. The way in which the control system is designed and component rating are described. In the final part of the paper the optimised hybrid vehicle is described. The authors describe both IC engine and electric motor substitution design in further development.

NOTATION

- E_1 energy input to the i.c. engine (J)
- E_2 energy input to the electric traction system (J)
- F objective function
- η gear ratio
- L_e electrical energy weighting factor
- L_m mechanical energy weighting factor
- x torque split ratio

1 INTRODUCTION

The difficulties in the world's oil supplies that occurred in 1973 and 1979, have led to a search for alternative energy sources upon the finite nature of this particular energy resource. It also prompted the adoption of energy conservation policies and emphasized the need to transfer energy demand away from oil to other sources of energy, such as coal, gas, wind, solar, and nuclear. The energy policies the inland deliveries of petroleum products, expressed as a percentage of the total energy consumed, dropped from 50 to 40 per cent over the period 1973-85 (1).

Although such an energy transfer is feasible in many energy sectors, it is more difficult in the transport area due to the operational requirements placed on many of the vehicles. Some energy transfer has been achieved in the rail system by the use of increased electrification but this is not a viable alternative in most road transport vehicles. The latter requires the energy store to be on-board the vehicle itself. Consequently, in the period 1973-85, the use of petroleum in the road transport sector, expressed as a percentage of the total energy consumed, dropped from 12 to 10 per cent (2).

A transfer of energy from oil to electricity, with its associated broad fuel base, can be achieved to a limited extent in the road transport sector by the increased use of electric vehicles. However such vehicles are limited in range and payload. As a consequence of this, electric vehicles must be used in situations where daily usage is well

The MS was received on 7 April 1987 and was accepted for publication on 21 August 1987.

2248 © IMEChE 1988

0885-1048/88 \$3.00 + .50

Downloaded from pib.sagepub.com at UNIV OF OTTAWA on June 21, 2014

FORD EXHIBIT 1105

- Bumby II
- Published in IEE Proceedings, Vol. 134, Pt. D (1987)
- J.R. Bumby, I. Forster

- Bumby III
- Published in Proceedings of the Institution of Mechanical Engineers, Vol. 202 No. D1 (1988)
- I. Forster, J.R. Bumby

- Bumby II and III disclose a "sub-optimal" control algorithm for a hybrid vehicle.

Introduction to the Bumby references

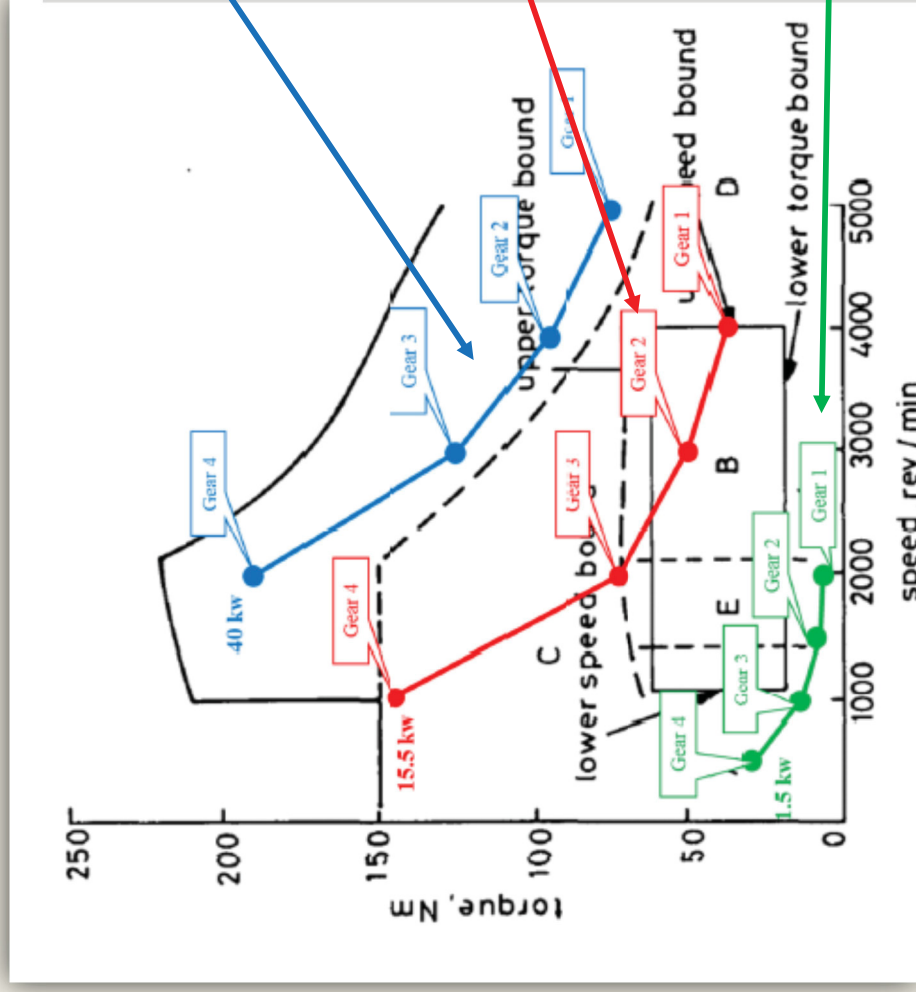

“[A]ll available gear ratios produce power at points above the box... the engine will be set to produce 90% of its maximum output, with the motor making up any additional output necessary to meet the driver’s demand power.”

Ex. 2102 at ¶ 94

“[B]ecause Gear 2 falls within the “box,” the “sub-optimal” control algorithm will select Gear 2 and operate the vehicle in engine-only mode.”

Ex. 2102 at ¶ 94

“[A]ll available gear ratios are to the left or below the “box,” and thus, the “sub-optimal” control algorithm would operate the vehicle in motor-only mode.”

Ex. 2102 at ¶ 94

Introduction to the Bumby references

Bumby IV (Ex. 1106)

A test-bed facility for hybrid i.c. engine/battery-electric road vehicle d

by J. R. Bumby, BSc, Ph
 This paper describes the design and construction of a test-bed facility for a hybrid i.c. engine/battery-electric road vehicle. The microprocessor control system is designed to allow the user to vary the engine speed and torque, the electric motor speed and torque, and the battery current. The system is capable of operating in a number of modes, including a constant speed mode, a constant torque mode, and a constant power mode. The system is also capable of operating in a closed-loop mode, where the engine speed and torque are controlled by a feedback loop. The system is designed to be used for the development and testing of control algorithms for hybrid vehicles.

Keywords: Hybrid electric automotive test-bed control.

List of symbols

- θ Final drive ratio
- θ_d Motor speed
- θ_d Motor speed
- ξ Damped frequency, rad/s
- ω_d Wheel rolling radius, m

1 Introduction

A hybrid electric vehicle is a vehicle which uses both an internal combustion engine and an electric motor to provide propulsion. The internal combustion engine is used to provide the majority of the propulsion, while the electric motor is used to provide additional propulsion when needed. The electric motor is also used to provide regenerative braking, where the kinetic energy of the vehicle is converted into electrical energy and stored in the battery. The hybrid electric vehicle is a more efficient and environmentally friendly mode of transport than a conventional internal combustion engine vehicle.

*School of Engineering and Applied Sciences, University of Durham, South Road, Durham, England.

Trans Inst M C Vol 10, No 2, April 1988

Page 2 of 12

Bumby V (Ex. 1107)

Integrated microprocessor control of a hybrid i.c. engine/battery-electric automotive power train

by P.W. Masding, BSc, PhD and J.R. Bumby, BSc, PhD, CEng, MIEE

This paper describes the development of a fully integrated microprocessor control system for a hybrid i.c. engine/battery-electric automotive power train. The system is designed to allow the user to vary the engine speed and torque, the electric motor speed and torque, and the battery current. The system is capable of operating in a number of modes, including a constant speed mode, a constant torque mode, and a constant power mode. The system is also capable of operating in a closed-loop mode, where the engine speed and torque are controlled by a feedback loop. The system is designed to be used for the development and testing of control algorithms for hybrid vehicles.

Keywords: Hybrid electric automotive power train; microprocessor control; electric vehicles, i.c. engines

Symbols

- a Zero of $g_s(w')$
- b Counter value from flywheel speed probe
- c Gain of $g_s(w')$
- d Number value from the flywheel speed probe
- e Gain of $g_s(w')$
- f Controller in 's'-plane form
- g Bitlinear discretisation of $g_s(w')$
- h Amature current, A
- i Flywheel inertia, kg m²
- j Constant relating dynamometer speed to load
- k Flywheel count to roadspeed conversion
- l $g_{s2}(w')$
- m Equivalent vehicle mass, kg
- n Speed, rev/min
- p Inlet manifold depression, mbar
- q Final drive ratio
- r Vehicle wheel radius, m
- s Laplace transform variable
- t Torque in gearbox output shaft, Nm
- u Engine torque, Nm
- v Controller design criteria, rise time, s
- w Control system base sampling period (20 ms)
- x $g_{s2}(w')$
- y $g_{s2}(w')$
- z $g_{s2}(w')$

*School of Engineering and Applied Sciences, University of Durham, South Road, Durham DH1 1TA, England

Trans Inst M C Vol 12 No 3, 1990

FORD EXHIBIT 1107

- Bumby IV
- Published in Transactions of the Institute of Measurement and Control, Vol. 10, No. 2 (1988)
- J.R. Bumby, P.W. Masding,

- Bumby V
- Published in Transactions of the Institute of Measurement and Control, Vol. 10, No. 2 (1990)
- P.W. Masding, J.R. Bumby

- Bumby IV “discloses no control algorithm at all.” POR at 17.

- Bumby V “discloses a “test rig” that uses vehicle speed to determine the mode.” POR at 17

Introduction to Masding Thesis

Masding Thesis (Ex. 2104)

- Masding Thesis
 - Dissertation thesis of P.W. Masding (co-author of Bumby IV and V)
 - Published in 1988.
 - Bumby V appears to be later adaptation of Masding Thesis
- Masding “reveals that a fundamental problem with the ‘sub-optimal’ control strategy of [Bumby II and III] was an ‘excessive numbers of gear shifts.’” POR at 18

Some Drive Train Control Problems In
Hybrid Ic Engine/Battery Electric Vehicles

The copyright of this thesis rests with the author.
No quotation from it should be published without
his prior written consent and information derived
from it should be acknowledged.

by Philip Wilson Masding B.Sc.

A Thesis Submitted for the Degree of Doctor of Philosophy

School of Engineering and Applied Science
University of Durham

1988



- 2 NOV 1989

3

Introduction to the Bumby references

Bumby V, Ex. 1107 at 19

an arbitrary speed-based mode controller was used to decide when to switch between all electric, all-i.c.-engine, and hybrid modes of operation. In addition, gear shifting occurs at fixed speeds.

Masding Thesis, Ex. 2104 at 240-41

At this point however the necessary software to implement such control has not been perfected, specifically problems have arisen in avoiding excessive numbers of gear shifts.

...

Even without shortcomings in

the software, changing gear on grounds of efficiency leads to considerably more shifts than occur in normal driving.

...

On the rig however above average use of the gears, coupled with the rather poor shift times associated with the pneumatic system, would probably lead to unacceptable driveability on the road.

A POSITA Would Not Have Combined The Bumby References

A POSITA Would Not Have Combined the Bumbly References

[T]he only reasons Ford presents to justify the combination of five different ...is that the articles share a common author and cite to each other.

The mere fact that a publication refers to other publications written by a similar group of authors, much less a common single author, provides no justification for combining the technology of the various references.

IPR '579, Paper No. 20, POR at 15-16 (citing *In re Nilssen*, 837 F.2d 1098 (Fed. Cir. 1987))

- “Dr. Davis agrees that having a common author does not mean papers are directed to the same project.” POR at 16.

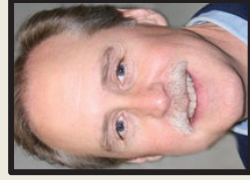

Q: And the fact that you are listed as an author on each of these doesn't mean it's all part of one project, right?
Dr. Davis: Oh, of course not necessarily, no.

IPR '579, Paper No. 20, POR at 16 (citing *Davis Tr.* at 197:20-23)

A POSITA Would Not Have Combined the Bumby References

- Bumby IV and V “teach away from using the [Bumb II and III’s] control algorithm.” POR at 16
- “[A] fundamental problem with the ‘sub-optimal’ control strategy of [Bumby II and III] was an ‘excessive numbers of gear shifts.’” POR at 18

Masding Thesis, Ex. 2104 at 240-41

At this point however the necessary software to implement such control has not been perfected, specifically problems have arisen in avoiding excessive numbers of gear shifts.

• • •

On the rig however above average use of the gears, coupled with the rather poor shift times associated with the pneumatic system, would probably lead to unacceptable driveability on the road.

A POSITA Would Not Have Combined the Bumby References

- Bumby IV and V “teach away from using the [Bumb II and III’s] control algorithm.” POR at 16
- “Dr. Davis testified that there was no evidence from the Bumby references that the ‘ sub-optimal’ control algorithm was ever implemented in a vehicle.” Motion for Observations at 3 .

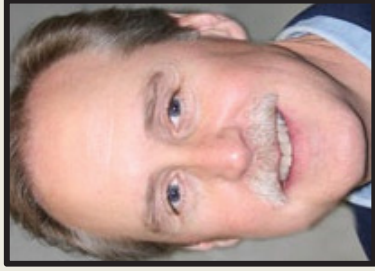

Q. Sitting here today, do you know whether or not Dr. Bumby or Dr. Masding ever actually implemented this control system on a vehicle?

A. That they actually developed it on a vehicle?

I didn't -- I don't see evidence that that was actually done, but that was of course the next step that they were going to take, so certainly they knew how to do that.

A POSITA Would Not Have Combined the Bumbly References

- The “sub-optimal” control algorithm “results in a hybrid car with worse fuel consumption than a conventional non-hybrid car.” POR at 19

Hannemann Dec., Ex. 2102 at 40



Weighting method	Vehicle MPG	
	Hybrid	Non-hybrid
1/3 : 1/3 : 1/3	49	57
40/50/10	53	61

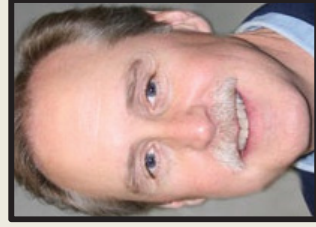

Q: And the champion in terms of gas mileage is actually Element H in Table 3A, the G plus 3 cylinder engine, correct?

Dr. Davis: Yes, that appears to be correct

**The Bumpy References Do Not Render Obvious
Independent Claims 1 Or 23
Or Dependent Claim 7**

'347 Patent Claim 1 Introduction

What is claimed is:

1. A hybrid vehicle, comprising:
an internal combustion engine controllably coupled to road wheels of said vehicle;
a first electric motor connected to said engine and operable to start the engine responsive to a control signal;
a second electric motor connected to road wheels of said vehicle, and operable as a motor, to apply torque to said wheels to propel said vehicle, and as a generator, for accepting torque from at least said wheels for generating current;
a battery, for providing current to said motors and accepting charging current from at least said second motor; and
a controller for controlling the flow of electrical and mechanical power between said engine, first and second motors, and wheels,
wherein said controller starts and operates said engine when torque require to be produced by said engine to propel the vehicle and/or to drive either one or both said electric motor(s) to charge said battery is at least equal to a setpoint (SP) above which said engine torque is efficiently produced, and wherein the torque produced by said engine when operated at said setpoint (SP) is substantially less than the maximum torque output (MTO) of said engine.

Claim 1 compares the “torque require[d] to be produced by said engine to propel the vehicle and/or to drive either one or both said electric motor(s) to charge said battery” to a “setpoint” to determine whether to “start and operate” the engine.

'347 Patent Claim 7 Introduction

7. The vehicle of claim 1, wherein said vehicle is operated in a plurality of operating modes responsive to the value for the road load (RL) and said setpoint SP, both expressed as percentages of the maximum torque output of the engine when normally-aspirated (MTO), and said operating modes include:

a low-load mode I, wherein said vehicle is propelled by torque provided by said second electric motor in response to energy supplied from said battery, while $RL < SP$,

a highway cruising mode IV, wherein said vehicle is propelled by torque provided by said internal combustion engine, while $SP < RL < MTO$, and an acceleration mode V, wherein said vehicle is propelled by torque provided by said internal combustion engine and by torque provided by either or both electric motor(s) in response to energy supplied from said battery, while $RL > MTO$.

Dependent claim 7 operates the vehicle in a plurality of modes by comparing the "road load" to a "setpoint."

'347 Patent Claim 23 Introduction

23. A method of control of a hybrid vehicle, said vehicle comprising an internal combustion engine capable of efficiently producing torque at loads between a lower level SP and a maximum torque output MTO, a battery, and one or more electric motors being capable of providing output torque responsive to supplied current, and of generating electrical current responsive to applied torque, said engine being controllably connected to wheels of said vehicle for applying propulsive torque thereto and to said at least one motor for applying torque thereto, said method comprising the steps of:

determining the instantaneous torque RL required to propel said vehicle responsive to an operator command; monitoring the state of charge of said battery;

employing said at least one electric motor to propel said vehicle when the torque RL required to do so is less than said lower level SP;

employing said engine to propel said vehicle when the torque RL required to do so is between said lower level SP and MTO;

employing both said at least one electric motor and said engine to propel said vehicle when the torque RL required to do so is more than MTO; and

employing said engine to propel said vehicle when the torque RL required to do so is less than said lower level SP and using the torque between RL and SP to drive said at least one electric motor to charge said battery when the state of charge of said battery indicates the desirability of doing so; and

wherein the torque produced by said engine when operated at said setpoint (SP) is substantially less than the maximum torque output (MTO) of said engine.

Claim 23 compares the “road load” to “setpoint” to determine what operating mode to transition into

'347 Patent Claim 23 Introduction

23. A method of control of a hybrid vehicle, said vehicle comprising an internal combustion engine capable of efficiently producing torque at loads between a lower level SP and a maximum torque output MTO, a battery, and one or more electric motors being capable of providing output torque responsive to supplied current, and of generating electrical current responsive to applied torque, said engine being controllably connected to wheels of said vehicle for applying propulsive torque thereto and to said at least one motor for applying torque thereto, said method comprising the steps of:

determining the instantaneous torque RL required to propel said vehicle responsive to an operator command; monitoring the state of charge of said battery;

employing said at least one electric motor to propel said vehicle when the torque RL required to do so is less than said lower level SP;

employing said engine to propel said vehicle when the torque RL required to do so is between said lower level SP and MTO;

employing both said at least one electric motor and said engine to propel said vehicle when the torque RL required to do so is more than MTO; and

employing said engine to propel said vehicle when the torque RL required to do so is less than said lower level SP and using the torque between RL and SP to drive said at least one electric motor to charge said battery when the state of charge of said battery indicates the desirability of doing so; and

wherein the torque produced by said engine when operated at said setpoint (SP) is substantially less than the maximum torque output (MTO) of said engine.

When the battery needs charging, and the “road load” is less than a “setpoint,” claim 23 operates the engine at least at “setpoint” and uses the torque between “road load” and “setpoint” to charge the battery

The claimed control system is absent from the Bumby References

The Bumby references do not disclose or suggest each limitation of the asserted claims:

- 1) “Dr. Davis’s description of the “sub-optimal” control algorithm fundamentally misrepresents how that algorithm works by selectively (and incorrectly) annotating Fig. 16 from [Bumby II] and Fig. 8 from [Bumby III].” POR at 25.
- 2) “The Bumby references do not disclose or suggest the battery charging mode of claim 1 or 23.” POR at 43
- 3) “Ford is trying to use their Reply to insert new evidence and arguments that could have (and should have) been presented in the petition.” Paper 34, Motion to Exclude at 5.

The claimed control system is absent from the Bumby References

The Bumby references do not disclose or suggest each limitation of the asserted claims:

- 1) “Dr. Davis’s description of the “sub-optimal” control algorithm fundamentally misrepresents how that algorithm works by selectively (and incorrectly) annotating Fig. 16 from [Bumby II] and Fig. 8 from [Bumby III].” POR at 25.
- 2) “The Bumby references do not disclose or suggest the battery charging mode of claim 1 or 23.” POR at 43
- 3) “Ford is trying to use their Reply to insert new evidence and arguments that could have (and should have) been presented in the petition.” Paper 34, Motion to Exclude at 5.

The “sub-optimal” control algorithm fails to meet the limitations of claims 1, 7, and 23

Claim 1

wherein said controller starts and operates said engine when torque require to be produced by said engine to propel the vehicle and/or to drive either one or both said electric motor(s) to charge said battery is at least equal to a setpoint (SP) above which said engine torque is efficiently produced, and wherein the torque produced by said engine when operated at said setpoint (SP) is substantially less than the maximum torque output (MTO) of said engine.

Claim 7

a low-load mode I, wherein said vehicle is propelled by torque provided by said second electric motor in response to energy supplied from said battery, while $RL < SP$,
a highway cruising mode IV, wherein said vehicle is propelled by torque provided by said internal combustion engine, while $SP < RL < MTO$, and

Claim 23

employing said at least one electric motor to propel said vehicle when the torque RL required to do so is less than said lower level SP ;
employing said engine to propel said vehicle when the torque RL required to do so is between said lower level SP and MTO ;

The “sub-optimal” is a transmission control system based on power

[T]he “sub-optimal” control algorithm determines a series of torque and drive shaft speed pairs (one for each available gear) that could be input into the transmission to meet the demand power as calibrated by pedal position.

IPR '579, Paper No. 20, POR at 22(citing Ex. 2102 at ¶¶ 46-53)

[The] “sub-optimal” control algorithm is actually a transmission control system based on power.

When the operator demands a particular power level, the “sub-optimal” control system calculates which gear ratios are available to provide that power and selects the gear to increase efficiency.

IPR '579, Paper No. 20, POR at 27

The “sub-optimal” is a transmission control system based on power

- “[T]he annotated figure from Bumby 1987 below shows the possible outputs for demand powers as calibrated by pedal position from 1.5 kW to 15.5 kW to 40 kW.” POR at 27.

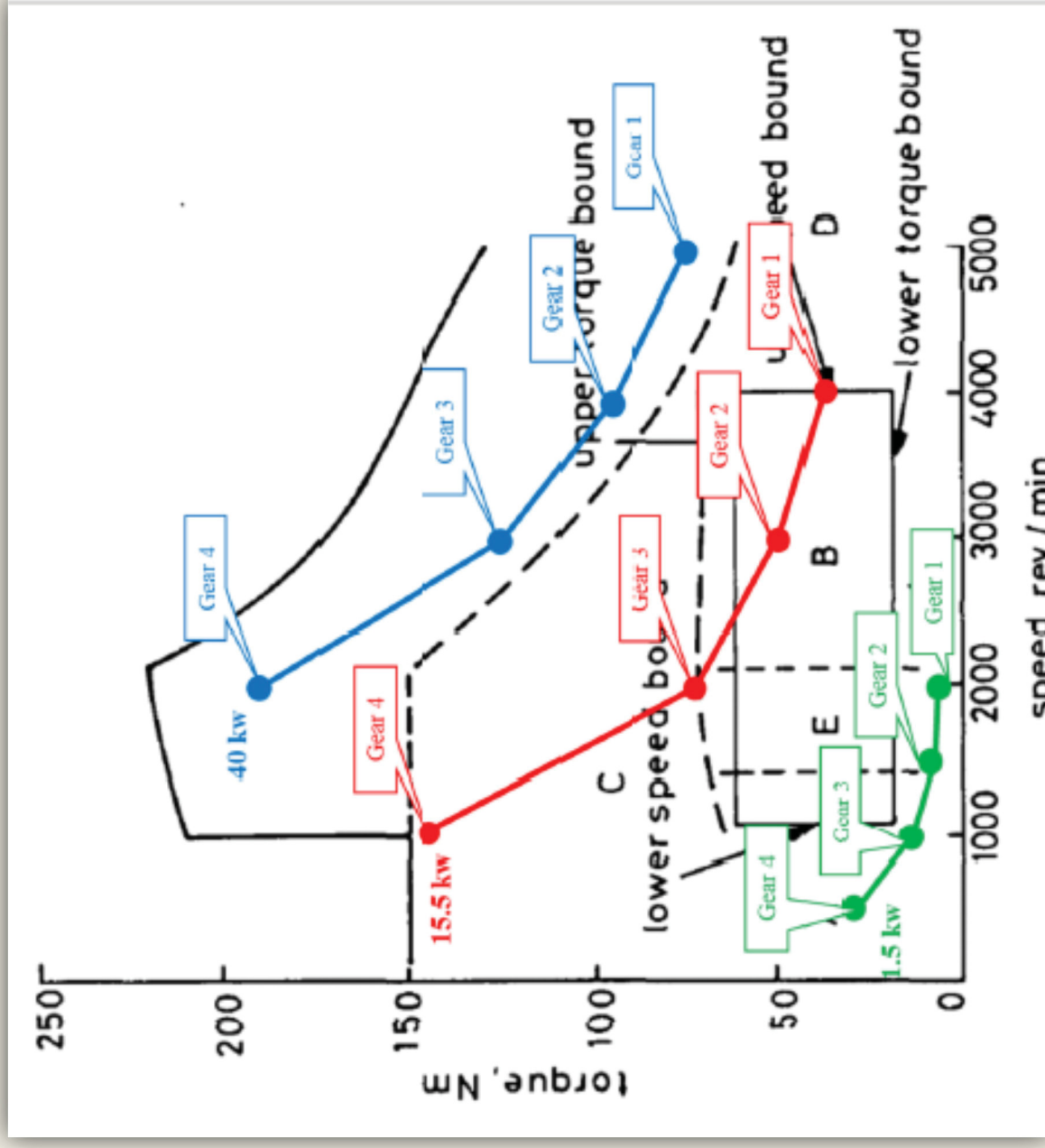

The “sub-optimal” is a transmission control system based on power

“[T]he engine will be set to produce 90% of its maximum output, with the motor making up any additional output necessary to meet the driver’s demand power.”

Ex. 2102 at ¶ 94

“[B]ecause Gear 2 falls within the “box,” the “sub-optimal” control algorithm will select Gear 2 and operate the vehicle in engine-only mode.”

Ex. 2102 at ¶ 94

“[A]vailable gear ratios are to the left or below the “box,” and thus, the “sub-optimal” control algorithm would operate the vehicle in motor-only mode.”

Ex. 2102 at ¶ 94

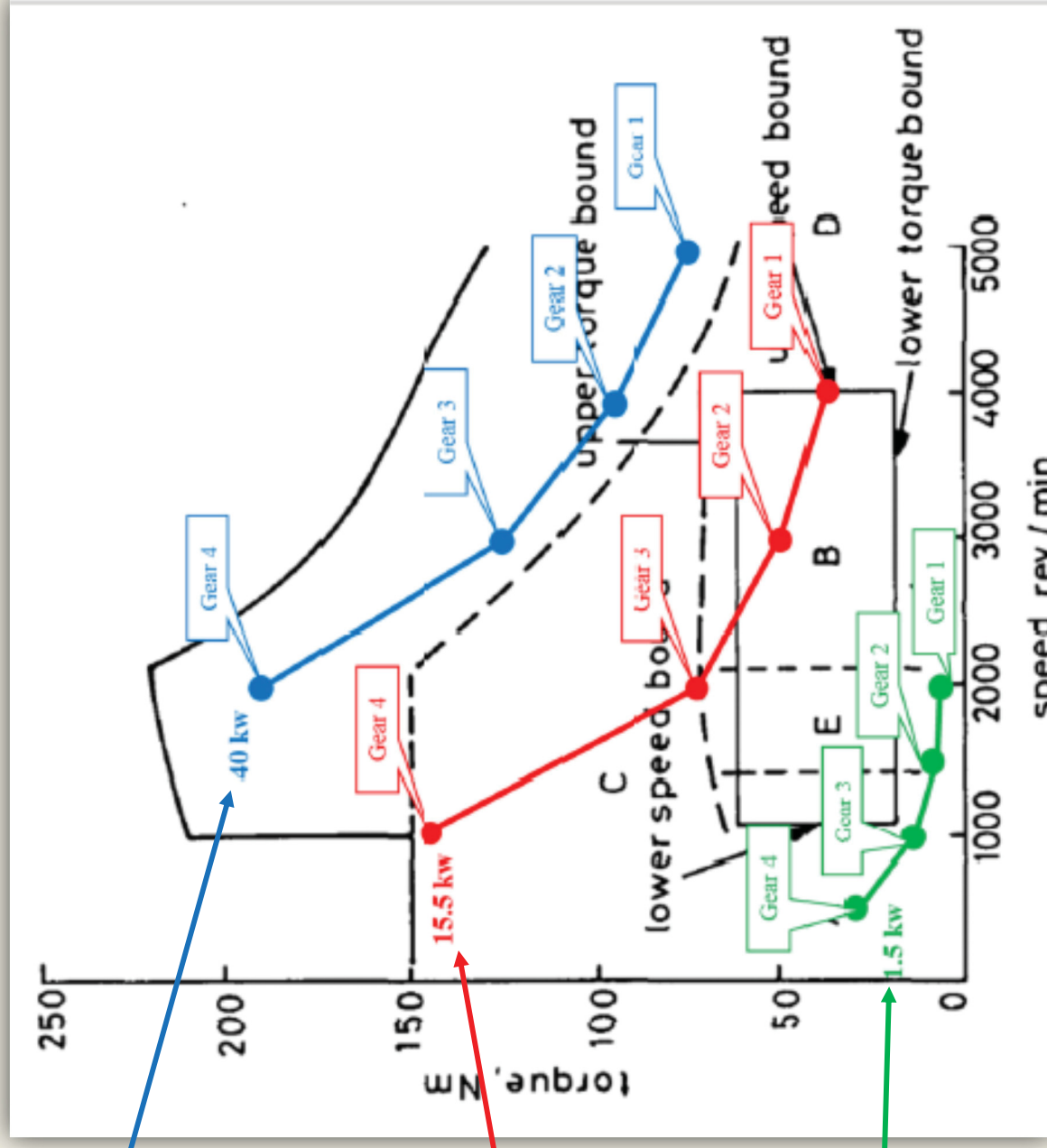

The “sub-optimal” control system does not disclose the challenged claims

- Bumbo IV and V “disclose a fundamentally different control strategy that uses demand power, calibrated by the pedal position, and the available gear ratios to determine whether to use the engine to propel the vehicle.” POR at 21-22.
 1. “[A] person of skill in the art would understand that the “sub-optimal” control algorithm controls based on power, not road load.” POR at 33.
 2. “One of skill in the art would understand that the speed bounds that help define the “box” in the “sub-optimal” algorithm are not solely physical constraints of the engine, but, along with the “torque” bounds, are in fact power-based gear ratio selection thresholds.” POR at 30.
 3. “[T]he “sub-optimal” control algorithm of [Bumbo II and III] is at its core a transmission control system.” POR at 31.

The “sub-optimal” control algorithm controls based on power, not road load

Bumby III, Ex. 1105 at 7

3.3 Sub-optimum control

To develop a control algorithm that can be implemented on an actual vehicle a sub-optimal control algorithm is postulated that seeks to restrict the operation of the i.c. engine to the high-efficiency region. This algorithm accepts demand power as its control variable and, by sensing road speed, transforms this power to a torque at the output of the transmission. Demand power, as far as the simulation is concerned, is simply transmission output power, but in reality would be driver-demand power, expressed as a function of accelerator pedal position. Knowing the fixed transmission ratios available, a set of torque and speed values at the torque split point can be defined, the number of which will correspond to the number of discrete gear ratios available.

The “sub-optimal” control algorithm controls based on power, not road load

- “The [torque and drive shaft speed pairs] generated by the “sub-optimal” algorithm, and shown on Fig. 8, are thus power values. Dr. Davis admitted this during his deposition.” POR at 22-23.

Bumby III, Ex. 1105 at 8

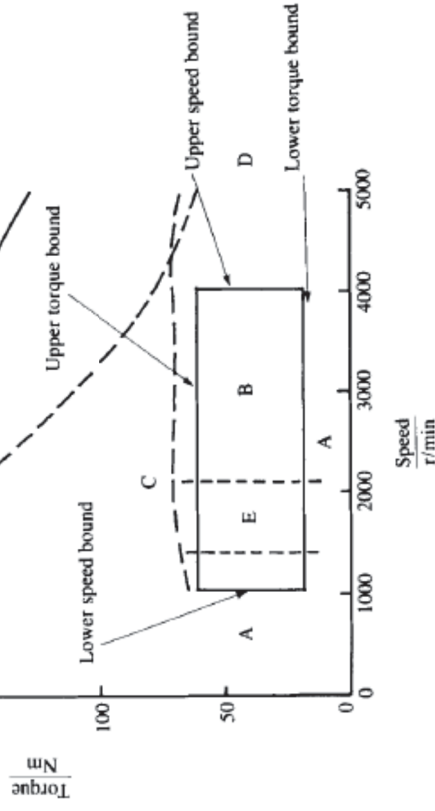
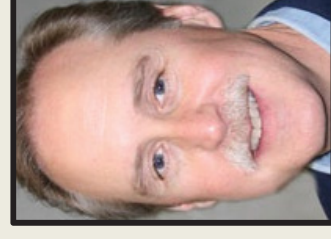

Fig. 8 Sub-optimum control operating regions

Q: Well, more than that, sir. If we put a pen on any point in Figure 8, we’re pointing to a power value, correct?

Dr. Davis: Sure, and you could calculate that.

The “sub-optimal” control algorithm must consider speed

- “Dr. Davis admitted during his deposition that the “sub-optimal” control algorithm must consider both torque and speed.” POR at 33.

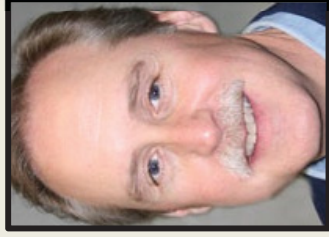

Q: So in the Bumby system, if the road load is 21 Newton meters, will the system use the engine to propel the vehicle?

Dr. Davis: Depends on the speed that you’re operating, because of course if you’re operating too low, an engine can’t function at that extremely low speed.

Q: What happens if it’s going too fast?

Dr. Davis: Then, again, you restrict operation.

The “sub-optimal” is a transmission control system based on power

- “Dr. Davis admitted during his deposition that the “sub-optimal” control algorithm is fundamentally about selecting the correct gear.” POR at 28.

Q: And what happens if Mr. Angileri really stomps on the gas and the point is now moved above the B box?

Dr. Davis: Above the upper torque bound?

Q: Well, yes, let’s go ahead and do that.

Dr. Davis: How far above?

Q: Just right above, right next to the C.

Dr. Davis: Then I would -- then the system is going to see that as a trigger to then bring extra torque available from the motor to meet the increased load demand. It would still be making decisions regarding the gear ratio selection.

Q: And what do you mean by making decisions regarding the gear selection?

Dr. Davis: It would still calculate where it would be in a different gear ratio. For example, I could be above the box B, but say slightly above the upper torque band, maybe in a gear four I’m slightly above it, but maybe in gear 3 I’m back in the box. And if I’m back in the box, I would keep the engine running. I wouldn’t have to provide additional torque from the electric motor at that condition.

The “sub-optimal” control algorithm requires a transmission

- “Dr. Davis’s description of the “sub-optimal” control algorithm fundamentally misrepresents how that algorithm works by selectively (and incorrectly) annotating Fig. 16 from [Bumby II] and Fig . 8 from [Bumby III].” POR at 25.

Davis Dec., Ex. 1108 at 98

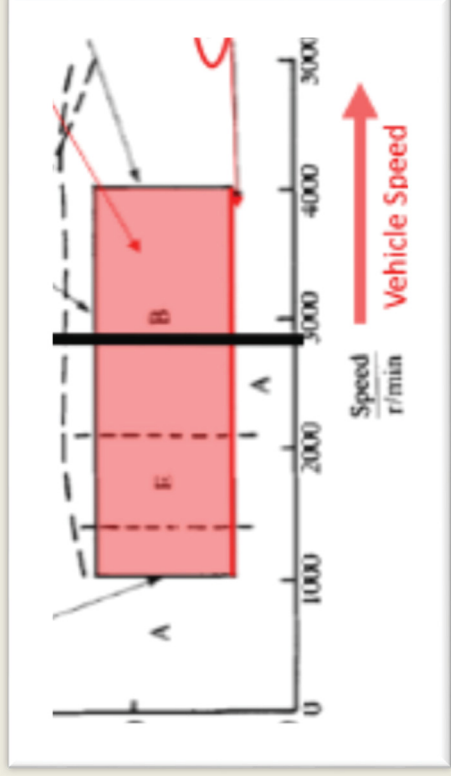

Q: Can you tell what vehicle speed we're talking about when we're talking about Region A?

Dr. Davis: Depends what gear we're in and more details about it, the system.

Q: Need to know kind of the wheel size, there's a conversion we have to do?

Dr. Davis: Yeah. More than that, yes.

The “sub-optimal” control algorithm requires a transmission

- “[T]he ‘sub-optimal’ control algorithm of Bumby 1987 and Forster is at its core a transmission control system.” POR at 31.
- “Dr. Davis testified that the ‘Masding Thesis discloses that a transmission is not necessarily required,’ and cites to a portion of the Masding thesis (Ex. 2104) that in turn cites to the Harding and Fersen papers.” Motion for Observations at 5.
- “Dr. Davis testified he could not recall reviewing the papers regarding the Lucas hybrid vehicle in Harding, et al. 1983, and the earlier hybrid built by Bosch described in Fersen 1974.” Motion for Observation at 4-5 (citing Ex. 2111, 28:12-30:6).
- Dr. Davis “testified that given the time difference between those papers and the Bumby references it was ‘highly unlikely’ they were using the ‘ sub-optimal’ control strategy.” See *id.*

The “sub-optimal” control algorithm requires a transmission

- Dr. Davis’s deposition testimony “shows that Dr. Davis’s examples provided in his declaration are contrary to the disclosure of the reference.” Motion for Observations at 6

Bumby II, Ex. 1104 at 11

“For all-electric operation, the gear ratio that puts the operating point nearest the motor break speed is selected.”

Motion for Observations at 6 (citing Ex. 1104, Bumby IV, at 11)

Dr. Davis

“...and it appears that then that speed would be somewhere in the vicinity of 2,000 RPM.”

Motion for Observations at 6 (citing to Ex. 2111, Davis Tr. at 42:24-44:3)

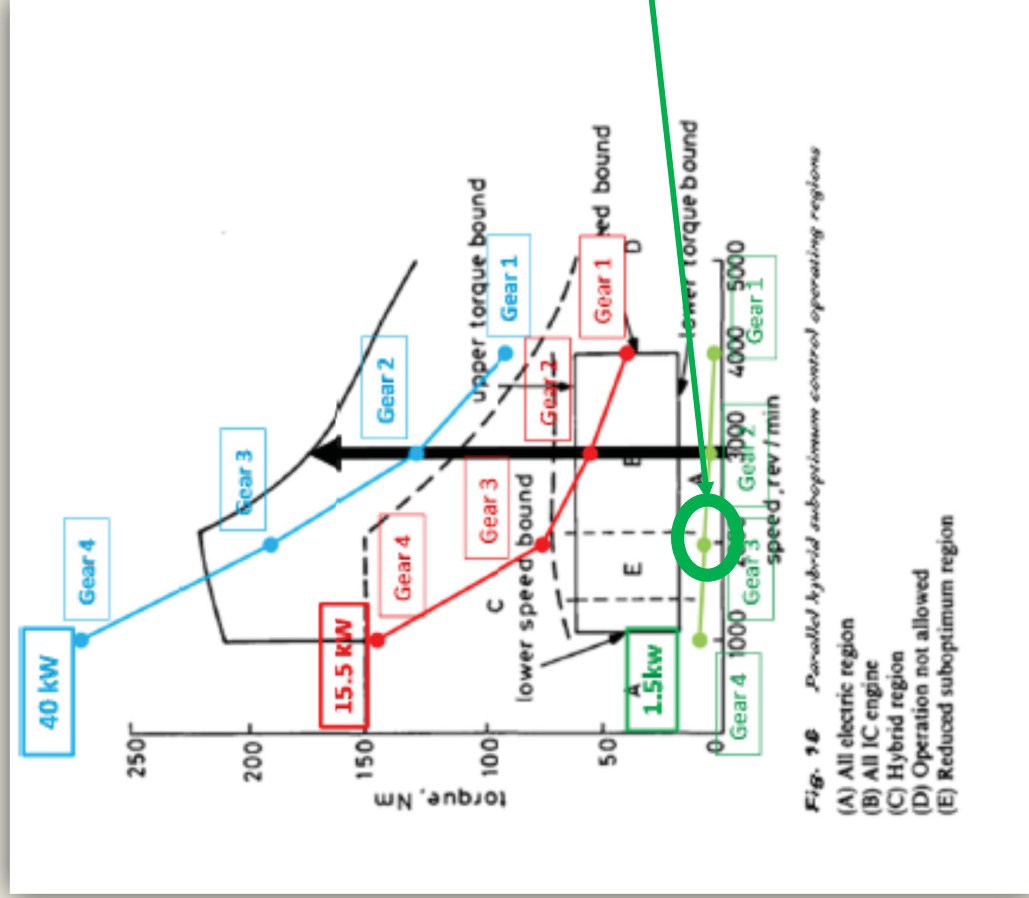
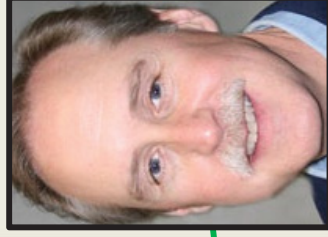

The “sub-optimal” control algorithm requires a transmission

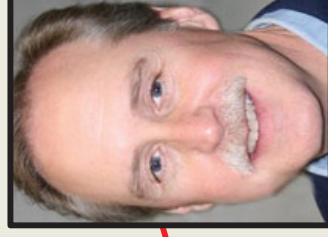
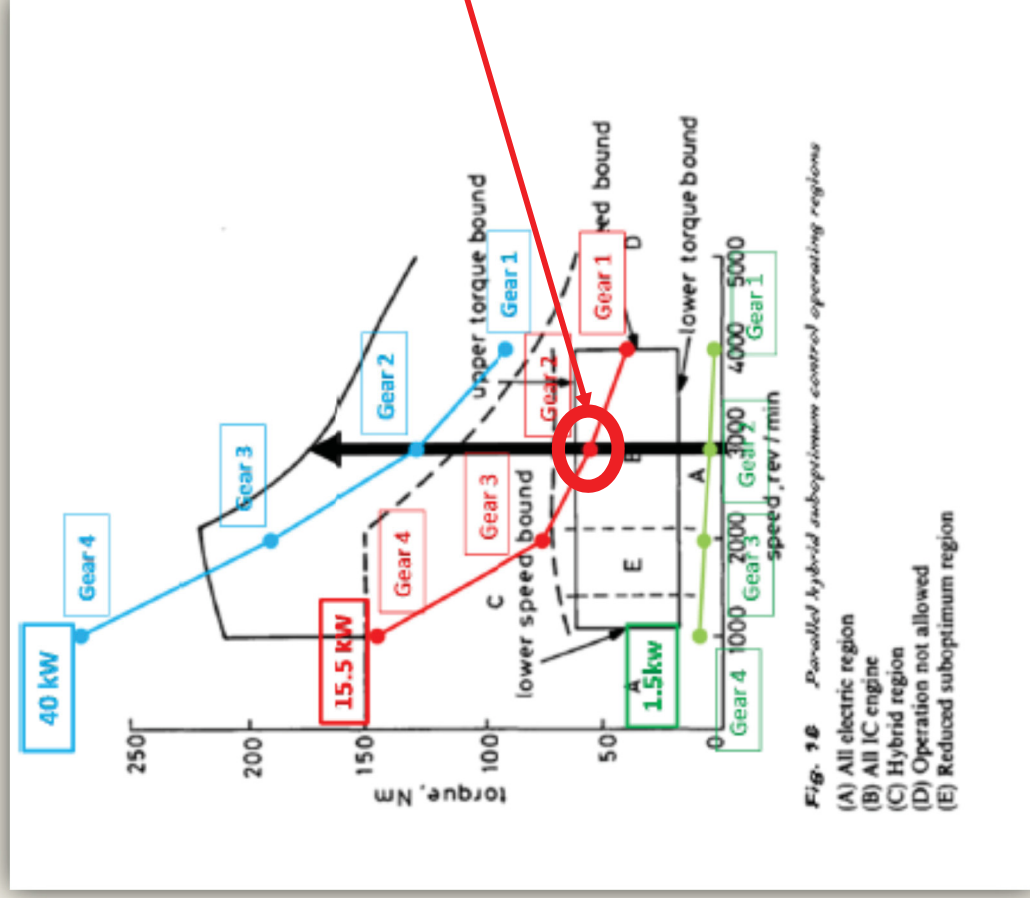

“And if I’m back in the box, I would keep the engine running.”

Fig. 16 Parallel hybrid suboptimum control operating regions

- (A) All electric region
- (B) All IC engine
- (C) Hybrid region
- (D) Operation not allowed
- (E) Reduced suboptimum region

The “sub-optimal” control algorithm requires a transmission

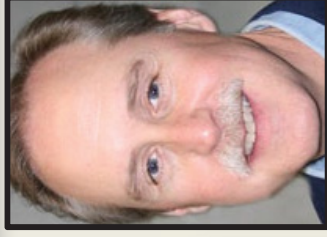

“So what they would do is select the highest gear, just as we would typically do in a conventional vehicle, in order to spin the engine more slowly, which would tend to get it at least in the speed region of the most efficient operating condition, which for this engine appears to be in the region somewhere between about around 1500 to 2,000 RPM...”

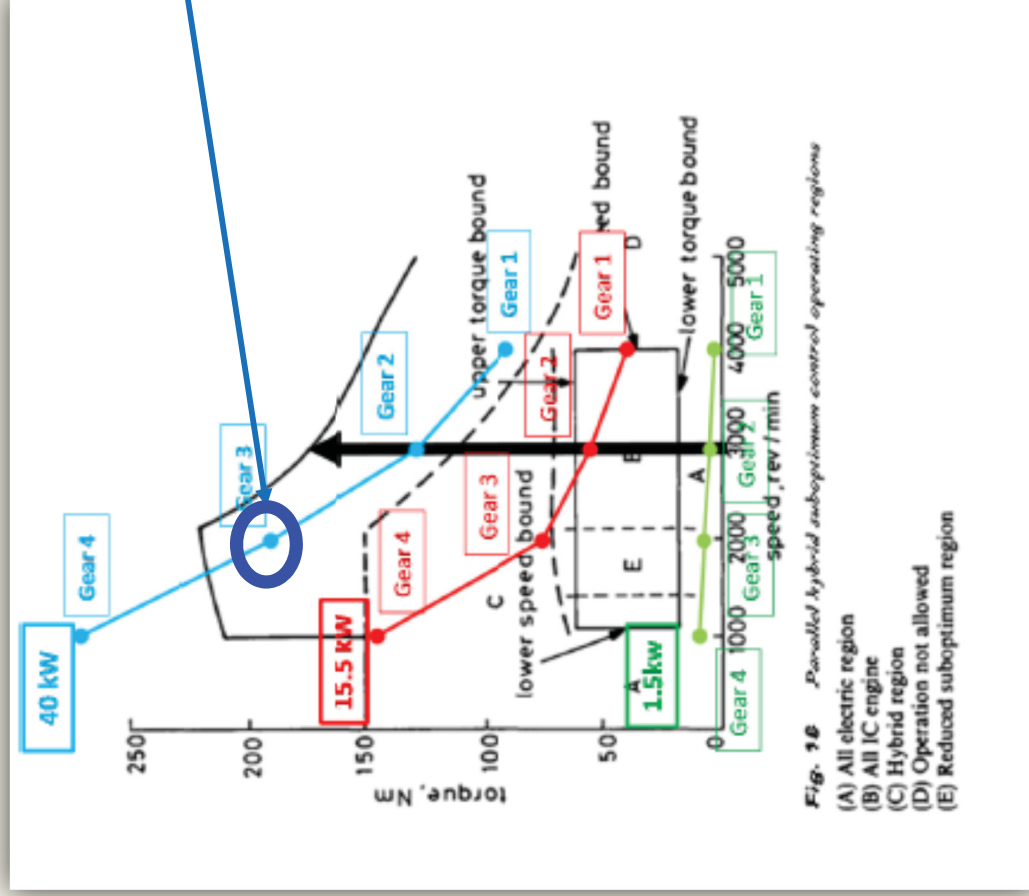
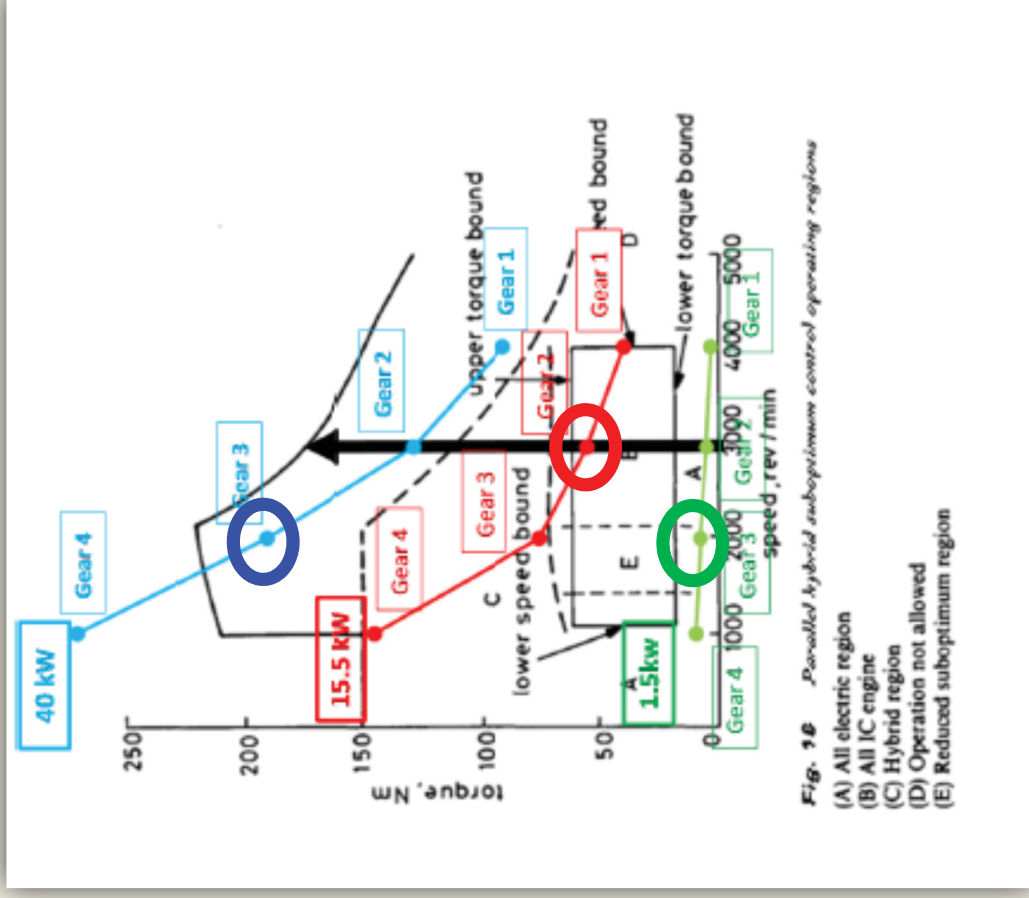

Fig. 16 Parallel hybrid suboptimum control operating regions
 (A) All electric region
 (B) All IC engine
 (C) Hybrid region
 (D) Operation not allowed
 (E) Reduced suboptimum region

The “sub-optimal” control algorithm requires a transmission



IPR2014-00579, Ex. 1140, Davis Reply Dec. at ¶ 47-48

The claimed control system is absent from the Bumby References

The Bumby references do not disclose or suggest each limitation of the asserted claims:

- 1) “Dr. Davis’s description of the “sub-optimal” control algorithm fundamentally misrepresents how that algorithm works by selectively (and incorrectly) annotating Fig. 16 from [Bumby II] and Fig. 8 from [Bumby III].” POR at 25.
- 2) “The Bumby references do not disclose or suggest the battery charging mode of claim 1 or 23.” POR at 43
- 3) “Ford is trying to use their Reply to insert new evidence and arguments that could have (and should have) been presented in the petition.” Paper 34, Motion to Exclude at 5.

'347 Patent Claim 1 – Battery Recharge

What is claimed is:

1. A hybrid vehicle, comprising:
an internal combustion engine controllably coupled to road wheels of said vehicle;
a first electric motor connected to said engine and operable to start the engine responsive to a control signal;
a second electric motor connected to road wheels of said vehicle, and operable as a motor, to apply torque to said wheels to propel said vehicle, and as a generator, for accepting torque from at least said wheels for generating current;
a battery, for providing current to said motors and accepting charging current from at least said second motor; and
a controller for controlling the flow of electrical and mechanical power between said engine, first and second motors, and wheels,
wherein said controller starts and operates said engine when torque require to be produced by said engine to propel the vehicle and/or to drive either one or both said electric motor(s) to charge said battery is at least equal to a setpoint (SP) above which said engine torque is efficiently produced, and wherein the torque produced by said engine when operated at said setpoint (SP) is substantially less than the maximum torque output (MTO) of said engine.

Claim 1 compares the “torque require[d] to be produced by said engine ... to drive either one or both said electric motor(s) to charge said battery” to a “setpoint” to determine whether to “start and operate” the engine.

'347 Patent Claim 23 – Battery Recharge

23. A method of control of a hybrid vehicle, said vehicle comprising an internal combustion engine capable of efficiently producing torque at loads between a lower level SP and a maximum torque output MTO, a battery, and one or more electric motors being capable of providing output torque responsive to supplied current, and of generating electrical current responsive to applied torque, said engine being controllably connected to wheels of said vehicle for applying propulsive torque thereto and to said at least one motor for applying torque thereto, said method comprising the steps of:

determining the instantaneous torque RL required to propel said vehicle responsive to an operator command; monitoring the state of charge of said battery;

employing said at least one electric motor to propel said vehicle when the torque RL required to do so is less than said lower level SP;

employing said engine to propel said vehicle when the torque RL required to do so is between said lower level SP and MTO;

employing both said at least one electric motor and said engine to propel said vehicle when the torque RL required to do so is more than MTO; and

employing said engine to propel said vehicle when the torque RL required to do so is less than said lower level SP and using the torque between RL and SP to drive said at least one electric motor to charge said battery when the state of charge of said battery indicates the desirability of doing so; and

wherein the torque produced by said engine when operated at said setpoint (SP) is substantially less than the maximum torque output (MTO) of said engine.

When the battery needs charging, and the “road load” is less than a “setpoint,” claim 23 operates the engine at least at “setpoint” and uses the torque between “road load” and “setpoint” to charge the battery

The Bumby references do not disclose the battery charging limitations of claim 1 and 23

- “[T]he Bumby references disclose nothing more using the engine to charge the battery when the battery state of charge is low, a well-known idea in the art.” POR at 46 .
- “The Bumby references do not disclose the battery charging limitation of claim 1 ... or claim 23.” POR at 43 .

Bumby II, Ex. 1104 at 13

Below the prescribed battery state of charge the energy-saving mode would be selected. If battery state of charge then falls further and reaches a lower value, then the battery charging mode would be initiated and maintained until the battery state of charge had recovered sufficiently to revert to the energy-saving mode. Electric and hybrid mode would be selected. If battery state of charge require substantial battery charge, and to provide this from the engine via the battery charge mode is not attractive.

The Bumby references do not disclose the battery charging limitations of claim 1 and 23

- “Operation of the engine in response to the state of charge of the battery is not the same as operation of the engine when “torque require to be produced by said engine to ... drive either one or both said electric motor(s) to charge said battery is at least equal to a setpoint (SP),” and Ford and Dr. Davis provide no argument otherwise.” POR at 48
- Dr. Davis also “offers the [following] non-sequitur:” (POR at 49)

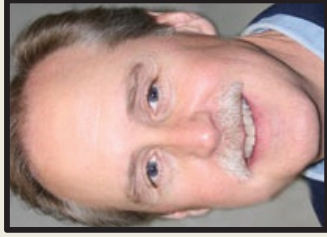

Indeed, the Bumby Project would not have included both a “hybrid mode” and “battery charge mode” if one of these two operating modes did not operate within the engine’s efficient operating region. In other words, if the battery state of charge mode did not operate within the engine’s most efficient region “B/E” then the “hybrid mode” most likely would. Otherwise, having two modes of operation that perform the same function would be redundant.

The Bumby references do not disclose the battery charging limitations of claim 1 and 23

- “Dr. Davis offers no evidence or disclosure in the Bumby references to support [his] assertion, but merely theorizes on the capabilities of the engine and motor in the Bumby references; such theorizing about mere capability is an improper basis for a finding of obviousness. See *In re Giannelli*, 739 F.3d 1375, 1380-81 (Fed. Cir. 2014).” POR at 54.

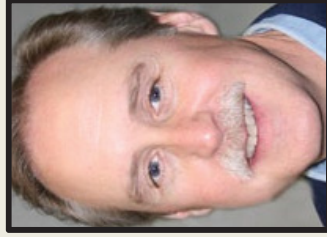

Since the Bumby Project discloses only operating the engine in the efficient region B/E, shown in Fig. 8, it would have been known that if the battery was too low to operate the motor in region A that corresponded to the low torque requirement, that the engine could be used. Based on the disclosures in the Bumby Project, it also would have been known that the engine could be operated at a higher torque level that was within the engine’s efficient range, highlighted in red. Then the excess torque from the engine could be used to charge the battery. While claim limitation [23.10] recites only “using the torque between RL and SP,” it would have been known that the engine could be operated at or above the setpoint while still being in the engine’s efficient operating region.

The Bumbly references do not disclose the battery charging limitations of claim 1 and 23

- “Dr. Davis testified that Fig. 7.12(b) of the Masding Thesis (Ex. 2104 at 233) illustrates the “battery recharge mode” disclosed in the Bumbly references.” Motion for Observations at 2.

Davis Reply Dec., Ex. 1140 at 50

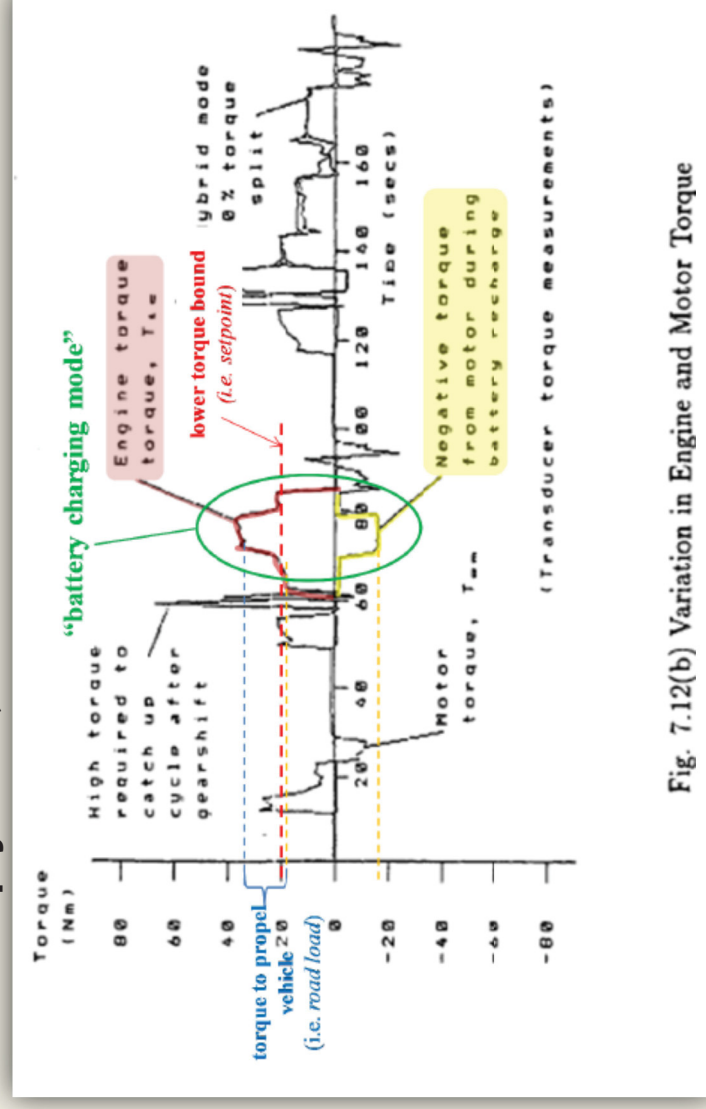

Fig. 7.12(b) Variation in Engine and Motor Torque

The Bumby references do not disclose the battery charging limitations of claim 1 and 23

- “Dr. Davis testified that Fig. 7.12(b) of the Masding Thesis (Ex. 2104 at 233), was not using the “sub-optimal” control algorithm.” Motion for Observations at 3.



Q. And is the test rig running over the ECE test cycle in Figure 7.12, is that running the suboptimal control algorithm as disclosed by the Bumby references?

A. **No, of course not.** As they expressed the route, he's trying to exercise the component level control, so he's using a simple speed-based algorithm in order to consistently and easily switch to different modes of operation.

The Bumby references do not disclose the battery charging limitations of claim 1 and 23

- “Dr. Davis testified that Fig. 7.12(b) of the Masding Thesis (Ex. 2104 at 233) shows that the “battery recharge mode” is entered based purely on time.” Motion for Observations at 2.

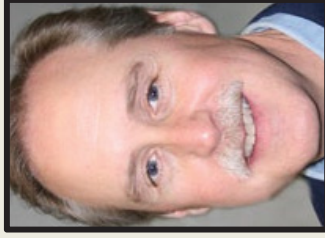

Q. So in Figure 7.12, what we're seeing is that the battery recharge mode, as you say, is based purely on time, right?

A. Well, entering the battery recharge mode and exiting that mode was based purely on time, because, again, they were trying to make sure their control of all these various submodes worked, and so they wanted to make sure of course that they tested their battery recharge mode.

The claimed control system is absent from the Bumby References

The Bumby references do not disclose or suggest each limitation of the asserted claims:

- 1) “Dr. Davis’s description of the “sub-optimal” control algorithm fundamentally misrepresents how that algorithm works by selectively (and incorrectly) annotating Fig. 16 from [Bumby II] and Fig. 8 from [Bumby III].” POR at 25.
- 2) “The Bumby references do not disclose or suggest the battery charging mode of claim 1 or 23.” POR at 43
- 3) “Ford is trying to use their Reply to insert new evidence and arguments that could have (and should have) been presented in the petition.” Paper 34, Motion to Exclude at 5.

The Bumby references disclose a conventional starter motor

Claim 1 at 58:23-25 (POR at 37).

a battery, for providing current to said motors and accepting charging current from at least said second motor; and

- “Ford and Dr. Davis rely entirely on [Bumby IV and V’s] disclosure of a ‘conventional starter motor’ to meet [the] claim limitation.” POR at 37.
- “Bumby 1988 and Masding however do not disclose a ‘first electric motor’ that can accept current from the battery.” POR at 38
- The “Masding Thesis ... discloses that the ‘test rig’ described by [Bumby IV and V] includes ... an additional battery: a ‘12v engine starter battery.’” POR at 42.

Power for the position switches comes from the 12v engine starter battery,

Masding Thesis, Ex. 2104 at 186.

Ford's petition re the "battery" limitation

- Ford's *entire* argument on this element in their Petition is reproduced below:

As illustrated in the figure shown in limitation [1.0] above, the Bumby Project discloses "a battery" that is connected electrically to the electric motor via a corresponding motor controller. (Ex. 1104 at 1.) The Bumby Project discloses that the battery provides current to the motor, for instance, in an "electric mode" where all "propulsion power [is] supplied by the electric traction system." (Ex. 1105 at 5-Table 2.) The Bumby Project also discloses a "regenerative braking" 35 mode where "during braking the vehicle kinetic energy is returned to the battery, with the traction motor acting as a generator." (Ex. 1105 at 5; Ex. 1108, Davis ¶¶259-265.)

IPR2014-00579, Paper No. 1, Petition at 34-35.

Dr. Davis's position is contradicted by his own work

- Dr. Davis “position ... is directly contradicted by his own contemporaneous work.” POR at 40



Q: Another problem with your daisy chain approach if you want to call it that is that if the 12 volt source that you're hooked up to fails, the whole battery stack would become inoperable, correct?

Dr. Davis: Not necessarily, no, certainly not.

Q: In fact, when you were confronted with the exact same situation in your amphibian hybrid electric vehicle development project, you chose a separate 12 volt supply rather than tapping into the 120 volt primary system.

Dr. Davis: Can you point to a particular reference there? I mean you've got the advantage over me. That was, what, 15, 20 years ago.

Dr. Davis's reply relies on two new references

- **“Dr. Davis relies on two new references as support for [his] new opinion: European Patent App. EP0136055 and the Challenged Exhibit, U.S. Patent 5,285,862. Neither of these references were put forward or cited to by Ford in their petition, and Dr. Davis made no mention of either in his original declaration.” Paper 34, Motion to Exclude at 4.**
- **During his deposition, “ Dr. Davis testified that he added new references ... European Patent Application EP0136055 and U.S . Patent No. 5,285,862 to his reply declaration.” Motion for Observations at 7-8 (citing Ex. 2111, at 65:21-66:10)**

END

IPR2014-00884

Introduction

- U.S. Patent No. 7,104,347
- Proposed claim construction for claim 24
- Ground 1 (§ 103):
 - Challenged claims: 1, 7, 10, 21
 - Asserted Art: Caraceni
- Ground 2 (§ 103):
 - Challenged claims: 23, 24
 - Asserted Art: Tabata '201 and Tabata '541

Introduction to the '347 Patent

- '347 Patent (Ex. 1201) is directed to hybrid vehicles and control systems thereof

- The '347 patent recognized that the "vehicle operational mode should preferably be controlled in response to the vehicle's actual torque requirements, i.e., the road load."

- Use of "road load" according to the patent provides "superior performance, in terms of both vehicle response to operator commands and fuel efficiency, under the widely varying conditions encountered in 'real world' driving situations."



US007104347B2
 (10) Patent No.: US 7,104,347 B2
 (45) Date of Patent: Sep. 12, 2006

(64) HYBRID VEHICLES
 (75) Inventors: Alex J. Severinsky, Washington, DC (US); Theodore Loncker, Holly, MI (US)
 (73) Assignee: Pace LLC, Boca Raton, FL (US)
 (*) Notice: Subject to any disclaimer, the term of this patent is extended or adjusted under 35 U.S.C. 154(b) by 265 days.
 (21) Appl. No.: 10,982,577
 (22) Filed: Mar. 7, 2003
 (65) Prior Publication Data
 US 2003/0217876 A1 Nov. 27, 2003

Related U.S. Application Data
 Division of application No. 09/822,866, filed on Apr. 2, 2001, which is a continuation-in-part of application No. 09/392,743, filed on Sep. 29, 1999, which is a continuation-in-part of application No. 09/254,817, filed on Mar. 9, 1999, now Pat. No. 6,329,672.
 Division of application No. 09/123,286, filed on Mar. 1, 1999, and provisional application No. 60/100,075, filed on Sep. 14, 1998.

(31) Int. Cl. (2006.01)
 B60K 6/02
 (52) U.S. Cl. 180/65.2; 180/65.4; 701/54
 (53) Field of Classification Search 180/65.2; 180/65.3; 65.4; 65.8; 165; 60/706; 711; 716; 60/718; 200/17; 40 R; 40 C; 322/16; 47/72.
 See application file for complete search history.

References Cited
 U.S. PATENT DOCUMENTS
 913,846 A 3/1959 Paper
 1,824,014 A 9/1931 English
 2,666,692 A 1/1954 Sims et al.
 (Continued)

FOREIGN PATENT DOCUMENTS
 DE 10 19 975
 DE 1997 441
 DE 1981 462 3/1998
 DE 1933 853 8/1998
 EP 0136 655 3/1985
 EP 516 882 10/1992
 EP 020 1212 5/1996
 EP 024 211 1/1996
 EP 076 940 3 4/1997
 (Continued)

OTHER PUBLICATIONS
 Simons, "Electric Vehicles", *Road & Track*, May 1992, pp. 126-129.
 Kopytska, "AC Propulsion CRX", *Road & Track*, Oct. 1992, pp. 126-129.
 Kubertsh, "Electric Hybrid Drive Systems . . .", SAE Paper No. 910247, 1991.
 (Continued)
 Primary Examiner—David R. Dunn
 (74) Attorney, Agent, or Firm—Michael de Angelis

ABSTRACT
 A hybrid vehicle comprises an internal combustion engine, a traction motor, a starter motor, and a battery bank, all controlled by a microprocessor in accordance with the vehicle's actual torque requirements. The microprocessor can only operate under conditions of high efficiency, typically only when the load is at least equal to 30% of the engine's maximum torque output. In some embodiments, a turbo-charger may be provided, activated only when the load exceeds a predetermined threshold. In some embodiments, an extended period, a two-speed transmission may further be provided, to further broaden the vehicle's load range. A hybrid brake system provides regenerative braking, with mechanical braking available in the event the battery bank is fully charged. In some embodiments, a brake system is provided to control the brake system to provide linear brake feel under varying circumstances.

41 Claims, 17 Drawing Sheets

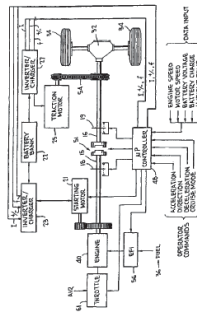

Introduction to the '347 Patent

- Independent claim 1 turns the engine on “when torque require to be produced by said engine to propel the vehicle and/or to drive either one or both said electric motor(s) to charge said battery is at least equal to a setpoint (SP) .”

- Dependent claim 7 recites a “vehicle [that] is operated in a plurality of operating modes responsive to the value for the road load (RL) and said setpoint SP.”

- Independent claim 23 similarly recites selecting various operating modes by comparing “setpoint” to “road load.”



(12) **United States Patent**
Severtsky et al.

(10) Patent No.: **US 7,104,347 B2**
(45) Date of Patent: **Sep. 12, 2006**

(54) **HYBRID VEHICLES**

(75) Inventors: **Alex J. Severtsky**, Washington, DC (US); **Theodore Loncker**, Holly, MI (US)

(73) Assignee: **Pace LLC**, Boca Raton, FL (US)

(*) Notice: Subject to any disclaimer, the term of this patent is extended or adjusted under 35 U.S.C. 154(b) by 265 days.

(21) Appl. No.: **10/982,577**
(22) Filed: **Mar. 7, 2003**

(65) **Prior Publication Data**
US 2003/021876 A1 Nov. 27, 2003

Related U.S. Application Data

(60) Division of application Ser. No. 09/822,866, filed on Apr. 2, 1999, which is a continuation-in-part of application No. 09/392,743, filed on Sep. 29, 1999, which is a continuation-in-part of application No. 09/254,817, filed on Mar. 9, 1999, now Pat. No. 6,329,672.

(60) Division of application Ser. No. 60/132,286, filed on Mar. 1, 1999, and provisional application No. 60/100,075, filed on Sep. 14, 1998.

(31) **Int. Cl.**
B60K 6/02 (2006.01)

(52) **U.S. Cl.** **180/65.2**; **180/65.4**; **701/54**

(58) **Field of Classification Search** **180/65.2**; **180/65.4**; **65.8**; **165**; **60/706**; **711**; **716**; **60/718**; **200/17**; **40 R**; **40 C**; **322/16**; **47/72**.

See application file for complete search history.

(86) **References Cited**

U.S. PATENT DOCUMENTS
913,846 A 3/1959 Paper
1,824,014 A 9/1931 English
2,666,692 A 1/1954 Sims et al.
(Continued)

FOREIGN PATENT DOCUMENTS
DE 194 000 10/1975
DE 194 041 10/1975
DE 19814602 3/1998
DE 19838853 8/1998
EP 01366655 3/1985
EP 510882 10/1992
EP 01366655 3/1985
EP 0242311 5/1996
EP 0769403 4/1997
(Continued)

OTHER PUBLICATIONS
Simpson, “Electric Vehicles”, *Road & Track*, May 1992, pp. 126-129.
Kopytska, “AC Propulsion CRX”, *Road & Track*, Oct. 1992, pp. 126-129.
Kuberski, “Electric Hybrid Drive Systems . . .”, SAE Paper No. 910247, 1991.
(Continued)

Primary Examiner—David R. Dunn
(74) Attorney, Agent, or Firm—Michael de Angelis

ABSTRACT
(57) A hybrid vehicle comprises an internal combustion engine, a traction motor, a starter motor, and a battery bank, all controlled by a microprocessor in accordance with the vehicle's load. The vehicle's load is defined as the torque required to propel the vehicle under conditions of high efficiency, typically only when the load is at least equal to 30% of the engine's maximum torque output. In some embodiments, a turbo-charger may be provided, activated only when the load is greater than a setpoint. In other embodiments, a two-speed transmission may further be provided, to further broaden the vehicle's load range. A hybrid brake system provides regenerative braking, with mechanical braking available in the event the battery bank is fully charged. The vehicle's load is controlled by a microprocessor which is provided to control the brake system to provide linear brake feel under varying circumstances.

41 Claims, 17 Drawing Sheets

Introduction to the '347 Patent

employing said at least one electric motor to propel said vehicle when the torque RL required to do so is less than said lower level SP;

employing said engine to propel said vehicle when the torque RL required to do so is between said lower level SP and MTO;

'347 Patent, Claim 23

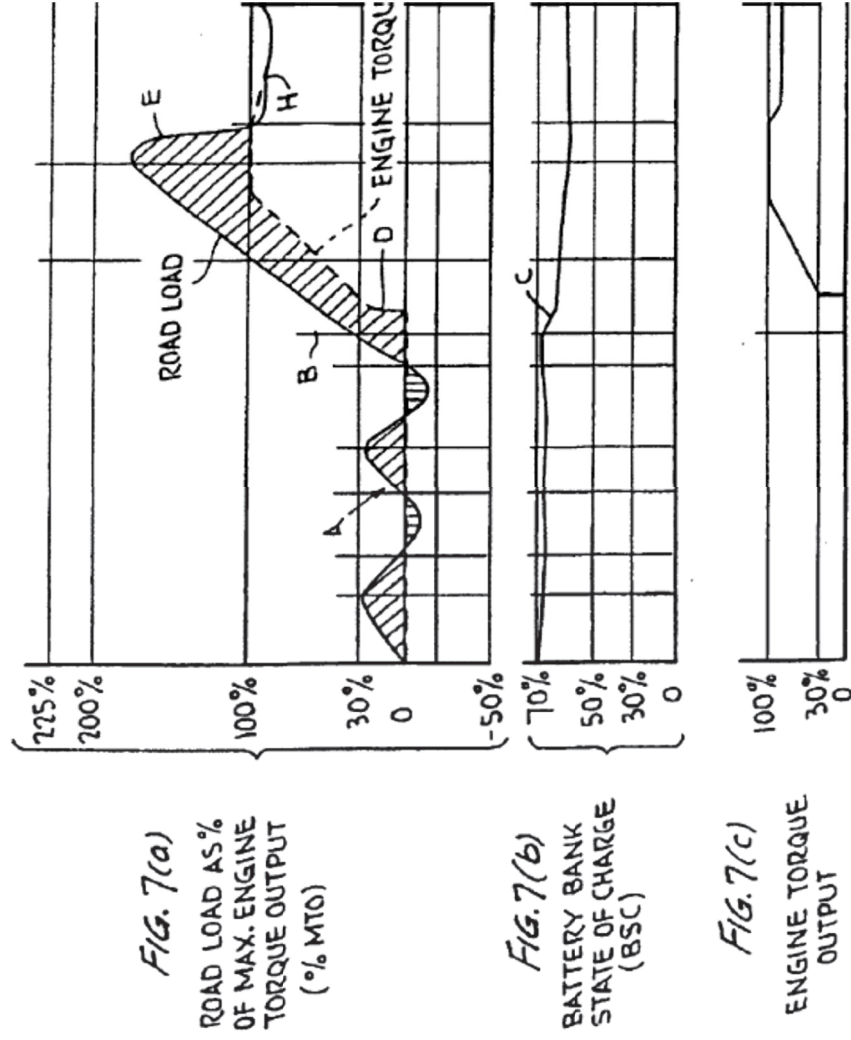
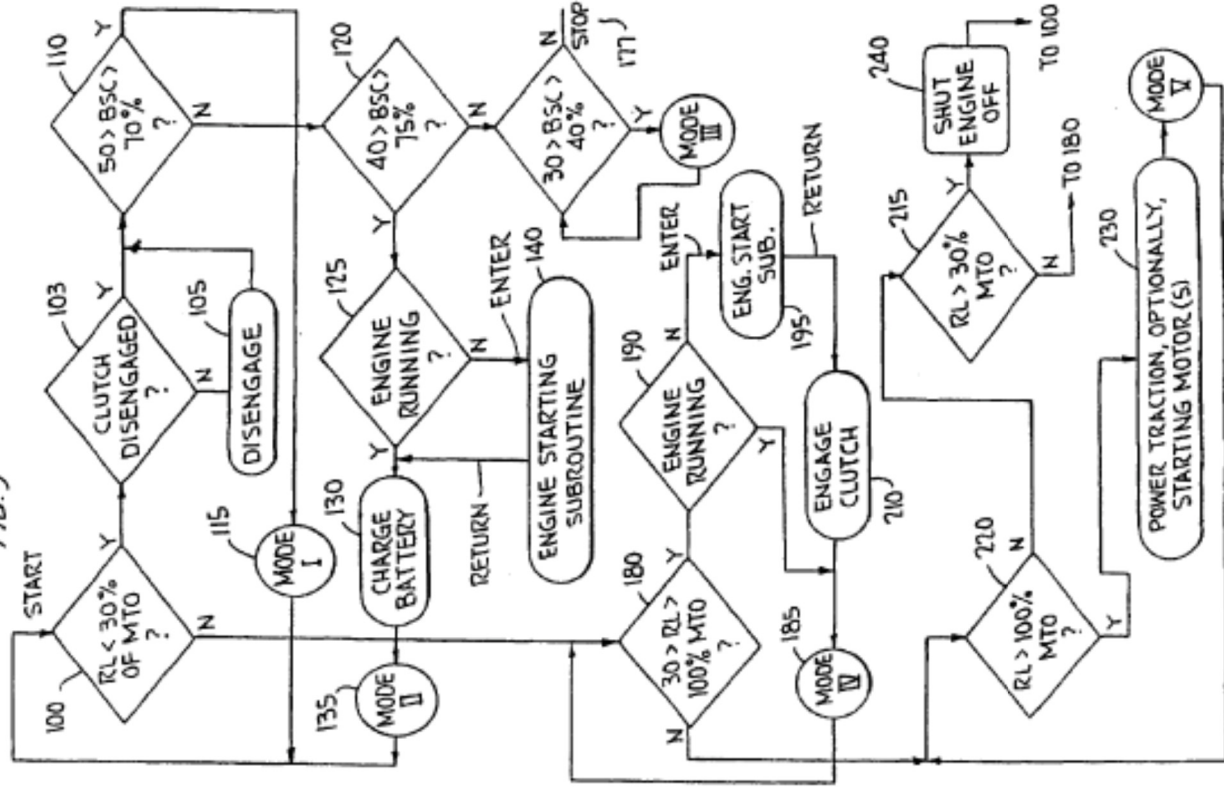

Fig. 9



'347 Patent, Fig. 7

'347 Patent, Fig. 9

Introduction to the '347 Patent

employing said at least one electric motor to propel said vehicle when the torque RL required to do so is less than said lower level SP;

employing said engine to propel said vehicle when the torque RL required to do so is between said lower level SP and MTO;

'347 Patent, Claim 23

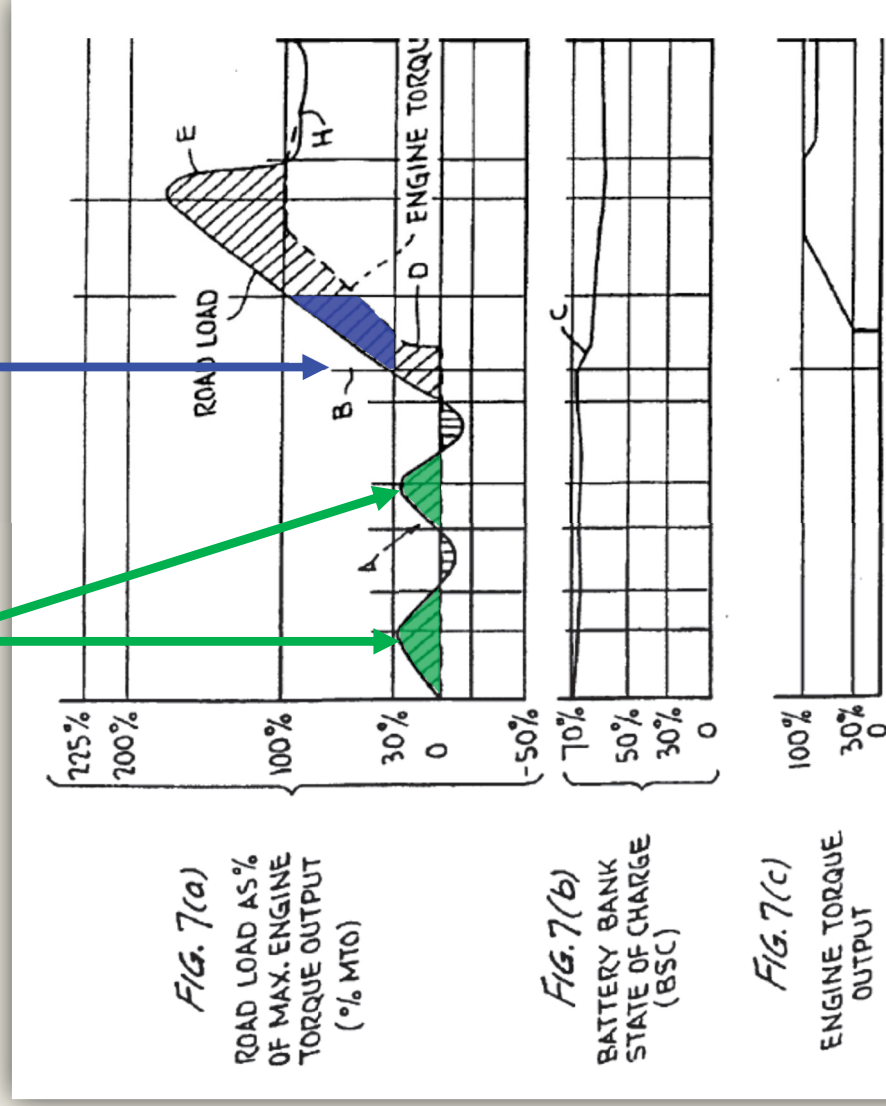
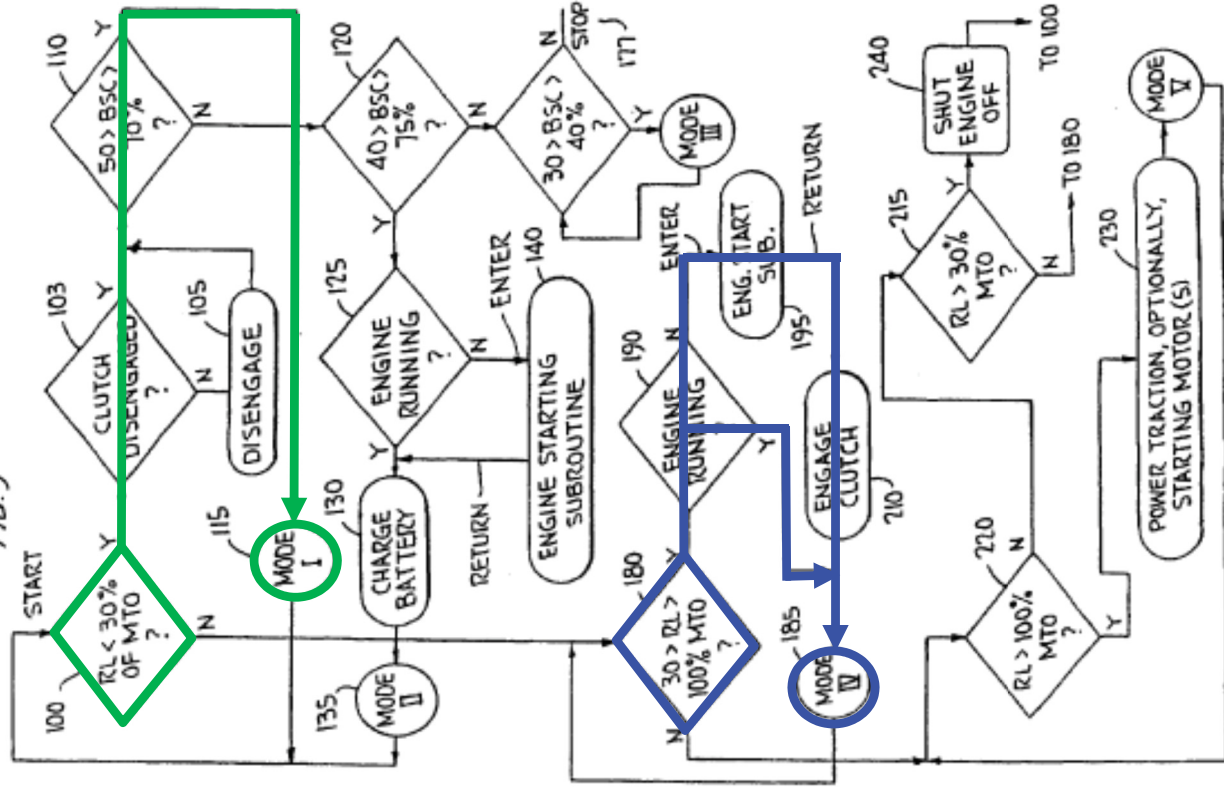

Fig. 9



Claim 24: Claim Construction of “monitor patterns of vehicle operation over time”

Disputed Claim Constructions

24. The method of claim 23, comprising the further step of employing said controller to monitor patterns of vehicle operation over time and vary said setpoint SP accordingly.

- “Ford and Dr. Davis’s gross misapplication of this claim language to Tabata ’541 is ... factually wrong.” POR at 13.
- Patent Owner respectfully requests that the Board adopt Patent Owner’s proposed construction:

Claim Term	Proposed Construction
“monitor patterns of vehicle operation over time”	“the controller tracks and records the driver’s repeated driving operations over time.”

“the controller tracks and records the driver’s repeated driving operations over time.”

- “The specification makes clear that the claimed control system can be altered based on “patterns of vehicle operation over time,” which refers to how the operator actually drives the car over some period of time, i.e. changing variables according to how the driver actually uses the car on a day to day basis.” POR at 13.

‘347 Patent, Ex. 1201 at col. 40:56-59

It is also within the scope of the invention for the microprocessor to monitor the vehicle’s operation over a period of days or weeks and reset this important setpoint in response to a repetitive driving pattern.

“the controller tracks and records the driver’s repeated driving operations over time.”

‘347 Patent, Ex. 1201 at col. 40:59-41:7

For example, suppose the operator drives the same route from a congested suburban development to a workplace about the same time every morning; typically the road load might remain under 20% of MTO for the first few minutes of each day, then vary between 0 and 50% of MTO for another few minutes as the operator passes through a few traffic lights, and then suddenly increase to 150% of MTO as the operator accelerates onto a highway. It is within the skill of the art to program a microprocessor to record and analyze such daily patterns, and to adapt the control strategy accordingly. For example, in response to recognition of a regular pattern as above, the transition point might be adjusted to 60% of MTO; this would prevent repetitive engine starts as the road load exceeded 30% of MTO for a few hundred yards at a time, as might often occur in suburban traffic.

“the controller tracks and records the driver’s repeated driving operations over time.”

- “Ford interprets claim 24 and ‘monitor patterns of vehicle operation over time’ to include monitoring the battery state of charge and adjusting the ‘setpoint’ based on the state of charge.” POR at 14
- “[W]hen the inventors wanted to claim changing control parameters based on the state of charge, they did so without using the word ‘pattern.’” POR at 15

‘347 Patent, claim 13

13. The vehicle of claim 12, wherein said time T is controlled responsive to the state of charge of the battery.

- “[T]he changing state of battery charge during normal vehicle operation is clearly not a ‘pattern.’” POR at 15 .

“the controller tracks and records the driver’s repeated driving operations over time.”

- Patent Owner’s construction “of the word ‘pattern’ is consistent with the plain and ordinary meaning of the word, which is how a person of ordinary skill in the art would have understood it at the time.” POR at 16.

Oxford Essential Dictionary, American Ed. (1998), Ex. 2210 at 3

pat·tern /pá·tərn/ • *n.* **1** decorative design. **2** regular or logical form, order, etc. **3** model or design, e.g., of a garment, from which copies can be made. **4** example of excellence; ideal; model (*a pattern of elegance*). • *v.tr.* **1** model (a thing) on a design, etc. **2** decorate with a pattern.

“the controller tracks and records the driver’s repeated driving operations over time.”

“Hybrid/Electric Vehicle Design Options and Evaluations” (1992), Ex. 1221 at 5

The key user-pattern information required to design a hybrid vehicle is the statistics of daily usage (fraction of days for which the total daily travel is less than selected values), as that permits the specification of the all-electric range of the vehicle on a rational basis.

Dr. Davis did not rely on the specification to determine the meaning of Claim 24

- “Dr. Davis admitted at his deposition that he did not rely on the specification to determine the meaning of ‘patterns of vehicle operation.’” POR at 14, n. 6.



Q: Looking at your declaration, pages 192 to 198 where you discuss Claim 24, it's true that you don't cite to any portions of the specification of the '347, right?

Dr. Davis: I don't think I did. It doesn't look like I quoted any of the language from the specification of the '347 here.

Q: Sitting here today, you don't recall any specific passages from the specification that you relied on to come to your understanding of what a pattern of vehicle operation meant in Claim 24, right?

Dr. Davis: I don't recall anything in particular, as I sit here today.

Ground 1: Caraceni

981124

HYBRID POWER UNIT DEVELOPMENT FOR FIAT MULTIPLA VEHICLE

A. Caraceni, G. Cipolla
ELASIS S.p.A. - Milan

R. Barbiero
FIAT AUTO - YAMAHA

Copyright © 1998 Society of Automotive Engineers, Inc.

ABSTRACT

In the "scenario" of increasing concerns for environmental pollution, hybrid vehicles will play a significant role in the near future. Compared to electric vehicles, the hybrid ones have an unrestricted driving range, higher performance and transport capability, still fulfilling ZEV emission regulation.

The hybrid vehicle features a power train that integrates a thermal engine with an electric motor. Among the several possible configurations for hybrid vehicle, the parallel hybrid one has been chosen for the FIAT MULTIPLA, for the following reasons:

- lower weight and volume of the electric unit to obtain the same driving mission;
- higher global efficiency of the system, due to direct thermal to mechanical energy conversion;
- a better vehicle performance (acceleration and max speed), thanks to the contribution of both motors to traction.

In the development of a hybrid parallel concept, the critical aspects to be overcome are related to the system mechanical complexity and the simultaneous control of the two motors.

In this paper, the Fiat Auto and Elasis approach to the hybrid vehicle is presented with particular reference to the powertrain unit and its control strategies.

INTRODUCTION

In the last years the European legislation and environmental issues have focused the attention to the inconvenience produced by traffic density in our most

29

congested European urban centers. Electric vehicles, as reported by several studies performed in different European cities, could substitute less than 10 % of the vehicles in circulation in the cities, provided that they can assure a real range of more than 80 km. On the contrary, a hybrid vehicle would allow a substitution of a bigger portion of the vehicle city park, thanks to their "range extension" and "peak performance" features.

The hybrid vehicle seems to be a very promising answer to today's different demands such as:

- free driving in emission protected zones
- ability to match different condition in urban or extra urban driving
- unrestricted range and transport capabilities like thermal vehicles
- same or similar driving characteristics as a conventional vehicle
- reduced dependency on batteries
- use of existing infrastructure
- commercially interesting image.

The mass production feasibility of the electric vehicle remains nowadays a big concern, primarily because of the battery problems. In case of the hybrid vehicle, battery dependency is reduced and so the hybrid vehicle is more acceptable to the public.

Conventional vehicles, especially those equipped with gasoline engines, have lower fuel economy and higher emissions especially in short range distance driving during warm-up phases, but offer high performance, long

FORD 1203

Caraceni (Ex. 1203) describes the hybrid Fiat Multipla, a parallel hybrid vehicle with an engine and a single traction motor

Ground 1: Introduction to Caraceni

- Caraceni discloses a system in which “[t]he driver can select between the following four operating modes”:

Caraceni, Ex. 1203 at 5-6

- hybrid mode
- electric mode
- economy mode
- recharge mode

Ground 1: Introduction to Caraceni



46. Similarly, photographs of what I understand to be the Fiat Multipla Hybrid⁵ show the vehicle mode selection dial in the center console, to the right of the driver's seat:



Ground 1: Introduction to Caraceni

- “Hybrid mode” in Caraceni:

Caraceni, Ex, 1203 at 6

“Parameters from engine and vehicle ECU, are exchanged through CAN protocol. The driver, through the accelerator pedal position, sets the required traction torque; this is then splitted (in hybrid mode) between the engine and the motor as a function of vehicle operating condition and battery state of charge to optimize fuel economy, emission and driveability.”

Ground 1: Introduction to Caraceni

Ex. 2215 at ¶ 55



Indeed, the “step function” shape of the “driver torque request” lines in Fig. 9 (which are identical across the three modes) confirms that the lines reflect different pedal positions, and the time between them:

Caraceni, Ex. 1203 at 6

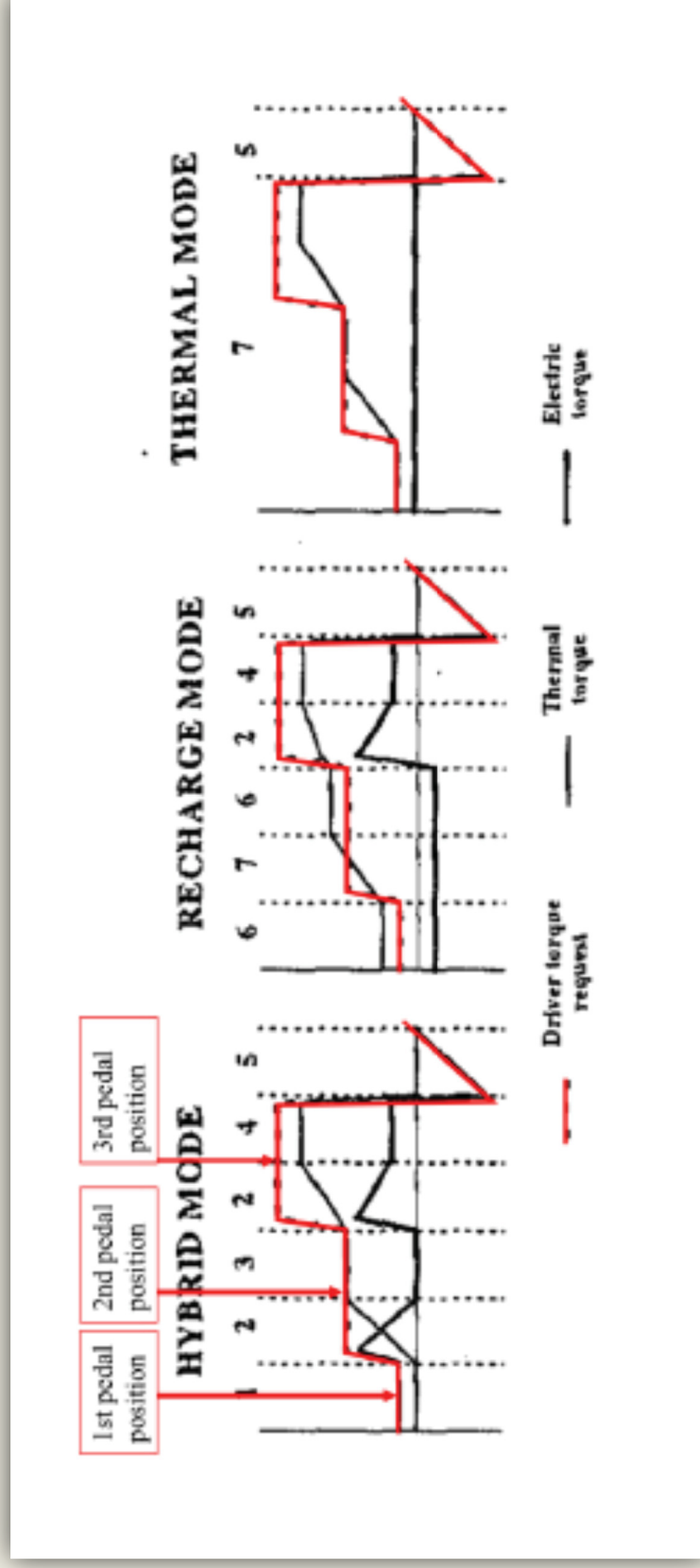

Caraceni Does Not Render Obvious Independent Claim 1 Or Dependent Claim 7

'347 Patent Claim 1 Introduction

What is claimed is:

1. A hybrid vehicle, comprising:
an internal combustion engine controllably coupled to road wheels of said vehicle;
a first electric motor connected to said engine and operable to start the engine responsive to a control signal;
a second electric motor connected to road wheels of said vehicle, and operable as a motor, to apply torque to said wheels to propel said vehicle, and as a generator, for accepting torque from at least said wheels for generating current;
a battery, for providing current to said motors and accepting charging current from at least said second motor; and
a controller for controlling the flow of electrical and mechanical power between said engine, first and second motors, and wheels,
wherein said controller starts and operates said engine when torque require to be produced by said engine to propel the vehicle and/or to drive either one or both said electric motor(s) to charge said battery is at least equal to a setpoint (SP) above which said engine torque is efficiently produced, and wherein the torque produced by said engine when operated at said setpoint (SP) is substantially less than the maximum torque output (MTO) of said engine.

Claim 1 compares the “torque require[d] to be produced by said engine to propel the vehicle and/or to drive either one or both said electric motor(s) to charge said battery” to a “setpoint” to determine whether to “start and operate” the engine.

'347 Patent Claim 7 Introduction

7. The vehicle of claim 1, wherein said vehicle is operated in a plurality of operating modes responsive to the value for the road load (RL) and said setpoint SP, both expressed as percentages of the maximum torque output of the engine when normally-aspirated (MTO), and said operating modes include:

a low-load mode I, wherein said vehicle is propelled by torque provided by said second electric motor in response to energy supplied from said battery, while $RL < SP$,

a highway cruising mode IV, wherein said vehicle is propelled by torque provided by said internal combustion engine, while $SP < RL < MTO$, and an acceleration mode V, wherein said vehicle is propelled by torque provided by said internal combustion engine and by torque provided by either or both electric motor(s) in response to energy supplied from said battery, while $RL > MTO$.

Dependent claim 7 operates the vehicle in a plurality of modes by comparing the "road load" to a "setpoint."

Caraceni does not disclose or suggest each limitation of the challenged claims

- 1) **“The use of a ‘setpoint’ is not explicitly or inherently disclosed by Caraceni.” POR at 23.**
- 2) **“[N]either Ford nor Dr. Davis explain how a vague reference to “specific fuel consumption” discloses or suggests a “predetermined torque value” of any kind, or how that value might be used.” POR at 24.**
- 3) **“Caraceni does not disclose or suggest the use of “road load.”” POR at 32.**
- 4) **“Caraceni does not disclose or suggest the “controller” of claim 1 that “starts and operates” the engine to charge the battery.” POR at 38**

Caraceni does not disclose or suggest each limitation of the challenged claims

- 1) “The use of a ‘setpoint’ is not explicitly or inherently disclosed by Caraceni.” POR at 23.**
- 2) “[N]either Ford nor Dr. Davis explain how a vague reference to “specific fuel consumption” discloses or suggests a “predetermined torque value” of any kind, or how that value might be used.” POR at 24.**
- 3) “Caraceni does not disclose or suggest the use of “road load.”” POR at 32.**
- 4) “Caraceni does not disclose or suggest the “controller” of claim 1 that “starts and operates” the engine to charge the battery.” POR at 38**

Claim 1 and 7 Introduction

Claim 1

wherein said controller starts and operates said engine when torque require to be produced by said engine to propel the vehicle and/or to drive either one or both said electric motor(s) to charge said battery is at least equal to a setpoint (SP) above which said engine torque is efficiently produced, and wherein the torque produced by said engine when operated at said setpoint (SP) is substantially less than the maximum torque output (MTO) of said engine.

Claim 7

a low-load mode I, wherein said vehicle is propelled by torque provided by said second electric motor in response to energy supplied from said battery, while RL<SP,
a highway cruising mode IV, wherein said vehicle is propelled by torque provided by said internal combustion engine, while SP<RL<MTO, and

Ford's flawed inherency argument

Ford's Petition at 32 (emphasis added)

In other words (as illustrated by time period 2) Caraceni discloses starting the engine to provide torque to propel the vehicle when the amount of torque to be produced by the engine is at least equal to a predetermined torque value or “setpoint.” (Ex. 1215, Davis at ¶¶276-279.)

Ford's flawed inherency argument

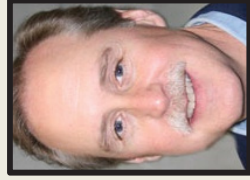

Looking again at the “hybrid mode” operation of the torque management graph illustrated in Figure 9, Caraceni inherently discloses a predetermined torque value or “setpoint” (dashed green line) below which the engine is not started and operated (time period 1) and the electric motor is used to propel the vehicle. In other words, below the disclosed “*setpoint*” the torque produced by the engine is inefficient (i.e., has a high specific fuel consumption value).

IPR ‘884, Ex. 1215, Davis Dec. at ¶ 275

Ford's flawed inherency argument

- “Dr. Davis used the wrong legal test for ‘inherency.’” POR at 26

“The mere fact that a certain thing may result from a given set of circumstances is not sufficient to establish inherency. That which may be inherent is not necessarily known. Obviousness cannot be predicated on what is unknown. Such a retrospective view of inherency is not a substitute for some teaching or suggestion supporting an obviousness rejection.”

In re Rijckaert, 9 F.3d 1531, 1534 (Fed. Cir. 1993) (emphasis added)

IPR '884, Paper No. 19, POR at 25

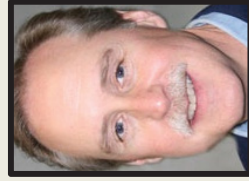

Q Right. But could the value that the system is using to switch between motor mode in time period 1 and engine mode in time period 2, could that value be reset? Is that technically possible?

Dr. Davis: I suppose technically that would be one design choice. But, again, as I say, in order to figure out where that value is occurring, you would first have to figure out what the torque requirements are. And so really the most kind of efficient way to do that would be to base it on the torque itself.

A “setpoint” is not inherent in Caraceni

- “[N]owhere does Caraceni disclose or suggest a controller that compares a ‘predetermined torque value’ to the ‘torque require to be produced by said engine to propel the vehicle.’” POR at 24
- “In fact, Caraceni does not tell the reader when to start the engine at all.” POR at 24

Caraceni, Ex. 1203 at 6

Furthermore when the vehicle operates with light loads it is convenient to use electric power instead of thermal one because of the high specific fuel consumption of the gasoline engine.

Caraceni, Ex. 1203 at 6

1. The electric motor provides all the required torque where engine has high specific fuel consumption

A “setpoint” is not inherent in Caraceni



Hannemann Dec, Ex. 2215 at 41-42.

“A person of ordinary skill in the art would understand that ‘specific fuel consumption’ is the rate of fuel consumption divided by the power output of the engine. See e.g. Ex. 2204 at 38. As noted in the Bosch Automotive Handbook, 4th Edition, with respect to conventional vehicles fuel consumption is not a control metric, but is determined experimentally by running vehicle tests. See Ex. 2204 at 328. Thus, one of ordinary skill in the art would understand that Caraceni is merely disclosing a general goal of hybrid vehicles, i.e. using fuel efficiently (which can be determined via testing a vehicle).”

Dr. Davis is applying the wrong standard of inherency

- “Dr. Davis is applying the wrong standard of inherency in his reply, and ... his reply contradicts his prior deposition testimony.” Motion for Observations at 4.

Deposition before his reply:

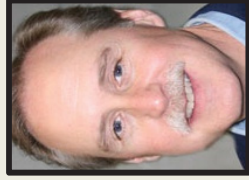

Q. And what's your understanding of the doctrine of inherency?

A. I don't know if I had that disclosed in mine. Again, I'm not a patent attorney. But I think "inherency" means that if something -- if one of ordinary skill in the art would know that something must be there in order for it to function, maybe, in the claimed way, that it would be inherently there.

IPR '884, Paper No. 29, Motion for Observations at 4 (citing Ex. 2212, Davis Tr. at 153:14-22)

Deposition after his reply:

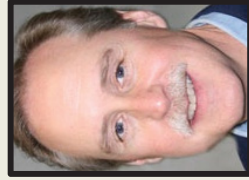

Q. So what's your non-legal definition of inherency?

A. That again, this particular attribute, if it's inherent it simply may exist or be obvious within the disclosed device.

IPR '884, Paper No. 29, Motion for Observations at 4 (citing Ex. 2217, Davis Tr. at 11:16-12:5)

Ford's flawed inherency argument

- “Dr. Davis testified that Caraceni does not ‘specifically disclose an engine fuel performance map.’” Motion for Observations at 4.
- Dr. Davis also “testified that the support for his opinion that someone of skill in the art would understand that Caraceni was using an ‘engine performance map’ was the ‘entire reference’ and not a specific disclosure therein.” *Id.* at 5.

Caraceni does not disclose or suggest each limitation of the challenged claims

- 1) **“The use of a ‘setpoint’ is not explicitly or inherently disclosed by Caraceni.” POR at 23.**
- 2) **“[N]either Ford nor Dr. Davis explain how a vague reference to “specific fuel consumption” discloses or suggests a “predetermined torque value” of any kind, or how that value might be used.” POR at 24.**
- 3) **“Caraceni does not disclose or suggest the use of “road load.”” POR at 32.**
- 4) **“Caraceni does not disclose or suggest the “controller” of claim 1 that “starts and operates” the engine to charge the battery.” POR at 38**

Caraceni does not disclose a “setpoint”

Caraceni, Ex. 1203 at 6

Furthermore when the vehicle operates with light loads it is convenient to use electric power instead of thermal one because of the high specific fuel consumption of the gasoline engine.

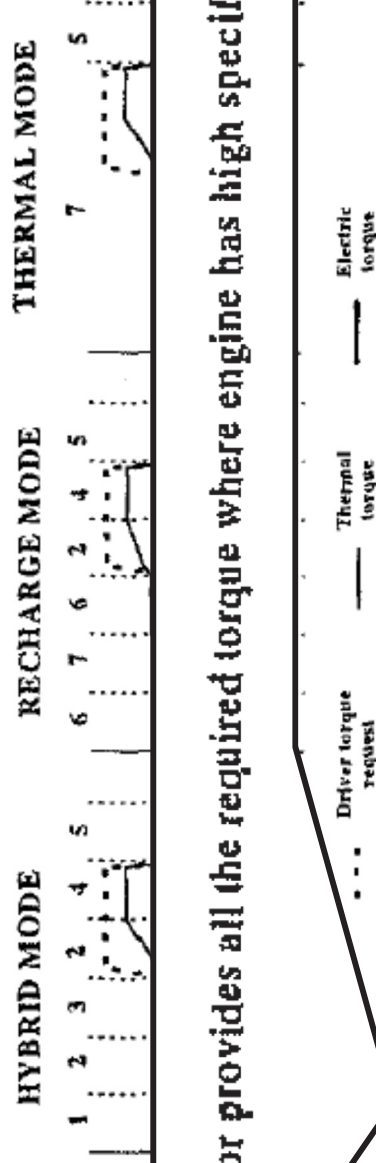

1. The electric motor provides all the required torque where engine has high specific fuel consumption

1. The electric motor provides all the required torque where engine has high specific fuel consumption
2. The engine delivers torque with limited torque gradient; the electric motor delivers complementary torque
3. The engine delivers the total requested torque
4. Electric motor torque is added when the requested torque is higher than the maximum engine torque
5. Braking torque is provided by the electric motor to recharge the batteries
6. The electric motor recharges the batteries; the thermal engine delivers torque for both traction and recharge
7. The electric motor does not deliver any positive torque for traction (limited vehicle performance)

Figure 9

Caraceni does not disclose a “setpoint”

- “To the extent the vehicle is ever propelled by only the motor in “hybrid mode,” all Caraceni discloses is that it is preferable to use the motor when the “specific fuel consumption” of the engine (i.e. the ratio of fuel consumption to power output of the engine) is high.” POR at 23.
- “The “specific fuel consumption” of an engine is defined as the rate of fuel consumption divided by the power produced.” POR at 21.
- A person of ordinary skill in the art would understand that good fuel efficiency is a goal of a control algorithm, not the algorithm itself.” POR at 23.

Caraceni does not disclose a “setpoint”

- “Ford’s Dr. Stein opined in a related IPR involving Caraceni that:” (POR at 29)



“It is well known that an engine operates at high specific fuel consumption at low speed and high torque conditions.”

IPR2014-00875, Ex. 1002, Stein Declaration at ¶ 272 (emphasis added).

- “Dr. Davis is simply wrong that ‘specific fuel consumption’ necessarily discloses high or low torque conditions, because as Dr. Stein testified, ‘high specific fuel consumption’ can occur in ‘high torque conditions.’” POR at 29.

Caraceni does not disclose or suggest each limitation of the challenged claims

- 1) **“The use of a ‘setpoint’ is not explicitly or inherently disclosed by Caraceni.” POR at 23.**
- 2) **“[N]either Ford nor Dr. Davis explain how a vague reference to “specific fuel consumption” discloses or suggests a “predetermined torque value” of any kind, or how that value might be used.” POR at 24.**
- 3) **“Caraceni does not disclose or suggest the use of “road load.”” POR at 32.**
- 4) **“Caraceni does not disclose or suggest the “controller” of claim 1 that “starts and operates” the engine to charge the battery.” POR at 38**

Caraceni uses pedal position, not “road load” to make mode determinations

- “Caraceni never states that “road load” is evaluated to effect mode switching.” POR at 36.

Caraceni, Ex. 1203 at 6

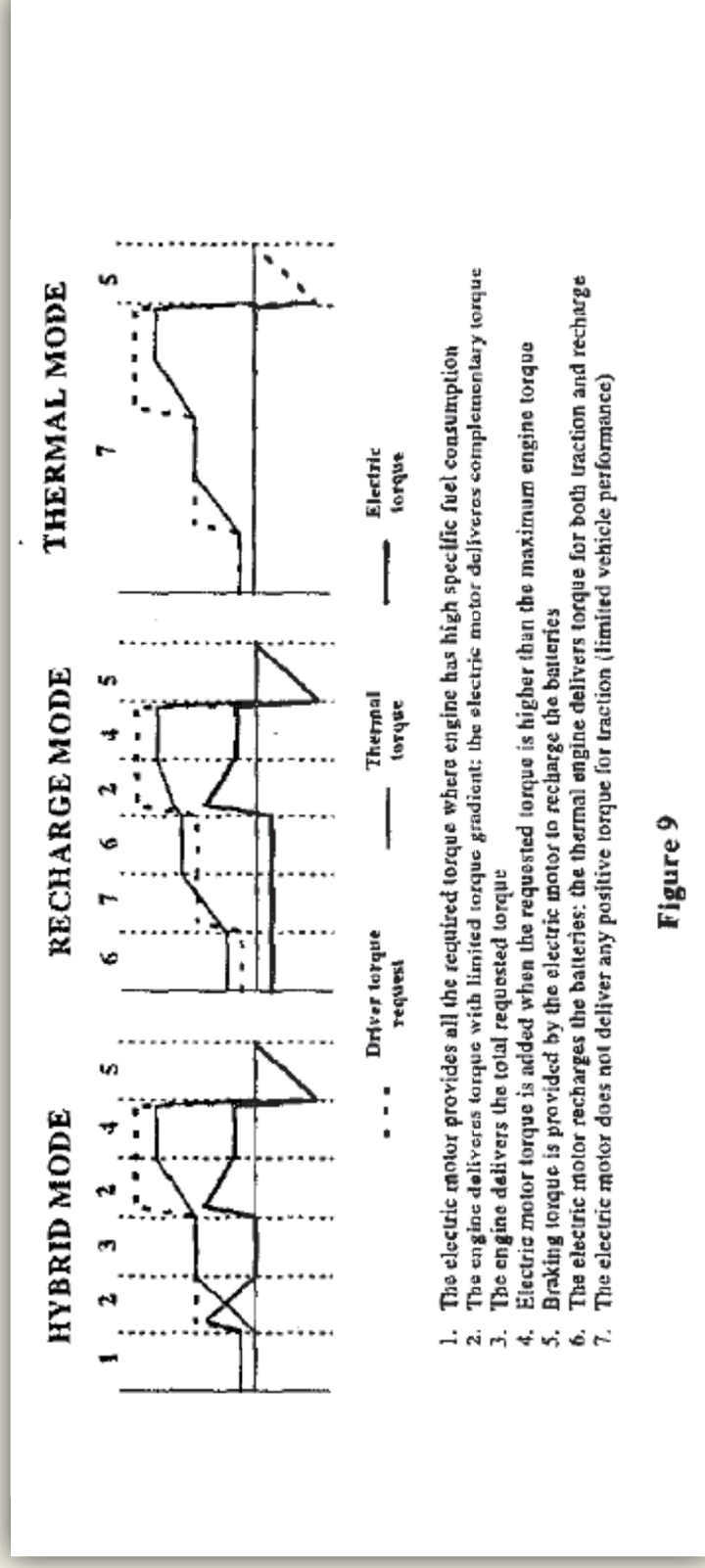

Figure 9

Caraceni uses pedal position, not “road load” to make mode determinations

- “Caraceni never states that “road load” is evaluated to effect mode switching.” POR at 36.

Caraceni, Ex. 1203 at 6

Parameters from engine and vehicle ECU, are exchanged through CAN protocol. The driver, through the accelerator pedal position, sets the required traction torque; this is then splitted (in hybrid mode) between the engine and the motor as a function of vehicle operating condition and battery state of charge to optimize fuel economy, emission and driveability. The electric torque request is then actuated through the inverter. The thermal engine torque request is supplied to the engine control unit that set the throttle angle accordingly.

Caraceni uses pedal position, not “road load” to make mode determinations

- “Like a conventional vehicle, Caraceni simply discloses that the driver presses the accelerator pedal to set the ‘ required traction torque.’” POR at 36.



Hannemann Dec., Ex. 2215 at 52.

[W]hile the accelerator pedal position may be one input to a more sophisticated system that calculates “road load,” the accelerator position alone is not determinative of “road load.” The “road load” can be different according to the operating conditions. For example, factors such as rolling resistance and wind resistance affect the “road load,” but are not necessarily indicated by pedal position.

Caraceni uses pedal position, not “road load” to make mode determinations

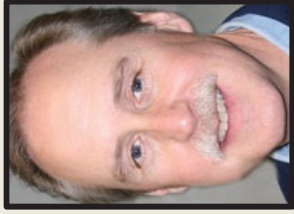

Davis Dec., Ex. 1215 at 115

“With respect to the accelerator pedal and brake pedal, Caraceni specifically discloses that these inputs are used to “set a required traction torque.” (Ex. 1203, Caraceni at 6.) This required traction torque is used to determine the torque required for propulsion of the vehicle (i.e., “road load (RL)”) from either the motor alone, the engine alone or a combination of both the motor and engine.”

Caraceni uses pedal position, not “road load” to make mode determinations

- “Dr. Davis admitted that vehicles going back to Ford’s Model T correlate pedal position with operator demand.” POR at 37.

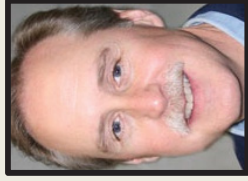

Q. Now, it is -- the statement I just read is true for every vehicle that has existed since the Model T that all torque required to drive the vehicle is provided by the internal combustion engine. All conventional cars operate that way, correct?

A. In conventional vehicles, the torque, you only have one source.

Q. Well, and the Model T didn’t calculate road load, right?

A. Again, you had -- the indicator to the engine in the Model T would be again the accelerator pedal or, you know, in the absence of that on that simple system, and that is an indicator of the operator’s desire and also to meet the instantaneous torque required to propel the vehicle.

IPR ‘884, Paper No. 19, POR at 37 (citing Ex. 2213 at 128:4-12)

Caraceni does not disclose or suggest each limitation of the challenged claims

- 1) “The use of a ‘setpoint’ is not explicitly or inherently disclosed by Caraceni.” POR at 23.
- 2) “[N]either Ford nor Dr. Davis explain how a vague reference to “specific fuel consumption” discloses or suggests a “predetermined torque value” of any kind, or how that value might be used.” POR at 24.
- 3) “Caraceni does not disclose or suggest the use of “road load.”” POR at 32.
- 4) “Caraceni does not disclose or suggest the “controller” of claim 1 that “starts and operates” the engine to charge the battery.” POR at 38

'347 Patent Claim 1 - Battery Recharge

What is claimed is:

1. A hybrid vehicle, comprising:
an internal combustion engine controllably coupled to road wheels of said vehicle;
a first electric motor connected to said engine and operable to start the engine responsive to a control signal;
a second electric motor connected to road wheels of said vehicle, and operable as a motor, to apply torque to said wheels to propel said vehicle, and as a generator, for accepting torque from at least said wheels for generating current;
a battery, for providing current to said motors and accepting charging current from at least said second motor;
and
a controller for controlling the flow of electrical and mechanical power between said engine, first and second motors, and wheels,
wherein said controller starts and operates said engine when torque require to be produced by said engine to propel the vehicle and/or to drive either one or both said electric motor(s) to charge said battery is at least equal to a setpoint (SP) above which said engine torque is efficiently produced, and wherein the torque produced by said engine when operated at said setpoint (SP) is substantially less than the maximum torque output (MTO) of said engine.

The controller of claim 1 “starts and operates” the engine when the “torque require[d] to be produced by said engine ... to drive either one or both said electric motor(s) to charge said battery” is at least equal to a “setpoint.”

“Recharge mode” in Caraceni must be manually selected by the driver

- “Ford and Dr. Davis rely on the ‘recharge mode’ for this limitation. However, ... ‘recharge mode’ must be manually selected by the driver.” POR at 38.
- “Dr. Davis was unable to answer whether or not manually switching into recharge mode meets the limitations of claim 1.” Motion for Observations at 6.

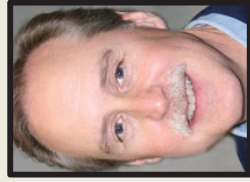

Q. I'm talking about any hybrid vehicle. So would a scenario in which a user is driving a hybrid vehicle and flips a switch that causes the engine to drive an electric motor to charge the battery, under that scenario would claim limitation 1.6 be satisfied?

MR. RONDINI: Objection, vague, calls for a legal conclusion.

Dr. Davis: I think I'd really have to see something and be able to sit down and really analyze it. I really don't think I can answer that as I sit here right now without, you know, doing a full analysis. And I -- I think I just have to really analyze that.

Q. You can't tell me one way or another if Claim 1.6 would be satisfied?

MR. RONDINI: Objection, vague, asked and answered.

Dr. Davis: Again, I would want to look at, you know, the actual hybrid electric vehicle and really analyze its operation and control in regards to the claim.

“Recharge mode” in Caraceni must be manually selected by the driver

- “Dr. Davis testified that when a driver selects ‘recharge mode’ in Caraceni, Dr. Davis was unable to answer whether or not the driver was aware of the torque required to be produced by the engine.” Motion for Observations at 7.



Q. I don't think you answered my question though. My question was whether when the user selects recharge mode does that user have any idea whether or not the torque required to drive the motor is above a setpoint?

MR. RONDINI: Objection, vague.

A. I can't answer whether he does or he doesn't. I really don't know. So I've been focusing more on the fact that it's the controller that actually starts and operates the engine. And that's based on various inputs.

IPR '884, Paper No. 29, Motion for Observations at 7 (citing Ex. 2217, Davis Tr. at 55:20-56:5)

“Recharge mode” in Caraceni must be manually selected by the driver

- “Dr. Davis argued at his deposition, nonsensically, that automatically switching to “economy mode” disclosed automatically switching to “recharge mode.”” POR at 40.
- Dr. Davis’s deposition testimony “contradicts Dr. Davis’s reliance on that disclosure of Caraceni for his opinion that it teaches automatically switching into recharge mode, and shows that Dr. Davis’s declaration testimony is contradicted by the reference itself.” Motion for Observations at 6.

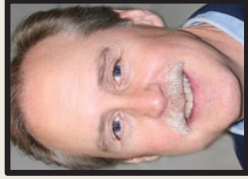

“Again, the paragraph discloses, I think we’ve read it before, that it – it automatically switches into economy mode if the battery reaches a certain threshold or level of discharge.”

IPR ‘884, Paper No. 29, Motion for Observations at 6 (citing Ex. 2217, Davis Tr. at 45:22-46:4)

“Recharge mode” in Caraceni must be manually selected by the driver

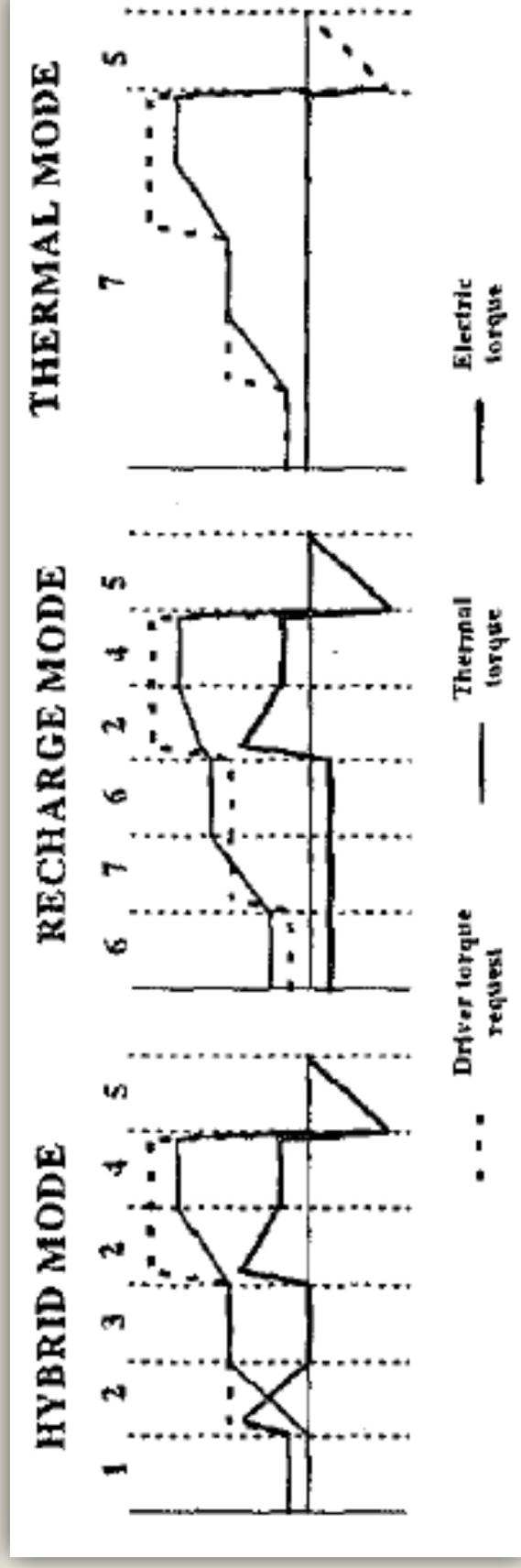

Fig. 9 also shows that during “recharge mode,” the engine is always on and providing torque to propel the vehicle. See Ex. 2215 at ¶ 99-100. In other words, nothing in Caraceni discloses or suggests that the engine is only turned on and operated by the controller when the “torque require[d] to be produced by said engine” is above a “setpoint.” See *id.* In fact, Caraceni teaches just the opposite – once the driver manually selects “recharge mode,” the engine is always turned on and used to propel the vehicle and charge the battery. See Ex. 2215 at ¶ 100.

Ground 2: Tabata '201 and Tabata '541

Ground 2: Introduction to Tabata '201

● Tabata '201 (Ex. 1215) discloses a system that compares the “instantaneous drive power” to various power thresholds to determine the operating mode.



US08841201A
 [11] Patent Number: 5,841,201
 [45] Date of Patent: Nov. 24, 1998

[54] HYBRID VEHICLE DRIVE SYSTEM HAVING
 A DRIVE SYSTEM INCLUDING BOTH ENGINE AND
 ELECTRIC MOTOR

[75] Inventors: Atsushi Tabata, Okazaki; Yutaka
 Tago, Aichi-ken; Ryuji Iboraki,
 Toyota; Tetsushi Mikami, Toyota;
 Hiroshi Hata, Toyota, all of Japan

[73] Assignee: Toyota Jidosha Kabushiki Kaisha,
 Toyota, Japan

[21] Appl. No.: 805,164

[22] Filed: Feb. 24, 1997

[30] Foreign Application Priority Data

Feb. 29, 1996 [JP] 8-042843
 May 27, 1996 [JP] 8-132105
 [51] Int. Cl.⁶ H02P 9/04
 [52] U.S. Cl. 290/40 C, 180/65.4, 290/16,
 290/27, 318/143, 322/16,
 322/17, 322/18, 322/19,
 322/40 C, 180/65.1, 65/4, 318/143, 143,
 322/14, 15, 16

[56] References Cited

U.S. PATENT DOCUMENTS
 5,176,313 1/1993 Kato et al. 180/245
 5,343,370 9/1994 Seretynsky 180/65.2
 5,545,528 8/1996 Kotani 290/40 C
 5,550,445 8/1996 Ni 318/153
 5,588,698 12/1996 Kinoshita 180/65.4

5,643,804 4/1997 Kinoshita et al. 322/18
 5,650,481 7/1997 Baral 364/231, 40
 5,656,621 8/1997 Baral 322/40
 5,698,855 12/1997 Ni 318/139
 5,722,011 3/1998 Iboraki et al. 47/3
 5,791,137 3/1998 Kinoshita et al. 322/14

FOREIGN PATENT DOCUMENTS

A-3-121928 5/1991 Japan
 A-6-80048 3/1994 Japan

Primary Examiner—Steven L. Stephan
 Assistant Examiner—Nicholas P. Szymanski
 Attorney, Agent, or Firm—Oliff & Berridge, P.C.

ABSTRACT

A hybrid drive system for a motor vehicle, having a power drive state in which there is available a power drive mode in which an engine and an electric motor are both operated as drive power sources for driving the vehicle, and which is a power drive mode in which only the electric motor is operated as a drive power source, and a power drive restricting device is provided to inhibit the vehicle from being driven in the power drive state and therefore in the power drive mode if the power drive selector is not manually operated. The hybrid drive system may have an engine assist device that provides an engine assist drive power source, together with the engine operated as a primary drive power source, according to a selected one of different drivability modes of the vehicle selected by a manually operated drivability performance selector.

12 Claims, 21 Drawing Sheets

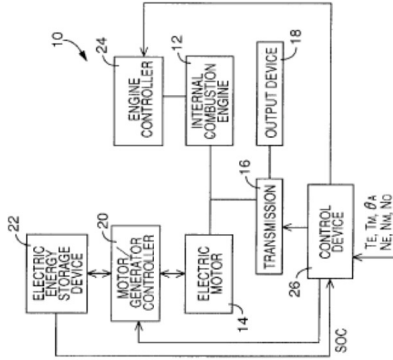

Ground 2: Introduction to Tabata '201

Tabata '201, Ex. 1204 at Fig. 15

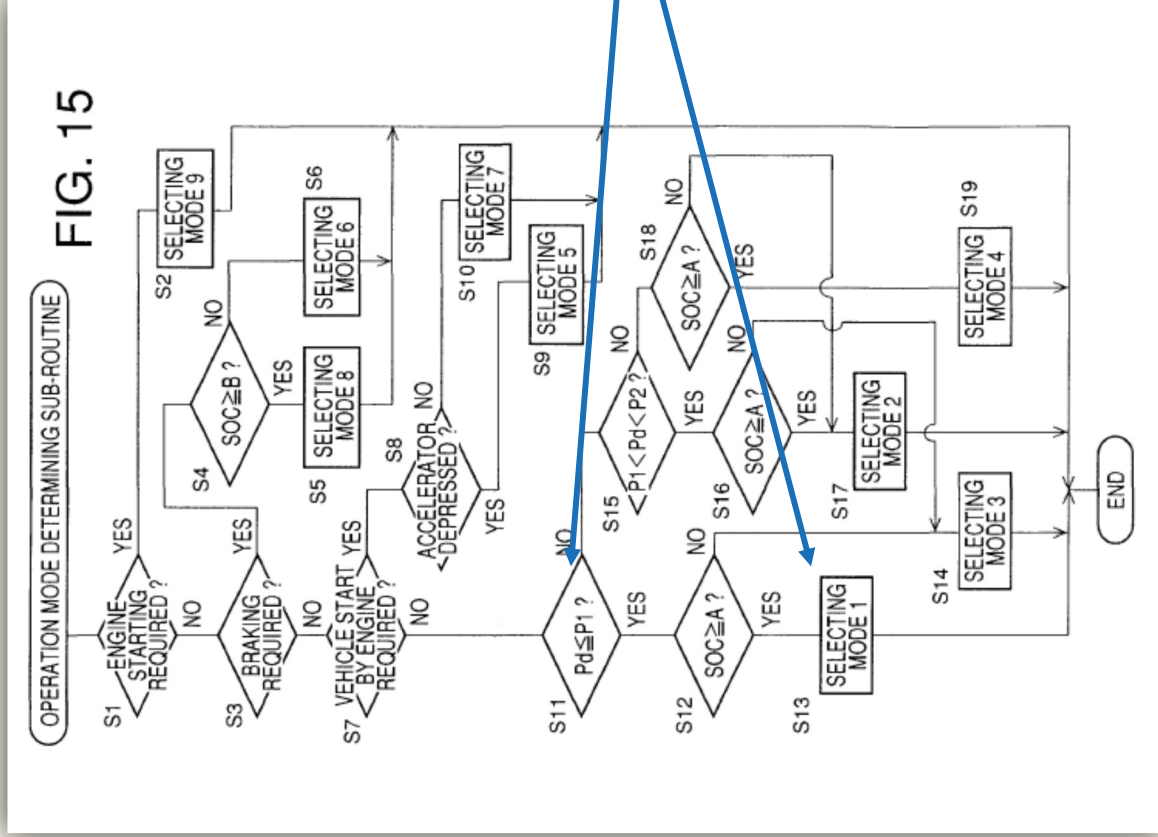

“If the ‘instantaneous drive power’ is less than threshold power value ‘P1,’ the ‘the vehicle is driven with only the motor/generator 214 as the drive power source.’”

POR at 46.

Ground 2: Introduction to Tabata '201

Tabata '201, Ex. 1204 at Fig. 15

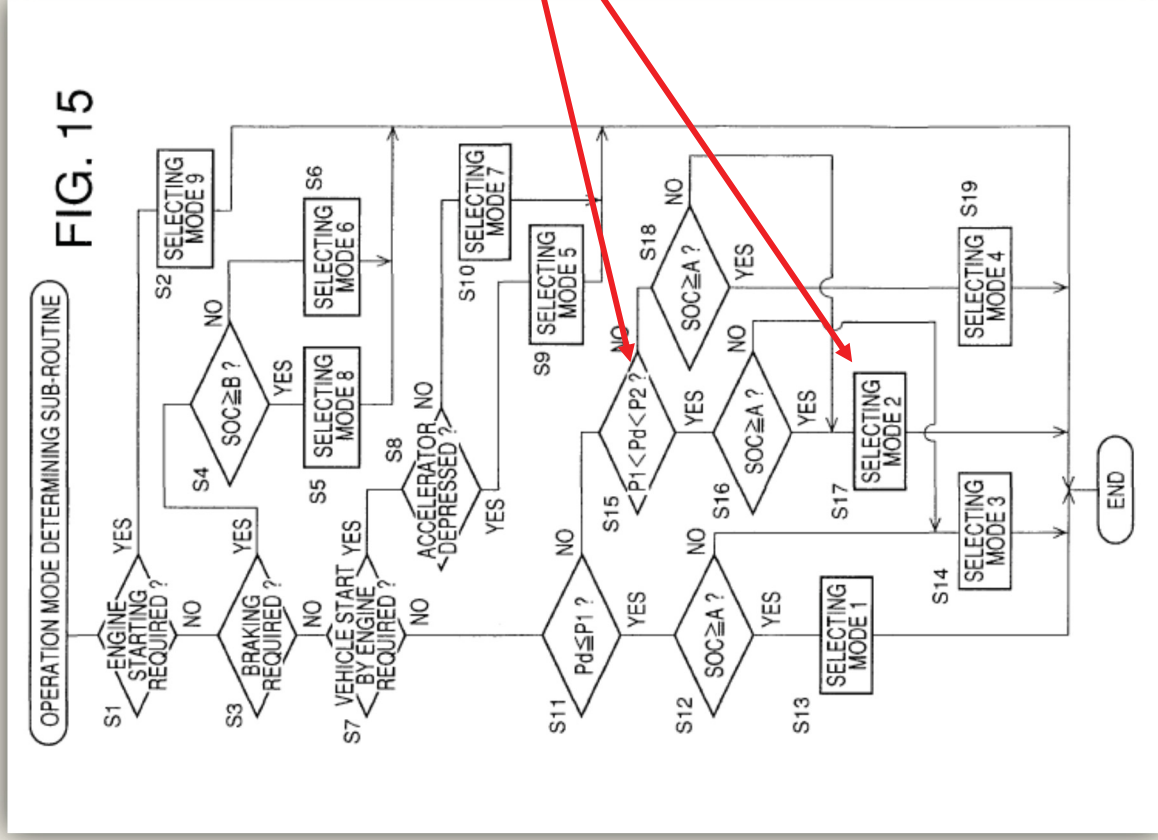

“[I]f the ‘ instantaneous drive power’ is greater than power threshold ‘ P1’ the ‘vehicle is driven with only the engine 212 used as the drive power source.’”

POR at 46.

Ground 2: Introduction to Tabata '201

- “Tabata '201 discloses a method of calculating the engine power output during ‘ engine drive & charging mode’ by determining the engine operating power that will produce the ‘ highest overall fuel consumption efficiency Value.’” POR at 54.

Tabata '201, Ex. 1204 at 18:38-18:65.

“[T]he lowest ratio of the fuel consumption amount M_{fc} to the output or power of the electric motor 14 during operation of the motor 14 by the electric energy which has been stored in the electric energy storage device 22 by operation of the motor 14 by the surplus power ($P_{ICE}-P_L$).”

Ground 2: Introduction to Tabata '541

Tabata '541, Ex. 1205 at 36:40-59

If a negative decision (NO) is obtained in step SH4, the control flow goes to step SH5 wherein the upper limit of the energy amount SOC of the storage device 58 (maximum energy amount B used in the sub-routine of FIG. 6) is changed from the normally used value of 80% to 40% of the full storage capacity, so that the energy amount SOC is held within the range between 30% and 40% of the full capacity, as a result of the operations in the operation modes selected according to the sub-routine of FIG. 6 with the upper limit B reduced to 40%. It will be understood that a portion of the hybrid drive controller 50 assigned to execute the sub-routine of FIG. 6 provides energy amount control means for controlling the energy amount SOC stored in the storage device 58 such that the total energy amount SOC does not exceed a predetermined upper limit. Step SH5 may be modified to change the threshold values P1, P2 used in the sub-routine of FIG. 6, rather than the upper limit B, so that the operation modes 1 and 4 that cause the storage device 58 to be discharged are more likely to be selected when the total energy amount SOC is larger than the upper limit 40%.

Tabata '201 Does Not Render Obvious Independent Claim 23 of the '347 Patent

'347 Patent Claim 23 Introduction

23. A method of control of a hybrid vehicle, said vehicle comprising an internal combustion engine capable of efficiently producing torque at loads between a lower level SP and a maximum torque output MTO, a battery, and one or more electric motors being capable of providing output torque responsive to supplied current, and of generating electrical current responsive to applied torque, said engine being controllably connected to wheels of said vehicle for applying propulsive torque thereto and to said at least one motor for applying torque thereto, said method comprising the steps of:

determining the instantaneous torque RL required to propel said vehicle responsive to an operator command; monitoring the state of charge of said battery;

employing said at least one electric motor to propel said vehicle when the torque RL required to do so is less than said lower level SP;

employing said engine to propel said vehicle when the torque RL required to do so is between said lower level SP and MTO;

employing both said at least one electric motor and said engine to propel said vehicle when the torque RL required to do so is more than MTO; and

employing said engine to propel said vehicle when the torque RL required to do so is less than said lower level SP and using the torque between RL and SP to drive said at least one electric motor to charge said battery when the state of charge of said battery indicates the desirability of doing so; and

wherein the torque produced by said engine when operated at said setpoint (SP) is substantially less than the maximum torque output (MTO) of said engine.

**Claim 23 determines the "road load,"
i.e. the instantaneous torque required to
propel the vehicle**

'347 Patent Claim 23 Introduction

23. A method of control of a hybrid vehicle, said vehicle comprising an internal combustion engine capable of efficiently producing torque at loads between a lower level SP and a maximum torque output MTO, a battery, and one or more electric motors being capable of providing output torque responsive to supplied current, and of generating electrical current responsive to applied torque, said engine being controllably connected to wheels of said vehicle for applying propulsive torque thereto and to said at least one motor for applying torque thereto, said method comprising the steps of:

determining the instantaneous torque RL required to propel said vehicle responsive to an operator command; monitoring the state of charge of said battery;

employing said at least one electric motor to propel said vehicle when the torque RL required to do so is less than said lower level SP;

employing said engine to propel said vehicle when the torque RL required to do so is between said lower level SP and MTO;

employing both said at least one electric motor and said engine to propel said vehicle when the torque RL required to do so is more than MTO; and

employing said engine to propel said vehicle when the torque RL required to do so is less than said lower level SP and using the torque between RL and SP to drive said at least one electric motor to charge said battery when the state of charge of said battery indicates the desirability of doing so; and

wherein the torque produced by said engine when operated at said setpoint (SP) is substantially less than the maximum torque output (MTO) of said engine.

Claim 23 compares the “road load” to “setpoint” to determine what operating mode to transition into

'347 Patent Claim 23 Introduction

23. A method of control of a hybrid vehicle, said vehicle comprising an internal combustion engine capable of efficiently producing torque at loads between a lower level SP and a maximum torque output MTO, a battery, and one or more electric motors being capable of providing output torque responsive to supplied current, and of generating electrical current responsive to applied torque, said engine being controllably connected to wheels of said vehicle for applying propulsive torque thereto and to said at least one motor for applying torque thereto, said method comprising the steps of:

determining the instantaneous torque RL required to propel said vehicle responsive to an operator command; monitoring the state of charge of said battery;

employing said at least one electric motor to propel said vehicle when the torque RL required to do so is less than said lower level SP;

employing said engine to propel said vehicle when the torque RL required to do so is between said lower level SP and MTO;

employing both said at least one electric motor and said engine to propel said vehicle when the torque RL required to do so is more than MTO; and

employing said engine to propel said vehicle when the torque RL required to do so is less than said lower level SP and using the torque between RL and SP to drive said at least one electric motor to charge said battery when the state of charge of said battery indicates the desirability of doing so; and

wherein the torque produced by said engine when operated at said setpoint (SP) is substantially less than the maximum torque output (MTO) of said engine.

When the battery needs charging, and the “road load” is less than a “setpoint,” claim 23 operates the engine at least at “setpoint” and uses the torque between “road load” and “setpoint” to charge the battery

Tabata '201 does not disclose all the limitations of claim 23

Tabata '201 fails to disclose each and every claim limitation of claim 23:

- 1) “Tabata '201 ... discloses a fundamentally different control strategy that uses demand power, calibrated by the pedal position, and compares that to power thresholds to determine the operational mode of the vehicle.” POR at 45.
- 2) “Tabata '201 discloses nothing more than the well-known general idea that an internal combustion engine in a hybrid vehicle can be used to charge a battery.” POR at 52.

Tabata '201 does not disclose all the limitations of claim 23

Tabata '201 fails to disclose each and every claim limitation of claim 23:

- 1) “Tabata '201 ... discloses a fundamentally different control strategy that uses demand power, calibrated by the pedal position, and compares that to power thresholds to determine the operational mode of the vehicle.” POR at 45.
- 2) “Tabata '201 discloses nothing more than the well-known general idea that an internal combustion engine in a hybrid vehicle can be used to charge a battery.” POR at 52.

Parties agree that power and torque are different

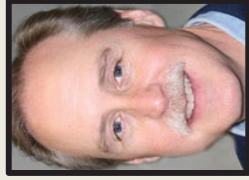

Q: That's my point. The passage you cite talks about 60 to 90 percent of its maximum power over a wide range of vehicle speeds, right?

Dr. Davis: Correct.

Q: And that is a different concept than percent of its maximum torque, correct?

Dr. Davis: Depends how you do the calculation.

Q: But it is different.

Dr. Davis: Well, power and torque are different.

Parties agree that power and torque are different

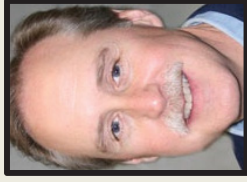

Dr. Davis: Well, torque and power are related, as we've discussed before.

Q. But they're not the same thing, right?

Dr. Davis: Definitely not, they're not the same thing.

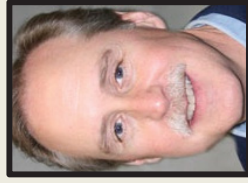

Q. But torque and power are different correct?

Dr. Davis: Yes, they are.

Engine power is different than engine torque

- “Dr. Davis agrees that Tabata ’201 compares the demand power to threshold values based on power. Dr. Davis contends however that a person of ordinary skill in the art would somehow believe that power and torque are the same thing.” POR at 46
- Ford is wrong for two reasons:
 - First, “an engine’s output power and output torque are significantly different.” POR at 47
 - Second “building a control strategy around one rather than the other has significant ramifications.” POR at 47.

Engine power is different than engine torque

Hannemann Dec., Ex. 2215 at 65-66.



“An engine’s output power and output torque are significantly different, because an engine can produce the same power output at a wide range of torque and speed combinations. Similarly, an engine can produce varying levels of power at the same engine torque output based on the engine speed.

A simple illustration can be seen by comparing an engine’s maximum power curve to the engine’s maximum torque curve, such as that shown in Figure 5 of Caraceni.”

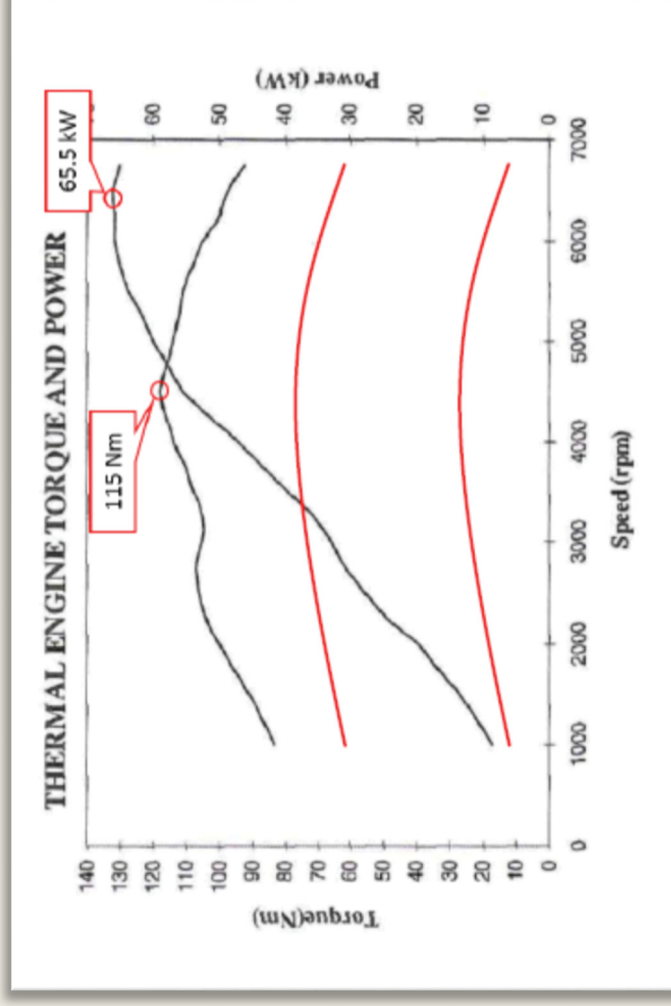

Engine power is different than engine torque

- “Dr. Davis’s deceptive argument is that because power is the product of torque and speed, and ‘engine speed’ and ‘vehicle speed’ are ‘known at all times’, the two metrics are the same.” POR at 47.



Davis Dec., Ex. 1215 at 147.

“In a vehicle, torque and power may be easily interchanged since the vehicle speed is known at all times. Likewise, the amount of power provided by the engine may also be expressed as torque since the engine speed is known at all times.”

See IPR '884, Paper No. 19, POR at 47; *id.* at 46-47 (citing Ex. 1215 at ¶¶ 368-69).

Ford does not dispute that a power based system would result in different components

● Mr. Hannemann’s engine operation charts “illustrate how different power and torque are.” POR at 48.

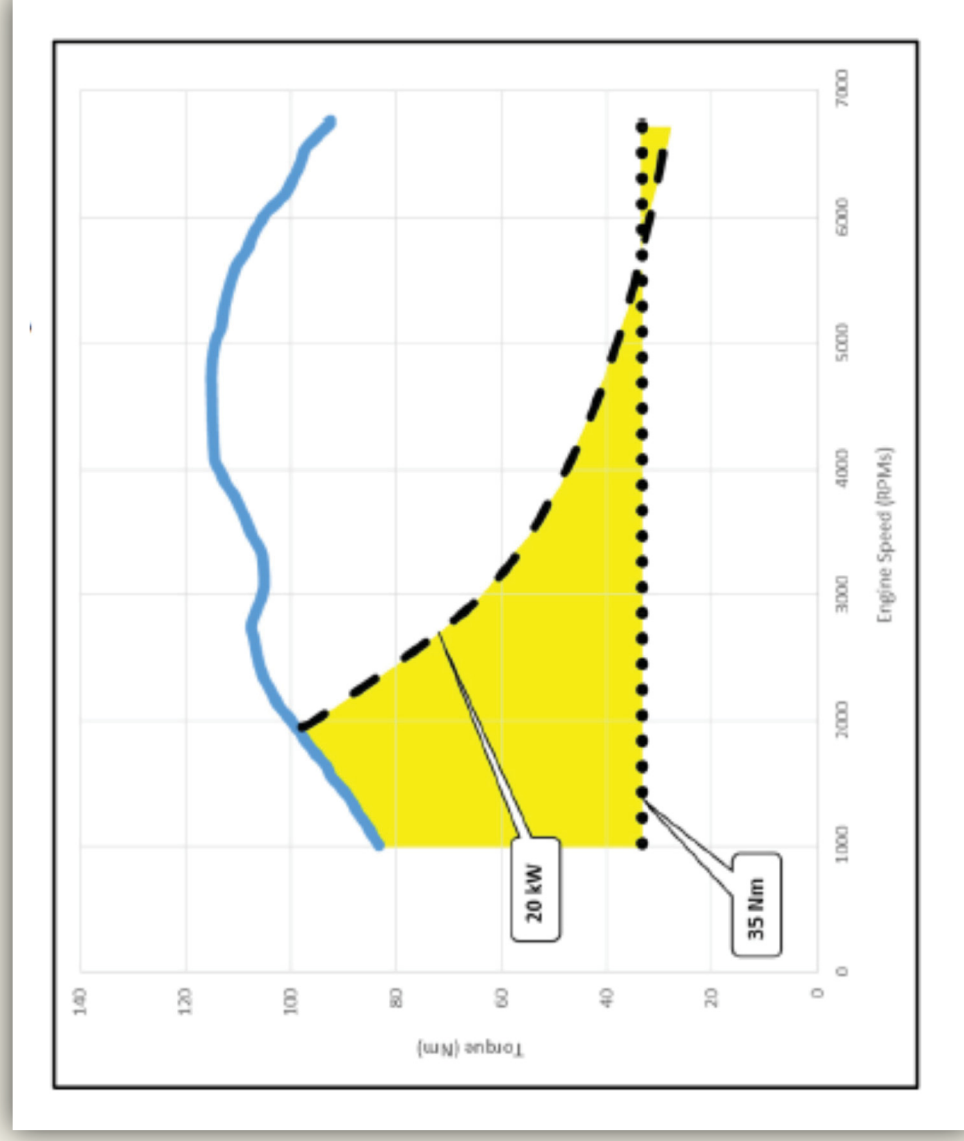

- “[T]he large yellow area on the left portion of the chart reflects an area of demand where a “road load” based strategy would use the engine to propel the vehicle, while an “instantaneous power demand” strategy would not use the engine, but would use the motor instead.” POR at 50
- “[U]sing a power-based control strategy instead of a “road load” based control strategy has important ramifications for choosing hybrid components in the vehicle.” *Id.*

Tabata '201 does not disclose all the limitations of claim 23

Tabata '201 fails to disclose each and every claim limitation of claim 23:

- 1) “Tabata '201 ... discloses a fundamentally different control strategy that uses demand power, calibrated by the pedal position, and compares that to power thresholds to determine the operational mode of the vehicle.” POR at 45.
- 2) “Tabata '201 discloses nothing more than the well-known general idea that an internal combustion engine in a hybrid vehicle can be used to charge a battery.” POR at 52.

Introduction to claim 23 battery charging limitation

‘347 Patent, Ex. 1201 at claim 23, col. 60:46-51

employing said engine to propel said vehicle when the torque RL required to do so is less than said lower level SP and using the torque between RL and SP to drive said at least one electric motor to charge said battery when the state of charge of said battery indicates the desirability of doing so; and

Tabata '201 does not disclose the battery charging limitation of claim 23

- **First, “Tabata ’201 does not disclose the use of ‘ road load’ and a ‘setpoint,’ because Tabata ’201 compares power demand to power thresholds.” POR at 53.**
- **Second, “Ford and Dr. Davis fail to offer any evidence or analysis as to the limitation ‘using the torque between RL and SP to drive said at least one electric motor to charge said battery,” and fails to even allege that such a limitation would have been obvious.” POR at 54**

Tabata '201 does not disclose the battery charging limitation of claim 23

- “[T]he prior art does not disclose or suggest the '347 patent's claimed control system that restricts engine operation, whether propelling the vehicle or charging the battery, to run when the torque produced by the engine will be produced at a 'setpoint.’” POR at 53.

'347 Patent, Ex. 1201 at col. 13:50-61.

“This is in accordance with another aspect of the invention, wherein the engine is operated only at high efficiency, leading directly to improved fuel economy. ... The starter motor, which is operated as a generator in these circumstances, is accordingly sized so as be able to accept at least 30% of MTO as input torque; .,.. Therefore the engine is never operated at less than 30% of MTO, and is thus never operated inefficiently.”

Dr. Davis combines unrelated embodiments of Tabata '201

- “Dr. Davis is mixing different embodiments from Tabata '201 but has not provided any analysis or explanation of why a person of skill in the art would be motivated to combine those embodiments.” Motion for Observations at 8.



142. Tabata '201 does not use “P1,” which I understand Dr. Davis contends is a “setpoint,” to determine the operating point of the engine during “engine drive & charging” mode. Instead, Tabata '201 discloses that the operating point of the engine is calculated based on “a ratio of the fuel consumption amount Mfc to the output or power of the electric motor 14 when the motor 14 is driven by the electric energy which has been stored in the electric energy storage device 22 by operation of the motor 14 by the surplus power (Pice-Pl) of the engine 12.” See Ex. 1204 at col. 17:34-47.

Dr. Davis combines unrelated embodiments of Tabata '201

- “Dr. Davis is mixing different embodiments from Tabata '541 but has not provided any analysis or explanation of why a person of skill in the art would be motivated to combine those embodiments, let alone combine each of the separate embodiments with Tabata '201.” Motion for Observations at 9.

Q. All right. So, in your opinion, you're relying on the setpoint that you marked on your Figure 7, right? As the setpoint that's claimed in claim limitation 23.10.

A. Yes. The road load is lower than that setpoint value, yes.

Q. And that setpoint falls along the line of .7 ETA ICE max?

A. Yes.

Davis Reply Dec., Ex. 1248 at 36

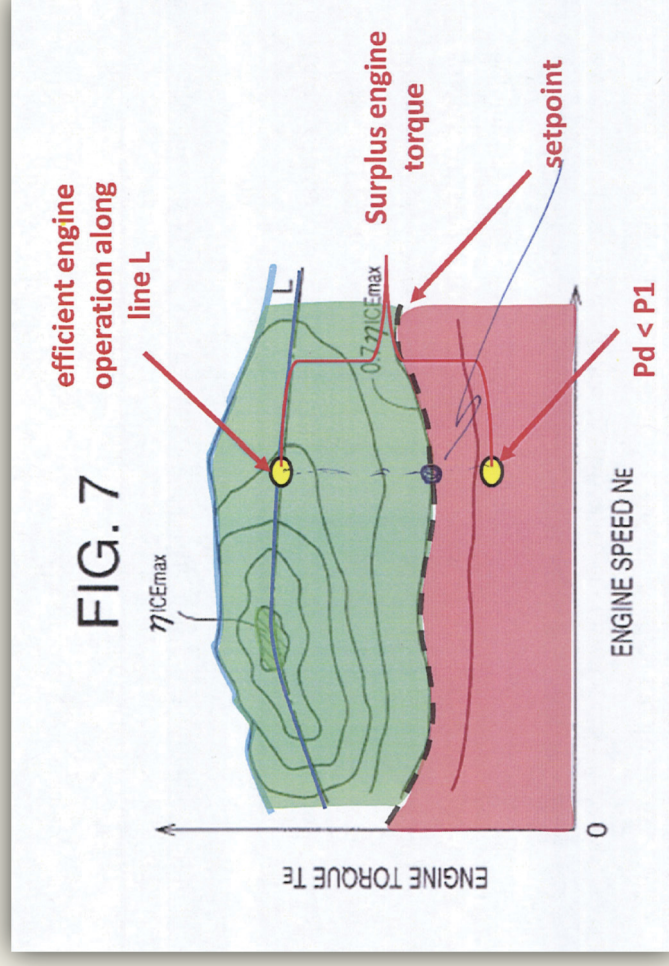

“Fig. 15 from Tabata '201 also illustrates a flow chart for determining the hybrid operation mode when the torque required for propulsion of the vehicle (“RL”) is greater than the lower level setpoint (“SP”) but less than a MTO, as shown in Fig. 15, annotated below.”

....
 “Tabata '201 also discloses that the ‘mode 2’ is invoked when torque required to propel the vehicle (i.e. ‘Pd’) is between a lower threshold value (i.e. ‘P1’) and an upper threshold (i.e. ‘P2’).”

Davis Dec., Ex. 1215 at 178

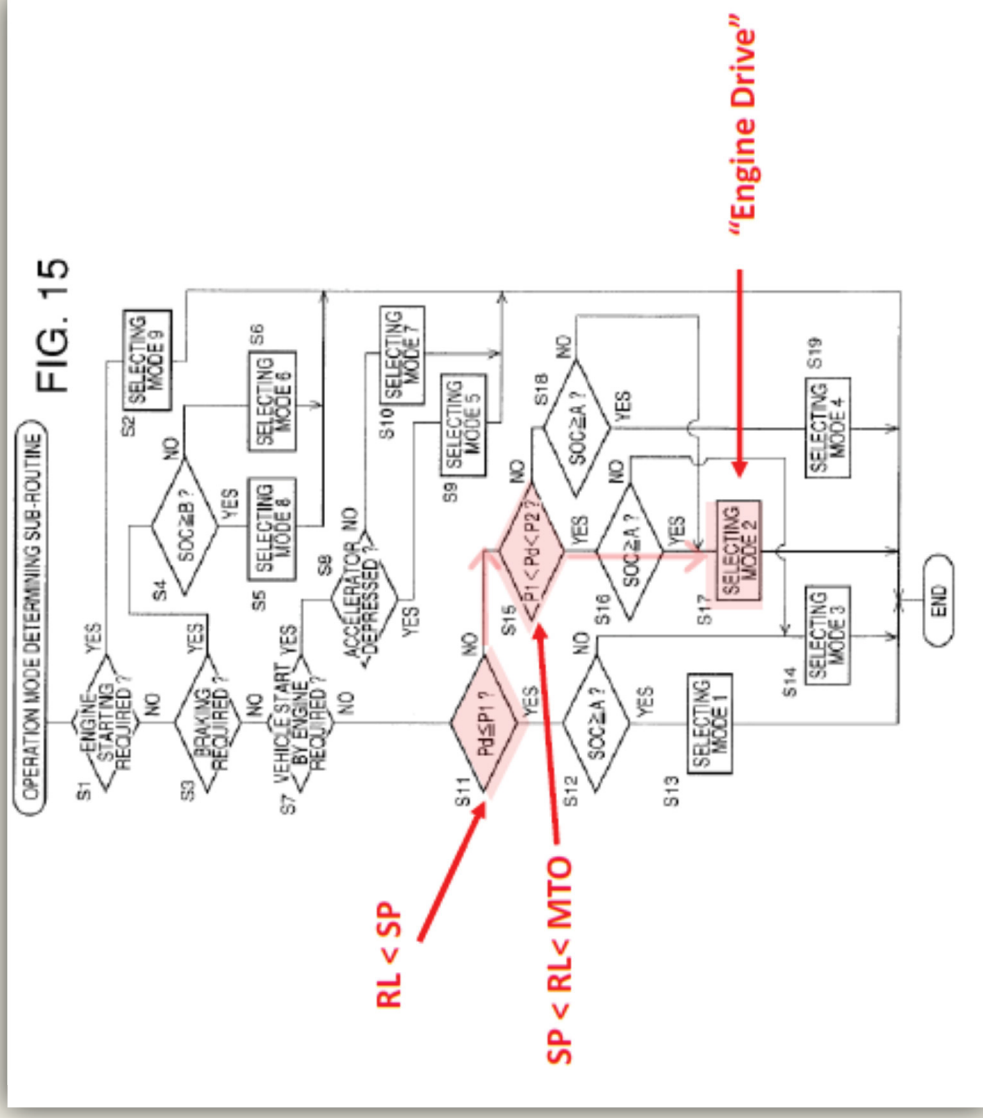

Tabata '541 Does Not Render Obvious Dependent Claim 24 of the '347 Patent

Claim 24 introduction

'347 Patent, Claim 24

24. The method of claim **23**, comprising the further step of employing said controller to monitor patterns of vehicle operation over time and vary said setpoint SP accordingly.

'347 Patent Claim 24 introduction

'347 Patent, Ex. 1201, col. 40:56-41:9

It is also within the scope of the invention for the microprocessor to monitor the vehicle's operation over a period of days or weeks and reset this important setpoint in response to a repetitive driving pattern. For example, suppose the operator drives the same route from a congested suburban development to a workplace about the same time every morning; typically the road load might remain under 20% of MTO for the first few minutes of each day, then vary between 0 and 50% of MTO for another few minutes as the operator passes through a few traffic lights, and then suddenly increase to 150% of MTO as the operator accelerates onto a highway. It is within the skill of the art to program a microprocessor to record and analyze such daily patterns, and to adapt the control strategy accordingly. For example, in response to recognition of a regular pattern as above, the transition point might be adjusted to 60% of MTO; this would prevent repetitive engine starts as the road load exceeded 30% of MTO for a few hundred yards at a time, as might often occur in suburban traffic. Similarly, the engine starting routine might be initiated after the same total distance had been covered each day.

Tabata '541 does not disclose varying a “setpoint” based on “patterns of vehicle operation over time”

- “The two portions of Tabata '541 that Dr. Davis relies on relate to monitoring the battery’s current state of charge, not a vehicle pattern.” POR at 57.
- “Dr. Davis testified that his opinions with regards to claim 24 were based on ‘several embodiments’ in Tabata ‘541.” Motion for Observation at 8-9 (citing Ex. 2217, Davis Tr. at 78:5-79:7).
- “Dr. Davis is mixing different embodiments from Tabata '541 but has not provided any analysis or explanation of why a person of skill in the art would be motivated to combine those embodiments, let alone combine each of the separate embodiments with Tabata '201.” *Id.* at 9 .

Tabata '541 does not disclose varying a “setpoint” based on “patterns of vehicle operation over time”

- **First, “Tabata '541 discloses nothing more than changing a power based threshold based on the current battery state of charge. Tabata '541 therefore does not disclose changing the ‘setpoint’ based on ‘monitor[ing] patterns of vehicle operation over time.’” POR at 56.**
- **Second, Tabata '541 makes a “one time comparison based on the current [battery] efficiency value and not based on past information much less ‘patterns of vehicle operation.’” *Id.* at 58.**
- **At his deposition, “Dr. Davis testified that looking at an instantaneous point of data was not a pattern.” Motion for Observations at 10.**

END