

NEAR-TERM HYBRID VEHICLE PROGRAM

FINAL REPORT — PHASE I



880-26206

UNCLAS
22358

63/85

(NASA-CR-163230) NEAR-TERM HYBRID VEHICLE
PROGRAM, PHASE I Final Report (General
Electric Co.) 146 P HC A07/HE A01 CSCL 13F

Contract No. 965180

Submitted to

Jet Propulsion Laboratory
California Institute of Technology
4800 Oak Grove Drive
Pasadena, California 91103

Submitted by

General Electric Company
Corporate Research and Development
Schenectady, New York 12301

October 8, 1979

GENERAL  ELECTRIC

SRD-79-134/1

NEAR-TERM HYBRID VEHICLE PROGRAM

FINAL REPORT — PHASE I

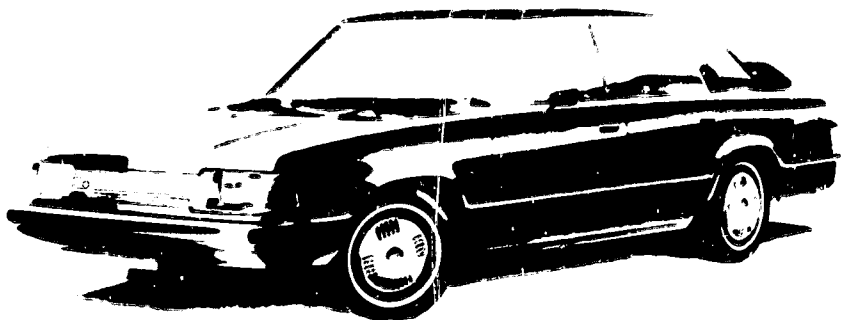

Contract No. 955190

Submitted to

**Jet Propulsion Laboratory
California Institute of Technology
4800 Oak Grove Drive
Pasadena, California 91103**

Submitted by

**General Electric Company
Corporate Research and Development
Schenectady, New York 12301**

October 8, 1979

GENERAL  ELECTRIC

FOREWORD

The Electric and Hybrid Vehicle (EHV) Program was established in DOE in response to the Electric and Hybrid Vehicle Research, Development, and Demonstration Act of 1976. Responsibility for the EHV Program resides with the Office of Electric and Hybrid Vehicle Systems of DOE. The Near-Term Hybrid Vehicle (NTHV) Program is an element of the EHV Program. DOE has assigned procurement and management responsibility for the Near-Term Hybrid Vehicle Program to Jet Propulsion Laboratory (JPL).

The overall objective of the DOE EHV Program is to promote the development of electric and hybrid vehicle technologies and to demonstrate the validity of these systems as transportation options which are less dependent on petroleum resources.

As part of the NTHV Program, General Electric and its subcontractors have completed studies leading to the Preliminary Design of a hybrid passenger vehicle which is projected to have the maximum potential for reducing petroleum consumption in the near term (commencing in 1985). This work has been done under JPL Contract Number 955190, Modification 3, Phase I of the Near-Term Hybrid Vehicle Program.

This report is Deliverable Item 7, Final Report. The material included in this report summarizes all of the effort in Phase I. In accordance with Data Requirement Description 7 of the Contract, the following documents are submitted as appendices:

APPENDIX A is the Mission Analysis and Performance Specification Studies Report. This is Deliverable Item 1 and reports on the work of Task 1. It presents the study methodology; the vehicle characterizations; the mission description, characterization, and impact on potential sales; the rationale for the selection of the ICE reference vehicle; and conclusions and recommendations of the mission analysis and performance specifications studies.

APPENDIX B is a three volume set that constitutes Deliverable Item 2 and reports on the work of Task 2. The three volumes are:

- Volume I -- Design Trade-Off Studies Report
- Volume II -- Supplement to Design Trade-Off Studies Report, Volume I
- Volume III -- Computer Program Listings.

Volume I presents the study methodology; the evaluation and comparison of candidate power trains; the control strategy and the selected design concept. Volume II presents reports submitted by subcontractors on heat engines, battery power sources, and vehicle

technology along with detailed background on motors and controls. Volume III consists of listings of computer programs used in analyzing the various design options.

APPENDIX C is the Preliminary Design Data Package. This is Deliverable Item 3 and reports on the work of Task 3. It presents the design methodology, the design decision rationale, the vehicle preliminary design summary, and the advanced technology developments. Included in the Preliminary Design Data Package are five appendices which present the detailed vehicle design; the vehicle ride and handling and front structural crashworthiness analysis; the microcomputer control of the propulsion system; the design study of the battery switching circuit, the field chopper, and the batter charger; and the recent HYVEC program refinements and computer results.

APPENDIX D is the Sensitivity Analysis Report. This is Deliverable Item 8 and reports on Task 4. It presents the study methodology, the selection of input parameters and output variables, the sensitivity study results, and the conclusions of the sensitivity analysis.

The three classifications - Appendix, Deliverable Item, and Task Number - will be used interchangeably in these documents. The work accomplished on this contract, which is fully described in this report and its appendices, was performed by the Electric Vehicle Program in the Power Electronics Laboratory of General Electric Corporate Research and Development in Schenectady, New York. Subcontractors and their areas of support were:

<u>Subcontractor</u>	<u>Area of Support</u>
• ESB, Inc.	Batteries
• General Electric Space Systems Division	Heat Engines
• Professor Gene Smith, University of Michigan	Mission Analysis and Sensitivity Analysis
• Triad Services	Vehicle Design and Analysis

Other contributors to the General Electric Vehicle Program whose consultations were applicable to this study were:

Source

Area of Consultation

- Diahatsu Motor Company Ltd. (Mr. Shoji Honda) Hybrid Vehicles
- General Electric DC Motor and Generator Department Motors
- General Electric Ordnance System Products Department Transmissions and other Mechanical Components
- Volkswagen AG Heat Engines and Hybrid Vehicle Power Trains

FRONTISPIECE

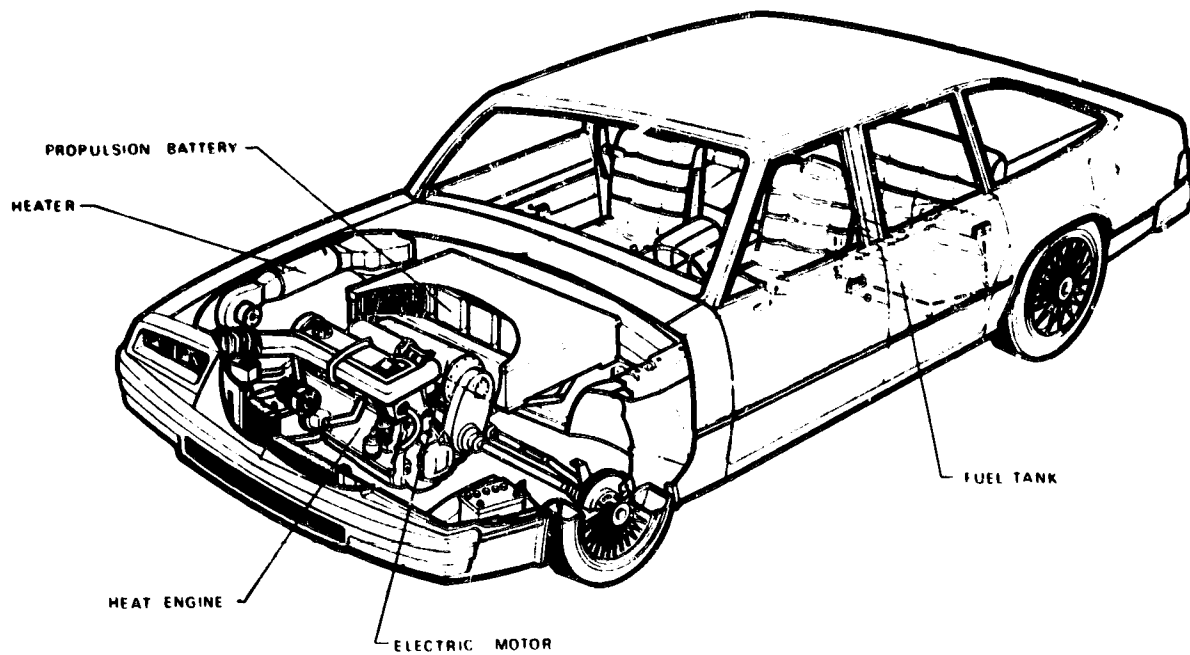

Near-Term Hybrid Vehicle, Three-Dimensional Cutaway

PRECEDING PAGE BLANK NOT FILMED

TABLE OF CONTENTS

<u>Section</u>		<u>Page</u>
1	INTRODUCTION AND SUMMARY	1-1
1.1	Introduction	1-2
1.2	Objectives	1-3
	1.2.1 Overall DOE EHV Program Objectives.	1-3
	1.2.2 DOE Near-Term Hybrid Vehicle Program Objectives.	1-5
	1.2.3 Specific Phase I Objectives	1-5
1.3	Description of Major Tasks	1-5
	1.3.1 Task 1, Mission Analysis and Performance Specification Studies	1-5
	1.3.2 Task 2, Design Trade-Off Studies.	1-5
	1.3.3 Task 3, Preliminary Design.	1-6
	1.3.4 Task 4, Sensitivity Analysis.	1-6
	1.3.5 Task 5, Proposal for Phase II	1-6
	1.3.6 Task 6, Phase I Documentation	1-6
	1.3.7 Task 7, Program Management and Integration	1-7
1.4	Summary of Phase I Program Results	1-8
	1.4.1 Preliminary Design Summary.	1-8
	1.4.2 Major Alternative Design Options.	1-15
	1.4.3 Interface Component and System Control Developments.	1-18
2	SUMMARY OF PHASE I ACTIVITY	2-1
2.1	Introduction	2-1
2.2	Task I - Mission Analysis and Performance Specification Studies Summary.	2-3
	2.2.1 Objectives.	2-3
	2.2.2 Methodology	2-3
	2.2.3 Conclusions	2-10
2.3	Task 2 - Design Trade-Off Studies.	2-12
	2.3.1 Objectives.	2-12
	2.3.2 Methodology	2-12
	2.3.3 Major Findings.	2-17
2.4	Task 3 - Preliminary Design.	2-20
	2.4.1 Objectives.	2-20
	2.4.2 Methodology	2-20
	2.4.3 Major Findings/Accomplishments.	2-22
2.5	Task 4 - Sensitivity Analysis.	2-24
	2.5.1 Objectives.	2-24
	2.5.2 Methodology	2-24
	2.5.3 Conclusions	2-25
3	SUMMARY OF THE HYBRID VEHICLE DESIGN.	3-1
3.1	General Layout and Styling	3-1
3.2	Power Train Specifications and Weight Breakdown.	3-4

TABLE OF CONTENTS (Cont'd)

<u>Section</u>		<u>Page</u>
3	(Cont'd)	
	3.2.1 Power Train Specifications	3-4
	3.2.2 Vehicle Weight and Weight Breakdown	3-14
	3.3 Vehicle Performance	3-17
	3.4 Measures of Energy Consumption	3-20
	3.5 Initial Cost and Ownership Cost	3-23
4	ALTERNATE DESIGN OPTIONS CONSIDERED AND THEIR RELATIONSHIP TO THE DESIGN ADOPTED	4-1
	4.1 Introduction	4-1
	4.2 Parallel Vs. Series Arrangement	4-3
	4.3 Secondary Energy Storage	4-4
	4.4 Power Split Fraction	4-5
	4.5 Battery Type	4-6
	4.6 Engine Type	4-9
	4.7 Electric Drive Options	4-11
	4.8 Transmission Type and Gear Ratios	4-12
	4.9 Torque Combination Options	4-14
5	DESCRIPTION OF COMPUTER SIMULATIONS	5-1
	5.1 Introduction	5-1
	5.2 Daily Travel Statistics	5-3
	5.3 Hybrid Vehicle Design Calculations (HYVELD)	5-7
	5.4 Hybrid Vehicle Simulation Calculation (HYVEC)	5-9
6	ECONOMIC ANALYSES	6-1
	6.1 Introduction	6-1
	6.2 Methods of Analysis	6-2
	6.2.1 Determination of Component Costs	6-2
	6.2.2 Calculation of the Initial Cost	6-2
	6.2.3 Calculation of the Ownership Cost	6-3
7	MAINTENANCE AND RELIABILITY CONSIDERATIONS	7-1
	7.1 Introduction	7-1
	7.2 Maintenance Considerations	7-1
	7.3 Reliability Considerations	7-3
8	DESIGN FOR CRASH SAFETY	8-1
	8.1 Introduction	8-1
	8.2 Methodology for Crashworthiness Evaluation	8-1
	8.3 Crashworthiness Analysis Conclusions	8-6
9	BIBLIOGRAPHY	9-1
	9.1 Mission Analysis and Use Patterns	9-1
	9.2 Characterization and Sales of Conventional ICE Passenger Cars	9-2

TABLE OF CONTENTS (Cont'd)

<u>Section</u>	<u>Page</u>
9 (Cont'd)	
9.3 Heat Engines and Transmissions	9-3
9.4 Electric Drive Systems	9-5
9.5 Batteries and Flywheel	9-6
9.6 Hybrid and Electric Vehicle Evaluations.	9-7

LIST OF ILLUSTRATIONS

<u>Figure</u>	<u>Page</u>
1.4.1-1 Near-Term Hybrid Vehicle, Three-Dimensional Cutaway	1-9
1.4.1-2 Artist's Rendering of the Hybrid Vehicle.	1-11
1.4.1-3 Battery State-of-Charge and Fuel Economy for Urban and Highway Driving	1-12
1.4.1-4 Total Energy and Petroleum Fuel Usage in Urban Driving for the Near-Term Hybrid Vehicle.	1-12
1.4.1-5 Ownership Cost as a Function of Gasoline Price.	1-13
1.4.1-6 Annual Net Dollar Savings as a Function of Gasoline Price.	1-13
2.1-1 Phase I Activities Flowchart.	2-2
2.2.2-1 Power-to-Weight Ratio Requirements	2-4
2.2.2-2 Projected 1985 Composite Fuel Economy	2-6
3.1-1 Near-Term Hybrid Vehicle, Three-Dimensional Cutaway	3-2
3.1-2 Artist's Rendering of the Near-Term Hybrid Vehicle	3-3
3.2.1-1 Hybrid Power Train.	3-7
3.2.1-2 Schematic of Drive Package.	3-9
3.2.1-3 Torque Transfer Unit.	3-12
3.2.1-4 Propulsion Source Sequencing Strategy	3-13
3.2.1-5 Hybrid Vehicle Microcomputer Control.	3-15
3.4-1 Battery State-of-Charge and Fuel Economy for Urban and Highway Driving	3-21
3.4-2 Total Energy and Petroleum Fuel Usage in Urban Driving	3-21
3.5.1 Ownership Cost as a Function of Gasoline Price.	3-25
3.5-2 Annual Net Dollar Savings as a Function of Gasoline Price.	3-25
4.9-1 Torque Combination Options.	4-15

x

LIST OF ILLUSTRATIONS (Cont'd)

<u>Figure</u>		<u>Page</u>
5.2-1	Calculation of Daily Travel Statistics Using the Monte Carlo Trip Length Generator Program . .	5-4
5.2-2	Daily Random Travel - Percent of Days - as a Function of Annual Miles.	5-5
5.2-3	Daily Random Travel - Percent of Vehicle Miles - as a Function of Annual Miles	5-6
5.3-1	Schematic of the Hybrid Vehicle Design (HYVELD) Calculation Procedure	5-8
5.4-1	Schematic of the Hybrid Vehicle Simulation Calculation (HYVEC)	5-10
8.2-1	Schematic of the Hybrid Vehicle Forward Structure and Components for Crash Simulation . .	8-2
8.2-2	Hybrid Vehicle Body Structure, Exploded View. . .	8-3
8.3-1	Maximum Deceleration as a Function of Maximum Intrusion (Refer to Table 8.2-1 for Run Identification)	8-7
8.3-2	Comparison of the Transverse Hybrid Driveline and Stock Malibu Crash Test Performance	8-8

LIST OF TABLES

<u>Table</u>		<u>Page</u>
1.4.2-1	Power Train Design Options Considered in Depth. .	1-16
2.2.2-1	Fuel Use by Size Class in 1985.	2-6
2.2.2-2	Daily and Annual Travel Distances Inside SMSAs for Various Driving Missions.	2-8
2.2.2-3	Daily and Annual Travel Distances Outside SMSAs for Various Missions.	2-9
2.3.2-1	Hybrid Power Train Configurations and Components Considered in the Design Trade-Off Study	2-15
2.3.2-2	Vehicle and Economic Factor Input Parameters for the Design Trade-Off Calculations	2-16
2.5.2-1	Summary of Parameter Sensitivities Studied Using HYVELD.	2-26
3.2.2-1	Weight Breakdown - Malibu Based Hybrid.	3-16
3.3-1	Vehicle Performance Characteristics	3-18
3.3-2	Vehicle Performance Characteristics	3-19
3.4-1	Energy Consumption Measures (Near-Term Hybrid Vehicle).	3-22
3.5-1	Cost Breakdown.	3-24

LIST OF TABLES (Cont'd)

<u>Table</u>		<u>Page</u>
4.2-1	Power Train Arrangement Considerations	4-3
4.3-1	Secondary Storage (Flywheel) Considerations	4-4
4.5-1	Storage Unit Characteristics in the Design Trade-Off Studies	4-7
4.5-2	Battery Type Considerations	4-8
4.6-1	Engine Type Considerations	4-9
4.7-1	Electric Drive System Considerations	4-11
4.8-1	Transmission Selection Considerations	4-12
5.1-1	Summary of the Use of Computer Simulations in the Phase I Study	5-2
7.2-1	Maintenance for DOE/GE Near-Term Electric Vehicle	7-2
7.3-1	Vehicle Maintenance and Reliability Factors	7-4
8.2-1	Summary of Crash Simulation Results	8-5

Section 1
INTRODUCTION AND SUMMARY

Section 1

INTRODUCTION AND SUMMARY

1.1 INTRODUCTION

This report is Deliverable Item 7, Final Report, and is the summary report of a series which document the results of Phase I of the Near-Term Hybrid Vehicle Program. This phase of the program was a study leading to the preliminary design of a 5-passenger hybrid vehicle utilizing two energy sources (electricity and gasoline/diesel fuel) to minimize petroleum usage on a fleet basis.

The program is sponsored by the US Department of Energy (DOE) and the California Institute of Technology, Jet Propulsion Laboratory (JPL). Responsibility for this program at DOE resides with the Office of Electric and Hybrid Vehicle Systems. Work on the Phase I portion of the program was done by General Electric Corporate Research and Development and its subcontractors under JPL contract 955190.

This report presents a complete summary of the work done on Phase I, in the following manner:

- Overall summary of the Phase I activity
- Summary of the individual tasks
- Summary of the hybrid vehicle design
- Summary of the alternative design options
- Summary of the computer simulations
- Summary of the economic analysis
- Summary of the maintenance and reliability considerations
- Summary of the design for crash safety
- Bibliography

These summaries are based on and are supported by the series of task reports that were submitted as deliverable items during the contract. The task reports are being resubmitted as appendices to this Final Report. The interrelationship of appendices, deliverable items, and tasks is tabulated below:

<u>Appendix</u>	<u>Deliverable Item</u>	<u>Task</u>	<u>Title</u>
A	1	1	Mission Analysis and Performance Specification Studies Report
B	2	2	Vol. I - Design Trade-Off Studies Report Vol. II - Supplement to Design Trade-Off Studies Report Vol. III - Computer Program Listings
C	3	3	Preliminary Design Data Package
D	8	4	Sensitivity Analysis Report

1.2 OBJECTIVES

The objectives that were set forth for this effort are identified in the following subsections.

1.2.1 OVERALL DOE EHV PROGRAM OBJECTIVES

The overall objective of the DOE EHV Program is to promote development of electric and hybrid vehicle technologies and to demonstrate the validity of these systems as transportation options which are less dependent on petroleum resources.

The Near-Term Hybrid Vehicle Program is an element of the EHV Program. DOE has assigned procurement and management responsibility for the Near-Term Hybrid Vehicle Program to JPL.

1.2.2 DOE NEAR-TERM HYBRID VEHICLE PROGRAM OBJECTIVES

The DOE Near-Term Hybrid Vehicle (NTHV) Program Objectives are summarized as follows:

- Advance the state of the art in hybrid vehicles
- Show that hybrid vehicles can be
 - Practical
 - Energy efficient
 - Safe
 - Producible
 - Affordable
 - Functional
- Develop validated vehicle designs that can be useful candidates for the demonstration program
- Provide analytical and test methodologies and tools for general application to hybrid vehicle technology.

The NTHV Program is planned as a multiyear project of two phases:

- Phase I -- Design Trade-Off Studies and Preliminary Design
- Phase II -- Final Design and Fabrication of Test Vehicles

1.2.3 SPECIFIC PHASE I OBJECTIVES

The specific objectives of Phase I of the Near-Term Hybrid Vehicle Program are to:

- Identify missions for hybrid vehicles that promise to yield high petroleum impact,
- Characterize the single vehicle concept which satisfies the mission or set of missions that provide the greatest potential reduction in petroleum consumption,
- Develop performance specifications for the characterized vehicle concept,
- Develop, through trade-off studies, a hybrid vehicle preliminary design that satisfies the performance specifications,
- Identify technologies that are critical to successful vehicle development,
- Develop a proposal for the Phase II activities that include vehicle design, critical technology development, and vehicle fabrication.

1.3 DESCRIPTION OF MAJOR TASKS

The Phase I program was divided into discrete tasks in accordance with the contract. The work consisted of the following major tasks:

- Task 1 - Mission Analysis and Performance Specification Studies
- Task 2 - Design Trade-off Studies
- Task 3 - Preliminary Design
- Task 4 - Sensitivity Analysis
- Task 5 - Proposal for Phase II
- Task 6 - Phase I Documentation
- Task 7 - Program Management and Integration

The work done on this program is described in subsequent sections of this report. Section 2, Summary of the Phase I Tasks, describes how the tasks interrelate and gives details of the four major tasks (Tasks 1 through 4). These sections include the specific tasks objectives, and a discussion of the methodology, and the major findings, conclusions, or recommendations. In addition, the complete reports associated with Tasks 1, 2, 3, and 4 are submitted as appendices to this report. A brief summary description of the major tasks and identification of the task reports follows.

1.3.1 TASK 1, MISSION ANALYSIS AND PERFORMANCE SPECIFICATION STUDIES

The major elements of Task 1 included the following: (1) definition of the missions or set of missions which maximize the potential for reduction of petroleum consumption by a single hybrid vehicle, (2) identification of vehicle characteristics associated with these missions, and (3) preparation of specifications defining the performance requirements which the vehicle should achieve to safely and efficiently perform the mission or set of missions identified in the mission analysis. The work done on this task is reported in its entirety in Appendix A, Mission Analysis and Performance Specification Studies Report.

1.3.2 TASK 2, DESIGN TRADE-OFF STUDIES

Task 2 included trade-off studies of alternate system configurations and components in order to arrive at a hybrid vehicle design concept which best achieves the vehicle specifications

developed in Task 1 and offers the greatest promise of reducing petroleum consumption. The work done in this task is reported in its entirety in Appendix B, Design Trade-off Studies Report, Volumes I, II, and III.

1.3.3 TASK 3, PRELIMINARY DESIGN

Task 3 carried out a preliminary design of the most promising hybrid vehicle concept identified in the Task 2 studies. It included definition of all major parameters and components, such as internal and external dimensions; all power train components; materials for body and chassis; weight breakdown by major sub-assemblies; projected production and life cycle costs; performance (including all categories specified in Task 1); and identification of technology development required to achieve this preliminary design. The work done on this task is reported in its entirety in Appendix C, Preliminary Design Data Package.

1.3.4 TASK 4, SENSITIVITY ANALYSIS

Task 4 carried out a sensitivity analysis which determined the impact of variations in selected parameters on the utility, the economic attractiveness, and the marketability of the hybrid vehicle. The parameters varied included travel characteristics, energy costs, hybrid vehicle lifetime, maintenance cost, and fuel economy of the Reference ICE Vehicle. The work done in Task 4 is reported in its entirety in Appendix D, Sensitivity Analysis Report.

1.3.5 TASK 5, PROPOSAL FOR PHASE II

Task 5 consisted of preparing a proposal for Phase II of the program which included a final vehicle design based upon results of Task 3 preliminary design. Subject to JPL approval of this final design, two hybrid vehicles with spares and support equipment will be fabricated in Phase II. The Phase II effort also includes testing the vehicles, delivering them to JPL, and providing field support during acceptance testing. The Phase II proposal was prepared in response to RFP JC-2-2974-305 issued by JPL on July 6, 1979. The proposal, Phase II of the Near-Term Hybrid Vehicle Program, Proposal RFP JC-2-2974-305, was submitted to JPL on August 24, 1979. It consisted of three volumes which were: Volume I - Technical Proposal; Volume II - Management Proposal; and Volume III - Cost Proposal.

1.3.6 TASK 6, PHASE I DOCUMENTATION

Task 6 consisted of preparation of monthly status reports; the separate reports for Tasks 1, 2, 3, and 4, respectively; the proposal for Phase II; and this final report for all of Phase

I. These reports have been identified where appropriate in the preceding paragraphs.

1.3.7 TASK 7, PROGRAM MANAGEMENT AND INTEGRATION

Task 7 consists of the program management and integration effort required to maintain technical and cost control and assure achievement of the Phase I objectives. This is mentioned for completeness, since it played a vital role in the successful execution of the program. It is not covered in this final report or in the technical reports which were submitted previously.

1.4 SUMMARY OF PHASE I PROGRAM RESULTS

The completed Phase I Program has resulted in the Preliminary Design of a hybrid vehicle which fully meets or exceeds the requirements set forth in JPL Contract 955190. This work is fully documented as discussed in Section 1.3. Highlights of the preliminary design are presented in the following sections along with the alternative options which were considered.

1.4.1 PRELIMINARY DESIGN SUMMARY

There are many aspects of the preliminary design that are considered important. The following sections discuss those deemed to be most relevant.

1.4.1.1 General Layout and Styling

The general characteristics of the vehicle layout and chassis are:

- Curb weight
 - 1786 kg (3930 lb)
- Body style
 - Four-door hatchback
 - Drag Coefficient - 0.40
 - Frontal area - 2.0 m^2 (21.5 ft^2)
- Chassis/Power Train Arrangement
 - Front wheel drive
 - Complete power train, including the batteries, in front of firewall
 - Fuel tank under rear seat
- Baseline ICE Vehicle
 - 1979 Chevrolet Malibu

A three-dimensional cutaway of the hybrid vehicle indicating the placement of the power train is shown in Figure 1.4.1-1. Note that the complete hybrid power train is located in front of the firewall with no intrusion into the passenger compartment. The drive train consists of an 80 hp (peak) 1.6 liter fuel-injected gasoline engine, a 45 hp (peak) separately excited dc motor, an automatically shifted transmission, clutches, and accessory drive components. An artist's rendering of the vehicle styling is shown

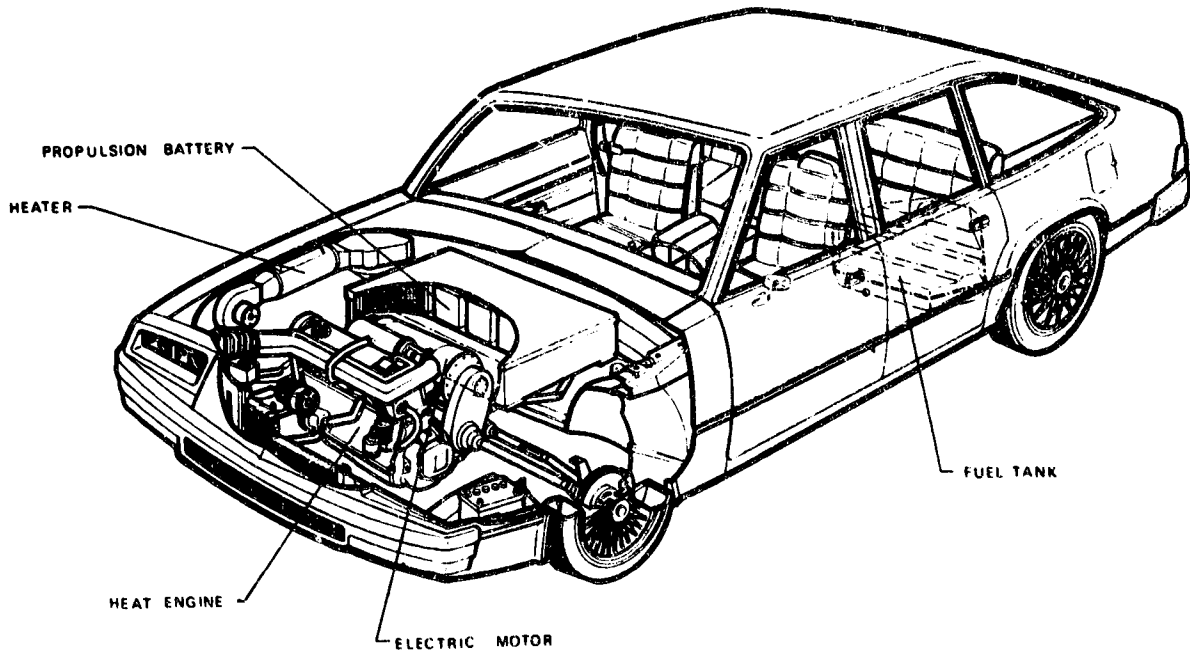

Figure 1.4.1-1. Near-Term Hybrid Vehicle, Three-Dimensional Cutaway

in Figure 1.4.1-2. A four-door hatchback body type was selected because it maximizes the all-purpose character of the five-passenger vehicle and hence its marketability.

1.4.1.2 Energy Use

The primary goal of the hybrid vehicle program is to conserve petroleum. The vehicle which was designed in Phase I offers great promise in meeting this goal. Figure 1.4.1-3 shows that the fuel economy of the near-term hybrid vehicle is in excess of 60 mpg for trips of 30 miles or less. Figure 1.4.1-4 illustrates the petroleum fuel energy savings when compared to the Reference ICE Vehicle (1985 model). The total energy used (fuel and electricity, including generating efficiency) by the near-term hybrid vehicle is about 5% less than the Reference ICE Vehicle.

1.4.1.3 Cost Considerations

A second important goal of the hybrid vehicle design was to be competitive with the Reference ICE Vehicle in first cost and equal or lower in total ownership cost. The hybrid vehicle sticker price is estimated at \$7600 in 1978 dollars, versus \$5700 in 1978 dollars for the Reference ICE Vehicle. The ownership cost advantage of the hybrid vehicle can be seen in Figures 1.4.1-5 and 1.4.1-6 which show the ownership cost and net annual dollar savings as a function of gasoline price. The hybrid vehicle has the advantage of lower ownership cost as gasoline prices exceed \$1/gal.

1.4.1.4 Major Features of the Design

The major features of the design are summarized in this subsection. In Section 3 of this Final Report, the Vehicle Performance characteristics and the Energy Consumption Measures are given in the format provided by JPL. These features are discussed in the following sections.

1.4.1.4.1 Vehicle Design - The Vehicle Design features which are considered to be of greatest importance in reducing technical risk while meeting JPL performance requirements are:

(1) A microprocessor-based controller evolved from vehicle and electrical system controls developed by GE/CRD for the Near-Term Electric Vehicle Program and the highly-refined electronic engine controls developed by VW,

(2) A drive motor based on the motor developed by GE DC Motor and Generator Department for the Near-Term Electric Program,

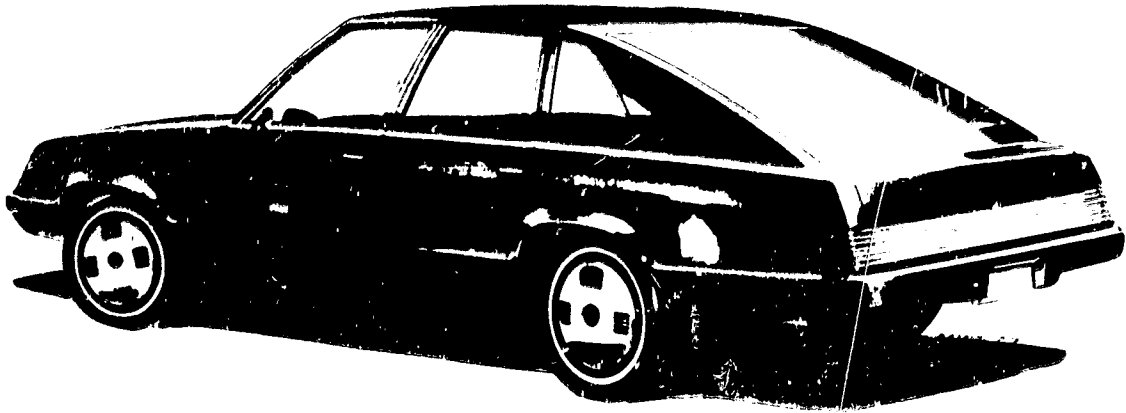

Left Rear Quarter View

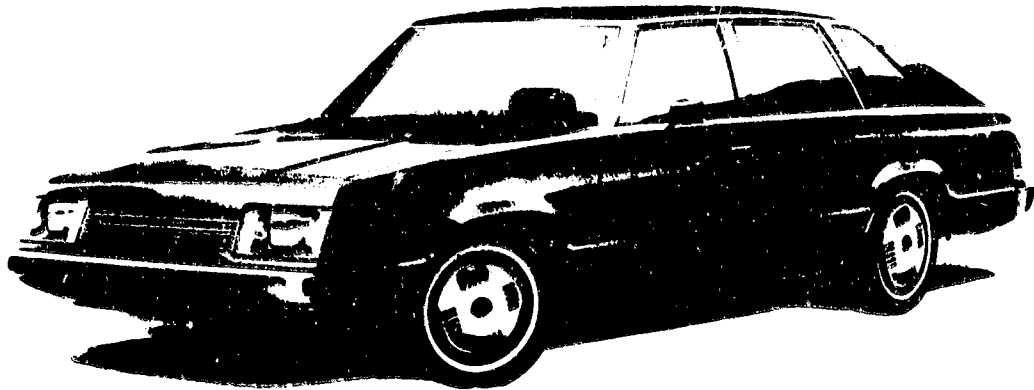

Left Front Quarter View

Figure 1.4.1-2. Artist's Rendering of the Hybrid Vehicle

ORIGINAL PAGE IS
OF FOUR (2000)

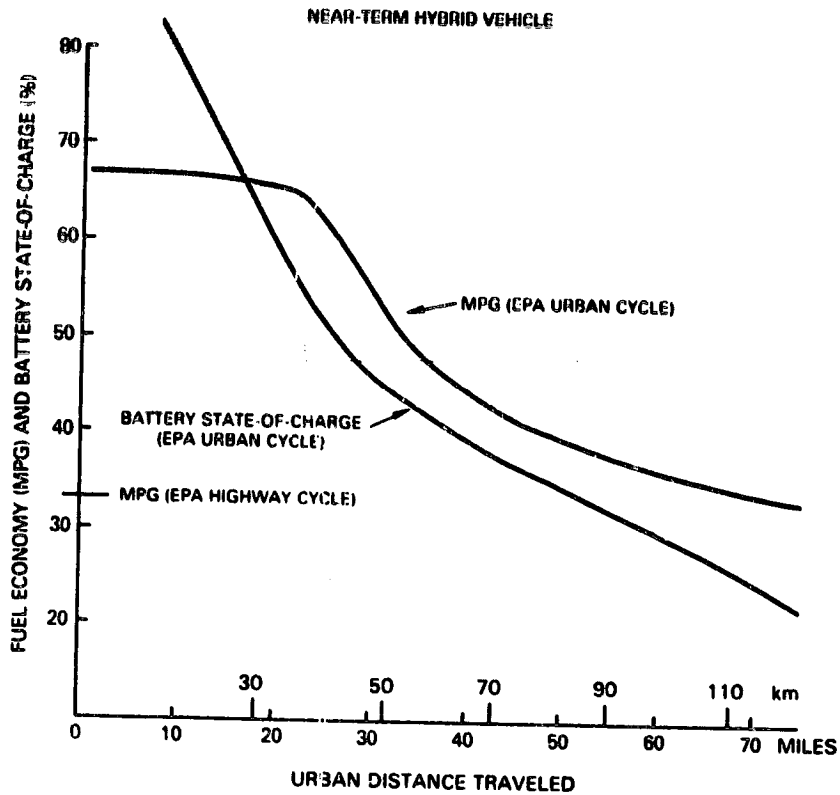

Figure 1.4.1-3. Battery State-of-Charge and Fuel Economy for Urban and Highway Driving

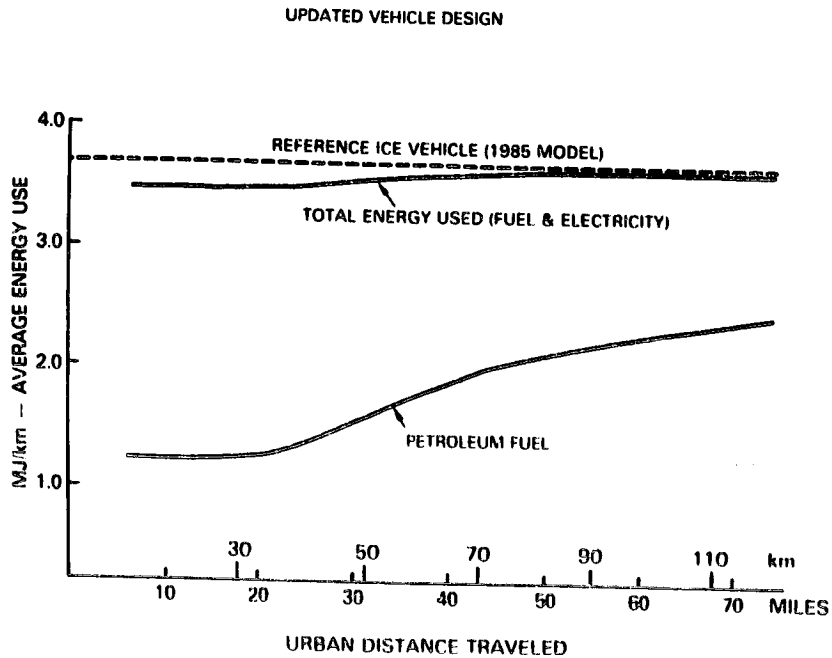

Figure 1.4.1-4. Total Energy and Petroleum Fuel Usage in Urban Driving for the Near-Term Hybrid Vehicle

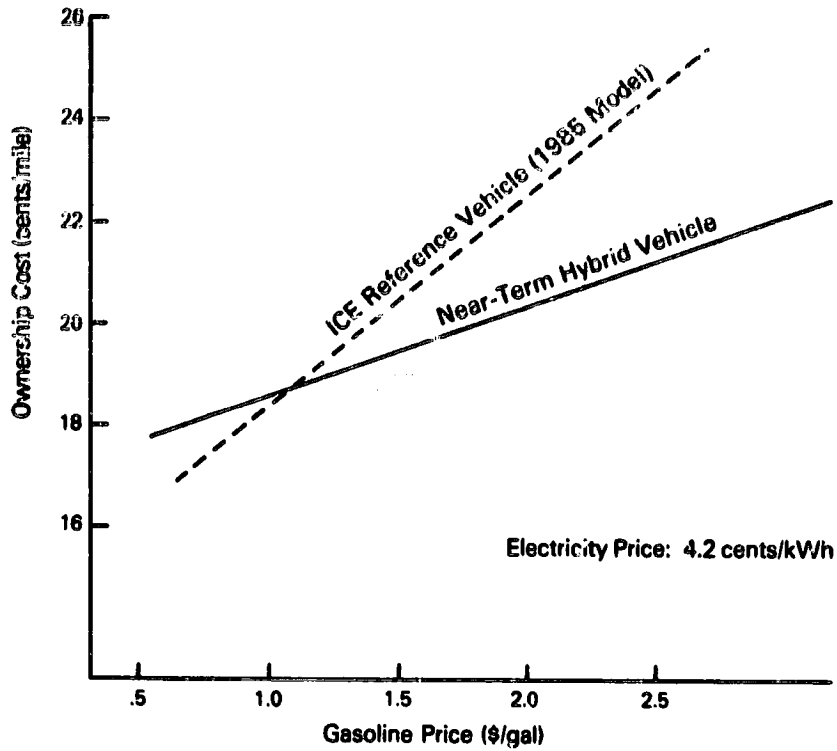

Figure 1.4.1-5. Ownership Cost as a Function of Gasoline Price

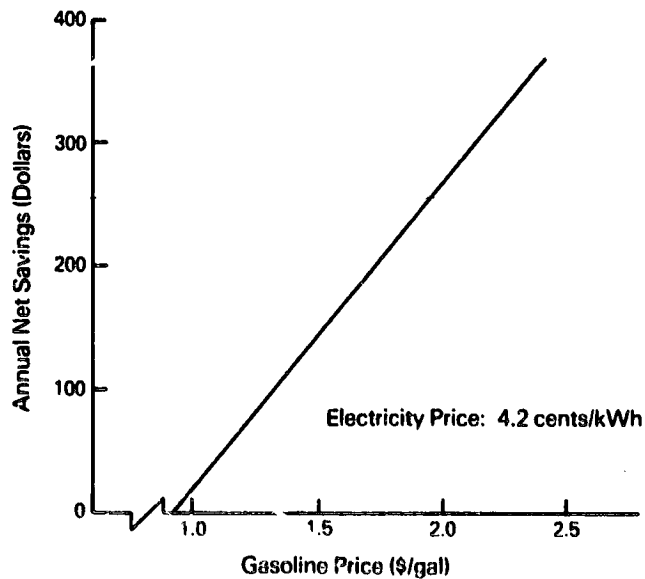

Figure 1.4.1-6. Annual Net Dollar Savings as a Function of Gasoline Price

(3) A battery subsystem based on the battery developed by Globe-Union for the Near-Term Electric Vehicle Program and recent developments on electrolyte circulation for the Argonne National Laboratory Near-Term Battery Program,

(4) An engine based on a VW production engine, VW advanced studies and experiments on emissions, and VW proprietary work on quick start for on/off engine operation,

(5) A vehicle subsystem design by Triad Services based on the extensive use of major components from late model production cars with a minimum of new design,

(6) A hybrid propulsion subsystem (including the battery) which is packaged entirely under the hood with no intrusion into the passenger compartment or the luggage compartment.

(7) Performance analysis models and computer programs which have been developed and validated by GE/CRD for second-by-second analysis of system performance during the Phase I Hybrid Vehicle Program.

1.4.1.4.2 Power Train Design

The Hybrid Vehicle designed in this study has the following power train characteristics:

(1) The propulsion subsystem is a parallel configuration in which the heat engine and the electric motor can deliver mechanical torque to the drive shaft, either together or individually.

(2) The electric motor (45 hp peak) will be used primarily for urban driving with moderate accelerations, speeds below 30 mph, ranges of less than 35 miles, and regenerative braking at all speeds.

(3) The heat engine (80 hp peak) will be used primarily for highway driving at speeds above 30 mph and to augment the electric motor for fast accelerations at lower speeds.

(4) The electric motor will augment the heat engine for fast accelerations at high speed and to maintain speed on steep grades.

(5) The engine can power the vehicle and drive the motor as a generator to recharge the batteries for extended range in urban areas. It can also be used to recharge the battery at rest when a source of electric power is not available. This use of the engine is not recommended except when no other method of recharging is available.

(6) Either the electric motor or the heat engine can operate the vehicle with reduced performance should one of the systems be inoperative.

1.4.1.4.3 Vehicle Performance

The hybrid vehicle has the following performance characteristics:

(1) It can perform all the driving missions required of a 5-passenger family sedan.

(2) It overcomes the range and acceleration limitations of the all-electric car.

(3) It offers acceleration, cruising speed, and passenger comforts comparable to the Reference ICE Vehicle (1979 Chevrolet Malibu).

(4) It results in 35% to 70% savings in petroleum (depending on daily travel) in normal urban driving compared to the Reference ICE Vehicle.

(5) It uses significantly less total energy in urban driving for the first 30 miles of travel and essentially the same energy for daily travel in excess of 75 miles compared to the Reference ICE Vehicle.

(6) The hybrid has a first cost of \$7600 in 1978 dollars compared to \$5700 for the Reference ICE Vehicle. For an annual mileage of 11,850 miles, electricity costs of 4.2 ¢/kwh, and gasoline costs of \$1/gal or higher, the hybrid vehicle has an ownership cost which is slightly less than that of the Reference ICE Vehicle.

1.4.2 MAJOR ALTERNATIVE DESIGN OPTIONS

A number of design options were evaluated in considerable depth before making the final decisions on the preliminary design. These are discussed in Section 4, Alternative Design Options Considered and Their Relationship to the Design Adopted.

1.4.2.1 Summary of Major Design Options Considered

The power train design options considered in depth and the ones chosen for the near-term preliminary design are listed in Table 1.4.2-1.

Table 1.4.2-1

POWER TRAIN DESIGN OPTIONS CONSIDERED IN DEPTH*

Considerations/Component	Selected Option	Principal Alternate Option
Type of Hybrid Arrangement	Parallel	Series
Use of Secondary Storage (flywheel)	No	Yes
Fraction of Peak Power from Heat Engine	2/3	-
Battery Type	ISCA Lead-Acid	Ni-Zn*
Engine Type	Fuel-injected, naturally aspirated gasoline	Turbocharged diesel*
Electric Drive Type	dc separately excited motor, field control, battery switching	dc separately excited motor with armature control and field control
Transmission Type and Gear Ratios	Automatic, gear box (3-speed)	Synchromesh gear box (4-speed)
Torque Combination	Single shaft	Power differential

* Options considered in depth means those analyzed using detailed vehicle simulations (HYVEC).

In some instances, more than one of the options evaluated were found to be attractive, and the selection of the preferred option was difficult. Those attractive options which were not selected for use in Phase II are discussed briefly in two categories, (1) technology which is not likely to be available for 1985 production but which would be monitored in case of a breakthrough, and (2) technology which is marginally near term and could be a good candidate for the Near-Term Hybrid Vehicle Program if technical uncertainties were resolved.

1.4.2.1.1 Alternative Options Which Should Be Monitored - The following options were identified which warrant monitoring during the Phase II Program:

Electric Drive

A contender for the electric drive was the ac induction motor with a pulsed-width modulated inverter. This option is attractive because of lower weight, smaller size, and higher efficiency of the motor. However, the probability of this type of system being in production in 1982, particularly at a competitive cost, is low. There is development work being done on this type of motor and inverter (ref. Appendix B - Vol. II, Section 4) and this work should be closely monitored.

Transmission

One of the attractive possibilities for improving the fuel economy of the hybrid vehicle and at the same time reducing the control complexity is the steel-belt continuously variable transmission (CVT). This type of transmission has been tested in a subcompact car by Borg-Warner, but the torque rating of that CVT was significantly lower than the torque required in the hybrid vehicle. As stated in subsection 4.8, there is little likelihood that a CVT of the proper size will be in production by 1985. This work, however, should be closely monitored.

1.4.2.1.2 Options Which Should Be Evaluated Further - The following options were identified as warranting further evaluation and development in Phase II. Such additional work was proposed in Task 5 - Phase II Proposal.

Turbocharged Diesel Engine Evaluation

Section 5.1 of Appendix C, Preliminary Design Data Package, discusses the significant improvement in fuel economy of the diesel engine powered hybrid compared with the gasoline engine powered hybrid. There is uncertainty that the diesel engine will meet the potential EPA particulate and NO_x emission standards and that the diesel engine can be operated in the on-off mode. This mode requires very fast starts under a range of engine temperature conditions. It was recommended in the Phase II proposal that a study be undertaken to evaluate engine emissions and cold starting on an engine dynamometer for operating cycles appropriate for the hybrid application.

Ni-Zn Batteries

Section 5.2 of Appendix C, Preliminary Design Data Package, discusses the significant reduction in vehicle weight and improvement in fuel economy for ranges over 30 miles that would result from the use of Ni-Zn batteries rather than the ISOA lead-acid batteries used in the preliminary design. However, there has been relatively little operating experience to date with Ni-Zn batteries in electric vehicles. Even more important, there is also uncertainty regarding their energy density and power characteristics, cycle life, and cost.

It was recommended in the Phase II Proposal that a two part development program be undertaken to furnish Ni-Zn batteries which

meet the requirements of the preliminary design. Part I of the program would be to design and fabricate a first-generation battery specifically for the hybrid application. These batteries would be evaluated and, if found suitable, Part 2 of the program would be undertaken. Part 2 would consist of design and fabrication of the second generation Ni-Zn batteries for use in the Near-Term Hybrid Integrated Test Vehicle.

1.4.3 INTERFACE COMPONENT AND SYSTEM CONTROL DEVELOPMENTS

A key feature of the hybrid vehicle designed in Phase I is that it offers excellent performance at relatively low technical risk. Design and analysis problems which are not considered high risk from a technology point-of-view but still must be solved in Phase II were identified. The approaches which would be taken to solve these problems are discussed in the Phase II Proposal. Those considerations are repeated in this section because they are not covered as a separate topic in any of the reports, yet their consideration constituted an important part of the technical effort in Phase I.

1.4.3.1 Identified Problems Requiring Development

The following important interface components and control developments have been identified:

- (1) Design and fabrication of a reliable torque transfer unit for combining the electric motor and heat engine outputs for input into the transaxle/gearbox,
- (2) Design and test of an automatic clutch for starting the vehicle from rest and operating it at low speeds on the electric drive,
- (3) Design and test of an automatic clutch for on/off operation of the heat engine when the vehicle is in motion,
- (4) Smooth and efficient blending of the electric motor and heat engine torques when both units are required to power the vehicle,
- (5) Development of the detailed control strategy for all vehicle operating modes and the software to implement it in the system microcomputer,
- (6) Simulation of component and power train transients on the computer,
- (7) Development and debugging of the system microcomputer hardware,
- (8) Development of the heat engine emission control system to meet the 1981 Federal Emission Standards during on/off operating modes of the engine,

- (9) Modification of the automatically shifted gearbox using input signals from the system microcomputer,
- (10) Development of the shared accessory drive system and heater/defroster/air conditioning systems compatible with the hybrid application.

1.4.3.2 Solution/Approaches to Identified Problems Requiring Development

The approaches to the solution of the design/analysis problems are discussed in the following paragraphs. These will have to be solved before the Phase II Final Design and fabrication is undertaken. Each of the design/analysis problems is treated separately.

(1) Torque Transfer Unit. The torque transfer unit, which combines the outputs of the electric motor and heat engine and transfers the resultant torque to the transaxle/gearbox must be developed. Preliminary drawings for this unit, which includes the clutch and Hy-Vo chain drive for each of the prime movers, were prepared in Phase I, Task 3.

(2) Automatic Clutch for the Electric Motor. Start-up and low-speed operation of the hybrid vehicle in the electric drive mode involves the use of a slipping clutch, much the same as a conventional ICE vehicle with a manual transmission. In the hybrid vehicle, this clutch operation should be made automatic with modulation of clutch pressure based on driver torque command (i.e., position of the accelerator pedal). The basic hardware for this clutch could be a standard automotive, dry clutch, but its control must be developed. Initial work will involve laboratory tests, but the final development should be done in a mule vehicle.

(3) Automatic Clutch for the Heat Engine. The operation of the clutch that couples and decouples the heat engine into the power train will be commanded by the system controller and should be automatic both with respect to timing and rate of engagement/disengagement. The basic hardware for this clutch will likely be a standard automotive component. Its operation will be developed with initial work done on the engine dynamometer, but the final work should be done in a hybrid test bed mule vehicle.

(4) Blending of Electric Motor and Heat Engine Torques. There are several operating modes in which the outputs of the electric motor and heat engine must be blended (i.e., power sharing). The blending involves both the phasing in of one of the prime movers when the other is already operating and also phasing out one of the prime movers when it is no longer needed. This load sharing will be done using the system controller and will involve determining the proper torque rise time, decay time, and sequencing procedure needed for smooth vehicle opera-

tion. The torque blending studies should be done in a hybrid test bed mule vehicle.

(5) Control Strategy and Software for Its Implementation.

Much work has been done in Phase I on developing the control strategy for the hybrid vehicle. This work will continue in both the computer simulation studies and the mule vehicle programs. The control strategy developed will be implemented in software for both the ITV system controller and the microcomputer for the hybrid test bed mule vehicle. All of these studies and controller developments should be coordinated so that the final control strategy and software used in the ITV are thoroughly evaluated and tested. The microcomputer for the hybrid test bed mule vehicle will be programmable so that the effect of changing control strategy parameters can be determined in the vehicle.

(6) Simulation of Power Train Transients. Power train transients are important in a number of vehicle operating modes (for example, blending of torques during acceleration, braking, passing maneuvers, shifting, etc.). These transients should be studied analytically as well as on the digital and hybrid computers. The results of these studies are needed to guide the design of the clutches, shifting mechanism and logic, and system controller logic and circuits.

(7) System Microcomputer Hardware. Microcomputer hardware development is needed for both the ITV and the hybrid test bed mule vehicle (HTBM). The hardware for the HTBM must be fabricated during the early part of the program. Development of the system controller hardware for the ITV will involve building up a specially designed microcomputer system from commercially available chips, interface units, etc. The ITV microcomputer must handle all operating modes of the hybrid vehicle while the microcomputer for the HTBM can include only those modes critical to the mule program.

(8) Heat Engine Emission Control System. The emission control system for the VW 1.6 l. EFI-L gasoline engine utilizes a three-way catalyst and feed-back control of A/F ratio using an O₂-sensor. This is the standard emission control approach for that type of engine, but since the on/off operating mode of the engine in the hybrid application is quite different from that in the conventional ICE vehicle, some development work is needed to ensure that the hybrid vehicle will meet the 1981 emission standards. Initial studies will be done on the engine dynamometer to determine the required catalyst size, substrate, and location relative to the engine exhaust for an appropriate engine cycle for the hybrid application. Particular attention should be given to catalyst warm-up and cool-down. Data should be obtained so that the emissions calculations made using HYVEC can be validated for the various driving cycles. Emission measurements should include the effect of cold start.

(9) Shifting Automatic Gearbox. The transaxle/gearbox to be used in the mule program and the ITV will be adapted from the three-speed automatic transmission used in the General Motors "X" body cars. This gearbox is a wide-range, lightweight unit especially designed for those recently introduced cars. In the hybrid application, the gearbox is shifted on command from the system microcomputer, but the shifting mechanism and internal clutches are essentially unchanged. Some adjustments might be necessary, but they can be kept to a minimum. The high-pressure hydraulic fluid needed to shift the gears is provided from a central accumulator that will be part of the closed-centered hydraulic system. Modifications to the automatic gearbox and development of the hydraulic system will be made early in Phase II. An early version of the modified gearbox is needed for the hybrid test bed mule vehicle. After further modifications, the final design will be tested and verified in the mechanical/electric mule vehicle before releasing units for the ITV.

(10) Accessory Systems. The operation and thus the design of the accessory systems on the hybrid vehicle will be significantly different from those on a conventional ICE vehicle. For example, the heater and defroster must operate satisfactorily even when significant waste heat is not available from the heat engine. This necessitates a gasoline burner to augment waste heat from the engine. Second, the accessory drive system must permit either the heat engine or the electric motor to drive the accessories (e.g., air-conditioner, alternator, hydraulic pump) or to share the load when both the heat engine and electric motor are operating. Further, it is necessary to design the accessory systems such that they require a minimum energy to operate. This requirement leads to the use of a closed-center hydraulic system and accumulator to supply high pressure fluid to the power steering, power brakes, and transmission shift systems. Available automotive components have been identified from which the accessory systems can be built, but considerable effort will be required in Phase II to design and test them.

1.5 ORGANIZATION OF THE FINAL REPORT

The remainder of this report is organized to be consistent with the Data Requirement Description 7 in the contract. References to the Task reports given in the appendices are made where appropriate. A short statement is made in each section to relate the work discussed to the Data Requirement Topic and to the proper Task and Appendix.

Section 2

SUMMARY OF PHASE I ACTIVITY

Section 2**SUMMARY OF PHASE I ACTIVITY****2.1 INTRODUCTION**

A summary of all Phase I activities is presented in this section. It is structured around Tasks 1, 2, 3, and 4. For each task the objectives are given, the methodology is discussed, and the findings, conclusions, or recommendations are presented. The material describing the work in each task is summarized from the appropriate appendix which is referenced. The Near-Term Hybrid Vehicle Program, Phase I, was divided into five tasks:

Task 1 - Mission Analysis and Performance Specification Studies

Task 2 - Design Trade-off Studies

Task 3 - Preliminary Design

Task 4 - Sensitivity Analysis

Task 5 - Proposal for Phase II

A flowchart of the Phase I activities is shown in Figure 2.1-1. As indicated in the figure, Tasks 1, 2, 3, and 5 were conducted in sequence with the output of one task being used as input to the next one. Task 4 was conducted concurrently with Task 3. Formal documentation was prepared at the conclusion of each task. The task reports for Tasks 1, 2, 3, and 4 are included under separate cover.

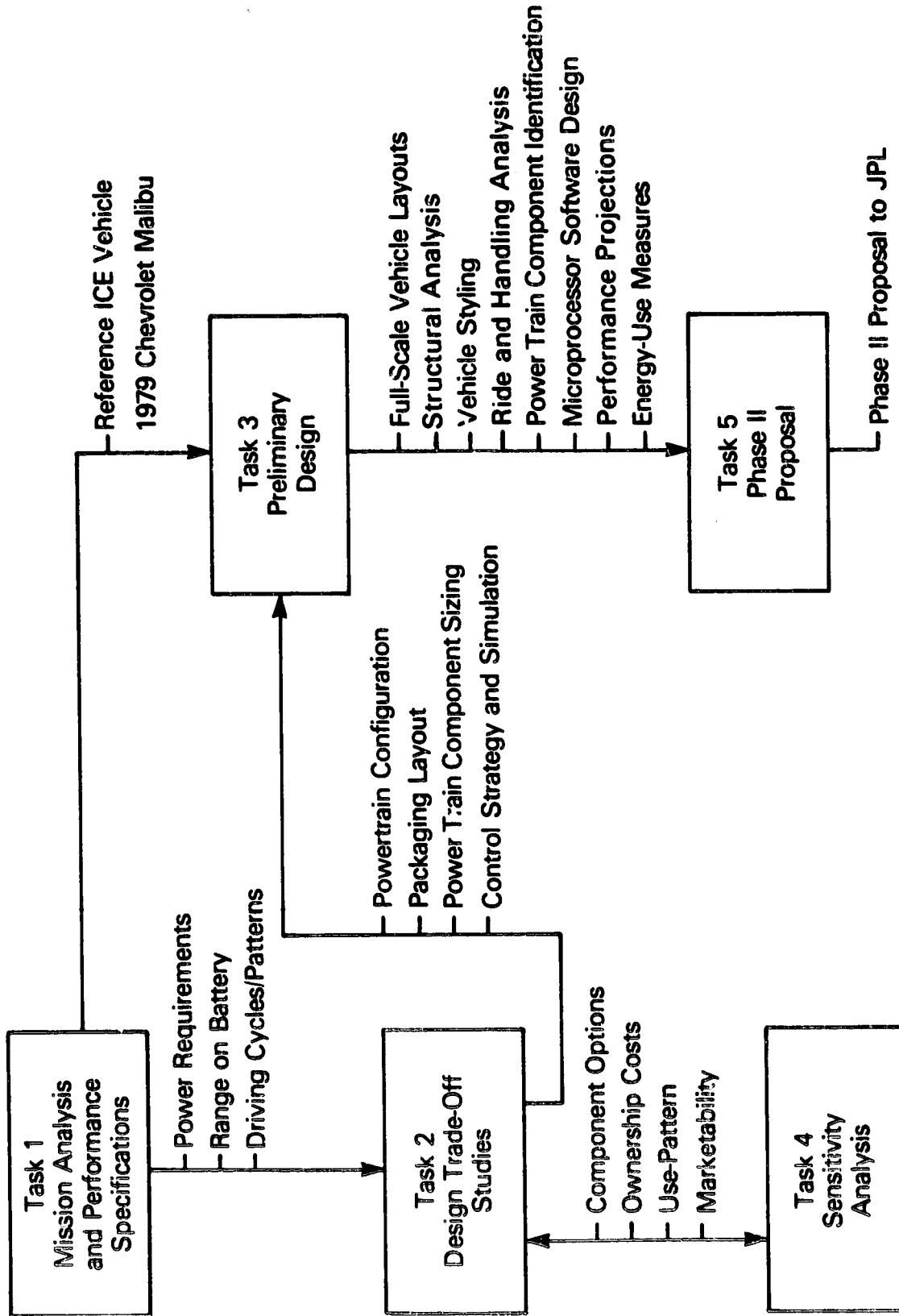

Figure 2.1-1. Phase I Activities Flowchart

2.2 TASK 1 - MISSION ANALYSIS AND PERFORMANCE SPECIFICATION STUDIES SUMMARY

This subsection summarizes the work on Task I which is given in Appendix A, Mission Analysis and Performance Specification Studies.

2.2.1 OBJECTIVES

The major objectives of the Task I study were to

- Characterize ICE vehicles in terms of weight, fuel economy, and performance,
- Characterize the use patterns of automobiles for various mission combinations,
- Determine the power requirement and electric range of the hybrid vehicle,
- Select and characterize the 1985 Reference ICE Vehicle.

2.2.2 METHODOLOGY

In the present study, passenger cars were categorized by size and passenger capacity. Four size classes were defined: small, compact, mid-size, and full size. Vehicle weight for each size class was estimated but was not used in defining the size class. Vehicle performance specifications were examined in terms of

- Top Speed
- Acceleration
- Gradability
- Low- and High-Speed Passing Capability

Performance (acceleration) required for safe operation was differentiated from performance required for ready acceptance in the marketplace. Performance requirements for the 1985 cars were then estimated based primarily on safe operation. Performance specifications for the hybrid/electric vehicle were determined and compared to the minimum requirements specified in Exhibit 1 of the contract (see Figure 2.2.2-1).

Projected characteristics of conventional ICE passenger cars were collected and examined. The characteristics of particular interest were:

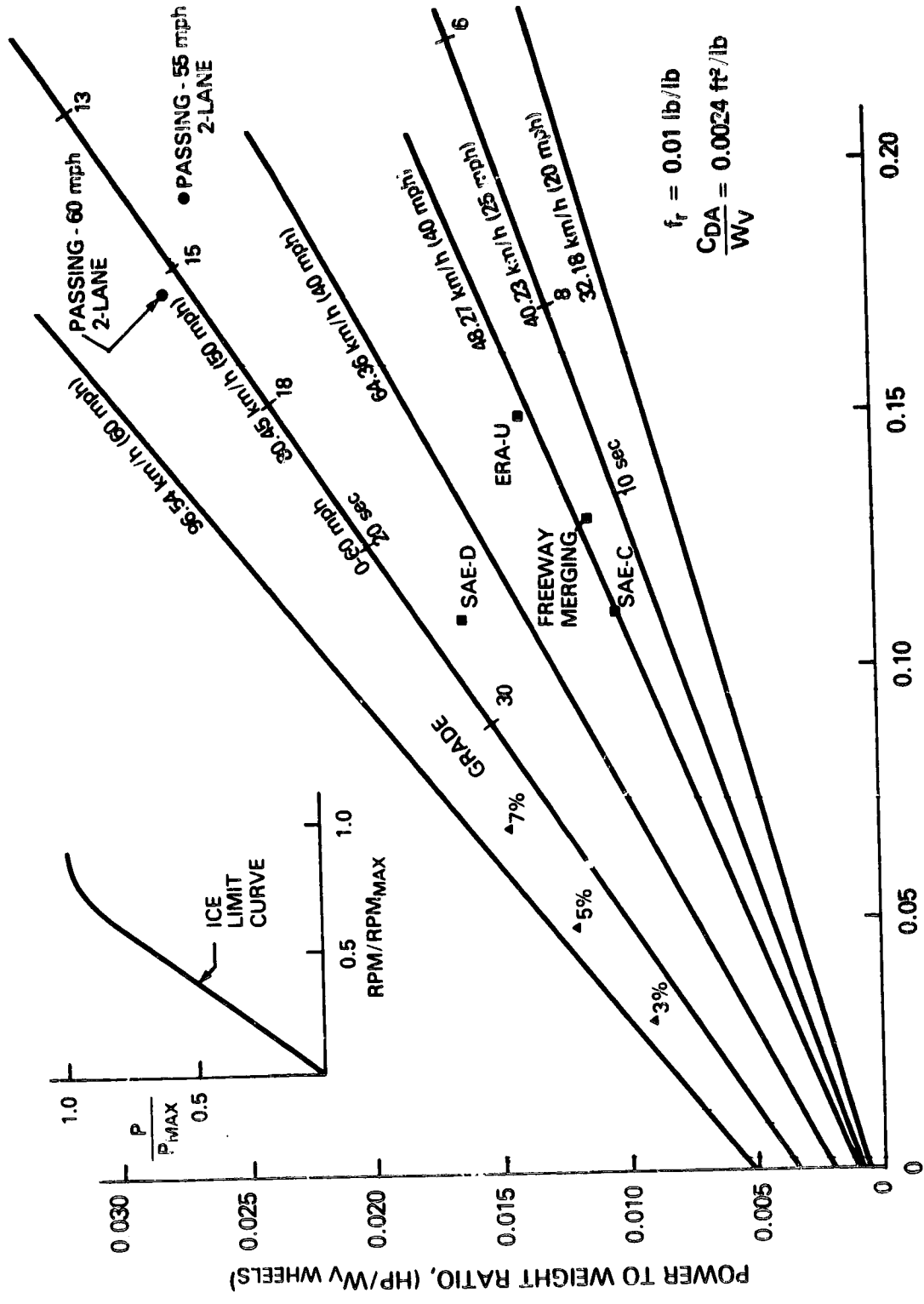

Figure 2.2.2-1. Power-to-Weight Ratio Requirements

- Exterior Dimensions
- Curb Weight
- Fuel Economy
- Exhaust Emission Standards

Data were correlated for the 1978 models and projected for 1985. The EPA urban and highway driving cycles were assumed to be representative of urban and highway driving in 1985 and were used to determine vehicle composite fuel economy for the conventional cars (see Figure 2.2.2-2). The 1977 sales mix of the four size classes was used as the basis for the 1985 sales mix in order to target the size class for the hybrid/electric vehicle (see Table 2.2.2-1).

2.2.2.1 Methodology for Mission Description and Characterization

In order to assess the effects of mission analysis on hybrid/electric vehicle design and marketability, local and regional car use was studied. Two regions were considered:

- Inside Standard Metropolitan Statistical Areas (SMSAs)
- Outside Standard Metropolitan Statistical Areas (SMSAs)

Data sources used include (1) national census surveys, (2) national transportation use-pattern surveys, and (3) car registration statistics. It was assumed that the sales mix by size class would be about the same during the next decade even though the actual size of the cars will be smaller in the future than at present.

The use pattern of the automobile varies over a wide range in terms of trip length, trip frequency, and trip purpose. Four general categories of trip purpose are defined:

- Earning a Living (Work Travel)
- Family Business
- Civic, Educational, or Religious
- Social or Recreational

The last three trip purposes were consolidated and called Personal Business. Use patterns of automobiles were characterized in terms of regular travel (e.g., work travel) and random travel (e.g., personal business). Mission sets were then described in terms of both random and nonrandom trips. A total of eight mission sets were specified and analyzed (four each for travel inside SMSAs and outside SMSAs).

Table 2.2.2-1

FUEL USE BY SIZE CLASS IN 1985

Size Class	Sales Mix %	I _w , lb	Composite mpg	Fraction of Fuel Used
Small	23.9	1900	43.8	0.16
Compact	23.3	2300	34.5	0.198
Mid-Size	24.3	2900	26.0	0.274
Full-Size	27.6	3500	22.0	0.367
				<u>0.999</u>

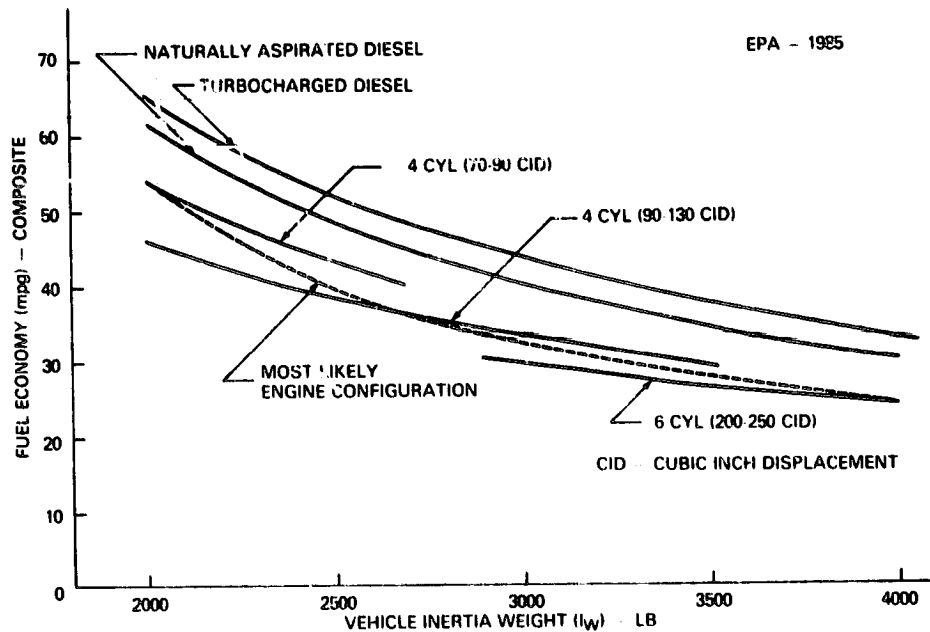

Figure 2.2.2-2. Projected 1985 Composite Fuel Economy

Characterization of automobile travel requires the following main factors:

- Annual Mileage (statistical distributions)
- Daily Travel (statistical distribution of trip length and number)
- Driving Mode

Since data pertinent to some of these factors is very limited, considerable judgement had to be used in developing inputs for the travel analysis. In the absence of data, for example, an estimate had to be made for annual mileage versus percent automobiles. Daily travel patterns were determined when at all possible through use of the Nationwide Personal Transportation Study. A computer program was written to simulate daily travel by using a Poisson distribution and a Monte Carlo simulation. The Poisson distribution determines both the number of days per year in which a specified number of trips is taken as well as the total number of trips per year. The Poisson distribution requires as input data the average number of trips per day and the average trip length. The Monte Carlo simulation uses a random number generator to predict trip length and requires the use of distribution functions for percent trips and percent vehicle miles in terms of the trip length. The results of the Monte Carlo trip simulation are used to determine the fraction of days and vehicle miles for which a hybrid/electric vehicle having a specified "electric" range can be operated primarily on the battery. Such correlations were developed for each of the mission sets. The travel and trip statistics are summarized in Tables 2.2.2-2 and 2.2.2-3.

Driving mode is usually described by a driving cycle or a combination of driving cycles. The EPA urban (FUDC) and the EPA highway (FHDC) driving cycles were examined as the means to represent urban and highway travel. The two parts (transient and stabilized) of the FUDC are used individually and in combination to describe city and suburban trips, and the FHDC is used to describe intercity travel which is considered as trips of over 100 miles.

2.2.2.2 Methodology Used in the Selection of the Reference ICE Vehicle

In order to properly assess the hybrid/electric vehicle it is necessary to identify a conventional internal combustion engine (ICE) vehicle having the same passenger carrying capacity and performance. The criteria for selection of the Reference ICE Vehicle were:

- Passenger Capacity
- Sales Volume
- Acceleration Performance

Table 2.2.2-2

DAILY AND ANNUAL TRAVEL DISTANCES INSIDE SMSAs
FOR VARIOUS MISSIONS

Mission	Annual Distance (miles)	Daily Distance (miles) Percentile *		
		50	75	90
Personal business only				
50th percentile	3,000	20	29	39
75th percentile	4,500	25	38	49
90th percentile	6,500	32	49	66
Personal business plus work trips				
50th percentile	6,625	21	32	43
75th percentile	8,125	26	39	57
90th percentile	10,125	32	51	76
All-purpose (excluding intercity travel)				
50th percentile	6,400	34	52	69
75th percentile	9,200	52	74	99
90th percentile	11,600	>100	>100	>100
All-purpose (including intercity travel)				
50th percentile	7,000	36	61	>100
75th percentile	11,300	50	84	>100
90th percentile	17,000	70	>100	>100

*Percentiles are for vehicle miles

Table 2.2.2-3

DAILY AND ANNUAL TRAVEL DISTANCES OUTSIDE SMSAS FOR VARIOUS MISSIONS

Mission	Annual Distance (miles)	Daily Distance (miles) Percentile *		
		50	75	90
Personal business only				
50th percentile	4,400	25	38	52
75th percentile	6,500	31	49	67
90th percentile	9,300	43	64	82
Personal business plus work trips				
50th percentile	6,275	23	36	54
75th percentile	8,375	31	49	68
90th percentile	11,175	42	64	90
All-purpose (excluding intercity travel)				
50th percentile	7,300	40	62	83
75th percentile	10,600	61	90	>100
90th percentile	12,700	>100	>100	>100
All-purpose (including intercity travel)				
50th percentile	9,000	43	72	>100
75th percentile	13,700	58	>100	>100
90th percentile	20,500	84	>100	>100
*Percentiles are for vehicle miles				

Selection of the Reference ICE Vehicle was directed to mid-size cars because hybrid/electric cars of that size class were judged to have the greatest potential for reducing gasoline consumption. Interior dimensional criteria noted by Consumers Union (April 1978) were used to identify several 1978/1979 model mid-size cars which would be acceptable as Reference ICE Vehicles. Fuel economy and acceleration characteristics were used for further narrowing of the list of potential Reference ICE Vehicles. The final selection of the Reference ICE Vehicle (1978/1979 Model)* was based on the availability of detailed information on the ICE vehicle which was selected.

2.2.3 CONCLUSIONS

GENERAL CONCLUSIONS AND OBSERVATIONS

The following general conclusions were formulated based on the work done on mission analysis:

(1) The statistical character of automobile use is important in determining the "electric" range of the hybrid/electric vehicle and the fraction of potential car buyers whose transportation needs would adequately be met by a specific hybrid/electric vehicle design.

(2) Statistical data on annual mileage including the relationships between annual mileage and trip length frequency along with fraction of vehicle miles in trips of specified length are important in calculating auto use statistics, but the available key input data is very limited.

(3) The auto use patterns in terms of daily travel and annual mileage are significantly different inside and outside of SMSAs, and these differences can significantly affect the selection of design range for hybrid/electric vehicles.

(4) The fraction of vehicle miles rather than the fraction of days on which the car can be operated primarily on the battery is the critical factor in selecting "electric" range.

(5) The EPA urban and highway cycles can be used to describe vehicle use, and the "stabilized" portion of the EPA urban cycle is a better representation of central city driving than the SAE J227a (B) cycle.

*Reference ICE Vehicle (1985 Model): GM mid-size; 2600 lb curb weight; length - 185 inches, width - 73 inches; fuel economy - 28/42 EPA uncorrected, 23/33 EPA corrected; acceleration - 0-60 mph, 16 sec.

**A 65%/35% annual split between urban and highway mileage is used rather than the national average of 55/45 because owners of hybrid/electric vehicles would more likely live in or near urban areas (inside SMSAs) and thus do proportionately more urban/suburban driving than the national average.

(6) The urban/highway mileage split of 65/35 is more realistic for metropolitan areas in which hybrid/electric vehicles will be most attractive than the more customary 55/45 split.**

SPECIFIC CONCLUSIONS

(1) The Chevrolet Malibu (1978) with a V-6, 231 CID engine, a 5-passenger mid-size car made by General Motors, was selected as the Reference ICE Vehicle. The projected characteristics of the 1985 model of that vehicle are used for comparison with the corresponding characteristics of the hybrid/electric vehicle.

(2) An "electric" range of 35 to 40 miles for the hybrid/electric vehicle is needed so that at least 50% of the potential midsize car buyers would drive at least 75% of annual urban vehicle miles using the electric drive as their primary propulsion means.

(3) A 0-96 km/h (0-60 mph) acceleration time* of 16 seconds was selected for the acceleration performance specification. The critical factor in this selection was safe, high-speed passing on two-lane roads. This level of performance resulted in more than adequate gradability, freeway merging capability, and top speed.

*Acceleration performance is given in terms of 0-96 km/hr (0-60 mph) rather than 0-90 km/hr (0-50 mph) as in the contract exhibits because it conforms more closely with the current practice of automotive publications for stating conventional vehicle performance. Thus most readers would have a better feel for the performance of the hybrid vehicle relative to conventional ICE vehicles if its performance is given in terms of the 0-60 mph acceleration time.

2.3 TASK 2 - DESIGN TRADE-OFF STUDIES

This subsection summarizes the work done on Task 2 which is reported fully in Appendix B - Design Trade-Off Studies Report, Volumes I, II, and III.

2.3.1 OBJECTIVES

The major objectives of the Task 2 study were to

- Characterize the major power train components including heat engines, electric motors and controllers, batteries, transmissions and torque combination units, and micro-processors,
- Evaluate and compare various hybrid power train configurations and component combinations in terms of total vehicle weight and initial cost,
- Simulate on the computer second-by-second hybrid vehicle operation over various complex driving cycles, and
- Select a hybrid power train and packaging arrangement for detailed preliminary design in Task 3.

2.3.2 METHODOLOGY

The approach used in the Design Trade-off Studies consisted of several steps. The first step involved the synthesis of total vehicle weight and cost from the specific weights and costs of individual components for a large number of candidate configurations. In this initial screening of components and drive-line configurations, the component and vehicle energy-use characteristics were averaged over the driving cycles of interest. In this first step, a wide range of drive-line components and combinations was considered using a Hybrid Vehicle Design Program (HYVELD) for the computer calculations. The objective of the vehicle-level screening was to identify those drive-line components and arrangements which are most attractive for more detailed consideration in the next step of the screening procedure.

The second step of the trade-off study involved second-by-second simulation of the hybrid/electric vehicle designs operating over several driving cycles. This simulation required detailed modeling of the various drive-line components and the control strategy for operation of the electric and heat engine drive systems. In this second step, vehicle characteristics, such as drag coefficient, frontal area, weight, etc., were fixed. The major emphasis was to determine the effect on electricity and gasoline use of power train changes, such as battery type and weight, engine type, motor voltage control technique, and variations in control strategy. The second-by-second vehicle simulations were per-

formed using the Hybrid Vehicle Calculations (HYVEC) computer program.

The third step in the Design Trade-off Study was to determine whether attractive hybrid power train arrangements could be packaged in a five-passenger car and if so, what were the primary considerations in comparing one power train layout to another.

2.3.2.1 Power Train Components and Configurations Considered

There is a myriad of possible hybrid/electric power train configurations and components which could be considered in design trade-off studies. Hence, some technical judgment was used at the outset of the study to reduce the contenders to a manageable number. For instance, the following generic hybrid arrangements were considered and then excluded:

- Electric drive through individual wheel-mounted motors
- The split power train in which one set of wheels is driven by the heat engine and the second set by the electric motor

Wheel-mounted motors were excluded because it was felt that for passenger-car size vehicles such motors are collectively less efficient, heavier, and more expensive than a single motor of the same combined horsepower. The split power train arrangement was ruled out because the control of such a system when there is power sharing between the heat engine and electric drives would present great difficulty with respect to flexibility and smoothness. In addition, the split power train arrangement is inherently heavier and more expensive than single drive shaft configurations.

The hybrid power train configurations and components considered in the present trade-off studies are listed in Table 2.3.2-1. As indicated in the table, both series and parallel configurations were analyzed in the first screening step, and a number of candidate components were studied for each function in the drive line. The effect of vehicle range and power-to-weight ratio on the relative attractiveness of the various component candidates from both the vehicle weight and cost points-of-view were investigated using the HYVELD computer program.

2.3.2.2 Component Characterization

In order to perform the trade-off studies it was necessary to characterize each of the components in Table 2.3.2-1. The degree of detail required for each component depended on whether it was included only in the vehicle level (first step) screening

or in both the vehicle level and second-by-second simulation screenings. For the initial screening, each component was characterized in terms of specific weight (lb/kW) and specific cost (\$/kW). For the second-by-second simulations, detailed characterization of the components was required including efficiencies (and/or losses) over the complete operating range (power and speed) of the component. For the batteries it was necessary to obtain charge/discharge characteristics over a wide range of charge/discharge currents. For the most part, the components were characterized using data taken on existing hardware. Extensive characterization data for each of the power train components is given in Appendix B (Volume I, Section 3).

In order to synthesize the power train, it is necessary to specify a number of vehicle characteristics and the degree of power sharing between the heat engine and electric drive systems. For the hybrid vehicle design calculations using HYVELD, the vehicle characteristics required are baseline chassis weight, payload, energy consumption per ton-mi, fraction of the energy from heat engine, and the performance parameters -- power-to-weight ratio and range on electricity. The power sharing between the heat engine and electric drive systems is specified in terms of the fraction of the peak power attainable from each drive system. The efficiency of the drive-line is specified as a single value averaged over the driving cycles of interest. As noted previously, the effect of the vehicle and power train specifications on the attractiveness of the various components is of particular importance.

2.3.2.3 Methodology for the Evaluation and Comparison of Candidate Power Trains

During the initial screening of the candidate hybrid/electric power trains, comparisons were made in terms of total vehicle weight, initial and operating costs, break-even gasoline price, and total energy used. These comparisons were made for fixed baseline vehicle chassis weight and vehicle performance specifications. The vehicles utilizing hybrid/electric power trains were also compared with the 1985 model of the Reference ICE Vehicle and an all-electric car having similar utility to a car owner. For all of these comparisons, economic factors such as interest rate, discount rate, finance period, payback period, inflation rate, etc. were held constant. In addition, the fuel economy of the Reference ICE Vehicle was fixed. Complete lists of the design and economic factors which were varied or held constant in the initial screening study are given in Table 2.3.2-2.

Candidate power trains included in the second-by-second simulation studies were compared in terms of range primarily on battery-stored electricity, fuel economy (mpg), heat engine emissions, and energy use. These comparisons were made for urban/surburan, highway, and intra-city driving using appropriate combinations of the Environmental Protection Agency's urban and highway cycles and the SAE J227a Schedule B cycle. In addition, the

Table 2.3.2-1

HYBRID POWER TRAIN CONFIGURATIONS AND COMPONENTS
CONSIDERED IN THE DESIGN TRADE-OFF STUDY

General Power Train Arrangements

1. Series
2. Parallel

Heat Engines

1. Fuel-injected Gasoline (naturally aspirated)
2. Diesel (naturally aspirated and turbocharged)
3. Uniform Charge Rotary
4. Single-shaft Gas Turbine
5. Stirling

Transmission/Clutches

1. Power Addition with Differential Action
2. Multi-speed Shifted Gearbox with Clutch
3. Torque Converter with Lock-up
4. Continuously Variable Transmission (CVT)

Electric Drives

1. DC Separately Excited with or without Armature Control
2. AC Induction with Pulse-width Modulated Inverter

Batteries (Primary Storage)

1. Lead-acid
2. Ni-Zn
3. Ni-Fe
4. LiAl-FeSx

Secondary Storage

1. Flywheel
2. Lead-Acid Batteries

Table 2.3.2-2

VEHICLE AND ECONOMIC FACTOR INPUT PARAMETERS
FOR THE DESIGN TRADE-OFF CALCULATIONS

Hybrid/Electric Design Parameter

Baseline Chassis Weight	*
Payload Weight	*
Power-to-weight Ratio	
Range (Design) - All-electric	
Range (Design) - Hybrid	
Electric Drive-line Efficiency	
Cost of Additional Chassis Weight	*
Weight Propagation Factor	*
Miles Traveled per Year	*
Fraction of Miles in City	*
Energy Consumption in City (kWh/ton-mi)	*
Energy Consumption on Highway (kWh/ton-mi)	*
Fraction of Energy from Engine in City	*
Fraction of Energy from Engine in Highway	*
Price of Electricity	*
Specific Cost of Motor/Generator (\$/kW)	
Specific Cost of Generator (\$/kW)	
Specific Cost of Controller (\$/kW)	
Specific Weight of Motor/Generator (\$/lb)	
Specific Weight of Generator (\$/lb)	
Specific Weight of Controller (\$/lb)	
Average Engine bsfc in City	*
Average Engine bsfc on Highway	*
Time for Sustained Power from the Flywheel	*

Conventional Vehicle Design Parameters

Power-to-weight Ratio	
Specific Weight of Engine	
Specific Weight of Transmission	
Specific Cost of Engine	
Specific Cost of Transmission	
Fuel Economy in City	*
Fuel Economy on Highway	*
Consumer Cost	*
Price of Gasoline	*
Maintenance Cost per Mile	*

Economic Factors

Discount Rate	*
Inflation Rate	*
Interest Rate	*
Payback Period	*
Finance Period	*
Tax Rate	*
Sales Tax	*

*Input Parameters Held Constant in Vehicle Synthesis Calculations

0-60 mph and 40-60 mph acceleration times obtained for the various candidate hybrid power trains were compared.

2.3.2.4 Vehicle-Level Power Train Layout Considerations

The results of the design trade-off studies yielded the power ratings of the heat engine and electric drive systems and the weight of the batteries needed to meet the vehicle performance and range requirements set forth by the Mission Analysis (Task 1). In addition, the trade-off studies identified particular components, such as heat engines, electric motors, and batteries, which are prime candidates for use in the Preliminary Design (Task 3). In order to investigate various options for packaging power train components of the required size into a five-passenger car, preliminary vehicle layouts were made using the 1979 Chevrolet Malibu (chassis and interior seating arrangement) as the baseline design. Various placements of the motor, engine, and batteries were made including front-and-rear-wheel drive and fore-and-aft-positioning of the batteries. These layouts formed the basis for trade-off considerations involving crashworthiness, service accessibility, handling, vehicle weight, and ease of battery maintenance.

2.3.2.5 Control Strategy and Vehicle Operation on Various Driving Cycles

Selection and evaluation of power train components must include careful consideration of the control strategy to be used. The control strategy involves coordinating use of the heat engine and electric drive systems. The power and speed requirements of the vehicle must be matched to the capabilities of the engine and motor. Power matching is accomplished by means of a transmission and/or power combination differential. The control strategy should be self-adaptive to varying levels of battery charge and rates of acceleration and deceleration. In addition, the control parameters for the various components should be easily sensed and used as inputs to the system controller. All of these aspects of developing and implementing a control strategy for the efficient, flexible, and smooth operation of the hybrid/electric power train were considered in the trade-off studies.

2.3.3 MAJOR FINDINGS

The major findings* from the Design Trade-Off Studies are:

(1) The parallel configuration with a 60/40 split between peak power of the heat engine and electric drive systems is near-optimum from the standpoints of vehicle weight, ownership cost, and energy usage (fuel and electricity).

*Detailed results of the design trade-off studies are given in Appendix B (Vol. I, Sections 5 and 8).

(2) Based primarily on economic considerations, a dc electric drive system utilizing a separately excited motor with field control and battery switching was selected for the Near-Term Hybrid Vehicle.

(3) The prime heat engine candidates are a fuel-injected gasoline engine and a turbocharged diesel. Both engines are 1.6 l in displacement and develop about 80 hp. The diesel engine yielded 25 to 30% better fuel economy in the hybrid application than the gasoline engine, but technology does not currently exist to reduce the NO_x and particulate emissions of the diesel to levels being considered by the Environmental Protection Agency for 1985 (0.2 gm/mi for particulates). The diesel also has possible cold-starting problems when used in an on/off mode.

(4) A complex control strategy involving integrated power sharing between the heat engine and the electric drive systems is required for the hybrid vehicle to have acceleration performance equivalent to a conventional ICE vehicle and at the same time high fuel economy and acceptable electric range. Implementation of the control strategy developed in the computer simulations will require the use of microprocessors in the hybrid vehicle control system.

(5) The initial hybrid vehicle simulations showed that 700 lb of ISOA lead-acid batteries yielded satisfactory electric range and vehicle acceleration performance.* The Ni-Zn batteries were found to be the most attractive for the hybrid application, but there is considerable uncertainty concerning the cycle life-time and cost of Ni-Zn batteries in the 1982 to 1985 time period.

(6) The vehicle layout studies showed that the complete hybrid power train including the lead-acid batteries can be packaged in the engine compartment of the 1979 Chevrolet Malibu without any intrusion into the passenger compartment.

(7) The initial selling price (in 1978 dollars) of the hybrid vehicle was calculated to be about \$7000 compared with \$5700 for a conventional ICE vehicle of the same performance and passenger-carrying capacity.† The ownership (life cycle) cost of the hybrid was calculated to be 17.8¢/mi compared with 18.5¢/mi for the Reference Vehicle for energy costs of \$1.00/gal for gasoline and 4.2¢/kWh for electricity. The lifetime of the hybrid vehicle was taken to be 12 yrs compared with 10 yrs for the conventional ICE vehicle because of the long life of the electrical components, the reduced use of the heat engine, and the improved vehicle components at 5% increase in cost.

(8) Detailed hybrid vehicle simulations showed that for the first 30 mi (the electric range of the vehicle) in urban driving,

* Battery weight was established as 770 lb during Preliminary Design.

† Selling price was modified to \$7600 during Preliminary Design.

the fuel economy was 80 mpg using a gasoline engine and 100 mpg using a diesel engine. Over the first 75 mi the average fuel economy of the hybrid was 42 mpg for the gasoline engine and 55 mpg using the diesel engine. The highway fuel economy of the hybrid vehicle is slightly better than that of the Reference ICE Vehicle (1985 model). In urban driving the hybrid would save about 75% of the fuel used by the conventional vehicle and in combined urban/highway driving the fuel saving is about 50%.

2.4 TASK 3 - PRELIMINARY DESIGN

This subsection summarizes the work done on Task 3 which is fully reported in Appendix C - Preliminary Design Data Package.

2.4.1 OBJECTIVES

The major objectives of the Task 3 effort were to

- Develop a detailed preliminary design (including full-scale layouts and styling) of the hybrid vehicle using the power train arrangement and components selected in Task 2,
- Perform ride and handling and barrier crash computer simulations of the hybrid vehicle design,
- Contact potential suppliers of major power train components and refine the sizing of those components,
- Perform the preliminary design of electric drive system components, including the power electronics, battery charger, and microcomputer,
- Refine the second-by-second hybrid vehicle simulation program, and
- Determine the performance and energy-use characteristics and ownership costs for the Near-Term Hybrid Vehicle.

2.4.2 METHODOLOGY

The preliminary design activities were concerned with developing detailed designs of the vehicle and power train subsystems from the design concepts evolved in Tasks 1 and 2. The primary activities undertaken in Task 3 were the following:

- Full-scale layouts of the vehicle and power train
- Vehicle styling
- Vehicle handling and crashworthiness simulations
- System microcomputer software study
- Battery switching, field chopper, and battery charger circuit design
- Refinement of HYVEC simulation calculations.

In Task 1, the Chevrolet Malibu (mid-size GM car) was selected as the Reference ICE Vehicle. Subsequent work in Task 2 indicated that the Malibu would also be a good choice for a base vehicle from which to build/fabricate the Near-Term Hybrid Vehicle.* Hence all the preliminary design layout work in Task 3 was done using the 1979

*This vehicle is to be built by 1982 and thus must use materials and automotive components available at that time.

Malibu as the starting point for the hybrid conversion. The Malibu was extensively redesigned with only the passenger compartment, window and door mechanisms, front and side glass, and door and roof metal being used essentially unchanged from the stock Malibu. The exterior of the Malibu (front and rear) was redesigned for improved aerodynamics and a fresh new look, and the front and underbody structures and front and rear suspensions along with the power train were replaced. The conversion approach significantly reduces the cost of building/fabricating the hybrid vehicle with a minimal sacrifice in vehicle attractiveness and utility. Experience gained with the General Electric Centennial and the DOE/GE Near-Term Electric Vehicle (which were essentially from-the-ground-up designs) has indicated that those parts of the vehicle being used from the stock Malibu (interior, window and door mechanisms, etc.) were particularly expensive and troublesome in the building of the new vehicles. Hence, the approach taken in the Near-Term Hybrid Vehicle Program is to redesign only the power train, running gear, load carrying structural members, and exterior styling of the vehicle and to utilize the interior and windows/doors of the stock Malibu. The introduction of front-wheel drive, downsized luxury cars, such as the Buick Riviera and Olds Toronado, by GM has provided some of the mechanical components required in the hybrid vehicle.

At the completion of the Design Trade-Off Studies, two options were still being considered for several of the hybrid power train components. These components and the options were:

- Heat Engine - fuel injected, gasoline (VW 1.6 l) or a turbocharged diesel (VW 1.6 l)
- Transmission - multi-speed, automatically shifted gearbox or a steel belt, traction drive continuously variable transmission (CVT)
- Torque Combination Unit - Single shaft or power differential
- Batteries - lead-acid or Ni-Zn

In all cases it was decided to proceed in the Preliminary Design Task with the more readily available and more highly developed component and to include the alternative option in an advanced technology development category. Hence, the detailed vehicle layouts were prepared using (1) a fuel-injected gasoline engine (1.6 l), (2) a multi-speed, automatically shifted gearbox, (3) a single shaft (fixed speed ratios between input/output shafts) torque combination unit, and (4) ISOA lead-acid batteries. Further discussions of the use of a turbocharged diesel engine, the steel-belt CVT, and Ni-Zn batteries in the hybrid/electric power train are included under advanced technology developments. The power differential torque combination was dropped from further consideration, because of the complexity of the control of such a unit and the belief that development of the single-shaft unit would permit adequate smoothness in power blending from the heat

engine and electric motor. The advantages of the diesel engine, CVT, and Ni-Zn batteries are significant, and they would have been included in the design except for the following disadvantages in each case: (1) diesel engine - NO_x and unregulated emissions (smoke and odor) and uncertainty regarding cold start in the on/off operating mode, (2) steel-belt CVT - uncertainty regarding the availability of a unit with desired overall speed ratio and torque capability by mid-1981, and (3) Ni-Zn batteries - uncertainty in performance, cycle life, and cost of cells available by 1981. The hybrid vehicle layout is such that the advanced-technology components can be substituted for their near-term counterparts. For example, the Ni-Zn batteries could replace the lead-acid batteries with little or no change in the rest of the electric drive system.

2.4.3 MAJOR FINDINGS/ACCOMPLISHMENTS

The major findings/accomplishments of the Preliminary Design Task were the following:

(1) Detailed vehicle layouts showed that the complete power train, including the batteries, could be packaged under the hood ahead of the firewall resulting in no intrusion into the passenger compartment.

(2) The ride, handling, and crashworthiness of the hybrid conversion were found to be comparable to those of the 1979 Chevrolet Malibu.

(3) The acceleration performance of the hybrid vehicle was calculated to be 0-30 mph in 5 seconds and 0-56 mph in 12.6 seconds.

(4) Energy-use calculations showed that the Near-Term Hybrid Vehicle* would use 41% less petroleum fuel and 5% less total energy (including electrical energy generation inefficiency) compared with the Reference ICE Vehicle in 1985 for 11,852 miles of annual driving (65% urban).

(5) The use of a turbocharged diesel and/or Ni-Zn batteries in the hybrid power train would lead to a more attractive hybrid design (25% better fuel economy and 400 lb lighter vehicle, respectively) than the baseline design which uses a gasoline engine and lead-acid batteries.

(6) The use of a steel-belt CVT in the hybrid power train would improve the 0-60 mph acceleration by about 1 second and reduce fuel consumption by about 20%, but such a transmission is not likely to be available before 1985.

*The power train for this vehicle is not fully optimized because it must utilize automotive components available in 1982. Thus its fuel economy and resultant petroleum savings are less than those of the more highly optimized hybrid vehicles discussed in Appendix B (Volume I, Section 8).

(7) The operation of the heater/defroster and air-conditioner significantly increases the energy-use of the hybrid vehicle when the electric motor is the primary propulsion unit.

2.5 TASK 4 - SENSITIVITY ANALYSIS

This subsection summarizes the work done on Task 4 which is fully reported in Appendix D - Sensitivity Analysis Report.

2.5.1 OBJECTIVES

The major objectives of the Task 4 study were to determine the impact of variations (from nominal values) in

- Travel characteristics
- Energy costs
- Component costs
- Vehicle lifetime
- Maintenance costs
- Fuel economy of the Reference ICE vehicle

on the

- Utility
- Economic attractiveness
- Marketability

of the 5-passenger hybrid vehicle selected as near-optimum in Task 2.

2.5.2 METHODOLOGY

The sensitivity studies were performed using the Hybrid Vehicle Design (HYVELD) computer program which was also employed extensively in the Design Trade-off Studies. HYVELD was developed so that the important parameters on which the vehicle design and economics depend could be easily changed by simply altering the inputs to the program.

A summary of the parameter sensitivities studied using HYVELD is given in Table 2.5.2-1. About 50 runs were made - divided into the groups indicated - to investigate the effect of one or, at most, three parameters at a time. All the studies pertain to the parallel hybrid configuration (without secondary energy storage) and are for a power-to-weight ratio K_p equal to 0.02 kW/lb. The sensitivity of hybrid vehicle design to power train configuration and component characteristics was studied in detail in Task 2 and was not repeated in Task 4. The HYVELD calculations yielded parametric results for other hybrid/electric vehicle configurations, but those results are not discussed in this task because the Design Trade-Off Studies indicated clearly that the parallel hybrid approach was far superior to the others.

Thus, it is the sensitivity of the parallel hybrid results to the parametric variations that is of prime importance.

2.5.3 CONCLUSIONS

The major conclusions drawn from the sensitivity analysis are the following:

(1) Changes in annual mileage are reflected directly in the fraction of the miles that the hybrid vehicle can be driven primarily on electricity with the marginal effect increasing rapidly when the fraction falls below 50%.

(2) For the lowest cost dc electric drive system and high-volume production, the initial cost of the hybrid vehicle would be \$1200 to \$1500 higher than that of the conventional ICE vehicle. This cost differential would be \$1600 to \$2100 for low-volume production of the electric components.

(3) For nominal energy costs (\$1.00/gal for gasoline and 4.2¢/kWh for electricity), the ownership cost of the hybrid vehicle is projected to be 0.5 to 1.0¢/mi less than the conventional ICE vehicle. To attain this ownership cost differential, the lifetime of the hybrid vehicle must be extended to 12 years and its maintenance cost reduced by 25% compared with the conventional vehicle.

(4) The ownership cost advantage of the hybrid vehicle increases rapidly as the price of fuel increases from \$1 to \$2/gal. The effect of the cost of electricity on ownership cost is small for electricity prices between 2.5¢ and 8.5¢/kWh.

(5) Annual mileage and fraction of miles in urban driving do not significantly affect the ownership cost differential between the hybrid and conventional vehicles.

(6) Changes in general economic conditions (i.e., the inflation rate) do not significantly affect the ownership cost differential between the hybrid and conventional vehicles.

(7) Annual fuel savings using the hybrid vehicle are strongly dependent on the fuel economy baseline used for the Reference ICE Vehicle (1985 model). Using projected 1985 fuel economy values, the hybrid vehicle would have a fuel savings of about 55% or 250 gal per vehicle per year.

(8) Hybrid vehicles would be economically attractive to a wide group of new car buyers with the ownership cost and fraction of fuel saved varying only slightly between the 35th and 90th percentile of car owners.

Table 2.5.2-1

SUMMARY OF PARAMETER SENSITIVITIES
STUDIED USING HYVELD

Sensitivity to	Parameters Varied	Number of Combinations
Energy Costs	Gasoline Price, Electricity Price	8
Annual Mileage	Annual Mileage	4
Fraction of mileage in City	Fraction of Mileage in City	4
Economic Conditions	Discount Rate, Interest Rate, Inflation Rate	3
Vehicle Lifetime and Maintenance Improvement	Vehicle Lifetime, Additional Cost Factor to Extend Life, Maintenance Improvement Factor	8
Percentile of Vehicle Random Travel	Annual Mileage, Fraction of Mileage in City, Vehicle Electric Range	12
Engine Type	Engine Type (Diesel and Gasoline), Diesel Fuel Price	4
Reference ICE Vehicle Fuel Economy	Urban and Highway Fuel Economy of the ICE Vehicle	3
Electric Drive-line Component Costs	Specific Cost of Each Electric Drive-line Component for Low and High Production Rates	6

(9) The economic attractiveness of the hybrid vehicle is not a strong function of design electric range for changes in range between 30 to 40 mi.

(10) Hybrid vehicles using diesel engines have a slight advantage in ownership cost (0.5 - 1.0¢/mi) compared to those using gasoline engines, but the gasoline engine-powered hybrid has a slightly greater ownership cost differential advantage compared to the corresponding conventional ICE vehicle (1985 model).

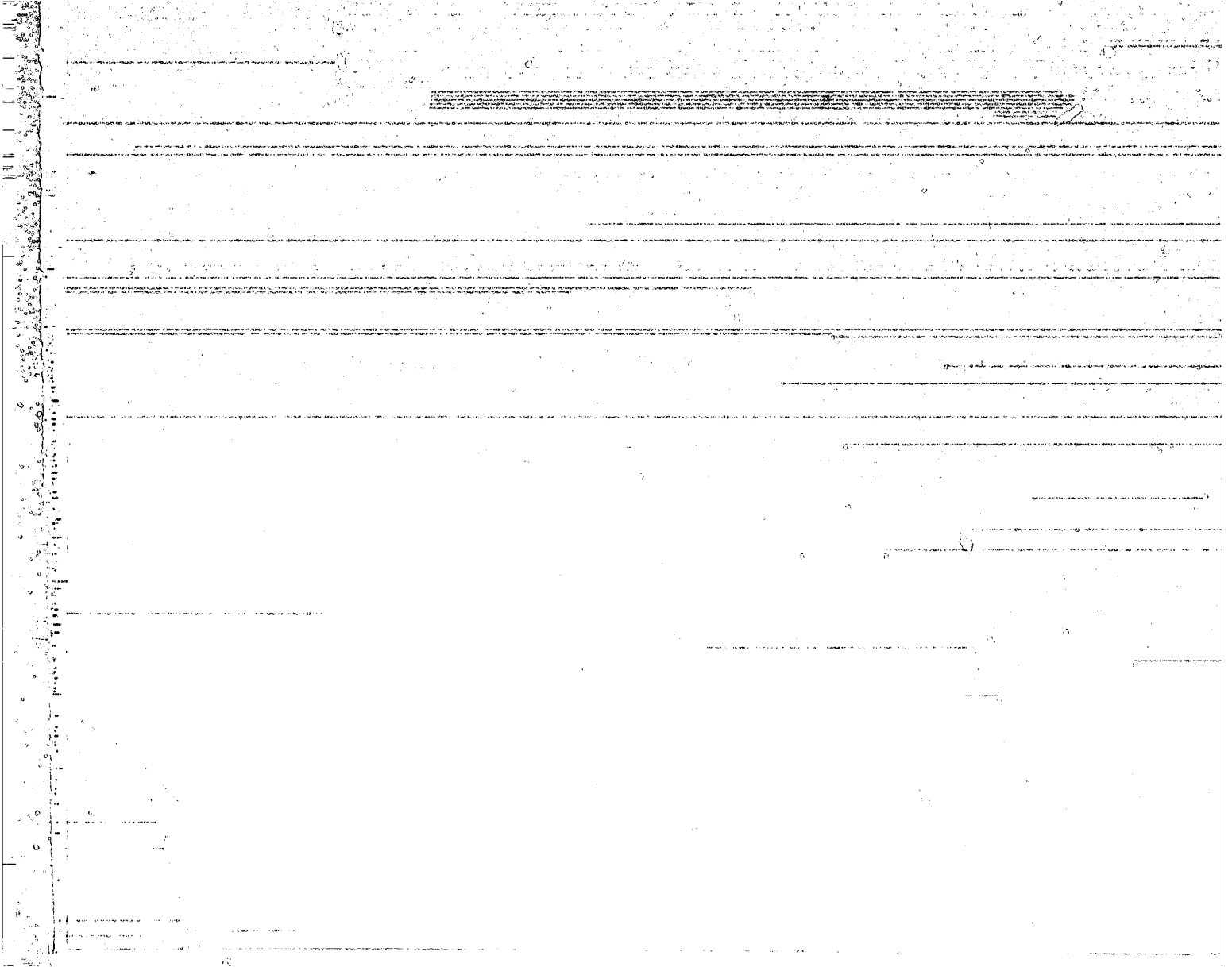

Section 3

SUMMARY OF THE NEAR-TERM HYBRID VEHICLE DESIGN

A summary of the Near-Term Hybrid Vehicle preliminary design is presented in this subsection. Topics addressed include the general layout and styling, the power train specifications with discussion of each major component, vehicle weight and weight breakdown, vehicle performance, measures of energy consumption, and initial cost and ownership cost.

3.1 GENERAL LAYOUT AND STYLING

The general characteristics of the vehicle layout and chassis are:

- Curb weight
 - 1786 kg (3930 lb)
- Body Style
 - Four-door hatchback
 - Drag Coefficient - 0.40 (effective wind weighted)
 - Frontal area - 2.0 m² (21.5 ft²)
- Rolling Resistance
 - .011 lb/lb (tires plus wheel bearings)
- Chassis/Power Train Arrangement
 - Front wheel drive
 - Complete power train, including the batteries, in front of firewall
 - Fuel tank under rear seat
- Reference ICE Vehicle
 - Chevrolet Malibu (1985 model)*

Full-scale drawings of the near-term hybrid vehicle have been prepared and 1/5 scale reductions are included in Appendix C, Preliminary Design Data Package. The starting point in preparing

*The Reference ICE Vehicle (1985 model) is assumed to have the same frontal area, drag coefficient, and rolling resistance as the hybrid/electric vehicle.

the drawings was the 1979 Malibu. No changes were made in the seating package. A three-dimensional cutaway of the hybrid vehicle indicating the placement of the power train is shown in Figure 3.1-1. Note that the complete hybrid power train is located in front of the firewall with no intrusion into the passenger compartment. An artist's rendering of the vehicle styling is shown in Figure 3.1-2. A four-door hatchback body type was selected because it maximizes the all-purpose character of the five-passenger vehicle.

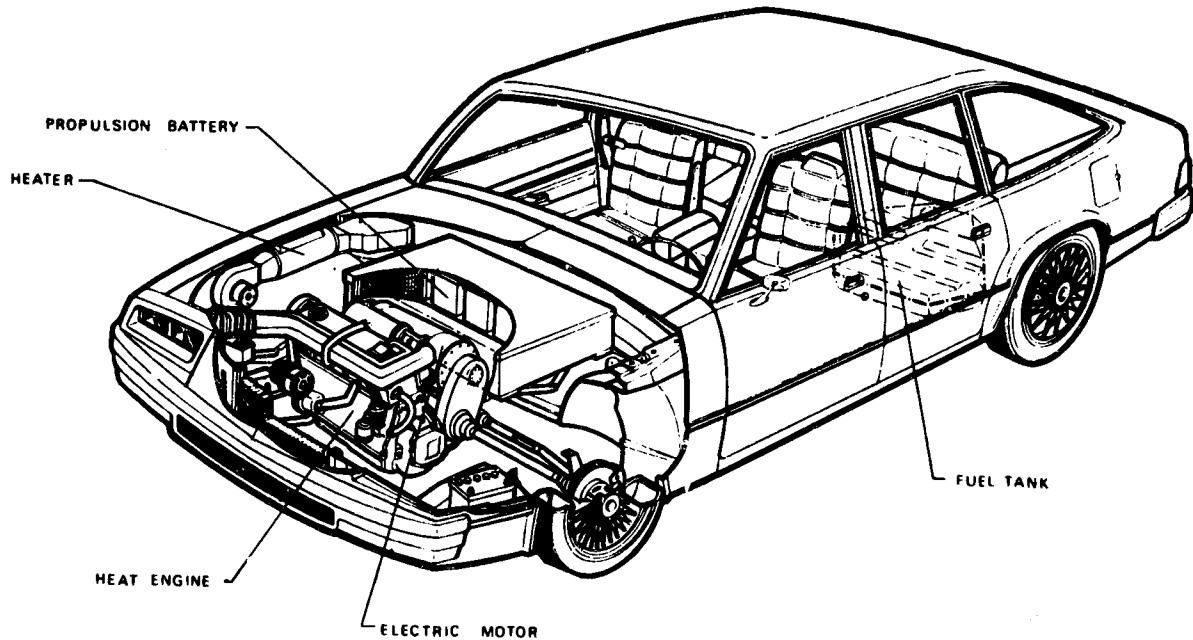
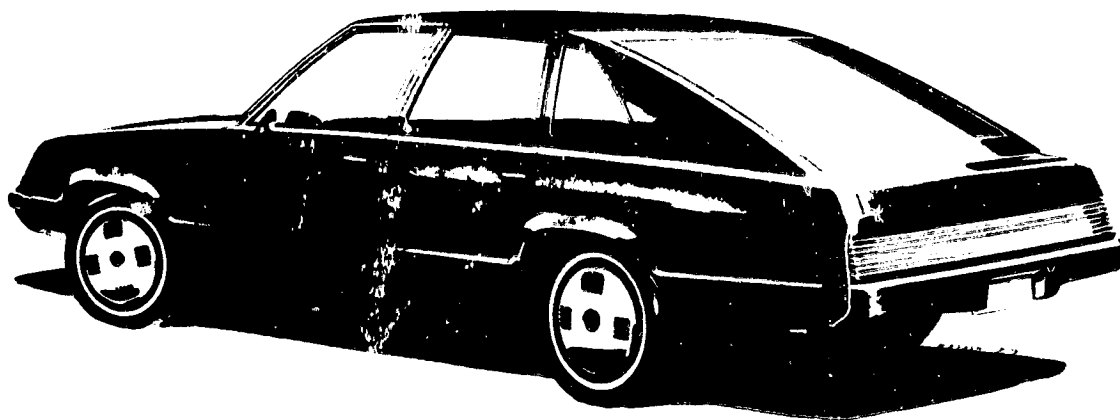
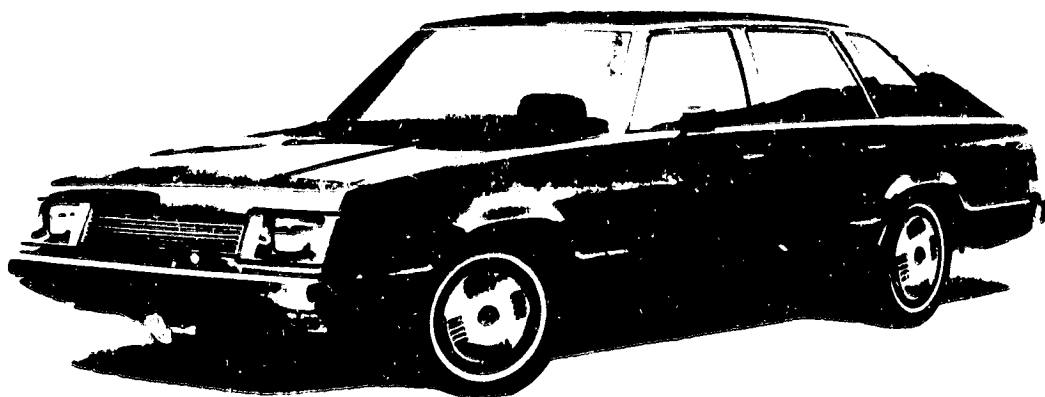

Figure 3.1-1. Near-Term Hybrid Vehicle,
Three-Dimensional Cutaway

ORIGINAL PAGE IS
OF POOR QUALITY



Left Rear Quarter View



Left Front Quarter View

Figure 3.1-2. Artist's Rendering of the Near-Term Hybrid Vehicle

3.2 POWER TRAIN SPECIFICATIONS AND WEIGHT BREAKDOWN

Specifications for the heat engine, electric drive system, batteries, and transmission and axle differential are presented in this subsection. Control strategy and the system microcomputer are discussed and the vehicle weight breakdown is presented.

3.2.1 POWER TRAIN SPECIFICATIONS

Full-scale drawings of the hybrid power train were prepared in Task 3. A one-fifth scale drawing of the power train is shown in Figure 3.2.1-1. As indicated in the figure, the hybrid vehicle uses front-wheel drive with both the heat engine and electric motor mounted in a transverse orientation above the transaxle. This is clearly a parallel hybrid configuration. Clutches are required to permit decoupling the drive system from the vehicle drive shaft and operating the heat engine and electric motor in combination and separately. A schematic of the power train is shown in Figure 3.2.1-2.

Specifications for each of the power train components are discussed in the following subsections.

3.2.1.1 Heat Engine

The heat engine used in the preliminary design of the hybrid vehicle is the Volkswagen fuel-injected 4-cylinder, 1.6 liter gasoline engine. This engine equipped with the Bosch K-Jetronic fuel injection system is used in the VW Rabbit and Audi 4000. The K-Jetronic system is often referred to as the CIS (Continuous Injection System) and utilizes a mechanical airflow sensor and distributing slots to control fuel flow to the engine. The VW 1.6 liter engine can also be equipped with the Bosch L-Jetronic system which utilizes solenoid-operated injection valves associated with each cylinder. The amount and timing of the fuel injection is controlled by a microprocessor which requires inputs from measurements of airflow, rpm, engine temperature, etc. The L-Jetronic system is a true electronically controlled fuel injection system and for that reason is more compatible with the overall implementation of the hybrid vehicle control strategy using a system microprocessor. Volkswagen does not currently market the L-Jetronic fuel injection system. However, discussions with VW indicated they are currently fleet-testing cars using the L-Jetronic system and have done much laboratory testing of engines using that system. Hence it is appropriate to use the more advanced L-Jetronic system in the Near-Term Hybrid Vehicle Program.

Considerable fuel consumption and emission data were available to characterize the electronically fuel-injected (EFI), 1.6-liter engine. Those data were used in the HYVEC simulation

studies. The EFI 1.6-liter engine is rated at 80 hp at 5500 rpm with a maximum torque of 84 ft/lb at 3200 rpm. Hence, the engine is sized almost exactly to meet the hybrid vehicle power requirement and is an ideal choice for the hybrid application.

3.2.1.2 ELECTRIC DRIVE SYSTEM

The electric drive system in the hybrid vehicle utilizes a dc separately excited motor with battery switching and field weakening to control motor speed and torque. The system uses a nominal voltage of 120 V with peak currents of about 400 A except during battery switching when the currents reach 500 A for a few seconds. The electric motor has a continuous rating (1-2 hours) of 18 kW (24 hp) and a peak rating (1-2 minutes) of 32.8 kW (44 hp). Discussions with the General Electric DC Motor and Generator Department indicate that the dc motor for the hybrid vehicle can be developed by a modest redesign of the electric motor used in the Near-Term DOE/GE electric car. The resultant motor for the hybrid vehicle would be essentially the same size (length and diameter) and weight as the one for the DOE/GE electric car, but it would be worked harder (with slightly higher currents and flux) in the hybrid application. Testing of the original design has indicated this is possible without significantly reducing the reliability and life of the motor.

The dc motor is controlled using field weakening and battery switching. The battery is arranged in two parallel banks so that it can be operated to yield 60 V or operated in series to yield 120 V. The base speed of the motor is 1100 rpm at 60 V and 2200 rpm at 120 V. A resistor is used when starting the motor and during short periods of battery switching. Field weakening is accomplished using a transistorized field chopper in essentially the same way as in the DOE/GE electric car.

The motor rating may be summarized as follows:

Design No. 2366-2913

Frame	OD 12 1/4 in.
Name Plate Rating	24 HP, Peak Power 44 hp (1 min.)
Weight	220 lb
Rated Voltage	108 V
Rated Current	190 A
Rated Field	8.2 A
Rated Flux	0.84 Megalines
Base Speed	2200 rpm
Maximum Speed	6000 rpm

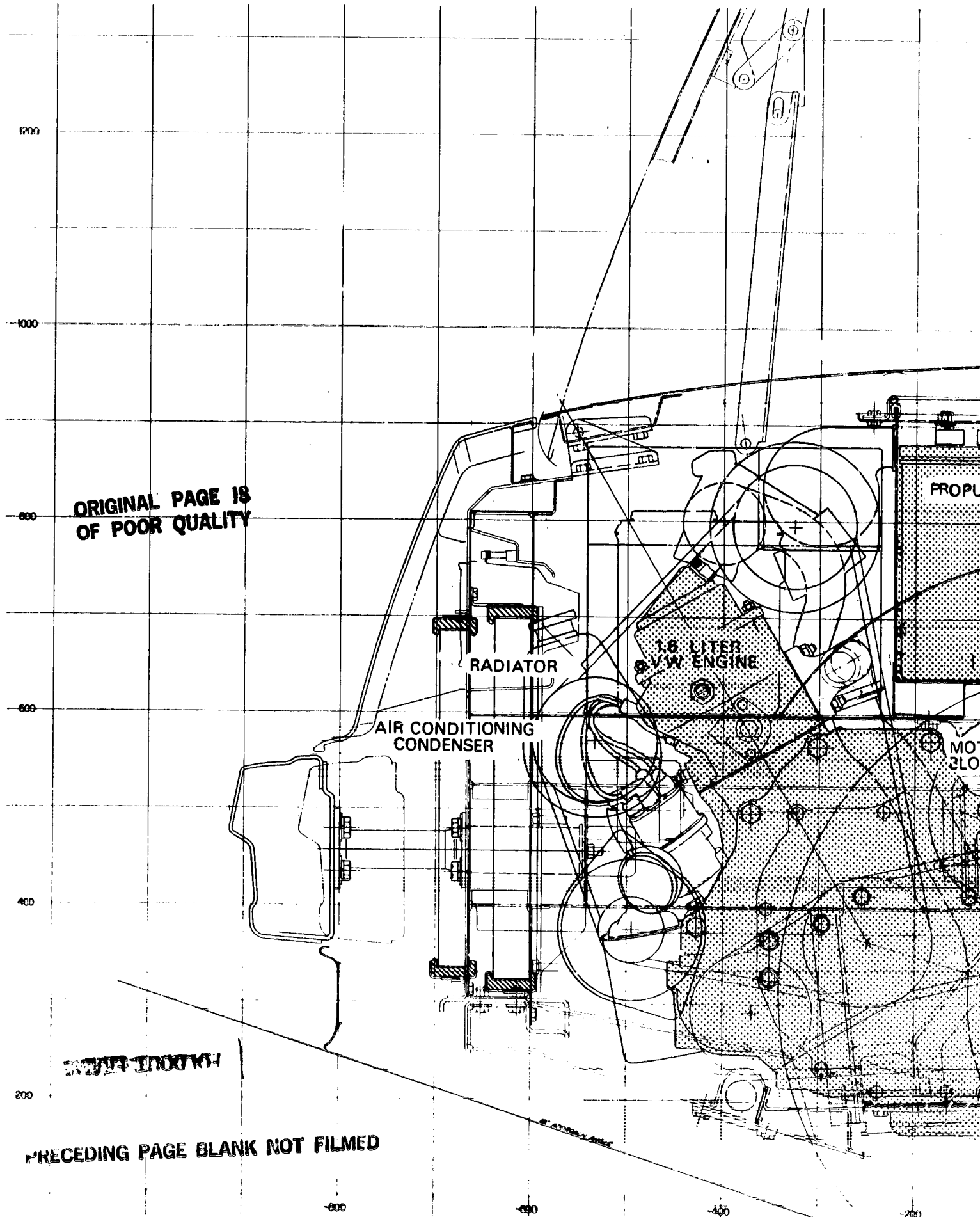

ORIGINAL PAGE IS
OF POOR QUALITY

RADIATOR

AIR CONDITIONING
CONDENSER

1.8 LITER
V.W. ENGINE

PROPULSION

MO. CLO.

PRECEDING PAGE BLANK NOT FILMED

PRECEDING PAGE BLANK NOT FILMED

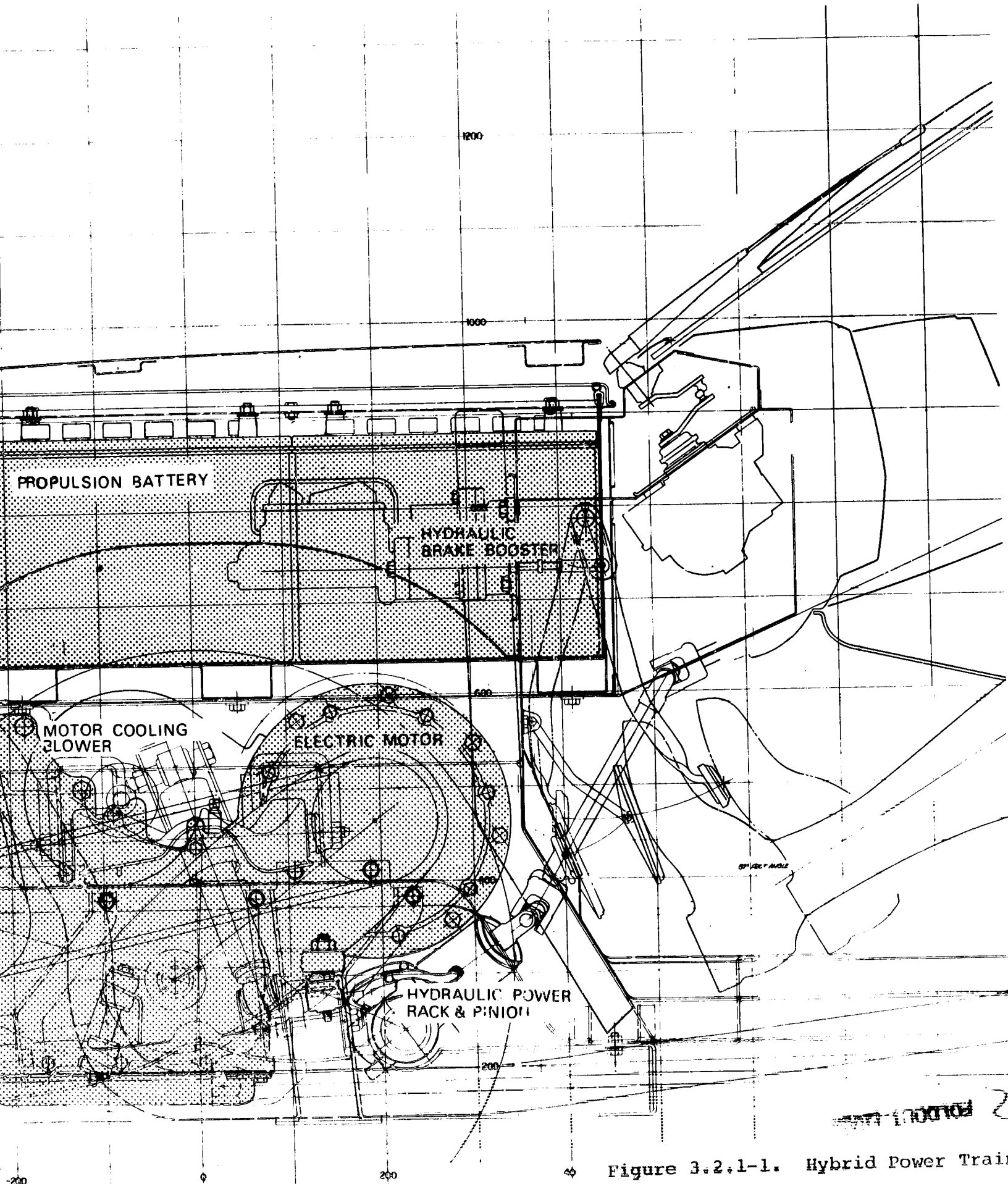

Figure 3.2.1-1. Hybrid Power Train

3-7/3-8

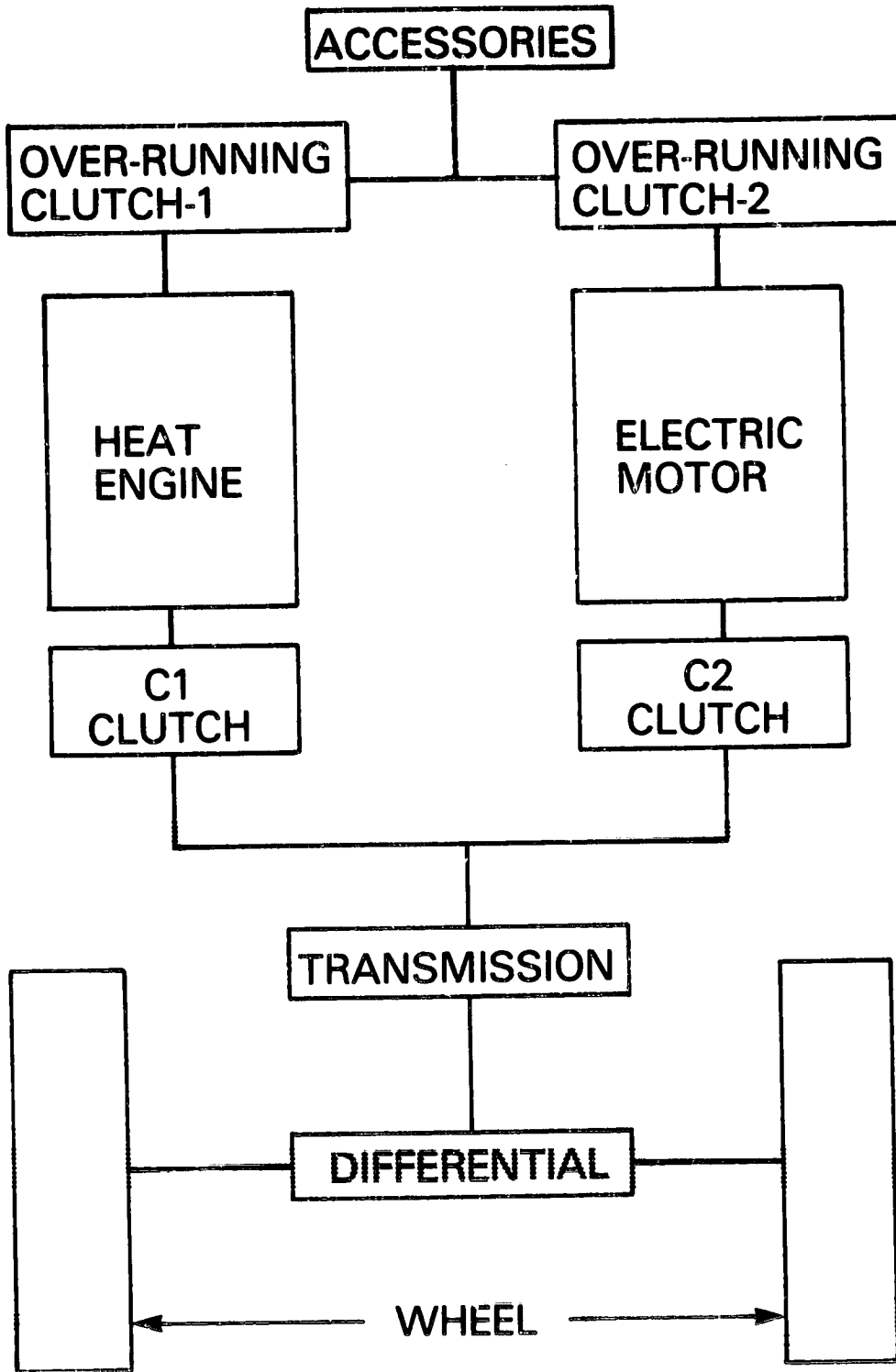

Figure 3.2.1-2. Schematic of Drive Package

3.2.1.3 Batteries

The hybrid vehicle is designed to utilize 770 lb of Improved State-of-the-Art (ISOA) lead-acid batteries. The batteries are positioned under the hood in front of the firewall as shown in Figure 3.2.1-1. The battery container has dimensions of 36 in. length, 26 in. width, and 13 in. height. The preferred battery module is 12 V, 105 AH/cell at the C/3 rate. The 770-lb battery pack stores 12.5 kWh at the C/3 rate for an energy density of 16.4 Wh/lb. The power characteristics of the battery are based on the voltage-current relationship for a 15 second pulse at 50% state-of-discharge during a C/3 rate discharge. The power characteristics specifications are the following:

<u>Pulse Current, A</u>	<u>Volts/Cell</u>	<u>Volts/Module</u>
210	1.82	10.9
315	1.71	10.3
420	1.61	9.6

For the maximum current pulse of 420 A, the corresponding power density is about 53 W/lb with a voltage droop of 20%. The lead-acid batteries used in the preliminary design of the hybrid vehicle have energy density and power characteristics comparable to those of the batteries developed by Globe-Union for the DOE/GE electric car. The cell capacity (AH) for the hybrid vehicle battery is considerably smaller, however, which means that new batteries must be designed and fabricated especially for the hybrid application.

3.2.1.4 Transmission and Axle Differential

For front-wheel drive vehicles, the transmission and axle differential are usually combined in a single unit termed the transaxle. Nevertheless, the speed change characteristics of the transmission and axle differential can be described separately. The transmission is an automatically shifted gearbox taken from an automatic transmission. In the Design Trade-off Studies, a four-speed transmission having an overall gear ratio of 3.46 was used. Such a gearbox would be part of a four-speed, overdrive automatic transmission. Unfortunately, such a transmission in a transaxle unit is not currently being marketed by a U.S. or foreign auto manufacturer or supplier. Such a unit might become available as auto manufacturers seek to improve fuel economy. The gearbox used in the preliminary design studies of the Near-Term Hybrid Vehicle is part of the three-speed automatic transmission used in the new GM X-body cars (e.g., Chevrolet Citation). That gearbox has ratios of 2.84/1.6/1 in 1st, 2nd, 3rd gear respectively. An axle ratio of 3.3 has been used in most of the HYVEC calculations. That value is compatible with maximum motor and engine speeds of 6000 rpm and yields good fuel economy in both urban and highway driving.

3.2.1.5 Torque Combination

The outputs of the heat engine and the electric motor are combined using the single-shaft approach in which there are fixed ratios between the rotational speeds of the heat engine, electric motor, and vehicle drive shaft. HYVEC simulation studies have shown that the heat engine and electric motor can be operated near optimum efficiency by varying the power split in the neighborhood of 50%. This can be done using the system microprocessor and avoids the need for a power differential which would vary the shaft speed ratios as a function of the desired power split between the heat engine and motor. The power differential is much more difficult to control than the single-shaft (fixed speed ratio) arrangement for torque combination. A preliminary drawing of the torque transfer unit, including the clutches required, is shown in Figure 3.2.1-3.

3.2.1.6 Control Strategy and the System Microprocessor

A detailed control strategy for operating the heat engine and electric motor has been developed as indicated in Figure 3.2.1-4. The key features of the control strategy are:

- On/off engine operation
- Regenerative braking whenever the battery can accept the charge
- Regenerative braking whenever the battery can accept the charge
- Electric motor idling when vehicle is at rest
- Electric drive system primary (battery state of discharge permitting) when vehicle speed is less than VMODE*
- Equal sharing of load between motor and engine when both are needed.
- Batteries recharged by heat engine in a narrow state-of-charge range ($0.7 < S < 0.8$)
- Electric motor dominant in determining shifting logic when it is operating
- Heat engine primary for highway driving
- Electric motor always used to initiate vehicle motion from rest and in low-speed maneuvers (e.g., parking)
- Vehicle operation controlled by a system microprocessor.
- Accessories driven by heat engine or electric motor, whichever is primary, and accessory load shared when both are operating.

Considerable work has been done to develop the microprocessor control logic (software) corresponding to the control strategy

*Vehicle speed at which the heat engine becomes the primary source of power

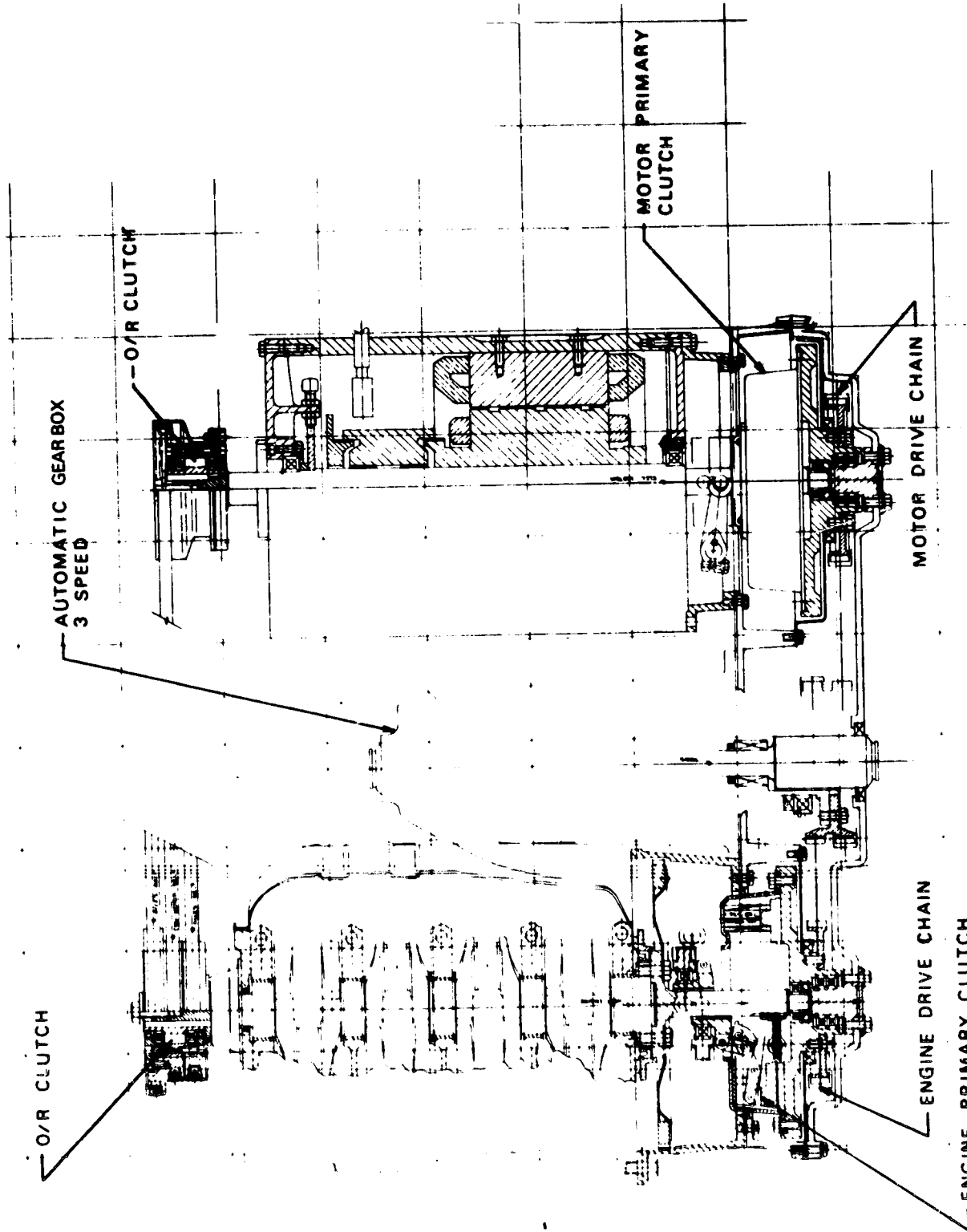
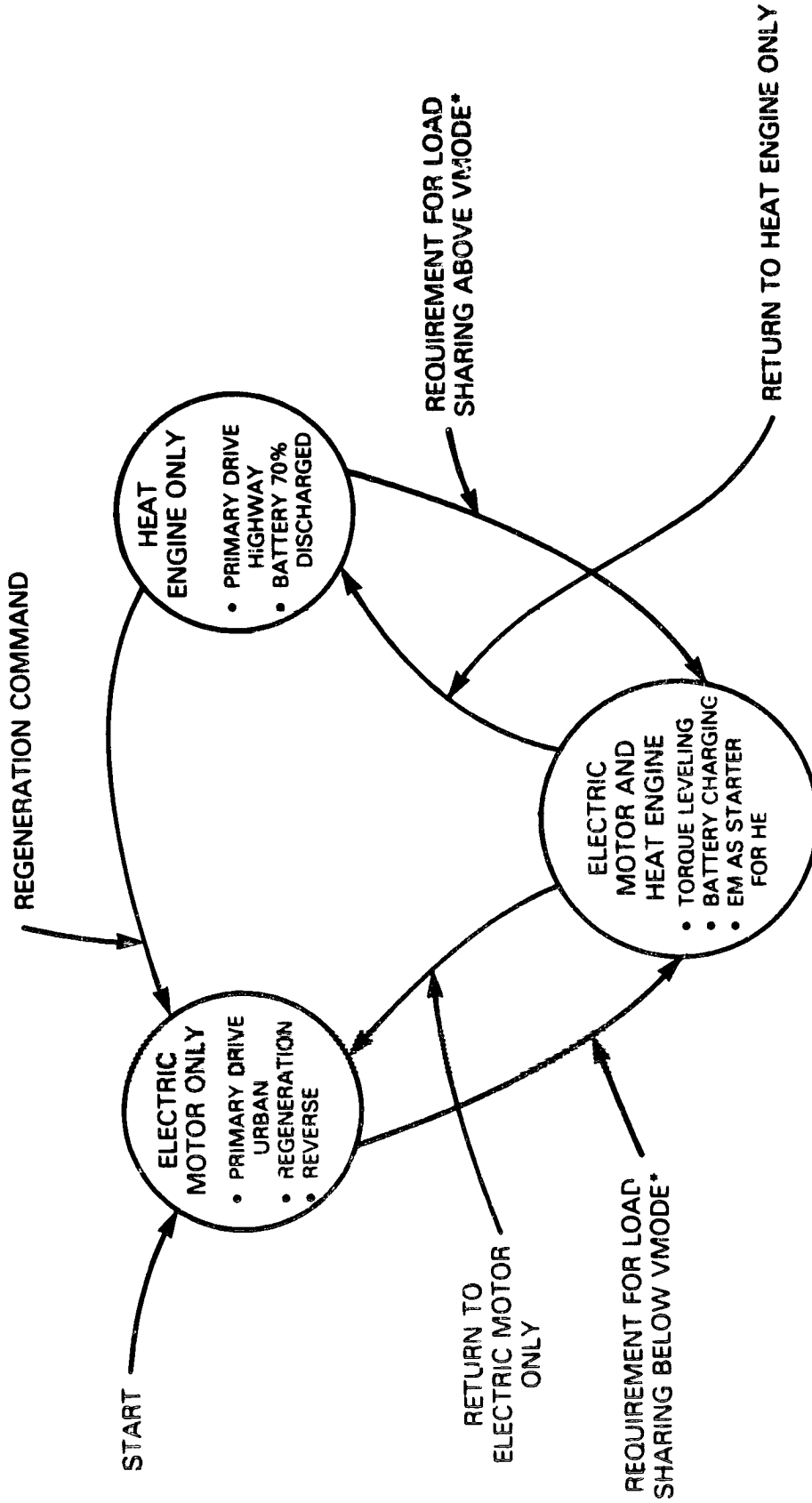

Figure 3.2.1-3. Torque Transfer Unit



* VEHICLE SPEED AT WHICH THE HEAT ENGINE BECOMES THE PRIMARY SOURCE OF POWER.

Figure 3.2.1-4. Propulsion Source Sequencing Strategy

used in the HYVEC simulations. The general approach taken is to develop a system controller which receives inputs from the microprocessors governing the heat engine and electric motor and which in turn sends control signals to those prime movers. The various microcomputer functions are shown in Figure 3.2.1.5.

3.2.2 VEHICLE WEIGHT AND WEIGHT BREAKDOWN

A weight breakdown for the Near-Term Hybrid Vehicle is given in Table 3.2.2-1. A vehicle curb weight of 3928 lb is projected leading to an inertia test weight of 4228. This is 228 lb greater than the 4000 lb used in the HYVEC calculations given in the Design Trade-Off Study Report.* The hybrid vehicle simulations have been rerun using HYVEC to include the effects of the increased vehicle weight and other changes in power train component characteristics made during the Preliminary Design Task. The HYVEC results for the Near-Term Hybrid Vehicle design are used in the discussions of vehicle characteristics presented in subsequent sections.

*The weight used in the Design Trade-Off Studies assumed optimum use of 1985 automotive technology and materials and a complete ground-up design. All the automotive components needed to do this will not be available by 1981/82 for use in the Near-Term Hybrid Vehicle. Hence its weight is greater than that of the optimum design.

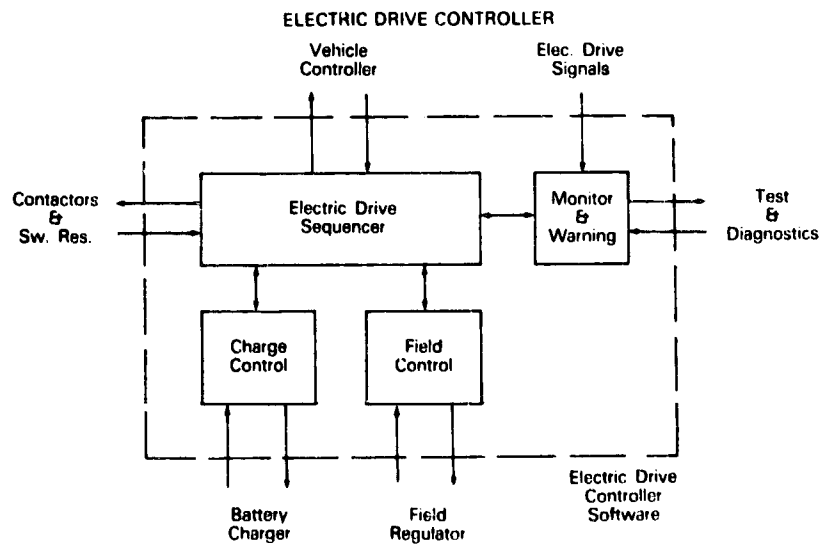
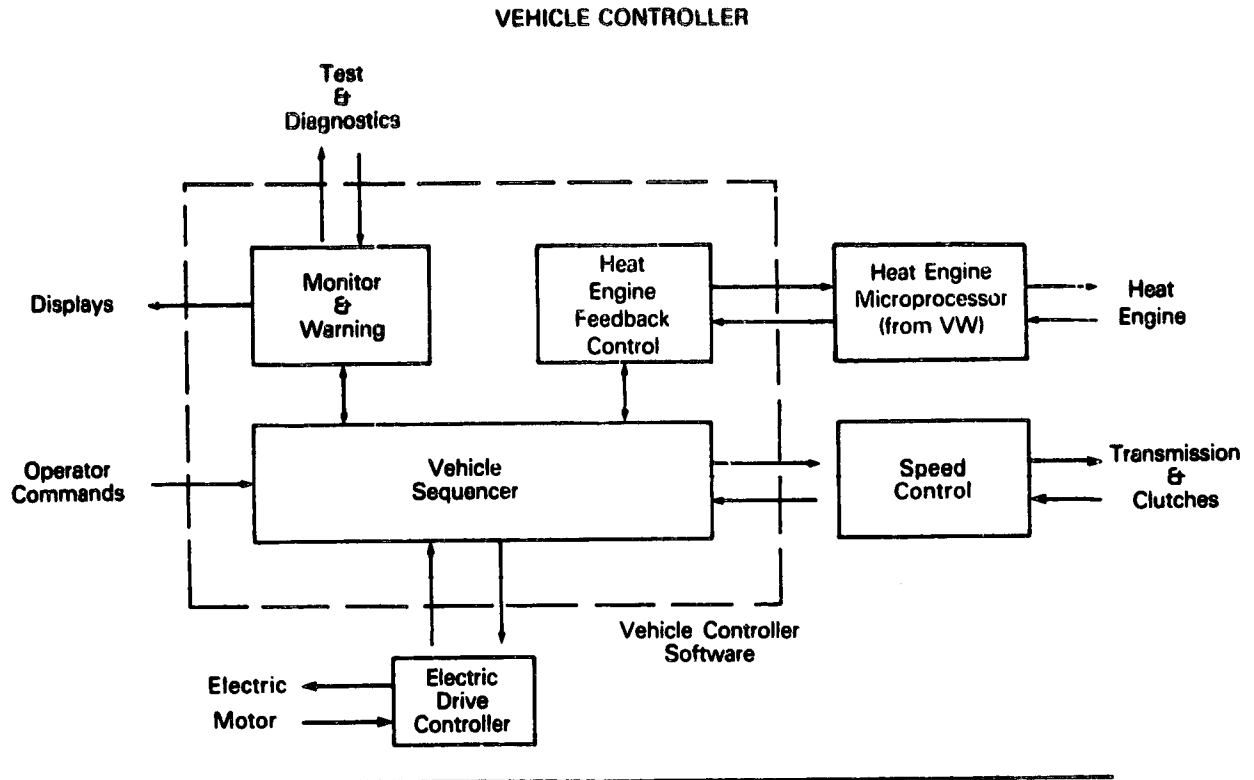

Figure 3.2.1-5. Hybrid Vehicle Microcomputer Control

Table 3.2.2-1

WEIGHT BREAKDOWN - MALIBU BASED HYBRID

<u>Chassis/Running gear</u>	<u>Weight (lb)</u>	
Structure	806	
Bumpers	164	
Suspension	230	
Wheels and tires	254	
Brakes	<u>128</u>	
	Subtotal	1582
<u>Exterior/Interior/Control</u>		
Seats	104	
Skins	153	
Human factor and control	484	
Air-conditioner	<u>113</u>	
	Subtotal	854
<u>Power train</u>		
Gasoline engine (VW 1.6l)	284	
Fuel system (incl. 10 gal. gasoline)	78	
Transaxle	90	
Electric motor	220	
Power electronics and controller	50	
Lead-acid batteries	<u>770</u>	
	Subtotal	1492
Total curb weight		3928 lb (1785 kg)

3.3 VEHICLE PERFORMANCE

A format for presenting and discussing the performance specifications of the hybrid vehicle and how well the preliminary design meets or exceeds the minimum specifications was set forth by JPL in the RFP for the contract. That format was followed in this and subsequent sections of this report, but for convenience of discussion the complete list (P1 to P17) will be divided into several parts. In this subsection, items P1 to P9 are considered. These items deal directly with vehicle performance, operation, and cost under normal (or routine) operating conditions and have been studied in considerable detail in the Phase I effort. Some of the other items which refer more to nonroutine vehicle operation, such as cold weather conditions, have not been studied in as great detail.

Vehicle performance characteristics of the preliminary design are given in Table 3.3-1 for items P1 through P9. In all respects, the Near-Term Hybrid Vehicle design meets or exceeds the minimum requirements. This includes minimum requirements R1 through R6 and constraints C1 through C6. The values given in Table 3.3-1 were taken from the updated HYVEC Calculations.

Initial estimates of battery rechargeability and maintenance (P11, P12) and cold/hot temperature operation (P10, P13) are given in Table 3.3-2. Considerable work is needed in Phase II to refine the estimates given in the table, especially in the area of battery warm-up after long soak periods at subzero temperatures.

Table 3.3-1

VEHICLE PERFORMANCE CHARACTERISTICS

P1	<u>Minimum Nonrefueled Range</u>		
P1.1	FHDC (Gasoline - 10 gal. tank)	550 km (a)	
P1.2	FUDC	120 km, (b)	400 km (a)
P1.3	J227a(B) (all-electric operation)	80 km (a)	
P2	<u>Cruise Speed</u> 130 km/h		
P3	<u>Maximum Speed</u>		
P3.1	Maximum Speed	150 km/h	
P3.2	Length of Time Maximum Speed Can Be Maintained on Level Road	1 min	
P4	<u>Accelerations</u>		
P4.1	0-50 km/h (0-30 mph)	5.0 s	(6.0) (c)
P4.2	0-90 km/h (0-56 mph)	12.6 s	(15.0) (c)
P4.3	40-90 km/h (25-56 mph)	8.6 s	(12.0) (c)
P5	<u>Gradability</u>		
	<u>Grade</u>	<u>Speed</u>	<u>Distance</u>
P5.1	3%	100 km/h (90) (c)	(Unlimited) (e)
P5.2	5%	95 km/h	(Unlimited)
P5.3	8%	80 km/h (50) (c)	(Unlimited)
P5.4	15%	40 km/h (26) (c)	(Unlimited)
P5.5	Maximum Grade, 25%		
P6	<u>Payload Capacity</u> (including passengers)		535 kg
P7	<u>Cargo Capacity</u>		0.5 m ³
P8	<u>Consumer Costs</u>		
P8.1	Consumer Purchase Price (1978 \$)		\$7600
P8.2	Consumer Life Cycle Cost (1978 \$)		0.11 \$/km
P9	<u>Emissions - Federal Test Procedure</u> ^(d) (Gasoline Engine)		
P9.1	Hydrocarbons (HC)		0.09 gm/km, 0.13 gm/km
P9.2	Carbon Monoxide (CO)		0.62 gm/km, 0.79 gm/km
P9.3	Nitrogen Oxides (NO _x)		0.48 gm/km, 0.57 gm/km

(a) Range at which the 10 gallon tank is empty.

(b) Range at which the battery is first recharged by the heat engine.

(c) JPL minimum specifications.

(d) The first number corresponds to first 50 km, second to 120 km.

(e) On heat engine alone.

Table 3.3-2

VEHICLE PERFORMANCE CHARACTERISTICS

P10 Ambient Temperature Capability

Temperature range over which minimum performance requirements can be met.

-20 °C to 40 °C

P11 Rechargeability

Maximum time to recharge from 80% depth-of-discharge (routine charge to 96% capacity)

6 hr

P12 Required Maintenance (Battery)

Routine maintenance required per month

Watering (1 or less, depending on use)

15 min/ea.

Equalization charge (2-4, depending on use)

12-15 hr/ea.

P13 Unserviced Storability

Unserviced storage over ambient temperature range of -30 °C to +50 °C

P13.1 Duration

≥ 5 days

P13.2 Warm-up time required

Battery heating (-20 °F)

10-15 min

Engine starting

<30 s

3.4 MEASURES OF ENERGY CONSUMPTION

The energy use of the Near-Term Hybrid Vehicle on the various driving cycles has been calculated using the HYVEC simulation program. The updated results are given in Figures 3.4-1 and 3.4-2.

A format for summarizing the measures of energy consumption of the hybrid vehicle was given by JPL in the RFP for the contract. Values for these energy-use measures (E1 through E8) are given in Table 3.4-1. No values are given for life cycle energy consumption per vehicle compared to the Reference ICE Vehicle, because information was not available concerning the energy required to fabricate and to dispose of the hybrid vehicle. Since the hybrid vehicle is about 1000 lb heavier than the Reference ICE Vehicle, it is reasonable to assume that the energy needed to fabricate the hybrid vehicle would be higher, but the net difference in fabrication energy will depend on the recycle pattern of those components which cause the weight difference between the vehicles. For example, much of the lead in the batteries and copper in the electric motor would be recycled with a significant favorable effect on the life cycle energy consumption of the hybrid vehicle. The material used to fabricate the exterior shell (doors, fenders, hood, etc.) of the vehicle will also have a strong influence on life cycle energy use. Life cycle energy use, including fabrication and disposal, will be considered during material selection in Phase II, but to date that subject has received only minimal attention.

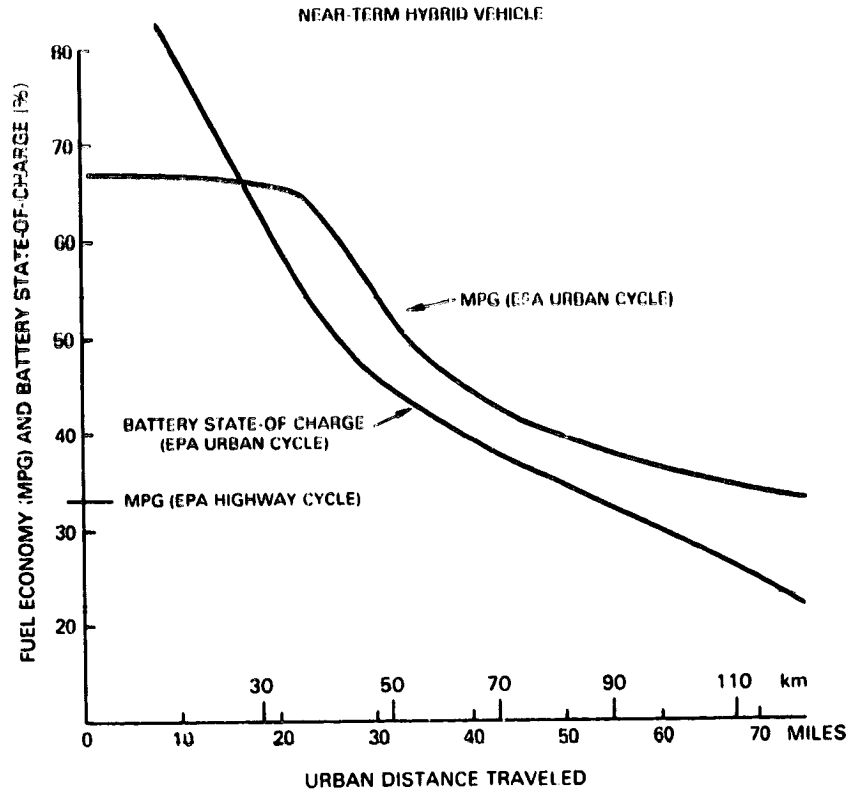

Figure 3.4-1. Battery State-of-Charge and Fuel Economy for Urban and Highway Driving

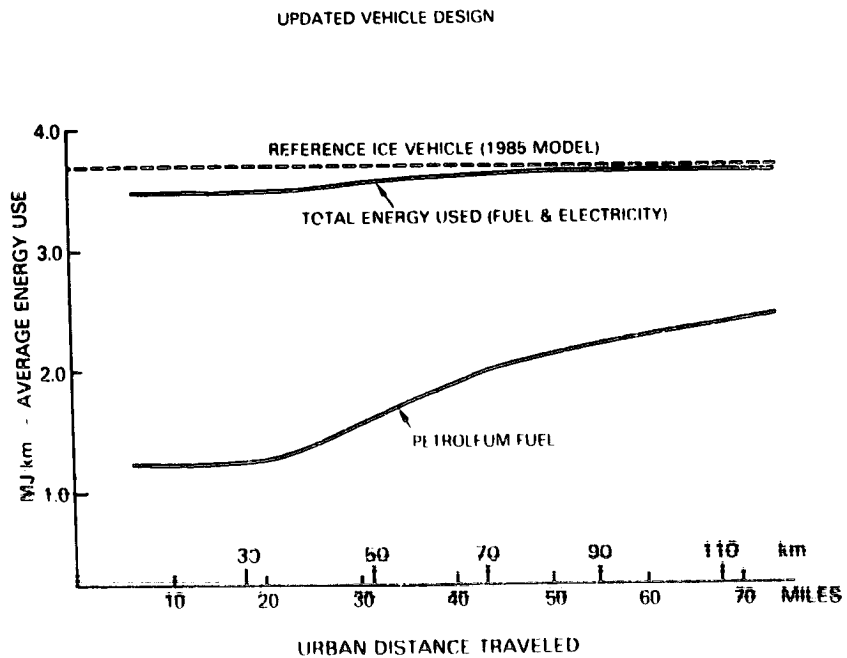

Figure 3.4.2. Total Energy and Petroleum Fuel Usage in Urban Driving

Table 3.4-1

ENERGY CONSUMPTION MEASURES
(Near-Term Hybrid Vehicle)

E1	Annual petroleum fuel energy consumption per vehicle compared to reference vehicle over contractor-developed mission ^(a)	25,710 MJ SAVED ^(b)
E2	Annual total energy consumption ^(c) per vehicle compared to reference vehicle over contractor-developed mission ^(a)	3,425 MJ SAVED ^(b)
E3	Potential annual fleet petroleum fuel energy savings compared to reference vehicle over contractor-developed mission ^(c)	25 x 10 ⁹ MJ
E4	Potential annual fleet total energy consumption ^(c) compared to reference vehicle over contractor-developed mission ^(d)	3.4 x 10 ⁹ MJ SAVED ^(b)
E5	Average energy consumption ^(c) over maximum nonrefueled range	
	E5.1 FHDC (gasoline only)	2.45 MJ/km (32 mpg)
	E5.2 FUDC ^(e)	3.59 MJ/km, 3.68 MJ/km, 3.8 MJ/km
	E5.3 J227a (B) (electricity only)	2.45 MJ/km
E6	Average petroleum fuel energy consumption over maximum nonrefueled range	
	E6.1 FHDC	2.45 MJ/km (33 mpg)
	E6.2 FUDC ^(e)	1.5 MJ/km (54 mpg), 2.45 MJ/km (33 mpg), 3.4 MJ/km (23.5 mpg)
	E6.3 J227a (B)	0 MJ
E7	Total energy consumed ^(c) versus distance traveled starting with full charge and full tank over the following cycles	
	E7.1 FHDC	2.45 MJ/km (Not a Function of Distance)
	E7.2 FUDC	(See Figure 1.4.1-4)
	E7.3 J227a (B)	2.45 MJ/km (Not a Function of Distance)
E8	Petroleum fuel energy consumed versus distance traveled starting with full charge and full tank over the following cycles ^(f)	
	E8.1 FHDC	2.45 MJ/km (Not a Function of Distance)
	E8.2 FUDC	(See Figure 1.4.1-4)
	E8.3 J227a (B)	0 MJ/km (Not a Function of Distance)

1 MJ = 0.278 kWh = 948 Btu = .00758 gal gasoline

10⁹ MJ/yr = 452 barrels crude oil/day

(a) Mission is 11,852 mi/yr; 65% EPA urban cycle, 35% EPA highway cycle

(b) The annual fuel and energy usages of the Reference ICE Vehicle (1985 model) are 456 gallons of gasoline and 60,158 MJ. A fleet of one million Reference Vehicles would use 60 x 10⁹ MJ.

(c) Includes energy needed to generate the electricity at the power plant (35% efficiency)

(d) For one million hybrid vehicles replacing one million Reference Vehicles

(e) The first number corresponds to the first 50 km; the second number to 120 km; the third number to 425 km, at which the gasoline tank is empty

(f) Does not include petroleum consumption resulting from generation of wall plug electricity used by the vehicle

3.5 INITIAL COST AND OWNERSHIP COST

The initial and ownership costs of the hybrid vehicle have been calculated using the methodology discussed in Section 6. An initial cost breakdown is shown in Table 3.5-1. The hybrid vehicle selling price is estimated to be \$7667 compared with \$5700 for the Reference ICE Vehicle.* The difference in power train costs is \$1562. Both the vehicle selling price and the power train cost difference are somewhat higher than found previously in the Design Trade-Off Study. The differences are due primarily to the more detailed information that is now available concerning the size and cost of the power train components.

The ownership cost of the Near-Term Hybrid Vehicle has been calculated from results obtained in the Design Trade-Off Study task by correcting for the change in selling price of the hybrid vehicle. This was done by calculating the fixed capital recovery factor (FCRS) and applying it to the initial price difference. The change in ownership cost was 0.63¢/mi for the nominal set of economic factors. The ownership costs for the near-term hybrid vehicle are shown in Figure 3.5-1 as a function of the price of gasoline. A breakeven price of gasoline of about \$1/gal is indicated in the figure. At gas prices in excess of \$1/gal, the hybrid vehicle has a lower ownership cost, resulting in the net annual savings shown in Figure 3.5-2. The sensitivity of the ownership costs to changes in the use pattern and the price of electricity are discussed in detail in Appendix D, Sensitivity Analysis.

*The Reference ICE Vehicle selling price (\$5700) is for a 1978 Chevrolet Malibu (V-6) with automatic transmission, air-conditioning, power steering, etc. The corresponding 1979 selling price is \$5825 (source: Automotive News, 1979 Market Data Book Issue). It was assumed that the selling price of the 1985 model Reference ICE Vehicle would be the same as that in 1978 in 1978 dollars.

Table 3.5-1
COST BREAKDOWN

<u>Chassis/Shell/Passenger Compartment</u>	OEM Price (\$)	Dealer Sticker Price (\$)
Base vehicle minus ICE power train	3482	
Additional weight	130	
Additional cost for extended life	<u>182</u>	
Subtotal	3794	4932
<u>Hybrid Power Train*</u>		
Heat engine	463	
Transmission	227	
Electric motor	365	
Controller (including microprocessor, field chopper, battery switching)	244	
Batteries (lead-acid)	688	
Battery charger (on-board)	<u>117</u>	
Subtotal	2104	2735
Total Hybrid Vehicle Price (1978 Dollars)	<u>5898</u>	<u>7667**</u>

*Cost of ICE power train (110 hp) is \$1173 (dealer sticker price).
 **Cost of Reference ICE Vehicle is \$5700 (dealer sticker price - 1978 dollars).

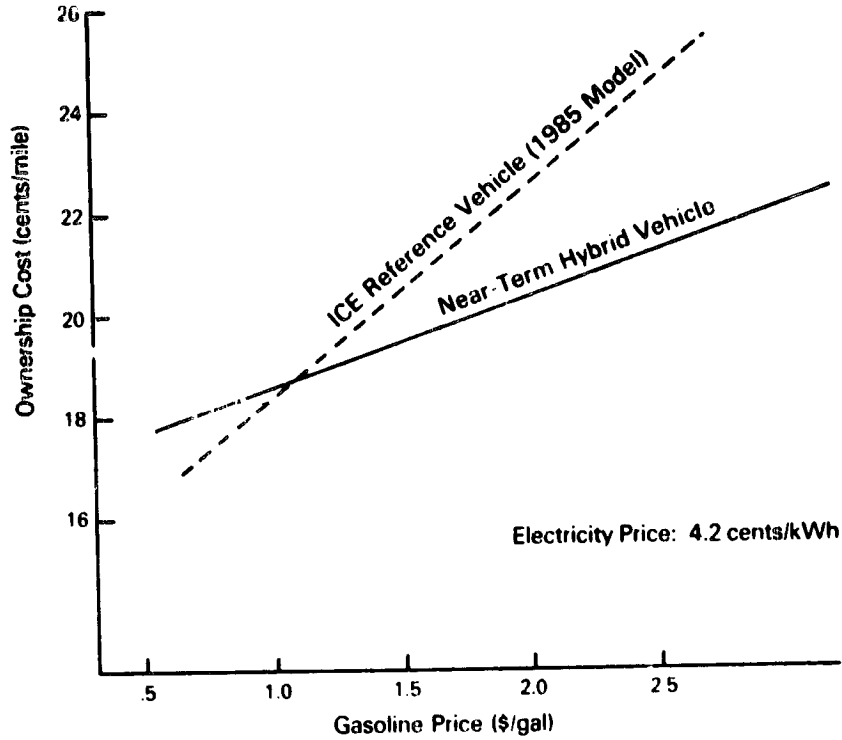

Figure 3.5-1. Ownership Cost as a Function of Gasoline Price

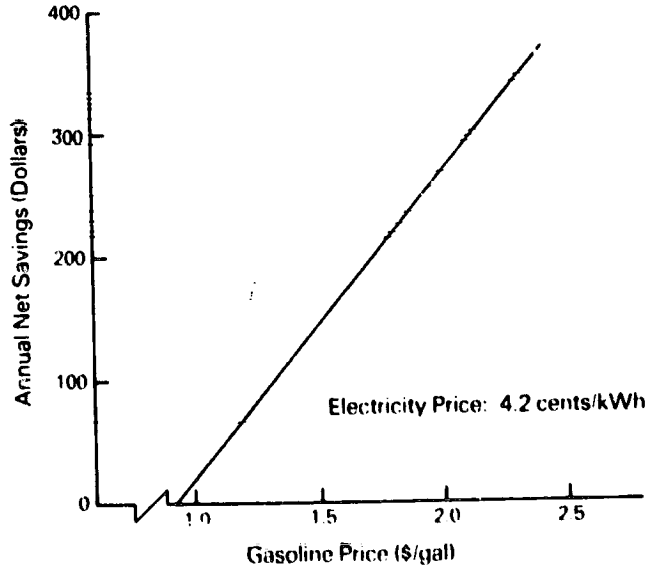

Figure 3.5-2. Annual Net Dollar Savings as a Function of Gasoline Price

Section 4

**ALTERNATIVE DESIGN OPTIONS CONSIDERED
AND THEIR RELATIONSHIP TO THE DESIGN ADOPTED**

Section 4

ALTERNATIVE DESIGN OPTIONS CONSIDERED AND THEIR RELATIONSHIP TO THE DESIGN ADOPTED

4.1 INTRODUCTION

A summary of the alternative design options considered and their relationship to the design adopted is presented in this section. Included are a listing of the factors to be considered as well as a method of ranking, a discussion of parallel vs. series arrangement, a consideration of secondary storage, power split fraction between heat engine and electric motor, battery type, engine type, electric drive options, transmission type and gear ratios, and torque combination options.

Hybrid power train trade-offs were considered in detail in Task 2 of the Phase I study and the quantitative results are discussed completely in Appendix B, Design Trade-Off Studies Report. In this section, those alternative power train options are identified and compared qualitatively with the hybrid power train designed in detail in Task 3.

The power train evaluations done in Task 2 were based on vehicle synthesis calculations and second-by-second computer simulations of hybrid vehicle operation over urban and highway driving cycles. Nearly all the alternative power train options were included in the vehicle synthesis evaluations, but only the most promising of the options were treated in the more detailed simulation studies. The options which were considered in the second step are clearly identified in subsequent discussions. All the calculations were done for five-passenger vehicles which would meet the minimum electric range and acceleration performance specifications set in Task 1 based on the characteristics and the use-pattern of the Reference ICE Vehicle (Chevrolet Malibu).

The hybrid power train option which was selected for the preliminary design task was not the one which in the calculations yielded the "best" hybrid vehicle from a purely technical point-of-view (i.e., lowest weight, maximum fuel economy, and minimum total energy-use). Other considerations, such as initial and ownership costs, maintenance and ruggedness, probability of the availability of components by 1982, likelihood of changes in emission standards, etc., were taken into account in addition to the technical attractiveness of the vehicle in selecting the power train for the Near-Term Hybrid Vehicle. All of these considerations are included in the power train comparisons given in the following sections.

In selecting the hybrid power train a number of decisions had to be made. Fortunately, for the most part the decisions were uncoupled and a decision in one area could be made with a

minimum interaction or dependency on a decision in another area. The same basic control strategy was used with all the power train options as it was essentially dictated by the prime program goal of using electricity to power the vehicle as much as possible on an annual average basis. Decisions had to be made in the following areas:

- (1) Parallel or series arrangement
- (2) Use of secondary storage - yes or no?
- (3) Fraction of peak power from the heat engine (i.e., power split fraction)
- (4) Battery type, weight, and size
- (5) Engine type
- (6) Electric drive type
- (7) Transmission type and gear ratios
- (8) Torque combination unit

Each of the decisions and the basis for them are discussed in the following sections. For each decision the factors considered are identified and each option is rated relative to the component or approach selected for the Near-Term Hybrid Vehicle.

The rating (or ranking) system used is the following:

- | | |
|----|---|
| +2 | significantly better |
| +1 | slightly better |
| 0 | reference (selected for the NTHV) |
| -1 | slightly worse |
| -2 | significantly worse |
| -x | much worse -- reason for eliminating from consideration |

Those power train options which were included in the detailed second-by-second simulation studies using HYVEC are identified with an asterisk.

4.2 PARALLEL VERSUS SERIES ARRANGEMENT

The first decision was whether the hybrid power train should utilize a parallel or series arrangement for the heat engine and electric motor. The vehicle synthesis calculations indicated that for the power-to-weight ratio required to meet the acceleration performance specifications, the weight and cost for vehicles using the series arrangement were much higher than those of a vehicle using the parallel arrangement. The differences were above 1100 lb and \$2800, respectively. If the comparisons had been made for a much lower power-to-weight ratio (e.g., 0.012 kW/lb rather than .02 kW/lb),[†] the differences would have been much smaller.

The relative ranking of the series and parallel arrangements are shown in Table 4.2-1. As indicated in the table, the series arrangement was eliminated from further consideration, and all further power train trade-offs were made using the parallel power train configuration which is much better suited for the power sharing required in the high-performance hybrid vehicle discussed in this study.

Table 4.2-1

POWER TRAIN ARRANGEMENT CONSIDERATIONS

Decision Factors	Option Selected	
	Parallel*	Series
Vehicle Weight	0	-x
Vehicle Cost	0	-x
System Control Complexity	0	+1
System Efficiency	0	-1
Energy Use	0	-x

*Included in HYVEC studies

[†]As shown in Figure 2.2.2-1, this power-to-weight ratio is needed for safe passing in two-lane highways (55 mph) and on that basis has been selected as the design value for the Near-Term Hybrid Vehicle.

4.3 SECONDARY ENERGY STORAGE

Consideration was given to the use of secondary energy storage in the hybrid power train. Vehicle synthesis calculations were made using a composite flywheel or high-power density lead-acid batteries as the secondary storage unit to reduce the power requirements on the primary battery. The calculations indicated that for the power-to-weight ratio of interest ($K_p = 0.02$ kW/lb) there was not a significant reduction in vehicle weight using secondary energy storage for the cases of lead-acid or Ni-Zn batteries. For higher performance vehicles ($K_p > 0.03$) or batteries with lower power density, such as Li-S, the reduction in vehicle weight using secondary energy storage would be significant.

Secondary storage considerations are summarized in Table 4.3-1. As indicated in the table, it was decided not to include secondary energy storage in the hybrid power train primarily because the slight improvements in vehicle weight and system efficiency were not large enough to compensate for the uncertainties regarding the availability and cost of the composite flywheel and CVT and the added complexity of packaging a flywheel along with the other components required in the hybrid power train.

Table 4.3-1

SECONDARY STORAGE (FLYWHEEL) CONSIDERATIONS

Decision Factors	Without Secondary Storage	With Secondary Storage (flywheel) (a)
Vehicle Weight	0	+1
Vehicle Cost	0	-1
System Control Complexity	0	-1
Storage Unit Availability	0	-x
Transmission Requirements (b) and Availability	0	-x
System Efficiency and Packaging Requirements	0	-2

(a) composite flywheel

(b) continuously variable transmission

*Included in HYVEC studies

4.4 POWER SPLIT FRACTION

One of the key considerations in designing a parallel hybrid vehicle is the power split between the heat engine and electric drive system. The power split can be expressed in terms of the parameter, F_{HE} , which is the fraction of the peak power which can be supplied by the heat engine alone. The fraction which can be supplied by the electric drive is simply $1 - F_{HE}$. The selection of the engine power fraction depends on both the power-to-weight ratio and battery type used in the vehicle.

Vehicle synthesis calculations showed that for lead-acid and Ni-Zn batteries, F_{HE} equal to about 0.6 results in a near-minimum vehicle weight for $K_p = 0.02$. Use of a larger engine would result in a slightly lower vehicle weight and cost, but unless the absolute power rating of the electric drive system is sufficiently large to permit vehicle operation primarily on electricity in most urban driving the gasoline saved using the hybrid vehicle will be unacceptably small. Hence the general approach in selecting F_{HE} for a specified K_p is to fix the absolute power rating of the electric drive system at that required for most urban driving (i.e., enough power so that at least 75% of the vehicle miles can be driven using the electrical drive system alone) and to determine the heat engine size required to satisfy the remaining power requirements (e.g., 0-60 mph acceleration time). Using this approach, the optimum F_{HE} for minimum vehicle weight and cost increases with K_p .

HYVEC calculations for the EPA urban and highway cycles showed that for a fixed vehicle inertia weight and electric drive system power rating, both the urban and highway fuel economy of the hybrid vehicle decreased as K_p was increased (i.e., as the required size of the heat engine increased). Hence as in a conventional ICE vehicle, the fuel economy of the hybrid vehicle decreases as the acceleration performance of the vehicle is improved. Accounting for engine efficiency and vehicle weight and cost effects, the present study indicates that the optimum engine power fraction would be slightly less than 0.6 for a hybrid vehicle having a 0-60 mph acceleration time of 14-15 seconds.

4.5 BATTERY TYPE

Selection of the battery type and size for the hybrid vehicle was based on vehicle synthesis and detailed simulation calculations. Vehicle designs were studied using the following types of batteries:

- ISOA lead-acid
- Advanced lead-acid (not shown in Table 4.5-2)
- Ni-Zn
- Ni-Fe
- Li-S†

The characteristics of the various batteries are discussed in detail in Appendix B, Volume I, Section 3.4. The results of the battery evaluation, which are summarized in Table 4.5-1, are the basis for the rankings of the battery systems given in Table 4.5-2.

The various battery systems are rated relative to the ISOA lead-acid battery in Table 4.5-2. All the advanced batteries have one or more significant advantages relative to the lead-acid battery, but unfortunately each of the advanced battery systems also has one or more serious drawbacks at least in the near term. In the case of Li-S,† technology is not sufficiently advanced to consider its use in a hybrid vehicle in the time period 1982-85. The other advanced batteries, Ni-Zn and Ni-Fe, were evaluated in detail using the HYVEC program. It was found that the performance of hybrid vehicles using Ni-Zn batteries was very attractive, but that the power characteristics of state-of-the-art Ni-Fe batteries were not good enough for use in the hybrid application. Hence it was concluded that the only two real options available for the Near-Term Hybrid Vehicle were lead-acid and Ni-Zn.

As noted in Table 4.5-2, Ni-Zn batteries have both significant advantages and disadvantages. The advantages are high energy density and good power characteristics. The disadvantages are inadequate cycle life and difficulty in determining the state-of-charge. These disadvantages have persisted for a number of years making the availability by 1982 of Ni-Zn batteries having satisfactory life and charging characteristics very uncertain. In addition, most projections of the cost of Ni-Zn batteries indicate values considerably higher than for lead-acid. For these reasons, it was decided to use the ISOA lead-acid batteries in the Near-Term Hybrid Vehicle. The vehicle design can, however, easily accommodate Ni-Zn batteries if sufficient progress is made in their development in the next few years.

Table 4.5-1
STORAGE UNIT CHARACTERISTICS USED IN THE DESIGN TRADE-OFF STUDIES

Storage Unit Battery Type	Primary Storage						Weight lb	Volume cu ft	Energy kWh	Energy Wh/lb	Energy Wh/cu ft	Power kW	Life Years	Power Wh/cu ft	Power Wh/lb
	Max. Discharge		Rate		Temp.										
	W lb	W lb	W lb	W lb	W lb	W lb									
Lead-Acid (AGU)	15	15	40	40	100	100	100	100	100	100	100	100	100	100	100
Lead-Acid (AGU)	15	15	40	40	100	100	100	100	100	100	100	100	100	100	100
Ni-Cd	15	15	40	40	100	100	100	100	100	100	100	100	100	100	100
Ni-MH	15	15	40	40	100	100	100	100	100	100	100	100	100	100	100
Li-Fe (AGU)	15	15	40	40	100	100	100	100	100	100	100	100	100	100	100
Li-Fe (AGU)	15	15	40	40	100	100	100	100	100	100	100	100	100	100	100

a. The lifetime of the storage unit is calculated from the data in table 4.5-1 and is generally as follows: $t = \frac{E}{P}$

b. $\frac{W_{dis}}{W_{total}} = \left(\frac{P}{P_0}\right)^2$

c. = energy equivalent

P_0 = all-electric vehicle power rating

P = battery power rating

$\left(\frac{W_{dis}}{W_{total}}\right)$ = value listed in table

d. 15 seconds

e. 15 seconds

Table 4.5-2

BATTERY TYPE CONSIDERATIONS

Decision Factor	Battery Type			
	ISOA lead-acid*	Ni-Zn*	Ni-Fe*	Li-S†
Energy Density	0	+2	+1	+2
Power Characteristic	0	+1	-x	0
Cycle Life	0	-2	+2	-1
Initial Cost	0	-1	-1	+1
Near-term Availability	0	-2	-1	-x
Maintenance and Charging	0	-1	-2	-1

*Included in HYVEC studies

†Lithium Aluminum Iron-Sulfide (LiAl-FeSx).

4.3 ENGINE TYPE

As indicated in Table 4.6-1, selection of the heat engine for the hybrid vehicle was dependent on a number of factors. Key considerations were engine weight and size as they affect power train packaging and the current state-of-development of the engines as it affects availability. Based on packaging and near-term availability considerations, only the reciprocating gasoline and turbocharged diesel engines could be considered for use in the Near-Term Hybrid Vehicle. A rotary gasoline engine could have been considered if a single rotor engine of about 70 hp had been available in a highly developed state rather than the two rotor engine (100 hp) used by Mazda in the RX-7. The naturally-aspirated (NA) diesel could have been used if 50 hp had been sufficient to meet the peak power requirements of the Near-Term Hybrid Vehicle designed. A 70 hp NA diesel engine would be too large to fit into the space available for the engine in the hybrid power train.

Table 4.6-1

ENGINE TYPE CONSIDERATIONS *

Decision Factors	Reciprocating Gasoline (fuel injected) (a)	Naturally Aspirating Diesel	Turbocharged Diesel (a)	Rotary Gasoline	Stirling	Gas Turbine
Weight (b)	0	-2	-1	+1	-x	+1
Size (b)	0	-x	-1	+1	-x	+1
Cost (b)	0	-2	-1	-1	-2	-2
Control (on/off mode)	0	-1	-1	-1	-1	-2
Fuel Economy (c)	0	+2	+2	0	+2	-1
Emissions (c)						
Gases	0	0	0	-1	+1	-1
Particulates	0	-2	-2	0	0	0
Transmission Requirements	0	0	0	0	0	-x
Near-Term Availability	0	0	-1	-x (d)	-x	-x

- (a) Included in HYVEC studies
- (b) Engine characteristic
- (c) Vehicle characteristic
- (d) Single rotor engines with 70-80 hp are not presently available

*The characteristics of various types of heat engines are discussed in detail in Appendix B (Vol. I), Sec. 3.2. Characterization of heat engines in a single table is not possible and the reader should consult Appendix B for the basis of the rankings given in Table 4.6-1.

Hybrid vehicle simulation calculations were made using both reciprocating gasoline and turbocharged diesel engines. The diesel engine yields higher fuel economy in urban driving for all ranges with the advantage of the diesel being 25% for ranges less than 30 mi and increasing to about 35% at 75 mi. In terms of total energy usage (fuel used by the engine plus that required to generate the electricity at the power plant), the advantage of the diesel powered hybrid is significantly reduced because the higher energy content (per gallon) of the diesel fuel is included in that calculation. The total energy advantage of the diesel is about 6% for ranges less than 30 mi and about 10% at 75 mi. The emissions calculations indicated that both the gasoline and diesel engine-powered hybrid vehicles would easily meet the 1982 emission standards of 0.4 g/mi HC and 3.4 g/mi Co for ranges up to at least 75 mi. The untreated NO_x emissions of the diesel-powered hybrid are lower than for the gasoline powered hybrid, but the use of the three-way catalyst would permit the NO_x emissions of the gasoline hybrid to be reduced to a lower level. Meeting an NO_x standard of 1.0 g/mi for ranges up to 75 mi would not present difficulty with either engine. However, meeting a standard of 0.4 g/mi NO_x would be considerably more difficult with the diesel because the three-way catalyst is not applicable.

The major emissions problem with the diesel is particulates or soot. Simulation calculations indicated soot emissions of about 0.15 g/mi for the first 30 mi and about 0.30 g/mi averaged over 75 mi. The proposed EPA particulate emission standards are 0.6 g/mi in 1981 and 0.2 g/mi in 1982. It would be necessary to reduce the particulate emissions of the turbocharged diesel to meet the 1982 standard.

It was decided to use the fuel-injected 1.6 l VW gasoline engine as the primary engine in the Near-Term Hybrid Vehicle because of the particulate emissions of the diesel and the uncertainty as to whether it could meet the emission standards to be set by EPA for 1982 and beyond. In addition, there was uncertainty regarding the cold-start capability of the diesel engine in the on/off operating mode. The fuel economy advantage of the diesel is attractive, however, and both the particulate emission and potential cold-start problems of diesel should be studied further in Phase II. Since both the gasoline and diesel engine use the same block and thus have much the same exterior profile, the turbocharged diesel could replace the gasoline engine in the hybrid power train without difficulty.

4.7 ELECTRIC DRIVE OPTIONS

The major electric drive system options considered were the dc separately excited motor with armature voltage control or battery switching and the ac induction motor with a pulsed-width modulated (PWM) inverter. In both cases, the power conditioning unit would use high-power transistors similar to those used in the armature chopper in the DOE/GE electric car. The decision factors considered and the relative ratings of the various electric drive systems are given in Table 4.7-1.

Table 4.7-1

ELECTRIC DRIVE SYSTEM CONSIDERATIONS

Decision Factors	dc-Battery Switching*	dc-Armature Control*	ac Induction Motor and PWM Inverter
Size/Weight	0	0	+1
Cost	0	-2	-2
Vehicle Control	0	+1	+1
Efficiency	0	0	+1
Ruggedness	0	-1	-1
Near-Term Availability	0	0	-2

*Included in HYVEC studies

The first decision made was to use the dc drive system rather than the ac. This decision was based on the projected higher cost of the ac system compared with the dc system using battery switching and the relative uncertainty regarding the availability by 1982 of a well-developed induction motor/PWM inverter suitable for use in the hybrid vehicle. The decision as to whether to use battery switching and a slipping clutch or an armature chopper to control the dc separately excited motor at low vehicle speeds was based almost completely on the projected higher cost of the power electronics in the armature chopper system. In addition, the ability of the battery switching circuits to withstand without failure higher currents and overloads than the transistorized armature chopper made control of the hybrid power train somewhat simpler. The decision to use battery switching rather than an armature chopper was a difficult one because it was recognized that the armature chopper afforded superior control of the vehicle at low speeds and that the cost and ruggedness characteristics of the power transistors will likely improve in the next few years as they become more highly developed. It was, however, concluded that for the near term, the battery switching approach would lead to a hybrid design which was more competitive in performance and cost with the conventional ICE vehicle.

4.8 TRANSMISSION TYPE AND GEAR RATIOS

The transmission options considered included gearboxes taken from conventional automatic and manual synchromesh transmissions and a steel-belt, traction-drive continuously variable transmission (CVT). The options are rated in Table 4.8-1 relative to the automatically shifted gearbox which was selected for use in the hybrid vehicle.

Table 4.8-1

TRANSMISSION SELECTION CONSIDERATIONS

Decision Factors	Automatic Gearbox (3 speed)*	Synchromesh Gearbox (4-speed)*	Steel-belt CVT*
Weight/size	0	0	-1
Cost	0	0	-1
Component Efficiency	0	+1	-1
Power Train Control	0	-2	+1
Vehicle Fuel Economy	0	+1	+2
Near-term Availability	0	0	-x

*Included in HYVEC studies

As indicated in the table, both the synchromesh gearbox and the CVT would yield better urban and highway fuel economy, based on hybrid vehicle simulation calculations, than the automatically shifted, three-speed gearbox. The four-speed synchromesh gearbox yielded better fuel economy by 5-10% because of its higher gear ratio range and the absence of hydraulic pumping losses. The prime disadvantage of the synchromesh gearbox is the difficulty in providing smooth, automatic shifting and power train control during the inevitable transients resulting from shifting. The automatic, hydraulically shifted gearbox has internal clutches and bands which permit power transfer during the shift and thus significantly reduce the transients resulting from the shift.

The steel-belt CVT yields better fuel economy because it permits both the electric motor and the heat engine to operate near their optimum torque and efficiency conditions for a wider range of vehicle speeds. In addition, the infinitely variable

character of the CVT significantly reduces transients during speed changes and thus simplifies the control of the power train. Discussions with the developer of the steel-belt CVT, Borg Warner, indicated that the transmission would not be available before 1985 and that considerable special development would be required for the hybrid application. Hence the CVT was not considered for inclusion in the Near-Term Hybrid Vehicle.

The automatically shifted gearbox used in the hybrid vehicle designed in Task 3 is currently marketed in the GM X-body car. It was designed as a transaxle unit for use with transverse-mounted ICE engines of 125 hp or slightly higher. The GM gearbox is a three-speed unit with an overall gear ratio of 2.85. It would be desirable to utilize a four-speed gearbox having a higher overall ratio if one with the proper shaft configuration should become available in 1980 or 1981.

4.9 TORQUE COMBINATION OPTIONS

The two options considered for combining the torque of the electric motor and heat engine are shown in Figure 4.9-1. They are (1) the single-shaft arrangement in which there is a fixed ratio between the motor and engine speeds and (2) the power differential in which the ratio between motor and engine speeds can vary with the torque split between the two prime movers. The relative complexity of the power differential arrangement, which requires the use of two over-running clutches to maintain the heat engine and electric motor in their operating speed ranges for all power train operating modes and torque split ratios, is evident from Figure 4.9-1. The operation of the power differential is discussed in some detail in Appendix B, Vol. I, Sec. 3.5.4.

It was concluded that the added complexity of the power differential and its control could not be justified in terms of possible improved power train efficiency. Hence all the detailed hybrid vehicle simulations were done using the simpler single-shaft approach.

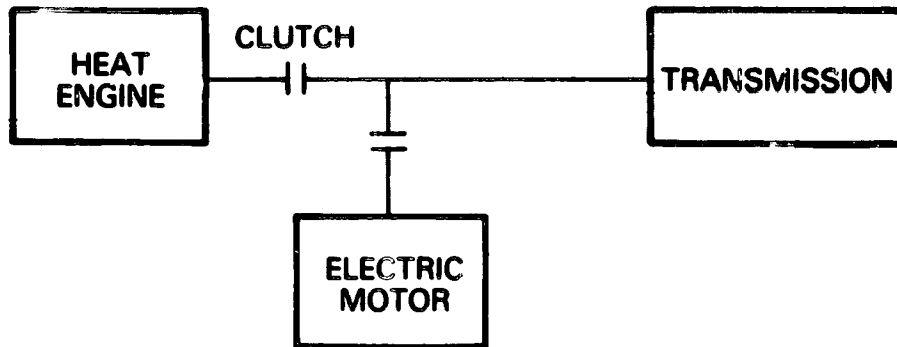
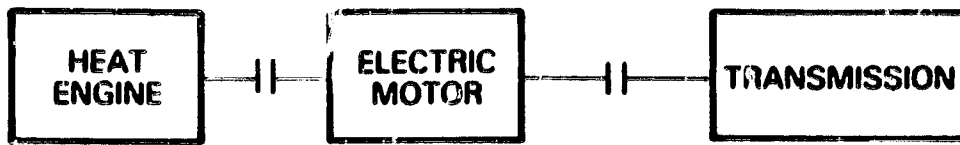

Single-Shaft Torque Combining Arrangements

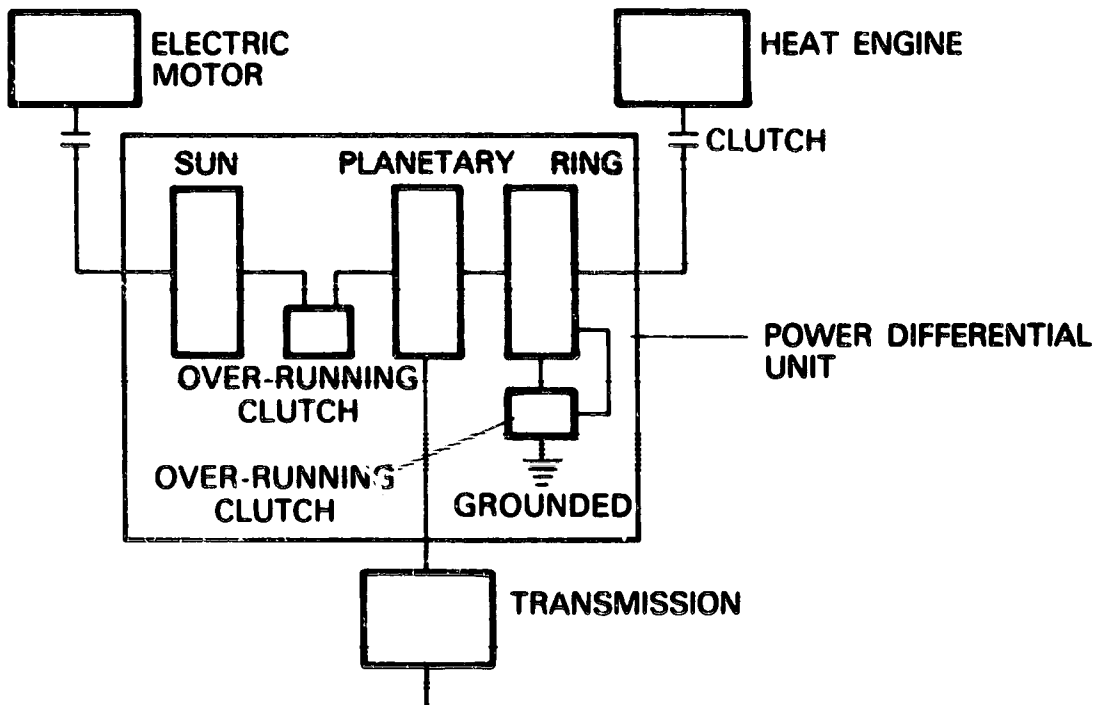

Schematic of the Power Differential Arrangement

Figure 4.9-1. Torque Combination Options

SECTION 7
DESCRIPTION OF COMPUTER SIMULATIONS

Section 5

DESCRIPTION OF COMPUTER SIMULATIONS

5.1 INTRODUCTION

Computer Simulations, their use, the task on which they were used, and the user/developer are given in this section. As shown in Table 5.1-1, extensive use was made of computer simulations in all tasks of the Phase I Study. Some of the computer programs were developed especially for the hybrid vehicle studies and others were available and in routine use as a vehicle design tool. In this report, only those programs which were developed as part of the Phase I effort are discussed in detail. Some information on the vehicle handling and crash simulation programs is given in Appendix C, Preliminary Design Data Package.

Table 5.1-1
 SUMMARY OF THE USE OF COMPUTER SIMULATIONS
 IN THE PHASE I STUDY

Program Name	Use	Task	User/Developer
Monte Carlo Trip Length Simulation	Determine daily travel statistics	Mission analysis	Prof. G.E. Smith, University of Michigan
Hybrid Vehicle Design (HYVELD)	Vehicle synthesis, economics and energy-use	Design Trade-off Studies, sensitivity analysis	GE/CRD
Hybrid Vehicle Calculations (HYVEC)	Second-by-second simulation of hybrid vehicle operation on driving cycles	Design trade-off studies, preliminary design	GE/CRD
Linear Range Handling Simulation	Transient handling simulation	Preliminary design	Triad Services
Mass-spring Collision Simulation (SMDYN)	Evaluation of crash worthiness in barrier collision	Preliminary design	Triad Services/ MGA Research

5.2 DAILY TRAVEL STATISTICS

A computer program was developed to analyze daily travel statistics, i.e., the fraction of days and the fraction of annual miles traveled on days for which the total miles traveled was less than a specified value. The calculation procedure used is shown schematically in Figure 5.2-1. The inputs to and outputs from each step of the calculation are indicated in the figure. In essence the daily travel statistics are calculated from input data concerned with annual travel statistics. The key element in the procedure is the Monte Carlo Trip Length Generator which randomly assigns trips of known length to days having a specified number of trips per day. This is done in a manner consistent with the input data on annual travel characteristics. One pass through the procedure for a given set of inputs corresponds to a single car. The procedure is repeated at least 300 times and the results combined to obtain the cumulative probability distributions shown in Figures 5.2-2 and 5.2-3. It should be noted that the procedure described in this section applies only to the random daily travel (e.g., shopping, family business, etc.) and that predictable travel, such as to-and-from work, must be accounted for separately.

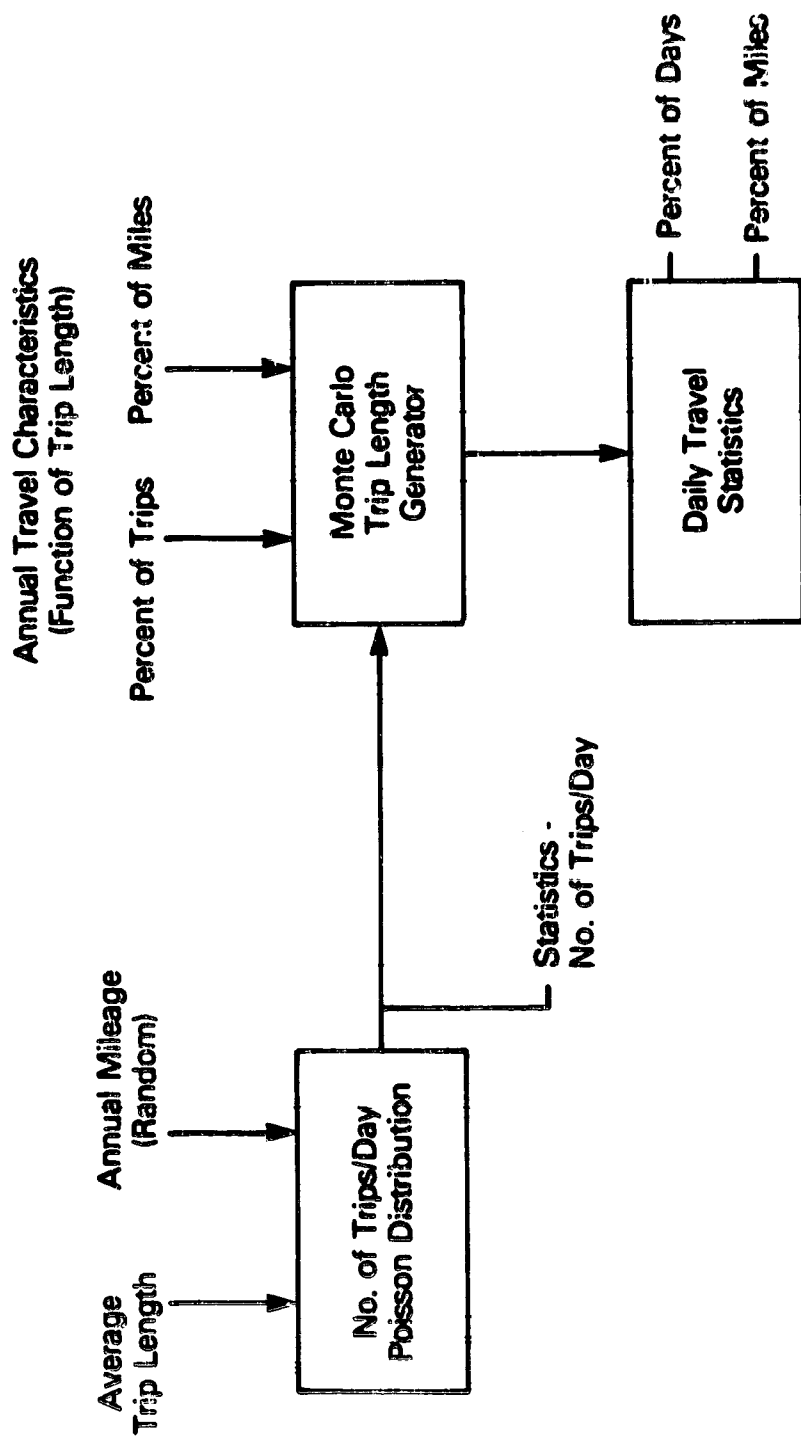

Figure 5.2-1 Calculation of Daily Travel Statistics Using the Monte Carlo Trip Length Generator Program

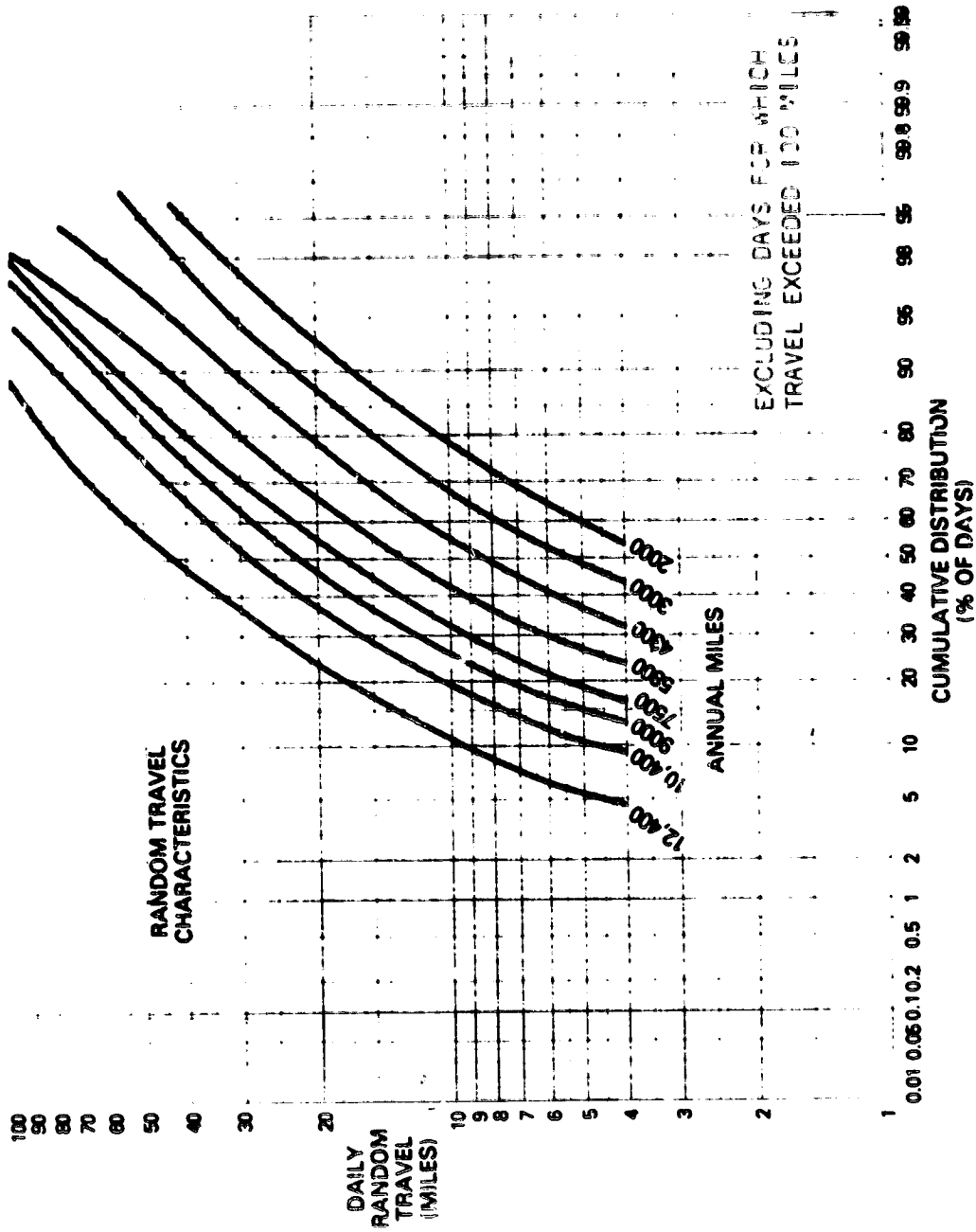

Figure 5.2-2 Daily Random Travel - Percent of Days - as a Function of Annual Miles

ORIGINAL PAGE IS
OF 5000

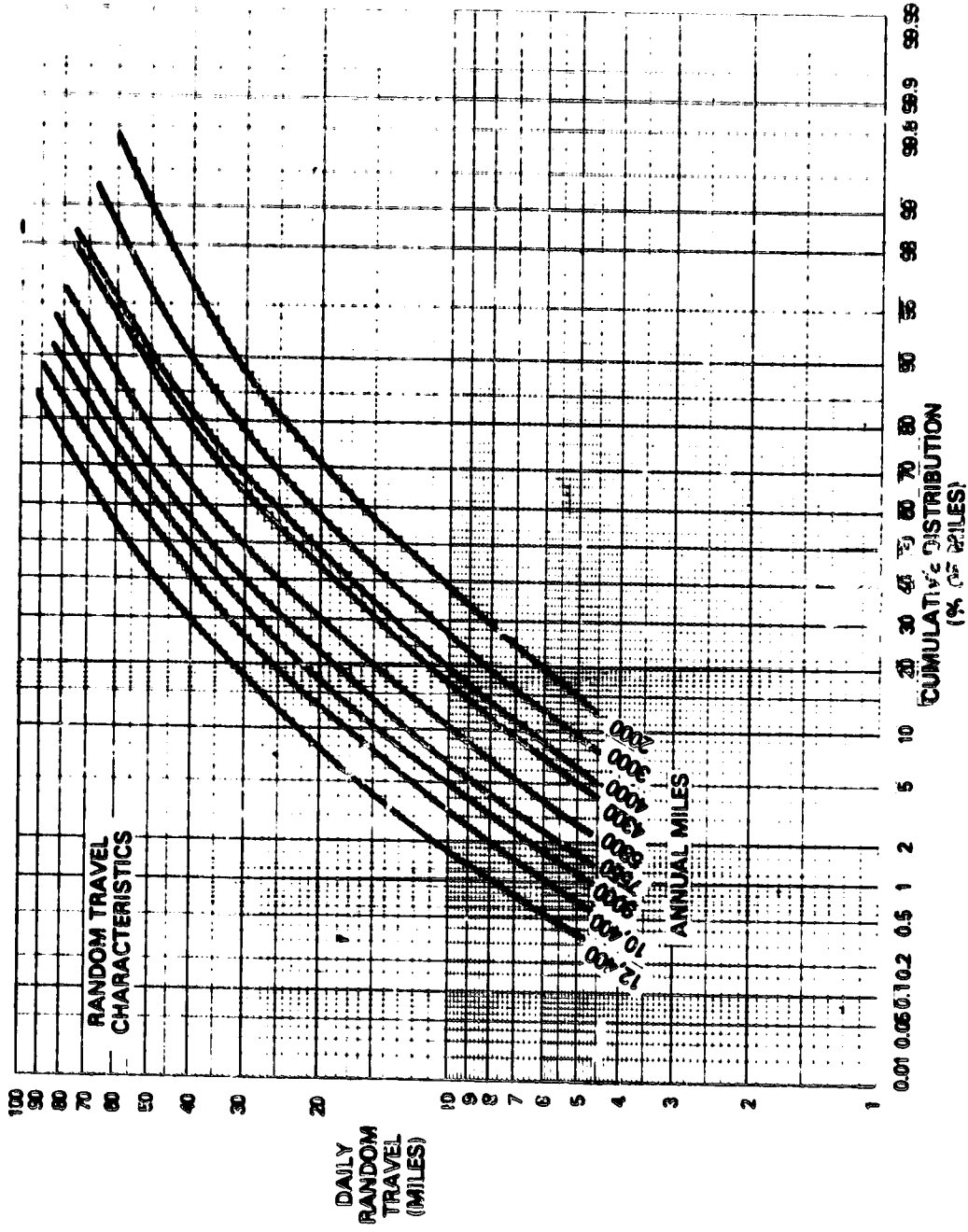

Figure 5.2-3 Daily Random Travel - Percent of Vehicle Miles - as a Function of Annual Miles

5.3 HYBRID VEHICLE DESIGN (HYVELD) CALCULATIONS

The computer program (HYVELD) was developed as part of the Design Trade-off Study. It was used extensively to perform the first step in the screening of the various power train configurations and component combinations. In addition, it was used as the primary tool in the Sensitivity Analysis Studies (Task 4). A complete listing of the program is given in Appendix B, Volume III.

As indicated in Figure 5.3-1, the HYVELD calculation procedure consists of three parts: (1) Vehicle Synthesis, (2) Economics, (3) Energy-use Comparisons. In the Vehicle Synthesis part of the program, the weight and cost of the vehicle and the size and cost of the various power train components are calculated for specified power train configurations and component characteristics. The passenger carrying capacity of the vehicle is set by inputting the appropriate baseline chassis weight, and the use-pattern is specified in terms of annual miles traveled and the fraction of those miles in urban driving. The vehicle performance is given in terms of power-to-weight ratio and electric range. Vehicle synthesis calculations are done sequentially for all-electric, series hybrids, and parallel hybrids with and without secondary energy storage. Calculations are done for a single engine type and a number of battery types (e.g., lead-acid, Ni-Zn, Ni-Fe, Li-S) in each run. The vehicle weight and cost for each power train configuration and component combination is built-up from the Reference ICE Vehicle by subtracting the weight and cost of the conventional power train and adding the weight and cost of the hybrid/electric driveline needed to meet the specified vehicle performance. The effect on the vehicle weight of the added power train weight is accounted for by using a weight propagation factor.

Economics calculations are made for each of the power train combinations treated in the Vehicle Synthesis section of HYVELD. The objectives of the economics calculations are to determine the ownership cost ($\text{\$/mi}$), breakeven gasoline price ($\text{\$/gal}$), and net dollars saved or lost ($\text{\$/yr}$) for specified unit energy costs, economic conditions (interest, inflation, and discount rates), vehicle life, and maintenance costs ($\text{\$/mi}$). The Reference ICE Vehicle is characterized in terms of its initial cost, fuel economy, life, and maintenance costs. The ownership cost ($\text{\$/mi}$) of the Reference ICE Vehicle is calculated for comparison with that of the hybrid/electric vehicles.

Energy-use calculations are also made for each of the power train combinations. Energy use (electricity and fuel) is calculated separately for urban and highway driving. The results are expressed both in terms of energy used per mile traveled and energy used per year. The fuel and energy used by the Reference ICE Vehicle is also calculated and compared with corresponding values for the hybrid/electric vehicles. Fuel and energy savings are then determined for each power train combination.

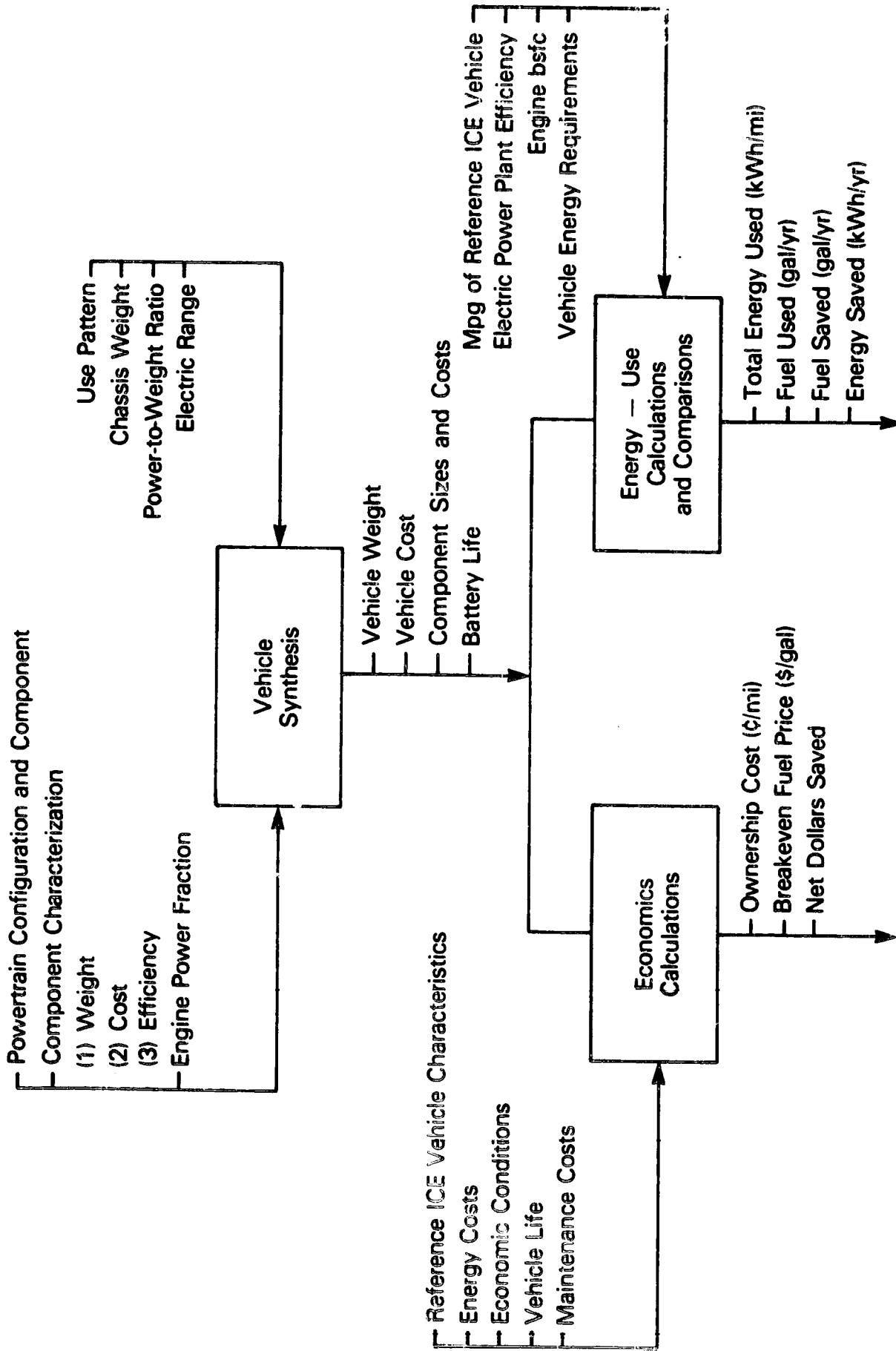

Figure 5.3-1 Schematic of the Hybrid Vehicle Design (HYVELD) Calculation Procedure.

5.4 HYBRID VEHICLE SIMULATION CALCULATION (HYVEC)

The computer program (HYVEC) was developed to simulate second-by-second operation of the hybrid vehicle over urban and highway driving cycles. The program was used extensively in the Design Trade-Off Studies to evaluate the hybrid power train configurations which were identified as the most promising in the first screening. HYVEC was also used in the Preliminary Design Task to update the hybrid vehicle energy-use and performance using refined component characteristics and vehicle weight projections. A complete listing of the program is given in Appendix B, Volume III.

A schematic of the HYVEC calculation procedure is shown in Figure 5.4-1. As indicated in the figure, the calculation for a particular driving cycle is performed starting at the wheels and working from component-to-component through the power train until the fuel and/or electricity needed to drive the vehicle for each increment of time is determined.

Detailed models based on experimental data and analysis are used for each of the power train components. For the electric drive system, motor voltage and current are determined and used as inputs to a battery model which describes the battery in terms of terminal voltage as a function of battery current and state-of-charge. Battery state-of-charge is expressed as the ratio of the AH-used to the cell AH capacity at the time-averaged discharge current. All the electrical power train components are modeled using scaling factors which permit the component sizes (ratings) to be changed without altering the basic inputs to the program. The electric motor is described in terms of the continuous rated power, base speed, and nominal rated voltage and flux. The battery is described in terms of cell AH-rating at the C/3 rate and the number of cells in each battery module (i.e., nominal battery voltage).

The mechanical driveline components, the heat engine and transmission, are modeled in a conventional manner. The heat engine is described by its maximum power and rpm. Fuel consumption and emissions characteristics are input as maps of bsfc and bSem (brake specific emissions - HC, CO, NO_x, particulates) as functions of percent speed and percent of the maximum power at that speed fraction. The multispeed gearbox transmissions are described in terms of the gear ratio and efficiency in the various gears, and the pumping losses if the gearbox is hydraulically shifted. The steel-belt CVT is described in terms of the maximum reduction speed ratio and the maximum overdrive speed ratio. Friction and pumping losses are combined into a single, speed-dependent loss term for the CVT.

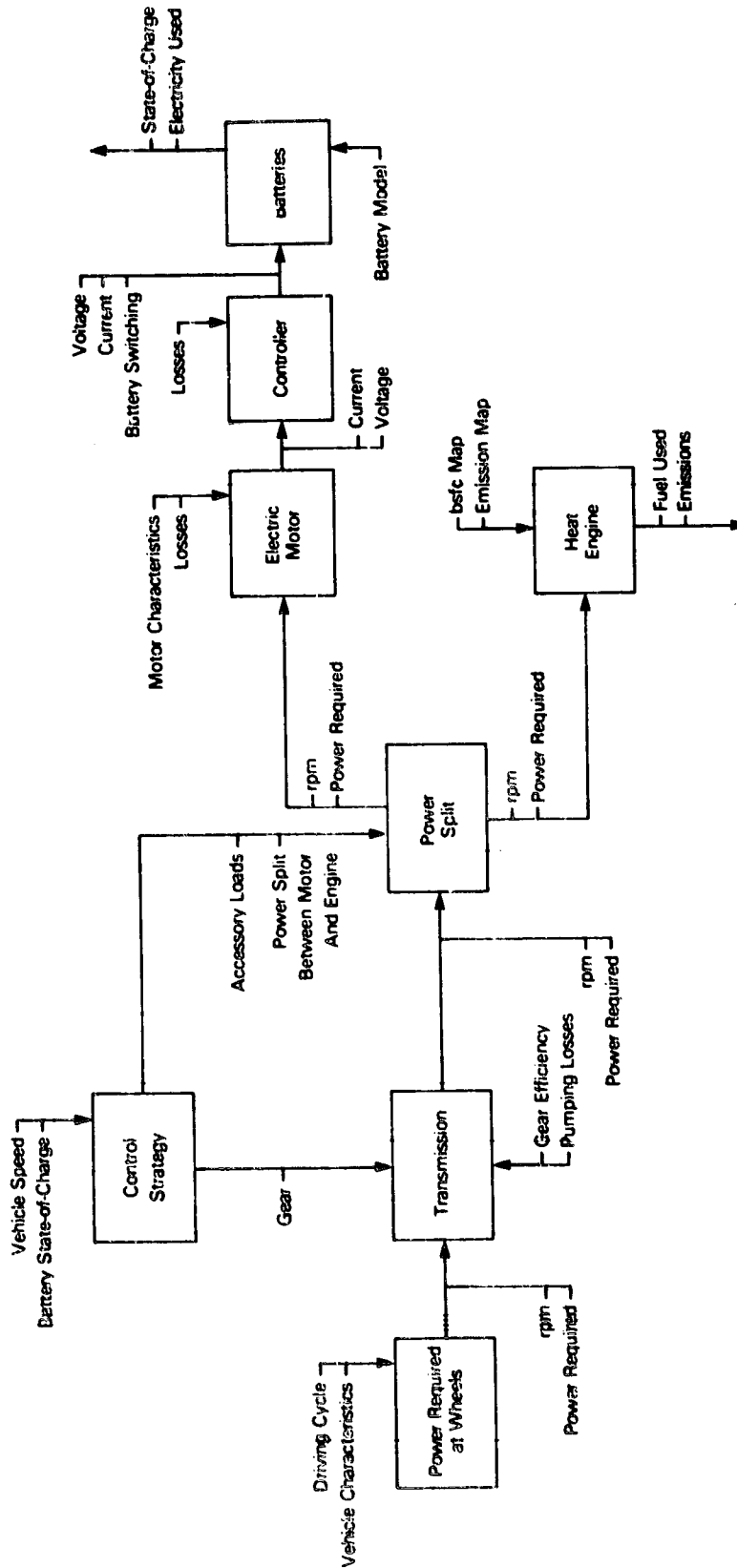

Figure 5.4-1 Schematic of the Hybrid Vehicle Simulation Calculation (HYVEC).

The control strategy for operating the hybrid power train is described in HYVEC by a series of statements which specify under what conditions the engine is on, what fraction of the power required is supplied by the electric motor, when the gear-box should be shifted or the battery charged, how the accessory loads should be met, etc. Development of the control strategy for the hybrid vehicle was a key part of the Phase I study, and the HYVEC program was an important tool in that development. The details of the control strategy evolved were discussed in Section 3.2.1.6.

The HYVEC program was also used to calculate the maximum effort acceleration performance of the hybrid vehicle. In those calculations, both the heat engine and electric motor are operated at the maximum power (or torque) attainable from them at each vehicle speed. The gear shifting strategy is such that the motor and engine are permitted to operate much nearer their maximum rpm than in usual driving. Particularly for the heat engine, this increases the power available at moderate vehicle speeds. The maximum power attainable from the electric drive system depends on the state-of-charge of the battery. As the battery charge is depleted, the voltage droop of the battery increases at high currents and the maximum power the battery can provide becomes smaller. Maximum effort acceleration calculations at specified levels of battery state-of-charge can be made with HYVEC.

Section 8

ECONOMIC ANALYSES

Section 6

ECONOMIC ANALYSES

6.1 INTRODUCTION

Initial and ownership costs of the hybrid vehicle relative to the Reference ICE Vehicle (1985 model) are important factors in determining the marketability of the hybrid vehicle. Hence considerable attention was given in the Phase I study to economic analyses and to the calculation of various component and vehicle cost factors. Almost all the economic calculations were done using the HYVELD program. In the Design Trade-Off Studies (Task 2), the initial and ownership costs were calculated for each of the power train configurations and component combinations evaluated. A major portion of the Sensitivity Analysis Study (Task 4) involved determining the effect of variations in component costs, use-pattern, economic conditions, and energy costs on the initial and ownership costs of a parallel hybrid vehicle similar to that designed in Task 3.

The results of the Task 2 and Task 4 studies, including the economic calculations, are presented in detail in Appendices B and D. Hence, in this report, the methods used in the economic analyses are emphasized and the results obtained are considered only in general terms. In particular, quantitative results for a wide range of economic parameters are given in Appendix D, Section 4.

The discussion of the economic analyses is divided into three parts: (1) Determination of component costs, (2) calculation of the initial vehicle cost, and (3) calculation of the ownership cost of the vehicle. The approaches discussed form the basis of the economic calculations done using HYVELD.

6.2 METHODS OF ANALYSIS

6.2.1 DETERMINATION OF COMPONENT COSTS

The costs of the components in the hybrid power train were calculated using specific cost values (\$/kW or \$/kWh) assigned to each component. The specific cost values were determined as part of the Design Trade-Off Study.* For the electric motor and power electronics, including the microcomputer, the specific cost values used were based on the results of a cost study done by GE as part of the GE/DOE Near-Term Electric Vehicle Program. The specific costs of the heat engine and transmission were based on published and unpublished results of the Pioneer Engineering and Manufacturing Company for conventional ICE automobiles. For the batteries, the specific cost (\$/kWh) of the various types was taken from the published cost goals for the DOE/ANL battery programs.

The cost values determined were treated in HYVELD as the OEM costs to the hybrid vehicle manufacturer in production rates comparable to those of the conventional automobile (i.e., components were mass produced by a number of suppliers for a large market).

6.2.2 CALCULATION OF THE INITIAL COST

The initial cost of the hybrid vehicle was calculated from that of the Reference ICE Vehicle (1978 model) by first subtracting the cost of the conventional driveline and then adding the cost of the hybrid power train and the additional weight needed to support it. For a particular hybrid vehicle design, the power train components were sized (i.e., kW or kWh rating of the components specified) in the Vehicle Synthesis part of the HYVELD program, and the cost of each component was found by simply multiplying the component rating (kW) times its specific cost (\$/kW). The added weight was determined by using a weight propagation factor and the associated cost was calculated on the basis of a fixed average cost per pound for standard automotive components and structure.

The initial cost calculated is the selling price to the consumer as indicated by the vehicle's sticker price. A factor of 1.3 was assumed between the OEM cost and vehicle sticker price. This factor accounts for dealer markup and other marketing expenses. The selling price of the Near-Term Hybrid Vehicle calculated using OEM component costs and a markup factor of 1.3 agrees well with that calculated starting from component manufacturing costs and a multiplication factor of 2.0 as suggested in the Electric and Hybrid Vehicle Cost Handbook prepared by JPL.

*Appendix B, Volume I, Section 3.

6.2.3 CALCULATION OF THE OWNERSHIP COST

Determination of the ownership cost (¢/mi) of the hybrid vehicle is a rather complex procedure because ownership cost is made up of a number of elements including

- Depreciation
- Battery replacement cost
- Fuel and electricity costs
- Routine maintenance and repair costs
- Miscellaneous (registration, insurance, etc.)

Some of these elements depend, in a complex manner, on general economic conditions, vehicle lifetime, and vehicle use pattern. The ownership cost of the Reference ICE Vehicle was calculated in a manner consistent with that used for the hybrid vehicle.

The method used in the HYVELD program to calculate each of the elements in the total ownership cost is discussed in the following paragraphs.

6.2.3.1 Depreciation

The annual cost of depreciation to the vehicle owner was calculated using the present worth/capital-recovery factor approach corrected for the front-end loaded depreciation typical of automobiles. It was assumed that the hybrid and conventional ICE vehicles were both bought new and sold at the end of the four-year finance period by their first owners. The difference between the original present worth and the depreciated present worth after four years was evenly distributed over the four-year period to obtain the annual cost of depreciation to the first owner. The nonlinear depreciation scheme used is often referred to as the "reverse sum of the digits" approach, which can be expressed analytically as

$$\frac{\text{Resale Value}}{\text{Original Value}} = \frac{N_F - 1}{N_V} \frac{\sum_{k=0}^{N_V - k} (N_V - k)}{\sum_{k=1}^{N_V} k}$$

where N_V is the lifetime of the vehicle and N_F is the finance period of the first owner. The nonlinear depreciation factor is then

$$NLLF = \frac{2N_V - N_F + 1}{N_V + 1}$$

The annual cost of depreciation (ACD) for the vehicle can be written as

$$ACD = (NLLF) (FF) (FRCV) (VIC)$$

where

VIC = Vehicle initial cost (less batteries)

$$FF = \text{Finance factor} = \frac{NF}{1 - (1 + IRE)^{-NF}}$$

FRCV = Fixed recovery factor

$$= \frac{DR - IF/1 + IF}{1 - \left(\frac{1 + DR}{1 + IF}\right)^{-NV}}$$

The economic condition factors used are defined as follows:

IRE = Effective interest rate = $(1 - Tx)IR$

Tx = Tax rate

IR = Interest rate

DR = Discount rate

IF = Inflation rate

The annual depreciation cost was then divided by the annual mileage to obtain the contribution of depreciation to the ownership cost. The same expressions apply to both the hybrid and conventional vehicles except that different values were used for vehicle initial cost and lifetime (i.e., VIC and N_V).

6.2.3.2 Battery Replacement Cost

The annualized replacement cost of the batteries (ACB) was calculated using the present worth/capital recovery factor approach. Hence

$$ACB = (FF) (FRCB) (BC)$$

where

BC = Battery cost (less salvage value)

FF = Finance factor

FRCB = Fixed recovery factor

$$Y_L = \frac{DR - IF}{1 + IF} \left/ 1 - \left(\frac{1 + DR}{1 + IF} \right)^{-Y_L} \right.$$

Y_L = Battery Life (years)

The battery life was determined by HYVELD from input values of battery cycle life and associated depth of discharge for that cycle life and calculated battery weight and electric energy use (kWh/mi). The annualized battery replacement cost was then divided by the annual mileage to obtain the contribution of battery replacement to the ownership cost.

6.2.3.3 Fuel and Electricity Costs

The fuel (gasoline) and electricity costs were calculated by HYVELD separately for urban and highway driving. For each type of driving, the energy required per mile at the wheels to drive the vehicle was determined based on the calculated total vehicle weight and input values of the specific energy requirement (kWh/ton-mi). The fraction of the driveshaft energy that is provided by the heat engine drive system was given by an input parameter which was determined from detailed HYVEC simulations. This fraction depends on the design electric range of the hybrid vehicle and its use pattern. The remainder of the energy required by the vehicle comes from the energy stored in the battery.

The electrical energy required (kWh) from the plug to recharge the batteries depends on the electrical energy needed to power the hybrid vehicle and the charge/discharge efficiency of the battery. The fuel used by the heat engine depends on the energy provided at the driveshaft from the engine and the average bsfc (lb/bhp/hr) of the engine over the urban and highway cycles. Average values of battery charge/discharge efficiency and engine bsfc's were used in the HYVELD calculations.

The fuel (gallons) and electricity (kWh) used in urban and highway driving were calculated as indicated for specified annual miles traveled and fraction of miles in urban driving. The annual fuel and electricity costs then follow directly from the assumed unit costs of gasoline (\$/gal) and electricity (¢/kWh). The total energy cost is the sum of the fuel and energy costs, and the contribution of energy cost to ownership cost was found by simply dividing the total energy cost by annual miles traveled.

The fuel costs (¢/mi) for the Reference ICE Vehicle were calculated from input values of miles per gallon for urban and highway driving.

6.2.3.4 Routine Maintenance and Repair Costs

All maintenance and repair costs, with the exception of battery replacement, were included in the category of routine

maintenance and repair. The maintenance costs of the hybrid vehicle (MCHV) were referenced to those of the conventional ICE vehicle (MCCV) as

$$MCHV = (1 - MIFHV)MCCV$$

where MIFHV is the maintenance improvement factor for the hybrid vehicle. The maintenance/repair cost of the conventional vehicle for the first owner (first four years of operation) was taken to be 3¢/mi in 1978 dollars. It is felt that after the hybrid vehicle is highly developed and road-tested, its maintenance costs will be less than those of the ICE vehicle because of the inherent low maintenance required of the electric drive system components and the fact that the heat engine is used for only a fraction of the vehicle miles driven each year. A nominal maintenance improvement factor of 25% was used for the hybrid vehicle.

6.2.3.5 Miscellaneous Costs

The miscellaneous cost category included the costs of vehicle registration and insurance - both fixed costs independent of miles driven. These costs were simply pro-rated over the annual miles traveled.

6.3 MAJOR FINDINGS

Extensive calculations were made in Tasks 2 and 4 dealing with the economic attractiveness of the hybrid vehicle relative to the Reference ICE Vehicle. The results of those calculations for various hybrid vehicle designs are discussed in detail in the final reports of those tasks (Appendices B and D). In this section, the major findings of the economic studies will be noted as they relate in a general way to the Phase I study.

(1) The initial cost (sticker price) of the hybrid vehicle is \$1500 to \$2000 higher than that of the Reference ICE Vehicle.

(2) The ownership cost ($\text{\$/mi}$) of the hybrid vehicle is comparable to that of the Reference ICE Vehicle for a gasoline price of $\text{\$/gal}$. At that fuel price, whether the ownership cost of the hybrid is slightly higher or lower depends on the relative vehicle lifetimes and maintenance costs.

(3) At a fuel price of $\text{\$/gal}$, the ownership cost of the hybrid vehicle is significantly lower ($3 - 4\text{\$/mi}$) than that of the Reference ICE Vehicle, even if the lifetime and maintenance cost of the two vehicles are the same. Increases in electricity cost (e.g., doubling the cost from 4.2 to $8.4\text{\$/kWh}$) have only a minor effect (about $0.5\text{\$/mi}$) on the relative ownership costs of the hybrid and ICE vehicles.

(4) The economic attractiveness, and thus the market penetration, of the hybrid vehicle is not strongly dependent on its use pattern - that is, annual mileage and fraction of miles in urban driving.

Section 7

MAINTENANCE AND RELIABILITY CONSIDERATIONS

Section 7

MAINTENANCE AND RELIABILITY CONSIDERATIONS

7.1 INTRODUCTION

A discussion of maintenance and reliability is presented in this section. The discussion considers factors relative to the hybrid vehicle, the Reference ICE Vehicle, and an all-electric vehicle. Additional information regarding maintenance and reliability of the hybrid vehicle is given in Appendix C, Section 4.8.

7.2 MAINTENANCE CONSIDERATIONS

Maintenance of the hybrid vehicle entails attention to the same items as maintenance of the Reference ICE Vehicle. In addition, the electric drive system of the hybrid vehicle must also be maintained. Considerable thought has been given to the maintenance of the electric drive system as part of the DOE/GE Near-term Electric Vehicle Program. Table 7.2-1, taken from the Operation and Maintenance Manual prepared for the DOE/GE Electric Car, lists maintenance actions and frequency for the electric drive-line. Most of those items would also be required for the hybrid vehicle. Routine maintenance and tune-ups for the heat engine should be less frequent for the hybrid vehicle, because the engine would be used only a fraction of the driving time (i.e., it would take longer in calendar time to accumulate a fixed number of equivalent miles or operating hours). The engine oil and coolant would have to be selected such that they could function longer between changes. One would expect that the brakes on the hybrid vehicle would last more vehicle miles than the brakes on the Reference ICE Vehicle because regenerative braking supplies much of the stopping torque in stop-and-go urban driving. After the electric motor and electronics are fully developed and road-tested for millions of miles, it is reasonable to expect that they will have long life and a minimum of routine maintenance. The batteries will, of course, require continuing attention if they are to have a long life, but most of that maintenance can be done by the car owner if the battery charging (including equalization charging) and watering systems are well designed.

In the calculations of ownership cost it was assumed that paid-for maintenance of the hybrid vehicle would be 25% less than for the Reference ICE Vehicle after the hybrid power train is well developed and road-tested. This assumption is primarily based on the less frequent need for engine maintenance/tune-ups and the expectancy that the electric motor/electronics are relatively maintenance free. It was also assumed that with proper design of the nonpropulsion components,* the effective lifetime (miles or years) of the hybrid vehicle could be extended beyond

*Additional chassis and running gear cost (5%) has been included for the hybrid vehicle.

Table 7.2-1

MAINTENANCE FOR DOE/GE NEAR-TERM ELECTRIC VEHICLE

Maintenance Item	Maintenance Action	Frequency
Propulsion Batteries	Perform watering procedure	Every 2 months
	Check operation of watering/vent valves	Every 2 months
	Check watering/venting tubing for evidence of cracks, pinching, looseness on fitting	Every 6 months and when battery compartment removed from vehicle
	Perform equalization procedure	Once every 7 normal charges
	Drop battery tray and clean battery tray of debris	Every 6 months
	Check specific gravities or open-circuit voltage	Every 6 months
Flame Arresters	Inspect and clean	Every 6 months
	Replace Flame Arresters	Every 2 years
Watering Tubing	Inspect and move or replace flattened section of off-board watering tubing	Every 12 months
AC Power Cord	Inspect for frayed or broken wires	Every 6 months
108 Volt DC System	Validate isolation of 108 dc system from chassis	Every 2 months
Ground-Fault Current Interrupter	Check normal trip mechanism via test button	Every 6 months
High-Amperage Heavy Cabling	Inspect cable from battery to OD switch to PCU and motor	Every 6 months
Drive Motor Brushes, Commutator Cleanliness	Inspect	Every 6 months
Drive Motor Brushes	Replace	Every 2 years

that of the Reference ICE Vehicle because of the expected longer calendar life of the heat engine and the longevity of the electric drive components. A hybrid vehicle life of 12 years or 120,000 miles was used in the cost calculations. It would, of course, be necessary to replace the battery pack several times during the hybrid vehicle lifetime, but that cost is included separate from the routine or repair maintenance costs.

7.3 RELIABILITY CONSIDERATIONS

The reliability of the hybrid vehicle should be greater than that of the Reference ICE Vehicle, because the hybrid vehicle has two, rather than one, drive systems. Both systems would have to be inoperable for the vehicle to be stranded or totally unusable. The hybrid power train is designed such that the vehicle can operate on either of the drive systems alone, but at reduced performance.

It is difficult to assess quantitatively the vehicle maintenance and reliability factors (P14 through P16). If the probability of a failure for each of the components in the power train is approximately the same, then it would be expected that system failures with the hybrid vehicle would be significantly more frequent than those with the Reference ICE Vehicle. Clearly, this cannot be permitted to be the case, or the hybrid vehicle could not be marketed in competition with the ICE vehicle. Hence a design goal for the hybrid vehicle (fully developed and tested) must be to maintain power train and vehicle failures to the same or lower frequency than that for the conventional ICE vehicle. Engine failures would be expected to be less frequent with the hybrid vehicle, because the engine is used less of the time. In addition, suitably designed electrical/electronic components have less frequent failures than mechanical components. Friction brake failures for the hybrid vehicle would be less frequent than for the conventional vehicle because the friction brakes are used less. Major repair of the electric drive system is expected to require less time than that of the engine, because the electrical components are smaller and lighter and it is feasible to replace the faulty component with a new or rebuilt one as is done with alternators, starter motors, and electronic ignition systems in conventional vehicles. In addition, it seems less difficult to engineer self-diagnostic capability into the electric drive system than into the engine system. Hence, it appears reasonable that repair of the electric drive system will take less time and exhibit less variability from case to case than repair of the conventional ICE vehicle. It is, of course, assumed that the power train is assembled such that suitable access is provided to the electric drive components and electronics. The factors P14 through P16 are estimated qualitatively in Table 7.3-1 in relation to the Reference ICE Vehicle only after the hybrid vehicle is well-developed and road-tested. Hence the maintenance/reliability factors are intended only as long-term design goals of the hybrid vehicle development program.

Table 7.3-1

VEHICLE MAINTENANCE AND RELIABILITY FACTORS*

Factor	Estimate Relative to ICE Vehicle
P14 Reliability	
P14.1 Mean usage between failures - power train	same as or less frequent failures
P14.2 Mean usage between failures - friction brakes	less frequent failures
P14.3 Mean usage between failures - vehicle	same as or less frequent failures
P15 Maintainability	
P15.1 Time to repair - mean	smaller
P15.2 Time to repair - variance	smaller
P16 Availability	
Minimum expected utilization rate defined as time in service divided by the sum of time in service and time under repair	higher

*Compared with an ICE vehicle after the hybrid vehicle is well developed and road-tested

Section 8
DESIGN FOR CRASH SAFETY

Section 8

DESIGN FOR CRASH SAFETY

8.1 INTRODUCTION

A discussion of the crashworthiness of the hybrid vehicle is given in this section. A methodology is developed which establishes a correlation between the hybrid vehicle design and the crashworthiness already established for the Reference ICE Vehicle (1979 Chevrolet Malibu).

8.2 METHODOLOGY FOR CRASHWORTHINESS EVALUATION

In order to provide a preliminary assessment of the crashworthiness of the hybrid vehicle's frontal structure and drive component placement, a computer study was conducted. Utilizing the preliminary design configuration, a series of vehicle collision simulations was made to evaluate the vehicle crash environment for a 30 mi/hr frontal barrier impact. The computer study was done using the lumped mass vehicle collision simulation program (SMDYN). A schematic of the forward structure and components used for the computer simulations is shown in Figure 8.2-1. As indicated in Figure 8.2-2 both the front and underbody structures of the hybrid vehicle will be redesigned in order to support the added weight and crash loads as compared with the stock Malibu.

The methodology used to evaluate the crashworthiness of the hybrid design was based on the fact that the hybrid's passenger compartment is identical to that of the 1978 Chevrolet Malibu and the assumption that occupant survivability in the hybrid configuration would occur if the hybrid's crash environment was found to be comparable to that of the Malibu. Compliance test crash data was obtained for a 1978 GM A-Body car. That data provided the basis of comparison for evaluating the proposed hybrid configurations. Since static crush data was not available for the Malibu structure, data from similar vehicles was used in the SMDYN model to attempt to duplicate on the computer the vehicle collision performance of the Malibu. Modifications were made to the crush data until a match was achieved between simulation results and the known Malibu deceleration pulse.

After the base vehicle (Malibu) simulation was completed, a series of calculations was made to study the following hybrid vehicle factors:

- Longitudinal and transverse heat engine package without a battery pack
- Both engine configurations with battery packs installed behind the heat engine

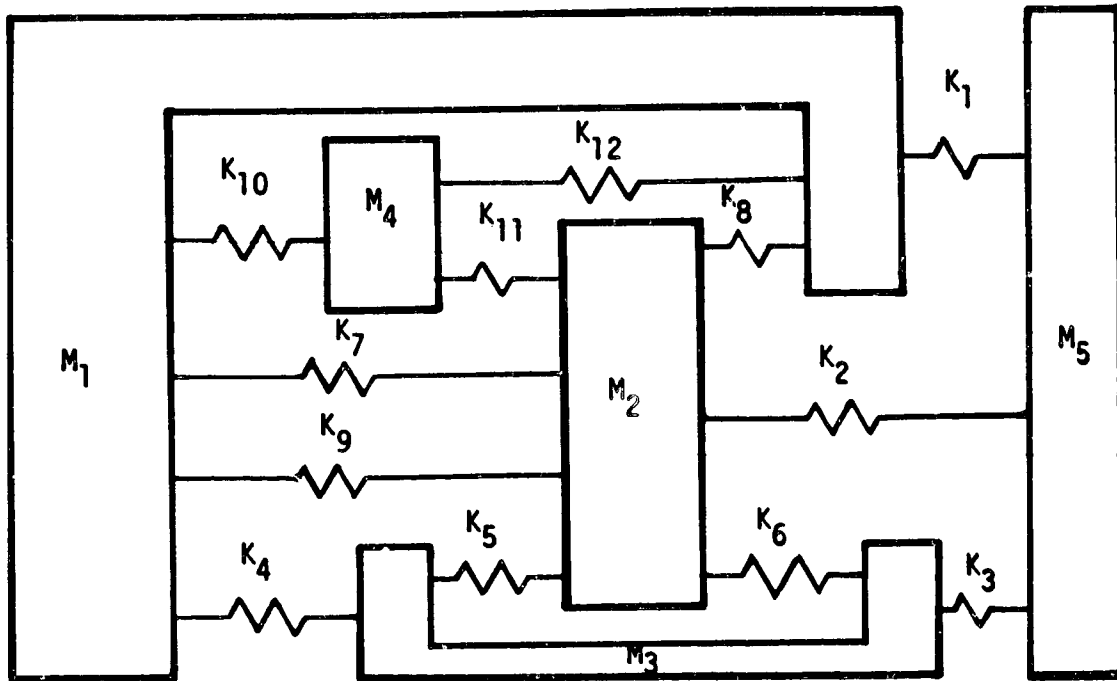

- | | |
|---|---|
| M ₁ - body | K ₅ - engine mount (rearward) |
| M ₂ - engine/drive system | K ₆ - engine mount (forward) |
| M ₃ - cross member/unsprung mass | K ₇ - transmission (rearward) |
| M ₄ - battery | K ₈ - transmission mount (forward) |
| M ₅ - barrier | K ₉ - drive system/firewall |
| K ₁ - upper sheet metal | K ₁₀ - battery/firewall |
| K ₂ - radiator/engine front | K ₁₁ - engine/battery |
| K ₃ - front frame rails | K ₁₂ - battery containment structure |
| K ₄ - rear frame rails | |

Figure 8.2-1. Schematic of the Hybrid Vehicle Forward Structure and Components for Crash Simulation

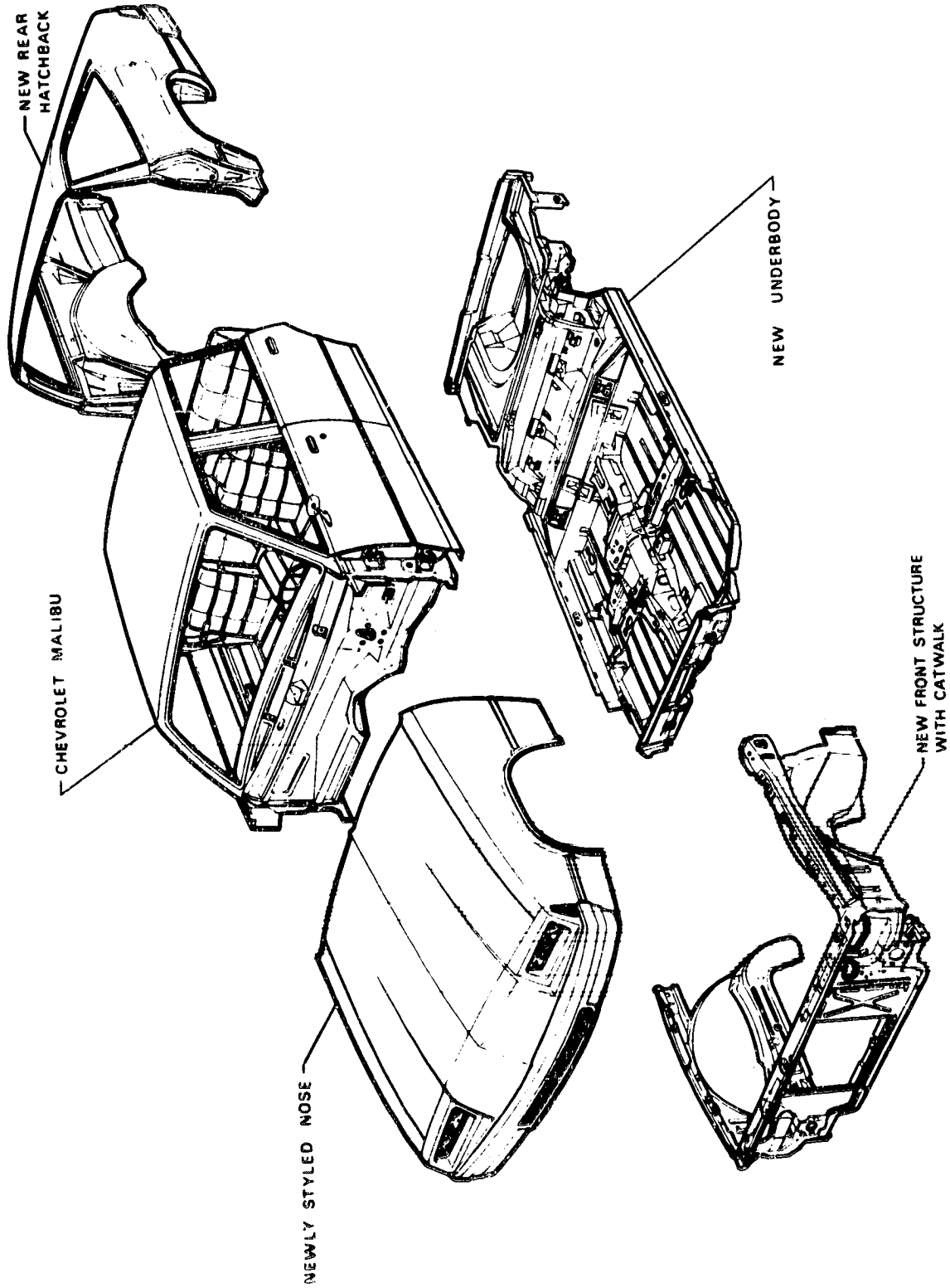

Figure 8.2-2. Hybrid Vehicle Body Structure, Exploded View

- Standard and soft battery pack crush characteristics
- Structural component changes
- Variations in vehicle height

The cases calculated and the results obtained are summarized in Table 8.2-1. The details of the crash simulation studies are given in Appendix C, Preliminary Design Data Package.

Table 8.2-1
SUMMARY OF CRASH SIMULATION RESULTS

RUN NO.	Configuration	Maximum Deceleration (G)	Maximum Crush (in.)	Drive System Intrusion (in.)	Battery Intrusion (in.)
1	Conventional Drive	32.35	28.76	4.38	-----
2	LDS Hybrid - No Batteries	24.67	25.82	16.64	-----
3	TDS Hybrid - No Batteries	23.01	28.99	10.87	-----
4	LDS Hybrid - Standard Batteries	26.72	26.90	16.9	7.45
5	TDS Hybrid - Standard Batteries	26.09	30.88	12.17	4.97
6	LDS Hybrid - Soft Batteries	24.81	27.00	17.82	3.45
7	TDS Hybrid - Soft Batteries	24.01	30.94	12.18	1.62
8	Light LDS Hybrid	30.90	23.81	14.18	4.46
9	Light TDS Hybrid	28.83	27.68	8.86	1.43
10	TDS Hybrid - Strengthened Frame	25.53	29.96	10.94	3.65
11	Light LDS Hybrid Strengthened Frame	33.97	22.82	14.21	2.02
12	Light LDS Hybrid Strengthened Frame	28.42	26.27	7.66	0.2
13	Light TDS Hybrid Strengthened Structure	26.58	24.80	6.61	0.0

8.3 CRASHWORTHINESS ANALYSIS CONCLUSIONS

The following conclusions were derived from the crash simulation study:

(1) The Transverse Drive System (TDS) package shows much greater promise of affording crash protection comparable to that of the conventional Malibu than does the Longitudinal Drive System (LDS) as shown in Figure 8.3-1 and 8.3-2. The LDS could afford similar levels of protection only if more structural crush space were available under the hood.

(2) For both drive system configurations, the maximum intrusion into the passenger compartment occurred in the tunnel area as a result of the movement of the heat engine and associated drive components. This area of the body structure should receive a high level of emphasis during Phase II.

(3) Increasing the structural resistance (but utilizing values within the state of the art of automotive technology) reduces passenger compartment intrusion without significantly affecting the peak deceleration levels of the TDS Hybrid System.

(4) Battery pack intrusion into the passenger compartment should not be a serious problem. The TDS layout can achieve a desired objective of preventing such intrusion. However, further test information is required for the interaction between the transverse heat engine and battery pack.

(5) Although occupant response was not addressed directly in the study, it seems likely that a hybrid vehicle design which paid careful attention to crashworthiness would satisfy FMVSS 208 injury criteria for fully restrained occupants. This conclusion is based on the similar passenger compartment decelerations for the Chevrolet Malibu and the TDS strengthened structure and on the occupant injury levels recorded in the GM A-Body tests.

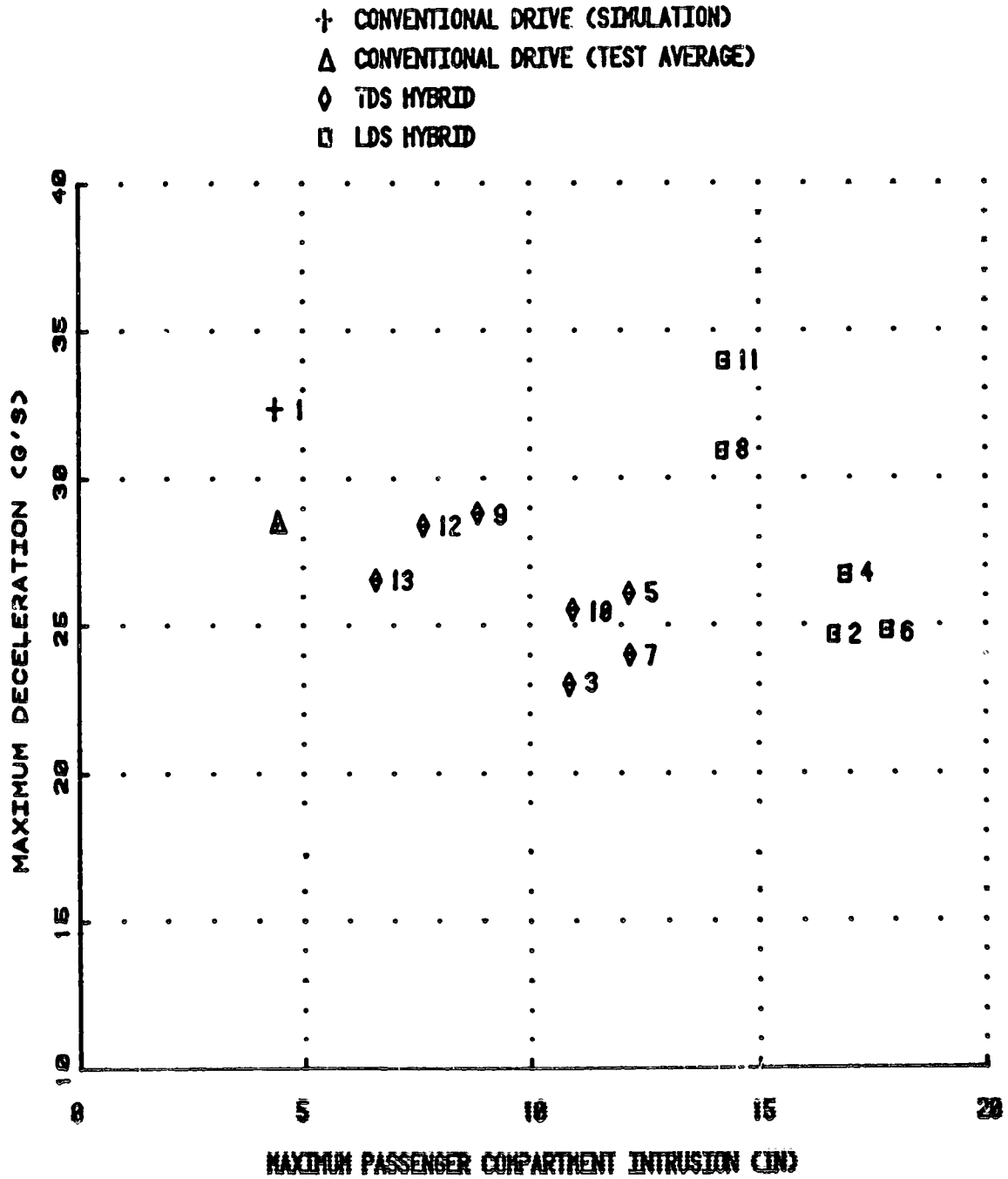

Figure 8.3-1. Maximum Deceleration as a Function of Maximum Intrusion (Refer to Table 8.2-1 for Run Identification)

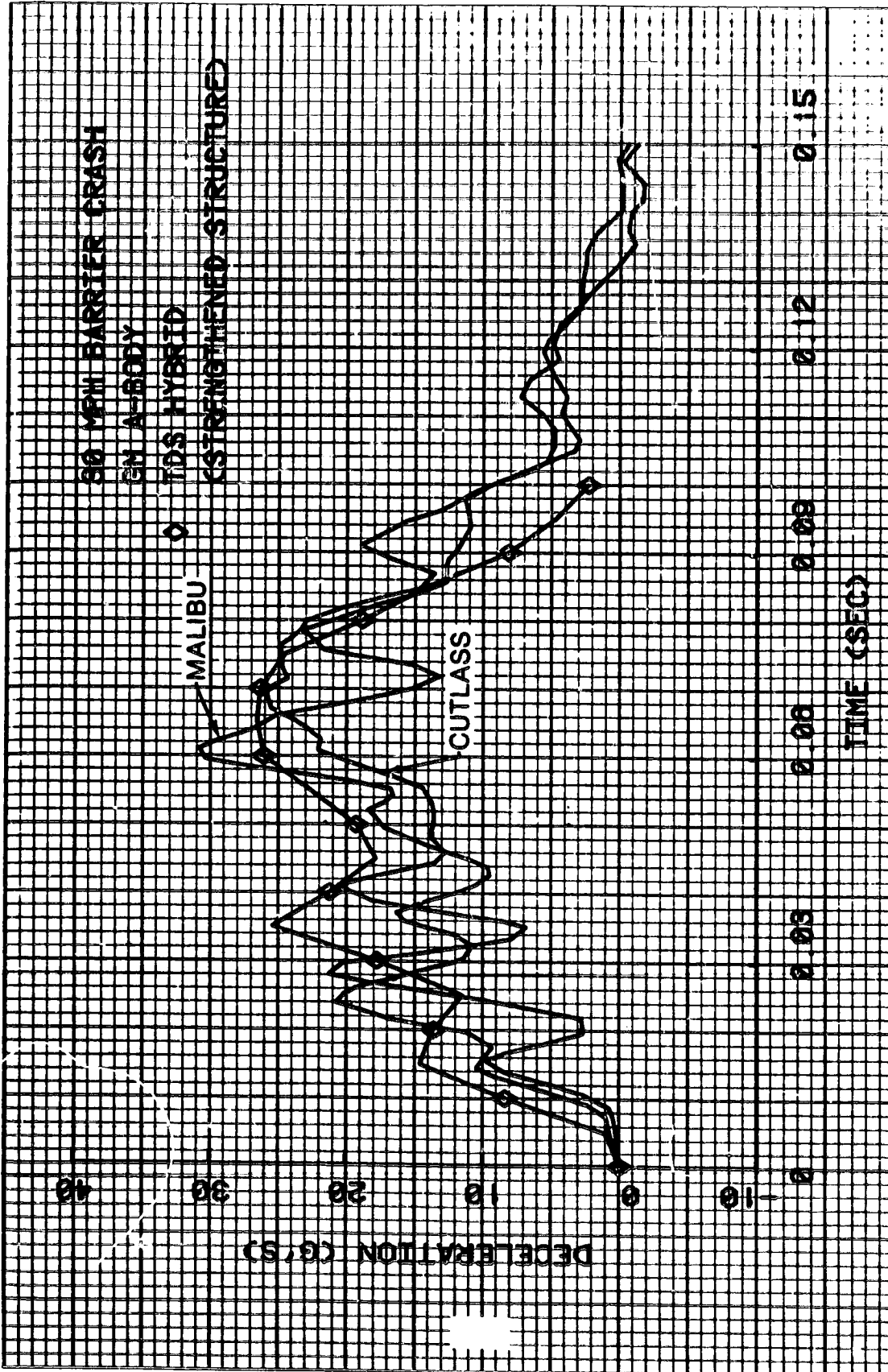

Figure 8.3-2. Comparison of the Transverse Hybrid Driveline and Stock Malibu Crash Test Performance

Section 9
BIBLIOGRAPHY

Section 9

BIBLIOGRAPHY

9.1 MISSION ANALYSIS AND USE PATTERNS

- 1) F.T. Surber and G.K. Deshpande, "Hybrid Vehicle Missions," paper presented at the 5th International Electric Vehicle Symposium, Philadelphia, PA, October 1978.
- 2) A Policy on Geometric Design of Rural Highways - 1965, American Association of State Highway Officials.
- 3) Statistical Abstract of the US, 1977, 98th Annual Edition, published by the US Department of Commerce, Bureau of Census.
- 4) Motor Vehicle Facts and Figures '77, published by the Motor Vehicle Manufacturers Association, Washington, DC.
- 5) US Department of Transportation/Federal Highway Administration, Nationwide Personal Transportation Study - Report No. 10, "Purposes of Automobile Trips and Travel," May 1974.
- 6) H.J. Schwartz, "The Computer Simulation of Automobile Use Patterns for Defining Battery Requirements for Electric Cars," Fourth International Electric Vehicle Symposium, Düsseldorf, West Germany, 1976.
- 7) US Department of Transportation/Federal Highway Administration, Nationwide Personal Transportation Study - Report No. 2, "Annual Miles of Automobile Travel," April 1972.

9.2 CHARACTERIZATION AND SALES OF CONVENTIONAL ICE PASSENGER CARS

- 1) General Motor's Response to the '81-'84 Fuel Economy Proposal and Special Order, 1977.
- 2) A.F. Burke, "The Moving Baseline of Conventional Engine-Powered Passenger Cars (1975-1985)," SAE Paper No. 780347, Detroit, MI, 1978.
- 3) B.D. McNutt, et al., "A Comparison of Fuel Economy Results from EPA Tests and Actual In-Use Experience 1974-1977 Model Year Cars," HCP/M8435-01, February 1978.
- 4) 1977 Year End Service D (New Passenger Cars), by State and and US; 1977 Year End Service K (Imported Cars), by State and US, R.L. Polk Company, Detroit, MI.
- 5) The Study of American Markets - Automotive, US News and World Report, 1977.
- 6) F.B. Rohles, Jr. and S.B. Wallis, Comfort Criteria for Air-Conditioned Automotive Vehicles, Paper No. 790122, Society of Automotive Engineers.

9.3 HEAT ENGINES AND TRANSMISSIONS

- 1) M. Dowdy et al., "Automotive Technology Status and Projection," Jet Propulsion Laboratory Publication 78-71, June 1978.
- 2) W.J. Bauer, Technical Material on the WR 34 Gas Turbine Engine, Williams Research Corporation, January 1979.
- 3) D. Yamamoto and T. Muroki, Development on Exhaust Emissions and Fuel Economy of the Rotary Engine at Toyo Kogyo, Paper No. 780417, Society of Automotive Engineers, March 1978.
- 4) T. Kohno, et al., Analysis of Light-Load Performance in Rotary Engines, Paper No. 790435, Society of Automotive Engineers, March 1979.
- 5) Development of a Motor Vehicle Materials Historical High-Volume Industrial Processing Rates Cost Data Bank (Intermediate Type Car), Pioneer Engineering and Manufacturing Company, Contract DOT-HS-5-01081, PB-263 070, May 1976.
- 6) Unpublished data on the Volkswagen 1.6-l and 1.3-l Fuel-Injected Gasoline Engines, supplied to Department of Transportation, Transportation Systems Center. Obtained from the Department of Transportation by General Electric Corporate Research and Development.
- 7) Dulieu et al., Metal-Supported Catalysts for Automotive Applications, Paper No. 770299, Society of Automotive Engineers, March 1977.
- 8) P. Oser, Catalyst Systems with an Emphasis on Three-Way Conversion and Novel Concepts, Paper No. 790306, Society of Automotive Engineers, March 1979.
- 9) B. Bates et al., Variable Displacement by Engine Valve Control, Paper No. 780145, Society of Automotive Engineers, March 1978.
- 10) R.S. Mueller and M.W. Vitvugt, Valve Selector Hardware, Paper No. 780146, Society of Automotive Engineers, March 1978.
- 11) Data Base for Light-Weight Automotive Diesel Power Plants, Contract DOT-TSC-1193, Volkswagenwerk, 21 September 1977.
- 12) Technical Instruction, Fuel Injection, Continuous Injection System (CIS); Robert Bosch GmbH, Stuttgart, Federal Republic of Germany, Publication No. VDT-VBP 741/1B, 1974.

- 13) Technical Instruction, Electroncially Controlled Fuel Injection; Robert Bosch GmbH, Publication No. VDT-VBP 751/1B, Stuttgart, Federal Republic of Germany.
- 14) Proceedings of the International Conference on Automotive Electronics, Dearborn, MI, 25 to 27 September 1978.
- 15) B.D. Lockhart, A Fuel Economy Development Vehicle with Electronic Programmed Engine Controls (EPEC), Paper No. 790231, Society of Automotive Engineers, March 1979.
- 16) Private communication received by General Electric Company, Schenectady, NY, from Borg-Warner on the Transmatic Steel-Belt Continuously Variable Transmission, March 1979.
- 17) L. Morello, Optimizing the Engine-Transmission System by Means of an Electronically Controlled Gearbox, Fourth International Symposium on Automotive Propulsion Systems, Washington, DC, April 1977.
- 18) Morse Chain, Division of Borg-Warner, Controlled Speed Accessory Drive, Semiannual Highway Vehicle Systems Contractors' Coordination Meeting, October 1977.
- 19) J. Daniels, "Automatics - The Road Ahead," Autocar, Vol. 150, No. 4305, May 1979.
- 20) J.J. Gumbleton et al., Optimizing Engine Parameters with Exhaust Gas Recirculation, SAE 740104.
- 21) "Performance Characteristics of Automotive Engines in the United States," 3rd Series, Bartlesville Energy Technology Center, Oklahoma, 1979.
 - Report No. 1 - 1977 Volvo 131-CID EFI
 - Report No. 6 - 1978 VW 90-CID Diesel
 - Report No. 7 - 1978 Ford Fiesta 98-CID
 - Report No. 10 - 1978 Honda 98-CID
 - Report No. 16 - 1975 Volvo 121-CID EFI

9.4 ELECTRIC DRIVE SYSTEMS

- 1) F.T. DeWolf, DC Motor for Electric Vehicle Program (Energy Research and Development Administration), General Electric Report DF78DCM007, October 1978.
- 2) R.D. King, Producibility Analysis of Electric Drive System for Near-Term Electric Vehicles (draft only), General Electric Company, Syracuse, NY, April 1979.
- 3) Near-Term Electric Vehicle - Phase II, Mid-Term Summary Report, General Electric Corporate Research and Development, July 1978.
- 4) B.K. Bose and H. Sutherland, A Microprocessor-Based Real Time Feedback Controller for an Electric Vehicle Drive System, Conference Record of IEEE Industrial Applications Society Annual Meeting, 1978.
- 5) Electric Car Design, Interim Summary Report, Phase I - Deliverable Item 9, Contract EY-76-03-0294, SRD-77-078, General Electric Company, May 1977.
- 6) Preliminary Power Train Design for a State-of-the Art Electric Vehicle, DOE/NASA/0592-78/1, Contract NAS 3-20592, Vol. 1 (of 2 volumes), Rohr Industries, Inc., September 1978.
- 7) Preliminary Power Train Design for a State-of-the Art Electric Vehicle, DOE/NASA/0592-78/1, Contract NAS 3-20952, Vol. 2 (of 2 volumes), Booz, Allen and Hamilton, September 1978.
- 8) E.P. Cornell, R.H. Guess, and F.G. Turnbull, "Advanced Motor Developments for Electric Vehicles," IEEE Transactions on Vehicular Technology, Vol. VT-26, No. 2, May 1977.
- 9) A.B. Plunkett and D.L. Plette, "Inverter-Induction Motor Drive for Transit Cars," IEEE Transactions on Industry Applications, Vol. IA-13, No. 1, pp. 26-37, January/February 1977.
- 10) E.L. Lustenader, G. Chang, E. Richter, F.G. Turnbull, and J.S. Hickey, "Flywheel Module for Electric Vehicle Regenerative Braking," 12th Intersociety Energy Conversion Engineering Conference, Washington, DC, August 1977.
- 11) A.B. Plunkett and F.G. Turbull, "Load Commutated Inverter/Synchronous Motor Drive without a Shaft Position Sensor," 1977 IEEE/IAS Annual Meeting Conference Record, Los Angeles, CA, IEEE Publication No. 77 CH1246-8-IA, pp. 748-757, October 1977.

- 12) A.B. Plunkett and F.G. Turbull, "System Design Method for a Load Commutated Inverter-Synchronous Motor Drive," 1978 IEEE/IAS Annual Meeting Conference Record, Toronto, Canada, IEEE Publication No. 78CH1346-6-IA, pp. 812-819, October 1978.

9.5 BATTERIES AND FLYWHEEL

- 1) J.M. Ponsford, Life Testing of Lead-Acid Batteries for Electric Vehicle Duties, Paper No. 790147, Society of Automotive Engineers, March 1979.
- 2) "Charging System," Nickel-Zinc Rechargeable Battery Product Characteristics Brochure, Energy Research Corporation.
- 3) E.J. Cairns, Zinc/Nickel Oxide Cells, General Motors Research Laboratory, Extended Abstract, Electrochemical Society Meeting, July 1978.
- 4) E.J. Cairns, Zinc/Nickel Oxide Cells: Status and Projections, General Motors Research Laboratory.
- 5) Design and Cost Study of Nickel-Zinc Batteries for Electric Vehicles, Final Report, Department of Energy Contract No. 31-109-38-3541, Energy Research Corporation, October 1976; additional data received from Miklein, April 1979.
- 6) E.A. Rowland and G.S. Hartman, Evaluation of Battery Performance for an Electric Vehicle with Regenerative Braking, Fifth International Electric Vehicle Symposium, October 1978.
- 7) E. Behrin et al., Energy Storage Systems for Automobile Propulsion: 1978 Study, UCRL-52553, Lawrence Livermore Laboratory, December 1978.
- 8) A.F. Burke, Characterization and Applications Analysis of Energy Storage Systems, Aerospace Report No. ATR-77(7538)-1, December 1977.
- 9) Presentation Aids for the 3rd EHV Program Contractors' Coordination Meeting, Arlington, VA, June 25-27, 1979.

9.6 HYBRID AND ELECTRIC VEHICLE EVALUATIONS

- 1) A.F. Burke, Hybrid Vehicle Systems Evaluations, Final Report on Task 4.5, Jet Propulsion Laboratory Report on Electric Hybrid Vehicle Project, December 1978.
- 2) D. Griffin, Volkswagen Taxi - Hybrid Test Program, JPL Report 900-851, December 1977.
- 3) "State of-the-Art Assessment of Electric and Hybrid Vehicles," NASA TM-73756, NASA Lewis Research Center, Cleveland, OH, September 1977.
- 4) N.H. Beachley and A.A. Frank, Increased Fuel Economy in Transportation Systems by Use of Energy Management - Third Year's Program, Report DOT-TST-77-21, Contract DOT-OS-30112-MOD 3, University of Wisconsin, July 1976.
- 5) L.E. Unnewehr, et al., Hybrid Vehicle for Fuel Economy, SAE 760121.

NEAR-TERM HYBRID VEHICLE PROGRAM

FINAL REPORT — PHASE I

Appendix A - Mission Analysis and Performance Specification Studies Report

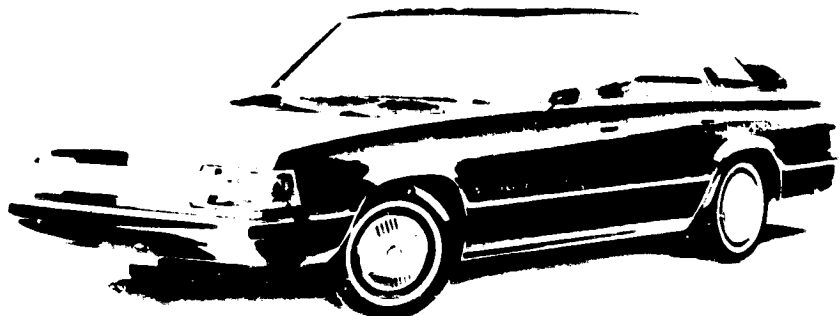

Contract No. 955190

Submitted to

Jet Propulsion Laboratory
California Institute of Technology
4800 Oak Grove Drive
Pasadena, California 91103

Submitted by

General Electric Company
Corporate Research and Development
Schenectady, New York 12301

October 8, 1979

GENERAL  ELECTRIC



FOREWORD

The Electric and Hybrid Vehicle (EHV) Program was established in DOE in response to the Electric and Hybrid Vehicle Research, Development, and Demonstration Act of 1976. Responsibility for the EHV Program resides in the Office of Electric and Hybrid Vehicle Systems of DOE. The Near-Term Hybrid Vehicle (NTHV) Program is an element of the EHV Program. DOE has assigned procurement and management responsibility for the Near-Term Hybrid Vehicle Program to the California Institute of Technology, Jet Propulsion Laboratory (JPL).

The overall objective of the DOE EHV Program is to promote the development of electric and hybrid vehicle technologies and to demonstrate the validity of these systems as transportation options which are less dependent on petroleum resources.

As part of the NTHV Program, General Electric and its subcontractors have completed studies leading to the Preliminary Design of a hybrid passenger vehicle which is projected to have the maximum potential for reducing petroleum consumption in the near term (commencing in 1985). This work has been done under JPL Contract 955190, Modification 3, Phase I of the Near-Term Hybrid Vehicle Program.

This volume is part of Deliverable Item 7, Final Report, of the Phase I studies. In accordance with Data Requirement Description 7, the following documents are submitted as appendices to the Final Report.

APPENDIX A is the Mission Analysis and Performance Specification Studies Report that constitutes Deliverable Item 1 and reports on the work of Task 1.

APPENDIX B is a three-volume set that constitutes Deliverable Item 2 and reports on the work of Task 2. The three volumes are:

- Volume I -- Design Trade-Off Studies Report
- Volume II -- Supplement to Design Trade-Off Studies Report, Volume I
- Volume III -- Computer Program Listings

APPENDIX C is the Preliminary Design Data Package that constitutes Deliverable Item 3 and reports on the work of Task 3.

APPENDIX D is the Sensitivity Analysis Report that constitutes Deliverable Item 8 and reports on Task 4.

The three classifications - Appendix, Deliverable Item, and Task number - may be used interchangeably in these documents. The interrelationship is tabulated below:

APPENDIX A

<u>Appendix</u>	<u>Deliverable Item</u>	<u>Task</u>	<u>Title</u>
A	1	1	Mission Analysis and Performance Specification Studies Report
B	2	2	Vol. I - Design Trade-Off Studies Report Vol. II - Supplement to Design Trade-Off Studies Report Vol. III - Computer Program Listings
C	3	3	Preliminary Design Data Package
D	8	4	Sensitivity Analysis Report

This is Appendix A, Mission Analysis and Performance Specification Studies Report, which reports on Task 1 and is Deliverable Item 1. It presents the study methodology, vehicle characterizations, mission description, characterization, and impact on potential sales, rationale for selection of the ICE Reference Vehicle, primary results of the study, and conclusions and recommendations.

TABLE OF CONTENTS

<u>Section</u>		<u>Page</u>
1	INTRODUCTION AND SUMMARY.	1-1
	1.1 Introduction	1-1
	1.2 Objectives of Mission Analysis and Performance Specification Studies (Task 1)	1-1
	1.3 Summary.	1-3
	1.3.1 Vehicle Characterizations	1-3
	1.3.2 Summary of Mission Description and Characterization.	1-3
	1.3.3 Summary of Rationale for the Selection of the ICE Reference Vehicle.	1-4
	1.3.4 Summary of the Primary Results.	1-7
2	STUDY METHODOLOGY	2-1
	2.1 Methodology for Vehicle Characterizations.	2-1
	2.2 Methodology for Mission Description and Characterization	2-4
	2.3 Methodology Used in the Selection of the ICE Reference Vehicle	2-5
	2.4 Presentation of Results.	2-5
3	VEHICLE CHARACTERIZATIONS	3-1
	3.1 Passenger Car Size Classes	3-1
	3.2 Performance Specifications	3-2
	3.3 Characterization of Conventional ICE Passenger Cars by Size Class	3-9
4	MISSION DESCRIPTION, CHARACTERIZATION, AND IMPACT ON POTENTIAL SALES	4-1
	4.1 Regional/Local Use Considerations.	4-1
	4.2 Mission Set Description.	4-10
	4.3 Travel Characteristics	4-14
	4.3.1 Annual Use.	4-14
	4.3.2 Daily Travel Patterns	4-19
	4.3.3 Driving Cycles.	4-42
5	RATIONALE FOR THE SELECTION OF THE ICE REFERENCE VEHICLE	5-1
	5.1 Hybrid Vehicle Size Class.	5-1
	5.2 Criteria for Selection of ICE Reference Vehicle.	5-1
	5.3 Selected ICE Reference Vehicle	5-4
6	PRIMARY RESULTS OF MISSION ANALYSIS AND PERFORMANCE SPECIFICATIONS STUDY.	6-1
	6.1 Vehicle Performance Specifications	6-2
	6.2 Mission Description and Daily Travel	6-4
	6.3 Mission Specifications	6-7
	6.4 ICE Reference Vehicle and Its Characteristics.	6-10

TABLE OF CONTENTS (Cont'd)

<u>Section</u>	<u>Page</u>
7	CONCLUSIONS AND RECOMMENDATIONS 7-1
	7.1 Conclusions. 7-1
	7.1.1 General Conclusions 7-1
	7.1.2 Specific Conclusions. 7-1
	7.2 Recommendations for Continuing Mission Analysis Activities. 7-3
8	REFERENCES. 8-1
	APPENDIX. A-1

LIST OF ILLUSTRATIONS

<u>Figure</u>		
1-1	Effect of Electric Vehicle Range on All-Electric Vehicle Travel Inside SMSA as a Percentage of Number of Days in a Year.	1-5
1-2	Effect of Electric Vehicle Range on All-Electric Vehicle Travel Inside SMSA as a Percentage of Annual Miles.	1-5
2-1	Work Flow Diagram for Task 1.	2-2
3-1	GM 1977 Sales Relation to Acceleration Characteristics	3-3
3-2	Power-to-Weight Ratio Requirements.	3-7
3-3	Acceleration Profiles	3-11
3-4	Baseline Fuel Economy - 1978 Technology, Urban Cycle	3-13
3-5	Baseline Fuel Economy - 1978 Technology, Highway Cycle	3-13
3-6	Projected 1985 Urban Fuel Economy	3-14
3-7	Projected 1985 Highway Fuel Economy	3-15
3-8	Projected 1985 Composite Fuel Economy	3-15
3-9	Composite Fuel Economy Comparisons.	3-16
4-1	Annual Random Travel Mileage Characteristics.	4-17
4-2	Daily Random Travel - Percent of Vehicle Miles.	4-27
4-3	Daily Random Travel - Percent of Days	4-28
4-4	Daily Random Travel - for All Travel - Percent of Vehicle Miles.	4-29

LIST OF ILLUSTRATIONS (Cont'd)

<u>Figure</u>		<u>Page</u>
4-5	Daily Random Travel - for All Travel - Percent of Days - as a Function of Annual Miles	4-30
4-6	Travel to Place of Work	4-31
4-7	Effect of Electric Vehicle Range on All-Electric Vehicle Travel Inside SMSA - Percent of Days.	4-32
4-8	Effect of Electric Vehicle Range on All-Electric Vehicle Travel Inside SMSA - Percent of Vehicle Miles	4-32
4-9	Effect of Electric Vehicle Range on All-Electric Vehicle Travel Outside SMSA - Percent of Days	4-33
4-10	Effect of Electric Vehicle Range on All-Electric Vehicle Travel Outside SMSA - Percent of Vehicle Miles	4-33
4-11	Effect of Vehicle Range on Vehicle Use - % of Vehicle Miles, Inside SMSA, Personal Plus Work Travel.	4-34
4-12	Effect of Vehicle Range on Vehicle Use - % of Days, Inside SMSA, Personal Plus Work Travel.	4-34
4-13	Effect of Vehicle Range on Vehicle Use - % of Vehicle Miles, Outside SMSA, Personal Plus Work Travel.	4-35
4-14	Effect of Vehicle Range on Vehicle Use - % of Days, Outside SMSA, Personal Plus Work Travel	4-35
4-15	Effect of Vehicle Range on Vehicle Use - % of Vehicle Miles, Inside SMSA, Personal Travel Only.	4-36
4-16	Effect of Vehicle Range on Vehicle Use - % of Days, Inside SMSA, Personal Travel Only	4-36
4-17	Effect of Vehicle Range on Vehicle Use - % of Vehicle Miles, Outside SMSA, Personal Travel Only	4-37
4-18	Effect of Vehicle Range on Vehicle Use - % of Days, Outside SMSA, Personal Travel Only.	4-37
4-19	Effect of Vehicle Range on Vehicle Use - % of Vehicle Miles, Inside SMSA, All-Purpose Local/Suburban Travel, Including Work Travel.	4-38
4-20	Effect of Vehicle Range on Vehicle Use - % of Days, Inside SMSA, All-Purpose Local/Suburban Travel, Including Work Travel	4-38
4-21	Effect of Vehicle Range on Vehicle Use - % of Vehicle Miles, Outside SMSA, All-Purpose Local/Suburban Travel, Including Work Travel.	4-39

LIST OF ILLUSTRATIONS (Cont'd)

<u>Figure</u>		<u>Page</u>
4-22	Effect of Vehicle Range on Vehicle Use - % of Days, Outside SMSA, All-Purpose Local/Suburban Travel, Including Work Travel	4-39
4-23	Effect of Vehicle Range on Vehicle Use - % of Vehicle Miles, Inside SMSA, All-Purpose, Including Intercity Travel.	4-40
4-24	Effect of Vehicle Range on Vehicle Use - % of Days, Inside SMSA, All-Purpose, Including Intercity Travel.	4-40
4-25	Effect of Vehicle Range on Vehicle Use - % of Vehicle Miles, Outside SMSA, All-Purpose, Including Intercity Travel.	4-41
4-26	Effect of Vehicle Range on Vehicle Use - % of Days, Outside SMSA, Including Intercity Travel.	4-41
4-27	EPA Urban Cycle (Transient)	4-44
4-28	EPA Urban Cycle (Stabilized).	4-45
4-29	The Effect of Trip Length and Ambient Temperature on Fuel Economy for an ICE Vehicle.	4-46

LIST OF TABLES

<u>Table</u>		
1-1	Daily and Annual Travel Distances Inside SMSAs for Various Missions.	1-6
3-1	Weights and Exterior Dimensions of Downsized Passenger Cars.	3-2
3-2	Acceleration Characteristics.	3-4
3-3	Relation of Maximum Grades to Design Speed Main Highways	3-5
3-4	Minimum Performance Requirements.	3-6
3-5	JPL - Minimum Specifications.	3-9
3-6	Mandatory Fuel Economy and Emissions Standards.	3-10
3-7	Projected Car Weights and Exterior Dimensions	3-12
3-8	Projected Fuel Economy Improvements (1978 to 1985).	3-14
3-9	Fuel Use by Size Class in 1985.	3-17

LIST OF TABLES (Cont'd)

<u>Table</u>		<u>Page</u>
4-1	Population Distribution, 1970	4-2
4-2	Population Density, 1970.	4-3
4-3	Household Ownership of Vehicles, 1974	4-4
4-4	Vehicle Miles Statistics, 1975.	4-6
4-5	Passenger Car Statistics, 1975.	4-7
4-6	New Car Sales Mix Statistics, 1977.	4-8
4-7	1977 Models -- By Market Class.	4-9
4-8	Distribution of Automobile Trips, Vehicle Miles of Travel, and Trip Length by Trip Purpose.	4-11
4-9	Percent of Automobile Trips and Vehicle Miles of Travel by Trip Purpose and Place of Residence -- in All Areas and Selected Places	4-12
4-10	Mission Sets to Be Analyzed	4-13
4-11	Estimated Motor Vehicle Travel in the United States and Related Data - 1974.	4-15
4-12	Vehicle Miles, by State and Highway System - 1974	4-16
4-13	Percentage Distribution of Automobiles vs Annual Miles Traveled.	4-19
4-14	Annual Travel Characteristics by Trip Length.	4-20
4-15	Average Trip Length	4-20
4-16	Poisson Distribution of Trips per Day	4-21
4-17	Cumulative Distribution of Trip Length.	4-23
4-18	Average Annual Mileage (AM) and Average Trip Length (L _{AVG}) in Miles.	4-26
4-19	Summary of Driving Cycle Characteristics.	4-43
5-1	Interior and Exterior Dimensions of Selected 1978 Passenger Cars	5-2
5-2	Sales of Mid-Size Passenger Car Models in 1978.	5-3
5-3	Engine Characteristics and Related Vehicle Fuel Economy for 1978 Mid-Size Cars	5-5
5-4	Acceleration Characteristics of 1978 Intermediate Passenger Cars	5-6
6-1	Daily and Annual Travel Distances Inside SMSAs for Various Missions.	6-5

LIST OF TABLES (Cont'd)

<u>Table</u>		<u>Page</u>
6-2	Daily and Annual Travel Distances Outside SMSAs for Various Missions.	6-6
6-3	Summary of the Characteristics of the ICE Reference Vehicle in 1978 and 1985.	6-11

Section 1
INTRODUCTION AND SUMMARY

Section 1

INTRODUCTION

1.1 INTRODUCTION

This is Appendix A, Mission Analysis and Performance Specification Studies Report (Deliverable Item 1) of the Phase I Final Report (Deliverable Item 7). This Appendix A reports on Task 1 of the Near-Term Hybrid Vehicle Program and is part of Deliverable Item 7, Final Report, which is the summary report of a series which documents the results of Phase I of the Near-Term Hybrid Vehicle Program. Phase I of the program was a study leading to the preliminary design of a five-passenger hybrid vehicle utilizing two energy sources (electricity and gasoline/diesel fuel) to minimize petroleum usage on a fleet basis.

The Near-Term Hybrid Vehicle Program is sponsored by the U.S. Department of Energy (DOE) and the California Institute of Technology, Jet Propulsion Laboratory (JPL). Responsibility for this program at DOE resides in the Office of Electric and Hybrid Vehicle Systems. Work on the Phase I portion of the Program was done by General Electric Company Corporate Research and Development and its subcontractors under JPL Contract 955190.

This report presents the study methodology; the vehicle characterizations; the mission description, characterization, and impact on potential sales; the rationale for the selection of the Reference Internal Combustion Engine (ICE) Vehicle, the primary results; and conclusions and recommendations of the mission analysis and performance specification report.

1.2 OBJECTIVES OF MISSION ANALYSIS AND PERFORMANCE SPECIFICATION STUDIES (TASK 1)

The major objectives of Task 1 - Mission Analysis and Performance Specification Studies are to:

- Perform an analysis of missions appropriate for a hybrid vehicle which meets or exceeds specified minimum constraints and performance requirements,
- Identify vehicle characteristics associated with these missions,
- Identify the mission or sets of missions which maximize the potential for reduction of petroleum consumption by a single hybrid design, and to
- Conduct performance specification studies directed at defining the performance requirements the vehicle should meet to safely and efficiently perform the mission or missions identified in the mission analysis.

The Task 1 report consists of the following major sections:

- Study Methodology
- Vehicle Characterizations
- Mission Description and Characterization
- Rationale for the Selection of the Reference ICE Vehicle
- Primary Results of Mission Analysis and Performance Specifications Study
- Conclusions and Recommendations for Continuing Work on Mission Analysis

1.3 SUMMARY

The results of the mission analysis and performance studies are briefly summarized in this subsection. A complete description of the approach to the studies and the results and conclusions are presented in later sections.

1.3.1 VEHICLE CHARACTERIZATIONS

For purposes of this analysis, four passenger car size classes were defined:

<u>Class</u>	<u>Passenger Capacity</u>
Small	2 front plus 2 rear with reduced comfort
Compact	4
Mid	5
Full	6

Vehicle performance was specified in terms of:

- Top Speed
- Acceleration
- Gradability
- Passing Capability

Conventional Internal Combustion Engine (ICE) passenger cars were characterized by size class for the years 1978 and were projected for 1985. These data were used to estimate the required and acceptable performance for the hybrid/electric car and also served as criteria for selecting the Reference ICE Vehicle.

1.3.2 SUMMARY OF MISSION DESCRIPTION AND CHARACTERIZATION

Personal transportation needs vary markedly from locality to locality and from region to region in the United States. This study has examined the differences in regional characteristics as they relate to hybrid/electric vehicle use and marketability. Two distinct types of areas are defined in terms of inside and outside Standard Metropolitan Statistical Areas (SMSAs). Urban areas are taken to be inside SMSAs. Small cities/towns/rural communities are taken to be outside SMSAs. Based on 1970 population data, about 60% of the US population lives inside SMSAs. Data on household ownership of vehicles in 1974 indicates that about 70% of passenger cars are owned by people living inside or on the fringe of SMSAs. A sales mix for 1977 for inside SMSAs and outside SMSAs was developed from new car sales data and was assumed to apply to 1985 even though the actual size of cars in each size class will be decreasing during the 1977 to 1985 time period. Four mission sets were specified and analyzed for each of the two distinct regions.

Mission Sets

Personal business travel only

Personal business plus trips to work

All-purpose (except trips of 100 or more miles per day)

All purposes

In order to characterize the mission sets, three main factors are required:

- Annual mileage
- Daily travel requirements
- Driving cycles

These are discussed in Section 4.3. The annual mileage and trip length data is used as inputs to a Monte Carlo trip simulation computer program to calculate annual driving statistics. The results of the Monte Carlo computer calculations were analyzed to determine the effect of hybrid/electric vehicle range solely on the battery, on the fraction of days and vehicle miles for which the vehicle can be operated primarily on stored electrical energy. Typical correlations for personal travel plus trips to work inside an SMSA area are shown in Figures 1-1 and 1-2. A summary of the travel statistics and hybrid/electric range implications is given in Table 1-1.

Three driving cycles were considered:

- EPA urban, Federal Urban Driving Cycle (FUDC)
- EPA highway, Federal Highway Driving Cycle (FHDC)
- SAE J227a Schedules B,C,D

It was concluded that the EPA urban and highway cycles could be adapted for use in the hybrid/electric vehicle design. The SAE J227 cycles were defined as a means of comparing all-electric vehicles of differing design and capability and do not represent actual driving conditions even in congested urban areas.

1.3.3 SUMMARY OF RATIONALE FOR THE SELECTION OF THE ICE REFERENCE VEHICLE

Selection of a conventional internal combustion engine (ICE) passenger vehicle is needed for comparison with the hybrid/electric vehicle. A contract specification for the hybrid/electric is that it must carry at least 5 adults. To maximize the potential fuel saving, the hybrid/electric has been targeted to be in the mid-size car class. The criteria for selection of the ICE Reference Vehicle were:

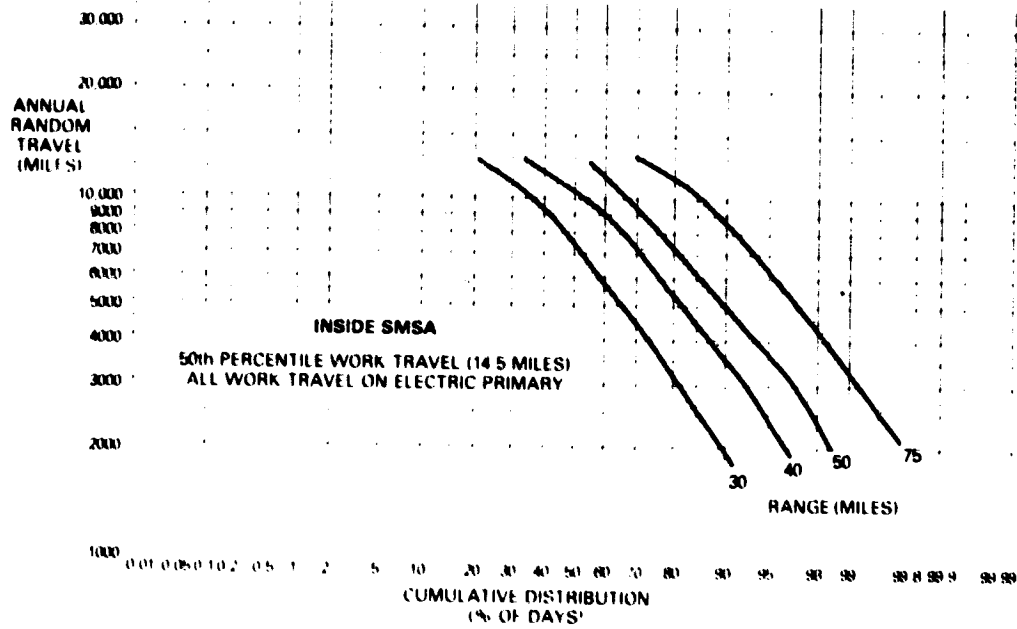

Figure 1-1. Effect of Electric Vehicle Range on All-Electric Vehicle Travel Inside SMSA as a Percentage of Number of Days in a Year

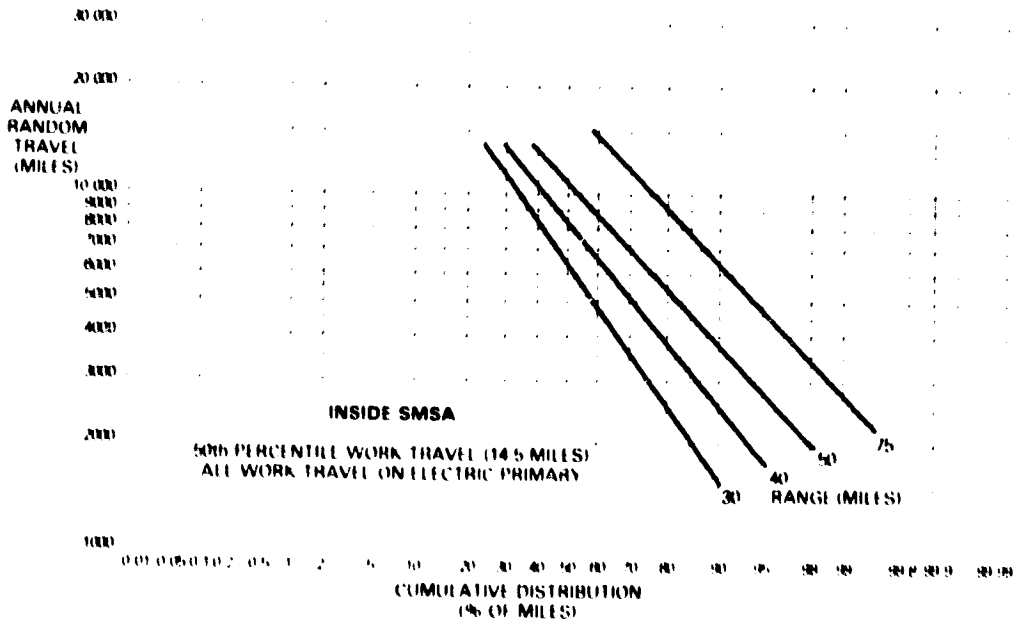

Figure 1-2. Effect of Electric Vehicle Range on All-Electric Vehicle Travel Inside SMSA as a Percentage of Annual Miles

Table 1-1
 DAILY AND ANNUAL TRAVEL DISTANCES INSIDE SMSAs
 FOR VARIOUS MISSIONS

Mission	Annual Distance (miles)	Daily Distance (miles) Percentile *		
		50	75	90
Personal business only				
50th percentile	3,000	20	29	39
75th percentile	4,500	25	38	49
90th percentile	6,500	32	49	66
Personal business plus work trips				
50th percentile	6,625	21	32	43
75th percentile	8,125	26	39	57
90th percentile	10,125	32	51	76
All-purpose (excluding intercity travel)				
50th percentile	6,400	34	52	69
75th percentile	9,200	52	74	99
90th percentile	11,600	>100	>100	>100
All-purpose (including intercity travel)				
50th percentile	7,000	36	61	>100
75th percentile	11,300	50	84	>100
90th percentile	17,000	70	>100	>100

*Percentiles are for vehicle miles

- Capacity for 5 adults
- High sales volume
- Acceptable acceleration

Both the General Motors Malibu/Cutlass and the Ford Motor Company Fairmont/Sephyr meet the above criteria. The Chevrolet Malibu using a V-6, 231 CID engine was selected as the ICE Reference Vehicle primarily because General Electric and its subcontractors have better access to information on the General Motors than on the Ford cars. A brochure on the Chevrolet Malibu is included in the Appendix.

1.3.4 SUMMARY OF PRIMARY RESULTS

The format used in presenting the results follows that given in Exhibit I of Contract No. 955190.

Vehicle Performance Specifications

P1, Minimum Nonrefuelable Range	
Urban, Suburban	-- 55 to 65 km (35-40 miles) on battery; * 110-130 km (70-80 miles) without any recharging of the battery by the heat engine
Highway	-- 400 km (250 miles) **
P2, Cruise Speed	
Electric Drive Only	-- 88 km/h (55 mph)
ICE Engine Only	-- 105 km/h (65 mph)
P3, Maximum Speed	-- 120 km/h (75 mph)
P4, Acceleration	-- 0-96 km/h (0-60 mph) in 16 seconds
P5, Gradability (minimum continuous)	
5%	-- 88 km/h (55 mph)
15%	-- 35 km/h (20 mph)
P6, Passenger Capacity	-- 5 adults
P7, Cargo Capacity	-- 0.5 m ³ (17.7 ft ³); 100 kg (220 lb)

* Heat engine used only to meet peak power demand.

** Depends on size of fuel tank; no battery recharging by heat engine in 500 miles.

Mission Specifications

- M1, Daily Travel -- see Tables 6-1 and 6-2
- M2, Payload -- passenger and cargo loads not assigned to specific type trips
- M3, Trip Length, Frequency and Purpose -- see Section 4.3
- M4, Driving Cycles -- EPA Urban (FUDC) and EPA Highway (FHDC)
- M5, Annual Vehicle Miles -- see Figures 4-7 through 4-10 for annual mileage statistics
- M6, Potential Number of Hybrid/Electric Vehicles in Use -- will be analyzed in later task
- M7, ICE Reference Vehicle -- Chevrolet Malibu with V-6, 231 CID engine
- M8, Reference ICE Vehicle Annual Fuel Consumption -- in 1985 all mid-size passenger cars estimated to use 27% of fuel used for personal transportation

Section 2
STUDY METHODOLOGY

Section 2

STUDY METHODOLOGY

A study methodology was devised which would provide the information needed to define the hybrid/electric car which will be designed in Task 2 and Task 3. In addition, the information developed will serve as a guide in the selection of the ICE Reference Vehicle. The study methodology consists of three major activities:

- Vehicle Characterizations
- Mission Description and Characterization
- Rationale for the Selection of the ICE Reference Vehicle

The Work Flow Diagram for this study is shown in Figure 2-1.

2.1 METHODOLOGY FOR VEHICLE CHARACTERIZATIONS

In the present study, passenger cars are categorized by size and passenger capacity. Four size classes are defined: small, compact, mid-size, and full-size. Vehicle weight for each size class is estimated but is not used in defining the size class. Vehicle performance specifications are examined in terms of the following:

- Top Speed
- Acceleration
- Gradability
- Low- and High-Speed Passing Capability

Performance (acceleration) required for safe operation was differentiated from performance required for ready acceptance in the marketplace. Performance requirements for the 1985 cars were then estimated based primarily on safe operation. Performance specifications for the hybrid/electric vehicle were proposed and compared to the minimum requirements specified in Exhibit 1 of the contract.

Projected characteristics of conventional ICE passenger cars were collected and examined. The characteristics of particular interest were:

- Exterior Dimensions
- Curb Weight
- Fuel Economy
- Exhaust Emission Standards

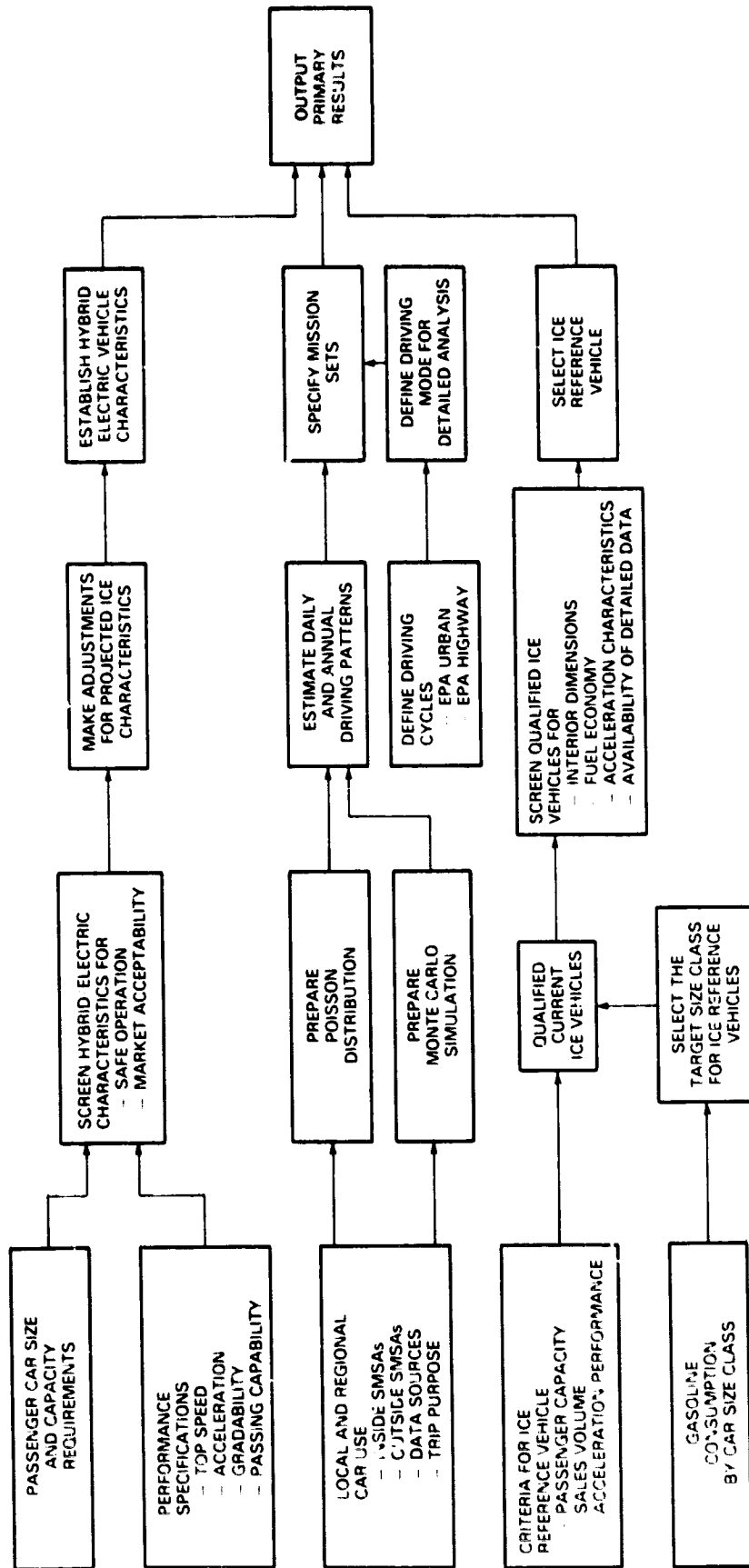

Figure 2-1. Work Flow Diagram for Task 1

Data were correlated for both 1978 model cars and cars projected for 1985. The EPA urban and highway driving cycles were assumed to be representative of urban and highway driving in 1985 and were used to determine vehicle composite fuel economy for the conventional cars. The 1977 sales mix of four size classes was used as the basis for the 1985 sales mix in order to target the size class for the hybrid/electric vehicle.

2.2 METHODOLOGY FOR MISSION DESCRIPTION AND CHARACTERIZATION

In order to assess the effects of mission analysis on hybrid/electric vehicle design and marketability, local and regional car use was studied. Two regions were considered:

- Inside Standard Metropolitan Statistical Areas (SMSAs)
- Outside Standard Metropolitan Statistical Areas (SMSAs)

Data sources used include (1) national census surveys, (2) national transportation use-pattern surveys, and (3) car registration statistics. It was assumed that the sales mix by size class would be about the same during the next decade even though the actual size of the cars will be smaller in the future than at present.

The use pattern of the automobile varies over a wide range in terms of trip length, trip frequency, and trip purpose. Four general categories of trip purpose are often defined:

- Earning a Living (Work Travel)
- Family Business
- Civic, Educational, or Religious
- Social or Recreational

The last three trip purposes were consolidated and called Personal Business. Use patterns of automobiles were characterized in terms of regular travel (e.g., work travel) and random travel (e.g., personal business). Mission sets were then described in terms of both random and non-random trips. A total of eight mission sets were specified and analyzed (four each for travel inside SMSAs and outside SMSAs).

Characterization of automobile travel requires the following main factors:

- Annual Mileage (statistical distributions)
- Daily Travel (statistical distribution of trip length and number)
- Driving Mode

Since data pertinent to some of these factors are very limited, considerable judgement had to be used in developing inputs for the travel analysis. In the absence of data, for example, an estimate had to be made for annual mileage versus percent automobiles. Daily travel patterns were determined when at all possible through use of the Nationwide Personal Transportation Study. A computer program was written to simulate daily travel by using a Poisson distribution and a Monte Carlo simulation. The Poisson distribution determines both the number of days per year in which a specified number of trips are taken as well as the total number of trips

per year. The Poisson distribution requires as input data the average number of trips per day and the average trip length. The Monte Carlo simulation uses a random number generator to predict trip length and requires the use of distribution functions for percent trips and percent vehicle miles in terms of the trip length. The results of the Monte Carlo trip simulation are used to determine the fraction of days and vehicle miles for which a hybrid/electric vehicle having a specified "electric" range can be operated primarily on the battery. Such correlations are developed for each of the mission sets.

Driving mode is usually described by a driving cycle or combinations of driving cycles. The EPA urban (FUDC) and the EPA highway (FHDC) driving cycles were examined as the means to represent urban and highway travel. The two parts (transient and stabilized) of the FUDC are used individually and in combination to describe city and suburban trips, and the FHDC is used to describe intercity travel which is considered as trips of over 100 miles.

2.3 METHODOLOGY USED IN THE SELECTION OF THE ICE REFERENCE VEHICLE

In order to properly assess the hybrid/electric car it is necessary to identify a conventional internal combustion engine (ICE) passenger car having the same passenger carrying capacity and performance. The criteria for selection of the ICE Reference Vehicle were:

- Passenger Capacity
- Sales Volume
- Acceleration Performance

Selection of the ICE Reference Vehicle was directed to mid-size cars because hybrid/electric cars of that size class were judged to have the greatest potential for reducing gasoline consumption. Interior dimensional criteria noted by Consumers Union (April 1978) were used to identify several 1978/1979 model mid-size cars which would be acceptable as ICE Reference Vehicles. Fuel economy and acceleration characteristics were used for further narrowing of the list of potential ICE Reference Vehicles. The final selection of the ICE Reference Vehicle was based on the availability of detailed information on the ICE vehicle which was selected.

2.4 PRESENTATION OF RESULTS

The results of the study are presented as:

- Vehicle Performance Specifications
- Mission Description and Daily Travel
- Mission Specifications
- ICE Reference Vehicle and Its Characteristics

Section 3

VEHICLE CHARACTERIZATIONS

In this section, vehicle passenger carrying capacity, acceleration performance, safe operation, and market acceptability are considered as they relate to 1985 cars. Based on those considerations, hybrid/electric vehicle specifications are proposed for use in this program. Conventional ICE passenger car size, weight, fuel economy, and sales mix are summarized and used to target the size class for the hybrid/electric vehicle to be designed in Tasks 2 and 3.

3.1 PASSENGER CAR SIZE CLASSES

Passenger cars will be categorized in this report in terms of four classes: small, compact, mid, and full. The primary distinguishing factor for each class is the interior size of the vehicle, and thus its capacity for carrying a specified number of adult passengers in comfort over a reasonable distance. In these terms, the four size classes are defined as follows:

<u>Class</u>	<u>Passenger Capacity</u>
Small	2 front plus 2 rear with reduced comfort
Compact	4
Mid	5
Full	6

The US auto industry is currently engaged in an extensive program of passenger car downsizing, which, in essence means reducing the exterior dimensions and the weight of the vehicle while maintaining a specified passenger carrying capacity. Thus, within a passenger car class, the size of the vehicle is being reduced, but not its passenger carrying capacity. The weight and exterior dimensions of selected car models, which are typical of downsized designs, are given in Table 3-1, grouped by size class. The data shown in the table will be used in Section 3.3 to project the size and weight characteristics of conventional ICE passenger cars marketed from 1980 to 1985. The electric/hybrid vehicles in each size class would by definition have the same passenger carrying capacity as conventional ICE vehicles in that class, but not the same weight or necessarily the same exterior dimensions.

3.2 PERFORMANCE SPECIFICATIONS

By vehicle performance specifications are meant the following: (1) top speed, (2) acceleration, (3) gradability, and (4) low- and high-speed passing capability. Vehicle performance depends both on the power-to-weight ratio of the vehicle and its gearing (i.e., axle ratio, transmission gear ratios, and shift logic). In determining the performance requirements, it seems advisable to differentiate between the performance required (1) for safe operation of the vehicle on streets, freeways, and highways as they are currently structured and trafficked and (2) for ready acceptance of a new vehicle design by potential buyers. Both of these aspects of setting performance specifications will be considered in the subsequent paragraphs.

Table 3-1

WEIGHTS AND EXTERIOR DIMENSIONS OF DOWNSIZED PASSENGER CARS

Manuf.	Model	Year Introd.*	Vehicle Class: Small			
			Curb Weight kg (lb)	Vehicle Dimensions cm (in.)		
				L	W	H
VW	Rabbit	1976	843.7 (1860)	393.7 (155)	160.0 (63)	129.7 (51)
Chevrolet	Chevette	1976	929.9 (2050)	411.5 (162)	157.5 (62)	132.1 (52)
Honda	Civic	1972	799.2 (1762)	381.0 (150)	149.9 (59)	132.1 (52)
Ford	Fiesta	1978	805.1 (1775)	373.4 (147)	157.5 (62)	132.1 (52)
Mazda	GLC	1977	891.3 (1965)	391.2 (154)	160.0 (63)	137.2 (54)
Toyota	Corolla		932.1 (2055)	419.1 (165)	157.5 (62)	139.7 (55)
Datsun	B-210		916.3 (2020)	411.5 (162)	154.9 (61)	137.2 (54)
Volvo	66	1977	839.2 (1850)	391.2 (154)	154.9 (61)	137.2 (54)
Vehicle Class: Compact						
Audi	Fox		952.5 (2100)	442.0 (174)	165.1 (65)	137.2 (54)
VW	Dasher	1976	997.9 (2200)	439.4 (173)	160.0 (63)	137.2 (54)
Toyota	Corona		1149.9 (2535)	439.4 (173)	162.6 (64)	137.2 (54)
Honda	Accord	1977	915.4 (2018)	414.0 (163)	162.6 (64)	132.1 (52)
Rehault	12		997.9 (2200)	442.0 (174)	165.1 (65)	144.8 (57)
Volvo	343	1977	997.0 (2154)	421.6 (166)	165.1 (65)	139.7 (55)
Saab	99		1179.4 (2600)	444.5 (175)	167.6 (66)	142.2 (56)
Chrysler	Horizon	1978	969.3 (2137)	419.1 (165)	167.6 (66)	137.2 (54)
Vehicle Class: Mid-Size						
Ford	Fairmont	1978	1247.4 (2750)	492.8 (194)	177.8 (70)	137.2 (54)
Chevrolet	Malibu	1978	1406.2 (3100)	490.2 (193)	182.9 (72)	137.2 (54)
Ford	Granada	1975	1478.7 (3260)	502.9 (198)	188.0 (74)	134.6 (53)
Dodge	Aspen	1976	1474.2 (3250)	500.4 (197)	185.4 (73)	139.7 (55)
Audi	5000	1978	1236.0 (2725)	482.6 (190)	177.8 (70)	137.2 (54)
Volvo	254		1437.9 (3170)	490.2 (193)	170.2 (67)	142.2 (56)
Merc. B.	230		1451.5 (3200)	485.1 (191)	177.8 (70)	142.2 (56)
Vehicle Class: Full-Size						
Chevrolet	Impala	1977	1678.3 (3700)	538.5 (212)	193.0 (76)	142.2 (56)
Chrysler	LeBaron	1977	1633.0 (3600)	523.2 (206)	185.4 (73)	139.7 (55)
Ford	LTD	1979	1637.9 (3611)	530.9 (209)	198.1 (78)	139.7 (55)
Oldsmobile	Toronado	1979	1746.4 (3850)	523.2 (206)	182.9 (72)	139.7 (55)

* The year of introduction is noted if the model represented a significant new design by the manufacturer rather than an evolution from previous designs.

From Reference 4.

Consider first the performance required for ready acceptance of a new vehicle design in the marketplace. As indicated in Figure 3-1, there is little doubt concerning the acceleration performance preferred by the majority of car buyers at the present time. In 1977, cars having a 0-60 mph acceleration capability of greater than 16 seconds represented only 16% of General Motor's sales and those having a 0-60 mph acceleration capability of less than 13 seconds represented about 65% of sales. Whether this acceleration capability is needed for safe operation or is preferred for purely emotional reasons will be considered later. According to Table 3-2, taken from Ref. (1), it is likely that conventional ICE cars marketed in 1985 by the US auto industry will exhibit significantly lower acceleration performance than those marketed in 1978. This lowering of performance would, of course, occur gradually over the next 5 years and would result in a lowering of the expectations of car buyers regarding car performance. Hence, it seems quite likely that the acceleration performance required of a new design in 1985 will be significantly less than that expected in 1978. Another factor to consider is that the speed limit is currently 55 mph and travel at speeds in excess of 65-70 mph is likely to result in a traffic citation even with the current rather lax enforcement of the 55 mph speed limit. Over a period of years the reduced speed limit may also tend to lower consumer interest in high performance cars as there will be less need for highway passing capability much in excess of 60 to 65 mph. Hence, from a consumer acceptance point-of-view, it seems likely that by 1985, a 0-60 mph acceleration capability of 15 seconds will be considered attractive and a 0-60 mph acceleration in 20 seconds acceptable.

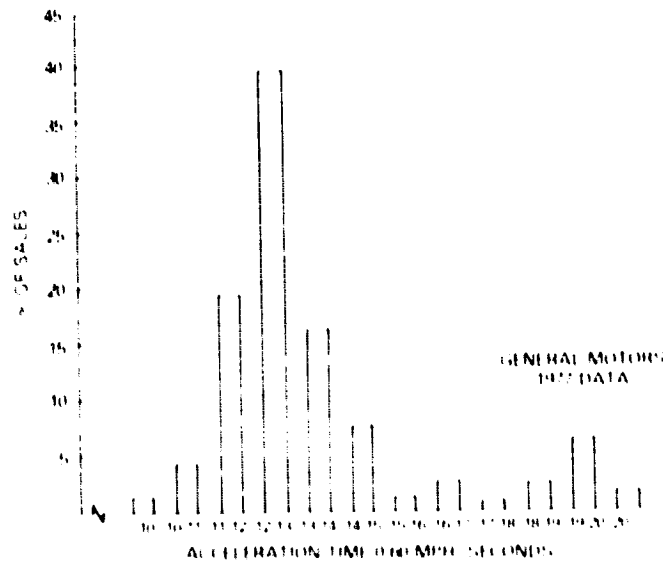

FIGURE 3-1. GM 1977 Sales Relation to Acceleration Characteristics (Reference 1)

Table 3-2

ACCELERATION CHARACTERISTICS (1)

Size Class	0-60 mph (0-96.5 km/h) (Automatic Transmission)	
	1977 (Seconds)	1985 (Seconds)
Small (Sub Compact)	11 - 24	17 - 21
Compact	12 - 19	17 - 18
Mid-Size	11 - 20	18 - 19
Large (Full-Size)	10 - 20	15 - 18

Next, consider the vehicle performance capability required for safe operation on urban streets/freeways and intercity highways. In order to be operated safely, a car must be able to (1) keep up with traffic on level roads and grades, (2) merge with flowing traffic on entering freeways and expressways, and (3) pass slower moving traffic at speeds up to the speed limit. Since the highway system in the mid-1980s will be essentially the same as that of today, the vehicles marketed in 1985 must be capable of safe operation on the roads as presently constructed. Today's highways were designed following the policies set forth in Reference 2 concerning maximum grades, expressway merging lane lengths, and required passing distances (Table 3-3). It will be assumed that the EPA urban and highway cycles will be representative of urban and highway driving in 1985 and that, if a vehicle can follow those cycles, it is capable of keeping up with traffic on level roads. Based on the highway design information given in Table 3-3, the minimum performance requirements set forth in Table 3-4 are suggested. These requirements should permit safe operation of the electric/hybrid vehicle in city/suburban and highway driving on the highway system as presently constructed and marked (i.e., designation of no-passing zones, etc.). For reasons of convenience, Table 3-4 specifies vehicle performance in terms of acceleration at a given speed or distance in which a specified speed change is to take place rather than the more familiar standing-start acceleration times (e.g., 0-30 mph or 0-60 mph in so-many seconds).

As noted above, the performance capability of conventional ICE cars is often stated in terms of the 0-60 mph acceleration time. In a sense, that acceleration time has acted as a proxy for the more meaningful performance capabilities listed in Table 3-4. It is of interest to ascertain the maximum 0-60 mph acceleration time for which all the performance requirements for safe operation of the vehicle in all types of driving are met. This could then be

Table 3-3

RELATION OF MAXIMUM GRADES TO DESIGN SPEED
MAIN HIGHWAYS

Type of Topography	Design speed, mph							
	30	40	50	60	65	70	75	80
Flat	6	5	4	3	3	3	3	3
Rolling	7	6	5	4	4	4	4	4
Mountainous	9	8	7	6	6	5	-	-

ELEMENTS OF SAFE PASSING SIGHT DISTANCE-2-LANE HIGHWAYS

Speed group, mph	30-40	40-50	50-60	60-70
Average passing speed, mph	34.9	43.8	52.6	62.0
Initial maneuver:				
a = average acceleration, mphps	1.40	1.43	1.47	1.50
t ₁ = time, seconds	3.6	4.0	4.3	4.5
d ₁ = distance traveled, feet	145	215	290	370
Occupation of left lane:				
t ₂ = time, seconds	9.3	10.0	10.7	11.3
d ₂ = distance traveled, feet	475	640	825	1030
Clearance length:				
d ₃ = distance traveled, feet	100	180	250	300
Opposing vehicle:				
d ₄ = distance traveled, feet	315	425	550	680
Total distance, d ₁ +d ₂ +d ₃ +d ₄ , feet	1035	1460	1915	2380

DERIVATION OF LENGTHS FOR ACCELERATION LANES

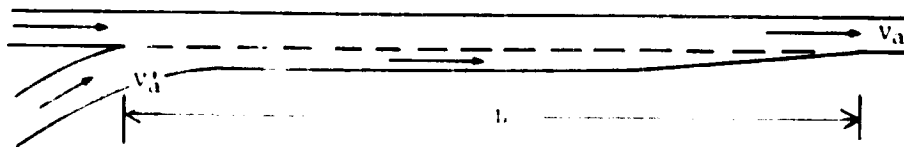

Highway		L-Length of Acceleration Lane-Feet for Entrance Curve Design Speed, MPH								
Design Speed, MPH	Speed Reached (V _a), MPH	Stop Condition	15	20	25	30	35	40	45	50
		And Initial Speed (V' _a), MPH								
		0	14	18	22	26	30	36	40	44
30	23	190	--	--	--	--	--	--	--	--
40	31	380	320	250	220	140	--	--	--	--
50	39	760	700	630	580	500	380	160	--	--
60	47	1,170	1,120	1,070	1,000	910	800	590	400	170
70	53	1,590	1,540	1,500	1,410	1,330	1,230	1,010	830	580

Note: Where lengths exceed 1,300 feet, or design speeds exceed 70 mph, uniform 50:1 tapers are recommended.

From Reference 2.

Table 3-4
MINIMUM PERFORMANCE REQUIREMENTS

Acceleration Situation	Requirement	Basis
City/Suburban Driving	3.2 mph/s at 31 mph (5.15 km/h/s at 49.88 km/h)	EPA Urban Cycle
Expressway Merging	0-35 mph in 300 ft (0-56.32 km/h in 91.44 m)	AASHO Design Policy
Passing on a 2-lane Road (55 MPH Speed Limit)	45-55 mph in 225 ft (72.41-88.5 km/h in 68.58 m)	AASHO Design Policy
<u>Gradability</u>	55 mph (88.5 km/h) on a 5% grade	Maintain Speed Limit on Grades in Rolling Terrain
<u>Top Speed</u>	Sustained Operation at 60 mph (96.54 km/h); speeds up to 70 mph (112.63 km/h) for passing	Speed Limit of 55 mph

used to determine the minimum power-to-weight ratio to consider in designing passenger cars. The power-to-weight ratios required at the wheels for various vehicle driving maneuvers are shown in Figure 3-2. The values given in Figure 3-2 were calculated using a variety of approximations including average rates of accelerations and times based on average speeds (e.g., $\bar{v} = (v_{final} + v_{initial})/2$). Except for steady-state maneuvers such as driving on a grade, the effective acceleration parameter $(a/g)_{eff}$ was assigned to an intermediate speed between \bar{v} and v_{final} based on available detailed calculations or engineering judgement. Fortunately, it appears that the critical conclusions can be extracted from Figure 3-2 without the need for precise calculations. It seems clear from Figure 3-2 that the high-speed passing maneuver on a 2-lane road is the most demanding relative to power required. Gradability and lower speed accelerations, including freeway merging, require much less power at the wheels. The differences when translated to engine (or powertrain) maximum power rating are smaller because it is possible to attain a greater fraction of the peak engine rated power at high vehicle speeds such as 50-60 mph than at vehicle speeds near 30-35 mph (see the ICE limit power curve in the upper left-hand corner of Figure 3-2). Note from Figure 3-2 that the 0-60 mph acceleration time corresponding to the 2-lane road passing requirement is about 15 seconds. Without a detailed study of 2-lane road passing, it would seem difficult to justify vehicle power-to-weight ratios much less than those resulting in 0-60 mph acceleration times of 15 or 16 seconds.

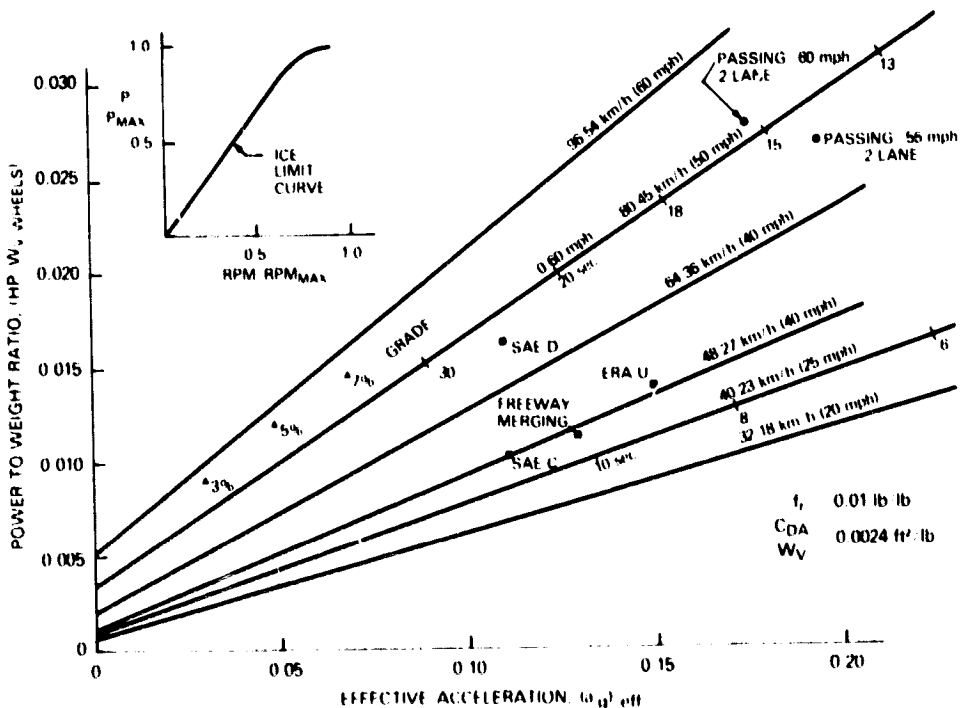

Figure 3-2. Power-to-Weight Ratio Requirements

The minimum JPL performance requirements (Exhibit 1 of RFP) and the hybrid vehicle design goals (Reference 3) are shown in Table 3-5. Direct comparisons between the JPL performance specifications and those proposed in Table 3-4 can only be made for gradability and the inferred 0-60 mph acceleration time. Unfortunately, the JPL acceleration time for minimum performance is given for a 0-56 mph acceleration rather than for the customary 0-60 mph acceleration. Using available vehicle acceleration profile test data (see Figure 3-3), a 0-56 mph acceleration time of 15 seconds was found to be equivalent to a 0-60 mph acceleration time of 17 seconds which is within the range (15-19 seconds) projected for 1985 by the US auto industry for 5- and 6-passenger cars (Table 3-2). The power requirement inferred from Figure 3-2 in the present analysis is only slightly greater than that corresponding to a 0-60 mph acceleration time of 17 seconds, and is also within the range projected by the auto industry. The JPL acceleration goal of 0-60 mph in 14 seconds would certainly be attractive to potential hybrid vehicle buyers, but that much power does not seem to be needed for safe operation and would likely exceed that available in conventional ICE cars in 1985. There does not appear to be significant differences between the JPL minimum acceleration specification and those developed in the present study so that the power-to-weight of the hybrid design will be such that the minimum performance requirements set forth in Table 3-4 will be met yielding an equivalent 0-60 mph acceleration time of 15-16 seconds. It can be expected that the gradability of the hybrid vehicle will be better than the JPL minimum requirement (55 mph on a 3% grade) and probably also better than 55 mph on a 5% grade, at least for some distance, depending on the state-of-charge of the battery. Maintaining a gradability of 55 mph on a 7% grade would certainly be desirable and would appear to be a strong possibility.

3.3 CHARACTERIZATION OF CONVENTIONAL ICE PASSENGER CARS BY SIZE CLASS

At various times during the electric/hybrid study program, it will become necessary to obtain projected characteristics of the conventional ICE passenger cars marketed in the mid-1980s in the various size classes. The characteristics of particular interest are exterior dimensions, curb weight, and fuel economy (urban and highway). Projection of these characteristics for 1985 model passenger cars is clearly subject to some uncertainty. Fortunately, the uncertainty is considerably reduced by the necessity of the auto industry to meet the legally mandated CAFE* of 27.5 mpg in 1985. In addition to the fleet fuel economy standard, the passenger cars must also meet exhaust emission standards. The fuel economy and emission standards which must be met between 1978 and 1985 are summarized in Table 3-6.

Table 3-5

JPL - MINIMUM SPECIFICATIONS

<u>Acceleration</u>	<u>Time (Seconds)</u>
0 - 31 mph (49.88 km/h)	6
0 - 56 mph (90.1 km/h)	15
25 - 56 mph (passing) (40.23 - 90.1 km/h)	12
	<u>Speed</u>
<u>Grade (%)</u>	<u>km/h</u> <u>(mph)</u>
3	90.1 (56)
8	49.88 (31)
15	25.74 (16)

JPL - GOAL SPECIFICATIONS

<u>Acceleration</u>	<u>Time (Seconds)</u>
0 - 30 mph (48.27 km/h)	6
0 - 60 mph (96.54 km/h)	14
19 - 35 mph (passing) (30.57 - 56.32 km/h)	4
37 - 55 mph (passing) (59.53 - 88.50 km/h)	9
	<u>Speed</u>
<u>Grade (%)</u>	<u>km/h</u> <u>(mph)</u>
5	88.50 (55)
7	48.27 (30)
20	19.31 (12)

*Corporate Average Fuel Economy

Table 3-6

MANDATORY FUEL ECONOMY AND EMISSIONS STANDARDS

Year		Sales Weighted Average mpg ^(a)					
1978		18					
1979		19					
1980		20					
1981		22					
1982		24					
1983		26					
1984		27					
1985		27.5					
(a) Composite - 55% urban cycle, 45% highway cycle.							
LIGHT-DUTY VEHICLE EMISSION STANDARDS							
Year		49 - States (Fed.) grams/mile			California grams/mile		
		HC	CO	NO _x	HC	CO	NO _x
1973 (a)		3.2	39	3	3.2	39	3
1974		3.2	29	3	3.2	39	3
1975 (b)		1.5	15	3	0.9	9	2
1976		1.5	15	3	0.9	9	2
1977		1.5	15	2	0.4	9	1.5
1978		1.5	15	2	0.4	9	1.5
1979		1.5	15	2	0.4	9	1.5
1980		0.4	15	2	0.4	9	1.0
1981		0.4	7	1 (c)	0.4	9	1.0
1982		0.4	3.4	1	0.4	9 (d)	0.4 (e)
1983		0.4	3.4	1	0.4	9	0.4
1984		0.4	3.4	1	0.4	9	0.4
1985		0.4	3.4	1	0.4	9	0.4

(a) 1972 CVS-C test procedures used for 1973-74.

(b) 1975 CVS-CH test procedure used for 1975 and beyond.

(c) Diesels and cars with other innovative fuel-saving engines could qualify for a NO_x standard of 1.5 grams/mile (1977 amendments to the 1970 Clean Air Act).

(d) California is considering a CO standard of 7 grams/mile.

(e) California is considering an NO_x standard of 1 gram/mile if vehicle can be certified for 100,000 mi rather than 50,000 mi.

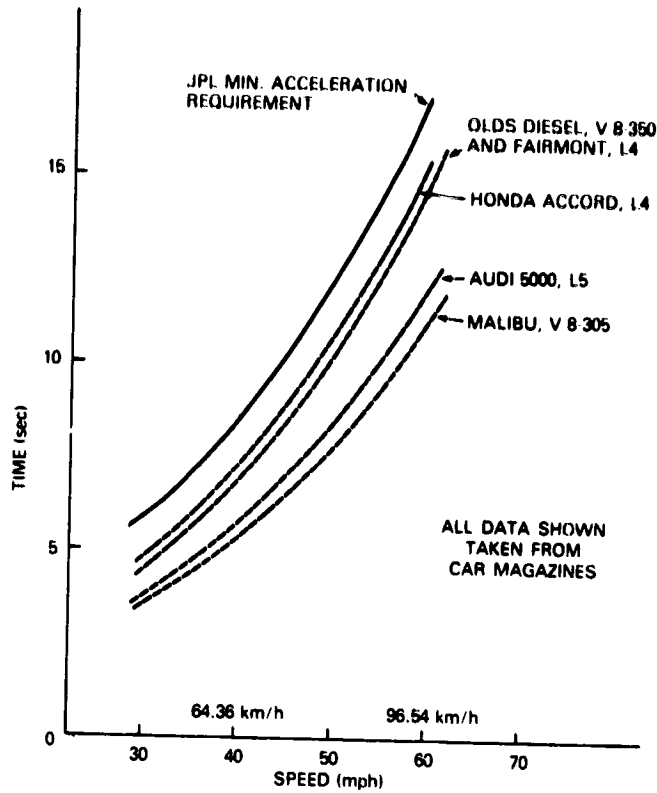

Figure 3-3. Acceleration Profiles

The approach used to obtain the passenger car characterizations given in this section is the same as that presented in Reference 4. In fact, some of the results given in Reference 4 will be used essentially unchanged in the present study because the referenced work is quite recent and little has happened in the interim to influence projections. The projected exterior dimensions and curb weights of downsized designs in the various size classes are summarized in Table 3-7. In the case of the US auto industry, 1978/79 designs are the first in an expected series of downsized designs in each class size. Significant additional size and weight reductions can be expected in subsequent redesigns as the auto industry utilizes extensively front wheel drive and smaller, more compact engines. This is especially true for mid- and full-size cars. Further weight reductions will also occur in all size classes with the use of lighter weight materials. Vehicle weights much less than those projected for 1985 would require a drastic change in structural design, such as the use of fiberglass, graphite composite, or foam-filled sandwich-type body construction. There is no reason to believe this will happen within the mid-1980 time period, because of the very large retooling investment required.

The fuel economy of the downsized 1985 passenger cars has been projected using 1978 EPA fuel economy results as the baseline. Fuel economy (urban and highway) using 1978 engine technology is shown in Figures 3-4 and 3-5 as a function of vehicle inertia weight for both gasoline and diesel engines. Improvements in fuel economy between 1978 and 1985 can result from a number of technological developments and/or styling changes. A breakdown of projected improvements from

Table 3-7
 PROJECTED CAR WEIGHTS AND EXTERIOR DIMENSIONS

Car Class and Year	Curb Weight		Length		Width		Height	
	kg	(lb)	cm	(in.)	cm	(in.)	cm	(in.)
<u>Small</u> 1978 1985	798.3-932.2	(1760-2055)	381.0-411.5	(150-162)	149.9-160.0	(59-63)	132.1-139.7	(52-55)
	725.8	(1600)	381.0	(150)	152.4	(60)	132.1	(52)
<u>Compact</u> 1978 1985	916.3-1179.4	(2020-2600)	414.0-444.5	(163-175)	160.0-167.6	(63-66)	137.2-142.2	(54-56)
	907.2	(2000)	431.8	(170)	162.6	(64)	137.2	(54)
<u>Mid-Size</u> 1978 1985	1236.1-1478.7	(2725-3260)	482.6-500.4	(190-197)	177.8-188.0	(70-74)	134.6-142.2	(53-56)
	1179.4	(2600)	469.9	(185)	185.4	(73)	137.2	(54)
<u>Full-Size</u> 1978 1985	1633.0-1814.4	(3600-4000)	523.2-546.1	(206-215)	188.0-198.1	(74-78)	134.6-142.2	(53-56)
	1451.5	(3200)	508.0	(200)	190.5	(75)	139.7	(55)

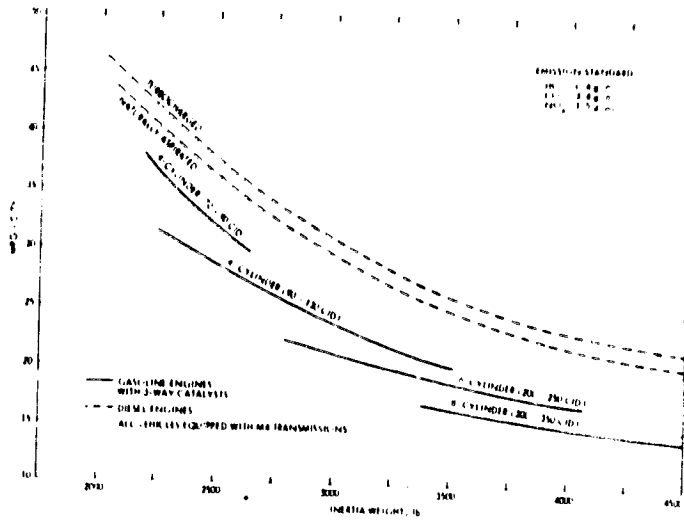

Figure 3-4. Baseline Fuel Economy - 1978 Technology, Urban Cycle(4)

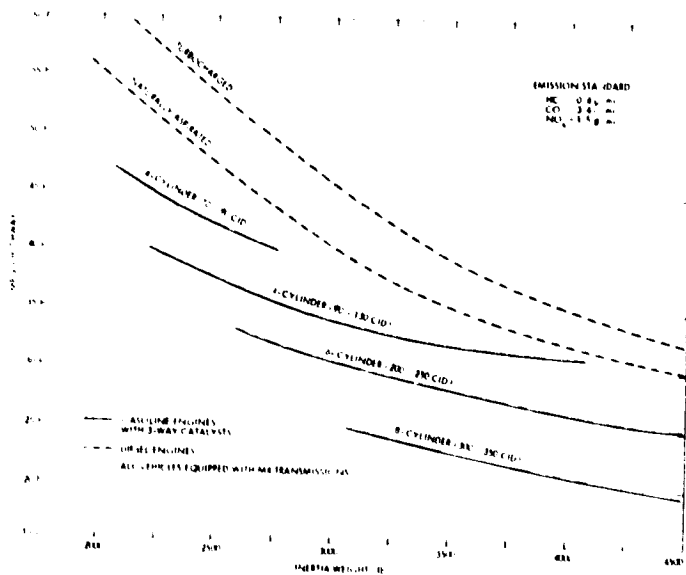

Figure 3-5. Baseline Fuel Economy - 1978 Technology, Highway Cycle(4)

various sources is given in Table 3-8. It has been assumed that the improvements indicated can be achieved along with meeting the 1985 statutory emission standards of 0.4 gram/mile HC, 3.4 grams/mile CO, and 1.0 gram/mile NO_x. This will doubtlessly require a refined 3-way catalyst system with microprocessor logic and control. The fuel economy for the 1985 vehicles is obtained by simply multiplying the baseline 1985 values by the fuel economy improvement factors in the table. The resultant 1985 fuel economy projections are shown in Figures 3-6, 3-7, and 3-8. The present results for

Table 3-8

PROJECTED FUEL ECONOMY IMPROVEMENTS (1978 to 1985)

Source	% Improvement	
	City	Highway
Engine Development	10%	10%
Lower C _D (0.5 to 0.38)	3%	7%
Improved Lubricants	2%	2%
Transmission Developments	3%	5%
Total	18%	24%

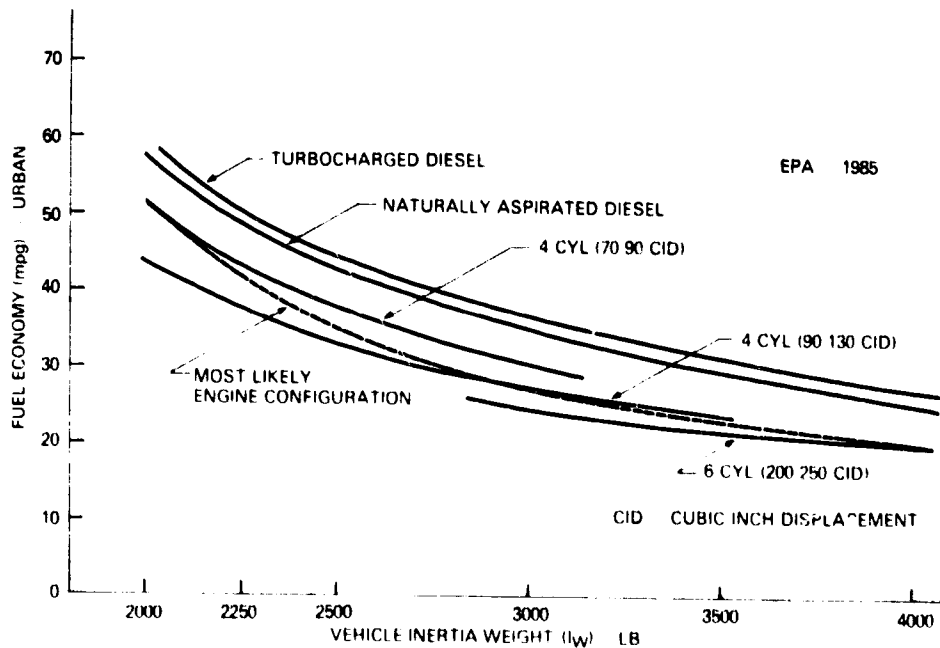

Figure 3-6. Projected 1985 Urban Fuel Economy

The composite fuel economy are compared with the guideline values given by JPL (Assumptions and Guidelines, received 27 Sept. 1978) in Figure 3-9. The JPL projections are, in general, lower than the present results. The differences are about 25% for 2000-lb cars and 15% for 3000 to 4000-lb cars. Reference (5) indicates that on-road fuel economy is somewhat lower than that measured by EPA. Therefore, it seems appropriate to correct the fuel economy projections (Figures 3-6, 3-7, and 3-8) based on the 1978 EPA values to account for this discrepancy. This has been done using the formula

$$(FE)_{cor.} = 0.71 (FE)_{EPA \text{ based}} + 2.83 \quad (1)$$

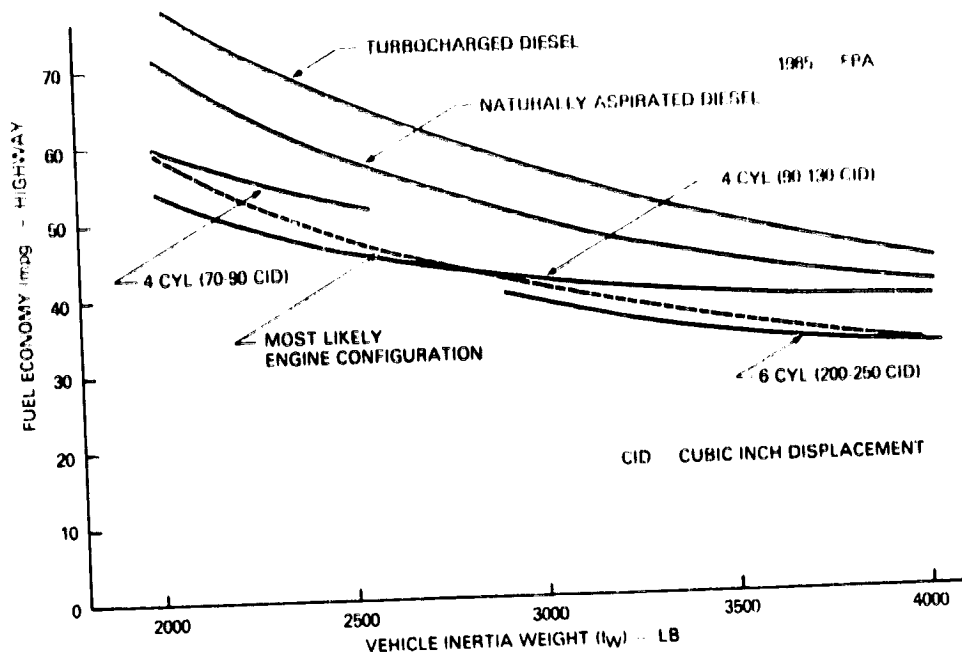

Figure 3-7. Projected 1985 Highway Fuel Economy

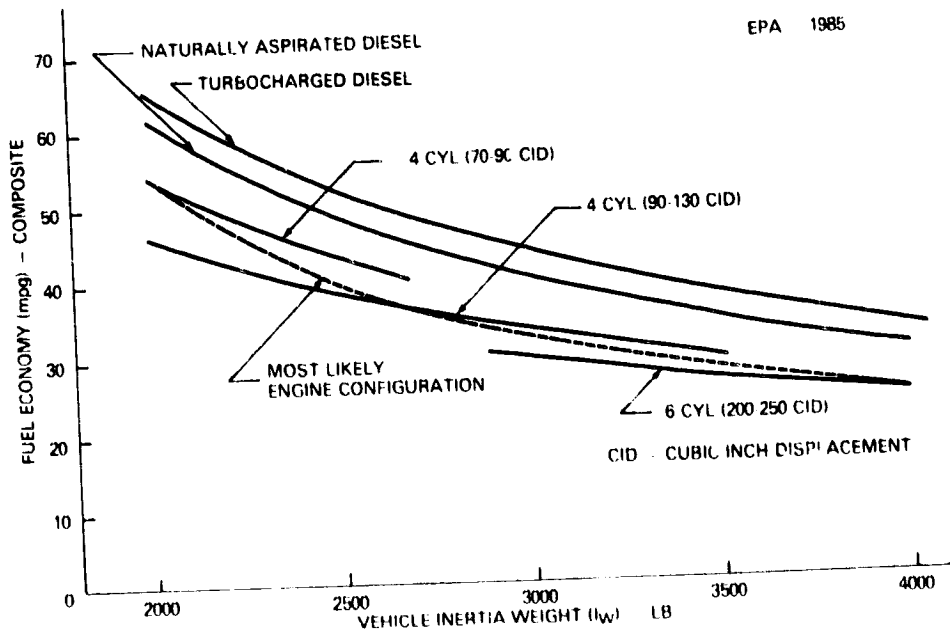

Figure 3-8. Projected 1985 Composite Fuel Economy

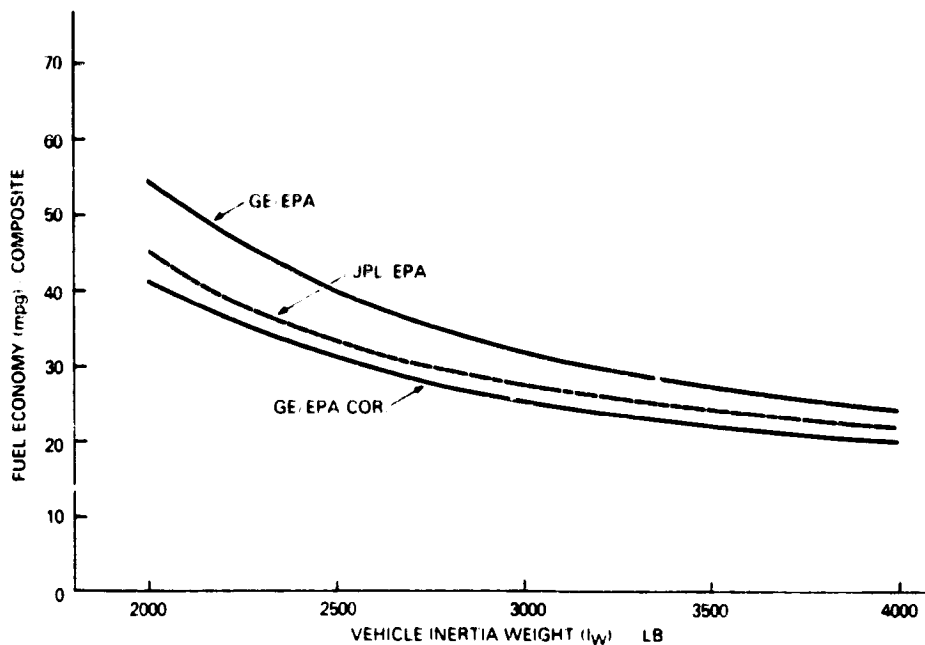

Figure 3-9. Composite Fuel Economy Comparisons

given by JPL in Ref. (6). The corrected composite fuel economy projection for gasoline-powered cars is shown in Figure 3-9. Because data to do otherwise are simply not available⁽⁵⁾, the same correction has been made for both urban and highway fuel economy.

Unless directed by JPL to do otherwise, General Electric (GE) plans to use GE fuel economy projections during the hybrid vehicle study rather than those given in Ref. (6). This approach is preferred for a number of reasons. First, the differences between the JPL and GE projections are not really significant in terms of their effect on the conclusions to be drawn from the study. Second, the basis for the GE projections is known in detail whereas the same depth of information relative to the JPL projections was not readily available. Third, the GE projections include separate results for urban and highway driving and for diesel engines. Such information was not supplied by JPL as part of their guidelines/assumptions.⁽⁶⁾

The fuel economy projections and sales mix information discussed in Section 4 can be combined to determine the fraction of the fuel used by the various size classes. Those results for 1985 are given in Table 3-9. It was assumed that the sales mix in 1985 (in terms of size classes) will be the same as in 1977, and that all size classes are driven the same average annual mileage. As would be expected, Table 3-9 indicates that the larger cars use about 64% of the fuel. This simple calculation did not differentiate between urban and highway mileage. Nevertheless, it does indicate that the development of electric/hybrid 5- and 6-passenger cars has a greater potential for reducing national petroleum requirements than similar developments for small and compact size cars. This important point will be discussed later.

Table 3-9
 FUEL USE BY SIZE CLASS IN 1985

Size Class	Sales Mix %	Iw, lb	Composite mpg	Fraction of Fuel Used
Small	23.9	1900	43.8	0.16
Compact	23.3	2300	34.5	0.198
Mid-Size	24.3	2900	26.0	0.274
Full-Size	27.6	3500	22.0	0.367
				<u>0.999</u>

Section 4

**MISSION DESCRIPTION, CHARACTERIZATION,
AND IMPACT ON POTENTIAL SALES**

Section 4

MISSION DESCRIPTION, CHARACTERIZATION, AND IMPACT ON POTENTIAL SALES

For the hybrid/electric passenger car to have a significant impact on petroleum conservation, the hybrid/electric car must be designed so that it will meet the transportation needs (i.e., mission requirements) of a significant fraction of potential new car buyers in a convenient and economical manner. In this section of the report, automobile use patterns within and outside metropolitan areas are described statistically so as to target the hybrid/electric vehicle design characteristics to meet the expected uses. From this analysis, various mission sets are defined and the associated vehicle "electric" range requirements for the mission sets are determined.

4.1 REGIONAL / LOCAL USE CONSIDERATIONS

Personal transportation needs vary markedly throughout the United States due to a number of factors including local traffic congestion, the availability of public transportation, commuter distances, shopping locations, etc. Differences in local/regional life styles are reflected in the way people use their cars and, as a result, in the sales mix of cars that are purchased. Hence, in order to assess the effects of mission analysis on electric/hybrid vehicle design and marketability, it is advisable to consider local/regional characteristics in both regards. Much of the previous work in this area centered primarily around national averages -- for example, average trip length, average annual mileage, average fraction of mileage in urban driving, average sales mix, etc.

The present study is structured to consider differences in regional characteristics. A clear distinction will be made according to whether a car user lives within or near a large metropolitan area or in a small city/town or rural community. Considerable data is available from which the differences of interest can be assessed. The data sources include (1) national census surveys, (2) national transportation use-pattern surveys, and (3) state highway and car registration statistics. As discussed in the following sections, significant differences relative to the design and use of electric/hybrid vehicles are readily apparent.

Population data for 1970⁽⁷⁾ for urban and rural areas are given in Table 4-1. Those data indicate that about 60% of the US population lives in urban areas (central cities and suburbs) and about 40% lives in small cities/towns and rural communities. Table 4-2 indicates that about the same 60/40 split applies to urban Standard Metropolitan Statistical Areas (SMSAs) and to other areas. Therefore, when no other data is available, information pertinent to those living inside SMSAs is assumed appropriate to urban areas and information pertinent to those living

Table 4-1

POPULATION DISTRIBUTION, 1970⁽⁷⁾

<u>Residence</u>	<u>Percent</u>
Urban	
Inside urbanized areas	
Central cities	31.5
Urban fringe	<u>26.8</u>
Subtotal	58.3
Outside urbanized areas	15.2
Rural	<u>26.5</u>
Total	100.0
<u>Class</u>	
Urban	
Places of 1,000,000 or more	9.2
Places of 500,000 to 1,000,000	6.4
Places of 250,000 to 500,000	5.1
Places of 100,000 to 250,000	7.0
Places of 50,000 to 100,000	8.2
Places of 25,000 to 50,000	8.8
Places of 10,000 to 25,000	10.5
Places of 5,000 to 10,000	6.4
Places under 5,000	4.4
Unincorporated	<u>0.4</u>
Subtotal	73.5
Rural	
Places of 1,000 to 2,000	3.3
Places of up to 1,000	1.9
Other rural	<u>21.3</u>
Subtotal	<u>26.5</u>
Total	100.0

outside SMSAs is assumed appropriate to small cities/towns/rural communities. Information on the household ownership of vehicles in 1974 is given in Table 4-3. This indicates that approximately 70% of passenger cars are owned by people living in or on the fringe of metropolitan areas. However, only about 27% of the passenger cars are owned by those living in central city areas. This means that almost 75% of the passenger cars are used by people living in the less densely populated suburban, small city/town, and rural areas.

Table 4-2
POPULATION DENSITY, 1970⁽⁷⁾

Residence	Population Density (persons/mi ²)	Percent
Urban	2760	73.5
Rural	15	<u>26.5</u>
		100.0
Inside SMSAs [†]	360	
urban	NA*	60.5
rural	NA	<u>8.1</u>
Subtotal		68.6
Outside SMSAs [†]	20	
urban	NA	13.0
rural	NA	<u>18.4</u>
Subtotal		<u>31.4</u>
Total		100.0
*NA - Not available †SMSA - Standard Metropolitan Statistical Area		

It is also of interest to consider the differences in the annual vehicle miles driven by people living in various types of areas, and what fraction of their vehicle miles can be classified as urban (or highway). One approach to assess these differences considers the urban and rural miles driven in selected states relative to the number of passenger cars registered in each state.

Table 4-3
HOUSEHOLD OWNERSHIP OF VEHICLES, 1974 (7,8)

Residence	Total No. of Households (10 ⁶)	Passenger Cars (%)				Total No. of Pass. Cars (10 ⁶)	One or More Pickup Trucks (%)
		None	One	Two	Three or More		
Metropolitan areas	22.3	28.7	44.9	21.9	4.5	24	7.4
Central cities	26.2	11.7	47.2	33.2	7.9	37	15.5
Suburban rings							
Outside metropolitan areas	22.3	16.2	54.7	24.2	4.9	28	28.7
All households	70.8	18.5	48.8	26.8	5.9	89	17.1

Such statistical data for 1975 is given in Tables 4-4 and 4-5 taken from Refs. 7 and 8. As indicated in the tables, the annual miles per vehicle and the portion of those miles driven in urban areas varies significantly from state-to-state. In general, the vehicle miles per year are lower and the portion of those miles driven in urban areas is higher for the more populous states, especially those in the Northeast (e.g., Connecticut, New York, and Rhode Island). The national averages of about 10,000 vehicle miles/yr and 55% thereof driven in urban areas, respectively, are close to those given in Table 4-4 for all states combined. Since hybrid/electric vehicles are more likely to have greater market potential in more populous areas, the lower annual mileage and higher fraction of urban miles in those areas are particularly noteworthy. The effect of urban population on daily travel patterns will be discussed in a subsequent section of this report.

The differences in regional transportation needs as perceived by car buyers will also be reflected in the sales mix and its variations from State-to-State in the US. Detailed new car sales information is available each year from R.L. Polk. Such data for 1977 for domestic and imported passenger cars (Ref. 9) was used to calculate the sales mix information given in Table 4-6. The domestic cars were assigned to the four market classes -- small, compact, intermediate (or mid), standard (or full) -- according to the designations used by the US auto industry (see Table 4-7 taken from Automotive News, 1977 Market Data Book Issue). It is clear from Table 4-6 that there are significant differences in the sales mix between the various states depending primarily on the transportation needs and conditions in the respective states. A 1977 sales mix for urban and rural/small town areas has been inferred from the State-by-State results as indicated near the bottom of Table 4-6. Further, a sales mix for inside SMSAs and outside SMSAs was developed from the urban/rural sales mixes by using the 1977 national sales mix and 70/30 split between SMSAs and outside SMSAs. The difference between the national sales mix and that inferred for the SMSAs is probably not significant, but outside SMSAs sales mix is certainly significantly different from the national sales mix. As would be expected, persons living in less populous areas tend to buy larger cars than those living in more congested urban areas.

Projections as to how the sales mix will change in the next 5 to 10 years are rather difficult to make for at least three reasons. First, the US auto industry is reducing car sizes in each of the market classes, and the consumer response to these design changes is not yet clear. Second, as the Corporate Average Fuel Economy (CAFE) Standards become more difficult to meet, the pricing strategy of the auto industry can be expected to favor smaller cars. This is already becoming evident in 1979. Third, if the price of gasoline continues to increase at a rate faster than inflation, more car buyers can be expected to purchase cars somewhat smaller than they have been accustomed to. All of these factors will interact making it very difficult to assess

Table 4-4

VEHICLE MILES STATISTICS, 1975, Ref. 8.

State	10 ⁹ Vehicle Miles			Fraction Urban Miles
	Urban	Rural	Total	
Connecticut	14.7	3.5	18.2	0.807
Georgia	17.3	22.0	39.3	0.44
North Carolina	13.4	23.0	36.4	0.368
New York	42.5	22.6	65.1	0.653
New Jersey	38.3	10.2	48.5	0.790
Nebraska	4.7	6.5	11.2	0.420
Ohio	34.6	29.5	64.1	0.54
Pennsylvania	33.3	30.4	63.7	0.523
California	94.8	37.8	132.6	0.715
Massachusetts	23.5	5.6	29.1	0.808
Wisconsin	14.1	14.4	28.5	0.495
Iowa	8.0	11.6	19.6	0.408
Illinois	40.8	20.2	61.0	0.669
Indiana	18.8	18.6	37.4	0.503
Maryland	13.2	12.0	25.2	0.524
Rhode Island	4.7	1.0	5.7	0.825
Virginia	15.7	18.9	34.6	0.454
Michigan	35.3	22.9	58.2	0.607
Minnesota	14.2	11.5	25.7	0.553
<u>All</u>	729.4	600.6	1330.0	0.548

the relative importance of each of the factors even in the 1985 to 1990 time period. In the present report, it will be assumed that the sales mix will not change significantly in terms of the four classes (small, compact, mid, full), but it will be recognized that the size of the car typical of each class will become smaller as the downsizing programs of the auto industry continue. Hence, people will, in fact, be buying smaller cars in the next 5 to 10 years, but the class name assigned to them will be unchanged. For example, the Ford Fairmont is presently designated a compact car by the US Auto Industry, but that size car will be assigned to the mid-size category in future years. As discussed in the next section, classification of car sizes by passenger carrying capacity makes more sense and can more easily be projected into the future than the present system of using primarily car length and weight.

Table 4-5
PASSENGER CAR STATISTICS, 1975, Ref. 8.

State	Total Vehicle Miles (10 ⁹)	Car Registration (10 ⁶)	Miles Per Yr	Fraction Urban Miles
Connecticut	14.4	1.79	8045	0.807
Georgia	31.0	2.51	12350	0.440
North Carolina	28.7	2.86	10035	0.368
New York	51.4	6.74	7626	0.653
New Jersey	38.3	3.74	10241	0.790
Nebraska	8.9	0.82	10854	0.420
Ohio	50.6	6.29	8045	0.540
Pennsylvania	50.3	6.59	7633	0.523
California	104.7	11.22	9332	0.715
Massachusetts	23.0	2.78	8273	0.808
Wisconsin	22.6	2.13	10610	0.495
Iowa	15.5	1.54	10065	0.408
Illinois	48.1	5.35	8990	0.669
Indiana	29.5	2.57	11479	0.503
Maryland	19.9	2.07	9614	0.524
Rhode Island	4.5	0.50	9000	0.825
Virginia	27.3	2.71	10074	0.454
Michigan	45.9	4.63	9914	0.607
Minnesota	20.2	1.95	10358	0.553
<u>All</u>	1050.2	106.7	9843	0.548

In Section 5, where the rationale for the selection of the hybrid vehicle size and Reference ICE vehicle are discussed, it is recognized qualitatively that, in the future, some people will tend to buy a car in the next smaller category, but no attempt will be made to assess this effect quantitatively.

Table 4-6
 NEW CAR SALES MIX STATISTICS, 1977, Ref. 9.

Region	Yr	% Sales - New Cars			
		Small	Compact	Mid	Full
US	1977	23.9	23.3	24.3	27.6
US	1976	22.1	22.4	29.5	24.7
New Jersey	1977	22.3	25.8	23.9	28.0
New York	1977	19.1	27.0	25.8	28.1
Rhode Island	1977	25.0	30.8	25.0	19.2
Connecticut	1977	30.4	28.9	21.7	18.9
North Carolina	1977	26.1	21.3	26.2	26.4
Georgia	1977	23.6	19.9	29.7	26.9
Nebraska	1977	20.8	18.6	27.5	33.2
Indiana	1977	18.4	20.3	29.0	32.3
Wisconsin	1977	16.7	23.5	26.4	33.3
California	1977	28.1	28.2	24.3	19.5
Ohio	1977	19.1	23.2	27.1	30.7
Massachusetts	1977	26.2	29.5	23.5	20.8
Urban	1977	27.0	29.5	23.5	20.0
Rural	1977	18.5	21.0	28.0	32.5
SMSAs *	1977	26.4	24.6	23.0	26.1
Outside SMSAs **	1977	18.5	21.0	28.0	32.5

* 70/30 split in new car sales between SMSAs and outside SMSAs
 ** Taken to be same as rural States

Table 4-7

1977 MODELS -- BY MARKET CLASS

<u>Small *</u>	<u>Compact</u>
<u>SUBCOMPACTS</u>	<u>COMPACTS</u>
Astre	Aspen
Bobcat	Camaro
Chevette	Comet
Gremlin	Dart
Monza	Firebird
Mustang II	Granada
Pinto	Hornet
Skyhawk	Maverick
Starfire	Monarch
Sunbird	Nova
Vega	Omega
	Pacer
	Skylark
	Valiant
	Ventura
	Volare
<u>Mid-Size</u>	<u>Full-Size</u>
<u>INTERMEDIATES</u>	<u>STANDARD SIZE</u>
Century	STANDARD
Charger SE	Buick
Chevelle	Chevrolet
Cordoba	Chrysler
Coronet/Charger	Dodge
Cougar	Ford
Cutlass	Mercury
Diplomat	Oldsmobile
Elite	Plymouth
Fury	Pontiac
Grand Prix	Riviera
LeBaron	Thunderbird
LeMans	Toronado
LTD II	LUXURY STANDARD
Matador	Cadillac
Monaco	Eldorado
Montego	Lincoln
Monte Carlo	Mark V
Thunderbird	
Torino	
LUXURY INTERMEDIATE	
Seville	
Versailles	

*Imported cars were assigned to each class by manufacturer. For example, all Toyota, Datsun, and Honda sales were assigned to the small category. Other foreign manufacturers were assigned according to the size of their models with the highest sales. Information on foreign car sales is available from R.L. Polk by manufacturer only, not by model as for domestic cars.

4.2 MISSION SET DESCRIPTION

The use pattern of automobiles covers a wide range in terms of trip length, trip frequency, and trip purpose; certain combinations of which are suitable for hybrid vehicles, and others are not. Four general categories relating to trip purpose have been defined in the National Personal Transportation Study (NPTS):⁽¹⁰⁾

- Earning a living (work travel)
- Family business
- Civic, educational, and religious
- Social and recreational

In the present study the latter three categories have been consolidated and called personal travel. The relative contribution of each category in terms of annual mileage and annual trips is indicated in Table 4-8. This distribution is further modified depending upon whether incorporated or unincorporated areas are considered as indicated in Table 4-9. Thus, the specification of the place of residence becomes important in describing a vehicle mission profile. For purposes of the mission analysis presented in this report, the specification of the place of residence is divided into two general categories, i.e., inside and outside the Standard Metropolitan Statistical Areas (SMSAs).

The hybrid/electric vehicle is expected to have its most significant impact on petroleum consumption when operating under such conditions that its primary energy source is battery-stored energy. While an on-board heat engine can be used to recharge the battery, this mode of operation should be minimized in order to have maximum impact on petroleum savings. For this reason, the mission should focus on those applications where an all-electric mode of operation can be considered for the hybrid vehicle. This suggests that use patterns resulting in days of travel with daily mileage less than some prescribed value should be identified. The fact that a value of daily travel mileage is to be specified below which the hybrid will use electricity as the principal energy source does not suggest that the hybrid will be incapable of operating under conditions of daily travel beyond this value. Under such conditions, the hybrid vehicle will utilize the heat engine as its primary energy source and the battery system will function so as to load-level the heat engine. In this mode of operation, the hybrid vehicle range will be a function of the fuel storage capacity.

Daily travel less than the prescribed distance can be categorized in terms of random and non-random trips. Random trips are those which consist of varying length and frequency while non-random trips are those of known length and frequency (such as commuting to and from work). Trip length and frequency rather than whether a trip is random or non-random in nature are considerably more important in determining applicability of a

Table 4-8

DISTRIBUTION OF AUTOMOBILE TRIPS, VEHICLE MILES OF TRAVEL,
AND TRIP LENGTH BY TRIP PURPOSE

Trip Purpose	Percent of Automobile		Average Trip Length (miles)
	Trips	Travel	
Earning a living			
Home-to-work	31.9	33.7	9.4
Related business	4.3	7.9	16.1
Subtotal	36.2	41.6	10.2
Family business			
Shopping	15.2	7.5	4.4
Medical and dental	1.8	1.6	8.4
Other	14.0	10.2	6.5
Subtotal	31.0	19.3	5.6
Civic, educational and religious	9.3	4.9	4.7
Social and recreational			
Visiting friends and relatives	8.9	12.1	12.0
Pleasure driving	1.4	3.1	20.0
Vacations	0.1	2.5	160.0
Other	12.0	15.3	11.4
Subtotal	22.4	33.0	13.1
Other and unknown	1.1	1.2	9.4
Total	100.0	100.0	8.9

Table 4-9
 PERCENT OF AUTOMOBILE TRIPS AND VEHICLE MILES OF TRAVEL BY TRIP PURPOSE AND PLACE OF RESIDENCE -- IN ALL AREAS AND SELECTED PLACES

Trip Purpose	Place of Residence			All Areas and Places
	Unincorporated Areas	Incorporated Places		
		1,000,000 and Over	All	
	Automobile Trips (%)			
Earning a living	35.8	46.3	36.5	36.2
Family business	31.5	25.9	30.8	31.0
Civic, educat. and religious	10.0	8.8	8.9	9.3
Social and recreational	21.4	17.9	22.8	22.4
Other	1.3	1.1	1.0	1.1
Total	100.0	100.0	100.0	100.0
	Vehicle Miles of Travel (%)			
Earning a living	41.8	50.7	41.5	41.6
Family business	21.5	12.5	18.0	19.3
Civic, educat. and religious	6.0	4.9	4.3	4.9
Social and recreational	29.0	31.4	35.3	33.0
Other	1.7	0.5	0.9	1.2
Total	100.0	100.0	100.0	100.0

hybrid vehicle. However, whether a trip is random or non-random is crucial in performing a statistical analysis in order to predict trip behavior; therefore, the distinction must be recognized.

The methodology used for predicting daily and annual driving patterns (described in detail in Section 4.3) is basically that of Schwartz, (11) Surber and Deshpande (12) in which a Poisson distribution is used to generate the number of days per year in which a specified number of trips is taken, and a Monte Carlo simulation is used to generate the length of these trips. Schwartz, however, applied this technique to all travel regardless of whether the trips were random or not. Surber and Deshpande did account for the non-random nature of travel-to-work by excluding such trips from their random trip length generation.

For reasons discussed above it is preferable to describe a mission set in terms of random and non-random trips both inside and outside SMSAs rather than use the four categories outlined in the NPTS. Thus, a total of eight mission sets have been specified and analyzed as part of this task. One mission set includes only personal business travel inside the SMSAs consisting entirely of random trips in terms of both frequency and length. Another set includes the combination of the first set with trips to work inside the SMSAs which are non-random both in frequency and trip length. A third set includes all personal business travel, trips to work, and any other random trips resulting in a daily travel of less than 100 miles, again inside the SMSAs. Thus, this third set includes all travel with the exception of travel resulting in more than 100 miles in one day which may be construed to represent intercity travel. The fourth set includes all travel regardless of daily mileage. The other four sets of the eight are the same as the four sets described except that they occur outside of the SMSAs rather than inside. These eight-mission sets are summarized in Table 4-10.

Table 4-10

MISSION SETS TO BE ANALYZED

<u>Inside SMSAs</u>	<u>Outside SMSAs</u>
Personal business travel only	Personal business travel only
Personal business plus trips to work	Personal business plus trips to work
All-purpose (except trips of 100 or more miles per day)	All-purpose (except trips of 100 or more miles per day)
All purposes	All purposes

It should be mentioned again that the reason for excluding daily travel in excess of some value (100 miles per day) is to assess the impact of the hybrid vehicle in applications where battery-stored energy is the primary energy source. Daily travel in excess of this value will be accomplished with the heat engine as the primary energy source with the battery system serving only to load-level the heat engine.

4.3 TRAVEL CHARACTERISTICS

The travel characteristics of an automobile consist of three main factors:

- Annual mileage
- Daily travel in terms of number of trips and trip length
- The particular driving mode or cycles which characterize the method in which daily travel is accomplished

In many cases, the test or survey data which defines these three factors is limited or nonexistent. In such cases, estimates have been made, or interpolation/extrapolation has been used, to augment limited data. The methodology employed to analyze the above three factors in order to characterize the mission sets outlined in Section 4.2 are described below.

4.3.1 ANNUAL USE

Considerable data is available to evaluate average annual vehicle miles. Such a set of data is the Highway Statistics published annually by the Federal Highway Administration under the Department of Transportation. An example of such data is presented in Tables 4-11 and 4-12. The disadvantage of such data is that it permits determination of average annual vehicle mileage only and does not give a fractional distribution of vehicle annual mileage. The NPTS⁽¹³⁾ includes data on annual mileage distribution; this data is presented in Table 4-13. This data is limited in that it is ten years old and gives no information regarding annual mileage distribution with regard to work trips, personal business, intercity travel, etc. In the absence of such data an estimate has been made for annual mileage versus percent of automobiles as indicated in Figure 4-1. Estimates are shown for personal business only both inside and outside SMSAs as well as for all-purpose trips both inside and outside SMSAs. The curve for all-purpose travel inside SMSAs is taken to be essentially parallel to the data in Table 4-13, but depressed for any given percentile because the data in Table 4-13 represents annual mileage for all vehicles; and vehicles inside SMSAs tend to have lower annual mileage than the national average. The curve for all-purpose travel outside SMSAs is: (1) elevated above that for inside SMSAs because of the higher annual mileage characteristic of vehicles outside SMSAs, and (2) somewhat flatter (less slope) than that for inside SMSAs because people living outside of SMSAs in geographically smaller communities tend to take more relatively short trips due to the limited size of the area. The curves for personal business are taken to have annual mileages of approximately 46% of the all-purpose figures at any given percentile since this is approximately the percentage of annual mileage accounted for by family business and civic, educational, religious, and social travel as indicated in the NPTS data.⁽¹⁰⁾

Table 4-11
ESTIMATED MOTOR VEHICLE TRAVEL IN THE UNITED STATES AND RELATED DATA - 1974 (1)

TABLE 4-11
DECEMBER 1975

Source: Program Management Division
Office of Highway Planning, FHWA

ITEM	PASSENGER VEHICLES						CARGO VEHICLES ^{1/}				ALL MOTOR VEHICLES	
	PERSONAL PASSENGER VEHICLES			BUSES			ALL PASSENGER VEHICLES	SINGLE-UNIT TRUCKS	COMBINATION TRUCKS	ALL TRUCKS		
	PASSENGER CARS ^{2/}	MOTOR-CYCLES ^{2/}	ALL PERSONAL PASSENGER VEHICLES	COMMERCIAL	SCHOOL	ALL BUSES						
Motor-vehicle travel: (million vehicle-miles)												
Main rural roads			314,752		520	1,555	216,557	95,504	43,741	1,291,545	446,212	
Local rural roads			113,352		1,010	1,100	114,452	21,335	1,474	22,510	137,262	
All rural roads			428,134		1,930	2,955	431,119	107,140	45,215	1,52,355	583,474	
Urban streets			589,757		520	2,075	591,332	104,229	10,110	114,339	706,171	
Total travel	995,544	22,347	1,017,891	2,450	2,450	5,050	1,022,951	211,369	55,325	266,654	1,289,645	
Number of vehicles registered (thousands)	104,817.4	4,566.4	109,383.8	30.1	356.8	446.9	110,270.7	23,524.4	1,064.6	24,589.0	134,859.7	
Average miles traveled per vehicle	9,494	4,500	9,262	28,968	6,867	11,322	9,277	9,585	51,968	10,346	9,563	
Fuel consumed (million gallons)	73,797	4.7	74,244	525	333	855	75,102	21,116	10,023	31,199	106,301	
Average fuel consumption per vehicle (gallons)	70.4	90	67.6	5,227	933	1,320	681	5.2	5,471	1,259	788	
Average miles traveled per gallon of fuel consumed	13.45	50.00	13.71	4.97	7.32	5.90	13.62	10.01	5.49	8.55	12.13	

^{1/} For the 50 States and District of Columbia.
^{2/} Separate estimates of passenger car and motorcycle travel are not available by highway category.

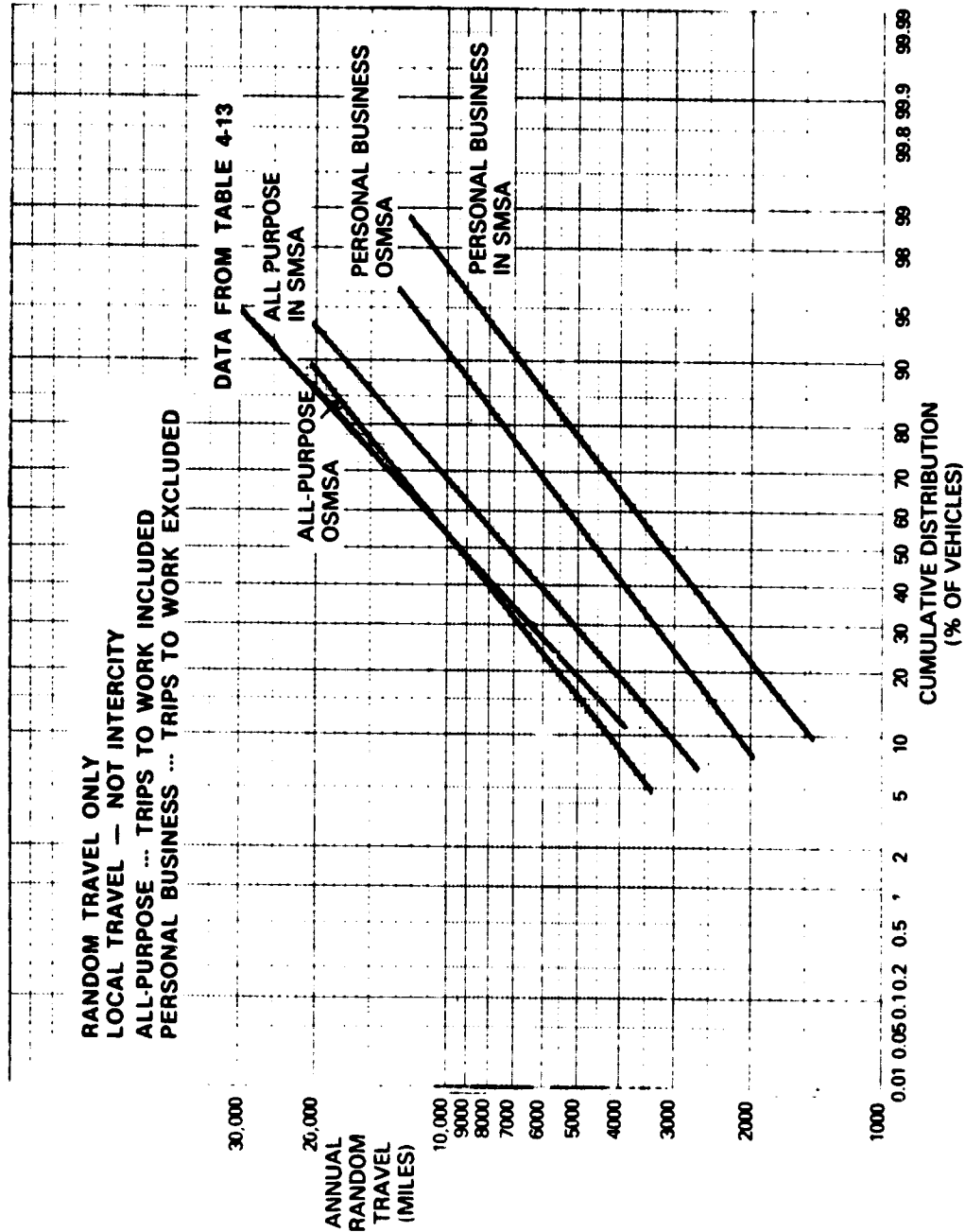

Figure 4-1. Annual Random Travel Mileage Characteristics

Table 4-12
VEHICLE MILES, BY STATE AND H

Source: Program Management Division
Office of Highway Planning, FHWA

(In millions of miles)

FEDERAL HIGHWAY ADMINISTRATION REGION	STATE	FEDERAL-AID HIGHWAY SYSTEM													
		INTERSTATE RURAL			INTERSTATE URBAN			TOTAL INTER-STATE	OTHER PRIMARY			SECONDARY			
		FINAL 01	TRAVELED WAY 1/ 31	TOTAL RURAL	FINAL 02	TRAVELED WAY 2/ 32	TOTAL URBAN		RURAL 03	URBAN 04	TOTAL	STATE RURAL 05	STATE URBAN 06	LOCAL RURAL 07	
REGION 1	Connecticut	819	248	1,067	2,777	459	3,236	4,303	1,298	1,880	3,178	1,051	909	-	
	Maine	600	151	751	108	14	124	875	1,542	1,28	2,070	1,023	214	-	
	Massachusetts	1,795	123	1,918	3,401	1,391	4,792	6,710	2,165	9,055	11,220	491	1,102	-	
	New Hampshire	685	27	712	200	59	259	971	1,441	361	1,792	424	114	-	
	New Jersey	966	108	1,074	3,795	946	4,741	5,815	3,020	8,835	9,080	66	56	1,77	
	New York	3,384	302	3,686	6,953	409	7,362	11,048	8,753	13,435	22,185	2,420	1,944	1,77	
	Rhode Island	140	21	161	666	78	744	1,106	312	1,055	1,367	247	89	-	
	Vermont	523	37	560	48	56	516	616	915	278	1,193	449	15	17	
Total	8,832	1,017	9,849	18,148	3,367	21,515	31,364	19,444	42,632	52,076	6,611	4,884	4,55		
REGION 3	Delaware	144	(2)	144	346	(2)	346	490	981	583	1,564	417	234	-	
	Dist. of Col.	1,482	-	1,482	3,332	430	3,762	5,244	3,563	6,771	10,055	1,826	1,600	-	
	Maryland	5,981	341	6,322	2,906	744	3,650	9,772	9,641	15,209	24,540	2,792	4,864	-	
	Pennsylvania	3,393	480	3,873	2,000	881	2,881	5,756	2,445	4,903	2,491	406	24	-	
	Virginia	1,028	371	1,399	257	125	382	1,781	2,222	1,098	3,320	1,472	270	1,1	
	West Virginia	-	-	-	-	-	-	-	-	-	-	-	-	-	
	Total	11,928	1,192	13,120	9,029	2,340	11,369	24,499	21,865	25,071	46,936	14,488	7,578	4,2	
REGION 4	Alabama	1,653	576	2,229	813	586	1,399	3,628	5,070	4,149	9,219	1,882	340	1,1	
	Florida	3,710	1,275	4,985	2,742	1,185	3,928	8,913	6,272	3,282	10,154	4,946	2,230	1,4	
	Georgia	4,186	683	4,869	3,427	112	3,539	8,409	6,909	2,325	9,234	1,473	413	1,9	
	Kentucky	2,904	158	3,062	972	537	1,409	4,651	3,004	2,315	7,319	4,340	840	1,4	
	Mississippi	1,451	120	1,571	443	353	796	2,367	4,697	1,061	5,758	1,107	107	1,4	
	North Carolina	2,383	778	3,161	1,112	592	1,704	4,865	6,502	3,038	9,540	10,801	3,136	1,1	
	South Carolina	2,396	260	2,656	709	30	739	3,355	6,132	3,123	9,255	3,425	1,332	1,1	
	Tennessee	4,100	130	4,230	2,578	232	2,810	7,040	6,394	4,690	11,084	1,506	277	1,1	
	Total	22,823	3,980	26,803	12,796	3,628	16,424	43,227	47,580	23,983	71,563	31,621	8,695	8,1	
REGION 5	Illinois	4,277	768	5,045	6,667	498	7,165	12,207	8,464	10,091	18,555	844	1,141	1,1	
	Indiana	4,125	122	4,247	2,701	273	2,974	7,221	6,794	2,714	9,508	3,881	1,098	1,1	
	Michigan	3,306	117	3,423	1,075	1,075	6,099	9,522	6,891	7,398	14,299	1,796	301	6,1	
	Minnesota	1,164	183	1,347	2,052	469	2,521	3,868	4,903	3,491	8,394	1,094	104	3,1	
	Ohio	5,988	10	6,008	8,104	664	8,768	14,766	7,839	7,629	11,468	5,116	2,515	2,1	
	Wisconsin	1,985	190	2,175	1,123	351	1,474	3,609	5,814	3,356	9,170	2,191	6	2,1	
	Total	20,845	1,350	22,195	25,670	3,328	28,998	51,193	40,705	34,679	75,384	14,882	5,221	14,1	
REGION 6	Arkansas	1,553	-	1,553	636	-	636	2,189	3,237	1,395	4,632	2,783	-	-	
	Louisiana	1,404	49	1,453	1,269	99	1,368	1,251	2,948	1,994	4,942	4,281	1,095	-	
	New Mexico	1,627	253	1,880	425	127	552	2,532	1,862	704	2,446	1,182	198	-	
	Oklahoma	2,246	42	2,288	1,469	-	1,469	1,657	4,080	1,468	5,548	2,657	740	-	
	Texas	6,910	1,114	8,024	9,788	467	10,255	15,284	12,259	5,427	22,686	8,845	3,140	-	
	Total	13,745	1,898	15,643	13,587	693	14,280	29,923	24,386	14,088	39,374	19,728	4,702	-	
REGION 7	Iowa	1,814	196	2,010	667	184	851	2,861	5,905	1,729	7,634	-	-	-	
	Kansas	1,495	18	1,513	719	90	764	2,282	4,301	1,396	5,697	653	-	-	
	Missouri	3,071	410	3,481	3,405	189	3,594	7,079	5,989	1,963	7,952	4,447	1,034	-	
	Nebraska	1,163	-	1,163	368	20	388	1,551	3,064	826	3,890	600	-	-	
	Total	7,543	624	8,167	5,169	443	5,612	13,773	19,239	5,904	25,143	5,706	1,064	-	
REGION 8	Colorado	1,709	184	1,893	1,400	-	1,400	3,303	2,858	2,162	5,020	1,403	313	-	
	Montana	772	335	1,107	67	-	67	1,174	1,468	262	1,930	92	-	-	
	North Dakota	464	33	497	44	3	47	644	1,304	206	1,600	244	-	-	
	South Dakota	815	143	958	34	5	39	997	1,765	307	2,071	304	-	-	
	Utah	758	693	1,451	1,026	52	1,078	2,529	1,061	764	1,827	644	477	-	
	Wyoming	964	111	1,075	36	-	36	1,111	1,013	93	1,106	273	-	-	
Total	5,582	1,509	7,091	2,607	68	2,675	9,766	9,670	3,886	13,556	2,983	1,014	-		
REGION 9	Arizona	1,724	708	2,432	495	74	574	3,106	1,777	699	2,476	504	-	-	
	California	6,444	1,234	7,678	17,044	3,481	20,525	21,277	11,635	24,912	36,517	2,423	811	-	
	Hawaii	64	120	184	403	189	592	776	840	626	1,476	216	24	-	
	Nevada	745	114	859	112	10	162	1,021	742	455	1,237	343	-	-	
	Total	8,977	2,140	11,117	18,134	3,844	22,053	33,200	15,044	28,567	40,706	3,946	1,142	-	
REGION 10	Alaska	925	169	1,094	131	10	141	1,235	691	448	1,139	243	-	-	
	Hawaii	1,923	24	1,947	1,184	84	1,268	1,224	2,459	1,428	4,104	1,148	-	-	
	Oregon	1,278	712	2,000	3,113	202	3,315	4,342	3,829	3,829	6,914	1,144	-	-	
	Washington	4,121	925	5,046	4,454	87	4,541	9,781	7,401	6,224	14,024	4,184	1,440	-	
Total	10,409	14,665	25,070	19,677	1,073	20,750	26,177	20,714	17,125	39,742	10,119	2,584	-		
U. S. Total		104,408	14,665	119,073	109,647	18,028	127,675	246,718	207,714	171,226	378,942	17,114	10,212	50	

1/ Travelled-way includes travel on highways in the Interstate System status of completion group 2. This group consists of all those which is adequate for present traffic but will need further construction and improvement to bring it to full Interstate standards. In some instances there are divided highways with full control of access and in others they are two-, three-, or four-lane undivided highways with no access control.

Table 4-12

CLE MILES, BY STATE AND HIGHWAY SYSTEM - 1974

(In millions of miles)

TABLE 4-2
NOVEMBER 1975

TOTAL INTER-STATE	FEDERAL AID HIGHWAY SYSTEM									NOT ON FEDERAL-AID SYSTEM						TOTAL RURAL	TOTAL URBAN AND MUNICIPAL	TOTAL										
	OTHER PRIMARY			SECONDARY						FEDERAL AID URBAN	TOTAL FEDERAL AID RURAL	TOTAL FEDERAL AID URBAN	TOTAL FEDERAL AID	OTHER STATE RURAL	OTHER STATE AND MUNICIPAL				LOCAL RURAL	LOCAL URBAN AND MUNICIPAL								
	RURAL	URBAN	TOTAL	STATE RURAL	STATE URBAN	LOCAL RURAL	LOCAL URBAN	TOTAL	14												15	16	17	18	19	20	21	22
4,303	1,299	1,890	3,176	1,051	909	6	40	2,008	1,106	3,420	7,171	10,591	294	1,436	286	5,438	3,950	14,045	18,005									
475	1,542	2,017	2,070	1,023	214	-	-	1,217	101	3,316	967	4,283	1,116	313	433	4,685	1,885	1,828	6,713									
4,770	2,841	9,055	11,220	491	1,102	116	2,436	4,845	2,928	5,390	20,310	25,700	37	869	525	1,106	5,952	22,285	28,237									
4,835	1,441	341	1,792	424	114	4	4	946	528	2,811	1,244	4,177	213	173	370	1,249	1,829	47,284	5,078									
11,048	3,020	6,060	9,080	66	56	1,738	1,747	3,617	6,958	5,915	19,572	25,490	935	2,944	3,578	14,297	16,431	44,177	65,262									
1,105	8,753	13,435	22,189	2,420	1,984	1,790	1,343	7,533	4,572	16,649	741	28,697	3,465	4,206	51	122	1,102	914	4,630									
616	312	1,015	1,367	247	49	21	217	974	759	2,138	352	2,500	67	3	210	244	2,415	609	3,024									
31,364	19,444	37,632	52,076	6,611	4,894	4,544	5,910	21,854	16,049	40,453	81,790	122,243	2,836	6,325	9,602	38,101	52,491	126,216	170,107									
490	981	583	1,564	417	238	-	-	655	667	1,542	1,614	3,196	-	-	126	193	1,468	1,807	3,475									
4,244	3,563	1,045	1,065	1,826	1,600	505	464	552	164	2,063	2,662	2,063	-	-	84	84	2,724	2,957	2,957									
9,772	9,441	15,209	24,960	4,792	4,864	71	109	11,826	912	7,376	9,622	17,058	540	72	3,502	2,724	11,418	18,478	23,896									
1,751	2,222	1,098	3,320	1,572	270	1,197	73	7,141	3,042	11,733	10,109	25,842	172	166	2,077	5,377	17,992	15,652	31,634									
24,489	21,865	25,071	46,936	14,468	7,578	4,274	1,352	21,702	4,747	33,757	50,017	103,774	4,391	2,812	10,807	19,897	68,955	72,732	141,687									
3,628	5,070	4,149	9,219	1,882	340	1,307	312	3,861	348	10,498	6,578	17,066	42	81	1,342	5,381	11,872	12,050	23,922									
8,813	6,872	3,282	10,154	4,946	2,230	1,928	537	9,651	10,917	18,741	20,934	39,676	1,420	1,172	3,882	15,872	24,043	37,978	62,022									
4,651	6,909	2,325	9,234	3,473	413	1,979	613	6,478	351	17,230	7,241	24,471	93	534	2,539	7,445	19,562	15,220	35,082									
2,367	4,651	4,004	7,319	4,340	940	250	90	5,580	39	12,775	5,313	18,089	1,457	660	1,184	2,421	17,437	8,394	23,811									
4,865	4,697	1,061	5,758	1,107	1,440	344	344	3,004	714	8,221	3,022	11,843	8	8	627	1,248	9,456	4,278	13,734									
3,355	4,865	6,502	3,038	9,440	10,891	3,136	3	14,051	940	20,557	8,839	29,396	1,883	647	40	3,034	22,480	12,580	35,000									
7,040	6,394	3,123	9,255	2,426	1,332	173	22	4,953	-	12,347	5,216	17,563	416	1,360	433	240	11,196	6,816	20,012									
43,227	47,580	23,983	71,564	11,621	8,694	8,192	2,160	50,664	14,417	114,192	65,679	179,871	5,387	4,467	12,288	42,325	131,867	112,471	244,338									
12,207	8,464	10,091	18,555	844	1,141	1,232	734	4,651	3,847	16,285	22,975	39,260	1,091	2,471	2,694	13,694	20,070	39,140	59,210									
9,522	6,794	2,714	9,508	3,881	1,098	1,977	125	7,281	4,768	16,899	11,679	28,578	140	99	6,597	18,418	18,575	36,993										
3,868	4,903	3,431	8,334	1,756	301	6,623	1,377	10,057	12,136	18,693	27,321	46,204	24	50	3,105	6,366	21,522	33,927	55,749									
14,766	7,839	7,629	15,468	5,116	2,515	2,658	2,799	13,088	1,830	21,611	23,541	45,152	13	49	1,974	4,796	12,611	11,977	24,588									
3,609	5,814	3,356	9,170	2,191	6	1,851	609	4,657	3,707	11,992	9,152	21,143	72	2	1,864	4,844	13,927	14,038	27,965									
51,193	40,705	34,679	75,384	14,882	5,224	18,324	6,271	44,702	27,017	96,106	102,190	198,296	1,600	3,037	16,498	48,158	114,204	153,385	267,589									
2,189	3,237	1,395	4,632	2,783	559	270	106	3,718	520	7,843	3,216	11,059	93	72	980	1,311	8,916	4,599	13,515									
3,251	2,948	1,994	4,942	4,281	1,055	3	-	5,329	2,400	9,105	6,827	15,932	946	456	1,412	699	11,463	8,082	19,445									
2,532	1,862	704	2,566	1,182	198	10	6	1,397	1,341	4,934	2,901	7,833	118	50	588	847	5,640	3,798	9,438									
1,657	4,080	1,468	5,548	2,657	740	339	1,158	4,094	2,444	4,564	7,179	16,743	365	21	1,057	3,308	10,996	21,494	24,980									
15,284	12,259	9,827	21,646	8,845	3,140	-	-	11,985	6,355	29,133	29,177	58,310	1,583	753	3,451	14,594	34,167	44,528	78,691									
29,923	24,386	14,498	39,374	19,728	5,702	822	1,270	27,522	13,060	60,579	49,300	109,879	3,105	1,452	7,448	20,759	71,172	71,511	142,683									
2,861	5,905	1,729	7,634	-	-	2,317	460	2,777	578	10,232	3,618	13,850	102	59	941	4,113	11,275	7,790	19,065									
2,892	4,301	1,326	5,687	653	34	1,531	517	2,739	476	8,002	3,182	11,184	71	33	1,237	2,678	9,310	5,893	15,203									
7,079	5,969	1,963	7,932	4,447	1,036	10	32	4,425	3,182	13,907	9,811	23,718	54	230	1,816	1,892	15,777	13,931	29,710									
1,551	3,064	826	3,890	600	15	842	113	1,570	401	5,660	1,747	7,416	5	-	2,854	6,339	6,339	4,601	10,940									
13,773	19,239	5,904	25,143	5,700	1,084	4,704	1,122	12,611	4,641	19,410	18,358	56,168	232	322	4,619	13,437	42,701	32,217	74,918									
3,303	2,858	2,162	5,020	1,403	333	-	-	1,736	1,880	6,164	5,793	11,947	24	16	1,786	2,383	7,974	8,182	16,156									
1,174	1,668	212	1,934	92	379	1	1	472	430	3,246	750	4,006	-	-	1,135	682	4,481	1,442	5,823									
644	1,304	296	1,600	296	2	523	23	734	279	2,710	617	3,327	1	2	722	269	3,433	938	4,371									
997	1,766	307	2,073	305	-	476	12	791	114	3,505	472	3,977	29	2	560	525	4,094	999	5,093									
2,529	1,061	766	1,827	604	677	149	210	1,640	31	1,265	2,762	6,027	27	101	544	718	3,846	3,601	7,457									
1,119	1,013	93	1,106	273	7	17	3	300	186	2,179	333	2,512	2	1	381	357	2,761	691	3,452									
9,766	9,670	1,886	13,556	2,953	1,014	1,544	249	5,775	2,928	21,268	10,757	32,025	83	122	5,148	4,974	26,499	15,853	42,352									
3,106	1,777	699	2,476	504	61	1,047	1,206	3,510	484	7,710	4,305	10,016	249	4	1,198	1,979	7,197	8,289	14,486									
28,297	11,615	21,842	35,517	2,921	891	4,000	4,845	12,459	24,408	28,230	74,751	100,981	55	12,500	11,900	34,998	88,606	127,600										
776	850	626	1,476	216	24	50	167	244	244	1,307	1,035	2,343	15	-	241	771	1,603	2,317	3,920									
1,021	782	455	1,237	341	54	117	600	2,101	1,025	2,101	1,025	3,126	28	25	175	2,304	2,304	1,917	4,194									
33,200	15,044	25,662	40,706	3,986	1,032	4,211	6,887	17,116	24,984	35,188	81,618	117,006	556	84	14,354	19,401	50,298	101,103	151,401									
1,215	641	448	1,139	71	71	-	-	128	-	844	521	1,465	-	6	308	122	1,252	841	2,095									
1,221	1,422	340	1,992	68	106	71	1	1,222	-	1,458	791	4,219	-	-	653	789	4,117	1,440	5,417									
1,142	2,659	1,525	4,184	1,188	428	1,008	146	3,344	1,882	7,992	10,792	18,479	46	52	2,950	1,191	9,706	5,417	15,231									
9,901	7,901	6,223	14,024	3,168	1,442	3,011	1,511	9,562	1,588	12,068	11,907	34,975	78	56	5,741	4,720	24,889											

Table 4-13
 PERCENTAGE DISTRIBUTION OF AUTOMOBILES
 vs ANNUAL MILES TRAVELED

<u>Annual Mileage</u>	<u>Percent of Automobile</u>
<500	2.6
1,000- 3,000	8.4
3,000- 7,000	27.1
7,000-12,000	34.1
12,000-17,000	11.0
17,000-22,000	7.6
22,000-27,000	3.8
>27,000	5.4
	<u>100.0</u>

4.3.2 DAILY TRAVEL PATTERNS

The 1969 Nationwide Personal Transportation Study represents the most comprehensive study of personal driving habits published to date, and the data from this study has been issued in a series of reports. While this data is now ten years old, it is the only published data available and has been used for a number of analyses such as those by Schwartz, (11) Surber and Deshpande. (12)

The NPTS data is very comprehensive but covers trip purposes or missions other than the mission sets outlined in Section 4.2. Accordingly, only selected portions of the NPTS data have been used in defining daily travel patterns in this investigation. Specifically, the data used include the percent of annual trips and percent of annual vehicle miles versus trip length range as taken from Schwartz (11) and presented here in Table 4-14. Additional data used includes average trip length for different purposes both inside and outside of SMSAs. This latter data is included in Table 4-15.

The data included in these two tables has been used to predict daily travel patterns consistent with the mission sets outlined in Section 4.2. The specific methodology for accomplishing this prediction is the following. A computer program was written to simulate daily travel patterns by using a Poisson distribution and a Monte Carlo simulation in a manner similar to that of Schwartz (11) and Surber and Deshpande. (12) The Poisson distribution determines both the number of days per year in which a specified number of trips (i.e., 0, 1, 2, etc.) will be taken as well as the total number of trips per year. The Poisson distribution requires as known data the average number of trips per day, this being merely the annual mileage divided by the product of 365 days per year and the average trip length. A sample Poisson distribution is given in Table 4-16.

Table 4-14

ANNUAL TRAVEL CHARACTERISTICS BY TRIP LENGTH

Trip Length (miles one way)	Percent of Annual Trips	Percent of Annual Vehicle Miles
<5	54.1	11.1
5-10	19.6	13.8
10-15	13.8	18.7
15-20	4.3	9.1
20-30	4.0	11.8
30-40	1.6	6.6
40-50	0.8	4.3
50-100	1.0	7.6
>100	0.8	17.0

Source: Schwartz⁽¹¹⁾

Table 4-15

AVERAGE TRIP LENGTH

Trip Purpose	Average Trip Length, Miles	
	Inside SMSAs	Outside SMSAs
All purposes	8.4	9.8
Family business	4.9	6.7
Social and recreational	13.0	13.3

Source: NPTS⁽¹⁰⁾

Table 4-16
 POISSON DISTRIBUTION OF TRIPS PER DAY

Number of Trips Per Day, X	Calculated Annual Probability, P(X)	Number of Days Per Year with X Trips	Total Number of Trips
0	0.159	58	0
1	0.292	107	107
2	0.269	98	196
3	0.165	60	180
4	0.076	28	112
5	0.028	10	50
6	0.009	3	18
7	<u>0.002</u>	<u>1</u>	<u>7</u>
	0.999	365	670

Table 4-16 uses the Poisson distribution equation

$$P(X) = \frac{\lambda^X e^{-\lambda}}{\lambda!}$$

where

λ = average number of trips per day

X = number of trips per day (0,1,2,-----)

The numbers presented in Table 4-16 are based on an annual mileage of 4500 miles and an average trip length of 6.7 miles so that the average number of trips per day is

$$\lambda = \frac{(4500)}{(365)(6.7)} = 1.84$$

The Monte Carlo simulation then uses a random number generator to predict a trip length for each of the total annual trips to represent the annual driving pattern of one vehicle. The number of days in which daily travel is within a specified mileage range as well as the total annual mileage represented by these days is determined. This simulation is then repeated many times (approximately 300), and averages are taken to determine average annual mileage, average number of days per year with daily mileage within a given mileage range, and the annual mileage within the same mileage range.

The use of a Monte Carlo simulation requires the use of a distribution function for the variable being simulated which in

this application is the trip length. The distribution function in this investigation was generated by using the data in Table 4-14 in conjunction with the average annual mileage and total annual trips as given in Table 4-16 to calculate an average trip length in a specified trip length range. The average trip length in a specified range was calculated using the following relation:

$$L_{AVG} = \frac{(AM) \cdot (P_{AM})}{(AT) \cdot (P_{AT})}$$

where

L_{AVG} = average trip length in a specified range

AM = annual mileage

AT = annual number of trips

P_{AM} = percentage of annual mileage in a specified range

P_{AT} = percentage of annual trips in a specified range

The annual number of trips is obtained by using the Poisson distribution as indicated in Table 4-16. The average trip length for various mileage ranges can thus be obtained by using the above equation and the data in Tables 4-14 and 4-16. The results for such calculations are presented in Table 4-17. The column labeled cumulative distribution is the summation of the percent of annual trips in a given mileage category, and this very column represents the distribution function for the average trip length. Thus, these last two columns are used to generate the probability function for use in the Monte Carlo simulation. The average trip length for each mileage range is assumed to occur at the middle of the distribution function range, and the distribution function is represented by a series of straight lines connecting such points.

Table 4-17

CUMULATIVE DISTRIBUTION OF TRIP LENGTH

Trip Length (miles one way)	Percent of Annual Trips, P _{AT}	Percent of Annual Vehicle Miles, P _{AM}	Average Trip Length, Miles, R _{AVG}	Cumulative Distribution
0-5	54.1	11.1	1.38	0.541
5-10	19.6	13.8	4.73	0.737
10-15	13.8	18.7	9.10	0.875
15-20	4.3	9.1	14.21	0.918
20-30	4.0	11.8	19.81	0.958
30-40	1.6	6.6	27.71	0.974
40-50	0.8	4.3	36.10	0.982
50-100	1.0	7.6	51.04	0.992
> 100	0.8	17.0	142.72	1.000

The trip length distribution function is dependent not only upon the annual mileage but also upon the percent of annual trips and the percent of annual vehicle miles within a given trip mileage range. In the present investigation, as in all previous studies (References 3 and 11), the percent of annual trips and percent of annual vehicle miles represented by a given trip mileage range were assumed to be independent of annual mileage, i.e., the data presented in Table 4-14 is assumed to be constant and independent of annual mileage. Such an assumption is questionable since it would seem likely that a change in annual mileage would cause a redistribution of percent trips and percent vehicle miles within given trip mileage ranges. However, since the only published data available is the NPTS data presented in Table 4-14, this data was used independently of the annual mileage.

In summary, the computer program described above requires the average annual mileage and average trip length as input parameters. Internally, the program computes a Poisson distribution similar to Table 4-16. The total annual number of trips from this computation is then used with the data given in Table 4-14 and the average annual mileage to generate a distribution function similar to the last two columns of Table 4-17. This distribution function is then used in a Monte Carlo simulation resulting in an output of average annual mileage, average number of days in which total travel is within a specified mileage range, and the total annual mileage driven within this specified mileage range.

This computer program was used to simulate annual driving characteristics for mission sets defined in Section 4.1. Inasmuch as the computer program by design simulates random travel, the program was used to augment non-random travel. For example, travel characteristics for work trips plus personal business were obtained by using the computer program to generate random trip data for the personal business portion only, and work trip data (which is predictable and non-random) was added to the personal business travel. As indicated above, the computer program requires average annual mileage and average trip length as input parameters. The average annual mileage for personal business and for all-purpose (excluding intercity travel) were taken from Figure 4-1 at the 30th, 50th, 75th, and 90th percentile. The average trip length was obtained by using the values from Table 4-15 designated therein as all purpose and family business to represent the all-purpose and personal business travel designation of this investigation. Inasmuch as average trip length is expected to vary with annual mileage, the following relationship was assumed to relate average trip length to annual mileage

$$L_{AVG}(X) = \sqrt{\frac{AM(Y)}{AM(50)}}$$

where X denotes the X th percentile, and AM annual mileage. The average trip lengths given in Table 4-15 are taken as the average trip lengths for the 50th percentile. The average annual mileage and average trip length for various purposes and percentiles were

obtained by using the above relationship, the data from Table 4-15, and from Figure 4-1. These data, shown in Table 4-18, were used in the computer program to generate random trip data and annual driving characteristics. Annual mileage for days in which travel exceeded 100 miles was subtracted from the total mileage. This was done with the assumption that daily travel in excess of 100 miles would represent intercity travel. The results of these computations are presented in Figures 4-2 and 4-3. Inclusion of daily travel in excess of 100 miles corresponds to all purpose travel and is presented in Figures 4-4 and 4-5.

In order to augment personal business travel by work-related travel, it is necessary to use work trip length data. Such data has been collected by the Bureau of the Census and is presented in Figure 4-6. This data can be used to determine annual work-related travel to add to the data in Figure 4-1 to determine annual travel for work trips plus personal business. For example, at the 50th percentile, annual work travel inside SMSAs is 250 days/year \times 14.5 miles/day = 3625 miles/year. When added to the annual mileage of 3000 miles/year from Figure 4-1, this gives a total of 6625 miles/year.

This work trip data can also be added to the data of Figures 4-2 and 4-3 to represent non-random behavior. In such calculations, only work travel for the 50th percentile worker is used. The relationship between the percentile of work travel and the percentile of personal travel is also statistical in nature. Using the 50th percentile work travel distance and the data of Figures 4-2 and 4-3, it is possible to generate annual mileage versus percent days and percent vehicle miles for different daily mileage ranges. For example, consider a daily range of 30 miles. For 50th percentile work travel of 14.5 miles per day (roundtrip) this leaves 15.5 miles per day of random travel. From Figure 4-2, for a random annual mileage of 9000 miles, these 15.5 miles per day account for 11.5% of the vehicle miles. The total annual mileage is $9000 + 250 \times 14.5 = 12,625$ miles, and a 30 mile range would then account for

$$(9000 \times 0.115 + 3625) / (9000 + 3625) = 0.37 \text{ or } 37\%$$

of the annual travel. Repetition of such calculations for various annual random travel mileage yields the results presented in Figures 4-7 through 4-10. Calculations for additional work travel distances will be made as part of the sensitivity studies.

Figures 4-7 through 4-10 can be used in conjunction with Figures 4-1 to generate daily travel requirements for various percentiles of random annual driving. For example, the 50th percentile personal business travel inside SMSAs represents 3000 miles per year random travel (Figure 4-1) plus 3625 miles of annual work travel for an annual mileage of 6625 miles. From Figure 4-7, this represents 81% of all days of driving with a vehicle range of 30 miles, 92.5% with a 40-mile range, 97% with a 50-mile range, and more than 99% with a 75-mile range. From Figure 4-8, 3000 miles per year random travel represents 76% of

Table 4-18
 AVERAGE ANNUAL MILEAGE (AM) AND AVERAGE TRIP LENGTH (LAVG) IN MILES

Travel Pattern	Percentile							
	30		50		75		90	
	AM	LAVG	AM	LAVG	AM	LAVG	AM	LAVG
All-Purpose Outside SMSAs	6,700	8.5	9,000	9.8	14,000	12.2	20,500	14.8
All-Purpose Inside SMSAs	4,900	7.0	7,000	8.4	11,000	10.5	17,000	13.1
Personal Business Outside SMSAs	3,300	5.7	4,500	6.7	6,600	8.1	9,300	9.6
Personal Business Inside SMSAs	2,200	4.2	3,000	4.9	4,500	6.0	6,500	7.2

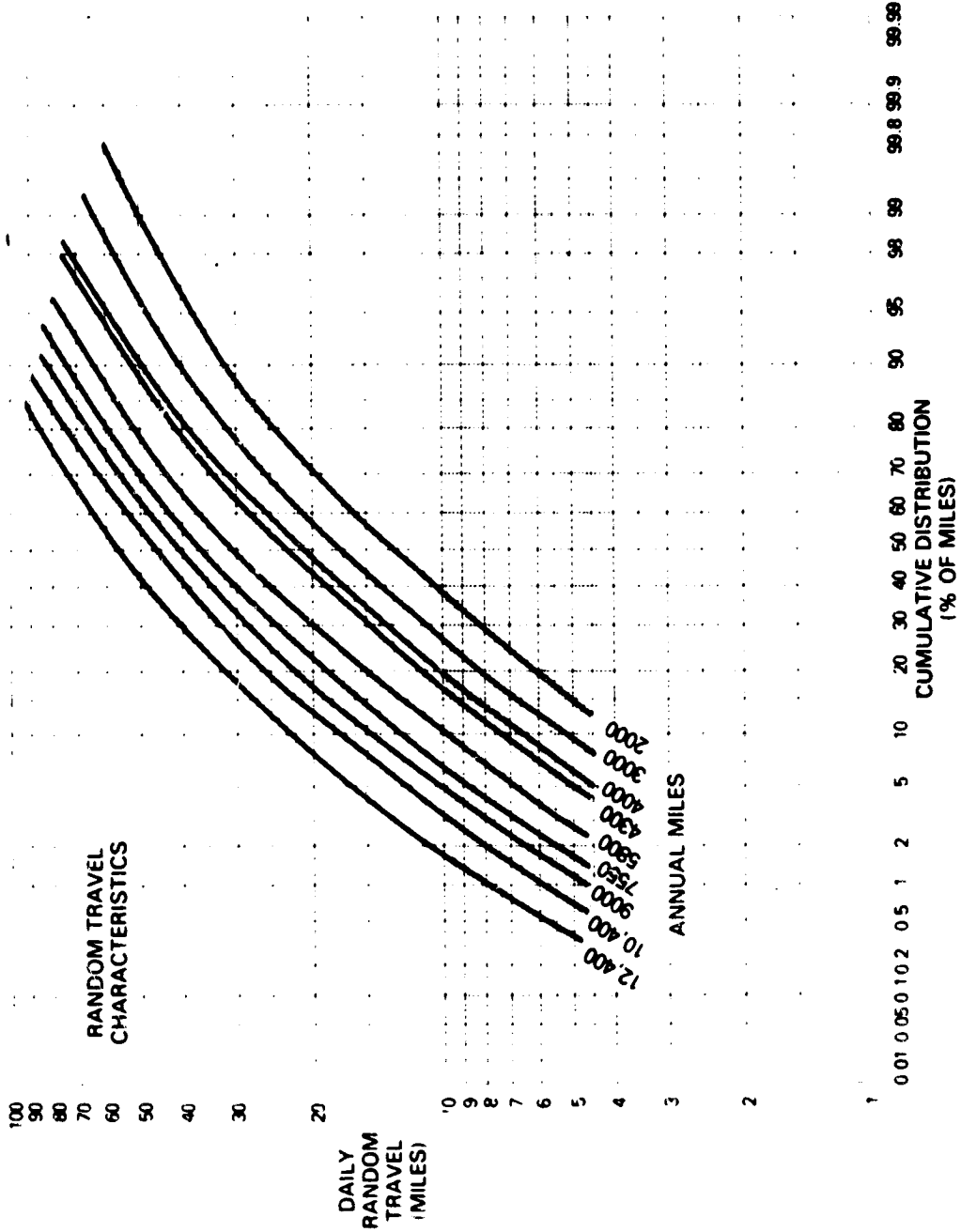

Figure 4-2. Daily Random Travel - Percent of Vehicle Miles - as a Function of Annual Miles

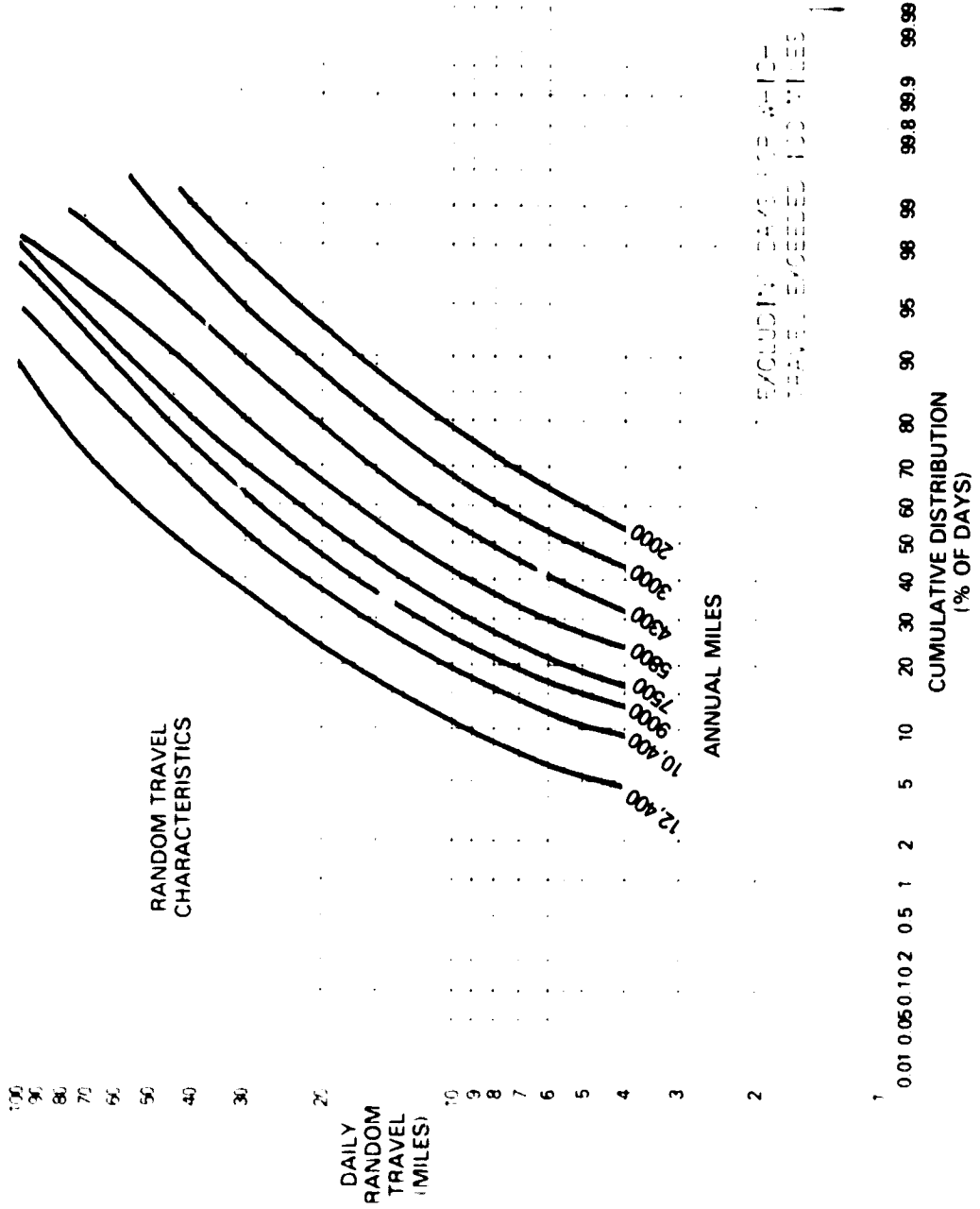

Figure 4-3. Daily Random Travel - Percent of Days - as a Function of Annual Miles

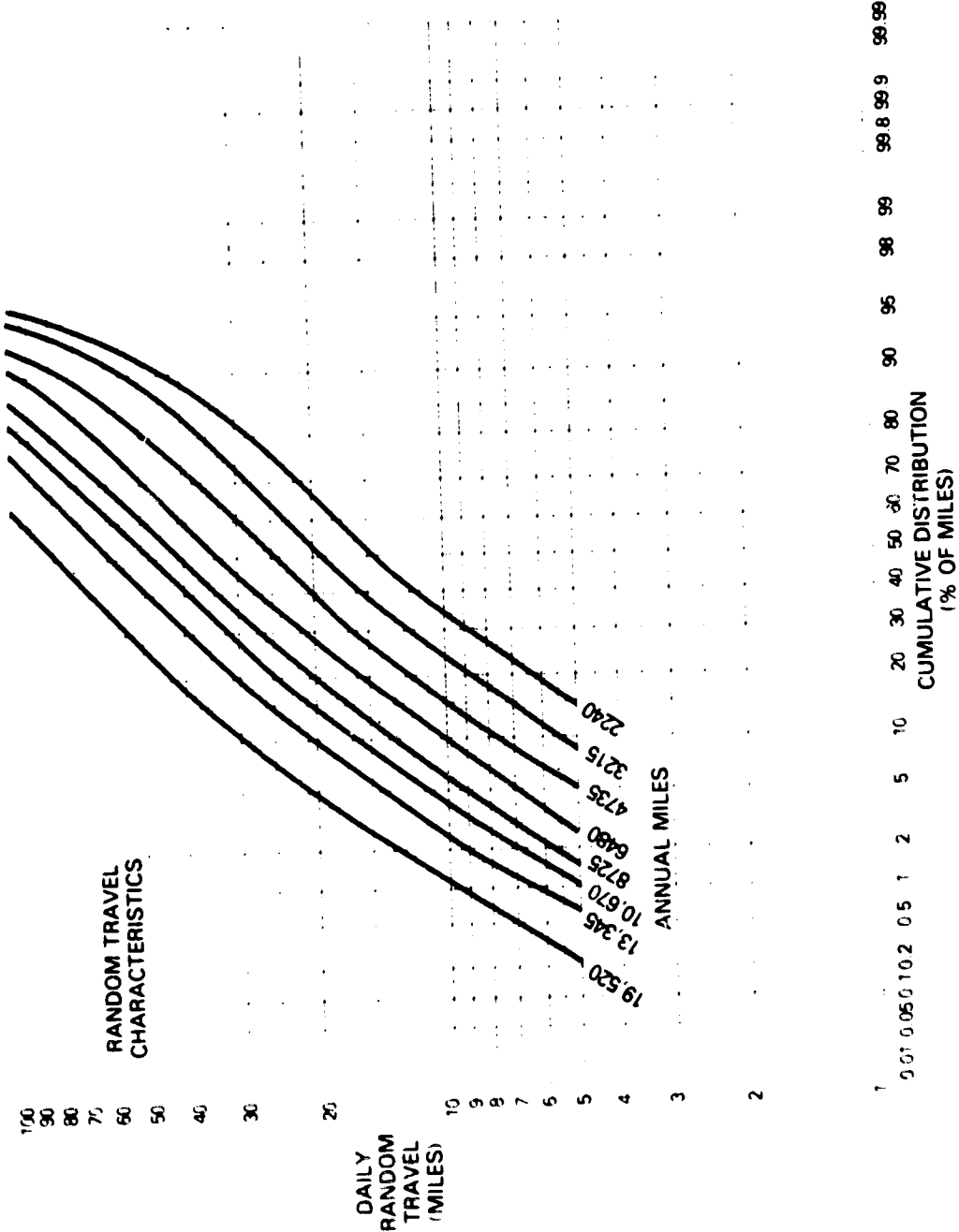

Figure 4-4. Daily Random Travel for All Travel - Percent of Vehicle Miles - as a Function of Annual Miles

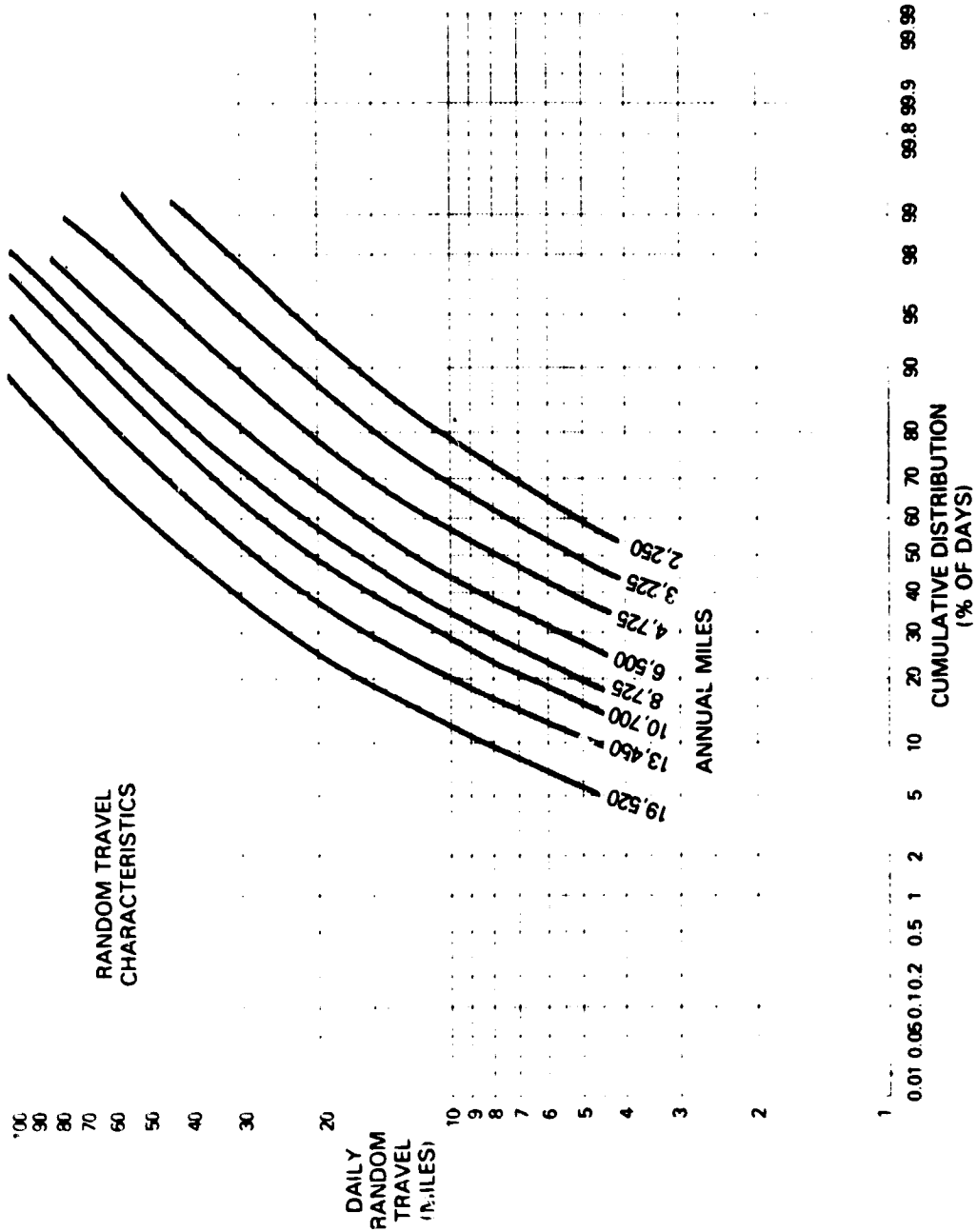

Figure 4-5. Daily Random Travel for All Travel - Percent of Days - as a Function of Annual Miles

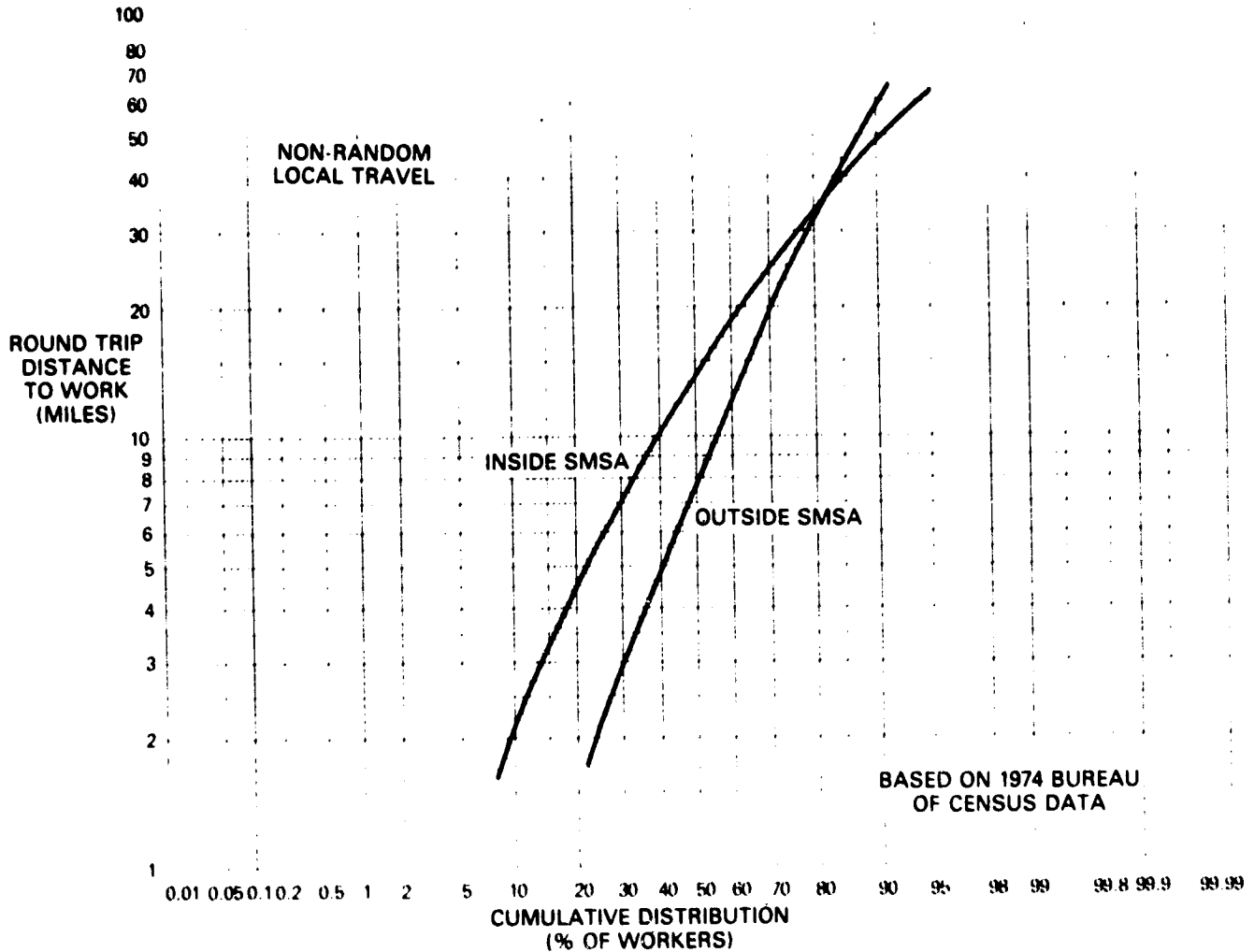

Figure 4-6. Travel to Place of Work

annual vehicle miles with a 30-mile range, 87% with a 40-mile range, 94% with a 50-mile range, and almost 99% with a 75-mile range. Repetition of these calculations for various percentiles of annual random travel for personal business both inside and outside SMSAs produces the data presented in Figures 4-11 through 4-14. In a similar manner, Figure 4-1 can be used with Figures 4-2 and 4-3 to generate Figures 4-15 through 4-18. Also, use of Figures 4-1, 4-2, and 4-3 will produce Figures 4-19 through 4-22. Finally, Figures 4-1, 4-4, and 4-5 can be used to generate Figures 4-23 through 4-26. Figures 4-19 through 4-22 represent similar vehicle use patterns represented by Figures 4-23 through 4-26, but the first set of figures does not include any daily mileage figures in excess of 100 miles.

Figures 4-11 through 4-26 are used in Section 6.2 to define annual travel and daily mileage for the various mission sets under consideration.

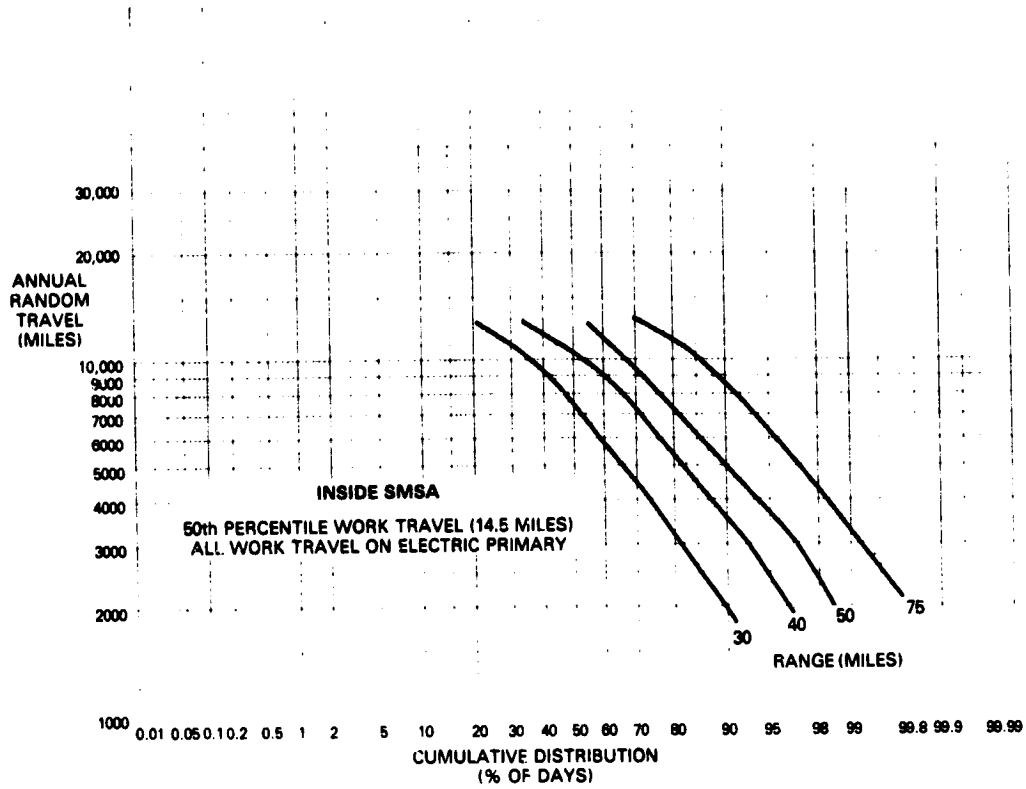

Figure 4-7. Effect of Electric Vehicle Range on All-Electric Vehicle Travel Inside SMSA - Percent of Days

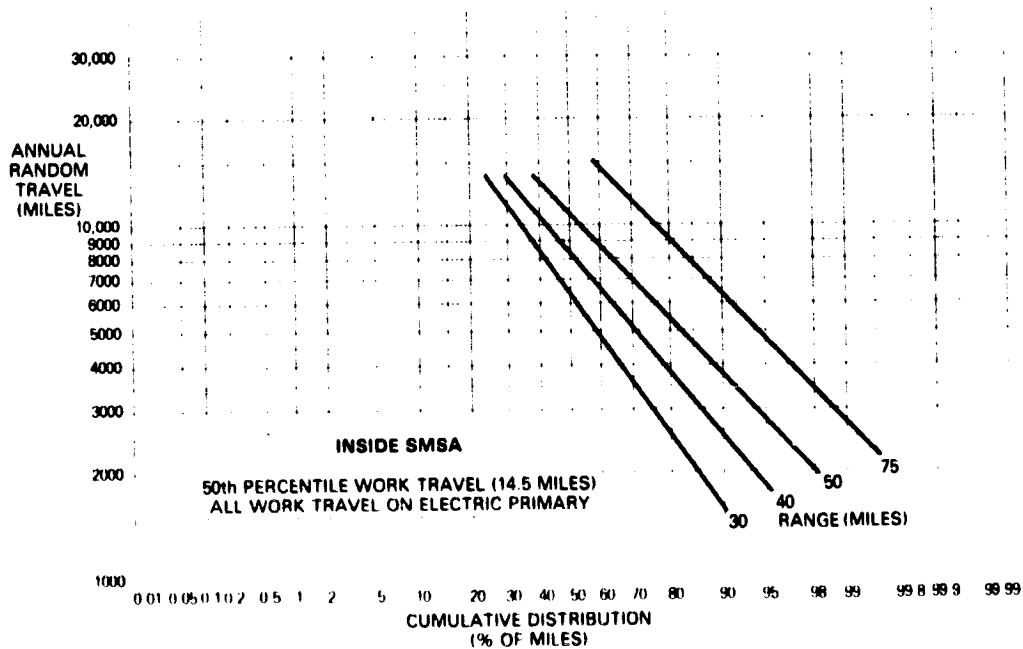

Figure 4-8. Effect of Electric Vehicle Range on All-Electric Vehicle Travel Inside SMSA - Percent of Vehicle Miles

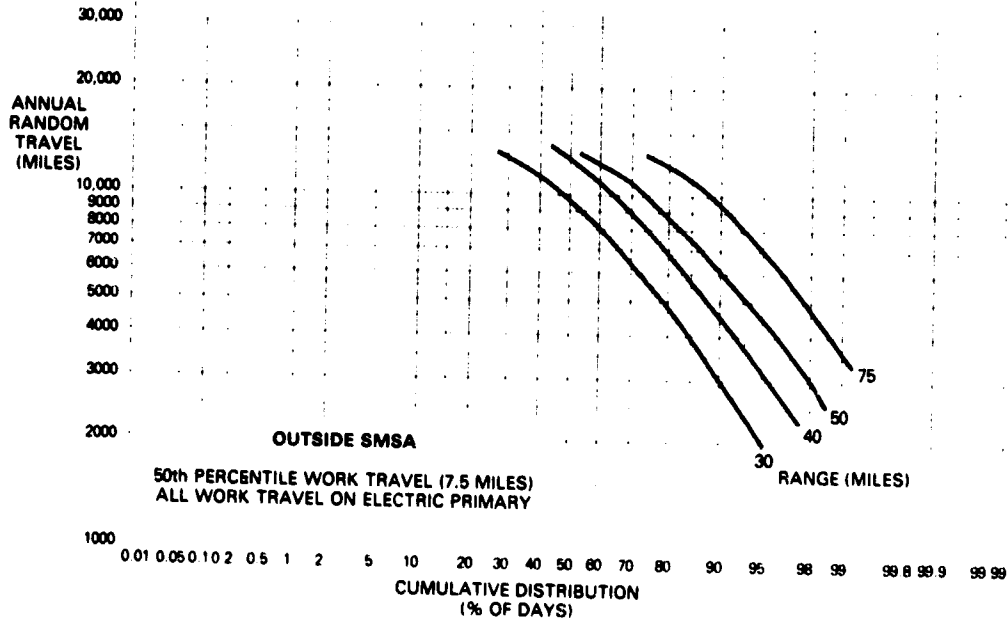

Figure 4-9. Effect of Electric Vehicle Range on All-Electric Vehicle Travel Outside SMSA - Percent of Days

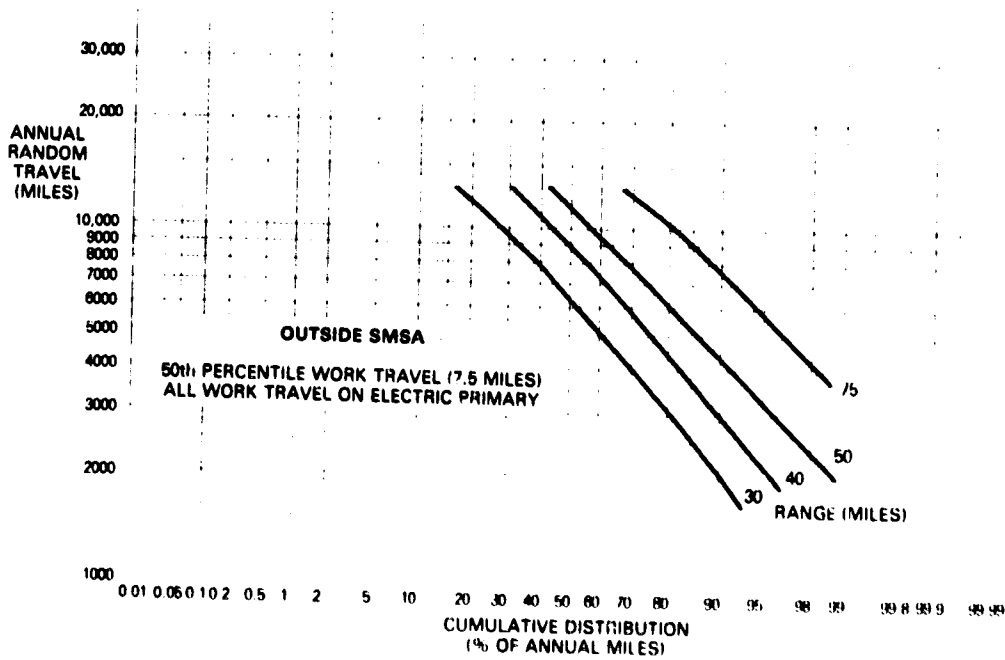

Figure 4-10. Effect of Electric Vehicle Range on All-Electric Vehicle Travel Outside SMSA - Percent of Vehicle Miles

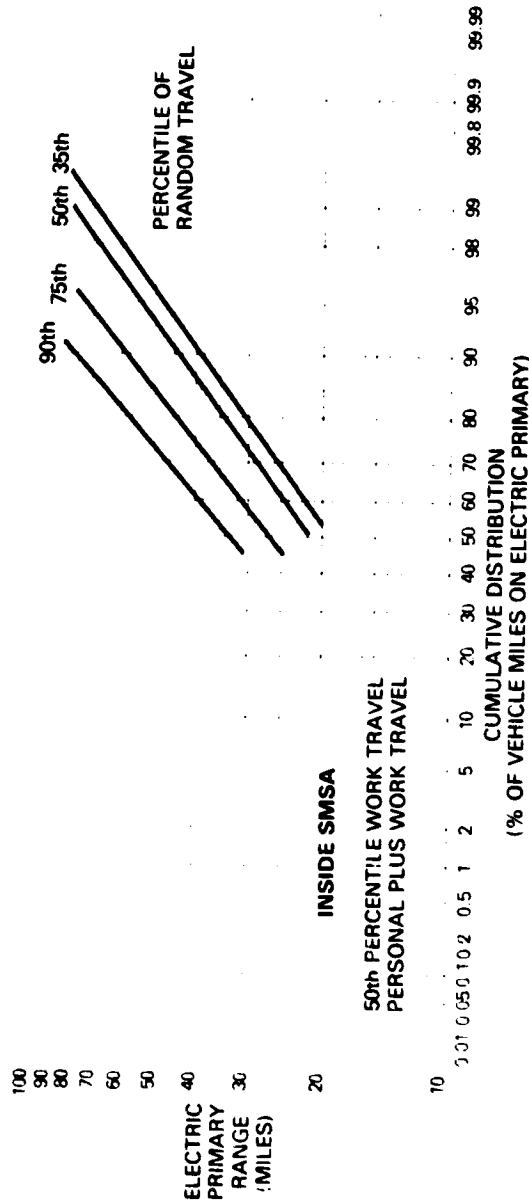

Figure 4-11. Effect of Vehicle Range on Vehicle Use - % of Vehicle Miles, Inside SMSA, Personal Plus Work Travel

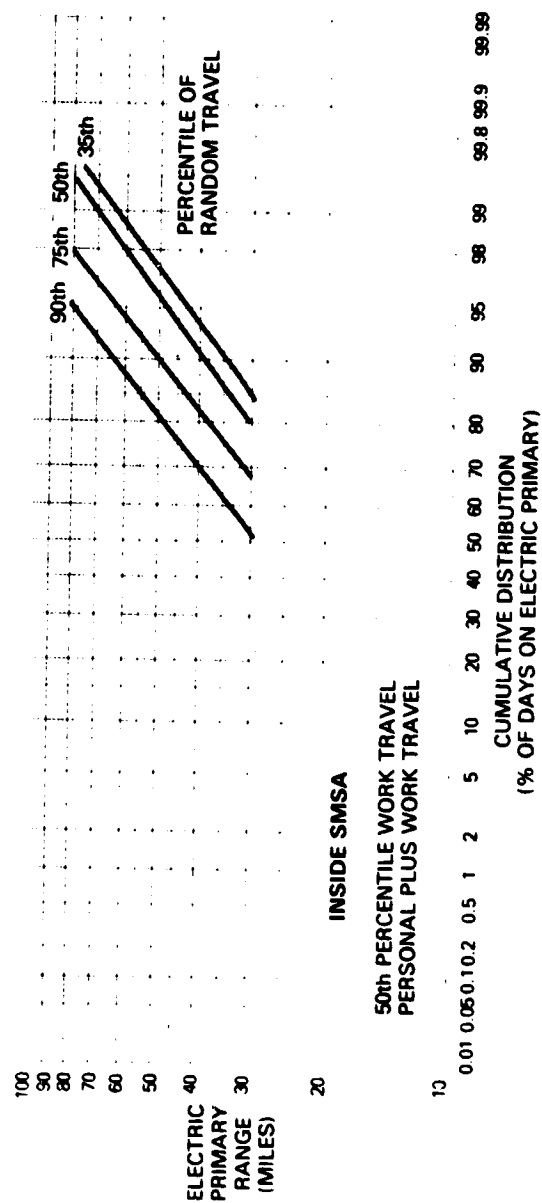

Figure 4-12. Effect of Vehicle Range on Vehicle Use - % of Days, Inside SMSA, Personal Plus Work Travel

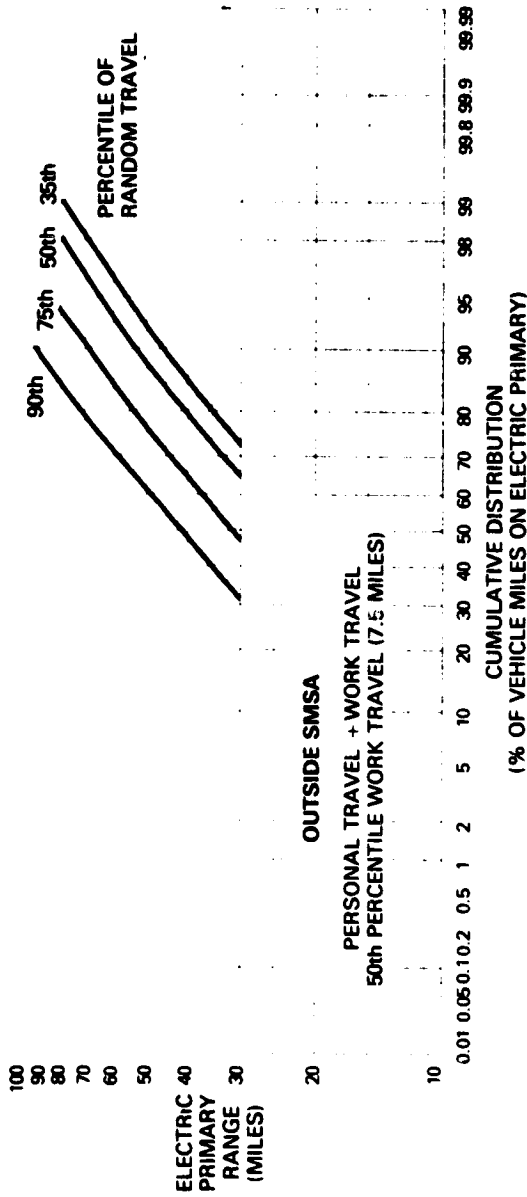

Figure 4-13. Effect of Vehicle Range on Vehicle Use - % of Vehicle Miles, Outside SMSA, Personal Plus Work Travel

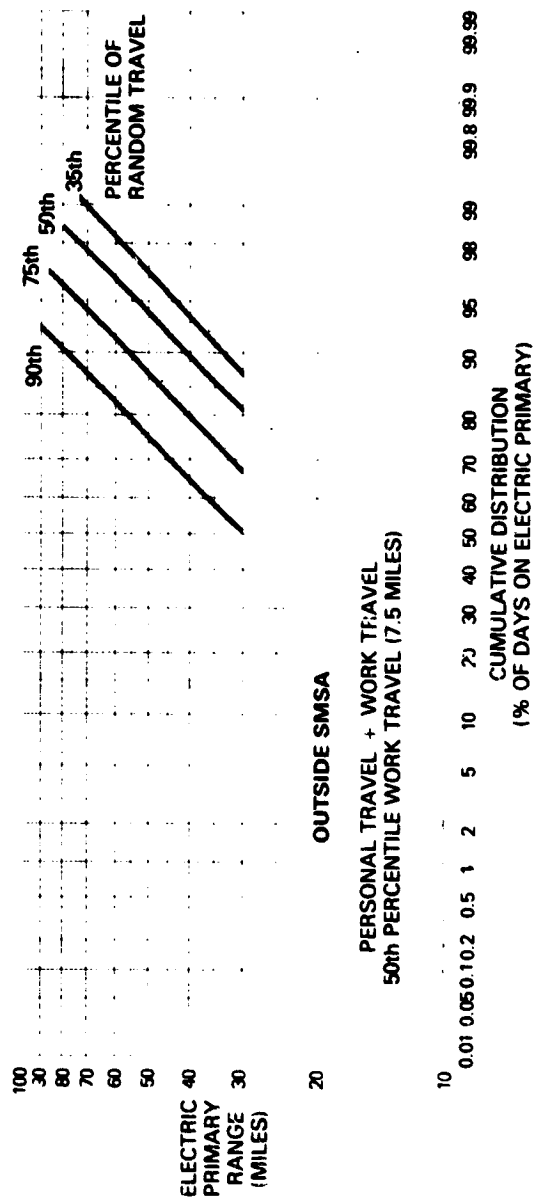

Figure 4-14. Effect of Vehicle Range on Vehicle Use - % of Days, Outside SMSA, Personal Plus Work Travel

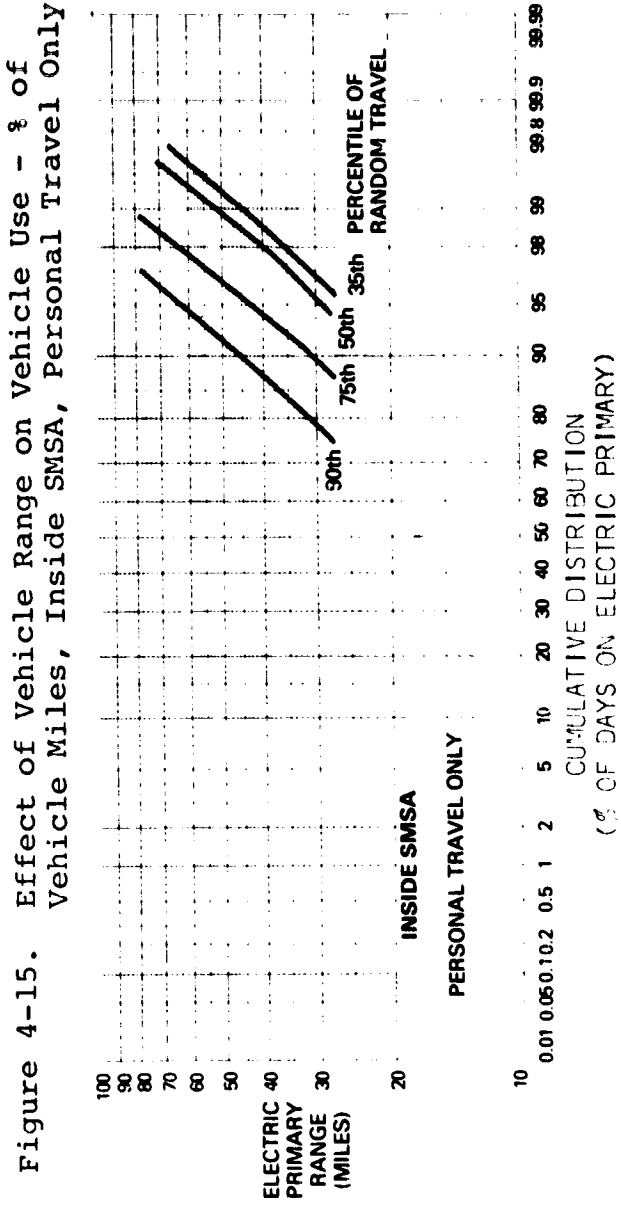
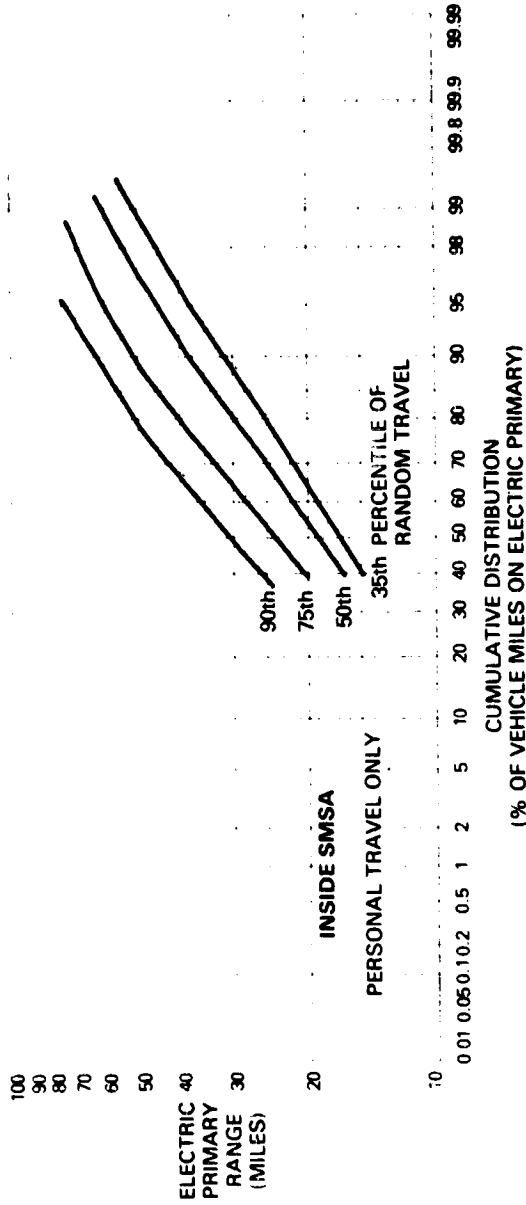

Figure 4-16. Effect of Vehicle Range on Vehicle Use - % of Days, Inside SMSA, Personal Travel Only

ORIGINAL PAGE IS OF POOR QUALITY

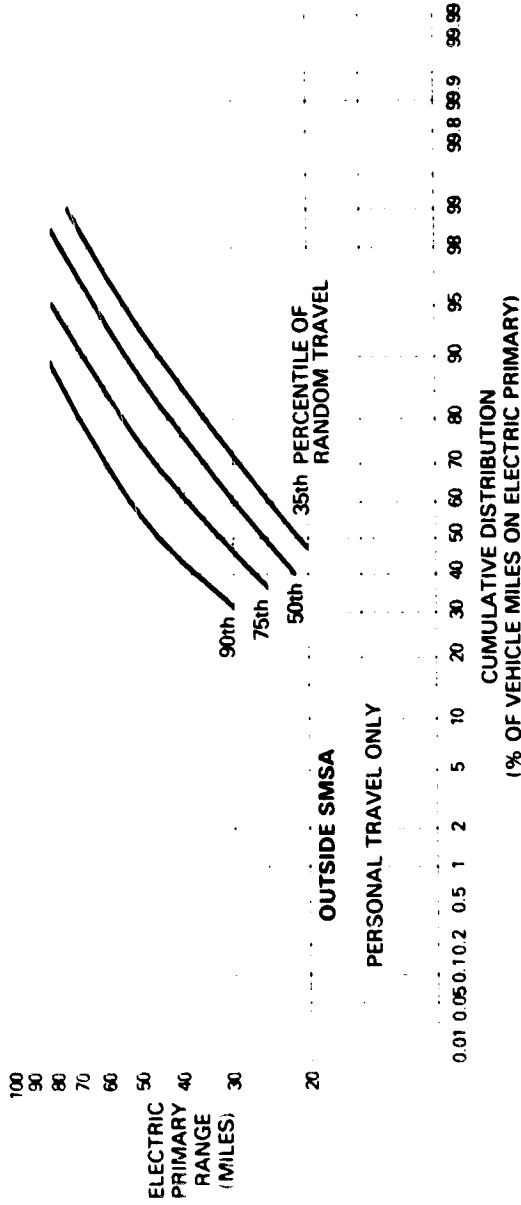

Figure 4-17. Effect of Vehicle Range on Vehicle Use - % of Vehicle Miles, Outside SMSA, Personal Travel Only

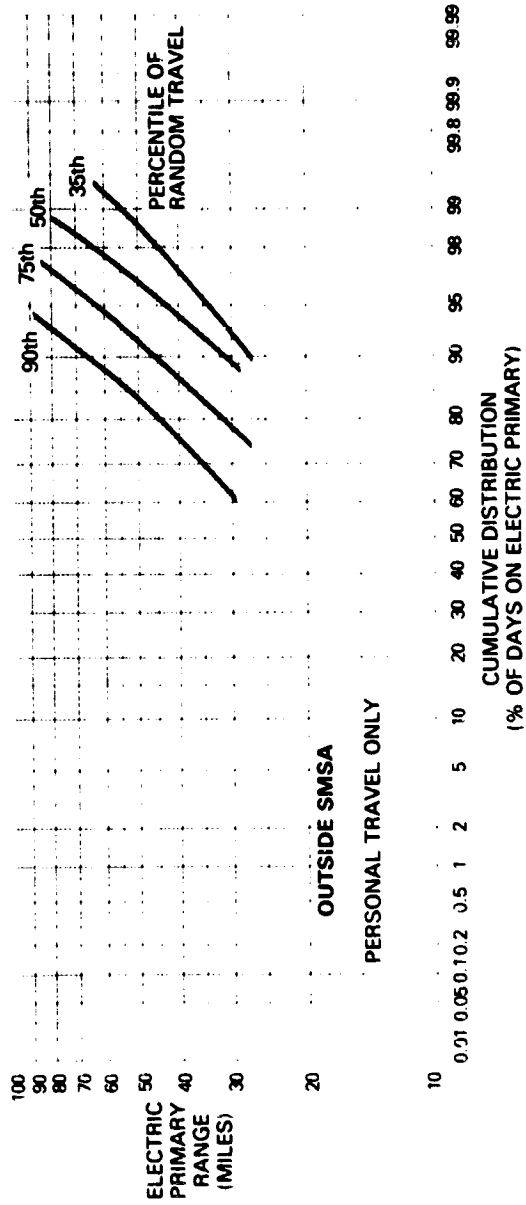

Figure 4-18. Effect of Vehicle Range on Vehicle Use - % of Days, Outside SMSA, Personal Travel Only

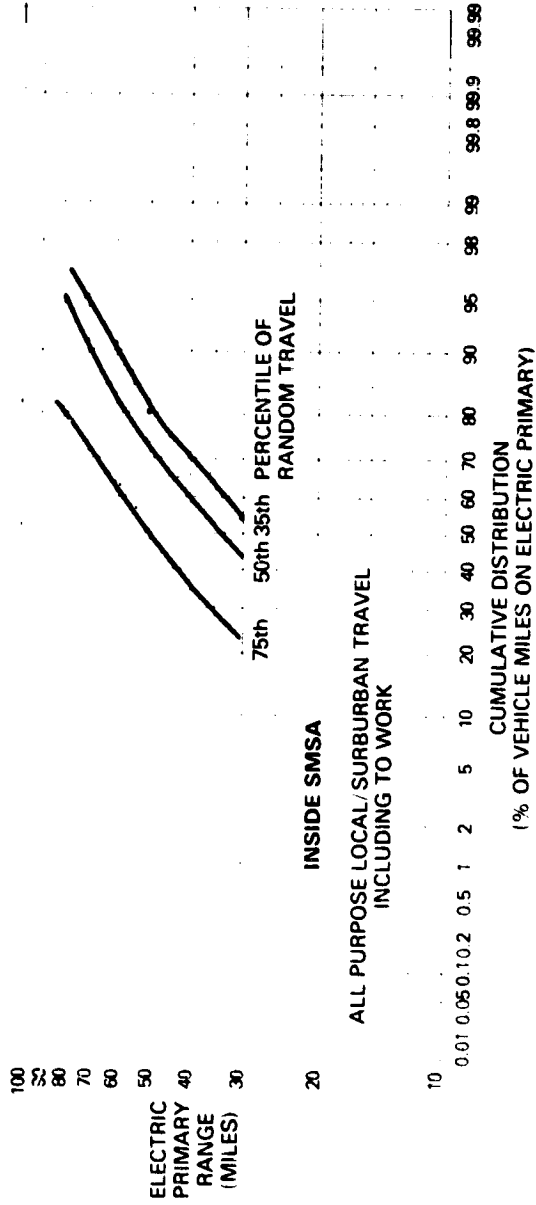

Figure 4-19. Effect of Vehicle Range on Vehicle Use - % of Vehicle Miles, Inside SMSA, All-Purpose Local/Suburban Travel, Including Work Travel

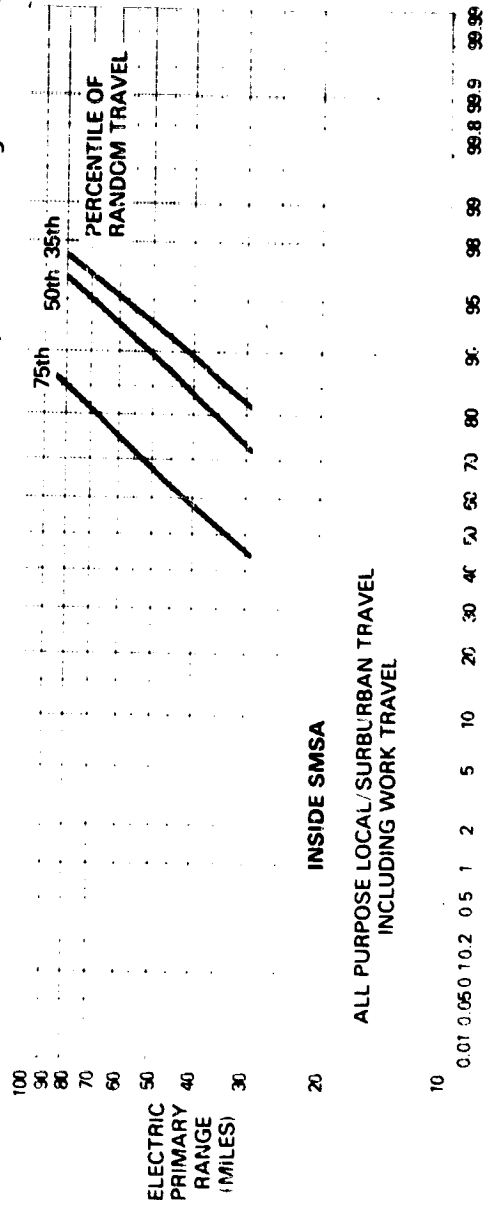

Figure 4-20. Effect of Vehicle Range on Vehicle Use - % of Days, Inside SMSA, All-Purpose Local/Suburban Travel, Including Work Travel

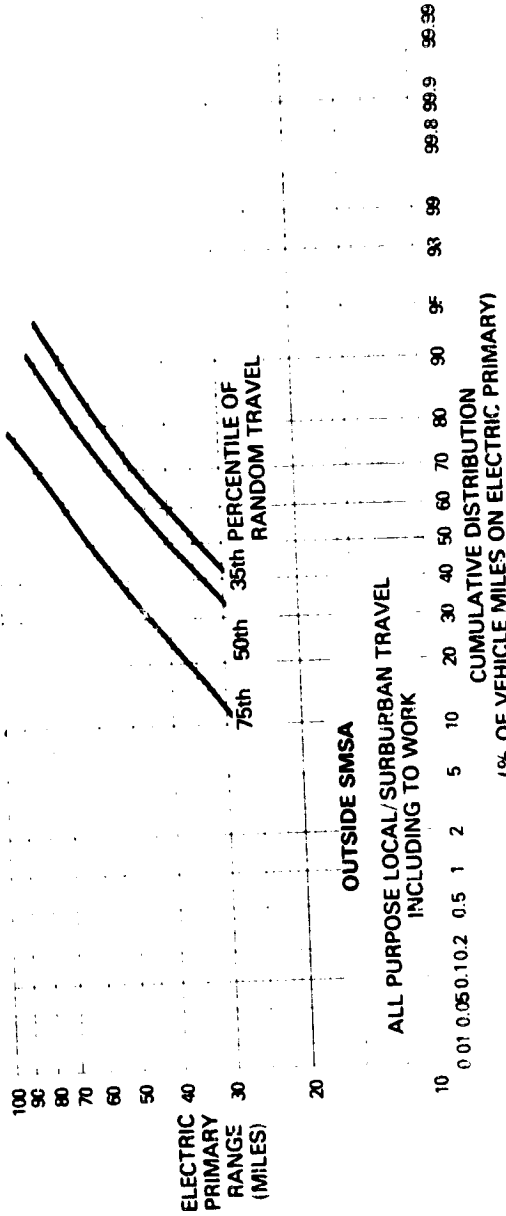

Figure 4-21. Effect of Vehicle Range on Vehicle Use - % of Vehicle Miles, Outside SMSA, All-Purpose Local/Suburban Travel, Including Work Travel

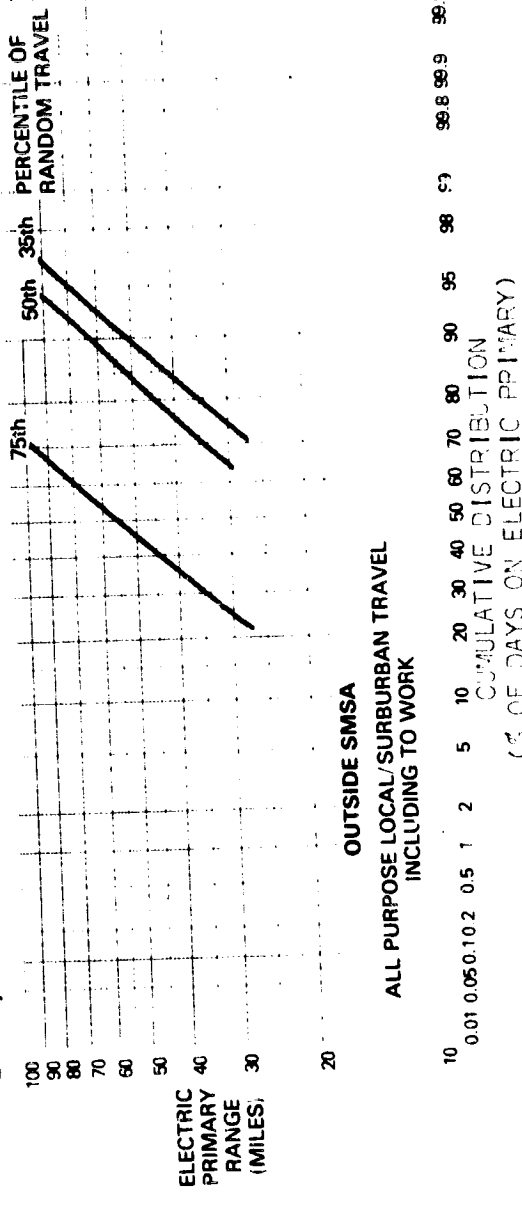

Figure 4-22. Effect of Vehicle Range on Vehicle Use - % of Days, Outside SMSA, All-Purpose Local/Suburban Travel, Including Work Travel

ORIGINAL PAGE IS OF POOR QUALITY

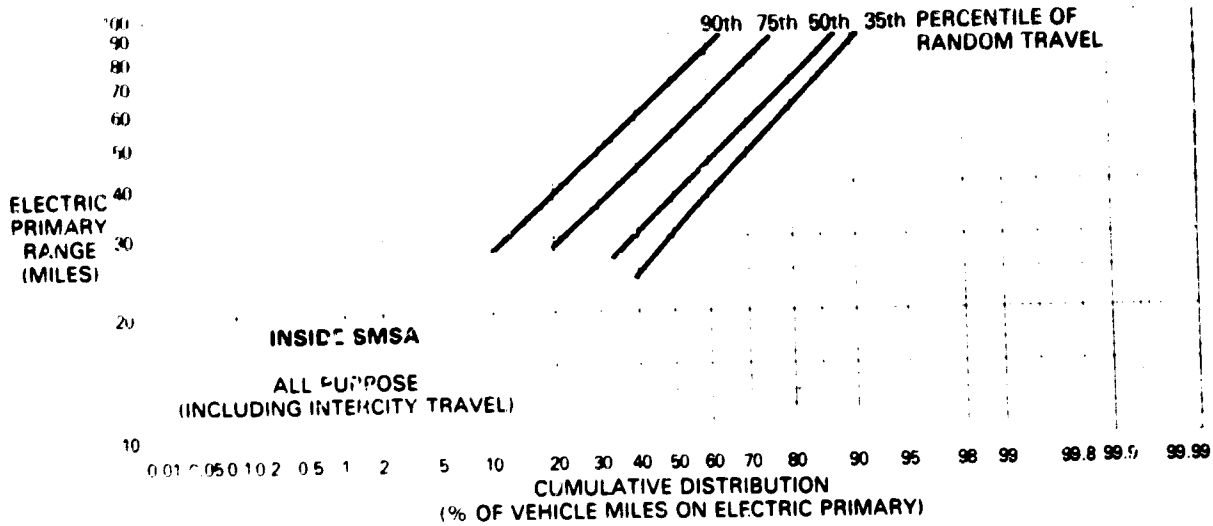

Figure 4-23. Effect of Vehicle Range on Vehicle Use - % of Vehicle Miles, SMSA, All-Purpose, Including Intercity Travel

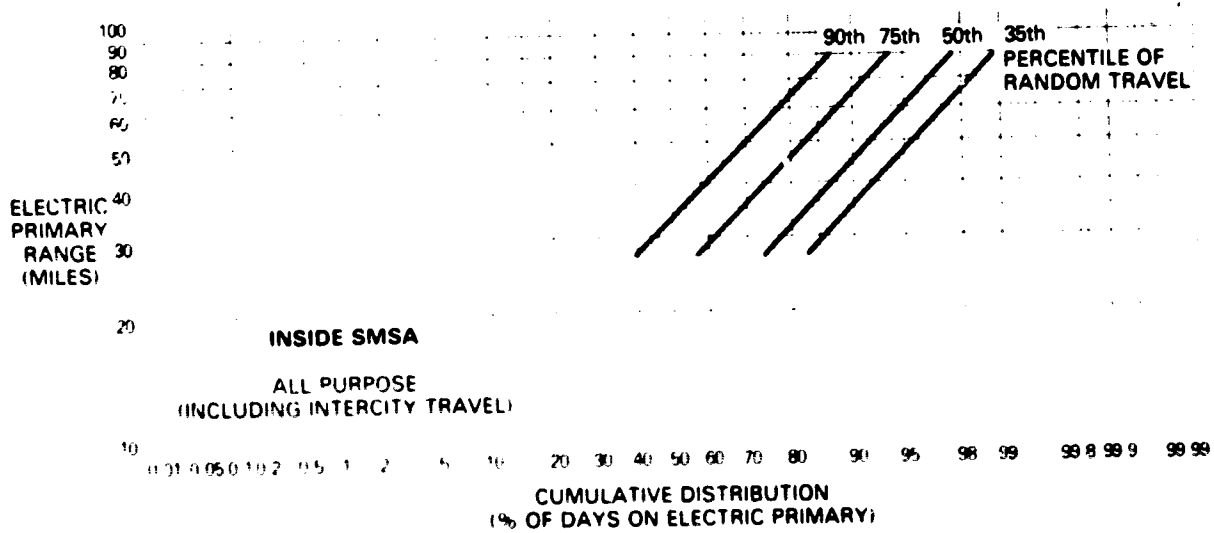

Figure 4-24. Effect of Vehicle Range on Vehicle Use - % of Days, Inside SMSA, All-Purpose, Including Intercity Travel

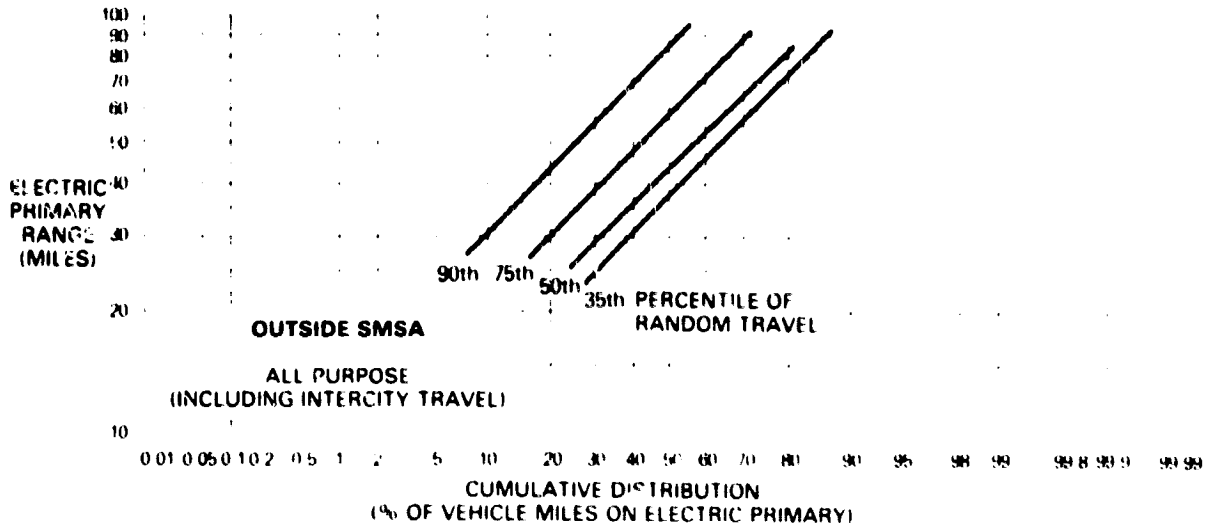

Figure 4-25. Effect of Vehicle Range on Vehicle Use - % of Vehicle Miles, Outside SMSA, All-Purpose, Including Intercity Travel

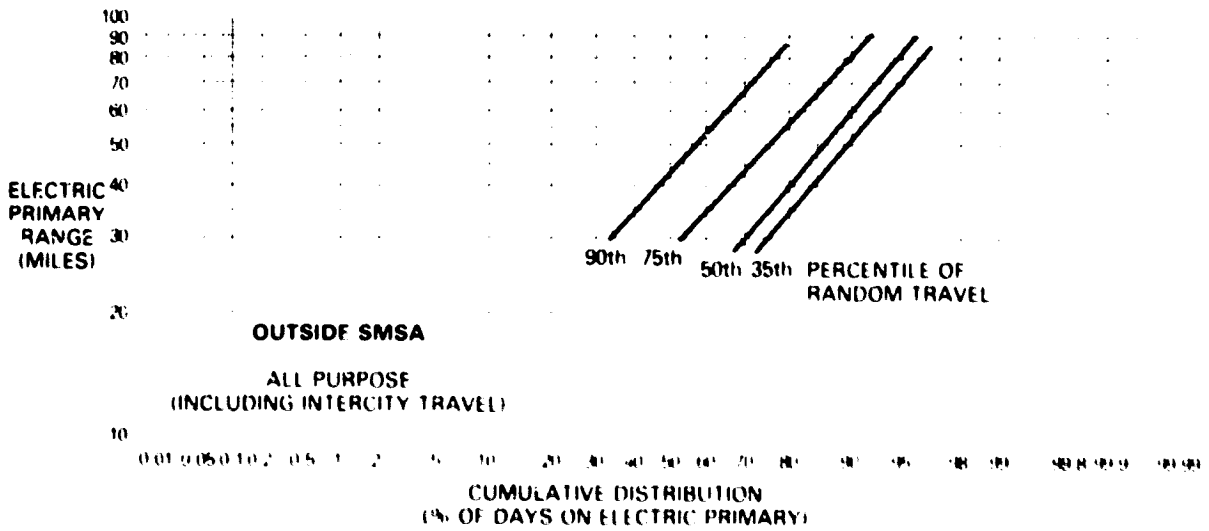

Figure 4-26. Effect of Vehicle Range on Vehicle Use - % of Days, Outside SMSA, Including Intercity Travel

4.3.3 DRIVING CYCLES

A number of driving cycles can be utilized as a means of representing vehicle operation in city and highway driving. A summary of selected characteristics of the following driving cycles are given in Table 4-19:

- (a) EPA urban (FUDC)
- (L) EPA highway (FHDC)
- (c) SAE J227a B, C, D.

The first two driving cycles are used by the Environmental Protection Agency (EPA) to certify that passenger cars meet Federal Exhaust Emission Standards and to estimate fuel economy for the various car models. The EPA cycles were developed from actual pursuit data taken in traffic and are intended to simulate realistically the manner in which cars are actually driven (e.g., acceleration and braking rates, speeds and speed modulation, idle times, etc.). The SAE J227a cycles were developed purely as a means of comparing all-electric vehicles of differing design and capability on a common cycle. It has never been claimed that vehicles were driven in actual traffic conditions in modes like the SAE B, C, D cycles. For this reason, the plan is to adapt the EPA urban and highway cycles rather than the SAE cycles for use on the hybrid/electric design Tasks 2 and 3. The vehicle power-to-weight ratios needed to follow the SAE cycles are significantly less than the power-to-weight specified from other considerations (e.g., 0-60 mph acceleration, high-speed passing, etc.), so exclusion of the SAE cycles has no impact on vehicle design from the power requirement point of view. The hybrid/electric vehicle non-refueled SAE J227a Schedule B operation will be calculated, however, for comparison purposes as required.

A closer look at the EPA urban cycle, which consists of two parts (Figures 4-27 and 4-28), is recommended. The first portion of the cycle (50% s) is termed the (cold) transient, the second part is called the (hot) stabilized. As indicated in Figures 4-27 and 4-28, the characters of the two parts are surprisingly different as far as average speed and stops/mile are concerned. The "transient" part has nearly two minutes of high-speed driving (55 mph) and only 1.4 stops/mile. The peak power demand for the EPA urban cycle occurs in the "transient" part of the cycle. The second part of the EPA urban cycle is relatively low speed (maximum speed of only 34 mph) and has 1.4 stops/mile. It appears that the "stabilized" part of the urban cycle is a better representation of neighborhood and business district driving than either the SAE B or C cycles. Likewise, the "transient" part seems to be a reasonable representation of suburban or boulevard/expressway driving in which traffic often permits reasonable speeds and less stops/mile than in more congested neighborhood business district driving.

The EPA highway cycle was developed to obtain fuel economy data for highway driving. It is really typical of driving on the open highway at near constant speed (55 mph) with a stop every 10 to 20 miles. The EPA highway cycle is characteristic of freeway/expressway travel only during off-peak hours.

Table 4-19
SUMMARY OF DRIVING CYCLE CHARACTERISTICS

Driving Cycle	Cruising Speed (mph)	Length (miles)	Time (seconds)	Accel. (mph/sec)	Decel. (mph/sec)	Cruise Distance (miles)	Stops/Mile	Idle Time (seconds)
SMP Cycle	40	0.193	72	1.00	3.25	0.106	5.46	25
	50	0.31	60	1.67	2.59	0.167	3.2	25
	45	0.917	121	1.67	3.47	0.625	1.09	25
EPA City*	55	7.4	1372	1.77	2.90		2.4	246
Highway	55	10.3	765	1.67	1.30		1.1	5

* EPA City -

Cold start, 505 seconds, 3.6 miles, 5 stops, 1.4 stops/mile, max. speed 55 mph.

Hot start, 277 seconds, 3.86 miles, 13 stops, 3.4 stops/mile, max. speed 34 mph.

† Cruising speed and acceleration/deceleration. Values shown for the EPA cycles are maximum values.

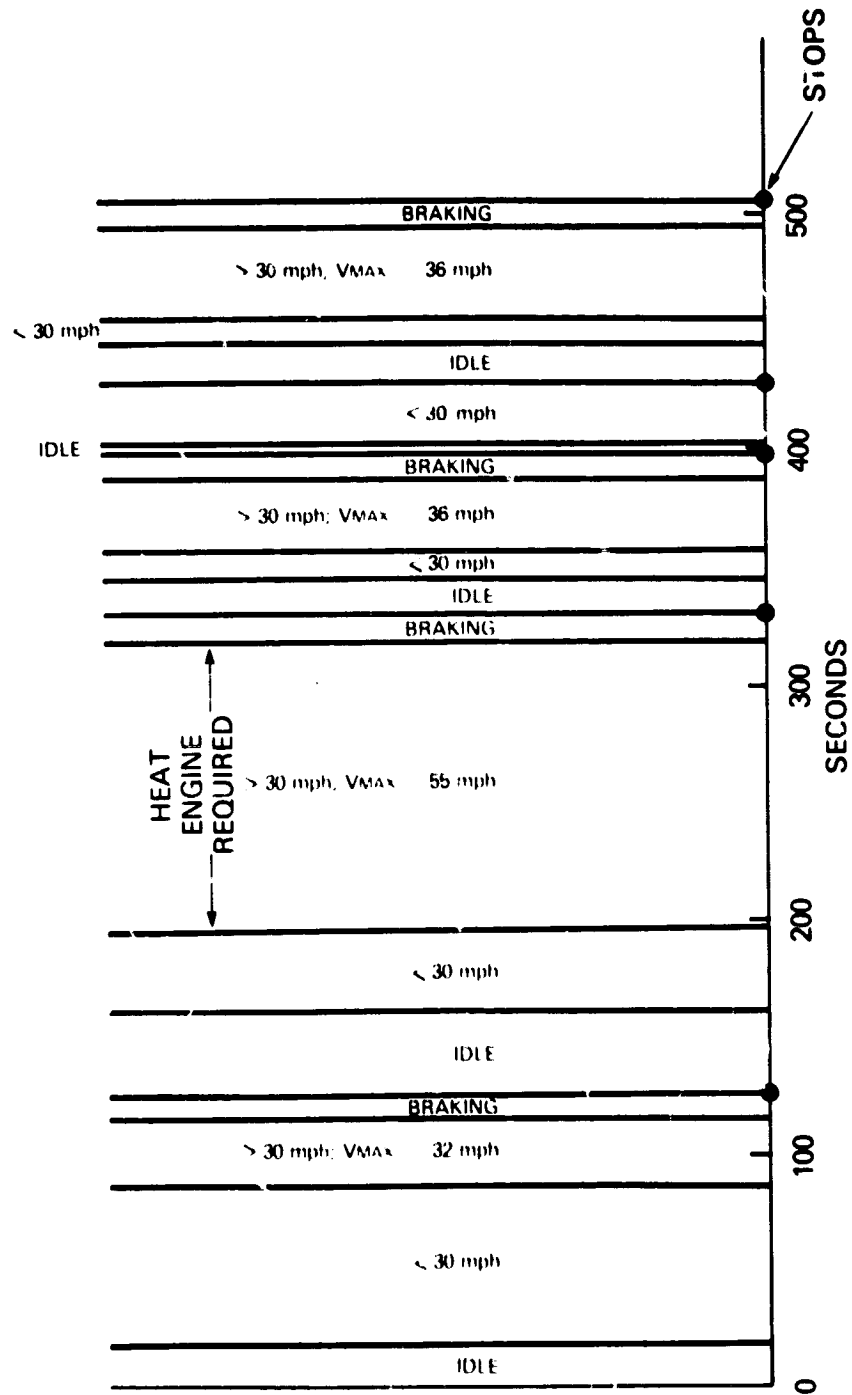

Figure 4-27. EPA Urban Cycle (Transient)

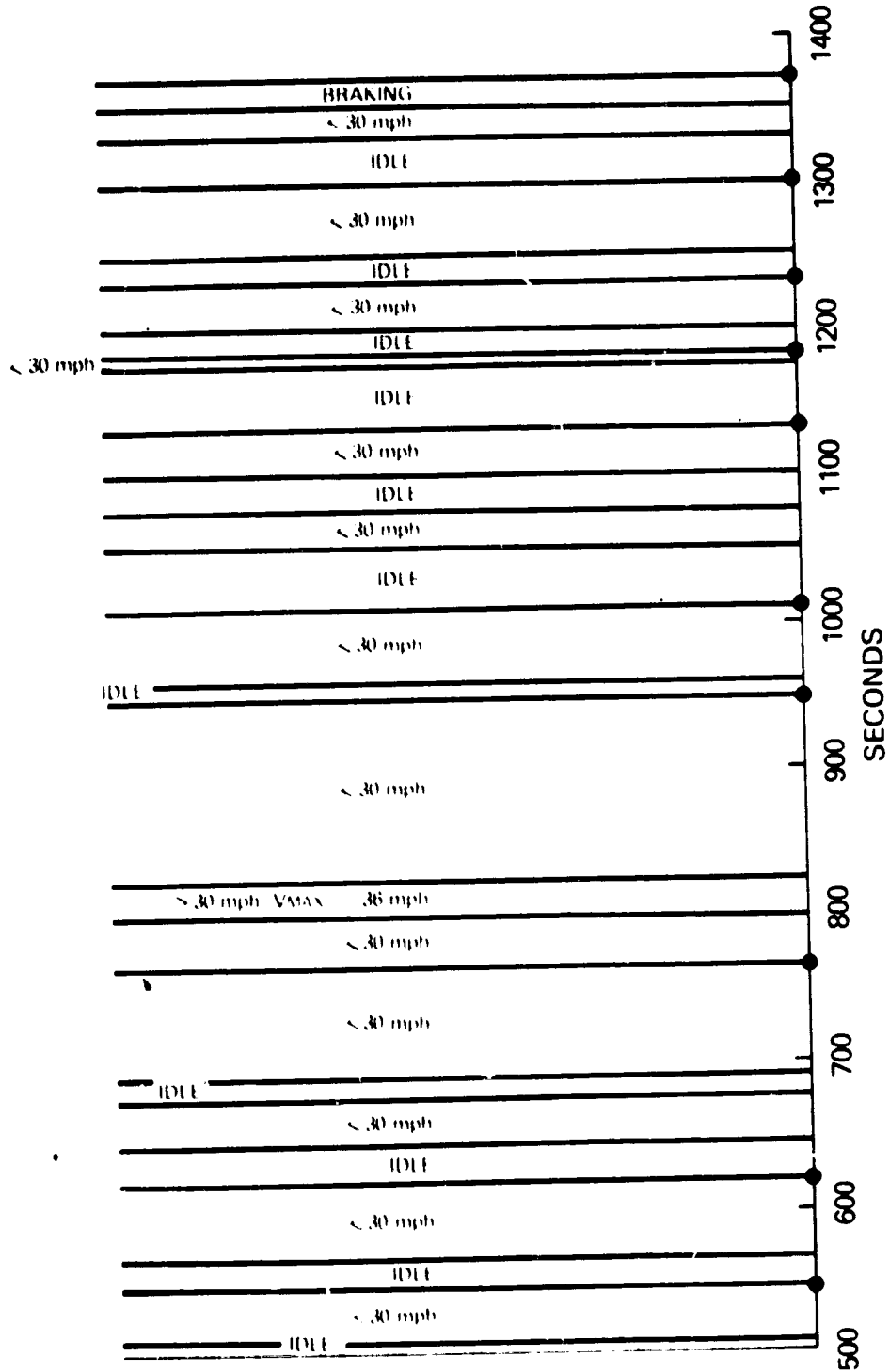

Figure 4-28. I/P Urban Cycle (Stabilized)

Based on the discussions in the foregoing paragraphs, it seems appropriate to use the EPA urban cycle in its entirety, or the "transient" and "stabilized" parts individually, to represent urban driving (to/from work and random personal travel) and to use the EPA highway cycle to represent only intercity travel (trips usually greater than 100 miles). Undoubtedly, there are some random trips of less than 100 miles on high mileage days, especially in the all-purpose mission set, which would logically qualify as highway driving. Such trips can be accounted for by adjustments in the annual random urban mileage.

The split between urban and intercity (highway) travel used by EPA and DOT to determine the composite fuel economy for passenger cars is 55% urban/45% highway. The urban/rural mileage data given in Table 4-4 for various states shows rather clearly that the urban/rural mileage split in most states departs markedly from the national average 55/45 split. Relatively few states have ratios close to 55/45. Many states, especially in the more populous areas including California and New York, have urban mileage fractions between 65% and 75%. Hence, although more study of this point is needed, it is being assumed at the present time for the design trade-off studies (Task 2) that inside SMSAs, 70% of the total annual mileage is driven on the EPA urban cycle, and 30% on the highway cycle. The primary use of the 70/30 split is in the determination of operating cost and break-even gasoline price.

Various combinations of the urban "transient" and "stabilized" cycles and the intercity highway cycle can be used to determine energy usage (electricity and gasoline) for specified daily travel and mission sets. The effect of these cycle mixes on vehicle "electric" range requirements and associated operating costs can only be determined by detailed vehicle simulations. This will be done as part of Task 2 and 3. A detailed determination of the urban cycle mixes appropriate for the to/from work and personal travel missions must await the simulation study results. Every attempt will be made to keep the driving cycle descriptions as simple as possible and consistent with realistic vehicle energy usage, both for electricity, and gasoline.

The effect of the driving cycle on the heat engine warmup time is also important and should be considered. This is especially true for the Reference ICE Vehicle. A recent study of the effect of trip length on fuel economy for conventional vehicles is reported in Ref. (5). Figure 4-29, taken from that reference, shows that the EPA urban and highway fuel economy values are at best applicable only under very special conditions (trip length, ambient temperature, etc.). It is not surprising that most car owners have found that the fuel economy they experience differs significantly from the EPA mpg values. Usually, owners find on-road fuel economy considerably lower than the EPA values. As indicated in Table 4-14, trips less than 7.5 miles length (EPA urban cycle) account for 66% of the trips

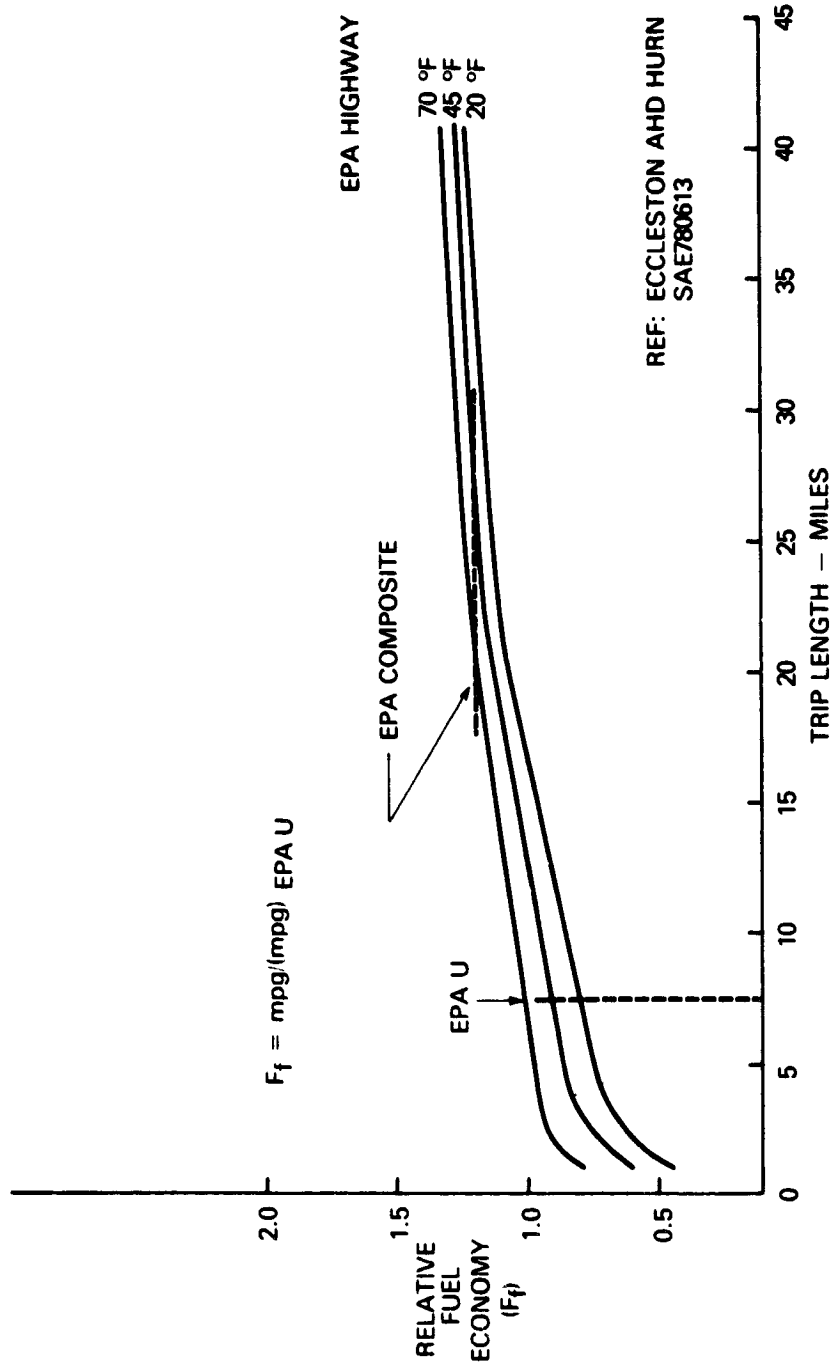

REF: ECCLESTON AND HURN
SAE780613

Figure 4-29. The Effect of Trip Length and Ambient Temperature on Fuel Economy for an ICE Vehicle

and 18% of the miles. Figure 4-29 shows that a trip length of at least 20 miles is needed before the EPA composite fuel economy value can be expected. Trips of less than 20 miles account for 92% of all trips and 53% of total vehicle miles. Therefore, it is clear that in estimating the fuel economy of the reference ICE vehicle on the various mission sets and percentile daily travel days the effect of engine warmup should be included. Likewise, the effect should also be included in the hybrid/electric calculations. This means that average trip length as well as daily travel (miles) must be considered in determining daily fuel usage. Fortunately, such travel statistics are available from the mission analysis. They will be incorporated into the work on energy consumption in Task 2.

Section 5

RATIONALE FOR THE SELECTION OF THE ICE REFERENCE VEHICLE

5.1 HYBRID VEHICLE SIZE CLASS

For purposes of this study it is necessary to identify a conventional internal combustion engine (ICE) passenger vehicle for comparison with the electric/hybrid car to be designed according to the present contract. The contract specifies that the hybrid vehicle should have a passenger capacity of at least five adults. This means that the hybrid vehicle must be either a mid-size (5-passenger) or a full-size (6-passenger) car. As indicated in Table 3-9, cars in these two classes use approximately 64% of the fuel consumed for personal transportation. The development of a hybrid/electric car in either class thus has the potential for saving a large quantity of petroleum if the market penetration of the hybrid design is significant. Hence, the key factor in deciding whether the hybrid vehicle should be mid- or full-size is the effect of size on market penetration.

It seems probable that the sales mix will increasingly favor the mid-size car during the next 5-10 years, especially in urban areas. In addition, the use pattern of the mid-size car is expected to be more consistent with the hybrid/electric concept which assures that much of the driving can be done using primarily battery-stored energy. Full-size cars probably will be purchased by people willing to pay for comfort on long trips and those seeking status. The present study will be directed toward the design of a hybrid/electric mid-size car which will be attractive to people who do most of their driving in urban/suburban areas with only occasional long intercity trips. This section is concerned with the selection of a conventional ICE passenger car for comparison with such a mid-size hybrid/electric car.

5.2 CRITERIA FOR SELECTION OF ICE REFERENCE VEHICLE

The criteria for the selection of the ICE reference vehicle are the following:

- 5-passenger capacity (mid-size)
- high sales volume
- acceleration performance of 0-96.54 km/h (0-60 mph) in 15-17 seconds

The high sales volume criterion is used as an indication of good consumer acceptance. It would also be highly desirable if the Reference ICE Vehicle represented a recent downsized design in the mid-size class since this would facilitate extrapolation of 1978/79 characteristics to those pertinent to 1985. In this respect, the Chevrolet Malibu/Olds Cutlass, Ford Fairmont, and Audi 5000 are of particular interest. The exterior and interior dimensions of those models and other selected 1978 passenger cars are

Table 5-1
 INTERIOR AND EXTERIOR DIMENSIONS OF SELECTED 1978 PASSENGER CARS

Vehicle	Curb Wt lb	Exterior Dimensions (inches)		Eng/HP	Interior Dimensions (inches)		
		L	W		Front Shoulder	Rear Shoulder	Fore-Aft Rear
Audi 5000	2825	190	70	I5/103	56.0	55.5	27.0
Fairmont	2890	194	71	I6/88	57.0	57.0	28.5
Malibu	3155	193	72	V6/95	57.5	57.0	28.5
Cutlass	3275	197	72	V6/105	56.0	56.5	29.0
Saab 99	2670	178	66	I4/115	53.0	53.0	27.5
Impala	3890	212	76	V8/145	61.0	61.5	29.0
LTD (1979)	3650	209	78	V8/145	61.7	61.7	29.0
LTD II	4145	220	80	V8/134	58.5	56.0	29.5
Delta 88	3655	218	78	V6/105	61.0	61.5	29.0
Pontiac Catalina	3900	214	78	V8/140	61.5	61.0	29.0
Cadillac Seville	4290	204	72	V8/170	55.5	55.5	30.0
Mercedes 300 SD	3890	191	70	I5/110 (TC)	56.0	55.5	28.0

Source: Consumers Union, April 1978 issue, and 1979 Sales Brochures

given in Table 5-1. By definition, a 5-passenger car carries two people in the front and three people in the rear seat. Using the criteria stated by Consumers Union in the April 1978 issue, this requires a rear shoulder width of at least 57 in., and a rear fore-aft dimension of at least 27 in. On this basis, the Chevrolet Malibu and the Ford Fairmont are 5-passenger cars, but the Ford 5000 is a little too narrow to fall into this category. The differences in weight and size between the 5- and 6-passenger cars are readily apparent from Table 3-7 and Table 5-1.

As indicated in Table 5-2, the new downsized mid-size car models have been well received by the public. Both the Malibu/Cutlass/Regal and Fairmont/Zephyr experienced impressive sales in 1978. Hence, both the Malibu and Fairmont meet the criteria of high volume sales.

Table 5-2
SALES OF MID-SIZE PASSENGER CAR MODELS IN 1978

<u>General Motors</u>		
<u>Division</u>	<u>Model</u>	<u>Sales (10³)</u>
Chevrolet	Malibu	374
Chevrolet	Monte Carlo	355
Oldsmobile	Cutlass	520
Buick	Century	75
Buick	Regal	248
Pontiac	Le Mans	<u>125</u>
Total		1700
<u>Ford Motor Company</u>		
<u>Division</u>	<u>Model</u>	<u>Sales (10³)</u>
Ford	Fairmont	406
Mercury	Zephyr	121
Ref: Automotive News, January 15, 1979		

Engine characteristics and related vehicle fuel economy for 1978 mid-size cars are given in Table 5-3. Data is given for both the General Motors Corporation and Ford Motor Company mid-size models. At the present time, mid-size cars are marketed using 4-, 6-, and 8-cylinder engines. Except for the Fairmont equipped with an L4 engine and manual 4-speed transmission, most mid-size cars are bought with 6-cylinder or small V-8 engines and automatic (A3) transmissions.

Acceleration characteristics of the Malibu, Cutlass, and Fairmont are summarized in Table 5-4. The information shown indicates that meeting the acceleration criteria of 0-60 mph in 15 to 17 seconds using a 6-cylinder engine (100-110 HP) and an automatic transmission presents no problems.

Either the General Motors (Malibu/Cutlass) or Ford Motor Company (Fairmont/Zephyr) mid-size cars could be used as the Reference ICE Vehicle. Both the Malibu and Fairmont meet all the criteria. The Malibu/Cutlass has been selected as the Reference ICE Vehicle primarily because General Electric, through its subcontractors, has access to more detailed information on the General Motors cars than on the Ford Motor Company cars. For example, arrangements have been made with General Motors to obtain data from their computer program (GPSIM) runs for the Malibu using several drive-lines (V-6, V-8 engines and automatic and manual transmissions). Unfortunately, the results of the GPSIM computer runs have not been received for inclusion in this report, but assurances have been obtained from General Motors that they will be provided in the near future.* It is evident (Table 5-1) that the Fairmont is slightly lighter than the Malibu. Expectations are that, in the coming years, GM will reduce the weight of their mid-size cars and by 1985 will eventually utilize front-wheel drive in that size class. A summary of General Motors' plans regarding the use of front-wheel drive is given in Automotive News, 11 December 1978, indicating that the mid-size cars are likely to be the last to be redesigned in this way. Nevertheless, the General Electric projections of the weight and fuel economy of the ICE reference vehicle will assume the utilization of front-wheel drive by 1985.

5.3 SELECTED ICE REFERENCE VEHICLE

The ICE reference vehicle is taken to be the Chevrolet Malibu using a V-6, 231 CID engine. Currently, this engine is manufactured by the Oldsmobile and Buick Divisions of General Motors and is marketed by the Chevrolet Division only in California. A 1978 Malibu with the V-6, 231 CID engine is estimated to have 0 to 60 mph acceleration of less than 15 seconds and an EPA fuel economy of at least 19 mpg urban and 28 mpg highway. The cited acceleration time and fuel economies are those of the heavier Cutlass, as predicted by the GM GPSIM computer program. Therefore, they should be met or exceeded by the slightly lighter Malibu. GPSIM calculations of the performance and fuel economy of the Malibu with the V-6 engine and various transmissions and axle ratios are expected to be available to General Electric in the near future. A further discussion of the ICE reference vehicle and its characteristics is given in Section 6.4.

*GPSIM computer runs for the 1979 Malibu were not received from General Motors as had been expected.

Table 5-3
ENGINE CHARACTERISTICS AND RELATED VEHICLE FUEL ECONOMY
FOR 1978 MID-SIZE CARS

General Motors Corporation					
Engine Type	Displacement (in ³)	HP/rpm	Axle Ratio	1978 Fuel Economy *	
				Urban	Highway
V-6	200	95/3800	2.73	19	26
V-6	231	105/3400	2.41	19	28
V-8	260	110/3400	2.29	19	27
V-8	305	145/3800	2.29	17	25
Ford Motor Company					
Engine Type	Displacement (in ³)	HP/rpm	Axle Ratio	1978 Fuel Economy *	
				Urban	Highway
L-4	140	69/4800	3.08	22	33 (I _W = 3000)
L-6	200	85/3600	3.08	19	25
V-8	302	139/3600	2.47	16	23

*EPA Buyer's Guide Data, Sept. 14, 1977.

C-2

Table 5-4
ACCELERATION CHARACTERISTICS OF 1978 INTERMEDIATE PASSENGER CARS

Eng/Trm/HP	Curb Weight		Acceleration in Seconds		Source
	kg	(lb)	0-48.27 kmh (0-30 mph)	0-96.54 kmh (0-60 mph)	
<u>Malibu</u>					
V6/A3/95	1431.1	(3155)	6.6	18.2	Consumers Union Car and Driver Road and Track
V8/M4/145	1597.1	(3521)	3.4	10.8	
V8/A3/145	1576.3	(3475)	3.6	11.4	
<u>Cutlass</u>					
V8/A3/110	1526.4	(3365)	5.6	15.5	Consumers Union
			N.A.	15.2	General Motors
			N.A.	15.8	GM GPSIM Calculation
<u>Fairmont</u>					
L6/A3/85	1310.9	(2890)	5.4	15.8	Consumers Union
L4/M4/88	1299.6	(2865)	5.6	15.4	Consumers Union
L4/A3/88	1299.6	(2865)	N.A.	16.4	Ford Motor Co.
V8/A3/140	1359.9	(2998)	N.A.	11.1	Ford Motor Co.
N.A. - Not Available					

Section 6

**PRIMARY RESULTS OF MISSION ANALYSIS
AND PERFORMANCE SPECIFICATIONS STUDY**

Deliverable Item Number 1, "Mission Analysis and Performance Specification Studies Report" of Contract No. 955190 includes a number of items specified in the Data Requirements Description. Among these items are the primary results of the study. The primary results of the study are reported in the following subsections.

- 6.1 Vehicle Performance Specifications
- 6.2 Mission Description and Daily Travel
- 6.3 Mission Specifications
- 6.4 ICE Reference Vehicle and Its Characteristics

Subsections 6.1 and 6.3 are patterned after Exhibit I of Contract No. 955190 and use the same identification code as the contract.

The primary results are presented in a condensed form below and in an expanded form in the pages which follow.

CONDENSED RESULTS

Vehicle Performance Specifications

- P1, Minimum Non-refuelable Range
 - 56 to 64 km (35-40 miles) on battery
 - 402 km (250 miles) with 17.85 liter (10 gallon) fuel tank
- P2, Cruise Speed
 - Electric Drive only: 88 km/h (55 mph)
 - ICE Engine only: 105 km/h (65 mph)
 - 121 km/h (65 mph)
- P3, Maximum Speed: 121 km/h (65 mph)
- P4, Acceleration: 0-96 km/h (0-60 mph) in 16 seconds
- P5, Gradability (minimum continuous)
 - 5%: 88 km/h (55 mph)
 - 15%: 32 km/h (20 mph)
- P6, Passenger Capacity: 5 adults
- P7, Cargo Capacity: 0.5 m³ (17.7 ft³); 100 kg (220 lb)

Mission Specifications

- M1, Daily Travel: -- See Tables 6-1 and 6-2
- M2, Payload: -- passenger and cargo loads not assigned to specific type trips
- M3, Trip Length, Frequency and Purpose: -- see Section 4.3
- M4, Driving Cycles: -- EPA Urban (FHDC) and EPA Highway (FHDC)
- M5, Annual Vehicle Miles: -- see Figures 4-1 through 4-10 for annual mileage statistics
- M6, Potential Number of Hybrid/Electric Vehicles in Use: -- will be analyzed in later task
- M7, ICE Reference Vehicle: -- Chevrolet Malibu with V-6, 231 CID engine
- M8, Reference ICE Vehicle Annual Fuel Consumption: -- in 1985 all mid-size passenger cars estimated to use 27% of fuel used for personal transportation

6.1 VEHICLE PERFORMANCE SPECIFICATIONS

P1 Minimum Nonrefuelable Range -

P1.1 Highway Driving (FHDC)

- (a) 402 km (250 miles) between gasoline refueling stops [i.e., about 37.85 liter (10 gallons) fuel tank capacity]
- (b) battery-stored electricity sufficient to load-level the heat engine for 804 km (500 miles) highway driving without recharge from the heat engine

P1.2 Urban/Suburban Driving (FUDC)

- (a) 56-64 km (35-40 miles) using electric drive as primary system
- (b) 112-128 km (70-80 miles) using heat engine as primary system, but no battery recharging with heat engine

P1.3 SAE J227a(B)

To be calculated during Task 2 and Task 3 for comparison purposes.

P2 Cruise Speed -

- (a) electric drive only - 88 km/h (55 mph)
- (b) heat engine drive only - 105 km/h (65 mph)

P3 Maximum Speed -

- (a) 121 km/h (75 mph) continuous as long as battery charge level permits - combined efforts of electric and heat engine drives

P4 Acceleration (minimum values) -

0-48 km/h (0-30 mph) 6 seconds
 0-96 km/h (0-60 mph) 16 seconds
 Safe passing on a two-lane road

P5 Gradability (minimum values) -

<u>Grade</u>	<u>Speed</u>	<u>Distance*</u>
3%	88 km/h (55 mph)	Unlimited
5%	88 km/h (55 mph)	Unlimited
8%	64 km/h (40 mph)	Unlimited
15%	32 km/h (20 mph)	Unlimited

Maximum Grade: 25%

P6 Passenger Capacity -

5 passengers (350 kg)

*On heat engine alone, distance determined by fuel available.

P7 Cargo Capacity -

0.5 m³ (17.7 ft³)
 100 kg (220 lb)

P8 Consumer Costs -

Consumer Purchase Price (1978, \$)

List price of 4-door Malibu sedan with automatic transmission, power steering, power brakes, radio, and air conditioning was \$5725. (Reference: Automotive News, 1978 Market Data Book Issue.)

Consumer Life Cycle Cost (1978, \$)

12¢/km (19¢/mile) based on 10,000 miles/year. (Reference: Automotive News, 1978 Market Data Book Issue.)

P9 Emissions - Federal Test Procedure -

Standards have been set for conventional ICE passenger cars; applicability of those standards to an electric/hybrid whose emissions will depend on battery state-of-charge has not yet been established.

The passenger car emission standards for 1978, 1981, and 1985 are as follows:

<u>Year</u>	<u>Standards (gram/mile)</u>		
	<u>HC</u>	<u>CO</u>	<u>NO_x</u>
1978	1.5	15	2
1981	0.4	7	1
1985	0.4	3.4	1

The electric/hybrid will meet the above standards for all operating modes except possibly when the battery is being recharged by the heat engine. Meeting the NO_x standard during battery charging may prove to be difficult. This will be investigated during other tasks of the program.

P10 through P17 -

Will be treated during the design trade-off and preliminary design tasks of the program.

6.2 MISSION DESCRIPTION AND DAILY TRAVEL

Figures 4-11 thru 4-26 have been used to generate daily range capabilities for the eight mission sets defined in Section 4.2. This data is presented in Table 6-1 for the four mission sets inside the SMSAs and in Table 6-2 for the four mission sets outside the SMSAs. The percentiles listed under daily distance in these tables are for percent vehicle miles, not for percent days.

The assumption that daily travel in excess of 100 miles means intercity travel is reasonable in most instances but there are certainly exceptions where there are many short trips in one day all within a city and totaling 100 miles or more. On the other hand, daily travel of considerably less than 100 miles could be intercity travel. The larger the metropolitan area in which a vehicle is based, the greater the daily travel distance that would constitute intercity travel. Since data is not available to define the distribution of intercity travel, the criterion specified herein has been selected. Future sensitivity studies of the mission analysis will examine the significance of this assumption.

Comparisons between Tables 6-1 and 6-2 indicate that any vehicle capable of meeting annual and daily travel requirements for outside SMSAs would also meet requirements inside SMSAs. Thus, it would seem reasonable to let Table 6-2 represent the mission data for all vehicles. However, inasmuch as the purpose of the hybrid vehicle study is to assess impact on total fuel consumption, it is also necessary to factor in the relative sales and potential market penetration both inside and outside SMSAs. For this reason, a distinction between vehicle missions inside and outside of SMSAs will be retained. It is highly unlikely that a different design for inside and outside SMSAs is reasonable. A final decision on whether vehicle use patterns inside or outside SMSAs dictate the final design will be made when the fuel consumption impact study is completed (Task 2).

**Table 6-1
DAILY AND ANNUAL TRAVEL DISTANCES INSIDE SMSAs
FOR VARIOUS MISSIONS**

Mission	Annual Distance (miles)	Daily Distance (miles) Percentile *		
		50	75	90
Personal business only				
50th percentile	3,000	20	29	39
75th percentile	4,500	25	38	49
90th percentile	6,500	32	49	66
Personal business plus work trips				
50th percentile	6,625	21	32	43
75th percentile	8,125	26	39	57
90th percentile	10,125	32	51	76
All-purpose (excluding intercity travel)				
50th percentile	6,400	34	52	69
75th percentile	9,200	52	74	99
90th percentile	11,600	>100	>100	>100
All-purpose (including intercity travel)				
50th percentile	7,000	36	61	>100
75th percentile	11,300	50	84	>100
90th percentile	17,000	70	>100	>100
*Percentiles are for vehicle miles				

**Table 6-2
DAILY AND ANNUAL TRAVEL DISTANCES OUTSIDE SMSAs
FOR VARIOUS MISSIONS**

Mission	Annual Distance (miles)	Daily Distance (miles) Percentile*		
		50	75	90
Personal business only				
50th percentile	4,400	25	38	52
75th percentile	6,500	31	49	67
90th percentile	9,300	43	64	82
Personal business plus work trips				
50th percentile	6,275	23	36	54
75th percentile	8,375	31	49	68
90th percentile	11,175	42	64	90
All-purpose (excluding intercity travel)				
50th percentile	7,800	40	62	83
75th percentile	10,600	61	90	>100
90th percentile	12,700	>100	>100	>100
All-purpose (including intercity travel)				
50th percentile	9,000	43	72	>100
75th percentile	13,700	58	>100	>100
90th percentile	20,500	84	>100	>100

*Percentiles are for vehicle miles

6.3 MISSION SPECIFICATIONS**M1 Daily Travel -**

Daily travel requirements are summarized in Tables 6-1 and 6-2.

M2 Payload (in terms of cargo and passengers) -

No attempt was made to assign passenger and cargo loads to specific type trips because such information was not needed to proceed with the design of the hybrid 5-passenger, mid-size passenger car.

M3 Trip Lengths, Trip Frequency, and Trip Purpose -

Trip purposes were subdivided only as needed to obtain design constraints for the hybrid vehicle. In this regard, only to/from work travel, local random personal travel, all-purpose travel, and intercity travel were considered separately. Work travel and intercity travel were not considered random travel and hence were not included in the random trip calculations. Trip frequency (trips per day) and trip length were calculated as indicated in Section 4.3. Results are summarized in Table 4-18.

M4 Driving Cycles -

It was concluded that all travel could be described in terms of the EPA urban (FUDC) and highway (FHDC) cycles. Travel in congested city areas is better simulated by the "stabilized" portion (Figure 4-28) of the EPA urban cycle than the J227a(B) cycle. The EPA highway cycle applies only to intercity travel. The "transient" portion of the EPA urban cycle applies to relatively uncongested expressway travel (Figure 4-27). An important factor as far as driving cycles are concerned is the assumed split between the mileage on the FUDC AND FHDC cycles. The customary split of 55/45 is the national average, but does not apply to those living in urban areas, especially in the Northeast. A more appropriate split would seem to be 70/30 (Table 4-4) for those living in the near metropolitan areas. The assumed split between urban and highway mileage is an important input for the economic calculations.

M5 Annual Vehicle Miles Traveled Per Vehicle -

This is an important factor in determining mission specifications and vehicle range requirements. Unfortunately, very little data is available in this area. Annual vehicle-miles-traveled distributions (that is fraction of vehicles traveling a specified mileage or less - see Figure 4-1) are required to interpret and apply the random trip computer results to the various mission sets. It was necessary to make a "best judgement" estimate of the annual miles traveled distributions for personal and all-purpose travel. Estimates were made for

inside SMSAs and outside SMSAs for both types of travel. Data/information on intercity travel is also needed, but such is not critical in determining the required "electric" range of the hybrid vehicle. Additional data on annual vehicle miles traveled per vehicle will be sought during the other tasks of the program.

M6 Potential Number of Vehicles in Use as a Percentage of Total Vehicle Fleet -

It is not possible as yet to estimate the function of mid-size vehicle sales in 1985 which could be hybrid/electric. If possible, this will be attempted in a later task after the economics of hybrid vehicle use has been assessed. It is estimated that in 1985 about 24% of the vehicles in the passenger car fleet will be mid-size vehicles.

M7 Reference Conventional ICE Vehicle -

The Reference ICE Vehicle selected for comparison with the mid-size hybrid vehicle is the Chevrolet Malibu with a V-6, 231 CID engine and a three-speed automatic transmission. This vehicle is a popular (high sales volume) 5-passenger car meeting the performance requirements determined for the hybrid electric design. A brochure describing the Chevy Malibu is included in the Appendix.

M8 Estimated Annual Fuel Consumption of the Reference ICE Vehicle -

It was estimated that in 1985 mid-size passenger cars will use about 27% of the gasoline consumed for personal transportation (Table 3-9). This estimate will be refined as part of later tasks of the program.

MISSION RELATED VEHICLE CHARACTERISTICS

V1 Capacity (Passengers and Cargo) -

5 passengers
17.7 ft³ or 200 lb of cargo

V2 Range, Speed, Acceleration, and Gradability -

(a) Range

Range, primarily on stored electrical energy utilized through the electric drive system is a key design parameter for the hybrid/electric vehicle. The range requirement depends on a number of factors including the mission set, travel distance to/from work, and annual vehicle miles in random personal travel. The latter mileage varies considerably from owner to owner (Figure 4-1). The viability of the hybrid/electric vehicle for a particular car owner depends to a large extent on whether the "electric" range provided permits him to operate the vehicle most days and for a significant fraction of his total urban miles on stored electricity rather than gasoline. If that is not the case, the owner would not realize the cost advantage of electrical energy. Range requirement results from

the mission and trip analysis studies (see Section 4 for the detailed approach) are given in Figures 4-11 through 4-23 for various percentiles of car users. From the range studies it was concluded that between 35 and 40 miles were required so that at least 50% of the mid-size car users could operate on stored electrical energy for between 50 and 75% of their annual vehicle miles in urban driving. The results given in Figures 4-11 through 4-23 will be utilized on a continuing basis in the design trade-off studies (Task 2) to further refine the "electric" range of the hybrid vehicle.

(h) Speed

There is little uncertainty regarding speed requirements as they are set by the 55-mph speed limit and the desire of most car owners to travel slightly in excess of the speed limit when traffic conditions permit to attain speeds well in excess of the speed limit for passing. Therefore, a cruise speed of 60 to 65 mph and a maximum passing speed of 65 to 70 mph will be specified. These speeds will make the hybrid/electric vehicle competitive with the conventional ICE vehicles.

(c) Acceleration and Gradability

Performance of a passenger car is often stated in terms of its 0-60 mph acceleration time. Acceleration performance is important to the car owner both for safety reasons and for the "good feeling" he gets from driving a responsive vehicle. The analysis discussed in Section 3 indicates that safe operation of the vehicle on 2-lane suburban and rural roads and on some limited-access expressways requires a power-to-weight ratio (HP/lb) consistent with a 0-60 mph acceleration time of 15-16 seconds. The associated gradability would depend somewhat on the vehicle gearing and shift logic, but should permit maintenance of 55 mph on grades up to 5%, and 40 mph on grades up to 8%. A maximum gradability of 25% will be used as a design target.

V3 Cost Constraints

Cost constraints are not set by the mission analysis, but certainly will greatly influence the marketability of a hybrid mid-size vehicle. The purchase price of mid-size cars (high sales volume, popular models) in 1978 ranged from \$4500 to \$6000 depending on installed equipment (e.g., air conditioning, radio, etc.). The price of a well equipped Malibu was about \$5700 in 1978. Data for 1978 (Automotive News, Market Book Issue) indicates an operating cost of about 19.5¢/mi for a mid-size passenger car. Every attempt will be made to design the hybrid/electric mid-size car so that it is cost-competitive with the Reference ICE Vehicle in terms of both initial and operating costs. These considerations will be central to the work in Tasks 2 and 3.

V4 Ambient Conditions, Availability and Amenities

The hybrid/electric vehicle will be designed to be equivalent in all respects as far as these factors are concerned. These factors were not felt to be effected significantly by mission set, thus, they were not considered in Task 1. They will be considered in Tasks 2 and 3.

6.4 ICE REFERENCE VEHICLE AND ITS CHARACTERISTICS

A 5-passenger mid-size car, the Chevrolet Malibu, has been selected as the ICE reference vehicle for comparison with the hybrid vehicle designs to be developed in Tasks 2 and 3. The characteristics of the Reference Vehicle in 1978, and those projected for a mid-size car in 1985, are summarized in Table 6-3. The acceleration performance indicated for the reference vehicle is consistent with that required of the hybrid vehicle designs. The 1978 fuel economies are those measured by EPA and corrected to account for actual on-the-road experience. The 1985 fuel economies reflect improvements due to reduced curb weight for mid-size cars, lower aerodynamic drag, wider range, and more efficient automatic transmissions, etc. It has been assumed that the fuel economy improvement indicated can be achieved along with meeting the 1985 emission standards of 0.4 gram/mile HC, 3.4 gram/mile CO, and 1.0 gram/mile NO_x.

Table 6-3

**SUMMARY OF THE CHARACTERISTICS OF THE
ICE REFERENCE VEHICLE IN 1978 AND 1985**

	<u>1978</u>	<u>1985 (estimate)</u>
Model	Chevrolet Malibu, 4-door, 5-passenger	GM Mid-Size
Engine (gasoline)	V-6, 231 CID, 105HP	L4 or V-6, 85HP
Transmission	3-speed, automatic	4-speed, automatic with lock-up
Curb Weight kg (lb)	1451.5 (3200)	1179.4 (2600)
Length, cm (in.)	490.2 (193)	469.9 (185)
Width, cm (in.)	182.9 (72)	185.4 (73)
Height, cm (in.)	137.2 (54)	137.2 (54)
Fuel Economy, km/l (mpg)		
urban-corrected	7.226 (17)	9.648 (22.7)
-uncorrected	8.075 (19)	11.900 (28)
highway-corrected	9.648 (22.7)	13.898 (32.7)
-uncorrected	11.900 (28)	17.850 (42)
Emissions gram/km (gram/mile)		
HC	0.932 (1.5)	0.249 (0.4)
CO	9.32 (15.0)	2.113 (3.4)
NO _x	1.24 (2.0)	0.622 (1.0)
Performance (seconds)		
0-48.3 km/hr (0-30 mph)	6	6
0-96.5 km/hr (0-60 mph)	16	16
72.4-104.6 km/hr (45-65 mph)	11	11
Range on 56.8 liters (15 gallons)		
urban, km (miles)	410.3 (255)	547.1 (340)
highway, km (miles)	547.1 (340)	788.4 (490)

Section 7**CONCLUSIONS AND RECOMMENDATIONS****7.1 CONCLUSIONS****7.1.1 GENERAL CONCLUSIONS AND OBSERVATIONS**

The following general conclusions were formulated based on the work done on mission analysis:

(1) The statistical character of automobile use is important in determining the "electric" range of the hybrid/electric car and the fraction of potential car buyers whose transportation needs would adequately be met by a specific hybrid/electric car design.

(2) Statistical data on annual mileage including the relationships between annual mileage and trip length frequency along with fraction of vehicle miles in trips of specified length are important in calculating auto use statistics, but the available key input data is very limited.

(3) The auto use patterns in terms of daily travel and annual mileage are significantly different inside and outside of SMSAs, and these differences can significantly effect the selection of design range for hybrid/electric cars.

(4) The fraction of vehicle miles rather than the fraction of days on which the car can be operated primarily on the battery is the critical factor in selecting "electric" range.

(5) The EPA urban and highway cycles can be used to describe vehicle use, and the "stabilized" portion of the EPA urban cycle is a better representation of central city driving than the SAE J227a (B) cycle.

(6) The urban/highway mileage split of 70/30* is more realistic for metropolitan areas in which hybrid/electric vehicles will be most attractive than the more customary 55/45 split.

7.1.2 SPECIFIC CONCLUSIONS

(1) The Chevrolet Malibu with a V-6, 231 CID engine, a 5-passenger mid-size car made by General Motors, was selected as the ICE reference vehicle.

*An urban/highway mileage split of 65/35 was used as nominal in the Design Trade-off and Sensitivities Studies (see Appendices B and D).

(2) An "electric" range of 35 to 40 miles for the hybrid/electric vehicle is needed so that at least 50% of the potential mid-size car buyers would drive at least 75% of annual urban vehicle miles using the electric drive as their primary propulsion means.

(3) A 0-96.5 km/h (0-60 mph) acceleration time of 16 seconds was selected for the acceleration performance specification. The critical factor in this selection was safe, high-speed passing on two-lane roads. This level of performance resulted in more than adequate gradability, freeway merging capability, and top speed.

7.2 RECOMMENDATIONS FOR CONTINUING MISSION ANALYSIS ACTIVITIES

Continuing activity on mission analysis is required as it relates to the design of the hybrid/electric vehicle, its potential sales, and thus its gasoline saving potential. Areas needing additional work were cited in previous sections of this report. Those areas are summarized below:

(1) A sensitivity analysis should be made of the calculated travel characteristics to statistical trip frequency/length and annual mileage data which were used as input to the Monte Carlo travel simulation program.

(2) The impact of statistical travel characteristics on hybrid/electric sales potential and energy usage should be examined.

(3) A study should be made on the detail needed in describing the driving cycle mixes (EPA urban, both transient and stabilized; and highway cycle) to calculate properly the operating costs and energy usage for the various mission sets.

(4) Further detailed evaluations should be made with regards to high-speed passing on a 2-lane road as the critical factor in setting power requirements using specific power train configurations.

(5) Interpretation of the GPSIM computer results for the ICE reference vehicle (Chevrolet Malibu with V-6, 231 CID engine) will be needed after the computer results have been received from General Motors.

Section 8

REFERENCES

1. General Motors' Response to the 81-84 Fuel Economy Proposal and Special Order, 1977.
2. A Policy on Geometric Design of Rural Highways - 1965, American Association of State Highway Officials.
3. F.T. Surber and G.K. Deshpande, "Hybrid Vehicle Missions," paper presented at the 5th International Electric Vehicle Symposium, Philadelphia, Pa., Oct. 1978.
4. A.F. Burke, "The Moving Baseline of Conventional Engine-Powered Passenger Cars (1975-1985)," SAE Paper No. 780347, Detroit, Mich., 1978.
5. B.D. McNutt, et al., "A Comparison of Fuel Economy Results from EPA Tests and Actual In-Use Experience, 1974-1977 Model Year Cars," HCP/M8435-01, Feb. 1978.
6. "Near-Term Hybrid Passenger Vehicle Development Program - Phase I, Guidelines and Assumptions," Jet Propulsion Laboratory, received 27 Sept. 1978.
7. Statistical Abstract of the US, 1977, 98th Annual Edition, published by the US Department of Commerce, Bureau of Census.
8. Motor Vehicle Facts and Figures '77, published by the Motor Vehicle Manufacturers Association, Washington, DC.
9. 1977 Year End Service D (New Passenger Cars), by State and US; 1977 Year End Service K (Imported Cars), by State and US, purchased from R.L. Polk Company, Detroit, Michigan.
10. US Department of Transportation/Federal Highway Administration, Nationwide Personal Transportation Study - Report No. 10, "Purposes of Automobile Trips and Travel," May 1974.
11. H.J. Schwartz, "The Computer Simulation of Automobile Use Patterns for Defining Battery Requirements for Electric Cars," Fourth International Electric Vehicle Symposium; Düsseldorf, West Germany (1976).
12. F.T. Surber and G.K. Deshpande, "Hybrid Vehicle Missions," Fifth International Electric Vehicle Symposium, Philadelphia, Pa. (1978).
13. US Department of Transportation/Federal Highway Administration, Nationwide Personal Transportation Study - Report No. 2, "Annual Miles of Automobile Travel," April 1972.

APPENDIX

Note: The Chevrolet Malibu Brochure number 3804, dated July 1978, was included only in those copies of this report which were delivered to the Government.

APPENDIX

CHEVROLET MALIBU TECHNICAL SPECIFICATIONS

Model	5-passenger, 4-door sedan
Engine (gasoline)	V-6, 231 CID, 105 HP
Transmission	3 speed, automatic
Curb Weight, kg (lb)	1451.5 (3200)
Exterior Dimensions, cm (in.)	
Length	490.2 (193)
Width	182.9 (72)
Height	137.2 (54)
Fuel Economy 1978, km/liter (mpg)	
EPA-Urban	8.08 (19)
-Highway	11.90 (28)
EPA Corrected	
-Urban	7.22 (17)
-Highway	9.65 (22.7)
Emissions, g/km (g/mi)	
HC	0.93 (1.5)
CO	9.32 (15.0)
NO _x	1.24 (2.0)
Acceleration, seconds	
0-48.27 km/h (0-30 mph)	6
0-96.54 km/h (0-60 mph)	16
72.40-104.58 km/h (45-65 mph)	11
Range, 56.78 liters (15 gallons)	
Urban, km (miles)	410.3 (255)
Highway, km (miles)	547.1 (340)

BASIC INTERIOR DIMENSIONS - REFERENCE VEHICLE

According to the basic plan outlined in the original proposal, the interior dimensions as relating to the occupant seating package would be utilized in the hybrid vehicle. Listed below are the interior dimensions of the reference ICE vehicle (1979 Malibu 4-door sedan) which will be used in the preliminary packaging exercises.

<u>Front Compartment</u>		<u>Degrees</u>	<u>Inches</u>	<u>Millimeters</u>
W20	Centerline Occupant to Centerline Car		14.48	368
H61	Effective Headroom		38.70	983
L64	Maximum Effective Leg Room		42.75	1086
H30	H Point to Heel Hard (chair height)		8.97	228
L40	Back Angle	26.5		
L42	Hip Angle	99.5		
L44	Knee Angle	131.0		
L46	Foot Angle	87.0		
L53	H Point to Heel Point		35.07	891
L17	H Point Travel		6.73	171
H58	H Point Rise		.98	25
W3	Shoulder Room		57.32	1456
W5	Hip Room		52.20	1326
W16	Seat Width		49.49	1257
<u>Rear Compartment</u>				
L50	H Point Couple		32.56	827
W25	Centerline Occupant to Centerline Car		13.27	337
H63	Effective Head Room		37.68	957
L51	Maximum Effective Leg Room		38.00	965
H31	H Point to Heel Point (chair height)		11.73	298
L41	Back Angle	27		
L43	Hip Angle	92		
L45	Knee Angle	102		
L47	Foot Angle	118.5		
W4	Shoulder Room		57.08	1450
W5	Hip Room		55.59	1412
<u>Control Location</u>				
H18	Steering Wheel Angle	19.5		
L7	Steering Wheel Torso Clearance		13.38	340
L13	Brake Pedal Knee Clear		24.42	595
L52	Brake Pedal to Accelerator		4.48	114

NEAR-TERM HYBRID VEHICLE PROGRAM

FINAL REPORT — PHASE I

Appendix B — Design Trade-Off Studies Report
Vol II — Supplement to Design Trade-Off Studies

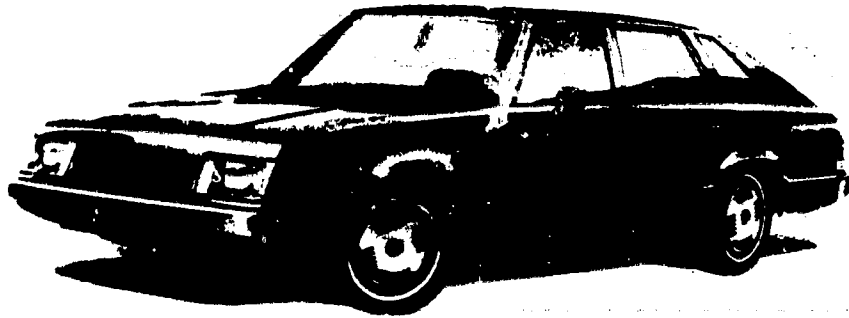

(NASA-CR-163228) NEAR-TERM HYBRID VEHICLE PROGRAM, PHASE I. APPENDIX B: DESIGN TRADE-OFF STUDIES REPORT. VOLUME 2: SUPPLEMENT TO DESIGN TRADE-OFF STUDIES Final Report (General Electric Co.) 319 p 63/85 22356
N80-26204
Unclas
AC A11/10/85 KCI

Contract No. 955190

Submitted to

Jet Propulsion Laboratory
California Institute of Technology
4800 Oak Grove Drive
Pasadena, California 91103

Submitted by

General Electric Company
Corporate Research and Development
Schenectady, New York 12301

October 8, 1979

GENERAL ELECTRIC

SRD-79-134/4

NEAR-TERM HYBRID VEHICLE PROGRAM

FINAL REPORT — PHASE I

**Appendix B — Design Trade-Off Studies Report
Vol 1: — Supplement to Design Trade-Off Studies**

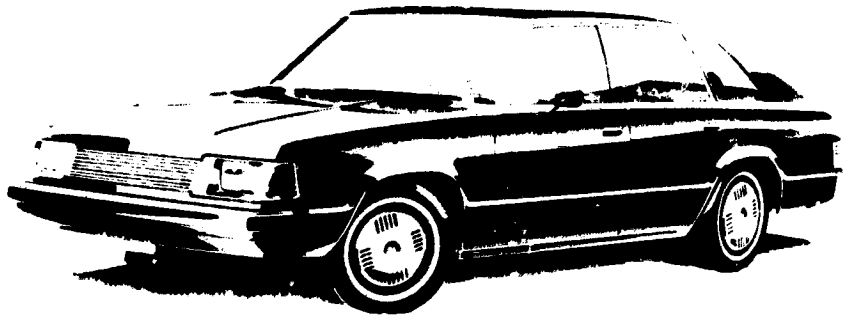

Contract No. 955190

Submitted to

**Jet Propulsion Laboratory
California Institute of Technology
4800 Oak Grove Drive
Pasadena, California 91103**

Submitted by

**General Electric Company
Corporate Research and Development
Schenectady, New York 12301**

October 8, 1979

GENERAL  ELECTRIC

FOREWORD

The Electric and Hybrid Vehicle (EHV) Program was established in DOE in response to the Electric and Hybrid Vehicle Research, Development, and Demonstration Act of 1976. Responsibility for the EHV Program resides in the Office of Electric and Hybrid Vehicle Systems of DOE. The Near-Term Hybrid Vehicle (NTHV) Program is an element of the EHV Program. DOE has assigned procurement and management responsibility for the Near-Term Hybrid Vehicle Program to the California Institute of Technology, Jet Propulsion Laboratory (JPL).

The overall objective of the DOE EHV Program is to promote the development of electric and hybrid vehicle technologies and to demonstrate the validity of these systems as transportation options which are less dependent on petroleum resources.

As part of the NTHV Program, General Electric and its subcontractors have completed studies leading to the Preliminary Design of a hybrid passenger vehicle which is projected to have the maximum potential for reducing petroleum consumption in the near term (commencing in 1985). This work has been done under JPL Contract 955190, Modification 3, Phase I of the Near-Term Hybrid Vehicle Program.

This volume is part of Deliverable Item 7, Final Report, of the Phase I studies. In accordance with Data Requirement Description 7 of the Contract, the following documents are submitted as appendices:

APPENDIX A is the Mission Analysis and Performance Specification Studies Report that constitutes Deliverable Item 7 and reports on the work of Task 1.

APPENDIX B is a three-volume set that constitutes Deliverable Item 2 and reports on the work of Task 2. The three volumes are:

- Volume I -- Design Trade-Off Studies Report
- Volume II -- Supplement to Design Trade-Off Studies Report, Volume I
- Volume III -- Computer Program Listings

APPENDIX C is the Preliminary Design Data Package that constitutes Deliverable Item 3 and reports on the work of Task 3.

APPENDIX D is the Sensitivity Analysis Report that constitutes Deliverable Item 8 and reports on Task 4.

The three classifications - Appendix, Deliverable Item, and Task number - may be used interchangeably in these documents. The interrelationship is tabulated below:

<u>Appendix</u>	<u>Deliverable Item</u>	<u>Task</u>	<u>Title</u>
A	1	1	Mission Analysis and Performance Specification Studies Report
B	2	2	Vol. I - Design Trade-Off Studies Report Vol. II - Supplement to Design Trade-Off Studies Report Vol. III - Computer Program Listings
C	3	3	Preliminary Design Data Package
D	8	4	Sensitivity Analysis Report

This is Volume II, Supplement to Design Trade-Off Studies Report Volume I, of Appendix B. This volume reports on work done on Task 2 and is part of Deliverable Item 7, Final Report, which is the summary report of a series which documents the results of Phase I of the Near-Term Hybrid Vehicle Program. Phase I was a study leading to the preliminary design of a five-passenger vehicle utilizing two energy sources (electricity and gasoline/diesel fuel) to minimize petroleum usage on a fleet basis.

This volume presents reports submitted by subcontractors on heat engines, battery power sources, and vehicle technology. These subcontractor reports have been reproduced as submitted to General Electric and are presented in this volume to make available source material that was used in the Design Trade-Off Studies.

The subcontractor reports are submitted in separate sections in which the General Electric imposed Work Statement is presented first, followed by the subcontractor report submitted in response to the Work Statement. The order of presentation is

- Section 1 - Heat Engine Trade-Off Study performed by General Electric Company, Space Division
- Section 2 - Assessment of Battery Power Sources performed by ESB Technology Company
- Section 3 - Vehicle Technology performed by Triad Services, Incorporated

Material from a number of internal General Electric studies which were used during the Design Trade-Off Studies was summarized and is presented in Section 4 - Motors and Controls for Hybrid Vehicles. Included in Section 4 are attachments which describe pertinent studies and developments. These are:

- Attachment A - Proposed Development Program on Advanced Electric Vehicle, October 1975
- Attachment B - Centennial Electric Car

- Attachment C - Electric Vehicle AC Drive Study**
- Attachment D - Propulsion System Design Trade-off Studies**
- Attachment E - Producibility Analysis**
- Attachment F - Required Motor and Controller Data**

The attachments are submitted without any editorial rewrite or attempt to present a continuously narrative text but only as a means to record background information.

TABLE OF CONTENTS

<u>Section</u>		<u>Page</u>
1	HEAT ENGINE TRADE-OFF STUDY WORK STATEMENT	1-1
2	ASSESSMENT OF BATTERY POWER SOURCE WORK STATEMENT.	2-1
3	VEHICLE TECHNOLOGY WORK STATEMENT	3-1
4	MOTORS AND CONTROLS FOR HYBRID VEHICLES	4-1
4	PROPOSED DEVELOPMENT PROGRAM ON ADVANCED	
Att. A	ELECTRIC VEHICLE OCTOBER 1975	4A-1
4	CENTENNIAL ELECTRIC CAR	4B-1
Att. B		
4	ELECTRIC VEHICLE AC DRIVE STUDY	4C-1
Att. C		
4	PROPULSION SYSTEM DESIGN TRADE-OFF STUDIES	4D-1
Att. D		
4	PRODUCIBILITY ANALYSIS	4E-1
Att. E		
4	REQUIRED MOTOR AND CONTROLLER DATA	4F-1
Att. F		

LIST OF ILLUSTRATIONS

<u>Figure</u>		<u>Page</u>
4-1	Direct Current Separately Excited Motor Used in Near-Term Electric Vehicle	4-2
4-2	Comparison of PM Disc Synchronous Motor with dc Separately Excited Motor	4-3
4-3	Comparison of High-Speed Induction Motor and Gear Reducer with dc Separately Excited Motor	4-3
4-4	Candidate Motors	4-5
4-5	Candidate Motors and Controls	4-6
4-6	Vehicle Performance Computations	4-8
4C-1	Energy for J227, a Schedule D Driving Cycle	4C-2

LIST OF ILLUSTRATIONS (Cont'd)

<u>Figure</u>		<u>Page</u>
4C-2	Influence of Motor and Control on System Weight	4C-10
4C-3	Influence of Motor and Controller on System Efficiency	4C-10
4C-4	Influence of Motor and Controller on ac - System Range Improvement over dc System	4C-11
4C-5	Relative Cost of Motor and Control Options	4C-11
4D-1	Maximum Drive Shaft Torque Specification for a Nominal Design Motor	4D-3
4D-2	General Specification for D.S. Torque	4D-4
4D-3	Motor Voltage for Nominal Design	4D-5
4D-4	Power Circuit Diagram	4D-20
4D-5	Effect of ϵ Exponent in Voltage Corner Point Equation	4D-25
4D-6	Calculated Efficiency Versus per Unit dc Current	4D-27
4D-7	Total Cost as a Function of Module Cost	4D-29

LIST OF TABLES

<u>Table</u>		<u>Page</u>
4-1	DC Motor Data	4-9
4-2	AC Motor Data	4-10
4C-1	Relative Moto. and Exciter Costs	4C-7
4C-2	Effect of Motor Type and Control on Range Change	4C-8
4C-3	Motor Data	4C-9
4C-4	Power Converter Data	4C-9
4D-1	AC Motor Data	4D-15

Section 1
HEAT ENGINE TRADE-OFF STUDY

WORK STATEMENT

to

General Electric Company
Space Division
Space Systems Operator
Philadelphia, PA 19101

INTRODUCTION

Contract No. 955190 between California Institute of Technology Jet Propulsion Laboratory and General Electric Company covers a program entitled "Phase I of the Near-Term Hybrid Passenger Vehicle Development Program" under which studies shall be conducted leading to a preliminary design of a hybrid passenger vehicle that is projected to have the maximum potential for reducing petroleum consumption in the near term (commencing in 1985). Effort under Contract 955190 is being conducted pursuant to an Interagency Agreement between the Department of Energy (DOE) and the National Aeronautics and Space Administration (NASA) and in furtherance of work under Prime Contract NAS7-100 between NASA and the California Institute of Technology. This work statement covers heat engine technology under General Electric Purchase Order A02000-220406.

SCOPE OF WORK

In support of General Electric Corporate Research and Development's work under Contract 955190, the Subcontractor shall furnish the necessary personnel, materials, services, facilities, and otherwise do all things necessary for or incident to the performance of the following tasks:

1. Provide a description of the system and components of state-of-the-art electronic fuel gasoline engines:
 - Engines currently being marketed
 - Engines in advanced stage of development of testing
 - System components and control
 - Sensors
 - Microprocessors and control logic
2. Consider the use of fuel-injected engines in the on/off operating mode:
 - Fuel cutoff techniques
 - Engine startup at relatively high vehicle velocity (≈ 30 mph)

- Emissions (steady-state NO_x emissions, sizing catalyst, warmup, fuel cutoff during deceleration)
 - Thermal effects and cooling
 - Accessory drives
 - Engine durability
3. Selection and characterization of fuel-injected engines in the 60 - 80 hp range (probably four-cylinder) for use in the hybrid vehicle.

NOTE WITH RESPECT TO SUBCONTRACTOR'S DATA

It is understood that all data furnished hereunder may be furnished to the California Institute of Technology Jet Propulsion Laboratory and DOE and NASA with no restrictions.

HEAT ENGINE TRADEOFF STUDY
NEAR-TERM HYBRID VEHICLE PROGRAM - PHASE I

PREPARED BY:

W. S. Chiu
General Electric Company
Space Division
Energy Operation
P. O. Box 8661
Philadelphia, PA. 19101

PREPARED FOR:

General Electric Company
Corporate Research and Development
One River Road
Schenectady, N. Y. 12345

Purchase Order No. A02000-220406

HEAT ENGINE TRADEOFF STUDY
NEAR-TERM HYBRID VEHICLE PROGRAM - PHASE I

TABLE OF CONTENTS

<u>Section</u>	<u>Title</u>	<u>Page</u>
	INTRODUCTION	1
1.0	PRELIMINARY SCREENING OF ENGINE TYPES.	1
1.1	Selection Criteria	1
1.2	Candidate Engines.	2
1.3	Engine Type Selection.	2
1.4	Selection of an Otto-Cycle Engine.	4
2.0	DESCRIPTION OF SYSTEM AND COMPONENTS	6
2.1	Engine Currently Being Marketed.	6
2.2	Advanced Engines under Development	8
2.3	System Components and Control.	8
2.3.1	Fuel Delivery Subsystem.11
2.3.2	Air Induction Subsystem.12
2.3.3	Primary Sensors.12
2.3.4	Electronic Control Unit.13
3.0	ON/OFF OPERATING MODE.14
3.1	Start-Up14
3.1.1	Mechanical Clutch.14
3.1.2	Valve Deactivation14
3.2	Fuel Cut-Off19
3.3	Emissions.19
3.3.1	Steady State19
3.3.2	Catalytic Converter.21
3.3.3	Cold Start23
3.3.4	Fuel Cut-Off24
3.4	Mechanical Effects24
4.0	SELECTION AND CHARACTERIZATION OF HYBRID VEHICLE ENGINE.27
4.1	Selection of the Engine.28
4.2	Engine Characteristics28
	REFERENCES47

HEAT ENGINE TRADEOFF STUDY
NEAR-TERM HYBRID VEHICLE PROGRAM - PHASE I

INTRODUCTION

A heat engine/electric hybrid vehicle will employ heat engine power for high speed (e.g. above 30 MPH) cruising, and electric power for low speed cruising, acceleration, passing and hill-climbing. When the engine is turned on it will operate at or near the wide-open throttle (WOT) conditions to maximize its efficiency.

For a five-passenger highway vehicle cruising at a steady speed of 90 Km/hr (50 MPH), the power requirement is in the order of 30 HP. Since the engine efficiency peaks at 40 to 50% of the maximum engine speed, the engine maximum rated power should be sized between 60 to 80 HP for a hybrid vehicle.

1.0 PRELIMINARY SCREENING OF ENGINE TYPES

1.1 Selection Criteria

Since the electric system (batteries, generator and motor) serves as a second prime mover, the cost, weight and volume constraints of a hybrid heat engine are more stringent than in conventional automobiles. The desired hybrid engine should be light-weight, durable and cost effective.

A hybrid engine should meet the 1981 Federal Statutory Emission Standard as a conventional automobile. For modes of operation involving on-off, the emission control techniques developed for conventional automobiles can be adopted.

Another consideration of the hybrid engine is its speed compatibility with the electric generator, especially for the system configurations where a direct coupling between the two components is required. For the on-off modes of operation, the fuel economy sensitivity to the speed or load variation also becomes an important consideration.

In order to develop an engine by 1980 and for it to be ready for mass production by 1985, the present product maturity of the candidate hybrid engines is an important parameter in making the final selection of a heat engine for a near-term hybrid vehicle.

1.2 Candidate Engines

To make a rational selection of the most suitable hybrid engine, a set of screening criteria, which are based upon the requirement discussed above, are developed. All feasible heat engines are identified and a gross evaluation of the engine characteristics against the screening criteria are performed for the selection of preliminary candidates. A more in-depth tradeoff study of these preliminary engine candidates are followed and reported in the following sections.

Table 1 shows such a matrix. The goal of the rated power range is set to be from 60 to 80 HP. The fuel consumption, weight and cost of various engine types, as classified by different thermodynamic cycles, are presented as the average value of each type relative to a typical conventional spark-ignition gasoline engine of equivalent power rating.

1.3 Engine Type Selection

From a fuel consumption point of view, turbo-charged diesel, Stirling and regenerative type gas-turbine engines offer better efficiencies than gasoline engines. However, both the Stirling engine and the gas-turbine in the 60 to 80 HP range are still in early developmental stages. Their availability for a 1980 demonstration will require substantial developmental efforts. Even though a 50 HP VW diesel engine is currently on market, it is not selected for the present study due to the uncertainty in the future Federal regulation on the exhaust particulate emission.

Advance developments in the recent years on the Otto-cycle engines, particularly on fuel delivery and the emission controls, have improved their fuel consumption significantly while successfully meet the Federal emission requirements. To select an efficient and reliable engine for the near-term hybrid vehicle without substantial development of the engine system, an advanced Otto-cycle engine appears to be most attractive.

Engine Type	Relative Fuel Consumption	Emissions	Relative Weight	Noise	Relative Cost	Reliability & Maintenance	Other Characteristics	Critical Elements	Developed By 1980	Production By 1985
<u>Otto Cycle</u> Reciprocating: Conventional EFI Stratified Charged	1.0 .82 .90	High NOxCO Low Moderate	1.0 1.0 1.0	Mod. Mod. Mod.	1.6 1.3 1.2	Good Good Good	↑ Fuel economy sensitive to speed/load. ↓	Catalyst Catalyst None	Yes Yes Yes	Yes Yes Yes
Lean Mixture	.94	Low	1.0	Mod.	1.4	Good		None	Possible	Possible
Turbo-Charged	.86	High NOx	0.8	Slightly Higher	1.5	Good	Direct coupling to elec. gen. or driveshaft	Turbo matching Seals	Yes Yes	Yes Yes
Rotary-Wankel	1.2	High HC	0.6	Lower	1.2	Good		none	Yes	Yes
<u>Diesel Cycle</u> Naturally-Aspirated	.8	High NOx Smoke & Odor	1.3	High	1.6	Excellent	Good Fuel Economy over Wide Speed/Load Ranges.	none	Yes	Yes
Turbo-Charged	.72	High NOx Smoke & Odor	1.1	High	1.8	Excellent		none	Yes	Yes
<u>Spark Ignition</u> Rotary Drive	.78	Extremely Low	1.3	Low	2.0	Good	Fuel Economy Sensitive to Speed	Seals High Temp. material	Yes	Yes (with major effort)
<u>Spark Ignition</u> Non-Regenerative	1.5	High NOx	0.7	Low	2.0	Excellent	Fuel Economy Sensitive to Speed/Load	High Temp material	Yes	Yes
Regenerative	.9	High NOx	0.7	Low	2.2	Good	Need Speed Reduction Gear	High Temp. regenerator	Doubtful	Doubtful
<u>Rankine Cycle</u> Steam	1.2	Low	1.3	Low	1.8	Good	Fuel Economy sensitive to Speed/Load	none	Yes	Yes (with major effort)
Organic Fluid	1.9	Low	0.6	Low	1.8	Fair	Need Speed Reduction Gear	Organic fluids	Yes	Yes (with major effort)

*REFERENCES 1-14

1.4 Selection of An Otto-Cycle Engine

The air/fuel ratio for a spark-ignition gasoline engine should be carefully controlled in order to achieve the optimum engine efficiency which is obtained at an equivalence ratio, λ , of approximately 1.1 where:

$$\lambda = \frac{\text{actual volume of air drawn into engine}}{\text{theoretical requirement of air for stoichiometric combustion}}$$

The specific fuel consumption deteriorates rapidly as λ moves away from 1.1.

On the other hand, to meet the stringent exhaust emission regulations while maintaining a good engine performance, use of a three-way catalytic converter appears to hold the most promise in early 1980's (Reference 12). To achieve high conversion efficiencies for all exhaust emissions -- unburnt hydrocarbons (HC), carbon monoxide (CO) and oxides of nitrogen (NO_x), the engine should be operated at an equivalence ratio around 1.0 and maintained it within a narrow range of ± 0.01 .

The electronic fuel injection system with a feedback control of an oxygen sensor at the exhaust makes it possible to achieve the accurate control of the fuel delivery rate within the above narrow range. It has demonstrated capabilities and advantages which include:

- Reduction of exhaust emission below the levels required by the 1981 Federal Statutory Emission Standards.
- Good vehicle performance and drivability.
- Reliable.

The technology has been well-demonstrated in many passenger cars currently in the market. Maturity of the technology and hardware as well as the demonstrated good performance and low emission make the EFI engine coupled with a three-way catalyst a logical choice for the hybrid vehicle in the early 1980's.

So far a stratified-charged spark-ignition (SI) engine, such as the Honda engine (Reference 14), has not demonstrated its ability to meet 1981 Federal emission standards without additional emission control equipment, such as a catalyst. Its fuel consumption is also not as good as a well-tuned EFI engine. The Ford Proco engine is still in the development stage and little information is available.

A turbo-charged V-6 SI engine has been marketed by Buick in 1978. The power output has been increased by 50%. However, so far a potentially better fuel economy has not been realized to a great extent (Reference 13). At WOT the fuel consumption is, in fact, poorer due to a fuel-rich requirement to help control detonation. Further technology development will be required until the turbo-charged SI engine becomes an attractive candidate for hybrid application.

2.0 DESCRIPTION OF SYSTEM AND COMPONENTS

2.1 Engine Currently Being Marketed

Development of Electronic Fuel Injection (EFI) systems started in the 1950's. Approximately 300 systems were first introduced by Chrysler Corporation during model year 1958. Concerns on exhaust emission control in the late 1960's led to a more successful development in EFI. Robert Bosch of West Germany succeeded in marketing the first high volume production EFI system to Volkswagon in 1967. The EFI system developed by Bendix Corporation was introduced by Cadillac in its 1975 model. At the present time, EFI systems have been quite popular among many passenger car models. Table 2 lists some of the EFI engines and their emissions and performance data which are currently marketed. It is interesting to note that so far the only engines meeting 1981 emission standards, especially NO_x , are those using three-way catalysts.

EFI systems for most of the foreign cars are developed by Robert Bosch, while for domestic cars, Bendix Corporation is the major supplier.

The electronic engine control system developed by Ford Motor Company applies a similar principle as the EFI systems. Instead of using injectors for fuel delivery, Ford selected to modify the conventional carburetor with a feedback control loop. In addition, data available (Reference 21) is not as extensive as that on the EFI systems. Therefore, the Ford system is not included in Table 1 as one of the Electronic Fuel Injection systems.

TABLE 2. EFI - ENGINES CURRENTLY BEING MARKETED

CAR MODEL (YEAR)	TYPE	EMISSION CONTROL	EMISSION LEVELS (gm/mile)				FUEL ECONOMY (MPG)	
			HC	CO	NOx	CITY	HIGHWAY	
VW (76)	L4, 97 CID	EGR/OXI. CAT.	0.3	4.8	0.8	26	38	
SAAB (78)	L4, 121 CID	3-WAY CAT.	0.19	3.9	0.28	22	30	
(77)		EGR/AIR INJ.	0.89	6.0	1.7	22	31	
VOLVO (77)	L4, 130 CID	3-WAY CAT.	0.2	2.7	0.18	18	28	
(76)		EGR/AIR INJ.	0.8	9.1	1.9	18	25	
(78)	V6, 163 CID	3-WAY CAT.	0.35	3.6	0.85	16	26	
(77)		EGR/OXI. CAT.	0.2	1.1	1.25	14	26	
(76)		EGR/AIR INJ.	1.3	13.0	2.6	15	27	
BMW (76)	L4, 122 CID	EGR/AIR INJ.	0.4	5.0	1.4	20	30	
AUDI (77)	L4, 97 CID	EGR/OXI. CAT.	0.2	2.0	1.2	24	36	
(77)	L4, 114 CID	EGR/OXI. CAT.	0.3	2.3	1.4	18	26	
AMC	L4, 122 CID							
CADILLAC	V8, 500 CID							

1981 FEDERAL EMISSIONS STANDARDS: 0.4 7.0 1.0

2.2 Advanced Engines under Development

There is expected to be no major technology break-through in the passenger car engine between now and the early 1980's. Existing basic engine types will be pretty much maintained. Major efforts in the near-term engine development are in the fine-tuning of the existing engine types, especially in a better control of fuel/air mixture through the improvement of either a carburetor or fuel injection systems. It is believed that most of the fine-tuning techniques developed in the next few years can be adopted in the heat engine selected for the near-term hybrid vehicle.

2.3 System Components and Control

The basic system, components and control of an electronic fuel injection system for gasoline engines has been described in detail in published literature (References 15-22). Despite some differences in design details among various systems, their basic principle of operation is similar. In these systems, detecting elements sense the engine operating conditions and pass their information in the form of electric signals to an electronic control unit. Processing these signals, the control unit then determines the amount of fuel required by the engine and controls the proper fuel delivery to insure proper air/fuel ratio.

A typical EFI system is schematically depicted in Figure 1. Figure 2 shows a simplified block diagram of its feed-back control. The system generally consists of four subsystems: the fuel delivery, the air-induction, the primary sensors, and the electronic control unit.

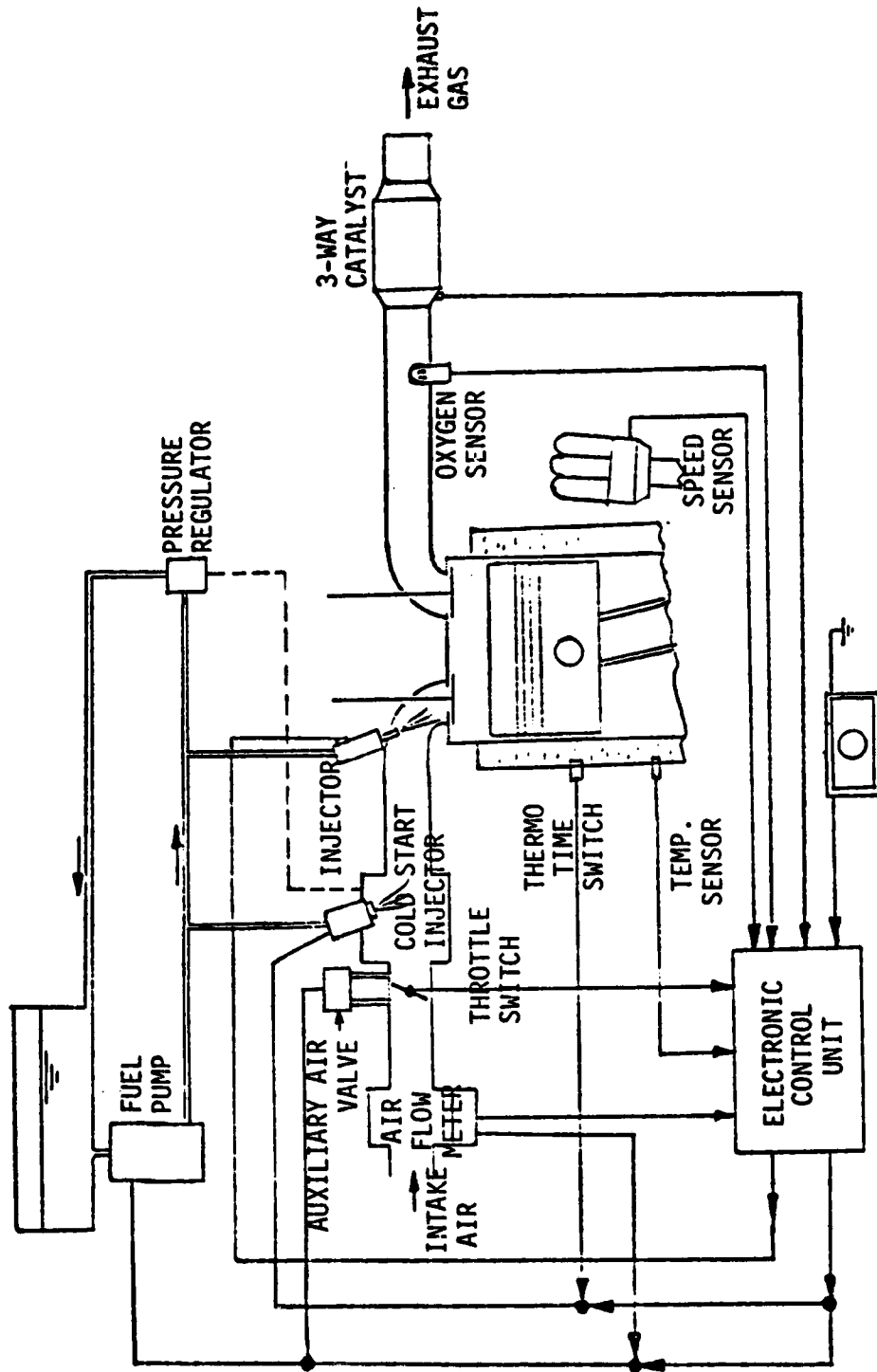

Figure 1. TYPICAL ELECTRONIC FUEL INJECTION (EFI) SYSTEM

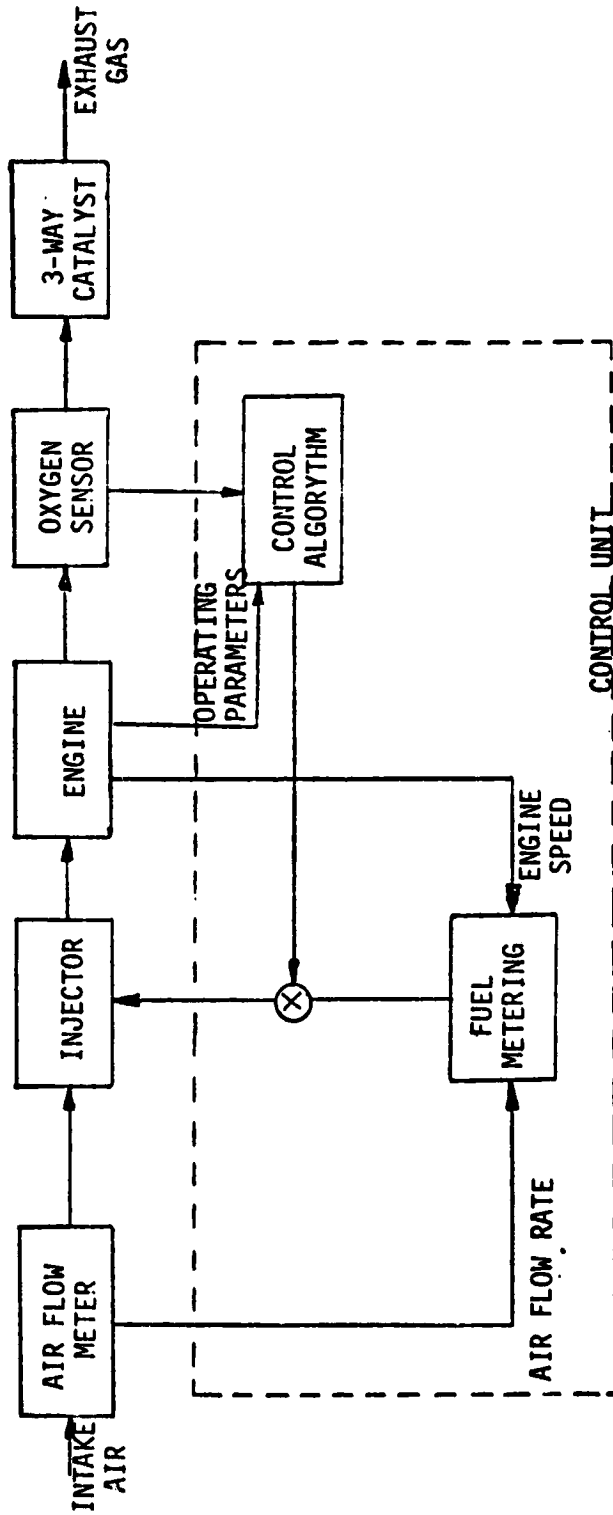

Figure 2. SIMPLIFIED BLOCK DIAGRAM OF EFI SYSTEM

2.3.1 Fuel Delivery Subsystem

The subsystem includes the fuel tank pick-up, an electric fuel pump, injectors for each cylinder, a fuel pressure regulator, supply and return line with a fuel filter. The fuel is held at a constant, low pressure (typically 2.5 to 3 bars) prior to the injectors and return to the tank at no pressure. As a result, cool fuel is delivered at all times during engine operation and formation of vapor bubbles in the fuel circulation system is prevented.

The solenoid-operated fuel injectors are installed in the intake manifold and spray fuel in front of the intake valves. Injection of fuel can be timed to take place for a group of injectors in order to reduce equipment costs. The amount of fuel delivered for each camshaft revolution can also be divided into two or more pulses to improve the uniformity in the distribution of the fuel mixture. For example, Bosch EFI-L system for 4-cylinder engines combines all four injectors into one single group and delivers two pulses of fuel injection for every camshaft rotation.

Since the fuel pressure is maintained constant, the flow rate and the stroke of the injector valve stem is also constant (approximately 0.15 min.), the fuel delivery rate per injection is thus controlled by the valve opening duration which is determined by the electronic control unit as a function of engine speed and air flow rate.

A separated injector is installed at the common intake manifold for cold start purposes. It has a swirl type nozzle for better fuel atomization and delivers extra amounts of fuel to enrich the mixture for easy starting. A thermo-time switch can be utilized to control the duration during which the start valve is switched on depending on the engine coolant temperature. This prevents the wetting of the spark plugs with a rich starting mixture.

2.3.2 Air-Induction Subsystem

This subsystem includes the integrated intake manifold, throttle-body assembly for primary air control, and an auxiliary air valve controlled by water temperature and supplies additional cold-start air.

Air flow measurements can be accomplished by sensing the throttle valve position, intake air pressure and temperature. The signals are input to the electronic control unit for air flow calculations.

An advanced air-flow meter has been developed by Bosch (References 18 and 19). The meter is located at the upstream side of the throttle valve as illustrated in Figure 1. One advantage of this system over the previous one is that, if necessary, the exhaust gas recirculation (EGR) can be incorporated without effecting the air flow measurement.

2.3.3 Primary Sensors

There are five primary sensors: (a) An engine speed sensor is usually mounted integral with the distributor. It provides the electronic control unit with data on engine speed for air flow calculations and engine phasing data for synchronizing injector-open timing. (b) An intake manifold pressure sensor measures absolute pressures in the intake manifold to provide for continuous calculation of air flow to the engine. This pressure sensor is not required if a separated air-flow meter is employed. (c) Throttle-position sensor provides both the absolute and rate of change of throttle-position needed for fuel-injection control. It senses closed-throttle, part-throttle, or wide-open throttle and conveys this information to the electronic control unit for electronic processing. (d) Three temperature sensors measure the intake air, engine coolant and catalytic converter temperature. An intake air temperature sensor is used in combination with the intake manifold pressure transducer to precisely determine the density of the inducted air. An engine coolant temperature sensor is mounted in the coolant passage and is needed for control of fuel enrichment, EGR cut-off or injection during cold operation. A temperature sensor is also mounted in the catalytic converter to control engine cold-start operation to accelerate catalyst warm-up period. (e) An oxygen sensor is mounted

in the exhaust manifold and measures oxygen concentration in exhaust gases. The output signal from this probe is used to regulate precisely the air/fuel mixture and makes it possible, together with the catalytic converter, to lower the noxious exhaust emissions. The most common oxygen sensor is a galvanic device with a zirconium dioxide solid electrolyte and a porous platinum electrode.

2.3.4 Electronic Control Unit (ECU)

The ECU is the heart of an EFI system. It receives information from the sensors that monitor key engine operating parameters; it processes this information using a selected control logic and computes the exact fuel requirement relative to air flow; it transmits electric pulses to the solenoid-operated injector valves. If necessary, the unit can also control EGR and other special operations, such as ignition advance. The current ECU utilizes integrated circuit to the greatest possible extent and has demonstrated excellent reliability.

Recent developments on the microprocessor based, electronic engine control system (Reference 23) may offer a better performance and economic tradeoff of alternate design approaches in the 1980's. This will increase the degree of freedom and accuracy of engine control and further improve the engine performance. However, many development efforts are needed to make it a reliable product in the harsh environment of the automotive application. It is considered to be premature to be implemented into the present hybrid vehicle demonstration program.

3.0 ON/OFF OPERATING MODE

The heat engine for a hybrid vehicle will be frequently on or off at a relatively high speed (1200-1500 rpm) at wide-open throttle as opposed to a conventional heat engine which starts at low idle (~600 to 800 rpm). The frequent on/off mode will be a new experience for heat engine development. Some considerations on this unusual operation are discussed as follows.

3.1 Start-Up

Two basic approaches can be adopted for controlling engine on/off operation: use of an engine clutch or a valve deactivation.

3.1.1 Mechanical Clutch

Use of a clutch represents the simpler approach of the two. The clutch engages or disengages the engine with the rest of the drive train during engine on or off cycle, respectively. The maturity and the availability of the component makes it attractive. However, several problem areas could be associated with this operation. First, since the engine will be turned on at a high speed, the vehicle at the instance of clutch engagement may experience a rough transition of speed due to the difference in engine speed and that of the drive train. A control system to improve the drivability will have to be developed. Secondly, each time the engine is started, there may be a short period of metal-to-metal contact of the connecting rod and main bearing. This may reduce bearing life somewhat. An auxiliary oil pump and modified bearing design have been suggested (Reference 24) to alleviate this problem.

3.1.2 Valve Deactivation

The valve deactivation approach, on the other hand, does not have the two problems discussed above. Valve deactivators (valve selectors) were developed for cylinder cut-out (terms such as engine limiting or variable displacement engine are also used) applications (References 27-29). The concept is to cut-out a number of cylinders from operation from a multi-cylinder engine, such as a V-8, when the full power from all cylinders is not needed. This allows fewer cylinders to operate at near the wide-open throttle and minimize the engine fuel consumption. While cylinders are not firing, a significant

amount of pumping work is required to overcome the throttling losses across the intake and the exhaust valves. With valves being closed, the engine needs only to overcome the friction loss. Figure 3 shows the test data of motoring work for a typical V-8 and small L-4 engines. It is seen that with the intake and the exhaust valve deactivated, the motoring work to run an inactivated engine can be reduced to an acceptable level.

Incorporating valve deactivators, a hybrid vehicle engine will be at identical speeds as the drive train at all times regardless whether the engine is on or off. Drivability of the vehicle will not be penalized due to frequent on/off operation of the engine and the engine lubrication can be ensured.

The hardwares of the valve deactivators have been well-developed for larger size engines (V-8 and 2.1L Pinto L-4) and their reliability demonstrated (References 28 and 29). Figure 4 illustrates the hardware design and its operation. Cost of adding valve deactivators for all cylinders is compatible with that of a clutch. The developed hardwares are, however, only applicable to engines having rocker arms in the valve train.

For smaller size engines with overhead cams and no rocker arms, new designs and developments of a valve deactivator will be required. One feasible design is shown in Figure 5. This is a modified version from that developed by Eaton Corporation (Reference 29) which is designed to be installed on the rocker arm studs. When the upper and lower body projections are "in-phase" as shown in Figure 5, the upper and the lower bodies of the valve deactivator become one integral part and valve motion follows the cam profile. As the solenoid is energized, it rotates the upper body during the time when the cam is at its base-circle and forces the upper and lower body projections to be "out-of-phase". Body projections thus will be allowed to move along the mating slots. The relative motions between the upper and the lower body permit the cam shaft to continue its rotation while the valves are deactivated. This mechanism requires only slight modification from the existing Eaton's hardware. Its development is considered to be of no major problem. Considering possible problems which may occur in the on/off operation with the clutch, it is recommended that valve deactivation be considered for the near-term hybrid vehicle.

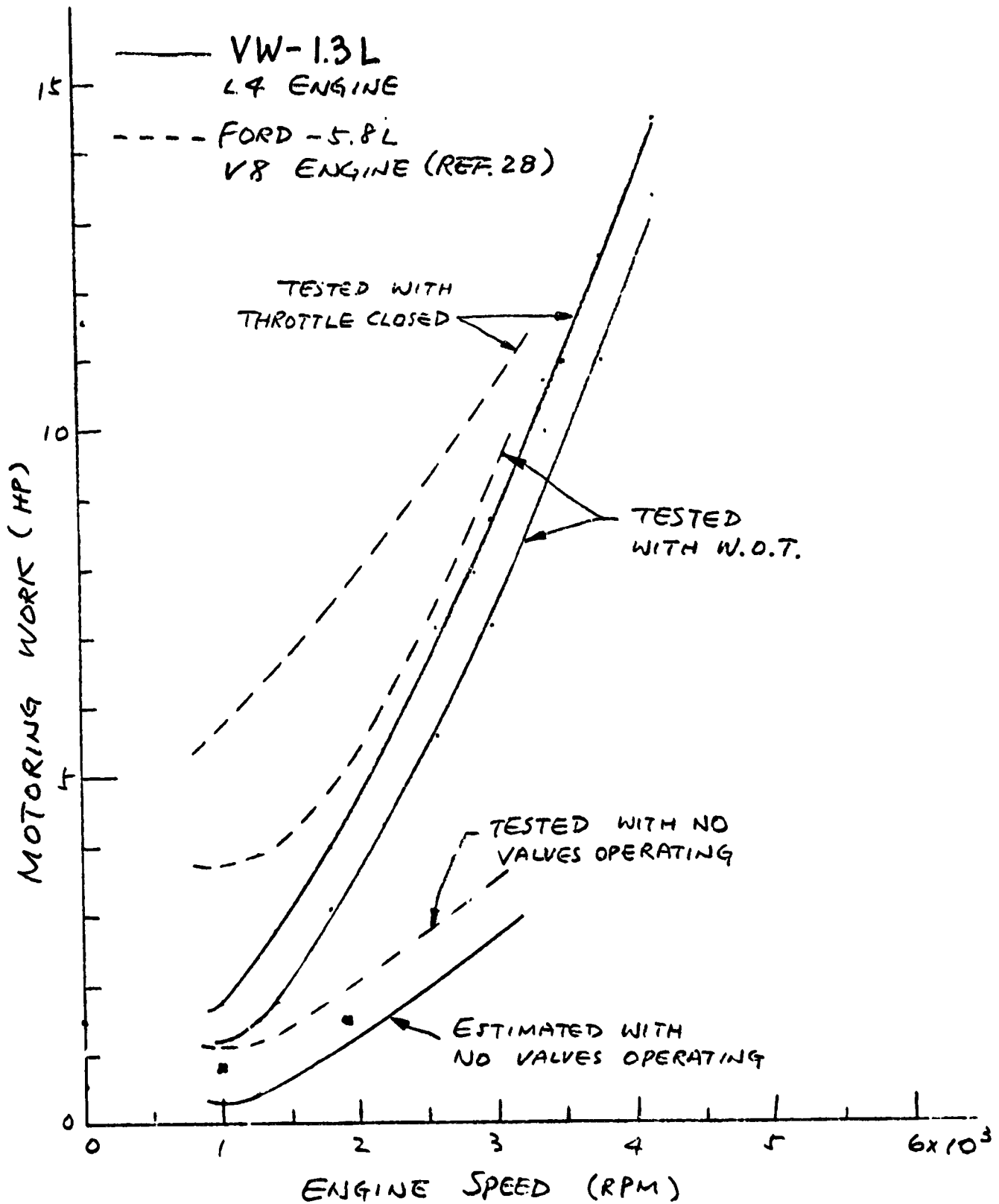

FIG 3. MOTORING WORK

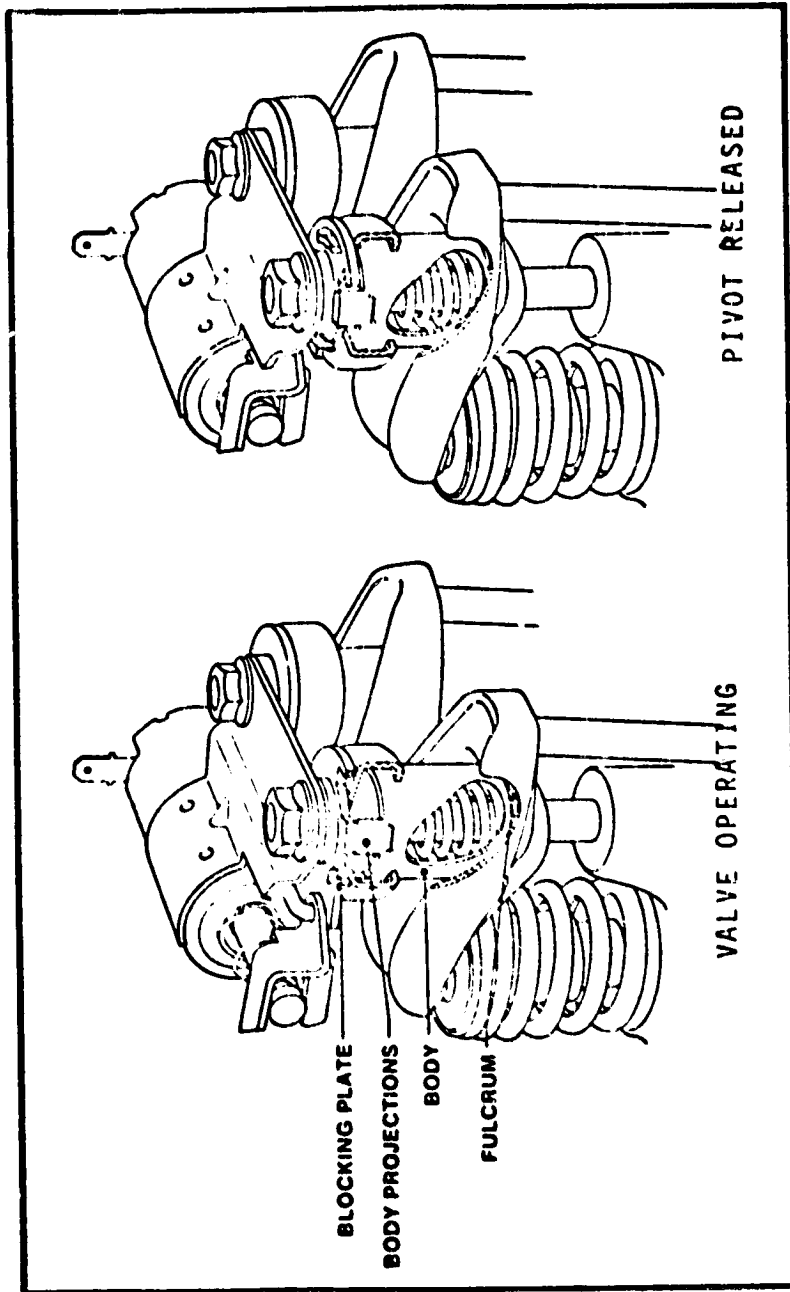
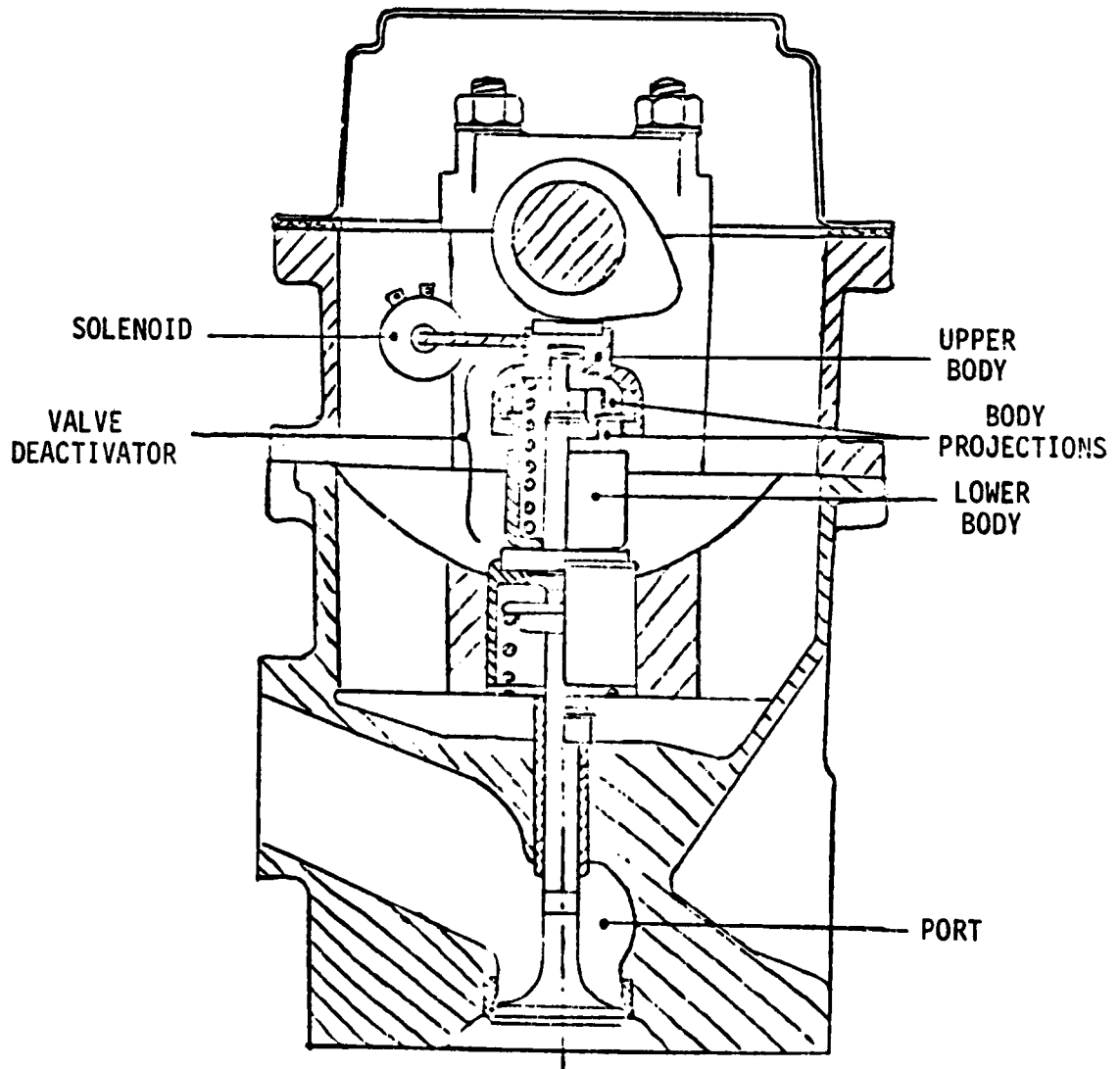

Figure 4. EATON'S VALVE SELECTOR MECHANISM (Reference 29)

Figure 5. VALVE DEACTIVATOR



The sequence for turning the engine on is as follows. First, the intake and the exhaust valves are activated as the vehicle speed exceeds the desired level (e.g. 30 mph). After additional full crank revolutions, solenoids for the fuel injections are energized to start the normal operation.

3.2 Fuel Cut-Off

As has been discussed previously, fuel delivery will be cut-off during vehicle deceleration and as the vehicle is at low speed (below 30 mph). The fuel injection should be terminated before the valve deactivation takes place. To avoid misfire or fuel rich for any one of the cylinders, the fuel cut-off and valve deactivation sequence should be carefully monitored. Figure 6 illustrates one of the fuel cut-off techniques.

The example given in Figure 6 is for a four-cylinder, four-stroke engine. Fuel injections are delivered twice per engine operating cycle (720° crank angle). For each cylinder valves are deactivated at least two full crank revolutions after the fuel is cut-off. This ensures that complete combustion will take place at every cylinder and prevent any unusually high unburnt hydrocarbon emission.

3.3 Emissions

3.3.1 Steady State

Several investigations have been conducted relating to the effect of on/off operation for hybrid vehicles on their exhaust emission levels. (References 25, 26, 30 and 31). The effect of a hybrid operation on vehicle emissions depends on the operating characteristics of the system and the emission characteristics of the engine and its emission control strategies. Nevertheless, the hybrid vehicle, compared to its conventional counterpart, showed substantial reductions in both unburnt hydrocarbons and carbon monoxide emissions. This is due to the elimination of engine idling and low load operations. However, the oxides of nitrogen emission tends to increase slightly for hybrid vehicles using a smaller engine than a conventional one. Again, this is due to the wide-open throttle operation for a hybrid system. Table 3 shows the potential emission reductions of hybrid systems from the conventional counterparts as reported by some earlier studies (References 30 and 31).

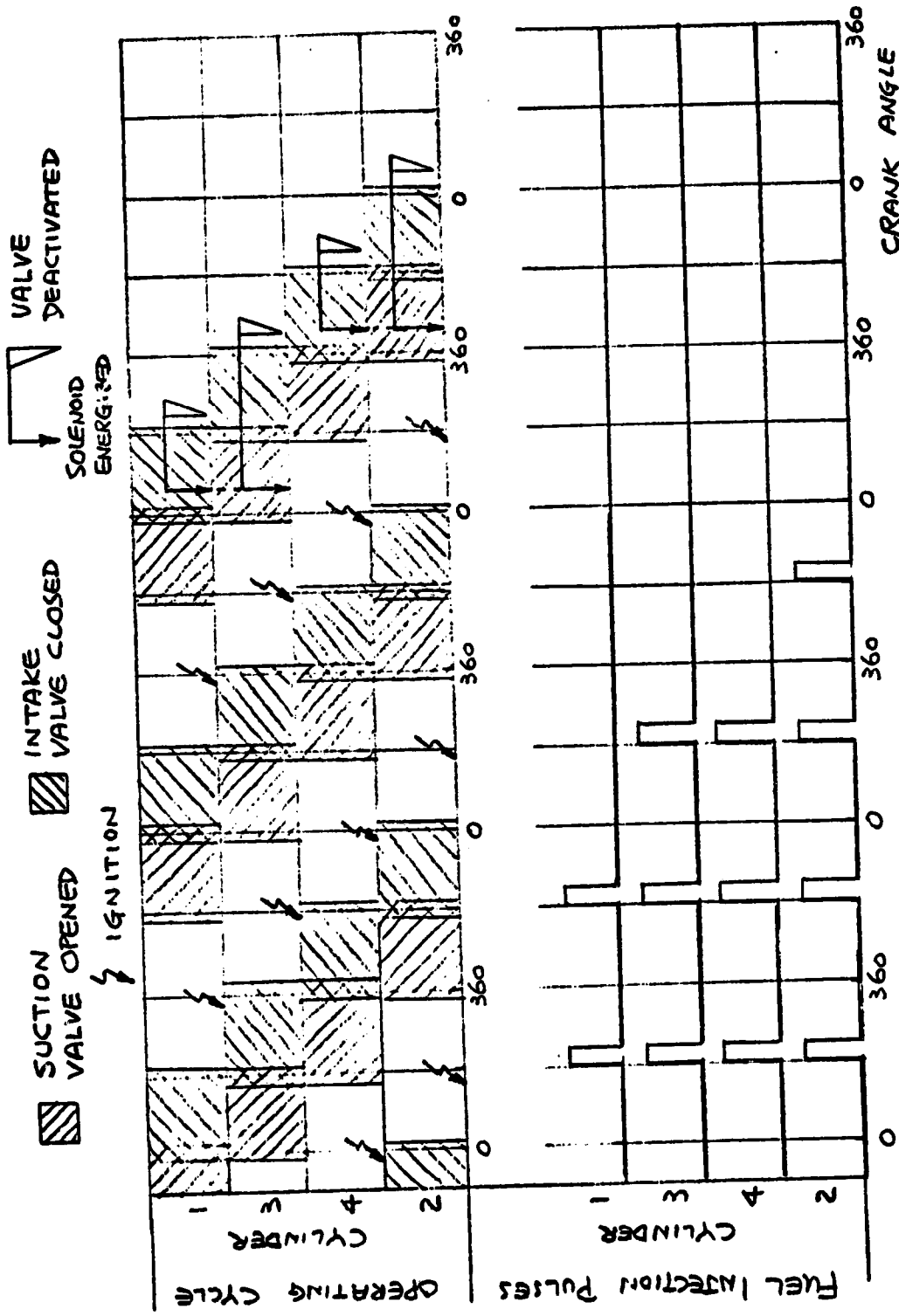

FIG. 6 FUEL CUT-OFF SEQUENCE FOR A EFI-ENGINE WITH VALVE DEACTIVATION

Table 3. POTENTIAL EMISSION REDUCTION OF HYBRID VEHICLES

Changed From Conventional Vehicle (Based on GM/MILE)

	<u>UHC</u>	<u>CO</u>	<u>NO_x</u>
Reference 30	-76%	-40%	+17%
Reference 31	-65%	-40%	+30%

For an existing EFI engine using a three-way catalyst, the emission levels are significantly below the 1981 Federal standard as indicated in Table 2. Use of this system for the hybrid application will likely meet the emission requirements. Incorporation of more complicated emission controls, such as the exhaust gas recirculation (EGR), retarding ignition timing, two-stage catalyst and air-injection (References 32-35), are not considered to be necessary at the present time, but can be added to the engine if need arises in the future.

3.3.2 Catalytic Converter

The three-way catalytic converter proves to be the most effective way developed so far to reduce the toxic emissions below the regulating levels. In order to achieve high conversion efficiencies for all HC, CO and NO_x emissions, the air/fuel ratio must be controlled in the vicinity of stoichiometrics. Figure 7 shows typical emission-reduction characteristics of the three-way catalyst. As indicated, the equivalence ratio, λ , (A/F / A/F of stoichiometrics) must be maintained within a narrow bend of 0.995 to 1.003 in order to achieve 85% or better conversion efficiencies for all three emissions. This accurate control of air/fuel ratio has been demonstrated with the electronic fuel injection system with an oxygen sensor feed-back from the exhaust as discussed in Section 2. Detailed discussions of the catalyst are also given in several publications (References 36-39).

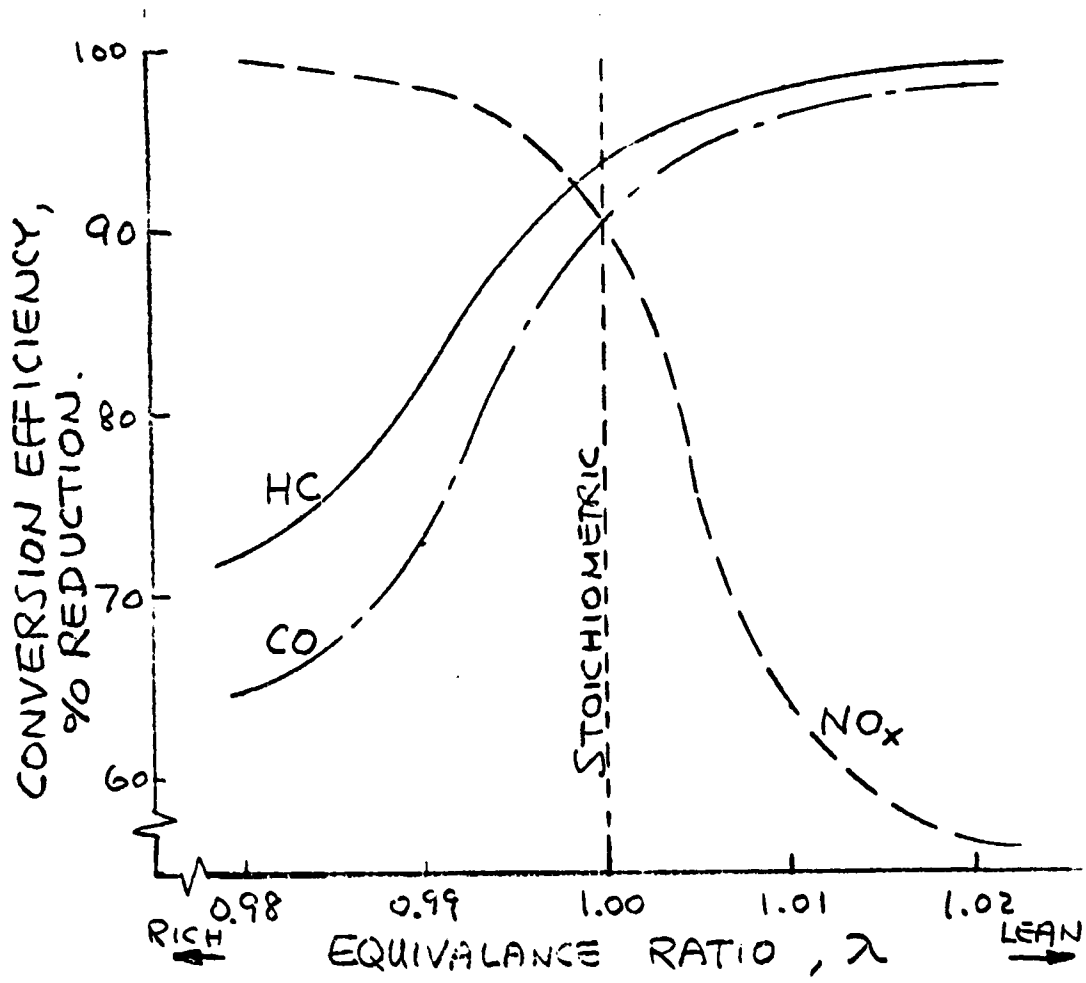

FIG. 7. 3-WAY CATALYST CHARACTERISTICS

Discussion with Matthey Bishop, Inc. personnel has concluded that for a 1.6 liter engine, the catalyst should be sized in the order of 100 cubic inches. No major problems are foreseen for hybrid on/off operations. However, the following concerns should be investigated during future testing.

Durability due to the thermal "shock" in frequent on/off operation.

Proper insulation of the catalyst material to reduce temperature variation and use of a metal support of the catalyst material (References 38 and 39) can alleviate this problem.

Cold start.

Catalyst will be effective only after it exceeds approximately 600°F. In addition to several alternate approaches which will be discussed in the following section, the metal supported catalyst also offers a faster warm-up period for the catalyst.

Oven temperature.

In case of misfire or extreme fuel rich operations, catalyst material may be damaged if the temperature exceeds 2500°F. With accurate fuel injection controls using EFI and the fuel cut-off strategy described in Section 3.2, this problem should be minimal.

3.3.3 Cold Start

In some conventional vehicles, over 50% of the total HC/CO emissions are produced during the first several minutes of urban driving cycle tests while the engine is still cold (Reference 35). For a hybrid vehicle the engine will be turned on only at high speed and wide-open throttle, cold start HC/CO emission will probably be less severe. However, means to control this high HC/CO emission should still be investigated.

At cold start both the oxygen sensor and the catalyst are ineffective. A swirl-type cold start injector and hot-spot in the intake manifold should be incorporated to promote fuel atomization and vaporization. Fuel enrichment and spark retardation can be utilized to provide fast warm-up of exhaust gas. Pre-heat systems at the intake manifold and exhaust system, which are heated with the battery electric power, will accelerate warm-up of air, exhaust gas and catalyst material. Since production of cold start HC/CO is a complicated

phenomenon and no accurate analytical tool is available to carry out a reasonable prediction, development of cold-start emission control should be conducted during the actual test.

3.3.4 Fuel Cut-Off

Even though some HC spikes may be anticipated during the fuel cut-off, testing conducted by Ford (Reference 28) did not indicate any noticeable increase in total HC emission with accurate electronic fuel control.

3.4 Mechanical Effects

The four areas which will be considered are structural effects, wear characteristics, noise and thermal effects, all of which are affected to some degree by the change in speed range and engine on/off operating mode, while the increased number of start-ups influences only wear.

The structural loading of the reciprocating elements of an internal combustion engine consists of a combination of the cycle combustion pressure induced forces and the acceleration loads of the elements. Since only small variations in pressure occur due to speed variation, and since the acceleration loads increase as the square of the speed, these inertia forces will be significant in this discussion. The design of the reciprocating elements is based on a cyclic life requirement, and is generally predicated on fatigue loading and characteristics. The effect of cycle forces is even further reduced since the contribution is basically a compression stress in the elements (above top dead center where forces are highest) and fatigue is primarily associated with tension stresses.

The data shown in Figure 8 for a typical material indicates that fatigue properties are fairly constant for a life greater than one million cycles, which is less than one percent of the design life of a typical automobile engine. It is thereby unlikely that the hybrid engine's operating speed range will have any impact on the design of these elements, since their design always accommodated operation at full speed for a finite portion of engine life, and the flatness of fatigue allowables indicates little, if any, changes in design would be necessary.

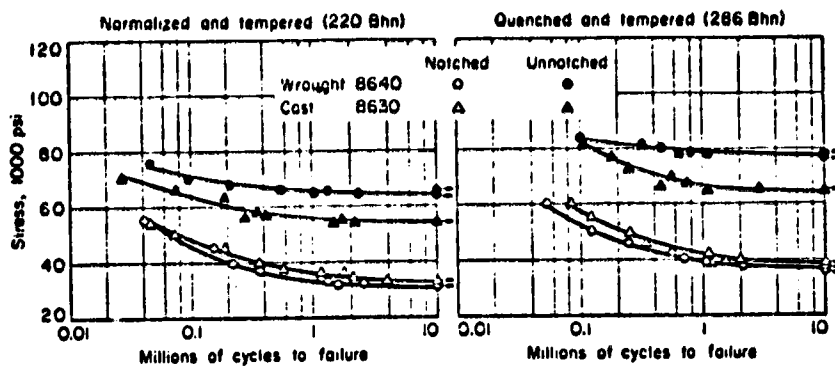

Figure 8. CYCLIC FATIGUE STRESS

The crankshaft, cam shaft, flywheel and other rotating members are subjected to tensile stresses through bending and/or centrifugal force, both of which are speed related. Again, however, the flatness of the fatigue curves and reduced number of cycles provide design adequacy.

The engine bearings are designed to satisfy operation over a range of operating speeds, but the most severe operation occurs during start-up, before an oil film can be established and when metal-to-metal contact initially exists. Hydrodynamic bearing design is simplified as the operating speed range is reduced. Problems with whirl are reduced and bearing geometry can be optimized to enhance bearing life. The significant number of start-up cycles could conceivably create a wear problem, however, since metal-to-metal contact can occur without the hydrodynamic film effect. If a problem is encountered, solutions include:

- A hydrostatic system utilizing either a separate oil pump or pressurized container to be used only at start-up.
- Incorporation of rolling element bearings.
- Incorporation of improved wear characteristic bearing materials.
- Redesign of bearings to extend capability.
- Adopt valve deactivation techniques to maintain engine shaft rotation.

The noise problem of the hybrid engine will be attributable to the wide-open throttle operation or high engine speed to charge the battery at low vehicle speed if it is needed. The road noises generally encountered along with high speed engine noise in common proportional systems tend to balance each other. Some methods of reducing this effect are to utilize the reduced speed range to advantage by providing improved mechanical balancing and damping systems, tuning of the circulation systems to optimize at the higher flow rates, and enhanced acoustic insulation.

The frequent on/off engine operation introduces more cyclic thermal variation of the engine parts. Similar to the cyclic fatigue characteristics of a conventional engine design which falls at the flat portion of the fatigue curves, it is believed that additional thermal cycles in hybrid applications will not require substantial design change. However, to minimize the thermal cyclic effect and improve cold-start capability and emission characteristics for the next engine on-cycle, the fan and water pump can be turned off during the engine off cycle.

4.0 SELECTION AND CHARACTERIZATION OF HYBRID VEHICLE ENGINE

4.1 Selection of the Engine

Based on the tradeoff studies discussed above, it is concluded that an EFI engine combined with a three-way catalyst appears to be the best candidate heat engine system for the near-term hybrid vehicle. As shown in Table 2 of Section 2.1, EGR alone will be unable to reduce the nitrogen oxides emission below the 1980's regulatory level without severe penalty on engine performance. Since NO_x level for a hybrid vehicle is expected to be higher than a conventional counterpart, as discussed in Section 3.3.1, use of a three-way catalyst presents a logical choice.

One existing EFI engine in the size of 60 to 80 HP is a 97 CID, L4 VW engine. The engine specifications are listed in Table 4 for reference. A smaller engine is also made available by VW in Europe. It is a 4-cylinder, 80 CID, EFI engine delivering 61 HP at 6000 rpm.

TABLE 4. ENGINE SPECIFICATIONS FOR VW 97-CID (1.6 L) ENGINE

Number of Cylinders	4
Bore	3.366"
Stroke	2.717"
Displacement	96.66 in ³
Compression Ratio	8:1
Cylinder Head Type	Overhead Cam
HP at Engine Speed	75 at 5800 rpm
Torque at Engine Speed	73 ft-lbs at 3500 rpm
Fuel System Type	EFI
Maximum Air Flow	98 CFM
Emission Control	EGR/OXI. CAT.

4.2 Engine Characteristics

Using an EFI and the feed-back control from the oxygen sensor at the exhaust, a remarkable control of air/fuel ratio can be accomplished. Figure 9 shows the equivalence ratio operated in a VW-1.6 L engine. The air/fuel ratio can be practically controlled within 1% of the stoichiometric ratio. Fuel enrichments are incorporated in this engine at the wide-open throttle (WOT) and idling conditions for extra power requirements. For hybrid vehicle this fuel enrichment is not considered to be necessary except during the cold-start condition. Figure 10 is the performance map for the same engine. As can be seen, the best engine efficiency occurs approximately at 94% throttling-opening at mid-speed range. As the fuel enrichment at WOT is eliminated, the best engine efficiency will take place at WOT. Thus, if a hybrid vehicle using a VW-1.6 L engine is operated between 1500 and 4200 rpm and 90% to 100% throttle openings, the engine efficiency throughout the operating range can be maximized.

Table 5 lists the performance and emission characteristics at various speeds and loads of the VW-1.6 L engine. All emission data shown is the measurement without the catalytic converter. When a three-way catalyst is used, based on the catalytic conversion efficiencies shown in Figure 7, reductions of the HC, CO and NO_x emissions should be 94, 91 and 90%, respectively. It is also noted that high CO and low NO_x emissions at full load (WOT) conditions are due to the fuel enrichment incorporated in this engine.

For the smaller VW-1.3 L (80 CID) engine, similar engine characteristics are found. Figure 11 shows the performance map while Table 6 lists the performance and emission data.

FIG. 9. EQUIVALENCE RATIO FOR VW-1.6 L EFI ENGINE

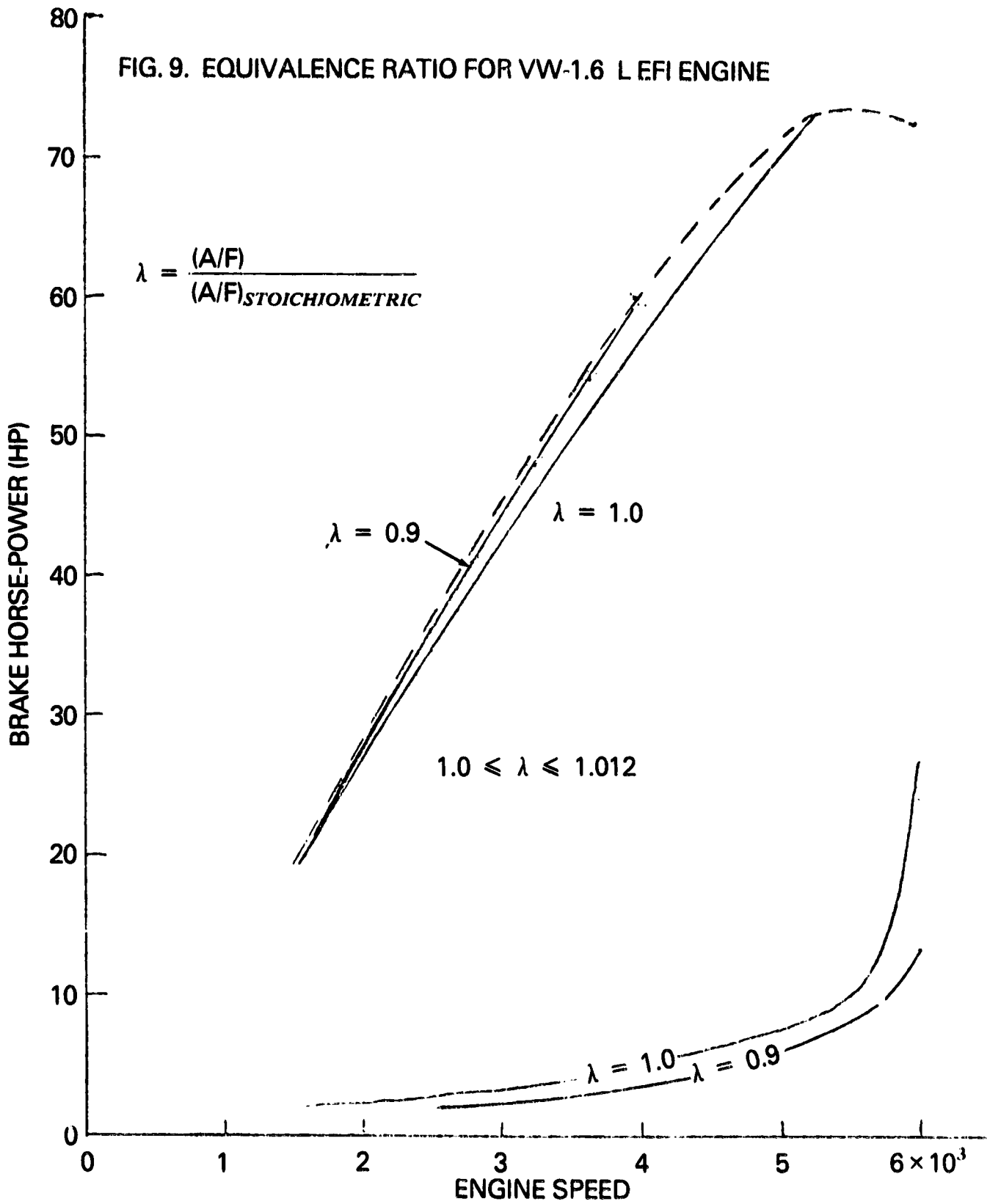

FIG. 10. PERFORMANCE MAP FOR VW-1.6 L (97 CID) EFI ENGINE

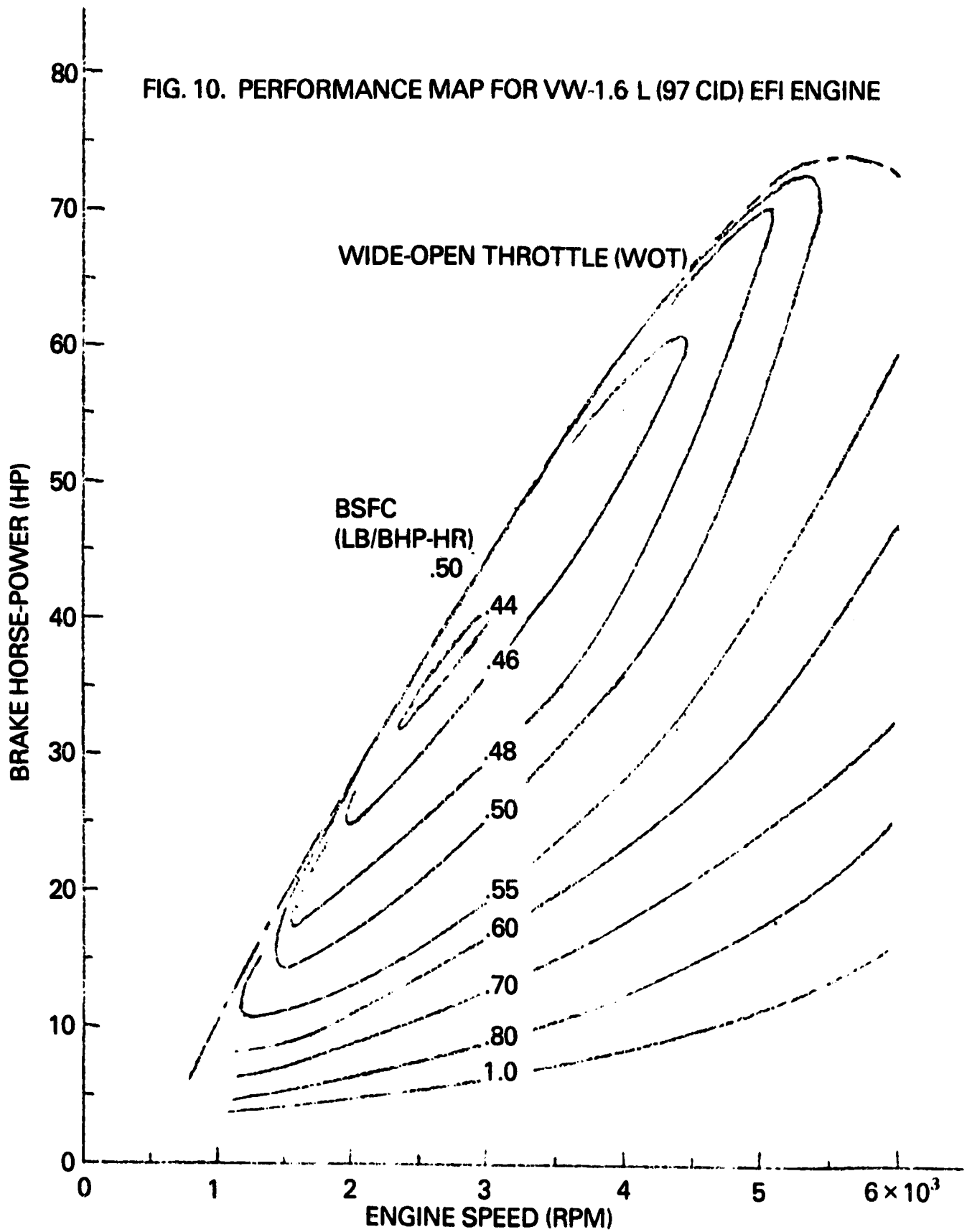

Table 5. PERFORMANCE AND EMISSION TEST DATA FOR VW-1.6 L ENGINE

PERFORMANCE & EMISSION TEST DATA											
ENGINE: VW 1.6 L (97 CID) EFI											
HP	BMEP (PSI)	BSFC (LB/BHP-HR)	EMISSIONS (GM/BHP-HR)*		HP	BMEP (PSI)					
			BSCO	BSHC							
			BSNOX								
ENGINE SPEED = 1200 RPM											
14	100	.605	256	3.68	.83	21	110	.575	223	3.24	1.0
14	97	.521	29.8	2.1	8.64	18.9	100	.476	17.6	1.75	9.58
11.8	84	.528	15.5	1.78	8.28	15.8	84	.486	16.8	1.71	8.0
9.5	66	.566	15.6	1.87	5.71	12.6	67.6	.524	17.4	1.82	6.89
7.1	50	.646	17.7	2.03	4.01	9.5	50	.560	17.7	2.17	5.79
4.7	34	.882	23.4	2.24	2.89	6.	34	.759	24.5	2.55	4.0
2.3	16	1.48	43.5	2.93	2.64	3.1	16	1.327	38.7	3.14	2.87
0	0					0	0				
* All emission data before catalyst											
PERFORMANCE & EMISSION TEST DATA											
ENGINE: VW 1.6 L (97 CID) EFI											
HP	BMEP (PSI)	BSFC (LB/BHP-HR)	EMISSIONS (GM/BHP-HR)*		HP	BMEP (PSI)					
			BSCO	BSHC							
			BSNOX								

PERFORMANCE & EMISSION TEST DATA											
ENGINE: VW 1.6 L (97 CID) EFI											
HP	BMEP (PSI)	BSFC (LB/BHP-HR)	EMISSIONS (GM/BHP-HR)*		HP	BMEP (PSI)					
			BSCO	BSHC							
			BSNOX								
ENGINE SPEED = 2000 RPM											
28	119	.512	142.5	2.79	3.14	34	119	.510	125	2.73	4.65
27.5	116	.446	16.8	1.81	12.9	33	116	.447	16.7	1.94	14.9
23.7	100	.474	19.7	1.94	12.1	28.4	100	.461	17.3	1.93	14.1
19.7	84	.495	18.9	1.98	11.06	23.7	84	.496	20.7	2.05	13.2
15.8	66	.521	18.0	2.26	11.4	19	67	.513	20.7	2.37	13.4
11.9	50	.579	17.7	2.31	8.9	14.2	50	.595	22.7	2.56	11.1
7.9	34	.743	23.4	2.65	6.42	9.4	34	.727	24	2.73	8.5
3.9	16	1.12	32.8	3.33	4.2	4.7	16	1.189	37	3.4	6.17
0	0					0	0				
* All emission data before catalyst											

Table 5. PERFORMANCE AND EMISSION TEST DATA FOR VW-1.6 L ENGINE (continued)

PERFORMANCE & EMISSION TEST DATA				PERFORMANCE & EMISSION TEST DATA			
ENGINE: VW 1.6 L (97 CID) EFI				ENGINE: VW 1.6 L (97 CID) EFI			
HP	BMEP (PSI)	BSFC (LB/BHP-HR)	EMISSIONS (GM/BHP-HR)* BSCO BSCH BSNOX	HP	BMEP (PSI)	BSFC (LB/BHP-HR)	EMISSIONS (GM/BHP-HR)* BSCO BSCH BSNOX
ENGINE SPEED = 2800 RPM				ENGINE SPEED = 3200 RPM			
41	123	.519	144.0 2.88 4.2	48	128	.513	139.0 2.56 5.0
38.6	116	.445	15.3 1.99 15.5	44	117	.452	14.9 1.77 17.3
33	100	.463	16.2 1.75 14.5	38	100	.472	15.8 1.95 16.18
27.6	84	.495	18.0 1.98 13.5	31	84	.493	17.5 2.13 15.45
22	66	.513	20.4 2.18 14.05	25	66	.533	20.3 2.27 16.44
16.6	50	.582	23.1 2.49 11.63	19	50	.588	24.5 2.47 14.16
11	34	.715	26.7 2.69 7.27	12.6	34	.720	29.6 2.81 11.67
5.5	16	1.112	36.4 3.4 7.09	6.2	16	1.110	41.0 3.48 9.52
PERFORMANCE & EMISSION TEST DATA				PERFORMANCE & EMISSION TEST DATA			
ENGINE: VW 1.6 L (97 CID) EFI				ENGINE: VW 1.6 L (97 CID) EFI			
HP	BMEP (PSI)	BSFC (LB/BHP-HR)	EMISSIONS (GM/BHP-HR)* BSCO BSCH BSNOX	HP	BMEP (PSI)	BSFC (LB/BHP-HR)	EMISSIONS (GM/BHP-HR)* BSCO BSCH BSNOX
ENGINE SPEED = 3600 RPM				ENGINE SPEED = 4000 RPM			
54.2	126	.497	118.1 2.19 6.49	59.5	125	.493	99.2 2.07 8.7
49.7	116	.447	15.9 1.43 17.46	55.3	116	.452	15.4 1.52 18.7
42.6	98	.467	15.8 1.72 16.90	47.5	100	.467	16.2 1.66 17.82
35.7	82	.479	17.4 1.89 16.02	39.4	82	.492	16.6 1.85 18.02
28.4	66	.521	19.3 2.11 16.97	30.8	66	.525	17.9 2.81 19.32
21.3	50	.597	23.5 2.19 15.68	23.1	50	.605	23.2 2.34 18.25
14.2	32	.75	32.5 2.62 12.75	15.5	34	.742	28.8 2.52 15.7
7.2	16	1.194	46.9 5.14 19.83	7.4	16	1.219	47.7 3.24 13.9

* All emission data before catalyst

Table 5. PERFORMANCE AND EMISSION TEST DATA FOR VW-1.6 L ENGINE (continued)

PERFORMANCE & EMISSION TEST DATA

ENGINE: VW 1.6 L (97 CID) EFI

HP	BMEP (PSI)	BSFC (LB/BHP-HR)	EMISSIONS (GM/BHP-HR)*	
			BSCO	BSHC
66	120	.510	97.5	1.95
63.4	116	.468	14.4	1.48
54.4	98	.485	15.7	1.62
45.3	82	.507	17.2	1.77
36.2	66	.550	18.2	1.99
27.9	50	.608	20.3	2.08
18.2	34	.765	27.0	2.42
9.1	16	1.179	45.5	2.93

ENGINE SPEED = 4600 RPM

PERFORMANCE & EMISSION TEST DATA

ENGINE: VW 1.6 L (97 CID) EFI

HP	BMEP (PSI)	BSFC (LB/BHP-HR)	EMISSIONS (GM/BHP-HR)*	
			BSCO	BSHC
72.8	117.6	.517	81.5	1.88
72	116	.487	14.7	1.37
61.6	98.5	.505	15.7	1.53
51	82	.526	17.0	1.67
41	66	.566	18.2	1.91
30.7	50	.630	20.2	2.02
20.5	32	.789	26.4	2.24
10.3	16	1.242	38.7	2.79

ENGINE SPEED = 5200 RPM

PERFORMANCE & EMISSION TEST DATA

ENGINE: VW 1.6 L (97 CID) EFI

HP	BMEP (PSI)	BSFC (LB/BHP-HR)	EMISSIONS (GM/BHP-HR)*	
			BSCO	BSHC
72.5	101	.531	15.7	1.34
71	100	.528	15.9	1.38
58	81	.561	18.1	1.59
46.7	65	.607	19.3	1.98
35.5	50	.679	23.4	2.03
24.1	34	.834	40.2	2.16
13.4	19	1.240	60.3	2.84

ENGINE SPEED = 6000 RPM

PERFORMANCE & EMISSION TEST DATA

ENGINE:

HP	BMEP (PSI)	BSFC (LB/BHP-HR)	EMISSIONS (GM/BHP-HR)*	
			BSCO	BSHC

ENGINE SPEED =

* All emission data before catalyst

FIG. 11. PERFORMANCE MAP FOR VW-1.3 L (80 CID) EFI ENGINE

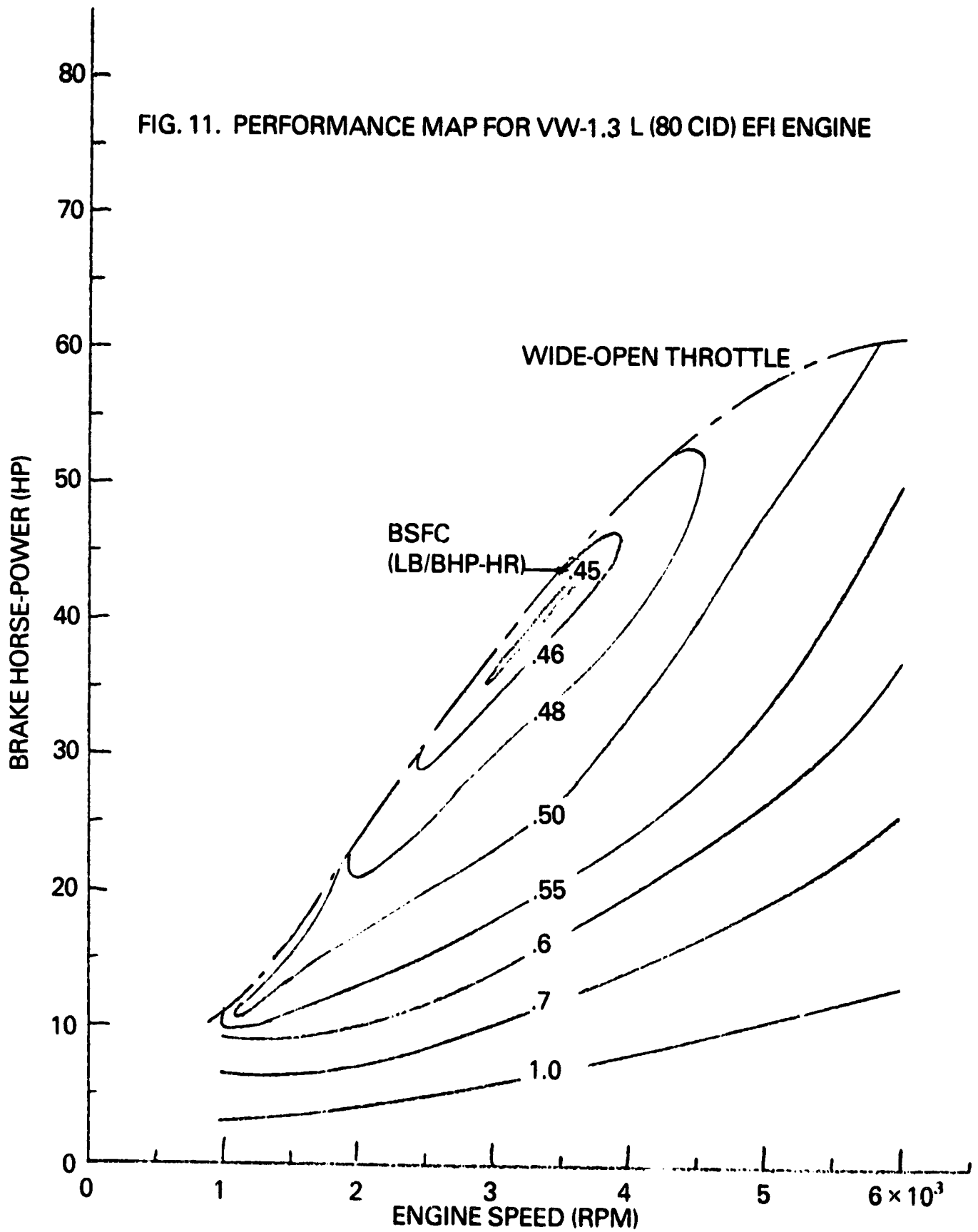

Table 6. PERFORMANCE AND EMISSION TEST DATA FOR VW-1.3 L ENGINE

PERFORMANCE & EMISSION TEST DATA

ENGINE: VW 1.3 L (80 CID) EFI

HP	BMEP (PSI)	BSFC (LB/BHP-HR)	EMISSIONS (GM/BHP-HR)* BSCO BSCH BSNOX
12.5	107	.53	53.6 3.72 8.4
11.7	100	.503	13.6 3.08 112.1
9.5	81	.568	15.3 2.94 9.66
7.1	62	.612	16.68 2.99 6.25
4.7	40	.821	23.8 3.28 3.98
2.1	19	1.59	56.67 5.06 3.66

ENGINE SPEED = 1200 RPM

* All emission data before catalyst.

PERFORMANCE & EMISSION TEST DATA

ENGINE: VW 1.3 L (80 CID) EFI

HP	BMEP (PSI)	BSFC (LB/BHP-HR)	EMISSIONS (GM/BHP-HR)* BSCO BSCH BSNOX
23.2	119	.476	46.1 2.44 9.16
19.7	101	.492	15.5 2.32 12.33
15.7	81	.515	17.0 2.33 10.64
11.8	60	.558	15.76 2.93 11.35
7.9	41	.653	18.59 3.31 7.54
4	20	1.108	31.0 2.79 3.25

ENGINE SPEED = 2000 RPM

* All emission data before catalyst.

PERFORMANCE & EMISSION TEST DATA

ENGINE: VW 1.3 L (80 CID) EFI

HP	BMEP (PSI)	BSFC (LB/BHP-HR)	EMISSIONS (GM/BHP-HR)* BSCO BSCH BSNOX
16.9	108.8	.525	77.93 2.77 5.3
15.7	100	.509	16.27 2.25 9.55
12.6	81	.528	14.60 2.30 8.17
9.4	60	.618	17.13 2.71 6.29
6.3	40	.739	20.48 2.85 3.92
3.2	20	1.316	35.93 3.26 3.08

ENGINE SPEED = 1600 RPM

* All emission data before catalyst.

PERFORMANCE & EMISSION TEST DATA

ENGINE: VW 1.3 L (80 CID) EFI

HP	BMEP (PSI)	BSFC (LB/BHP-HR)	EMISSIONS (GM/BHP-HR)* BSCO BSCH BSNOX
28.3	122	.470	42.2 2.34 10.85
28.4	122	.466	25.28 2.32 12.43
23.7	101	.477	14.94 2.43 13.84
18.9	80	.503	16.72 2.54 13.4
14.2	60	.549	19.79 3.11 14.22
9.5	41	.619	19.05 3.47 11.62
4.7	20	1.047	30.0 3.60 4.82

ENGINE SPEED = 2400 RPM

* All emission data before catalyst.

Table 6. PERFORMANCE AND EMISSION TEST DATA FOR VW-1.3 L ENGINE (continued)

PERFORMANCE & EMISSION TEST DATA											
ENGINE: VW 1.3 L (80 CID) EFI											
PERFORMANCE & EMISSION TEST DATA					PERFORMANCE & EMISSION TEST DATA						
ENGINE: VW 1.3 L (80 CID) EFI											
HP	BMEP (PSI)	BSFC (LB/BHP-HR)	EMISSIONS (GM/BHP-HR) * BSCO BSCH BSNOX	HP	BMEP (PSI)	BSFC (LB/BHP-HR)	EMISSIONS (GM/BHP-HR) * BSCO BSCH BSNOX	HP	BMEP (PSI)	BSFC (LB/BHP-HR)	EMISSIONS (GM/BHP-HR) * BSCO BSCH BSNOX
ENGINE SPEED = 2800 RPM											
34.6	126	.463	33.82 2.28 12.56	40.2	126	.471	39.55 2.50 11.7	37.9	122	.465	15.65 2.17 14.91
27.6	101	.480	16.81 2.34 14.27	21.5	101	.493	17.17 2.07 14.19	25.3	81	.507	20.16 2.80 14.68
22.1	80	.508	17.42 2.78 15.29	19.1	62	.555	23.67 3.14 16.02	12.3	40	.689	30.90 3.58 13.41
16.6	60	.556	21.36 3.33 16.14	6.2	19	1.01	42.2 3.97 9.19	5.6	20	.925	32.27 3.86 7.14

PERFORMANCE & EMISSION TEST DATA											
ENGINE: VW 1.3 L (80 CID) EFI											
PERFORMANCE & EMISSION TEST DATA					PERFORMANCE & EMISSION TEST DATA						
ENGINE: VW 1.3 L (80 CID) EFI											
HP	BMEP (PSI)	BSFC (LB/BHP-HR)	EMISSIONS (GM/BHP-HR) * BSCO BSCH BSNOX	HP	BMEP (PSI)	BSFC (LB/BHP-HR)	EMISSIONS (GM/BHP-HR) * BSCO BSCH BSNOX	HP	BMEP (PSI)	BSFC (LB/BHP-HR)	EMISSIONS (GM/BHP-HR) * BSCO BSCH BSNOX
ENGINE SPEED = 3600 RPM											
45.3	129	.460	52.2 2.80 10.1	48.5	125	.476	54.74 2.72 10.06	47.5	122	.465	25.58 2.48 13.3
35.4	101	.479	16.57 1.95 13.53	39.6	101	.484	14.75 2.07 13.51	31.5	82	.516	16.44 2.075 13.84
28.4	82	.498	17.91 2.32 13.60	23.7	60	.547	18.51 2.90 17.17	15.9	61	.691	22.2 3.46 17.29
21.2	60	.563	20.66 2.96 16.60	17.9	20	1.114	38.4 3.98 15.18	7.1	20	1.125	40.5 3.91 11.66
14.4	41	.687	24.96 3.36 14.79								

* All emission data before catalyst.

Table 6. PERFORMANCE AND EMISSION TEST DATA FOR VW-1.3 L ENGINE (continued)

PERFORMANCE & EMISSION TEST DATA				PERFORMANCE & EMISSION TEST DATA			
ENGINE: VW 1.3 L (80 CID) EFI				ENGINE: VW 1.3 L (80 CID) EFI			
HP	BMEP (PSI)	BSFC (LB/BHP-HR)	EMISSIONS (GM/BHP-HR) * BSCO BSCH BSNOX	HP	BMEP (PSI)	BSFC (LB/BHP-HR)	EMISSIONS (GM/BHP-HR) * BSCO BSCH BSNOX
ENGINE SPEED = 4600 RPM							
53.8	121	.484	48.38 2.32 11.67	58.5	116	.487	23.69 2.07 16.10
45.2	47.6	.493	16.23 2.0 15.07	51.2	101	.501	18.51 2.06 17.04
36.3	82	.525	16.74 2.17 16.33	41.0	81	.530	15.33 1.79 13.77
27.2	62	.566	19.74 2.76 20.07	30.8	62	.586	23.38 2.86 21.88
18.2	41	.693	28.35 3.34 20.11	20.6	41	.697	31.75 3.44 22.09
9.0	21	1.078	43.44 3.99 18.55	10.3	21	1.095	47.28 4.34 21.84

PERFORMANCE & EMISSION TEST DATA				PERFORMANCE & EMISSION TEST DATA			
ENGINE: VW 1.3 L (80 CID) EFI				ENGINE:			
HP	BMEP (PSI)	BSFC (LB/BHP-HR)	EMISSIONS (GM/BHP-HR) * BSCO BSCH BSNOX	HP	BMEP (PSI)	BSFC (LB/BHP-HR)	EMISSIONS (GM/BHP-HR) * BSCO BSCH BSNOX
ENGINE SPEED = 6000 RPM							
61.1	106	.529	45.92 2.40 15.3				
58.7	101	.531	39.6 2.26 16.29				
47.7	82	.554	22.23 1.95 16.54				
35.5	62	.615	28.98 2.64 19.44				
23.9	41	.729	34.35 3.29 21.04				
11.7	20	1.145	46.32 3.33 19.49				

* All emission data before catalyst.

Even though the 130-CID Volvo engine (Reference 14) may be slightly oversized (90 HP at 5200 rpm) for the five-passenger hybrid vehicle, its characteristics offer several interesting comparisons with the smaller VW engines. Contrary to the VW engine, the Volvo engine does not implement fuel enrichment at WOT and idling. Also, instead of maintaining slightly lean mixtures ($\lambda > 1.0$) as shown in Figure 8, as in the VW engines, it maintains a slightly rich ($\lambda < 1.0$) mixture throughout most of the operating range. The range of the equivalence ratio is $0.995 \leq \lambda \leq 1.001$. As a result, the Volvo engine has its best engine efficiency at WOT as shown in Figure 12.

The slightly better engine efficiency for the Volvo engine is attributed to a slight advance of ignition timing. At 2500 rpm and full load, for instance, the ignition timing is 28° BTDC as opposed to 25.6° BTDC for VW 1.6 L engine.

Operating at slightly rich mixture also offers an advantage of lower NO_x emission. Figure 13 shows the comparison of specific emission levels before catalyst at 2500 rpm engine speed. The Volvo engine produces lower NO_x emission than the VW. After the three-way catalyst, all three emissions are substantially reduced. Table 7 lists the Volvo engine emission levels after the three-way catalyst. Figures 14, 15 and 16 are the emission maps superimposed on the performance map for BSCO, BSHC and BSNO_x , respectively. As can be seen, operating at WOT not only offers a better fuel economy, but also results in lower combined emissions in general.

FIG. 12. PERFORMANCE MAP FOR 1977 VOLVO 130-CID EFI ENGINE
 90 BHP @ 5200 RPM

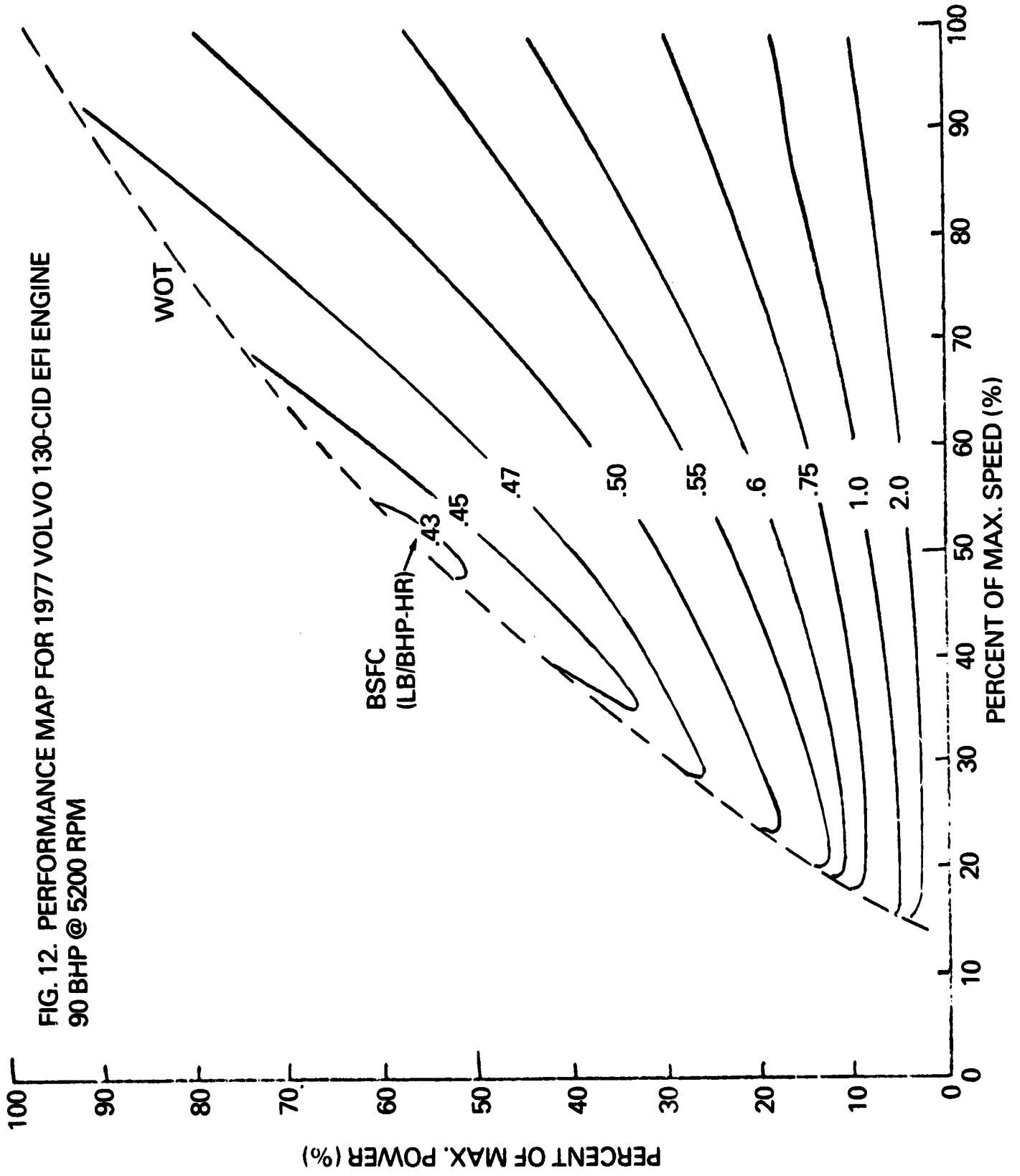

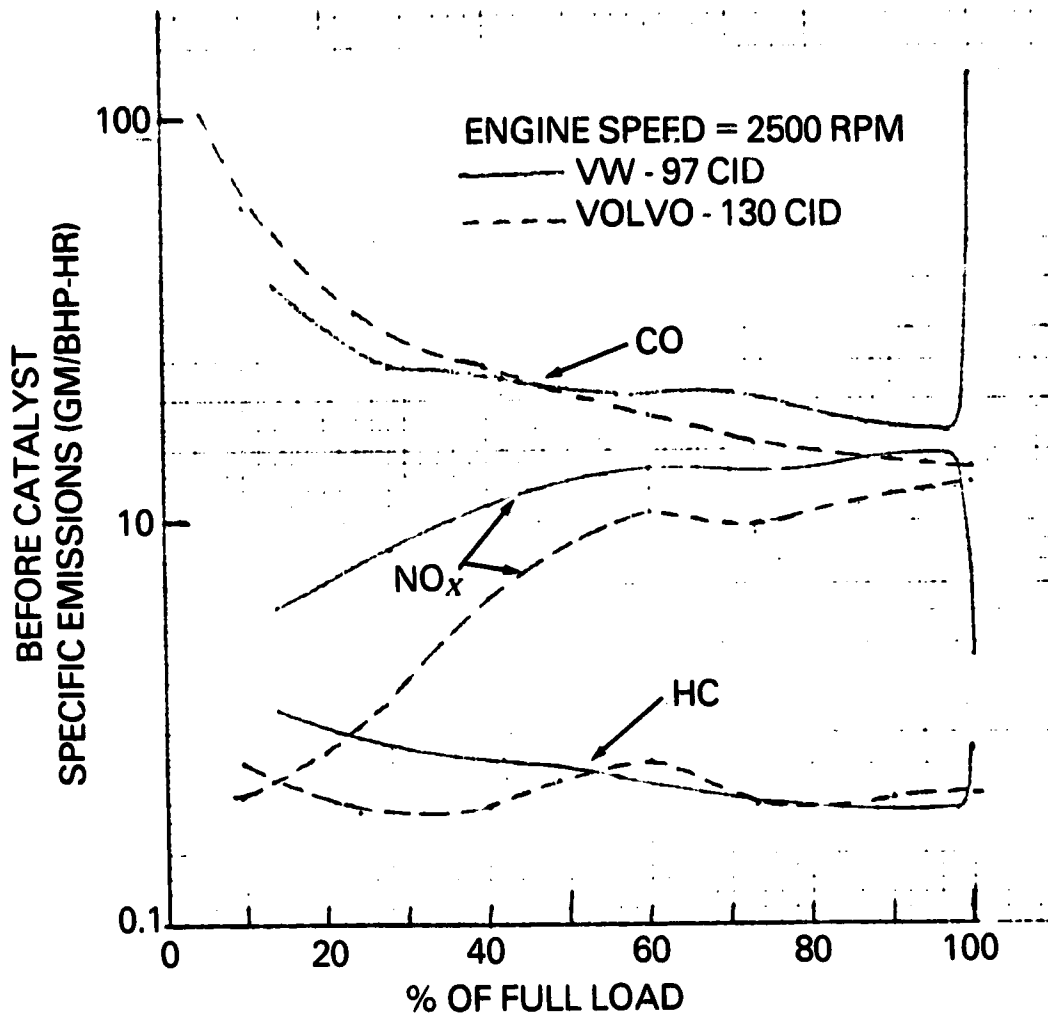

FIG. 13. COMPARISON OF EMISSIONS BETWEEN VW & VOLVO ENGINES

Table 7. PERFORMANCE AND EMISSION TEST DATA FOR VOLVO 130 CID ENGINE

ENGINE: VOLVO 130 CID				ENGINE: VOLVO 130 CID			
ENGINE SPEED (RPM): 900				ENGINE SPEED (RPM): 1200			
FULL LOAD POWER (HP): 5.2				FULL LOAD POWER (HP): 18.2			
% LOAD	BSFC (LB/BHP-HR)	EMISSIONS (gm/BHP-HR) BSCO BSHC BSN0X		% LOAD	BSFC (LB/BHP-HR)	EMISSIONS (gm/BHP-HR) BSCO BSHC BSN0X	
100	.865	.096 .173 .327		100	.505	2.2 .33 .176	
90				90	.482	1.12 .226 .152	
75				75	.522	1.15 .184 .044	
60				60	.551	2.47 .211 .037	
50	1.384	.308 .115 .308		40	.819	.875 .139 .028	
40				25	1.133	1.956 .2 .022	
25				10	2.222	.555 .277 .11	
10	7.5	12.5 9.2 0		0	8.0	10 .333 .667	
0	32	13 17 1					
ENGINE: VOLVO 130 CID				ENGINE: VOLVO 130 CID			
ENGINE SPEED (RPM): 1500				ENGINE SPEED (RPM): 1800			
FULL LOAD POWER (HP): 24.9				FULL LOAD POWER (HP): 32.1			
% LOAD	BSFC (LB/BHP-HR)	EMISSIONS (gm/BHP-HR) BSCO BSHC BSN0X		% LOAD	BSFC (LB/BHP-HR)	EMISSIONS (gm/BHP-HR) BSCO BSHC BSN0X	
100	.462	2.55 .24 .136		100	.461	1.28 .14 .096	
90	.473	1.77 .223 .076		90	.448	1.41 .165 .093	
75	.492	1.89 .16 .064		75	.479	1.49 .157 .083	
60	.487	.953 .133 .047		60	.518	1.97 .196 .0825	
40	.64	.58 .14 .03		40	.586	2.92 .226 .047	
25	.828	2.61 .171 .034		25	.75	4.1 .225 .025	
10	2.04	8.75 .333 .042		10	1.844	22.6 .656 .0625	
0	3.5	3.167 .666 .166		0	5.0	70.2 1.9 .18	

Table 7. PERFORMANCE AND EMISSION TEST DATA FOR VOLVO 130 CID ENGINE (continued)

ENGINE: VOLVO 130 CID			
ENGINE SPEED (RPM): 2300			
FULL LOAD POWER (HP): 42			
% LOAD	BSFC (LB/BHP-HR)	EMISSIONS (gm/BHP-HR)	
		BSCO	BSHC BSN0x
100	.445	1.86	.144 .066
90	.449	1.615	.112 .096
75	.471	1.188	.118 .089
60	.494	.835	.136 .096
40	.572	1.53	.108 .072
25	.731	3.05	.183 .086
10	1.575	5.2	.3 .075
0	4.0	16.0	.667 .2

ENGINE: VOLVO 130 CID			
ENGINE SPEED (RPM): 2500			
FULL LOAD POWER (HP): 48.9			
% LOAD	BSFC (LB/BHP-HR)	EMISSIONS (gm/BHP-HR)	
		BSCO	BSHC BSN0x
100	.425	2.01	.127 .063
90	.432	1.5	.105 .07
75	.455	1.03	.133 .06
60	.469	.541	.109 .058
40	.541	1.765	.127 .066
25	.672	3.07	.147 .057
10	1.286	4.02	.204 .061
0	2.296	12.3	.346 .077

ENGINE: VOLVO 130 CID			
ENGINE SPEED (RPM): 3400			
FULL LOAD POWER (HP): 64.0			
% LOAD	BSFC (LB/BHP-HR)	EMISSIONS (gm/BHP-HR)	
		BSCO	BSHC BSN0x
100	.450	2.68	.153 .3
90	.455	2.37	.128 .172
75	.475	1.97	.098 .138
60	.496	1.264	.142 .075
40	.576	1.813	.14 .0545
25	.731	2.625	.119 .05
10	1.444	7.14	.19 .079
0	2.7	5.2	.233 .1

ENGINE: VOLVO 130 CID			
ENGINE SPEED (RPM): 4000			
FULL LOAD POWER (HP): 72			
% LOAD	BSFC (LB/BHP-HR)	EMISSIONS (gm/BHP-HR)	
		BSCO	BSHC BSN0x
100	.458	4.16	.153 .28
90	.468	3.71	.154 .214
75	.493	3.44	.118 .155
60	.517	4.8	.196 .1085
40	.597	5.55	.191 .08
25	.768	5.66	.166 .061
10	1.438	7.0	.174 .087
0	2.310	10.45	.214 .119

Table 7. PERFORMANCE AND EMISSION TEST DATA FOR VOLVO 130 CID ENGINE (continued)

% LOAD	BSFC (LB/BHP-HR)	EMISSIONS (gm/BHP-HR)	
		BSCO	BSHC
100	.476	6.76	.361
90	.491	4.98	.195
75	.510	3.82	.34
60	.542	3.1	.103
40	.662	2.335	.166
25	.844	3.03	.133
10	1.652	5.36	.213
0	2.185	7.23	.277

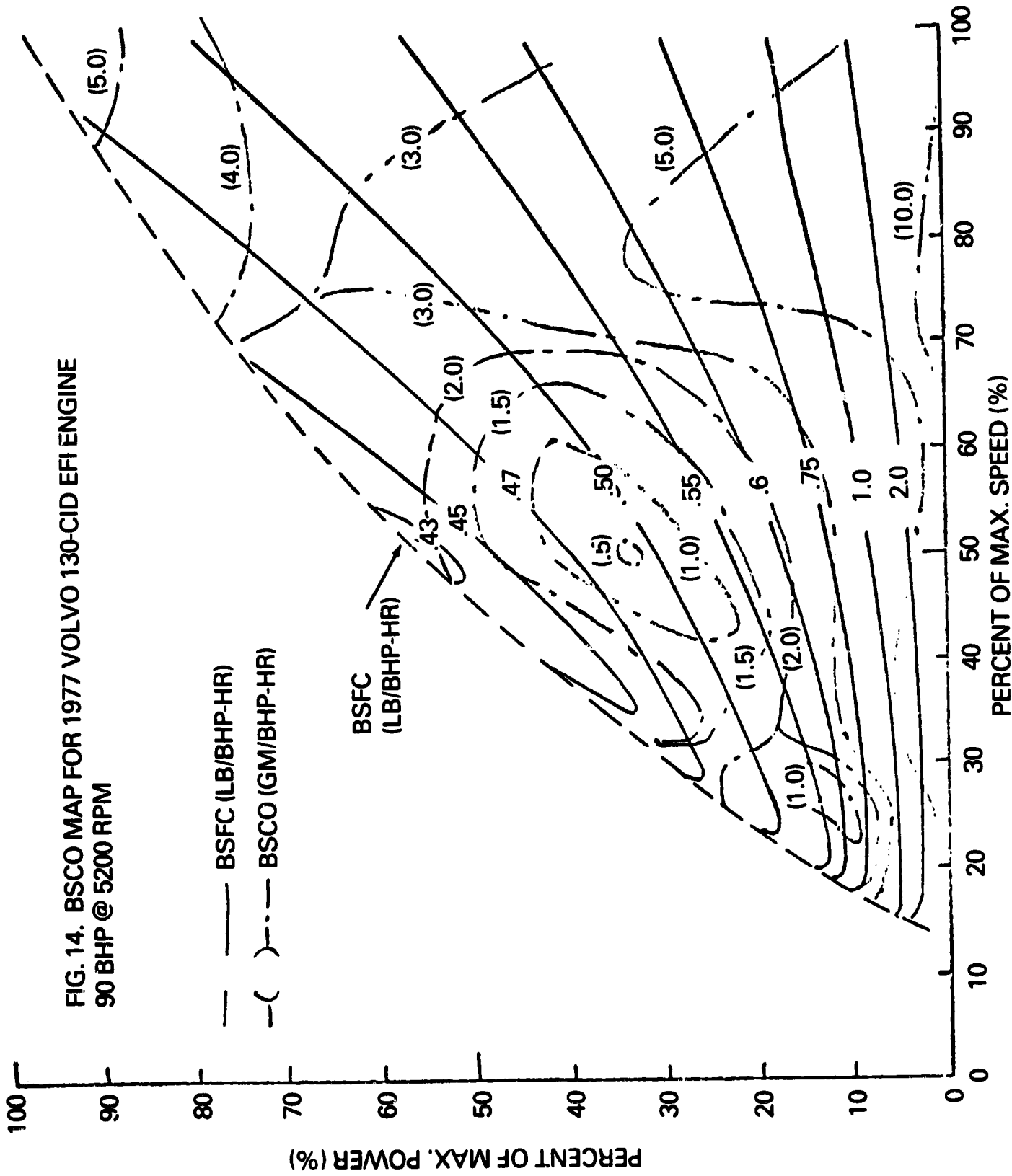

FIG. 15. BSHC MAP FOR 1977 VOLVO 130-CID EFI ENGINE
90 BHP @ 5200 RPM

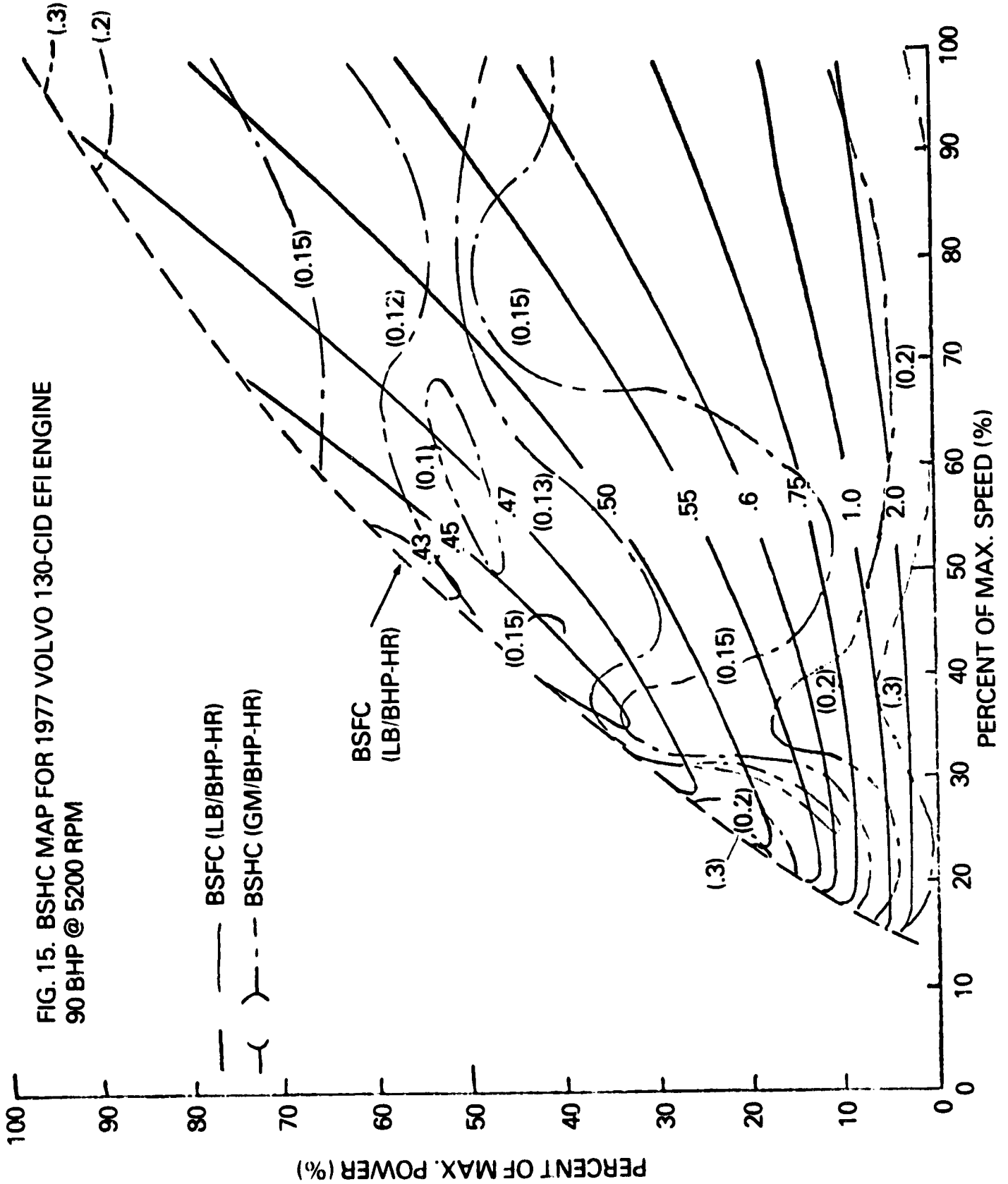
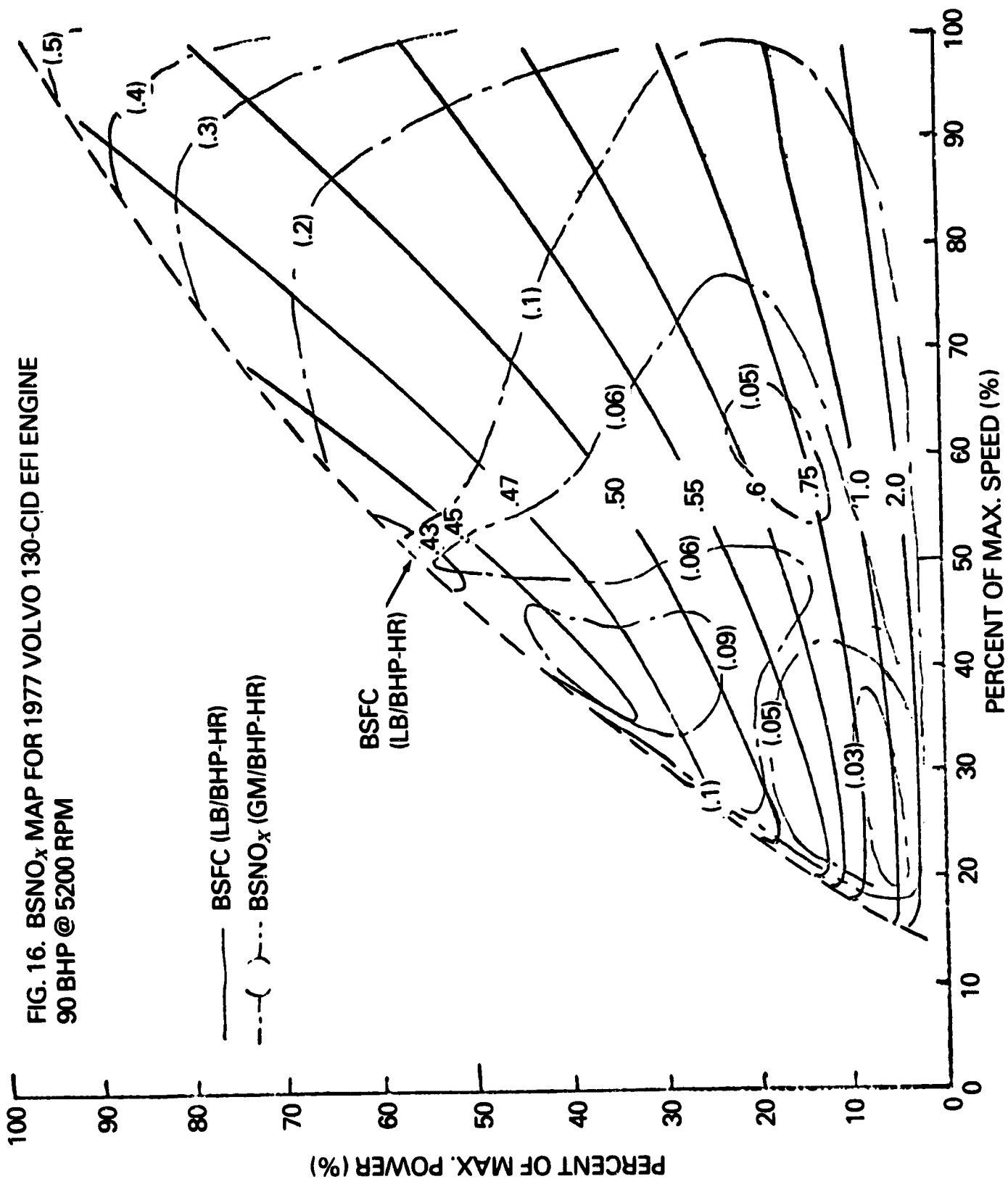

FIG. 16. BSNO_x MAP FOR 1977 VOLVO 130-CID EFI ENGINE
90 BHP @ 5200 RPM



REFERENCES

HEAT ENGINES - GENERAL

1. "Should We Have A New Engine?---An Automobile Power Systems Evaluation" Volume II, Technical Reports, Jet Propulsion Laboratory, California Institute of Technology.
2. "State-of-the-Art Assessment of Electric and Hybrid Vehicles", NASA TM-73756, NASA Lewis Research Center, Cleveland, Ohio, September, 1977.
3. Sternlicht, B., "Which Automotive Engines in the Future?", ASME Paper #74-DGP-16. Diesel and Gas Engine Power Division, April, 1974.
4. Coon, C. W. and Wood, C. D., "Improvement of Automobile Fuel Economy", SAE Paper 74069, October, 1974.
5. Barnes-Moss, H. W. and Scott, W. M., "The Light Duty Diesel Engine for Private Transportation", SAE Paper 750331, February, 1975.
6. Yamaoka, K. and Tado, H., "More Horsepower from Small Rotary Engines", Automotive Engineering, June, 1972.
7. Folsom, L. R., Artiles, A. A. and Joyce, J. P., "Thermal Energy Storage/Heat Engine for Highway Vehicle Propulsion", ERDA Highway Vehicle Systems Contractors' Coordination Meeting, Dearborn, Michigan, October, 1977.
8. Heitmann, A. M. and Rizika, J. W., "Low Cost Small Gas Turbine", ASME Paper 74-GT-133, March, 1974.
9. Wagner, C. E. "Status of Chrysler Upgraded Engine Program", ERDA Highway Vehicle Systems Contractors' Coordination Meeting, Dearborn, Michigan, October, 1977.
10. "Automotive Technology Status and Projections", Volumes I and II, Jet Propulsion Laboratory Publication 78-71, 1978.
11. Wiedemann, B. and Hofbrauer, P., "Data Base for Light-Weight Automotive Diesel Power Plants", SAE 780634.
12. Burke, A. F., "The Moving Baseline of Conventional Engine-Powered Passenger Cars (1975-1985)", SAE 780347.
13. Wallace, T. F., "Buick's Turbocharged V-6 Power Train for 1978", SAE 780413.

14. "Performance Characteristics of Automotive Engines in the United States", 3rd Series, Bartlesville Energy Technology Center, Oklahoma, 1979.
Report No. 1. 1977 Volvo 131-CID EFI
Report No. 6. 1978 VW 90-CID Diesel
Report No. 7. 1978 Ford Fiesta 98-CID
Report No.10. 1978 Honda 98-CID
Report No.16. 1975 Volvo 121-CID EFI

ELECTRONIC FUEL INJECTION SYSTEMS

15. Rivard, J. G., "Closed-Loop Electronic Fuel Injection Control of the Internal Combustion Engine", SAE Paper 730005, 1973.
16. Flanagan, C. D., "The Role of Electronics in Automotive Engine Control", SAE Paper 780840, 1978.
17. Givens, L., "Cadillac's Electronic Fuel Injection", Automotive Engineering, February, 1976.
18. Scholl, H., "Electronic Applications to the Automobile by Robert Bosch GMBH", SAE Paper 780834, 1978.
19. Glöckler, O. and Kraus, B., "Electronically Controlled Fuel Injection System", Volume 5, pp. 7-18, Bosch Technical Brief, 1975.
20. Nakagawa, R., "The Status of Automotive Electronics in Japan", SAE Paper 780835, 1978.
21. Hagen, D. F., "Electronic Engine Controls at Ford Motor Company", SAE Paper 780842, 1978.
22. Schweitzer, P. H. and Volz, C., "Electronic Optimizer Control for I.C. Engine: Most MPG for Any MPH", SAE Paper 750370.
23. Microprocessor Controller Development, SAE Publication SP-426, 1978.

HYBRID VEHICLE OPERATIONS

23. Beachley, N. H. and Frank, A. A., "Increased Fuel Economy in Transportation Systems by Use of Energy Management - Third Year's Program", Report DOT-TST-77-21, Contract DOT-OS-30112-MOD 3, University of Wisconsin, July, 1976.
25. Unnewehr, L. E., et al, "Hybrid Vehicle for Fuel Economy", SAE 760121.
26. Wouk, V., "An Experimental ICE/Battery Electric Hybrid with Low Emissions and Low Fuel Consumption Capability", SAE 760123.

VALVE DEACTIVATION

27. Bechtold, R. L., "An Investigative Study of Engine Limiting" DoE Report BERL/RI-77/13, Bartlesville Energy Research Center, DoE, February, 1978.
28. Bates, B., Dossall, J. M., and Smith, D. H., "Variable Displacement by Engine Valve Control", SAE 780145.
29. Mueller, R. S. and Uitvlugt, M. W., "Valve Selector Hardware", SAE 780146.

EMISSIONS

30. Liddle, S. G., "Emissions from Hybrid Vehicles", SAE 739115, 1973.
31. Hinton, M. G., Jr., Iura, T., Roessler, W. U., and Sampson, H. T., "Exhaust Emission Characteristics of Hybrid Heat Engine/Electric Vehicles", SAE 710825.
32. Schultz, R. J., "Emission Control at GM", SAE 780843.
33. Gumbleton, J. J., et al, "Optimizing Engine Parameters with Exhaust Gas Recirculation", SAE 740104.
34. Kimoda, H., et al, "An Approach to the Low Emission Engine with the Consideration of Fuel Economy", SAE 750416.
35. Dowdy, M. W., and Baisley, R. L., "Automotive Fuel Economy and Emissions Program", JPL Publication 78-21, DOT Contract No. RA 75-41, Jet Propulsion Laboratory, 1978.

CATALYSTS

36. Seiter, R. E., and Clarke, R. J., "Ford Three-Way Catalyst and Feed-Back Fuel Control System", SAE 780203.
37. Morgan, C. R. et al, "Thermal Response and Emission Breakthrough of Platinum Monolithic Catalytic Converters", SAE 730569.
38. Dulieu, C. A. et al, "Metal Supported Catalysts for Automotive Applications", SAE 770299.
39. Lichterstein, I. E. and Mundy, J. P., "MMT Plugging of Oxidation Catalysts on Ceramic and Metal Supports during Engine Dyno Studies of Catalyst Durability", SAE 780005.

Section 2
ASSESSMENT OF BATTERY POWER SOURCES

WORK STATEMENT

ESB Technology Company
Yardley, PA 19067

INTRODUCTION

Contract No. 955190 between California Institute of Technology Jet Propulsion Laboratory and General Electric Company covers a program entitled "Phase I of the Near-Term Hybrid Passenger Vehicle Development Program" under which studies shall be conducted leading to a preliminary design of a hybrid passenger vehicle that is projected to have the maximum potential for reducing petroleum consumption in the near-term (commencing in 1985). Effort under Contract 955190 is being conducted pursuant to an Interagency agreement between the Department of Energy (DOE) and the National Aeronautics and Space Administration (NASA) and in furtherance of work under Prime Contract NAS7-100 between NASA and the California Institute of Technology. This work statement covers battery technology under General Electric Purchase Order A02000-220267.

SCOPE OF WORK

In support of General Electric Corporate Research and Development's work under Contract 955190, the Subcontractor shall furnish the necessary personnel, materials, services, facilities, and otherwise do all things necessary for or incident to the performance of the following tasks.

1. Provide consultation, as requested, on lead-acid batteries, such as:
 - Review of weight, size, performance characteristics of batteries based upon ISOA development program
 - Provision of cost estimates for such batteries in production quantities
 - Provision of estimates of cycle life of such batteries as a function of depth of discharge
2. Review prospective performance capabilities, cost and state-of-the-art of other promising battery types and recommend which one of them would appear to be the most suitable for use in the hybrid vehicle program. (It is recognized that considerable judgement must go into this recommendation, with some risk for error.) Provide the rationale for this recommendation.
3. Provide estimates of performance characteristics for the battery system recommended in Item 2, including the following:

- Weight
 - Size
 - Specific power (W/lb) as a function of specific energy (Wh/lb)
 - Terminal voltage versus ampere-hours of discharge for various values of constant current
 - Approximate values of charge voltage as a function of charge current and state-of-charge
 - Charging restrictions, such as maximum voltage and current
 - Cost
 - Hazards
 - Cycle life as a function of depth of discharge
4. Define development steps needed in Phase II of program to make the battery selected in Item 2 a viable selection. This would include cost estimates.
 5. Provide inputs for Trade-Off Studies Report.
 6. Provide inputs for incorporation in the General Electric Phase II proposal.
 7. Perform a series of tests on two existing battery systems to determine the capability of the batteries to supply high current pulses in accordance with the "Pulse Testing of Batteries" two-page work description.

NOTE WITH RESPECT TO SUBCONTRACTOR'S DATA

With respect to Tasks 1 through 6 the following paragraph applies:

It is understood that all data in the Subcontractor's reports, furnished by the Subcontractor to General Electric Corporate Research and Development hereunder, may be furnished to the California Institute of Technology Jet Propulsion Laboratory and DOE and NASA with no restrictions.

With respect to Task 7 the following paragraph applies:

It is understood that only Form, Fit, and Function data will be provided for the ESB batteries to be tested under paragraph 7 of ARTICLE II. No description of the batteries will be required other than that given in the two-page Attachment to this Instruction. Accordingly, it is hereby agreed that ESB's EV 106 and experimental XPV 23 batteries to be tested hereunder shall not be subject to paragraphs (g) and (h) of Article 31. Rights in Technical Data of the General Provisions incorporated in Exhibit "A" dated 78 Oct. 16.

Attachment to
 Instruction No. 1
 to Purchase Order A02000-220267
 79 Mar 02

Pulse Testing of Batteries

Program Definition

Data on the performance of EV batteries at various constant current pulses is not available. In order to permit an accurate assessment of the batteries capability for supplying high current pulses a series of tests on two existing battery systems will be conducted.

Test Units

ESB Technology Company will provide for test (at no charge to GE) the following units:

Unit (A) 2 EV 106 batteries connected in series
 Unit (B) 2 ESB Experimental Type XPV 23 Mcd 3

These units remain the property of ESB Technology Company.

Test Sequence

1. "A" test units:
 - a) Constant current discharge @ 60 A. Room temp - to limiting battery voltage (5.10) with discharge continued to 4.5 V. Recharge (to stabilized gravity level).
 - b) Pulse test at 500 A as detailed below. Recharge (to stabilized gravity level).
 - c) Repeat (a).
 - d) Pulse test (b) @ 400 A.
 - e) Repeat (a).
 - f) Pulse test (b) @ 300 A.
 - g) Repeat (a).
2. "B" test units:

Repeat test sequence 1 (a through g).

Pulse Test - (A & B Test Units)

- A.
 1. Discharge for 12 min (10% DoD) @ 60 A.
 2. Discharge for 15 sec @ 500 A (Sequence b).
 3. Discharge for 18 min (25% DoD) @ 60 A.
 4. Discharge for 15 sec @ 500 A (Sequence b).

5. Discharge for 12 min (35% DoD) @ 60 A.
 6. Discharge for 15 sec @ 500 A (Sequence b).
 7. Stand open circuit for 1 min. Regen.
 8. Discharge for 15 sec @ 500 A (Sequence b).
 9. Stand open circuit for 1 min.
 10. Discharge for 15 sec @ 500 A (Sequence b).
 11. Discharge for 18 min (50% DoD) @ 60 A.
 12. Discharge for 15 sec @ 500 A (Sequence b).
 13. Discharge for 12 min (60% DoD) @ 60 A.
 14. Discharge for 15 sec @ 500 A (Sequence b).
 15. Discharge for 18 min (75% DoD) @ 60 A.
 16. Discharge for 15 sec @ 500 A (Sequence b).
 17. Stand open circuit for 1 min.
 18. Discharge for 15 sec @ 500 A.
 19. Stand open circuit for 1 min.
 20. Discharge for 15 sec @ 500 A.
 21. Discharge for 6 min @ 60 A.
- B. 1 through 21 - Pulse values are 400 A.
- C. 1 through 21 - Pulse values are 300 A.

Data Collection

Record - Amperes

- Battery Volts
- Ampere-hours discharged
- Watt-hours discharged

10 data bits before and immediately after pulse

25 data bits during pulse

Temp.

Sp.Gr. at beginning and end of test.

Battery Size and Weight

Brief description of battery construction - no proprietary data on construction, weights, etc. will be provided.

THE ASSESSMENT OF
BATTERY POWER SOURCES
THE
GE PHASE I HYBRID VEHICLE

PREPARED FOR
GENERAL ELECTRIC COMPANY
CORPORATE RESEARCH AND DEVELOPMENT
P.O. A0200-22067
ESB Project 6047

FEBRUARY 16, 1979

REPORT PREPARED BY

G. S. Hartman
A. M. Chreitzberg
G. C. Kugler
E. Pearlman

ESB TECHNOLOGY COMPANY
YARDLEY, PA.

INDEX

	<u>PAGE</u>
1. Introduction.....	1
2. Status of Competitive Battery for Hybrid Vehicles.....	3
2.1 Lithium Metal Sulfide Cell Systems.....	3
2.2 Sodium Sulfur System.....	4
2.3 Conclusions re Molten Salt Systems.....	5
2.4 Nickel Iron Battery System.....	7
2.5 Nickel Zinc Battery Systems.....	8
2.6 Lead Acid Batteries.....	9
3. Conclusions and Recommendations.....	14
Appendix A.....	Pages 1-16
Appendix B.....	Page 1-5
Appendix C.....	Page 1-3
Appendix D.....	Page 1-7

1. INTRODUCTION

The initial detailed work statement specified the work to be performed on battery system evaluation was:

- (1) Review battery characteristics [Wh/lb, (W/lb) steady' (W/lb) peak' cycle life, cost, etc.] used in hybrid powertrain screening studies.
- (2) Lead-acid batteries (ISOA and advanced) - provide quantitative discussion of the following:
 - (a) Relationships between battery voltage and other battery characteristics (ex. size and weight, lifetime, cost, power density, etc.)
 - (b) Differences in design of batteries for hybrid as compared to all-electric vehicles.
 - (c) Battery life as a function of average depth of discharge before overnight charging; criteria for indicating depth of discharge and battery depletion in a hybrid vehicle.
 - (d) Relationships between depth of discharge and capability of battery to meet peak (pulsed-secs) power demand.
 - (e) Analytical model and supporting data for charging battery using heat engine on the road while driving.
- (3) NiZn and NiFe batteries - provide quantitative discussion of the following:
 - (a) Projected potential of NiZn batteries especially high power capability and lifetime; effect of average depth of discharge on battery life.
 - (b) Projected potential of NiFe batteries especially high power capability and self-discharge tendency.

- (c) Attractiveness of a hybrid battery pack using NiFe with a NiZn or Pb-acid; lifetime of the secondary storage battery (Pb-acid or NiZn) used in hybrid mode.
 - (d) Optimum voltage and package size for NiZn and NiFe batteries.
 - (e) Maintenance requirements of NiZn and NiFe batteries in vehicle applications.
 - (f) Modeling of NiZn and NiFe batteries in vehicle simulation programs.
- (4) Provide estimates of costs (OEM in 1978 dollars) of lead-acid, NiZn, and NiFe batteries; discuss the effect on cost of various battery characteristic trade-off (ex. lifetime and energy density, high power capability, etc.).

Subsequent discussions at ESB on December 5, 1978 provided further clarification on the information to be provided. The battery assessment was to utilize the following guidelines:

- (1) a. Battery technology as of 1981 with adequate battery units available in prototype quantities.
- b. Prototype quality must be adequate to provide 100,000 systems/year in 1985.
- (2) Candidate battery systems are:
 - Lead Acid - ISOA
 - Lead Acid - Advanced
 - NiZn
 - Li-S
 - NaS
- (3) Performance of vehicle must be comparable to 1/c unit, i.e. 0 to 60 mph in 15 sec.

- (4) Peak power for acceleration (passing) may be up to 25 sec. in duration.
- (5) Concept is to maximize use of battery and minimize use of internal combustion engine.
- (6) Vehicle should reach its daily end of duty cycle with the least possible battery reserve and least use of petroleum based fuel.

2. STATUS OF COMPETITIVE BATTERY FOR HYBRID VEHICLES

2.1 Lithium Metal Sulfide Cell Systems

Appendix A contains the technical analysis and performance data available on this system. Some additional facts are worth noting:-

- During the last few years the power characteristics of the system have been improved but at a sacrifice in cycle life, or the cycle life has been increased at a sacrifice in power output.
- The cost data given in Table 5 does not include cost of the oven to maintain battery/cell at desired temperature.
- Cost is based on having capitalization to do mechanized assembly in dry boxes or in controlled atmosphere areas.
- There do not appear to be significant freeze-thaw problems in the Li-FeS system.
- System must use cylindrical vacuum type thermos chamber to contain prismatic cell to meet heat loss goal of 150 W on 40 Kwhr battery.
- Overcharging results in the development of Fe₂S₃ which corrodes lower cost current collectors. ANL reports they have developed a cell bi-pass system (at a cost of \$5.00/Kwhr that can handle up to 5% of the current in a series string of cells on overcharge.
- Major Obstacles to be overcome are:
 - Economics - oven costs and mechanical assembly in glove box.

- Power per unit Wt. simultaneously with acceptable cycle life.
- Offers possibility in 1990's if above obstacles can be overcome.

2.2 Sodium Sulfur System

Appendix B contains technical data and analysis of this system.

- Chloride in England will provide first real test of the system in 1979.
- There still remains the problem of β alumina tube and seal reliability (and cost);
- Progress has been made in overcoming the corrosion problems by placing the sodium on the outside of the β alumina tube and thus permit use of carbon steel containers.
- Freeze-thaw problem remains and warm-up after freeze becomes major problem as cells get larger in size. Thaw problem appears to be related to differential expansion of sulfur and β alumina causing tube cracking at glass seal interface.
- Calcium and potassium impurities in Na decrease life of β alumina in cycling tests.
- Overcharging is not permitted. While NaS systems do not develop gas pressures, insoluble compounds are formed in the sulfur mix which increases the cell resistance and cause imbalance in the series - parallel assembly
- Major obstacles to be overcome
 - Economics (tube costs are @2.50/sq. cm with goal of 1-2 ¢/sq cm of surface)
 - Reliability and cost of seals
 - Reliability and cycle life of β alumina tube

- Freeze-thaw problem
- Safety under EV mechanical environment.

2.3 Conclusions re Molten Salt Systems

1. Life cycling data is sketchy
 - British Railroad 6 cell 250 Whr unit gave 1000 cycles.
 - (a) R. J. Banes & D. A. Teagle - Experimental Study of Six Interconnected Na-S cells, J. Power Sources 3, 45 (1978).
2. Cell and component evaluations are still being actively pursued but few batteries have ever been assembled and/or tested.
3. First Molten Salt application will be '83 BEST facility test of 2.5 M Whr. Na-S battery. Chloride will be testing a Na/S battery in a van in '79.
4. Reliability in β alumina tubes is a continuing problem.
5. System does not appear suitable for consumer EV usage since safety is still of major concern.
 - Cell balancing by overcharge is not feasible due to the inability to overcharge without permanent damage to cell.
7. Thermal shock problems remain unresolved as to how to survive start up after freezing in large Na-S cells.
8. Seal reliability continues to require study and further improvement.
9. Basic material costs do not look too excessive with Na @ 41¢/lb but substantial capital investment will be required to minimize costs.
10. β alumina cost reduction will only be achieved as a consequence of the development of a load leveling or other large market demand.
11. Power density of molten salt cells is not attractive. Present prediction is that power/Wt and cycle life cannot be mutually achieved; NaS has better capability than Li(Al)/E 5.

11.
 - Na/S requires substantial paralleling of cells.
 - Li/FeS can multiple plate cells thus reducing need for paralleling.
12. Molten Salt
 - Systems will not be developed to permit "battery" evaluation to be completed by 1981 on a single design concept.

2.4 Nickel Iron Battery System

Appendix C contains the technical analysis and data on this system. As indicated, non proprietary data is limited but additional comments are warranted.

NiFe

- Best nickel iron cells in Europe are Daug (German) cells but little data are available although tests have been underway for some time.
- Swedish Su iron electrode costs are said to be 1/3 of Ni electrode cost but since process is proprietary these cannot be justified.
- Swedish Su electrode is reported to have highest efficiency due to .8mm thickness. Westinghouse iron electrode is reported only 60/70% as efficient as SU.
- Problems of iron contamination on nickel electrode are beginning to be reported.
- Thermal control is required since NiFe system is inherently inefficient at high and low temperatures.
- Water addition and frequent servicing is needed.
- Electrolyte circulation has been proposed as a means of overcoming thermal problems but this introduces even more difficult problems.
- O.C. capacity loss is 2.2%/day for the SU electrode.
- Low cell voltage necessitates additional cells in series.
1.12v for NiFe vs 1.50v for NiZn vs 1.95v for Pb.

2.5 Nickel Zinc Battery Systems

Appendix D contains the technical analysis and data on this system. Major emphasis has been given to conventional nickel zinc systems since data on the ESB Vibrocell[®] system is still limited. Additional comments on the nickel zinc system follow.

- Cycle life is still the major problem. It is aggravated by very high temperature rise during cycling of present cells.
- System tests with large size cells in excess of 100v show wide performance variations.
- Zinc poisoning of the nickel electrode is emerging as a problem.
- Separators for EV-Hi power applications are still sought. Inorganic separators that reportedly have long life are too resistant to permit high rate discharge.
- Cost of Ni and cost of cell assemblies remain as major obstacles.

The ESB Vibrocell[®] capacity degradation with cycling appears to be less than with conventional cells.

- Vibrocell[®] is probably more sensitive to power demands due to need for spacing between electrodes.
- Polarization appears to be minimal in the Vibrocell[®] negative.

2.6 Lead Acid Batteries

The lead acid battery has been the most widely used power source for propelling electric vehicles in use today. The golf cart, the forklift trucks, and mine locomotive are typical examples of motive power use. In general, these applications stress long life, reasonable power and energy density and cost. Weight has never been of major concern.

The other major usage of lead acid batteries is the SLI market where major emphasis has been directed toward maximizing cold cranking (amps) performance.

The Department of Energy's contracts with ESB, Globe and C&D (Eltra) managed by Argonne National Labs are directed at two levels of improvement.

1. Improved State-of-the-Art.
2. Advanced Batteries.

These goals are given in Table 1. Each of the three subcontractors has expressed confidence in being able to simultaneously achieve all of the ISOA goals.

Figure 1 shows a typical Ragone plot (Watts/Kg vs Watt hr/Kg) for the present Golf Car (EV106) battery to which have been added a line for "Improved Golf Car" and the ISOA and Advanced Battery goals. Data from ESB experimental cells and batteries tested in July 1978 have been added to indicate performance that has been achieved. Similar results have been indicated by other DOE contractors. Life test data is still being accumulated but the risk in this area does not appear to be too great. Cost goals (based on '76 estimates) should be achievable; actual prices will rise since '76 estimates were based on 25¢/lb lead with Feb '79 lead at the 44¢/lb and rising!

Since this development effort is based on "Improving the State-of-the-Art", manufacturing facilities are available to supply initial requirements for the EV market and scale up can be accomplished on a schedule consistent with the scale up required by the vehicle manufacturers.

Table 1

ARGONNE NATIONAL LABORATORY
CONTRACT 31-109-38-4207

PRELIMINARY BATTERY DEVELOPMENTAL GOALS

		<u>ISOA</u>	<u>ADVANCED</u>
		20 - 30	30 - 40
1.	BATTERY CAPACITY (kW-HR) ^A (100% RATED)		
2.	BATTERY DIMENSION (CM H X CM W X CM L)	29.5x40.6x264	29.5x40.6x264
3.	SPECIFIC ENERGY ^A (W-HR/KG)	40	60
4.	SPECIFIC POWER (W/KG) PEAK BATTERY - 15 SEC. AVG.	100	150
5.	DUTY CYCLE CHARGE (HR) DISCHARGE (HR)	4 - 8 2 - 4	4 - 8 2 - 4
6.	LIFETIME DEEP DISCHARGES ^B	800	1000
7.	PRICE/ENERGY ^C (\$/kW-HR)	50	40
8.	ENERGY EFFICIENCY (%) ^D	60	60
9.	TYPICAL INSTALLATION VOLTAGE ^E	96-120V	96-120V

^A C/3 RATE DISCHARGE; 8-HR CHARGE. THE 3 HR RATE IS DEFINED AS A 3 HR CAPACITY OF A BATTERY TO 1.75V/CELL AT 26.7°C (80°F)

^B 80% DEPTH OF DISCHARGE FROM RATED CAPACITY.

^C PRICE F. O. B. TO AUTO MANUFACTURER WITH PRODUCTION ~ 10,000/YR.

^D AT BATTERY TERMINALS INCLUDING AUXILIARY EQUIPMENT, EXCLUDING CHARGER.

^E FOR COMPACT PASSENGER CAR.

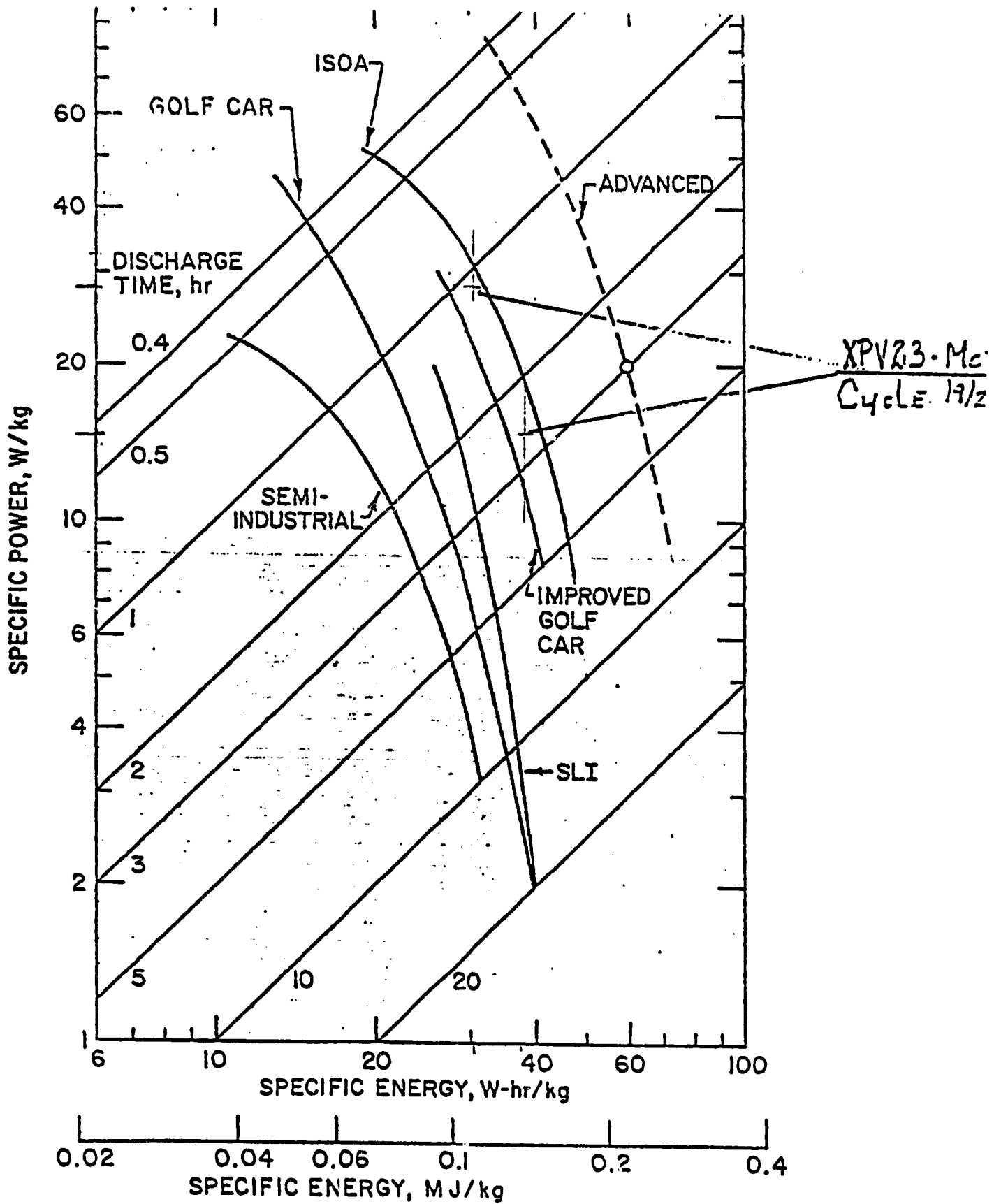

Performance of Various Lead Acid Battery Systems

Figure 1

The goals of the Advanced Battery program are more severe and will require significant breakthrough to simultaneously achieve all of them! Achievement of several goals with a relaxation of others appears to be a more moderate level of achievement in the next two to three years.

Based on the best available data, the performance of the lead acid battery available in 1981 to meet the Phase I Hybrid goals will be that described by the DOE ISOA program.

Table 2

Energy Storage and Power Parameters(Projected to 1981)

Battery Type	wh/lb	No Load-Leveling		Load Levelled		Secondary Storage	
		(w/lb) _{sp}	(w/lb) _{pp}	wh/lb	(w/lb) _{sp}	(w/lb) _{sp}	(w/lb) _{pp}
1. Lead-acid - EV 1978	13	20	50	16	20	100	
2. Lead-acid - 1981 (ISOA)	18.2	45	70	24	35	150	
3. Ni-Zn	30	55	85	40	55	200	
4. Ni-Fe	25	25	60	32	25	75	
5. Li-FeS (Mark IA)	30	20	30	35	20	35	
Flywheel (composite)	7	-	-	-	-	-	-

2-19

Cost and Lifetime Parameters

Battery Type	\$/Kwh	\$/lb	Cycle Life	Years Life
1. Lead-acid - EV 1978	50	.85	500	2
2. Lead-acid - 1981 (ISOA)	50	.65	800	4
3. Ni-Zn	200	2.6	200	3
4. Ni-Fe	200	1.6	1000	6
5. Li-FeS	200	5.3	800	5
Flywheel (composite)	400	4.0	-	10

3. CONCLUSIONS AND RECOMMENDATIONS

Lead acid batteries are the only energy storage sources that are sufficiently developed and available to meet the requirements and schedules for pure electric and hybrid electric vehicles. Advanced battery systems now under development still have sufficient problems to make them doubtful candidates for mass production or use for the next decade.

Table 2 tabulates the projected 1981 data on the systems examined in this effort. Data on Flywheel is included based on information supplied by GE.

Appendix A

Li(Al)/FeS_x Battery Systems

Under DOE sponsorship and the direction of ANL Eagle-Picher, Gould Inc., and others are in the process of commercialization of technology developed by ANL and these industrial organizations for the Li/LiCl-KCl/FeS_x molten salt system.

The enclosed information has been gleaned from ANL, IECEC, and other publications during 1978 and represents the better cell designs fabricated and tested. Ragone plot data are very difficult to obtain from these publications because in most cases the cells tested are not discharged at more than two or three rates and Whr/kg data are not always calculated and published with its associated W/kg values but rather a peak W/kg value is given for each of a variety of cell designs.

Table 1 summarizes early cells manufactured in 1976 and tested in 1977 and represents prismatic designs made in the discharged state. Table 2 is similar data for two plateau Li/FeS₂ cells made in the discharge state about the same time at ANL.

Table 3 gives data for selected Eagle-Picher cells showing peak power and specific energy in Whr/kg for their two plateau FeS₂ cells. Table 4 gives Ragone plot data read from curves in the paper by Dr. Duane Barney at the Second Annual Battery & Electrochemical Technology Conference, June 5-7, 1978, entitled "Development Status of Li/Metal Sulfide Batteries." See enclosures 1 and 2 for applicable curves. Gould cells have lower energy densities to date.

The corresponding Ragone plot is given as Figure 1.

Table 5 is a recent ANL optimization study comparing performance and costs as a function of the number of positive plates in their proposed multiplate cell. These data were given by H. Shimotake at the May 9-10, 1978 Annual DOE Review at ANL. See enclosure 3.

Figure 2 summarizes this and earlier data and compares performance to ANL goals for cells and batteries. While projections have been made, no experimental data on EV batteries have been published; however, tests by Eagle-Picher on the Mark IA 40 kWhr battery should now be in progress. Enclosure 4 summarizes the present state of the art in cells vs. battery goals as a function of calendar year of development.

Major concerns are power density in Li/FeS cells which give relatively good cycle life, and cycle life in Li/FeS₂ cells which give higher and relatively good power and energy density. Projected costs have also risen and are likely to increase even more.

Table 1

Uncharged Prismatic LiAl/FeS Cells*

Cell S/N	Capacity Ahr	Specific Energy Whr/Kg	Specific Power Whr/l	Specific Power W/Kg	Cycle Life	Efficiency % Ahr	Whr
R-5	42	63	160	25	> 610	96	85
R-6	45	67	160	29	> 500	96	86
R-7	76	100	100	45	179	95	85
R-9	77	100	100	45	7	95	85

* Al/Fe-Li₂S; R-6 contains Cu (10%_w); R-7, 9 contains Cu (20%_w).

Table 2

Uncharged Prismatic LiAl/FeS Cells**

R-2	65	110	120	110	143	99	80
R-3	72	105	110	110	14	92	60
R-8	72	105	110	110	> 360	99	85

** Al/Fe-Li₂S-Co.

F. Hirschfeld, Mechanical Engineering, June 1977, p 31.

TABLE 3

Single Pouch Two Plateau Li-Al/IC₂ Cells

Cell S/N	Capacity Ahr	Specific Energy, Whr/kg		Peak Power W	Internal Cell Resistance mΩ
		40 mA/cm ²	80 mA/cm ²		
18L-034	210	120	99	100	6.0
18H-040	117	98	84	126	5.3
173	222	91	79	120	6.9
16A1	155	83	67	94	9.0

TABLE 4

Effect of Discharge Rate on Specific Energy
430°C (400-600 Hrs Life)

Cell S/N	Discharge Rate hrs	Current A	Specific Energy Whr/kg	Specific Power W/kg	Peak Power	
					100% W	50% W
034	9	24	112	22		
	6	37	103	30		
	3	73	82	52	105	49
173	9	25	91	20		
	6	37	85	28		
	3	74	67	50	105	70

References (1) E. C. Gay et al, Review of Industrial Participation in the ANL Li-Fes_x Battery Development Program, with ICSEC, Paper 789202, p. 190, August 10, 1978.

Table 5

Design & Cost Optimization: Multiplate LMA PES Cell
(300 cm² Area)

Number of PES Plates	Specific Energy Wh/kg	Specific Power W/kg	Est. Materials	Cost, \$/kWhr	
				Other Parts	Total
2	109	176	9	20	29
3	116	190	8	27	35
4	115	190	7	36	43

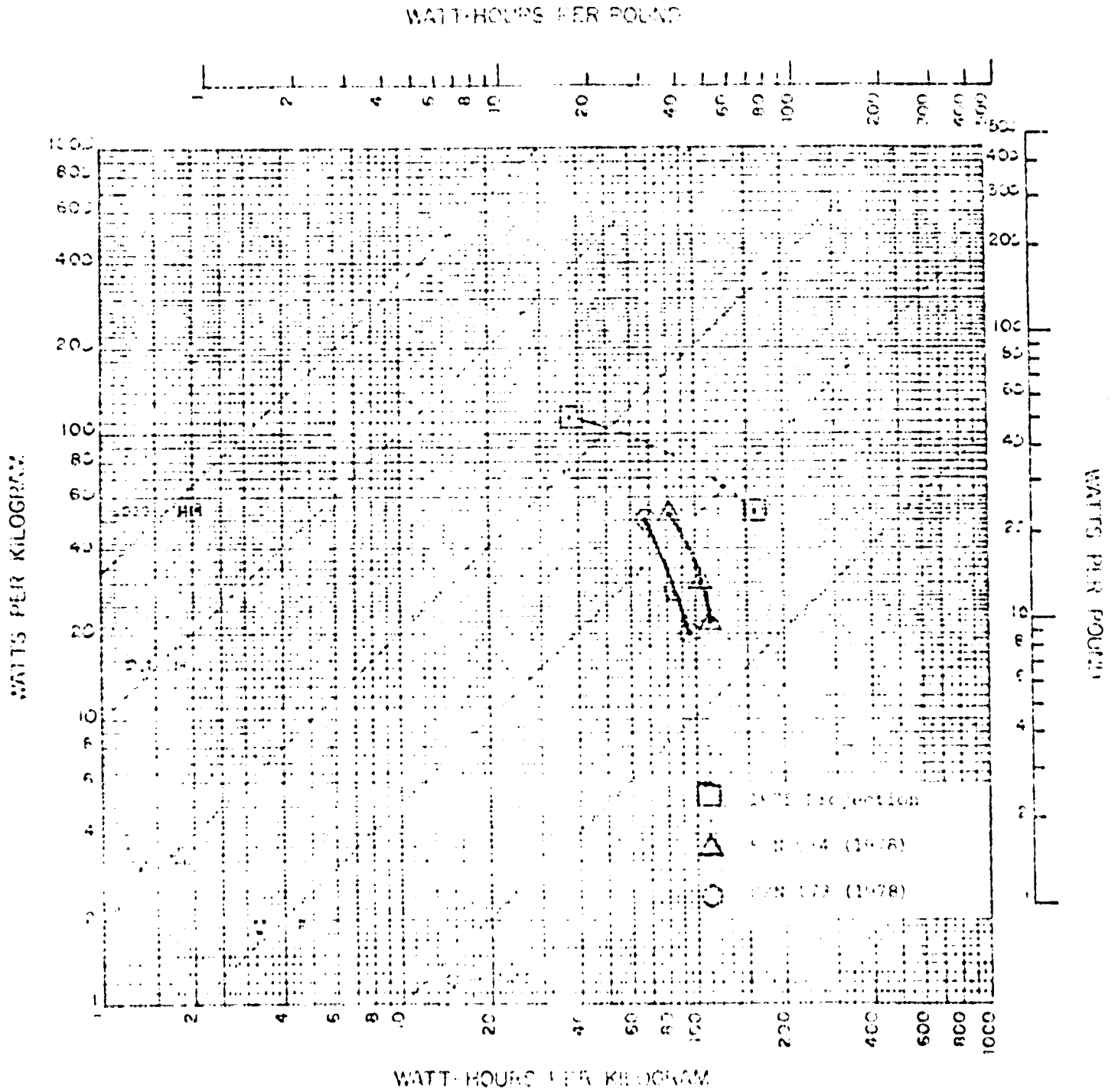

Figure 1. Eagle-Picher Ref. 2 Cells - S/N 054 and 173

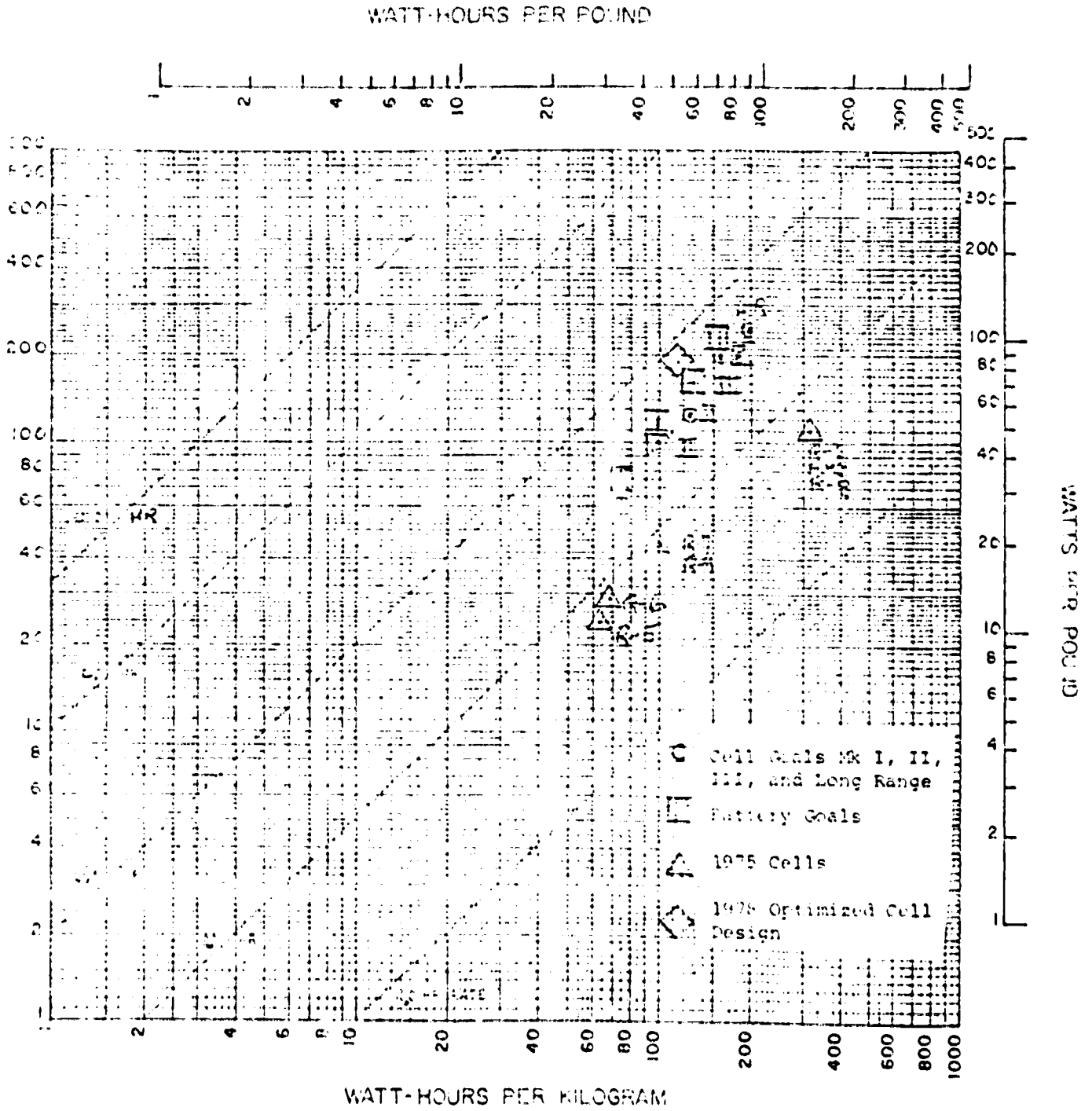
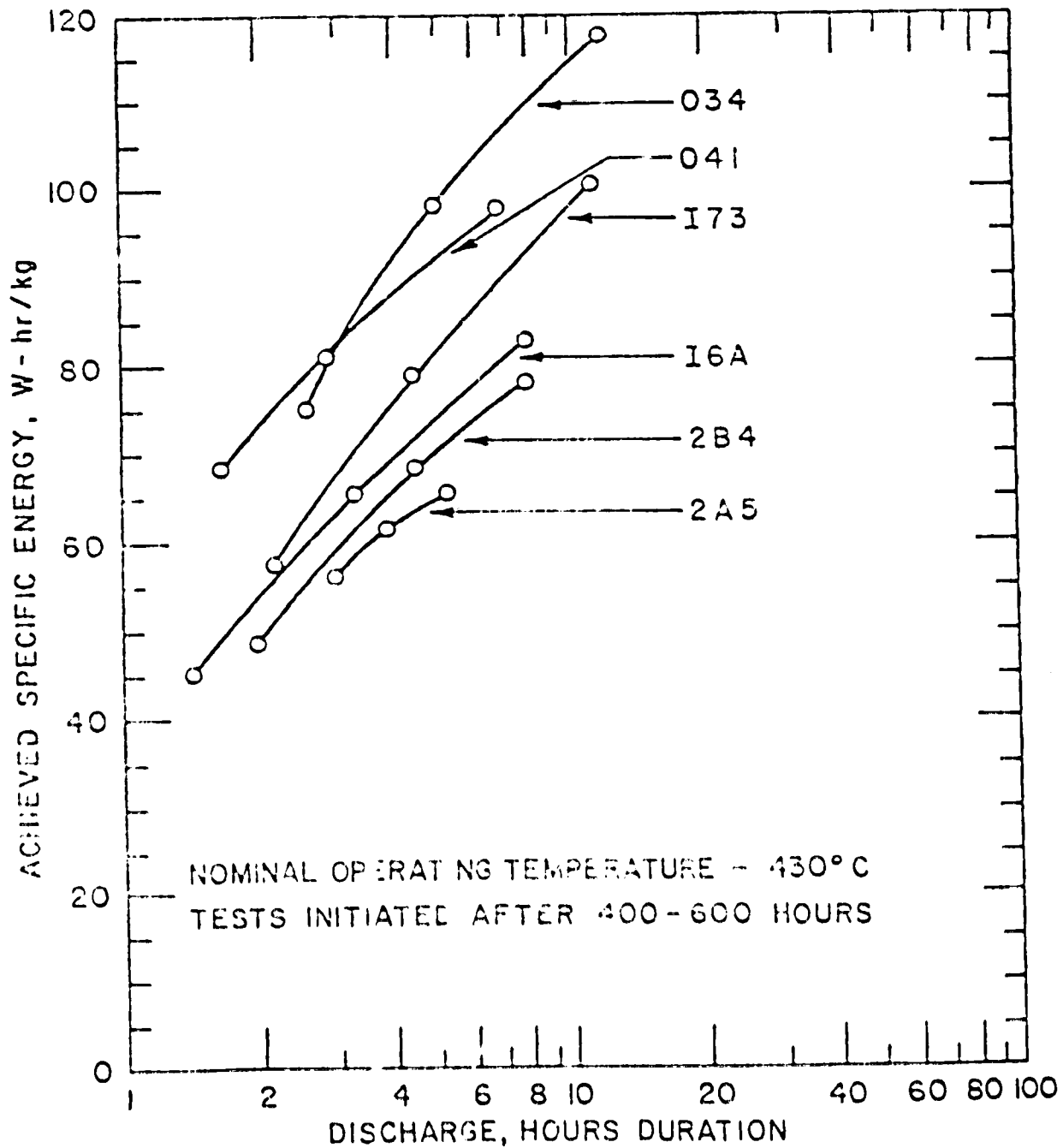

Figure 2. Li(Al)/FeS_x Cell Performance vs. Goals

Specific Energy of Eagle-Picher FeS₂ Cells vs. Discharge Rate in Hours.

SPECIFIC ENERGY OF EAGLE PICHER FeS₂ CELLS



SPECIFIC POWER OF EAGLE PITCHER FeS₂ CELLS

CELL	WATTS PEAK POWER CHARGED	WATTS PEAK POWER 50% CHARGED	RESISTANCE MILLI-OHMS
041	136	79	5.3
034	108	60	6.6
I73	125	70	6.9
I6A	95	57	9.4
2B4	97	65	7.5
2A5	86	69	8.5

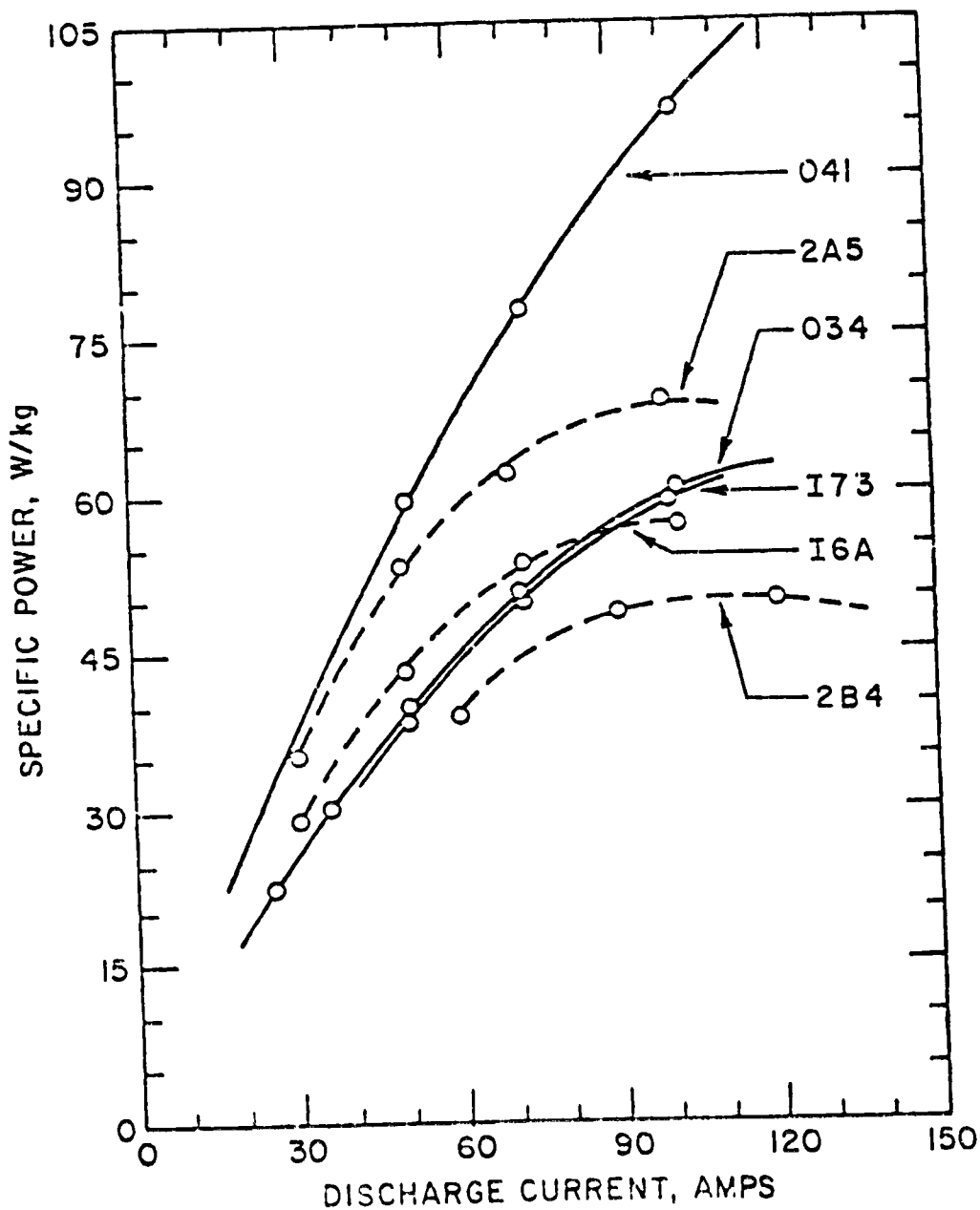

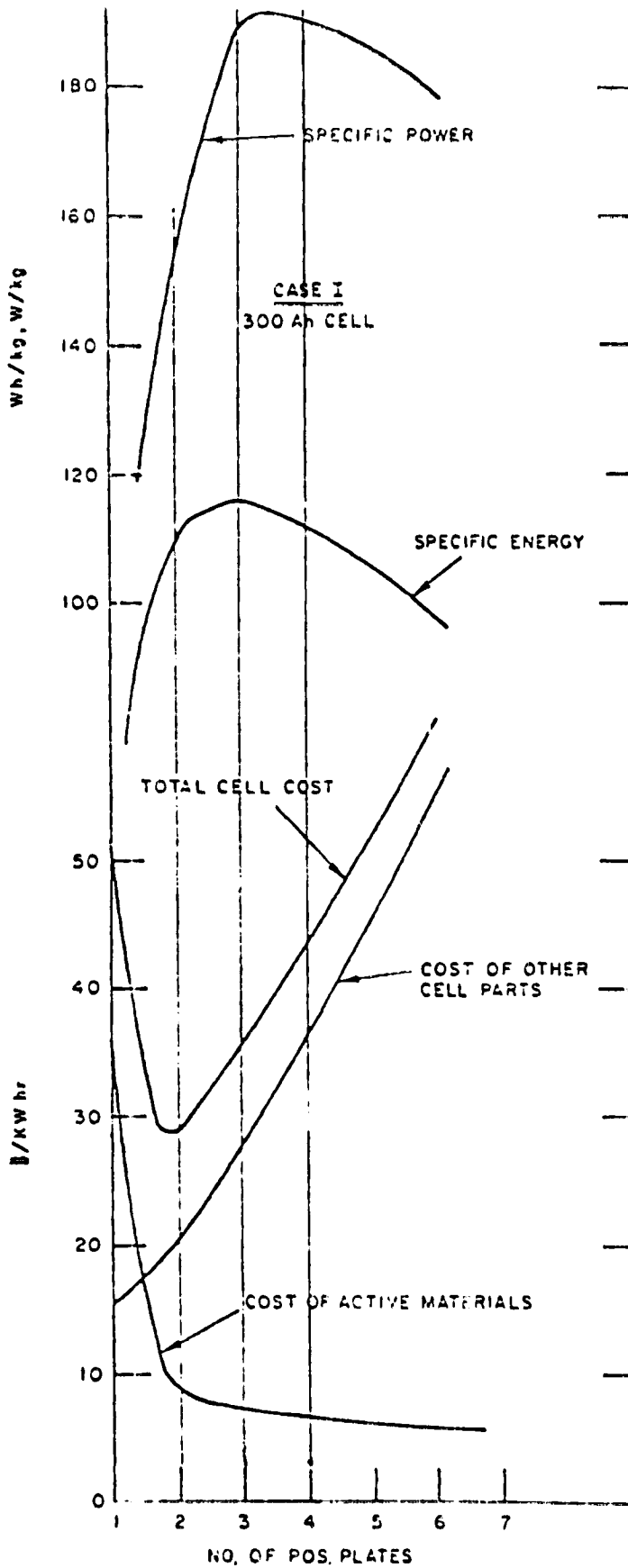

DESIGN AND COST OPTIMIZATION OF A
MULTIPLATE LIAl/FeS CELL

2-29

Enclosure 3. Specific Energy, Power & Cost per Cell vs. Number of Positive Plates in Multiplate Li/FeS Cells.

SPECIFIC ENERGY OF FeS CELLS

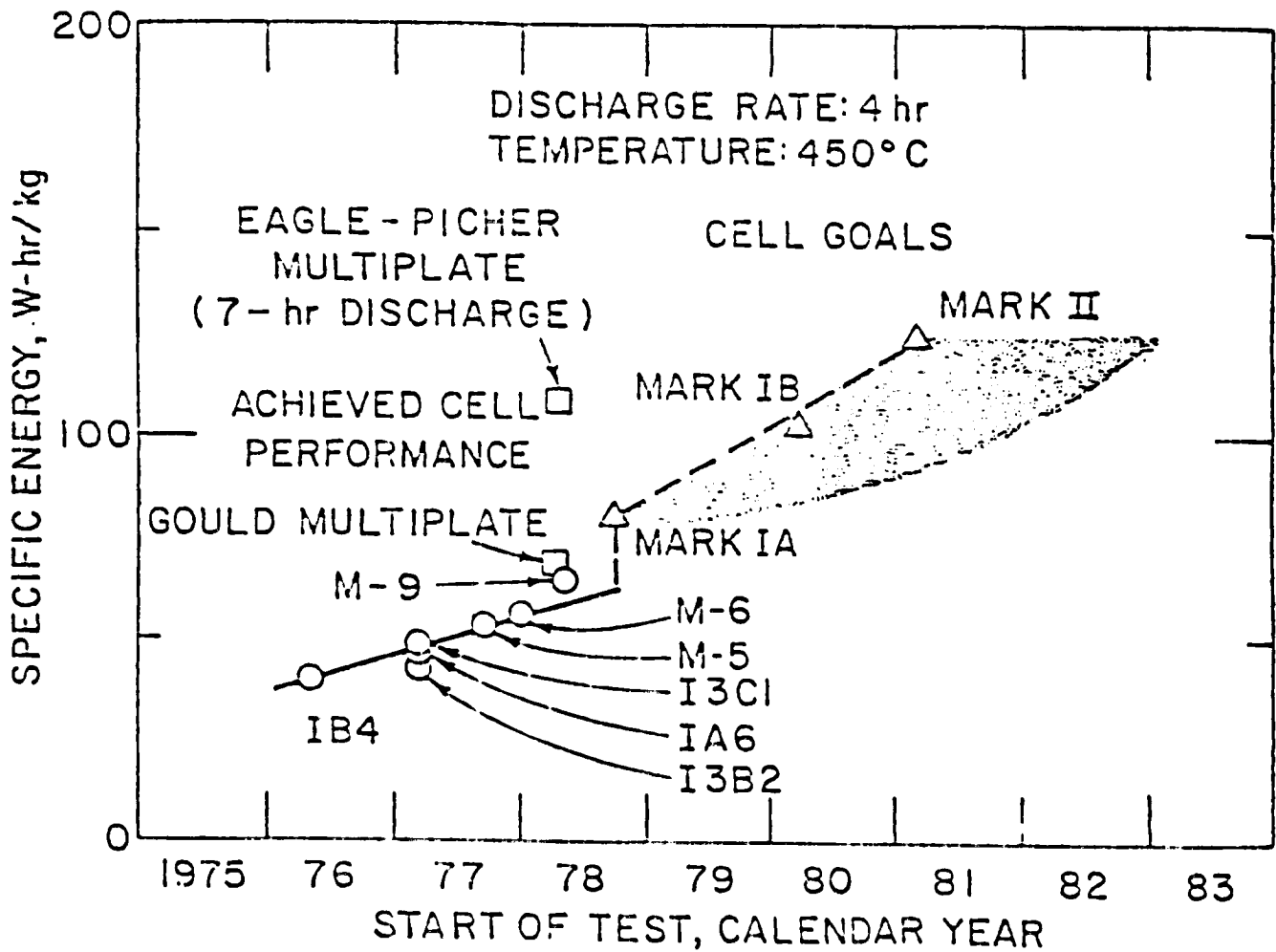

PEAK SPECIFIC POWER OF FeS CELLS

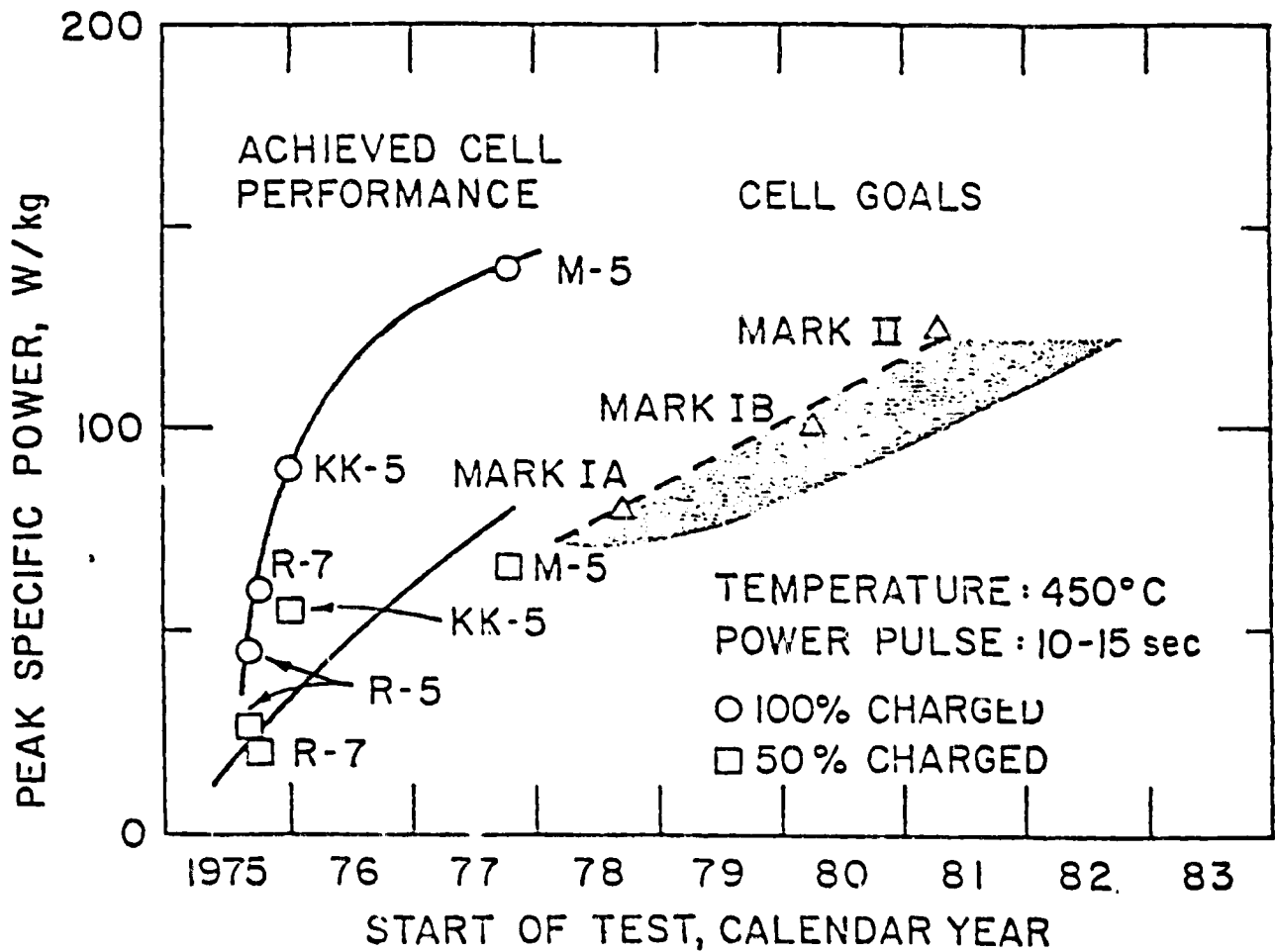

SPECIFIC ENERGY OF FeS_2 CELLS

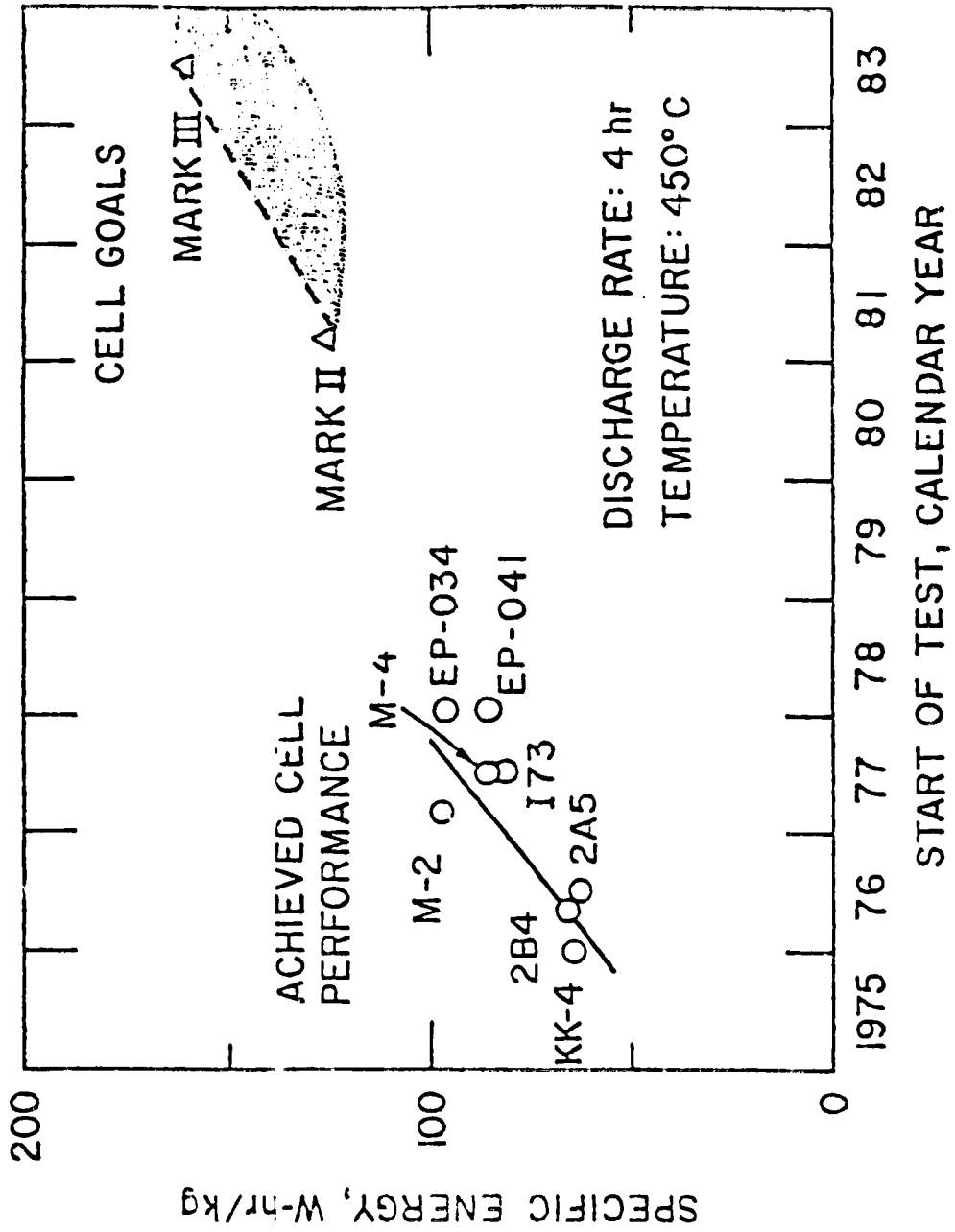

2-32

QUALITY IS
OUR BUSINESS

PEAK SPECIFIC POWER OF FeS₂ CELLS

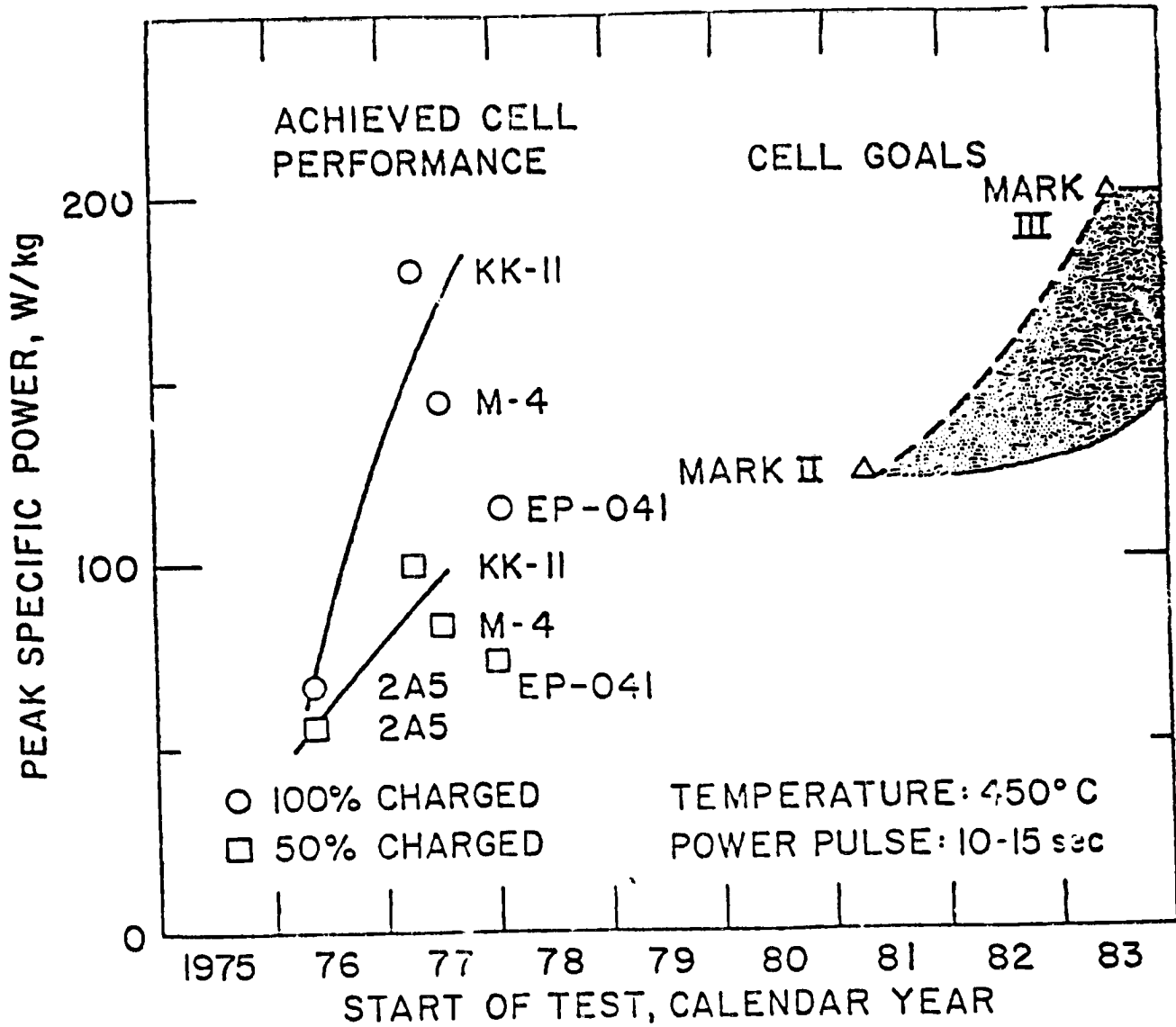

CYCLE LIFE OF FeS CELLS

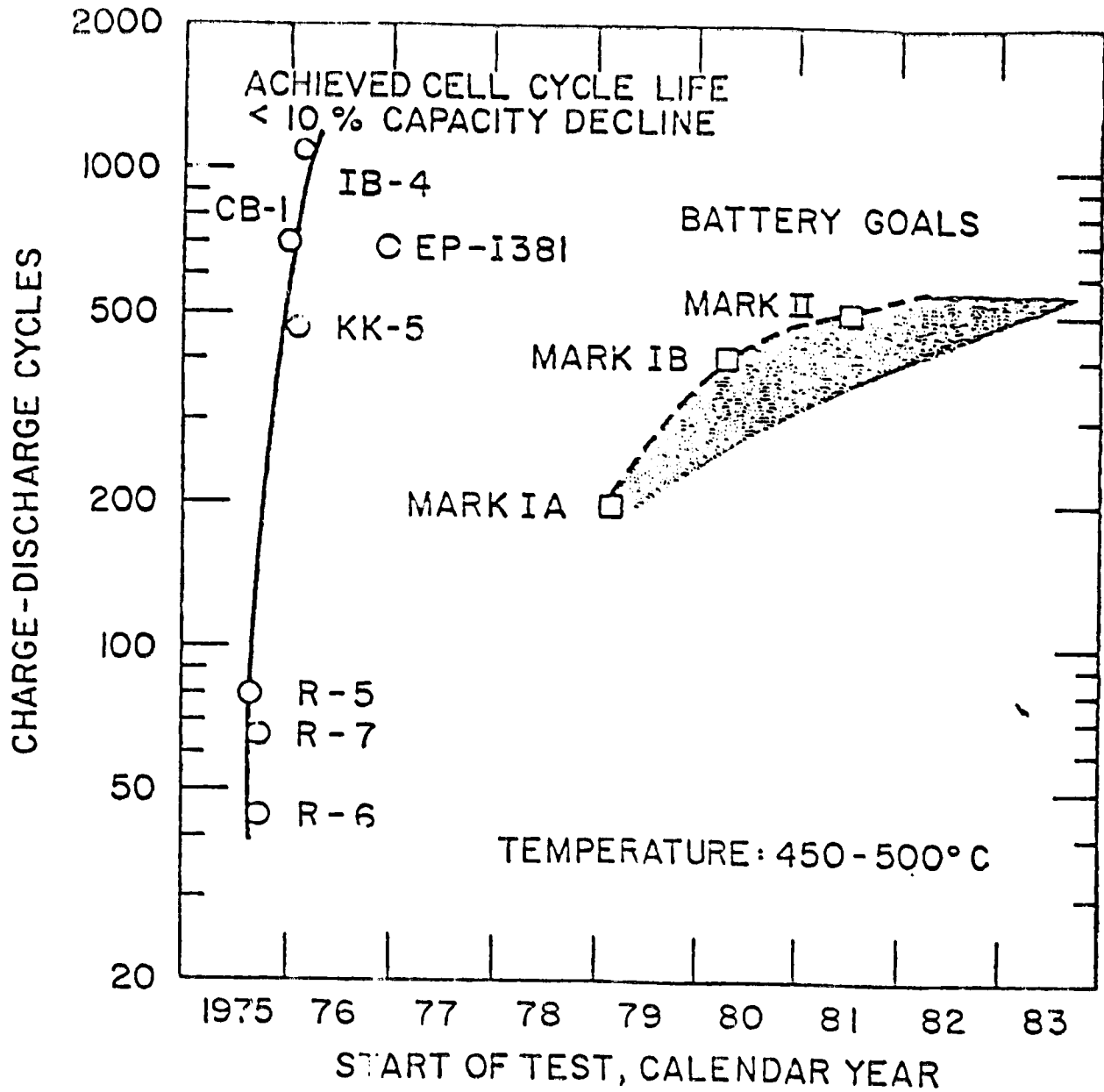

CYCLE LIFE OF FeS₂ CELLS

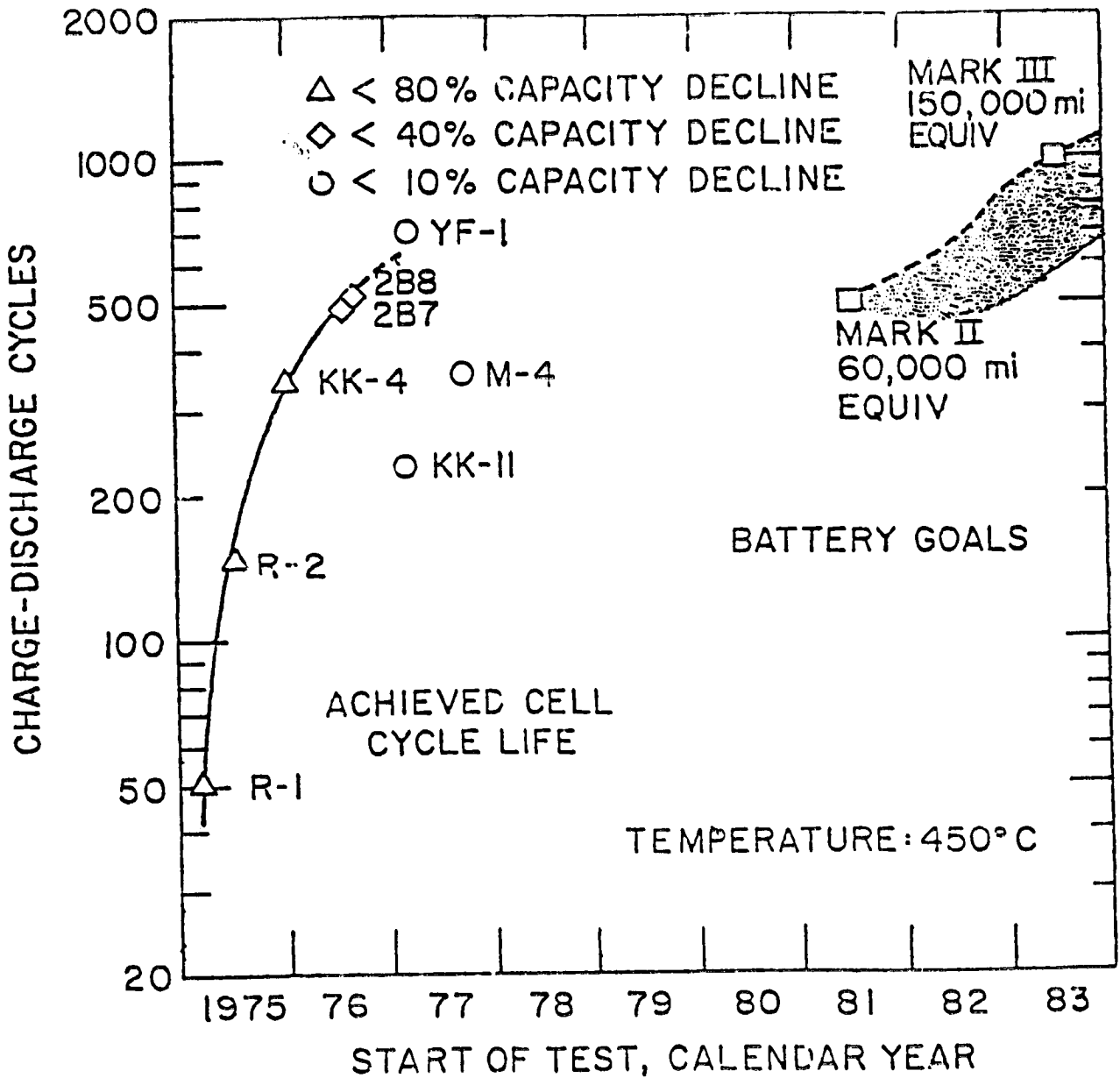

PROGRAM GOALS FOR THE LITHIUM/ IRON
SULFIDE ELECTRIC VEHICLE BATTERY

	Mark I	Mark II	Mark III	Long-Range
<u>Specific Energy, W-hr/kg</u>				
Cell (average) ^a	100	125	160	200
Battery	75	100	130	155
<u>Energy Density, W-hr/liter</u>				
Cell (average)	320	400	525	650
Battery	100	200	300	375
<u>Peak Power, W/kg^b</u>				
Cell (average) ^a	100	125	200	250
Battery	75	100	160	200
<u>Jacket Heat Loss, W</u>	300	150	125	75-125
<u>Lifetime</u>				
Deep Discharges	400	500	1,000	1,000
Equivalent Miles	40,000	60,000	150,000	200,000

^a Individual cells for Mark I will have 10% excess capacity and power above that shown to allow for cell failures and mismatching; individual cells for Mark II will have 4% excess capacity and power.

^b Peak power sustainable for 15 sec at 0 to 50% of battery discharge; at 80% discharge, peak power is to be 70% of value shown.

Ford Na⁺/S Battery System

Table 1 gives the best estimates which can be derived for the Ford A-130-12 EV cells. The cell now being tested for EV applications on their DOE contract.

Table 11 gives the estimated energy, power and energy-power densities Ford projects for the Ford Fiesta battery composed of 48 cells in series and 14 sub-cells bundled in parallel in each cell. This battery has been described as the 1. kWh unit type (SAE) 98-1214.

Figures 1 and 2 are an one plot giving the difference between cell and battery performance. Ford's slides by M. A. Pulack gave the following energy densities as realistic targets for EV's.

Assembly Condition	Volume Density Whr/l	Weight Density Whr/kg
Theoretical	350	760
Single sub-cell	358	175
Battery with thermal management	222	155
Installed in EV	115	120

The last energy density penalty for installation is common to all systems and includes weight and volume needed for mounting the battery against shock and vibration and ready interchange.

Note in Table 11 the energy factor 1.41 as the excess energy to assure the required energy is available to give the required range of 100 miles at the test weight of 2470 lbs:

	Weight-lbs
Base Vehicle	1254
Payload	350
Meter and controller	206
Battery	565
Mounting structure	96
Test Weight:	2470

Ford's estimate requires an energy of 29.7 kWh per 100 miles. The 40 kWh battery described would deliver 40/1.41 = 28.4 kWh.

The major open issues are listed by Ford as long term stability of performance, reproducibility of cells, life of cells on EV regime in automobile, optimization of cell arrangement, insulation and thermal management.

We have to add that at the time this data was issued at the November 1978 Program Review, Ford scientists stated privately that cool-down to the frozen state and warm-up back to 35°C cannot be accomplished without cracking the beta tubes.

Ford believes, and we have confirmed, that it is the differential expansion of the beta and the sulfur electrode which is responsible. We have taken 20 Whr Na-S cells through this thermal freeze thaw shock successfully but not large tube Na-S cells. It will be a major problem area for Ford.

TABLE I

Basic EV Na/S Cell Characteristics
(Estimates)

Discharge Time Hr	Current A	Capacity Ahr	Voltage Mean Volts	Energy Whr	Power W	Energy Density		Power	
						$\frac{\text{Whr}}{\text{kg}}$	$\frac{\text{Whr}}{\text{l}}$	$\frac{\text{W}}{\text{kg}}$	$\frac{\text{W}}{\text{l}}$
5	6	30	2.01	60	12	181	370	36	74
4	7.5	30	1.97	59	15	178	364	45	91
3	10	30	1.92	58	19	175	358	58	119
2	15	30	1.85	56	28	169	346	85	173
1	30	30	1.75	52	52	157	321	157	321
15 sec					147				
Cell Volume:		0.162 l							
Cell Weight:		0.331 kg							
Recharge Time:		8 hrs							

Source: Ford Na/S Program Review, Newport Beach, Calif., 1 November 1978.

TABLE 11

Ford Fiesta 40 kWhr Na/S Battery
Type 48 (A-130-12) 14

Discharge Time	Current	Capacity to 1.6 V	Voltage Mean	Energy Output	Power	Energy Density	Power Density		
Hrs	Amps	Ahr	Volts	kWhr	kW	Whr/kg	Whr/L	W/kg	W/L
5	84	420	96.5	40.3	8	157	237	31	47
4	105	420	94.6	39.6	10	155	233	39	59
3	140	420	92.2	38.9	13	152	229	51	76
2	210	420	88.8	37.6	19	147	221	74	112
1	420	420	84.0	34.9	35	136	205	137	206
15 sec					99			387	582

Battery Weight: 256 kg (Including heat retaining insulation and close packed cells with all equipment for thermal management).

Battery Volume: 170 L

Recharge Time: 8 hrs

$$E_{\text{Battery}} = 1.41 E_{\text{required}} = F_1 \cdot F_2 \cdot F_3 \cdot F_4 \cdot E_{\text{required}}$$

$$F_1 = \text{depth of discharge factor} = 1.25$$

$$F_2 = \text{single cell failure factor} = 1 + \frac{1}{N_p} \text{ where } N_p = \text{number of cells in parallel} = 14$$

$$F_3 = \text{non-uniform operation factor} = 1 + \frac{0.152}{N_p}$$

$$F_4 = \text{cell aging factor} = 1.1$$

∴ E_{required} is 28 kWhr for above battery.

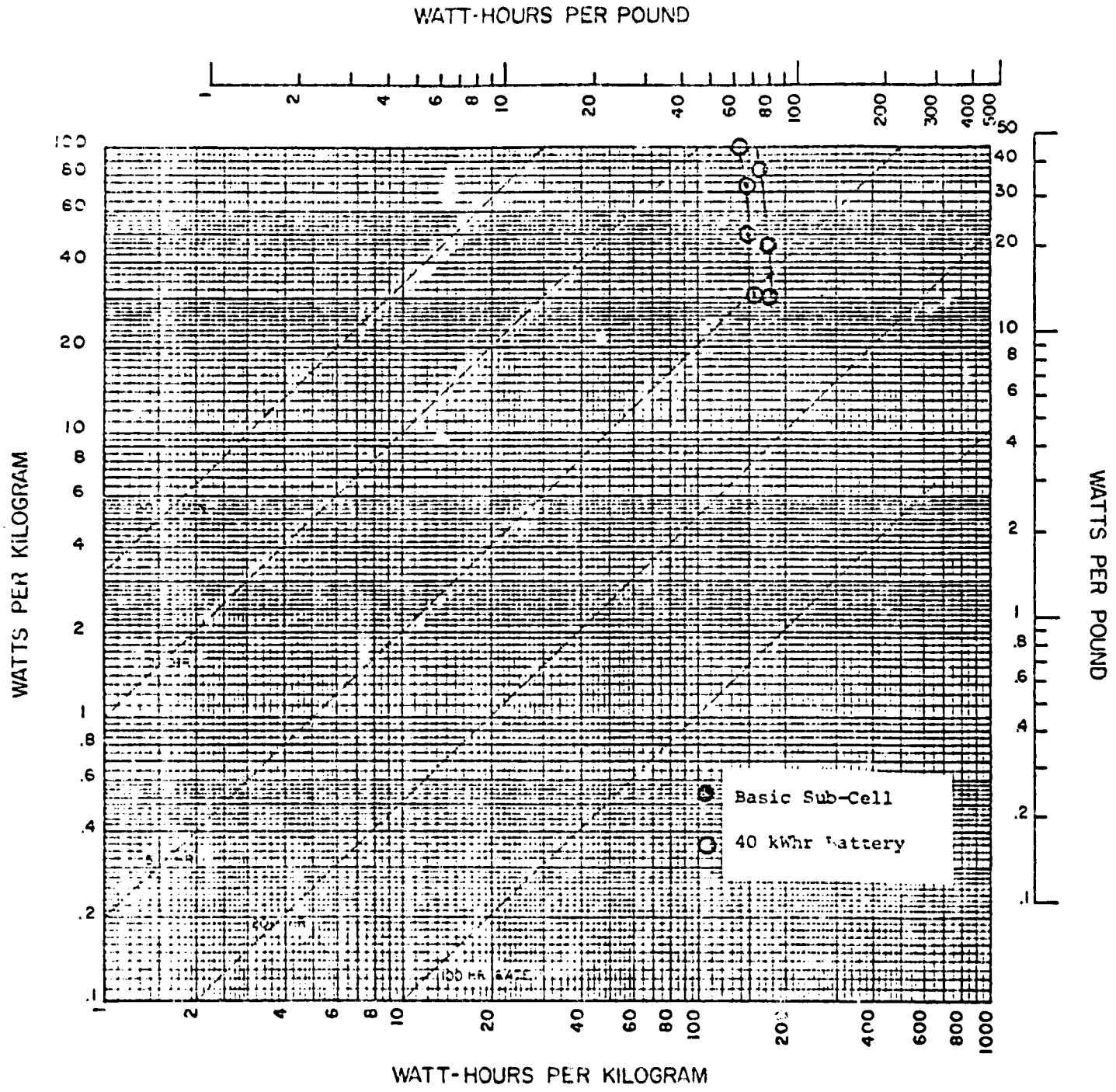

Figure 1. Weight Energy Density of Ford Fiesta Na/S Battery

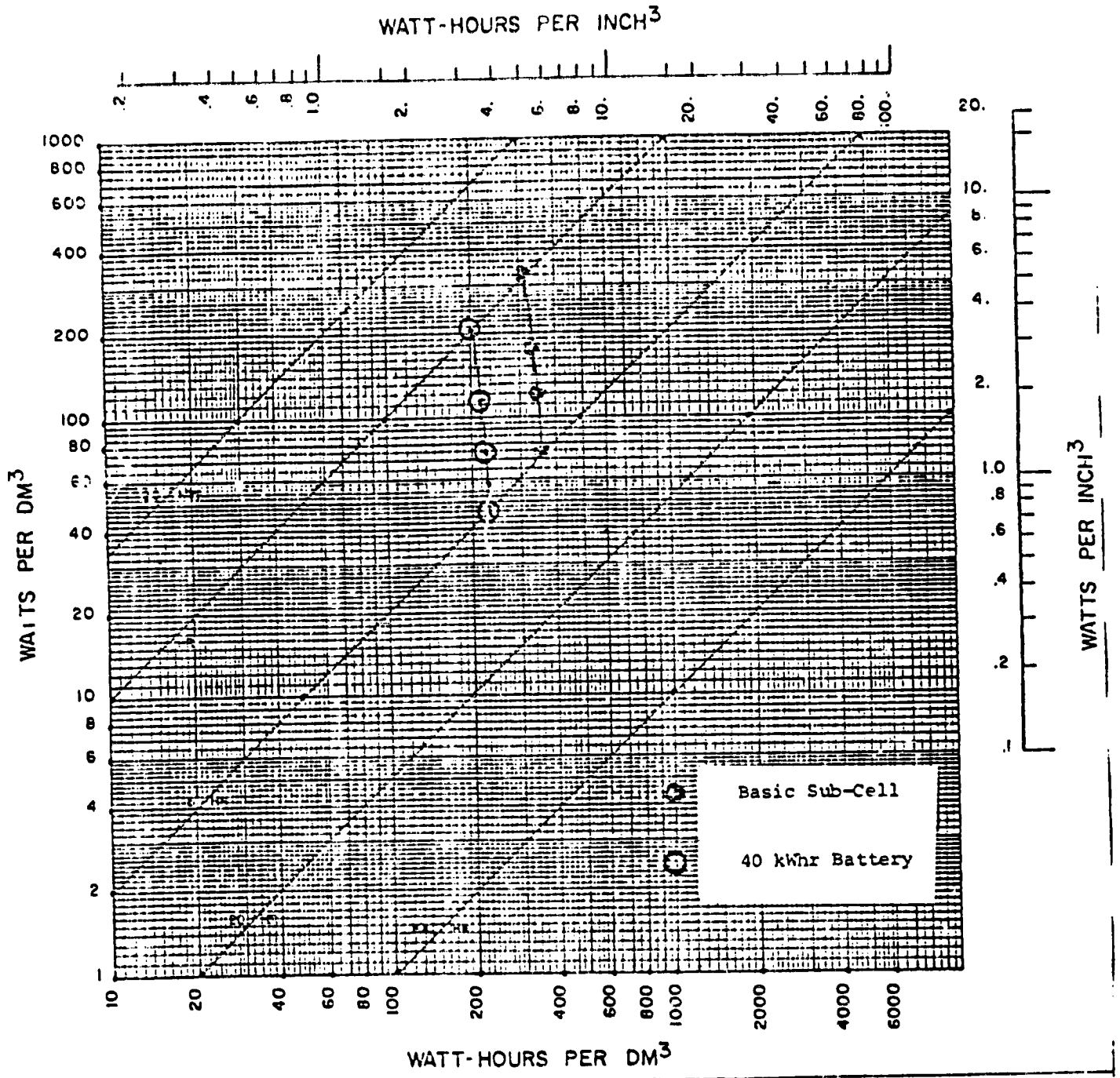

Figure 2. Volume Energy Density of Ford Fiesta Na/S Battery

Appendix C
Nickel Iron Battery System

NICKEL/IRON EV BATTERIES

1. Background

The U. S. Department of Energy has let two contracts for the development of nickel/iron electric vehicle batteries: one to Westinghouse Electric Corporation and one to Eagle-Picher Industries, Inc. Westinghouse has demonstrated laboratory cell performance which nearly matches the long-term program goals and is developing an alternative nickel electrode production scheme which uses the lowest-cost forms of nickel. Eagle-Picher has begun assembly and testing of full-scale improved nickel/iron cells. The iron electrode technology being developed in conjunction with the Swedish National Development Co. (Åkersberga, Sweden) may offer the potential for the best energy efficiency ever achieved in a nickel/iron battery.

2. Goals and Present Specifications

	Goals	Present
Price (\$/kWhr)	60	120
Specific Power (W/kg)	100 @ 17% V drop	100 @ 24% V drop
Energy Efficiency (% at C/3 Disch. and 6-hr charge)	60	55
Life (Cycles at 80% rated capacity)	2000	1500
Specific Energy (Whr/kg)	60	44

3. Nickel/Iron Battery Advantages Disadvantages

Advantages:

- Cell reversal not damaging
- Long life

Disadvantages:

- History of high cost
- Open circuit cell voltage only 1.2 V
- Self-discharge is somewhat high and worsens with age
(Westinghouse projects their future battery to lose 1.67% per day so that a two-week open circuit stand would result in a loss of approximately one quarter of the original capacity.)

- Poor low temperature performance
(A Ni/Fe system with an electrolyte temperature of 0°C yields only 43% of its 25°C capacity [to a 1.0V per cell cut-off]. This may require heaters and extra insulation compared to other systems.)
- Maintenance (watering) requirements probably higher than Pb-acid systems.
- Thermal management (heat build-up) problems may be severe.

4. General Comments

A hybrid vehicle pack using Ni/Fe and lead-acid would hold no significant advantage. The Ni/Fe system energy and power densities, although higher than Pb/acid, are not that much better to justify the complexities and additional expense of going hybrid. If the cycle life of Ni/Zn is improved, the Ni/Zn - Pb/acid hybrid would be more attractive.

The modeling of Ni/Fe batteries in vehicle simulation programs is not possible without specific performance and/or specifications from the EV battery contractors. Both Eagle Picher and Westinghouse have been guarding the release of information pertaining to the Ni/Fe vehicle battery program.

In addition to the program in the United States, DAUG (Deutsche Automobilgesellschaft MBH) in Esslingen, Germany has had a serious Ni/Fe vehicle battery program for years and is testing batteries in van-type vehicles.

The ability to supply prototype quantities of Ni/Fe batteries in '81 and large quantities in '85 would probably be shared by all three companies - Westinghouse, Eagle-Picher and DAUG. The cost estimates, however, are always to be questioned in an untried vehicle system. I have heard unofficial comments in Sweden, for instance, that the cost estimates for the production of the SU iron electrode were unrealistically low. The process is, however, proprietary and therefore not open to objective analysis.

Ni/Fe Power and Energy Densities at Different Rates

<u>Rate</u>	<u>Westinghouse Claims:</u>	<u>G. E. Curve</u>
C	54.8 W/kg (54.8 Wh/kg)	46.9 W/kg (46.9 Wh/kg)
C/3	20.6 W/kg (61.8 Wh/kg)	22 W/kg (66 Wh/kg)
C/5	13.2 W/kg (66 Wh/kg)	14 W/kg (70 Wh/kg)

Nickel Zinc Battery System

NICKEL/ZINC EV BATTERIES1. Background

Under the provisions of the McCormack Act, the U. S. Department of Energy has contracted with three companies to develop Nickel-Zinc EV batteries. These companies (Yardney Electric, Energy Research and Gould) along with Eagle Picher had completed Phase I study contracts before being granted the development contracts. In addition, General Motors is carrying out an in-house Ni-Zn development without benefit of government funding. All of these efforts are concerned with Nickel-Zinc batteries of "conventional" design; i.e., cells with closely packed electrode elements, incorporating barrier type separators. In addition to this work, ESB and its Swedish subsidiary, AB Tudor, are working on the development of vibrating anode Nickel-Zinc batteries for electric vehicles. Support of this effort from DOE is expected in the form of a development contract with ESB.

2. Design Goals and Present State-of-Art Performance

Listed below are the major areas of interest of Nickel-Zinc EV batteries along with the goals desired by DOE in each area. Present estimated state-of-art is indicated in each category.

<u>Characteristic</u>	<u>Goals</u>	<u>Present State-of-Art</u>	
Specific Energy (Whr/kg) @ C/3	> 70	70	(1)
Volumetric Energy (Whr/l) @ C/3	>120	120	(1)
Specific Power (W/kg) (5 sec. ave. @ 80% Disch.)	>125	125	(1)
(20 min. sustained @ C/3 and 50% DOD)	> 45	--	
Cycle Life (80% DOD @ C/3)	>400	75-100	
Wet Life (years)	> 2	2	
Cost (\$/kWhr)	< 75	200 (est.)	(2)
Energy Efficiency (%)	> 60	~65	

(1) Obtainable on early cycles only.

(2) 1978 dollars, up to 1000 EV batteries per year

3. Nickel-Zinc EV Battery Performance (Conventional Type)

a) Advantages

Potential High Energy Density and Specific Power
High Voltage per cell (1.60 V average)

b) Disadvantages

Life - Limited by three major factors: separator degradation, shorting by zinc dendrites, capacity fall-off due to shape change of negative electrode.

Charging - Sensitive to overcharge because of tendency to form zinc dendrites during overcharge. Nickel cathodes require overcharge to develop full capacity.

Cost - Tends to be high, especially with the high energy density nickel cathodes (e.g., sintered type) needed to achieve performance.

Maintenance - Frequent water additions necessary due to overcharge requirements of nickel electrode.

c) Electrical Performance

Attached are three figures depicting state-of-the-art nickel-zinc cell (conventional type) electrical performance. Figure 1 is a Ragone plot depicting the relationship of specific power (W/kg) to energy density (Whr/lb). The solid line represents data taken from three sources. The Energy Research data is from ANL-K76-3541-1, Final Report, "Design and Cost Study of Nickel-Zinc Batteries for Electric Vehicle." The Yardney data is from ANL-K76-3543-1, Final Report, "Design and Cost Study Zinc/Nickel Oxide Battery for Electric Vehicle Propulsion." The ESB data is from proprietary data developed during internal R & D programs. For purposes of comparison the Ragone plot obtained from the GRC and CCM data is superimposed as a dotted line. Agreement is fairly close, with the available electrical data indicating a slightly lower energy density at low rates of discharge, but possibly a higher specific power at high rates of discharge. Figure 2 gives typical discharge performance of a Yardney 310 Ahr cell at rates of C, C/3 and C/5. Figures 3 & 4 are discharge characteristics curves and power curves for ESB 25 Ah nickel zinc cells.

All of this information, it must be emphasized, is based on the performance of Ni-Zn cells during early cycles. Presently available "conventional" Nickel-Zinc batteries tend to lose capacity by fading within 50 deep cycles, and could lose as much as 50% of original capacity within 100-150 cycles, depending on the rate of discharge. Cycle life is also dependent upon depth of discharge; however, no definitive data on this is available.

ANL, through its DOE funding, is basing Ni-Zn development on a 25 kWhr battery size. At 30 Whr/lb, battery weight would be about 833 lb and its volume about 6.6 cu ft. Cell capacity is designated at 300 Ahr, giving a battery voltage of about 83.3 volts, or 52 cells in series. If such a battery comprised 1/3 the vehicle weight, a range of about 80-120 miles per charge can be expected, depending on the type of driving cycle used.

RAGONE PLOT Ni-Zn BATTERIES

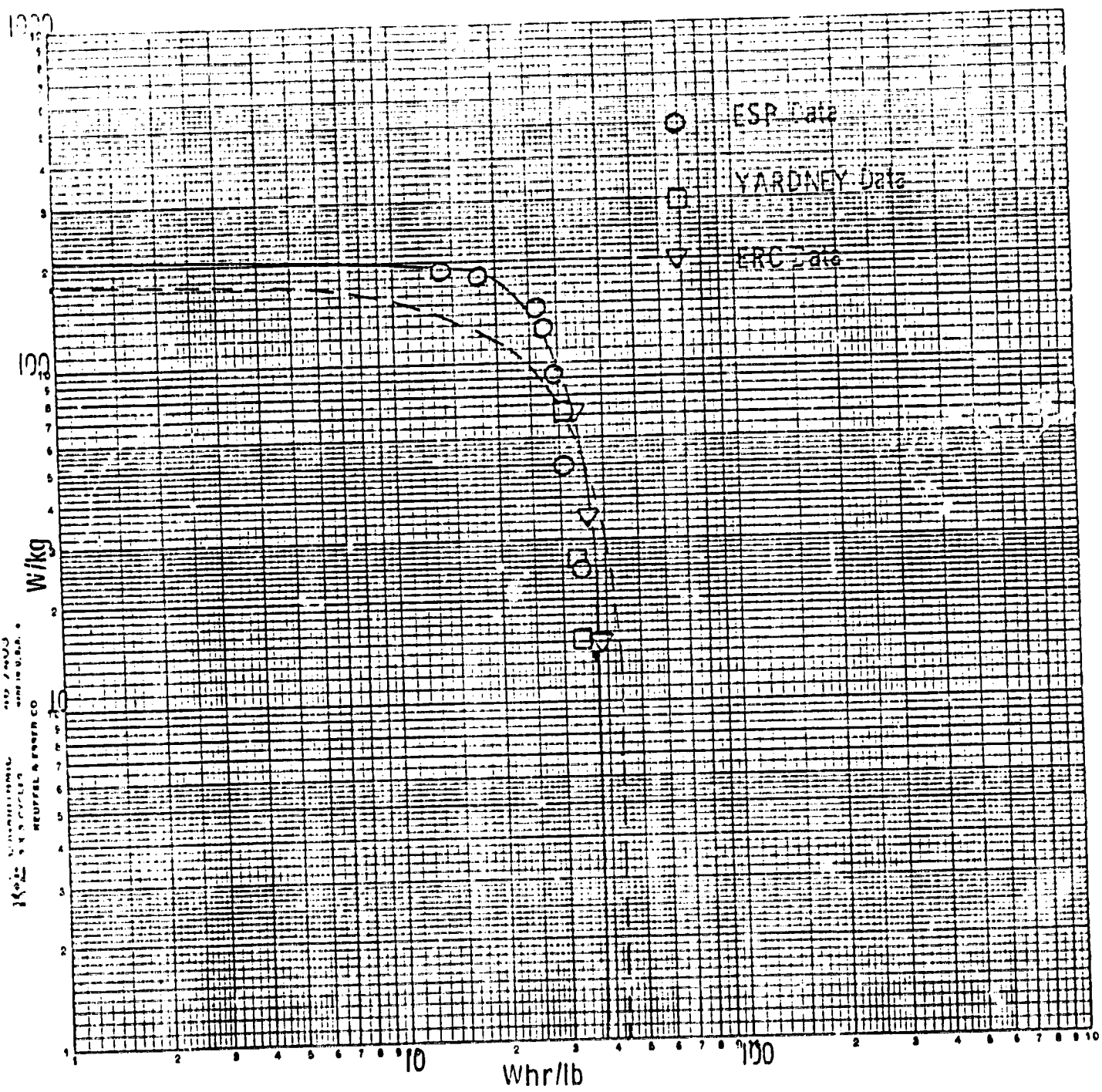
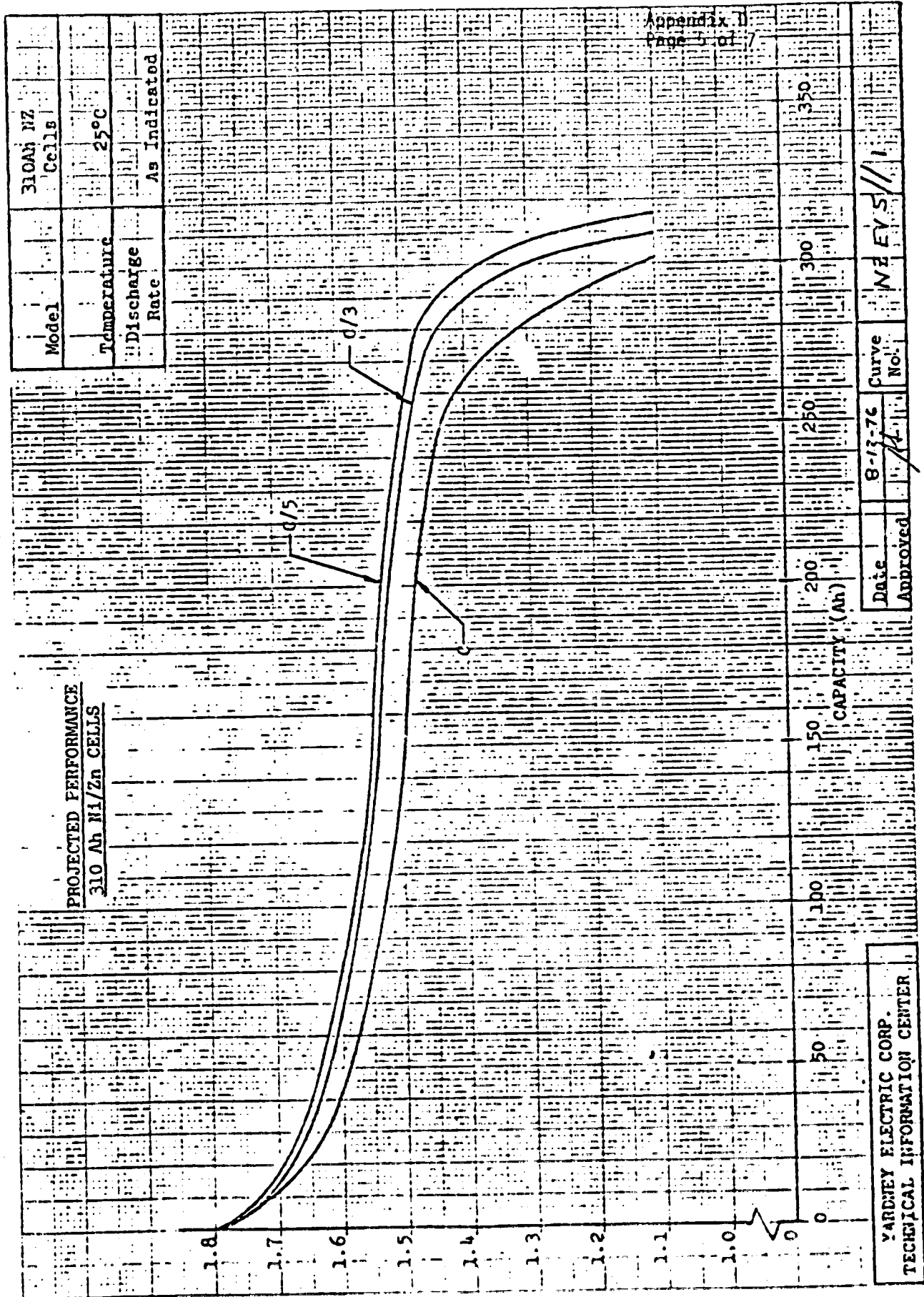

FIGURE 1
2-48



CELL VOLTAGE
FIGURE 2 2-49

SUPPLEMENT #1 TO
THE ASSESSMENT OF
BATTERY POWER SOURCES
THE
GE PHASE I HYBRID VEHICLE

PREPARED FOR
GENERAL ELECTRIC COMPANY
CORPORATE RESEARCH AND DEVELOPMENT
P.O. A0200-22067
ESB Project 6047

FEBRUARY 16, 1979

PREPARED BY

D. T. Ferrell

ESB TECHNOLOGY COMPANY
YARDLEY, PA.

At the request of Dr. A. F. Burke on February 12, 1979, we have assembled information on other DOE battery programs, and have provided our assessment of them.

The first group (Pages 1-7) are from DOE/ET-0033 dated October 1978 which is the Program Overview for Energy Storage Systems for FY 1978.

PAN-10 and PAN-4 (Pages 8 & 9) are from a Paul Nelson presentation in May 1978 on the ANL program. This is undoubtedly optimistic. Ford Na/S EV program is on approximately the Mark II schedule EDA Zn-Cl₂H₂O is only a slightly faster track.

The 4 DOE Advanced Battery Programs are:

	5 YR(Tech.)	Probability 10 YR(Comm.)	20 YR (Comm.)
EDA Zn-Cl ₂ H ₂ O	0.95	0.5	0.75
Ford Na-S (beta alumina)	0.8	0.25	0.5
Dow Na-S (glass)	0.2	0.0	0.2
ANL Li-MS	0.9	0.5	0.75

The probabilities are assessments for EV's, and reflect some pessimism about non-lead-acid EV's in general

Since this document page contains assessments and probabilities of a judgemental nature, further dissemination or discussion of this page outside GF (without express concurrence of ESB Inc. is requested. Information contained on the balance of this supplement are not subjected to this restriction.

TABLE 1. MAJOR PROJECT LISTING

PROJECT	NAME AND LOCATION OF PROJECT MANAGER	PERFORMING ORGANIZATION	BA (\$K) FUNDING FY 1978	(\$K) TEC
BATTERIES AND ELECTROCHEMICAL SUBPROGRAM				
Near-Term Batteries				
Electric Vehicle Batteries* (Lead/Acid, Nickel/Iron, Nickel/Zinc)	N.P. YAO, ANL	ANL and eight industrial subcontractors	5,700	46,700
Adv. Lead/Acid Batteries for Load Leveling	H. Shimotake, ANL	RFP	300	5,000
Advanced Batteries in Engineering Development* (Li/S, Na/S, Zn/Cl)	P. Nelson, ANL/K. Klunder, DOE	Ford, Dow, EDA, ANL (with five industrial subcontractors)	10,700	101,000
Solar Applications	N.P. YAO, ANL	ANL and TBD	500	5,000
Industrial Electrolytic Processes*	G. Cook, ANL	Diamond Shamrock, U. of Illinois Argonne National Lab	1,250	12,000
CHEMICAL AND THERMAL SUBPROGRAM				
Hydride Storage Vessel Development	F. Salzano BNL	INCO, Billings, Foster-Wheeler	850	15,000
Electrolyzer Development for H ₂ Production*	F. Salzano BNL	GE. TELEDYNE	1,300	12,000
Seasonal Storage in Aquifer for Building Heating and Cooling	H. Hoffman ORNL	Desert Reclamation Auburn University Texas A&M	400	5,000
Retrofit System for Industrial Process Heat Recovery	H. Hoffman ORNL W. Masica NASA/Lewis	Rocket Research, Boeing, Martin-Marietta, Westinghouse	500	6,000
Chemical Heat Pump for Building Heating and Cooling	W. Wilson SLL	Martin-Marietta, Rocket Research, EIC, Chemical Energy Specialists	400	5,000

* Key Project

TABLE 1. MAJOR PROJECT LISTING

(Continued)

PROJECT	NAME AND LOCATION OF PROJECT MANAGER	PERFORMING ORGANIZATION	BA (SK) FUNDING FY 1978	(SK) TEC
MECHANICAL AND MAGNETIC SUBPROGRAM				
Mechanical Energy Storage for Electric and Hybrid Vehicles*	Thomas Barlow Livermore, Calif.	LLL and Industry	1,800	7,800
Superconducting Magnetic Energy Storage for Transmission Stability	John Rogers Los Alamos, N. Mex.	LASL and Industry	1,050	5,100
No-Oil Compressed Air System Development	Walter Loscutoff Richland, Wash.	PNL and Industry	160	10,000
TECHNICAL AND ECONOMIC ANALYSIS SUBPROGRAM				
STOR R&D Program Evaluation and Review System	L. Holt DOE	NAS, LLL, LeHigh Univ., U. of Maryland	950	3,000
Energy Storage for National Transportation	E. Behrin LLL	LLL-lead lab, ANL, BNL, LBL, Battelle (Industrial Subcontractors)	500	1,250
Energy Storage for Solar Systems	L. Framan NASA-JPL	NASA-JPL lead lab (DOE Labs, Industrial Subcontractors)	700	2,000
Decentralized Storage Systems Studies	J. Asbury ANL	ANL-lead lab (Industry and University Subcontractors)	900	3,500

*Key Project

TABLE 2. COMMERCIAL TECHNOLOGY TIMETABLE

SUBPROGRAM	1980-1984	1985-1990	AFTER 1990
BATTERIES AND ELECTROCHEMICAL SYSTEMS	<ul style="list-style-type: none"> ● NEAR TERM ELECTRIC CARS ● DISPERSED UTILITY LOAD LEVELING 	<ul style="list-style-type: none"> ● ADVANCED ELECTRIC CARS ● ADVANCED BATTERIES FOR LOAD LEVELING 	<ul style="list-style-type: none"> ● SOLAR ELECTRIC STORAGE ● IMPROVED ELECTROCHEMICAL PROCESSES
CHEMICAL AND THERMAL SYSTEMS	<ul style="list-style-type: none"> ● H₂ FOR CHEMICAL FEEDSTOCK ● SOLAR SEASONAL HEATING AND COOLING 	<ul style="list-style-type: none"> ● H₂ SUPPLEMENTATION OF NATURAL GAS ● CHEMICAL HEAT PUMPS WITH STORAGE ● THERMAL STORAGE FOR LOAD LEVELING 	<ul style="list-style-type: none"> ● H₂ AND THERMOCHEMICAL STORAGE FOR SOLAR ● H₂ FOR VEHICLES
MECHANICAL AND MAGNETIC SYSTEMS	<ul style="list-style-type: none"> ● UTILITY STORAGE (UPH CAES) ● FLYWHEEL REGENERATIVE BRAKING 		<ul style="list-style-type: none"> ● ADVANCED CAES ● SMES FOR UTILITY LOAD LEVELING

● FUNDS LIMITED
 ● TECHNOLOGY LIMITED

Technologies to serve both mobile and stationary applications are being developed. Development progress in the two areas can be measured against the goals stated below.

Mobile Storage Goals

- Batteries for transportation having an energy density of 140 watt-hours per kilogram, a peak power capability of 200 watts per kilogram, and capital costs less than \$40 per kilowatt-hour
- Flywheel regenerative braking systems resulting in a 30 percent energy savings when incorporated into battery-powered vehicles for city driving
- Hydride materials for hydrogen-fueled vehicles that store twice as much hydrogen as iron titanium hydride, with an energy density of more than 800 watt-hours per kilogram

Stationary Storage Goals

- Battery, chemical, thermal, and mechanical storage systems having appropriate characteristics for use in smoothing the intermittent availability of power from solar and wind energy systems

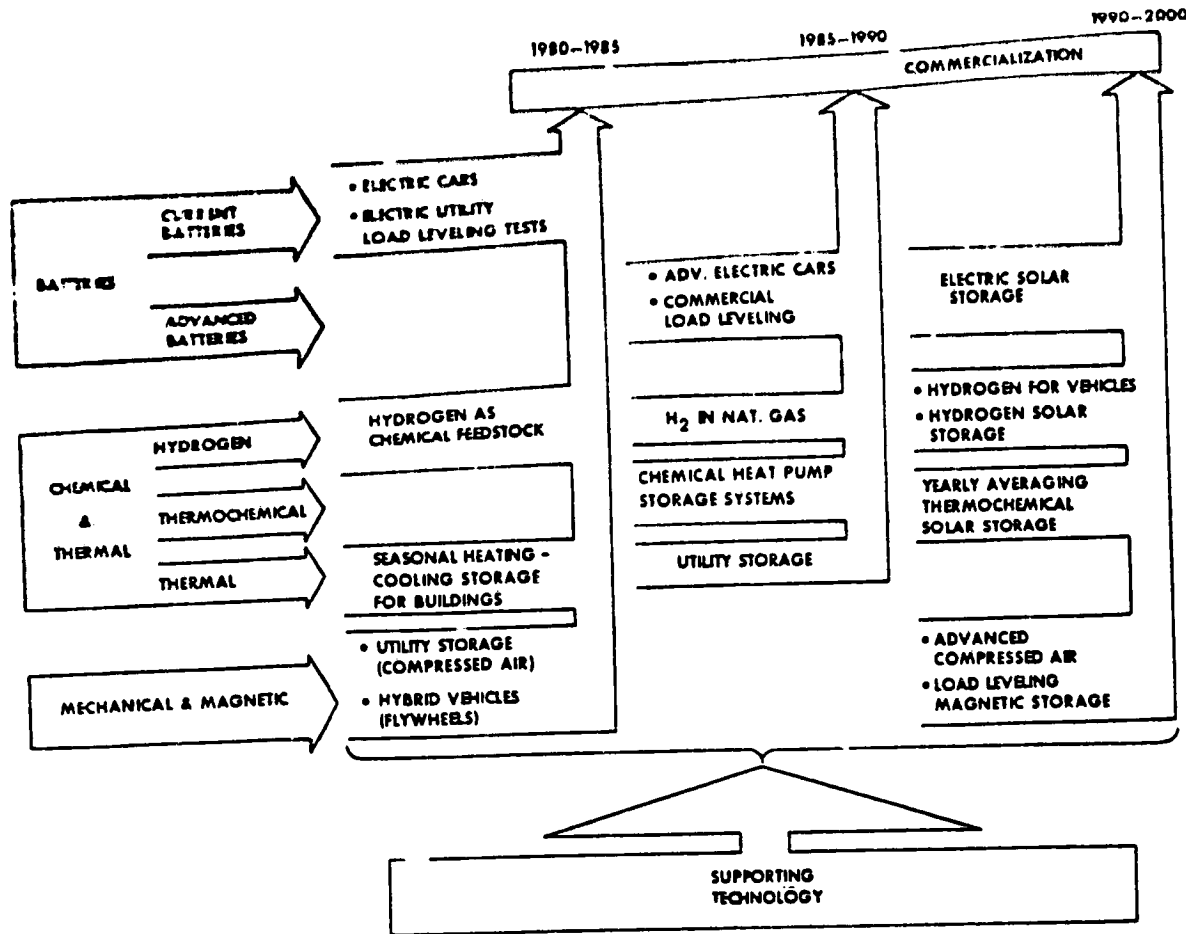

Figure 4. Storage Delivery Strategy Diagram

Technology Options for Energy Storage

Different applications require that different amounts of energy be stored for various duty cycles. A spectrum of technologies is being developed to meet these different needs. As shown in Table 2, some of these technologies are expected to be commercialized within the next decade while others will not be commercially available until the year 2,000 or later.

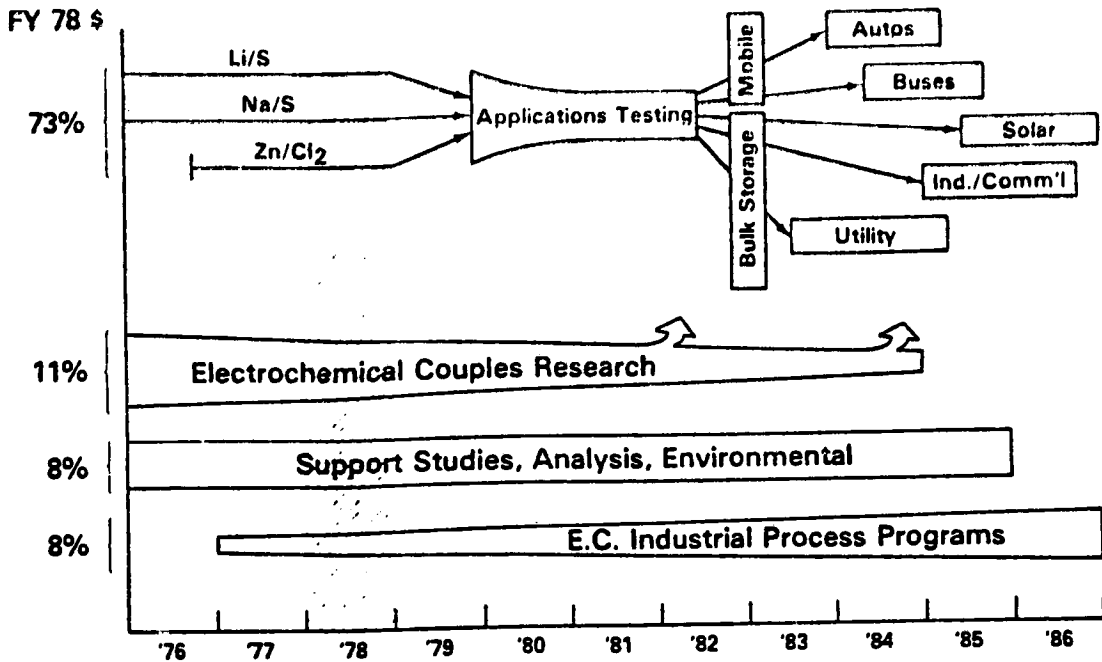

Figure 12. Advanced Battery Program Thrust and Emphasis

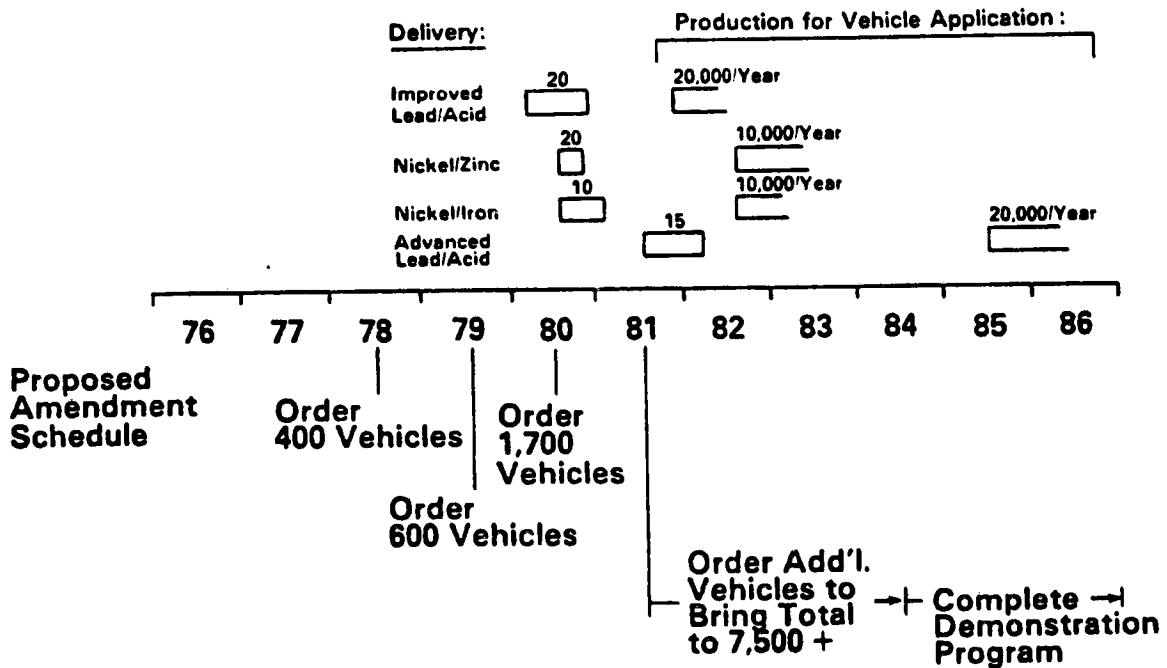

Figure 13. Near Term Battery Program

- Develop and test improved near-term batteries to support vehicle buys legislated by the Electric and Hybrid Vehicle Demonstration Act.
- Start advanced lead/acid battery development for near-term load leveling.

Figure 15 shows the major milestones of the batteries and electrochemical systems subprogram for FY 1978 through FY 1982.

The subprogram is divided into the areas of:

- Near Term Battery Program
- Advanced Batteries in Engineering Development

ACTIVITY/MILESTONE	FY78	FY79	FY80	FY81	FY82	ACTIVITY/MILESTONE	FY78	FY79	FY80	FY81	FY82
Near-Term Batteries (Lead/Acid, Nickel/Iron, Nickel/Zinc) 1. Select contractors for advanced lead-acid battery for load leveling (with EES) 2. Deliver prototype battery for EV (a) 3. Deliver improved prototype battery for EV (b)		△***	△	△	▽	Electrochemical Systems Research 1. Make Go/No-Go decision on redox couples after 2. Select single zinc/bromine contractor for development with EPRI 3. Develop single zinc/bromine battery and test system		△***		⊙	
Advanced Batteries in Engineering Development (Lithium/Metal Sulfide, Sodium/Sulfur, and Zinc/Chlorine) 1. Order Li/MS cells for EV application 2. Begin testing of multi-kW batteries 3. Begin battery tests in vehicles (c) 4. Satisfy cell performance/life requirements for BEST tests 5. Begin BEST facility tests (d) a. Zinc/chlorine b. Sodium/sulfur c. Lithium/metal sulfide	▽	△	△***	⊙	△	Batteries-Solar Applications 1. Conduct Solar-Photovoltaic Battery Workshop 2. Develop Program Plan 3. Conduct system studies 4. Initiate hardware development		▽		▽	
					△	Industrial Electrolytic Processes 1. Issue RFPs 2. Select contractors to survey needs and risks for programs in a. Aluminum production b. Chlorine/caustic production c. Metal winning d. Metal recycling e. Electro-organic synthesis					⊙

KEY.

- △ Begin Milestones
- ▽ End Milestones
- ⊙ GO/NO-GO
- ** Program Controlled Milestone
- *** Division Controlled Milestone
- (a) Five prototypes per system
- (b) Fifteen improved prototypes per system
- (c) Co-managed with Transportation Energy Conservation
- (d) Co-managed with Electrical Energy Systems

Figure 15. Milestone Chart

TABLE 4. STATUS AND GOALS VEHICLE BATTERIES

Battery	Status		Development FY 1978		Year	Goals*	
	Wh/kg	Cycles	Wh/kg	Cycles		Wh/kg	Cycles
<u>Near Term Batteries</u>							
Lead/Acid	30	300	35	300	1980	40-50	600-800
Nickel/Iron	44	1500	50	1500	1980	60	2000
Nickel/Zinc	60	300	70	350	1981	75	800
<u>Advanced Batteries</u>							
Zinc/Chlorine	70	300	80	400	1980	110	1000
Sodium/Sulfur	80	300	100	400	1981	140	1000
Lithium/Metal-Sulfide	80	400	90	500	1981	140	1000

*Goal dates for near term batteries apply to full size vehicle batteries available in quantities required to support the EHV Demonstration Act. Advanced battery goal dates refer to first test module in laboratory.

PAN-10

**STAGES IN DEVELOPMENT OF
LITHIUM/METAL SULFIDE VEHICLE BATTERIES
FULL-SCALE BATTERY PROJECTS**

<u>Stage</u>	<u>Purpose</u>	<u>Demonstration of Goals^a</u>
Mark I	First Test in Vehicle Eagle-Picher	1979
Mark II	Commercially Viable Prototype EP and Gould Phase I Contractors	1981 — 1983
Mark III	High-Performance Commercial Battery	1983 — 1986

^aDate of demonstration is dependent on funding rate.

**OIL SAVED THROUGH THE USE OF BATTERIES
FOR ELECTRIC VEHICLES AND UTILITY LOAD-LEVELING**

PRODUCTION SCHEDULE

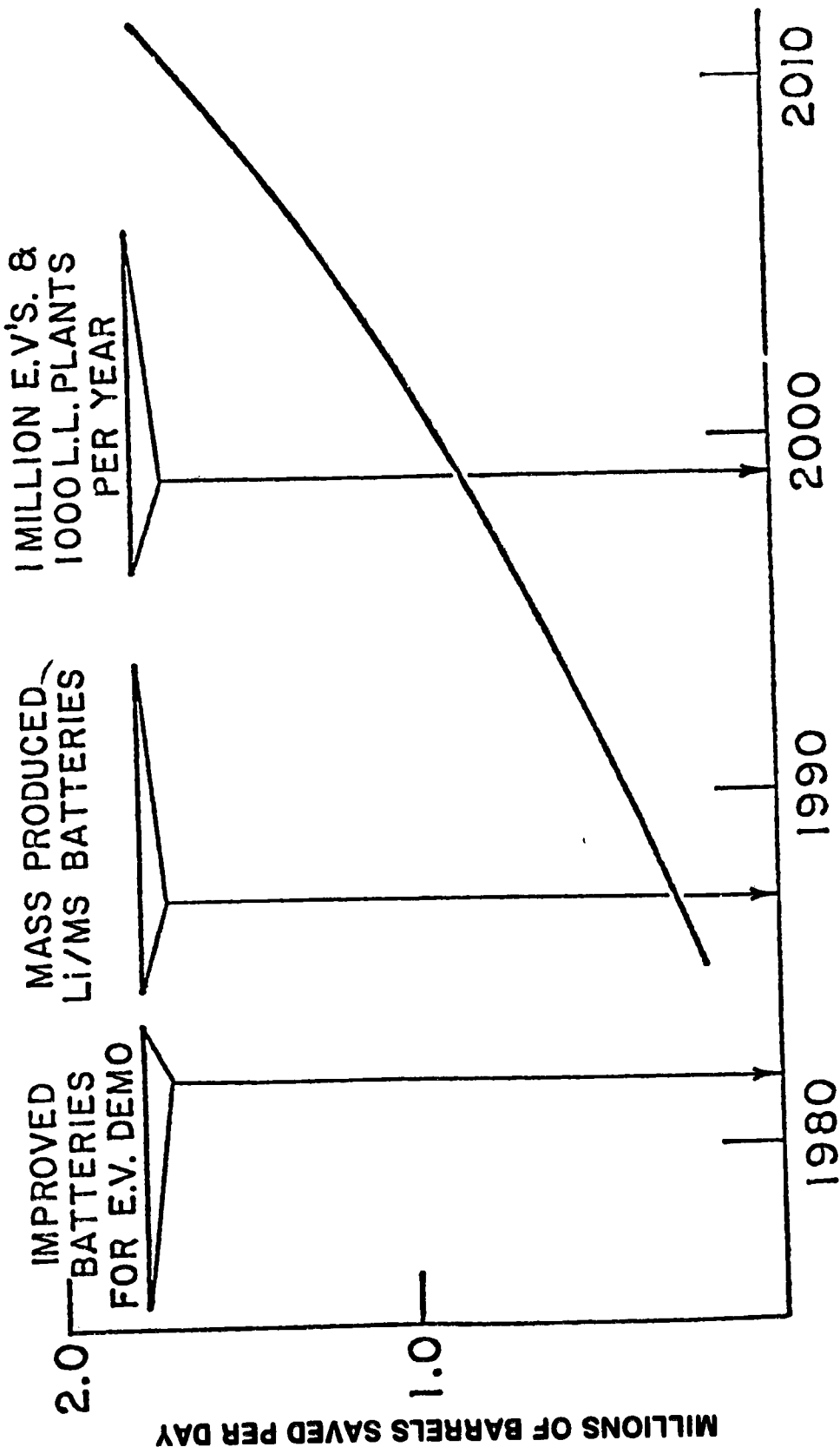

**CUMULATIVE SAVINGS TO YEAR 2020
OIL SAVED 4.7 BILLION bbls
VALUE \$ 92 BILLION**

SUPPLEMENT #2 TO

THE ASSESSMENT OF
BATTERY POWER SOURCES
THE
GE PHASE I HYBRID VEHICLE

PREPARED FOR

GENERAL ELECTRIC COMPANY
CORPORATE RESEARCH AND DEVELOPMENT

P.O. A0200-22067

ESB PROJECT 6047

MARCH 1, 1979

PREPARED BY

E. Pearlman

G. S. Hartman

ESB TECHNOLOGY COMPANY
YARDLEY, PA.

PRECEDING PAGE BLANK NOT FILMED.

SUPPLEMENT 2

NICKEL HYDROGEN BATTERIES

At the GE Phase I Hybrid Vehicle program review on February 20, 1979, Mr. E. Rowland requested an assessment on the nickel hydrogen battery system as applicable to E.V. application

Attached are Supplement #2, pages 2 to 6 describing the Ni-H₂ system.

In addition pages 99 & 100 are reproduced from the paper by Sidney Gross, Energy Conversion, Vol. 15, pp. 95 - 112 (1976) and shown as pages 5 and 6.

None of the information provided in Supplements 1 or 2 modifies the recommendations made in our original report.

SUPPLEMENT 2

NICKEL HYDROGEN BATTERIES

(1) The nickel-hydrogen system has been investigated and used mainly on satellite battery applications. Some have flown successfully on satellites, coupled with charging from solar panels. Their best performance characteristic is the increase in cycle life over Ni-Cd batteries, which suffer capacity losses with cycling due to Cd passivation. The attached material (from Kirk-Othner, Encyclopedia of Chemical Technology, Vol. 3, Third Ed. 1978) gives some of the available data on Ni-H₂ batteries.

(2) Recent work which has been reported by companies such as EIC, HAC and COMSAT indicate certain changes (improvements?) in the technology. Operating pressures have increased to 34-68 atm., in an attempt to increase energy density and discharge rate capability. In addition, common pressure vessels have been experimentally tried. While these improvements have increased both energy density and discharge rate capability, the high H₂ pressures have also resulted in an increased rate of self-discharge. In addition, the common pressure container introduces the problem of capacity rundown caused by parasitic currents. On one test a 4-cell battery was operated at about 30 atm in a common pressure vessel. In 72 hours capacity fell from 8.8 Ahr to 5.6 Ahr, while pressure fell from 400 psig to 300 psig. This loss corresponds to a rate of over 10% per day.

(3) The use of the Ni-H₂ system in EV applications is not indicated at this time because of these important limitations:

- 3.1 Pressure Vessel Construction - Present technology requires that each cell of the battery, or at best sections of several cells, be contained in pressure vessels holding up to 1000 psig of hydrogen. This in itself is so dangerous that it alone probably eliminates the system from consideration.
- 3.2 Cost Considerations - The battery has all of the inherent costs of satellite type sealed, sintered, nickel cadmium batteries, plus the additional costs of high pressure battery containers, and the use of platinum doped electrodes for hydrogen recombination.
- 3.3 Electrical performance - Charged stand losses are too high for most EV applications, and in addition there is a question about maximum specific power available. Most data presented does not indicate discharge rates greater than C/2.

(4) The possibility exists for hydrogen storage utilizing surface adsorption or chemical hydrides. There is some work going on in this area, but none has reached the level of cell or battery demonstration. If there is to be a Ni-H₂ EV battery this could be the only way to solve the high pressure storage problem.

Nickel-Hydrogen Cells. In the mid 1970s nickel-hydrogen cells were developed in the United States (79) and in Europe to overcome some of the problems associated with deep cycle nickel-cadmium, long-life cells for space satellite use. The memory effect (80) of the cadmium electrode was eliminated and gravimetric energy density improved. The overall electrochemical reaction is simple:

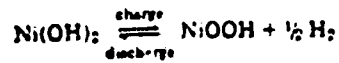

However, the generation and migration of water in the half-cell reactions must be considered in the cell design.

At the nickel electrode:

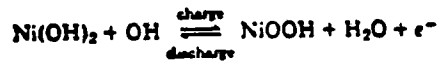

At the hydrogen electrode:

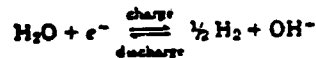

Hydrogen is present in the gaseous state, and the cells operate at a much higher pressure range 304–2030 kPa (3–20 atm) than Ni-Cd cells 0–304 kPa (0–3 atm). Cells are designed as pressure vessels and are cylindrical in shape with hemispherical caps. Electric terminals are made with ceramic-to-metal seals in the end caps. A cutaway view of a typical construction is shown in Figure 14.

The positive electrodes are of a conventional sintered type. The hydrogen reacting (negative) electrode usually consists of a Teflon-bonded platinum black layer and a porous Teflon layer pressed into a fine mesh nickel screen.

Typical voltage performance discharge curves are given in Figure 15.



Figure 14. Cutaway view of a typical construction of a nickel-hydrogen cell.

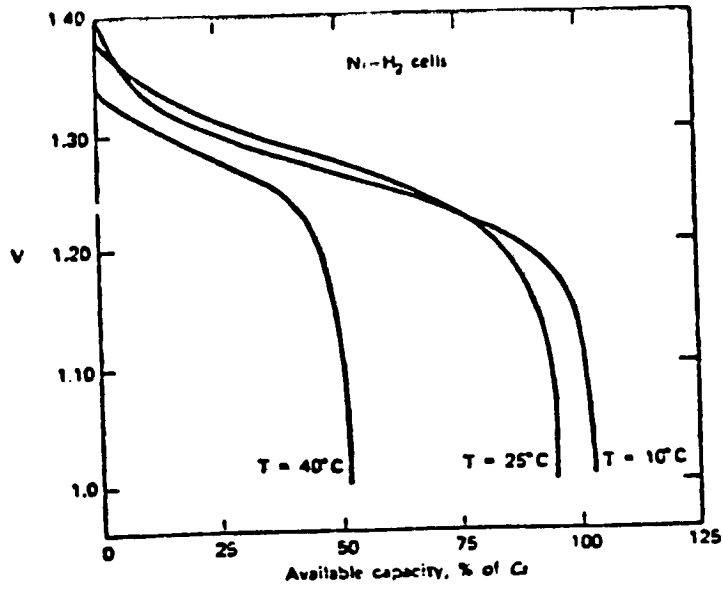

Figure 15. Typical voltage performance discharge curves of a nickel-hydrogen cell. Discharge rate, $C/2$ h; Charge rate, $C/5$ h; C_0 = capacity at $C/5$ h and 20°C ; C = capacity.

Nickel-hydrogen battery

The nickel-hydrogen system has an open circuit potential of 1.358 V and a theoretical energy density of 177 W hr/lb. This is a recently developed system [53-66] but the technology is advancing rapidly because the nickel electrode is well developed from nickel-cadmium battery technology, and the hydrogen electrode is well developed from hydrogen-oxygen fuel cell technology. The Teflonated hydrogen electrode negative functions best with platinum catalyst, but nickel is satisfactory for electric vehicle applications, and is used in Russian designs [65]. Both electrodes are known to be long-lived, so very long operating lifetimes are expected with this system. An energy density of 25 W hr/lb has been achieved on prototype cells, and design studies show up to 40 W hr/lb should be attainable. Power density of 40 W/lb has been realized, and could be increased to 200 W/lb on an optimized design.

20 $\frac{W}{lb}$

A nickel-hydrogen battery consists of a series stack of nickel and hydrogen electrodes installed inside a pressure vessel filled with hydrogen gas. The electrodes are separated by gas diffusion screens, but the hydrogen gas need not be isolated from the nickel electrodes since they will not react chemically. The battery operates positive-limited, and is completely sealed. Figure 7 shows a typical battery module design [64]. Except for the pressure vessel, no costly materials are used. Typical operating characteristics of a single cell are shown in Fig. 8 and are

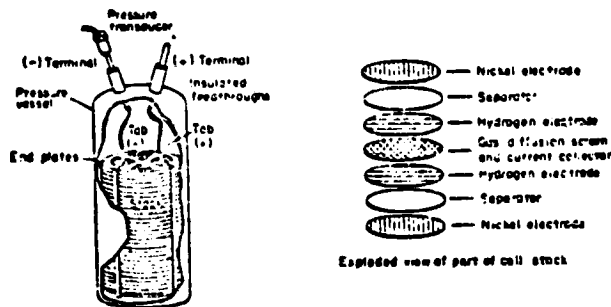
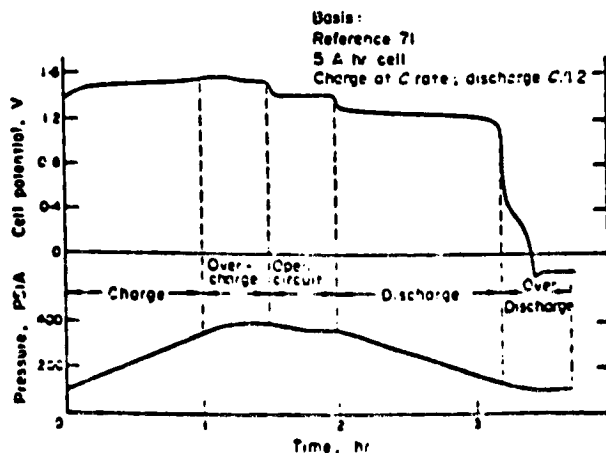

Fig. 7. Typical nickel-hydrogen battery design.



2-68

SIDNEY GROSS

seen to be comparable to nickel cadmium cell performance.

An important attribute of the nickel-hydrogen system is that it is inherently protected against damage by reversal, permitting the full capacity of the battery to be used. Hydrogen pressure drops to approx. 100 psi during continuous reversal. Also significant is the ability of the system to tolerate overcharge without ill effect, though suitable means of heat removal must be provided. Hydrogen pressure increases to a maximum of 400-500 psi during continuous overcharge.

The major disadvantage of the nickel-hydrogen system is the need for a pressure vessel to contain the hydrogen, which comprises a significant share of the battery weight. Structural safety factors will have to be relatively high for commercial applications, limiting the overall energy density. For example, it is calculated [66] that a 1000 W battery for traction applications would deliver 35 W hr/lb with a titanium pressure vessel, or 30 W hr/lb with an Inconel pressure vessel. Even with the lower value, this is quite attractive for electric vehicles in view of the good electrical performance and expected long life.

A possible improvement to the nickel-hydrogen battery would be development of a satisfactory means of storing hydrogen in solids. Metal hydrides are able to store hydrogen even more compactly than liquid hydrogen. Using this principle, an electrochemically reversible hydrogen electrode has been developed in which the hydrogen is stored on interstitial sites of a metal lattice, using Ti_2Ni and $TiNi$ intermetallic phases [67]. The electrode is capable of very high energy density, and conceivably could eliminate or minimize the need for a pressure vessel with the nickel-hydrogen battery.

PULSED TESTS OF LEAD-ACID BATTERIES
ESB Technology Corporation
June 1979

PRECEDING PAGE BLANK NOT FILLED

Battery: PV-23
Pulse Current: 300 A

<u>Ah out at Beginning of Pulse</u>	<u>% of Ah at 60 A</u>	<u>Voltage During Pulse(*)</u>	<u>Volts at 60 A After Pulse</u>	<u>Wh out After Pulse</u>
12.1	7.1	5.400/5.365	6.000	73
31.4	18.5	5.360/5.330	5.950	188
44.8 [†]	26.3	5.285/5.255	—	267
46.1 [†]	27.1	5.325/5.265	—	274
47.4 [†]	27.9	5.355/5.265	5.890	281
67.1	39.5	5.190/5.190	5.835	396
80.7	47.5	5.115/5.115	5.775	474
100.2 [†]	58.9	5.030/4.970	—	586
101.4 [†]	59.7	5.045/4.985	—	592
102.7 [†]	60.0	5.010/4.250	—	598
110.2	64.8		5.675	640

(*)15 s pulse; a/b : a-voltage at 1 s, b-voltage at 15 s

[†]Pulses repeated with open circuit pause between each one

Battery: PV-23
Pulse Current: 400 A

<u>Ah out at Beginning Pulse</u>	<u>% of Ah at 60 A</u>	<u>Voltage During Pulse*</u>	<u>Volts at 60 A After Pulse</u>	<u>Wh out After Pulse</u>
12.0	7.1	5.175/5.145	6.060	73
31.9	18.8	5.140/5.110	6.010	192
45.9 [†]	27.0	5.065	5.955	273
47.6 [†]	28.0	5.110/5.050	--	282
49.3 [†]	29.0	5.110/5.045	5.895	291
69.4	40.8	4.970/4.940	5.845	407
83.3	49.0	4.885/4.855	5.770	487
103.1 [†]	60.6	4.710/4.675	--	600
104.9 [†]	61.7	4.76 /4.670	--	608
106.5 [†]	62.6	4.700/4.640	--	616
114.3	67.2		5.675	659

*15 s pulse; a/b : a-voltage at 1 s, b-voltage at 15 s

[†]Pulses repeated with open circuit pause between each one

Battery: PV-23
Pulse Current: 400 A

<u>Ah out at Beginning Pulse</u>	<u>% of Ah at 60 A</u>	<u>Voltage During Pulse*</u>	<u>Volts at 60 A After Pulse</u>	<u>Wh out After Pulse</u>
12.1	7.1	4.985/4.955	6.045	73
32.2	18.9	4.910/4.880	6.015	192
46.5†	27.4	4.810/4.780	--	276
48.7†	28.6	4.875/4.755	--	286
50.8†	29.9	4.895/4.740	5.905	296
71.1	41.8	4.660/4.615	5.815	413
85.2	50.1	4.575/4.515	5.765	493
105.0†	61.8	4.395/4.32	--	608
107.6†	63.3	4.405/4.285	--	617
109.7†	64.5	4.395/4.245	5.670	626
118.0	69.4		5.670	669

*15 s pulse; a/b : a-voltage at 1 s, b-voltage at 15 s

†Pulses repeated with open circuit pause between each one

Battery: EV-106
Pulse Current: 400 A

<u>Ah out at Beginning Pulse</u>	<u>% of Ah at 60 A</u>	<u>Voltage During Pulse*</u>	<u>Volts at 60 A After Pulse</u>	<u>Wh out After Pulse</u>
11.9	8.8	5.07	6.025	73
31.6	23.4	5.00	5.960	189
45.4†	33.6	4.97/4.92	--	270
47.0†	34.8	4.95/4.92	--	278
48.8†	36.1	4.92/4.89	5.890	286
68.4	50.7	4.77/4.74	5.790	400
82.2	60.8	4.62/4.56	5.700	478
101.9†	75.5	4.30/4.18	--	588
103.6†	76.7	4.29/4.11	--	595
105.2†	77.9	4.22/4.05	5.520	602
112.9	83.6		5.485	642

*15 s pulse; a/b : a-voltage at 1 s, b-voltage at 15 s

†Pulses repeated with open circuit pause between each one

Battery: EV-106
Pulse Current: 300 A

<u>Ah out at Beginning of Pulse</u>	<u>% of Ah at 60 A</u>	<u>Voltage During Pulse*</u>	<u>Volts at 60 A After Pulse</u>	<u>Wh out After Pulse</u>
12.0	8.8	5.375	6.045	74
31.5	23.3	5.350/5.32	5.995	189
44.8 [†]	33.2	5.310/5.280	--	269
46.1 [†]	34.1	5.300/5.280	--	276
47.4 [†]	35.0	5.300/5.270	5.920	283
66.7	49.4	5.190/5.160	5.870	396
79.9	59.2	5.09	5.810	472
99.2 [†]	73.5	4.955/4.925	--	--
100.6 [†]	74.5	4.960/4.900	--	--
101.8 [†]	75.4	4.935/4.875	5.675	596
109.0	80.7		5.675	637

*15 s pulse; a/b : a-voltage at 1 s, b-voltage at 15 s

[†]Pulses repeated with open circuit pause between each one

Battery: EV-106
Pulse Current: 500 A

<u>Ah out at Beginning Pulse</u>	<u>% of Ah at 60 A</u>	<u>Voltage During Phase*</u>	<u>Volts at 60 A After Pulse</u>	<u>Wh out After Pulse</u>
12.0	8.8	4.785	6.020	72
32.4	24.0	4.720/4.690	5.965	192
46.5†	34.4	4.650/4.620	--	--
48.6†	36.0	4.640/4.580	--	--
50.7†	37.5	4.610/4.550	5.875	293
70.8	52.4	4.440/4.385	5.765	408
84.9	62.3	4.290/4.200	5.695	487
105.3	78.0	3.985/3.955	--	600

*15 s pulse; a/b : a-voltage at 1 s, b-voltage at 15 s

†Pulses repeated with open circuit pause between each one

Note:

The following graphs were prepared by Dr. A.F. Burke, General Electric Corporate Research and Development. They are included in the Assessment of Battery Power Sources for completeness.

ALL INFORMATION CONTAINED HEREIN IS UNCLASSIFIED

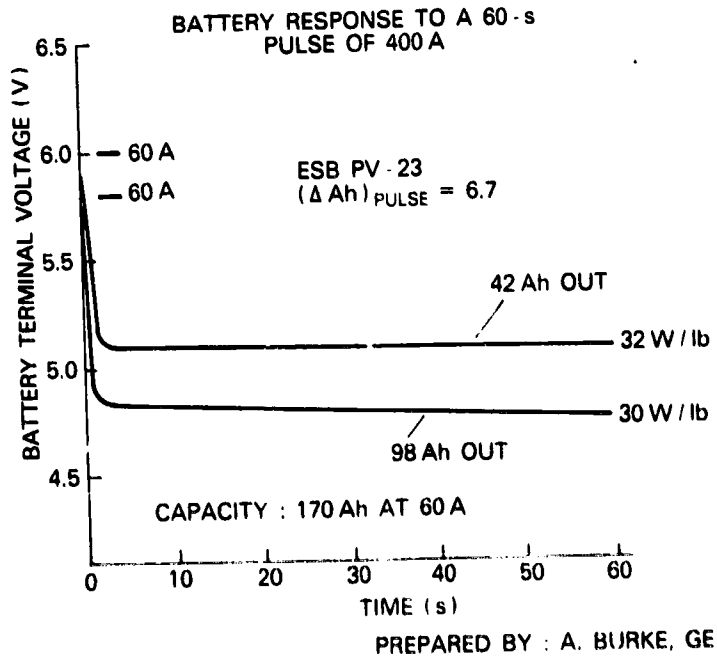
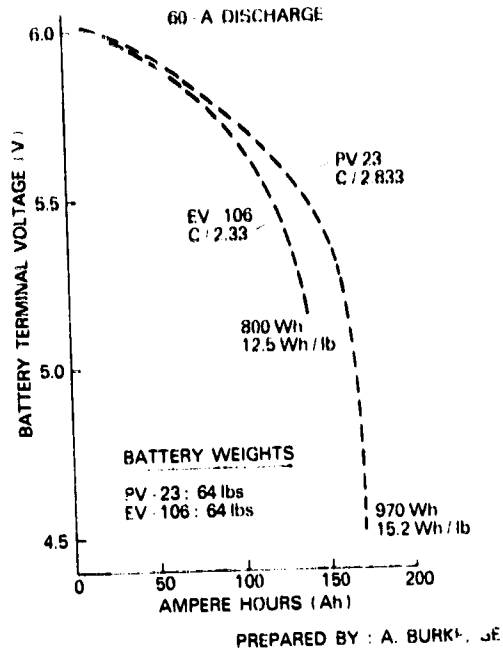

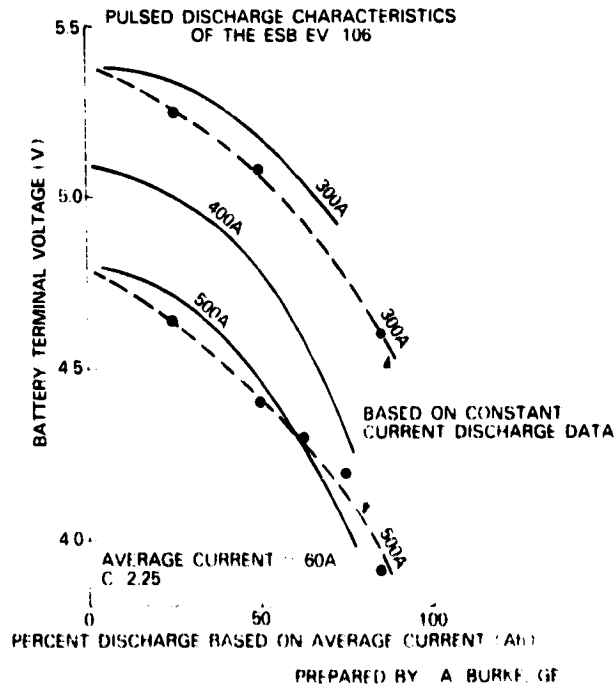
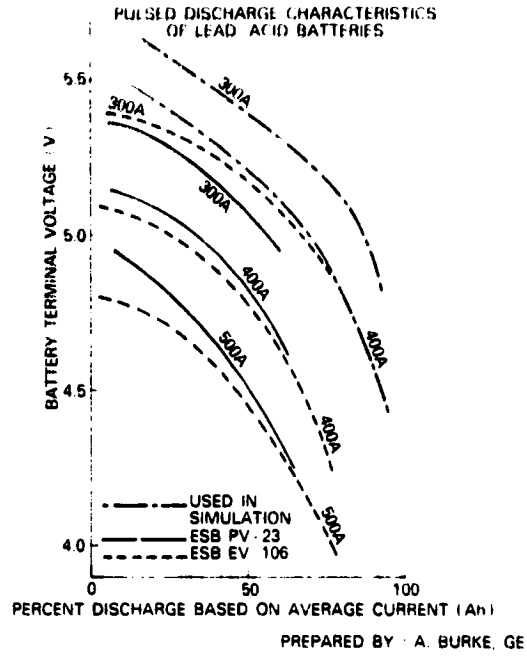

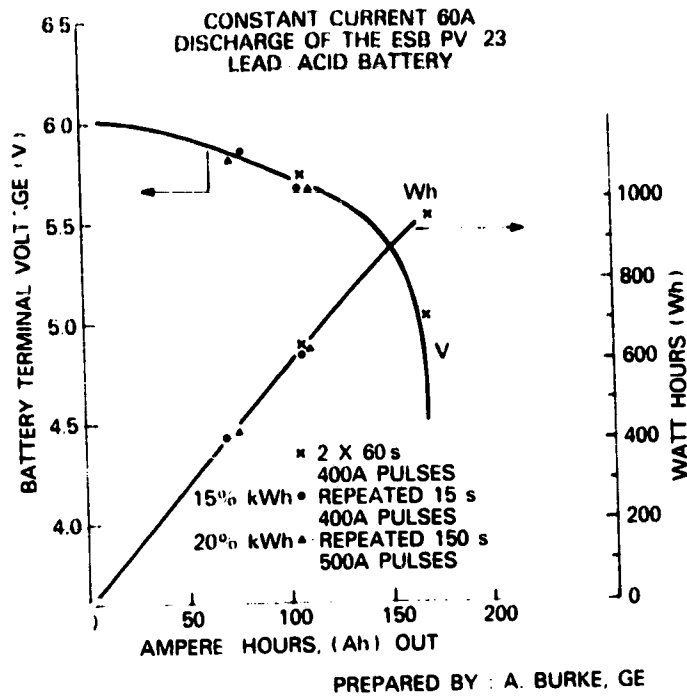

**DISCHARGE CHARACTERISTIC OF THE
ESB EV 105 AT 60A**

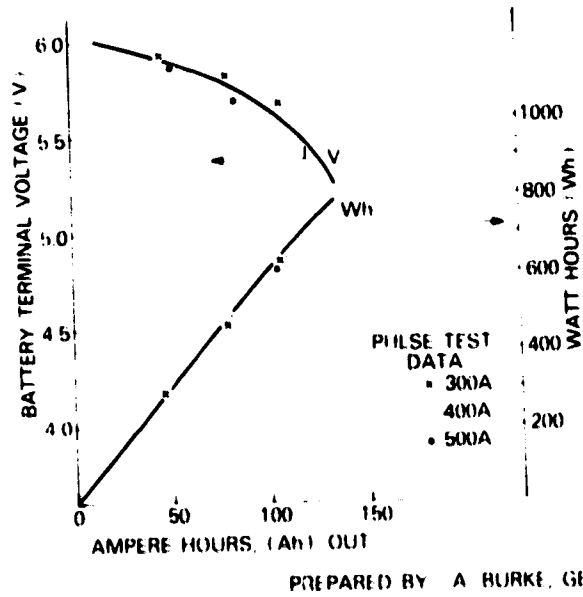

Section 3
VEHICLE TECHNOLOGY

WORK STATEMENT

Triad Services, Incorporated
32049 Howard Street
Madison Heights, MI 48071

INTRODUCTION

Contract NO. 955190 between California Institute of Technology Jet Propulsion Laboratory and General Electric Company covers a program entitled "Phase I of the Near-Term Hybrid Passenger Vehicle Development Program" under which studies shall be conducted leading to a preliminary design of a hybrid passenger vehicle that is projected to have the maximum potential for reducing petroleum consumption in the near-term (commencing in 1985). Effort under Contract 955190 is being conducted pursuant to an Interagency Agreement between the Department of Energy (DOE) and the National Aeronautics and Space Administration (NASA) and in furtherance of work under Prime Contract NAS7-100 between NASA and the California Institute of Technology. This work statement covers vehicle technology under General Electric Purchase Order A02000-220147.

SCOPE OF WORK

In support of General Electric Corporate Research and Development's work under Contract 955190, the Subcontractor shall furnish the necessary personnel, materials, services, facilities, and otherwise do all things necessary for or incident to the performance of the following tasks.

1. Provision of the following with respect to the Reference Conventional ICE vehicle.
 - Consultation to assist in its selection
 - Weight and cost information on key components
 - Performance information on auxiliaries, such as power steering, power brakes, air conditioning, lighting and electrical accessories, heating and ventilating
2. Consultation on selection of preferred passenger compartment heating procedure for hybrid vehicle considering such approaches as:
 - Waste heat from the engine
 - Thermal energy storage
 - Auxiliary burner
3. Consultation on air conditioning for the hybrid vehicle, especially methods of taking advantage of the reduced input speed variation for the hybrid as compared with the conventional ICE vehicle.

4. Trade-off studies of power assist systems (power steering and power brakes) to determine the preferred approach and performance for the hybrid vehicle.
5. Consultation and recommendations on specification of tire drag aerodynamic drag and aerodynamic frontal area for both:
 - The conventional ICE vehicle
 - AND
 - The hybrid vehicles
6. Recommended weight and/or power scaling factors to be applied in building up the hybrid vehicle around the seating package of the reference conventional ICE vehicle.
7. Packaging studies of various hybrid configurations, using the reference ICE vehicle as a base, including styling consideration.
8. Layouts of the vehicle embodying the preferred hybrid configuration.
9. Vehicle Dynamics - For the preferred configuration, identification of dynamic design requirements and analysis as required to assure adequate performance in the following areas:
 - Handling - both linear and nonlinear ranges
 - Brake system, including consideration of regenerative braking and front vs. rear wheel braking regeneratively
10. Structural Considerations - For the preferred configuration, analysis as required to assure adequate performance in the following areas:
 - Local stresses and overall stiffness
 - Vehicle structural crashworthiness (Occupant protection will be assumed to be adequate, based upon reference conventional ICE occupant protection, if vehicle is crashworthy)
11. Safety - Identification of applicable NHTSA and FMVSS safety recommendations and requirements and definition of design approaches which will satisfy those requirements, together with rationale thereof.
12. Cost - Consultation on estimating production costs of major elements of the hybrid vehicle structure and auxiliaries.

NOTE WITH RESPECT TO SUBCONTRACTOR'S DATA

It is understood that all data in the Subcontractor's reports, furnished by the Subcontractor to General Electric Corporate Research and Development hereunder, may be furnished to the California Institute of Technology Jet Propulsion Laboratory and the Department of Energy and the National Aeronautics and Space Agency with no restrictions.

DEVELOPMENT OF WEIGHT PROPAGATION FACTORS

I PURPOSE

The purpose of this study was to develop a set of equations which would predict with some accuracy the gross vehicle weight of proposed hybrid vehicles for the purposes of trade-off analysis.

II METHOD

Detail weight breakdowns for thirteen different vehicles were analyzed to attempt to establish relationships between vehicle gross weight, number of passengers, engine size, and wheel-base and certain component weights. Algebraic functions were derived for these relationships utilizing the least squares technique.

Vehicle weights were divided into 29 categories for the purpose of analyzing the data. Weights of each category for the 13 vehicles, where data formats allowed, were studied in order to determine if functional relationships existed between the weights and the independent parameters stated earlier.

III VEHICLES STUDIED

The 13 vehicles studied and their gross weights are listed below:

VEHICLE	GVW
. Dasher 4-Dr	2923
. Fiat 124	2786
. Fiat 128	2610
. Subaru DL	2410
. Chevette	2781
. Oldsmobile F-83 (1972)	4460
. Chevrolet Corvette	3711
. Chevrolet Vega	3097
. Ford Pinto	3276
. Chevrolet Chevelle (1975)	4443
. Chevrolet Camaro (1974)	4287
. Volkswagen Rabbit	2583
. Buick Regal (1978)	4034

IV DEFINITIONS:

W_c = Vehicle curb wt-lbs.
 W_g = Vehicle gross wt-lbs.
 P = Number of vehicle passengers

- L = Vehicle wheelbase - inches
- F = Fuel system capacity - gallons
- D = Engine displacement - cubic inches

V RESULTS

The following relationships have been developed for the various vehicle elements.

A Gross Vehicle Weight Related Elements.

SYSTEM	RELATIONSHIP
Structural	$.0437 Wg + .0000356 Wg^2$
Bumpers	$.00147Wg + .0000101 Wg^2$
Suspension	$.02526Wg + .00000736Wg^2$
Wheels & Tires	20 + $.04666Wg$
Brakes	9.2+ $.02368 Wg$
Tools	$.00281 Wg$
<hr/>	
TOTAL	29.2+ $.14358 W + 5.3 W^2 \times 10^{-5}$

B Engine Displacement Related Items.

Engine & Transmission (including fluids)	290 + $.91D$
Exhaust System	9 + $.19D$
Cooling System	24 + $.08D$
<hr/>	
TOTAL	323 + $1.18D$

C Number of Passenger Related.

Seats & Related	23.2P
-----------------	-------

D Wheelbase Related. (not glass)

Skins 1.4L

E Fuel Capacity Related.

Fuel System (inc. evap.
emission control) 1.53F

F Insensitive Components.

Certain items are relatively insensitive to any of the variables considered in the context of this program. These items deal primarily with human factors (ie elements designed to tolerate loads supplied by the driver).

Those items which will be considered fixed in weight are listed below:

Doors (4 Dr) & Deck	174.0	
Exterior Trim	4.5	
Instrument Panel	20.0	
Interior Trim	60.0	
W/S Wipers	7.6	
Fixed Glass	48.0	(windshield plus rear window)
Park Brake	5.1	
Brake Actuation	5.3	
Brake Hydraulics	15.8	
Controls	9.8	
Power Strg.Gear	30.6	
Steering Linkage	19.8	
Strg.Col. & Wheel	16.6	
Hydraulics	14.7	
Acc. Electrical	59.5	
Heater	15.5	
Restraint SYstem	31.8	
Air Conditioner	<u>126.0</u>	

TOTAL 664.6 lbs

G Summary

Totalling all of these functions, a relationship can be written for the curb weight of a vehicle.

$$Wc = 1017 + .144 Wg + 5.3 \times 10^{-5} Wg^2 + 1.18D + 27.2P + 1.4L + 1.53F$$

Substituting $W_g = W_c + \text{payload}$

and $K = 1017 + \text{payload}$

where: Payload = luggage + passenger load

+ max fuel load + battery load + motor wt.

+ control weight

and $K_1 = K + 1.18D + 23.2P + 1.4L + 1.53F$

then: $6.3 \times 10^{-5} W_g^2 + .856 W_g + K_1 = 0$

Solving for W_g

$$W_g = \frac{.856 - \sqrt{.733 - (21.2 \times 10^{-5}) K_1}}{10.6 \times 10^{-5}}$$

As a check, substituting the appropriate values for the reference vehicle.

$$\begin{aligned} K &= 1017 + 750(\text{pass}) + 200(\text{lugg.}) + 108(\text{fuel}) \\ &= 2075 \end{aligned}$$

$$\begin{aligned} K_1 &= K + 1.18(200) + 23.2(5) + 1.4(108.1) + 1.53(18.1) \\ &= 2607 \end{aligned}$$

$$W_g = 4069$$

$$W_c (\text{calculated}) = 4069 - 1058 = 3011 \text{ pounds}$$

which compares with an actual curb weight of 3084 pounds.

VI PROJECTIONS OF FUTURE PRODUCTION VEHICLE WEIGHTS.

As a result of some conversations with knowledgeable people within the automobile industry, it was the consensus of opinion that a reduction in vehicle weight by 1985 will not exceed 10% to 12% for the same sized vehicle compared to 1979 vehicles. This weight reduction will come from basic re-design of components with the use of more specialized parts (less commonality across vehicle lines) rather than by the substitution of other materials for any fundamental parts.

The reasons for not shifting to aluminum or plastic components

in lieu of steel are:

- 1) Cost effectiveness [\$1.00 + per pound penalty].
- 2) Requirement for significant investment in tooling and equipment.
- 3) Inadequate supply of aluminum or resin products to meet potential automotive requirements.

VEHICLE DRAG PROJECTIONS

For the purposes of the trade-off analysis, some reasonable drag estimate must be made for the proposed hybrid vehicle. The three basic elements of the total vehicle drag which will be considered are the aerodynamic drag, tire hystereses losses, and the tire rolling resistance and chassis losses.

A Aerodynamic Drag.

Vehicle frontal area and drag coefficient must both be established in order to determine the total aerodynamic drag.

The frontal area is really a function of the seating package selected. Utilizing the 1979 Chevrolet Malibu seating arrangement, a frontal area of 21 square feet is a reasonable estimate.

As demonstrated by the full sized wind tunnel tests of the GE Centennial 100 vehicle, it is apparent that a drag coefficient of the order of .33 is possible. This value must be tempered by two factors. First, the fact that the hybrid vehicle will require some heat exchanger for its internal combustion engine will increase the drag by approximately 6% to .35. Second, the aerodynamic performance of the vehicle in yaw must be considered since the vehicle will never operate in a zero wind condition. Making the assumption that a 10 mph wind is typical, and that the average speed of the vehicle is about 40 miles per hour, a yaw angle range of $\pm 15^\circ$ would seem reasonable.

During scale wind tunnel tests of the GE Centennial in December of 1975, the effect of yaw angle was determined to be an increase of 11% on the drag coefficient. For the purposes of calculation, therefore, drag coefficient of .39 should be used.

B Speed Influences on Tire Rolling Losses.

Based on data from a report entitled "Tire Rolling Loss Measurements" written by Calspan Corporation under contract to the DOT, the influence of vehicle speed on tire losses was determined to be

$$F = .00003 WV$$

where F = Drag force - pounds
W = Weight - pounds
V = Speed - mph

C Tire Rolling Losses.

Tire rolling losses for radial ply tires in equilibrium operating conditions are known to be of the order of .011 pounds per pound at their rated load. However, the effect of warm-up is significant and can account for variations of up to 50% in tire rolling loss from "cold" to "warm" tires. Figure 1 is a plot of trip length verses rolling resistance illustrating this effect. This factor should be included in the trade-off analysis with the value selected based on the mission profile.

D Total Vehicle Drag.

Summing the effects outlined above, the expressions for the drag of the hybrid vehicle in the equilibrium condition [warm tires] can be written:

$$\begin{aligned} F &= .011 W + .00003 WV + (.00249) (AC_D) v^2 \\ &= .011 W + .00003 WV + .02 v^2 \end{aligned}$$

where

W = vehicle wt. (pounds)
V = vehicle speed (mph)

E Effective Vehicle Weight.

The weight of the vehicle must be increased effectively for acceleration calculations to account for the rotating inertia of the wheels and tires. This amounts to approximately 70% of the wheel and tire weight. Utilizing the factors developed in section I, the weight of the vehicle must be increased by (.028) (Wg) for the purposes of acceleration calculations.

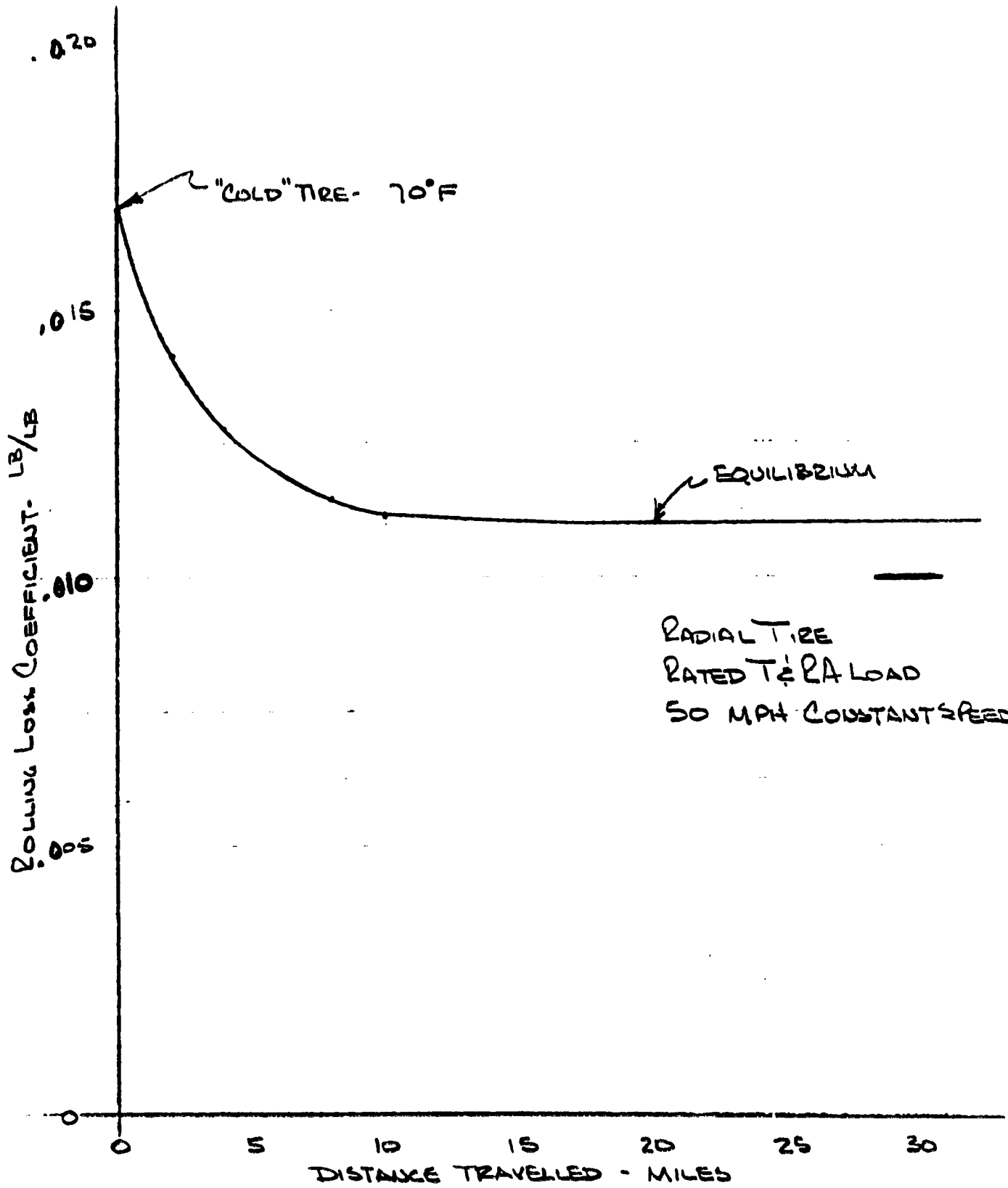

3-12

INFLUENCE OF DISTANCE TRAVELLED ON TIRE DEGR.

FIG. 1

HEATER AND AIR CONDITIONER PERFORMANCE

In order to provide "equivalent value" in the hybrid vehicle relative to the reference vehicle, the heater and air conditioning systems should have the same or similar performance. Tests were conducted on a 1979 Malibu 4-door sedan with 200 cubic inch 6 cylinder engine to establish these performance levels. The vehicle was instrumented with thermocouples and air flow measuring apparatus in order to measure the heat transfer to the passenger compartment.

HEATER PERFORMANCE

After an overnight soak at ambient temperatures of between 5 and 11 degrees F., the reference vehicle was started and driven at 20 mph with the heater blower on maximum. Air temperatures across the heater core and blower air flow were measured as a function of time. "Breath level" interior compartment temperatures were also monitored in order to place some measure on the vehicle warm-up time. Figure 1, illustrates the breath level temperature as a function of time, and the heat transfer to the compartment as a function of time.

AIR CONDITIONER PERFORMANCE

Similar instrumentation to the heater tests was used to measure the heat transfer from the air across the evaporator. Figure 2 illustrates the "pull down" capability of the system as a function of time after a hot soak. The engine was at idle and the vehicle not in motion. Figure 3 shows the heat transfer from the air across the evaporator for the air conditioning system while operating at its maximum capacity.

HEATING REQ'MTS. 1979 MALIBU

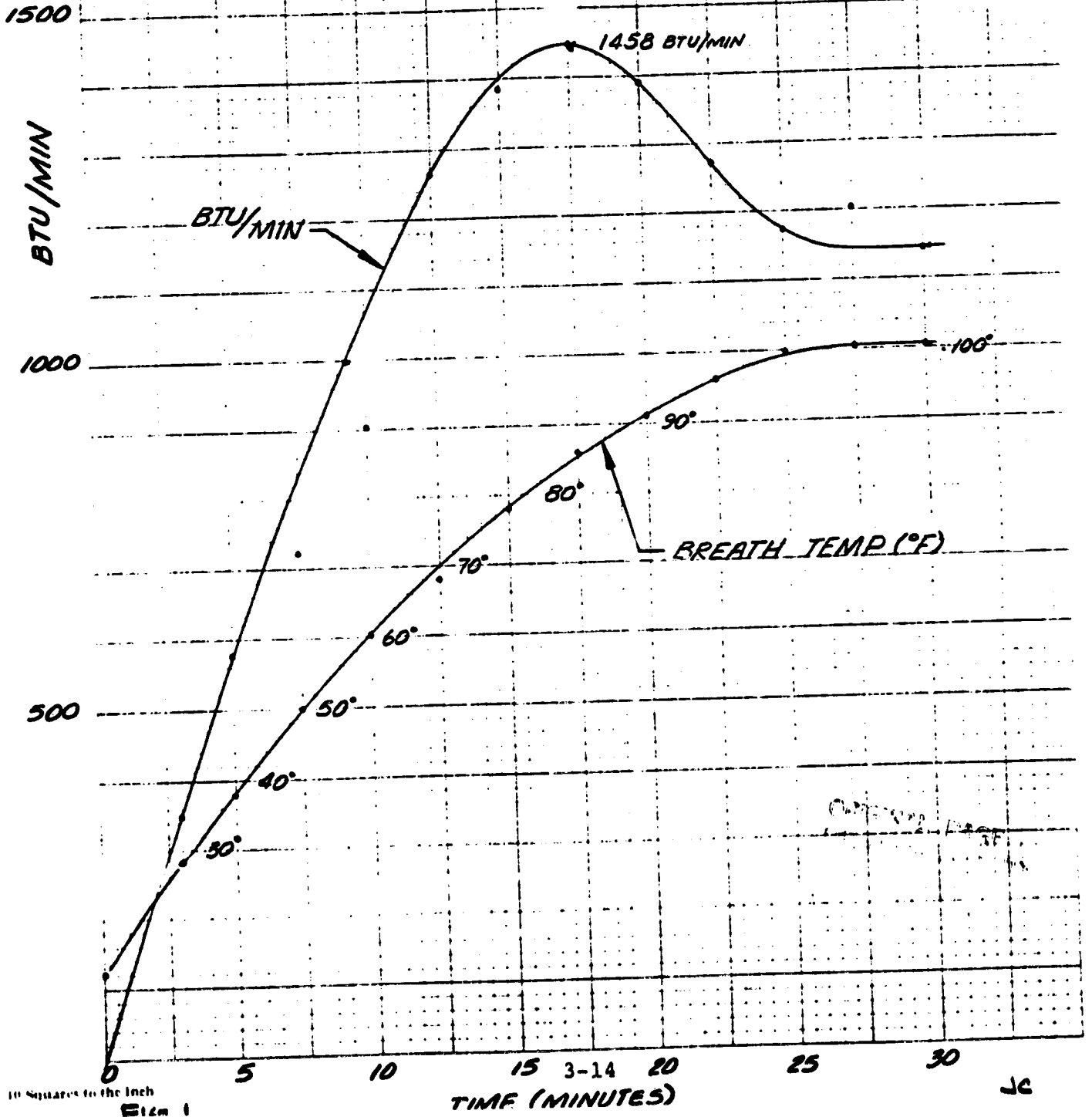

10 Squares to the Inch
E12m 1

AIR CONDITIONER PULL-DOWN PERFORMANCE
1979 MALIBU
100°F O.A.T. - RECIRC. MODE

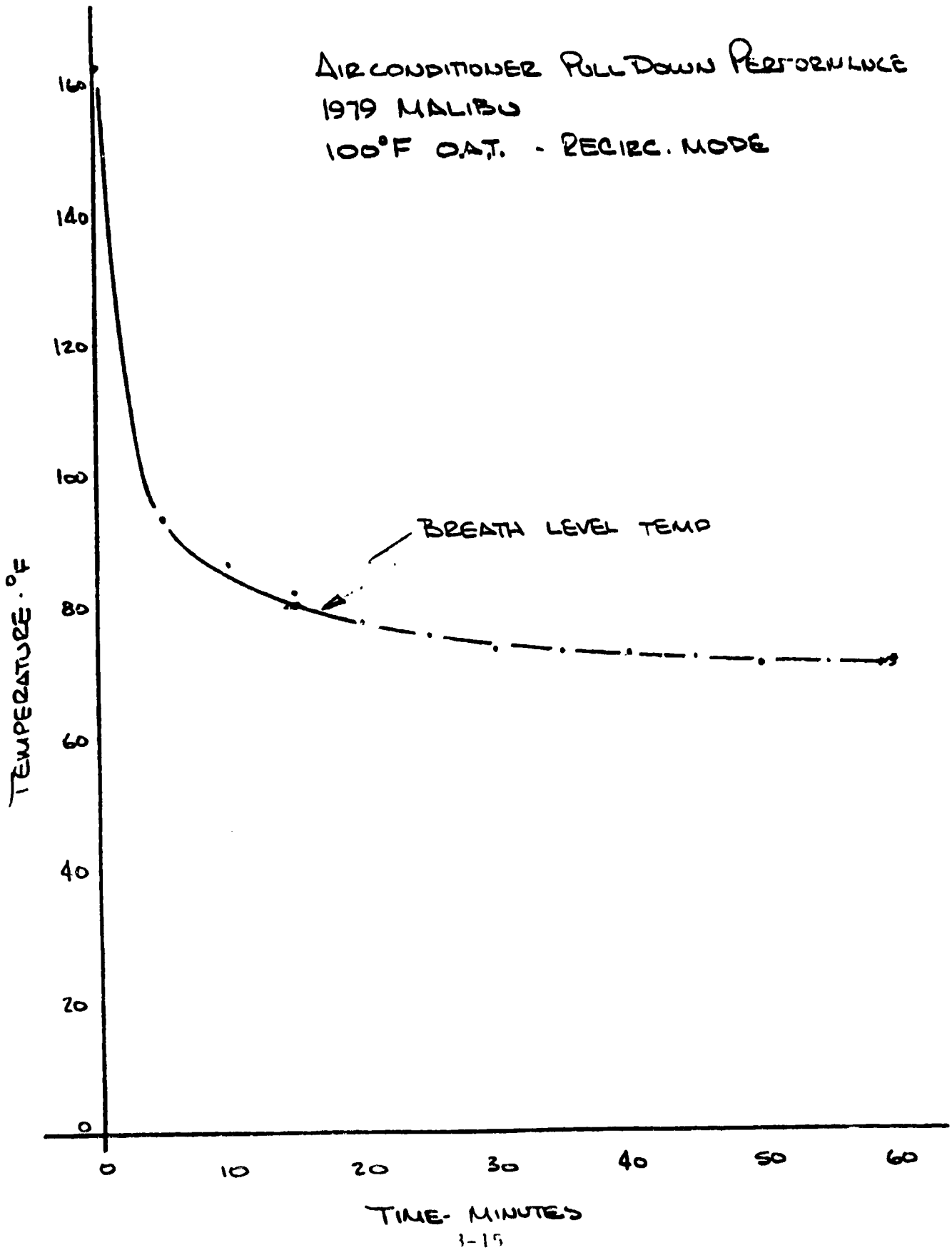

AIR CONDITIONER PERFORMANCE
1979 MALIBU

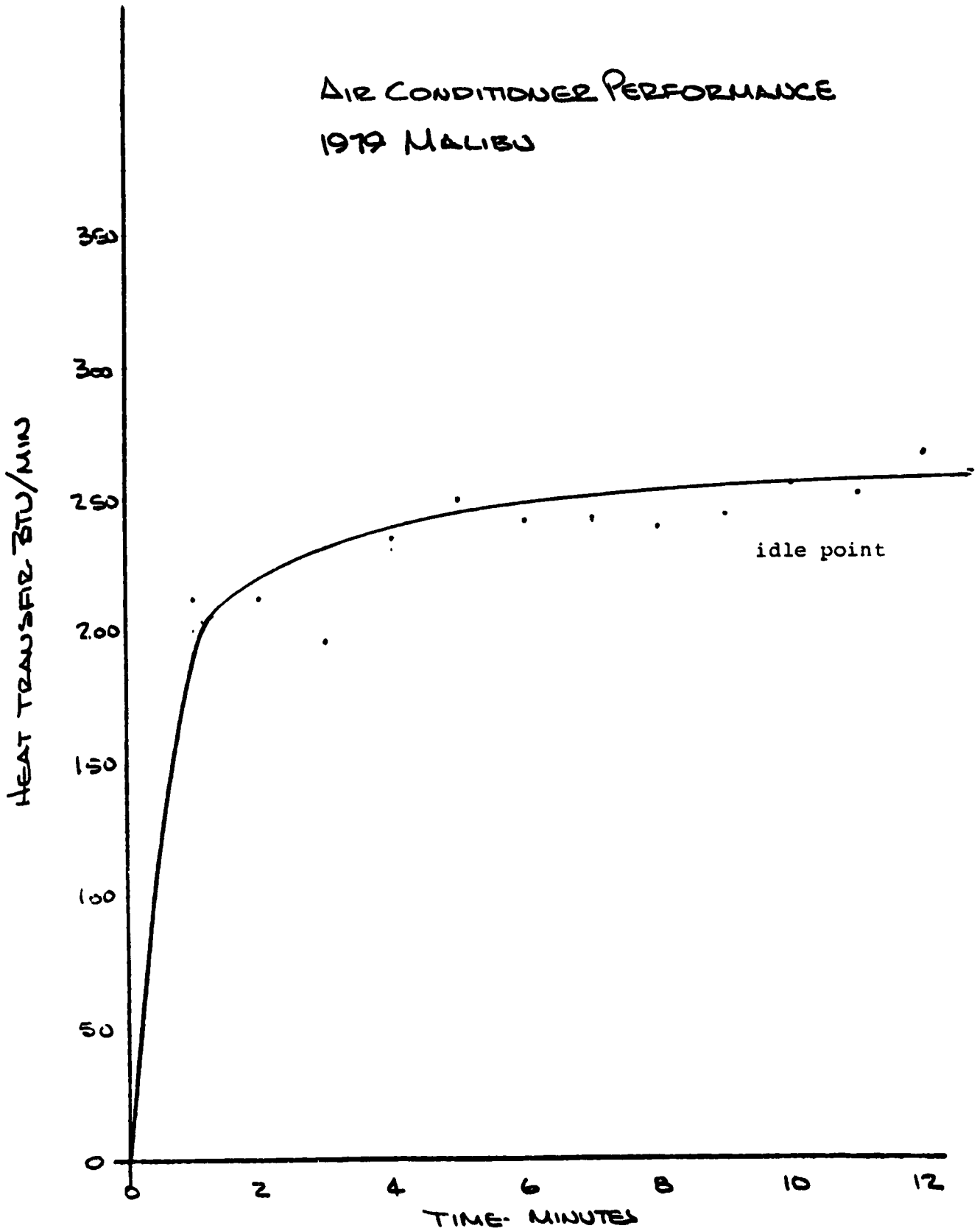

3-16

FIG 3

1-17-79
IND

A/C TEMPERATURE DROP

1-17-79

Time (Min.)	Thermocouple Lead (°F)				Inches		
	1	2	3	6	Pitot Tube	Static Tube	Diff.
Start	67	66	67	71	3.74	3.74	0
1	70	61	45	58	4.64	2.85	1.79
2	71	60	45	55	4.64	2.85	1.79
3	70	58	44	54	4.62	2.88	1.74
4	70	57	39	52	4.62	2.92	1.70
5	70	57	38	52	4.62	2.92	1.70
6	71	56	38	51	4.62	2.92	1.70
7	70	56	37	50	4.60	2.94	1.66
8	70	55	37	49	4.58	2.96	1.62
9	71	55	36	49	4.58	2.95	1.63
10	70	55	35	48	4.58	2.97	1.61
11	70	55	36	48	4.59	2.98	1.61
12	71	55	34	48	4.58	2.98	1.60
13	69	55	38	48	4.58	2.98	1.60
14	73	55	39	48	4.58	2.98	1.60
15	72	54	38	48	4.58	2.98	1.60

Thermocouple Lead

Location

- | | |
|---|-------------------------|
| 1 | Outside Air |
| 2 | Air to A/C Core |
| 3 | Air From A/C Core |
| 6 | Passenger Compt. Breath |

HEATING TEMPERATURE RISE

1-17-79

Time (Min.)	Thermocouple Lead (°F)						Inches		
	1	2	3	4	5	6	Pitot Tube	Static Tube	Diff.
Start	12	24	11	13	12	11	3.43	3.43	0
3	13	28	18	52	73	18	3.80	3.14	.66
5	13	38	25	78	99	30	3.84	3.11	.73
7 1/2	11	50	42	107	130	56	3.86	3.07	.79
10	13	60	49	129	154	85	3.90	3.04	.86
12 1/2	10	68	42	146	172	106	3.95	2.98	.97
15	12	78	50	159	187	121	4.00	2.92	1.08
17 1/2	12	86	53	167	193	170*	4.01	2.91	1.10
20	13	91	58	166	192	184	4.02	2.89	1.13
22 1/2	12	96	68	167	192	188	4.03	2.88	1.15
25	14	100	76	167	192	182	4.04	2.87	1.17
27 1/2	12	103	76	168	193	185	4.05	2.85	1.20
30	12	106	80	167	192	186	4.06	2.84	1.22

Thermocouple Lead

1
2
3
4
5
6

Location

Outside Air
Passenger Compt. Breath
Air to Heater Core
Air from Heater Core
Heater Core Water Temp.
Radiator Water Temp.

*Rise is Rapid

ACCESSORY POWER REQUIREMENTS

Accessory power requirements for the hybrid vehicle were derived from measurements on the reference vehicle. Power requirements for the air conditioner, the alternator, and the power steering pump were determined by measurements made on a Chevrolet Malibu using a strain gauged crankshaft pulley. The results of these tests follow.

A Air Conditioner Power Requirements. (Drive Ratio* 1.4:1)

Figure 1 is a plot of compressor horsepower as a function of compressor speed. The compressor is operating at its maximum load. The ratio of compressor speed to vehicle speed is 50.4 rpm/mph.

B Alternator Power Requirements. (Drive Ratio 3.1:1)

Figure 2 is a plot of alternator power requirements as a function of speed and charging current. The ratio of alternator speed to car speed is 111.6 rpm/mph.

C Power Steering Power Requirements. (Drive Ratio 1.2:1)

Figure 3 is a plot of road load power steering pump requirements with zero steering effort applied. In addition to these losses, which are essentially parasitic, there is an additional requirement for parking and high speed maneuvers. Figure 3 also presents the instantaneous power required by the power steering pump for maximum performance.

Although these power levels are high, they represent instantaneous values. Tests run on simulated city and highway driving cycles yield more realistic power steering system power requirements for the purposes of range calculations.

Losses on the city driving cycle are approximately .75 horsepower while the highway driving cycle will drop these values to about .65 horsepower on the average.

*Ratio to engine speed

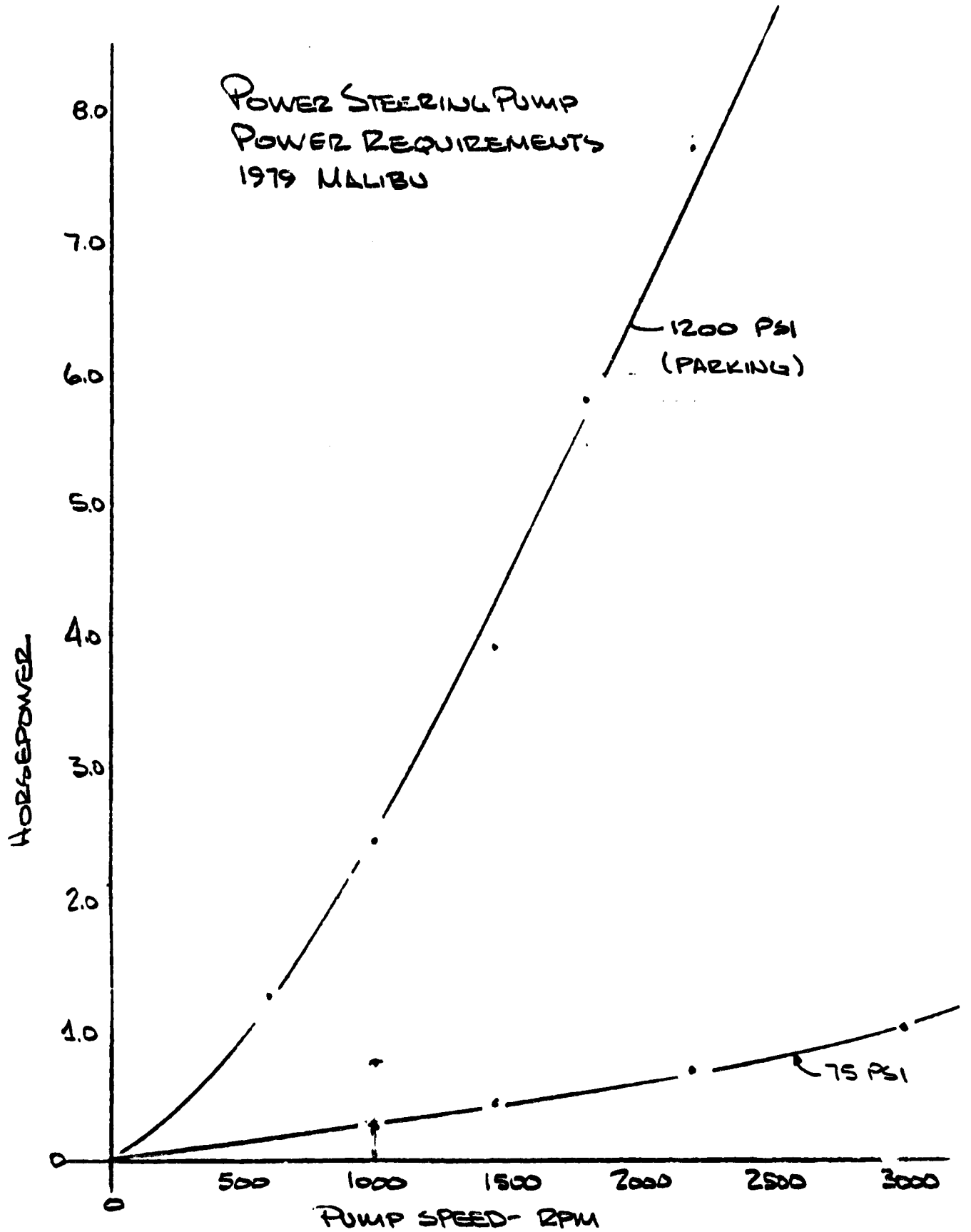

3-20

FIG 3

1-17-79
MAP

ALTERNATOR POWER REQUIREMENTS DELCO TRON - 1979 MALIBU

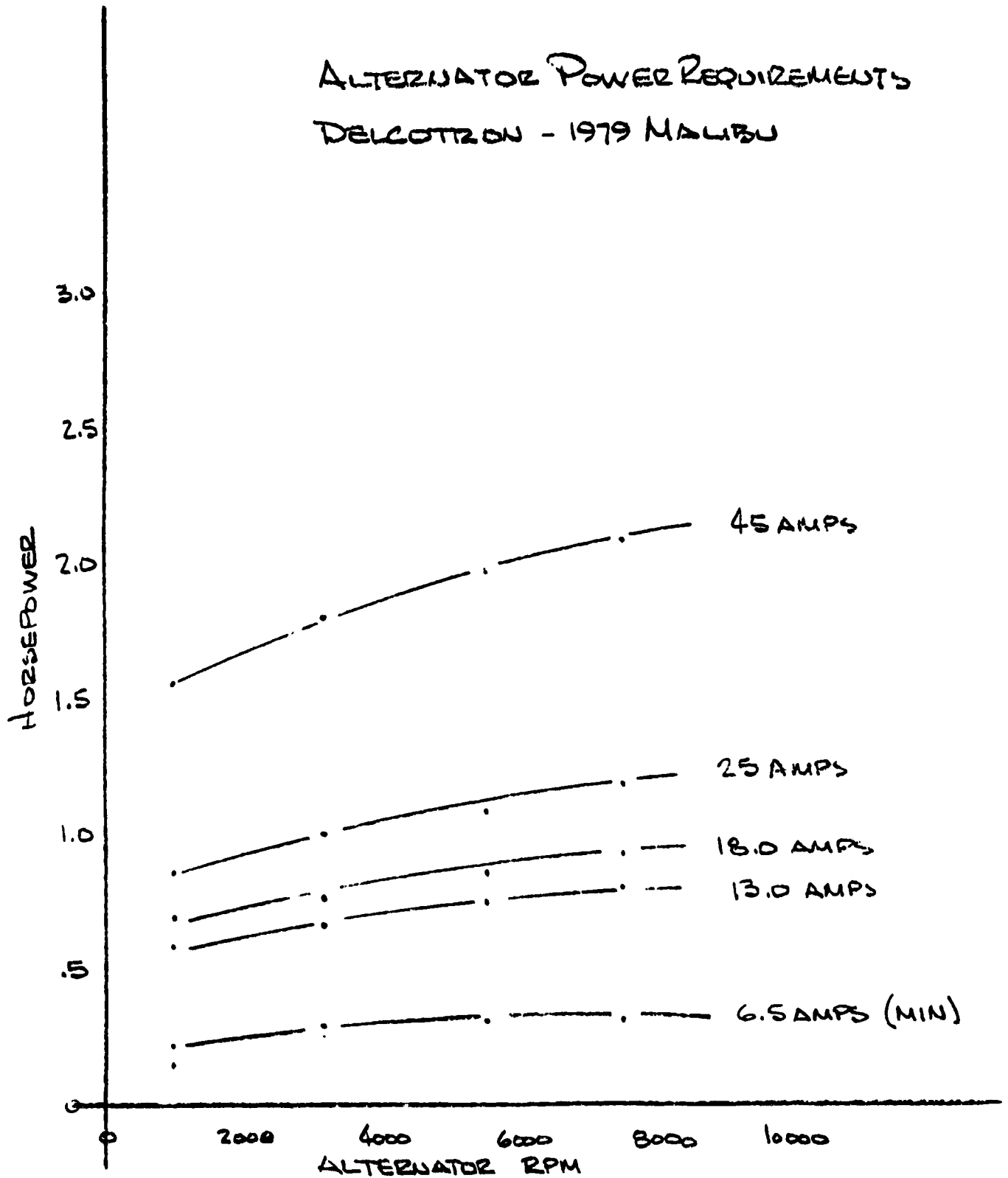

3-21

FIG 2

1-15-79
MAP

AIR CONDITIONING COMPRESSOR POWER REQUIREMENTS

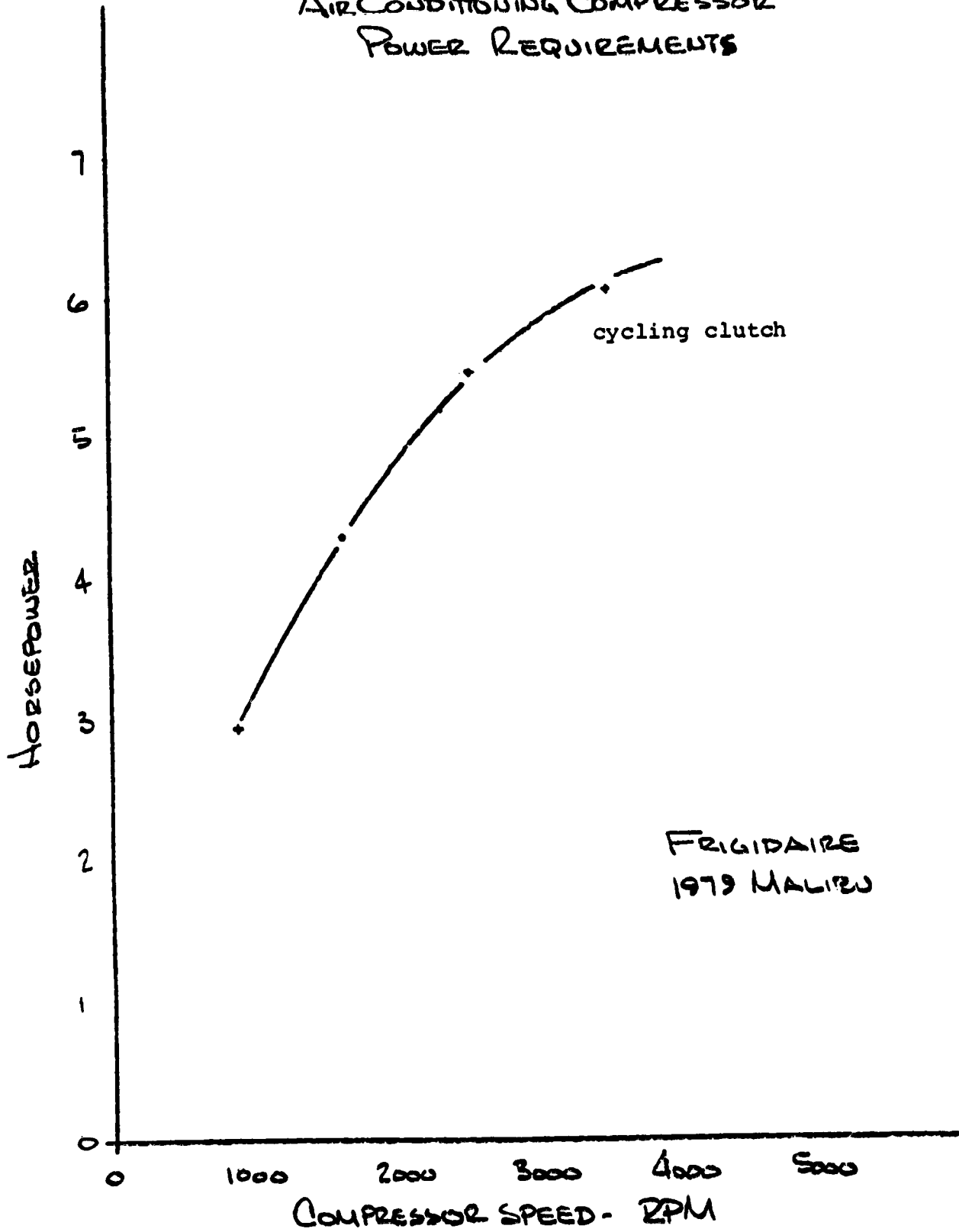

3-22

FIG 1

1-15-79
MAP



RECEIVED
FEB 1 1979
A. F. BURKE

TRIAD SERVICES INC. • 32049 HOWARD ST. • MADISON HEIGHTS, MICH. 48071 • 313/589-2355

February 6, 1979

Dr. A. F. Burke
General Electric Company
Corporate Research and Development
Building 37 - Room 2078
P.O. Box 43
Schenectady, New York 12301

Dear Andy:

The following chart summarizes the results of the accessory power system tests run on a 1979 Malibu vehicle.

<u>Accessory</u>	<u>Power Requirements (Watts)</u>
Parking Lights	101
Low Beam Headlights	203
High Beam Headlights	254
Turn Signals (avg.)	84
Hazard Lights (avg.)	179
Interior Lights	45
Windshield Wipers	
dry - low speed	98
wet - low speed	90
dry - high speed	83
wet - high speed	70
Ventilation Fan	
low speed	32
2nd speed	73
3rd speed	112
high speed	159
Rear Window De-fogger	231
Radio	10
Cigarette Lighter	62
Horn	25
Engine Ignition System	25
Air Conditioner Clutch	44

The regulated charging system voltage on a charged battery was 14.6 volts D.C.

We are continuing with our preliminary packaging studies. I hope to have some drawings available when I see you on the 21st.

Very truly yours,

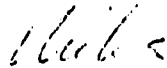

Michael A. Pocobello

MAP/np

cc: R. H. Guess

WEIGHT ANALYSIS FOR TRADE-OFF STUDIES

ASSUMPTIONS

- . 4 DOOR SEDAN
- . 1979 MALIBU SEATING PACKAGE
- . POWER STEERING STANDARD
- . POWER BRAKES STANDARD
- . AIR CONDITIONING STANDARD

WEIGHT RELATIONSHIP

$$W_G = \frac{.856 - \sqrt{.733 - (21.2 \times 10^{-5})K1}}{10.6 \times 10^{-5}}$$

WHERE

$$K1 = K + 1.18D + 23.2P + 1.4L + 1.53F$$

AND

$$K = 1017 + \text{LUGGAGE} + \text{PASSENGER LOAD} + \\ \text{MAX. FUEL LOAD} + \text{BATTERY LOAD} \\ + \text{MOTOR WEIGHT} + \text{CONTROL WEIGHT}$$

D = ENGINE DISPLACEMENT (CU. IN.)

P = NUMBER OF PASSENGERS

L = WHEELBASE (INCHES)

F = FUEL CAPACITY (GALLONS)

TOTAL VEHICLE DRAG

$$F = .011 w + .00003 wv + .02v^2$$

WHERE W = TEST WEIGHT (POUNDS)

V = VEHICLE SPEED (MPH)

ASSUMPTIONS

- . 1979 MALIBU FRONTAL AREA (21 FT²)
- . YAW WEIGHTED DRAG COEFFICIENT OF .39
- . "WARM" RADIAL PLY TIRES

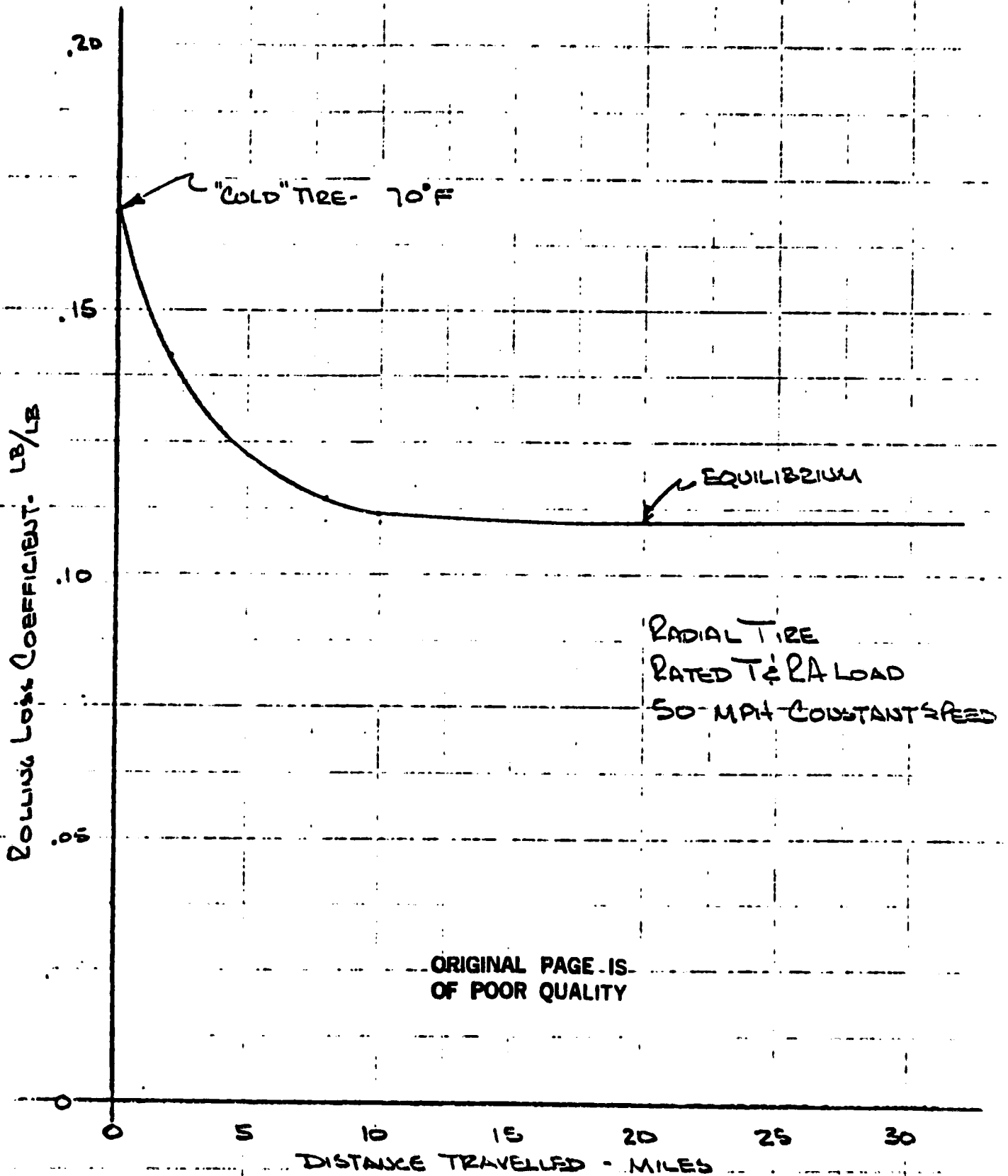

ORIGINAL PAGE IS
OF POOR QUALITY

3-28

INFLUENCE OF DISTANCE TRAVELLED ON TIRE DRAG

Fig. 1

AUXILIARY POWER REQUIREMENTS

<u>Accessory</u>	<u>Power Requirements (Watts)</u>
Parking Lights	101
Low Beam Headlights	203
High Beam Headlights	254
Turn Signals (avg.)	84
Hazard Lights (avg.)	179
Interior Lights	45
Windshield Wipers	
dry - low speed	98
wet - low speed	90
dry - high speed	83
wet - high speed	70
Ventilation Fan	
low speed	32
2nd speed	73
3rd speed	112
high speed	159
Rear Window De-fogger	231
Radio	10
Cigarette Lighter	62
Horn	25
Engine Ignition System	25
Air Conditioner Clutch	44

ACCESSORY POWER SYSTEMS

SYSTEMS

- . POWER STEERING
- . POWER BRAKES
- . AIR CONDITIONER
- . LIGHTING
- . HEATER & DEFROSTER
- . WINDSHIELD WIPING
- . TRANSMISSION CLUTCHING
- . COMFORT & CONVENIENCE ITEMS

CONVENTIONAL ACCESSORY POWER SYSTEMS

SYSTEM	POWER SOURCE
POWER STEERING	OPEN CENTERED HYDRAULIC
POWER BRAKES	ENGINE MANIFOLD VACUUM BOOSTED
AIR CONDITIONER	VAPOR-COMPRESSION-ENGINE DRIVEN
LIGHTING	ALTERNATOR (14.6V)
HEATER & DEFROSTING	WASTE HEAT AND ALTERNATOR
WINDSHIELD WIPING	ALTERNATOR
TRANSMISSION CLUTCHING	OPEN CENTERED HYDRAULIC
COMFORT & CONVENIENCE	ALTERNATOR
ENGINE STARTING	ACCESSORY BATTERY

HEATER/DEFROSTER

- WASTE ENGINE AND MOTOR HEAT
- AUXILIARY BURNER
- STORED HEAT (MOULTEN SALT?)
- HEAT PUMP AUGMENTED BY WASTE HEAT

POWER BRAKE SYSTEMS

- OPEN-CENTER HYDRAULIC BOOSTER
- CLOSED-CENTER HYDRAULICALLY BOOSTED WITH CHARGING VALVE
- CLOSED-CENTER HYDRAULICALLY BOOSTED WITH VARIABLE DISPLACEMENT PUMP
- MANUAL DRUM BRAKES/REGEN TO ZERO SPEED

POWER STEERING SYSTEMS

- OPEN-CENTERED HYDRAULIC SYSTEM
- CLOSED-CENTER HYDRAULIC SYSTEM WITH CHARGING VALVE
- CLOSED-CENTER HYDRAULIC SYSTEM WITH VARIABLE DISPLACEMENT PUMP

ACCESSORY ELECTRICAL SYSTEMS

- SEPARATE ALTERNATOR DRIVEN FROM PRIME MOVERS
- ALTERNATOR INTEGRAL WITH DRIVE MOTOR
- DC/DC CONVERTER
- HIGH VOLTAGE ACCESSORIES - POWERED FROM MAIN BATTERY PACK

TRANSMISSION CLUTCHING

OPEN CENTERED HYDRAULIC

- . DRIVELINE INTEGRAL
- . ACCESSORY PACKAGE

CLOSED-CENTER HYDRAULIC

ELECTRO-MAGNETIC

ENGINE STARTING SYSTEMS

- LOW VOLTAGE SYSTEM/SMALL MOTOR/
CRUDE GEARSET. INTENDED FOR
INFREQUENT USE.
- HIGH VOLTAGE SYSTEM/LUBRICATED GEARSET/
HIGH MOTOR RATING FOR FREQUENT USE
- DRIVE MOTOR STARTS ENGINE THROUGH DRIVE-
LINE (VEHICLE MUST BE IN MOTION)
- DRIVE MOTOR STARTS ENGINE INDEPENDENT
OF VEHICLE DRIVE

POSSIBLE SYSTEM ALTERNATES

- . HEAT ENGINE IDLING
 - . ACCESSORIES DRIVEN BY HEAT ENGINE
 - . HEATER AND A/C CONVENTIONAL
 - . ENGINE STARTING CONVENTIONAL
 - . ACCELERATION RESPONSE BETTER

- . ELECTRIC MOTOR IDLING
 - . NO ARMATURE ELECTRONICS
 - . OVER-RUNNING CLUTCH ACCESSORY DRIVE
 - . DRIVE MOTOR STARTS ENGINE
 - . HEATER ?

- . NEITHER PRIME MOVER IDLING
 - . SEPARATE ACCESSORY DRIVE MOTOR?
 - . SEPARATE ENGINE STARTING MOTOR?
 - . HEATER AND AC?
 - . STORAGE FOR POWER STEERING AND TRANSMISSION SHIFTING
 - . ACCESSORY POWER SOURCE?

PACKAGING CONSIDERATIONS - MAJOR SYSTEMS

- (1) SEATING PACKAGE - 1979 MALIBU - 4 DOOR
- (2) ENGINE - 4 CYL (70-80 HP)
- (3) LEAD ACID BATTERIES (700 POUNDS)
- (4) ELECTRIC MOTOR - (GE 2364)
- (5) 4 SPEED AUTOMATIC TRANSMISSION
- (6) 12 GALLON FUEL TANK
- (7) PARALLEL HYBRID WITH DIFFERENTIAL
DRIVELINE INPUT
- (8) CATALYTIC CONVERTER FOR EMISSION CONTROL

BASIC INTERIOR DIMENSIONS-REFERENCE VEHICLE

Front Compartment

		DEGREES	IN	MM
W20	Centerline Occupant to Centerline Car		14.48	368
H61	Effective Headroom		38.70	983
L64	Maximum Effective Leg Room		42.75	1086
H30	H Point to Heel Hard (chair height)		8.97	228
L40	Back Angle	26.5		
L42	Hip Angle	99.5		
L44	Knee Angle	131.0		
L46	Foot Angle	87.0		
L53	H Point to Heel Point		35.07	891
L17	H Point Travel		6.73	171
H58	H Point Rise		.98	25
W3	Shoulder Room		51.32	1456
W5	Hip Room		52.20	1326
W16	Seat Width		49.49	1257

Rear Compartment

L50	H Point Couple		32.56	827
W25	Centerline Occupant to Centerline Car		13.27	337
H63	Effective Head Room		37.68	957
L51	Maximum Effective Leg Room		38.00	965
H31	H Point to Heel Point (chair height)		11.73	298
L41	Back Angle	27		
L43	Hip Angle	92		
L45	Knee Angle	102		
L47	Foot Angle	118.5		
W4	Shoulder Room		57.08	1450
W6	Hip Room		55.59	1412

Control Location

		DEGREES	IN	MM
H18	Steering Wheel Angle	19.5		
L7	Steering Wheel Torso Clearance		13.38	340
L13	Brake Pedal Knee Clear		24.42	595
L52	Brake Pedal to Accelerator		4.48	114

CRITERION FOR SELECTION OF PACKAGE

- (1) CRASHWORTHINESS
 - . STRUCTURAL REQUIREMENTS
 - . DYNAMICS
 - . FUEL SYSTEM PROTECTION
- (2) VEHICLE MASS
- (3) HANDLING CHARACTER
 - . WEIGHT DISTRIBUTION
 - . POLAR MOMENT OF INERTIA
 - . SUSPENSION TYPES
- (4) SERVICEABILITY
 - . ENGINE
 - . CONTROL SYSTEM
 - . BATTERY
- (5) LUGGAGE COMPARTMENT
 - . SIZE
 - . LOCATION
- (6) PASSENGER COMPARTMENT INTRUSION

MECHANICAL COMPONENT /
PACKAGING SCHEMATIC

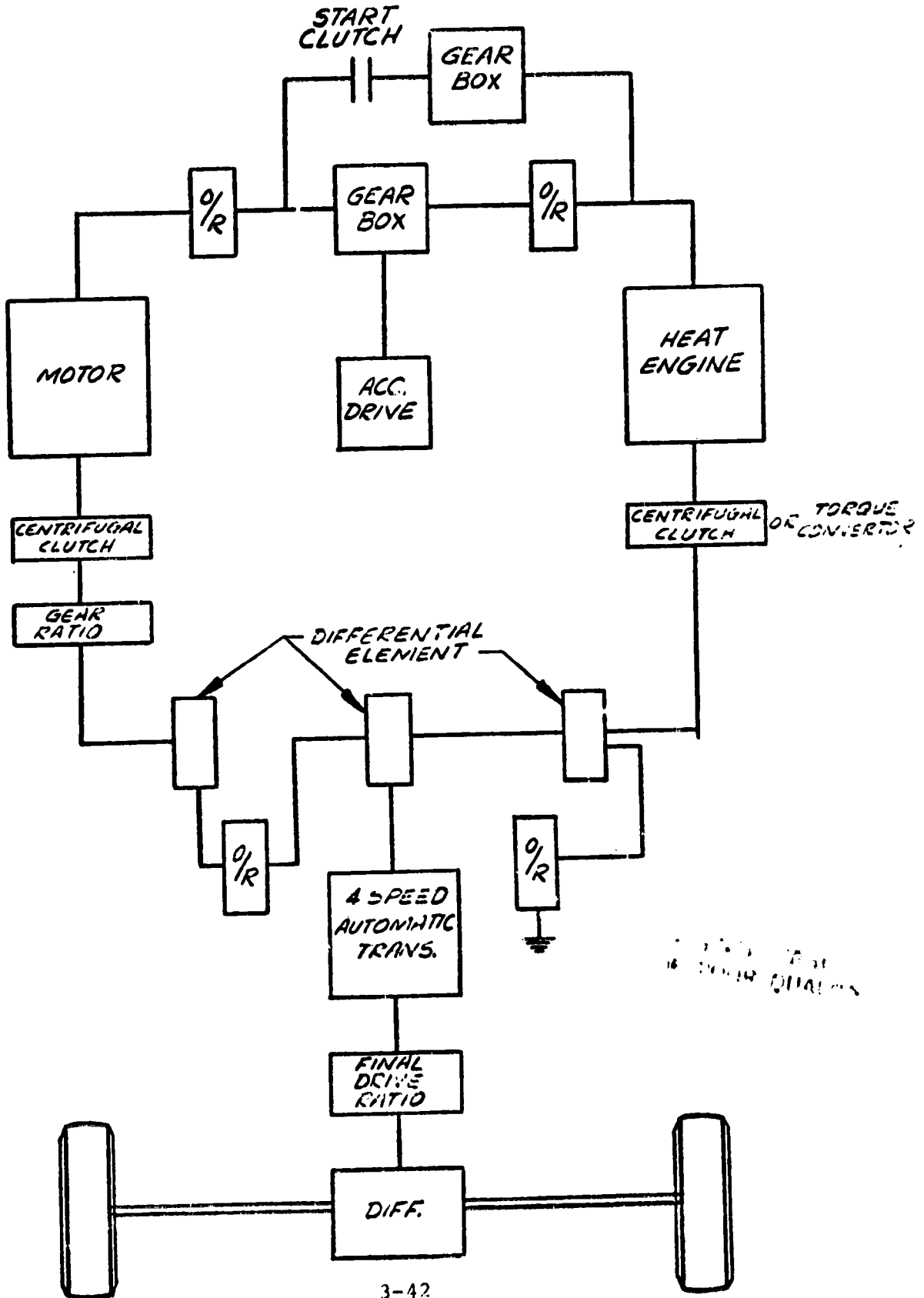

3-42

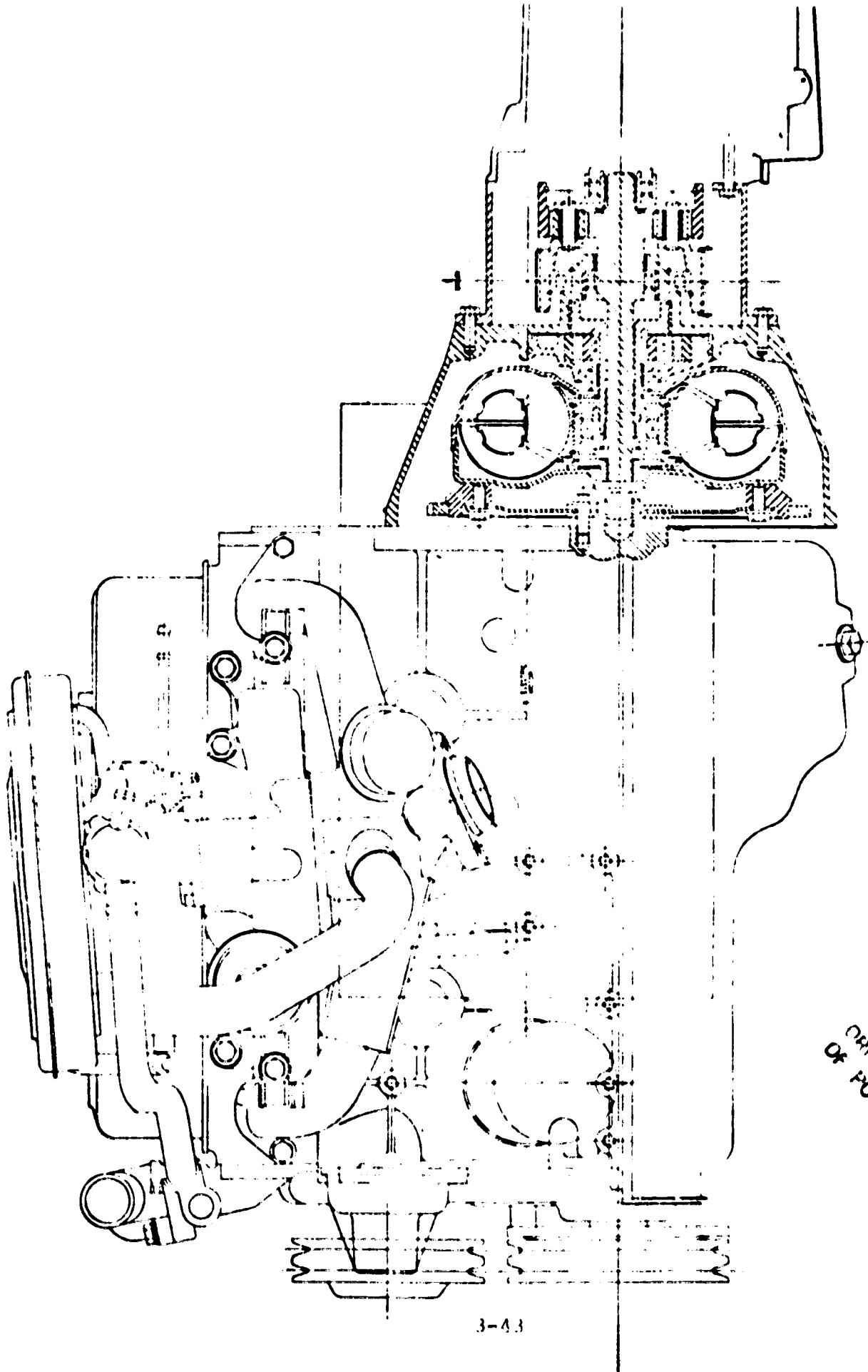

ORIGINAL DRAWING IS
OF POOR QUALITY

3-43

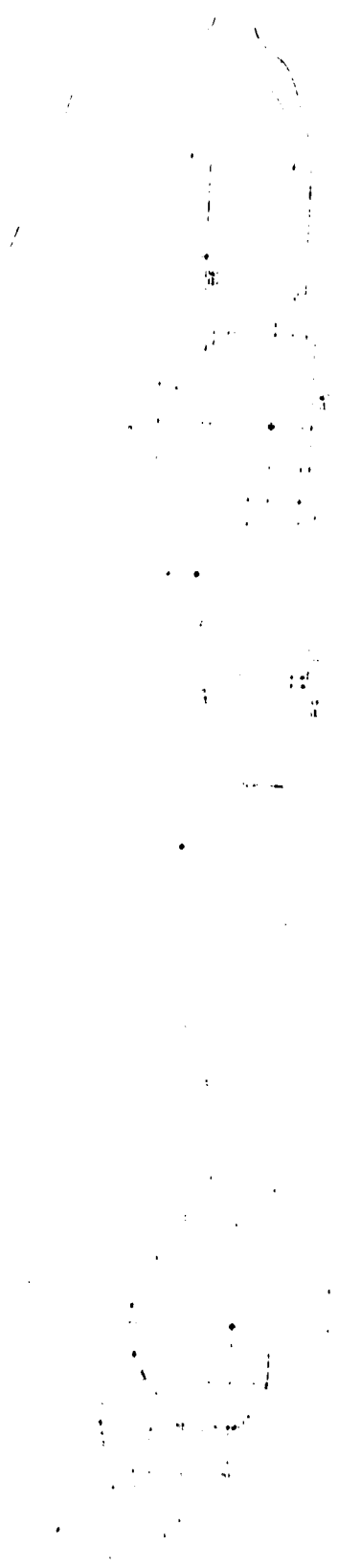

Packaging Composite

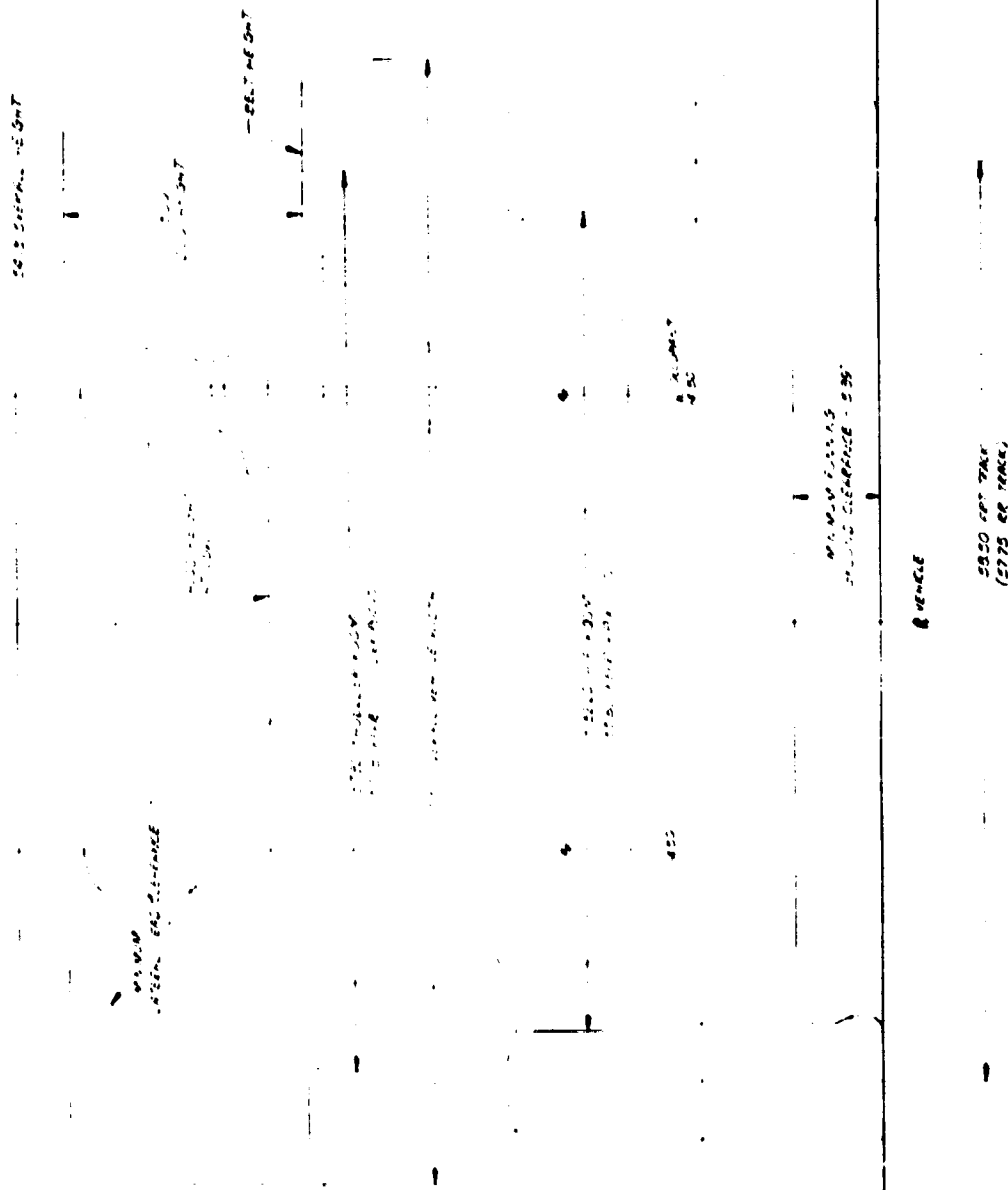

Preliminary Layout - Space Relation

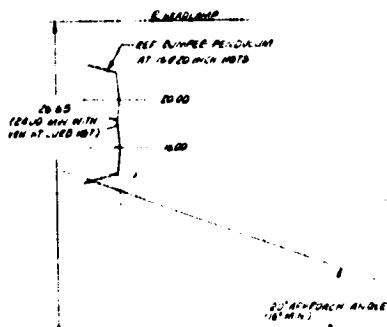

HOOD HEIGHT

25.00" DIA. HOOD ANGLE

25.00" DIA. HOOD ANGLE

45° DRIVE TO

45° DRIVE TO

45° DRIVE TO

45° DRIVE TO

Preliminary Layout

PRECEDING PAGE BLANK NOT FILMED

FOLDOUT FRAME

3-47

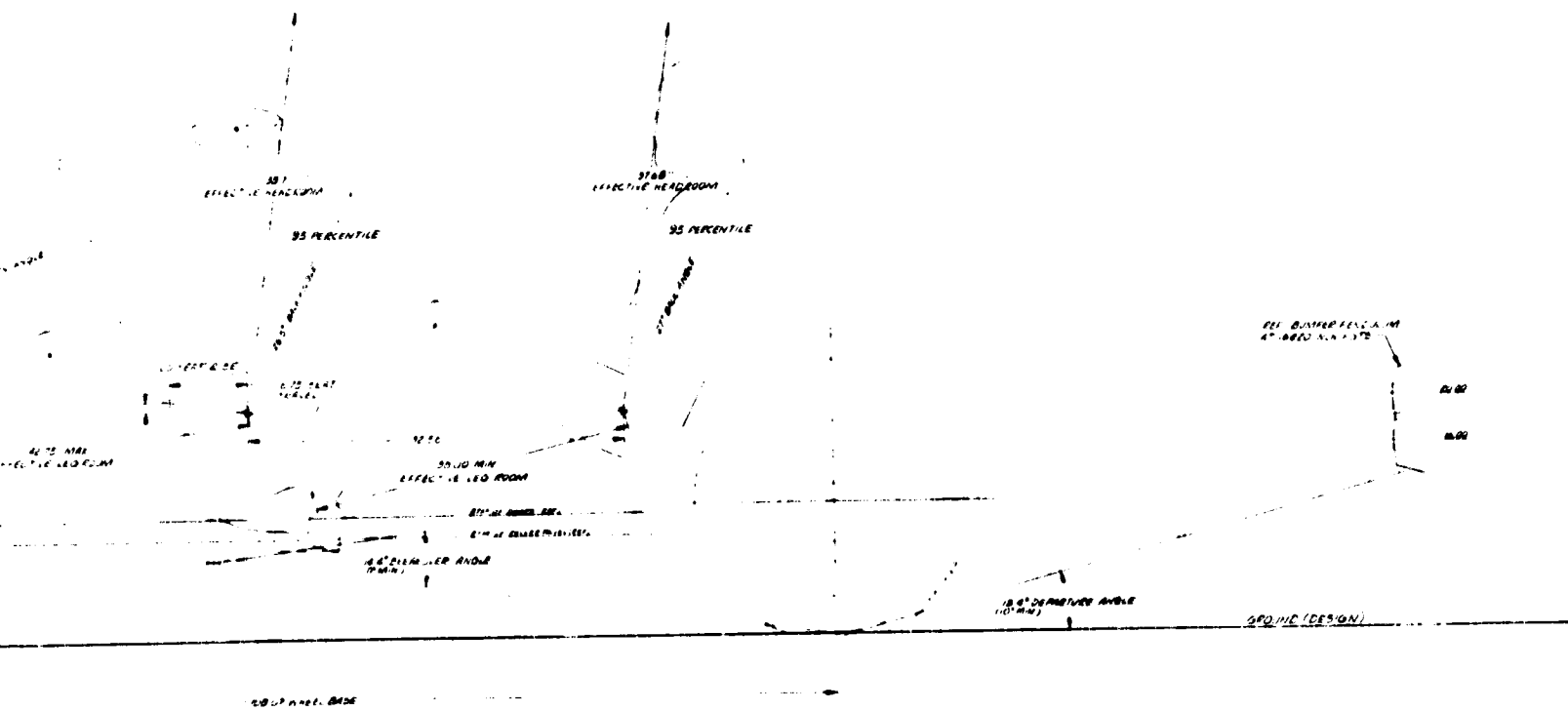

ry Layout - Space Relation

FOLDOUT FRAME

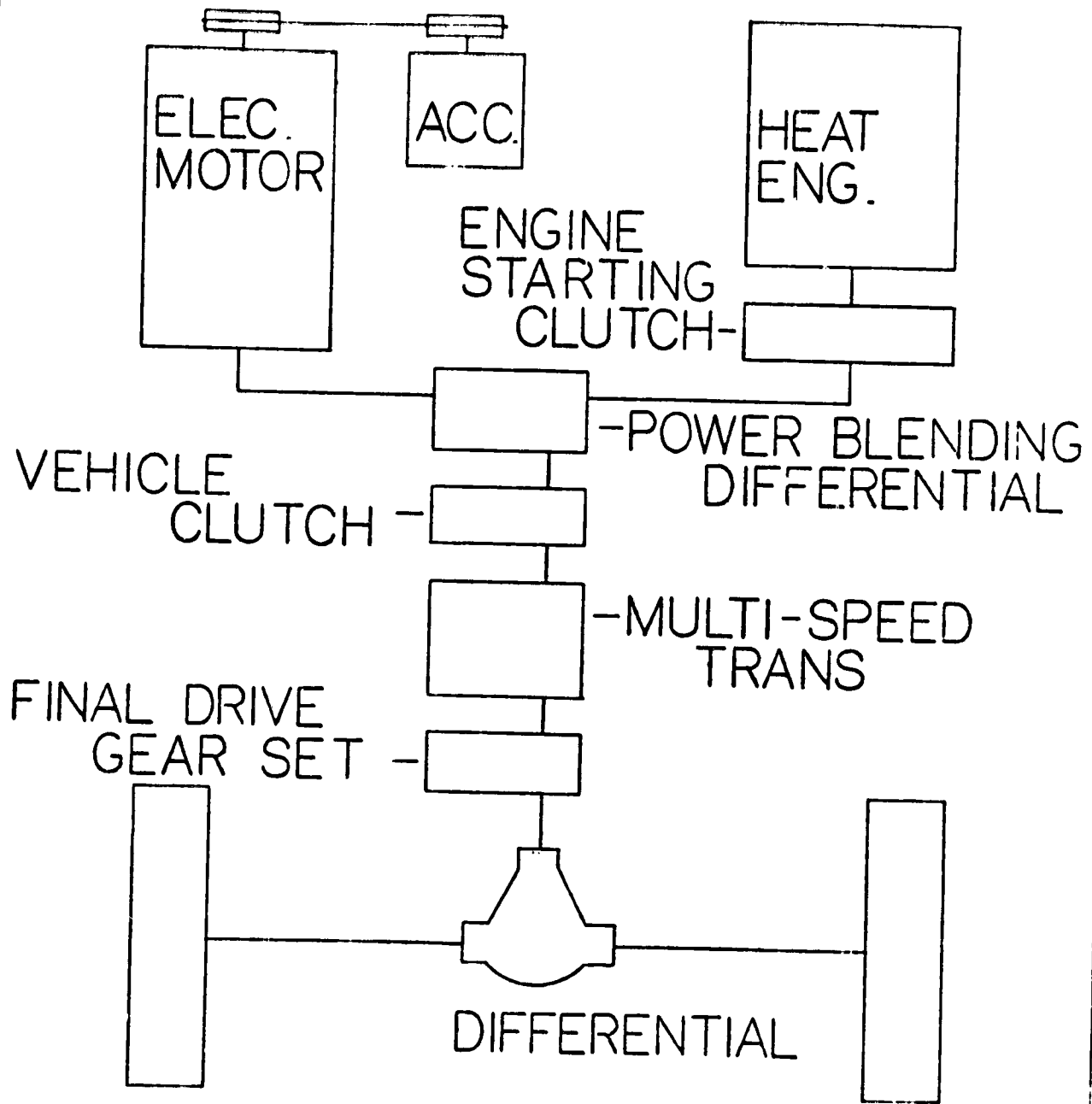

SCHMATIC
DRIVE ARRANGEMENT

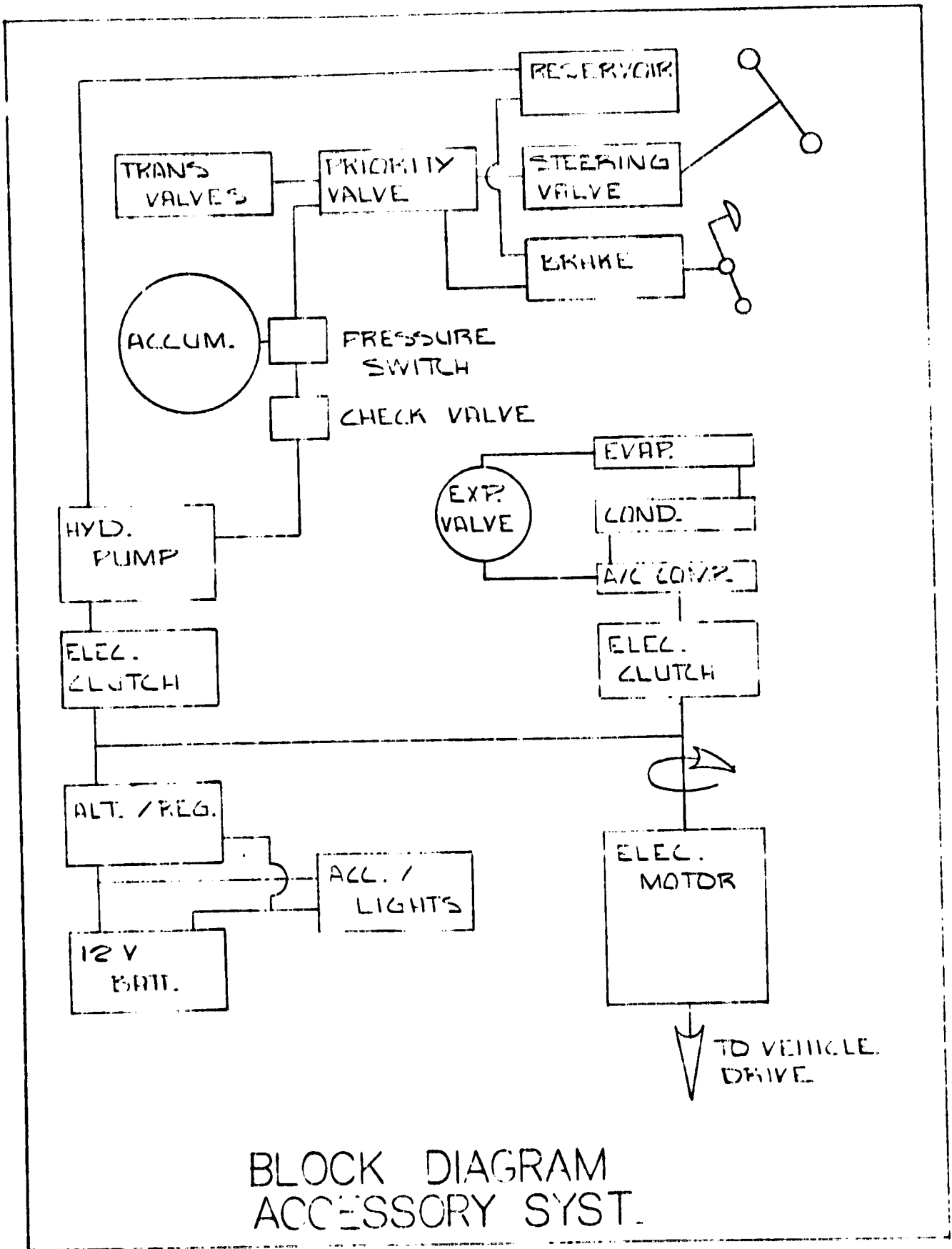

3-50

Section 4
MOTORS AND CONTROLS FOR HYBRID VEHICLES

Section 4**MOTORS AND CONTROLS FOR HYBRID VEHICLES****4.1 BACKGROUND**

In 1975, General Electric Corporate Research and Development began a long-range program to make substantial improvements in motors and controls for electric and hybrid vehicles.

Initially, a comprehensive survey was made considering all types of motors and controls which were amenable to electric and hybrid vehicles depending upon the time frame in which they were used. This survey was presented orally to the Department of Energy (then called Research and Development Administration) as part of a comprehensive plan to develop advanced electric vehicles (see Attachment A). The General Electric Company, Electric Storage Battery Inc., and Triad Services Inc., recommended the overall program and offered to submit an unsolicited proposal. This offer was declined, and the proposal was never formalized. The survey of motors and controls was not published, but the draft version has been used heavily by General Electric in program definition, proposed preparation, and reports in this, as well as a number of other subsequent projects.

Several major developments either planned, under way, or completed which followed this comprehensive design are:

1. Development of an electric vehicle designed from the ground up to demonstrate the state-of-the-technology drive system and to establish a baseline against which to identify and measure improvements.⁽¹⁾ This was actually built with a commercially available General Electric direct current series motor and SCR chopper direct current armature control and is identified as the GE-100 Centennial Electric (see Attachment B).
2. Development of an inductor motor/alternator with flywheel and load inverter for acceleration and regenerative braking for the Department of Energy.⁽²⁾
3. Development of a Department of Energy Near-Term Electric Vehicle with improved performance and utilizing regeneration advancements in the state-of-the-technology in the separately excited direct current motor (Figure 4-1), the regenerative armature chopper utilizing new transistorized power modules, microcomputer controls, and on the improved lead-acid battery.⁽³⁾
4. Development of a high-speed induction motor being built for National Aeronautics and Space Agency (NASA) Lewis Research Center featuring low volume, low weight, and low cost.⁽⁴⁾ This development is aimed at electric vehicles

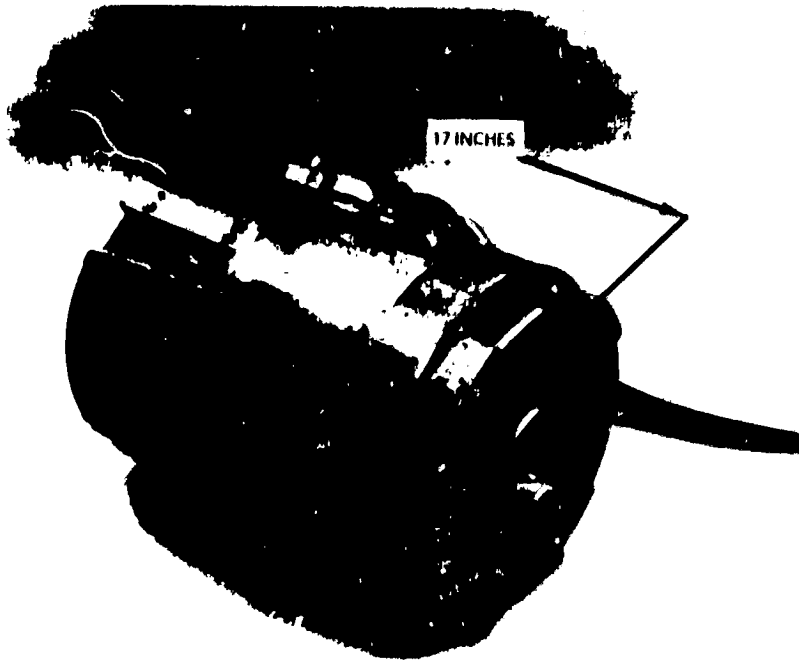

Figure 4-1. Direct Current Separately Excited Motor Used in Near-Term Electric Vehicle

that will succeed the Near-Term Vehicles perhaps in the mid 1980's. A proof-of-concept motor is shown in Figure 4-3, which compares it to the equivalent direct current separately excited motor developed in Item 3.

5. Development of an advanced permanent magnet disc motor on a General Electric program intended to produce very lightweight, low volume, and very low-cost electric drives. This work is aimed at the truly advanced electric vehicle in the latter part of the 1980's and early 1990's.^(5,6) A proof-of-concept motor has been developed and is shown in Figure 4-2 which compares it to the equivalent direct current separately excited motor developed in Item 3.

Each of the items listed above was accomplished after extensive modeling and analysis. These studies were consulted extensively in the sections that follow to make the required design trade-off studies for the hybrid vehicle program.

4.1.1 PREVIOUS TRADE-OFF STUDIES

The overall drive system requirements and the detailed evaluation of alternate direct current drives were made for the Near-Term Electric Vehicle Program, Phases I and II. These will not be repeated in this study. Specific designs and ratings will be scaled to accomplish the trade-off using direct current drives for the hybrid vehicle.

ORIGINAL PAGE IS
OF POOR QUALITY

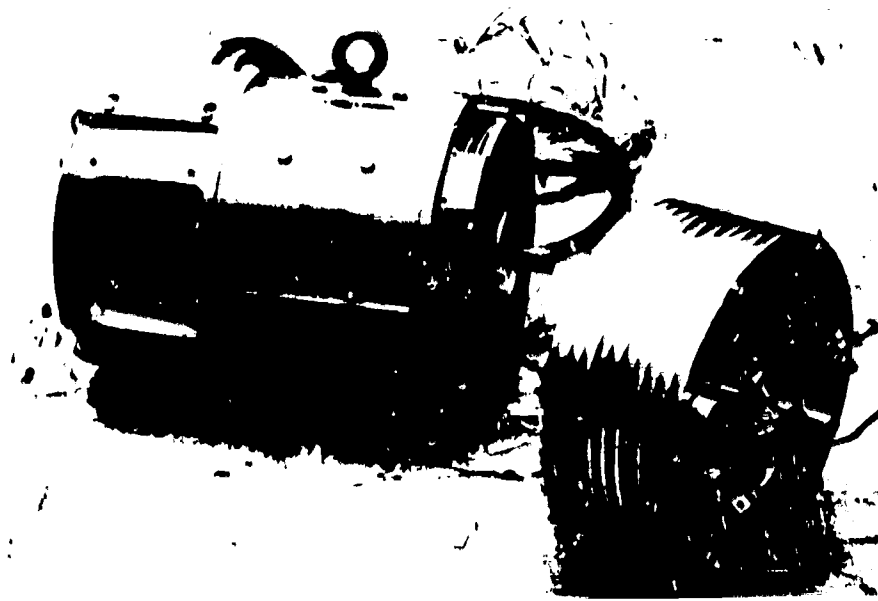

Figure 4-2. Comparison of PM Disc Synchronous Motor with dc Separately Excited Motor

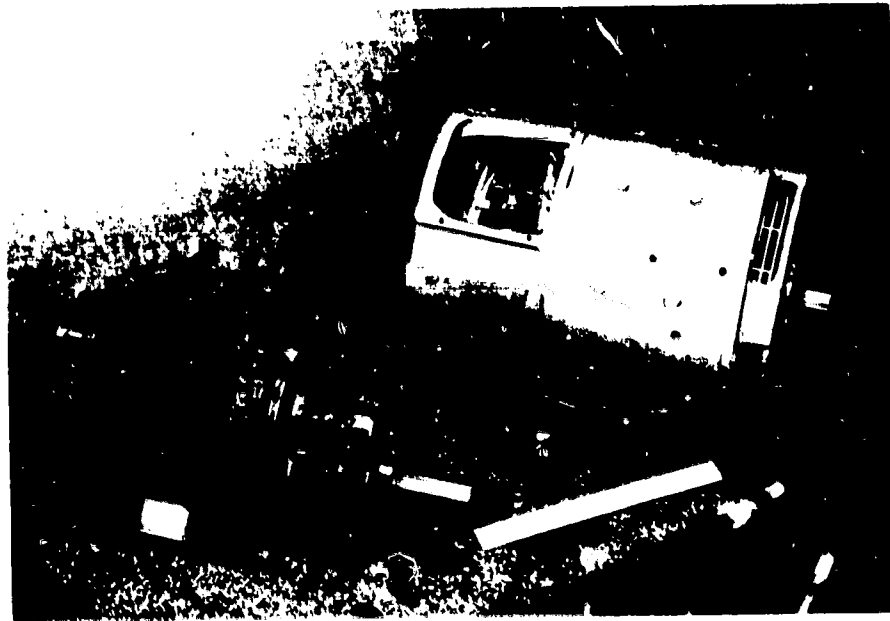

Figure 4-3. Comparison of High-Speed Induction Motor and Gear Reducer with dc Separately Excited Motor

Document PASF 15
of 6000000000

The alternating current drive evaluations have met the overall drive system requirements as developed in the Near-Term Electric Vehicle Program, Phases I and II. Additional studies have been undertaken and are described subsequently.

In early 1978, General Electric Corporate Research and Development conducted a trade-off study of a myriad of alternate ac drive systems to identify an appropriate drive or drives that should be undertaken by General Electric. This study was not published, but summary sheets are presented as Attachment C which reports the findings, conclusions, and recommendations. The two motor development programs mentioned earlier, the NASA high-speed ac induction motor and the longer range General Electric synchronous ac permanent magnet disc motor programs were specifically recommended and are the direct result of this study.

4.1.2 PRESENT TRADE-OFF STUDY

As part of the hybrid vehicle trade-off studies, additional work has been done to examine the application of ac drives to the hybrid vehicle. An internal memorandum was issued describing the specific information needed. The resulting information is given in Attachment D. This attachment provides the necessary scaling factors for ac motors and controls for determining size, weight, and cost.

Detailed information of reference ac and dc motors to determine dynamic performance was provided by the General Electric DC Motor and Generator and Small AC Motor Departments, respectively. These designs and this scaling methodology are given in Attachment D.

4.1.3 PRODUCIBILITY ANALYSIS

A detailed study of producibility and cost of the power conditioning unit for the Near-Term Electric Vehicle has been made and is used in the detailed trade-off studies. This is given in Attachment E.

4.2 TECHNICAL DISCUSSION

This section summarizes the trade-offs that were made during the studies noted in Section 4.1 of this volume.

The electric propulsion system chosen is one that has regeneration capability. Preliminary evaluation of the hybrid vehicle requirements indicated the drive for the Near-Term Electric Vehicle would come close to fulfilling the hybrid vehicle requirements.

Figures 4-4 and 4-5 show the alternate types of motors and controls which were considered. Initial screening results are as follows.

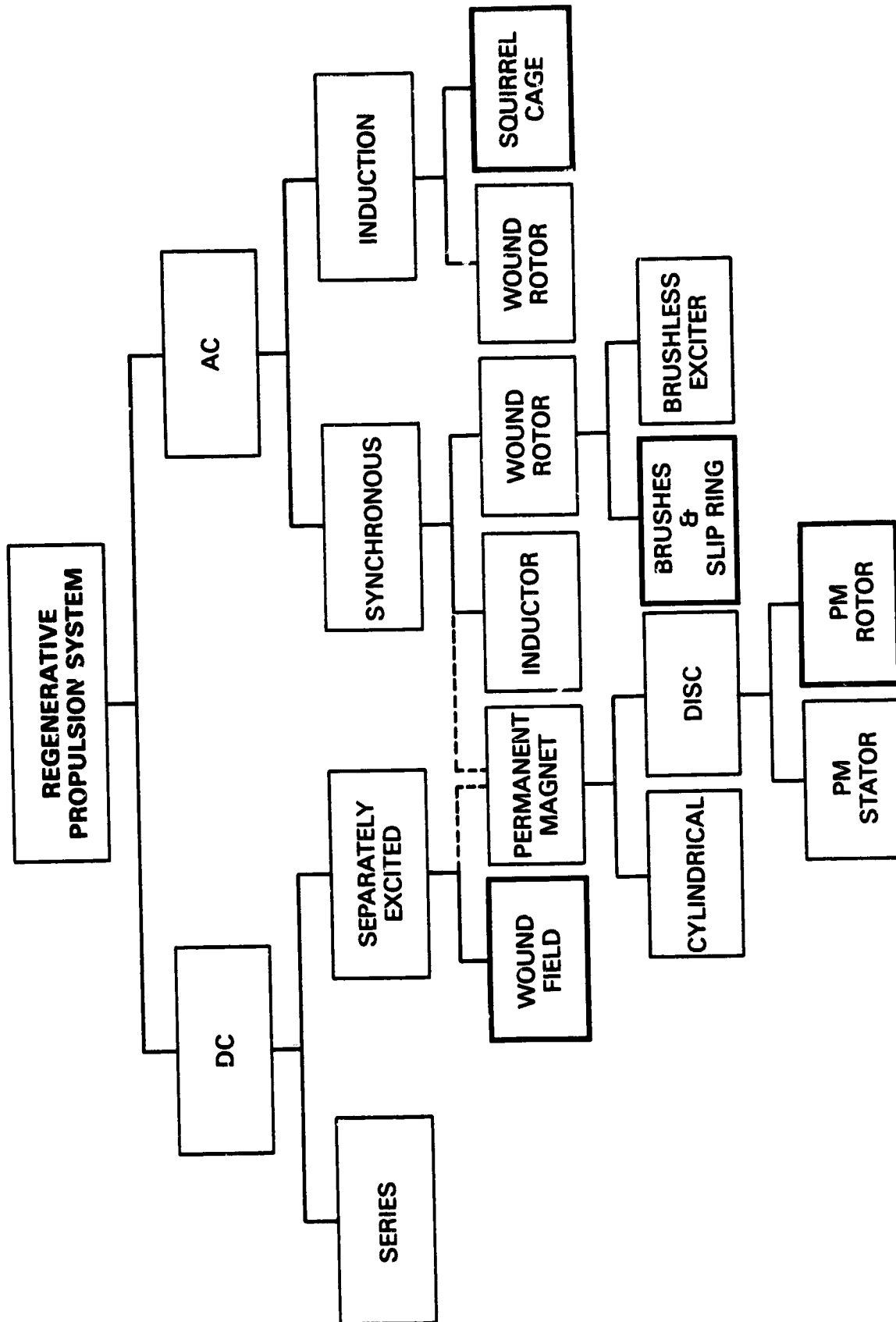

Figure 4-4. Candidate Motors

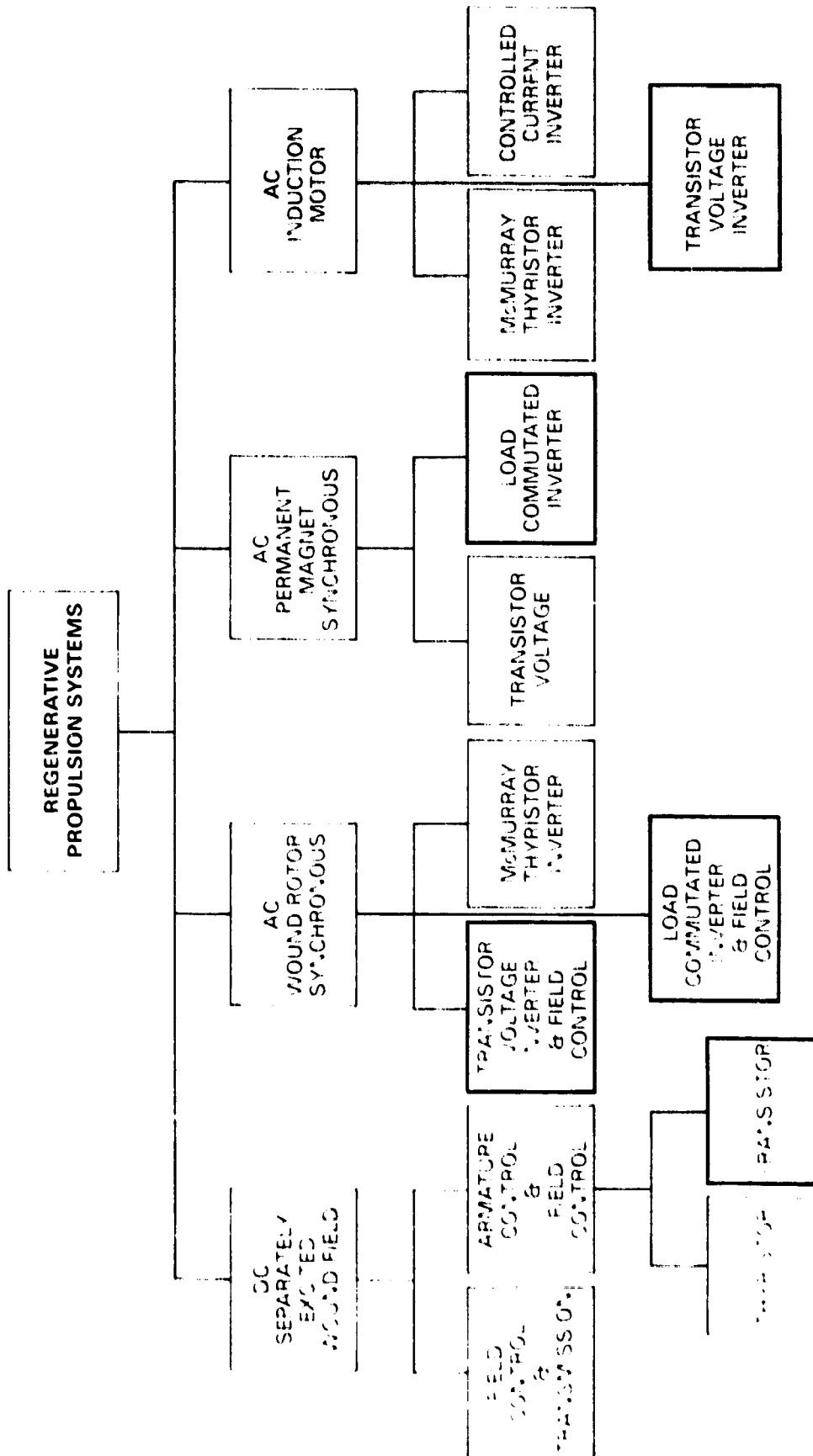

Figure 4-5. Candidate Motors and Controls

1. DC Motors - The Near-Term Electric Vehicle Program selected the wound field separately excited dc motor with transistorized chopper to be the preferred choice for dc drives. These were assigned the rating of ninety in the General Electric ac drives study. Of particular importance is the possibility of using this type of motor with field control and a shifting transmission for an alternate approach to armature control.
2. Permanent Magnet Motors, AC & DC. These were considered to be highly desirable long-range candidates in the General Electric ac Drives Study. However, these would not mature soon enough for long-scale manufacture in the mid-1980's as required by the DOE contract. This applies to both the ac and dc versions of these motors.
3. AC Synchronous Motors - Wound Field. This type of motor with either a transistorized PWM inverter or a load-commutated thyristor inverter was highly rated in the General Electric study. It was not chosen because the motor is about 20% larger and heavier than the induction motor; the motors are not as highly developed or production-ready as the induction motor; and the system cost is about 10% higher. The performance in range is essentially the same. In addition, separate field excitation is required. Rotating exciters are not considered further due to inward size, weight, and cost. Experience in application of brushes and slip rings to propulsion-type transportation has indicated this may be a source of maintenance and reliability problems.
4. AC Synchronous Motors - Inductor. These motors lend themselves quite well to driving a flywheel since they have controllable excitation on the stator, can be completely sealed and evacuated, and have high rotor inertia which can be utilized for energy storage. However, since these motors are heavier and more costly, they are not good candidates for vehicle propulsion motors.
5. AC Induction Motors. This type of motor with transistorized voltage inverter offers the best ac drive that utilizes technology that can be in high-volume manufacture during the time frame of this program. There are two alternates: a high-speed (15,000 rpm) motor with gear reducer which offers lower weight and cost but is not in present manufacture; and a lower speed (5000 rpm) motor which is a derivative of a production motor.
6. Scaling of Motor Data. A major consideration in the development of the motor subroutine for the simulations of the hybrid vehicle performance studies is that the program must be flexible enough to be used for propulsion motors of different sizes and ratings. The electric motor model used in the hybrid vehicle simulation program uses normalized parameters of a reference motor (Figure 4-6). The

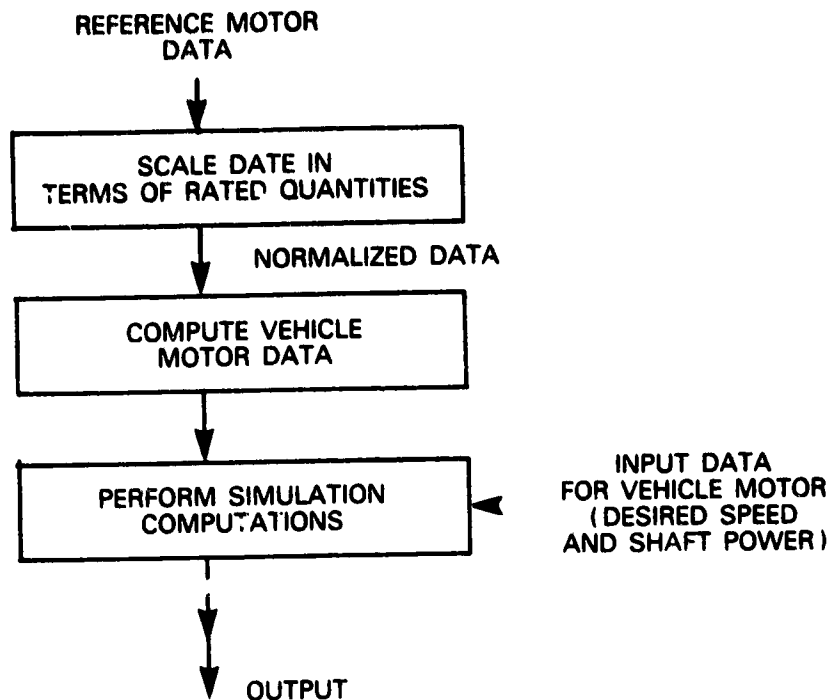

Figure 4-6. Vehicle Performance Computations

normalization of the reference motor data makes possible the use of the same data for different sized vehicles (up to +50% duration from the size of the reference motor). The data for the two reference motors used are shown in Tables 4-1 and 4-2. The input data required of the vehicle motor is the rated speed, voltage, flux and continuous duty output power. All the motor parameters are normalized in terms of the rated voltage, current, speed, and flux of the reference motor.

Table 4-1
DC MOTOR DATA

Continuous Duty Rating	20 hp
Base Speed	2500 rpm
Max Speed	5000 rpm
Rated Current	175 A
Rated Voltage	96 V
Rated Field Current	4.9 A

Armature Winding

Winding Resistance	0.024Ω
Winding Inductance Unsaturated	0.52 mH

Field Winding - Separately Excited

Winding Resistance	4.3Ω
Winding Inductance Unsaturated	2.3 H
Turns per Pole	330

Torque Constant $k_t = 0.352$ lbft/A-megaline
 Voltage Constant $k_e = 0.05$ V/rpm-megaline

Table 4-2
AC MOTOR DATA

Continuous Duty Rating	20 hp
Base Speed (60 Hz)	1800 rpm
Voltage per Phase (LN)	266 V
Line Current	23.32 A
Power Factor	0.87
Slip	0.0297
Stator Resistance (per Phase at 95 °C)	0.3322Ω
Rotor Resistance (per Phase Referred to Stator)	0.2466Ω
Stator Reactance	1.157Ω
Rotor Reactance (per Phase Referred to Stator)	1.184Ω
Magnetizing Reactance (per Phase Referred to Stator)	42.45Ω
Magnetizing Branch Resistance (in Series with Reactance)	1.467Ω

4.3 CONCLUSIONS

The motors and controls to be used in the detailed trade-off studies are as follows:

4.3.1 DC DRIVE SYSTEMS

- Alternate A
 - Separately excited dc motor
 - Transistorized regenerative armature chopper
 - Transistorized field control
 - Fixed-gear reduction
- Alternate B
 - Separately excited dc motor
 - Transistorized field control
 - Shifting transmission and clutch
 - Armature resistor for motor starting at no load

4.3.2 AC DRIVE SYSTEM

- Alternate A
 - AC induction motor (5000 rpm)
 - Transistorized voltage inverter
 - Fixed-gear reduction
- Alternate B*
 - AC induction motor/gear reducer (15,000/5,000 rpm)
 - Transistorized voltage inverter
 - Fixed-gear reduction

***Note:** Alternates A & B are considered to be so nearly equivalent that all calculations will be made using Alternate A since detailed motor characteristics are available for Alternate A. Should Alternate B become available as a result of the NASA program, then it will be considered for this application.

REFERENCES

1. Electric Car Design Interim Summary Report, SRD-77-078, Contract No. EY-76-C-03-1294, Phase I-Deliverable Item #9, General Electric Company, Schenectady, N.Y., May 9, 1977.
2. Near-Term Electric Vehicle Program, Contract No. EY-76-C-03-1294, Phase I Final Report, General Electric Company, Schenectady, N.Y., August 1977.
3. Preliminary Power Train Design for a State-of-the-Art Electric Vehicle, DOE/NASA/0592-78/1, Contract NAS 3-20592, Vol. 1 (of 2 Vol), Rohr Industries, Inc., September 1978.
4. Preliminary Power Train Design for a State-of-the-Art Electric Vehicle, DOE/NASA/0592-78/1, Contract NAS 3-20592, Vol. 2 (of 2 Vol.), Booz, Allen and Hamilton, September 1978.
5. Demonstration of an Inductor Motor/Alternator/Flywheel Energy Storage System, SRD-78-014-2, Contract No. EY-76-C-02-4010, Phase I-Final Report, General Electric Company, Schenectady, N.Y., January 27, 1978.
6. R.H. Guess and E.L. Lustenader, "Development of a High Performance and Lightweight Hybrid Flywheel/Battery Powered Electric Vehicle Drive," Fourth International Electric Vehicle Symposium, Dusseldorf, Germany, August, 1976.
7. R.H. Guess, W.R. Nial, and M. Pocobello, "Design of a Current Technology Electric Vehicle," NATO/CCMS Fourth International Symposium on Automotive Propulsion Systems, Washington, D.C., April 17-22, 1977.
8. Proposed Development Program for Advanced Electric Vehicles, General Electric Company, Chrysler Corporation, and ESB, Inc., presented to The Honorable Frank E. Moss and The Honorable Mike McCormack, U.S. House of Representatives, Washington, D.C., February 19, 1976.
9. Proposed Development Program for Advanced Electric Vehicles, General Electric Company, Chrysler Corporation, and ESB, Inc., presented to Austin N. Heller, Assistant Administrator for Conservation, Washington, D.C., January 23, 1976.
10. Near-Term Electric Vehicle Program, Contract No. EY-76-C-03-1294, Phase II - Mid-Term Summary Report, SRD-78-073, General Electric Company, Schenectady, N.Y., July 1, 1978.
11. E.P. Cornell, R.H. Guess, and F.G. Turnbull, "Advanced Motor Developments for Electric Vehicles," IEEE Transactions on Vehicular Technology, Vol. VT-26, No. 2, May 1977.

12. Electric Vehicle Motors, General Electric Company Brochure GEP-356, August 1975.
13. AC Motor Buyers' Guide, General Electric Company Brochure GEP-1087D.
14. A.B. Plunkett and D.L. Plette, "Inverter-Induction Motor Drive for Transit Cars," IEEE Transactions on Industry Applications, Vol. IA-13, No. 1, January/February 1977, pp. 26-37.
15. G.B. Kliman and A.B. Plunkett, "Development of a Modulation Strategy for a PWM Inverter Drive," IAS Conference Record of the 10th Meeting, October 1975.
16. J.A. Chiera, L. Coffman, J.F. Haupt, and L. Ishler, AC Electric Wheel Design Study Final Report, DOA, MERDC Contract No. DAAK02-70-C-0600, General Electric Company, Schenectady, N.Y., February 26, 1971.
17. T.A. Lipo and A.B. Plunkett, "A Novel Approach to Induction Motor Transfer Functions," IEEE Transactions on Power Apparatus and Systems, Vol. PAS-93, No. 5, September/October 1974, pp. 1410-1418.
18. A.B. Plunkett, "Direct Flux and Torque Regulation in a PWM Inverter-Induction Motor Drive," IEEE Transactions on Industry Applications, Vol. IA-13, No. 2, March/April 1977, pp. 139-146.
19. Electric Vehicle Conceptual Design Report, SRD-76-103, Contract EY-76-C-03-1294, General Electric Company, Schenectady, N.Y., September 10, 1976.
20. Electric Car Design Trade-Off Studies Report, SRD-77-013, Contract EY-76-C-03-1294, Phase I - Deliverable Item #3, General Electric Company, Schenectady, N.Y., February 10, 1977.
21. Conceptual Design Review Report, Phase I - Deliverable Item #4, Contract EY-76-C-03-1294, General Electric Company, Schenectady, N.Y., October 4, 1976.
22. Preliminary Design Review Report, Phase I - Deliverable Item #5, Contract EY-76-C-03-1294, General Electric Company, Schenectady, N.Y., October 4, 1976.
23. Electric Car Design Development Plan Report, SRD-77-012, Contract EY-76-C-03-1294, Phase I - Deliverable Item #6, General Electric Company, Schenectady, N.Y., February 10, 1977.
24. E.L. Lustenader, G. Chang, E. Richter, F.G. Turnbull, and J.S. Hickey, "Flywheel Module for Electric Vehicle Regenerative Braking," 12th Intersociety Energy Conversion Engineering Conference, Washington, D.C., August 1977.

25. A.B. Plunkett and F.G. Turnbull, "Load Commutated Inverter/Synchronous Motor Drive Without a Shaft Position Sensor," 1977 IEEE/IAS Annual Meeting Conference Record, Los Angeles, CA., IEEE Publication No. 77 CH1246-8-IA, October 1977, pp. 748-757.
26. R.L. Steigerwald and T.A. Lipo, "Analysis of a Novel Forced Commutation Starting Scheme for a Load Commutated Synchronous Motor Drive," 1977 IEEE/IAS Annual Meeting Conference Record, Los Angeles, CA., IEEE Publication No. 77 CH1246-8-IA, October 1977, pp. 739-747.
27. E.L. Lustenader, J.S. Hickey, W.R. Nial, E. Richter, F.G. Turnbull, and G. Chang, "Laboratory Evaluation of a Composite Flywheel Energy Storage System," 13th Intersociety Energy Conversion Engineering Conference, San Diego, CA., August 1978.
28. E.L. Lustenader and E.S. Zorzi, "A Status of the 'Alpha-Ply' Composite Flywheel Concept Development," Society for the Advancement of Material and Process Engineering, 1978 National SAMPE Symposium.
29. A.B. Plunkett and F.G. Turnbull, "System Design Method of a Load Commutated Inverter-Synchronous Motor Drive," 1978 IEEE/IAS Annual Meeting Conference Record, Toronto, Canada, IEEE Publication No. 78 CH1346-6-IA, October 1-5, 1978, pp. 812-819.
30. R.L. Steigerwald, "Characteristics of a Current-Fed Inverter With Commutation Applied Through Load Neutral Point," 1978 IEEE/IAS Annual Meeting Conference Record, Toronto, Canada, IEEE Publication No. 78 CH1346-6-IA, October 1-5, 1978, pp. 502-516.
31. E. Richter, "New Developments in Very High Speed Electrical Alternator," Intersociety Energy Conversion Engineering Conference, Boston, 1971.
32. B.R. Pelly, Thyristor Phase-Controlled Converters and Cycloconverters, Wiley-Interscience, N.Y., 1971, Chapters 3 and 5.
33. G. Moltgen, Line Commutated Thyristor Converters, Pitman, London, England, 1972, Chapter 4.

Section 4
ATTACHMENTS

Section 4 Attachment A
PROPOSED DEVELOPMENT PROGRAM
ON ADVANCED ELECTRIC VEHICLE
OCTOBER 1975

PROPOSED DEVELOPMENT PROGRAM

ON

ADVANCED ELECTRIC VEHICLE

for

**Energy Research and Development Administration
Washington, D.C.
October 2, 1975**

by

**Electric Storage Battery, Inc.
General Electric Company
Triad Services, Inc.**

**All questions regarding this proposed
program should be submitted to:**

**Mr. M.W. Goldman
Representative – Science and Technology
General Electric Company
777 14th Street N.W.
Washington, D.C. 20005
Telephone: 202-637-4275**

ADVANCED ELECTRIC VEHICLE REQUIREMENTS

- **IMPROVED RANGE**
 - **Higher Overall Drive System Efficiency**
 - **Improved Battery Performance, KWH/#**
 - **Recovery of Braking Energy**
 - **Reduce Battery Peak Power Drains**
 - **Better Aerodynamics**
- **IMPROVE ACCELERATION WITHOUT AFFECTING BATTERY CAPACITY**
- **REDUCE VEHICLE WEIGHT AND COST**
 - **Smaller Motor and Electronics**
 - **Better Battery Utilization**
 - **Lighter Vehicle Materials**
- **IMPROVE RIDE QUALITY AND HANDLING CHARACTERISTICS**
- **MEETS SAFETY REQUIREMENTS**

ELECTRIC VEHICLE DRIVE SYSTEM OPTIONS

<u>ENERGY STORAGE</u>		<u>POWER CONDITIONING UNIT</u>	<u>TRACTION MOTOR</u>	<u>TRANSMISSION</u>	<u>REGENERATION</u>	<u>COMMENT</u>
<u>Main</u>	<u>Secondary</u>					
Lead Acid Battery	---	Chopper or Contactors	D.C. Series or Compound	---	---	Baseline of Current Tech.
Lead Acid	NiCd	Chopper	D.C. Series	Gear Change	Partial	GE DELTA, NiCd Reduces Main Battery Drain on Acceleration
Lead Acid	---	Small Chopper-Regenerative	Small D.C. Shunt	4-Speed Shifting	Partial	Partial Regeneration to Battery, Improved Performance
Lead Acid	Flywheel, Gear, D.C. Shunt Motor	---	D.C. Shunt	---	Full	Classical Ward Leonard, Field Control Chopper (Partial Regeneration to Battery Possible)
Lead Acid	Flywheel, AC Inductor Motor	Inverter/Rectifier	D.C. Shunt	---	Full	Modified Ward Leonard
Lead Acid	Flywheel	Small Chopper	Small D.C. Shunt	I.V.T.	Full	Flywheel for Acceleration Secured to D.C. Traction Motor
Lead Acid	Small Flywheel	Small Inverter/Rectifier	Small, High Speed AC Inductor Motor	High-Speed I.V.T.	Full	High Speed AC Traction Motor Allows Small Flywheel

ADVANCED ELECTRIC VEHICLE DEVELOPMENT PROGRAMS

Immediate – 0 to 1 Year

Near Term – 1 to 1½ Years

Mid Term – 2 to 3 Years

Long Term – 3 to 5 Years

**SUGGESTED
ADVANCED ELECTRIC VEHICLE DEVELOPMENT**

<u>TIME FRAME</u>	<u>TECHNOLOGY STATUS</u>	<u>VEHICLE SYSTEM</u>
Immediate	State of the Art	<ul style="list-style-type: none"> • Evaluate Baseline System Lead Acid - Chopper - D.C.
Near Term	Modest Advance in State of the Art	<ul style="list-style-type: none"> • New Vehicle - Improved Lead Acid - Small Regenerative Chopper and D.C. Shunt Motor - 4 Speed Shifting Transmission
Mid Term	Significant Advance in State of the Art	<ul style="list-style-type: none"> • New Vehicle - Improved Lead Acid - AC Inductor/Flywheel - Inverter/Rectifier - D.C. Shunt Motor
Long Term	Ultimate System (Barring a Revolutionary Battery Breakthrough)	<ul style="list-style-type: none"> • New Vehicle - Improved Lead Acid - Small Chopper and Shunt Motor - Infinitely Variable Transmission (IVT) • New Vehicle - Improved Lead Acid - Small High Speed Inductor Motor - Small Inverter - High Speed IVT

BATTERY-FLYWHEEL REGENERATIVE PROPULSION SYSTEM

● BASIC CONCEPT

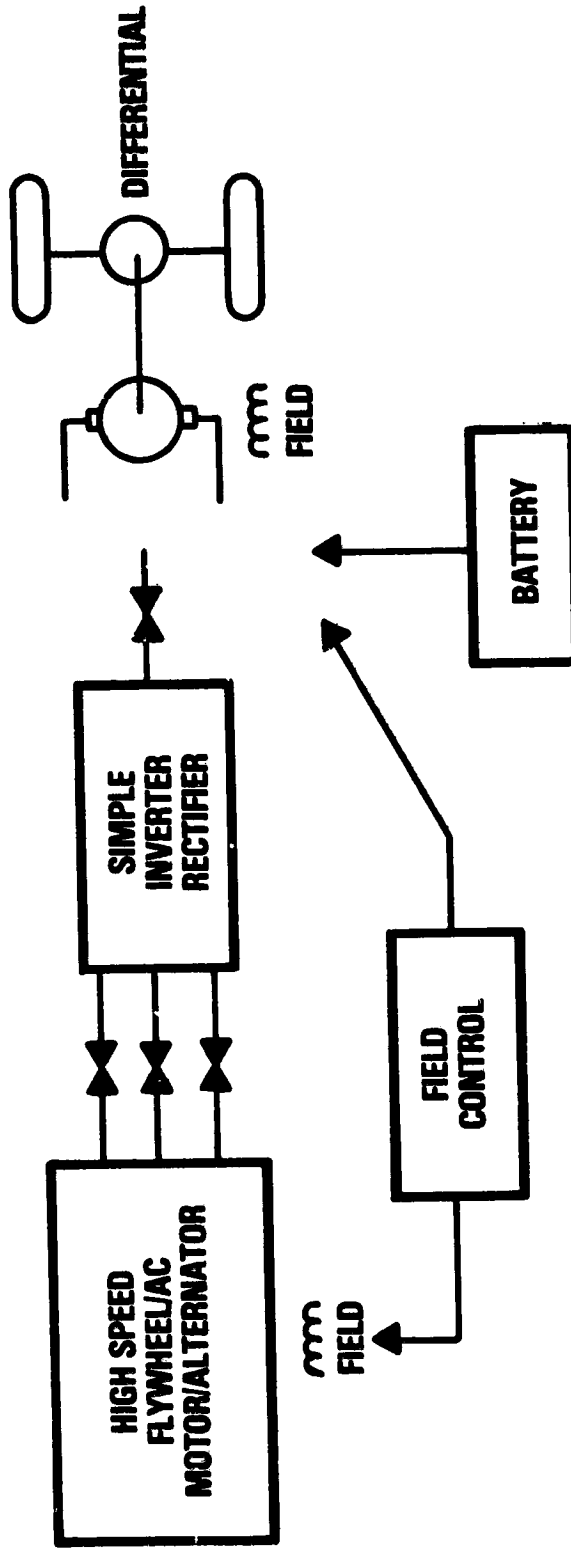

- Battery - for Primary Energy Storage
- Flywheel - Provides Acceleration Energy
 - Store Recovered Braking Energy
 - Reduces Battery Peak Current
- Hybrid System - Extends Vehicle Range
 - Regeneration
 - Increased Battery Capacity
 - Longer Battery Life

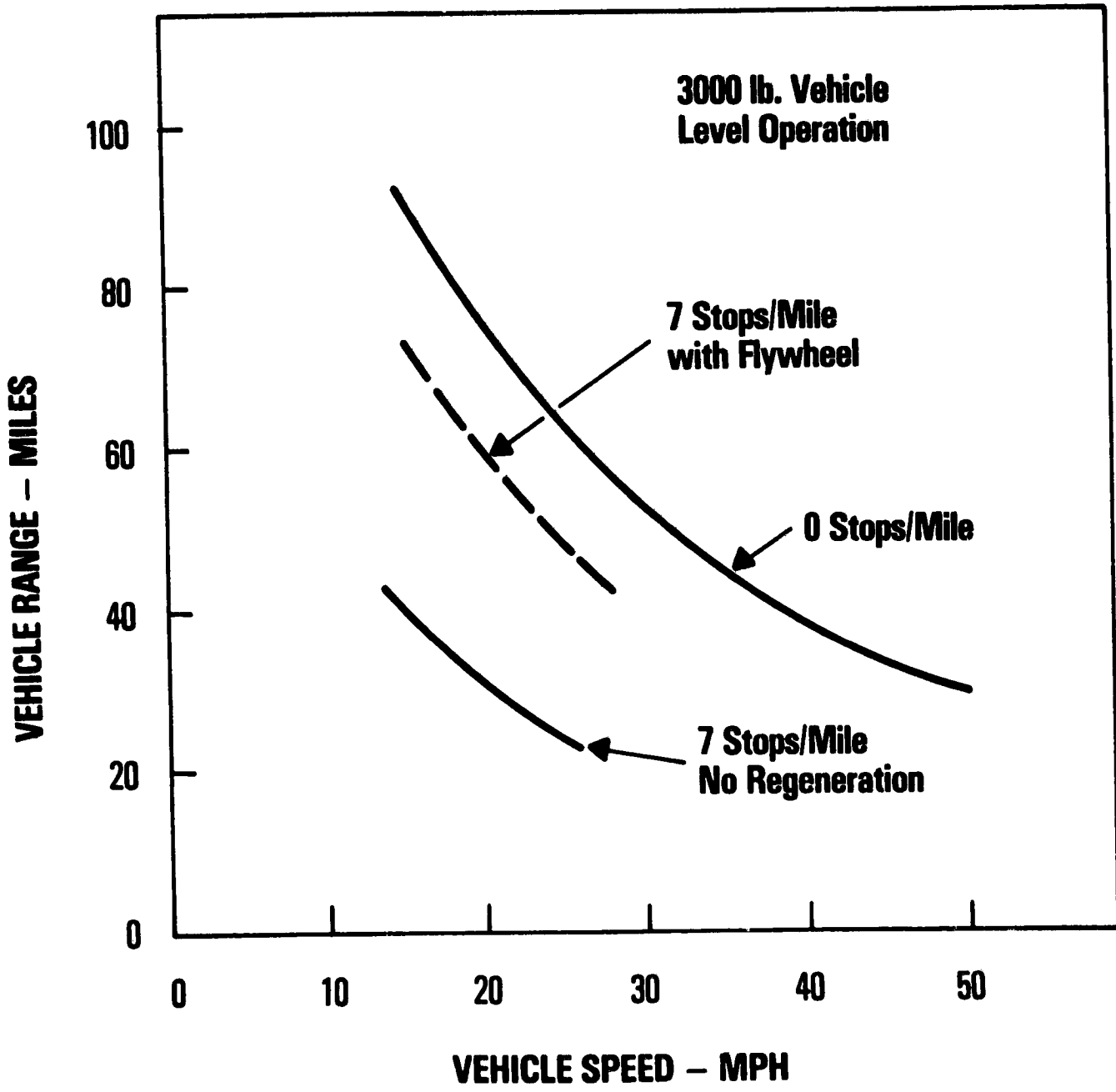

BATTERY ELECTRIC VEHICLE MID TERM DEVELOPMENT

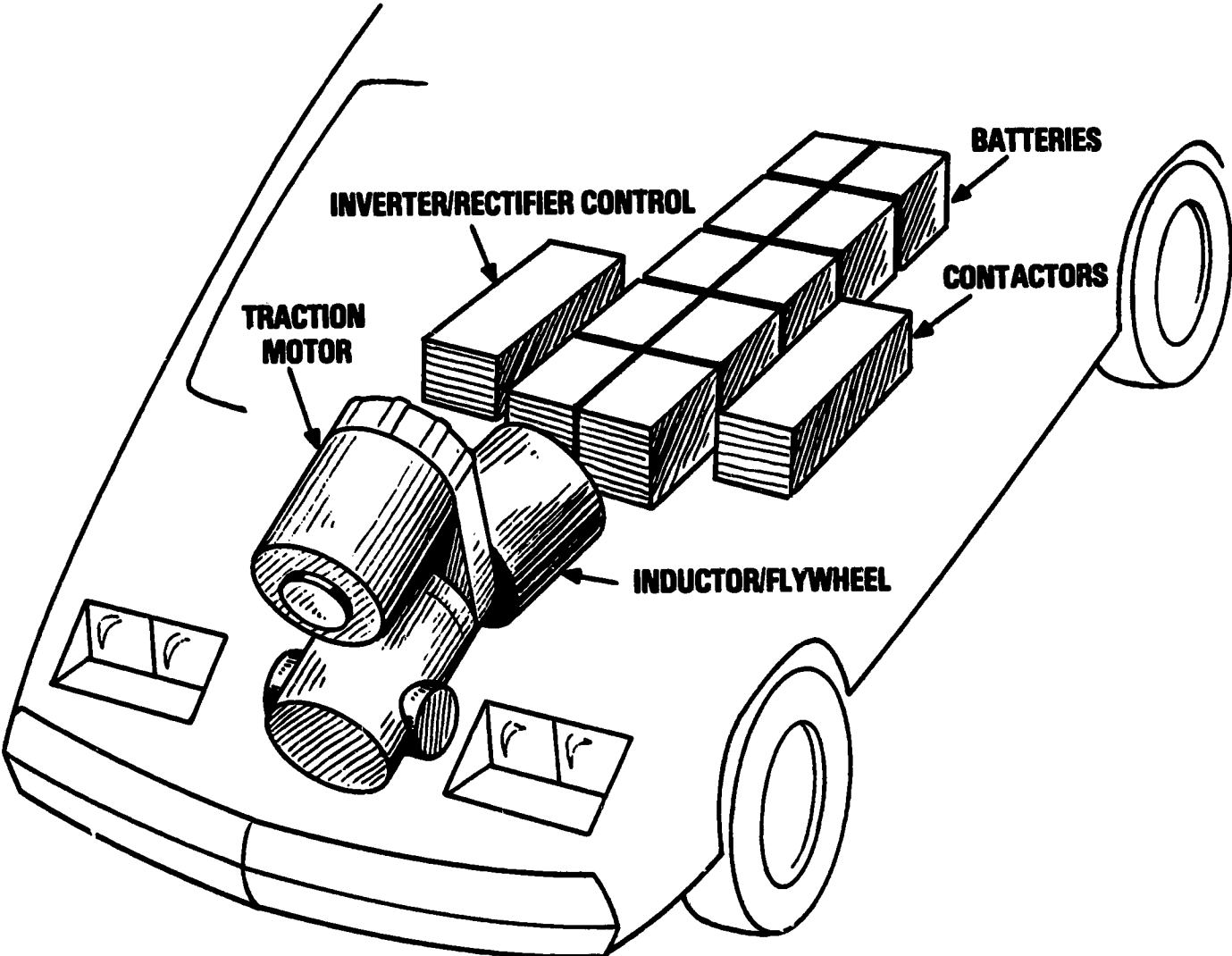

ADVANCED ELECTRIC VEHICLE DEVELOPMENT PROGRAM

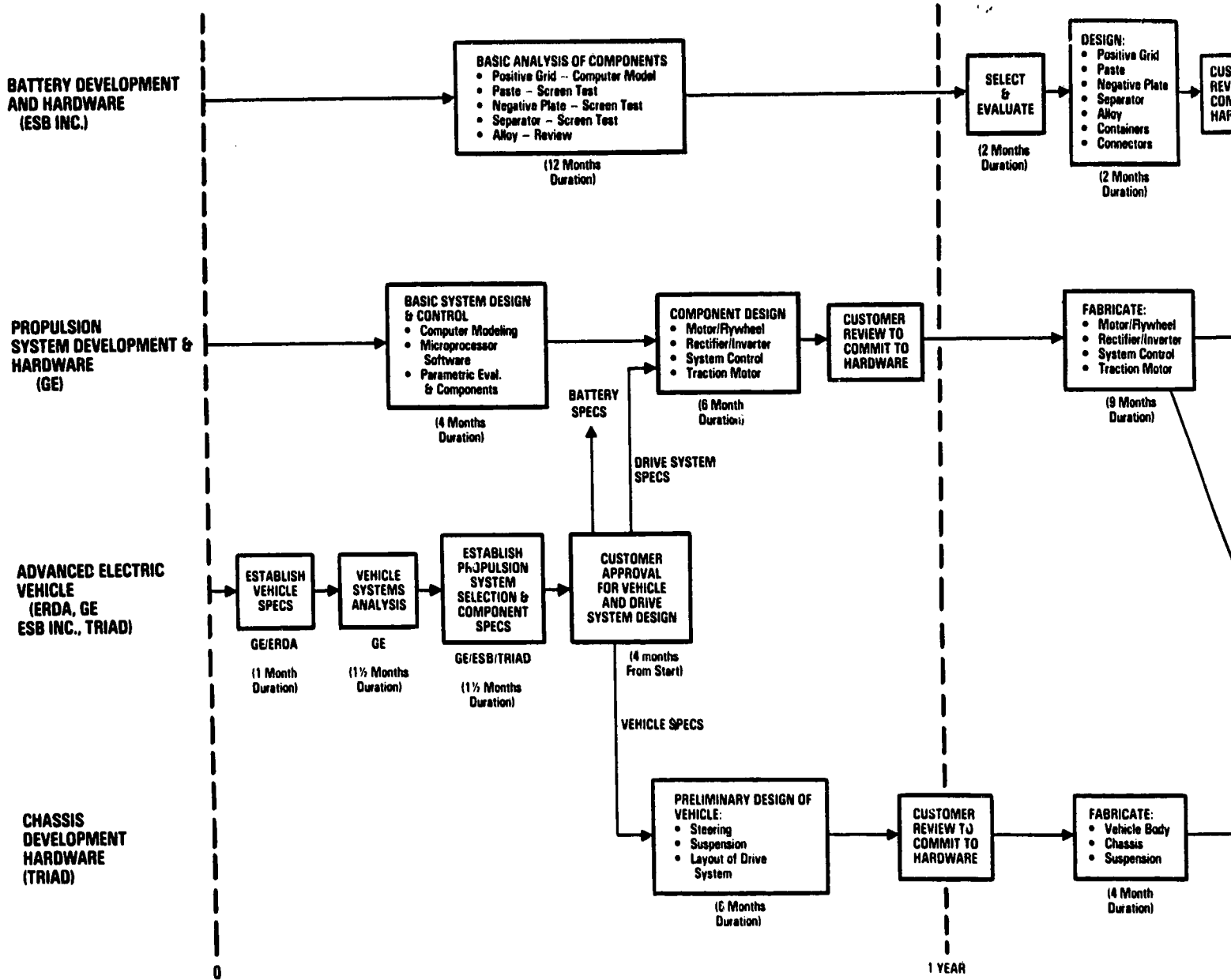

PRECEDING PAGE BLANK NOT FILMED

WELDOUT FRAME

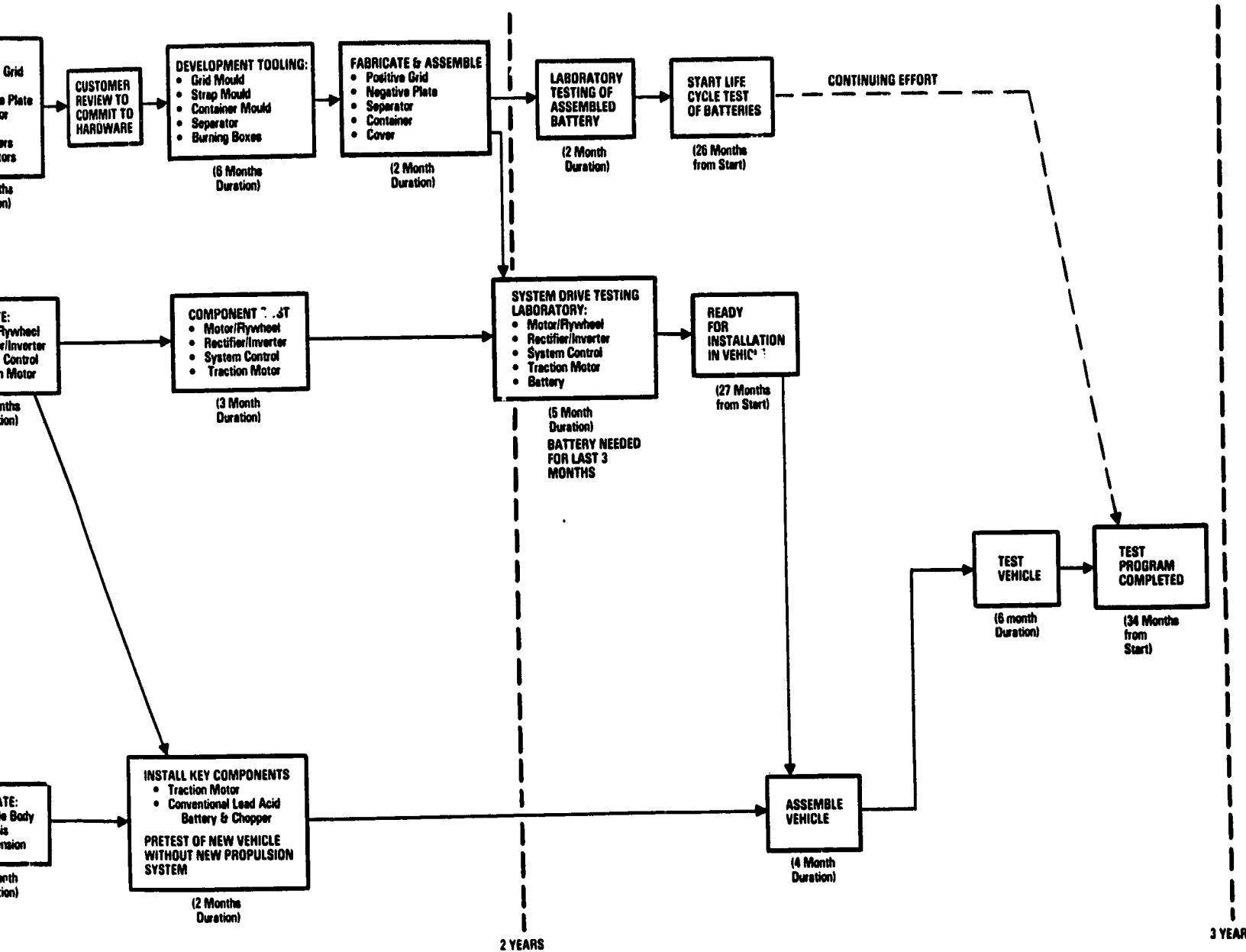

BUILDOUT FRAME 2

**BUDGETARY ESTIMATES
ADVANCED ELECTRIC VEHICLE DEVELOPMENTS**

<u>TIME FRAME</u>	<u>TECHNOLOGY STATUS</u>	<u>VEHICLE SYSTEM</u>	
Immediate	State of the Art	<ul style="list-style-type: none"> Evaluate Baseline System Lead Acid - Chopper - D.C. 	\$ 250 K
Near Term	Modest Advance in State of the Art	<ul style="list-style-type: none"> New Vehicle - Improved Lead Acid - Small Regenerative Chopper and D.C. Shunt Motor - 4 Speed Shifting Transmission 	\$ 500 K
Mid Term	Significant Advance in State of the Art	<ul style="list-style-type: none"> New Vehicle - Improved Lead Acid - AC Inductor/Flywheel - Inverter/Rectifier - D.C. Shunt Motor 	\$1,000 K
		<ul style="list-style-type: none"> New Vehicle - Improved Lead Acid - Small Chopper and Shunt Motor - Infinitely Variable Transmission (IVT) 	\$ 750 K
Long Term	Ultimate System (Barring a Revolutionary Battery Breakthrough)	<ul style="list-style-type: none"> New Vehicle - Improved Lead Acid - Small High Speed Inductor Motor - Small Inverter - High Speed IVT 	\$1,500 K

Section 4 Attachment B
CENTENNIAL ELECTRIC CAR

hatchback-type rear door. The front doors open out and forward on hinged links - one pivoted beneath the driver's seat, the other hinged at the toeboard. As a result, the doors can be opened fully even when the Centennial Electric is parked within 14 inches of an obstacle.

One of the prime considerations of the vehicle's design was to duplicate the "feel" of a conventional car. For example, the front seating arrangement, instrument panel, and floor-mounted, automatic shift lever are similar to those found in conventional autos. Dials on the instrument panel show the amount of energy stored in the battery (similar to a fuel gauge) and measure electric current in amperes. Rounding out the panel are the usual warning lights showing whether the power is on, the battery is charging, the lights are at high beam, or if there is a brake failure. The shift lever indicates "neutral," "park," "forward," and "reverse."

Including batteries, the Centennial Electric weighs 3,250 pounds. It stands 53.5 inches high, and is 160 inches long, 65.1 inches wide, and has a wheelbase of 92 inches. Ground clearance is six inches. Auxiliary equipment includes a gasoline-type heater, AM/FM/CE radio, and electric windshield wipers and defrosters. Fans, headlights, and other accessories operate off a standard 12-volt battery, which is connected to an on-board battery charger.

In addition to the Centennial Electric, the GE Research and Development Center presently is in the final stage of developing and building two advanced electric vehicles for the U.S. Department of Energy as part of its Near-Term Electric Vehicle Program. The two "integrated test vehicles" will contain new technology not commercially available at this time, and will have improved performance characteristics.

The General Electric Company's

Centennial Electric

An Experimental Electric Vehicle



79GPR002

GENERAL ELECTRIC



QUALITY PAGE IS
QUALITY

The Centennial Electric

General Electric, the world's leading supplier of motors and controls for all existing types of electric vehicles, has unveiled an experimental, subcompact-sized auto that it describes as "the electric car of today."

The four-passenger test vehicle - announced in September 1978 - was designed "from the ground up" to achieve top performance from off-the-shelf components and battery systems now commercially available in the marketplace. In honor of GE's 100th birthday, which the company celebrated in 1978, the sleek, two-toned blue vehicle has been named the "Centennial Electric."

This new test vehicle was designed to provide hard data about exactly where technology stands in the formidable quest to develop a practical electric car. It is equipped with improved lead-acid batteries, coupled with advanced solid state controls and a highly efficient electric traction motor. The vehicle is designed primarily for stop-and-go urban driving, and has an in-town range of about 45 miles between battery charges. About 11 million of the 111 million vehicles now on the nation's highways are second cars and delivery trucks used primarily for just this type of short-trip driving.

Electrics still must demonstrate that they can compete with conventional vehicles in such areas as reliability, safety, handling characteristics, and driver and passenger comfort, along with initial purchase price and trade-in value. A primary reason for building the Centennial Electric was to establish just how close existing electrical and electronic components and battery systems can approach these goals.

The development of a practical electric car is an obvious response to the world's dwindling petroleum reserves. Although GE has no plans at this time to manufacture or market electric vehicles, it foresees long-range opportunities as a supplier of components for this emerging market.

GE's Centennial Electric is literally "a laboratory on four wheels," designed so that its systems and components can be readily replaced by improved versions that come out of GE laboratories and product departments. One of GE's future plans, for example, is to test an AC drive system in the vehicle.

GE's front-wheel-drive electric was produced in a three-year project headed by the company's Research and Development Center in Schenectady, N.Y. The drive motor, solid state controls, plastic windows and other plastic parts, headlamps, and numerous other components were supplied off-the-shelf by more than a dozen GE product departments.

Triad Services, Inc., a leading electric automobile design firm based in Dearborn, Mich., designed and built the low-slung test car to GE specifications as an integrated concept, with all elements keyed to the GE propulsion system.

The car is powered by 18 six-volt, lead-acid batteries made especially for GE's Electric Vehicle Systems Operation, Salem, Va., by Globe-Union Inc., Milwaukee, Wisc. They are derived from the deep-discharge batteries now used commercially to power golf carts and forklift trucks, and can be recharged in six to eight hours by plugging them into a 220-volt electrical outlet.

Initial tests show that the vehicle has a range of 75 miles at a constant 40 miles per hour, a cruising speed of 55 mph, and a passing speed of up to 60 mph. It can accelerate from zero to 30 mph in nine seconds. By way of comparison, a conventional gasoline-powered car of similar size and weight can reach the same speed in about six seconds. Although the car is not for sale, it was designed to sell for about \$6,000 if 100,000 of them were manufactured annually in one plant.

The Centennial Electric is one of only a handful of electric vehicles that have been designed from scratch.

Many existing electrics are modifications of gasoline-powered compacts or are essentially "glorified" golf carts. For example, GE's test car has no grill because there is no radiator to cool. It has a low center-of-gravity because 1,225 pounds of batteries are slung on a movable trolley beneath the vehicle and run nearly its full length. The 24-horsepower DC series traction motor is tilted at an angle because the geometry of the drive train is simpler.

Among the features of the GE electric is the seating arrangement for rear-seat passengers. To keep the car low to reduce air drag and to permit easier entry and exiting, the seats face to the rear and are entered through a

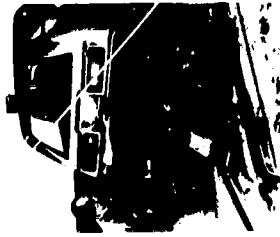

FACT SHEETS
GE-100 CENTENNIAL ELECTRIC VEHICLE

VEHICLE ORIGIN

- | | |
|--|----------------------|
| ● Developer | GE-CRD |
| ● Propulsion System, Electrical Components, Plastics | General Electric Co. |
| ● Battery | Globe-Union, Inc. |
| ● Vehicle Design & Fabrication | Triad Services, Inc. |

VEHICLE DESCRIPTION

Type	3-Door Commuter
Color	Two-tone Blue
Capacity	4 Adults
Curb Weight (including battery)	3250 #
Gross Weight	3850 #
Frontal Area	19.9 ft ²
C _D - Drag Coefficient	
- 0° Yaw	0.337
- Weighted for Yaw	0.367
Wheel Base	92 in.
Width	66.1 in.
Length	160 in.
Height	53.6 in.
Ground Clearance	6 in.

FACT SHEETS
GE-100 CENTENNIAL ELECTRIC VEHICLE

VEHICLE SPECIAL FEATURES

- Designed from ground up as Electric Vehicle
 - reduced aerodynamic drag
 - designed to meet Federal Motor Vehicle Safety Standards

- Utilizes commercially available components

- Excellent handling
 - front wheel drive
 - low center of gravity
 - low polar moment of inertia
 - good front to rear weight balance

- Unique packaging
 - batteries in separate tunnel
 - batteries removable as single unit
 - side doors open parallel to body (14" clearance)
 - full height gull wing rear hatch
 - rear facing back seats with ample room for two full-sized adults

- Minimum difference in driving "feel"
 - location of controls
 - similarity of instruments
 - similar handling characteristics

- Selected materials
 - stainless steel underbody
 - mild steel body
 - Lexan[®] polycarbonate resin side and rear windows
 - Lexan[®] headlamps covers
 - Noryl[®] thermoplastic resin dashboard and console

*Lexan[®] and Noryl[®] are registered trademarks of General Electric Company

FACT SHEETS
GE-100 CENTENNIAL ELECTRIC VEHICLE

PERFORMANCE (Measured)

Range

Urban - SAE J227a Schedule D	45 miles
40 MPH Constant Speed	75 miles
55 MPH - Cruising (calculated)	50 miles

Acceleration

0 - 30 MPH	9 sec
0 - 40 MPH	14 sec
0 - 50 MPH	30 sec

Speed

Cruising	55 mph
Passing	60 mph

Grade

Maximum	30%
---------	-----

FACT SHEETS
GE-100 CENTENNIAL ELECTRIC VEHICLE

DRIVE TRAIN DESCRIPTION

Armature Chopper & Controls	EV-1 (GE)
Chopper Efficiency	> 95%
DC Series Motor - 24 HP, 230#	5BT2364 (GE)
Maximum Motor Efficiency	86%
Propulsion Battery (3-year life) 108 V - 1225 #	(18) GC-419 (6V lead-acid) Globe-Union
Battery Recharge Time 230 V - 30 A	6 - 8 hours
Power Wiring Resistance	0.002 Ω
Drive Train Mechanical Efficiency	98%
Fixed Gear Ratio	5.62 : 1
Motor/Vehicle Speed Ratio	80.5 RPM/MPH

FACT SHEETS
GE-100 CENTENNIAL ELECTRIC VEHICLE

GE PRODUCTS

DEPARTMENT

- EV-1 Controls, Contactors Industry Control Dept.
 - 5BT2364 Motor DC Motor & Gen. Dept.
 - Lexan[®] Windows* & Headlamp Covers Plastic Sales Dept.
 - Noryl[®] Instrument Panel, Dash, Console, Wheel Covers Plastic Sales Dept.
 - Connectors, Plugs, Receptables Wiring Devices Dept.
 - Instruments & Shunts Meter Dept.
 - Wire & Cable Wire & Cable Dept.
 - Radio Audio Products Dept.
 - Head, Rear & Marker Lights Miniature Lamp Dept.
 - Interior Surface Finish Laminated & Insulating Products Dept.
 - Microswitches & Switchettes Appliance Control Products Dept.
 - Lubricants & Sealants Silicone Products Dept.
- * Windshield by Pittsburgh Plate Glass

FACT SHEETS
 GE 100 CENTENNIAL ELECTRIC VEHICLE

ENERGY CONSUMPTION - KWh/Mile

(Battery and Charger Efficiency ≈ 70%)

<u>Type of Driving</u>	Energy Consumption (KWh-mi)	
	Input to Charger From Wallplug	From Battery
● SAE J227a - Schedule D	0.429	0.300
● 40 MPH Constant Speed	0.285	0.193

VEHICLE SUMMARY DATA SHEET

- 1.0 Vehicle manufacturer General Electric/Triad Services, Inc.
- 2.0 Vehicle GE Reference Electric Vehicle
- 3.0 Price and availability One of a kind - experimental prototype \$250K
estimated replacement value
- 4.0 Vehicle weight and load
- | | |
|------------------------------------|--------------------|
| 4.1 Curb weight, kg (lbm) | <u>1475 (3250)</u> |
| 4.2 Gross vehicle weight, kg (lbm) | <u>1747 (3850)</u> |
| 4.3 Cargo weight, kg (lbm) | <u>-0-</u> |
| 4.4 Number of passengers | <u>4</u> |
| 4.5 Payload, kg (lbm) | <u>272 (600)</u> |
- 5.0 Vehicle Size
- | | |
|---|--------------------|
| 5.1 Wheelbase, m (in.) | <u>2.34 (92)</u> |
| 5.2 Length, m (in.) | <u>4.06 (160)</u> |
| 5.3 Width, m (in.) | <u>1.68 (66.1)</u> |
| 5.4 Height, m (in.) | <u>1.36 (53.6)</u> |
| 5.5 Head room, m (in.) | <u>.97 (38.3)</u> |
| 5.6 Leg room, m (in.) | <u>1.06 (41.9)</u> |
| 5.7 Frontal area, m ² (ft ²) | <u>1.77 (19)</u> |
| 5.8 Road clearance, m (in.) | <u>.15 (6)</u> |
| 5.9 Number of seats | <u>4</u> |
- 6.0 Auxiliaries and options
- 6.1 Lights (number, type, and function) Dual Beam Headlights (4),
Front Parking & Direction, Front Side Markers (Parking &
Direction), Rear Tail Lamp Assembly (Backup, Taillight, Di-
rectional, Stop), Rear Lic. Plate Lamp, Rear Side Markers
(Tail) - Dome light, 2 courtesy lamps, Dash cluster illumina-
tion lamps.

6.2	Windshield wipers	Non-Depressed Park	Yes
6.3	Windshield washers	Integral with wiper motor	Yes
6.4	Defroster	Gas Heater - Ram air & blower	Yes
6.5	Heater	Gas Heater - Ram air & blower	Yes
6.6	Radio		No
6.7	Fuel gauge	Battery state of charge	Yes
6.8	Ampmeter		Yes
6.9	Tachometer		No
6.10	Speedometer	BDO	Yes
6.11	Odometer	+ Trip Odometer	Yes
6.12	Right- or left-hand drive		LH
6.13	Transmission	Direct Drive	No
6.14	Regenerative braking		No
6.15	Mirrors	Interior Rear View & L&R Exterior	Yes
6.16	Power steering		No
6.17	Power brakes		No
6.18	Other	Radio - AM/FM/Stereo CB Tranceiver	Yes

7.0 Batteries

7.1 Propulsion batteries

7.1.1	Type and manufacturer	GC-419 - Globe-Union, Inc.	Lead-acid
7.1.2	Number of modules		18
7.1.3	Number of cells	3 each	54
7.1.4	Operating voltage, V	6 volts each	108
7.1.5	Capacity, Ah	75A for 106 minutes	132.5
7.1.6	Size of each battery, m (in.)	L = 0.26 (10 3/8), W = 0.18 (7 3/16), H = 0.29 (11 11/32)	
7.1.7	Weight kg (lbm)	per module 30.9 (68.1)	
7.1.8	History (age, number of cycles, etc.)	New - Few cycles operating vehicle during shakedown	

7.2 Auxiliary battery

7.2.1	Type and manufacturer	Snowmobile Garden Tractor Globe-Union, Inc. - Lead-Acid
7.2.2	Number of cells	6

7.2.3 Operating voltage, V 12

7.2.4 Capacity, Ah 20 hour rate 30

7.2.5 Size, m (in.) L = 197 (7 3/4), W = 130 (5 1/8),
H = 187 (7 3/8)

7.2.6 Weight, kg (lbm) 10 (21.8)

8.0 Controller

8.1 Type and manufacturer SCR EV-1C General Electric

8.2 Voltage rating, V 84 - 144 volts

8.3 Current rating, A 850 Peak, 375 Max Avg Batt, 150-200 Motor on duty cycle

8.4 Size, m (in.) L = 36.56 (14), W = 20.47 (8.06),
H - 17.68 (6.96) - H over hinged control 27.89 (10.98)

8.5 Weight, kg (lbm) 23.1 (51)

9.0 Propulsion motor

9.1 Type and manufacturer DC Series 5BT2364 General Electric

9.2 Insulation class F

9.3 Voltage rating, V 108

9.4 Current rating, A 195

9.5 Horsepower (rated), kW (hp) 17.9 (24)

9.6 Size, m (in.) OD = 0.29 (11.38), L (over shaft) = 0.51 (20.00)

9.7 Weight, kg (lbm) 104.36 (230)

9.8 Speed (rated), rpm 3000

10.0 Battery charger

10.1 Type and manufacturer Lab Model - Ferro Resonant, GE-CRD

10.2 On- or off-board type off

10.3 Input voltage required, V 1 - ϕ 220V

10.4 Peak current demand, A 27.5A

10.5 Recharge time, h 6 - 8

NOTE: On-Board Accessory Charger

- .1 - EVA DC-DC Transformer Isolated
- .2 - On Board
- .3 - 85 - 125V DC (Main Battery)
- .4 - 2.5A
- .5 - 4 - 6 hours
- .6 - L = .32 (12.5), W = 0.1 (4), H = 0.08 (3)
- .7 - 2.7 kg (6)
- .8 - Yes, Regulated

- 10.6 Size, m (in.) L = 0.38 (14), W = 0.28 (11), H = 0.28 (11)
- 10.7 Weight, kg (lbm) 43 (95)
- 10.8 Automatic turnoff feature Adjustable Timer - 12 hour max.

11.0 Body

- 11.1 Manufacturer and type Triad Services, Inc. - Hatchback
- 11.2 Materials Stainless steel underbody, Steel & Fiberglass body
- 11.3 Number of doors and type 2 parallelogram linkage side, 1 gull wing rear hatch
- 11.4 Number of windows and type glass windshield, mar resistant Lexan[®] - 2 fixed in side doors, 2 sliding in side doors, 2 fixed in rear quarters, 1 fixed in rear door
- 11.5 Number of seats and type 2 front full buckets, 2 removable rear-facing jump seats
- 11.6 Cargo space volume m³ (ft³) to window level 1.36 (48)
- 11.7 Cargo space dimensions, m (ft) L = 1.83 (6), W = 1.22 (4), H = 0.61 (2)

12.0 Chassis

- 12.1 Frame
- 12.1.1 Type and manufacturer unibody - Triad Services, Inc.
- 12.1.2 Materials Stainless steel backbone, fiberglass panels
- 12.1.3 Modifications New
- 12.2 Springs and shocks
- 12.2.1 Type and manufacturer Spring - new coils, shocks - Monroe take-aparts
- 12.2.2 Modifications New
- 12.3 Axles
- 12.3.1 Manufacturer Audi and Subaru
- 12.3.2 Front Audi Fox front wheel drive
- 12.3.3 Rear Subaru hubs, no axle
- 12.4 Transmission
- 12.4.1 Type and manufacturer New - Morse HyVo Chain Drive, Chrysler parking pawl, BW differential

- 12.4.2 Gear ratios Chain 1.36 to 1.0, Differential 4.135 to 1
- 12.4.3 Driveline ratio Overall 5.620 to 1
- 12.5 Steering
- 12.5.1 Type and manufacturer New - Triad Services, Inc.
- 12.5.2 Turning ratio 18.5 to 1
- 12.5.3 Turning diameter, m (ft) 9.75 (32)
- 12.6 Brakes
- 12.6.1 Front Inboard Chevelle with copper drums
- 12.6.2 Rear Subaru drums
- 12.6.3 Parking Vega coupled to front Chevelle
- 12.6.4 Regenerative None
- 12.7 Tires
- 12.7.1 Manufacturer and type Michelin radial
- 12.7.2 Size B78 - 13
- 12.7.3 Pressure, kPa (psi):
- | | | |
|-------|----------------------|------------------|
| Front | <u>165.5 - 179.3</u> | <u>(24 - 26)</u> |
| Rear | <u>165.5 - 179.3</u> | <u>(24 - 26)</u> |
- 12.7.4 Rolling radius, m (in.) 0.30 (11.8)
- 12.7.5 Wheel weight, kg (lbm):
- | | | |
|--------------|-----------------------------------|-------------------|
| Without drum | <u>Front brakes inboard-wheel</u> | <u>6.81 (15)</u> |
| With drum | <u>- wheel & tire</u> | <u>14.07 (31)</u> |
- 12.7.6 Wheel track, m (in.):
- | | | |
|-------|-------------|---------------|
| Front | <u>1.38</u> | <u>(54.5)</u> |
| Rear | <u>1.47</u> | <u>(58.0)</u> |
- 13.0 Performance
- 13.1 Manufacturer-specified maximum speed (wide-open throttle), km/h (mph) 96.5 (60)
- 13.2 Manufacturer-recommended maximum cruise speed (wide-open throttle), km/h (mph) 88.5 (55)
- 13.3 Tested at cruise speed, km/h (mph) 96.5 (60)

Section 4 Attachment C
ELECTRIC VEHICLE AC DRIVE STUDY

Section 4 Attachment C

ELECTRIC VEHICLE AC DRIVE STUDY

In late 1977 General Electric Corporate Research and Development undertook a study of promising ac traction motor drives both medium-term and long-range. The study recommended an ac induction motor with transistor voltage inverter for development in the medium-term and a permanent magnet synchronous disk motor with thyristor load-commutated inverter for long-range development. The medium-term ac induction motor is being developed on NASA Contract Number DEN3-59. The ac PM synchronous motor is being developed on a General Electric-funded program.

WORK STATEMENT FOR ELECTRIC VEHICLE AC DRIVE STUDY

OBJECTIVE

This study will identify the most promising ac traction motor electric drive system concepts for an electric automobile for medium-term development starting in 1978. Exploratory longer-term concepts will be identified and the more promising examined.

APPROACH

At least three different vehicle duty cycles will be used to identify the range of applicability of the various drive concepts. The three principal duty cycles are:

- The SAEXJ227D duty cycle (as the standard) (Figure C-1)
- The SAEXJ227A duty cycle which has additional stop-start duty typical of delivery vehicles
- A steady speed, few stop-type duty for commuter car applications

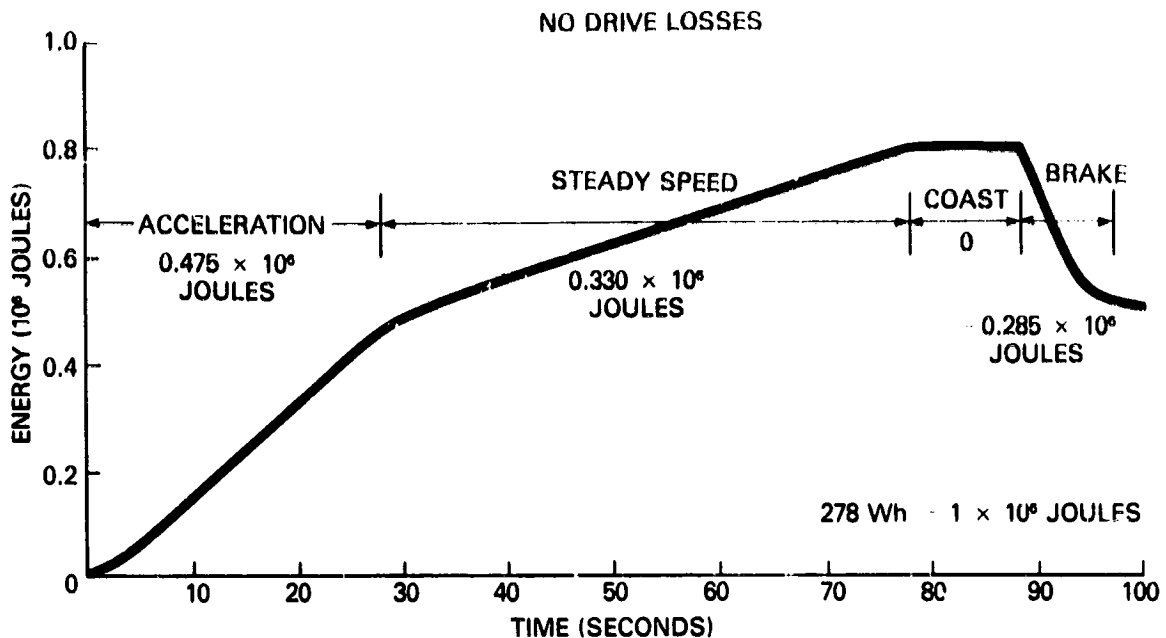

Figure C-1. Energy for J227, a Schedule D Driving Cycle

It is expected that some of the drive concepts can be optimum for one type of duty, such as steady speed running, while others will be better for other duty cycles such as stop-start running. The GE/ERDA 3000-pound electric automobile will be used as the basic vehicle for which each drive will be designed. All drives will meet the ERDA performance goals.

CONSTRAINTS

The drives will consist of the energy source, a power converter, an ac electric traction motor(s), and a mechanical drive coupling the motor to the wheels.

Three electrical energy source systems will be considered: a lead-acid battery, a flywheel, and a hybrid flywheel-battery system.

The motor types to be considered will include:

- Synchronous motor
 - Wound rotor
 - Inductor
 - Permanent magnet
- Inductor motor

Both the conventional and disc forms will be examined.

Power converters to be examined will include:

- Voltage converter
- Current converter
- Transistors
- Thyristors

The mechanical drives to be considered will include:

- Fixed-gear reduction
- Infinitely variable transmission
- Direct drive (wheel motors)

The performance of the candidate drive systems will be evaluated using a simplified vehicle performance program to determine:

- Drive efficiency
- Drive weight
- Range
- Vehicle performance

An estimate of the weight and cost of the candidate systems will be provided on a comparison rather than absolute basis. A

subjective assessment of other drive system characteristics, such as operational complexity, reliability, fabricability, etc. will be made.

TASKS

- Task 1 - Gather existing information and build background.
- Task 2 - Establish the electric vehicle performance baseline and specify the three duty cycles.
- Task 3 - Design in some detail an ac induction motor for the drive and evaluate the motor weight change required as a function of the duty cycle and type of mechanical transmission used.
- Task 4 - Select and examine other types of traction motors including advanced concepts based on the detailed design of Task 3. Estimate the costs, weights and efficiencies.
- Task 5 - Design power conversion apparatus for each type of motor in enough detail to estimate size, weight, costs, performance, and efficiency.
- Task 6 - Assemble the results of the drive evaluation into a matrix of drive system candidates and derive a system "cost" evaluation equation to rank the resulting systems.
- Task 7 - Prepare a report.

II. AC DRIVE STUDY METHODOLOGY

The initial screening considered the following:

1. Motor variations

- Synchronous
 - PM disc
 - PM conventional
 - Wound field on rotor
 - Inductor (field on stator)
- Induction
 - Cast rotor
- DC separately excited motor (reference design)

2. Power converter variations

- Inverter suitable for each motor
 - Thyristor
 - .. McMurray voltage
 - .. Auto - sequential current
 - .. Third harmonic load commutated
- Transistor
 - .. Voltage
 - .. Current
- DC transistor regenerative chopper with bypass and field control (reference design)

3. Gearing

- Fixed gearing
 - Limit in speed to 15,000 rpm

- .. Mist bearings
- .. Double gear reduction
- Gear changing
 - Fixed gear changes
 - .. Three or four-to-one speed ratio for motor

Preliminary designs of motors and controls were made to determine cost, weight, efficiency, and vehicle range for each. Quite early in the study gear change versus fixed-gearing was determined a stand-off when one considered the weight, cost, and gear efficiency of the transmission, as well as the more complex control. This is aggravated by the fact that the motor and control would be sized by the maximum power requirements which occur when passing at high speeds and when maintaining high speed on a grade. These factors negated the possibility of reducing propulsion equipment, weight, and cost for accelerations at low speeds through gear changing.

The inductor motor was rejected early in the study because of weight, cost, inertia, and low efficiency. It is ideally suited for operating with an energy storage flywheel but is not viable as a propulsion motor.

RESULTS OF THE STUDY

The results of the study are summarized in Tables C-1 through C-4 and in Figures C-2 through C-5.

Table C-1
 RELATIVE MOTOR AND EXCITER COSTS

Motor and Control Type	Exciter Cost (\$)				Motor and Exciter Relative Costs
	Cost (\$)	Inverter	Field Chopper	Total Cost (\$)	
Separately Excited with dc Chopper	872	675	100	1647	1.00
McMurray ac Induction Motor	200	2547	-	2747	1.67
McMurray ac Wound Synchronous Motor	242	2547	100	2889	1.75
Load-Commutated Inverter's & ac Wound Synchronous Motor	242	1537.5	100	1779.5	1.08*
Load-Commutated Inverter PM Synchronous Motor Including Field Exciter	200	1537.5	100	1737.5	1.05*
Controlled Current ac Induction Motor	200	4897	100	5097	3.09
Transistor Voltage ac Induction Motor	200	1425	100	1625	0.99*
Transistor Voltage ac Wound Synchronous Motor	242	1425	100	1767	1.07*
Load-Commutated Inverter Improved PM Synchronous Improved Capacity	100	1537.5	100	1637.5	0.99*
Transistor Voltage PM Synchronous Motor with Real dc Motor Price	200	2850	100	3050	1.85
Load-Commutated Inverter ac Inductor Motor	466	1537.5	100	2103.5	1.28
Transistor Voltage ac Induction Motor (5000 rpm)	276	1425	100	1701	1.03*

*Lowest cost options

Table C-2
EFFECT OF MOTOR TYPE AND CONTROL ON RANGE CHANGE

Motor and Control Type	Weight			Efficiency			Range (Miles)	Range Change (%)
	Motor	PCU	Total	Motor	PCU	Combined		
dc Chopper	218	49	267	0.84	0.97	0.81	60.0	0
McMurray 1 ac Induction Motor (1500 rpm)	100	140	240	0.935	0.90	0.842	62.8	+4.67
McMurray ac-wound synchronous motor	121	140	261	0.93	0.90	0.837	62.1	+3.5
Load-Commutated Inverter ac-wound synchronous Motor	121	150	271	0.93	0.925	0.86	63.6	+6.0
Load-Commutated Inverter PM Synchronous Motor Including Field Exciter	100	150	250	0.935	0.925	0.865	64.4	+7.33*
Controlled Current ac Induction Motor (15,000 rpm)	100	423	523	0.935	0.905	0.846	58.6	-2.33
Transistor Voltage 1 ac Induction Motor (15,000 rpm)	100	87	187	0.935	0.945	0.884	66.9	+11.50*
Transistor Voltage ac-wound Synchronous Inverter	121	87	208	0.93	0.945	0.879	66.2	+10.33*
Load-Commutated Improved PM Synchronous Motor Improved Capacity	50	100	150	0.96	0.925	0.888	67.9	+13.2
Transistor voltage PM Synchronous Motor with Real dc Motor Price	100	174	274	0.935	0.918	0.858	63.4	+5.7
Load-Commutated ac Induction Motor	233	150	383	0.90	0.925	0.833	62.1	+3.5
Transistor Voltage ac Induction Motor (5000 rpm)	138	87	225	0.925	0.945	0.874	65.8	+9.71*

*Highest range options

Table C-3
MOTOR DATA

Motor Type	Weight lb	Average Efficiency	Cost (\$)
dc Commutator	218	0.84	872
ac Induction High-Speed Motor (15,000 rpm) + Gear	100	0.935	200
ac Rotating Field Synchronous Motor	121	0.93	250
ac PM Motor	100	< 0.935	200
ac Inductor* Motor	233	0.90	466
ac Induction* Low-Speed Motor (5000 rpm)	138	0.925	276

*ac Inductor and ac Induction (5000 rpm) added later on same basis

Table C-4
POWER CONVERTER DATA

Power Converter Type	Weight (lb)	Average Efficiency (%)	Cost (\$)
dc Chopper with Bypass	49	97.0	775
ac Transistor Inverter for Induction Motor	87	94.5	1425
ac SCR McMurray Inverter	140	90.0	2547
ac SCR Load-Commutated Inverter	150 (125, measured)	92.5 (93.0)	1538
ac SCR Current Inverter (ASCI)	423	90.5	4897
ac Transistor Inverter for PM Motor	174	91.8	2850

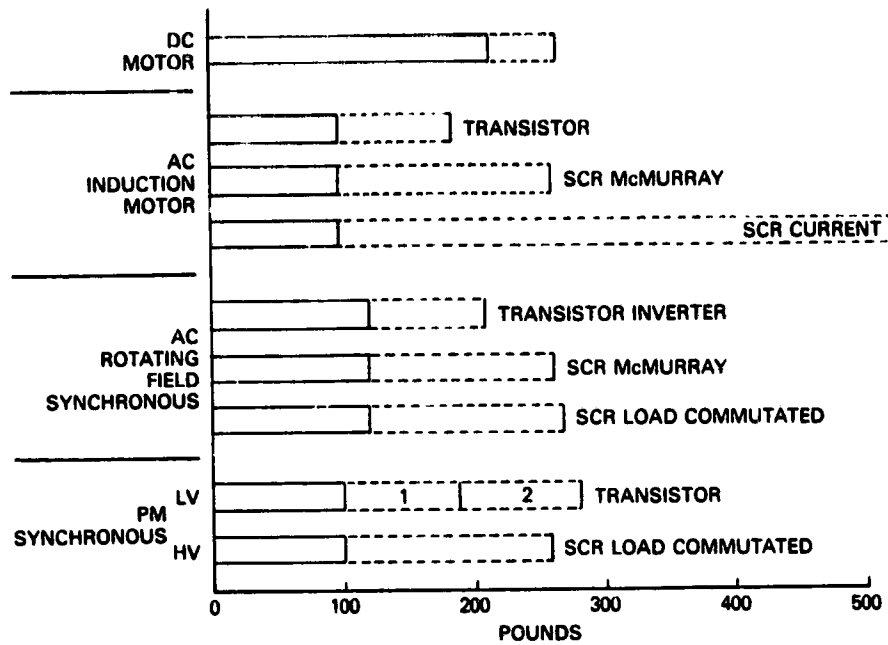

Figure C-2. Influence of Motor and Control on System Weight

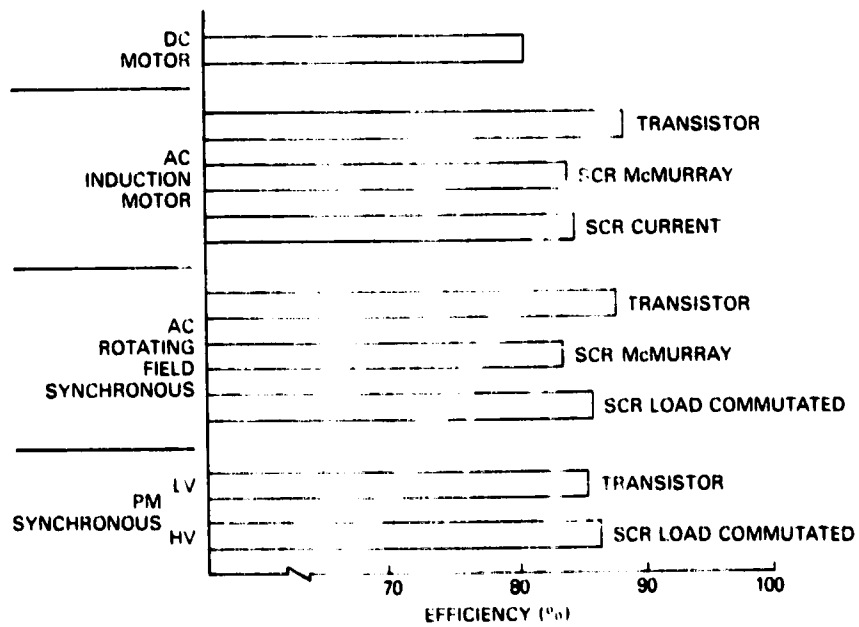

Figure C-3. Influence of Motor and Controller on System Efficiency

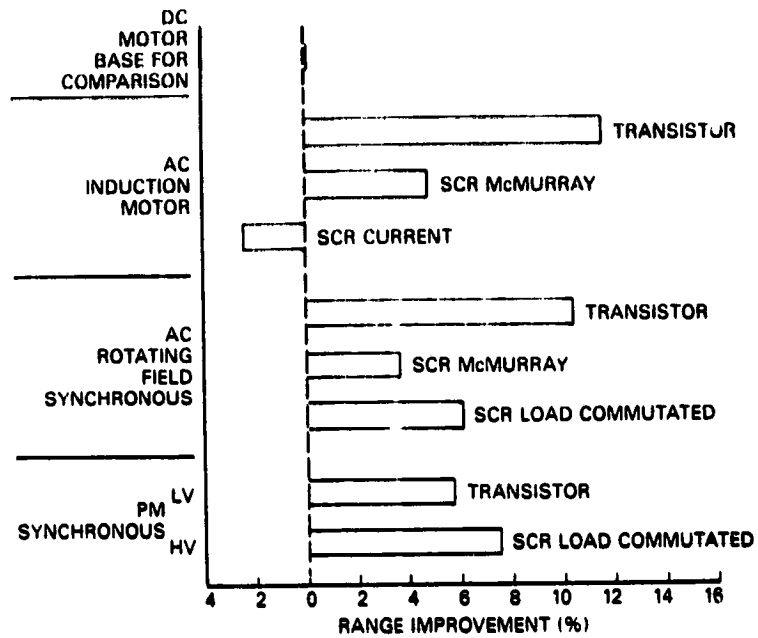

Figure C-4. Influence of Motor and Controller on ac - System Range Improvement over dc System

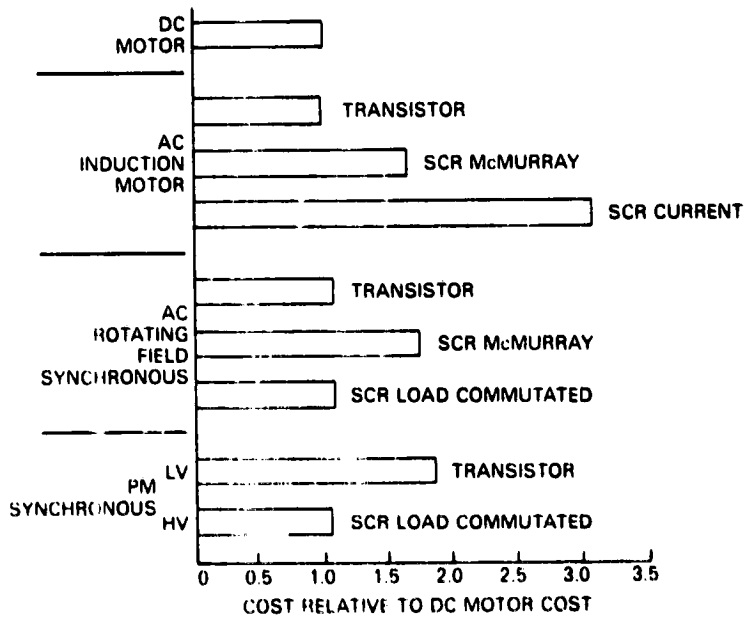

Figure C-5. Relative Cost of Motor and Control Options

III. RECOMMENDATIONS

NEAR-TERM

For the near-term the induction motor with a transistor inverter is recommended. The induction motor features include lightweight, high-efficiency, rugged construction, and low cost. The transistor inverter features lightweight, high-efficiency power modules.

Developments recommended include:

- High-power transistors
- Simple base drive
- PWM generator
- Control strategy to minimize currents

FAR-TERM

For the far-term an innovative PM synchronous motor with a load-commutated SCR inverter is recommended. The PM synchronous motor would feature low magnetic loss. A feature of the load-commutated SCR inverter would be its high-voltage capability.

Developments recommended include:

- Theory of motor design
- Mechanical construction designs
- Smooth-starting capability with load commutation

Section 4 Attachment D
PROPULSION SYSTEM DESIGN TRADE-OFF STUDIES

Section 4 Attachment D

PROPULSION SYSTEM DESIGN TRADE-OFF STUDIES

In early November 1978, preliminary evaluation of the electric propulsion requirements for the hybrid vehicle were established. Based on the recommendations of the General Electric ac drives study, an ac induction motor with transistor voltage inverter was selected as the preferred ac drive. The separately excited motor with transistor regenerative armature chopper with field control or the separately excited dc motor with a shifting transmission and field control were selected as the preferred dc drives. These three systems were to be compared in the detailed trade-off studies.

For purposes of the study, an induction motor of a more conventional speed range was chosen for evaluation. This motor, the Tri Clad 700 ac severe duty, energy power design (Reference 14), is in volume production and can be modified for electric vehicle duty as was the dc motor which is a modified version of the industrial truck motors (Reference 12). Should the high-speed ac induction motor program be as successful as anticipated and should the motor be put in high-volume production, then it can be substituted for the lower speed system for slightly improved weight.

I. SUMMARY OF DRIVE MOTOR STUDIES

Information in this subsection was prepared to aid in the selection of a drive motor. The procedures and methodology presented are to serve as a guide only toward motor selection. Data pertinent to a specific vehicle would have to be used in place of the data used to illustrate an example of how the motor calculations are made. The material on motors was prepared by W.R. Oney, General Electric Corporate Research and Development.

Figure D-1 is the "Maximum Drive Shaft Torque Specification for a Nominal Design "Motor" with:

- Maximum torque = 100 lb-ft
- Corner point speed = 2400 rpm
- Maximum speed = 6000 rpm
- Constant power = 2400 to 6000 rpm

Figure D-2 is a general specification for drive shaft (DS) torque where the variables are T_{MAX} (maximum torque), N_o (corner point and base speed), N_{MAX} (maximum rpm), and S_{MAX} (maximum per rpm and speed which is 60 mph). The corner point may vary $\pm 25\%$ in both rpm (1800 to 3000 rpm) and torque (75 to 125 lb-ft).

Figure D-3 is a map of the "Motor Voltage for a Nominal Design." Motor voltage is constant volts/cycle up to the corner point. From the corner point to the maximum speed, the motor voltage V varies as $V_o \times S^c$, where:

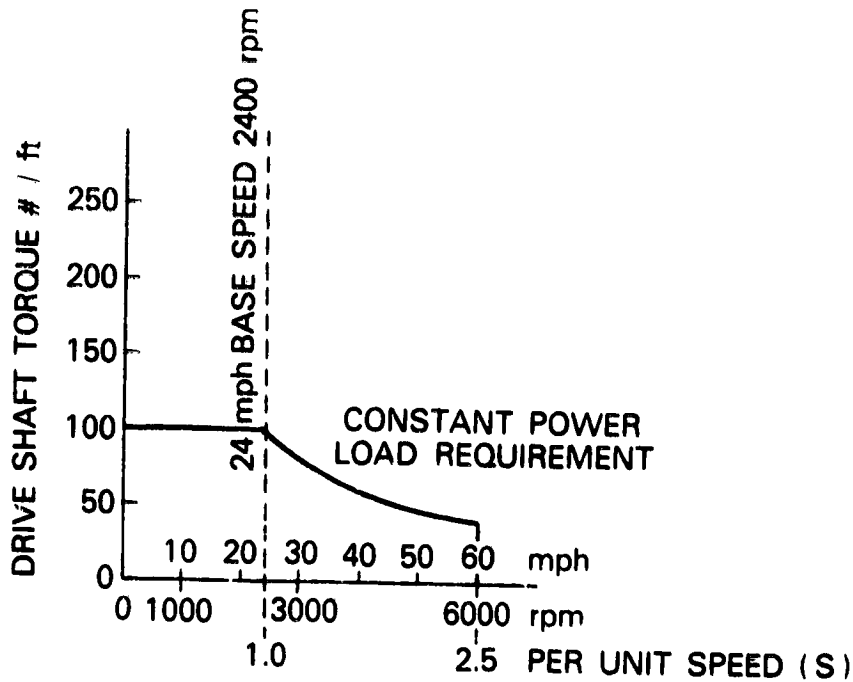

Figure D-1. Maximum Drive Shaft Torque Specification for a Nominal Design Motor

- V_o is the corner point voltage ($0.632 \leq V_o \leq 1.0$)
- S is the pu speed or pu rpm
- ϵ is an exponent ($0 \leq \epsilon \leq 0.5$)

At maximum speed, N_{MAX} and S_{MAX} , the motor voltage is the highest ac voltage attainable when using a battery. It is designated V_{MAX} for convenience. It is assumed that power conditioner kVA is proportional to current and motor torque is proportional to D^2L or weight. These assumptions are satisfactory for small perturbations. When given T_{MAX} , N_o , and S_{MAX} , the lowest subsystem motor-controller cost occurs for the condition:

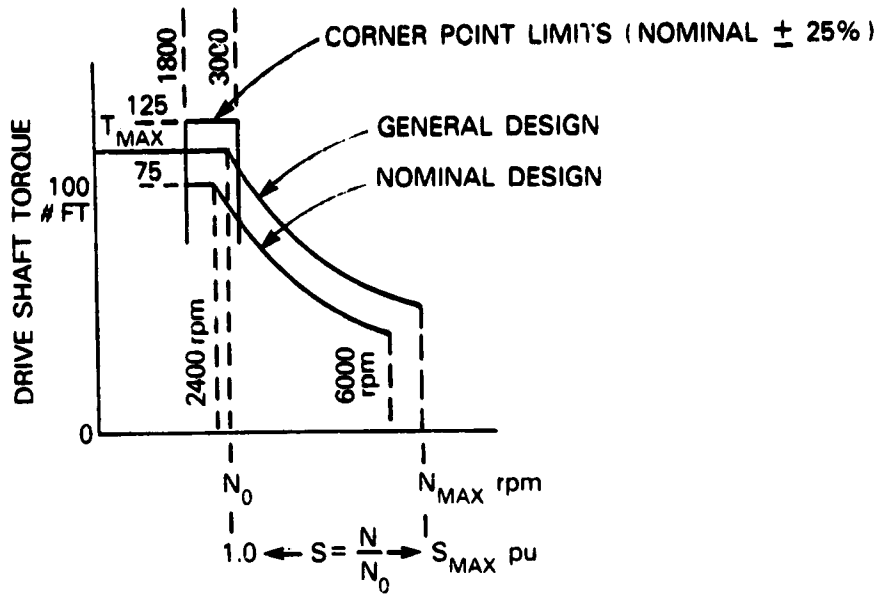

Figure D-2. General Specification for D.S. Torque

$$\frac{V_{MAX}}{V_0} = \sqrt[3]{2 \times \frac{M_c}{PC_c} S_{MAX}}$$

where:

M_c = motor cost for a corner point voltage $V_0 = 0.632$

PC_c = power conditioner cost for a corner point voltage of $V_0 = 1.0$.

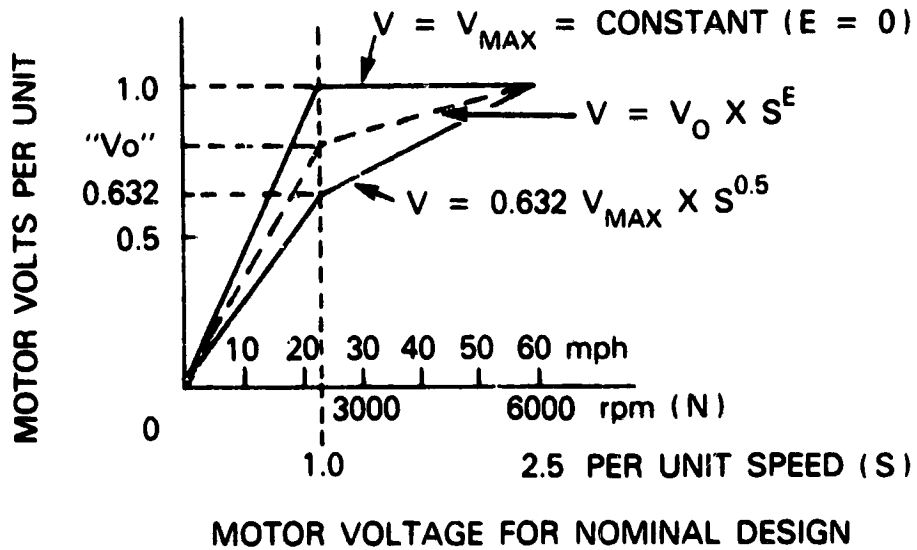

Figure D-3. Motor Voltage for Nominal Design

The exponent is:

$$E = \frac{\ln \frac{V_{MAX}}{V_0}}{\ln S_{MAX}}$$

The limits of $\frac{M_c}{PC_c}$ in the above equation are:

$$\frac{S_{MAX}^{0.5}}{2} \geq \frac{M_c}{PC_c} \geq \frac{1}{2 S_{MAX}}$$

Results outside these limits must be evaluated on their own merits.

Total cost and weight of motor-controller subsystem:

$$\begin{aligned} \text{Total Cost} &= \text{kVA}_{PC} \times \left(\frac{\$}{\text{kVA}} \right) + \text{Motor Weight} \times \left(\frac{\$}{\text{lbs}} \right) \\ \text{Total Weight} &= \text{kVA}_{PC} \times \left(\frac{\text{lbs}}{\text{kVA}} \right) + \text{Motor Weight} \end{aligned}$$

A. MOTOR EVALUATION

If the motor shaft is direct connected to the transmission, the motor cost/lb is:

$$\begin{aligned} \left(\frac{\$}{\text{lb}} \right)_M &= 1.8 \times \left(\frac{N_o}{1800} \right)^{0.5} \times \left(\frac{S_{MAX}}{2.5} \right)^{0.5} \\ \text{Motor Weight (lb)} &= \left[138 \times \left(\frac{T_{MAX}}{100} \right) \right] \times S_{MAX}^{1-2^c} \\ \text{Motor Cost (\$)} &= \text{Motor Weight (lb)} \times \left(\frac{\$}{\text{lb}} \right)_M \end{aligned}$$

If the motor has an internal step down gear like a gearmotor with a ratio of r, the motor estimated cost per pound is:

$$\begin{aligned} \frac{\$}{\text{lb}}_M &= 1.8 \times \frac{N_o}{1800}^{0.5} \times \frac{S_{MAX}}{2.5}^{0.5} \times r^{1.5} \\ &= 1.8 \times \sqrt{\frac{N_o r^3 S_{MAX}}{4500}} \end{aligned}$$

where N_o is the rpm of the shaft which connects the gearmotor with the transmission.

$$\begin{aligned} \text{Motor weight for an aluminum gearmotor (lb)} &= \left[\left(\frac{138}{r} \right) \times \left(\frac{T_{MAX}}{100} \right) \right] \\ &\quad \times S_{MAX}^{1-2^c} \end{aligned}$$

$$\text{Again: Motor Cost (\$)} = \text{Motor Weight (lb)} \times \left(\frac{\$}{\text{lb}} \right)_M$$

The lowest cost system will favor the more expensive controller. Therefore, the motor will be heavy. Weight may be reduced by using a gear motor (or its equivalent). However, motor shaft torque-to-inertia diminishes directly with r . Self-accelerating torque will be an important consideration for the final design.

Surface speed of the rotor which is related to rotational stresses has been ignored in the mathematics model.

Motor envelope dimensions are calculated using a volume density of 13.5 in.³ per pound and an overall length-to-diameter of 1.45. A blower is needed to cool the motor, but blower dimensions and mounting are not included in this envelope. Gears for a gearmotor have not been sized.

Efficiency at the corner point will be 87 to 91%. Efficiency over the duty cycle may be calculated from its equivalent circuit. Typical data might be used until the final design is started.

B. SUMMARY STATEMENT

These equations and their constants will enable the designer to focus on a design which should be just short of a final design. All equations and their constants should then be re-evaluated using new empirical data. This will minimize the uncertainty of the results by shortening the sealing range.

C. EMPIRICAL DATA

Reference Motor -- T/C 700 Aluminum Motor; Open 4-Pole

- Horse power = 20
- rpm = 1755
- $T_{MAX} = 2.0 \text{ pu} = 2 \times 59.9 \text{ lb/ft}$
- Efficiency = 86 to 88%
- Power factor = 80 to 83%
- Weight = 149 lb
- Inertia = 1.91 lb/ft

Reference Motor -- High-Efficiency Design; Open 4-Pole

- Horse power = 20
- rpm = 1760 @ 60 Hz
- $T_{MAX} = 2.0 \text{ pu} = 2 \times 59.7$
- Efficiency = 0.92
- Power factor = 0.87
- Weight = 204 lb
- Inertia = $1.91 \times 6/4.375 = 2.62 \text{ lb/ft}$

Reference Motor -- NASA Induction Motor; No gears

- Continuous horsepower = 22 @ 42V per phase
- rpm = 5370 @ 180 Hz
- Torque $(J1=900)^* = 65.2 \text{ lb/ft @ 45 V/pH}$
- Efficiency = 94.6 @ 22 hp
- Power factor = 69.4 @ 22 hp
- Weight = 90 lb
- Inertia = 0.55 lb/ft^2

Note: Calculated performance characteristics are speculative.

*The Maximum Torque of Motor is 122 lb/ft at a slip of 4.5% with 45 V/pH and 1040 A. This is not a cost-effective operating point because current is disproportionally high or torque-per-ampere is low.

$$(\$/\text{lb})_{\text{Motor}} = A \times \sqrt{\frac{N_o S_{\text{MAX}} r^3}{4500}}$$

$$\text{Motor Weight alone (lb)} = \left[\left(\frac{B}{r} \right) \times \left(\frac{T_{\text{MAX}}}{100} \right) \right] \times S_{\text{MAX}}^{1-2\epsilon}$$

	<u>A</u>	$\frac{K_2}{B}$	<u>r</u>
Aluminum motor	1.8	138	1
High efficiency	1.9	182	1
NASA induction motor	2.0	138	r

Note: Each succeeding motor type requires more development.

D. BACKGROUND FOR K₂

Torque per ampere degrades approaching T_{MAX}. So: Operate to only 90% of T_{MAX}.

Reference motor has a useful T_{MAX} = 0.90 x 2 x 59.9 lb/ft.
 DS Load is specified as T_{MAX} = 100 lb/ft. Motor Shaft Load = 100/η_T.
 Assume Torque ∝ D²L ∝ Weight

The weight of a motor that will produce a useful 100 lb/ft is:

$$\text{Weight} = 149 \times \frac{100/\eta_T}{107.8} = 138 \text{ lb}$$

\uparrow
 η_T = 1.0

E. METHODOLOGY

The following material and calculations are presented to show methodology only and also to serve as a sample calculation.

Sample calculation for nominal design

$$T_{\text{MAX}} = 100; N_o = 2400; S_{\text{MAX}} = 2.5; \text{Let } r = 1.0$$

Corner Point Calculations for Optimum Power Conditioner

$$(V_o = V_{BAT}; \epsilon = 0)$$

From F.G.T. 1/20/79, p. 14A:

If \$M = \$37.50

62 kVA power conditioner will

weigh 1.4 lbs/kVA

cost \$11/kVA or $\frac{\$682}{V_o=V_{BAT}} = PC_c$

Corner Point Calculations for Optimum Motor:

$$(V_o = 0.632 V_{BAT}; \epsilon = 0.5)$$

$$\begin{aligned} \text{Motor Weight (lb)} &= \left[138 \times \frac{T_{MAX}}{100} \right] \times S_{MAX}^{1-2\epsilon} \\ &= 138 \text{ lb} \end{aligned}$$

$$\begin{aligned} \text{Motor \$/lb} &= 1.8 \left(\frac{N_o}{1800} \right)^{0.5} \times \left(\frac{S_{MAX}}{2.5} \right)^{0.5} \\ &= \$2.0785/\text{lb} \end{aligned}$$

$$\text{Motor Cost } (M_c) = 138 \times 2.0785$$

$$= \frac{\$286.83}{V_o = 0.632 V_{BAT}}$$

F. LOWEST COST SUBSYSTEM

$$\frac{M_C}{PC_C} = \frac{286.83}{682} = 0.4706$$

$$\begin{aligned} \text{Lowest Cost } \frac{V_{BAT}}{V_O} &= \sqrt[3]{2 \times \frac{M_C}{PC_C} \times S_{MAX}} \\ &= 1.28116 \quad \text{or} \quad \frac{V_O}{V_{BAT}} = 0.7805 \end{aligned}$$

$$\epsilon = \frac{\ln \frac{V_{BAT}}{V_O}}{\ln S_{MAX}} = 0.2704$$

$$\begin{aligned} \text{PC-kVA} &= \left[62 \times \left(\frac{100}{100} \times \frac{2400}{2400} \right) \right] \times 2.5^{0.2704} \\ &= 79.43 \end{aligned}$$

$$\begin{aligned} \text{Motor Weight (lb)} &= \left[138 \times \left(\frac{100}{100} \right) \right] \times 2.5^{1-2} \times .2704 \\ &= 210.19 \text{ lb} \end{aligned}$$

$$\begin{aligned} \text{Total Cost} &= \text{PC-kVA} \times \left(\frac{\text{lb}}{\text{kVA}} \right) + \text{Motor Weight} \times \left(\frac{\$}{\text{lb}} \right) \\ &= 79.43 \times 11 + 210.19 \times 2.0785 = \underline{\underline{\$1311}} \end{aligned}$$

$$\begin{aligned} \text{Subsystem Weight} &= \text{PC-kVA} \left(\frac{\text{lb}}{\text{kVA}} \right) + \text{Motor Weight} \\ &= 79.43 \times 1.4 + 210.19 = 321 \text{ lb} \end{aligned}$$

G. HIGH MODULE COST

If \$M = \$150

$$PC_C = 11.25 \times (\$M) + 250 = \$1937$$

$$\$5/kVA = \frac{1937}{62} = \$31.25$$

$$\frac{M_L}{PC_L} = \frac{286.83}{1937} = 0.14808 \approx \frac{1}{2} \times S_{MAX}$$

Therefore: Let $V_O = V_{BAT}$ & $\epsilon = 0$

and $PC - kVA = 62$

also Motor Weight (lb) $138 \times \frac{100}{100} \times 2.5^{1-2 \times 0} = 345$

Subsystem Cost = \$1937 + Motor Weight x \$/lb
 = 1937 + 345 x 2.0785 = \$2654

Subsystem Weight = 62 x 1.4 + 345 = 431.8 lb

Note: $K_\alpha \approx 1 - .0214 \times \frac{345}{138}^{5/3} = 0.90$

Again, for \$M = 150; assume a gear motor with $r = 2.5$ and assume motor power factor and efficiency unchanged (but actually that would not be the case).

Then,

$$\text{Motor Weight} = \frac{345}{r} = \frac{345}{2.5} = 142 \text{ lb}$$

$$\begin{aligned}
 (\$/\text{lb})_{\text{Motor}} &:: 1.8 \times \frac{No}{1800}^{0.5} \times \frac{S_{MAX}}{2.5}^{0.5} \times r^{1.5} \\
 &= 1.8 \times \left(\frac{2400}{1800}\right)^{0.5} \times \left(\frac{2.5}{2.5}\right)^{0.5} \times 2.5^{1.5}
 \end{aligned}$$

$$= \$8.216/\text{lb}$$

$$\text{Motor Cost} = 142 \times \$8.216 = \$1166$$

$$\text{Subsystem Cost} = \$1937 + 1166 = \$3103$$

$$\text{Subsystem Weight} = 86 + 142 = 228 \text{ lb}$$

$$\text{Note: } K_{\alpha} = 1 - .0214 \times \frac{345}{138}^3 \times 2.5^{1/3} = 0.86$$

The Inertia Ratio for 138-lb motor is 0.0214.

$$K_{\alpha} = 1 - 0.0214 \times \frac{\text{Wt Motor}}{138}^{5/3} \times r^{1/3}$$

$$= 1 - 0.0214 \times \frac{138 \times \frac{T_{\text{MAX}}}{100} \times S_{\text{MAX}}^{1-2\epsilon}}{138}^{5/3} \times r^{1/3}$$

$$K_{\alpha} = 1 - 0.0214 \times \frac{T_{\text{MAX}}}{100} \times S_{\text{MAX}}^{1-2\epsilon} \times r^{1/3}$$

Rather than use the gearmotor try a less optimum V_O/V_{BAT} .
 For PC = 1.4 lb/kVA; \$M = 150; \$/kVA = 31.25. Motor cost is \$2.0785/lb. One can then construct the following table.

V_O/V_{BAT}		PC-kVA	Motor Weight (lb)	Cost Subsystem (\$)	Weight Subsystem (lb)	K_{α}
1.0	0	62.0	345	2654	431	0.90
0.9	0.1150	68.9	279.4	2733	375	--
0.8	0.2435	77.5	220.8	2880	329	--
0.7	0.3893	88.6	169.1	3120	293	--
0.632	0.500	98.0	138.0	3350	275	0.98
No Gearmotor:		\$3350	0.98	\$3418		
Gearmotor:		\$3103	0.86	\$3608		

III. AC MOTOR DATA

Specific data defining the characteristics of an ac induction motor was needed as identified by the internal memorandum which follows. This data was furnished for use on the program in the form of a General Electric Company proprietary computer program devised by the Small AC Motor Department. The data is given in General Electric Company Brochure GEP-1087D, AC Motor Buyers' Guide, and in Table D-1.

Table D-1
AC MOTOR DATA

Continuous Duty Rating, hp	20.00
Base Speed (60 Hz), rpm	1800.00
Voltage per phase (LN), V	266.00
Line Current, A	23.32
Power Factor	0.87
Slip	0.0297
Stator Resistance (per phase at 95 °C), ohms	0.3322
Rotor Resistance (per Phase Referred to Stator), ohms	0.2466
Stator reactance, ohms	1.159
Rotor Reactance per Phase Referred to Stator), ohms	1.184
Magnetizing Reactance (per phase referred to stator), ohms	42.45
Magnetizing Branch Resistance (in Series with Reactance), ohms	1.467

TO: MEMO FOR THE RECORD
FROM: C.B. Somuah
DATE: March 14, 1979
SUBJECT: TEST DATA ON AC INDUCTION MOTOR

As part of the Hybrid Vehicle Simulation studies, characteristics of ac induction motors in the horsepower range of 18 - 25 are required. The following list gives the specifications for the motor and also the type of test data required. The data is required for the computation of the winding resistances, leakage reactances, and the motor friction, windage and core losses. Alternatively, if these parameters are already available from test data or computer calculations, then they can be supplied instead of the test data.

MOTOR SPECIFICATIONS (3 Phase)

Continuous Duty = 18 - 25 hp at 1800 rpm
Peak Power = 2 x continuous duty
(20 sec.)
Voltage Rating = 80 - 250 volts rms
(L-L)

REQUIRED TEST DATA

- (1) No Load (Light Running) Test
- Power versus voltage
 - Current versus voltage
 - Power factor versus voltage
 - Slip versus voltage
- (2) Short Circuit (Locked Rotor) Test
- Power versus current
 - Power factor versus current
 - Voltage versus current

/dl1
cc: A. Burke
R. Guess

C.B.S.

4D-16

II. SUMMARY OF AC POWER CONDITIONER STUDY

The ac power conditioner study resulted in the development of parametric equations, related to a specific duty cycle, for:

- Weight
- Volume
- Efficiency
- Losses
- Cost
- Component requirements

In addition, the effect of battery voltage level was examined and a comparison was made with other power conditioning systems.

$$1. \quad I_{dc} = \frac{(\text{peak motor kVA}) (\text{power factor of motor}) (10^3)}{(0.95) (\text{battery voltage})} \text{ A}$$

$$2. \quad \text{Maximum fundamental frequency}$$

$$= \frac{(\text{maximum motor speed}) (\text{number of motor poles})}{120} \text{ Hz}$$

$$3. \quad \text{Maximum chopping frequency}$$

$$= (9) (f) / \text{speed ratio at constant power Hz}$$

$$9 = \text{chopping frequency ratio}$$

$$4. \quad \text{rms kVA over duty cycle} \\ (\text{proportional to amperes})$$

$$5. \quad \text{Weight} = 88 \left(\frac{I_{ac}}{483} \right) \left(\frac{\text{rms kVA over duty cycle}}{42.23} \right) \text{ lb}$$

$$6. \text{ Volume} = 2 \left(\frac{I_{dc}}{483} \right) \left(\frac{\text{rms kVA over duty cycle}}{42.23} \right) \text{ ft}^3$$

$$7. \text{ Power conditioner losses} = 100 + 1952 \left(\frac{I_{dc}}{483} \right) + 54 \left(\frac{I_{dc}}{483} \right)^2 + 3.5 \left(\frac{I_{dc}}{483} \right) \left(\frac{f}{200} \right) + 140 \left(\frac{I_{dc}}{483} \right)^2 \left(\frac{f}{200} \right) \text{ W}$$

(constant power region)

$$8. \text{ Power conduction losses} = 100 + 1952 \left(\frac{I_{dc}}{483} \right) + 54 \left(\frac{I_{dc}}{483} \right)^2 + 50 \left(\frac{I_{dc}}{483} \right) \left(\frac{f_{chop}}{720} \right) + 504 \left(\frac{I_{dc}}{483} \right)^2 \left(\frac{f_{chop}}{720} \right) \text{ W}$$

(constant torque region)

$$9. \text{ Efficiency} = 100 \left[\frac{E_{BATT} \cdot I_{dc} - P_{losses}}{E_{BATT} \cdot I_{dc}} \right] \%$$

10. Power conditioner cost = 11.25 (\$M) + \$250, \$M = power transistor module cost

11. Power conditioner cost/kVA peak = [11.25(\$M) + 250] / 62
 if \$M = 37.50, then $\frac{\text{cost}}{\text{kVA}} = 11 \text{ \$/kVA peak}$

12. PCU weight/kVA = 1.4 lb/kVA peak

13. PCU Volume/kVA peak = 0.003 ft³/kVA peak

14. Battery voltage level. In order to reduce weight, volume, and cost and increase efficiency, one may increase battery voltage to the limits imposed by power transistor switching voltage ratings.

$E_{BATT \text{ max}} = 150$ for regenerative systems

$E_{BATT \text{ max}} = 216$ for nonregenerative systems

Based on V_{CEO} (SUS) rating of 450 V.

15. Comparison with other ac systems. For the present study, the National Aeronautics and Space Agency ac Controller and Rohr 312 are equivalent except the weight of the Rohr 312 may not include dc capacitors or a dc contactor.

A. DESIGN EQUATIONS FOR AC POWER CONDITIONING STUDY

Based on engineering calculations, the rating of the power conditioner is 62 kVA at the corner point.

For a six-step waveform, the line-to-neutral ac voltage is equal to 0.45 (E Battery)

$$V_{L-N} = 0.45(108) = 48.6 \text{ V}$$

$$I_{rms} = \frac{62,000}{3(48.6)} = 425 \text{ A rms}$$

$$\begin{aligned} \text{ac Power} &= \text{kVA} \cdot \text{power factor} \\ &= 62,000 (0.8) = 49,600 \text{ W} \end{aligned}$$

$$\begin{aligned} \text{dc Current (average)} &= \frac{\text{ac power}}{(\text{Eff pec}) (E_{BATT})} = \frac{49,600}{(0.95)(108)} = 483 \text{ A} \\ &\qquad\qquad\qquad \text{assumed} \end{aligned}$$

$$\begin{aligned} \text{Peak Transistor } I_{rms} &= I_{rms} [1.2 + (\text{harmonic component})] \\ &= 425 [1.2 + (1.76 \times 10^{-3}) (1.37 \times 10^{-4}) (2.26)] \\ &= 425 (1.2 + 0.545) = 425 (1.959) \\ &+ 832 \text{ A} \end{aligned}$$

The circuit diagram is given in Figure D-4.

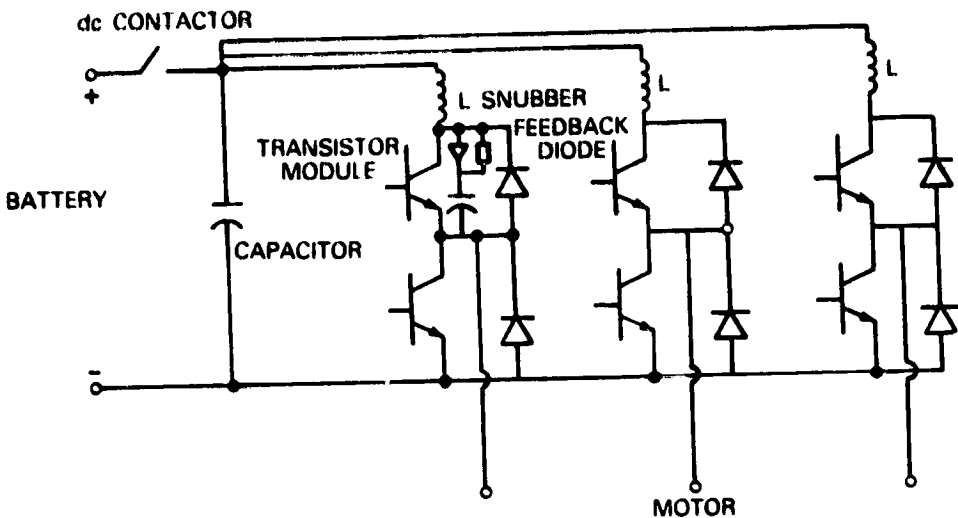

Figure D-4. Power Circuit Diagram

Power Conditioner Losses at Maximum Frequency

Assume battery cable inductance (L) = 2 μh

1. Commutation loss (no recovery)

$$P = \frac{1}{2} LI^2 f = \frac{1}{2} (2) (10^{-6}) (483)^2 (200)$$

P = 46.6 W/phase = 140 W total
in square wave at maximum frequency

2. Transistor and feedback diode correlation loss

$$P = \left(\frac{E_{ON}}{TRANS} \right) (I_{AVE}) (\text{Ratio of on time}) + \left(\frac{E_{ON}}{Diode} \right) (I_{AVE}) (\text{Ratio of on time})$$

$$P = (1.8) \left(\frac{483}{3} \right) \left(\frac{2}{3} \right) + (2.4) \left(\frac{483}{3} \right) \left(\frac{1}{3} \right)$$

P = 322 W device

$$P_{TOTAL} = 3 \times 322.5 = 1932 W$$

3. Transistor switching loss

$$P = I_{AVE} E_{dc} \frac{t_{fall}}{t_{period}}$$

$$P = \frac{483}{3} (108) \frac{2 \times 10^{-6}}{2500 \times 10^{-6}} \quad \text{at 200 Hz, } t_{period} \text{ equals } 2500 \mu\text{s}$$

$$P = 3.5 \text{ W}$$

4. Total losses

$$\text{Transistor \& diode loss} = 140 + 1932 + 3.5 = 2076 \text{ W}$$

(square wave at 200 Hz)

Power Conditioner Losses at Maximum Chopping Frequency

In the PWM mode maximum frequency of chopping is

$$200 \frac{1}{2.5} \times 9 = 720 \text{ Hz}$$

speed ratio

1. Commutation loss

$$P = 3 \frac{1}{2} (L) (I^2) (f)$$

$$= (3) \frac{1}{2} (2) (10^{-6}) (483)^2 (720)$$

$$= 504 \text{ W}$$

2. Conduction loss = same = 1932 W

3. Switching loss

$$P = \frac{183}{3} (108) \frac{2 \times 10^{-6}}{694 \times 10^{-6}} \quad \text{at 720 Hz, period is equal to } 694 \mu\text{s}$$

$$P = 50.1 \text{ W}$$

4. Total losses in transistor = 504 + 1932 + 50 = 2486 W
& diode (at 9 x f below corner point)

Additional Losses in AC Power Conditioner

1. Base drive loss = $\frac{I_C}{100} \times V_{BE}$ gain of Darlington

= $\frac{483}{100} \times 4 = 20 \text{ W}$

2. Control power = 100 W (assumed)

3. Capacitor loss = $I^2 R$

I harmonic = $(425(0.545))^2$

P = $(425)^2 (0.545)^2 (0.001) = 54 \text{ W}$

Total System Efficiency

1. PCU efficiency = $\frac{(108)(483) - \overbrace{2075 - 20 - 100 - 54}^{2249}}{(108)(483)}$

(square wave at 100 Hz)

= 95.7%

2. PCU efficiency = $\frac{(108)(483) - \overbrace{2486 - 20 - 100 - 54}^{2660}}{(108)(483)}$

(at 9f at 80 Hz fundamental)

= 94.9%

The electrical design is for the peak instantaneous voltage, current, etc., corresponding to the 2.0 per unit torque requirement. The continuous rating of the system is one-half of the peak rating. Therefore, the continuous rating is 3/kVA.

The 2.0 torque from the duty cycle corresponds to 62 kVA, the 0.4 torque corresponds to 24.8 kVA. The rms kVA which is proportional to torque is as follows:

$$\begin{aligned} \text{rms kVA} &= \frac{(62)^2(20) + (24.8)^2(20)}{50} \\ &= 42.23 \text{ kVA} \end{aligned}$$

The ratio of peak to rms kVA is $62/42.23 = 1.47$ for the specified duty cycles.

In order to calculate the parametric equation relating weight to power conditioner electrical specifications, two factors are paramount. First, for those items that have no thermal storage capability, for example, power transistors and diodes, the weight will be proportional to the peak battery current. If the peak current is increased, additional components will be required leading to a direct increase in weight. Second, for these items that do have thermal storage capability (compared to the 20s 62 kVA specification), e.g., heat sinks, the weight will be proportional to the rms kVA over the duty cycle. For these components if the rms current is increased over the duty cycle, there will be a direct increase in the system weight. Therefore, the weight equation will be composed of three items: first, a constant of proportionality; second, a term proportional to peak dc current; and third, a term proportional to rms kVA over the duty cycle.

$$\text{Weight} = K_1 \frac{I_{dc}}{483} \frac{\text{rms kVA over duty cycle}}{42.23}$$

In order to determine K, one needs to calculate the weight of the 31-kVA, 108-V design.

Component and Heat-Sink Weight

1. A representative heat sink for power transistors would be a Wakefield 132-4.5. It has a thermal resistance of 0.15 °C per watt and a one-minute thermal time constant. Its weight (with a clamp) is 1800 g.
2. Solid-state device = 200 g independent of current rating
of current rating
3. Snubber = 200 g
4. Driver electronics = 200 g
Total electronics 2400 g ≈ 5 lb
5. dc Contactor ≈ 3.75 lb
6. Control circuits and microprocessor ≈ 5 lb
7. dc Capacitors ≈ 20 lb

Total Weight of AC Propulsion System

	<u>Unit Weight (lb)</u>	<u>Total Weight (lb)</u>
6 Transistor/Diode Modules	5.00	30.00
1 Control Circuit	5.00	5.00
1 dc Contactor	3.75	3.75
1 Capacitor	<u>20.00</u>	<u>20.00</u>
Subtotal		58.75
Package Weight	assuming it is 50% of total	29.38
Total Weight		88 lb

Weight Equation

$$\text{Weight} = 88 \frac{I_{dc}}{483} \frac{\text{rms kVA over duty cycle}}{42.23} \text{ lb.}$$

Based on this

equation, several conclusions can be reached:

1. Effect of battery voltage - If battery voltage increases, dc current decreases and weight is decreased.
2. Effect of ϵ exponent in voltage corner point equation - As ϵ increases, from zero to 0.5 the corner point current increases, thereby increasing the weight directly, as shown in Figure D-5.

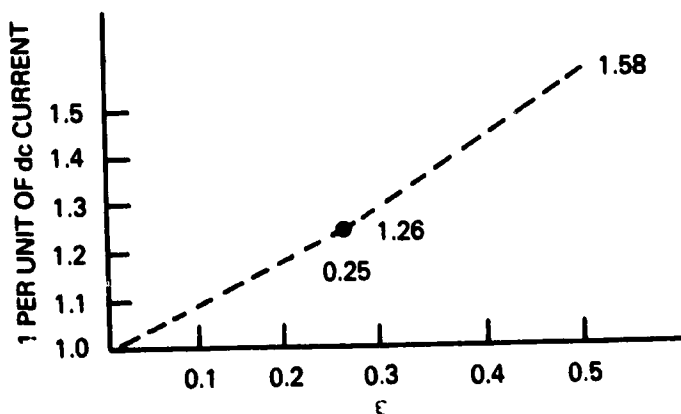

Figure D-5. Effect of ϵ Exponent in Voltage Corner Point Equation

Power Conditioner Size

Size is again proportional to the weight, and the same factors that influence weight influence size. Assume that size is related to continuous kVA. The present dc power conditioner is 1.60 ft³ and weighs 95 lb. It has a one-minute rating of 48.6 kW and a continuous rating of 24.3 kV.

$$\text{Volume} = K_2 \frac{I_{oc}}{483} \frac{\text{rms kVA over duty cycle}}{42.23}$$

The calculation of the K_2 coefficient proceeds as follows.

$$\text{for the dc controller, } \frac{\text{ft}^3}{\text{kW}} = \frac{1.6}{24.3} = 0.0658 \left(\frac{\text{ft}^3}{\text{kW}} \right)$$

$$\text{for the ac controller, } \text{ft}^3 = 0.0658 (31) = 2.04$$

$$\text{Volume} = 2 \frac{I_{\text{dc}}}{483} \left(\frac{\text{rms kVA over duty cycle}}{42.23} \right) \text{ft}^3$$

Dimensions are flexible, and a rectangular or cubic package is permissible. The thermal path for forced air will influence the shape.

Power Conditioner Losses

Use the equation in the form of $P = K_1 + K_2 I + K_3 I^2 + K_4 \left(\frac{f}{f_B} \right) (I) + K_5 \left(\frac{f}{f_B} \right) (I)^2$.

K_1 = loss that is not a function of current, i.e., control power, pins, base drive power etc.

K_2 = loss that is proportional to current, i.e., transistor with voltage drop independent of current.

K_3 = resistive loss, proportional to I^2 .

K_4 = loss due to operation at higher frequency than base frequency (f_B of 200 Hz) to account for transistor switching loss increment.

K_5 = loss due to operation at a higher frequency than base frequency to account for additional resistive losses.

In the constant power mode of operation:

$$P_{\text{Losses}} = 100 + 1952 \left(\frac{I}{483} \right) + 54 \left(\frac{I}{483} \right)^2 + 3.5 \left(\frac{I}{483} \right) \left(\frac{f}{200} \right) + 140 \left(\frac{I}{483} \right)^2 \frac{f}{200}$$

In the constant torque mode of operation:

$$P_{Losses} = 100 + 1952 \frac{I}{483} + 54 \frac{I^2}{483^2} + 50 \frac{I}{483} \frac{f/chop}{720} + 504 \frac{I^2}{483^2} \frac{f/chop}{720}$$

with $f \text{ chop} = \frac{(9)(f)}{\text{speed ratio}}$.

Power Conditioner Efficiency

$$\begin{aligned} \text{Efficiency} &= 100 \frac{(E_{dc})(I_{dc}) - P_{Losses}}{E_{dc}I_{dc}} \\ &= (100) \cdot \frac{(108)(483) - 2249}{(108)(483)} = 95.7 \end{aligned}$$

The part-load efficiency is calculated and plotted as follows.

(Figure D-6)

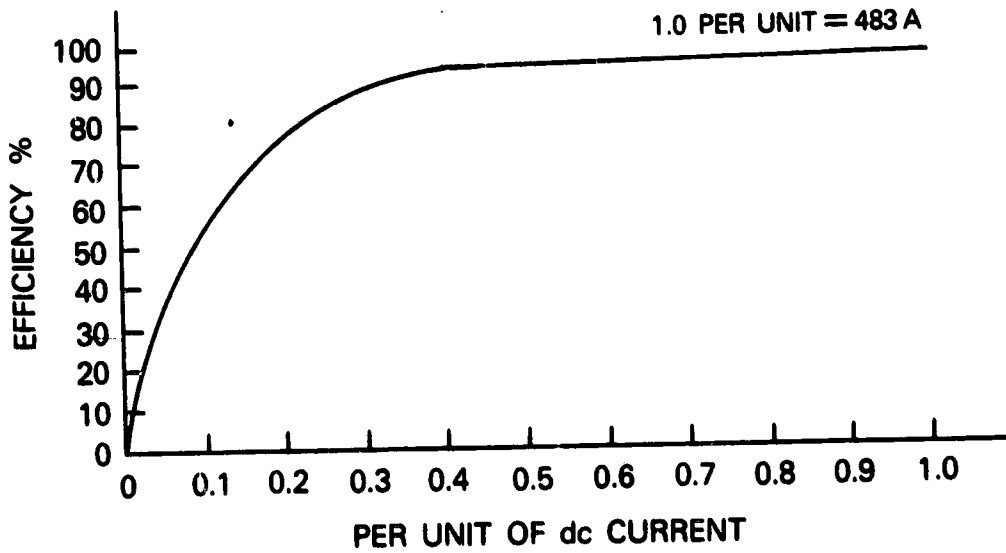

Figure D-6. Calculated Efficiency Versus per Unit dc Current

Cost of Power Conditioner

<u>Major Component</u>	<u>Number in Circuit</u>	<u>(\$) Cost (ea)</u>	<u>(\$) Total Cost</u>
1. Transistor & Diode Module	6	\$M*	6 (\$M)*
2. dc Capacitor	1	20	20
3. dc Contactor	1	10	10
4. Control Circuits	1	100	100

*Module cost (\$M) will be a parameter in the cost equation.

The total cost of major components = 6(\$M) + 130 dollars.

Assuming that minor electrical parts add 25% to the total cost of major electrical parts, the total cost of all components = 125[6(\$M) + 130].

Assuming that packaging and assembly add 50% to the total cost of major and minor electrical parts, the total cost of equipment = 1.5[1.25(6(\$M) + 130)]. Collecting terms, results in:

$$\underline{\text{Total cost of power conditioner}} = 11.25(\$M) + \$250$$

The cost of a power module (\$M) has been treated as a variable, the total cost as a function of the module cost is given in Figure D-7.

Cost/kVA Peak

$$\frac{\text{Cost of Power Conditioner}}{\text{kVA}} = \frac{(11.25)(\$M) + 250}{62} \quad \$/\text{kVA}$$

if \$M = \$37.50, then \$/kVA = 11

if \$M = \$50., then \$/kVA = 13

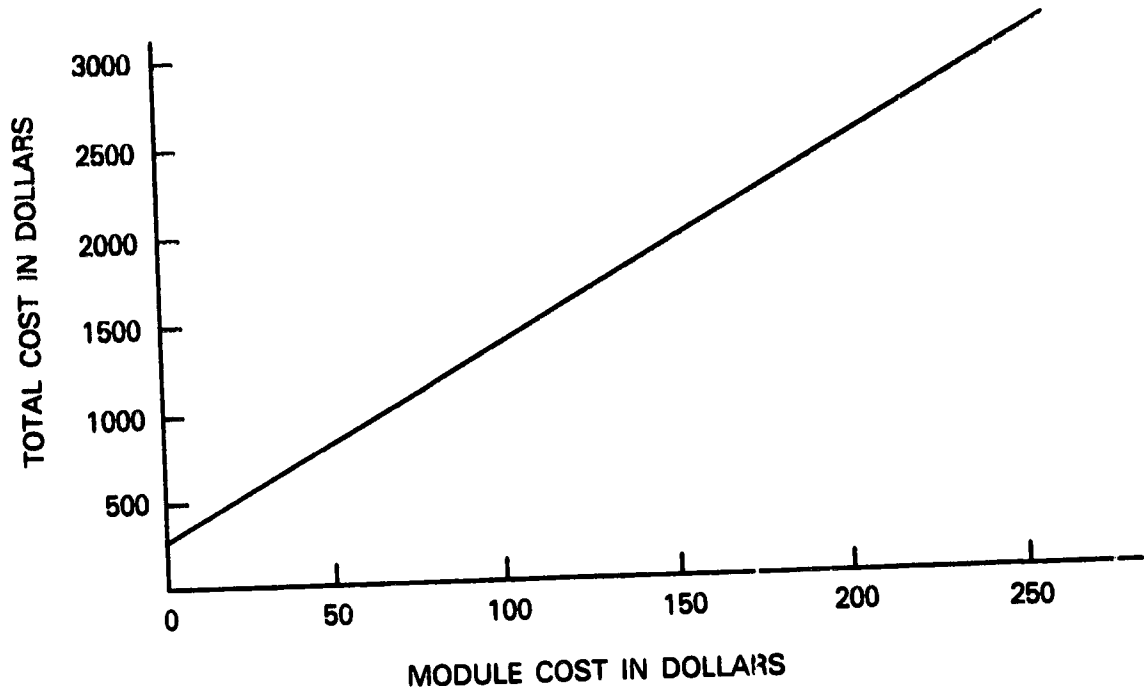

Figure D-7. Total Cost as a Function of Module Cost
 If \$M = 37.50, then Total Cost = \$675
 If \$M = 50.00, then Total Cost = \$825

Weight/kVA Peak

Weight/kVA = $88/62 = 1.4$ lb/kVA peak constant over 25% range of variables.

Weight/kVA Continuous

Weight/kVA continuous = $88/31 = 2.8$ lb/kVA continuous.

Volume/kVA Peak

Vol/kVA peak = $2.04/62 = 0.03$ ft³/kVA peak

B. EFFECT OF BATTERY VOLTAGE LEVEL

1. Factors That Would Favor an Increase in Battery Voltage

1. The conduction voltage $V_{CE(SAT)}$ of power transistors is independent of current and equal to 1.5-1.8 v for Darlington transistors, results in higher efficiency.
2. Less current means a smaller area of silicon for power transistors and diodes resulting in lower cost.
3. Less current means less transistor switching loss, resulting in higher efficiency.
4. Less current means less resistive loss (I^2R) in capacitors, cables, etc. which results in higher efficiency.
5. Less current permits smaller size of series reactive elements (if required), which results in smaller size.
6. Less current allows smaller cables resulting in a lighter weight vehicle.

2. Factors That Would Favor a Decrease in Battery Voltage

1. Transistor voltage rating (V_{CED} and V_{SUS}) during switching off should be limited to approximately one-half of the battery voltage. Since the present transistor V_{CED} rating is 450 v, maximum battery voltage equals 450/2 or 225 V dc. During regeneration, the battery voltage level will increase.

2. Low ESR electrolytic capacitors have dc voltage ratings less than 150 V. However, computer grade electrolytic (slightly higher ESR) capacitors have voltage ratings to 450 V.
3. Snubber loss is proportional to the square of the battery voltage $P = 1/2 CE^2 f$ or $1/2 LI^2 f$, results in slightly lower efficiency.

3. Summary

For maximum efficiency, lowest weight, and smaller size, increase dc voltage to the limit imposed by present power transistor switching voltage ratings; approximately 216 V for nonregenerative systems or 150 V for regenerative systems.

C. TRANSISTORIZED AC POWER TRANSISTOR

PROPULSION SYSTEMS COMPARISON

Parameter	Hybrid ¹ Vehicle Study	Rohr ² 312	NASA ³ ac Controller
Battery voltage, volts	108	96	108
kVA (maximum)	62	88	50
kW (maximum at .8 power factor)	50	70	40
Maximum fundamental frequency, Hz	200	300	500
Efficiency, %	95	92-97	94-97
Peak transistor current, A	827	-	680
Battery current, A	480	-	400
Approximate weight, lb	88	46 ⁴	87

¹Present study calculations

²NASA CR-135340 April 1978

³Present contract calculations and progress reports

⁴Weight of contactor or dc capacitors may not be included in this total

Section 4 Attachment E
PRODUCIBILITY ANALYSIS

FOREWORD

A cost-reduced redesign for the Power Conditioning Unit (PCU) developed on the Near-Term Electric Vehicle Program - Phase II has been completed. The costs based on this methodology have been used in the detailed trade-off studies. The producibility analysis which was completed is presented here.

PRODUCIBILITY ANALYSIS OF ELECTRICAL DRIVE SUBSYSTEM
FOR NEAR TERM ELECTRIC VEHICLE

Robert D. King

General Electric Company
HMED - Advanced Development Engineering
Syracuse, N.Y.

April 2, 1979

PRODUCTION OF THIS DOCUMENT IS UNCLASSIFIED

I. INTRODUCTION

This producibility analysis estimates the selling price of a production Electrical Drive Subsystem, EDSS, for the Near-Term Electric Vehicle. Results from this cost estimate will be integrated with the cost estimate of the vehicle, to be provided by Chrysler Corporation, to establish the selling price of a production version of the Near-Term Electric Vehicle. Production quantities of 100,000 electric vehicles per year starting in 1982, are assumed for this cost analysis.

Manufacturing cost, for this analysis, is defined as the sum of the material cost, material handling, labor (direct and indirect), and factory overhead. Acquisition (selling price) includes the manufacturing cost plus payback of investment for plant, equipment, research and development, and profit (after taxes). EDSS selling price does not include any cost of sales adders, since it is only a subsystem that will be integrated into the total vehicle.

Major components (using Integrated Test Vehicle, ITV, terminology) of the EDSS include: Microcomputer (μ computer), Power Conditioning Unit (PCU), electric drive motor, on-board charger power unit, and propulsion batteries. Additional EDSS components include: internal EDSS electrical interface, component temperature sensing and control, plus cooling fans. Figure 1-1 illustrates a functional block diagram of the major EDSS components and electrical interface. Operator interface with EDSS are all assumed to be elec-

FIGURE 1-1. ELECTRIC DRIVE SUBSYSTEM BLOCK DIAGRAM (ITV TERMINOLOGY)

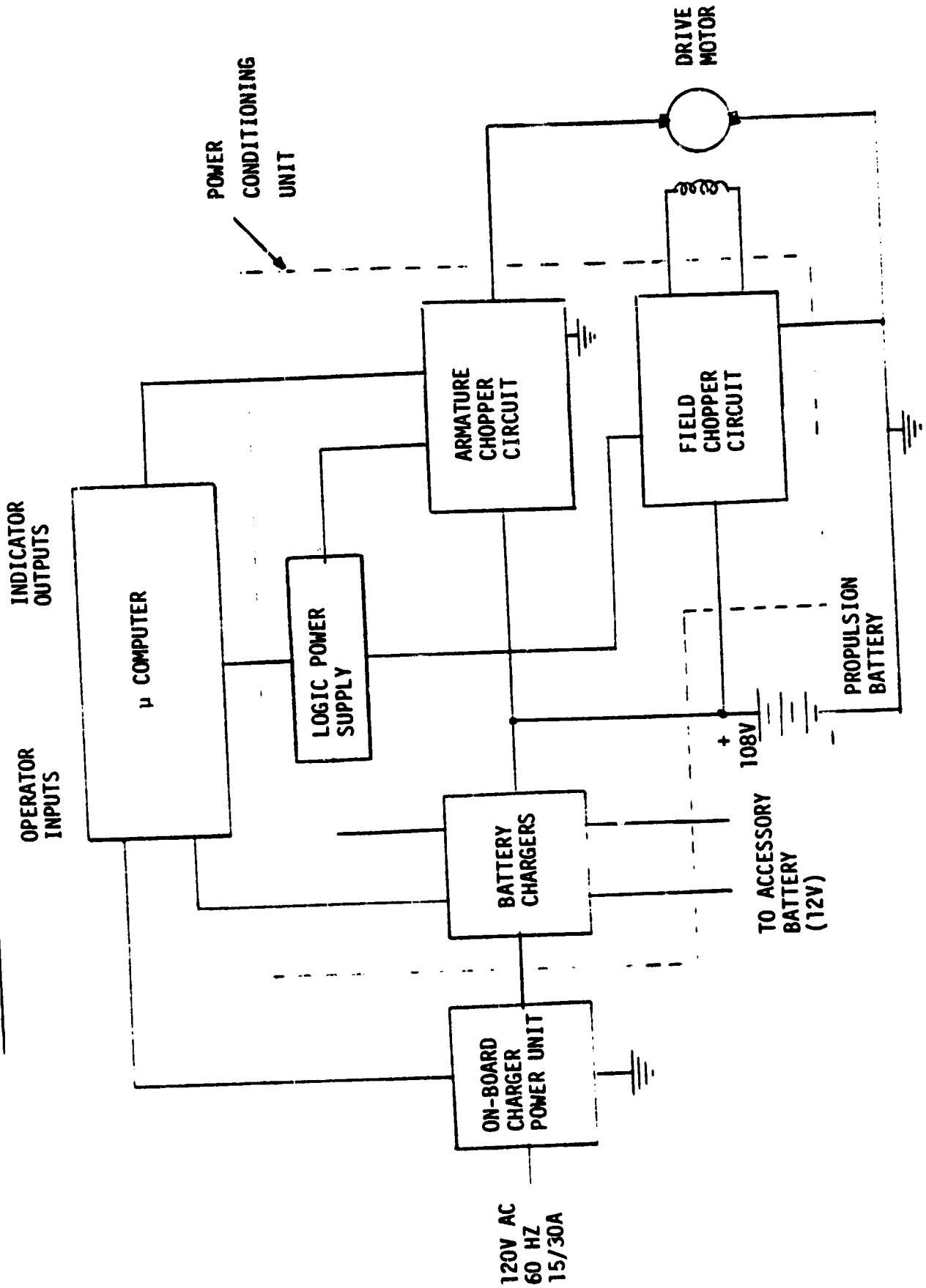

4E-6

trical; i.e., a voltage proportional to accelerator pedal position, brake differential pressure transducer, and logic levels corresponding to selector switch positions, etc. Conversely, EDSS provides electrical signals with sufficient power to drive indicator lights and the fuel gauge in the instrument panel.

Redesign and simplification of the ITV EDSS is necessary to achieve a low cost electrical drive subsystem for a high volume Production Electrical Vehicle (PEV). Producibility of the redesigned EDSS is improved via system simplification, Large Scale Integration (LSI), alternate packaging concepts, and high volume automated production/testing techniques.

EDSS producibility analysis manufacturing and selling price results presented in the report are appropriate only for the following assumptions:

- 1) Costs are in first quarter 1979 dollars
- 2) 100,000 EDSS systems (vehicles) are produced per year starting in 1982
- 3) Major plant and equipment investments are amortized over 10 years (1,000,000 vehicles)
- 4) R&D and production prototype programs are amortized over three years (300,000 vehicles)
- 5) Vehicle R&D and production prototype programs have been completed prior to 1982 production
- 6) Automated manufacturing and computerized testing techniques are used extensively to reduce production costs
- 7) Production Electric Vehicle, PEV, performance equal or superior to Integrated Test Vehicle, ITV

- 8) Drive motor cost based on a G02V index of 100 in General Electric's Apparatus Handbook
- 9) Drive motor length dimension and weight can be optimized for minimal EDSS system cost
- 10) EDSS cost optimization allows alternate component packaging techniques.

II. EDSS PRODUCIBILITY ANALYSIS RESULTS

Electric vehicle Electrical Drive System (EDSS) producibility analysis results presented in this section are appropriate only for the assumptions stated in Section I. Table 2-1 provides a functional summary of the estimated manufacturing cost of the EDSS. Material costs are obtained from vendor quotes/estimates of the components in production quantity. Labor estimates are based on typical assembly times for similar General Electric Electronic systems. Table 2-2 illustrates that the selling price estimate of a Production Electric Vehicle (PEV) EDSS is \$2,697.89.

In this study, propulsion batteries and drive motor are obtained via subcontracts. These subcontracted items are assumed delivered directly to the vehicle manufacturer for installation. Therefore, no overhead adders or profits are attached to these subcontracted items.

The following section provides detail on the cost methodology, ITV simplification, and packaging techniques used in obtaining the PEV EDSS costs.

TABLE 2-1
EDSS FUNCTIONAL COST SUMMARY

<u>FUNCTION</u>	<u>MATERIAL COST(\$)</u>	<u>LABOR (MINUTES)</u>	<u>EST. MFG. COST (\$), 100K QTY.</u>	
EV Integrated Control	38.88	27.6	73.58	+
Battery Chargers & Logic Power Supply Brd.	106.03	119.4	233.72	PCU
PCU Backplane & Housing	9.11	29.7	34.66	+
Armature/Field Base Drive Brd.	48.68	63.5	113.83	+
Armature Chopper Pwr. Ckt.	218.26	23.8	314.68	+
On-Baord Charger Pwr. Unit	58.49	18.0	93.05	
Battery Cable/Connectors	16.40	4.0	25.30	
Misc. (Fan, Wiring, Sys. Test, etc.)	36.46	36.0	76.59	
PCU/PU/OBCPU Subtotal	\$532.31	322.0 Min.	\$965.41	
Propulsion Batteries/Connectors			693.00	
Drive Motor			820.00	
Total Manufacturing Cost			\$2,478.41	
Equipment/Development Amortization			22.00	
TOTAL EDSS MANUFACTURING COST + R&D			\$2,500.41	

TABLE 2-2
EDSS SELLING PRICE SUMMARY

	COST/UNIT (\$)
EDSS Manufacturing Cost (less drive motor & propulsion batteries)	\$965.41
Equipment/Development Amortization	22.00
Profit (10% after taxes)	197.48
Drive Motor (subcontract)	820.00
Propulsion Batteries (subcontract)	<u>693.00</u>
TOTAL EDSS SELLING PRICE	\$2,697.89

III. ELECTRIC DRIVE SUBSYSTEM COST METHODOLOGY

Electric Drive Subsystem production cost reduction is achieved via system simplification, large scale integration (LSI), alternate packaging concepts, and high volume automated production/testing techniques. The following sections outline the methodology leading to cost models used for obtaining EDSS production cost estimates presented in Section II.

A. EDSS System Simplification

EDSS design and packaging of these units for the present Integrated Test Vehicle (ITV) are not conducive to low cost, high volume producibility. After reviewing the present ITV design, the following simplifications were assumed for the Production Electric Vehicle (PEV) cost models:

- 1) Separate the field chopper and 108 volt battery charger functions
- 2) Combine the 108 volt and accessory battery (12V) charger functions with redesigned circuitry
- 3) Expand the functions of the μ computer in the PEV
- 4) Simplify base drive functions via VMOS circuitry
- 5) Reduce the armature chopper rating via different drive motor
- 6) Simplify Logic Power Supply
- 7) Simplify on-board Charger Power Unit

Separating the field chopper and the 108 volt battery charger functions simplifies control circuitry and utilizes lower cost power semiconductors.

The 108 volt battery charger for the PEV is an UP/DOWN chopper design that is controlled via the μ computer. Improved power factor and more efficient utilization of the battery charger power source results from this redesign concept. With the addition of a transformer and control system modifications, the 108 volt and 12 volt battery charger functions can be combined and, thus, reduce the battery charger costs by using common components. Figure 3-1 illustrates the combined battery charger block diagrams. This configuration assumes that the 12 volt accessory battery is charged and maintained at full charge from the 108 volt battery during normal driving. Input 120 VAC power is used only to charge the 108 volt battery bank.

Increasing the number of functions performed in the μ computer and dedicated digital interface circuitry reduces EDSS system costs. With rapidly declining costs of μ processors and μ computers, due to extremely high volume commercial, industrial, and automotive applications, expansion of μ computer functions to replace dedicated hardware reduces system costs.

Pulse Width Modulation (PWM) functions, including field chopper, armature chopper and fuel gauge in the PEV, are performed with dedicated digital circuitry under μ processor control. Since the desired output of the PWM circuitry is a one-bit digital signal; i.e., on or off, Digital to Analog (D/A) conversion is not necessary. Fuel gauge PWM output signal is low pass filtered in the analog fuel gauge. Therefore, the μ computer output interface

FIGURE 3-1. EV PATTERY CHARGER SUMMARY

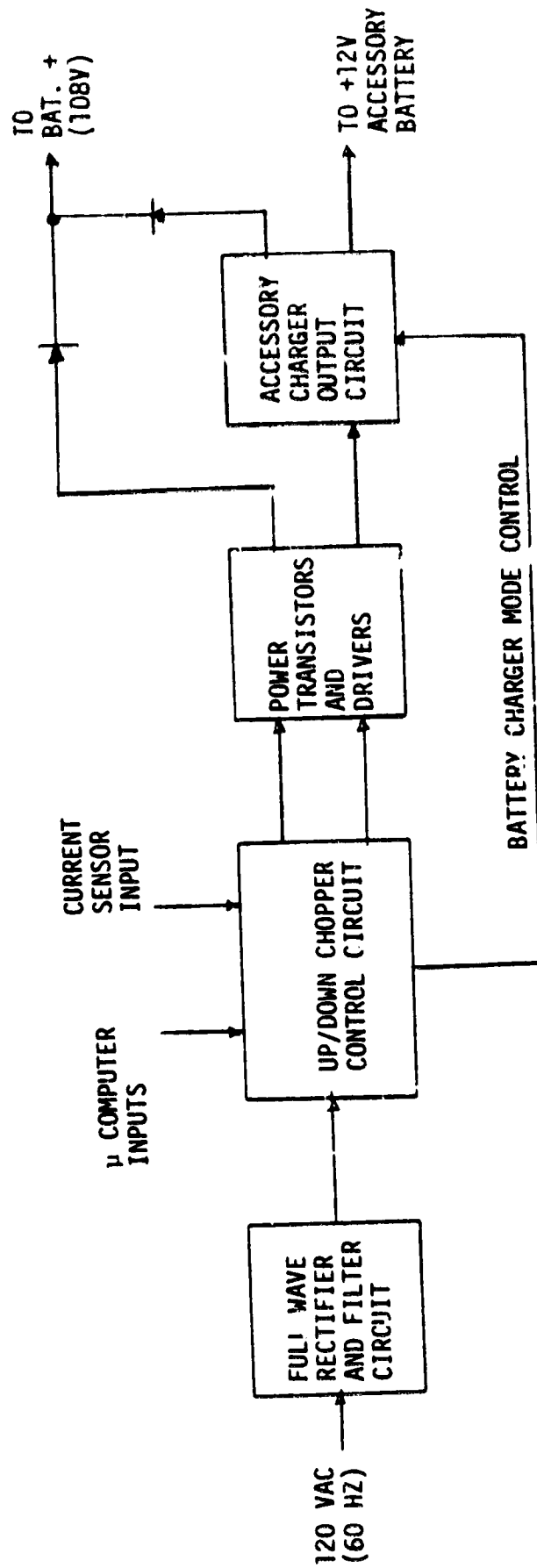

4E-14

in the PEV is simplified and all D/A converters used in the ITV have been eliminated. Figure 3-2 illustrates the μ computer block diagram with general inputs and outputs. The CPU portion of this μ computer requires from 3 to 6 IC's, depending on the configuration selected. Integrated packaging, discussed in greater detail below, significantly simplifies the input interface circuitry.

Simplified base drive circuitry for armature and field choppers reduce EDSS system costs for the PEV. Off-the-shelf VMOS power transistors provide the interface and power amplification between the logic level control signals and the power semiconductors. Optical isolation circuits plus isolated base drive power supplies achieves an efficient low noise, low volume implementation. Figures 3-3 and 3-4 illustrate the block diagram of the armature and field chopper with the VMOS interface between the control logic and power semiconductors.

Simplification of the armature chopper power circuit of the ITV is necessary to reduce the EDSS system cost. However, due to the relatively small number of high cost items, including high power semiconductors, capacitors and contactors, it is difficult to achieve the dramatic cost reduction necessary for the PEV in its present configuration. Two possible approaches to reducing costs include: utilization of a single higher current rated power module that is presently being developed, or select a different motor that is designed with a lower base speed which essentially halves the current rating of the armature chopper. The initial technique reduces the power

FIGURE 3-2. μ COMPUTER SUMMARY

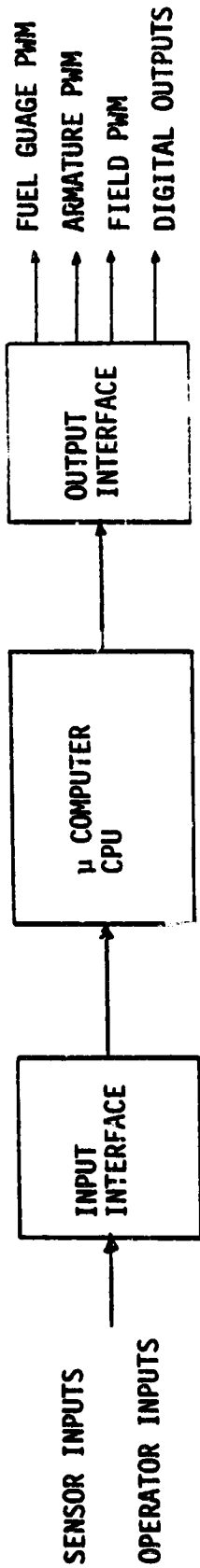

4E-16

FIGURE 3-3. EV ARMATURE CHOPPER SUMMARY

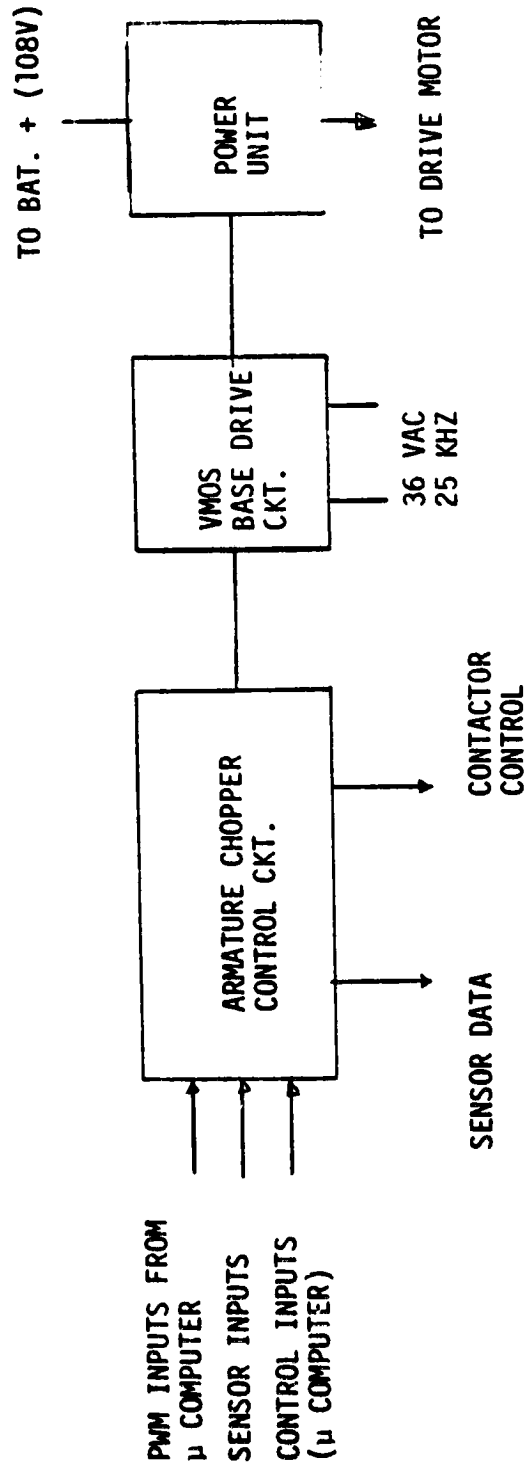

4E-17

FIGURE 3-4. EV FIELD CHOPPER SUMMARY

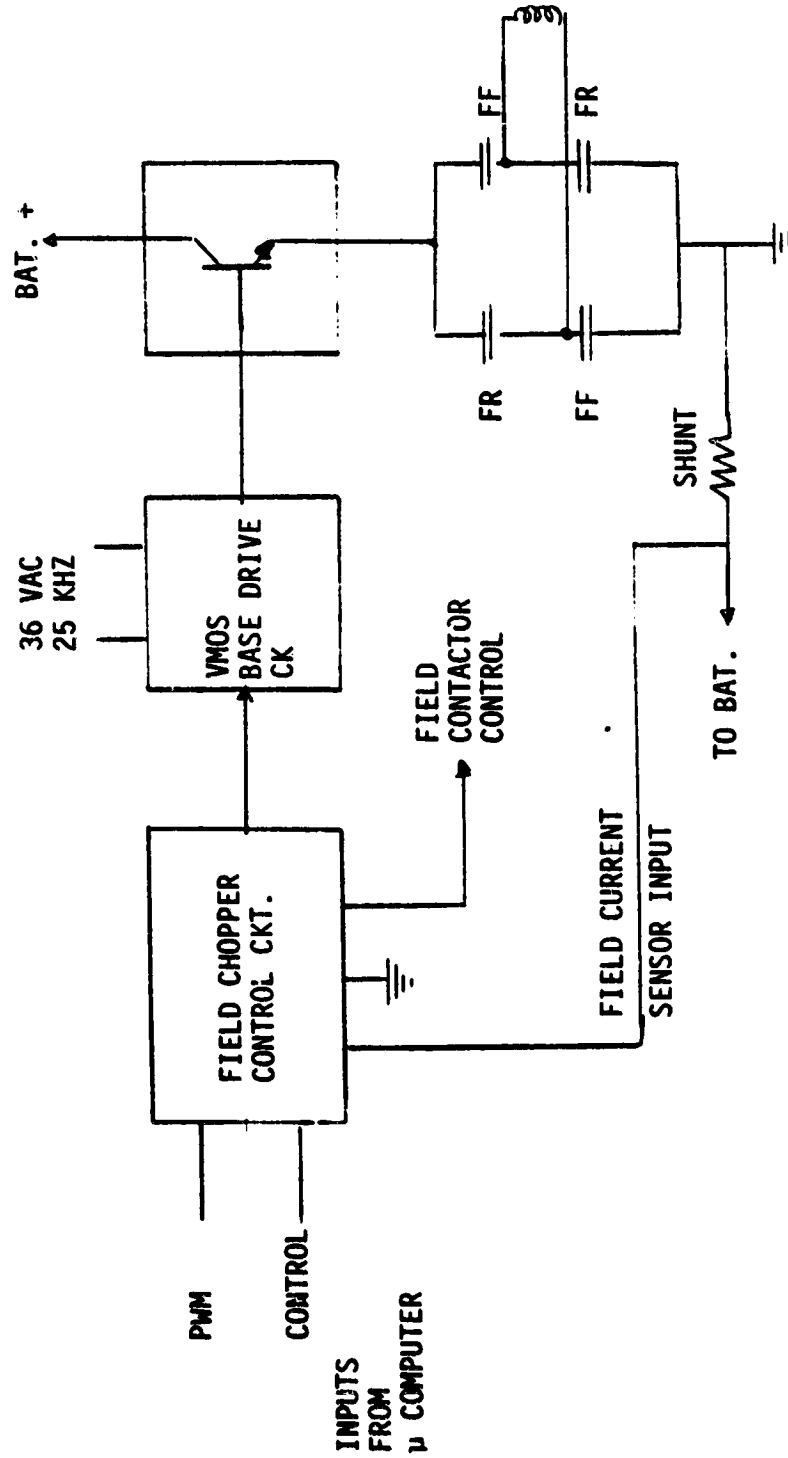

4E-18

semiconductor cost by 1/3, but no reduction in capacitor cost. The latter design provides increased torque per amp at lower speeds. Armature chopper bypass mode is utilized at a lower speed than the ITV design. In addition, this design concept is expected to increase gradability of the vehicle. Halving the current rating on the armature chopper includes: 1/3 power semiconductor, 1/2 rating of snubber circuit, and 1/2 rating on base drive circuit (3 amp instead of 6 amp base drive circuit). Disadvantages of this concept include: the required motor is physically larger, has increased weight, and is more costly than a production version of the ITV drive motor. Preliminary tradeoffs indicate a 1750/5000 RPM motor reduces PEV system cost and is the design assumed for this producibility analysis. However, future device development may warrant a reevaluation of this armature chopper/motor tradeoff.

Reduced logic power supply requirements, due to reduced μ computer and I/O power requirements, reduced base drive requirements, and low power integrated control circuits, allow a lower cost, reduced weight and smaller volume implementation. Three DC LPS outputs (+5V, \pm 15V), compared with the five required for ITV (+5V, \pm 15V, +12V) have estimated power requirements less than 20% of the ITV design. Using a 1750/5000 RPM motor with a 50% derated armature chopper, as discussed above, the required base drive power supply output power is approximately 40% of the ITV design. As a result of the reduced LPS input power requirement, it is possible to use the accessory battery (12V) to power the LPS. Since the accessory battery voltage variation, \pm 17%, is considerably less than the \pm 46% existing on the 108V propulsion battery, less regulation simplifies the design. An additional option (although not exercised for this study) available when the LPS is operated

from the accessory battery uses off-the-shelf modular printed circuit board mounted DC/DC converters to supply the +5V, $\pm 15V$ logic power. LPS operation from the 12V battery yields reduced noise with fewer transient conditions compared to operation from the 108V battery.

Figure 3-5 illustrates the block diagram of the LPS used for costing the EDSS for the PEV.

Productization of the On-Board Charger Power Unit requires packaging and component modifications. Figure 3-6 illustrates the unit's block diagram. Its primary functions include: EMI filtering, ground fault current interrupter circuit, detection of either 15 A or 30 A power source, and safety power circuit breakers. Cost reduction of the On-Board Charger Power Unit is primarily due to quantity discount on components and automated assembly.

B. Large Scale Integration Reduces System Costs

Large Scale Integrated Circuits (LSI) as well as Medium Scale Integrated Circuits (MSI) reduce material and labor cost for the PEV EDSS. Nearly all discrete semiconductor devices have been eliminated in the control functions. Initially, in the redesigned circuit, the control functions were configured with low power MSI circuitry using a minimum number of discrete devices (resistors, transistors). VMOS devices are used with this design to interface the logic control functions with the power semiconductors, eliminating magnetic components from the ITV design. Further cost reduction is achieved by replacing multiple MSI devices for particular functions with custom LSI. In other portions of circuitry, Hybrid Integrated Circuits (HIC's) integrate several MSI circuits and discrete resistors into a single

FIGURE 3-5. EV LOGIC POWER SUPPLY BLOCK DIAGRAM

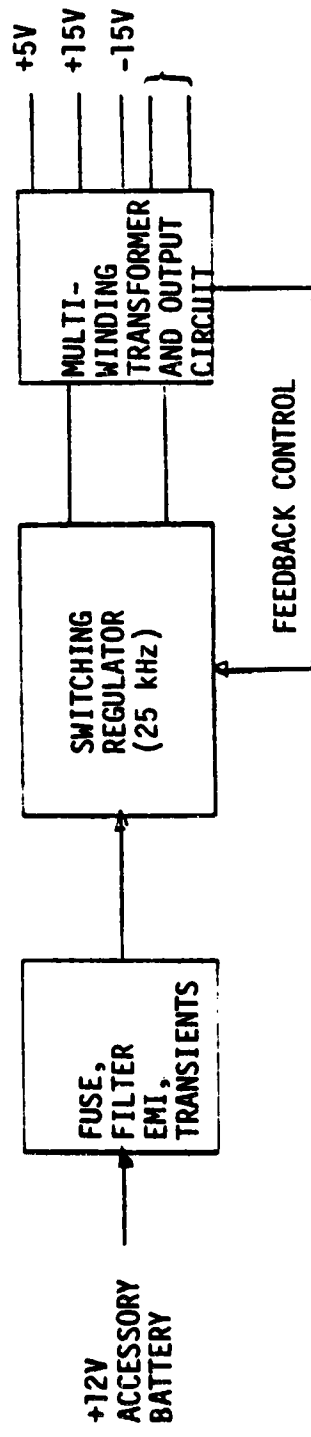

4E-21

FIGURE 3-6. ON-BOARD CHARGER POWER UNIT BLOCK DIAGRAM

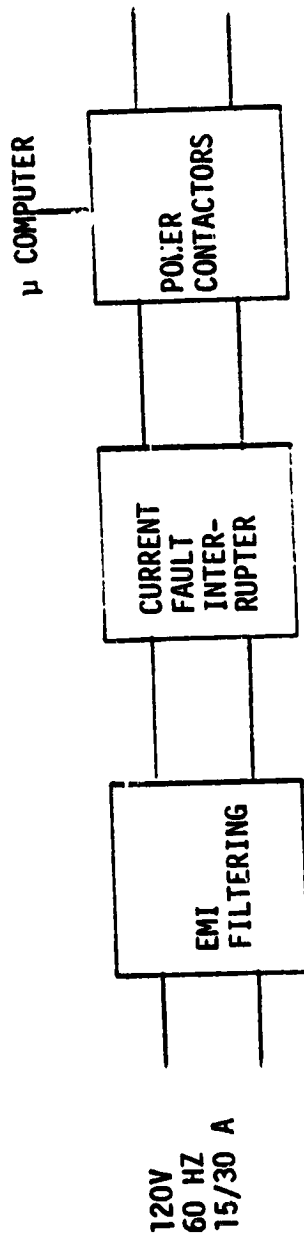

4E-22

IC. LSI implementation reduces the number of components, which reduces both assembly and testing labor. LSI also tends to require less power, reducing the size and cost of logic power supplies.

Production cost estimates for the LSI implementations were obtained from vendors and by comparison with similar LSI components used by General Electric's manufactured electronic systems. Detailed information of integrated circuit packaging and functional partitioning is presented in the following section.

C. PEV EDSS Component Packaging

Reduction of the physical size of the EDSS components in the PEV allows alternate low cost packaging concepts. Cost optimizations, presented in previous sections, suggest that PEV functional partitioning different from the ITV EDSS are utilized. This section presents these packaging concepts at the module and board level.

Production Electric Vehicle (PEV) EDSS contains three electronic modules; i.e., Power Conditioning Unit (PCU), Power Unit (PU), and the On-Board Charger Power Unit. The PCU module contains the Electric Vehicle Integrated Control function, battery charger functions, and logic power supply. The Power Unit module contains the base drive functions and power component function. Power semiconductors, for armature and field choppers, power filters, plus main and bypass contactors are included in the power component function. Figure 3-7 illustrates the interrelationship of each module in the EDSS of the PEV.

FIGURE 3-7. PRODUCTION ELECTRIC VEHICLE ELECTRIC DRIVE SUBSYSTEM

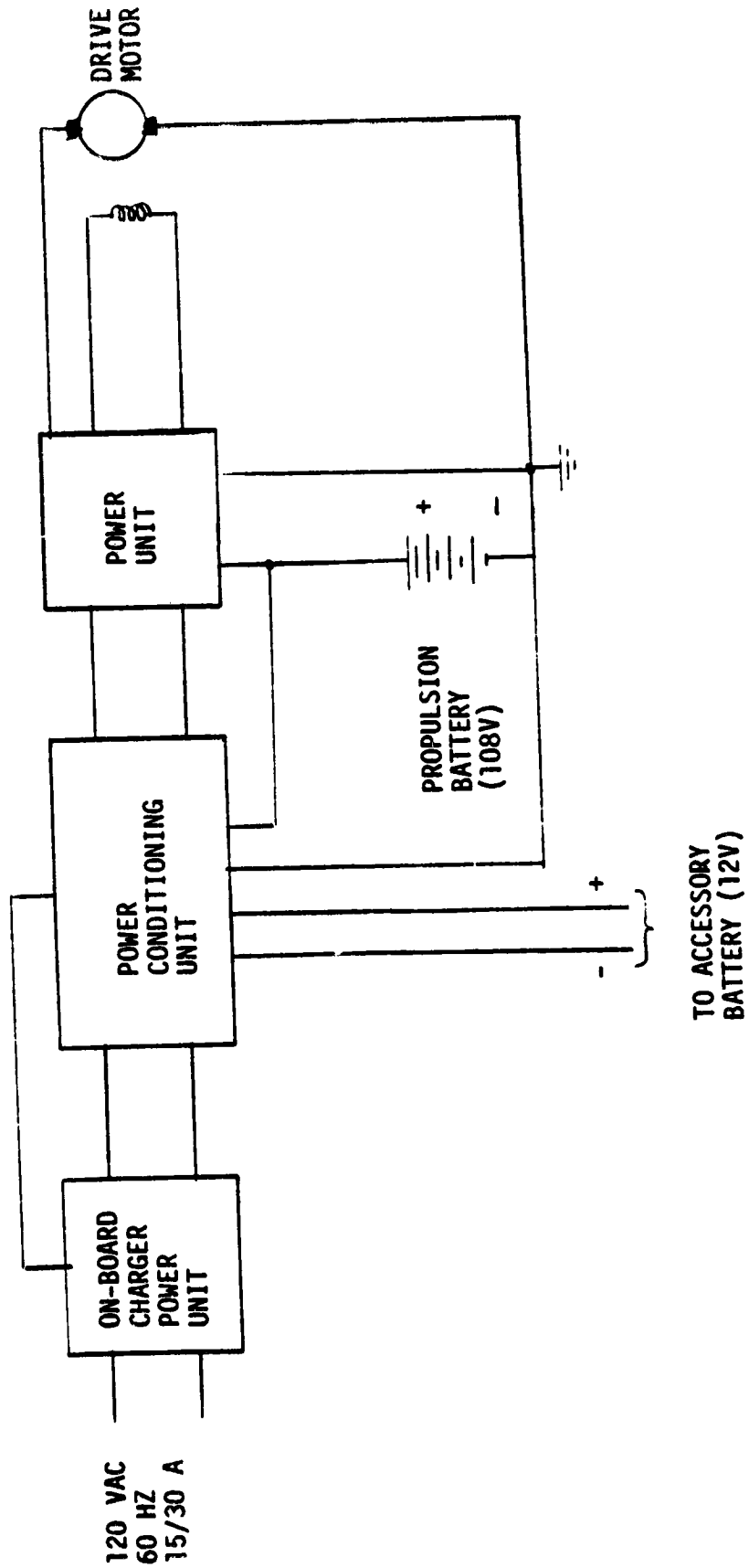

4E-24

Electric Vehicle Integrated Control (EVIC) function contains the μ computer with its input/output interface circuitry plus all the armature chopper logic and field reversing logic. The complete electric vehicle integrated control function is implemented on a single board containing 13 Dual In-Line Package (DIP) IC's. Since there are no discrete devices on this board, automated manufacturing, assembly and testing is used extensively.

The second board in the PCU contains the combined battery charger (108V and 12V) and the logic power supply. Transformers are potted and mounted directly on the rear of the board with leads protruding through the Printed Circuit (PC) board to be manually soldered. All electronic components are mounted, reflow soldered and tested prior to mounting the magnetic components on the rear of the board.

Both PC boards in the PCU plug into a PC backplane containing sockets and required terminal blocks for interconnecting wiring harnesses. This modular PCU design facilitates system testing and vehicle field maintenance. PCU field trouble shooting requires replacing a particular board with a "known good" board and shipping the failed board back to the factory for rework. The PCU is housed in a low cost lightweight molded case.

Low cost power unit packaging for the PEV includes the following: adequate power semiconductor cooling capability, minimal cable resistance and inductance from batteries to power unit to drive motor, lightweight, and convenient accessibility for assembly and maintenance. A power unit package solution, incorporating the above features, integrates the PU into

the drive motor end bell. However, to minimize the effect of the power unit on the motor design and mounting, the power unit is packaged in a low cost aluminum die cast shield that is bolted to the existing end bell. Cooling is provided via natural convection using finned construction and forced convection by diverting a portion of the air from the motor blower fan through the power unit. Using a 50% derated armature chopper, resulting from a 1750/5000 RPM motor as discussed in Section 3A, the entire power unit, including the base drive PC board is mounted within the motor end shield. Power filter capacitors and power contactors with built-in shunts are also mounted within the shield. Depending on the total resistance of the battery, cable and motor, an additional bypass contactor with series power resistor may be necessary to limit the current. This mode would provide additional torque for starting from "pot holes" or on very steep grades.

The on-board charger power unit is mounted in its own housing as a safety feature to avoid injury in event of a 120 VAC grounding problem. Slight modifications in the design reduce the assembly and testing labor. Component mounting is facilitated via a molded base plate and housing.

Although the drive motor used in the PEV is heavier than in the ITV design, the estimated EDSS net weight is 25 pounds lighter than the ITV design.

Two cost estimation techniques were used to estimate manufacturing costs in this producibility analysis. The first technique, used for PEV EDSS major subcontractors (propulsion batteries and drive motor), obtained direct vendor quotes for 100,000 units per year. The second technique was used for the PCU, PU, and On-Board Charger Power Unit (OBCPU). This technique estimated base material cost and labor time required for each function. These estimates were multiplied by appropriate overhead factors to arrive at the manufacturing cost for each function. The acquisition (selling) price added amortization costs for plant, equipment, research and development, and profit (after taxes) to the manufacturing cost of the PCU, PU and OBCPU.

Base material costs (1st quarter 1979 dollars) of hardware required for the simplified (cost reduced) design were obtained via vendor quotes for 100,000 quantities. In cases where the vendor would not provide a quote for 100K quantities, an estimated material cost is extrapolated from vendor cost data for lower quantities. Appropriate overhead for material handling and labor costs (direct and indirect) are based on typical high quantity General Electric electronic manufacturing factors.

Required investment and development costs assumed for this producibility analysis are summarized in Table 3-1. Major manufacturing facility investments are required to efficiently produce EDSS's drive motors and electronic control systems in quantities of 100,000 per year. Automated assembly and testing is used extensively to reduce manual labor and minimize large quantity production costs. Two amortization schedules are assumed; i.e., 10 years for major plant and equipment investment, and three years for required development and component test equipment. Thus, payback

for manufacturing facility investment is added in the selling price of the first million cars, whereas payback for R&D and test equipment is added to the first 300,000 systems.

TABLE 3-1
 REQUIRED INVESTMENT/DEVELOPMENT AMORTIZATION COSTS

<u>ITEM</u>	<u>ASSUMED INVESTMENT (\$M)</u>	<u>NUMBER OF YEARS AMORTIZED</u>	<u>ADDITIONAL COST PER VEHICLE \$</u>
Motor Manufacturing Facility	10.0	10	-- (Included in Motor Quote)
Electronic Assembly Facility	6.0	10	6.0
Custom Chip Development	.50	3	1.67
Software Development/ Modifications	.3	3	1.00
System and Component Automated Test Equip- ment	1.0	3	3.33
Production Prototype Development	3.0	3	10.00
TOTALS	\$20.8M		\$22.00/EDSS

III. CONCLUSIONS

Manufacturing and selling price estimates for a Production Electric Vehicle (PEV) Electrical Drive Subsystem, with vehicle performance equal or superior to the ITV, are presented. Cost estimate results are based on a cost reduced version of the EDSS for the ITV. Typical overhead rates for material and labor were used. Automated assembly and testing procedures are used to reduce labor costs.

Cost estimates presented, based on simplified models, are believed to be reasonably accurate. However, test data from the ITV and the development and cost optimization of a production prototype electric vehicle are required to establish an improved cost estimate of the EDSS for a PEV.

Section 4 Attachment F
REQUIRED MOTOR AND CONTROLLER DATA

FOREWORD

In order to conduct the hybrid vehicle design trade-off studies, considerable input information and data were needed. This section contains the motor and controller data which were requested.

TO: F.G. Turnbull
FROM: A.F. Burke
DATE: November 10, 1978
SUBJECT: Information/Data Required on AC Motor/Controller
Drive Systems for the Hybrid Vehicle Design
Trade-Off Studies

As part of the hybrid vehicle design trade-off studies, I need information/data on ac drive systems. This data will be used in both the screening and comparison of various power-train configurations and the simulation of hybrid vehicle operation over various driving cycles. Computer programs which use the requested data as inputs and for modeling of the various components currently exist and are being readied for running on the GE computer. (The programs were developed while I was at JPL.) Detailed information/data is needed for ac drive systems in the following size range:

Continuous rating: 15 - 35 KW
Peak rating (30 seconds): 30 - 70 KW

The information/data needed for the ac motor and inverter/controller are listed in detail separately for each component in Tables I and II. In short, I need information on the size and weight, torque and rpm, current and voltage, loss and efficiency, scaling, and cost characteristics of the ac components. I realize that for some of the parameters there may be a significant uncertainty*, especially in projecting the 1978 state-of-the-art to the 1981-1985 time period. It is important that those instances be noted and some measure of the uncertainty be given either as a range of values or a band of curves.

Scalability of the information/data to drive systems in the range of interest is important as it is not possible in this early stage of our work to know the exact size (KW) of the electric drive system needed in the 5-passenger hybrid vehicle we are studying. Scalability can be given in terms of

* There are probably even different design approaches that may be taken. I leave it to you to decide when results should be given for different types of motors and/or inverter/controllers.

ORIGINAL PAGE IS
OF POOR QUALITY

4F-3 PRECEDING PAGE BLANK NOT FILMED

November 10, 1978

"specific" values of the characteristics (ex. lb/KW, in³/KW, \$/KW, etc.) and/or models (i.e. analytic expressions) for currents, voltages, losses, etc. referenced to a baseline component size.

I need this information on ac drive systems by the end of November, if possible, and by mid-December at the latest. The information can, of course, be updated and expanded over the following few months.

A.F.B.

/dl1

Enc.

cc: R.H. Guess

TABLE I

INFORMATION/DATA FOR AC MOTORS FOR VEHICLE DRIVE SYSTEMS

- (1) Weight vs. KW-continuous rating
- (2) Volume (dimensions are preferred) vs. KW-continuous rating
- (3) Over-load factor for accelerations (30 seconds)
- (4) Normalized maximum torque curve [T/T_o vs. $RPM/(RPM)$]
- (5) Current-voltage vs. torque and rpm using optimum control
- (6) Scaling rules (sizing and losses)
- (7) Voltage level trade-off considerations
- (8) Loss calculation procedure or efficiency vs. torque and rpm using optimum control
- (9) Efficiency for regenerative braking
- (10) Estimated cost vs. KW-continuous rating

TABLE II
INFORMATION/DATA FOR AC INVERTER/CONTROLLER

- (1) Weight vs. KW-peak rating
- (2) Volume (dimensions are preferred) vs. KW-peak rating
- (3) Loss calculation procedure or efficiency vs. current-voltage
- (4) Transient current characteristics as seen by the battery for drive and braking modes
- (5) Scaling rules (sizing and losses)
- (6) Estimated cost vs. KW-peak rating, including listing of high cost components
- (7) Motor start-up and control options

NEAR-TERM HYBRID VEHICLE PROGRAM

FINAL REPORT -- PHASE I

Appendix B -- Design Trade-Off Studies Report

Volume III -- Computer Program Listings

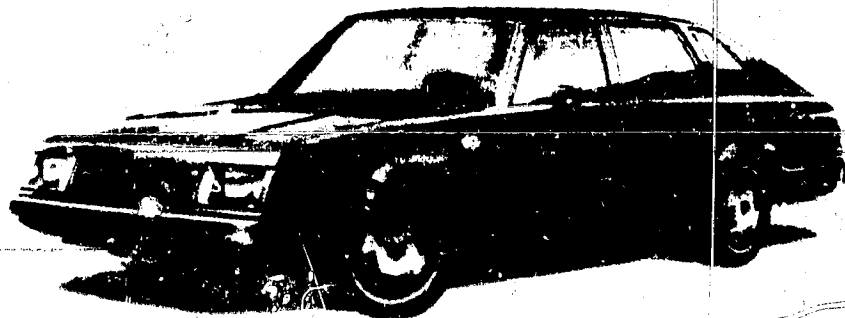

Contract No. 955190

Submitted to

Jet Propulsion Laboratory
California Institute of Technology
4800 Oak Grove Drive
Pasadena, California 91103

Submitted by

General Electric Company
Corporate Research and Development
Schenectady, New York 12301

October 8, 1979



SRD-79-1346

N80-26205

(NASA-CR-163229) NEAR-TERM HYBRID VEHICLE
PROGRAM, PHASE I. APPENDIX B: DESIGN
TRADE-OFF STUDIES REPORT. VOLUME 3:
COMPUTER PROGRAM LISTINGS. Final Report
(General Electric Co.) 115 P HC A06/MF A01 G3/85

Unclas
22357