

AO 120 (Rev. 08/10)

TO: <b>Mail Stop 8</b> <b>Director of the U.S. Patent and Trademark Office</b> <b>P.O. Box 1450</b> <b>Alexandria, VA 22313-1450</b>	<b>REPORT ON THE                  FILING OR DETERMINATION OF AN                  ACTION REGARDING A PATENT OR                  TRADEMARK</b>
---	--

In Compliance with 35 U.S.C. § 290 and/or 15 U.S.C. § 1116 you are hereby advised that a court action has been filed in the U.S. District Court for the District of Delaware on the following  
 Trademarks or  Patents. (  the patent action involves 35 U.S.C. § 292.):

DOCKET NO.	DATE FILED	U.S. DISTRICT COURT for the District of Delaware
PLAINTIFF JOHN D'AGOSTINO,		DEFENDANT Mastercard Inc.; Mastercard International Inc., (d/b/a Mastercard Worldwide); Orbiscom Ltd.; Orbiscom Inc.; Citigroup Inc.; Discover Financial Services; Xerxes Eng.
PATENT OR TRADEMARK NO.	DATE OF PATENT OR TRADEMARK	HOLDER OF PATENT OR TRADEMARK
1 8,036,988	10/11/2011	John D'Agostino
2 7,840,486	11/23/2010	John D'Agostino
3		
4		
5		

In the above—entitled case, the following patent(s)/ trademark(s) have been included:

DATE INCLUDED	INCLUDED BY <input type="checkbox"/> Amendment <input type="checkbox"/> Answer <input type="checkbox"/> Cross Bill <input type="checkbox"/> Other Pleading	
PATENT OR TRADEMARK NO.	DATE OF PATENT OR TRADEMARK	HOLDER OF PATENT OR TRADEMARK
1		
2		
3		
4		
5		

In the above—entitled case, the following decision has been rendered or judgement issued:

DECISION/JUDGEMENT
--------------------

CLERK	(BY) DEPUTY CLERK	DATE
-------	-------------------	------

Copy 1—Upon initiation of action, mail this copy to Director    Copy 3—Upon termination of action, mail this copy to Director  
 Copy 2—Upon filing document adding patent(s), mail this copy to Director    Copy 4—Case file copy

UNITED STATES PATENT AND TRADEMARK OFFICE  
**CERTIFICATE OF CORRECTION**

PATENT NO. : 7,840,486 B2  
APPLICATION NO. : 11/252009  
DATED : November 23, 2010  
INVENTOR(S) : John D'Agostino

Page 1 of 1

It is certified that error appears in the above-identified patent and that said Letters Patent is hereby corrected as shown below:

Column 9, line 7, claim 1.f)

replace "purchase with defined"  
with -- purchase within defined --

Signed and Sealed this  
Twelfth Day of February, 2013



Teresa Stanek Rea  
*Acting Director of the United States Patent and Trademark Office*

**UNITED STATES PATENT AND TRADEMARK OFFICE  
CERTIFICATE OF CORRECTION**Page  1  of  1 

PATENT NO. : 7,840,486

APPLICATION NO.: 11/252,009

ISSUE DATE : November 23, 2010

INVENTOR(S) : John D'Agostino

It is certified that an error appears or errors appear in the above-identified patent and that said Letters Patent is hereby corrected as shown below:

Column 9, line 7, claim 1.f)

replace "purchase with defined"  
with -- purchase within defined --

**MAILING ADDRESS OF SENDER (Please do not use customer number below):**

Maxey Law Offices  
15500 Roosevelt, Blvd., Suite 305  
Clearwater, FL 33760

This collection of information is required by 37 CFR 1.322, 1.323, and 1.324. The information is required to obtain or retain a benefit by the public which is to file (and by the USPTO to process) an application. Confidentiality is governed by 35 U.S.C. 122 and 37 CFR 1.14. This collection is estimated to take 1.0 hour to complete, including gathering, preparing, and submitting the completed application form to the USPTO. Time will vary depending upon the individual case. Any comments on the amount of time you require to complete this form and/or suggestions for reducing this burden, should be sent to the Chief Information Officer, U.S. Patent and Trademark Office, U.S. Department of Commerce, P.O. Box 1450, Alexandria, VA 22313-1450. DO NOT SEND FEES OR COMPLETED FORMS TO THIS ADDRESS. **SEND TO: Attention Certificate of Corrections Branch, Commissioner for Patents, P.O. Box 1450, Alexandria, VA 22313-1450.**

*If you need assistance in completing the form, call 1-800-PTO-9199 and select option 2.*

## Privacy Act Statement

The **Privacy Act of 1974 (P.L. 93-579)** requires that you be given certain information in connection with your submission of the attached form related to a patent application or patent. Accordingly, pursuant to the requirements of the Act, please be advised that: (1) the general authority for the collection of this information is 35 U.S.C. 2(b)(2); (2) furnishing of the information solicited is voluntary; and (3) the principal purpose for which the information is used by the U.S. Patent and Trademark Office is to process and/or examine your submission related to a patent application or patent. If you do not furnish the requested information, the U.S. Patent and Trademark Office may not be able to process and/or examine your submission, which may result in termination of proceedings or abandonment of the application or expiration of the patent.

The information provided by you in this form will be subject to the following routine uses:

1. The information on this form will be treated confidentially to the extent allowed under the Freedom of Information Act (5 U.S.C. 552) and the Privacy Act (5 U.S.C. 552a). Records from this system of records may be disclosed to the Department of Justice to determine whether disclosure of these records is required by the Freedom of Information Act.
2. A record from this system of records may be disclosed, as a routine use, in the course of presenting evidence to a court, magistrate, or administrative tribunal, including disclosures to opposing counsel in the course of settlement negotiations.
3. A record in this system of records may be disclosed, as a routine use, to a Member of Congress submitting a request involving an individual, to whom the record pertains, when the individual has requested assistance from the Member with respect to the subject matter of the record.
4. A record in this system of records may be disclosed, as a routine use, to a contractor of the Agency having need for the information in order to perform a contract. Recipients of information shall be required to comply with the requirements of the Privacy Act of 1974, as amended, pursuant to 5 U.S.C. 552a(m).
5. A record related to an International Application filed under the Patent Cooperation Treaty in this system of records may be disclosed, as a routine use, to the International Bureau of the World Intellectual Property Organization, pursuant to the Patent Cooperation Treaty.
6. A record in this system of records may be disclosed, as a routine use, to another federal agency for purposes of National Security review (35 U.S.C. 181) and for review pursuant to the Atomic Energy Act (42 U.S.C. 218(c)).
7. A record from this system of records may be disclosed, as a routine use, to the Administrator, General Services, or his/her designee, during an inspection of records conducted by GSA as part of that agency's responsibility to recommend improvements in records management practices and programs, under authority of 44 U.S.C. 2904 and 2906. Such disclosure shall be made in accordance with the GSA regulations governing inspection of records for this purpose, and any other relevant (*i.e.*, GSA or Commerce) directive. Such disclosure shall not be used to make determinations about individuals.
8. A record from this system of records may be disclosed, as a routine use, to the public after either publication of the application pursuant to 35 U.S.C. 122(b) or issuance of a patent pursuant to 35 U.S.C. 151. Further, a record may be disclosed, subject to the limitations of 37 CFR 1.14, as a routine use, to the public if the record was filed in an application which became abandoned or in which the proceedings were terminated and which application is referenced by either a published application, an application open to public inspection or an issued patent.
9. A record from this system of records may be disclosed, as a routine use, to a Federal, State, or local law enforcement agency, if the USPTO becomes aware of a violation or potential violation of law or regulation.

**UNITED STATES PATENT AND TRADEMARK OFFICE  
CERTIFICATE OF CORRECTION**Page  1  of  1 

PATENT NO. : 7,840,486

APPLICATION NO.: 11/252,009

ISSUE DATE : November 23, 2010

INVENTOR(S) : John D'Agostino

It is certified that an error appears or errors appear in the above-identified patent and that said Letters Patent is hereby corrected as shown below:

Column 9, line 7, claim 1.f)

replace "purchase with defined"  
with -- purchase within defined --

**MAILING ADDRESS OF SENDER (Please do not use customer number below):**

Maxey Law Offices  
15500 Roosevelt, Blvd., Suite 305  
Clearwater, FL 33760

This collection of information is required by 37 CFR 1.322, 1.323, and 1.324. The information is required to obtain or retain a benefit by the public which is to file (and by the USPTO to process) an application. Confidentiality is governed by 35 U.S.C. 122 and 37 CFR 1.14. This collection is estimated to take 1.0 hour to complete, including gathering, preparing, and submitting the completed application form to the USPTO. Time will vary depending upon the individual case. Any comments on the amount of time you require to complete this form and/or suggestions for reducing this burden, should be sent to the Chief Information Officer, U.S. Patent and Trademark Office, U.S. Department of Commerce, P.O. Box 1450, Alexandria, VA 22313-1450. DO NOT SEND FEES OR COMPLETED FORMS TO THIS ADDRESS. **SEND TO: Attention Certificate of Corrections Branch, Commissioner for Patents, P.O. Box 1450, Alexandria, VA 22313-1450.**

*If you need assistance in completing the form, call 1-800-PTO-9199 and select option 2.*

## Privacy Act Statement

The **Privacy Act of 1974 (P.L. 93-579)** requires that you be given certain information in connection with your submission of the attached form related to a patent application or patent. Accordingly, pursuant to the requirements of the Act, please be advised that: (1) the general authority for the collection of this information is 35 U.S.C. 2(b)(2); (2) furnishing of the information solicited is voluntary; and (3) the principal purpose for which the information is used by the U.S. Patent and Trademark Office is to process and/or examine your submission related to a patent application or patent. If you do not furnish the requested information, the U.S. Patent and Trademark Office may not be able to process and/or examine your submission, which may result in termination of proceedings or abandonment of the application or expiration of the patent.

The information provided by you in this form will be subject to the following routine uses:

1. The information on this form will be treated confidentially to the extent allowed under the Freedom of Information Act (5 U.S.C. 552) and the Privacy Act (5 U.S.C. 552a). Records from this system of records may be disclosed to the Department of Justice to determine whether disclosure of these records is required by the Freedom of Information Act.
2. A record from this system of records may be disclosed, as a routine use, in the course of presenting evidence to a court, magistrate, or administrative tribunal, including disclosures to opposing counsel in the course of settlement negotiations.
3. A record in this system of records may be disclosed, as a routine use, to a Member of Congress submitting a request involving an individual, to whom the record pertains, when the individual has requested assistance from the Member with respect to the subject matter of the record.
4. A record in this system of records may be disclosed, as a routine use, to a contractor of the Agency having need for the information in order to perform a contract. Recipients of information shall be required to comply with the requirements of the Privacy Act of 1974, as amended, pursuant to 5 U.S.C. 552a(m).
5. A record related to an International Application filed under the Patent Cooperation Treaty in this system of records may be disclosed, as a routine use, to the International Bureau of the World Intellectual Property Organization, pursuant to the Patent Cooperation Treaty.
6. A record in this system of records may be disclosed, as a routine use, to another federal agency for purposes of National Security review (35 U.S.C. 181) and for review pursuant to the Atomic Energy Act (42 U.S.C. 218(c)).
7. A record from this system of records may be disclosed, as a routine use, to the Administrator, General Services, or his/her designee, during an inspection of records conducted by GSA as part of that agency's responsibility to recommend improvements in records management practices and programs, under authority of 44 U.S.C. 2904 and 2906. Such disclosure shall be made in accordance with the GSA regulations governing inspection of records for this purpose, and any other relevant (*i.e.*, GSA or Commerce) directive. Such disclosure shall not be used to make determinations about individuals.
8. A record from this system of records may be disclosed, as a routine use, to the public after either publication of the application pursuant to 35 U.S.C. 122(b) or issuance of a patent pursuant to 35 U.S.C. 151. Further, a record may be disclosed, subject to the limitations of 37 CFR 1.14, as a routine use, to the public if the record was filed in an application which became abandoned or in which the proceedings were terminated and which application is referenced by either a published application, an application open to public inspection or an issued patent.
9. A record from this system of records may be disclosed, as a routine use, to a Federal, State, or local law enforcement agency, if the USPTO becomes aware of a violation or potential violation of law or regulation.

**IN THE UNITED STATES PATENT AND TRADEMARK OFFICE**

In re Application of:  
John D'Agostino

Patent Number: 7,840,486

Serial Number: 11/252,009

Issue Date: November 23, 2010

Filed: October 17, 2005

Docket Number: 253.001

For: SYSTEM AND METHOD FOR PERFORMING SECURE CREDIT CARD PURCHASES

**CERTIFICATE OF MAILING OR TRANSMISSION UNDER 37 CFR 1.8:**

I hereby certify that this correspondence is being electronically transmitted using EFS-Web, or Deposited with the United States Postal Service on the date shown below with sufficient postage as first class mail in an envelope addressed to : \_\_\_\_\_, Commissioner for Patents, P.O. Box 1450, Alexandria, VA 22313-1450, or Transmitted by facsimile on the date shown below to the United States Patent and Trademark Office at (571) 273-8300.

December 29, 2012  
Date

/Stephen Lewellyn/  
Stephen Lewellyn

Commissioner for Patents  
Office of Patent Publication  
ATTN: Certificate of Correction Branch  
P.O. Box 1450  
Alexandria, VA 22313-1450

**REQUEST FOR CERTIFICATE OF CORRECTION**

Dear Commissioner,

A Certificate of Correction under U.S.C. § 255 is respectfully requested for the above-identified patent in order to correct Applicant's mistake. The changes in the patent needed to correct the Applicant errors are as follows:

<u>Column, Line</u>	<u>Reads</u>	<u>Should Read</u>
Column 9, line 7	purchase with defined	purchase within defined

The above errors for which correction is requested under 35 U.S.C. § 255 were made as a result of the Applicant's mistake, which occurred in good faith. The errors are considered sufficiently important to justify the processing of a Certificate of Correction under 35 U.S.C. § 255. A form PTO/SB/44, in duplicate, is enclosed herewith, in addition to payment of the fee, as set forth in 37 C.F.R. § 1.20(a), in the amount of \$100.

Issuance of the Certificate of Correction would neither expand nor contract the scope of the claims, and re-examination is not required.

Respectfully submitted,  
Maxey Law Offices, PLLC

December 29, 2012  
Date: \_\_\_\_\_

/Stephen Lewellyn/

\_\_\_\_\_  
Stephen Lewellyn  
Registration No. 51942  
15500 Roosevelt Blvd., Suite 305  
Clearwater, Florida 33760  
Tel: 727-230-4949



## Electronic Patent Application Fee Transmittal

<b>Application Number:</b>	11252009			
<b>Filing Date:</b>	17-Oct-2005			
<b>Title of Invention:</b>	SYSTEM AND METHOD FOR PERFORMING SECURE CREDIT CARD PURCHASES			
<b>First Named Inventor/Applicant Name:</b>	John D'Agostino			
<b>Filer:</b>	Stephen James Lewellyn			
<b>Attorney Docket Number:</b>				
Filed as Small Entity				
<b>Utility under 35 USC 111(a) Filing Fees</b>				
<b>Description</b>	<b>Fee Code</b>	<b>Quantity</b>	<b>Amount</b>	<b>Sub-Total in USD(\$)</b>
<b>Basic Filing:</b>				
<b>Pages:</b>				
<b>Claims:</b>				
<b>Miscellaneous-Filing:</b>				
<b>Petition:</b>				
<b>Patent-Appeals-and-Interference:</b>				
<b>Post-Allowance-and-Post-Issuance:</b>				
Certificate of correction	1811	1	100	100
<b>Extension-of-Time:</b>				

Description	Fee Code	Quantity	Amount	Sub-Total in USD(\$)
<b>Miscellaneous:</b>				
<b>Total in USD (\$)</b>				<b>100</b>

## Electronic Acknowledgement Receipt

<b>EFS ID:</b>	14584168
<b>Application Number:</b>	11252009
<b>International Application Number:</b>	
<b>Confirmation Number:</b>	4322
<b>Title of Invention:</b>	SYSTEM AND METHOD FOR PERFORMING SECURE CREDIT CARD PURCHASES
<b>First Named Inventor/Applicant Name:</b>	John D'Agostino
<b>Correspondence Address:</b>	JOHN D'AGOSTINO - 5168 NORTHRIDGE ROAD #309 - SARASOTA FL 34238 US 3058588000 -
<b>Filer:</b>	Stephen James Lewellyn
<b>Filer Authorized By:</b>	
<b>Attorney Docket Number:</b>	
<b>Receipt Date:</b>	29-DEC-2012
<b>Filing Date:</b>	17-OCT-2005
<b>Time Stamp:</b>	15:04:56
<b>Application Type:</b>	Utility under 35 USC 111(a)

### Payment information:

Submitted with Payment	yes
Payment Type	Credit Card
Payment was successfully received in RAM	\$100

RAM confirmation Number	7312
Deposit Account	
Authorized User	

**File Listing:**

Document Number	Document Description	File Name	File Size(Bytes)/ Message Digest	Multi Part /.zip	Pages (if appl.)
1	Request for Certificate of Correction	253001_Certificate_of_Correction_Form.pdf	193225 1eeb2ad52fe5ff4d9eeddcb45456c2b2e7e ca1b	no	4

**Warnings:**

**Information:**

2	Request for Certificate of Correction	253001_Certificate_of_Correction_Form.pdf	69973 5d2fe2aa0befcac4e15368419aba9c486321 c6b0	no	2
---	---------------------------------------	---	---	----	---

**Warnings:**

**Information:**

3	Fee Worksheet (SB06)	fee-info.pdf	29864 97a188f7c16d52f04f73f3eed6cc69a77006a bf2	no	2
---	----------------------	--------------	---	----	---

**Warnings:**

**Information:**

<b>Total Files Size (in bytes):</b>	293062
-------------------------------------	--------

This Acknowledgement Receipt evidences receipt on the noted date by the USPTO of the indicated documents, characterized by the applicant, and including page counts, where applicable. It serves as evidence of receipt similar to a Post Card, as described in MPEP 503.

**New Applications Under 35 U.S.C. 111**

If a new application is being filed and the application includes the necessary components for a filing date (see 37 CFR 1.53(b)-(d) and MPEP 506), a Filing Receipt (37 CFR 1.54) will be issued in due course and the date shown on this Acknowledgement Receipt will establish the filing date of the application.

**National Stage of an International Application under 35 U.S.C. 371**

If a timely submission to enter the national stage of an international application is compliant with the conditions of 35 U.S.C. 371 and other applicable requirements a Form PCT/DO/EO/903 indicating acceptance of the application as a national stage submission under 35 U.S.C. 371 will be issued in addition to the Filing Receipt, in due course.

**New International Application Filed with the USPTO as a Receiving Office**

If a new international application is being filed and the international application includes the necessary components for an international filing date (see PCT Article 11 and MPEP 1810), a Notification of the International Application Number and of the International Filing Date (Form PCT/RO/105) will be issued in due course, subject to prescriptions concerning national security, and the date shown on this Acknowledgement Receipt will establish the international filing date of the application.

UNITED STATES PATENT AND TRADEMARK OFFICE  
**CERTIFICATE OF CORRECTION**

PATENT NO. : 7,840,486 B2  
APPLICATION NO. : 11/252009  
DATED : November 23, 2010  
INVENTOR(S) : John D'Agostino

Page 1 of 1

It is certified that error appears in the above-identified patent and that said Letters Patent is hereby corrected as shown below:

Column 7, line 25,

replace "FIGS. 3 and 4"  
with -- FIGS. 2 and 3 --

Column 11, line 9, claim 24.c)

replace "said selected payment category"  
with -- said designated payment category --

Signed and Sealed this  
Twenty-sixth Day of April, 2011

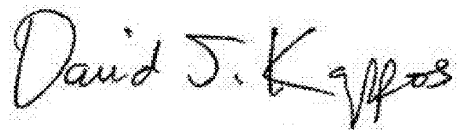

David J. Kappos  
*Director of the United States Patent and Trademark Office*

**SPE RESPONSE FOR CERTIFICATE OF CORRECTION**

Paper No.: \_\_\_\_\_

DATE : 3-23-11

TO SPE OF : ART UNIT 3691

SUBJECT : Request for Certificate of Correction for Appl. No.: 11252009 Patent No.: 7840486

Please respond to this request for a certificate of correction within 7 days.

**FOR IFW FILES:**

Please review the requested changes/corrections as shown in the **COCIN** document(s) in the IFW application image. No new matter should be introduced, nor should the scope or meaning of the claims be changed.

Please complete the response (see below) and forward the completed response to scanning using document code **COCX**.

**FOR PAPER FILES:**

Please review the requested changes/corrections as shown in the attached certificate of correction. Please complete this form (see below) and forward it with the file to:

**Certificates of Correction Branch (C of C)  
Randolph Square – 9D10-E  
Palm Location 7580**

Omega Lewis  
Certificates of Correction Branch  
**703-756-1575**

**Thank You For Your Assistance**

**The request for issuing the above-identified correction(s) is hereby:**

Note your decision on the appropriate box.

**Approved**

All changes apply.

**Approved in Part**

Specify below which changes **do not** apply.

**Denied**

State the reasons for denial below.

Comments: \_\_\_\_\_

\_\_\_\_\_

\_\_\_\_\_

\_\_\_\_\_

\_\_\_\_\_

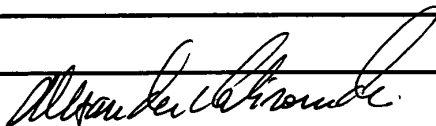

**SPE**

3691  
**Art Unit**

**SPE RESPONSE FOR CERTIFICATE OF CORRECTION**

Paper No.: \_\_\_\_\_

DATE : 3-23-11

TO SPE OF : ART UNIT 3691

SUBJECT : Request for Certificate of Correction for Appl. No.: 11252009 Patent No.: 7840486

Please respond to this request for a certificate of correction within 7 days.

**FOR IFW FILES:**

Please review the requested changes/corrections as shown in the **COCIN** document(s) in the IFW application image. No new matter should be introduced, nor should the scope or meaning of the claims be changed.

Please complete the response (see below) and forward the completed response to scanning using document code **COCX**.

**FOR PAPER FILES:**

Please review the requested changes/corrections as shown in the attached certificate of correction. Please complete this form (see below) and forward it with the file to:

**Certificates of Correction Branch (C of C)  
Randolph Square – 9D10-E  
Palm Location 7580**

Omega Lewis  
Certificates of Correction Branch  
**703-756-1575**

**Thank You For Your Assistance**

**The request for issuing the above-identified correction(s) is hereby:**

Note your decision on the appropriate box.

- |  |   |
|--|---|
| <input type="checkbox"/> <b>Approved</b>         | <b>All changes apply.</b>                               |
| <input type="checkbox"/> <b>Approved in Part</b> | <b>Specify below which changes <b>do not</b> apply.</b> |
| <input type="checkbox"/> <b>Denied</b>           | <b>State the reasons for denial below.</b>              |

Comments: \_\_\_\_\_  
\_\_\_\_\_  
\_\_\_\_\_  
\_\_\_\_\_  
\_\_\_\_\_

\_\_\_\_\_  
**SPE**

\_\_\_\_\_  
**Art Unit**

## Electronic Patent Application Fee Transmittal

<b>Application Number:</b>	11252009			
<b>Filing Date:</b>	17-Oct-2005			
<b>Title of Invention:</b>	SYSTEM AND METHOD FOR PERFORMING SECURE CREDIT CARD PURCHASES			
<b>First Named Inventor/Applicant Name:</b>	John D'Agostino			
<b>Filer:</b>	Stephanus H. Yang			
<b>Attorney Docket Number:</b>				
Filed as Large Entity				
<b>Utility under 35 USC 111(a) Filing Fees</b>				
<b>Description</b>	<b>Fee Code</b>	<b>Quantity</b>	<b>Amount</b>	<b>Sub-Total in USD(\$)</b>
<b>Basic Filing:</b>				
<b>Pages:</b>				
<b>Claims:</b>				
<b>Miscellaneous-Filing:</b>				
<b>Petition:</b>				
<b>Patent-Appeals-and-Interference:</b>				
<b>Post-Allowance-and-Post-Issuance:</b>				
Certificate of correction	1811	1	100	100
<b>Extension-of-Time:</b>				



Description	Fee Code	Quantity	Amount	Sub-Total in USD(\$)
<b>Miscellaneous:</b>				
<b>Total in USD (\$)</b>				<b>100</b>

## Electronic Acknowledgement Receipt

<b>EFS ID:</b>	9668248
<b>Application Number:</b>	11252009
<b>International Application Number:</b>	
<b>Confirmation Number:</b>	4322
<b>Title of Invention:</b>	SYSTEM AND METHOD FOR PERFORMING SECURE CREDIT CARD PURCHASES
<b>First Named Inventor/Applicant Name:</b>	John D'Agostino
<b>Correspondence Address:</b>	JOHN D'AGOSTINO - 5168 NORTHRIDGE ROAD #309 - SARASOTA FL 34238 US 3058588000 -
<b>Filer:</b>	Stephanus H. Yang
<b>Filer Authorized By:</b>	
<b>Attorney Docket Number:</b>	
<b>Receipt Date:</b>	16-MAR-2011
<b>Filing Date:</b>	17-OCT-2005
<b>Time Stamp:</b>	10:50:56
<b>Application Type:</b>	Utility under 35 USC 111(a)

### Payment information:

Submitted with Payment	yes
Payment Type	Credit Card
Payment was successfully received in RAM	\$100

RAM confirmation Number	8606
Deposit Account	
Authorized User	

**File Listing:**

Document Number	Document Description	File Name	File Size(Bytes)/ Message Digest	Multi Part /.zip	Pages (if appl.)
1	Fee Worksheet (PTO-875)	fee-info.pdf	29757 645fc70a0470c6004f3a3f6c6e61f62e0532fd4	no	2

**Warnings:**

**Information:**

**Total Files Size (in bytes):** 29757

This Acknowledgement Receipt evidences receipt on the noted date by the USPTO of the indicated documents, characterized by the applicant, and including page counts, where applicable. It serves as evidence of receipt similar to a Post Card, as described in MPEP 503.

**New Applications Under 35 U.S.C. 111**

If a new application is being filed and the application includes the necessary components for a filing date (see 37 CFR 1.53(b)-(d) and MPEP 506), a Filing Receipt (37 CFR 1.54) will be issued in due course and the date shown on this Acknowledgement Receipt will establish the filing date of the application.

**National Stage of an International Application under 35 U.S.C. 371**

If a timely submission to enter the national stage of an international application is compliant with the conditions of 35 U.S.C. 371 and other applicable requirements a Form PCT/DO/EO/903 indicating acceptance of the application as a national stage submission under 35 U.S.C. 371 will be issued in addition to the Filing Receipt, in due course.

**New International Application Filed with the USPTO as a Receiving Office**

If a new international application is being filed and the international application includes the necessary components for an international filing date (see PCT Article 11 and MPEP 1810), a Notification of the International Application Number and of the International Filing Date (Form PCT/RO/105) will be issued in due course, subject to prescriptions concerning national security, and the date shown on this Acknowledgement Receipt will establish the international filing date of the application.

**IN THE UNITED STATES PATENT AND TRADEMARK OFFICE**

In re Application of:  
John D'Agostino

Patent Number: 7,840,486

Serial Number: 11/252,009

Issue Date: November 23, 2010

Filed: October 17, 2005

Docket Number: 253.001

For: SYSTEM AND METHOD FOR PERFORMING SECURE CREDIT CARD PURCHASES

**CERTIFICATE OF MAILING OR TRANSMISSION UNDER 37 CFR 1.8:**

I hereby certify that this correspondence is being electronically transmitted using EFS-Web, or Deposited with the United States Postal Service on the date shown below with sufficient postage as first class mail in an envelope addressed to : \_\_\_\_\_, Commissioner for Patents, P.O. Box 1450, Alexandria, VA 22313-1450, or Transmitted by facsimile on the date shown below to the United States Patent and Trademark Office at (571) 273-8300.

March 16, 2011

/Stephanus Yang/

Date

Stephanus Yang

Commissioner for Patents  
Office of Patent Publication  
ATTN: Certificate of Correction Branch  
P.O. Box 1450  
Alexandria, VA 22313-1450

**REQUEST FOR CERTIFICATE OF CORRECTION**

Dear Sir,

A Certificate of Correction under U.S.C. § 255 is respectfully requested for the above-identified patent in order to correct Applicant's mistake. The changes in the patent needed to correct the Applicant errors are as follows:

<u>Column, Line</u>	<u>Reads</u>	<u>Should Read</u>
Column 7, line 25	"FIGS. 3 and 4"	FIGS. 2 and 3
Column 11, line 9	selected payment category	designated payment category

The above errors for which correction is requested under 35 U.S.C. § 255 were made as a result of the Applicant's mistake, which occurred in good faith. The errors are considered sufficiently important to justify the processing of a Certificate of Correction under 35 U.S.C. § 255. A form PTO/SB/44, in duplicate, is enclosed herewith, in addition to payment of the fee, as set forth in 37 C.F.R § 1.20(a), in the amount of \$100.

Issuance of the Certificate of Correction would neither expand nor contract the scope of the claims, and re-examination is not required.

Respectfully submitted,  
Maxey Law Offices, PLLC

March 16, 2011  
Date: \_\_\_\_\_

*/Stephanus Yang/*

\_\_\_\_\_  
Stephanus Yang  
Registration No. 66,352  
15500 Roosevelt Blvd., Suite 305  
Clearwater, Florida 33760  
Tel: 727-230-4949

**UNITED STATES PATENT AND TRADEMARK OFFICE  
CERTIFICATE OF CORRECTION**Page  1  of  1 

PATENT NO. : 7,840,486

APPLICATION NO.: 11/252,009

ISSUE DATE : November 23, 2010

INVENTOR(S) : John D'Agostino

It is certified that an error appears or errors appear in the above-identified patent and that said Letters Patent is hereby corrected as shown below:

Column 7, line 25,

replace "FIGS. 3 and 4"  
with -- FIGS. 2 and 3 --

Column 11, line 9, claim 24.c)

replace "said selected payment category"  
with -- said designated payment category --

**MAILING ADDRESS OF SENDER (Please do not use customer number below):**

Maxey Law Offices  
15500 Roosevelt, Blvd., Suite 305  
Clearwater, FL 33760

This collection of information is required by 37 CFR 1.322, 1.323, and 1.324. The information is required to obtain or retain a benefit by the public which is to file (and by the USPTO to process) an application. Confidentiality is governed by 35 U.S.C. 122 and 37 CFR 1.14. This collection is estimated to take 1.0 hour to complete, including gathering, preparing, and submitting the completed application form to the USPTO. Time will vary depending upon the individual case. Any comments on the amount of time you require to complete this form and/or suggestions for reducing this burden, should be sent to the Chief Information Officer, U.S. Patent and Trademark Office, U.S. Department of Commerce, P.O. Box 1450, Alexandria, VA 22313-1450. DO NOT SEND FEES OR COMPLETED FORMS TO THIS ADDRESS. **SEND TO: Attention Certificate of Corrections Branch, Commissioner for Patents, P.O. Box 1450, Alexandria, VA 22313-1450.**

*If you need assistance in completing the form, call 1-800-PTO-9199 and select option 2.*

## Privacy Act Statement

The **Privacy Act of 1974 (P.L. 93-579)** requires that you be given certain information in connection with your submission of the attached form related to a patent application or patent. Accordingly, pursuant to the requirements of the Act, please be advised that: (1) the general authority for the collection of this information is 35 U.S.C. 2(b)(2); (2) furnishing of the information solicited is voluntary; and (3) the principal purpose for which the information is used by the U.S. Patent and Trademark Office is to process and/or examine your submission related to a patent application or patent. If you do not furnish the requested information, the U.S. Patent and Trademark Office may not be able to process and/or examine your submission, which may result in termination of proceedings or abandonment of the application or expiration of the patent.

The information provided by you in this form will be subject to the following routine uses:

1. The information on this form will be treated confidentially to the extent allowed under the Freedom of Information Act (5 U.S.C. 552) and the Privacy Act (5 U.S.C. 552a). Records from this system of records may be disclosed to the Department of Justice to determine whether disclosure of these records is required by the Freedom of Information Act.
2. A record from this system of records may be disclosed, as a routine use, in the course of presenting evidence to a court, magistrate, or administrative tribunal, including disclosures to opposing counsel in the course of settlement negotiations.
3. A record in this system of records may be disclosed, as a routine use, to a Member of Congress submitting a request involving an individual, to whom the record pertains, when the individual has requested assistance from the Member with respect to the subject matter of the record.
4. A record in this system of records may be disclosed, as a routine use, to a contractor of the Agency having need for the information in order to perform a contract. Recipients of information shall be required to comply with the requirements of the Privacy Act of 1974, as amended, pursuant to 5 U.S.C. 552a(m).
5. A record related to an International Application filed under the Patent Cooperation Treaty in this system of records may be disclosed, as a routine use, to the International Bureau of the World Intellectual Property Organization, pursuant to the Patent Cooperation Treaty.
6. A record in this system of records may be disclosed, as a routine use, to another federal agency for purposes of National Security review (35 U.S.C. 181) and for review pursuant to the Atomic Energy Act (42 U.S.C. 218(c)).
7. A record from this system of records may be disclosed, as a routine use, to the Administrator, General Services, or his/her designee, during an inspection of records conducted by GSA as part of that agency's responsibility to recommend improvements in records management practices and programs, under authority of 44 U.S.C. 2904 and 2906. Such disclosure shall be made in accordance with the GSA regulations governing inspection of records for this purpose, and any other relevant (*i.e.*, GSA or Commerce) directive. Such disclosure shall not be used to make determinations about individuals.
8. A record from this system of records may be disclosed, as a routine use, to the public after either publication of the application pursuant to 35 U.S.C. 122(b) or issuance of a patent pursuant to 35 U.S.C. 151. Further, a record may be disclosed, subject to the limitations of 37 CFR 1.14, as a routine use, to the public if the record was filed in an application which became abandoned or in which the proceedings were terminated and which application is referenced by either a published application, an application open to public inspection or an issued patent.
9. A record from this system of records may be disclosed, as a routine use, to a Federal, State, or local law enforcement agency, if the USPTO becomes aware of a violation or potential violation of law or regulation.

## Electronic Patent Application Fee Transmittal

<b>Application Number:</b>	11252009			
<b>Filing Date:</b>	17-Oct-2005			
<b>Title of Invention:</b>	SYSTEM AND METHOD FOR PERFORMING SECURE CREDIT CARD PURCHASES			
<b>First Named Inventor/Applicant Name:</b>	John D'Agostino			
<b>Filer:</b>	Stephanus H. Yang			
<b>Attorney Docket Number:</b>				
Filed as Small Entity				
<b>Utility under 35 USC 111(a) Filing Fees</b>				
<b>Description</b>	<b>Fee Code</b>	<b>Quantity</b>	<b>Amount</b>	<b>Sub-Total in USD(\$)</b>
<b>Basic Filing:</b>				
<b>Pages:</b>				
<b>Claims:</b>				
<b>Miscellaneous-Filing:</b>				
<b>Petition:</b>				
<b>Patent-Appeals-and-Interference:</b>				
<b>Post-Allowance-and-Post-Issuance:</b>				
Certificate of correction	1811	1	100	100
<b>Extension-of-Time:</b>				



Description	Fee Code	Quantity	Amount	Sub-Total in USD(\$)
<b>Miscellaneous:</b>				
<b>Total in USD (\$)</b>				<b>100</b>

## Electronic Acknowledgement Receipt

<b>EFS ID:</b>	9668056
<b>Application Number:</b>	11252009
<b>International Application Number:</b>	
<b>Confirmation Number:</b>	4322
<b>Title of Invention:</b>	SYSTEM AND METHOD FOR PERFORMING SECURE CREDIT CARD PURCHASES
<b>First Named Inventor/Applicant Name:</b>	John D'Agostino
<b>Correspondence Address:</b>	JOHN D'AGOSTINO - 5168 NORTHRIDGE ROAD #309 - SARASOTA FL 34238 US 3058588000 -
<b>Filer:</b>	Stephanus H. Yang
<b>Filer Authorized By:</b>	
<b>Attorney Docket Number:</b>	
<b>Receipt Date:</b>	16-MAR-2011
<b>Filing Date:</b>	17-OCT-2005
<b>Time Stamp:</b>	10:27:47
<b>Application Type:</b>	Utility under 35 USC 111(a)

### Payment information:

Submitted with Payment

no

### File Listing:

Document Number	Document Description	File Name	File Size(Bytes)/ Message Digest	Multi Part /.zip	Pages (if appl.)
1	Request for Certificate of Correction	253001_Certificate_of_Correction_03082011.pdf	384304 4d8ea7c76100d1ee00b78adcebe0f4a781c a128	no	2
<b>Warnings:</b>					
<b>Information:</b>					
2	Request for Certificate of Correction	253001_Certificate_of_Correction_Form_03082011.pdf	164665 2d294b6bbdd3f2f044de5287cf70b1b162 2ed5d	no	2
<b>Warnings:</b>					
<b>Information:</b>					
3	Fee Worksheet (PTO-875)	fee-info.pdf	29846 2bf1e947c0f5a0f4e341e62920f9ed89ae09 faa	no	2
<b>Warnings:</b>					
<b>Information:</b>					
<b>Total Files Size (in bytes):</b>			578815		
<p><b>This Acknowledgement Receipt evidences receipt on the noted date by the USPTO of the indicated documents, characterized by the applicant, and including page counts, where applicable. It serves as evidence of receipt similar to a Post Card, as described in MPEP 503.</b></p> <p><b><u>New Applications Under 35 U.S.C. 111</u></b>  <b>If a new application is being filed and the application includes the necessary components for a filing date (see 37 CFR 1.53(b)-(d) and MPEP 506), a Filing Receipt (37 CFR 1.54) will be issued in due course and the date shown on this Acknowledgement Receipt will establish the filing date of the application.</b></p> <p><b><u>National Stage of an International Application under 35 U.S.C. 371</u></b>  <b>If a timely submission to enter the national stage of an international application is compliant with the conditions of 35 U.S.C. 371 and other applicable requirements a Form PCT/DO/EO/903 indicating acceptance of the application as a national stage submission under 35 U.S.C. 371 will be issued in addition to the Filing Receipt, in due course.</b></p> <p><b><u>New International Application Filed with the USPTO as a Receiving Office</u></b>  <b>If a new international application is being filed and the international application includes the necessary components for an international filing date (see PCT Article 11 and MPEP 1810), a Notification of the International Application Number and of the International Filing Date (Form PCT/RO/105) will be issued in due course, subject to prescriptions concerning national security, and the date shown on this Acknowledgement Receipt will establish the international filing date of the application.</b></p>					



UNITED STATES PATENT AND TRADEMARK OFFICE

UNITED STATES DEPARTMENT OF COMMERCE  
United States Patent and Trademark Office  
Address: COMMISSIONER FOR PATENTS  
P.O. Box 1450  
Alexandria, Virginia 22313-1450  
www.uspto.gov

APPLICATION NO.	ISSUE DATE	PATENT NO.	ATTORNEY DOCKET NO.	CONFIRMATION NO.
11/252,009	11/23/2010	7840486		4322

7590 11/03/2010  
JOHN D'AGOSTINO  
5168 NORTHRIDGE ROAD #309  
SARASOTA, FL 34238

**ISSUE NOTIFICATION**

The projected patent number and issue date are specified above.

**Determination of Patent Term Adjustment under 35 U.S.C. 154 (b)**  
(application filed on or after May 29, 2000)

The Patent Term Adjustment is 0 day(s). Any patent to issue from the above-identified application will include an indication of the adjustment on the front page.

If a Continued Prosecution Application (CPA) was filed in the above-identified application, the filing date that determines Patent Term Adjustment is the filing date of the most recent CPA.

Applicant will be able to obtain more detailed information by accessing the Patent Application Information Retrieval (PAIR) WEB site (<http://pair.uspto.gov>).

Any questions regarding the Patent Term Extension or Adjustment determination should be directed to the Office of Patent Legal Administration at (571)-272-7702. Questions relating to issue and publication fee payments should be directed to the Application Assistance Unit (AAU) of the Office of Data Management (ODM) at (571)-272-4200.

APPLICANT(s) (Please see PAIR WEB site <http://pair.uspto.gov> for additional applicants):

John D'Agostino, Sarasota, FL;

**PART B - FEE(S) TRANSMITTAL**

**Complete and send this form, together with applicable fee(s), to: Mail Mail Stop ISSUE FEE  
 Commissioner for Patents  
 P.O. Box 1450  
 Alexandria, Virginia 22313-1450  
 or Fax (571)-273-2885**

**INSTRUCTIONS:** This form should be used for transmitting the ISSUE FEE and PUBLICATION FEE (if required). Blocks 1 through 5 should be completed where appropriate. All further correspondence including the Patent, advance orders and notification of maintenance fees will be mailed to the current correspondence address as indicated unless corrected below or directed otherwise in Block 1, by (a) specifying a new correspondence address; and/or (b) indicating a separate "FEE ADDRESS" for maintenance fee notifications.

CURRENT CORRESPONDENCE ADDRESS (Note: Use Block 1 for any change of address)

Note: A certificate of mailing can only be used for domestic mailings of the Fee(s) Transmittal. This certificate cannot be used for any other accompanying papers. Each additional paper, such as an assignment or formal drawing, must have its own certificate of mailing or transmission.

7590 09/01/2010

**JOHN D'AGOSTINO**  
 5168 NORTHRIDGE ROAD #309  
 SARASOTA, FL 34238

**Certificate of Mailing or Transmission**

I hereby certify that this Fee(s) Transmittal is being deposited with the United States Postal Service with sufficient postage for first class mail in an envelope addressed to the Mail Stop ISSUE FEE address above, or being facsimile transmitted to the USPTO (571) 273-2885, on the date indicated below.

Stephen Lewellyn	(Depositor's name)
/Stephen Lewellyn/	(Signature)
10/12/2010	(Date)

APPLICATION NO.	FILING DATE	FIRST NAMED INVENTOR	ATTORNEY DOCKET NO.	CONFIRMATION NO.
11/252,009	10/17/2005	John D'Agostino		4322

TITLE OF INVENTION: SYSTEM AND METHOD FOR PERFORMING SECURE CREDIT CARD PURCHASES

APPLN. TYPE	SMALL ENTITY	ISSUE FEE DUE	PUBLICATION FEE DUE	PREV. PAID ISSUE FEE	TOTAL FEE(S) DUE	DATE DUE
nonprovisional	YES	\$755	\$300	\$0	\$1055	12/01/2010

EXAMINER	ART UNIT	CLASS-SUBCLASS
SHRESTHA, BIJENDRA K	3691	705-044000

<p>1. Change of correspondence address or indication of "Fee Address" (37 CFR 1.363).</p> <p><input type="checkbox"/> Change of correspondence address (or Change of Correspondence Address form PTO/SB/122) attached.</p> <p><input type="checkbox"/> "Fee Address" indication (or "Fee Address" Indication form PTO/SB/47; Rev 03-02 or more recent) attached. <b>Use of a Customer Number is required.</b></p>	<p>2. For printing on the patent front page, list <u>Maxey Law Offices, PLLC</u></p> <p>(1) the names of up to 3 registered patent attorneys or agents OR, alternatively,</p> <p>(2) the name of a single firm (having as a member a registered attorney or agent) and the names of up to 2 registered patent attorneys or agents. If no name is listed, no name will be printed.</p> <p>1 _____                  2 <u>Stephen Lewellyn</u>                  3 _____</p>
---	--

3. ASSIGNEE NAME AND RESIDENCE DATA TO BE PRINTED ON THE PATENT (print or type)

PLEASE NOTE: Unless an assignee is identified below, no assignee data will appear on the patent. If an assignee is identified below, the document has been filed for recordation as set forth in 37 CFR 3.11. Completion of this form is NOT a substitute for filing an assignment.

(A) NAME OF ASSIGNEE \_\_\_\_\_ (B) RESIDENCE: (CITY and STATE OR COUNTRY) \_\_\_\_\_

Please check the appropriate assignee category or categories (will not be printed on the patent):  Individual  Corporation or other private group entity  Government

<p>4a. The following fee(s) are submitted:</p> <p><input checked="" type="checkbox"/> Issue Fee</p> <p><input checked="" type="checkbox"/> Publication Fee (No small entity discount permitted)</p> <p><input type="checkbox"/> Advance Order - # of Copies _____</p>	<p>4b. Payment of Fee(s): (Please first reapply any previously paid issue fee shown above)</p> <p><input type="checkbox"/> A check is enclosed.</p> <p><input type="checkbox"/> Payment by credit card. Form PTO-2038 is attached.</p> <p><input type="checkbox"/> The Director is hereby authorized to charge the required fee(s), any deficiency, or credit any overpayment, to Deposit Account Number _____ (enclose an extra copy of this form).</p>
---	--

5. Change in Entity Status (from status indicated above)

a. Applicant claims SMALL ENTITY status. See 37 CFR 1.27.  b. Applicant is no longer claiming SMALL ENTITY status. See 37 CFR 1.27(g)(2).

NOTE: The Issue Fee and Publication Fee (if required) will not be accepted from anyone other than the applicant; a registered attorney or agent; or the assignee or other party in interest as shown by the records of the United States Patent and Trademark Office.

Authorized Signature /Stephen Lewellyn/ Date 10-12-2010  
 Typed or printed name Stephen Lewellyn Registration No. 51,942

This collection of information is required by 37 CFR 1.311. The information is required to obtain or retain a benefit by the public which is to file (and by the USPTO to process) an application. Confidentiality is governed by 35 U.S.C. 122 and 37 CFR 1.14. This collection is estimated to take 12 minutes to complete, including gathering, preparing, and submitting the completed application form to the USPTO. Time will vary depending upon the individual case. Any comments on the amount of time you require to complete this form and/or suggestions for reducing this burden, should be sent to the Chief Information Officer, U.S. Patent and Trademark Office, U.S. Department of Commerce, P.O. Box 1450, Alexandria, Virginia 22313-1450. DO NOT SEND FEES OR COMPLETED FORMS TO THIS ADDRESS. SEND TO: Commissioner for Patents, P.O. Box 1450, Alexandria, Virginia 22313-1450.

Under the Paperwork Reduction Act of 1995, no persons are required to respond to a collection of information unless it displays a valid OMB control number.

**IN THE UNITED STATES PATENT AND TRADEMARK OFFICE**

In re Application of:  
John D'Agostino

Group Art Unit: 3691

Serial No.: 11/252,009

Examiner: Shrestha, Bijendra

Filed:

Dkt. No.: 253.001

For: SYSTEM AND METHOD FOR PERFORMING SECURE CREDIT CARD PURCHASES

**CERTIFICATE OF MAILING OR TRANSMISSION UNDER 37 CFR 1.8:**

I hereby certify that this correspondence is being electronically transmitted using EFS-Web, or Deposited with the United States Postal Service on the date shown below with sufficient postage as first class mail in an envelope addressed to : \_\_\_\_\_, Commissioner for Patents, P.O. Box 1450, Alexandria, VA 22313-1450, or Transmitted by facsimile on the date shown below to the United States Patent and Trademark Office at (571) 273-8300.

October 12, 2010

/Stephen Lewellyn/

Date

Stephen Lewellyn

**RESPONSE TO NOTICE OF ALLOWANCE DATED SEPT. 1, 2010**

Commissioner for Patents  
P.O. Box 1450  
Alexandria, VA 22313-1450

Dear Sir,

In response to the Notice of Allowance dated September 1, 2010, the Applicant submits herewith:

1. Form PTOL-85;
2. Issue Fee in accordance with 37 CFR 1.18(a) for small entity in the amount of \$755.00; and
3. Publication Fee in accordance with 37 CFR 1.18(d) in the amount of \$300.00.

October 12, 2010

Date: \_\_\_\_\_

Respectfully submitted,  
Maxey Law Offices, PLLC  
/Stephen Lewellyn/

\_\_\_\_\_  
Stephen Lewellyn  
Registration No. 51,942  
15500 Roosevelt Blvd., Suite 305  
Clearwater, Florida 33760  
Tel: 727-230-4949

## Electronic Patent Application Fee Transmittal

<b>Application Number:</b>	11252009			
<b>Filing Date:</b>	17-Oct-2005			
<b>Title of Invention:</b>	SYSTEM AND METHOD FOR PERFORMING SECURE CREDIT CARD PURCHASES			
<b>First Named Inventor/Applicant Name:</b>	John D'Agostino			
<b>Filer:</b>	Stephen James Lewellyn			
<b>Attorney Docket Number:</b>				
Filed as Small Entity				
<b>Utility under 35 USC 111(a) Filing Fees</b>				
<b>Description</b>	<b>Fee Code</b>	<b>Quantity</b>	<b>Amount</b>	<b>Sub-Total in USD(\$)</b>
<b>Basic Filing:</b>				
<b>Pages:</b>				
<b>Claims:</b>				
<b>Miscellaneous-Filing:</b>				
<b>Petition:</b>				
<b>Patent-Appeals-and-Interference:</b>				
<b>Post-Allowance-and-Post-Issuance:</b>				
Utility Appl issue fee	2501	1	755	755
Publ. Fee- early, voluntary, or normal	1504	1	300	300

Description	Fee Code	Quantity	Amount	Sub-Total in USD(\$)
<b>Extension-of-Time:</b>				
<b>Miscellaneous:</b>				
<b>Total in USD (\$)</b>				<b>1055</b>



## Electronic Acknowledgement Receipt

<b>EFS ID:</b>	8606209
<b>Application Number:</b>	11252009
<b>International Application Number:</b>	
<b>Confirmation Number:</b>	4322
<b>Title of Invention:</b>	SYSTEM AND METHOD FOR PERFORMING SECURE CREDIT CARD PURCHASES
<b>First Named Inventor/Applicant Name:</b>	John D'Agostino
<b>Correspondence Address:</b>	JOHN D'AGOSTINO - 5168 NORTHRIDGE ROAD #309 - SARASOTA FL 34238 US 3058588000 -
<b>Filer:</b>	Stephen James Lewellyn
<b>Filer Authorized By:</b>	
<b>Attorney Docket Number:</b>	
<b>Receipt Date:</b>	12-OCT-2010
<b>Filing Date:</b>	17-OCT-2005
<b>Time Stamp:</b>	14:20:41
<b>Application Type:</b>	Utility under 35 USC 111(a)

### Payment information:

Submitted with Payment	yes
Payment Type	Credit Card
Payment was successfully received in RAM	\$1055

RAM confirmation Number		614			
Deposit Account					
Authorized User					
<b>File Listing:</b>					
Document Number	Document Description	File Name	File Size(Bytes)/ Message Digest	Multi Part /.zip	Pages (if appl.)
1	Issue Fee Payment (PTO-85B)	PTOL_85.pdf	104121	no	1
			45a541138f7259e04da260985134b84455809b47		
<b>Warnings:</b>					
<b>Information:</b>					
2	Transmittal Letter	253001_NOA_response.pdf	60963	no	1
			5e451a77f2dc44d7056d220cfa4aba2a62df3c3		
<b>Warnings:</b>					
<b>Information:</b>					
3	Fee Worksheet (PTO-875)	fee-info.pdf	31651	no	2
			620d99609316a37c4598f67bdc96c0f31012d9f1		
<b>Warnings:</b>					
<b>Information:</b>					
<b>Total Files Size (in bytes):</b>			196735		
<p><b>This Acknowledgement Receipt evidences receipt on the noted date by the USPTO of the indicated documents, characterized by the applicant, and including page counts, where applicable. It serves as evidence of receipt similar to a Post Card, as described in MPEP 503.</b></p> <p><b><u>New Applications Under 35 U.S.C. 111</u></b>  <b>If a new application is being filed and the application includes the necessary components for a filing date (see 37 CFR 1.53(b)-(d) and MPEP 506), a Filing Receipt (37 CFR 1.54) will be issued in due course and the date shown on this Acknowledgement Receipt will establish the filing date of the application.</b></p> <p><b><u>National Stage of an International Application under 35 U.S.C. 371</u></b>  <b>If a timely submission to enter the national stage of an international application is compliant with the conditions of 35 U.S.C. 371 and other applicable requirements a Form PCT/DO/EO/903 indicating acceptance of the application as a national stage submission under 35 U.S.C. 371 will be issued in addition to the Filing Receipt, in due course.</b></p> <p><b><u>New International Application Filed with the USPTO as a Receiving Office</u></b>  <b>If a new international application is being filed and the international application includes the necessary components for an international filing date (see PCT Article 11 and MPEP 1810), a Notification of the International Application Number and of the International Filing Date (Form PCT/RO/105) will be issued in due course, subject to prescriptions concerning national security, and the date shown on this Acknowledgement Receipt will establish the international filing date of the application.</b></p>					



UNITED STATES PATENT AND TRADEMARK OFFICE

UNITED STATES DEPARTMENT OF COMMERCE
United States Patent and Trademark Office
Address: COMMISSIONER FOR PATENTS
P.O. Box 1450
Alexandria, Virginia 22313-1450
www.uspto.gov

NOTICE OF ALLOWANCE AND FEE(S) DUE

7590 09/01/2010
JOHN D'AGOSTINO
5168 NORTHRIDGE ROAD #309
SARASOTA, FL 34238

EXAMINER: SHRESTHA, BIJENDRA K
ART UNIT: 3691 PAPER NUMBER:
DATE MAILED: 09/01/2010

Table with 5 columns: APPLICATION NO., FILING DATE, FIRST NAMED INVENTOR, ATTORNEY DOCKET NO., CONFIRMATION NO.
11/252,009 10/17/2005 John D'Agostino 4322
TITLE OF INVENTION: SYSTEM AND METHOD FOR PERFORMING SECURE CREDIT CARD PURCHASES

Table with 7 columns: APPLN. TYPE, SMALL ENTITY, ISSUE FEE DUE, PUBLICATION FEE DUE, PREV. PAID ISSUE FEE, TOTAL FEE(S) DUE, DATE DUE
nonprovisional YES \$755 \$300 \$0 \$1055 12/01/2010

THE APPLICATION IDENTIFIED ABOVE HAS BEEN EXAMINED AND IS ALLOWED FOR ISSUANCE AS A PATENT. PROSECUTION ON THE MERITS IS CLOSED. THIS NOTICE OF ALLOWANCE IS NOT A GRANT OF PATENT RIGHTS. THIS APPLICATION IS SUBJECT TO WITHDRAWAL FROM ISSUE AT THE INITIATIVE OF THE OFFICE OR UPON PETITION BY THE APPLICANT. SEE 37 CFR 1.313 AND MPEP 1308.

THE ISSUE FEE AND PUBLICATION FEE (IF REQUIRED) MUST BE PAID WITHIN THREE MONTHS FROM THE MAILING DATE OF THIS NOTICE OR THIS APPLICATION SHALL BE REGARDED AS ABANDONED. THIS STATUTORY PERIOD CANNOT BE EXTENDED. SEE 35 U.S.C. 151. THE ISSUE FEE DUE INDICATED ABOVE DOES NOT REFLECT A CREDIT FOR ANY PREVIOUSLY PAID ISSUE FEE IN THIS APPLICATION. IF AN ISSUE FEE HAS PREVIOUSLY BEEN PAID IN THIS APPLICATION (AS SHOWN ABOVE), THE RETURN OF PART B OF THIS FORM WILL BE CONSIDERED A REQUEST TO REAPPLY THE PREVIOUSLY PAID ISSUE FEE TOWARD THE ISSUE FEE NOW DUE.

HOW TO REPLY TO THIS NOTICE:

I. Review the SMALL ENTITY status shown above.

If the SMALL ENTITY is shown as YES, verify your current SMALL ENTITY status:

- A. If the status is the same, pay the TOTAL FEE(S) DUE shown above.
B. If the status above is to be removed, check box 5b on Part B - Fee(s) Transmittal and pay the PUBLICATION FEE (if required) and twice the amount of the ISSUE FEE shown above, or

If the SMALL ENTITY is shown as NO:

- A. Pay TOTAL FEE(S) DUE shown above, or
B. If applicant claimed SMALL ENTITY status before, or is now claiming SMALL ENTITY status, check box 5a on Part B - Fee(s) Transmittal and pay the PUBLICATION FEE (if required) and 1/2 the ISSUE FEE shown above.

II. PART B - FEE(S) TRANSMITTAL, or its equivalent, must be completed and returned to the United States Patent and Trademark Office (USPTO) with your ISSUE FEE and PUBLICATION FEE (if required). If you are charging the fee(s) to your deposit account, section "4b" of Part B - Fee(s) Transmittal should be completed and an extra copy of the form should be submitted. If an equivalent of Part B is filed, a request to reapply a previously paid issue fee must be clearly made, and delays in processing may occur due to the difficulty in recognizing the paper as an equivalent of Part B.

III. All communications regarding this application must give the application number. Please direct all communications prior to issuance to Mail Stop ISSUE FEE unless advised to the contrary.

IMPORTANT REMINDER: Utility patents issuing on applications filed on or after Dec. 12, 1980 may require payment of maintenance fees. It is patentee's responsibility to ensure timely payment of maintenance fees when due.

**PART B - FEE(S) TRANSMITTAL**

**Complete and send this form, together with applicable fee(s), to: Mail Mail Stop ISSUE FEE  
 Commissioner for Patents  
 P.O. Box 1450  
 Alexandria, Virginia 22313-1450  
 or Fax (571)-273-2885**

**INSTRUCTIONS:** This form should be used for transmitting the ISSUE FEE and PUBLICATION FEE (if required). Blocks 1 through 5 should be completed where appropriate. All further correspondence including the Patent, advance orders and notification of maintenance fees will be mailed to the current correspondence address as indicated unless corrected below or directed otherwise in Block 1, by (a) specifying a new correspondence address; and/or (b) indicating a separate "FEE ADDRESS" for maintenance fee notifications.

CURRENT CORRESPONDENCE ADDRESS (Note: Use Block 1 for any change of address)

Note: A certificate of mailing can only be used for domestic mailings of the Fee(s) Transmittal. This certificate cannot be used for any other accompanying papers. Each additional paper, such as an assignment or formal drawing, must have its own certificate of mailing or transmission.

7590 09/01/2010

**JOHN D'AGOSTINO**  
 5168 NORTHRIDGE ROAD #309  
 SARASOTA, FL 34238

**Certificate of Mailing or Transmission**

I hereby certify that this Fee(s) Transmittal is being deposited with the United States Postal Service with sufficient postage for first class mail in an envelope addressed to the Mail Stop ISSUE FEE address above, or being facsimile transmitted to the USPTO (571) 273-2885, on the date indicated below.

_____ (Depositor's name)
_____ (Signature)
_____ (Date)

APPLICATION NO.	FILING DATE	FIRST NAMED INVENTOR	ATTORNEY DOCKET NO.	CONFIRMATION NO.
11/252,009	10/17/2005	John D'Agostino		4322

TITLE OF INVENTION: SYSTEM AND METHOD FOR PERFORMING SECURE CREDIT CARD PURCHASES

APPLN. TYPE	SMALL ENTITY	ISSUE FEE DUE	PUBLICATION FEE DUE	PREV. PAID ISSUE FEE	TOTAL FEE(S) DUE	DATE DUE
nonprovisional	YES	\$755	\$300	\$0	\$1055	12/01/2010

EXAMINER	ART UNIT	CLASS-SUBCLASS
SHRESTHA, BIJENDRA K	3691	705-044000

<p>1. Change of correspondence address or indication of "Fee Address" (37 CFR 1.363).</p> <p><input type="checkbox"/> Change of correspondence address (or Change of Correspondence Address form PTO/SB/122) attached.</p> <p><input type="checkbox"/> "Fee Address" indication (or "Fee Address" Indication form PTO/SB/47; Rev 03-02 or more recent) attached. <b>Use of a Customer Number is required.</b></p>	<p>2. For printing on the patent front page, list</p> <p>(1) the names of up to 3 registered patent attorneys or agents OR, alternatively, 1 _____</p> <p>(2) the name of a single firm (having as a member a registered attorney or agent) and the names of up to 2 registered patent attorneys or agents. If no name is listed, no name will be printed. 2 _____</p> <p>3 _____</p>
---	---

3. ASSIGNEE NAME AND RESIDENCE DATA TO BE PRINTED ON THE PATENT (print or type)

PLEASE NOTE: Unless an assignee is identified below, no assignee data will appear on the patent. If an assignee is identified below, the document has been filed for recordation as set forth in 37 CFR 3.11. Completion of this form is NOT a substitute for filing an assignment.

(A) NAME OF ASSIGNEE \_\_\_\_\_ (B) RESIDENCE: (CITY and STATE OR COUNTRY) \_\_\_\_\_

Please check the appropriate assignee category or categories (will not be printed on the patent):  Individual  Corporation or other private group entity  Government

<p>4a. The following fee(s) are submitted:</p> <p><input type="checkbox"/> Issue Fee</p> <p><input type="checkbox"/> Publication Fee (No small entity discount permitted)</p> <p><input type="checkbox"/> Advance Order - # of Copies _____</p>	<p>4b. Payment of Fee(s): (Please first reapply any previously paid issue fee shown above)</p> <p><input type="checkbox"/> A check is enclosed.</p> <p><input type="checkbox"/> Payment by credit card. Form PTO-2038 is attached.</p> <p><input type="checkbox"/> The Director is hereby authorized to charge the required fee(s), any deficiency, or credit any overpayment, to Deposit Account Number _____ (enclose an extra copy of this form).</p>
---	--

5. Change in Entity Status (from status indicated above)

a. Applicant claims SMALL ENTITY status. See 37 CFR 1.27.  b. Applicant is no longer claiming SMALL ENTITY status. See 37 CFR 1.27(g)(2).

NOTE: The Issue Fee and Publication Fee (if required) will not be accepted from anyone other than the applicant; a registered attorney or agent; or the assignee or other party in interest as shown by the records of the United States Patent and Trademark Office.

Authorized Signature \_\_\_\_\_ Date \_\_\_\_\_

Typed or printed name \_\_\_\_\_ Registration No. \_\_\_\_\_

This collection of information is required by 37 CFR 1.311. The information is required to obtain or retain a benefit by the public which is to file (and by the USPTO to process) an application. Confidentiality is governed by 35 U.S.C. 122 and 37 CFR 1.14. This collection is estimated to take 12 minutes to complete, including gathering, preparing, and submitting the completed application form to the USPTO. Time will vary depending upon the individual case. Any comments on the amount of time you require to complete this form and/or suggestions for reducing this burden, should be sent to the Chief Information Officer, U.S. Patent and Trademark Office, U.S. Department of Commerce, P.O. Box 1450, Alexandria, Virginia 22313-1450. DO NOT SEND FEES OR COMPLETED FORMS TO THIS ADDRESS. SEND TO: Commissioner for Patents, P.O. Box 1450, Alexandria, Virginia 22313-1450.

Under the Paperwork Reduction Act of 1995, no persons are required to respond to a collection of information unless it displays a valid OMB control number.



UNITED STATES PATENT AND TRADEMARK OFFICE

UNITED STATES DEPARTMENT OF COMMERCE
United States Patent and Trademark Office
Address: COMMISSIONER FOR PATENTS
P.O. Box 1450
Alexandria, Virginia 22313-1450
www.uspto.gov

Table with 5 columns: APPLICATION NO., FILING DATE, FIRST NAMED INVENTOR, ATTORNEY DOCKET NO., CONFIRMATION NO.
11/252,009 10/17/2005 John D'Agostino 4322

7590 09/01/2010
JOHN D'AGOSTINO
5168 NORTHRIDGE ROAD #309
SARASOTA, FL 34238

EXAMINER

SHRESTHA, BIJENDRA K

ART UNIT PAPER NUMBER

3691

DATE MAILED: 09/01/2010

Determination of Patent Term Adjustment under 35 U.S.C. 154 (b)
(application filed on or after May 29, 2000)

The Patent Term Adjustment to date is 0 day(s). If the issue fee is paid on the date that is three months after the mailing date of this notice and the patent issues on the Tuesday before the date that is 28 weeks (six and a half months) after the mailing date of this notice, the Patent Term Adjustment will be 0 day(s).

If a Continued Prosecution Application (CPA) was filed in the above-identified application, the filing date that determines Patent Term Adjustment is the filing date of the most recent CPA.

Applicant will be able to obtain more detailed information by accessing the Patent Application Information Retrieval (PAIR) WEB site (http://pair.uspto.gov).

Any questions regarding the Patent Term Extension or Adjustment determination should be directed to the Office of Patent Legal Administration at (571)-272-7702. Questions relating to issue and publication fee payments should be directed to the Customer Service Center of the Office of Patent Publication at 1-(888)-786-0101 or (571)-272-4200.

<b>Notice of Allowability</b>	<b>Application No.</b>	<b>Applicant(s)</b>	
	11/252,009	D'AGOSTINO, JOHN	
	<b>Examiner</b>	<b>Art Unit</b>	
	BIJENDRA K. SHRESTHA	3691	

**-- The MAILING DATE of this communication appears on the cover sheet with the correspondence address--**

All claims being allowable, PROSECUTION ON THE MERITS IS (OR REMAINS) CLOSED in this application. If not included herewith (or previously mailed), a Notice of Allowance (PTOL-85) or other appropriate communication will be mailed in due course. **THIS NOTICE OF ALLOWABILITY IS NOT A GRANT OF PATENT RIGHTS.** This application is subject to withdrawal from issue at the initiative of the Office or upon petition by the applicant. See 37 CFR 1.313 and MPEP 1308.

1.  This communication is responsive to 7/26/2010.
2.  The allowed claim(s) is/are 1,3,4,6-13 and 15-33.
3.  Acknowledgment is made of a claim for foreign priority under 35 U.S.C. § 119(a)-(d) or (f).
  - a)  All    b)  Some\*    c)  None    of the:
    1.  Certified copies of the priority documents have been received.
    2.  Certified copies of the priority documents have been received in Application No. \_\_\_\_\_ .
    3.  Copies of the certified copies of the priority documents have been received in this national stage application from the International Bureau (PCT Rule 17.2(a)).

\* Certified copies not received: \_\_\_\_\_.

Applicant has THREE MONTHS FROM THE "MAILING DATE" of this communication to file a reply complying with the requirements noted below. Failure to timely comply will result in ABANDONMENT of this application.  
**THIS THREE-MONTH PERIOD IS NOT EXTENDABLE.**

4.  A SUBSTITUTE OATH OR DECLARATION must be submitted. Note the attached EXAMINER'S AMENDMENT or NOTICE OF INFORMAL PATENT APPLICATION (PTO-152) which gives reason(s) why the oath or declaration is deficient.
5.  CORRECTED DRAWINGS ( as "replacement sheets") must be submitted.
  - (a)  including changes required by the Notice of Draftsperson's Patent Drawing Review ( PTO-948) attached
    - 1)  hereto or 2)  to Paper No./Mail Date \_\_\_\_\_.
  - (b)  including changes required by the attached Examiner's Amendment / Comment or in the Office action of Paper No./Mail Date \_\_\_\_\_.

**Identifying indicia such as the application number (see 37 CFR 1.84(c)) should be written on the drawings in the front (not the back) of each sheet. Replacement sheet(s) should be labeled as such in the header according to 37 CFR 1.121(d).**
6.  DEPOSIT OF and/or INFORMATION about the deposit of BIOLOGICAL MATERIAL must be submitted. Note the attached Examiner's comment regarding REQUIREMENT FOR THE DEPOSIT OF BIOLOGICAL MATERIAL.

**Attachment(s)**

- |  |   |
|--|---|
| 1. <input checked="" type="checkbox"/> Notice of References Cited (PTO-892)  | 5. <input type="checkbox"/> Notice of Informal Patent Application                       |
| 2. <input type="checkbox"/> Notice of Draftsperson's Patent Drawing Review (PTO-948)                               | 6. <input type="checkbox"/> Interview Summary (PTO-413),<br>Paper No./Mail Date _____ . |
| 3. <input checked="" type="checkbox"/> Information Disclosure Statements (PTO/SB/08),<br>Paper No./Mail Date _____ | 7. <input checked="" type="checkbox"/> Examiner's Amendment/Comment                     |
| 4. <input type="checkbox"/> Examiner's Comment Regarding Requirement for Deposit<br>of Biological Material         | 8. <input checked="" type="checkbox"/> Examiner's Statement of Reasons for Allowance    |
|  | 9. <input type="checkbox"/> Other _____.  |

/Hani M. Kazimi/  
 Primary Examiner, Art Unit 3691

**EXAMINER STATEMENT**

1. This action is responsive to the amendment filed with Request for Continued Examination (RCE) on 07/26/2010. Of the original claims 1-43 filed, claims 13, 15-24 have been amended, and claims 2, 5, 14 and 34-43 have been canceled by applicant's amendment. Therefore, claims 1, 3-4, 6-13 and 15-33 are under consideration for prosecution of this application.

**EXAMINER'S AMENDMENT**

2. An examiner's amendment to the record appears below. Should the changes and/or additions be unacceptable to applicant, an amendment may be filed as provided by 37 CFR 1.312. To ensure consideration of such an amendment, it MUST be submitted no later than the payment of the issue fee.

Authorization for this examiner's amendment was given in a telephone interview with attorney Stephen Lewellyn (registration # 51,942) on August 11, 2010. The application has been amended as follows:

**AMENDMENT IN THE CLAIMS**

*1 (Currently Amended). A method of performing secure credit card purchases, said method comprising:*

*a) contacting a custodial authorizing entity having custodial responsibility of account parameters of a customer's account that is used to make credit card purchases;*

*b) supplying said custodial authorizing entity with at least account identification data of said customer's account;*

*c) defining a payment category including at least limiting purchases to a single merchant for at least one transaction, said single merchant limitation being included in said payment category prior to any particular merchant being identified as said single merchant;*

*d) designating said payment category thereby designating at least that a transaction code generated in accordance with said payment category can be used by only one merchant;*

*e) generating a transaction code by a processing computer of said custodial authorizing entity, said transaction code reflecting at least the limits of said designated payment category to make a purchase within said designated payment category;*

*f) communicating said transaction code to a merchant to consummate a purchase with defined purchase parameters;*

*g) verifying that said defined purchase parameters are within said designated payment category; and*

*h) providing authorization for said purchase so as to confirm at least that said defined purchase parameters are within said designated payment category and to authorize payment required to complete the purchase.*

*2 (canceled).*



Art Unit: 3691

3 (Previously Presented). The method of claim 1 further comprising the step of designating said single merchant subsequent to generating said transaction code.

4 (Previously Presented). The method of claim 1 wherein said step of communicating the transaction code to said merchant to consummate said purchase within defined purchase parameters further comprises designation of said single merchant.

5 (canceled).

6 (Previously Amended). The method of claim 1 wherein said step of generating said transaction code further comprises said customer obtaining said transaction code.

7 (Previously Presented). The method of claim 1 further comprising obtaining said authorization for said purchase from the custodial authorizing entity.

8 (Previously Presented). The method of claim 1 further comprising a step of communicating promotional information of offered subject matter to the customer by the merchant, pre-determining the purchase parameters of the purchase, and corresponding said designated payment category to said purchase parameters.

Art Unit: 3691

9 (*Previously Presented*). The method of claim 1 further comprising the merchant communicating the transaction code to the custodial authorizing entity for verification.

10 (*Previously Presented*). The method of claim 1 further comprising generating a transaction code which reflects at least one of a plurality of said payment categories.

11 (*Previously Amended*). The method of claim 10 further comprising defining at least one of said plurality of payment categories to include amount parameters for a cost of one or more purchases.

12 (*Previously Amended*). The method of claim 10 further comprising defining at least one of said plurality of payment categories to include time parameters during which the purchase can be completed.

13 (*Currently Amended*). The method of claim 10 further comprising defining at least one of said plurality of payment categories to include ~~the ability to use~~ using said transaction code for a single transaction at a fixed amount for purchase within a predetermined period of time.

14 (*Canceled*).

Art Unit: 3691

15 (Currently Amended). The method of claim 10 further comprising defining at least one of said plurality of payment categories to include ~~the ability to use~~ using said transaction code for a single transaction at a maximum amount for purchase within a predetermined period of time.

16 (Currently Amended). The method of claim 15 further comprising defining at least one of said plurality of payment categories to include ~~the ability to limit~~ limiting purchases to said single transaction at said maximum amount for purchase within said predetermined period of time.

17 (Currently Amended). The method of claim 10 further comprising defining at least one of said plurality of payment categories to include ~~the ability to use~~ using said transaction code for at least two purchases at a maximum total amount for items purchased within a predetermined time period.

18 (Currently Amended). The method of claim 17 further comprising defining at least one of said plurality of payment categories to include ~~the ability to limit~~ limiting purchases to said at least two purchases at said maximum total amount for items purchased within said predetermined time period.

19 (Currently Amended). The method of claim 10 further comprising defining at least one of said plurality of payment categories to include ~~the ability to use~~ using

Art Unit: 3691

*said transaction code for at least two purchases for a repeating transaction at a fixed amount payable at each of a fixed number of time intervals.*

*20 (Currently Amended). The method of claim 19 further comprising defining at least one of said plurality of payment categories to include ~~the ability to limit~~ limiting purchases to said repeating transaction at said fixed amount payable at each of said fixed number of time intervals.*

*21 (Currently Amended). The method of claim 10 further comprising defining at least one of said plurality of payment categories to include ~~the ability to use~~ using said transaction code for a repeating transaction at a fixed amount payable at each of an unspecified number of time intervals.*

*22. (Currently Amended): The method of claim 21 further comprising defining at least one of said plurality of payment categories to include ~~the ability to limit~~ limiting purchases to said repeating transaction at said fixed amount payable at each of said unspecified number of time intervals.*

*23. (Currently Amended): The method of claim 10 wherein said plurality of payment categories further include at least one of the group consisting of:*

*a) ~~the ability to use~~ using said transaction code for a single transaction at a fixed amount for a purchase within a predetermined period of time,*

b) ~~the ability to use~~ using said transaction code for a single transaction at a maximum amount for a purchase within a predetermined period of time,

c) ~~the ability to use~~ using said transaction code for multiple transactions at a maximum total amount for purchases within a predetermined time period,

d) ~~the ability to use~~ using said transaction code for a repeating transaction at a fixed amount for purchases payable at each of a fixed number of time intervals, and

e) ~~the ability to use~~ using said transaction code for a repeating transaction at a fixed amount for purchases payable at each of an unspecified number of time intervals.

24. (Currently Amended): The method of claim 10 wherein said plurality of payment categories further include at least one of the group consisting of:

a) ~~the ability to use~~ using said transaction code for a single transaction at a fixed amount for a purchase,

b) ~~the ability to use~~ using said transaction code for a single transaction at a maximum amount for a purchase,

c) ~~the ability to use~~ using said transaction code for multiple transactions at a maximum total amount for purchases,

d) ~~the ability to use~~ using said transaction code for a repeating transaction at a fixed amount for purchases payable at each of a fixed number of time intervals, and

e) ~~the ability to use~~ using said transaction code for a repeating transaction at a fixed amount for purchases payable at each of an unspecified number of time intervals.

25. (Previously Presented): The method of claim 1 further comprising generating said transaction code to further reflect an identification of said single merchant.

26. (Previously Amended): The method of claim 25 further comprising defining said payment category to include limiting purchases to a limited time interval during which said purchase is permitted.

27. (Currently Amended) A method of performing secure credit card purchases, said method comprising:

a) identifying a pre-established account that is used to make credit card purchases;

b) designating at least one of a plurality of pre-defined payment categories which limit a nature of a subsequent purchases, at least one of said payment categories including limiting purchases to a single merchant, said single

*merchant limitation being included in said payment category prior to any particular merchant being identified as said single merchant;*

*c) generating a transaction code by a processing computer of a custodial authorizing entity of said pre-established account, said transaction code associated with at least said pre-established account and the limits of said selected payment category, and different from said pre-established account;*

*d) communicating said transaction code to a merchant to consummate a purchase within defined purchase parameters;*

*e) verifying that said defined purchase parameters correspond to said designated payment category; and*

*f) providing authorization for said purchase so as to confirm at least that said defined purchase parameters are within said designated payment category and to authorize payment required to complete the purchase; and*

*g) associating the purchase with said pre-established account.*

28. *(Currently Amended): A method of performing secure credit card purchases, said method comprising:*

*a) identifying a pre-established account that is used to make credit card purchases;*

*b) selecting a predetermined payment category which limits a nature, of a series of subsequent purchases to a single merchant, said single merchant limitation being included in said payment category prior to any particular merchant being identified as said single merchant;*

c) *generating a transaction code by a processing computer of a custodial authorizing entity of said pre-established account, said transaction code associated with at least said pre-established account and the limits of said selected payment category and different from said pre-established account;*

d) *communicating said transaction code to a merchant to consummate a purchase within defined purchase parameters;*

e) *verifying that said defined purchase parameters correspond to said selected payment category;*

f) *providing authorization for said purchase so as to confirm at least that said defined purchase parameters are within said selected payment category and to authorize payment required to complete the purchase; and*

g) *associating the purchase with said pre-established account.*

29. *(Previously Presented): The method of claim 28 wherein said step of selecting said payment category which limits said nature of said series of subsequent purchases to said single merchant further comprises limiting said nature of said series of subsequent purchases to a fixed amount for each of said subsequent purchases.*

30. *(Previously Presented): The method of claim 28 wherein said step of selecting said payment category which limits said nature of said series of subsequent purchases to said single merchant further comprises limiting said*



Art Unit: 3691

*nature of said series of subsequent purchases to a maximum total amount for said subsequent purchases.*

31. *(Previously Presented): The method of claim 28 wherein said step of verifying that said defined purchase parameters correspond to said selected payment category further identifies said merchant as said single merchant.*

32. *(Previously Amended): A method of performing secure credit card purchases, said method comprising the steps of:*

*a) identifying a pre-established account that is used to make credit card purchases;*

*b) selecting a pre-determined payment category which limits a nature of a subsequent purchase to a single merchant, said single merchant limitation being included in said payment category prior to any particular merchant being identified as said single merchant;*

*c) generating a transaction code by a processing computer of a custodial authorizing entity of said pre-established account, said transaction code associated with at least said pre-established account and the limits of said selected payment category, and different from said pre-established account;*

*d) designating a merchant as said single merchant;*

*e) communicating said transaction code to said merchant to consummate a purchase within defined purchase parameters;*

*f) verifying that said defined purchase parameters correspond to said selected payment category;*

*g) providing authorization for said purchase so as to confirm at least that said defined purchase parameters are within said selected payment category and to authorize payment required to complete the purchase; and*

*h) associating the purchase with said pre-established account.*

33. *(Previously Presented): The method of claim 32 wherein said step of verifying that said defined purchase parameters correspond to said selected payment category further identifies said merchant as said single merchant.*

34 *(canceled).*

35 *(canceled).*

36 *(canceled).*

37 *(canceled).*

38 *(canceled).*

39 *(canceled).*

40 *(canceled).*

41 *(canceled).*

42 *(canceled).*

43 *(canceled).*

***Reasons for Allowance***

3. With regards to claim 1, the prior art of records does neither anticipate nor render obvious, inter alia, as a whole, the uniquely patentable feature of: “defining a payment category including at least limiting purchases to a single merchant for at least one transaction, said single merchant limitation being included in said payment category prior to any particular merchant being identified as said single merchant” in a method of performing secure credit card purchases.

The reasons for allowance for all the other independent claims and dependent claims are the same as set forth for claim 1 above because they all include same/similar limitation indicated above for the reasons for allowance.

***Discussion of Cited Prior Art***

4. The applicant's arguments/remarks filed in response dated July 26, 2010, see pages 16-22 are persuasive and compelling that the cited prior art of Franklin et al., U.S. Patent No. 6,000,832, Yanagihara et al. U.S. Pub No. 2001/0011249, and Langhans et al., U.S. Patent No. 5,500,513 does neither disclose or renders obvious the unique features as listed above.

Any comments considered necessary by applicant must be submitted no later than the payment of the issue fee and, to avoid processing delays, should preferably accompany the issue fee. Such submissions should be clearly labeled "Comments on Statement of Reasons for Allowance".

### **Conclusion**

5. Any inquiry concerning this communication or earlier communications from the examiner should be directed to Bijendra K. Shrestha whose telephone number is (571) 270-1374. The examiner can normally be reached on 8:00 AM-4:30 PM (Monday-Friday).

If attempts to reach the examiner by telephone are unsuccessful, the examiner's supervisor, Alexander Kalinowski can be reached on (571) 272-6771. The fax phone number for the organization where this application or proceeding is assigned is 571-273-8300.

Information regarding the status of an application may be obtained from the Patent Application Information Retrieval (PAIR) system. Status information for published applications may be obtained from either Private PAIR or Public PAIR. Status information for unpublished applications is available through Private PAIR only. For more information about the PAIR system, see <http://pair-direct.uspto.gov>. Should you have questions on access to the Private PAIR system, contact the Electronic Business Center (EBC) at 866-217-9197 (toll-free). If you would like assistance from a USPTO Customer Service

Application/Control Number: 11/252,009

Page 16

Art Unit: 3691

Representative or access to the automated information system, call 800-786-9199 (IN USA OR CANADA) or 571-272-1000.

/Bijendra K. Shrestha/  
Examiner, Art Unit 3691  
08/13/2010

/Hani M. Kazimi/  
Primary Examiner, Art Unit 3691

<b>Notice of References Cited</b>	Application/Control No. 11/252,009	Applicant(s)/Patent Under Reexamination D'AGOSTINO, JOHN	
	Examiner BIJENDRA K. SHRESTHA	Art Unit 3691	Page 1 of 1

**U.S. PATENT DOCUMENTS**

*	Document Number Country Code-Number-Kind Code	Date MM-YYYY	Name	Classification
	A US-			
	B US-			
	C US-			
	D US-			
	E US-			
	F US-			
	G US-			
	H US-			
	I US-			
	J US-			
	K US-			
	L US-			
	M US-			

**FOREIGN PATENT DOCUMENTS**

*	Document Number Country Code-Number-Kind Code	Date MM-YYYY	Country	Name	Classification
	N				
	O				
	P				
	Q				
	R				
	S				
	T				

**NON-PATENT DOCUMENTS**

*	Include as applicable: Author, Title Date, Publisher, Edition or Volume, Pertinent Pages)
U	Lee et al.: Evolutionary business models for e-cash with smart cards, Korea Advanced Institute of Science and Technology, Korea, <a href="http://koasas.kaist.ac.kr/bitstream/10203/4774/1/2000-092.pdf">http://koasas.kaist.ac.kr/bitstream/10203/4774/1/2000-092.pdf</a> , pages 352-358
V	Jones, R.: Prepaid cards, an emerging internet payment mechanism, the Nuvantage Group, June 2001, pages 1-9
W	
X	

\*A copy of this reference is not being furnished with this Office action. (See MPEP § 707.05(a).)  
Dates in MM-YYYY format are publication dates. Classifications may be US or foreign.

<b>Index of Claims</b> 	<b>Application/Control No.</b> 11252009	<b>Applicant(s)/Patent Under Reexamination</b> D'AGOSTINO, JOHN
	<b>Examiner</b> Shrestha, Bijendra K	<b>Art Unit</b> 3691

✓	<b>Rejected</b>
=	<b>Allowed</b>

-	<b>Cancelled</b>
÷	<b>Restricted</b>

N	<b>Non-Elected</b>
I	<b>Interference</b>

A	<b>Appeal</b>
O	<b>Objected</b>

Claims renumbered in the same order as presented by applicant
  CPA
  T.D.
  R.1.47

CLAIM		DATE							
Final	Original	08/13/2010							
1	1	=							
	2	-							
2	3	=							
3	4	=							
	5	-							
4	6	=							
5	7	=							
6	8	=							
7	9	=							
8	10	=							
9	11	=							
10	12	=							
11	13	=							
	14	-							
12	15	=							
13	16	=							
14	17	=							
15	18	=							
16	19	=							
17	20	=							
18	21	=							
19	22	=							
20	23	=							
21	24	=							
22	25	=							
23	26	=							
24	27	=							
25	28	=							
26	29	=							
27	30	=							
28	31	=							
29	32	=							
30	33	=							
	34	-							
	35	-							
	36	-							

<b><i>Index of Claims</i></b> 	<b>Application/Control No.</b> 11252009	<b>Applicant(s)/Patent Under Reexamination</b> D'AGOSTINO, JOHN
	<b>Examiner</b> Shrestha, Bijendra K	<b>Art Unit</b> 3691

✓	<b>Rejected</b>
=	<b>Allowed</b>

-	<b>Cancelled</b>
÷	<b>Restricted</b>

N	<b>Non-Elected</b>
I	<b>Interference</b>

A	<b>Appeal</b>
O	<b>Objected</b>

Claims renumbered in the same order as presented by applicant
  CPA
  T.D.
  R.1.47

CLAIM		DATE								
Final	Original	08/13/2010								
	37	-								
	38	-								
	39	-								
	40	-								
	41	-								
	42	-								
	43	-								



<b>Issue Classification</b> 	<b>Application/Control No.</b> 11252009	<b>Applicant(s)/Patent Under Reexamination</b> D'AGOSTINO, JOHN
	<b>Examiner</b> BIJENDRA K SHRESTHA	<b>Art Unit</b> 3691

ORIGINAL						INTERNATIONAL CLASSIFICATION														
CLASS		SUBCLASS				CLAIMED					NON-CLAIMED									
705		44				G	0	6	Q	40 / 00 (2006.01.01)										
<b>CROSS REFERENCE(S)</b>																				
CLASS	SUBCLASS (ONE SUBCLASS PER BLOCK)																			
705	41																			

Claims renumbered in the same order as presented by applicant
  CPA
  T.D.
  R.1.47

Final	Original	Final	Original	Final	Original	Final	Original	Final	Original	Final	Original	Final	Original	Final	Original
1	1	14	17	30	33										
	2	15	18		34										
2	3	16	19		35										
3	4	17	20		36										
	5	18	21		37										
4	6	19	22		38										
5	7	20	23		39										
6	8	21	24		40										
7	9	22	25		41										
8	10	23	26		42										
9	11	24	27		43										
10	12	25	28												
11	13	26	29												
	14	27	30												
12	15	28	31												
13	16	29	32												

/BIJENDRA K SHRESTHA/ Examiner.Art Unit 3691  (Assistant Examiner)	08/13/2010  (Date)	<b>Total Claims Allowed:</b>  30	
/Hani Kazimi/ Primary Examiner.Art Unit 3691  (Primary Examiner)	08/16/2010  (Date)	O.G. Print Claim(s)  1	O.G. Print Figure  1

<b>Search Notes</b>  	<b>Application/Control No.</b>  11252009	<b>Applicant(s)/Patent Under Reexamination</b>  D'AGOSTINO, JOHN
	<b>Examiner</b>  Shrestha, Bijendra K	<b>Art Unit</b>  3691

<b>SEARCHED</b>			
<b>Class</b>	<b>Subclass</b>	<b>Date</b>	<b>Examiner</b>
705	44	08/13/2010	bks

<b>SEARCH NOTES</b>		
<b>Search Notes</b>	<b>Date</b>	<b>Examiner</b>
updated EAST Search attached	08/13/2010	bks
EIC SEARCH attached		
Google, Inventors and Assignee Searched		
Consulted with Primary Examiner Hani Kazimi		

<b>INTERFERENCE SEARCH</b>			
<b>Class</b>	<b>Subclass</b>	<b>Date</b>	<b>Examiner</b>
705	44	08/13/2010	bks

--	--



UNITED STATES PATENT AND TRADEMARK OFFICE

UNITED STATES DEPARTMENT OF COMMERCE  
 United States Patent and Trademark Office  
 Address: COMMISSIONER FOR PATENTS  
 P.O. Box 1450  
 Alexandria, Virginia 22313-1450  
 www.uspto.gov

BIB DATA SHEET

CONFIRMATION NO. 4322

<b>SERIAL NUMBER</b> 11/252,009	<b>FILING or 371(c) DATE</b> 10/17/2005 <b>RULE</b>	<b>CLASS</b> 705	<b>GROUP ART UNIT</b> 3691	<b>ATTORNEY DOCKET NO.</b>		
<b>APPLICANTS</b> John D'Agostino, Sarasota, FL;						
<b>** CONTINUING DATA *****</b> This application is a CON of 10/037,007 11/09/2001 ABN which is a CIP of 09/231,745 01/15/1999 PAT 6,324,526						
<b>** FOREIGN APPLICATIONS *****</b>						
<b>** IF REQUIRED, FOREIGN FILING LICENSE GRANTED *** SMALL ENTITY **</b> 11/03/2005						
Foreign Priority claimed <input type="checkbox"/> Yes <input checked="" type="checkbox"/> No	35 USC 119(a-d) conditions met <input type="checkbox"/> Yes <input checked="" type="checkbox"/> No	<input type="checkbox"/> Met after Allowance	<b>STATE OR COUNTRY</b> FL	<b>SHEETS DRAWINGS</b> 2	<b>TOTAL CLAIMS</b> 44	<b>INDEPENDENT CLAIMS</b> 6
Verified and Acknowledged	/BIJENDRA K SHRESTHA/ Examiner's Signature	Initials				
<b>ADDRESS</b> JOHN D'AGOSTINO 5168 NORTHRIDGE ROAD #309 SARASOTA, FL 34238 UNITED STATES						
<b>TITLE</b> System and method for performing secure credit card purchases						
<b>FILING FEE RECEIVED</b> 1400	FEES: Authority has been given in Paper No. _____ to charge/credit DEPOSIT ACCOUNT No. _____ for following:		<input type="checkbox"/> All Fees <input type="checkbox"/> 1.16 Fees (Filing) <input type="checkbox"/> 1.17 Fees (Processing Ext. of time) <input type="checkbox"/> 1.18 Fees (Issue) <input type="checkbox"/> Other _____ <input type="checkbox"/> Credit			

**EAST Search History**

**EAST Search History (Prior Art)**

Ref #	Hits	Search Query	DBs	Default Operator	Plurals	Time Stamp
L1	1942	705/44 and credit card	US-PGPUB; USPAT	ADJ	ON	2010/08/14 16:11
L2	1	705/44 and credit card and single (merchant or vendor) and payment category	US-PGPUB; USPAT	ADJ	ON	2010/08/14 16:12
L3	1	705/44 and card and single (merchant or vendor) and payment category	US-PGPUB; USPAT	ADJ	ON	2010/08/14 16:13
L4	6	705/44 and card and payment category	US-PGPUB; USPAT	ADJ	ON	2010/08/14 16:13
L5	3	credit card and single (merchant or vendor) and payment category	US-PGPUB; USPAT	ADJ	ON	2010/08/14 16:15
L6	2	credit card and single merchant and payment category	US-PGPUB; USPAT	ADJ	ON	2010/08/14 16:16

**8/14/2010 4:16:57 PM**

**C:\Documents and Settings\bshrestha\My Documents\EAST\Workspaces**

**\11252009Allowance.wsp**

IN THE UNITED STATES PATENT AND TRADEMARK OFFICE

Applicant: John D'Agostino  
Serial No.: 11/252,009  
Filing Date: October 17, 2005  
For: SYSTEM AND METHOD FOR PERFORMING SECURE CREDIT CARD PURCHASES



Confirmation No. 4322  
Customer No. 04219  
Shrestha, B., Examiner  
Group Art Unit 3691

2800 S.W. Third Avenue  
Historic Coral Way  
Miami, Florida 33129

Mail Stop Amendment  
Commissioner for Patents  
P.O. Box 1450  
Alexandria, VA 22313-1450

Dear Sir:

INFORMATION DISCLOSURE STATEMENT

In accordance with Applicant's duty of disclosure, the attached information is provided for consideration by the U.S. Patent and Trademark Office ("PTO") in connection with the above-captioned application. The information is identified on attached forms PTO/SB/08A and PTO/SB/08B. In accordance with 37 C.F.R. §1.98(a)(2)(ii), copies of U.S. patents or U.S. patent application publications have not been enclosed.

09/07/2007 ATRINH 00000016 11252009  
04 FC:1806

Furthermore, in accordance with the duty of disclosure and in an abundance of caution, as reflected on the attached form PTO/SB/08B, Applicant directs the Examiner's attention to Reexamination of U.S. Patent No. 6,324,526 filed on March 28, 2005,

180.00 OP

ALL REFERENCES CONSIDERED EXCEPT WHERE LINED THROUGH. /BKS/

and having Control No. 90/007,481. Said Reexamination is presently under Appeal before the Board of Patent Appeals and Interferences. Additionally, Applicant notes that each of the references cited in said reexamination that have not been previously provided are referenced herein.

The Examiner is respectfully requested to return an initialed copy of each form PTO/SB/08A and PTO/SB/08B evidencing consideration of this information with the next Office Action.

The Applicant points out that this Information Disclosure Statement is being presented after the issuance of a first Office Action, but before the issuance of a Final Office Action, and in accordance with 37 C.F.R. 1.97(c), a check in the amount of \$180.00 is enclosed as the fee under 1.17(p).

In the event that any fee may be required by the filing of this paper, the Commissioner is hereby authorized to charge any fees and/or credit to our **Deposit Account No. 13-1227**.

Respectfully submitted,

MALLOY & MALLOY, P.A.  
Attorneys for Applicant  
2800 S.W. Third Avenue  
Historic Coral Way  
Miami, Florida 33129  
(305) 858-8000

By 

Peter A. Matos  
Reg. No. 37,884

Dated: 9/5/07

ALL REFERENCES CONSIDERED EXCEPT WHERE LINED THROUGH. /BKS/

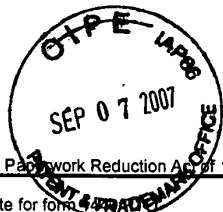

PTO/SB/08A (09-06)  
 Approved for use through 03/31/2007. OMB 0651-0031  
 U.S. Patent and Trademark Office; U.S. DEPARTMENT OF COMMERCE

Under the Paperwork Reduction Act of 1995, no persons are required to respond to a collection of information unless it contains a valid OMB control number.

<b>INFORMATION DISCLOSURE          STATEMENT BY APPLICANT</b> <i>(Use as many sheets as necessary)</i>	<b>Complete if Known</b>	
	Application Number	11/252,009
	Filing Date	October 17, 2005
	First Named Inventor	John D'Agostino
	Art Unit	3691
	Examiner Name	Bijendra K. Shrestha
Attorney Docket Number	1.706-B.04	

Sheet 1 of 7

U. S. PATENT DOCUMENTS					
Examiner Initials*	Cite No. <sup>1</sup>	Document Number	Publication Date MM-DD-YYYY	Name of Patentee or Applicant of Cited Document	Pages, Columns, Lines, Where Relevant Passages or Relevant Figures Appear
		Number-Kind Code <sup>2</sup> (if known)			
		US- 3,938,091	02/10/1976	Atalla et al.	
		US- 4,423,316	12/27/1983	Sano et al.	
		US- 4,707,592	11/17/1987	Ware	
		US- 4,720,860	01/19/1988	Weiss	
		US- 4,725,719	02/16/1988	Oncken et al.	
		US- 4,747,050	05/24/1988	Brachtl et al.	
		US- 4,797,920	01/10/1989	Stein	
		US- 5,097,505	03/17/1992	Weiss	
		US- 5,130,519	07/14/1992	Bush et al.	
		US- 5,163,097	11/10/1992	Pegg	
		US- 5,193,114	03/09/1993	Moseley	
		US- 5,196,840	03/23/1993	Leith et al.	
		US- 5,202,826	04/13/1993	McCarthy	
		US- 5,239,583	08/24/1993	Parrillo	
		US- 5,287,268	02/15/1994	McCarthy	
		US- 5,317,636	05/31/1994	Vizcaino	
		US- 5,323,338	06/21/1994	Hawthorne	
		US- 5,326,960	07/05/1994	Tannenbaum	
		US- 5,350,906	09/27/1994	Brody et al.	

FOREIGN PATENT DOCUMENTS						
Examiner Initials*	Cite No. <sup>1</sup>	Foreign Patent Document	Publication Date MM-DD-YYYY	Name of Patentee or Applicant of Cited Document	Pages, Columns, Lines, Where Relevant Passages Or Relevant Figures Appear	T <sup>6</sup>
		Country Code <sup>3</sup> Number <sup>4</sup> Kind Code <sup>5</sup> (if known)				
		EP 0 081 921 A1	06/22/1983	Easterby		
		GB 2 145 265 A	03/20/1985	Miura		
		WO 91/12693	05/08/1992	Hawthorne et al.		
		FR 2 661 996 - A1	11/15/1991	Bremard		
		GB 2 252 270 A	08/05/1992	Wren-Hilton		
		WO 93/14476	07/22/1993	Reinikainen		

Examiner Signature	/Bijendra K. Shrestha/	Date Considered	08/13/2010
--------------------	------------------------	-----------------	------------

\*EXAMINER: Initial if reference considered, whether or not citation is in conformance with MPEP 609. Draw line through citation if not in conformance and not considered. Include copy of this form with next communication to applicant. <sup>1</sup> Applicant's unique citation designation number (optional). <sup>2</sup> See Kinds Codes of USPTO Patent Documents at [www.uspto.gov](http://www.uspto.gov) or MPEP 901.04. <sup>3</sup> Enter Office that issued the document, by the two-letter code (WIPO Standard ST.3). <sup>4</sup> For Japanese patent documents, the indication of the year of the reign of the Emperor must precede the serial number of the patent document. <sup>5</sup> Kind of document by the appropriate symbols as indicated on the document under WIPO Standard ST.16 if possible. <sup>6</sup> Applicant is to place a check mark here if English language Translation is attached.

This collection of information is required by 37 CFR 1.97 and 1.98. The information is required to obtain or retain a benefit by the public which is to file (and by the USPTO to process) an application. Confidentiality is governed by 35 U.S.C. 122 and 37 CFR 1.14. This collection is estimated to take 2 hours to complete, including gathering, preparing, and submitting the completed application form to the USPTO. Time will vary depending upon the individual case. Any comments on the amount of time you require to complete this form and/or suggestions for reducing this burden, should be sent to the Chief Information Officer, U.S. Patent and Trademark Office, P.O. Box 1450, Alexandria, VA 22313-1450. DO NOT SEND FEES OR COMPLETED FORMS TO THIS ADDRESS. SEND TO: Commissioner for Patents, P.O. Box 1450, Alexandria, VA 22313-1450.

If you need assistance in completing the form, call 1-800-PTO-9199 (1-800-786-9199) and select option 2.

ALL REFERENCES CONSIDERED EXCEPT WHERE LINED THROUGH. /BKS/



Under the Paperwork Reduction Act of 1995, no persons are required to respond to a collection of information unless it contains a valid OMB control number.

Substitute for form 1449/PTO  <b>INFORMATION DISCLOSURE STATEMENT BY APPLICANT</b> (Use as many sheets as necessary)		<b>Complete if Known</b>	
		Application Number	11/252,009
		Filing Date	October 17, 2005
		First Named Inventor	John D'Agostino
		Art Unit	3691
		Examiner Name	Bijendra K. Shrestha
Sheet <b>2</b>	of <b>7</b>	Attorney Docket Number	1.706-B.04

U. S. PATENT DOCUMENTS					
Examiner Initials*	Cite No. <sup>1</sup>	Document Number	Publication Date MM-DD-YYYY	Name of Patentee or Applicant of Cited Document	Pages, Columns, Lines, Where Relevant Passages or Relevant Figures Appear
		Number-Kind Code <sup>2</sup> (if known)			
		US- 5,363,449	11/08/1994	Bestock	
		US- 5,428,684	06/27/1995	Akiyama et al.	
		US- 5,466,919	11/14/1995	Hovakimian	
		US- 5,478,994	12/26/1995	Rahman et al.	
		US- 5,485,510	01/16/1996	Colbert	
		US- 5,500,513	03/19/1996	Langhans et al.	
		US- 5,504,808	04/02/1996	Hamrick, Jr.	
		US- 5,555,497	09/10/1996	Helbling	
		US- 5,577,109	11/19/1996	Stimson et al.	
		US- 5,583,918	12/10/1996	Nakagawa	
		US- 5,606,614	02/25/1997	Brady et al.	
		US- 5,621,201	04/15/1997	Langhans et al.	
		US- 5,627,355	05/06/1997	Rahman et al.	
		US- 5,671,279	09/23/1997	Elgarnal	
		US- 5,677,955	10/14/1997	Doggett et al.	
		US- 5,694,471	12/02/1997	Chen et al.	
		US- 5,696,908	12/09/1997	Muehlberger et al.	
		US- 5,715,314	02/03/1998	Payne et al.	
		US- 5,721,768	02/24/1998	Stimson et al.	

FOREIGN PATENT DOCUMENTS						
Examiner Initials*	Cite No. <sup>1</sup>	Foreign Patent Document	Publication Date MM-DD-YYYY	Name of Patentee or Applicant of Cited Document	Pages, Columns, Lines, Where Relevant Passages Or Relevant Figures Appear	T <sup>6</sup>
		Country Code <sup>3</sup> Number <sup>4</sup> Kind Code <sup>5</sup> (if known)				
		EP 0 590 861 A2	04/06/1994	Colbert		
		EP 0 590 861 A3	04/06/1994	Colbert		
		EP 0 590 961 A2	04/06/1994	Kazuo et al.		
		WO 95/07512	03/16/1995	Ziarno		
		WO 96/08756	03/21/1996	Hawthorn et al.		
		WO 96/42150	12/27/1996	Pittenger et al.		

Examiner Signature	/Bijendra K. Shrestha/	Date Considered	08/13/2010
--------------------	------------------------	-----------------	------------

\*EXAMINER: Initial if reference considered, whether or not citation is in conformance with MPEP 609. Draw line through citation if not in conformance and not considered. Include copy of this form with next communication to applicant. <sup>1</sup> Applicant's unique citation designation number (optional). <sup>2</sup> See Kinds Codes of USPTO Patent Documents at [www.uspto.gov](http://www.uspto.gov) or MPEP 901.04. <sup>3</sup> Enter Office that issued the document, by the two-letter code (WIPO Standard ST.3). <sup>4</sup> For Japanese patent documents, the indication of the year of the reign of the Emperor must precede the serial number of the patent document. <sup>5</sup> Kind of document by the appropriate symbols as indicated on the document under WIPO Standard ST.16 if possible. <sup>6</sup> Applicant is to place a check mark here if English language Translation is attached.

This collection of information is required by 37 CFR 1.97 and 1.98. The information is required to obtain or retain a benefit by the public which is to file (and by the USPTO to process) an application. Confidentiality is governed by 35 U.S.C. 122 and 37 CFR 1.14. This collection is estimated to take 2 hours to complete, including gathering, preparing, and submitting the completed application form to the USPTO. Time will vary depending upon the individual case. Any comments on the amount of time you require to complete this form and/or suggestions for reducing this burden, should be sent to the Chief Information Officer, U.S. Patent and Trademark Office, P.O. Box 1450, Alexandria, VA 22313-1450. DO NOT SEND FEES OR COMPLETED FORMS TO THIS ADDRESS. SEND TO: Commissioner for Patents, P.O. Box 1450, Alexandria, VA 22313-1450.

If you need assistance in completing the form, call 1-800-PTO-9199 (1-800-786-9199) and select option 2.

ALL REFERENCES CONSIDERED EXCEPT WHERE LINED THROUGH. /BKS/

Under the Paperwork Reduction Act of 1995, no persons are required to respond to a collection of information unless it contains a valid OMB control number.

Substitute for form 1449/PTO

**INFORMATION DISCLOSURE  
STATEMENT BY APPLICANT**

(Use as many sheets as necessary)

**Complete if Known**

Application Number	11/252,009
Filing Date	October 17, 2005
First Named Inventor	John D'Agostino
Art Unit	3691
Examiner Name	Bijendra K. Shrestha
Attorney Docket Number	1.706-B.04

Sheet 3 of 7

**U. S. PATENT DOCUMENTS**

Examiner Initials*	Cite No. <sup>1</sup>	Document Number	Publication Date MM-DD-YYYY	Name of Patentee or Applicant of Cited Document	Pages, Columns, Lines, Where Relevant Passages or Relevant Figures Appear
		Number-Kind Code <sup>2</sup> (if known)			
		US- 5,724,424	03/03/1998	Gifford	
		US- 5,727,163	03/10/1998	Bezos	
		US- 5,729,594	03/17/1998	Klingman	
		US- 5,748,908	05/05/1998	Yu	
		US- 5,757,917	05/26/1998	Rose et al.	
		US- 5,768,381	06/16/1998	Hawthorne	
		US- 5,777,305	07/07/1998	Smith et al.	
		US- 5,777,306	07/07/1998	Masuda	
		US- 5,794,221	08/11/1998	Egendorf	
		US- 5,815,657	09/29/1998	Williams et al.	
		US- 5,822,737	10/13/1998	Ogram	
		US- 5,825,881	10/20/1998	Colvin, Sr.	
		US- 5,826,241	10/20/1998	Stein et al.	
		US- 5,826,243	10/20/1998	Musmanno et al.	
		US- 5,832,087	11/03/1998	Hawthorne	
		US- 5,864,830	01/26/1999	Armetta et al.	
		US- 5,868,236	02/09/1999	Rademacher	
		US- 5,883,810	03/16/1999	Franklin et al.	
		US- 5,890,137	03/30/1999	Koreeda	

**FOREIGN PATENT DOCUMENTS**

Examiner Initials*	Cite No. <sup>1</sup>	Foreign Patent Document	Publication Date MM-DD-YYYY	Name of Patentee or Applicant of Cited Document	Pages, Columns, Lines, Where Relevant Passages Or Relevant Figures Appear	T <sup>6</sup>
		Country Code <sup>3</sup> Number <sup>4</sup> Kind Code <sup>5</sup> (if known)				
		WO 97/15893	05/01/1997	Ukuda		
		WO 97/19549	05/29/1997	Beeder et al.		
		CA 2,167,543	07/19/1997	Durward		
		WO 98/26376	06/18/1998	Walker et al.		
		GB 2 327 831 A	02/03/1999	Hawthorne		
		WO 99/49424	09/30/1999	Flitcroft et al.		

Examiner Signature	/Bijendra K. Shrestha/	Date Considered	08/13/2010
--------------------	------------------------	-----------------	------------

\*EXAMINER: Initial if reference considered, whether or not citation is in conformance with MPEP 609. Draw line through citation if not in conformance and not considered. Include copy of this form with next communication to applicant. <sup>1</sup> Applicant's unique citation designation number (optional). <sup>2</sup> See Kinds Codes of USPTO Patent Documents at [www.uspto.gov](http://www.uspto.gov) or MPEP 901.04. <sup>3</sup> Enter Office that issued the document, by the two-letter code (WIPO Standard ST.3). <sup>4</sup> For Japanese patent documents, the indication of the year of the reign of the Emperor must precede the serial number of the patent document. <sup>5</sup> Kind of document by the appropriate symbols as indicated on the document under WIPO Standard ST.16 if possible. <sup>6</sup> Applicant is to place a check mark here if English language Translation is attached.

This collection of information is required by 37 CFR 1.97 and 1.98. The information is required to obtain or retain a benefit by the public which is to file (and by the USPTO to process) an application. Confidentiality is governed by 35 U.S.C. 122 and 37 CFR 1.14. This collection is estimated to take 2 hours to complete, including gathering, preparing, and submitting the completed application form to the USPTO. Time will vary depending upon the individual case. Any comments on the amount of time you require to complete this form and/or suggestions for reducing this burden, should be sent to the Chief Information Officer, U.S. Patent and Trademark Office, P.O. Box 1450, Alexandria, VA 22313-1450. DO NOT SEND FEES OR COMPLETED FORMS TO THIS ADDRESS. SEND TO: Commissioner for Patents, P.O. Box 1450, Alexandria, VA 22313-1450.

If you need assistance in completing the form, call 1-800-PTO-9199 (1-800-786-9199) and select option 2.

ALL REFERENCES CONSIDERED EXCEPT WHERE LINED THROUGH. /BKS/

Under the Paperwork Reduction Act of 1995, no persons are required to respond to a collection of information unless it contains a valid OMB control number.

Substitute for form 1449/PTO

**INFORMATION DISCLOSURE  
STATEMENT BY APPLICANT**

(Use as many sheets as necessary)

Sheet 4

of 7

**Complete if Known**

Application Number	11/252,009
Filing Date	October 17, 2005
First Named Inventor	John D'Agostino
Art Unit	3691
Examiner Name	Bijendra K. Shrestha
Attorney Docket Number	1.706-B.04

U. S. PATENT DOCUMENTS					
Examiner Initials*	Cite No. <sup>1</sup>	Document Number	Publication Date MM-DD-YYYY	Name of Patentee or Applicant of Cited Document	Pages, Columns, Lines, Where Relevant Passages or Relevant Figures Appear
		Number-Kind Code <sup>2</sup> (if known)			
		US- 5,893,907	04/13/1999	Ukuda	
		US- 5,903,878	05/11/1999	Talati et al.	
		US- 5,953,710	09/14/1999	Fleming	
		US- 5,956,699	09/21/1999	Wong et al.	
		US- 5,984,180	11/16/1999	Albrecht	
		US- 6,000,832	12/14/1999	Franklin et al.	
		US- 6,029,890	02/29/2000	Austin	
		US- 6,144,948	11/07/2000	Walker et al.	
		US- 6,163,771	12/19/2000	Walker et al.	
		US- 6,188,761 B1	02/13/2001	Dickerman et al.	
		US- 6,240,397 B1	05/29/2001	Sachs	
		US- 6,267,292 B1	07/31/2001	Walker et al.	
		US- 6,298,335 B1	10/02/2001	Bernstein	
		US- 6,324,526 B1	11/27/2001	D'Agostino	
		US- 6,339,766 B1	01/15/2002	Gephart	
		US- 6,341,724 B2	01/29/2002	Campisano	
		US- 6,343,279 B1	01/29/2002	Bissonette et al.	
		US- 6,375,084 B1	04/23/2002	Stanford et al.	
		US- 6,422,462 B1	07/23/2002	Cohen	

FOREIGN PATENT DOCUMENTS						
Examiner Initials*	Cite No. <sup>1</sup>	Foreign Patent Document	Publication Date MM-DD-YYYY	Name of Patentee or Applicant of Cited Document	Pages, Columns, Lines, Where Relevant Passages Or Relevant Figures Appear	T <sup>6</sup>
		Country Code <sup>3</sup> -Number <sup>4</sup> -Kind Code <sup>5</sup> (if known)				
		GB 2 361 790 A	10/31/01	Arndt et al.		
		WO 00/42486	07/20/2000	D'Agostino		

Examiner Signature	/Bijendra K. Shrestha/	Date Considered	08/13/2010
--------------------	------------------------	-----------------	------------

\*EXAMINER: Initial if reference considered, whether or not citation is in conformance with MPEP 609. Draw line through citation if not in conformance and not considered. Include copy of this form with next communication to applicant. <sup>1</sup> Applicant's unique citation designation number (optional). <sup>2</sup> See Kinds Codes of USPTO Patent Documents at [www.uspto.gov](http://www.uspto.gov) or MPEP 901.04. <sup>3</sup> Enter Office that issued the document, by the two-letter code (WIPO Standard ST.3). <sup>4</sup> For Japanese patent documents, the indication of the year of the reign of the Emperor must precede the serial number of the patent document. <sup>5</sup> Kind of document by the appropriate symbols as indicated on the document under WIPO Standard ST.16 if possible. <sup>6</sup> Applicant is to place a check mark here if English language Translation is attached.

This collection of information is required by 37 CFR 1.97 and 1.98. The information is required to obtain or retain a benefit by the public which is to file (and by the USPTO to process) an application. Confidentiality is governed by 35 U.S.C. 122 and 37 CFR 1.14. This collection is estimated to take 2 hours to complete, including gathering, preparing, and submitting the completed application form to the USPTO. Time will vary depending upon the individual case. Any comments on the amount of time you require to complete this form and/or suggestions for reducing this burden, should be sent to the Chief Information Officer, U.S. Patent and Trademark Office, P.O. Box 1450, Alexandria, VA 22313-1450. DO NOT SEND FEES OR COMPLETED FORMS TO THIS ADDRESS. SEND TO: Commissioner for Patents, P.O. Box 1450, Alexandria, VA 22313-1450.

If you need assistance in completing the form, call 1-800-PTO-9199 (1-800-786-9199) and select option 2.

ALL REFERENCES CONSIDERED EXCEPT WHERE LINED THROUGH. /BKS/



Under the Paperwork Reduction Act of 1995, no persons are required to respond to a collection of information unless it contains a valid OMB control number.

Substitute for form 1449/PTO  <b>INFORMATION DISCLOSURE                  STATEMENT BY APPLICANT</b>  (Use as many sheets as necessary)		<b>Complete if Known</b>	
		Application Number	11/252,009
		Filing Date	October 17, 2005
		First Named Inventor	John D'Agostino
		Art Unit	3691
		Examiner Name	Bijendra K. Shrestha
Sheet 6	of 7	Attorney Docket Number	1.706-B.04

NON PATENT LITERATURE DOCUMENTS			
Examiner Initials*	Cite No. <sup>1</sup>	Include name of the author (in CAPITAL LETTERS), title of the article (when appropriate), title of the item (book, magazine, journal, serial, symposium, catalog, etc.), date, page(s), volume-issue number(s), publisher, city and/or country where published.	T <sup>2</sup>
		ERAN GABBER and ABRAHAM SILBERSCHATZ, A Minimal Distributed Protocol for Electronic Commerce, www.usenix.org/publications (Article), Oakland, USA, November 18-21, 1996	
		CITI.COM, Total Fraud Protection... Solutions for your safety and peace of mind, (printout) CBSD002144-CBSD002153	
		OWEN THOMAS, Money Changers, www.ecompany.com, (Article), October 2000	
		Netchex - a short brief, www.tml.hut.fi/Studies/Tik-110.50/1997/Ecommerce/netchex-5.html, (Article), November 5, 2002	
		GE CAPITAL FINANCIAL INC., GE Pre-Authorization System, (GE's website printout)	
		MATT BARTHEL, Diebold Plans Major Push in Market for Debit-Card Point of Sale Terminals, 09/28/1993, American Banker, PP 1-2	
		BOB WOODS, New Dell E-Commerce Guarantee Called "Weak", 08/13/1998, Newbytes News PP 1-2	
		ANNE FINNIGAN, The Safe Way to Shop Online, Good Housekeeping, 09/1998, PP 1-2	
		PAUL DEMERY, Attaching the Smart Card Fortress, Credit Card Management, 09/1998, PP 1-4	
		LARRY CHASE, Taking Transactions Online, Target Marketing, 10/1998, 1-4	

Examiner Signature	/Bijendra K. Shrestha/	Date Considered	08/13/2010
--------------------	------------------------	-----------------	------------

\*EXAMINER: Initial if reference considered, whether or not citation is in conformance with MPEP 609. Draw line through citation if not in conformance and not considered. Include copy of this form with next communication to applicant.  
 1 Applicant's unique citation designation number (optional). 2 Applicant is to place a check mark here if English language Translation is attached.  
 This collection of information is required by 37 CFR 1.98. The information is required to obtain or retain a benefit by the public which is to file (and by the USPTO to process) an application. Confidentiality is governed by 35 U.S.C. 122 and 37 CFR 1.14. This collection is estimated to take 2 hours to complete, including gathering, preparing, and submitting the completed application form to the USPTO. Time will vary depending upon the individual case. Any comments on the amount of time you require to complete this form and/or suggestions for reducing this burden, should be sent to the Chief Information Officer, U.S. Patent and Trademark Office, P.O. Box 1450, Alexandria, VA 22313-1450. DO NOT SEND FEES OR COMPLETED FORMS TO THIS ADDRESS. SEND TO: Commissioner for Patents, P.O. Box 1450, Alexandria, VA 22313-1450.

If you need assistance in completing the form, call 1-800-PTO-9199 (1-800-786-9199) and select option 2.  
**ALL REFERENCES CONSIDERED EXCEPT WHERE LINED THROUGH. /BKS/**

Under the Paperwork Reduction Act of 1995, no persons are required to respond to a collection of information unless it contains a valid OMB control number.

Substitute for form 1449/PTO		<b>Complete if Known</b>	
<b>INFORMATION DISCLOSURE STATEMENT BY APPLICANT</b>  (Use as many sheets as necessary)		Application Number	11/262,009
		Filing Date	October 17, 2005
		First Named Inventor	John D'Agostino
		Art Unit	3691
		Examiner Name	Bijendra K. Shrestha
		Attorney Docket Number	1.706-B.04
Sheet	7	of	7

NON PATENT LITERATURE DOCUMENTS			
Examiner Initials*	Cite No. <sup>1</sup>	Include name of the author (in CAPITAL LETTERS), title of the article (when appropriate), title of the item (book, magazine, journal, serial, symposium, catalog, etc.), date, page(s), volume-issue number(s), publisher, city and/or country where published.	T <sup>2</sup>
		Virtual Credit Card (VCC), www.geocities.com/Eureka/Park/5014/vcc.htm, (printout). June 28, 1999	
		Smart Cards, disc.cba.uh.edu, (printout), November 1, 2001	
		VINCENT MOSCARITOLO & ROBERT HETTINGA, Digital Commerce for the Rest of Us Apple in a Geodesic Economy, www.shipwright.com/rants/rant_15.html, (article), September 4, 1996	
		BLACK IVES & MICHAEL EARL, Mondex International Reengineering Money, London Business School Article, isds.bus.lsu.edu/cases/mondex.html, November 1, 2001	
		Smart Card New Ltd's Information Gateway, www.smartcard.co.uk/articles/electronicmoney.html, November 1, 2001	
		Putting Risk in Perspective, (Article) Internet Outlook (July 20, 1997), Volume 1 No. 3, www.webreference.com, November 1, 2001	
		KEITH LAMOND, Credit Card Transactions Real World and Online. www.virtualschools.edu/mon/ElectronicProperty/klamond/credit_card.htm, September 11, 2001	
		STEVEN P. KETCHPEL & ANDREAS PAEPCKE, Shopping Models: A Flexible Architecture for Information Commerce, dbpubs.stanford.edu:8090, October 1, 2002, (Stanford, USA)	
		Re-examination of U.S. Patent No. 6,324,526 granted to John D'Agostino, assigned Serial No. 90/007,481 filed on March 28, 2005	

Examiner Signature	/Bijendra K. Shrestha/	Date Considered	08/13/2010
--------------------	------------------------	-----------------	------------

\*EXAMINER: Initial if reference considered, whether or not citation is in conformance with MPEP 609. Draw line through citation if not in conformance and not considered. Include copy of this form with next communication to applicant.

1 Applicant's unique citation designation number (optional). 2 Applicant is to place a check mark here if English language Translation is attached. This collection of information is required by 37 CFR 1.98. The information is required to obtain or retain a benefit by the public which is to file (and by the USPTO to process) an application. Confidentiality is governed by 35 U.S.C. 122 and 37 CFR 1.14. This collection is estimated to take 2 hours to complete, including gathering, preparing, and submitting the completed application form to the USPTO. Time will vary depending upon the individual case. Any comments on the amount of time you require to complete this form and/or suggestions for reducing this burden, should be sent to the Chief Information Officer, U.S. Patent and Trademark Office, P.O. Box 1450, Alexandria, VA 22313-1450. DO NOT SEND FEES OR COMPLETED FORMS TO THIS ADDRESS. SEND TO: Commissioner for Patents, P.O. Box 1450, Alexandria, VA 22313-1450.

If you need assistance in completing the form, call 1-800-PTO-9199 (1-800-786-9199) and select option 2.

ALL REFERENCES CONSIDERED EXCEPT WHERE LINED THROUGH. /BKS/



Under the Paperwork Reduction Act of 1995, no persons are required to respond to a collection of information unless it contains a valid OMB control number.

Substitute for form PTO 49/PTO

**INFORMATION DISCLOSURE STATEMENT BY APPLICANT**

(Use as many sheets as necessary)

Sheet 1 of 7

**Complete if Known**

Application Number	11/252,009
Filing Date	October 17, 2005
First Named Inventor	John D'Agostino
Art Unit	3691
Examiner Name	Bijendra K. Shrestha
Attorney Docket Number	1.706-B.04

**U. S. PATENT DOCUMENTS**

Examiner Initials*	Cite No. <sup>1</sup>	Document Number	Publication Date MM-DD-YYYY	Name of Patentee or Applicant of Cited Document	Pages, Columns, Lines, Where Relevant Passages or Relevant Figures Appear
		Number-Kind Code <sup>2</sup> (if known)			
		US- 3,938,091	02/10/1976	Atalla et al.	
		US- 4,423,316	12/27/1983	Sano et al.	
		US- 4,707,592	11/17/1987	Ware	
		US- 4,720,860	01/19/1988	Weiss	
		US- 4,725,719	02/16/1988	Oncken et al.	
		US- 4,747,050	05/24/1988	Brachtl et al.	
		US- 4,797,920	01/10/1989	Stein	
		US- 5,097,505	03/17/1992	Weiss	
		US- 5,130,519	07/14/1992	Bush et al.	
		US- 5,163,097	11/10/1992	Pegg	
		US- 5,193,114	03/09/1993	Moseley	
		US- 5,196,840	03/23/1993	Leith et al.	
		US- 5,202,826	04/13/1993	McCarthy	
		US- 5,239,583	08/24/1993	Parillo	
		US- 5,287,268	02/15/1994	McCarthy	
		US- 5,317,636	05/31/1994	Vizcaino	
		US- 5,323,338	06/21/1994	Hawthorne	
		US- 5,326,960	07/05/1994	Tannenbaum	
		US- 5,350,906	09/27/1994	Brody et al.	

**FOREIGN PATENT DOCUMENTS**

Examiner Initials*	Cite No. <sup>1</sup>	Foreign Patent Document	Publication Date MM-DD-YYYY	Name of Patentee or Applicant of Cited Document	Pages, Columns, Lines, Where Relevant Passages Or Relevant Figures Appear	T <sup>6</sup>
		Country Code <sup>3</sup> -Number <sup>4</sup> -Kind Code <sup>5</sup> (if known)				
		EP 0 081 921 A1	06/22/1983	Easterby		
		GB 2 145 265 A	03/20/1985	Miura		
		WO 91/12693	05/08/1992	Hawthorne et al.		
		FR 2 661 996 - A1	11/15/1991	Bremard		
		GB 2 252 270 A	08/05/1992	Wren-Hilton		
		WO 93/14476	07/22/1993	Reinikainen		

Examiner Signature	/Bijendra K. Shrestha/	Date Considered	08/13/2010
--------------------	------------------------	-----------------	------------

\*EXAMINER: Initial if reference considered, whether or not citation is in conformance with MPEP 609. Draw line through citation if not in conformance and not considered. Include copy of this form with next communication to applicant. <sup>1</sup> Applicant's unique citation designation number (optional). <sup>2</sup> See Kinds Codes of USPTO Patent Documents at [www.uspto.gov](http://www.uspto.gov) or MPEP 901.04. <sup>3</sup> Enter Office that issued the document, by the two-letter code (WIPO Standard ST.3). <sup>4</sup> For Japanese patent documents, the indication of the year of the reign of the Emperor must precede the serial number of the patent document. <sup>5</sup> Kind of document by the appropriate symbols as indicated on the document under WIPO Standard ST.16 if possible. <sup>6</sup> Applicant is to place a check mark here if English language Translation is attached.

This collection of information is required by 37 CFR 1.97 and 1.98. The information is required to obtain or retain a benefit by the public which is to file (and by the USPTO to process) an application. Confidentiality is governed by 35 U.S.C. 122 and 37 CFR 1.14. This collection is estimated to take 2 hours to complete, including gathering, preparing, and submitting the completed application form to the USPTO. Time will vary depending upon the individual case. Any comments by the amount of time you require to complete this form and/or suggestions for reducing this burden, should be sent to the Chief Information Officer, U.S. Patent and Trademark Office, P.O. Box 1450, Alexandria, VA 22313-1450. DO NOT SEND FEES OR COMPLETED FORMS TO THIS ADDRESS. SEND TO: Commissioner for Patents, P.O. Box 1450, Alexandria, VA 22313-1450.

If you need assistance in completing the form, call 1-800-PTO-9199 (1-800-786-9199) and select option 2.

ALL REFERENCES CONSIDERED EXCEPT WHERE LINED THROUGH. /BKS/

Under the Paperwork Reduction Act of 1995, no persons are required to respond to a collection of information unless it contains a valid OMB control number.

Substitute for form 1449/PTO  <b>INFORMATION DISCLOSURE STATEMENT BY APPLICANT</b> <i>(Use as many sheets as necessary)</i>	<b>Complete if Known</b>	
	Application Number	11/252,009
	Filing Date	October 17, 2005
	First Named Inventor	John D'Agostino
	Art Unit	3691
	Examiner Name	Bijendra K. Shrestha
Attorney Docket Number	1.706-B.04	
Sheet	3	of 7

U. S. PATENT DOCUMENTS					
Examiner Initials*	Cite No. <sup>1</sup>	Document Number	Publication Date MM-DD-YYYY	Name of Patentee or Applicant of Cited Document	Pages, Columns, Lines, Where Relevant Passages or Relevant Figures Appear
		Number-Kind Code <sup>2</sup> (if known)			
		US- 5,724,424	03/03/1998	Gifford	
		US- 5,727,163	03/10/1998	Bezos	
		US- 5,729,594	03/17/1998	Klingman	
		US- 5,748,908	05/05/1998	Yu	
		US- 5,757,917	05/26/1998	Rose et al.	
		US- 5,768,381	06/16/1998	Hawthorne	
		US- 5,777,305	07/07/1998	Smith et al.	
		US- 5,777,306	07/07/1998	Masuda	
		US- 5,794,221	08/11/1998	Egendorf	
		US- 5,815,657	09/29/1998	Williams et al.	
		US- 5,822,737	10/13/1998	Ogram	
		US- 5,825,881	10/20/1998	Colvin, Sr.	
		US- 5,826,241	10/20/1998	Stein et al.	
		US- 5,826,243	10/20/1998	Musmanno et al.	
		US- 5,832,087	11/03/1998	Hawthorne	
		US- 5,864,830	01/26/1999	Armetta et al.	
		US- 5,868,236	02/09/1999	Rademacher	
		US- 5,883,810	03/16/1999	Franklin et al.	
		US- 5,890,137	03/30/1999	Koreeda	

FOREIGN PATENT DOCUMENTS						
Examiner Initials*	Cite No. <sup>1</sup>	Foreign Patent Document	Publication Date MM-DD-YYYY	Name of Patentee or Applicant of Cited Document	Pages, Columns, Lines, Where Relevant Passages Or Relevant Figures Appear	T <sup>6</sup>
		Country Code <sup>3</sup> Number <sup>4</sup> Kind Code <sup>5</sup> (if known)				
		WO 97/15893	05/01/1997	Ukuda		
		WO 97/19549	05/29/1997	Beeder et al.		
		CA 2,167,543	07/19/1997	Durward		
		WO 98/26376	06/18/1998	Walker et al.		
		GB 2 327 831 A	02/03/1999	Hawthorne		
		WO 99/49424	09/30/1999	Filtcroft et al.		

Examiner Signature	/Bijendra K. Shrestha/	Date Considered	08/13/2010
--------------------	------------------------	-----------------	------------

\*EXAMINER: Initial if reference considered, whether or not citation is in conformance with MPEP 609. Draw line through citation if not in conformance and not considered. Include copy of this form with next communication to applicant. <sup>1</sup> Applicant's unique citation designation number (optional). <sup>2</sup> See Kinds Codes of USPTO Patent Documents at [www.uspto.gov](http://www.uspto.gov) or MPEP 901.04. <sup>3</sup> Enter Office that issued the document, by the two-letter code (WIPO Standard ST.3). <sup>4</sup> For Japanese patent documents, the indication of the year of the reign of the Emperor must precede the serial number of the patent document. <sup>5</sup> Kind of document by the appropriate symbols as indicated on the document under WIPO Standard ST.16 if possible. <sup>6</sup> Applicant is to place a check mark here if English language Translation is attached.

This collection of information is required by 37 CFR 1.97 and 1.98. The information is required to obtain or retain a benefit by the public which is to file (and by the USPTO to process) an application. Confidentiality is governed by 35 U.S.C. 122 and 37 CFR 1.14. This collection is estimated to take 2 hours to complete, including gathering, preparing, and submitting the completed application form to the USPTO. Time will vary depending upon the individual case. Any comments on the amount of time you require to complete this form and/or suggestions for reducing this burden, should be sent to the Chief Information Officer, U.S. Patent and Trademark Office, P.O. Box 1450, Alexandria, VA 22313-1450. DO NOT SEND FEES OR COMPLETED FORMS TO THIS ADDRESS. SEND TO: Commissioner for Patents, P.O. Box 1450, Alexandria, VA 22313-1450.

If you need assistance in completing the form, call 1-800-PTO-9199 (1-800-786-9199) and select option 2.

ALL REFERENCES CONSIDERED EXCEPT WHERE LINED THROUGH. /BKS/



Under the Paperwork Reduction Act of 1995, no persons are required to respond to a collection of information unless it contains a valid OMB control number.

Substitute for form 1449/PTO

**INFORMATION DISCLOSURE  
STATEMENT BY APPLICANT**

(Use as many sheets as necessary)

Sheet 2

of 7

**Complete if Known**

Application Number	11/252,009
Filing Date	October 17, 2005
First Named Inventor	John D'Agostino
Art Unit	3691
Examiner Name	Bijendra K. Shrestha
Attorney Docket Number	1.706-B.04

**U. S. PATENT DOCUMENTS**

Examiner Initials*	Cite No. <sup>1</sup>	Document Number	Publication Date MM-DD-YYYY	Name of Patentee or Applicant of Cited Document	Pages, Columns, Lines, Where Relevant Passages or Relevant Figures Appear
		Number-Kind Code <sup>2</sup> (if known)			
		US- 5,363,449	11/08/1994	Bestock	
		US- 5,428,684	06/27/1995	Akiyama et al.	
		US- 5,466,919	11/14/1995	Hovakimian	
		US- 5,478,994	12/26/1995	Rahman et al.	
		US- 5,485,510	01/16/1996	Colbert	
		US- 5,500,513	03/19/1996	Langhans et al.	
		US- 5,504,808	04/02/1996	Hamrick, Jr.	
		US- 5,555,497	09/10/1996	Helbling	
		US- 5,577,109	11/19/1996	Stimson et al.	
		US- 5,583,918	12/10/1996	Nakagawa	
		US- 5,606,614	02/25/1997	Brady et al.	
		US- 5,621,201	04/15/1997	Langhans et al.	
		US- 5,627,355	05/06/1997	Rahman et al.	
		US- 5,671,279	09/23/1997	Elgamal	
		US- 5,677,955	10/14/1997	Doggett et al.	
		US- 5,694,471	12/02/1997	Chen et al.	
		US- 5,696,908	12/09/1997	Muehlberger et al.	
		US- 5,715,314	02/03/1998	Payne et al.	
		US- 5,721,768	02/24/1998	Stimson et al.	

**FOREIGN PATENT DOCUMENTS**

Examiner Initials*	Cite No. <sup>1</sup>	Foreign Patent Document	Publication Date MM-DD-YYYY	Name of Patentee or Applicant of Cited Document	Pages, Columns, Lines, Where Relevant Passages Or Relevant Figures Appear	T <sup>6</sup>
		Country Code <sup>3</sup> -Number <sup>4</sup> -Kind Code <sup>5</sup> (if known)				
		EP 0 590 861 A2	04/06/1994	Colbert		
		EP 0 590 861 A3	04/06/1994	Colbert		
		EP 0 590 961 A2	04/06/1994	Kazuo et al.		
		WO 95/07512	03/16/1995	Ziarno		
		WO 96/08756	03/21/1996	Hawthorn et al.		
		WO 96/42150	12/27/1996	Pittenger et al.		

Examiner Signature	/Bijendra K. Shrestha/	Date Considered	08/13/2010
--------------------	------------------------	-----------------	------------

\*EXAMINER: Initial if reference considered, whether or not citation is in conformance with MPEP 609. Draw line through citation if not in conformance and not considered. Include copy of this form with next communication to applicant. <sup>1</sup> Applicant's unique citation designation number (optional). <sup>2</sup> See Kinds Codes of USPTO Patent Documents at [www.uspto.gov](http://www.uspto.gov) or MPEP 901.04. <sup>3</sup> Enter Office that issued the document, by the two-letter code (WIPO Standard ST.3). <sup>4</sup> For Japanese patent documents, the indication of the year of the reign of the Emperor must precede the serial number of the patent document. <sup>5</sup> Kind of document by the appropriate symbols as indicated on the document under WIPO Standard ST.16 if possible. <sup>6</sup> Applicant is to place a check mark here if English language Translation is attached.

This collection of information is required by 37 CFR 1.97 and 1.98. The information is required to obtain or retain a benefit by the public which is to file (and by the USPTO to process) an application. Confidentiality is governed by 35 U.S.C. 122 and 37 CFR 1.14. This collection is estimated to take 2 hours to complete, including gathering, preparing, and submitting the completed application form to the USPTO. Time will vary depending upon the individual case. Any comments on the amount of time you require to complete this form and/or suggestions for reducing this burden, should be sent to the Chief Information Officer, U.S. Patent and Trademark Office, P.O. Box 1450, Alexandria, VA 22313-1450. DO NOT SEND FEES OR COMPLETED FORMS TO THIS ADDRESS. SEND TO: Commissioner for Patents, P.O. Box 1450, Alexandria, VA 22313-1450.

If you need assistance in completing the form, call 1-800-PTO-9199 (1-800-786-9199) and select option 2.

ALL REFERENCES CONSIDERED EXCEPT WHERE LINED THROUGH. /BKS/

Under the Paperwork Reduction Act of 1995, no persons are required to respond to a collection of information unless it contains a valid OMB control number.

Substitute for form 1449/PTO

**INFORMATION DISCLOSURE  
STATEMENT BY APPLICANT**

(Use as many sheets as necessary)

Sheet 4

of 7

**Complete if Known**

Application Number	11/252,009
Filing Date	October 17, 2005
First Named Inventor	John D'Agostino
Art Unit	3691
Examiner Name	Bijendra K. Shrestha
Attorney Docket Number	1.706-B.04

**U. S. PATENT DOCUMENTS**

Examiner Initials*	Cite No. <sup>1</sup>	Document Number	Publication Date MM-DD-YYYY	Name of Patentee or Applicant of Cited Document	Pages, Columns, Lines, Where Relevant Passages or Relevant Figures Appear
		Number-Kind Code <sup>2</sup> (if known)			
		US- 5,893,907	04/13/1999	Ukuda	
		US- 5,903,878	05/11/1999	Talati et al.	
		US- 5,953,710	09/14/1999	Fleming	
		US- 5,956,699	09/21/1999	Wong et al.	
		US- 5,984,180	11/16/1999	Albrecht	
		US- 6,000,832	12/14/1999	Franklin et al.	
		US- 6,029,890	02/29/2000	Austin	
		US- 6,144,948	11/07/2000	Walker et al.	
		US- 6,163,771	12/19/2000	Walker et al.	
		US- 6,188,761 B1	02/13/2001	Dickerman et al.	
		US- 6,240,397 B1	05/29/2001	Sachs	
		US- 6,267,292 B1	07/31/2001	Walker et al.	
		US- 6,298,335 B1	10/02/2001	Bernstein	
		US- 6,324,526 B1	11/27/2001	D'Agostino	
		US- 6,339,766 B1	01/15/2002	Gephart	
		US- 6,341,724 B2	01/29/2002	Campisano	
		US- 6,343,279 B1	01/29/2002	Bissonette et al.	
		US- 6,375,084 B1	04/23/2002	Stanford et al.	
		US- 6,422,462 B1	07/23/2002	Cohen	

**FOREIGN PATENT DOCUMENTS**

Examiner Initials*	Cite No. <sup>1</sup>	Foreign Patent Document	Publication Date MM-DD-YYYY	Name of Patentee or Applicant of Cited Document	Pages, Columns, Lines, Where Relevant Passages Or Relevant Figures Appear	T <sup>6</sup>
		Country Code <sup>3</sup> -Number <sup>4</sup> -Kind Code <sup>5</sup> (if known)				
		GB 2 361 790 A	10/31/01	Arndt et al.		
		WO 00/42486	07/20/2000	D'Agostino		

Examiner Signature	/Bijendra K. Shrestha/	Date Considered	08/13/2010
--------------------	------------------------	-----------------	------------

\*EXAMINER: Initial if reference considered, whether or not citation is in conformance with MPEP 609. Draw line through citation if not in conformance and not considered. Include copy of this form with next communication to applicant. <sup>1</sup> Applicant's unique citation designation number (optional). <sup>2</sup> See Kinds Codes of USPTO Patent Documents at [www.uspto.gov](http://www.uspto.gov) or MPEP 901.04. <sup>3</sup> Enter Office that issued the document, by the two-letter code (WIPO Standard ST.3). <sup>4</sup> For Japanese patent documents, the indication of the year of the reign of the Emperor must precede the serial number of the patent document. <sup>5</sup> Kind of document by the appropriate symbols as indicated on the document under WIPO Standard ST.16 if possible. <sup>6</sup> Applicant is to place a check mark here if English language Translation is attached.

This collection of information is required by 37 CFR 1.97 and 1.98. The information is required to obtain or retain a benefit by the public which is to file (and by the USPTO to process) an application. Confidentiality is governed by 35 U.S.C. 122 and 37 CFR 1.14. This collection is estimated to take 2 hours to complete, including gathering, preparing, and submitting the completed application form to the USPTO. Time will vary depending upon the individual case. Any comments on the amount of time you require to complete this form and/or suggestions for reducing this burden, should be sent to the Chief Information Officer, U.S. Patent and Trademark Office, P.O. Box 1450, Alexandria, VA 22313-1450. DO NOT SEND FEES OR COMPLETED FORMS TO THIS ADDRESS. SEND TO: Commissioner for Patents, P.O. Box 1450, Alexandria, VA 22313-1450.

If you need assistance in completing the form, call 1-800-PTO-9199 (1-800-786-9199) and select option 2.

ALL REFERENCES CONSIDERED EXCEPT WHERE LINED THROUGH. /BKS/

Under the Paperwork Reduction Act of 1995, no persons are required to respond to a collection of information unless it contains a valid OMB control number.

Substitute for form 1449/PTO		<b>Complete if Known</b>	
<b>INFORMATION DISCLOSURE STATEMENT BY APPLICANT</b> <i>(Use as many sheets as necessary)</i>		Application Number	11/252,009
		Filing Date	October 17, 2005
		First Named Inventor	John D'Agostino
		Art Unit	3691
		Examiner Name	Bijendra K. Shrestha
		Attorney Docket Number	1.706-B.04
Sheet	5	of	7

U. S. PATENT DOCUMENTS					
Examiner Initials*	Cite No. <sup>1</sup>	Document Number	Publication Date MM-DD-YYYY	Name of Patentee or Applicant of Cited Document	Pages, Columns, Lines, Where Relevant Passages or Relevant Figures Appear
		Number-Kind Code <sup>2</sup> (if known)			
		US- 6,598,031 B1	07/22/2003	Ice	
		US- 2002/0120587 A1	08/29/2002	D'Agostino	
		US- 2003/0018567 A1	01/23/2003	Flitcroft et al.	
		US- 2003/0028481 A1	02/06/2003	Flitcroft et al.	
		US- 2003/0097331 A1	05/22/2003	Cohen	
		US- 6,636,833 B1	10/21/2003	Flitcroft et al.	
		US- 2003/0216997 A1	11/20/2003	Cohen	
		US-			
		US-			
		US-			
		US-			
		US-			
		US-			
		US-			
		US-			
		US-			
		US-			
		US-			
		US-			
		US-			

FOREIGN PATENT DOCUMENTS						
Examiner Initials*	Cite No. <sup>1</sup>	Foreign Patent Document	Publication Date MM-DD-YYYY	Name of Patentee or Applicant of Cited Document	Pages, Columns, Lines, Where Relevant Passages Or Relevant Figures Appear	T <sup>6</sup>
		Country Code <sup>3</sup> -Number <sup>4</sup> -Kind Code <sup>5</sup> (if known)				

Examiner Signature	/Bijendra K. Shrestha/	Date Considered	08/13/2010
--------------------	------------------------	-----------------	------------

\*EXAMINER: Initial if reference considered, whether or not citation is in conformance with MPEP 809. Draw line through citation if not in conformance and not considered. Include copy of this form with next communication to applicant. <sup>1</sup> Applicant's unique citation designation number (optional). <sup>2</sup> See Kinds Codes of USPTO Patent Documents at [www.uspto.gov](http://www.uspto.gov) or MPEP 901.04. <sup>3</sup> Enter Office that issued the document, by the two-letter code (WIPO Standard ST.3). <sup>4</sup> For Japanese patent documents, the indication of the year of the reign of the Emperor must precede the serial number of the patent document. <sup>5</sup> Kind of document by the appropriate symbols as indicated on the document under WIPO Standard ST.16 if possible. <sup>6</sup> Applicant is to place a check mark here if English language Translation is attached.

This collection of information is required by 37 CFR 1.97 and 1.98. The information is required to obtain or retain a benefit by the public which is to file (and by the USPTO to process) an application. Confidentiality is governed by 35 U.S.C. 122 and 37 CFR 1.14. This collection is estimated to take 2 hours to complete, including gathering, preparing, and submitting the completed application form to the USPTO. Time will vary depending upon the individual case. Any comments on the amount of time you require to complete this form and/or suggestions for reducing this burden, should be sent to the Chief Information Officer, U.S. Patent and Trademark Office, P.O. Box 1450, Alexandria, VA 22313-1450. DO NOT SEND FEES OR COMPLETED FORMS TO THIS ADDRESS. SEND TO: Commissioner for Patents, P.O. Box 1450, Alexandria, VA 22313-1450.

If you need assistance in completing the form, call 1-800-PTO-9199 (1-800-786-9199) and select option 2.

ALL REFERENCES CONSIDERED EXCEPT WHERE LINED THROUGH. /BKS/

Under the Paperwork Reduction Act of 1995, no persons are required to respond to a collection of information unless it contains a valid OMB control number.

Substitution for form 1449/PTO  <b>INFORMATION DISCLOSURE STATEMENT BY APPLICANT</b>  (Use as many sheets as necessary)		<b>Complete if Known</b>	
		Application Number	11/252,009
		Filing Date	October 17, 2005
		First Named Inventor	John D'Agostino
		Art Unit	3691
		Examiner Name	Bijendra K. Shrestha
Sheet 6	of 7	Attorney Docket Number	1.706-B.04

NON PATENT LITERATURE DOCUMENTS			
Examiner Initials*	Cite No. <sup>1</sup>	Include name of the author (in CAPITAL LETTERS), title of the article (when appropriate), title of the item (book, magazine, journal, serial, symposium, catalog, etc.), date, page(s), volume-issue number(s), publisher, city and/or country where published.	T <sup>2</sup>
		ERAN GABBER and ABRAHAM SILBERSCHATZ, A Minimal Distributed Protocol for Electronic Commerce, www.usenix.org/publications (Article), Oakland, USA, November 18-21, 1996	
		CITI.COM, Total Fraud Protection... Solutions for your safety and peace of mind, (printout) CBSD002144-CBSD002153	
		OWEN THOMAS, Money Changers, www.ecompany.com, (Article), October 2000	
		Netchex - a short brief, www.tml.hut.fi/Studies/Tik-110.50/1997/Ecommerce/netchex-5.html, (Article), November 5, 2002	
		GE CAPITAL FINANCIAL INC., GE Pre-Authorization System, (GE's website printout)	
		MATT BARTHEL, Diebold Plans Major Push in Market for Debit-Card Point of Sale Terminals, 09/28/1993, American Banker, PP 1-2	
		BOB WOODS, New Dell E-Commerce Guarantee Called "Weak", 08/13/1998, Newbytes News PP 1-2	
		ANNE FINNIGAN, The Safe Way to Shop Online, Good Housekeeping, 09/1998, PP 1-2	
		PAUL DEMERY, Attaching the Smart Card Fortress, Credit Card Management, 09/1998, PP 1-4	
		LARRY CHASE, Taking Transactions Online, Target Marketing, 10/1998, 1-4	

Examiner Signature	/Bijendra K. Shrestha/	Date Considered	08/13/2010
--------------------	------------------------	-----------------	------------

\*EXAMINER: Initial if reference considered, whether or not citation is in conformance with MPEP 609. Draw line through citation if not in conformance and not considered. Include copy of this form with next communication to applicant.  
<sup>1</sup> Applicant's unique citation designation number (optional). <sup>2</sup> Applicant is to place a check mark here if English language Translation is attached.  
 This collection of information is required by 37 CFR 1.98. The information is required to obtain or retain a benefit by the public which is to file (and by the USPTO to process) an application. Confidentiality is governed by 35 U.S.C. 122 and 37 CFR 1.14. This collection is estimated to take 2 hours to complete, including gathering, preparing, and submitting the completed application form to the USPTO. Time will vary depending upon the individual case. Any comments on the amount of time you require to complete this form and/or suggestions for reducing this burden, should be sent to the Chief Information Officer, U.S. Patent and Trademark Office, P.O. Box 1450, Alexandria, VA 22313-1450. DO NOT SEND FEES OR COMPLETED FORMS TO THIS ADDRESS. SEND TO: Commissioner for Patents, P.O. Box 1450, Alexandria, VA 22313-1450.

If you need assistance in completing the form, call 1-800-PTO-9199 (1-800-786-9199) and select option 2.

ALL REFERENCES CONSIDERED EXCEPT WHERE LINED THROUGH. /BKS/

Under the Paperwork Reduction Act of 1995, no persons are required to respond to a collection of information unless it contains a valid OMB control number.

Substitute for form 1449/PTO  <b>INFORMATION DISCLOSURE STATEMENT BY APPLICANT</b>  (Use as many sheets as necessary)		<b>Complete if Known</b>	
		Application Number	11/262,009
		Filing Date	October 17, 2005
		First Named Inventor	John D'Agostino
		Art Unit	3691
		Examiner Name	Bijendra K. Shrestha
Sheet 7	of 7	Attorney Docket Number	1.706-B.04

NON PATENT LITERATURE DOCUMENTS			
Examiner Initials*	Cite No. <sup>1</sup>	Include name of the author (in CAPITAL LETTERS), title of the article (when appropriate), title of the item (book, magazine, journal, serial, symposium, catalog, etc.), date, page(s), volume-issue number(s), publisher, city and/or country where published.	T <sup>2</sup>
		Virtual Credit Card (VCC), www.geocities.com/Eureka/Park/5014/vcc.htm, (printout). June 28, 1999	
		Smart Cards, disc.cba.uh.edu, (printout), November 1, 2001	
		VINCENT MOSCARITOLO & ROBERT HETTINGA, Digital Commerce for the Rest of Us Apple in a Geodesic Economy, www.shipwright.com/rants/rant_15.html, (article), September 4, 1996	
		BLACK IVES & MICHAEL EARL, Mondex International Reengineering Money, London Business School Article, isds.bus.lsu.edu/cases/mondex.html, November 1, 2001	
		Smart Card New Ltd's Information Gateway, www.smartcard.co.uk/articles/electronicmoney.html, November 1, 2001	
		Putting Risk in Perspective, (Article) Internet Outlook (July 20, 1997), Volume 1 No. 3, www.webreference.com, November 1, 2001	
		KEITH LAMOND, Credit Card Transactions Real World and Online. www.virtualschools.edu/mon/ElectronicProperty/klamond/credit_card.htm, September 11, 2001	
		STEVEN P. KETCHPEL & ANDREAS PAEPCKE, Shopping Models: A Flexible Architecture for Information Commerce, dbpubs.stanford.edu:8090, October 1, 2002, (Stanford, USA)	
		Re-examination of U.S. Patent No. 6,324,526 granted to John D'Agostino, assigned Serial No. 90/007,481 filed on March 28, 2005	

Examiner Signature	/Bijendra K. Shrestha/	Date Considered	08/13/2010
--------------------	------------------------	-----------------	------------

\*EXAMINER: Initial if reference considered, whether or not citation is in conformance with MPEP 609. Draw line through citation if not in conformance and not considered. Include copy of this form with next communication to applicant.

<sup>1</sup> Applicant's unique citation designation number (optional). <sup>2</sup> Applicant is to place a check mark here if English language Translation is attached. This collection of information is required by 37 CFR 1.98. The information is required to obtain or retain a benefit by the public which is to file (and by the USPTO to process) an application. Confidentiality is governed by 35 U.S.C. 122 and 37 CFR 1.14. This collection is estimated to take 2 hours to complete, including gathering, preparing, and submitting the completed application form to the USPTO. Time will vary depending upon the individual case. Any comments on the amount of time you require to complete this form and/or suggestions for reducing this burden, should be sent to the Chief Information Officer, U.S. Patent and Trademark Office, P.O. Box 1450, Alexandria, VA 22313-1450. DO NOT SEND FEES OR COMPLETED FORMS TO THIS ADDRESS. SEND TO: Commissioner for Patents, P.O. Box 1450, Alexandria, VA 22313-1450.

If you need assistance in completing the form, call 1-800-PTO-9199 (1-800-786-9199) and select option 2.

ALL REFERENCES CONSIDERED EXCEPT WHERE LINED THROUGH. /BKS/

**EAST Search History****EAST Search History (Prior Art)**

<b>Ref #</b>	<b>Hits</b>	<b>Search Query</b>	<b>DBs</b>	<b>Default Operator</b>	<b>Plurals</b>	<b>Time Stamp</b>
S1	0	single merchant limitation	US-PGPUB; USPAT	ADJ	ON	2010/07/29 15:35
S2	638	single merchant	US-PGPUB; USPAT	ADJ	ON	2010/07/29 15:35
S3	363	single merchant and limitation	US-PGPUB; USPAT	ADJ	ON	2010/07/29 15:35
S4	69	single merchant and limitation and prepaid card	US-PGPUB; USPAT	ADJ	ON	2010/07/29 15:36
S5	0	single merchant and limitation and prepaid card and anonimity	US-PGPUB; USPAT	ADJ	ON	2010/07/29 15:37
S6	0	single merchant and limitation and prepaid card and payment category	US-PGPUB; USPAT	ADJ	ON	2010/07/29 15:38
S7	6	single merchant and limitation and prepaid card and transaction code	US-PGPUB; USPAT	ADJ	ON	2010/07/29 15:38
S8	0	single merchant and limitation and prepaid card andcode	US-PGPUB; USPAT	ADJ	ON	2010/07/29 15:39
S9	67	single merchant and limitation and prepaid card and code	US-PGPUB; USPAT	ADJ	ON	2010/07/29 15:39

S10	44	single merchant and transaction code	US-PGPUB; USPAT	ADJ	ON	2010/07/29 15:42
S11	44	single merchant and transaction code	US-PGPUB; USPAT	ADJ	ON	2010/07/29 15:43
S12	54	merchant specific and transaction code	US-PGPUB; USPAT	ADJ	ON	2010/07/29 23:26
S13	51	"5732136"	US-PGPUB; USPAT	ADJ	ON	2010/07/29 23:46

**8/14/2010 4:18:12 PM**

**C:\Documents and Settings\bshrestha\My Documents\EAST\Workspaces  
\11252009SecondRCE.wsp**



UNITED STATES PATENT AND TRADEMARK OFFICE

UNITED STATES DEPARTMENT OF COMMERCE  
United States Patent and Trademark Office  
Address: COMMISSIONER FOR PATENTS  
P.O. Box 1450  
Alexandria, Virginia 22313-1450  
www.uspto.gov

APPLICATION NO.	FILING DATE	FIRST NAMED INVENTOR	ATTORNEY DOCKET NO.	CONFIRMATION NO.
-----------------	-------------	----------------------	---------------------	------------------

11/252,009      10/17/2005      John D'Agostino           4322

<sup>7590</sup>  
JOHN D'AGOSTINO  
5168 NORTHRIDGE ROAD #309  
SARASOTA, FL 34238

08/30/2010

EXAMINER
----------

SHRESTHA, BIJENDRA K

ART UNIT	PAPER NUMBER
----------	--------------

3691

MAIL DATE	DELIVERY MODE
-----------	---------------

08/30/2010

PAPER

**Please find below and/or attached an Office communication concerning this application or proceeding.**

The time period for reply, if any, is set in the attached communication.



<b>Examiner-Initiated Interview Summary</b>	<b>Application No.</b> 11/252,009	<b>Applicant(s)</b> D'AGOSTINO, JOHN	
	<b>Examiner</b> BIJENDRA K. SHRESTHA	<b>Art Unit</b> 3691	

**All Participants:**

- (1) BIJENDRA K. SHRESTHA.  
(2) Stephen Lewellyn, Attorney.

**Status of Application:** \_\_\_\_\_

- (3) \_\_\_\_\_  
(4) \_\_\_\_\_

**Date of Interview:** 11 August 2010

**Time:** 11AM

**Type of Interview:**

- Telephonic  
 Video Conference  
 Personal (Copy given to:  Applicant  Applicant's representative)

Exhibit Shown or Demonstrated:  Yes  No  
If Yes, provide a brief description: .

**Part I.**

Rejection(s) discussed:

Claims discussed:

Prior art documents discussed:

**Part II.**

**SUBSTANCE OF INTERVIEW DESCRIBING THE GENERAL NATURE OF WHAT WAS DISCUSSED:**

*Discussed patentability of application subjected to updated search. Examiner indicated the phrases "ability to use" and "ability to limit" pertains to intended use language and requested to replace by words "using" and "limiting" respectively. Also requested to include " processing computer" of the custodial authorizing entity in a method steps in the recited claims.*

**Part III.**

- It is not necessary for applicant to provide a separate record of the substance of the interview, since the interview directly resulted in the allowance of the application. The examiner will provide a written summary of the substance of the interview in the Notice of Allowability.  
 It is not necessary for applicant to provide a separate record of the substance of the interview, since the interview did not result in resolution of all issues. A brief summary by the examiner appears in Part II above.

/Hani M. Kazimi/  
Primary Examiner, Art Unit 3691

(Applicant/Applicant's Representative Signature – if appropriate)

## AMENDMENT IN THE CLAIMS

1 (Currently Amended). A method of performing secure credit card purchases, said method comprising:

- a) contacting a custodial authorizing entity having custodial responsibility of account parameters of a customer's account that is used to make credit card purchases;
- b) supplying said custodial authorizing entity with at least account identification data of said customer's account;
- c) defining a payment category including at least limiting purchases to a single merchant for at least one transaction, said single merchant limitation being included in said payment category prior to any particular merchant being identified as said single merchant;
- d) designating said payment category thereby designating at least that a transaction code generated in accordance with said payment category can be used by only one merchant;
- e) generating a transaction code by a processing computer of said custodial authorizing entity, said transaction code reflecting at least the limits of said designated payment category to make a purchase within said designated payment category;
- f) communicating said transaction code to a merchant to consummate a purchase with defined purchase parameters;
- g) verifying that said defined purchase parameters are within said designated payment category; and
- h) providing authorization for said purchase so as to confirm at least that said defined purchase parameters are within said designated payment category and to authorize payment required to complete the purchase.

2 (canceled).

3 (Previously Presented). The method of claim 1 further comprising the step of designating said single merchant subsequent to generating said transaction code.

4 (Previously Presented). The method of claim 1 wherein said step of communicating the transaction code to said merchant to consummate said purchase within defined purchase parameters further comprises designation of said single merchant.

5 (canceled).

6 (Previously Amended). The method of claim 1 wherein said step of generating said transaction code further comprises said customer obtaining said transaction code.

7 (Previously Presented). The method of claim 1 further comprising obtaining said authorization for said purchase from the custodial authorizing entity.

8 (Previously Presented). The method of claim 1 further comprising a step of communicating promotional information of offered subject matter to the customer by the merchant, pre-determining the purchase parameters of the purchase, and corresponding said designated payment category to said purchase parameters.

9 (Previously Presented). The method of claim 1 further comprising the merchant communicating the transaction code to the custodial authorizing entity for verification.

10 (Previously Presented). The method of claim 1 further comprising generating a transaction code which reflects at least one of a plurality of said payment categories.

11 (Previously Amended). The method of claim 10 further comprising defining at least one of said plurality of payment categories to include amount parameters for a cost of one or more purchases.

12 (Previously Amended). The method of claim 10 further comprising defining at least one of said plurality of payment categories to include time parameters during which the purchase can be completed.

13 (Currently Amended). The method of claim 10 further comprising defining at least one of said plurality of payment categories to include ~~the ability to use~~ using said transaction code for a single transaction at a fixed amount for purchase within a predetermined period of time.

14 (Canceled).

15 (Currently Amended). The method of claim 10 further comprising defining at least one of said plurality of payment categories to include ~~the ability to use~~ using said transaction code for a single transaction at a maximum amount for purchase within a predetermined period of time.

16 (Currently Amended). The method of claim 15 further comprising defining at least one of said plurality of payment categories to include ~~the ability to limit~~ limiting purchases to said single transaction at said maximum amount for purchase within said predetermined period of time.

17 (Currently Amended). The method of claim 10 further comprising defining at least one of said plurality of payment categories to include ~~the ability to use~~ using said transaction code for at least two purchases at a maximum total amount for items purchased within a predetermined time period.

18 (Currently Amended). The method of claim 17 further comprising defining at least one of said plurality of payment categories to include ~~the ability to limit~~ limiting purchases to said at least two purchases at said maximum total amount for items purchased within said predetermined time period.

19 (Currently Amended). The method of claim 10 further comprising defining at least one of said plurality of payment categories to include ~~the ability to use~~ using said transaction code for at least two purchases for a repeating transaction at a fixed amount payable at each of a fixed number of time intervals.

20 (Currently Amended). The method of claim 19 further comprising defining at least one of said plurality of payment categories to include ~~the ability to limit~~ limiting purchases to said repeating transaction at said fixed amount payable at each of said fixed number of time intervals.

21 (Currently Amended). The method of claim 10 further comprising defining at least one of said plurality of payment categories to include ~~the ability to use~~ using said transaction code for a repeating transaction at a fixed amount payable at each of an unspecified number of time intervals.

22. (Currently Amended): The method of claim 21 further comprising defining at least one of said plurality of payment categories to include ~~the ability to limit~~ limiting purchases to said repeating transaction at said fixed amount payable at each of said unspecified number of time intervals.

23. (Currently Amended): The method of claim 10 wherein said plurality of payment categories further include at least one of the group consisting of:

a) ~~the ability to use~~ using said transaction code for a single transaction at a fixed amount for a purchase within a predetermined period of time,

b) ~~the ability to use~~ using said transaction code for a single transaction at a maximum amount for a purchase within a predetermined period of time,

c) ~~the ability to use~~ using said transaction code for multiple transactions at a maximum total amount for purchases within a predetermined time period,

d) ~~the ability to use~~ using said transaction code for a repeating transaction at a fixed amount for purchases payable at each of a fixed number of time intervals, and

e) ~~the ability to use~~ using said transaction code for a repeating transaction at a fixed amount for purchases payable at each of an unspecified number of time intervals.

24. (Currently Amended): The method of claim 10 wherein said plurality of payment categories further include at least one of the group consisting of:

a) ~~the ability to use~~ using said transaction code for a single transaction at a fixed amount for a purchase,

b) ~~the ability to use~~ using said transaction code for a single transaction at a maximum amount for a purchase,

c) ~~the ability to use~~ using said transaction code for multiple transactions at a maximum total amount for purchases,

d) ~~the ability to use~~ using said transaction code for a repeating transaction at a fixed amount for purchases payable at each of a fixed number of time intervals, and

e) ~~the ability to use~~ using said transaction code for a repeating transaction at a fixed amount for purchases payable at each of an unspecified number of time intervals.

25. (Previously Presented): The method of claim 1 further comprising generating said transaction code to further reflect an identification of said single merchant.

26. (Previously Amended): The method of claim 25 further comprising defining said payment category to include limiting purchases to a limited time interval during which said purchase is permitted.

27. (Currently Amended) A method of performing secure credit card purchases, said method comprising:

- a) identifying a pre-established account that is used to make credit card purchases;
- b) designating at least one of a plurality of pre-defined payment categories which limit a nature of a subsequent purchases, at least one of said payment categories including limiting purchases to a single merchant, said single merchant limitation being included in said payment category prior to any particular merchant being identified as said single merchant;
- c) generating a transaction code by a processing computer of a custodial authorizing entity of said pre-established account, said transaction code associated with at least said pre-established account and the limits of said selected payment category, and different from said pre-established account;
- d) communicating said transaction code to a merchant to consummate a purchase within defined purchase parameters;
- e) verifying that said defined purchase parameters correspond to said designated payment category; and
- f) providing authorization for said purchase so as to confirm at least that said defined purchase parameters are within said designated payment category and to authorize payment required to complete the purchase; and
- g) associating the purchase with said pre-established account.

28. (Currently Amended): A method of performing secure credit card purchases, said method comprising:

- a) identifying a pre-established account that is used to make credit card purchases;



b) selecting a predetermined payment category which limits a nature, of a series of subsequent purchases to a single merchant, said single merchant limitation being included in said payment category prior to any particular merchant being identified as said single merchant;

c) generating a transaction code by a processing computer of a custodial authorizing entity of said pre-established account, said transaction code associated with at least said pre-established account and the limits of said selected payment category and different from said pre-established account;

d) communicating said transaction code to a merchant to consummate a purchase within defined purchase parameters;

e) verifying that said defined purchase parameters correspond to said selected payment category;

f) providing authorization for said purchase so as to confirm at least that said defined purchase parameters are within said selected payment category and to authorize payment required to complete the purchase; and

g) associating the purchase with said pre-established account.

29. (Previously Presented): The method of claim 28 wherein said step of selecting said payment category which limits said nature of said series of subsequent purchases to said single merchant further comprises limiting said nature of said series of subsequent purchases to a fixed amount for each of said subsequent purchases.

30. (Previously Presented): The method of claim 28 wherein said step of selecting said payment category which limits said nature of said series of subsequent purchases to said single

merchant further comprises limiting said nature of said series of subsequent purchases to a maximum total amount for said subsequent purchases.

31. (Previously Presented): The method of claim 28 wherein said step of verifying that said defined purchase parameters correspond to said selected payment category further identifies said merchant as said single merchant.

32. (Previously Amended): A method of performing secure credit card purchases, said method comprising the steps of:

- a) identifying a pre-established account that is used to make credit card purchases;
- b) selecting a pre-determined payment category which limits a nature of a subsequent purchase to a single merchant, said single merchant limitation being included in said payment category prior to any particular merchant being identified as said single merchant;
- c) generating a transaction code by a processing computer of a custodial authorizing entity of said pre-established account, said transaction code associated with at least said pre-established account and the limits of said selected payment category, and different from said pre-established account;
- d) designating a merchant as said single merchant;
- e) communicating said transaction code to said merchant to consummate a purchase within defined purchase parameters;
- f) verifying that said defined purchase parameters correspond to said selected payment category;

g) providing authorization for said purchase so as to confirm at least that said defined purchase parameters are within said selected payment category and to authorize payment required to complete the purchase; and

h) associating the purchase with said pre-established account.

33. (Previously Presented): The method of claim 32 wherein said step of verifying that said defined purchase parameters correspond to said selected payment category further identifies said merchant as said single merchant.

34 (canceled).

35 (canceled).

36 (canceled).

37 (canceled).

38 (canceled).

39 (canceled).

40 (canceled).

41 (canceled).

42 (canceled).

43 (canceled).

Doc code: RCEX

Doc description: Request for Continued Examination (RCE)

PTO/SB/30EFS (07-09)

Approved for use through 07/31/2012. OMB 0651-0031  
U.S. Patent and Trademark Office; U.S. DEPARTMENT OF COMMERCE

Under the Paperwork Reduction Act of 1995, no persons are required to respond to a collection of information unless it contains a valid OMB control number.

**REQUEST FOR CONTINUED EXAMINATION(RCE)TRANSMITTAL  
(Submitted Only via EFS-Web)**

Application Number	11252009	Filing Date	2005-10-17	Docket Number (if applicable)	253.001	Art Unit	3691
First Named Inventor	John D'Agostino			Examiner Name	Shrestha, Bijendra K		

**This is a Request for Continued Examination (RCE) under 37 CFR 1.114 of the above-identified application.**  
Request for Continued Examination (RCE) practice under 37 CFR 1.114 does not apply to any utility or plant application filed prior to June 8, 1995, or to any design application. The Instruction Sheet for this form is located at WWW.USPTO.GOV

**SUBMISSION REQUIRED UNDER 37 CFR 1.114**

Note: If the RCE is proper, any previously filed unentered amendments and amendments enclosed with the RCE will be entered in the order in which they were filed unless applicant instructs otherwise. If applicant does not wish to have any previously filed unentered amendment(s) entered, applicant must request non-entry of such amendment(s).

Previously submitted. If a final Office action is outstanding, any amendments filed after the final Office action may be considered as a submission even if this box is not checked.

Consider the arguments in the Appeal Brief or Reply Brief previously filed on \_\_\_\_\_

Other \_\_\_\_\_

Enclosed

Amendment/Reply

Information Disclosure Statement (IDS)

Affidavit(s)/ Declaration(s)

Other \_\_\_\_\_

**MISCELLANEOUS**

Suspension of action on the above-identified application is requested under 37 CFR 1.103(c) for a period of months \_\_\_\_\_  
(Period of suspension shall not exceed 3 months; Fee under 37 CFR 1.17(i) required)

Other \_\_\_\_\_

**FEES**

**The RCE fee under 37 CFR 1.17(e) is required by 37 CFR 1.114 when the RCE is filed.**

The Director is hereby authorized to charge any underpayment of fees, or credit any overpayments, to Deposit Account No \_\_\_\_\_

**SIGNATURE OF APPLICANT, ATTORNEY, OR AGENT REQUIRED**

Patent Practitioner Signature

Applicant Signature

Doc code: RCEX

Doc description: Request for Continued Examination (RCE)

PTO/SB/30EFS (07-09)

Approved for use through 07/31/2012. OMB 0651-0031

U.S. Patent and Trademark Office; U.S. DEPARTMENT OF COMMERCE

Under the Paperwork Reduction Act of 1995, no persons are required to respond to a collection of information unless it contains a valid OMB control number.

Signature of Registered U.S. Patent Practitioner			
Signature	/Stephen Lewellyn/	Date (YYYY-MM-DD)	2010-07-26
Name	Stephen Lewellyn	Registration Number	51942

This collection of information is required by 37 CFR 1.114. The information is required to obtain or retain a benefit by the public which is to file (and by the USPTO to process) an application. Confidentiality is governed by 35 U.S.C. 122 and 37 CFR 1.11 and 1.14. This collection is estimated to take 12 minutes to complete, including gathering, preparing, and submitting the completed application form to the USPTO. Time will vary depending upon the individual case. Any comments on the amount of time you require to complete this form and/or suggestions for reducing this burden, should be sent to the Chief Information Officer, U.S. Patent and Trademark Office, U.S. Department of Commerce, P.O. Box 1450, Alexandria, VA 22313-1450.

*If you need assistance in completing the form, call 1-800-PTO-9199 and select option 2.*

## Privacy Act Statement

The Privacy Act of 1974 (P.L. 93-579) requires that you be given certain information in connection with your submission of the attached form related to a patent application or patent. Accordingly, pursuant to the requirements of the Act, please be advised that: (1) the general authority for the collection of this information is 35 U.S.C. 2(b)(2); (2) furnishing of the information solicited is voluntary; and (3) the principal purpose for which the information is used by the U.S. Patent and Trademark Office is to process and/or examine your submission related to a patent application or patent. If you do not furnish the requested information, the U.S. Patent and Trademark Office may not be able to process and/or examine your submission, which may result in termination of proceedings or abandonment of the application or expiration of the patent.

The information provided by you in this form will be subject to the following routine uses:

1. The information on this form will be treated confidentially to the extent allowed under the Freedom of Information Act (5 U.S.C. 552) and the Privacy Act (5 U.S.C. 552a). Records from this system of records may be disclosed to the Department of Justice to determine whether the Freedom of Information Act requires disclosure of these records.
2. A record from this system of records may be disclosed, as a routine use, in the course of presenting evidence to a court, magistrate, or administrative tribunal, including disclosures to opposing counsel in the course of settlement negotiations.
3. A record in this system of records may be disclosed, as a routine use, to a Member of Congress submitting a request involving an individual, to whom the record pertains, when the individual has requested assistance from the Member with respect to the subject matter of the record.
4. A record in this system of records may be disclosed, as a routine use, to a contractor of the Agency having need for the information in order to perform a contract. Recipients of information shall be required to comply with the requirements of the Privacy Act of 1974, as amended, pursuant to 5 U.S.C. 552a(m).
5. A record related to an International Application filed under the Patent Cooperation Treaty in this system of records may be disclosed, as a routine use, to the International Bureau of the World Intellectual Property Organization, pursuant to the Patent Cooperation Treaty.
6. A record in this system of records may be disclosed, as a routine use, to another federal agency for purposes of National Security review (35 U.S.C. 181) and for review pursuant to the Atomic Energy Act (42 U.S.C. 218(c)).
7. A record from this system of records may be disclosed, as a routine use, to the Administrator, General Services, or his/her designee, during an inspection of records conducted by GSA as part of that agency's responsibility to recommend improvements in records management practices and programs, under authority of 44 U.S.C. 2904 and 2906. Such disclosure shall be made in accordance with the GSA regulations governing inspection of records for this purpose, and any other relevant (i.e., GSA or Commerce) directive. Such disclosure shall not be used to make determinations about individuals.
8. A record from this system of records may be disclosed, as a routine use, to the public after either publication of the application pursuant to 35 U.S.C. 122(b) or issuance of a patent pursuant to 35 U.S.C. 151. Further, a record may be disclosed, subject to the limitations of 37 CFR 1.14, as a routine use, to the public if the record was filed in an application which became abandoned or in which the proceedings were terminated and which application is referenced by either a published application, an application open to public inspections or an issued patent.
9. A record from this system of records may be disclosed, as a routine use, to a Federal, State, or local law enforcement agency, if the USPTO becomes aware of a violation or potential violation of law or regulation.

**IN THE UNITED STATES PATENT AND TRADEMARK OFFICE**

In re Application of:  
John D'Agostino

Group Art Unit: 4322

Serial No.: 11/252,009

Examiner: Shrestha, Bijendra K

Filed: 10/17/2005

Dkt. No.: 253.001

For: SYSTEM AND METHOD FOR PERFORMING SECURE CREDIT CARD PURCHASES

**CERTIFICATE OF MAILING OR TRANSMISSION UNDER 37 CFR 1.8:**

I hereby certify that this correspondence is being electronically transmitted using EFS-Web, or Deposited with the United States Postal Service on the date shown below with sufficient postage as first class mail in an envelop addressed to : \_\_\_\_\_, Commissioner for Patents, P.O. Box 1450, Alexandria, VA 22313-1450, or Transmitted by facsimile on the date shown below to the United States Patent and Trademark Office at (571) 273-8300.

July 26, 2010

/Stephen Lewellyn/

Date

Stephen Lewellyn

**PETITION FOR EXTENSION OF TIME UNDER 37 CFR 1.136(a)**

Commissioner for Patents  
P.O. Box 1450  
Alexandria, VA 22313-1450

Dear Sir,

In accordance with the provisions of 37 C.F.R. § 1.136(a), it is respectfully requested that a **one-month** extension of time be granted in which to respond to the Final Office Action mailed March 29, 2010, said period of response being extended from June 29, 2010 to July 29, 2010 in the above-identified application. The appropriate petition fee under 37 CFR 1.17(a)(i) is attached herewith.

Respectfully submitted,  
Maxey Law Offices, PLLC

/Stephen Lewellyn/

July 26, 2010

Date: \_\_\_\_\_

\_\_\_\_\_  
Stephen Lewellyn  
Registration No. 51,942  
13630 58th Street North, Suite 101  
Clearwater, Florida 33760  
Tel: 727-230-4949

## Electronic Patent Application Fee Transmittal

<b>Application Number:</b>	11252009			
<b>Filing Date:</b>	17-Oct-2005			
<b>Title of Invention:</b>	System and method for performing secure credit card purchases			
<b>First Named Inventor/Applicant Name:</b>	John D'Agostino			
<b>Filer:</b>	Stephen James Lewellyn			
<b>Attorney Docket Number:</b>				
Filed as Small Entity				
<b>Utility under 35 USC 111(a) Filing Fees</b>				
<b>Description</b>	<b>Fee Code</b>	<b>Quantity</b>	<b>Amount</b>	<b>Sub-Total in USD(\$)</b>
<b>Basic Filing:</b>				
<b>Pages:</b>				
<b>Claims:</b>				
<b>Miscellaneous-Filing:</b>				
<b>Petition:</b>				
<b>Patent-Appeals-and-Interference:</b>				
<b>Post-Allowance-and-Post-Issuance:</b>				
<b>Extension-of-Time:</b>				
Extension - 1 month with \$0 paid	2251	1	65	65



Description	Fee Code	Quantity	Amount	Sub-Total in USD(\$)
<b>Miscellaneous:</b>				
Request for continued examination	2801	1	405	405
<b>Total in USD (\$)</b>				<b>470</b>

## Electronic Acknowledgement Receipt

<b>EFS ID:</b>	8085966
<b>Application Number:</b>	11252009
<b>International Application Number:</b>	
<b>Confirmation Number:</b>	4322
<b>Title of Invention:</b>	System and method for performing secure credit card purchases
<b>First Named Inventor/Applicant Name:</b>	John D'Agostino
<b>Correspondence Address:</b>	JOHN D'AGOSTINO - 5168 NORTHRIDGE ROAD #309 - SARASOTA FL 34238 US 3058588000 -
<b>Filer:</b>	Stephen James Lewellyn
<b>Filer Authorized By:</b>	
<b>Attorney Docket Number:</b>	
<b>Receipt Date:</b>	26-JUL-2010
<b>Filing Date:</b>	17-OCT-2005
<b>Time Stamp:</b>	12:47:53
<b>Application Type:</b>	Utility under 35 USC 111(a)

### Payment information:

Submitted with Payment	yes
Payment Type	Credit Card
Payment was successfully received in RAM	\$470

RAM confirmation Number		8583			
Deposit Account					
Authorized User					
<b>File Listing:</b>					
Document Number	Document Description	File Name	File Size(Bytes)/ Message Digest	Multi Part /.zip	Pages (if appl.)
1	Amendment After Final	253001_response_07092010.pdf	125790	no	23
			d928e506d3243940834ac0cec021f0b590769a8		
<b>Warnings:</b>					
<b>Information:</b>					
2	Request for Continued Examination (RCE)	253001_RCE_Request.pdf	697473	no	3
			6ffc00631e5c794f93508f814c891be9a7ebe6d2		
<b>Warnings:</b>					
<b>Information:</b>					
3	Extension of Time	253001_time_07262010.pdf	65069	no	1
			4a9b6fd5fe370084a4a0e387069709c7a0665238		
<b>Warnings:</b>					
<b>Information:</b>					
4	Fee Worksheet (PTO-875)	fee-info.pdf	31447	no	2
			784bd10e0d9a2f18cd405e3ec1f050e134513eeb		
<b>Warnings:</b>					
<b>Information:</b>					
<b>Total Files Size (in bytes):</b>			919779		
<p><b>This Acknowledgement Receipt evidences receipt on the noted date by the USPTO of the indicated documents, characterized by the applicant, and including page counts, where applicable. It serves as evidence of receipt similar to a Post Card, as described in MPEP 503.</b></p> <p><b><u>New Applications Under 35 U.S.C. 111</u></b>  <b>If a new application is being filed and the application includes the necessary components for a filing date (see 37 CFR 1.53(b)-(d) and MPEP 506), a Filing Receipt (37 CFR 1.54) will be issued in due course and the date shown on this Acknowledgement Receipt will establish the filing date of the application.</b></p> <p><b><u>National Stage of an International Application under 35 U.S.C. 371</u></b>  <b>If a timely submission to enter the national stage of an international application is compliant with the conditions of 35 U.S.C. 371 and other applicable requirements a Form PCT/DO/EO/903 indicating acceptance of the application as a national stage submission under 35 U.S.C. 371 will be issued in addition to the Filing Receipt, in due course.</b></p> <p><b><u>New International Application Filed with the USPTO as a Receiving Office</u></b>  <b>If a new international application is being filed and the international application includes the necessary components for an international filing date (see PCT Article 11 and MPEP 1810), a Notification of the International Application Number and of the International Filing Date (Form PCT/RO/105) will be issued in due course, subject to prescriptions concerning national security, and the date shown on this Acknowledgement Receipt will establish the international filing date of the application.</b></p>					

**IN THE UNITED STATES PATENT AND TRADEMARK OFFICE**

In re Application of:  
John D'Agostino

Group Art Unit: 4322

Serial No.: 11/252,009

Examiner: Shrestha, Bijendra K

Filed: 10/17/2005

Dkt. No.: 253.001

For: SYSTEM AND METHOD FOR PERFORMING SECURE CREDIT CARD  
PURCHASES

**CERTIFICATE OF MAILING OR TRANSMISSION UNDER 37 CFR 1.8:**

I hereby certify that this correspondence is being electronically transmitted using EFS-Web, or Deposited with the United States Postal Service on the date shown below with sufficient postage as first class mail in an envelop addressed to : \_\_\_\_\_, Commissioner for Patents, P.O. Box 1450, Alexandria, VA 22313-1450, or Transmitted by facsimile on the date shown below to the United States Patent and Trademark Office at (571) 273-8300.

July 26, 2010  
Date

/Stephen Lewellyn/  
Stephen Lewellyn

**RESPONSE TO FINAL OFFICE ACTION**

Commissioner for Patents  
P.O. Box 1450  
Alexandria, VA 22313-1450

Dear Commissioner:

This paper is submitted in response to the Final Office Action dated March 29, 2010. Reconsideration of the application in view of the following amendments, remarks, and/or arguments is respectfully requested.

The Applicant respectfully requests the Office to recognize the Power of Attorney and Change in Address in this pending application that was filed December 10, 2009.

### **AMENDMENT IN THE CLAIMS**

1 (Previously Amended). A method of performing secure credit card purchases, said method comprising:

- a) contacting a custodial authorizing entity having custodial responsibility of account parameters of a customer's account that is used to make credit card purchases;
- b) supplying said custodial authorizing entity with at least account identification data of said customer's account;
- c) defining a payment category including at least limiting purchases to a single merchant for at least one transaction, said single merchant limitation being included in said payment category prior to any particular merchant being identified as said single merchant;
- d) designating said payment category thereby designating at least that a transaction code generated in accordance with said payment category can be used by only one merchant;
- e) generating a transaction code by said custodial authorizing entity, said transaction code reflecting at least the limits of said designated payment category to make a purchase within said designated payment category;
- f) communicating said transaction code to a merchant to consummate a purchase with defined purchase parameters;

g) verifying that said defined purchase parameters are within said designated payment category; and

h) providing authorization for said purchase so as to confirm at least that said defined purchase parameters are within said designated payment category and to authorize payment required to complete the purchase.

2 (canceled).

3 (Previously Presented). The method of claim 1 further comprising the step of designating said single merchant subsequent to generating said transaction code.

4 (Previously Presented). The method of claim 1 wherein said step of communicating the transaction code to said merchant to consummate said purchase within defined purchase parameters further comprises designation of said single merchant.

5 (canceled).

6 (Previously Amended). The method of claim 1 wherein said step of generating said transaction code further comprises said customer obtaining said transaction code.

7 (Previously Presented). The method of claim 1 further comprising obtaining said authorization for said purchase from the custodial authorizing entity.

8 (Previously Presented). The method of claim 1 further comprising a step of communicating promotional information of offered subject matter to the customer by the merchant, pre-determining the purchase parameters of the purchase, and corresponding said designated payment category to said purchase parameters.

9 (Previously Presented). The method of claim 1 further comprising the merchant communicating the transaction code to the custodial authorizing entity for verification.

10 (Previously Presented). The method of claim 1 further comprising generating a transaction code which reflects at least one of a plurality of said payment categories.

11 (Previously Amended). The method of claim 10 further comprising defining at least one of said plurality of payment categories to include amount parameters for a cost of one or more purchases.

12 (Previously Amended). The method of claim 10 further comprising defining at least one of said plurality of payment categories to include time parameters during which the purchase can be completed.

13 (Currently Amended). The method of claim 10 further comprising defining at least one of said plurality of payment categories to include ~~parameters permitting use of the~~ ability to use said transaction code for a single transaction at a fixed amount for purchase within a predetermined period of time.

14 (Canceled).

15 (Currently Amended). The method of claim 10 further comprising defining at least one of said plurality of payment categories to include the ability to use ~~parameters permitting use of~~ said transaction code for a single transaction at a maximum amount for purchase within a predetermined period of time.

16 (Currently Amended). The method of claim 15 further comprising defining at least one of said plurality of payment categories to include the ability to limit ~~parameters to limit~~ purchases to said single transaction at said maximum amount for purchase within said predetermined period of time.



17 (Currently Amended). The method of claim 10 further comprising defining at least one of said plurality of payment categories to include the ability to use parameters ~~permitting use of~~ said transaction code for at least two purchases at a maximum total amount for items purchased within a predetermined time period.

18 (Currently Amended). The method of claim 17 further comprising defining at least one of said plurality of payment categories to include the ability to limit ~~parameters to limit~~ purchases to said at least two purchases at said maximum total amount for items purchased within said predetermined time period.

19 (Currently Amended). The method of claim 10 further comprising defining at least one of said plurality of payment categories to include the ability to use parameters ~~permitting use of~~ said transaction code for at least two purchases for a repeating transaction at a fixed amount payable at each of a fixed number of time intervals.

20 (Currently Amended). The method of claim 19 further comprising defining at least one of said plurality of payment categories to include the ability to limit ~~parameters to limit~~ purchases to said repeating transaction at said fixed amount payable at each of said fixed number of time intervals.

21 (Currently Amended). The method of claim 10 further comprising defining at least one of said plurality of payment categories to include the ability to use parameters permitting use of said transaction code for a repeating transaction at a fixed amount payable at each of an unspecified number of time intervals.

22. (Currently Amended): The method of claim 21 further comprising defining at least one of said plurality of payment categories to include the ability to limit parameters to limit purchases to said repeating transaction at said fixed amount payable at each of said unspecified number of time intervals.

23. (Currently Amended): The method of claim 10 wherein ~~at least some of~~ said plurality of payment categories ~~further to~~ include at least one of the group consisting of:

a) the ability to use parameters permitting use of said transaction code for a single transaction at a fixed amount for a purchase within a predetermined period of time,

b) the ability to use parameters permitting use of said transaction code for a single transaction at a maximum amount for a purchase within a predetermined period of time,

c) the ability to use parameters permitting use of said transaction code for multiple transactions at a maximum total amount for purchases within a predetermined time period,

d) the ability to use parameters permitting use of said transaction code for a repeating transaction at a fixed amount for purchases payable at each of a fixed number of time intervals, and

e) the ability to use parameters permitting use of said transaction code for a repeating transaction at a fixed amount for purchases payable at each of an unspecified number of time intervals.

24. (Currently Amended): The method of claim 10 wherein ~~at least some of~~ said plurality of payment categories further to include at least one of the group consisting of:

a) the ability to use parameters permitting use of said transaction code for a single transaction at a fixed amount for a purchase,

b) the ability to use parameters permitting use of said transaction code for a single transaction at a maximum amount for a purchase,

c) the ability to use parameters permitting use of said transaction code for multiple transactions at a maximum total amount for purchases,

d) the ability to use parameters permitting use of said transaction code for a repeating transaction at a fixed amount for purchases payable at each of a fixed number of time intervals, and

e) the ability to use parameters permitting use of said transaction code for a repeating transaction at a fixed amount for purchases payable at each of an unspecified number of time intervals.

25. (Previously Presented): The method of claim 1 further comprising generating said transaction code to further reflect an identification of said single merchant.

26. (Previously Amended): The method of claim 25 further comprising defining said payment category to include limiting purchases to a limited time interval during which said purchase is permitted.

27. (Previously Amended) A method of performing secure credit card purchases, said method comprising:

a) identifying a pre-established account that is used to make credit card purchases;

b) designating at least one of a plurality of pre-defined payment categories which limit a nature of a subsequent purchases, at least one of said payment categories

including limiting purchases to a single merchant, said single merchant limitation being included in said payment category prior to any particular merchant being identified as said single merchant;

c) generating a transaction code by a custodial authorizing entity of said pre-established account, said transaction code associated with at least said pre-established account and the limits of said selected payment category, and different from said pre-established account;

d) communicating said transaction code to a merchant to consummate a purchase within defined purchase parameters;

e) verifying that said defined purchase parameters correspond to said designated payment category; and

f) providing authorization for said purchase so as to confirm at least that said defined purchase parameters are within said designated payment category and to authorize payment required to complete the purchase; and

g) associating the purchase with said pre-established account.

28. (Previously Amended): A method of performing secure credit card purchases, said method comprising:

a) identifying a pre-established account that is used to make credit card purchases;

b) selecting a predetermined payment category which limits a nature, of a series of subsequent purchases to a single merchant, said single merchant limitation being included in said payment category prior to any particular merchant being identified as said single merchant;

c) generating a transaction code by a custodial authorizing entity of said pre-established account, said transaction code associated with at least said pre-established account and the limits of said selected payment category and different from said pre-established account;

d) communicating said transaction code to a merchant to consummate a purchase within defined purchase parameters;

e) verifying that said defined purchase parameters correspond to said selected payment category;

f) providing authorization for said purchase so as to confirm at least that said defined purchase parameters are within said selected payment category and to authorize payment required to complete the purchase; and

g) associating the purchase with said pre-established account.

29. (Previously Presented): The method of claim 28 wherein said step of selecting said payment category which limits said nature of said series of subsequent purchases to

said single merchant further comprises limiting said nature of said series of subsequent purchases to a fixed amount for each of said subsequent purchases.

30. (Previously Presented): The method of claim 28 wherein said step of selecting said payment category which limits said nature of said series of subsequent purchases to said single merchant further comprises limiting said nature of said series of subsequent purchases to a maximum total amount for said subsequent purchases.

31. (Previously Presented): The method of claim 28 wherein said step of verifying that said defined purchase parameters correspond to said selected payment category further identifies said merchant as said single merchant.

32. (Previously Amended): A method of performing secure credit card purchases, said method comprising the steps of:

a) identifying a pre-established account that is used to make credit card purchases;

b) selecting a pre-determined payment category which limits a nature of a subsequent purchase to a single merchant, said single merchant limitation being included in said payment category prior to any particular merchant being identified as said single merchant;

c) generating a transaction code by a custodial authorizing entity of said pre-established account, said transaction code associated with at least said pre-established account and the limits of said selected payment category, and different from said pre-established account;

d) designating a merchant as said single merchant;

e) communicating said transaction code to said merchant to consummate a purchase within defined purchase parameters;

f) verifying that said defined purchase parameters correspond to said selected payment category;

g) providing authorization for said purchase so as to confirm at least that said defined purchase parameters are within said selected payment category and to authorize payment required to complete the purchase; and

h) associating the purchase with said pre-established account.

33. (Previously Presented): The method of claim 32 wherein said step of verifying that said defined purchase parameters correspond to said selected payment category further identifies said merchant as said single merchant.

34 (canceled).

35 (canceled).



Serial No: 11/252,009  
Docket No: 253,001  
July 26, 2010  
Page 14 of 23

36 (canceled).

37 (canceled).

38 (canceled).

39 (canceled).

40 (canceled).

41 (canceled).

42 (canceled).

43 (canceled).

## REMARKS

### **A. Status of the Claims**

Claims 1, 3, 4 and 6-43 are pending in the application. By the foregoing amendment claims 13, 15-24 are amended and claims 14, 34-43 are canceled without prejudice.

### **B. The Claim Objections Are Overcome**

The Office objected to claim 34 for reciting "...credit card account of the issuer." By the foregoing amendment, claim 34 is canceled without prejudice. Accordingly, the objection should be withdrawn.

### **C. The 35 U.S.C. § 112, Second Paragraph, Rejections Are Overcome**

Claims 34-43 stand rejected under 35 U.S.C. § 112, second paragraph, as being indefinite for reciting in the preamble "a system for performing secure credit card transactions", and the body of the claim not containing any limitations indicating the structure of the system.

By the foregoing amendment claims 34-43 are canceled without prejudice. Accordingly, the rejections are overcome.

**D. The 35 U.S.C. § 112, First Paragraph, Rejections Are Overcome**

Claims 13-24, 27, 28, 32 and 34 stand rejected under 35 U.S.C. § 112, first paragraph, as failing to comply with the written description requirement. This rejection is respectfully traversed.

**1. Claims 13-24**

The Office contends the amendment to claims 13-24 filed December 10, 2009 where the phrases “the ability to use” was replaced by “parameters to limit” and where the phrases “the ability to limit” was replaced by “parameters to limit” with respect to payment categories are not supported by the specification. Action at pg. 4.

The Applicant respectfully disagrees. The specification describes at paragraph [034] (emphasis added):

Once the customer's authorization is confirmed, details of the anticipated transaction are established so as to determine a payment category, and the a transaction code is issued to the customer. The customer, either directly or through a representative, can then utilize the transaction code to consummate a transaction within the defined parameters of the payment category.

Nevertheless, the Applicant has amended claims 13-24 to recite “the ability to use” and “the ability to limit” in order to expedite prosecution. Accordingly, the rejections have been overcome.

**2. Claims 27, 28, 32 and 34**

The Office contends the amendment to claims 27, 28, 32 and 34 filed December 10, 2009 where the amendment replaced the phrase “credit-card” account by “pre-established” account broadens the claim limitation without support in the specification. Action at pg. 4. This is not correct.

Initially, with reference to originally filed claims 27, 28, 29 and 33, support for this amendment is clearly found. Further, there was no antecedent basis for the recitation of “credit card account”, and the recitation of “account” is clearly in reference to the recited “pre-established account” in line 2 of claim 27 and line 2 of claim 28. In view of the foregoing amendment, the rejection is moot with respect to claims 32 and 34.

Accordingly, the rejections have been overcome.

**E. The 35 U.S.C. § 103 Rejections Are Overcome**

Claims 1, 3-4 and 6-43 stand rejected under 35 U.S.C. § 103(a) as being unpatentable over US 6,000,832 to Franklin et al. in view of US 2001/0011249 to Yanagihara et al. further in view of US 5,500,513 to Langhans et al. This rejection is respectfully traversed.

**1. Claims 1, 3, 4 and 6-26**

The Office correctly notes Franklin et al. as modified by Yanagihara et al. does not teach the recited feature “said single merchant limitation being included in said

payment category prior to any particular merchant being identified as said single merchant”. Action at pg. 7. The Office contends Langhans et al. teaches the disputed claimed feature, and asserts “it would be obvious to one of ordinary skill in the art at the time the invention was made to allow said single merchant limitation being included in said payment category prior to any particular merchant being identified as said single merchant of Franklin et al. because Langhans et al. teach that including above features would enable to control application of certain authorization parameters based [on] merchant category codes (Langhans et al., column 12, lines 20-23)”. The Office further contends the disputed claimed feature is taught in Langhans et al. wherein “Langhans et al. teach a vendor list features which restrict and consolidate spending to specific merchants. Based on comparison of vendor data stored in the electronic approved vendor list and the merchant information transmitted in authorization request, the purchase is approved or disapproved (Langhans et al. column 2, lines 45-55). In Fig. 10, steps 128 and 130, Langhans et al. specifically teach Test 130 determines if a particular vendor is on an approved vendor list (Langhans et al., column 7, lines 65-67). Action at pg. 22.

The Applicant respectfully disagrees. Initially, it is important to note Langhans et al. is directed towards an automated purchasing control system which can be customized according to a business’s hierarchal structure. Langans et al. teaches merchant type category codes for grouping lists of identified and approved vendors to which a transaction from a specific account can be compared against to determine if the account

has been authorized to consummate a purchase within an approved merchant category code and if the merchant is on an approved vendor list. Langhans et al. is not directed towards generating a temporary account number on a transactional basis.

Contrary to the Office's contention, comparing merchant information transmitted in an authorization request against vendor data stored in an approved vendor list and determining if a particular vendor is on an approved vendor list **does not** teach a single merchant limitation being included in a payment category prior to any particular merchant being identified as said single merchant.

Langhans et al. is clear a vendor must be on an approved vendor list or the transaction will be declined (col. 2, lines 50-55). In order to be included on an approved vendor list, a vendor must be identified. This is directly opposite to the recited claimed feature "prior to any particular merchant being identified as said single merchant." Moreover, there is nothing in Langhans et al. that teaches a transaction being limited to a single merchant. The Office cannot consistent with the specification of Langhans et al. read "an approved vendor list" to mean "a single merchant limitation being included in a payment category prior to any particular merchant being identified as said single merchant" as recited by the Applicant's claim 1.

Franklin et al. requires that a particular merchant for a specific transaction to be known and identified to generate the transaction code by entering the transaction-specific

data into a MAC coding unit for generating a transaction account number (column 9, lines 48-64).

Further, not only does Langhans et al not teach the disputed claim limitation, and contrary to Office's assertion, it would not have been obvious to a person of ordinary skill in the art at the time of the invention to allow said single merchant limitation being included in said payment category prior to any particular merchant being identified as said single merchant of Franklin et al. because Langhans et al. teach that including above features would enable to control application of certain authorization parameters based on merchant category codes.

Dispensing with a known and identified merchant for a specific transaction being entered in to the MAC coding unit to generate a transaction account number in favor of the claimed said single merchant limitation being included in said payment category prior to any particular merchant being identified as said single merchant defies the common sense approach to obviousness set forth in Supreme Courts ruling in *KSR Int'l Co. v. Teleflex, Inc.* There is no reason why one of ordinary skill in the art would redesign the system of Franklin et al. (alone or as modified by Yanagihara et al.) to meet the disputed limitation and risk jeopardizing the functionality the system was designed to provide: the ability to generate a code number that is unique to one specific transaction between a particular customer and a particular merchant. *See* MPEP 2143.01 at 2100-129

(modifications are not obvious when they render the prior art unsuitable for its intended purpose).

Accordingly, for these reasons, claim 1 is patentable over Franklin et al. in view of Yanagihara et al. further in view of Langhans et al. Claims 3, 4 and 6-26 depend from claim 1, and thus are patentable for the same reasons. Reconsideration and withdrawal of the rejection are respectfully requested.

**2. Claim 27**

Claim 27 is directed towards a method of performing secure credit card purchases. The selecting step includes selecting a predetermined payment category which limits a nature, of a series of subsequent purchases to a single merchant, said single merchant limitation being included in said payment category prior to any particular merchant being identified as said single merchant.

To avoid unnecessary duplication, claim 27 is patentable for same reasons provided above with respect to claim 1. Thus, reconsideration and withdrawal of the rejection are respectfully requested.

**3. Claims 28-31**

Claim 28 is directed towards a method of performing secure credit card purchases. The selecting step includes selecting a predetermined payment category



which limits a nature, of a series of subsequent purchases to a single merchant, said single merchant limitation being included in said payment category prior to any particular merchant being identified as said single merchant.

To avoid unnecessary duplication, claim 28 is patentable for same reasons provided above with respect to claim 1. Claims 29-31 dependent from claim 28, and thus are patentable for the same reasons. Reconsideration and withdrawal of the rejection are respectfully requested.

#### **4. Claims 32 and 33**

Claim 32 is directed towards a method of performing secure credit card purchases. The selecting step includes selecting a predetermined payment category which limits a nature, of a series of subsequent purchases to a single merchant, said single merchant limitation being included in said payment category prior to any particular merchant being identified as said single merchant.

To avoid unnecessary duplication, claim 32 is patentable for same reasons provided above with respect to claim 1. Claim 33 dependents from claim 32, and thus is patentable for the same reasons. Reconsideration and withdrawal of the rejection are respectfully requested.

Serial No: 11/252,009  
Docket No: 253,001  
July 26, 2010  
Page 23 of 23

**F. Conclusion**

In view of the foregoing, it is respectfully submitted that each of the pending claims is in condition for allowance, and a Notice of Allowance is earnestly solicited. The Examiner is invited to contact the undersigned at (727) 230-4949 with any questions, comments, or suggestions relating to the referenced patent application.

Respectfully submitted,  
Maxey Law Offices, PLLC

July 26, 2010  
Date: \_\_\_\_\_

/Stephen Lewellyn/

\_\_\_\_\_  
Stephen Lewellyn  
Registration No. 51,942  
15500 Roosevelt Blvd., Suite 305  
Clearwater, Florida 33760  
Tel: 727-230-4949

**IN THE UNITED STATES PATENT AND TRADEMARK OFFICE**

In re Application of:  
John D'Agostino

Group Art Unit: 4322

Serial No.: 11/252,009

Examiner: Shrestha, Bijendra K

Filed: 10/17/2005

Dkt. No.: 253.001

For: SYSTEM AND METHOD FOR PERFORMING SECURE CREDIT CARD  
PURCHASES

**CERTIFICATE OF MAILING OR TRANSMISSION UNDER 37 CFR 1.8:**

I hereby certify that this correspondence is being electronically transmitted using EFS-Web, or Deposited with the United States Postal Service on the date shown below with sufficient postage as first class mail in an envelop addressed to : \_\_\_\_\_, Commissioner for Patents, P.O. Box 1450, Alexandria, VA 22313-1450, or Transmitted by facsimile on the date shown below to the United States Patent and Trademark Office at (571) 273-8300.

July 26, 2010  
Date

/Stephen Lewellyn/  
Stephen Lewellyn

**RESPONSE TO FINAL OFFICE ACTION**

Commissioner for Patents  
P.O. Box 1450  
Alexandria, VA 22313-1450

Dear Commissioner:

This paper is submitted in response to the Final Office Action dated March 29, 2010. Reconsideration of the application in view of the following amendments, remarks, and/or arguments is respectfully requested.

The Applicant respectfully requests the Office to recognize the Power of Attorney and Change in Address in this pending application that was filed December 10, 2009.

### **AMENDMENT IN THE CLAIMS**

1 (Previously Amended). A method of performing secure credit card purchases, said method comprising:

- a) contacting a custodial authorizing entity having custodial responsibility of account parameters of a customer's account that is used to make credit card purchases;
- b) supplying said custodial authorizing entity with at least account identification data of said customer's account;
- c) defining a payment category including at least limiting purchases to a single merchant for at least one transaction, said single merchant limitation being included in said payment category prior to any particular merchant being identified as said single merchant;
- d) designating said payment category thereby designating at least that a transaction code generated in accordance with said payment category can be used by only one merchant;
- e) generating a transaction code by said custodial authorizing entity, said transaction code reflecting at least the limits of said designated payment category to make a purchase within said designated payment category;
- f) communicating said transaction code to a merchant to consummate a purchase with defined purchase parameters;

g) verifying that said defined purchase parameters are within said designated payment category; and

h) providing authorization for said purchase so as to confirm at least that said defined purchase parameters are within said designated payment category and to authorize payment required to complete the purchase.

2 (canceled).

3 (Previously Presented). The method of claim 1 further comprising the step of designating said single merchant subsequent to generating said transaction code.

4 (Previously Presented). The method of claim 1 wherein said step of communicating the transaction code to said merchant to consummate said purchase within defined purchase parameters further comprises designation of said single merchant.

5 (canceled).

6 (Previously Amended). The method of claim 1 wherein said step of generating said transaction code further comprises said customer obtaining said transaction code.

7 (Previously Presented). The method of claim 1 further comprising obtaining said authorization for said purchase from the custodial authorizing entity.

8 (Previously Presented). The method of claim 1 further comprising a step of communicating promotional information of offered subject matter to the customer by the merchant, pre-determining the purchase parameters of the purchase, and corresponding said designated payment category to said purchase parameters.

9 (Previously Presented). The method of claim 1 further comprising the merchant communicating the transaction code to the custodial authorizing entity for verification.

10 (Previously Presented). The method of claim 1 further comprising generating a transaction code which reflects at least one of a plurality of said payment categories.

11 (Previously Amended). The method of claim 10 further comprising defining at least one of said plurality of payment categories to include amount parameters for a cost of one or more purchases.

12 (Previously Amended). The method of claim 10 further comprising defining at least one of said plurality of payment categories to include time parameters during which the purchase can be completed.

13 (Currently Amended). The method of claim 10 further comprising defining at least one of said plurality of payment categories to include ~~parameters permitting use of the~~ ability to use said transaction code for a single transaction at a fixed amount for purchase within a predetermined period of time.

14 (Canceled).

15 (Currently Amended). The method of claim 10 further comprising defining at least one of said plurality of payment categories to include the ability to use ~~parameters permitting use of~~ said transaction code for a single transaction at a maximum amount for purchase within a predetermined period of time.

16 (Currently Amended). The method of claim 15 further comprising defining at least one of said plurality of payment categories to include the ability to limit ~~parameters to limit~~ purchases to said single transaction at said maximum amount for purchase within said predetermined period of time.

17 (Currently Amended). The method of claim 10 further comprising defining at least one of said plurality of payment categories to include the ability to use parameters ~~permitting use of~~ said transaction code for at least two purchases at a maximum total amount for items purchased within a predetermined time period.

18 (Currently Amended). The method of claim 17 further comprising defining at least one of said plurality of payment categories to include the ability to limit ~~parameters to limit~~ purchases to said at least two purchases at said maximum total amount for items purchased within said predetermined time period.

19 (Currently Amended). The method of claim 10 further comprising defining at least one of said plurality of payment categories to include the ability to use parameters ~~permitting use of~~ said transaction code for at least two purchases for a repeating transaction at a fixed amount payable at each of a fixed number of time intervals.

20 (Currently Amended). The method of claim 19 further comprising defining at least one of said plurality of payment categories to include the ability to limit ~~parameters to limit~~ purchases to said repeating transaction at said fixed amount payable at each of said fixed number of time intervals.



21 (Currently Amended). The method of claim 10 further comprising defining at least one of said plurality of payment categories to include the ability to use parameters permitting use of said transaction code for a repeating transaction at a fixed amount payable at each of an unspecified number of time intervals.

22. (Currently Amended): The method of claim 21 further comprising defining at least one of said plurality of payment categories to include the ability to limit parameters to limit purchases to said repeating transaction at said fixed amount payable at each of said unspecified number of time intervals.

23. (Currently Amended): The method of claim 10 wherein ~~at least some of~~ said plurality of payment categories ~~further to~~ include at least one of the group consisting of:

a) the ability to use parameters permitting use of said transaction code for a single transaction at a fixed amount for a purchase within a predetermined period of time,

b) the ability to use parameters permitting use of said transaction code for a single transaction at a maximum amount for a purchase within a predetermined period of time,

c) the ability to use parameters permitting use of said transaction code for multiple transactions at a maximum total amount for purchases within a predetermined time period,

d) the ability to use parameters permitting use of said transaction code for a repeating transaction at a fixed amount for purchases payable at each of a fixed number of time intervals, and

e) the ability to use parameters permitting use of said transaction code for a repeating transaction at a fixed amount for purchases payable at each of an unspecified number of time intervals.

24. (Currently Amended): The method of claim 10 wherein ~~at least some of~~ said plurality of payment categories ~~further to~~ include at least one of the group consisting of:

a) the ability to use parameters permitting use of said transaction code for a single transaction at a fixed amount for a purchase,

b) the ability to use parameters permitting use of said transaction code for a single transaction at a maximum amount for a purchase,

c) the ability to use parameters permitting use of said transaction code for multiple transactions at a maximum total amount for purchases,

d) ~~the ability to use parameters permitting use of~~ said transaction code for a repeating transaction at a fixed amount for purchases payable at each of a fixed number of time intervals, and

e) ~~the ability to use parameters permitting use of~~ said transaction code for a repeating transaction at a fixed amount for purchases payable at each of an unspecified number of time intervals.

25. (Previously Presented): The method of claim 1 further comprising generating said transaction code to further reflect an identification of said single merchant.

26. (Previously Amended): The method of claim 25 further comprising defining said payment category to include limiting purchases to a limited time interval during which said purchase is permitted.

27. (Previously Amended) A method of performing secure credit card purchases, said method comprising:

a) identifying a pre-established account that is used to make credit card purchases;

b) designating at least one of a plurality of pre-defined payment categories which limit a nature of a subsequent purchases, at least one of said payment categories

including limiting purchases to a single merchant, said single merchant limitation being included in said payment category prior to any particular merchant being identified as said single merchant;

c) generating a transaction code by a custodial authorizing entity of said pre-established account, said transaction code associated with at least said pre-established account and the limits of said selected payment category, and different from said pre-established account;

d) communicating said transaction code to a merchant to consummate a purchase within defined purchase parameters;

e) verifying that said defined purchase parameters correspond to said designated payment category; and

f) providing authorization for said purchase so as to confirm at least that said defined purchase parameters are within said designated payment category and to authorize payment required to complete the purchase; and

g) associating the purchase with said pre-established account.

28. (Previously Amended): A method of performing secure credit card purchases, said method comprising:

a) identifying a pre-established account that is used to make credit card purchases;

b) selecting a predetermined payment category which limits a nature, of a series of subsequent purchases to a single merchant, said single merchant limitation being included in said payment category prior to any particular merchant being identified as said single merchant;

c) generating a transaction code by a custodial authorizing entity of said pre-established account, said transaction code associated with at least said pre-established account and the limits of said selected payment category and different from said pre-established account;

d) communicating said transaction code to a merchant to consummate a purchase within defined purchase parameters;

e) verifying that said defined purchase parameters correspond to said selected payment category;

f) providing authorization for said purchase so as to confirm at least that said defined purchase parameters are within said selected payment category and to authorize payment required to complete the purchase; and

g) associating the purchase with said pre-established account.

29. (Previously Presented): The method of claim 28 wherein said step of selecting said payment category which limits said nature of said series of subsequent purchases to

said single merchant further comprises limiting said nature of said series of subsequent purchases to a fixed amount for each of said subsequent purchases.

30. (Previously Presented): The method of claim 28 wherein said step of selecting said payment category which limits said nature of said series of subsequent purchases to said single merchant further comprises limiting said nature of said series of subsequent purchases to a maximum total amount for said subsequent purchases.

31. (Previously Presented): The method of claim 28 wherein said step of verifying that said defined purchase parameters correspond to said selected payment category further identifies said merchant as said single merchant.

32. (Previously Amended): A method of performing secure credit card purchases, said method comprising the steps of:

a) identifying a pre-established account that is used to make credit card purchases;

b) selecting a pre-determined payment category which limits a nature of a subsequent purchase to a single merchant, said single merchant limitation being included in said payment category prior to any particular merchant being identified as said single merchant;

c) generating a transaction code by a custodial authorizing entity of said pre-established account, said transaction code associated with at least said pre-established account and the limits of said selected payment category, and different from said pre-established account;

d) designating a merchant as said single merchant;

e) communicating said transaction code to said merchant to consummate a purchase within defined purchase parameters;

f) verifying that said defined purchase parameters correspond to said selected payment category;

g) providing authorization for said purchase so as to confirm at least that said defined purchase parameters are within said selected payment category and to authorize payment required to complete the purchase; and

h) associating the purchase with said pre-established account.

33. (Previously Presented): The method of claim 32 wherein said step of verifying that said defined purchase parameters correspond to said selected payment category further identifies said merchant as said single merchant.

34 (canceled).

35 (canceled).

Serial No: 11/252,009  
Docket No: 253,001  
July 26, 2010  
Page 14 of 23

36 (canceled).

37 (canceled).

38 (canceled).

39 (canceled).

40 (canceled).

41 (canceled).

42 (canceled).

43 (canceled).



## REMARKS

### **A. Status of the Claims**

Claims 1, 3, 4 and 6-43 are pending in the application. By the foregoing amendment claims 13, 15-24 are amended and claims 14, 34-43 are canceled without prejudice.

### **B. The Claim Objections Are Overcome**

The Office objected to claim 34 for reciting "...credit card account of the issuer." By the foregoing amendment, claim 34 is canceled without prejudice. Accordingly, the objection should be withdrawn.

### **C. The 35 U.S.C. § 112, Second Paragraph, Rejections Are Overcome**

Claims 34-43 stand rejected under 35 U.S.C. § 112, second paragraph, as being indefinite for reciting in the preamble "a system for performing secure credit card transactions", and the body of the claim not containing any limitations indicating the structure of the system.

By the foregoing amendment claims 34-43 are canceled without prejudice. Accordingly, the rejections are overcome.

**D. The 35 U.S.C. § 112, First Paragraph, Rejections Are Overcome**

Claims 13-24, 27, 28, 32 and 34 stand rejected under 35 U.S.C. § 112, first paragraph, as failing to comply with the written description requirement. This rejection is respectfully traversed.

**1. Claims 13-24**

The Office contends the amendment to claims 13-24 filed December 10, 2009 where the phrases “the ability to use” was replaced by “parameters to limit” and where the phrases “the ability to limit” was replaced by “parameters to limit” with respect to payment categories are not supported by the specification. Action at pg. 4.

The Applicant respectfully disagrees. The specification describes at paragraph [034] (emphasis added):

Once the customer's authorization is confirmed, details of the anticipated transaction are established so as to determine a payment category, and the a transaction code is issued to the customer. The customer, either directly or through a representative, can then utilize the transaction code to consummate a transaction within the defined parameters of the payment category.

Nevertheless, the Applicant has amended claims 13-24 to recite “the ability to use” and “the ability to limit” in order to expedite prosecution. Accordingly, the rejections have been overcome.

**2. Claims 27, 28, 32 and 34**

The Office contends the amendment to claims 27, 28, 32 and 34 filed December 10, 2009 where the amendment replaced the phrase “credit-card” account by “pre-established” account broadens the claim limitation without support in the specification. Action at pg. 4. This is not correct.

Initially, with reference to originally filed claims 27, 28, 29 and 33, support for this amendment is clearly found. Further, there was no antecedent basis for the recitation of “credit card account”, and the recitation of “account” is clearly in reference to the recited “pre-established account” in line 2 of claim 27 and line 2 of claim 28. In view of the foregoing amendment, the rejection is moot with respect to claims 32 and 34.

Accordingly, the rejections have been overcome.

**E. The 35 U.S.C. § 103 Rejections Are Overcome**

Claims 1, 3-4 and 6-43 stand rejected under 35 U.S.C. § 103(a) as being unpatentable over US 6,000,832 to Franklin et al. in view of US 2001/0011249 to Yanagihara et al. further in view of US 5,500,513 to Langhans et al. This rejection is respectfully traversed.

**1. Claims 1, 3, 4 and 6-26**

The Office correctly notes Franklin et al. as modified by Yanagihara et al. does not teach the recited feature “said single merchant limitation being included in said

payment category prior to any particular merchant being identified as said single merchant”. Action at pg. 7. The Office contends Langhans et al. teaches the disputed claimed feature, and asserts “it would be obvious to one of ordinary skill in the art at the time the invention was made to allow said single merchant limitation being included in said payment category prior to any particular merchant being identified as said single merchant of Franklin et al. because Langhans et al. teach that including above features would enable to control application of certain authorization parameters based [on] merchant category codes (Langhans et al., column 12, lines 20-23)”. The Office further contends the disputed claimed feature is taught in Langhans et al. wherein “Langhans et al. teach a vendor list features which restrict and consolidate spending to specific merchants. Based on comparison of vendor data stored in the electronic approved vendor list and the merchant information transmitted in authorization request, the purchase is approved or disapproved (Langhans et al. column 2, lines 45-55). In Fig. 10, steps 128 and 130, Langhans et al. specifically teach Test 130 determines if a particular vendor is on an approved vendor list (Langhans et al., column 7, lines 65-67). Action at pg. 22.

The Applicant respectfully disagrees. Initially, it is important to note Langhans et al. is directed towards an automated purchasing control system which can be customized according to a business’s hierarchal structure. Langans et al. teaches merchant type category codes for grouping lists of identified and approved vendors to which a transaction from a specific account can be compared against to determine if the account

has been authorized to consummate a purchase within an approved merchant category code and if the merchant is on an approved vendor list. Langhans et al. is not directed towards generating a temporary account number on a transactional basis.

Contrary to the Office's contention, comparing merchant information transmitted in an authorization request against vendor data stored in an approved vendor list and determining if a particular vendor is on an approved vendor list **does not** teach a single merchant limitation being included in a payment category prior to any particular merchant being identified as said single merchant.

Langhans et al. is clear a vendor must be on an approved vendor list or the transaction will be declined (col. 2, lines 50-55). In order to be included on an approved vendor list, a vendor must be identified. This is directly opposite to the recited claimed feature "prior to any particular merchant being identified as said single merchant." Moreover, there is nothing in Langhans et al. that teaches a transaction being limited to a single merchant. The Office cannot consistent with the specification of Langhans et al. read "an approved vendor list" to mean "a single merchant limitation being included in a payment category prior to any particular merchant being identified as said single merchant" as recited by the Applicant's claim 1.

Franklin et al. requires that a particular merchant for a specific transaction to be known and identified to generate the transaction code by entering the transaction-specific

data into a MAC coding unit for generating a transaction account number (column 9, lines 48-64).

Further, not only does Langhans et al not teach the disputed claim limitation, and contrary to Office's assertion, it would not have been obvious to a person of ordinary skill in the art at the time of the invention to allow said single merchant limitation being included in said payment category prior to any particular merchant being identified as said single merchant of Franklin et al. because Langhans et al. teach that including above features would enable to control application of certain authorization parameters based on merchant category codes.

Dispensing with a known and identified merchant for a specific transaction being entered in to the MAC coding unit to generate a transaction account number in favor of the claimed said single merchant limitation being included in said payment category prior to any particular merchant being identified as said single merchant defies the common sense approach to obviousness set forth in Supreme Courts ruling in *KSR Int'l Co. v. Teleflex, Inc.* There is no reason why one of ordinary skill in the art would redesign the system of Franklin et al. (alone or as modified by Yanagihara et al.) to meet the disputed limitation and risk jeopardizing the functionality the system was designed to provide: the ability to generate a code number that is unique to one specific transaction between a particular customer and a particular merchant. *See* MPEP 2143.01 at 2100-129

(modifications are not obvious when they render the prior art unsuitable for its intended purpose).

Accordingly, for these reasons, claim 1 is patentable over Franklin et al. in view of Yanagihara et al. further in view of Langhans et al. Claims 3, 4 and 6-26 depend from claim 1, and thus are patentable for the same reasons. Reconsideration and withdrawal of the rejection are respectfully requested.

**2. Claim 27**

Claim 27 is directed towards a method of performing secure credit card purchases. The selecting step includes selecting a predetermined payment category which limits a nature, of a series of subsequent purchases to a single merchant, said single merchant limitation being included in said payment category prior to any particular merchant being identified as said single merchant.

To avoid unnecessary duplication, claim 27 is patentable for same reasons provided above with respect to claim 1. Thus, reconsideration and withdrawal of the rejection are respectfully requested.

**3. Claims 28-31**

Claim 28 is directed towards a method of performing secure credit card purchases. The selecting step includes selecting a predetermined payment category

which limits a nature, of a series of subsequent purchases to a single merchant, said single merchant limitation being included in said payment category prior to any particular merchant being identified as said single merchant.

To avoid unnecessary duplication, claim 28 is patentable for same reasons provided above with respect to claim 1. Claims 29-31 dependent from claim 28, and thus are patentable for the same reasons. Reconsideration and withdrawal of the rejection are respectfully requested.

#### **4. Claims 32 and 33**

Claim 32 is directed towards a method of performing secure credit card purchases. The selecting step includes selecting a predetermined payment category which limits a nature, of a series of subsequent purchases to a single merchant, said single merchant limitation being included in said payment category prior to any particular merchant being identified as said single merchant.

To avoid unnecessary duplication, claim 32 is patentable for same reasons provided above with respect to claim 1. Claim 33 dependents from claim 32, and thus is patentable for the same reasons. Reconsideration and withdrawal of the rejection are respectfully requested.



Serial No: 11/252,009  
Docket No: 253,001  
July 26, 2010  
Page 23 of 23

**F. Conclusion**

In view of the foregoing, it is respectfully submitted that each of the pending claims is in condition for allowance, and a Notice of Allowance is earnestly solicited. The Examiner is invited to contact the undersigned at (727) 230-4949 with any questions, comments, or suggestions relating to the referenced patent application.

Respectfully submitted,  
Maxey Law Offices, PLLC

July 26, 2010  
Date: \_\_\_\_\_

/Stephen Lewellyn/

\_\_\_\_\_  
Stephen Lewellyn  
Registration No. 51,942  
15500 Roosevelt Blvd., Suite 305  
Clearwater, Florida 33760  
Tel: 727-230-4949

**IN THE UNITED STATES PATENT AND TRADEMARK OFFICE**

In re Application of:  
John D'Agostino

Group Art Unit: 4322

Serial No.: 11/252,009

Examiner: Shrestha, Bijendra K

Filed: 10/17/2005

Dkt. No.: 253.001

For: SYSTEM AND METHOD FOR PERFORMING SECURE CREDIT CARD  
PURCHASES

**CERTIFICATE OF MAILING OR TRANSMISSION UNDER 37 CFR 1.8:**

I hereby certify that this correspondence is being electronically transmitted using EFS-Web, or Deposited with the United States Postal Service on the date shown below with sufficient postage as first class mail in an envelop addressed to : \_\_\_\_\_, Commissioner for Patents, P.O. Box 1450, Alexandria, VA 22313-1450, or Transmitted by facsimile on the date shown below to the United States Patent and Trademark Office at (571) 273-8300.

July 26, 2010  
Date

/Stephen Lewellyn/  
Stephen Lewellyn

**RESPONSE TO FINAL OFFICE ACTION**

Commissioner for Patents  
P.O. Box 1450  
Alexandria, VA 22313-1450

Dear Commissioner:

This paper is submitted in response to the Final Office Action dated March 29, 2010. Reconsideration of the application in view of the following amendments, remarks, and/or arguments is respectfully requested.

The Applicant respectfully requests the Office to recognize the Power of Attorney and Change in Address in this pending application that was filed December 10, 2009.

**IN THE UNITED STATES PATENT AND TRADEMARK OFFICE**

In re Application of:  
John D'Agostino

Group Art Unit: 4322

Serial No.: 11/252,009

Examiner: Shrestha, Bijendra K

Filed: 10/17/2005

Dkt. No.: 253.001

For: SYSTEM AND METHOD FOR PERFORMING SECURE CREDIT CARD PURCHASES

**CERTIFICATE OF MAILING OR TRANSMISSION UNDER 37 CFR 1.8:**

I hereby certify that this correspondence is being electronically transmitted using EFS-Web, or Deposited with the United States Postal Service on the date shown below with sufficient postage as first class mail in an envelop addressed to : \_\_\_\_\_, Commissioner for Patents, P.O. Box 1450, Alexandria, VA 22313-1450, or Transmitted by facsimile on the date shown below to the United States Patent and Trademark Office at (571) 273-8300.

July 26, 2010  
Date

/Stephen Lewellyn/  
Stephen Lewellyn

**RESPONSE TO FINAL OFFICE ACTION**

Commissioner for Patents  
P.O. Box 1450  
Alexandria, VA 22313-1450

Dear Commissioner:

This paper is submitted in response to the Final Office Action dated March 29, 2010. Reconsideration of the application in view of the following amendments, remarks, and/or arguments is respectfully requested.

The Applicant respectfully requests the Office to recognize the Power of Attorney and Change in Address in this pending application that was filed December 10, 2009.

### **AMENDMENT IN THE CLAIMS**

1 (Previously Amended). A method of performing secure credit card purchases, said method comprising:

- a) contacting a custodial authorizing entity having custodial responsibility of account parameters of a customer's account that is used to make credit card purchases;
- b) supplying said custodial authorizing entity with at least account identification data of said customer's account;
- c) defining a payment category including at least limiting purchases to a single merchant for at least one transaction, said single merchant limitation being included in said payment category prior to any particular merchant being identified as said single merchant;
- d) designating said payment category thereby designating at least that a transaction code generated in accordance with said payment category can be used by only one merchant;
- e) generating a transaction code by said custodial authorizing entity, said transaction code reflecting at least the limits of said designated payment category to make a purchase within said designated payment category;
- f) communicating said transaction code to a merchant to consummate a purchase with defined purchase parameters;

g) verifying that said defined purchase parameters are within said designated payment category; and

h) providing authorization for said purchase so as to confirm at least that said defined purchase parameters are within said designated payment category and to authorize payment required to complete the purchase.

2 (canceled).

3 (Previously Presented). The method of claim 1 further comprising the step of designating said single merchant subsequent to generating said transaction code.

4 (Previously Presented). The method of claim 1 wherein said step of communicating the transaction code to said merchant to consummate said purchase within defined purchase parameters further comprises designation of said single merchant.

5 (canceled).

6 (Previously Amended). The method of claim 1 wherein said step of generating said transaction code further comprises said customer obtaining said transaction code.

7 (Previously Presented). The method of claim 1 further comprising obtaining said authorization for said purchase from the custodial authorizing entity.

8 (Previously Presented). The method of claim 1 further comprising a step of communicating promotional information of offered subject matter to the customer by the merchant, pre-determining the purchase parameters of the purchase, and corresponding said designated payment category to said purchase parameters.

9 (Previously Presented). The method of claim 1 further comprising the merchant communicating the transaction code to the custodial authorizing entity for verification.

10 (Previously Presented). The method of claim 1 further comprising generating a transaction code which reflects at least one of a plurality of said payment categories.

11 (Previously Amended). The method of claim 10 further comprising defining at least one of said plurality of payment categories to include amount parameters for a cost of one or more purchases.

12 (Previously Amended). The method of claim 10 further comprising defining at least one of said plurality of payment categories to include time parameters during which the purchase can be completed.

13 (Currently Amended). The method of claim 10 further comprising defining at least one of said plurality of payment categories to include ~~parameters permitting use of the~~ ability to use said transaction code for a single transaction at a fixed amount for purchase within a predetermined period of time.

14 (Canceled).

15 (Currently Amended). The method of claim 10 further comprising defining at least one of said plurality of payment categories to include the ability to use ~~parameters permitting use of~~ said transaction code for a single transaction at a maximum amount for purchase within a predetermined period of time.

16 (Currently Amended). The method of claim 15 further comprising defining at least one of said plurality of payment categories to include the ability to limit ~~parameters to limit~~ purchases to said single transaction at said maximum amount for purchase within said predetermined period of time.

17 (Currently Amended). The method of claim 10 further comprising defining at least one of said plurality of payment categories to include the ability to use parameters ~~permitting use of~~ said transaction code for at least two purchases at a maximum total amount for items purchased within a predetermined time period.

18 (Currently Amended). The method of claim 17 further comprising defining at least one of said plurality of payment categories to include the ability to limit ~~parameters to limit~~ purchases to said at least two purchases at said maximum total amount for items purchased within said predetermined time period.

19 (Currently Amended). The method of claim 10 further comprising defining at least one of said plurality of payment categories to include the ability to use parameters ~~permitting use of~~ said transaction code for at least two purchases for a repeating transaction at a fixed amount payable at each of a fixed number of time intervals.

20 (Currently Amended). The method of claim 19 further comprising defining at least one of said plurality of payment categories to include the ability to limit ~~parameters to limit~~ purchases to said repeating transaction at said fixed amount payable at each of said fixed number of time intervals.



21 (Currently Amended). The method of claim 10 further comprising defining at least one of said plurality of payment categories to include the ability to use parameters permitting use of said transaction code for a repeating transaction at a fixed amount payable at each of an unspecified number of time intervals.

22. (Currently Amended): The method of claim 21 further comprising defining at least one of said plurality of payment categories to include the ability to limit parameters to limit purchases to said repeating transaction at said fixed amount payable at each of said unspecified number of time intervals.

23. (Currently Amended): The method of claim 10 wherein ~~at least some of~~ said plurality of payment categories ~~further to~~ include at least one of the group consisting of:

a) the ability to use parameters permitting use of said transaction code for a single transaction at a fixed amount for a purchase within a predetermined period of time,

b) the ability to use parameters permitting use of said transaction code for a single transaction at a maximum amount for a purchase within a predetermined period of time,

c) the ability to use parameters permitting use of said transaction code for multiple transactions at a maximum total amount for purchases within a predetermined time period,

d) the ability to use parameters permitting use of said transaction code for a repeating transaction at a fixed amount for purchases payable at each of a fixed number of time intervals, and

e) the ability to use parameters permitting use of said transaction code for a repeating transaction at a fixed amount for purchases payable at each of an unspecified number of time intervals.

24. (Currently Amended): The method of claim 10 wherein ~~at least some of~~ said plurality of payment categories further to include at least one of the group consisting of:

a) the ability to use parameters permitting use of said transaction code for a single transaction at a fixed amount for a purchase,

b) the ability to use parameters permitting use of said transaction code for a single transaction at a maximum amount for a purchase,

c) the ability to use parameters permitting use of said transaction code for multiple transactions at a maximum total amount for purchases,

d) the ability to use parameters permitting use of said transaction code for a repeating transaction at a fixed amount for purchases payable at each of a fixed number of time intervals, and

e) the ability to use parameters permitting use of said transaction code for a repeating transaction at a fixed amount for purchases payable at each of an unspecified number of time intervals.

25. (Previously Presented): The method of claim 1 further comprising generating said transaction code to further reflect an identification of said single merchant.

26. (Previously Amended): The method of claim 25 further comprising defining said payment category to include limiting purchases to a limited time interval during which said purchase is permitted.

27. (Previously Amended) A method of performing secure credit card purchases, said method comprising:

a) identifying a pre-established account that is used to make credit card purchases;

b) designating at least one of a plurality of pre-defined payment categories which limit a nature of a subsequent purchases, at least one of said payment categories

including limiting purchases to a single merchant, said single merchant limitation being included in said payment category prior to any particular merchant being identified as said single merchant;

c) generating a transaction code by a custodial authorizing entity of said pre-established account, said transaction code associated with at least said pre-established account and the limits of said selected payment category, and different from said pre-established account;

d) communicating said transaction code to a merchant to consummate a purchase within defined purchase parameters;

e) verifying that said defined purchase parameters correspond to said designated payment category; and

f) providing authorization for said purchase so as to confirm at least that said defined purchase parameters are within said designated payment category and to authorize payment required to complete the purchase; and

g) associating the purchase with said pre-established account.

28. (Previously Amended): A method of performing secure credit card purchases, said method comprising:

a) identifying a pre-established account that is used to make credit card purchases;

b) selecting a predetermined payment category which limits a nature, of a series of subsequent purchases to a single merchant, said single merchant limitation being included in said payment category prior to any particular merchant being identified as said single merchant;

c) generating a transaction code by a custodial authorizing entity of said pre-established account, said transaction code associated with at least said pre-established account and the limits of said selected payment category and different from said pre-established account;

d) communicating said transaction code to a merchant to consummate a purchase within defined purchase parameters;

e) verifying that said defined purchase parameters correspond to said selected payment category;

f) providing authorization for said purchase so as to confirm at least that said defined purchase parameters are within said selected payment category and to authorize payment required to complete the purchase; and

g) associating the purchase with said pre-established account.

29. (Previously Presented): The method of claim 28 wherein said step of selecting said payment category which limits said nature of said series of subsequent purchases to

said single merchant further comprises limiting said nature of said series of subsequent purchases to a fixed amount for each of said subsequent purchases.

30. (Previously Presented): The method of claim 28 wherein said step of selecting said payment category which limits said nature of said series of subsequent purchases to said single merchant further comprises limiting said nature of said series of subsequent purchases to a maximum total amount for said subsequent purchases.

31. (Previously Presented): The method of claim 28 wherein said step of verifying that said defined purchase parameters correspond to said selected payment category further identifies said merchant as said single merchant.

32. (Previously Amended): A method of performing secure credit card purchases, said method comprising the steps of:

a) identifying a pre-established account that is used to make credit card purchases;

b) selecting a pre-determined payment category which limits a nature of a subsequent purchase to a single merchant, said single merchant limitation being included in said payment category prior to any particular merchant being identified as said single merchant;

c) generating a transaction code by a custodial authorizing entity of said pre-established account, said transaction code associated with at least said pre-established account and the limits of said selected payment category, and different from said pre-established account;

d) designating a merchant as said single merchant;

e) communicating said transaction code to said merchant to consummate a purchase within defined purchase parameters;

f) verifying that said defined purchase parameters correspond to said selected payment category;

g) providing authorization for said purchase so as to confirm at least that said defined purchase parameters are within said selected payment category and to authorize payment required to complete the purchase; and

h) associating the purchase with said pre-established account.

33. (Previously Presented): The method of claim 32 wherein said step of verifying that said defined purchase parameters correspond to said selected payment category further identifies said merchant as said single merchant.

34 (canceled).

35 (canceled).

Serial No: 11/252,009  
Docket No: 253,001  
July 26, 2010  
Page 14 of 23

36 (canceled).

37 (canceled).

38 (canceled).

39 (canceled).

40 (canceled).

41 (canceled).

42 (canceled).

43 (canceled).



## REMARKS

### **A. Status of the Claims**

Claims 1, 3, 4 and 6-43 are pending in the application. By the foregoing amendment claims 13, 15-24 are amended and claims 14, 34-43 are canceled without prejudice.

### **B. The Claim Objections Are Overcome**

The Office objected to claim 34 for reciting "...credit card account of the issuer." By the foregoing amendment, claim 34 is canceled without prejudice. Accordingly, the objection should be withdrawn.

### **C. The 35 U.S.C. § 112, Second Paragraph, Rejections Are Overcome**

Claims 34-43 stand rejected under 35 U.S.C. § 112, second paragraph, as being indefinite for reciting in the preamble "a system for performing secure credit card transactions", and the body of the claim not containing any limitations indicating the structure of the system.

By the foregoing amendment claims 34-43 are canceled without prejudice. Accordingly, the rejections are overcome.

**D. The 35 U.S.C. § 112, First Paragraph, Rejections Are Overcome**

Claims 13-24, 27, 28, 32 and 34 stand rejected under 35 U.S.C. § 112, first paragraph, as failing to comply with the written description requirement. This rejection is respectfully traversed.

**1. Claims 13-24**

The Office contends the amendment to claims 13-24 filed December 10, 2009 where the phrases “the ability to use” was replaced by “parameters to limit” and where the phrases “the ability to limit” was replaced by “parameters to limit” with respect to payment categories are not supported by the specification. Action at pg. 4.

The Applicant respectfully disagrees. The specification describes at paragraph [034] (emphasis added):

Once the customer's authorization is confirmed, details of the anticipated transaction are established so as to determine a payment category, and the a transaction code is issued to the customer. The customer, either directly or through a representative, can then utilize the transaction code to consummate a transaction within the defined parameters of the payment category.

Nevertheless, the Applicant has amended claims 13-24 to recite “the ability to use” and “the ability to limit” in order to expedite prosecution. Accordingly, the rejections have been overcome.

**2. Claims 27, 28, 32 and 34**

The Office contends the amendment to claims 27, 28, 32 and 34 filed December 10, 2009 where the amendment replaced the phrase “credit-card” account by “pre-established” account broadens the claim limitation without support in the specification. Action at pg. 4. This is not correct.

Initially, with reference to originally filed claims 27, 28, 29 and 33, support for this amendment is clearly found. Further, there was no antecedent basis for the recitation of “credit card account”, and the recitation of “account” is clearly in reference to the recited “pre-established account” in line 2 of claim 27 and line 2 of claim 28. In view of the foregoing amendment, the rejection is moot with respect to claims 32 and 34.

Accordingly, the rejections have been overcome.

**E. The 35 U.S.C. § 103 Rejections Are Overcome**

Claims 1, 3-4 and 6-43 stand rejected under 35 U.S.C. § 103(a) as being unpatentable over US 6,000,832 to Franklin et al. in view of US 2001/0011249 to Yanagihara et al. further in view of US 5,500,513 to Langhans et al. This rejection is respectfully traversed.

**1. Claims 1, 3, 4 and 6-26**

The Office correctly notes Franklin et al. as modified by Yanagihara et al. does not teach the recited feature “said single merchant limitation being included in said

payment category prior to any particular merchant being identified as said single merchant”. Action at pg. 7. The Office contends Langhans et al. teaches the disputed claimed feature, and asserts “it would be obvious to one of ordinary skill in the art at the time the invention was made to allow said single merchant limitation being included in said payment category prior to any particular merchant being identified as said single merchant of Franklin et al. because Langhans et al. teach that including above features would enable to control application of certain authorization parameters based [on] merchant category codes (Langhans et al., column 12, lines 20-23)”. The Office further contends the disputed claimed feature is taught in Langhans et al. wherein “Langhans et al. teach a vendor list features which restrict and consolidate spending to specific merchants. Based on comparison of vendor data stored in the electronic approved vendor list and the merchant information transmitted in authorization request, the purchase is approved or disapproved (Langhans et al. column 2, lines 45-55). In Fig. 10, steps 128 and 130, Langhans et al. specifically teach Test 130 determines if a particular vendor is on an approved vendor list (Langhans et al., column 7, lines 65-67). Action at pg. 22.

The Applicant respectfully disagrees. Initially, it is important to note Langhans et al. is directed towards an automated purchasing control system which can be customized according to a business’s hierarchal structure. Langans et al. teaches merchant type category codes for grouping lists of identified and approved vendors to which a transaction from a specific account can be compared against to determine if the account

has been authorized to consummate a purchase within an approved merchant category code and if the merchant is on an approved vendor list. Langhans et al. is not directed towards generating a temporary account number on a transactional basis.

Contrary to the Office's contention, comparing merchant information transmitted in an authorization request against vendor data stored in an approved vendor list and determining if a particular vendor is on an approved vendor list **does not** teach a single merchant limitation being included in a payment category prior to any particular merchant being identified as said single merchant.

Langhans et al. is clear a vendor must be on an approved vendor list or the transaction will be declined (col. 2, lines 50-55). In order to be included on an approved vendor list, a vendor must be identified. This is directly opposite to the recited claimed feature "prior to any particular merchant being identified as said single merchant." Moreover, there is nothing in Langhans et al. that teaches a transaction being limited to a single merchant. The Office cannot consistent with the specification of Langhans et al. read "an approved vendor list" to mean "a single merchant limitation being included in a payment category prior to any particular merchant being identified as said single merchant" as recited by the Applicant's claim 1.

Franklin et al. requires that a particular merchant for a specific transaction to be known and identified to generate the transaction code by entering the transaction-specific

data into a MAC coding unit for generating a transaction account number (column 9, lines 48-64).

Further, not only does Langhans et al not teach the disputed claim limitation, and contrary to Office's assertion, it would not have been obvious to a person of ordinary skill in the art at the time of the invention to allow said single merchant limitation being included in said payment category prior to any particular merchant being identified as said single merchant of Franklin et al. because Langhans et al. teach that including above features would enable to control application of certain authorization parameters based on merchant category codes.

Dispensing with a known and identified merchant for a specific transaction being entered in to the MAC coding unit to generate a transaction account number in favor of the claimed said single merchant limitation being included in said payment category prior to any particular merchant being identified as said single merchant defies the common sense approach to obviousness set forth in Supreme Courts ruling in *KSR Int'l Co. v. Teleflex, Inc.* There is no reason why one of ordinary skill in the art would redesign the system of Franklin et al. (alone or as modified by Yanagihara et al.) to meet the disputed limitation and risk jeopardizing the functionality the system was designed to provide: the ability to generate a code number that is unique to one specific transaction between a particular customer and a particular merchant. *See* MPEP 2143.01 at 2100-129

(modifications are not obvious when they render the prior art unsuitable for its intended purpose).

Accordingly, for these reasons, claim 1 is patentable over Franklin et al. in view of Yanagihara et al. further in view of Langhans et al. Claims 3, 4 and 6-26 depend from claim 1, and thus are patentable for the same reasons. Reconsideration and withdrawal of the rejection are respectfully requested.

**2. Claim 27**

Claim 27 is directed towards a method of performing secure credit card purchases. The selecting step includes selecting a predetermined payment category which limits a nature, of a series of subsequent purchases to a single merchant, said single merchant limitation being included in said payment category prior to any particular merchant being identified as said single merchant.

To avoid unnecessary duplication, claim 27 is patentable for same reasons provided above with respect to claim 1. Thus, reconsideration and withdrawal of the rejection are respectfully requested.

**3. Claims 28-31**

Claim 28 is directed towards a method of performing secure credit card purchases. The selecting step includes selecting a predetermined payment category

which limits a nature, of a series of subsequent purchases to a single merchant, said single merchant limitation being included in said payment category prior to any particular merchant being identified as said single merchant.

To avoid unnecessary duplication, claim 28 is patentable for same reasons provided above with respect to claim 1. Claims 29-31 dependent from claim 28, and thus are patentable for the same reasons. Reconsideration and withdrawal of the rejection are respectfully requested.

#### **4. Claims 32 and 33**

Claim 32 is directed towards a method of performing secure credit card purchases. The selecting step includes selecting a predetermined payment category which limits a nature, of a series of subsequent purchases to a single merchant, said single merchant limitation being included in said payment category prior to any particular merchant being identified as said single merchant.

To avoid unnecessary duplication, claim 32 is patentable for same reasons provided above with respect to claim 1. Claim 33 dependents from claim 32, and thus is patentable for the same reasons. Reconsideration and withdrawal of the rejection are respectfully requested.



Serial No: 11/252,009  
Docket No: 253.001  
July 26, 2010  
Page 23 of 23

**F. Conclusion**

In view of the foregoing, it is respectfully submitted that each of the pending claims is in condition for allowance, and a Notice of Allowance is earnestly solicited. The Examiner is invited to contact the undersigned at (727) 230-4949 with any questions, comments, or suggestions relating to the referenced patent application.

Respectfully submitted,  
Maxey Law Offices, PLLC

July 26, 2010  
Date: \_\_\_\_\_

/Stephen Lewellyn/

\_\_\_\_\_  
Stephen Lewellyn  
Registration No. 51,942  
15500 Roosevelt Blvd., Suite 305  
Clearwater, Florida 33760  
Tel: 727-230-4949

### **AMENDMENT IN THE CLAIMS**

1 (Previously Amended). A method of performing secure credit card purchases, said method comprising:

- a) contacting a custodial authorizing entity having custodial responsibility of account parameters of a customer's account that is used to make credit card purchases;
- b) supplying said custodial authorizing entity with at least account identification data of said customer's account;
- c) defining a payment category including at least limiting purchases to a single merchant for at least one transaction, said single merchant limitation being included in said payment category prior to any particular merchant being identified as said single merchant;
- d) designating said payment category thereby designating at least that a transaction code generated in accordance with said payment category can be used by only one merchant;
- e) generating a transaction code by said custodial authorizing entity, said transaction code reflecting at least the limits of said designated payment category to make a purchase within said designated payment category;
- f) communicating said transaction code to a merchant to consummate a purchase with defined purchase parameters;

g) verifying that said defined purchase parameters are within said designated payment category; and

h) providing authorization for said purchase so as to confirm at least that said defined purchase parameters are within said designated payment category and to authorize payment required to complete the purchase.

2 (canceled).

3 (Previously Presented). The method of claim 1 further comprising the step of designating said single merchant subsequent to generating said transaction code.

4 (Previously Presented). The method of claim 1 wherein said step of communicating the transaction code to said merchant to consummate said purchase within defined purchase parameters further comprises designation of said single merchant.

5 (canceled).

6 (Previously Amended). The method of claim 1 wherein said step of generating said transaction code further comprises said customer obtaining said transaction code.

7 (Previously Presented). The method of claim 1 further comprising obtaining said authorization for said purchase from the custodial authorizing entity.

8 (Previously Presented). The method of claim 1 further comprising a step of communicating promotional information of offered subject matter to the customer by the merchant, pre-determining the purchase parameters of the purchase, and corresponding said designated payment category to said purchase parameters.

9 (Previously Presented). The method of claim 1 further comprising the merchant communicating the transaction code to the custodial authorizing entity for verification.

10 (Previously Presented). The method of claim 1 further comprising generating a transaction code which reflects at least one of a plurality of said payment categories.

11 (Previously Amended). The method of claim 10 further comprising defining at least one of said plurality of payment categories to include amount parameters for a cost of one or more purchases.

12 (Previously Amended). The method of claim 10 further comprising defining at least one of said plurality of payment categories to include time parameters during which the purchase can be completed.

13 (Currently Amended). The method of claim 10 further comprising defining at least one of said plurality of payment categories to include ~~parameters permitting use of the~~ ability to use said transaction code for a single transaction at a fixed amount for purchase within a predetermined period of time.

14 (Canceled).

15 (Currently Amended). The method of claim 10 further comprising defining at least one of said plurality of payment categories to include the ability to use ~~parameters permitting use of~~ said transaction code for a single transaction at a maximum amount for purchase within a predetermined period of time.

16 (Currently Amended). The method of claim 15 further comprising defining at least one of said plurality of payment categories to include the ability to limit ~~parameters to limit~~ purchases to said single transaction at said maximum amount for purchase within said predetermined period of time.

17 (Currently Amended). The method of claim 10 further comprising defining at least one of said plurality of payment categories to include the ability to use parameters ~~permitting use of~~ said transaction code for at least two purchases at a maximum total amount for items purchased within a predetermined time period.

18 (Currently Amended). The method of claim 17 further comprising defining at least one of said plurality of payment categories to include the ability to limit ~~parameters to limit~~ purchases to said at least two purchases at said maximum total amount for items purchased within said predetermined time period.

19 (Currently Amended). The method of claim 10 further comprising defining at least one of said plurality of payment categories to include the ability to use parameters ~~permitting use of~~ said transaction code for at least two purchases for a repeating transaction at a fixed amount payable at each of a fixed number of time intervals.

20 (Currently Amended). The method of claim 19 further comprising defining at least one of said plurality of payment categories to include the ability to limit ~~parameters to limit~~ purchases to said repeating transaction at said fixed amount payable at each of said fixed number of time intervals.

21 (Currently Amended). The method of claim 10 further comprising defining at least one of said plurality of payment categories to include the ability to use parameters permitting use of said transaction code for a repeating transaction at a fixed amount payable at each of an unspecified number of time intervals.

22. (Currently Amended): The method of claim 21 further comprising defining at least one of said plurality of payment categories to include the ability to limit parameters to limit purchases to said repeating transaction at said fixed amount payable at each of said unspecified number of time intervals.

23. (Currently Amended): The method of claim 10 wherein ~~at least some of~~ said plurality of payment categories ~~further to~~ include at least one of the group consisting of:

a) the ability to use parameters permitting use of said transaction code for a single transaction at a fixed amount for a purchase within a predetermined period of time,

b) the ability to use parameters permitting use of said transaction code for a single transaction at a maximum amount for a purchase within a predetermined period of time,

c) the ability to use parameters permitting use of said transaction code for multiple transactions at a maximum total amount for purchases within a predetermined time period,

d) the ability to use parameters permitting use of said transaction code for a repeating transaction at a fixed amount for purchases payable at each of a fixed number of time intervals, and

e) the ability to use parameters permitting use of said transaction code for a repeating transaction at a fixed amount for purchases payable at each of an unspecified number of time intervals.

24. (Currently Amended): The method of claim 10 wherein ~~at least some of~~ said plurality of payment categories ~~further to~~ include at least one of the group consisting of:

a) the ability to use parameters permitting use of said transaction code for a single transaction at a fixed amount for a purchase,

b) the ability to use parameters permitting use of said transaction code for a single transaction at a maximum amount for a purchase,

c) the ability to use parameters permitting use of said transaction code for multiple transactions at a maximum total amount for purchases,



d) ~~the ability to use parameters permitting use of~~ said transaction code for a repeating transaction at a fixed amount for purchases payable at each of a fixed number of time intervals, and

e) ~~the ability to use parameters permitting use of~~ said transaction code for a repeating transaction at a fixed amount for purchases payable at each of an unspecified number of time intervals.

25. (Previously Presented): The method of claim 1 further comprising generating said transaction code to further reflect an identification of said single merchant.

26. (Previously Amended): The method of claim 25 further comprising defining said payment category to include limiting purchases to a limited time interval during which said purchase is permitted.

27. (Previously Amended) A method of performing secure credit card purchases, said method comprising:

a) identifying a pre-established account that is used to make credit card purchases;

b) designating at least one of a plurality of pre-defined payment categories which limit a nature of a subsequent purchases, at least one of said payment categories

including limiting purchases to a single merchant, said single merchant limitation being included in said payment category prior to any particular merchant being identified as said single merchant;

c) generating a transaction code by a custodial authorizing entity of said pre-established account, said transaction code associated with at least said pre-established account and the limits of said selected payment category, and different from said pre-established account;

d) communicating said transaction code to a merchant to consummate a purchase within defined purchase parameters;

e) verifying that said defined purchase parameters correspond to said designated payment category; and

f) providing authorization for said purchase so as to confirm at least that said defined purchase parameters are within said designated payment category and to authorize payment required to complete the purchase; and

g) associating the purchase with said pre-established account.

28. (Previously Amended): A method of performing secure credit card purchases, said method comprising:

a) identifying a pre-established account that is used to make credit card purchases;

b) selecting a predetermined payment category which limits a nature, of a series of subsequent purchases to a single merchant, said single merchant limitation being included in said payment category prior to any particular merchant being identified as said single merchant;

c) generating a transaction code by a custodial authorizing entity of said pre-established account, said transaction code associated with at least said pre-established account and the limits of said selected payment category and different from said pre-established account;

d) communicating said transaction code to a merchant to consummate a purchase within defined purchase parameters;

e) verifying that said defined purchase parameters correspond to said selected payment category;

f) providing authorization for said purchase so as to confirm at least that said defined purchase parameters are within said selected payment category and to authorize payment required to complete the purchase; and

g) associating the purchase with said pre-established account.

29. (Previously Presented): The method of claim 28 wherein said step of selecting said payment category which limits said nature of said series of subsequent purchases to

said single merchant further comprises limiting said nature of said series of subsequent purchases to a fixed amount for each of said subsequent purchases.

30. (Previously Presented): The method of claim 28 wherein said step of selecting said payment category which limits said nature of said series of subsequent purchases to said single merchant further comprises limiting said nature of said series of subsequent purchases to a maximum total amount for said subsequent purchases.

31. (Previously Presented): The method of claim 28 wherein said step of verifying that said defined purchase parameters correspond to said selected payment category further identifies said merchant as said single merchant.

32. (Previously Amended): A method of performing secure credit card purchases, said method comprising the steps of:

a) identifying a pre-established account that is used to make credit card purchases;

b) selecting a pre-determined payment category which limits a nature of a subsequent purchase to a single merchant, said single merchant limitation being included in said payment category prior to any particular merchant being identified as said single merchant;

c) generating a transaction code by a custodial authorizing entity of said pre-established account, said transaction code associated with at least said pre-established account and the limits of said selected payment category, and different from said pre-established account;

d) designating a merchant as said single merchant;

e) communicating said transaction code to said merchant to consummate a purchase within defined purchase parameters;

f) verifying that said defined purchase parameters correspond to said selected payment category;

g) providing authorization for said purchase so as to confirm at least that said defined purchase parameters are within said selected payment category and to authorize payment required to complete the purchase; and

h) associating the purchase with said pre-established account.

33. (Previously Presented): The method of claim 32 wherein said step of verifying that said defined purchase parameters correspond to said selected payment category further identifies said merchant as said single merchant.

34 (canceled).

35 (canceled).

Serial No: 11/252,009  
Docket No: 253,001  
July 26, 2010  
Page 14 of 23

36 (canceled).

37 (canceled).

38 (canceled).

39 (canceled).

40 (canceled).

41 (canceled).

42 (canceled).

43 (canceled).

## REMARKS

### **A. Status of the Claims**

Claims 1, 3, 4 and 6-43 are pending in the application. By the foregoing amendment claims 13, 15-24 are amended and claims 14, 34-43 are canceled without prejudice.

### **B. The Claim Objections Are Overcome**

The Office objected to claim 34 for reciting "...credit card account of the issuer." By the foregoing amendment, claim 34 is canceled without prejudice. Accordingly, the objection should be withdrawn.

### **C. The 35 U.S.C. § 112, Second Paragraph, Rejections Are Overcome**

Claims 34-43 stand rejected under 35 U.S.C. § 112, second paragraph, as being indefinite for reciting in the preamble "a system for performing secure credit card transactions", and the body of the claim not containing any limitations indicating the structure of the system.

By the foregoing amendment claims 34-43 are canceled without prejudice. Accordingly, the rejections are overcome.

**D. The 35 U.S.C. § 112, First Paragraph, Rejections Are Overcome**

Claims 13-24, 27, 28, 32 and 34 stand rejected under 35 U.S.C. § 112, first paragraph, as failing to comply with the written description requirement. This rejection is respectfully traversed.

**1. Claims 13-24**

The Office contends the amendment to claims 13-24 filed December 10, 2009 where the phrases “the ability to use” was replaced by “parameters to limit” and where the phrases “the ability to limit” was replaced by “parameters to limit” with respect to payment categories are not supported by the specification. Action at pg. 4.

The Applicant respectfully disagrees. The specification describes at paragraph [034] (emphasis added):

Once the customer's authorization is confirmed, details of the anticipated transaction are established so as to determine a payment category, and the a transaction code is issued to the customer. The customer, either directly or through a representative, can then utilize the transaction code to consummate a transaction within the defined parameters of the payment category.

Nevertheless, the Applicant has amended claims 13-24 to recite “the ability to use” and “the ability to limit” in order to expedite prosecution. Accordingly, the rejections have been overcome.



**2. Claims 27, 28, 32 and 34**

The Office contends the amendment to claims 27, 28, 32 and 34 filed December 10, 2009 where the amendment replaced the phrase “credit-card” account by “pre-established” account broadens the claim limitation without support in the specification. Action at pg. 4. This is not correct.

Initially, with reference to originally filed claims 27, 28, 29 and 33, support for this amendment is clearly found. Further, there was no antecedent basis for the recitation of “credit card account”, and the recitation of “account” is clearly in reference to the recited “pre-established account” in line 2 of claim 27 and line 2 of claim 28. In view of the foregoing amendment, the rejection is moot with respect to claims 32 and 34.

Accordingly, the rejections have been overcome.

**E. The 35 U.S.C. § 103 Rejections Are Overcome**

Claims 1, 3-4 and 6-43 stand rejected under 35 U.S.C. § 103(a) as being unpatentable over US 6,000,832 to Franklin et al. in view of US 2001/0011249 to Yanagihara et al. further in view of US 5,500,513 to Langhans et al. This rejection is respectfully traversed.

**1. Claims 1, 3, 4 and 6-26**

The Office correctly notes Franklin et al. as modified by Yanagihara et al. does not teach the recited feature “said single merchant limitation being included in said

payment category prior to any particular merchant being identified as said single merchant”. Action at pg. 7. The Office contends Langhans et al. teaches the disputed claimed feature, and asserts “it would be obvious to one of ordinary skill in the art at the time the invention was made to allow said single merchant limitation being included in said payment category prior to any particular merchant being identified as said single merchant of Franklin et al. because Langhans et al. teach that including above features would enable to control application of certain authorization parameters based [on] merchant category codes (Langhans et al., column 12, lines 20-23)”. The Office further contends the disputed claimed feature is taught in Langhans et al. wherein “Langhans et al. teach a vendor list features which restrict and consolidate spending to specific merchants. Based on comparison of vendor data stored in the electronic approved vendor list and the merchant information transmitted in authorization request, the purchase is approved or disapproved (Langhans et al. column 2, lines 45-55). In Fig. 10, steps 128 and 130, Langhans et al. specifically teach Test 130 determines if a particular vendor is on an approved vendor list (Langhans et al., column 7, lines 65-67). Action at pg. 22.

The Applicant respectfully disagrees. Initially, it is important to note Langhans et al. is directed towards an automated purchasing control system which can be customized according to a business’s hierarchal structure. Langans et al. teaches merchant type category codes for grouping lists of identified and approved vendors to which a transaction from a specific account can be compared against to determine if the account

has been authorized to consummate a purchase within an approved merchant category code and if the merchant is on an approved vendor list. Langhans et al. is not directed towards generating a temporary account number on a transactional basis.

Contrary to the Office's contention, comparing merchant information transmitted in an authorization request against vendor data stored in an approved vendor list and determining if a particular vendor is on an approved vendor list **does not** teach a single merchant limitation being included in a payment category prior to any particular merchant being identified as said single merchant.

Langhans et al. is clear a vendor must be on an approved vendor list or the transaction will be declined (col. 2, lines 50-55). In order to be included on an approved vendor list, a vendor must be identified. This is directly opposite to the recited claimed feature "prior to any particular merchant being identified as said single merchant." Moreover, there is nothing in Langhans et al. that teaches a transaction being limited to a single merchant. The Office cannot consistent with the specification of Langhans et al. read "an approved vendor list" to mean "a single merchant limitation being included in a payment category prior to any particular merchant being identified as said single merchant" as recited by the Applicant's claim 1.

Franklin et al. requires that a particular merchant for a specific transaction to be known and identified to generate the transaction code by entering the transaction-specific

data into a MAC coding unit for generating a transaction account number (column 9, lines 48-64).

Further, not only does Langhans et al not teach the disputed claim limitation, and contrary to Office's assertion, it would not have been obvious to a person of ordinary skill in the art at the time of the invention to allow said single merchant limitation being included in said payment category prior to any particular merchant being identified as said single merchant of Franklin et al. because Langhans et al. teach that including above features would enable to control application of certain authorization parameters based on merchant category codes.

Dispensing with a known and identified merchant for a specific transaction being entered in to the MAC coding unit to generate a transaction account number in favor of the claimed said single merchant limitation being included in said payment category prior to any particular merchant being identified as said single merchant defies the common sense approach to obviousness set forth in Supreme Courts ruling in *KSR Int'l Co. v. Teleflex, Inc.* There is no reason why one of ordinary skill in the art would redesign the system of Franklin et al. (alone or as modified by Yanagihara et al.) to meet the disputed limitation and risk jeopardizing the functionality the system was designed to provide: the ability to generate a code number that is unique to one specific transaction between a particular customer and a particular merchant. *See* MPEP 2143.01 at 2100-129

(modifications are not obvious when they render the prior art unsuitable for its intended purpose).

Accordingly, for these reasons, claim 1 is patentable over Franklin et al. in view of Yanagihara et al. further in view of Langhans et al. Claims 3, 4 and 6-26 depend from claim 1, and thus are patentable for the same reasons. Reconsideration and withdrawal of the rejection are respectfully requested.

**2. Claim 27**

Claim 27 is directed towards a method of performing secure credit card purchases. The selecting step includes selecting a predetermined payment category which limits a nature, of a series of subsequent purchases to a single merchant, said single merchant limitation being included in said payment category prior to any particular merchant being identified as said single merchant.

To avoid unnecessary duplication, claim 27 is patentable for same reasons provided above with respect to claim 1. Thus, reconsideration and withdrawal of the rejection are respectfully requested.

**3. Claims 28-31**

Claim 28 is directed towards a method of performing secure credit card purchases. The selecting step includes selecting a predetermined payment category

which limits a nature, of a series of subsequent purchases to a single merchant, said single merchant limitation being included in said payment category prior to any particular merchant being identified as said single merchant.

To avoid unnecessary duplication, claim 28 is patentable for same reasons provided above with respect to claim 1. Claims 29-31 dependent from claim 28, and thus are patentable for the same reasons. Reconsideration and withdrawal of the rejection are respectfully requested.

#### **4. Claims 32 and 33**

Claim 32 is directed towards a method of performing secure credit card purchases. The selecting step includes selecting a predetermined payment category which limits a nature, of a series of subsequent purchases to a single merchant, said single merchant limitation being included in said payment category prior to any particular merchant being identified as said single merchant.

To avoid unnecessary duplication, claim 32 is patentable for same reasons provided above with respect to claim 1. Claim 33 dependents from claim 32, and thus is patentable for the same reasons. Reconsideration and withdrawal of the rejection are respectfully requested.

Serial No: 11/252,009  
Docket No: 253,001  
July 26, 2010  
Page 23 of 23

**F. Conclusion**

In view of the foregoing, it is respectfully submitted that each of the pending claims is in condition for allowance, and a Notice of Allowance is earnestly solicited. The Examiner is invited to contact the undersigned at (727) 230-4949 with any questions, comments, or suggestions relating to the referenced patent application.

Respectfully submitted,  
Maxey Law Offices, PLLC

July 26, 2010  
Date: \_\_\_\_\_

/Stephen Lewellyn/

\_\_\_\_\_  
Stephen Lewellyn  
Registration No. 51,942  
15500 Roosevelt Blvd., Suite 305  
Clearwater, Florida 33760  
Tel: 727-230-4949

Under the Paperwork Reduction Act of 1995, no persons are required to respond to a collection of information unless it displays a valid OMB control number.

<b>PATENT APPLICATION FEE DETERMINATION RECORD</b> Substitute for Form PTO-875					Application or Docket Number <b>11/252,009</b>		Filing Date <b>10/17/2005</b>		<input type="checkbox"/> To be Mailed		
<b>APPLICATION AS FILED – PART I</b>											
(Column 1)			(Column 2)			SMALL ENTITY <input checked="" type="checkbox"/> OR		OTHER THAN SMALL ENTITY			
FOR		NUMBER FILED	NUMBER EXTRA		RATE (\$)	FEE (\$)	OR		RATE (\$)	FEE (\$)	
<input type="checkbox"/> BASIC FEE <small>(37 CFR 1.16(a), (b), or (c))</small>		N/A	N/A		N/A				N/A		
<input type="checkbox"/> SEARCH FEE <small>(37 CFR 1.16(k), (l), or (m))</small>		N/A	N/A		N/A		N/A				
<input type="checkbox"/> EXAMINATION FEE <small>(37 CFR 1.16(o), (p), or (q))</small>		N/A	N/A		N/A		N/A				
TOTAL CLAIMS <small>(37 CFR 1.16(i))</small>		minus 20 =	*		X \$ =		X \$ =				
INDEPENDENT CLAIMS <small>(37 CFR 1.16(h))</small>		minus 3 =	*		X \$ =		X \$ =				
<input type="checkbox"/> APPLICATION SIZE FEE <small>(37 CFR 1.16(s))</small>		If the specification and drawings exceed 100 sheets of paper, the application size fee due is \$250 (\$125 for small entity) for each additional 50 sheets or fraction thereof. See 35 U.S.C. 41(a)(1)(G) and 37 CFR 1.16(s).									
<input type="checkbox"/> MULTIPLE DEPENDENT CLAIM PRESENT <small>(37 CFR 1.16(j))</small>											
* If the difference in column 1 is less than zero, enter "0" in column 2.											
<b>APPLICATION AS AMENDED – PART II</b>					SMALL ENTITY		OR		OTHER THAN SMALL ENTITY		
(Column 1)			(Column 2)		(Column 3)			SMALL ENTITY		OTHER THAN SMALL ENTITY	
AMENDMENT	<b>07/26/2010</b>		CLAIMS REMAINING AFTER AMENDMENT		HIGHEST NUMBER PREVIOUSLY PAID FOR	PRESENT EXTRA	RATE (\$)	ADDITIONAL FEE (\$)		RATE (\$)	ADDITIONAL FEE (\$)
	Total <small>(37 CFR 1.16(o))</small>		* 30	Minus	** 44	= 0	X \$26 =	0	OR	X \$ =	
	Independent <small>(37 CFR 1.16(h))</small>		* 4	Minus	***6	= 0	X \$110 =	0	OR	X \$ =	
	<input type="checkbox"/> Application Size Fee <small>(37 CFR 1.16(s))</small>										
	<input type="checkbox"/> FIRST PRESENTATION OF MULTIPLE DEPENDENT CLAIM <small>(37 CFR 1.16(j))</small>										
							TOTAL ADD'L FEE	<b>0</b>	OR	TOTAL ADD'L FEE	
AMENDMENT			CLAIMS REMAINING AFTER AMENDMENT		HIGHEST NUMBER PREVIOUSLY PAID FOR	PRESENT EXTRA	RATE (\$)	ADDITIONAL FEE (\$)		RATE (\$)	ADDITIONAL FEE (\$)
	Total <small>(37 CFR 1.16(o))</small>		*	Minus	**	=	X \$ =		OR	X \$ =	
	Independent <small>(37 CFR 1.16(h))</small>		*	Minus	***	=	X \$ =		OR	X \$ =	
	<input type="checkbox"/> Application Size Fee <small>(37 CFR 1.16(s))</small>										
	<input type="checkbox"/> FIRST PRESENTATION OF MULTIPLE DEPENDENT CLAIM <small>(37 CFR 1.16(j))</small>										
							TOTAL ADD'L FEE		OR	TOTAL ADD'L FEE	
* If the entry in column 1 is less than the entry in column 2, write "0" in column 3.											
** If the "Highest Number Previously Paid For" IN THIS SPACE is less than 20, enter "20".											
*** If the "Highest Number Previously Paid For" IN THIS SPACE is less than 3, enter "3".											
The "Highest Number Previously Paid For" (Total or Independent) is the highest number found in the appropriate box in column 1.											
							Legal Instrument Examiner: /TIA A. BENTLEY/				

This collection of information is required by 37 CFR 1.16. The information is required to obtain or retain a benefit by the public which is to file (and by the USPTO to process) an application. Confidentiality is governed by 35 U.S.C. 122 and 37 CFR 1.14. This collection is estimated to take 12 minutes to complete, including gathering, preparing, and submitting the completed application form to the USPTO. Time will vary depending upon the individual case. Any comments on the amount of time you require to complete this form and/or suggestions for reducing this burden, should be sent to the Chief Information Officer, U.S. Patent and Trademark Office, U.S. Department of Commerce, P.O. Box 1450, Alexandria, VA 22313-1450. DO NOT SEND FEES OR COMPLETED FORMS TO THIS ADDRESS. **SEND TO: Commissioner for Patents, P.O. Box 1450, Alexandria, VA 22313-1450.**

If you need assistance in completing the form, call 1-800-PTO-9199 and select option 2.





UNITED STATES PATENT AND TRADEMARK OFFICE

UNITED STATES DEPARTMENT OF COMMERCE  
United States Patent and Trademark Office  
Address: COMMISSIONER FOR PATENTS  
P.O. Box 1450  
Alexandria, Virginia 22313-1450  
www.uspto.gov

APPLICATION NO.	FILING DATE	FIRST NAMED INVENTOR	ATTORNEY DOCKET NO.	CONFIRMATION NO.
-----------------	-------------	----------------------	---------------------	------------------

11/252,009      10/17/2005      John D'Agostino      4322

<sup>7590</sup>  
JOHN D'AGOSTINO  
5168 NORTHRIDGE ROAD #309  
SARASOTA, FL 34238

03/29/2010

EXAMINER
----------

SHRESTHA, BIENDRA K

ART UNIT	PAPER NUMBER
----------	--------------

3691

MAIL DATE	DELIVERY MODE
-----------	---------------

03/29/2010

PAPER

**Please find below and/or attached an Office communication concerning this application or proceeding.**

The time period for reply, if any, is set in the attached communication.



### **DETAILED ACTION**

Claims 1-43 are presented for examination. Applicant filed an amendment on 12/10/2009 amending claims 1, 6, 11-24, ,26-28, 32 and 34, and canceling claims 2 and 5. After careful consideration of applicant's amendments and arguments, new ground of rejections of claims necessitated by applicant amendments has been established in the instant application as set forth in detail below. Applicant's arguments with respect to claims have been considered but are moot in view of the new ground(s) of rejection.

#### ***Information Disclosure Statement***

Applicant is respectfully requested to cite the references relevant to the instant application so that the Examiner can review it in limited available time.

#### ***Claim Objections***

Claim 34 objected to because of the following informalities: part c) of body of claim 34 recites " ....credit card account of the *issuer*". Examiner interprets the phrase as " credit card account of the *user*". Appropriate correction is required.

#### ***Claim Rejections - 35 USC § 112***

1. The following is a quotation of the second paragraph of 35 U.S.C. 112:

The specification shall conclude with one or more claims particularly pointing out and distinctly claiming the subject matter which the applicant regards as his invention.

2. Claims 34-43 are rejected under 35 U.S.C. § 112, second paragraph, as being indefinite for failing to particularly point out and distinctly claim the subject matter which applicant regards as the invention.

In particular, claim 34 recites in the preamble “a system for performing secure credit card purchases”, the body of the claim does not contain any limitations indicating the structure of the system. A system or an apparatus claim should always claim the structure or the hardware that performs the function.

Applicant provided the response that “custodial authorizing entity” as ... processing computer or like applicable hardware for generation of an exclusive transaction code” as described in specification at paragraph [013]) “would not cure the impending rejection under 35 USC § 112, Second Paragraph.

Applicant’s claimed limitations consists system claim with a body of claim written as set of method steps for carrying out the process. It is not clear if the claim is method or a system. Appropriate correction is required.

Examiner interpreted the claims 34-43 as a method claim for the prosecution of the application.

### ***Claim Rejections - 35 USC § 112***

3. The following is a quotation of the first paragraph of 35 U.S.C. 112:

The specification shall contain a written description of the invention, and of the manner and process of making and using it, in such full, clear, concise, and exact terms as to enable any person skilled in the art to which it pertains, or with which it is most nearly connected, to make and use the same and shall set forth the best mode contemplated by the inventor of carrying out his invention.

4. Claims 13-24, 27-28, 32 and 34 are rejected under 35 U.S.C. 112, first paragraph, as failing to comply with the written description requirement. The claim(s) contains subject matter which was not described in the specification in such a way as to reasonably convey to one skilled in the relevant art that the inventor(s), at the time the application was filed, had possession of the claimed invention.

5. As per claims 13-24, applicant amendment include replacement of phrases "the ability to use" by "parameters permitting use of" and "the ability to limit" by "parameters to limit" with respect to payment categories. The specification do not describe payment categories *parameters*; it rather describes 'plurality of payment categories.....variety of methods for accomplishing payment for fixed transactions, multiple transactions and/or a repeated transactions" (page 6, lines 8-11). Applicant is requested cite a portion of specification where claimed descriptions are made in response to this office action.

Examiner interprets "parameters of payment categories" as "using one of plurality of payment categories" for prosecution of this application.

6. As per claims 27-28, 32 and 34, applicant amendments include replacement of phrase "credit-card" account by "pre-established" account broadening the claim limitation without support in the specification. The written description specifically submits that "**transaction code** is to be used in substitution for specific **credit card number**.... which would normally identify a **customer's credit card account**.... " (page 15, lines 5-8). Appropriate correction is required.

Examiner interprets pre-established account as pre-established credit card account for prosecution of this application.

***Claim Rejections - 35 USC § 103***

7. The following is a quotation of 35 U.S.C. 103(a) which forms the basis for all obviousness rejections set forth in this Office action:

(a) A patent may not be obtained though the invention is not identically disclosed or described as set forth in section 102 of this title, if the differences between the subject matter sought to be patented and the prior art are such that the subject matter as a whole would have been obvious at the time the invention was made to a person having ordinary skill in the art to which said subject matter pertains. Patentability shall not be negated by the manner in which the invention was made.

8. Claims 1, 3-4, 6-43 are rejected under 35 U.S.C. 103(a) as being unpatentable over Franklin et al., U.S. Patent No. 6,000,832 (reference A in attached PTO-892) in view of Yanagihara et al. U.S. Pub No. 2001/0011249 (reference B in attached PTO-892) further in view of Langhans et al., U.S. Patent No. 5,500,513 (reference C in attached PTO-892).

9. As per claim 1, Franklin et al. teach a method of performing secure credit card purchases, said method comprising:

a) contacting a custodial authorizing entity having custodial responsibility of account parameters of customer's account that is used to make credit card purchases (see Fig. 1; Issuing Bank (26) connected to customer (22) and merchant (24) connected by Internet (34); column 4, lines 3-9; where commerce card is issued by credit card companies or card sponsoring companies);

b) supplying *said* custodial authorizing entity with at least account identification data of *said customer account* (see Fig. 4; Fig. 7);

c) defining a payment category including at least limiting purchases to a single merchant for at least one transaction (see column 9, lines 52-55); where code specific to a merchant is generated by the software supplied by the issuing bank installed on customer computer as described in column 2, lines 18-37) ;

d) designating *said* payment category thereby designating at least that a transaction code generated in accordance with *said* payment category can be used by only one merchant (see column 2, lines 27-37; where code generated include merchant ID);

e) generating a transaction code by *said* custodial authorizing entity, *said transaction code reflecting at least the limits of said designated payment category to make a purchase within said designated payment category* (see column 2, lines 17-21; where transaction code is obtained from a computer using customer account number and private key and software modules supplied by the issuing bank).

f) communicating *said* transaction code to a merchant to consummate a purchase with defined purchase parameters (see Fig. 3; column 5, lines 41-58);

g) verifying that *said* defined purchase parameters are within *said* designated payment category (see column 5, lines 59-67 to column 6, lines 1-12); and

h) providing authorization for *said* purchase so as to confirm at least that *said* defined purchase parameters are within *said* designated payment category and *to authorize payment required to complete the purchase* (see column 12, lines 27-48).

Franklin et al. teach generating a transaction code with transaction specific data (see Fig. 4; Transaction Specific Data which include good identification; column 9, lines 40-43) and but do not teach predefining and associating with the payment categories.

Yanagihara et al. teach predefining and associating the transaction code with the payment categories (see Fig. 2; Fig. 4; paragraph [0019])

Therefore, it would be obvious to one of ordinary skill in the art at the time the invention was made to allow predefining and associating the transaction code with the payment categories of Franklin et al. because Yanagihara et al. teach that including above features would enable user to use usage identification code which indicates purpose of use and usage limit to indicate maximum amount to withdraw (Yanagihara et al., paragraph [0019]).

Franklin et al. do not teach said single merchant limitation being included in said payment category prior to any particular merchant being identified as said single merchant.

Langhans et al. teach said single merchant limitation being included in said payment category prior to any particular merchant being identified as said single merchant (Langhans et al., column 11, lines 65-67 to column 12, lines 1-7; where merchant category code is identified prior to identifying any single merchant).

Therefore, it would be obvious to one of ordinary skill in the art at the time the invention was made to allow said single merchant limitation being included in said payment category prior to any particular merchant being identified as said single merchant of Franklin et al. because Langhans et al. teach that including above features



would enable to control application of certain authorization parameters based merchant category codes (Langhans et al., column 12, lines 20-23).

10. As per claim 3, Franklin et al. in view of Yanagihara et al. further in view of Langhans et al. teach claim 1 as described above. Franklin et al. further teaches the method comprising step of designating said single merchant subsequent to generating said transaction code (see Fig. 4; transaction specific data that include merchant identification).

11. As per claim 4, Franklin et al. in view of Yanagihara et al. further in view of Langhans et al. teach claim 1 as described above. Franklin et al. further teaches the method wherein

step of communicating the transaction code to said merchant to consummate said purchase within defined purchase parameters further comprises designation of said single merchant (see Fig. 4; column 9, lines 18-30; column 49-58).

12. As per claim 6, Franklin et al. in view of Yanagihara et al. further in view of Langhans et al. teach claim 1 as described above. Franklin et al. further teaches the method wherein

said step of generating said transaction code further comprises said customer obtaining said transaction code (see column 3, lines 21-37; where transaction code is obtained from a computer using customer account number and private key and software modules supplied by the issuing bank).

13. As per claim 7, Franklin et al. in view of Yanagihara et al. further in view of Langhans et al. teach claim 1 as described above. Franklin et al. further teaches the method comprising

obtaining said authorization for said purchase from the custodial authorizing entity (see column 5, lines 59—67).

14. As per claim 8, Franklin et al. in view of Yanagihara et al. further in view of Langhans et al. further in view of Langhans et al. teach claim 1 as described above. Franklin et al. further teaches the method comprising

a step of communicating promotional information of offered subject matter to the customer by the merchant, pre-determining the purchase parameters of the purchase, and corresponding said designated payment category to said purchase parameters (see column 9, lines 12-30; where customer surf the web for purchasing; Examiner notes that customer have access to promotional information of the offered subject matter in the web or merchant website).

15. As per claim 9, Franklin et al. in view of Yanagihara et al. further in view of Langhans et al. teach claim 1 as described above. Franklin et al. further teaches the method comprising

the merchant communicating the transaction code to the custodial authorizing entity for verification (see Fig. 7).

16. As per claims 10-14, Franklin et al. in view of Yanagihara et al. further in view of Langhans et al. teach claim 1 as described above.

Franklin et al. further teach the method comprising generating a transaction code which reflects at least one of a plurality of said payment categories that include amount parameters for a cost of one or more purchases, time parameters during which the purchase can be completed, parameters permitting use of said transaction code for a single transaction at a fixed amount for purchase within a predetermined period of time, parameters to limit purchases to said single transaction at said fixed amount for purchase within said predetermined period of time (see Fig. 4, column 2, lines 30-32; column 9, lines 49-58; column 10, lines 52-65; where transaction code include single purchase for specific amount for specific finite time period ).

17. As per claims 15-24, Franklin et al. in view of Yanagihara et al. further in view of Langhans et al. teach claim 10 as described above.

Franklin et al. do not teach parameters permitting or limiting a) use of transaction code for a single transaction at a fixed or maximum amount for a purchase within a predetermined period of time, c) use said transaction code for multiple transactions at a fixed or maximum total amount for purchases within a predetermined time period, d) the ability to use said transaction code for a repeating transaction at a fixed amount for purchases payable at each of a fixed number of time intervals, and e) use said transaction code for a repeating transaction at a fixed amount for purchases payable at each of an unspecified number of time intervals.

Yanagihara et al. teach storing a restrictive condition for withdrawal of amount from the money card and application of the predetermined condition during withdrawal of the money from the card ( Yanagihara et al., Fig. 2, Payment Condition (209) and

Transaction Record (210); paragraph [0005], [0006] and 0019]; the Examiner notes any above preconditions in claims 5-15 and 19-26 can be set in Payment Condition (209) in Fig. 2).

Therefore, it would be prima facie obvious to one of ordinary skill in the art at the time the invention was made to allow storing a restrictive condition for withdrawal of amount from the money card and application of the predetermined condition during withdrawal of the money from the card of Franklin et al. because Yanagihara et al. teach that including above features would enable user to use usage identification code which indicates purpose of use (Yanagihara et al., paragraph [0019]).

18. As per claim 25, Franklin et al. in view of Yanagihara et al. further in view of Langhans et al. teach claim 1 as described above.

Franklin et al. further teaches the method comprising generating said transaction code to further reflect an identification of said single merchant (see Fig. 4, column 9, lines 43, 52-55).

19. As per claim 26, Franklin et al. in view of Yanagihara et al. further in view of Langhans et al. teach claim 25 as described above. Franklin et al. further teaches the method defining said payment category to include limiting purchases to a limited time interval during which said purchase authorization is permitted (column 10, lines 52-65).

20. As per claim 27-28, Franklin et al. teach a method of performing secure credit card purchases, said method comprising

a) identifying a pre-established account that is used to make credit card purchases; b) designating at least one of a plurality payment categories which limit a nature of a subsequent purchases, at least one of said payment categories including at least including limiting purchases to a single merchant (see column 2, lines 9-21; column 4, lines 3-9; where commerce card is issued by credit card companies or card sponsoring companies; column 9, lines 49-58; where code number include merchant specific code for particular merchant );

c) generating a transaction code by a custodial authorizing of said pre-established account, said transaction code associated with at least said pre-established credit card account and the limits of said selected payment category, and different from said pre-established credit card account (see Fig. 4, column 2, lines 22-35);

d) communicating said transaction code to a merchant to consummate a purchase within defined purchase parameters (see column 2, lines 35-38);

e) verifying that said defined purchase parameters correspond to said designated payment category (see column 2, lines 47-64); and

f) providing authorization for said purchase so as to confirm at least that said defined purchase parameters are within said designated payment category and complete the purchase (see column 2, lines 65-67 to column 3, lines 1-6); and

g) associating the purchase with said pre-established credit card account (see column 12, lines 34-43).

Franklin teaches generating a transaction code with transaction specific data (see Fig. 4; Transaction Specific Data which include good identification; column 9, lines 40-43) and but do not teach predefining and associating with the payment categories.

Yanagihara et al. teach predefining and associating the transaction code with the payment categories (see Fig. 2; Fig. 4; paragraph [0019])

Therefore, it would be obvious to one of ordinary skill in the art at the time the invention was made to allow predefining and associating the transaction code with the payment categories of Franklin et al. because Yanagihara et al. teach that including above features would enable user to use usage identification code which indicates purpose of use and usage limit to indicate maximum amount to withdraw (Yanagihara et al., paragraph [0019]).

Franklin et al. do not teach said single merchant limitation being included in said payment category prior to any particular merchant being identified as said single merchant.

Langhans et al. teach said single merchant limitation being included in said payment category prior to any particular merchant being identified as said single merchant (Langhans et al., column 11, lines 65-67 to column 12, lines 1-7; where merchant category code is identified prior to identifying any single merchant).

Therefore, it would be obvious to one of ordinary skill in the art at the time the invention was made to allow said single merchant limitation being included in said payment category prior to any particular merchant being identified as said single merchant of Franklin et al. because Langhans et al. teach that including above features

would enable to control application of certain authorization parameters based merchant category codes (Langhans et al., column 12, lines 20-23).

21. As per claims 29-30, Franklin et al. in view of Yanagihara et al. further in view of Langhans et al. teach claim 28 as described above.

Franklin et al. do not teach restriction on purchases based on pre-selected payment categories.

Yanagihara et al. teach restriction on purchases based on payment categories such that it limits nature of subsequent purchases in terms of amount (Yanagihara, paragraphs [0006], [0021]).

Therefore, it would be prima facie obvious to one of ordinary skill in the art at the time the invention was made to allow storing a restrictive condition for withdrawal of amount from the money card and application of the predetermined condition during withdrawal of the money from the card of Franklin et al. because Yanagihara et al. teach that including above features would enable user to use usage identification code which indicates purpose of use (Yanagihara et al., paragraph [0019]).

22. As per claim 31, Franklin et al. in view of Yanagihara et al. further in view of Langhans et al. teach claim 28 as described above. Franklin et al. further teaches the method wherein

said step of verifying that said defined purchase parameters correspond to said selected payment category further identifies said merchant as said single merchant (see Fig. 4, column 9, lines 43, 52-55).

23. As per claim 32, Franklin et al. teach a method of performing secure card purchases, said method comprising:

a) identifying a pre-established credit card account that can be used to make credit card purchases (see column 2, lines 9-21); column 4, lines 3-9; where commerce card is issued by credit card companies or card sponsoring companies);

b) selecting a payment category which limits a nature of a subsequent purchase to single merchant (see Fig. 4, column 9, lines 43, 52-55); where code specific to a merchant is generated by the software supplied by the issuing bank installed on customer computer as described in column 2, lines 18-37);

c) generating a transaction code by a custodial authorizing entity of said pre-established credit card account, said transaction code associated with at least said credit card account and the limits of said selected payment category, and different from said pre-established credit card account (see column 2, lines 17-21; where transaction code is obtained from a computer using customer account number and private key and software modules supplied by the issuing bank;);

d) designating a merchant as said single merchant (see Fig. 4; column 9, lines 52-55);

e) communicating said transaction code to said merchant to consummate a purchase within defined purchase parameters (see column 2, lines 35-38);

f) verifying that said defined purchase parameters correspond to said selected payment category (see column 2, lines 47-64);



g) providing authorization for said purchase so as to confirm at least that said defined purchase parameters are within said selected payment category and to authorize payment required to complete the purchase (see column 2, lines 65-67 to column 3, lines 1-6); and

h) associating the purchase with said pre-established credit card account (see column 12, lines 34-43).

Franklin teaches generating a transaction code with transaction specific data (see Fig. 4; Transaction Specific Data which include good identification; column 9, lines 40-43) and but do not teach predefining and associating with the payment categories.

Yanagihara et al. teach predefining and associating the transaction code with the payment categories (see Fig. 2: Fig. 4; paragraph [0019])

Therefore, it would be obvious to one of ordinary skill in the art at the time the invention was made to allow predefining and associating the transaction code with the payment categories of Franklin et al. because Yanagihara et al. teach that including above features would enable user to use usage identification code which indicates purpose of use and usage limit to indicate maximum amount to withdraw (Yanagihara et al., paragraph [0019]).

Franklin et al. do not teach said single merchant limitation being included in said payment category prior to any particular merchant being identified as said single merchant.

Langhans et al. teach said single merchant limitation being included in said payment category prior to any particular merchant being identified as said single

merchant (Langhans et al., column 11, lines 65-67 to column 12, lines 1-7; where merchant category code is identified prior to identifying any single merchant).

Therefore, it would be obvious to one of ordinary skill in the art at the time the invention was made to allow said single merchant limitation being included in said payment category prior to any particular merchant being identified as said single merchant of Franklin et al. because Langhans et al. teach that including above features would enable to control application of certain authorization parameters based merchant category codes (Langhans et al., column 12, lines 20-23).

24. As per claim 33, Franklin et al. in view of Yanagihara et al. further in view of Langhans et al. teach claim 32 as described above. Franklin et al. further teaches the method wherein said step of verifying that said defined purchase parameters correspond to said selected payment category further identifies said merchant as said single merchant (see column 2, lines 50-64).

25. As per claim 34, Franklin et al. teach a system for performing secure credit\_card purchases (see Fig. 1) comprising:

a) a custodial authorizing entity, said custodial authorizing entity structured to maintain a pre-established account that is used to make credit card purchases for at least one user (see Fig. 1, Issuing Bank (26); column 2, lines 8-11); column 4, lines 3-9; where commerce card is issued by credit card companies or card sponsoring companies);

b) said custodial authorizing entity further structured to define at least one payment category available for selection by a customer, said payment category structured to limit at least one subsequent transaction to a single merchant (see column 2, lines 11-21);

c) said custodial authorizing entity further structured to generate a transaction code associated with at least the limits of said payment category selected by the customer and said credit card account of the user, said transaction code being different from said pre-established credit card account (see Fig. 4-6; column 2, lines 22-35; where transaction code is obtained from a computer using customer account number and private key and software modules supplied by the issuing bank);

d) said custodial authorizing entity further structured to receive said transaction code and designated purchase parameters associated with a purchase from a merchant, and to verify that said designated purchase parameters correspond to said selected payment category (see Fig. 7; column 2, lines 47-64); and

e) said custodial authorizing entity structured to provide the merchant with authorization for said purchase that confirms at least that said designated purchase parameters correspond to said selected payment category so that said purchase may be consummated by the merchant (see Fig. 7; column 2, lines 65-67 to column 3, lines 1-6).

Franklin et al. do not teach said single merchant limitation being included in said payment category prior to any particular merchant being identified as said single merchant.

Langhans et al. teach said single merchant limitation being included in said payment category prior to any particular merchant being identified as said single merchant (Langhans et al., column 11, lines 65-67 to column 12, lines 1-7; where merchant category code is identified prior to identifying any single merchant).

Therefore, it would be obvious to one of ordinary skill in the art at the time the invention was made to allow said single merchant limitation being included in said payment category prior to any particular merchant being identified as said single merchant of Franklin et al. because Langhans et al. teach that including above features would enable to control application of certain authorization parameters based merchant category codes (Langhans et al., column 12, lines 20-23).

26. As per claim 35, Franklin et al. in view of Yanagihara et al. further in view of Langhans et al. teach claim 34 as described above. Franklin et al. further teaches the system wherein

said single merchant is identified upon selection of said payment category and is associated with said transaction code (see column 9, lines 40-43; where merchant identification identifies the merchant).

27. As per claim 36, Franklin et al. in view of Yanagihara et al. further in view of Langhans et al. teach claim 34 as described above. Franklin et al. further teaches the system wherein

said custodial authorizing entity is structured to designate a first merchant to provide said transaction code for verification as said single merchant (see column 2,

lines 18-21; 27-31; where software module supplied by issuing bank generates codes number in digits for customer specific data such as merchant identification).

28. As per claim 37, Franklin et al. in view of Yanagihara et al. further in view of Langhans et al. teach claim 36 as described above. Franklin et al. further teaches the system wherein

said custodial authorizing entity is structured to designate said first merchant as said single merchant for subsequent transactions utilizing said transaction code (Examiner interprets that custodial authority supplied software generates identification code for merchant and subsequent transaction could be transacted with the given code for the merchant).

29. As per claim 38-42, Franklin et al. in view of Yanagihara et al. further in view of Langhans et al. teach claim 34 as described above.

Franklin et al. do not teach defining said payment category as a specific (maximum) dollar amount.

Yanagihara et al. teach defining said payment category as a specific maximum dollar amount (see paragraph [0019]).

Therefore, it would be prima facie obvious to one of ordinary skill in the art at the time the invention was made to allow defining said payment category as a specific maximum dollar amount of Franklin et al. because Yanagihara et al. teach that including above features would enable user to use usage identification code which indicates purpose of use and usage limit to indicate maximum amount to withdraw (Yanagihara et al., Fig. 2; paragraph [0019]).

30. As per claim 43, Franklin et al. in view of Yanagihara et al. further in view of Langhans et al. teach claim 34 as described above. Franklin et al. further teaches the system wherein

said payment category is further structured to limit said at least one subsequent transaction to a predetermined time period (see column 10, lines 52-65).

### ***Response to Arguments***

New ground of rejections of claims necessitated by applicant amendments has been established in the instant application. Applicant's arguments with respect to claims have been considered but are moot in view of the new ground(s) of rejection.

Nonobviousness cannot be established by attacking the references individually, when the rejection is predicated upon a combination of prior art disclosures. See *In re Merck & Co.*, 800 F.2d 1091, 1097 (Fed. Cir.1986). Here, the Appellant has attacked the references individually, when rejection was made using a combination of Franklin et al., Yanagihara et al. and Langhans et al.

As per claims 1, 27-28 and 32, Examiner respectfully disagrees that Langhans et al. fail to teach or suggest the claimed feature of single merchant limitation being included in payment category prior to any particular merchant being identified as a said single merchant, Langhans et al. teach vendor list features which restrict and consolidate spending to specific merchants. Based on comparison of vendor data stored in the an electronic approved vendor list and the merchant information transmitted in authorization request, the purchase is approved or disapproved

(Langhans et al., column 2, lines 45-55). In Fig. 10, steps 128 and 130, Langhans et al. specifically teach Test 130 determines if particular vendor is on an approved vendor list (Langhans et al. , column 7, lines 65-67). Franklin et al. teach inserting specific merchant specific ID of transaction specific data in transaction code generated by computer using software provided by an issuing bank (column 2, lines 26-32). The vendor list provided would not identify which one of them will be used for purchase of an item. The transaction code with specific merchant ID limits a transaction to a single merchant from plurality of merchants provided by the vendor list of Langhans et al.. Therefore, Franklin et al. in combination with Langhans et al. overcomes the applicant argument.

As per claims 3-4, 31 and 33, Franklin et al. teach step of communicating the transaction code *specific to one transaction* to a merchant to consummate a purchase within defined purchase parameters with transaction specific data comprising single identified merchant ID as shown in Fig. 4 (Franklin et al., column 2, lines 22-38; column 9, lines 18-58). Franklin et al. further teach generating transaction code using designated particular merchant ID of *particular merchant of visited website* with help wizard software invoked by a button U54 which automatically collect transaction specific data (Franklin et al., 9, lines 40-58). The applicant argument that Franklin et al. is based on the merchant being identified before transaction code has been generated is immaterial to recitation of claim 4. It is noted that the features upon which applicant argument is based are not recited in the rejected claim(s). Although the claims are interpreted in light of the specification, limitations from the specification are not read into

the claims. See *In re Van Geuns*, 988 F.2d 1181, 26 USPQ2d 1057 (Fed. Cir. 1993).

Examiner further notes that applicant specification submits “ customer contacts custodial authorizing entity.... provides additional information ....include the identification of the merchant or merchants involved...” prior to generating a transaction code (see page 13, lines 6-12; page 14, lines 1-9; page 15, lines 2-15).

### ***Conclusion***

31. Applicant's amendment necessitated the new ground(s) of rejection presented in this Office action. Accordingly, **THIS ACTION IS MADE FINAL**. See MPEP § 706.07(a). Applicant is reminded of the extension of time policy as set forth in 37 CFR 1.136(a).

A shortened statutory period for reply to this final action is set to expire THREE MONTHS from the mailing date of this action. In the event a first reply is filed within TWO MONTHS of the mailing date of this final action and the advisory action is not mailed until after the end of the THREE-MONTH shortened statutory period, then the shortened statutory period will expire on the date the advisory action is mailed, and any extension fee pursuant to 37 CFR 1.136(a) will be calculated from the mailing date of the advisory action. In no event, however, will the statutory period for reply expire later than SIX MONTHS from the date of this final action.



The prior art made of record and not relied upon is considered pertinent to applicant's disclosures. The following are pertinent to current invention, though not relied upon:

Benson et al. (U.S. Patent No. 5,845,281) teach method and system for managing a data object so as to comply with predetermined conditions for usage.

Demoff et al. (U.S. Patent No. 6,456,984) teach method and system for providing temporary credit authorizations.

Fleming (U.S. Patent No. 5,953,710) teaches children's credit or debit card system.

Foladare et al. (U.S. Patent No. 5,914,472) teach credit card spending authorization control system.

Franco (U.S. Patent No. 4,893,330) teaches method and apparatus for restricting credit card communication calls.

Kravitz (U.S. Patent No. 6,029,150) teaches payment and transactions in electronic commerce system.

Walker et al. (U.S. Patent No. 6,163,771) teach method and device for generating a single use financial account number.

Any inquiry concerning this communication or earlier communications from the examiner should be directed to Bijendra K. Shrestha whose telephone number is (571)270-1374. The examiner can normally be reached on 7:00AM-4:30PM (Monday-Friday); 2nd Friday OFF.

If attempts to reach the examiner by telephone are unsuccessful, the examiner's supervisor, Alexander Kalinowski can be reached on (571) 272-6771. The fax phone number for the organization where this application or proceeding is assigned is 571-273-8300.

Information regarding the status of an application may be obtained from the Patent Application Information Retrieval (PAIR) system. Status information for published applications may be obtained from either Private PAIR or Public PAIR. Status information for unpublished applications is available through Private PAIR only. For more information about the PAIR system, see <http://pair-direct.uspto.gov>. Should you have questions on access to the Private PAIR system, contact the Electronic Business Center (EBC) at 866-217-9197 (toll-free). If you would like assistance from a USPTO Customer Service Representative or access to the automated information system, call 800-786-9199 (IN USA OR CANADA) or 571-272-1000.

/Alexander Kalinowski/  
Supervisory Patent Examiner, Art Unit 3691  
/Bijendra K. Shrestha/  
Examiner, Art Unit 3691  
03/20/2010

<b>Notice of References Cited</b>	Application/Control No. 11/252,009	Applicant(s)/Patent Under Reexamination D'AGOSTINO, JOHN	
	Examiner BIJENDRA K. SHRESTHA	Art Unit 3691	Page 1 of 1

**U.S. PATENT DOCUMENTS**

*		Document Number Country Code-Number-Kind Code	Date MM-YYYY	Name	Classification
*	A	US-6,000,832	12-1999	Franklin et al.	700/232
*	B	US-2001/0011249	08-2001	YANAGIHARA et al.	705/41
*	C	US-5,845,281	12-1998	Benson et al.	1/1
*	D	US-6,456,984	09-2002	Demoff et al.	705/40
*	E	US-5,953,710	09-1999	Fleming, Stephen S.	705/38
*	F	US-5,914,472	06-1999	Foladare et al.	235/380
*	G	US-4,893,330	01-1990	Franco, Victor A.	379/91.02
*	H	US-6,029,150	02-2000	Kravitz, David William	705/39
*	I	US-5,991,749	11-1999	Morrill, Jr., Paul H.	705/44
*	J	US-5,991,750	11-1999	Watson, Craig	705/44
*	K	US-6,226,624	05-2001	Watson et al.	705/44
	L	US-			
	M	US-			

**FOREIGN PATENT DOCUMENTS**

*		Document Number Country Code-Number-Kind Code	Date MM-YYYY	Country	Name	Classification
	N					
	O					
	P					
	Q					
	R					
	S					
	T					

**NON-PATENT DOCUMENTS**

*		Include as applicable: Author, Title Date, Publisher, Edition or Volume, Pertinent Pages)
	U	
	V	
	W	
	X	

\*A copy of this reference is not being furnished with this Office action. (See MPEP § 707.05(a).)  
Dates in MM-YYYY format are publication dates. Classifications may be US or foreign.

<b>Index of Claims</b> 	<b>Application/Control No.</b> 11252009	<b>Applicant(s)/Patent Under Reexamination</b> D'AGOSTINO, JOHN
	<b>Examiner</b> Shrestha, Bijendra K	<b>Art Unit</b> 3691

✓	<b>Rejected</b>	-	<b>Cancelled</b>	N	<b>Non-Elected</b>	A	<b>Appeal</b>
=	<b>Allowed</b>	÷	<b>Restricted</b>	I	<b>Interference</b>	O	<b>Objected</b>

Claims renumbered in the same order as presented by applicant
  CPA
  T.D.
  R.1.47

CLAIM		DATE									
Final	Original	03/20/2010									
	1	✓									
	2	-									
	3	✓									
	4	✓									
	5	-									
	6	✓									
	7	✓									
	8	✓									
	9	✓									
	10	✓									
	11	✓									
	12	✓									
	13	✓									
	14	✓									
	15	✓									
	16	✓									
	17	✓									
	18	✓									
	19	✓									
	20	✓									
	21	✓									
	22	✓									
	23	✓									
	24	✓									
	25	✓									
	26	✓									
	27	✓									
	28	✓									
	29	✓									
	30	✓									
	31	✓									
	32	✓									
	33	✓									
	34	✓									
	35	✓									
	36	✓									

<b>Index of Claims</b> 	<b>Application/Control No.</b> 11252009	<b>Applicant(s)/Patent Under Reexamination</b> D'AGOSTINO, JOHN
	<b>Examiner</b> Shrestha, Bijendra K	<b>Art Unit</b> 3691

✓	<b>Rejected</b>	-	<b>Cancelled</b>	N	<b>Non-Elected</b>	A	<b>Appeal</b>
=	<b>Allowed</b>	÷	<b>Restricted</b>	I	<b>Interference</b>	O	<b>Objected</b>

<input type="checkbox"/> Claims renumbered in the same order as presented by applicant		<input type="checkbox"/> CPA		<input type="checkbox"/> T.D.		<input type="checkbox"/> R.1.47			
CLAIM		DATE							
Final	Original	03/20/2010							
	37	✓							
	38	✓							
	39	✓							
	40	✓							
	41	✓							
	42	✓							
	43	✓							

<b>Search Notes</b>  	<b>Application/Control No.</b>  11252009	<b>Applicant(s)/Patent Under Reexamination</b>  D'AGOSTINO, JOHN
	<b>Examiner</b>  Shrestha, Bijendra K	<b>Art Unit</b>  3691

<b>SEARCHED</b>			
<b>Class</b>	<b>Subclass</b>	<b>Date</b>	<b>Examiner</b>

<b>SEARCH NOTES</b>		
<b>Search Notes</b>	<b>Date</b>	<b>Examiner</b>
None	03/20/2010	bks

<b>INTERFERENCE SEARCH</b>			
<b>Class</b>	<b>Subclass</b>	<b>Date</b>	<b>Examiner</b>

--	--



UNITED STATES PATENT AND TRADEMARK OFFICE

UNITED STATES DEPARTMENT OF COMMERCE  
 United States Patent and Trademark Office  
 Address: COMMISSIONER FOR PATENTS  
 P.O. Box 1450  
 Alexandria, Virginia 22313-1450  
 www.uspto.gov

BIB DATA SHEET

CONFIRMATION NO. 4322

<b>SERIAL NUMBER</b> 11/252,009	<b>FILING or 371(c) DATE</b> 10/17/2005 <b>RULE</b>	<b>CLASS</b> 705	<b>GROUP ART UNIT</b> 3691	<b>ATTORNEY DOCKET NO.</b>		
<b>APPLICANTS</b> John D'Agostino, Sarasota, FL;						
<b>** CONTINUING DATA *****</b> This application is a CON of 10/037,007 11/09/2001 ABN which is a CIP of 09/231,745 01/15/1999 PAT 6,324,526						
<b>** FOREIGN APPLICATIONS *****</b>						
<b>** IF REQUIRED, FOREIGN FILING LICENSE GRANTED *** SMALL ENTITY **</b> 11/03/2005						
Foreign Priority claimed <input type="checkbox"/> Yes <input checked="" type="checkbox"/> No	35 USC 119(a-d) conditions met <input type="checkbox"/> Yes <input checked="" type="checkbox"/> No	<input type="checkbox"/> Met after Allowance	<b>STATE OR COUNTRY</b> FL	<b>SHEETS DRAWINGS</b> 2	<b>TOTAL CLAIMS</b> 44	<b>INDEPENDENT CLAIMS</b> 6
Verified and Acknowledged	/BIJENDRA K SHRESTHA/ Examiner's Signature	Initials				
<b>ADDRESS</b> JOHN D'AGOSTINO 5168 NORTHRIDGE ROAD #309 SARASOTA, FL 34238 UNITED STATES						
<b>TITLE</b> System and method for performing secure credit card purchases						
<b>FILING FEE RECEIVED</b> 1400	FEES: Authority has been given in Paper No. _____ to charge/credit DEPOSIT ACCOUNT No. _____ for following:		<input type="checkbox"/> All Fees <input type="checkbox"/> 1.16 Fees (Filing) <input type="checkbox"/> 1.17 Fees (Processing Ext. of time) <input type="checkbox"/> 1.18 Fees (Issue) <input type="checkbox"/> Other _____ <input type="checkbox"/> Credit			

**IN THE UNITED STATES PATENT AND TRADEMARK OFFICE**

In re Application of:  
John D'Agostino

Group Art Unit: 3691

Serial No.: 11/252,009

Examiner: Shrestha, Bijendra K.

Filed: 10/17/2005

Dkt. No.: 253.001

For: Reviewing Current Patent Application and Office Action

**CERTIFICATE OF MAILING OR TRANSMISSION UNDER 37 CFR 1.8:**

I hereby certify that this correspondence is being electronically transmitted using EFS-Web, or Deposited with the United States Postal Service on the date shown below with sufficient postage as first class mail in an envelop addressed to : \_\_\_\_\_, Commissioner for Patents, P.O. Box 1450, Alexandria, VA 22313-1450, or Transmitted by facsimile on the date shown below to the United States Patent and Trademark Office at (571) 273-8300.

December 10, 2009

/Stephen Lewellyn/

Date

Stephen Lewellyn

**RESPONSE TO NON-FINAL OFFICE ACTION**

Commissioner for Patents  
P.O. Box 1450  
Alexandria, VA 22313-1450

Commissioner:

This paper is submitted in response to the non-final office action dated 06/10/2009. A petition for a 3-month extension of time is filed concurrently herewith. Reconsideration of the application in view of the following amendments, remarks, and/or arguments is respectfully requested.



### AMENDMENT IN THE CLAIMS

1. (Currently Amended): A method of performing secure credit card purchases, said method comprising:

a) contacting a custodial authorizing entity having custodial responsibility of account parameters of a customer's account that ~~can be~~ is used to make credit card purchases;

b) supplying ~~the~~ said custodial authorizing entity with at least account identification data of said customer's account;

c) defining a payment category including at least ~~the ability to limit~~ limiting purchases to a single merchant for at least one transaction, said single merchant limitation being included in said payment category prior to any particular merchant being identified as said single merchant;

d) designating said payment category thereby designating at least that a transaction code generated in accordance with said payment category can be used by only one merchant;

e) generating a transaction code by said custodial authorizing entity, said transaction code reflecting at least the limits of said designated payment category ~~and the ability~~ to make a purchase within said designated payment category;

f) communicating ~~the~~ said transaction code to a merchant to consummate a purchase with ~~define~~ defined purchase parameters;

g) verifying that said defined purchase parameters are within said designated payment category; and

h) providing authorization for said purchase so as to confirm at least that said defined purchase parameters are within said designated payment category and to authorize payment required to complete the purchase.

2. (Canceled):

3. (Previously Presented): The method of claim 1 further comprising the step of designating said single merchant subsequent to generating said transaction code.

4. (Previously Presented): The method of claim 1 wherein said step of communicating the transaction code to said merchant to consummate said purchase within defined purchase parameters further comprises designation of said single merchant.

5. (Canceled):

6. (Currently Amended): The method of claim 1 wherein said step of generating said transaction code further comprises said customer ~~generating~~ obtaining said transaction code.

7. (Previously Presented): The method of claim 1 further comprising obtaining said authorization for said purchase from the custodial authorizing entity.

8. (Previously Presented): The method of claim 1 further comprising a step of communicating promotional information of offered subject matter to the customer by the merchant, pre-determining the purchase parameters of the purchase, and corresponding said designated payment category to said purchase parameters.

9. (Previously Presented): The method of claim 1 further comprising the merchant communicating the transaction code to the custodial authorizing entity for verification.

10. (Previously Presented): The method of claim 1 further comprising generating a transaction code which reflects at least one of a plurality of said payment categories.

11. (Currently Amended): The method of claim 10 further comprising defining at least one of said plurality of payment categories to include ~~the ability to designate~~ amount parameters for a cost of one or more purchases.

12. (Currently Amended): The method of claim 10 further comprising defining at least one of said plurality of payment categories to include ~~the ability to designate~~ time parameters during which the purchase can be completed.

13. (Currently Amended): The method of claim 10 further comprising defining at least one of said plurality of payment categories to include parameters permitting use of ~~the ability to use~~ said transaction code for a single transaction at a fixed amount for purchase within a predetermined period of time.

14. (Currently Amended): The method of claim 13 further comprising defining at least one of said plurality of payment categories to include parameters to limit purchases to said single transaction at said fixed amount for purchase within said predetermined period of time.

15. (Currently Amended): The method of claim 10 further comprising defining at least one of said plurality of payment categories to include ~~the ability to use~~ parameters

permitting use of said transaction code for a single transaction at a maximum amount for purchase within a predetermined period of time.

16. (Currently Amended): The method of claim 15 further comprising defining at least one of said plurality of payment categories to include ~~the ability to limit~~ parameters to limit purchases to said single transaction at said maximum amount for purchase within said predetermined period of time.

17. (Currently Amended): The method of claim 10 further comprising defining at least one of said plurality of payment categories to include ~~the ability to use~~ parameters permitting use of said transaction code for at least two purchases at a maximum total amount for items purchased within a predetermined time period.

18. (Currently Amended): The method of claim 17 further comprising defining at least one of said plurality of payment categories to include ~~the ability to limit~~ parameters to limit purchases to said at least two purchases at said maximum total amount for items purchased within said predetermined time period.

19. (Currently Amended): The method of claim 10 further comprising defining at least one of said plurality of payment categories to include ~~the ability to use~~ parameters

permitting use of said transaction code for at least two purchases for a repeating transaction at a fixed amount payable at each of a fixed number of time intervals.

20. (Currently Amended): The method of claim 19 further comprising defining at least one of said plurality of payment categories to include ~~the ability to limit~~ parameters to limit purchases to said repeating transaction at said fixed amount payable at each of said fixed number of time intervals.

21. (Currently Amended): The method of claim 10 further comprising defining at least one of said plurality of payment categories to include ~~the ability to use~~ parameters permitting use of said transaction code for a repeating transaction at a fixed amount payable at each of an unspecified number of time intervals.

22. (Currently Amended): The method of claim 21 further comprising defining at least one of said plurality of payment categories to include ~~the ability to limit~~ parameters to limit purchases to said repeating transaction at said fixed amount payable at each of said unspecified number of time intervals.

23. (Currently Amended): The method of claim 10 wherein ~~at least some of~~ said plurality of payment categories ~~further to~~ include at least one of the group consisting of:

a) ~~the ability to use~~ parameters permitting use of said transaction code for a single transaction at a fixed amount for a purchase within a predetermined period of time,

b) ~~the ability to use~~ parameters permitting use of said transaction code for a single transaction at a maximum amount for a purchase within a predetermined period of time,

c) ~~the ability to use~~ parameters permitting use of said transaction code for multiple transactions at a maximum total amount for purchases within a predetermined time period,

d) ~~the ability to use~~ parameters permitting use of said transaction code for a repeating transaction at a fixed amount for purchases payable at each of a fixed number of time intervals, and

e) ~~the ability to use~~ parameters permitting use of said transaction code for a repeating transaction at a fixed amount for purchases payable at each of an unspecified number of time intervals.

24. (Currently Amended): The method of claim 10 wherein ~~at least some of~~ said plurality of payment categories ~~further to~~ include at least one of the group consisting of:

a) ~~the ability to use~~ parameters permitting use of said transaction code for a single transaction at a fixed amount for a purchase,

b) ~~the ability to use~~ parameters permitting use of said transaction code for a single transaction at a maximum amount for a purchase,

c) ~~the ability to use~~ parameters permitting use of said transaction code for multiple transactions at a maximum total amount for purchases,

d) ~~the ability to use~~ parameters permitting use of said transaction code for a repeating transaction at a fixed amount for purchases payable at each of a fixed number of time intervals, and

e) ~~the ability to use~~ parameters permitting use of said transaction code for a repeating transaction at a fixed amount for purchases payable at each of an unspecified number of time intervals.

25. (Previously Presented): The method of claim 1 further comprising generating said transaction code to further reflect an identification of said single merchant.

26. (Currently Amended): The method of claim 25 further comprising defining said payment category to include ~~the ability to limit~~ limiting purchases to a limited time interval during which said purchase ~~authorization is permitted.~~ valid.

27. (Currently Amended) A method of performing secure credit card purchases, said method comprising:



a) identifying a pre-established account that ~~can be~~ is used to make credit card purchases;

b) designating at least one of a plurality of pre-defined payment categories which limit a nature of a subsequent purchases, at least one of said payment categories including ~~at least the ability to limit~~ limiting purchases to a single merchant, said single merchant limitation being included in said payment category prior to any particular merchant being identified as said single merchant;

c) generating a transaction code by a custodial authorizing entity of said pre-established account, said transaction code associated with at least said ~~credit card pre-established~~ pre-established account and the limits of said selected payment category, and different from said ~~credit card pre-established~~ pre-established account;

d) communicating said transaction code to a merchant to consummate a purchase within defined purchase parameters;

e) verifying that said defined purchase parameters correspond to said designated payment category; and

f) providing authorization for said purchase so as to confirm at least that said defined purchase parameters are within said designated payment category and to authorize payment required to complete the purchase; and

g) associating the purchase with said ~~credit card pre-established~~ pre-established account.

28. (Currently Amended): A method of performing secure credit card purchases, said method comprising:

a) identifying a pre-established account that ~~can be~~ is used to make credit card purchases;

b) selecting a predetermined payment category which limits a nature, of a series of subsequent purchases to a single merchant, said single merchant limitation being included in said payment category prior to any particular merchant being identified as said single merchant;

c) generating a transaction code by a custodial authorizing entity of said pre-established account, said transaction code associated with at least said ~~credit card pre-established~~ pre-established account and the limits of said selected payment category and different from said ~~credit card pre-established~~ pre-established account;

d) communicating said transaction code to a merchant to consummate a purchase within defined purchase parameters;

e) verifying that said defined purchase parameters correspond to said selected payment category;

f) providing authorization for said purchase so as to confirm at least that said defined purchase parameters are within said selected payment category and to authorize payment required to complete the purchase; and

g) associating the purchase with said ~~credit card pre-established~~ pre-established account.

29. (Previously Presented): The method of claim 28 wherein said step of selecting said payment category which limits said nature of said series of subsequent purchases to said single merchant further comprises limiting said nature of said series of subsequent purchases to a fixed amount for each of said subsequent purchases.

30. (Previously Presented): The method of claim 28 wherein said step of selecting said payment category which limits said nature of said series of subsequent purchases to said single merchant further comprises limiting said nature of said series of subsequent purchases to a maximum total amount for said subsequent purchases.

31. (Previously Presented): The method of claim 28 wherein said step of verifying that said defined purchase parameters correspond to said selected payment category further identifies said merchant as said single merchant.

32. (Currently Amended): A method of performing secure credit card purchases, said method comprising the steps of:

a) identifying a pre-established account that ~~can be~~ is used to make credit card purchases;

b) selecting a pre-determined payment category which limits a nature of a subsequent purchase to a single merchant, said single merchant limitation being included in said payment category prior to any particular merchant being identified as said single merchant;

c) generating a transaction code by a custodial authorizing entity of said pre-established account, said transaction code associated with at least said ~~credit card~~ pre-established account and the limits of said selected payment category, and different from said ~~credit card~~ pre-established account;

d) designating a merchant as said single merchant;

e) communicating said transaction code to said merchant to consummate a purchase within defined purchase parameters;

f) verifying that said defined purchase parameters correspond to said selected payment category;

g) providing authorization for said purchase so as to confirm at least that said defined purchase parameters are within said selected payment category and to authorize payment required to complete the purchase; and

h) associating the purchase with said ~~credit card~~ pre-established account.

33. (Previously Presented): The method of claim 32 wherein said step of verifying that said defined purchase parameters correspond to said selected payment category further identifies said merchant as said single merchant.

34. (Currently Amended): A system for performing secure credit card purchases comprising:

a) a custodial authorizing entity, said custodial authorizing entity structured to maintain a pre-established account that ~~can be~~ is used to make credit card purchases for at least one user;

b) said custodial authorizing entity further structured to define at least one payment category available for selection by a customer, said payment category structured to limit at least one subsequent transaction to a single merchant, said single merchant limitation being included in said payment category prior to any particular merchant being identified as said single merchant;

c) said custodial authorizing entity further structured to ~~issue~~ generate a transaction code associated with at least the limits of said payment category selected by the customer and said credit card account of the ~~issue~~ issuer, said transaction code being different from said ~~credit card~~ pre-established account;

d) said custodial authorizing entity further ~~structures~~ structured to receive said transaction code and designated purchase parameters associated with a purchase

from a merchant, and to verify that said designated purchase parameters correspond to said selected payment category; and

e) said custodial authorizing entity ~~structures~~ structured to provide the merchant with authorization for said purchase that confirms at least that said designated purchase parameters correspond to said selected payment category so that said purchase may be consummated by the merchant.

35. (Canceled):

36. (Previously Presented): A system for performing secure credit card purchases as recited in claim 34 wherein said custodial authorizing entity is structured to designate a first merchant to provide said transaction code for verification as said single merchant.

37. (Previously Presented): A system for performing secure credit card purchases as recited in claim 36 wherein said custodial authorizing entity is structured to designate said first merchant as said single merchant for subsequent transactions utilizing said transaction code.

38. (Previously Presented): A system for performing secure credit card purchases as recited in claim 34 wherein said payment category is further structured to limit said at least one subsequent transaction to a specified dollar amount.

39. (Previously Presented): A system for performing secure credit card purchases as recited in claim 38 wherein said payment category is further structured to limit each of a plurality of subsequent transactions to said specified dollar amount.

40. (Previously Presented): A system for performing secure credit card purchases as recited in claim 39 wherein said custodial authorizing entity is structured to designate a dollar amount of a first transaction associated with said transaction code and having said designated purchase parameters that correspond to remaining parameters of said selected payment category, as said specified dollar amount.

41. (Previously Presented): A system for performing secure credit card purchases as recited in claim 38 wherein said specified dollar amount is defined upon selection of said payment category and is associated with said transaction code.

42. (Previously Presented): A system for performing secure credit card purchases as recited in claim 34 wherein said payment category is further structured to limit said at least one subsequent transaction to a maximum dollar amount.

43. (Previously Presented): A system for performing secure credit card purchases as recited in claim 34 wherein said payment category is further structured to limit said at least one subsequent transaction to a predetermined time period.



## REMARKS

### **A. Status of the Claims**

Claims 1-43 are currently pending and stand rejected in this application. By the foregoing amendment, claims 1, 11-24, 26, 27, 28, 32 and 34 are amended, and claims 2, 5 and 35 are canceled without prejudice.

### **B. The Non-statutory Double Patenting Rejection is Overcome**

Claims 1-43 stand rejected on the ground of non-statutory double patenting over claims 1-16 of U.S. Pat. No. 6,324,526. This rejection is respectfully traversed.

A terminal disclaimer in compliance with 37 C.F.R. § 1.321(c) or 37 C.F.R. § 1.321(d) over U.S. Pat. No. 6,324,526 was timely filed in prior correspondence received by the Office on September 7, 2007. Accordingly, reconsideration and withdrawal of this rejection are respectfully requested. Should the Office maintain this rejection, the Applicant respectfully requests the Office to point out with specificity sufficient for a proper reply of why the terminal disclaimer filed September 7, 2007 does not overcome this rejection.

### **C. Claims 1-33 Are Directed Towards Statutory Subject Matter**

Claims 1-33 stand rejected under 35 U.S.C. § 101 as being directed to nonstatutory subject matter. This rejection is respectfully traversed.

The Office asserts the claimed method steps could simply be performed by mental process alone and are not statutory. This is not correct.

First, contrary to the Office's assertion, the claimed method cannot simply be performed by a mental process alone because the claimed method it is directly tied to systems utilized consummating purchases using purchasing accounts, i.e. purchasing cards. The claimed method involves banking and merchant infrastructures that include computing systems for maintaining and issuing purchasing cards, point of sale terminals, communication links between merchants, banking institutions, and consumers, etc. Clearly, the processes involved in issuing purchasing cards, maintaining purchasing accounts, and consummating purchases using purchasing cards cannot be performed by a mental process alone.

To further clarify the claimed method, by the forgoing amendment, claims 1-26 have been amended to recite generating a transaction code by said custodial authorizing entity, and claims 27-33 have been amended to recite generating a transaction code by a custodial authorizing entity. The specification describes a "custodial authorizing entity" as including sufficient facilities, preferably including a processing computer or the like applicable hardware for the generation of an exclusive transaction code. Specification at paragraph [013].

"The Supreme Court has defined the term "machine" as "a concrete thing,

consisting of parts, or of certain devices and combination of devices.” Burr v. Duryee, 68 U.S. (1 Wall.) 531, 570 (1863). This “includes every mechanical device or combination of mechanical powers and devices to perform some function and produce a certain effect or result.” Corning v. Burden, 56 U.S. 252, 267 (1853).” In re Nuijten, 500 F.3d 1346, 1355 (Fed. Cir. 2007). See also *Ex parte* PAUL FU et al., Appeal No. 2009-007405 (not binding precedent; copy enclosed) (Board reversed rejection premised on nonstatutory subject matter where the claimed process was tied to a network-based-market place).

For these reasons, the claimed method satisfies the machine prong of the *Bilski* Machine-or-Transformation test and the claimed method is statutory subject matter. Accordingly, reconsideration and withdrawal of this rejection are respectfully requested.

**D. Claims 34-43 Are Directed Towards Statutory Subject Matter**

Claims 34-43 stand rejected under 35 U.S.C. § 101 as being directed to nonstatutory subject matter. This rejection is respectfully traversed.

The Office asserts claim 34 does not recite structural components and the body of the claim is recited as method steps is at best directed towards software or programming code and deemed nonstatutory. Action at p. 6. This is not correct.

First, contrary to the Office’s assertion, claims 34-43 positively recite a “custodial authorizing entity”. The specification describes a “custodial authorizing entity” as including sufficient facilities, preferably including a processing computer or like

applicable hardware for the generation of an exclusive transaction code. Specification at paragraph [013].

As stated above, “The Supreme Court has defined the term “machine” as “a concrete thing, consisting of parts, or of certain devices and combination of devices.” *Burr v. Duryee*, 68 U.S. (1 Wall.) 531, 570 (1863). This “includes every mechanical device or combination of mechanical powers and devices to perform some function and produce a certain effect or result.” *Corning v. Burden*, 56 U.S. 252, 267 (1853).” In re *Nuijten*, 500 F.3d 1346, 1355 (Fed. Cir. 2007).

Accordingly, claims 34-43 are directed towards a system comprising a machine and are statutory subject matter under 35 U.S.C. § 101. Thus the 35 U.S.C. § 101 rejection of claims 34-43 is not proper, and the reconsideration and withdrawal of this rejection are respectfully requested.

In the event the Office maintains this rejection, the rejection is further improper for the following; While the test the Office articulates generally follows the *Bilski* Machine-or-Transformation test for determining whether a claimed process is statutory under § 101, the Office simply concluded that the claims do not pass the test. No claim construction analysis has been performed to determine whether the claims in fact fail to pass the test. Cf. *State St. Bank & Trust Co. v. Signature Fin. Group*, 149 F.3d 1368, 1370 (Fed. Cir. 1998) (“[W]hether the ... patent is invalid for failure to claim statutory subject matter under § 101[ ] is a matter of both claim construction and statutory

construction.”) Accordingly, the Office has failed to present a prima facie case that the claimed system is non-statutory under 35 U.S.C. § 101.

**E. The 35 U.S.C. § 112 Rejection of Claims 34-43 is Overcome**

Claims 34-43 stand rejected under 35 U.S.C. § 112, second paragraph, as being indefinite for failing to particularly point out and distinctly claim the subject matter which Applicant regards as the invention. This rejection is respectfully traversed.

The Office asserts the preamble of claim 34 recites “a system for performing secure credit card purchases”, and the body of the claim does not contain any limitations indicating the structure or the hardware the performs the function. Action at p. 6. The Applicant respectfully disagrees.

First, contrary to the Office’s assertion, claims 34-43 recite, *inter alia*, a “custodial authorizing entity”. The specification describes a “custodial authorizing entity” as including sufficient facilities, preferably including a processing computer or like applicable hardware for the generation of an exclusive transaction code. Specification at paragraph [013].

For at least this reason claims 34-43 recite structure and satisfy 35 U.S.C. § 112, second paragraph. MPEP 2173.02. Accordingly, reconsideration and withdrawal of this rejection are respectfully requested.

**F. Claims 1-43 are Nonobvious over Franklin et al., Yanagihara et al., and Langhans et al.**

Claims 1-43 stand rejected under 35 U.S.C. § 103(a) as being unpatentable over U.S. Pat. No. 6,000,832 to Franklin et al. (hereinafter Franklin et al.) in view of U.S. Pub. No. 2001/0011249 to Yanagihara et al. (hereinafter Yanagihara et al.) further in view of U.S. Pat. No. 5,500,513 to Langhans et al. (hereinafter Langhans et al.). This rejection is respectfully traversed.

**1. Claim 1**

Claim 1 recites, *inter alia*, defining a payment category including at least limiting purchases to a single merchant for at least one transaction, said single merchant limitation being included in said payment category prior to any particular merchant being identified as said single merchant (emphasis added).

The Office correctly notes Franklin et al. does not disclose the claim feature of said single merchant limitation being included in said payment category prior to any particular merchant being identified as said single merchant. The Office asserts Langhans et al. teaches said single merchant limitation being in said payment category prior to any particular merchant being identified as said single merchant, and states a merchant category code is identified prior to identifying any single merchant. The Office concludes it would have been obvious to one of ordinary skill in the art at the time the invention was made to allow said single merchant limitation being included in said

payment category prior to any particular merchant being identified as said single merchant of Franklin et al. because Langhans et al. teaches including above features would enable to control application of certain authorization parameters based on merchant category codes. Action at p. 9. The Applicant respectfully disagrees.

Initially, referring to Langhans et al., merchant category codes are disclosed as a subset of Standard Industrial Classification codes, plus some added codes, which are a standard used in the bank industry. Col. 7, lines 62-64. Related merchant category codes are organized into lists called merchant category code groups, which are assigned to purchasing accounts. Col. 12, lines 1-20. It is important to note here, a single “merchant category code” (Langhans et al., column 11, lines 65-67 to column 12, lines 1-7, cited by the Office) is not the same as a “single merchant”. But rather, a merchant category code is used to identify a type of merchant.

Referring to FIG. 10 and the related disclosure of Langhans et al., an authorization process for procurement is shown and described. Beginning at test 126 it is determined if an authorization request from a merchant includes a Standard Industrial Classification code of the merchant is acceptable for the account. At test 128 it is determined whether the merchant category code of the merchant is in an approved merchant category code. At test 130 it is determined whether the particular vendor (merchant) is on an approved vendor (merchant) list. Then, if the authorization request

passes test 130, at test 132 it is determined if the merchant category code of the merchant is listed in an assigned merchant category group.

Accordingly, Langhans et al. fails to teach or suggest the claimed feature of the single merchant limitation being included in said payment category prior to any particular merchant being identified as said single merchant. There is no disclosure in Langhans et al. that limits a transaction to a single merchant prior to any particular merchant being identified as the single merchant. In fact Langhans et al. teaches the exact opposite by cross checking that an authorization request received from a merchant is being received by a merchant that is has been placed on a previously approved merchant list.

Clearly Yanagihara et al. does not cure this deficiency as it is being cited solely to teach associating a transaction code with a payment category.

For these reasons, claim 1 and all of its dependents are patentable over Franklin et al., Langhans et al., and Yanagihara et al. The Office is respectfully requested to reconsider and withdraw the rejection.

### **3. Claim 3**

Claim 3 depends from claim 1 and recites further comprising the step of designating said single merchant subsequent to generating said transaction code.

The Office asserts Franklin et al. teaches this claimed feature. Action p.10. The Applicant respectfully disagrees.



Contrary to the Office's assertion and initially referring to FIG. 4 of Franklin et al., which the Office relies in making this assertion, there is shown a generation of a code number for using in making a purchase. More specifically, there is shown input parameters 68 that are entered to the MAC coding unit 58, which then computes a MAC or code number as a function of the private key, the transaction-specific data, and the customer-specific data. The MAC code here is being referenced by the Office to teach the instant "transaction code" as claimed. FIG. 4 does not teach the step of "designating said single merchant subsequent to generating said transaction code." With a thorough and complete review of Franklin et al., the Applicant cannot find any disclosure therein that teaches this step of designating said single merchant subsequent to generating said transaction code.

Thus, in addition to the reasons given above for claim 1, claim 3 is further is patentable over Franklin et al., Langhans et al., and Yanagihare et al. for these reasons.

#### **4. Claim 4**

Claim 4 depends from claim 1 and recites wherein said step of communicating the transaction code to said merchant to consummate said purchase within defined purchase parameters further comprises designation of said single merchant.

The Office asserts Franklin et al. teaches this claimed feature. Action p. 10. The Applicant respectfully disagrees.

Contrary to the Office's assertion, and as argued in a prior reply, any limitation to a particular merchant, as disclosed in Franklin et al., is based on the merchant being identified before the transaction code has been generated. In all cases in which Franklin et al. limits the transaction number with regard to the merchant, it is based on a particular merchant that has been identified prior to generating the substitute number. That is to say the merchant is identified along with other transactions specific data, the transaction number is then generated and reflects the identity of a merchant that has already been determined. Col. 5, lines 28-32, col. 9, lines 30-34, 40-44, 52-55, col. 10, lines 9-11. Moreover, the merchant limitation is not based on the fact that the merchant is a single merchant, but rather that the merchant is a particular (identified) merchant.

Thus, in addition to the reasons given above for claim 1, claim 4 is further is patentable over Franklin et al., Langhans et al., and Yanagihare et al. for these reasons.

**5. Claim 27**

Claim 27 recites the same claim feature of claim 1: said single merchant limitation being included in said payment category prior to any particular merchant being identified as said single merchant. Therefore, claim 27 is patentable for the same reasons as claim 1.

**6. Claim 28**

Claim 28 recites the same claim feature of claim 1: said single merchant limitation being included in said payment category prior to any particular merchant being identified as said single merchant. Therefore, claim 28 and its dependents are patentable for the same reasons as claim 1.

**7. Claim 31**

Claim 31 depends from claim 28 and recites wherein said step of verifying that said defined purchase parameters correspond to said selected payment category further identifies said merchant as said single merchant.

Claim 31, as in claim 4, specifies the single merchant being identified after the transaction code has been generated. Accordingly, claim 31 is patentable for the same reasons as claim 4.

**8. Claim 32**

Claim 32 recites the same claim feature of claim 1: said single merchant limitation being included in said payment category prior to any particular merchant being identified as said single merchant. Therefore, claim 32 and its dependents are patentable for the same reasons as claim 1.

**9. Claim 33**

Claim 33 depends from claim 32 and recites said step of verifying that said defined purchase parameters correspond to said selected payment category further identifies said merchant as said single merchant.

Claim 33, as in claim 4, specifies the single merchant being identified after the transaction code has been generated. Accordingly, claim 33 is patentable for the same reasons as claim 4.

**H. Clarifying Claim Amendments**

**1. Claim 1**

As previously presented, the contacting step recited “contacting a custodial authorizing entity having custodial responsibility of account parameters of a customer’s account that can be used to make credit card purchases.” The Applicant amended this step to clarify the customer’s account is an account that is used to make credit card purchases. Claims 27, 28, 32 and 34 are similarly amended.

As previously presented, the supplying step recited “supplying the custodial authorizing entity with at least account identification data.” The Applicant amended this step to clarify the at least account identification data to correspond to the customer’s account.

As previously presented, the generating step recited “generating a transaction code reflecting at least the limits of said designated payment category and the ability to make a purchase within said designated payment category.” The Applicant amended this step to clarify the transaction code being generated by the custodial authorizing entity and to clarify the transaction code reflecting at least the limits of said designated payment category to make a purchase within said designated payment category.

As previously presented, the providing authorization step recited “providing authorization for said purchase so as to confirm at least that said defined purchase parameters are within said designated payment category and complete the purchase.” The Applicant amended this step to clarify authorizing payment required to complete the purchase. Claims 27, 28 and 32 are similarly amended.

**2. Claim 11**

As previously presented, claim 11 recited “defining at least one of said plurality of payment categories to include the ability to designate amount parameters for a cost of one or more purchases.” The Applicant amended this claim to remove “the ability” language for clarity. Claims 12, 13, 15-22 are similarly amended.

Serial No: 11/252,009  
Docket No: 253.001  
December 10, 2009  
Page 31 of 31

**I. Conclusion**

In view of the foregoing, it is respectfully submitted that each of the pending claims is in condition for allowance, and a Notice of Allowance is earnestly solicited. The Examiner is invited to contact the undersigned at (727) 230-4949 with any questions, comments, or suggestions relating to the referenced patent application.

Respectfully submitted,  
Maxey Law Offices, PLLC

December 10, 2009  
Date: \_\_\_\_\_

/Stephen Lewellyn/

\_\_\_\_\_  
Stephen Lewellyn  
Registration No. 51,942  
13630 58th Street North, Suite 101  
Clearwater, Florida 33760  
Tel: 727-230-4949

UNITED STATES PATENT AND TRADEMARK OFFICE

-----  
BEFORE THE BOARD OF PATENT APPEALS  
AND INTERFERENCES  
-----

*Ex parte* PAUL FU,  
ERIK BECK HANSEN,  
GEORGE LIANG,  
DEBORAH LIU,  
NGAN-HA D. NGUYEN, and  
ANDREW LEIGH SANDLER

-----  
Appeal 2009-007405  
Application 10/882,633  
Technology Center 3600  
-----

Decided: November 4, 2009  
-----

Before HUBERT C. LORIN, JOSEPH A. FISCHETTI, and  
BIBHU R. MOHANTY, *Administrative Patent Judges*.

LORIN, *Administrative Patent Judge*.

DECISION ON APPEAL

### STATEMENT OF THE CASE

Paul Fu, et al. (Appellants) seek our review under 35 U.S.C. § 134 of the final rejection of claims 16-24 and 28. We have jurisdiction under 35 U.S.C. § 6(b) (2002).

### SUMMARY OF DECISION

We REVERSE.<sup>1</sup>

### THE INVENTION

The invention relates to commerce automation and, “in particular, to methods and systems to facilitate generation of invoices combining multiple transactions established utilizing a multi-seller network-based marketplace.” Specification [0002].

Claims 16-24 are directed to a method, claim 16 being the independent claim. Independent claim 28 is directed to a machine-readable medium. Claim 16, reproduced below, is illustrative of the subject matter on appeal.

16. A method to facilitate invoicing for transactions established between a plurality of buyers and a plurality of sellers in a network-based marketplace, the method including:

identifying a plurality of transactions to which a first user is a party;

---

<sup>1</sup> Our decision will make reference to the Appellants’ Appeal Brief (“App. Br.,” filed May 17, 2007) and Reply Brief (“Reply Br.,” filed Feb. 10, 2009), and the Examiner’s Answer (“Answer,” mailed Dec. 9, 2008).



Appeal 2009-007405  
Application 10/882,633

identifying one or more subsets of the plurality of transactions that satisfy combinable criteria relating to combining transactions into a single invoice; and

providing to the first user an indication of the combinability of transactions of the one or more subsets;

wherein the identification of the one or more subsets includes identifying each of the transactions of the one or more subsets as being between a common buyer and a common seller of the plurality of buyers and the plurality of sellers in the network-based marketplace.

#### THE REJECTIONS

The Examiner relies upon the following as evidence of unpatentability:

Hartman	US 6,615,226 B1	Sep. 2, 2003
Rotman	US 2003/0182222 A1	Sep. 25, 2003

The Examiner took Official Notice that “[i]t was old and well known in the art at the time of the invention to provide functionality to a user to easily make decisions/selections by use of an icon.” Answer 7.

The following rejections are before us for review:

1. Claims 16-24 are rejected under § 101 as being directed to nonstatutory subject matter.
2. Claims 16, 19, 21-24 and 28 are rejected under 35 U.S.C. §103(a) as being unpatentable over Rotman and Hartman.
3. Claims 17, 18, and 20 are rejected under 35 U.S.C. §103(a) as being unpatentable over Rotman, Hartman, and Official Notice.

## ISSUES

The issue of whether the Appellants have sustained their burden of showing that the Examiner erred in rejecting claims 16-24 under 35 U.S.C. § 101 as directed to non-statutory subject matter turns on whether the claims cover non-statutory subject matter, and specifically whether the process claimed is tied to a particular apparatus.

The issue of whether the Appellants have sustained their burden of showing that the Examiner erred in rejecting claims 16, 19, 21-24 and 28 and claims 17, 18, and 20 under 35 U.S.C. § 103(a) as unpatentable over Rotman and Hartman, and Rotman, Hartman, and Official Notice, respectively, turns on whether the cited prior art discloses or renders obvious the claimed invention having the step of “identifying one or more subsets of the plurality of transactions that satisfy combinable criteria relating to combining transactions into a single invoice.”

## FINDINGS OF FACT

We find that the following enumerated findings of fact (FF) are supported by at least a preponderance of the evidence. *Ethicon, Inc. v. Quigg*, 849 F.2d 1422, 1427 (Fed. Cir. 1988) (explaining the general evidentiary standard for proceedings before the Office).

### *The scope and content of the prior art*

1. Rotman relates to Rotman is directed to a method and system for improved online auctions. [0002]
2. In particular, Rotman seeks to improve communication between buyers and sellers about the real shipping costs for items being bid upon. [0006]-[0007]

3. To that end, Rotman describes a shipping calculator which can be included in a display of the item in auction. [0036]
4. Various features of the calculator to help give a buyer a more accurate estimate of the shipping cost are described. *E.g.*, [0038]
5. At [0063], referring to Fig. 14, Rotman describes steps by which a system applies a shipping rate to multiple items a buyer has purchased. Specifically, [0063] describes combining the multiple into a single shipment to which the shipping rate is applied.

6. [0063] of Rotman reads as follows:

[0063] In embodiments, the system can recognize when a given buyer has purchased multiple items from a given seller 102, and it can prompt the seller 102 to combine the items into a single shipment. The system 1000 can then apply the rate calculation to the combined shipment, rather than making separate calculations for all shipments. Thus, at a step 1404, the system determines whether there are multiple items at the step 1404, then at a step 1405 the system retrieves data for the first item's auction, either previously stored in the data storage facility 1020 (if a buyer 104 has used the calculator for this auction before) or by accessing the data in the auction directly, such as by a spider or API. At a step 1406 the system determines whether the item for which the data was retrieved at the step 1405 is the last item. If not, then the system returns to the step 1405 repeatedly until data for all items has been retrieved for use by the system. If at the step 1404 it is determined that there is only one item, or if at the step 1406 it is determined that the item is the last item, then processing proceeds to a step 1407.

7. Hartman relates to an online ordering system.

8. Fig. 1C of Hartman depicts a page with ordering information with indications that certain ordered items will be shipped together.  
*Any differences between the claimed subject matter and the prior art*
9. The prior art does not show the claim step of “identifying one or more subsets of the plurality of transactions that satisfy combinable criteria relating to combining transactions into a single invoice.”  
*The level of skill in the art*
10. Neither the Examiner nor the Appellants have addressed the level of ordinary skill in the pertinent art of facilitate invoicing for transactions. We will therefore consider the cited prior art as representative of the level of ordinary skill in the art. *See Okajima v. Bourdeau*, 261 F.3d 1350, 1355 (Fed. Cir. 2001) (“[T]he absence of specific findings on the level of skill in the art does not give rise to reversible error “where the prior art itself reflects an appropriate level and a need for testimony is not shown.”) (quoting *Litton Indus. Prods., Inc. v. Solid State Sys. Corp.*, 755 F.2d 158, 163 (Fed. Cir. 1985)).  
*Secondary considerations*
11. There is no evidence on record of secondary considerations of non-obviousness for our consideration.

#### PRINCIPLES OF LAW

##### *§ 101 - Patentable Subject Matter - Process*

[T]he proper inquiry under § 101 is not whether the process claim recites sufficient “physical steps,” but rather whether the claim meets the machine-or-transformation test. [fn]25 As a

Appeal 2009-007405  
Application 10/882,633

result, even a claim that recites “physical steps” but neither recites a particular machine or apparatus, nor transforms any article into a different state or thing, is not drawn to patent-eligible subject matter. Conversely, a claim that purportedly lacks any “physical steps” but is still tied to a machine or achieves an eligible transformation passes muster under § 101.

*In re Bilski*, 545 F.3d 943, 961 (Fed. Cir. 2008) (en banc).

*Obviousness*

Section 103 forbids issuance of a patent when ‘the differences between the subject matter sought to be patented and the prior art are such that the subject matter as a whole would have been obvious at the time the invention was made to a person having ordinary skill in the art to which said subject matter pertains.’

*KSR Int’l Co. v. Teleflex Inc.*, 550 U.S. 398, 406 (2007). The question of obviousness is resolved on the basis of underlying factual determinations including (1) the scope and content of the prior art, (2) any differences between the claimed subject matter and the prior art, and (3) the level of skill in the art. *Graham v. John Deere Co.*, 383 U.S. 1, 17-18 (1966). See also *KSR*, 550 U.S. at 407 (“While the sequence of these questions might be reordered in any particular case, the [*Graham*] factors continue to define the inquiry that controls.”) The Court in *Graham* further noted that evidence of secondary considerations “might be utilized to give light to the circumstances surrounding the origin of the subject matter sought to be patented.” *Graham*, 383 U.S. at 17-18.

#### ANALYSIS

*The rejection of claims 16-24 under § 101 as being directed to nonstatutory subject matter.*

According to the Examiner, the claims are directed to nonstatutory subject matter because the process claimed is neither (1) tied to another statutory class nor (2) transforms underlying subject matter to a different state of thing. Answer 6. The Appellants disagree, arguing that the claimed process is tied to a “network-based marketplace,” which the Appellants construe to be, for example, a machine - which is one of the statutory classes of subject matter. Reply Br. 1-2.

We will reverse the rejection because the Examiner has failed to present a prima facie case that the process claimed is nonstatutory under § 101. While the test the Examiner articulates generally follows the *Bilski* machine-or transformation test (*see supra*) for determining whether a claimed process is statutory under § 101, the Examiner simply concluded that the claims do not pass the test. No claim construction analysis has been performed to determine whether the claims in fact fail to pass the test. *Cf. State St. Bank & Trust Co. v. Signature Fin. Group*, 149 F.3d 1368, 1370 (Fed. Cir. 1998) (“[W]hether the ... patent is invalid for failure to claim statutory subject matter under § 101[ ] is a matter of both claim construction and statutory construction.”)

We would agree that the claimed process fails to pass the transformation prong of the *Bilski* machine-or transformation test. “A claimed process is patent-eligible if it transforms an article into a different state or thing. This transformation must be central to the purpose of the claimed process.” *Bilski*, 545 F.3d at 954. The claimed process does not transform an article into a different state or thing.

Appeal 2009-007405  
Application 10/882,633

However, the claimed process could be statutory if it passes the machine prong of the *Bilski* test. It would be satisfied if the claimed process is “tied to a particular machine.” *Bilski*, 545 F.3d at 954.

Here, the question is whether a network-based marketplace is a particular machine. It is recited in two places in independent claim 16 and the process is tied to it. The Specification illustrates the network-based marketplace in Fig. 1 and both in that Figure and the associated description (Specification [0021]), it is depicted and described in terms of a concrete thing comprising a combination of devices. It thus appears to be a machine. “The Supreme Court has defined the term “machine” as “a concrete thing, consisting of parts, or of certain devices and combination of devices.” *Burr v. Duryee*, 68 U.S. (1 Wall.) 531, 570 (1863). This “includes every mechanical device or combination of mechanical powers and devices to perform some function and produce a certain effect or result.” *Corning v. Burden*, 56 U.S. 252, 267 (1853).” *In re Nuijten*, 500 F.3d 1346, 1355 (Fed. Cir. 2007).

The Examiner has not explained why the claimed process, which is tied to a network-based marketplace and appears to be a machine, does not meet the machine prong of the *Bilski* test. Because that has not been done, the Examiner has failed to make out a prima facie case that the claimed process is not a statutory process under § 101.

*The rejection of claims 16, 19, 21-24 and 28 under 35 U.S.C. §103(a) as being unpatentable over Rotman and Hartman.*

The issue is whether the cited prior art discloses or renders obvious the claimed subject matter comprising the step of “identifying one or more

Appeal 2009-007405  
Application 10/882,633

subsets of the plurality of transactions that satisfy combinable criteria relating to combining transactions into a single invoice.”

The Examiner states that this step is disclosed at [0063] of Rotman. Answer 6.

We do not see in Rotman (FF 1-5) and in disclosure at [0063] (FF 6) in particular the claim step of, “identifying one or more subsets of the plurality of transactions that satisfy combinable criteria relating to combining transactions into a single invoice.” Rotman does not disclose or make obvious the claim requirement of satisfying combinable criteria relating to combining transactions into a single invoice. The disclosure at [0063] while it describes combining multiple items into a single shipment, it does so in order to apply a shipping rate to that single shipment without mention of combining the transactions into a single invoice and we do not find an explanation in the record accounting for this difference. We thus do not find that one of ordinary skill would arrive at the claimed subject matter given this information.

In response to the Appellants argument that the Rotman disclosure at [0063] does not disclose an invoice (App. Br. 11), the Examiner directs attention to Fig. 7 of Rotman which the Examiner characterizes as a summary of a bill and argues that a bill can be defined as an invoice. Whether Fig. 7 in fact depicts a bill is arguable. According to the associated description, Fig. 7 is a depiction of a page that displays a shipping calculator and shipping information and shipping cost/location choices a buyer can select. [0038]-[0039]. Nevertheless, even if we assume *arguendo* that this is a bill and the claim term “invoice” is reasonably broadly construed to cover a “bill” such as the one depicted in Fig. 7, the step at issue is still not



Appeal 2009-007405  
Application 10/882,633

disclosed. There is no disclosure of and the Examiner does not explain how one of ordinary skill would arrive at employing the claim step of, “identifying one or more subsets of the plurality of transactions that satisfy combinable criteria relating to combining transactions into a single invoice.” There is nothing in Fig. 7 or the associated description about, for instance, “identifying,” “subsets of the plurality of transactions,” “subsets of the plurality of transactions that satisfy combinable criteria,” or “subsets of the plurality of transactions that satisfy combinable criteria relating to combining transactions into a single invoice.”

We note that the Examiner cited Hartman as showing “providing an indication of the combinability of transactions of the one or more subsets (FIG 1C).” Answer 6. But the Examiner does not explain and we have been unable to determine from Fig. 1C (FF 8) that aspect of what is depicted are “subsets of the plurality of transactions that satisfy combinable criteria” (claim 16).

Accordingly, a prima facie case of obviousness for the claimed subject matter has not been established.

*The rejection of claims 17, 18, and 20 under 35 U.S.C. §103(a) as being unpatentable over Rotman, Hartman, and Official Notice.*

Claims 17, 18, and 20 depend from claim 16 whose rejection we reverse for the reasons stated above. For the same reasons, we will not sustain the rejections of claims 17, 18, and 20 over the cited prior art. *Cf. In re Fritch*, 972 F.2d 1260, 1266 (Fed. Cir. 1992) (“[D]ependent claims are nonobvious if the independent claims from which they depend are nonobvious.”).

Appeal 2009-007405  
Application 10/882,633

#### CONCLUSIONS

We conclude that the Appellants have shown that the Examiner erred in rejecting claims 16-24 under § 101 as being directed to nonstatutory subject matter; claims 16, 19, 21-24 and 28 under 35 U.S.C. §103(a) as being unpatentable over Rotman and Hartman; and, claims 17, 18, and 20 under 35 U.S.C. §103(a) as being unpatentable over Rotman, Hartman, and Official Notice.

#### DECISION

The decision of the Examiner to reject claims 16-24 and 28 is reversed.

REVERSED

mev

SCHWEGMAN, LUNDBERG & WOESSNER/EBAY  
P.O. BOX 2938  
MINNEAPOLIS MN 55402

## Electronic Patent Application Fee Transmittal

<b>Application Number:</b>	11252009			
<b>Filing Date:</b>	17-Oct-2005			
<b>Title of Invention:</b>	System and method for performing secure credit card purchases			
<b>First Named Inventor/Applicant Name:</b>	John D'Agostino			
<b>Filer:</b>	Stephen James Lewellyn			
<b>Attorney Docket Number:</b>				
Filed as Small Entity				
<b>Utility under 35 USC 111(a) Filing Fees</b>				
<b>Description</b>	<b>Fee Code</b>	<b>Quantity</b>	<b>Amount</b>	<b>Sub-Total in USD(\$)</b>
<b>Basic Filing:</b>				
<b>Pages:</b>				
<b>Claims:</b>				
<b>Miscellaneous-Filing:</b>				
<b>Petition:</b>				
<b>Patent-Appeals-and-Interference:</b>				
<b>Post-Allowance-and-Post-Issuance:</b>				
<b>Extension-of-Time:</b>				
Extension - 3 months with \$0 paid	2253	1	555	555

Description	Fee Code	Quantity	Amount	Sub-Total in USD(\$)
<b>Miscellaneous:</b>				
<b>Total in USD (\$)</b>				<b>555</b>

## Electronic Acknowledgement Receipt

<b>EFS ID:</b>	6609998
<b>Application Number:</b>	11252009
<b>International Application Number:</b>	
<b>Confirmation Number:</b>	4322
<b>Title of Invention:</b>	System and method for performing secure credit card purchases
<b>First Named Inventor/Applicant Name:</b>	John D'Agostino
<b>Correspondence Address:</b>	JOHN D'AGOSTINO - 5168 NORTHRIDGE ROAD #309 - SARASOTA FL 34238 US 3058588000 -
<b>Filer:</b>	Stephen James Lewellyn
<b>Filer Authorized By:</b>	
<b>Attorney Docket Number:</b>	
<b>Receipt Date:</b>	10-DEC-2009
<b>Filing Date:</b>	17-OCT-2005
<b>Time Stamp:</b>	13:47:02
<b>Application Type:</b>	Utility under 35 USC 111(a)

### Payment information:

Submitted with Payment	no
------------------------	----

### File Listing:

--	--

Document Number	Document Description	File Name	File Size(Bytes)/ Message Digest	Multi Part /.zip	Pages (if appl.)
1	Power of Attorney	253001_POA.pdf	191259 5d4226f1ca47c34b07749b3b686f68d40ca6b34	no	1
<b>Warnings:</b>					
<b>Information:</b>					
2	Extension of Time	253001_petition_time.pdf	63712 bd77c806e6b59619322918fd8f2725c943ca26392	no	1
<b>Warnings:</b>					
<b>Information:</b>					
3	Amendment/Req. Reconsideration-After Non-Final Reject	253001_response_v4.pdf	2869234 151dc4bd0a0b21b643b98c851fb6d6df52ba333	no	43
<b>Warnings:</b>					
<b>Information:</b>					
4	Fee Worksheet (PTO-875)	fee-info.pdf	29285 85389209410d1bb7d71fadbdbe0ec928b23cb1bf	no	2
<b>Warnings:</b>					
<b>Information:</b>					
<b>Total Files Size (in bytes):</b>			3153490		
<p><b>This Acknowledgement Receipt evidences receipt on the noted date by the USPTO of the indicated documents, characterized by the applicant, and including page counts, where applicable. It serves as evidence of receipt similar to a Post Card, as described in MPEP 503.</b></p> <p><b><u>New Applications Under 35 U.S.C. 111</u></b>  If a new application is being filed and the application includes the necessary components for a filing date (see 37 CFR 1.53(b)-(d) and MPEP 506), a Filing Receipt (37 CFR 1.54) will be issued in due course and the date shown on this Acknowledgement Receipt will establish the filing date of the application.</p> <p><b><u>National Stage of an International Application under 35 U.S.C. 371</u></b>  If a timely submission to enter the national stage of an international application is compliant with the conditions of 35 U.S.C. 371 and other applicable requirements a Form PCT/DO/EO/903 indicating acceptance of the application as a national stage submission under 35 U.S.C. 371 will be issued in addition to the Filing Receipt, in due course.</p> <p><b><u>New International Application Filed with the USPTO as a Receiving Office</u></b>  If a new international application is being filed and the international application includes the necessary components for an international filing date (see PCT Article 11 and MPEP 1810), a Notification of the International Application Number and of the International Filing Date (Form PCT/RO/105) will be issued in due course, subject to prescriptions concerning national security, and the date shown on this Acknowledgement Receipt will establish the international filing date of the application.</p>					

POWER OF ATTORNEY TO PROSECUTE APPLICATIONS BEFORE THE UNITED STATES  
PATENT AND TRADEMARK OFFICE

Inventor : John D'Agostino  
Serial No : 11/252,009  
Title : System And Method For Performing Secure Credit Card Purchases  
Filing Date : 10/17/2005  
Group/Art Unit : 3691  
Examiner : Shrestha, Bijendra K.  
Docket No. : 253.003

I hereby revoke all previous powers of attorney given in the above-identified application.

I hereby appoint Practitioner(s) associated with the Customer Number 34111, namely Brittany J. Mavey, Reg. No. 57,021 and Stephen J. Lowelijn, Reg. No. 51,942, at Maxey Law Offices, PLLC, 13630 58th Street North, Suite 101, Clearwater, Florida 33760-3734, telephone (727) 250-4949 as my/our attorney(s) or agent(s) to prosecute the application identified above, and to transact all business in the United States Patent and Trademark Office connected therewith.

Please recognize or change the correspondence address for the above-identified application to the address associated with Customer Number 34111.

I am the Applicant/Inventor

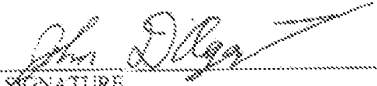
 12-10-09  
SIGNATURE DATE

John D'Agostino  
PRINTED NAME

(941) 238-1511  
TELEPHONE NUMBER

TOTAL NUMBER OF FORMS SUBMITTED HERewith 1

**IN THE UNITED STATES PATENT AND TRADEMARK OFFICE**

Inventor : John D'Agostino  
Serial No. : 11/252,009  
Title : SYSTEM AND METHOD FOR PERFORMING SECURE  
CREDIT CARD PURCHASES  
Filing Date : October 17, 2005  
Group/Art Unit : 3691  
Examiner : Shrestha, Bijendra K.  
Confirmation No. : 4322  
Docket No. : 253.001

---

**PETITION FOR EXTENSION OF TIME UNDER 37 CFR 1.136(a)**

Commissioner for Patents  
P.O. Box 1450  
Alexandria, VA 22313-1450

Dear Sir,

In accordance with the provisions of 37 C.F.R. § 1.136(a), it is respectfully requested that a **three-month** extension of time be granted in which to respond to the Non-final Office Action mailed 06/10/2009, said period of response being extended from 09/10/2009 to 12/10/2009 in the above-identified application. The appropriate petition fee under 37 CFR 1.17(a)(iii) is submitted herewith.

Respectfully submitted,  
Maxey Law Offices, PLLC

December 10, 2009  
Date: \_\_\_\_\_

/Stephen Lewellyn/  
\_\_\_\_\_  
Stephen Lewellyn  
Registration No. 51,942  
13630 58th Street North, Suite 101  
Clearwater, Florida 33760  
Tel: 727-230-4949



**IN THE UNITED STATES PATENT AND TRADEMARK OFFICE**

Inventor : John D'Agostino  
Serial No. : 11/252,009  
Title : SYSTEM AND METHOD FOR PERFORMING SECURE  
CREDIT CARD PURCHASES  
Filing Date : October 17, 2005  
Group/Art Unit : 3691  
Examiner : Shrestha, Bijendra K.  
Confirmation No. : 4322  
Docket No. : 253.001

---

**PETITION FOR EXTENSION OF TIME UNDER 37 CFR 1.136(a)**

Commissioner for Patents  
P.O. Box 1450  
Alexandria, VA 22313-1450

Dear Sir,

In accordance with the provisions of 37 C.F.R. § 1.136(a), it is respectfully requested that a **three-month** extension of time be granted in which to respond to the Non-final Office Action mailed 06/10/2009, said period of response being extended from 09/10/2009 to 12/10/2009 in the above-identified application. The appropriate petition fee under 37 CFR 1.17(a)(iii) is submitted herewith.

Respectfully submitted,  
Maxey Law Offices, PLLC

December 10, 2009  
Date: \_\_\_\_\_

/Stephen Lewellyn/

\_\_\_\_\_  
Stephen Lewellyn  
Registration No. 51,942  
13630 58th Street North, Suite 101  
Clearwater, Florida 33760  
Tel: 727-230-4949

## Electronic Patent Application Fee Transmittal

<b>Application Number:</b>	11252009			
<b>Filing Date:</b>	17-Oct-2005			
<b>Title of Invention:</b>	System and method for performing secure credit card purchases			
<b>First Named Inventor/Applicant Name:</b>	John D'Agostino			
<b>Filer:</b>	Stephen James Lewellyn			
<b>Attorney Docket Number:</b>				
Filed as Small Entity				
<b>Utility under 35 USC 111(a) Filing Fees</b>				
<b>Description</b>	<b>Fee Code</b>	<b>Quantity</b>	<b>Amount</b>	<b>Sub-Total in USD(\$)</b>
<b>Basic Filing:</b>				
<b>Pages:</b>				
<b>Claims:</b>				
<b>Miscellaneous-Filing:</b>				
<b>Petition:</b>				
<b>Patent-Appeals-and-Interference:</b>				
<b>Post-Allowance-and-Post-Issuance:</b>				
<b>Extension-of-Time:</b>				
Extension - 3 months with \$0 paid	2253	1	555	555

Description	Fee Code	Quantity	Amount	Sub-Total in USD(\$)
<b>Miscellaneous:</b>				
<b>Total in USD (\$)</b>				<b>555</b>

## Electronic Acknowledgement Receipt

<b>EFS ID:</b>	6610369
<b>Application Number:</b>	11252009
<b>International Application Number:</b>	
<b>Confirmation Number:</b>	4322
<b>Title of Invention:</b>	System and method for performing secure credit card purchases
<b>First Named Inventor/Applicant Name:</b>	John D'Agostino
<b>Correspondence Address:</b>	JOHN D'AGOSTINO - 5168 NORTHRIDGE ROAD #309 - SARASOTA FL 34238 US 3058588000 -
<b>Filer:</b>	Stephen James Lewellyn
<b>Filer Authorized By:</b>	
<b>Attorney Docket Number:</b>	
<b>Receipt Date:</b>	10-DEC-2009
<b>Filing Date:</b>	17-OCT-2005
<b>Time Stamp:</b>	14:12:07
<b>Application Type:</b>	Utility under 35 USC 111(a)

### Payment information:

Submitted with Payment	yes
Payment Type	Credit Card
Payment was successfully received in RAM	\$555

RAM confirmation Number	388
Deposit Account	
Authorized User	

**File Listing:**

Document Number	Document Description	File Name	File Size(Bytes)/ Message Digest	Multi Part /.zip	Pages (if appl.)
1	Extension of Time	253001_petition_time.pdf	63712 bd77c806e6b9619322918f8f82725c943ca 26392	no	1

**Warnings:**

**Information:**

2	Fee Worksheet (PTO-875)	fee-info.pdf	29285 1ac3053ff62358b77e256a3b8ee15a455d d765b	no	2
---	-------------------------	--------------	--	----	---

**Warnings:**

**Information:**

<b>Total Files Size (in bytes):</b>	92997
-------------------------------------	-------

This Acknowledgement Receipt evidences receipt on the noted date by the USPTO of the indicated documents, characterized by the applicant, and including page counts, where applicable. It serves as evidence of receipt similar to a Post Card, as described in MPEP 503.

**New Applications Under 35 U.S.C. 111**

If a new application is being filed and the application includes the necessary components for a filing date (see 37 CFR 1.53(b)-(d) and MPEP 506), a Filing Receipt (37 CFR 1.54) will be issued in due course and the date shown on this Acknowledgement Receipt will establish the filing date of the application.

**National Stage of an International Application under 35 U.S.C. 371**

If a timely submission to enter the national stage of an international application is compliant with the conditions of 35 U.S.C. 371 and other applicable requirements a Form PCT/DO/EO/903 indicating acceptance of the application as a national stage submission under 35 U.S.C. 371 will be issued in addition to the Filing Receipt, in due course.

**New International Application Filed with the USPTO as a Receiving Office**

If a new international application is being filed and the international application includes the necessary components for an international filing date (see PCT Article 11 and MPEP 1810), a Notification of the International Application Number and of the International Filing Date (Form PCT/RO/105) will be issued in due course, subject to prescriptions concerning national security, and the date shown on this Acknowledgement Receipt will establish the international filing date of the application.

Under the Paperwork Reduction Act of 1995, no persons are required to respond to a collection of information unless it displays a valid OMB control number.

<b>PATENT APPLICATION FEE DETERMINATION RECORD</b> Substitute for Form PTO-875					Application or Docket Number <b>11/252,009</b>		Filing Date <b>10/17/2005</b>		<input type="checkbox"/> To be Mailed			
<b>APPLICATION AS FILED – PART I</b>												
(Column 1)			(Column 2)			SMALL ENTITY <input checked="" type="checkbox"/>		OR			OTHER THAN SMALL ENTITY	
FOR		NUMBER FILED	NUMBER EXTRA		RATE (\$)	FEE (\$)	OR		RATE (\$)	FEE (\$)		
<input type="checkbox"/> BASIC FEE <small>(37 CFR 1.16(a), (b), or (c))</small>		N/A	N/A		N/A				N/A			
<input type="checkbox"/> SEARCH FEE <small>(37 CFR 1.16(k), (l), or (m))</small>		N/A	N/A		N/A		N/A					
<input type="checkbox"/> EXAMINATION FEE <small>(37 CFR 1.16(o), (p), or (q))</small>		N/A	N/A		N/A		N/A					
TOTAL CLAIMS <small>(37 CFR 1.16(i))</small>		minus 20 =	*		X \$ =		OR		X \$ =			
INDEPENDENT CLAIMS <small>(37 CFR 1.16(h))</small>		minus 3 =	*		X \$ =		OR		X \$ =			
<input type="checkbox"/> APPLICATION SIZE FEE <small>(37 CFR 1.16(s))</small>		If the specification and drawings exceed 100 sheets of paper, the application size fee due is \$250 (\$125 for small entity) for each additional 50 sheets or fraction thereof. See 35 U.S.C. 41(a)(1)(G) and 37 CFR 1.16(s).										
<input type="checkbox"/> MULTIPLE DEPENDENT CLAIM PRESENT <small>(37 CFR 1.16(j))</small>												
* If the difference in column 1 is less than zero, enter "0" in column 2.												
<b>APPLICATION AS AMENDED – PART II</b>					SMALL ENTITY		OR		OTHER THAN SMALL ENTITY			
(Column 1)			(Column 2)			(Column 3)						
AMENDMENT	<b>12/10/2009</b>	CLAIMS REMAINING AFTER AMENDMENT		HIGHEST NUMBER PREVIOUSLY PAID FOR	PRESENT EXTRA	RATE (\$)	ADDITIONAL FEE (\$)	OR		RATE (\$)	ADDITIONAL FEE (\$)	
	Total <small>(37 CFR 1.16(o))</small>	* 40	Minus	** 44	= 0	X \$26 =	0	OR		X \$ =		
	Independent <small>(37 CFR 1.16(h))</small>	* 5	Minus	***6	= 0	X \$110 =	0	OR		X \$ =		
	<input type="checkbox"/> Application Size Fee <small>(37 CFR 1.16(s))</small>											
	<input type="checkbox"/> FIRST PRESENTATION OF MULTIPLE DEPENDENT CLAIM <small>(37 CFR 1.16(j))</small>											
						TOTAL ADD'L FEE	<b>0</b>	OR		TOTAL ADD'L FEE		
AMENDMENT		CLAIMS REMAINING AFTER AMENDMENT		HIGHEST NUMBER PREVIOUSLY PAID FOR	PRESENT EXTRA	RATE (\$)	ADDITIONAL FEE (\$)	OR		RATE (\$)	ADDITIONAL FEE (\$)	
	Total <small>(37 CFR 1.16(o))</small>	*	Minus	**	=	X \$ =		OR		X \$ =		
	Independent <small>(37 CFR 1.16(h))</small>	*	Minus	***	=	X \$ =		OR		X \$ =		
	<input type="checkbox"/> Application Size Fee <small>(37 CFR 1.16(s))</small>											
	<input type="checkbox"/> FIRST PRESENTATION OF MULTIPLE DEPENDENT CLAIM <small>(37 CFR 1.16(j))</small>											
						TOTAL ADD'L FEE		OR		TOTAL ADD'L FEE		
* If the entry in column 1 is less than the entry in column 2, write "0" in column 3.												
** If the "Highest Number Previously Paid For" IN THIS SPACE is less than 20, enter "20".												
*** If the "Highest Number Previously Paid For" IN THIS SPACE is less than 3, enter "3".												
The "Highest Number Previously Paid For" (Total or Independent) is the highest number found in the appropriate box in column 1.												

Legal Instrument Examiner:  
/CRYSTAL QUEEN/

This collection of information is required by 37 CFR 1.16. The information is required to obtain or retain a benefit by the public which is to file (and by the USPTO to process) an application. Confidentiality is governed by 35 U.S.C. 122 and 37 CFR 1.14. This collection is estimated to take 12 minutes to complete, including gathering, preparing, and submitting the completed application form to the USPTO. Time will vary depending upon the individual case. Any comments on the amount of time you require to complete this form and/or suggestions for reducing this burden, should be sent to the Chief Information Officer, U.S. Patent and Trademark Office, U.S. Department of Commerce, P.O. Box 1450, Alexandria, VA 22313-1450. DO NOT SEND FEES OR COMPLETED FORMS TO THIS ADDRESS. SEND TO: Commissioner for Patents, P.O. Box 1450, Alexandria, VA 22313-1450.

If you need assistance in completing the form, call 1-800-PTO-9199 and select option 2.



UNITED STATES PATENT AND TRADEMARK OFFICE

UNITED STATES DEPARTMENT OF COMMERCE  
United States Patent and Trademark Office  
Address: COMMISSIONER FOR PATENTS  
P.O. Box 1450  
Alexandria, Virginia 22313-1450  
www.uspto.gov

APPLICATION NO.	FILING DATE	FIRST NAMED INVENTOR	ATTORNEY DOCKET NO.	CONFIRMATION NO.
-----------------	-------------	----------------------	---------------------	------------------

11/252,009      10/17/2005      John D'Agostino      4322

<sup>7590</sup>  
JOHN D'AGOSTINO  
5168 NORTHRIDGE ROAD #309  
SARASOTA, FL 34238

06/10/2009

EXAMINER
----------

SHRESTHA, BIENDRA K

ART UNIT	PAPER NUMBER
----------	--------------

3691

MAIL DATE	DELIVERY MODE
-----------	---------------

06/10/2009

PAPER

**Please find below and/or attached an Office communication concerning this application or proceeding.**

The time period for reply, if any, is set in the attached communication.

<b>Office Action Summary</b>	<b>Application No.</b> 11/252,009	<b>Applicant(s)</b> D'AGOSTINO, JOHN	
	<b>Examiner</b> BIJENDRA K. SHRESTHA	<b>Art Unit</b> 3691	

**-- The MAILING DATE of this communication appears on the cover sheet with the correspondence address --**  
**Period for Reply**

A SHORTENED STATUTORY PERIOD FOR REPLY IS SET TO EXPIRE 3 MONTH(S) OR THIRTY (30) DAYS, WHICHEVER IS LONGER, FROM THE MAILING DATE OF THIS COMMUNICATION.

- Extensions of time may be available under the provisions of 37 CFR 1.136(a). In no event, however, may a reply be timely filed after SIX (6) MONTHS from the mailing date of this communication.
- If NO period for reply is specified above, the maximum statutory period will apply and will expire SIX (6) MONTHS from the mailing date of this communication.
- Failure to reply within the set or extended period for reply will, by statute, cause the application to become ABANDONED (35 U.S.C. § 133). Any reply received by the Office later than three months after the mailing date of this communication, even if timely filed, may reduce any earned patent term adjustment. See 37 CFR 1.704(b).

**Status**

- 1)  Responsive to communication(s) filed on 19 May 2009.
- 2a)  This action is **FINAL**.                      2b)  This action is non-final.
- 3)  Since this application is in condition for allowance except for formal matters, prosecution as to the merits is closed in accordance with the practice under *Ex parte Quayle*, 1935 C.D. 11, 453 O.G. 213.

**Disposition of Claims**

- 4)  Claim(s) 1-43 is/are pending in the application.
  - 4a) Of the above claim(s) \_\_\_\_\_ is/are withdrawn from consideration.
- 5)  Claim(s) \_\_\_\_\_ is/are allowed.
- 6)  Claim(s) 1-43 is/are rejected.
- 7)  Claim(s) \_\_\_\_\_ is/are objected to.
- 8)  Claim(s) \_\_\_\_\_ are subject to restriction and/or election requirement.

**Application Papers**

- 9)  The specification is objected to by the Examiner.
- 10)  The drawing(s) filed on \_\_\_\_\_ is/are: a)  accepted or b)  objected to by the Examiner.  
 Applicant may not request that any objection to the drawing(s) be held in abeyance. See 37 CFR 1.85(a).  
 Replacement drawing sheet(s) including the correction is required if the drawing(s) is objected to. See 37 CFR 1.121(d).
- 11)  The oath or declaration is objected to by the Examiner. Note the attached Office Action or form PTO-152.

**Priority under 35 U.S.C. § 119**

- 12)  Acknowledgment is made of a claim for foreign priority under 35 U.S.C. § 119(a)-(d) or (f).
    - a)  All    b)  Some \*    c)  None of:
    - 1.  Certified copies of the priority documents have been received.
    - 2.  Certified copies of the priority documents have been received in Application No. \_\_\_\_\_.
    - 3.  Copies of the certified copies of the priority documents have been received in this National Stage application from the International Bureau (PCT Rule 17.2(a)).
- \* See the attached detailed Office action for a list of the certified copies not received.

**Attachment(s)**

- 1)  Notice of References Cited (PTO-892)
- 2)  Notice of Draftsperson's Patent Drawing Review (PTO-948)
- 3)  Information Disclosure Statement(s) (PTO/SB/08)  
 Paper No(s)/Mail Date \_\_\_\_\_.
- 4)  Interview Summary (PTO-413)  
 Paper No(s)/Mail Date. \_\_\_\_\_.
- 5)  Notice of Informal Patent Application
- 6)  Other: \_\_\_\_\_.



### **DETAILED ACTION**

This Non-Final Office action is in response to the action filed on May 19, 2009.  
Claims 1-43 are pending.

#### ***Continued Examination Under 37 CFR 1.114***

A request for continued examination under 37 CFR 1.114, including the fee set forth in 37 CFR 1.17(e), was filed in this application after final rejection. Since this application is eligible for continued examination under 37 CFR 1.114, and the fee set forth in 37 CFR 1.17(e) has been timely paid, the finality of the previous Office action has been withdrawn pursuant to 37 CFR 1.114. Applicant's submission filed on 05/19/2009 has been entered.

#### ***Priority***

Acknowledgment is made that this application is a Continuation of application # 10/ 037,007 ABN which is CIP of 09/231,745 filed on 01/15/1999 which is now patented (U.S. Patent No. 6,324,526).

#### ***Information Disclosure Statement***

Applicant is respectfully requested to cite the references relevant to the instant application so that the Examiner can review it in limited available time.

#### ***Double Patenting***

The nonstatutory double patenting rejection is based on a judicially created doctrine grounded in public policy (a policy reflected in the statute) so as to prevent the unjustified or improper timewise extension of the "right to exclude"

Art Unit: 3691

granted by a patent and to prevent possible harassment by multiple assignees. A nonstatutory obviousness-type double patenting rejection is appropriate where the conflicting claims are not identical, but at least one examined application claim is not patentably distinct from the reference claim(s) because the examined application claim is either anticipated by, or would have been obvious over, the reference claim(s). See, e.g., *In re Berg*, 140 F.3d 1428, 46 USPQ2d 1226 (Fed. Cir. 1998); *In re Goodman*, 11 F.3d 1046, 29 USPQ2d 2010 (Fed. Cir. 1993); *In re Longi*, 759 F.2d 887, 225 USPQ 645 (Fed. Cir. 1985); *In re Van Ornum*, 686 F.2d 937, 214 USPQ 761 (CCPA 1982); *In re Vogel*, 422 F.2d 438, 164 USPQ 619 (CCPA 1970); and *In re Thorington*, 418 F.2d 528, 163 USPQ 644 (CCPA 1969).

A timely filed terminal disclaimer in compliance with 37 CFR 1.321(c) or 1.321(d) may be used to overcome an actual or provisional rejection based on a nonstatutory double patenting ground provided the conflicting application or patent either is shown to be commonly owned with this application, or claims an invention made as a result of activities undertaken within the scope of a joint research agreement.

Effective January 1, 1994, a registered attorney or agent of record may sign a terminal disclaimer. A terminal disclaimer signed by the assignee must fully comply with 37 CFR 3.73(b).

Claims 1-43 are rejected on the ground of nonstatutory double patenting over claims 1-16 of U. S. Patent No. 6,324,526 since the claims, if allowed, would improperly extend the "right to exclude" already granted in the patent.

The subject matter claimed in the instant application is fully disclosed in the independent claims 1 and 16 of the patent and is covered by the patent since the patent and the application are claiming common subject matter, as follows:

*A method of performing secure credit card purchases, said method comprising steps of :*

*a) contacting a custodial authorizing entity having custodial responsibility of account parameters of customer's account that can be used to make credit card*

*purchases;*

*b) supplying the custodial authorizing entity with at least account identification data;*

*c) defining a payment category;*

*d) designating said payment category;*

*e) generating a transaction code reflecting at least the limits of said designated payment category and the ability to make a purchase within said designated payment category;*

*f) communicating the transaction code to a merchant to consummate a purchase with defined purchase parameters;*

*g) verifying that said defined purchase parameters are within said designated payment category; and*

*h) providing authorization for said purchase so as to confirm at least that said defined purchase parameters are within said designated payment category and complete the purchase.*

Furthermore, there is no apparent reason why applicant was prevented from presenting claims corresponding to those of the instant application during prosecution of the application which matured into a patent. See *In re Schneller*, 397 F.2d 350, 158 USPQ 210 (CCPA 1968). See also MPEP § 804.

### ***Claim Rejections - 35 USC § 101***

1. 35 U.S.C. 101 reads as follows:

Whoever invents or discovers any new and useful process, machine, manufacture, or composition of matter, or any new and useful improvement thereof, may obtain a patent therefor, subject to the conditions and requirements of this title.

2. Claims 1-33 are rejected under 35 U.S.C. 101 because the claimed invention is directed to non-statutory subject matter.

Regarding claims 1-33, as best understood, it appears that the claimed method steps could simply be performed by mental process alone and are not statutory.

Claims 1-33 are directed towards steps of “contacting”, “supplying”, “defining”, “designating”, “generating”, “communicating”, “verifying” and “providing” etc. Since the claims are directed to a process without including another machine, these claims fall within the scope of human intelligence alone, and are non-statutory.

Based on Supreme Court precedent and recent Federal Circuit decisions, a 35 U.S.C § 101 process must (1) be tied to a particular machine or (2) transform underlying subject matter (such as an article or materials) to a different state or thing. In re Bilski et al, 88 USPQ 2d 1385 CAFC (2008); Diamond v. Diehr, 450 U.S. 175, 184 (1981); Parker v. Flook, 437 U.S. 584, 588 n.9 (1978); Gottschalk v. Benson, 409 U.S. 63, 70 (1972); Cochrane v. Deener, 94 U.S. 780,787-88 (1876).

An example of a method claim that would not qualify as a statutory process would be a claim that recited purely mental steps. Thus, to qualify as a § 101 statutory process, the claim should positively recite the particular machine to which it is tied, for example by identifying the apparatus that accomplishes the method steps, or positively recite the subject matter that is being transformed, for example by identifying the material that is being changed to a different state.

Here, Applicant’s method steps are not tied to a particular machine and do not perform a transformation. Thus, the claims are non-statutory.

The mere recitation of the machine in the preamble with an absence of a machine in the body of the claim fails to make the claim statutory under 35 USC 101.

*Note the Board of Patent Appeals Informative Opinion Ex parte Langemyer et al.*

3. Claims 34-43 are rejected under 35 U.S.C. 101 because the claimed invention is directed to non-statutory subject matter.

As per claims 34-43, the system claim 34, in particular, fails to recite any structural components and body of the claim is recited as a method steps. Therefore, they are at best directed to software or programming code and deemed non-statutory.

***Claim Rejections - 35 USC § 112***

4. The following is a quotation of the second paragraph of 35 U.S.C. 112:

The specification shall conclude with one or more claims particularly pointing out and distinctly claiming the subject matter which the applicant regards as his invention.

5. Claims 34-43 are rejected under 35 U.S.C. § 112, second paragraph, as being indefinite for failing to particularly point out and distinctly claim the subject matter which applicant regards as the invention.

In particular, claim 34 recites in the preamble “a system for performing secure credit card purchases”, the body of the claim does not contain any limitations indicating the structure of the system. A system or an apparatus claim should always claim the structure or the hardware that performs the function.

Applicant’s claimed limitations consists system claim with a body of claim written as set of method steps for carrying out the process. It is not clear the if the claim is method or a system. Appropriate correction is required.

Examiner interpreted the claims 34-43 as a method claim for the prosecution of the application.

***Claim Rejections - 35 USC § 103***

6. The following is a quotation of 35 U.S.C. 103(a) which forms the basis for all obviousness rejections set forth in this Office action:

(a) A patent may not be obtained though the invention is not identically disclosed or described as set forth in section 102 of this title, if the differences between the subject matter sought to be patented and the prior art are such that the subject matter as a whole would have been obvious at the time the invention was made to a person having ordinary skill in the art to which said subject matter pertains. Patentability shall not be negatived by the manner in which the invention was made.

7. Claims 1-43 are rejected under 35 U.S.C. 103(a) as being unpatentable over Franklin et al., U.S. Patent No. 6,000,832 (reference A in attached PTO-892) in view of Yanagihara et al. U.S. Pub No. 2001/0011249 (reference B in attached PTO-892) further in view of Langhans et al., U.S. Patent No. 5,500,513 (reference C in attached PTO-892).

8. As per claim 1, Franklin et al. teach a method of performing secure credit card purchases, said method comprising:

a) contacting a custodial authorizing entity having custodial responsibility of account parameters of customer's account that can be used to make credit card purchases (see Fig. 1; Issuing Bank (26) connected to customer (22) and merchant (24) connected by Internet (34); column 4, lines 3-9; where commerce card is issued by credit card companies or card sponsoring companies);

b) supplying the custodial authorizing entity with at least account identification data (see Fig. 4; Fig. 7);

c) defining a payment category including at least the ability to limit purchases to a single merchant for at least one transaction (see column 9, lines 52-55); where code specific to a merchant is generated by the software supplied by the issuing bank installed on customer computer as described in column 2, lines 18-37) ;

d) designating said payment category thereby designating at least that a transaction code generated in accordance with said payment category can be used by only one merchant (see column 2, lines 27-37; where code generated include merchant ID);

e) generating a transaction code reflecting at least the limits of said designated payment category and the ability to make a purchase within said designated payment category (see Fig. 4-6; column 10, lines 44-65);

f) communicating the transaction code to a merchant to consummate a purchase with defined purchase parameters (see Fig. 3; column 5, lines 41-58);

g) verifying that said defined purchase parameters are within said designated payment category (see column 5, lines 59-67 to column 6, lines 1-12); and

h) providing authorization for said purchase so as to confirm at least that said defined purchase parameters are within said designated payment category and complete the purchase (see column 12, lines 27-43).

Franklin et al. teach generating a transaction code with transaction specific data (see Fig. 4; Transaction Specific Data which include good identification; column 9, lines 40-43) and but do not teach predefining and associating with the payment categories.

Yanagihara et al. teach predefining and associating the transaction code with the payment categories (see Fig. 2: Fig. 4; paragraph [0019])

Therefore, it would be obvious to one of ordinary skill in the art at the time the invention was made to allow predefining and associating the transaction code with the payment categories of Franklin et al. because Yanagihara et al. teach that including above features would enable user to use usage identification code which indicates purpose of use and usage limit to indicate maximum amount to withdraw (Yanagihara et al., paragraph [0019]).

Franklin et al. do not teach said single merchant limitation being included in said payment category prior to any particular merchant being identified as said single merchant.

Langhans et al. teach said single merchant limitation being included in said payment category prior to any particular merchant being identified as said single merchant (Langhans et al., column 11, lines 65-67 to column 12, lines 1-7; where merchant category code is identified prior to identifying any single merchant).

Therefore, it would be obvious to one of ordinary skill in the art at the time the invention was made to allow said single merchant limitation being included in said payment category prior to any particular merchant being identified as said single merchant of Franklin et al. because Laghans et al. teach that including above features would enable to control application of certain authorization parameters based merchant category codes (Laghans et al., column 12, lines 20-23).



9. As per claim 2, Franklin et al. in view of Yanagihara et al. further in view of Langhans et al. teach claim 1 as described above. Franklin et al. further teaches the method comprising

identification of said single merchant upon designation of said payment category (see column 9, lines 40-43; where merchant identification identify the merchant).

10. As per claim 3, Franklin et al. in view of Yanagihara et al. further in view of Langhans et al. teach claim 1 as described above. Franklin et al. further teaches the method comprising

step of designating said single merchant subsequent to generating said transaction code (see Fig. 4; transaction specific data that include merchant identification).

11. As per claim 4, Franklin et al. in view of Yanagihara et al. further in view of Langhans et al. teach claim 1 as described above. Franklin et al. further teaches the method wherein

step of communicating the transaction code to said merchant to consummate said purchase within defined purchase parameters further comprises designation of said single merchant (see Fig. 4; column 9, lines 18-30; column 49-58).

12. As per claim 5, Franklin et al. in view of Yanagihara et al. further in view of Langhans et al. teach claim 1 as described above. Franklin et al. further teaches the method wherein

said step of generating said transaction code further comprises said custodial authorizing entity generating said transaction code (see column 3, lines 29-36; 40-45).

13. As per claim 6, Franklin et al. in view of Yanagihara et al. further in view of Langhans et al. teach claim 1 as described above. Franklin et al. further teaches the method wherein

said step of generating said transaction code further comprises said customer generating said transaction code (see column 3, lines 21-37).

14. As per claim 7, Franklin et al. in view of Yanagihara et al. further in view of Langhans et al. teach claim 1 as described above. Franklin et al. further teaches the method comprising

obtaining said authorization for said purchase from the custodial authorizing entity (see column 5, lines 59—67).

15. As per claim 8, Franklin et al. in view of Yanagihara et al. further in view of Langhans et al. further in view of Langhans et al. teach claim 1 as described above. Franklin et al. further teaches the method comprising

a step of communicating promotional information of offered subject matter to the customer by the merchant, pre-determining the purchase parameters of the purchase, and corresponding said designated payment category to said purchase parameters (see column 9, lines 12-30; where customer surf the web for purchasing; Examiner notes that customer have access to promotional information of the offered subject matter in the web or merchant website).

16. As per claim 9, Franklin et al. in view of Yanagihara et al. further in view of Langhans et al. teach claim 1 as described above. Franklin et al. further teaches the method comprising

the merchant communicating the transaction code to the custodial authorizing entity for verification (see Fig. 7).

17. As per claims 10-14, Franklin et al. in view of Yanagihara et al. further in view of Langhans et al. teach claim 1 as described above.

Franklin et al. further teach the method comprising generating a transaction code which reflects at least one of a plurality of said payment categories that include the ability to designate amount parameters for a cost of one or more purchases, ability to designate time parameters during which the purchase can be completed, ability to use said transaction code for a single transaction at a fixed amount for purchase within a predetermined period of time, ability to limit purchases to said single transaction at said fixed amount for purchase within said predetermined period of time (see Fig.4, column 2, lines 30-32; column 9, lines 49-58; column 10, lines 52-65).

18. As per claims 15-24, Franklin et al. in view of Yanagihara et al. further in view of Langhans et al. teach claim 10 as described above.

Franklin et al. do not teach a) the ability to use said transaction code for a single transaction at a fixed or maximum amount for a purchase within a predetermined period of time, c) the ability to use said transaction code for multiple transactions at a fixed or maximum total amount for purchases within a predetermined time period, d) the ability to use said transaction code for a repeating transaction at a fixed amount for purchases

payable at each of a fixed number of time intervals, and e) the ability to use said transaction code for a repeating transaction at a fixed amount for purchases payable at each of an unspecified number of time intervals.

Yanagihara et al. teach storing a restrictive condition for withdrawal of amount from the money card and application of the predetermined condition during withdrawal of the money from the card ( Yanagihara et al., Fig. 2, Payment Condition (209) and Transaction Record (210); paragraph [0005], [0006] and 0019]; the Examiner notes any above preconditions in claims 5-15 and 19-26 can be set in Payment Condition (209) in Fig. 2).

Therefore, it would be prima facie obvious to one of ordinary skill in the art at the time the invention was made to allow storing a restrictive condition for withdrawal of amount from the money card and application of the predetermined condition during withdrawal of the money from the card of Franklin et al. because Yanagihara et al. teach that including above features would enable user to use usage identification code which indicates purpose of use (Yanagihara et al., paragraph [0019]).

19. As per claim 25, Franklin et al. in view of Yanagihara et al. further in view of Langhans et al. teach claim 1 as described above.

Franklin et al. further teaches the method comprising generating said transaction code to further reflect an identification of said single merchant (see Fig. 4, column 9, lines 43, 52-55).

20. As per claim 26, Franklin et al. in view of Yanagihara et al. further in view of Langhans et al. teach claim 25 as described above. Franklin et al. further teaches the

method defining said payment category to include the ability to limit purchases to a limited time interval during which said purchase authorization is valid column 10, lines 52-65).

21. As per claim 27-28, Franklin et al. teach a method of performing secure credit card purchases, said method comprising

a) identifying a pre-established account that can be used to make credit card purchases; b) designating at least one of a plurality payment categories which limit a nature of a subsequent purchases, at least one of said payment categories including at least the ability to limit purchases to a single merchant (see column 2, lines 9-21; column 4, lines 3-9; where commerce card is issued by credit card companies or card sponsoring companies; column 9, lines 49-58; where code number include merchant specific code for particular merchant);

c) generating a transaction code associated with at least said credit card account and the limits of said selected payment category, and different from said credit card account (see Fig. 4, column 2, lines 22-35);

d) communicating said transaction code to a merchant to consummate a purchase within defined purchase parameters (see column 2, lines 35-38);

e) verifying that said defined purchase parameters correspond to said designated payment category (see column 2, lines 47-64); and

f) providing authorization for said purchase so as to confirm at least that said defined purchase parameters are within said designated payment category and complete the purchase (see column 2, lines 65-67 to column 3, lines 1-6); and

g) associating the purchase with said credit card account (see column 12, lines 34-43).

Franklin teaches generating a transaction code with transaction specific data (see Fig. 4; Transaction Specific Data which include good identification; column 9, lines 40-43) and but do not teach predefining and associating with the payment categories.

Yanagihara et al. teach predefining and associating the transaction code with the payment categories (see Fig. 2; Fig. 4; paragraph [0019])

Therefore, it would be obvious to one of ordinary skill in the art at the time the invention was made to allow predefining and associating the transaction code with the payment categories of Franklin et al. because Yanagihara et al. teach that including above features would enable user to use usage identification code which indicates purpose of use and usage limit to indicate maximum amount to withdraw (Yanagihara et al., paragraph [0019]).

Franklin et al. do not teach said single merchant limitation being included in said payment category prior to any particular merchant being identified as said single merchant.

Langhans et al. teach said single merchant limitation being included in said payment category prior to any particular merchant being identified as said single

merchant (Langhans et al., column 11, lines 65-67 to column 12, lines 1-7; where merchant category code is identified prior to identifying any single merchant).

Therefore, it would be obvious to one of ordinary skill in the art at the time the invention was made to allow said single merchant limitation being included in said payment category prior to any particular merchant being identified as said single merchant of Franklin et al. because Laghans et al. teach that including above features would enable to control application of certain authorization parameters based merchant category codes (Laghans et al., column 12, lines 20-23).

22. As per claims 29-30, Franklin et al. in view of Yanagihara et al. further in view of Langhans et al. teach claim 28 as described above.

Franklin et al. do not teach restriction on purchases based on pre-selected payment categories.

Yanagihara et al. teach restriction on purchases based on payment categories such that it limits nature of subsequent purchases in terms of amount (Yanagihara, paragraphs [0006], [0021]).

Therefore, it would be prima facie obvious to one of ordinary skill in the art at the time the invention was made to allow storing a restrictive condition for withdrawal of amount from the money card and application of the predetermined condition during withdrawal of the money from the card of Franklin et al. because Yanagihara et al. teach that including above features would enable user to use usage identification code which indicates purpose of use (Yanagihara et al., paragraph [0019]).

23. As per claim 31, Franklin et al. in view of Yanagihara et al. further in view of Langhans et al. teach claim 28 as described above. Franklin et al. further teaches the method wherein

said step of verifying that said defined purchase parameters correspond to said selected payment category further identifies said merchant as said single merchant (see Fig. 4, column 9, lines 43, 52-55).

24. As per claim 32, Franklin et al. teach a method of performing secure card purchases, said method comprising:

a) identifying a pre-established credit card account that can be used to make credit card purchases (see column 2, lines 9-21); column 4, lines 3-9; where commerce card is issued by credit card companies or card sponsoring companies);

b) selecting a payment category which limits a nature of a subsequent purchase to single merchant (see Fig. 4, column 9, lines 43, 52-55); where code specific to a merchant is generated by the software supplied by the issuing bank installed on customer computer as described in column 2, lines 18-37);

c) generating a transaction code associated with at least said credit card account and the limits of said selected payment category, and different from said credit card account (see Fig. 4-6; column 10, lines 44-65);

d) designating a merchant as said single merchant (see Fig. 4; column 9, lines 52-55);



e) communicating said transaction code to said merchant to consummate a purchase within defined purchase parameters (see column 2, lines 35-38);

f) verifying that said defined purchase parameters correspond to said selected payment category (see column 2, lines 47-64);

g) providing authorization for said purchase so as to confirm at least that said defined purchase parameters are within said selected payment category and complete the purchase (see column 2, lines 65-67 to column 3, lines 1-6); and

h) associating the purchase with said-credit card account (see column 12, lines 34-43).

Franklin teaches generating a transaction code with transaction specific data (see Fig. 4; Transaction Specific Data which include good identification; column 9, lines 40-43) and but do not teach predefining and associating with the payment categories.

Yanagihara et al. teach predefining and associating the transaction code with the payment categories (see Fig. 2; Fig. 4; paragraph [0019])

Therefore, it would be obvious to one of ordinary skill in the art at the time the invention was made to allow predefining and associating the transaction code with the payment categories of Franklin et al. because Yanagihara et al. teach that including above features would enable user to use usage identification code which indicates purpose of use and usage limit to indicate maximum amount to withdraw (Yanagihara et al., paragraph [0019]).

Franklin et al. do not teach said single merchant limitation being included in said payment category prior to any particular merchant being identified as said single merchant.

Langhans et al. teach said single merchant limitation being included in said payment category prior to any particular merchant being identified as said single merchant (Langhans et al., column 11, lines 65-67 to column 12, lines 1-7; where merchant category code is identified prior to identifying any single merchant).

Therefore, it would be obvious to one of ordinary skill in the art at the time the invention was made to allow said single merchant limitation being included in said payment category prior to any particular merchant being identified as said single merchant of Franklin et al. because Laghans et al. teach that including above features would enable to control application of certain authorization parameters based merchant category codes (Laghans et al., column 12, lines 20-23).

25. As per claim 33, Franklin et al. in view of Yanagihara et al. further in view of Langhans et al. teach claim 32 as described above. Franklin et al. further teaches the method wherein said step of verifying that said defined purchase parameters correspond to said selected payment category further identifies said merchant as said single merchant (see column 2, lines 50-64).

26. As per claim 34, Franklin et al. teach a system for performing secure credit\_card purchases (see Fig. 1) comprising:

a) a custodial authorizing entity, said custodial authorizing entity structured to maintain a pre-established account that can be used to make credit card purchases for at least one user (see Fig. 1, Issuing Bank (26); column 2, lines 8-11); column 4, lines 3-9; where commerce card is issued by credit card companies or card sponsoring companies);

b) said custodial authorizing entity further structured to define at least one payment category available for selection by a customer, said payment category structured to limit at least one subsequent transaction to a single merchant (see column 2, lines 11-21);

c) said custodial authorizing entity further structured to issue a transaction code associated with at least the limits of said payment category selected by the customer and said credit card account of the user, said transaction code being different from said credit card account (see Fig. 4-6; column 2, lines 22-35);

d) said custodial authorizing entity further structured to receive said transaction code and designated purchase parameters associated with a purchase from a merchant, and to verify that said designated purchase parameters correspond to said selected payment category (see Fig. 7; column 2, lines 47-64); and

e) said custodial authorizing entity structured to provide the merchant with authorization for said purchase that confirms at least that said designated purchase parameters correspond to said selected payment category so that said purchase may be consummated by the merchant (see Fig. 7; column 2, lines 65-67 to column 3, lines 1-6).

Franklin et al. do not teach said single merchant limitation being included in said payment category prior to any particular merchant being identified as said single merchant.

Langhans et al. teach said single merchant limitation being included in said payment category prior to any particular merchant being identified as said single merchant (Langhans et al., column 11, lines 65-67 to column 12, lines 1-7; where merchant category code is identified prior to identifying any single merchant).

Therefore, it would be obvious to one of ordinary skill in the art at the time the invention was made to allow said single merchant limitation being included in said payment category prior to any particular merchant being identified as said single merchant of Franklin et al. because Laghans et al. teach that including above features would enable to control application of certain authorization parameters based merchant category codes (Laghans et al., column 12, lines 20-23).

27. As per claim 35, Franklin et al. in view of Yanagihara et al. further in view of Langhans et al. teach claim 34 as described above. Franklin et al. further teaches the system wherein

said single merchant is identified upon selection of said payment category and is associated with said transaction code (see column 9, lines 40-43; where merchant identification identifies the merchant).

28. As per claim 36, Franklin et al. in view of Yanagihara et al. further in view of Langhans et al. teach claim 34 as described above. Franklin et al. further teaches the system wherein

said custodial authorizing entity is structured to designate a first merchant to provide said transaction code for verification as said single merchant (see column 2, lines 18-21; 27-31; where software module supplied by issuing bank generates codes number in digits for customer specific data such as merchant identification).

29. As per claim 37, Franklin et al. in view of Yanagihara et al. further in view of Langhans et al. teach claim 36 as described above. Franklin et al. further teaches the system wherein

said custodial authorizing entity is structured to designate said first merchant as said single merchant for subsequent transactions utilizing said transaction code (Examiner interprets that custodial authority supplied software generates identification code for merchant and subsequent transaction could be transacted with the given code for the merchant).

30. As per claim 38-42, Franklin et al. in view of Yanagihara et al. further in view of Langhans et al. teach claim 34 as described above.

Franklin et al. do not teach defining said payment category as a specific (maximum) dollar amount.

Yanagihara et al. teach defining said payment category as a specific maximum dollar amount (see paragraph [0019]).

Therefore, it would be prima facie obvious to one of ordinary skill in the art at the time the invention was made to allow defining said payment category as a specific maximum dollar amount of Franklin et al. because Yanagihara et al. teach that including above features would enable user to use usage identification code which indicates

purpose of use and usage limit to indicate maximum amount to withdraw (Yanagihara et al., Fig. 2; paragraph [0019]).

31. As per claim 43, Franklin et al. in view of Yanagihara et al. further in view of Langhans et al. teach claim 34 as described above. Franklin et al. further teaches the system wherein

said payment category is further structured to limit said at least one subsequent transaction to a predetermined time period (see column 10, lines 52-65).

### ***Conclusion***

32. The prior art made of record and not relied upon is considered pertinent to applicant's disclosures. The following are pertinent to current invention, though not relied upon:

Benson et al. (U.S. Patent No. 5,845,281) teach method and system for managing a data object so as to comply with predetermined conditions for usage.

Demoff et al. (U.S. Patent No. 6,456,984) teach method and system for providing temporary credit authorizations.

Fleming (U.S. Patent No. 5,953,710) teaches children's credit or debit card system.

Foladare et al. (U.S. Patent No. 5,914,472) teach credit card spending authorization control system.

Franco (U.S. Patent No. 4,893,330) teaches method and apparatus for restricting credit card communication calls.

Kravitz (U.S. Patent No. 6,029,150) teaches payment and transactions in electronic commerce system.

Walker et al. (U.S. Patent No. 6,163,771) teach method and device for generating a single use financial account number.

Any inquiry concerning this communication or earlier communications from the examiner should be directed to Bijendra K. Shrestha whose telephone number is (571)270-1374. The examiner can normally be reached on 7:00AM-4:30PM (Monday-Friday); 2nd Friday OFF.

If attempts to reach the examiner by telephone are unsuccessful, the examiner's supervisor, Alexander Kalinowski can be reached on (571) 272-6771. The fax phone number for the organization where this application or proceeding is assigned is 571-273-8300.

Art Unit: 3691

Information regarding the status of an application may be obtained from the Patent Application Information Retrieval (PAIR) system. Status information for published applications may be obtained from either Private PAIR or Public PAIR. Status information for unpublished applications is available through Private PAIR only. For more information about the PAIR system, see <http://pair-direct.uspto.gov>. Should you have questions on access to the Private PAIR system, contact the Electronic Business Center (EBC) at 866-217-9197 (toll-free). If you would like assistance from a USPTO Customer Service Representative or access to the automated information system, call 800-786-9199 (IN USA OR CANADA) or 571-272-1000.

/Alexander Kalinowski/  
Supervisory Patent Examiner, Art Unit 3691

BKS/3691  
06/06/09



<b>Notice of References Cited</b>	Application/Control No. 11/252,009	Applicant(s)/Patent Under Reexamination D'AGOSTINO, JOHN	
	Examiner BIJENDRA K. SHRESTHA	Art Unit 3691	Page 1 of 1

**U.S. PATENT DOCUMENTS**

*	Document Number Country Code-Number-Kind Code	Date MM-YYYY	Name	Classification
*	A US-6,000,832	12-1999	Franklin et al.	700/232
*	B US-2001/0011249	08-2001	YANAGIHARA et al.	705/41
*	C US-5,500,513	03-1996	Langhans et al.	235/380
*	D US-5,845,281	12-1998	Benson et al.	707/9
*	E US-6,456,984	09-2002	Demoff et al.	705/40
*	F US-5,953,710	09-1999	Fleming, Stephen S.	705/38
*	G US-5,914,472	06-1999	Foladare et al.	235/380
*	H US-4,893,330	01-1990	Franco, Victor A.	379/91.02
*	I US-6,029,150	02-2000	Kravitz, David William	705/39
*	J US-6,163,771	12-2000	Walker et al.	705/18
*	K US-			
*	L US-			
*	M US-			

**FOREIGN PATENT DOCUMENTS**

*	Document Number Country Code-Number-Kind Code	Date MM-YYYY	Country	Name	Classification
*	N				
*	O				
*	P				
*	Q				
*	R				
*	S				
*	T				

**NON-PATENT DOCUMENTS**

*	Include as applicable: Author, Title Date, Publisher, Edition or Volume, Pertinent Pages)
*	U
*	V
*	W
*	X

\*A copy of this reference is not being furnished with this Office action. (See MPEP § 707.05(a).)  
Dates in MM-YYYY format are publication dates. Classifications may be US or foreign.

<b>Search Notes</b> 	<b>Application/Control No.</b> 11252009	<b>Applicant(s)/Patent Under Reexamination</b> D'AGOSTINO, JOHN
	<b>Examiner</b> Shrestha, Bijendra K	<b>Art Unit</b> 3691

<b>SEARCHED</b>			
<b>Class</b>	<b>Subclass</b>	<b>Date</b>	<b>Examiner</b>

<b>SEARCH NOTES</b>		
<b>Search Notes</b>	<b>Date</b>	<b>Examiner</b>
google/patents	06/0/20095	bks

<b>INTERFERENCE SEARCH</b>			
<b>Class</b>	<b>Subclass</b>	<b>Date</b>	<b>Examiner</b>

--	--

<b>Index of Claims</b> 	<b>Application/Control No.</b> 11252009	<b>Applicant(s)/Patent Under Reexamination</b> D'AGOSTINO, JOHN
	<b>Examiner</b> Shrestha, Bijendra K	<b>Art Unit</b> 3691

✓	<b>Rejected</b>
=	<b>Allowed</b>

-	<b>Cancelled</b>
÷	<b>Restricted</b>

N	<b>Non-Elected</b>
I	<b>Interference</b>

A	<b>Appeal</b>
O	<b>Objected</b>

Claims renumbered in the same order as presented by applicant
  CPA
  T.D.
  R.1.47

CLAIM		DATE								
Final	Original	06/05/2009								
	1	✓								
	2	✓								
	3	✓								
	4	✓								
	5	✓								
	6	✓								
	7	✓								
	8	✓								
	9	✓								
	10	✓								
	11	✓								
	12	✓								
	13	✓								
	14	✓								
	15	✓								
	16	✓								
	17	✓								
	18	✓								
	19	✓								
	20	✓								
	21	✓								
	22	✓								
	23	✓								
	24	✓								
	25	✓								
	26	✓								
	27	✓								
	28	✓								
	29	✓								
	30	✓								
	31	✓								
	32	✓								
	33	✓								
	34	✓								
	35	✓								
	36	✓								

<b><i>Index of Claims</i></b> 	<b>Application/Control No.</b> 11252009	<b>Applicant(s)/Patent Under Reexamination</b> D'AGOSTINO, JOHN
	<b>Examiner</b> Shrestha, Bijendra K	<b>Art Unit</b> 3691

✓	<b>Rejected</b>
=	<b>Allowed</b>

-	<b>Cancelled</b>
÷	<b>Restricted</b>

N	<b>Non-Elected</b>
I	<b>Interference</b>

A	<b>Appeal</b>
O	<b>Objected</b>

Claims renumbered in the same order as presented by applicant
  CPA
  T.D.
  R.1.47

CLAIM		DATE								
Final	Original	06/05/2009								
	37	✓								
	38	✓								
	39	✓								
	40	✓								
	41	✓								
	42	✓								
	43	✓								



UNITED STATES PATENT AND TRADEMARK OFFICE

UNITED STATES DEPARTMENT OF COMMERCE  
 United States Patent and Trademark Office  
 Address: COMMISSIONER FOR PATENTS  
 P.O. Box 1450  
 Alexandria, Virginia 22313-1450  
 www.uspto.gov

BIB DATA SHEET

CONFIRMATION NO. 4322

<b>SERIAL NUMBER</b> 11/252,009	<b>FILING or 371(c) DATE</b> 10/17/2005 <b>RULE</b>	<b>CLASS</b> 705	<b>GROUP ART UNIT</b> 3691	<b>ATTORNEY DOCKET NO.</b>		
<b>APPLICANTS</b> John D'Agostino, Sarasota, FL;						
<b>** CONTINUING DATA *****</b> This application is a CON of 10/037,007 11/09/2001 ABN which is a CIP of 09/231,745 01/15/1999 PAT 6,324,526						
<b>** FOREIGN APPLICATIONS *****</b>						
<b>** IF REQUIRED, FOREIGN FILING LICENSE GRANTED *** SMALL ENTITY **</b> 11/03/2005						
Foreign Priority claimed <input type="checkbox"/> Yes <input checked="" type="checkbox"/> No	35 USC 119(a-d) conditions met <input type="checkbox"/> Yes <input checked="" type="checkbox"/> No	<input type="checkbox"/> Met after Allowance	<b>STATE OR COUNTRY</b> FL	<b>SHEETS DRAWINGS</b> 2	<b>TOTAL CLAIMS</b> 44	<b>INDEPENDENT CLAIMS</b> 6
Verified and /BIJENDRA K SHRESTHA/ Acknowledged _____ Examiner's Signature	_____	Initials				
<b>ADDRESS</b> JOHN D'AGOSTINO 5168 NORTHRIDGE ROAD #309 SARASOTA, FL 34238 UNITED STATES						
<b>TITLE</b> System and method for performing secure credit card purchases						
<b>FILING FEE RECEIVED</b> 1400	FEES: Authority has been given in Paper No. _____ to charge/credit DEPOSIT ACCOUNT No. _____ for following:		<input type="checkbox"/> All Fees <input type="checkbox"/> 1.16 Fees (Filing) <input type="checkbox"/> 1.17 Fees (Processing Ext. of time) <input type="checkbox"/> 1.18 Fees (Issue) <input type="checkbox"/> Other _____ <input type="checkbox"/> Credit			

*[Handwritten signature]*

Application No. 11/252, 009  
Amdt. Dated May 13, 2009  
Reply to Office Action dated November 13, 2008

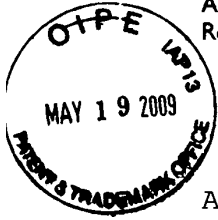

IN THE UNITED STATES PATENT AND TRADEMARK OFFICE

Applicant: John D'Agostino  
Serial No.: 11/252,009  
Filing Date: October 17, 2005

For: SYSTEM AND METHOD FOR PERFORMING SECURE CREDIT CARD  
PURCHASES

Shrestha, B., Examiner  
Group Art Unit 3691

Mail Stop RCE  
Commissioner for Patents  
P.O. Box 1450  
Alexandria, VA 22313-1450

Sir:

With regard to applicant's response on May 13, 2009, to the office action dated November 13, 2008, applicant wishes to correct several minor typographical errors, made by applicant, and contained within applicants remarks. Each error was inadvertent and typographical in nature.

(As submitted May 13, 2009, Page 17-18)

Claims 1-43 in my application, now clearly incorporate the limitation that a payment category be defined to include the ability to limit transactions to "a single merchant" and that said single merchant limitation must be included in said payment category prior to any particular merchant being identified as said single merchant. Please see

Application No. 11/252,009

Amdt. Dated May 13, 2009

Reply to Office Action dated November 13, 2008

claims 1c, 1d, 27b, 28b, 32b, 34b. A "single merchant"

limitation is also present in claims.

(Corrected)

Claims 1-43 in my application, now clearly incorporate the limitation that a payment category be defined to include the ability to limit transactions to **"a single merchant"** **and that said single merchant limitation must be included in said payment category prior to any particular merchant being identified as said single merchant.** Please see claims 1c, 1d, 27b, 28b, 32b, 34b. A ~~"single merchant"~~ ~~limitation is also present in claims.~~

(As submitted May 13, 2009, Page 22)

Applicant also points out the in the appeal of the Ex parte reexamination of U.S. Patent 6,324,526, The BPAI noted that the Board indicated that it appreciates the distinction between limiting transaction "single" merchant as opposed to a particular merchant.

(Corrected)

Applicant also points out the in the appeal of the Ex parte reexamination of U.S. Patent 6,324,526, which is the Grandparent of this application, The ~~BPAI noted that the~~ Board indicated that it appreciates the distinction between

Application No. 11/252, 009  
Amdt. Dated May 13, 2009  
Reply to Office Action dated November 13, 2008



limiting transactions to a "single" merchant as opposed to  
a particular merchant.

Respectfully Submitted,

John D'Agostino  
5158 Northridge Road, Unit 309  
Sarasota, FL 34238  
(941) 228-2727

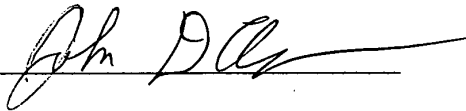
By: 

Date: 5/13/09



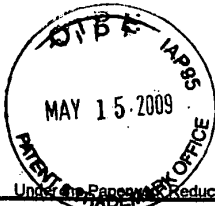

12 RCE ✓

PTO/SB/30 (04-09)  
 Approved for use through 05/31/2009. OMB 0651-0031  
 U.S. Patent and Trademark Office, U.S. DEPARTMENT OF COMMERCE

Under the Paperwork Reduction Act of 1995, no persons are required to respond to a collection of information unless it contains a valid OMB control number.

<b>Request for Continued Examination (RCE) Transmittal</b>  Address to: Mail Stop RCE Commissioner for Patents P.O. Box 1450 Alexandria, VA 22313-1450	Application Number	11/252,009
	Filing Date	10/17/2005
	First Named Inventor	John D'Agostino
	Art Unit	3691
	Examiner Name	Shrestha, Bijendra K
	Attorney Docket Number	

**This is a Request for Continued Examination (RCE) under 37 CFR 1.114 of the above-identified application.**  
 Request for Continued Examination (RCE) practice under 37 CFR 1.114 does not apply to any utility or plant application filed prior to June 8, 1995, or to any design application. See Instruction Sheet for RCEs (not to be submitted to the USPTO) on page 2.

1. **Submission required under 37 CFR 1.114** Note: If the RCE is proper, any previously filed unentered amendments and amendments enclosed with the RCE will be entered in the order in which they were filed unless applicant instructs otherwise. If applicant does not wish to have any previously filed unentered amendment(s) entered, applicant must request non-entry of such amendment(s).

a.  Previously submitted. If a final Office action is outstanding, any amendments filed after the final Office action may be considered as a submission even if this box is not checked.

i.  Consider the arguments in the Appeal Brief or Reply Brief previously filed on \_\_\_\_\_

ii.  Other \_\_\_\_\_

b.  Enclosed

i.  Amendment/Reply

ii.  Affidavit(s)/ Declaration(s)

iii.  Information Disclosure Statement (IDS)

iv.  Other \_\_\_\_\_

2. **Miscellaneous**

a.  Suspension of action on the above-identified application is requested under 37 CFR 1.103(c) for a period of \_\_\_\_\_ months. (Period of suspension shall not exceed 3 months; Fee under 37 CFR 1.17(i) required)

b.  Other \_\_\_\_\_

3. **Fees** The RCE fee under 37 CFR 1.17(e) is required by 37 CFR 1.114 when the RCE is filed.

The Director is hereby authorized to charge the following fees, any underpayment of fees, or credit any overpayments, to

a.  Deposit Account No. \_\_\_\_\_

i.  RCE fee required under 37 CFR 1.17(e)      05/18/2009 SSITHIB1 00000004 11252009

ii.  Extension of time fee (37 CFR 1.136 and 1.17)      01 FC:2801      405.00 OP

iii.  Other \_\_\_\_\_

b.  Check in the amount of \$ 960 \_\_\_\_\_ enclosed

c.  Payment by credit card (Form PTO-2038 enclosed)

**WARNING: Information on this form may become public. Credit card information should not be included on this form. Provide credit card information and authorization on PTO-2038.**

SIGNATURE OF APPLICANT, ATTORNEY, OR AGENT REQUIRED			
Signature	<i>John D'Agostino</i>	Date	May 13, 2009
Name (Print/Type)	John D'Agostino	Registration No.	

CERTIFICATE OF MAILING OR TRANSMISSION	
I hereby certify that this correspondence is being deposited with the United States Postal Service with sufficient postage as first class mail in an envelope addressed to: Mail Stop RCE, Commissioner for Patents, P. O. Box 1450, Alexandria, VA 22313-1450 or facsimile transmitted to the U.S. Patent and Trademark Office on the date shown below.	
Signature	<i>John D'Agostino</i>
Name (Print/Type)	John D'Agostino
Date	May 13, 2009

This collection of information is required by 37 CFR 1.114. The information is required to obtain or retain a benefit by the public which is to file (and by the USPTO to process) an application. Confidentiality is governed by 35 U.S.C. 122 and 37 CFR 1.11 and 1.14. This collection is estimated to take 12 minutes to complete, including gathering, preparing, and submitting the completed application form to the USPTO. Time will vary depending upon the individual case. Any comments on the amount of time you require to complete this form and/or suggestions for reducing this burden, should be sent to the Chief Information Officer, U.S. Patent and Trademark Office, U.S. Department of Commerce, P.O. Box 1450, Alexandria, VA 22313-1450. DO NOT SEND FEES OR COMPLETED FORMS TO THIS ADDRESS. SEND TO: Mail Stop RCE, Commissioner for Patents, P.O. Box 1450, Alexandria, VA 22313-1450.  
 If you need assistance in completing the form, call 1-800-PTO-9199 and select option 2.

May 13, 2009



RE:

Applicant: John D'Agostino  
Application Number: 11/252,009  
Art Unit: 3691  
Filed on: 10/17/2005  
Examiner: Shrestha, Bijendra K

The attached check is to cover the following USPTO fees.  
Request for continued examination, \$405  
Extension of time, \$555  
Total: \$960

Respectfully submitted,  
John D'Agostino

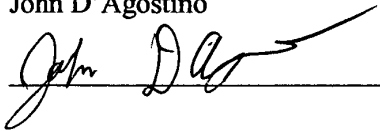
 5-13-09



Under the Paperwork Reduction Act of 1995, no persons are required to respond to a collection of information unless it displays a valid OMB control number.

<b>PATENT APPLICATION FEE DETERMINATION RECORD</b> Substitute for Form PTO-875					Application or Docket Number <b>11/252,009</b>		Filing Date <b>10/17/2005</b>		<input type="checkbox"/> To be Mailed														
<b>APPLICATION AS FILED – PART I</b>																							
(Column 1)			(Column 2)			SMALL ENTITY <input checked="" type="checkbox"/>		OR			OTHER THAN SMALL ENTITY												
FOR		NUMBER FILED		NUMBER EXTRA		RATE (\$)		FEE (\$)		RATE (\$)		FEE (\$)											
<input type="checkbox"/> BASIC FEE <small>(37 CFR 1.16(a), (b), or (c))</small>		N/A		N/A		N/A				N/A													
<input type="checkbox"/> SEARCH FEE <small>(37 CFR 1.16(k), (l), or (m))</small>		N/A		N/A		N/A				N/A													
<input type="checkbox"/> EXAMINATION FEE <small>(37 CFR 1.16(o), (p), or (q))</small>		N/A		N/A		N/A				N/A													
TOTAL CLAIMS <small>(37 CFR 1.16(i))</small>		minus 20 =		*		X \$ =				OR		X \$ =											
INDEPENDENT CLAIMS <small>(37 CFR 1.16(h))</small>		minus 3 =		*		X \$ =				OR		X \$ =											
<input type="checkbox"/> APPLICATION SIZE FEE <small>(37 CFR 1.16(s))</small>		If the specification and drawings exceed 100 sheets of paper, the application size fee due is \$250 (\$125 for small entity) for each additional 50 sheets or fraction thereof. See 35 U.S.C. 41(a)(1)(G) and 37 CFR 1.16(s).																					
<input type="checkbox"/> MULTIPLE DEPENDENT CLAIM PRESENT <small>(37 CFR 1.16(j))</small>																							
* If the difference in column 1 is less than zero, enter "0" in column 2.																							
TOTAL						TOTAL																	
<b>APPLICATION AS AMENDED – PART II</b>																							
(Column 1)			(Column 2)			(Column 3)			SMALL ENTITY		OR			OTHER THAN SMALL ENTITY									
AMENDMENT	<b>05/15/2009</b>		CLAIMS REMAINING AFTER AMENDMENT				HIGHEST NUMBER PREVIOUSLY PAID FOR		PRESENT EXTRA		RATE (\$)		ADDITIONAL FEE (\$)		RATE (\$)		ADDITIONAL FEE (\$)						
	Total <small>(37 CFR 1.16(o))</small>		* 43		Minus		** 44		= 0		X \$26 =		0		OR		X \$ =						
	Independent <small>(37 CFR 1.16(h))</small>		* 5		Minus		***6		= 0		X \$110 =		0		OR		X \$ =						
	<input type="checkbox"/> Application Size Fee <small>(37 CFR 1.16(s))</small>																						
	<input type="checkbox"/> FIRST PRESENTATION OF MULTIPLE DEPENDENT CLAIM <small>(37 CFR 1.16(j))</small>																						
TOTAL ADD'L FEE						0						OR						TOTAL ADD'L FEE					
AMENDMENT			CLAIMS REMAINING AFTER AMENDMENT				HIGHEST NUMBER PREVIOUSLY PAID FOR		PRESENT EXTRA		RATE (\$)		ADDITIONAL FEE (\$)		RATE (\$)		ADDITIONAL FEE (\$)						
	Total <small>(37 CFR 1.16(o))</small>		*		Minus		**		=		X \$ =				OR		X \$ =						
	Independent <small>(37 CFR 1.16(h))</small>		*		Minus		***		=		X \$ =				OR		X \$ =						
	<input type="checkbox"/> Application Size Fee <small>(37 CFR 1.16(s))</small>																						
	<input type="checkbox"/> FIRST PRESENTATION OF MULTIPLE DEPENDENT CLAIM <small>(37 CFR 1.16(j))</small>																						
TOTAL ADD'L FEE												OR						TOTAL ADD'L FEE					
* If the entry in column 1 is less than the entry in column 2, write "0" in column 3.												Legal Instrument Examiner: /DIANA BATES/											
** If the "Highest Number Previously Paid For" IN THIS SPACE is less than "20".																							
*** If the "Highest Number Previously Paid For" IN THIS SPACE is less than 3, enter "3".																							
The "Highest Number Previously Paid For" (Total or Independent) is the highest number found in the appropriate box in column 1.																							

This collection of information is required by 37 CFR 1.16. The information is required to obtain or retain a benefit by the public which is to file (and by the USPTO to process) an application. Confidentiality is governed by 35 U.S.C. 122 and 37 CFR 1.14. This collection is estimated to take 12 minutes to complete, including gathering, preparing, and submitting the completed application form to the USPTO. Time will vary depending upon the individual case. Any comments on the amount of time you require to complete this form and/or suggestions for reducing this burden, should be sent to the Chief Information Officer, U.S. Patent and Trademark Office, U.S. Department of Commerce, P.O. Box 1450, Alexandria, VA 22313-1450. DO NOT SEND FEES OR COMPLETED FORMS TO THIS ADDRESS. **SEND TO: Commissioner for Patents, P.O. Box 1450, Alexandria, VA 22313-1450.**

If you need assistance in completing the form, call 1-800-PTO-9199 and select option 2.

**REMARKS / ARGUMENTS**

This Request for Continued Examination (RCE) along with the attached Amendment is submitted in full response to the Office action dated November 13, 2008, wherein claims 1-44 are rejected under U.S.C. 103(a) as being unpatentable over Franklin et al., U.S. Patent No. 6,000,832 in view of Yanagihara et al. U.S. Pub No. 2001/0011249. The office action of November 13, 2008 was final. The corresponding fee for the RCE is included with this amendment.

An appropriate Request for an Extension of Time and the corresponding fee is also being filed concurrently herewith, and accordingly, Applicant respectfully requests

Application No. 11/252, 009  
Amdt. Dated May 13, 2009  
Reply to Office Action dated November 13, 2008

reconsideration of this application in view of the foregoing amendments and the following remarks.

As examiner requested, applicant points out the following with regard to the previously filed information disclosure statements. In view of the now completed Ex parte reexamination of U.S. patent 6,324,526 which is the grandparent of this application, applicant cites the following references.

U.S. Patent No. 6,422,462 to Cohen

U.S. Patent No. 5,826,243 to Musmanno

U.S. Patent No. 6,298,335 to Burnstein

A. In the currently amended claims, claims 1-43 are presented with all independent claims amended to clearly incorporate the "single merchant" limitation discussed below. Claim 28 has been canceled. Former claims 29-44 are presented as claims 28-43.

Claims 1-43 in my application, now clearly incorporate the limitation that a payment category be defined to include the ability to limit transactions to "a single merchant" and that said single merchant limitation must be included in said payment category prior to any particular merchant being identified as said single merchant. Please see

Application No. 11/252, 009  
Amdt. Dated May 13, 2009  
Reply to Office Action dated November 13, 2008

claims 1c, 1d, 27b, 28b, 32b, 34b. A "single merchant" limitation is also present in claims. Furthermore, the claims have been amended to make clear that a transaction code generated in association with the payment category will also include the limits of the category and therefore will be limited to a single merchant (see claims 1e, 27c, 28c, 32c, 34c). All other claims are dependent on the claims above and, therefore, also include said "single merchant" limitation in both the payment category and the transaction code.

My specifications clearly support the "single merchant limitation". Please see paragraph 36 which reads in part:  
*"The payment category may also include a multi-transaction authorization wherein more than one purchase may be made from one or a plurality of different merchants, each of which may or may not be identified by the customer and pre-coded in association with the transaction code..."*

*"...Accordingly, in some instances, wherein a customer, or an agent of the customer, such as a child, guardian, or caregiver, must make a number of transactions or purchases which are authorized by the customer, the customer may designate a maximum amount which can be spent utilizing a particular transaction code within a predetermined period*

Application No. 11/252, 009

Amdt. Dated May 13, 2009

Reply to Office Action dated November 13, 2008

of time, and/or can designate that only one merchant,

whether designated or not, can use the transaction code."

This "unidentified single merchant" limitation is not present in either of the critical references used to reject applicants claims (U.S. Patent No. 6,000,832 to Franklin or U.S. Pub No. 2001/0011249 to Yanagihara).

Specifically, the Franklin patent does not disclose a payment category whereby one or more transactions are limited to a single merchant which has not been identified. Indeed, the Franklin patent does not disclose a payment category which is limited to a single merchant, but rather a proxy number that is limited to a single transaction. In all cases in which the Franklin patent limits the transaction number with regard to the merchant, it is based on a particular merchant that has been identified prior to generating the substitute number. That is to say the merchant is identified along with other transactions specific data (see column 5, lines 28-32, column 9, lines 30-34, 40-44, 52-55, column 10, lines 9-11). The merchant limitation is not based on the fact that the merchant is a single merchant, but rather that the merchant is a particular (identified) merchant. The distinction between a single merchant limitation (as described in applicant's



Application No. 11/252, 009  
Amdt. Dated May 13, 2009  
Reply to Office Action dated November 13, 2008

claims) and a particular merchant limitation (as described in the Franklin invention) represents a fundamental difference. A credit card which can only be used with a particular merchant is well known in the art (for example, a Sear's card only works at Sears). However, several of applicant's claims describe a merchant limitation that is based exclusively on the fact that the merchant is a single merchant and not necessarily any particular merchant. This means that the transaction code can be used with any merchant for one or more transactions. However, it can never be used with more than one merchant. For example, the single merchant limitation could be represented by having a card number which could be used anywhere, but once a purchase was made (at Sears, for example) it could only be used at Sears for future purchases. To put it another way, a payment category which limits transactions to a single merchant is predetermined to limit those transactions even though said single merchant was not identified when the payment category was created (predetermined). Since the transaction code in applicant's invention reflects the limitations of the payment category, the transaction code is also limited to a single merchant whether or not said single merchant has been determined and identified.

Application No. 11/252, 009  
Amdt. Dated May 13, 2009  
Reply to Office Action dated November 13, 2008

It is a significant advantage to have a payment category, which limits transactions to a single merchant and can be "designated" by the customer in a simple method step. This makes it unnecessary for the customer to communicate, in advance, to the issuing entity, or even to know in advance, the identity of the merchant. Eliminating the need to identify the merchant to the issuing entity, in advance, significantly simplifies the process for both the customer and the issuer. Yet the customer can still benefit from the security advantage of a transaction code that is limited to a single merchant even if the identity of that single merchant has not yet been determined. It has been shown that customers are very reluctant to adopt security measures that impair the speed, efficiency, and ease-of-use of their credit cards. A payment category that is pre-defined to limit transactions to a single merchant offers a very simple and efficient method to adopt a highly effective security measure.

After very thorough reviews of the cited references, I can find no disclosure of the "single unidentified merchant" limitation in either the Franklin patent or the Yanagihara publication. Indeed, to the best of applicant's knowledge, this single merchant limitation, as described in

Application No. 11/252,009  
Amdt. Dated May 13, 2009  
Reply to Office Action dated November 13, 2008

applicant's specifications and stated in applicant's claims, was unknown in the art as of the priority date (January 15, 1999) of this application.

Applicant also points out the in the appeal of the Ex parte reexamination of U.S. Patent 6,324,526, The BPAI noted that the Board indicated that it appreciates the distinction between limiting transaction "single" merchant as opposed to a particular merchant.

In view of the fact that applicant has disclosed an important and advantageous feature that has not been disclosed in any of the examiner's references, and that this feature is clearly included in the amended claims, it is believed that claims 1-43 are now clearly in a condition of allowance and favorable re-consideration of the amended claims is respectfully requested.

#### **B. Conclusion**

Based on the foregoing remarks and the above amendments to the claims it is respectfully requested that this application be given full and favorable reconsideration. It is believed that upon doing so, this application will be

Application No. 11/252, 009

Amdt. Dated May 13, 2009

Reply to Office Action dated November 13, 2008

deemed to be in condition for immediate allowance, which  
action is now respectfully requested.

In addition, a request for an appropriate extension of  
time is enclosed herewith along with the corresponding PTO  
fees for the extension and the RCE.

Respectfully Submitted,

John D'Agostino

5168 Northridge Road Unit 309

Sarasota, FL 34238

(941) 228-1511

By:



Date:

5-13-09

Application No. 11/252, 009  
Amdt. Dated May 13, 2009  
Reply to Office Action dated November 13, 2008



**Amendments to the Claims**

This listing of claims will replace all prior versions, and listings, of the claims in the application:

1. (Currently Amended) A method of performing secure credit card purchases, said method comprising:

a) contacting a custodial authorizing entity having custodial responsibility of account parameters of a customer's account that can be used to make credit card purchases;

b) supplying the custodial authorizing entity with at least account identification data;

c) ~~Pre~~-Defining a payment category including at least the ability to limit purchases to a single ~~unidentified~~ merchant for at least one transaction, said single merchant limitation being included in said payment category prior to any particular merchant being identified as said single merchant;

d) designating said payment category thereby designating at least that a transaction code generated in accordance

Application No. 11/252, 009

Amdt. Dated May 13, 2009

Reply to Office Action dated November 13, 2008

with said payment category can be used by only one merchant;

e) generating a transaction code reflecting at least the limits of said designated payment category and the ability to make a purchase within said designated payment category;

f) communicating the transaction code to a merchant to consummate a purchase with define purchase parameters;

g) verifying that said defined purchase parameters are within said designated payment category; and

h) providing authorization for said purchase so as to confirm at least that said defined purchase parameters are within said designated payment category and complete the purchase.

2. (Previously Presented) The method of claim 1 further comprising identification of said single merchant upon designation of said payment category.

3. (Previously Presented) The method of claim 1 further comprising the step of designating said single merchant subsequent to generating said transaction code.

4. (Previously Presented) The method of claim 1 wherein said step of communicating the transaction code to said merchant to consummate said purchase within defined purchase parameters further comprises designation of said single merchant.

5. (Previously Presented) The method of claim 1 wherein said step of generating said transaction code further comprises said custodial authorizing entity generating said transaction code.

6. (Previously Presented) The method of claim 1 wherein said step of generating said transaction code further comprises said customer generating said transaction code.

7. (Previously Presented) The method of claim 1 further comprising obtaining said authorization for said purchase from the custodial authorizing entity.

8. (Previously Presented) The method of claim 1 further comprising a step of communicating promotional information of offered subject matter to the customer by the merchant, pre-determining the purchase parameters of the purchase, and corresponding said designated payment category to said purchase parameters.

9. (Previously Presented) The method of claim 1 further comprising the merchant communicating the transaction code to the custodial authorizing entity for verification.

10. (Previously Presented) The method of claim 1 further comprising generating a transaction code which reflects at least one of a plurality of said payment categories.

11. (Previously Presented) The method of claim 10 further comprising defining at least one of said plurality of

Application No. 11/252, 009  
Amdt. Dated May 13, 2009  
Reply to Office Action dated November 13, 2008

payment categories to include the ability to designate amount parameters for a cost of one or more purchases.

12. (Previously Presented) The method of claim 10 further comprising defining at least one of said plurality of payment categories to include the ability to designate time parameters during which the purchase can be completed.

13. (Previously Presented) The method of claim 10 further comprising defining at least one of said plurality of payment categories to include the ability to use said transaction code for a single transaction at a fixed amount for purchase within a predetermined period of time.

14. (Previously Presented) The method of claim 13 further comprising defining at least one of said plurality of payment categories to transaction at said fixed amount for purchase within said predetermined period of time.

15. (Previously Presented) The method of claim 10 further comprising defining at least one of said plurality of payment categories to include the ability to use said transaction code for a single transaction at a maximum amount for purchase within a predetermined period of time.

16. (Previously Presented) The method of claim 15 further comprising defining at least one of said plurality of payment categories to include the ability to limit



Application No. 11/252, 009  
Amdt. Dated May 13, 2009  
Reply to Office Action dated November 13, 2008

purchases to said single transaction at said maximum amount for purchase within said predetermined period of time.

17. (Previously Presented) The method of claim 10 further comprising defining at least one of said plurality of payment categories to include the ability to use said transaction code for at least two purchases at a maximum total amount for items purchased within a predetermined time period.

18. (Previously Presented) The method of claim 17 further comprising defining at least one of said plurality of payment categories to include the ability to limit purchases to said at least two purchases at said maximum total amount for items purchased within said predetermined time period.

19. (Previously Presented) The method of claim 10 further comprising defining at least one of said plurality of payment categories to include the ability to use said transaction code for at least two purchases for a repeating transaction at a fixed amount payable at each of a fixed number of time intervals.

20. (Previously Presented) The method of claim 19 further comprising defining at least one of said plurality of payment categories to include the ability to limit purchases to said repeating transaction at said fixed

Application No. 11/252, 009

Amdt. Dated May 13, 2009

Reply to Office Action dated November 13, 2008

amount payable at each of said fixed number of time intervals.

21. (Previously Presented) The method of claim 10 further comprising defining at least one of said plurality of payment categories to include the ability to use said transaction code for a repeating transaction at a fixed amount payable at each of an unspecified number of time intervals.

22. (Previously Presented) The method of claim 21 further comprising defining at least one of said plurality of payment categories to include the ability to limit purchases to said repeating transaction at said fixed amount payable at each of said unspecified number of time intervals.

23. (Previously Presented) The method of claim 10 wherein at least some of said plurality of payment categories to include:

a) the ability to use said transaction code for a single transaction at a fixed amount for a purchase within a predetermined period of time,

b) the ability to use said transaction code for a single transaction at a maximum amount for a purchase within a predetermined period of time,

Application No. 11/252, 009  
Amdt. Dated May 13, 2009  
Reply to Office Action dated November 13, 2008

c) the ability to use said transaction code for multiple transactions at a maximum total amount for purchases within a predetermined time period,

d) the ability to use said transaction code for a repeating transaction at a fixed amount for purchases payable at each of a fixed number of time intervals, and

e) the ability to use said transaction code for a repeating transaction at a fixed amount for purchases payable at each of an unspecified number of time intervals.

24. (Previously Presented) The method of claim 10 wherein at least some of said plurality of payment categories include:

a) the ability to use said transaction code for a single transaction at a fixed amount for a purchase,

b) the ability to use said transaction code for a single transaction at a maximum amount for a purchase,

c) the ability to use said transaction code for multiple transactions at a maximum total amount for purchases,

d) the ability to use said transaction code for a repeating transaction at a fixed amount for purchases payable at each of a fixed number of time intervals, and

e) the ability to use said transaction code for a repeating transaction at a fixed amount for purchases payable at each of an unspecified number of time intervals.

Application No. 11/252, 009  
Amdt. Dated May 13, 2009  
Reply to Office Action dated November 13, 2008

25. (Previously Presented) The method of claim 1 further comprising generating said transaction code to further reflect an identification of said single merchant.

26. (Previously Presented) The method of claim 25 further comprising defining said payment category to include the ability to limit purchases to a limited time interval during which said purchase authorization is valid.

27. (Currently Amended) A method of performing secure credit card purchases, said method comprising:

a) identifying a pre-established account that can be used to make credit card purchases;

b) designating at least one of a plurality of pre-defined payment categories which limit a nature of a subsequent purchases, at least one of said payment categories including at least the ability to limit purchases to a single merchant, said single merchant limitation being included in said payment category prior to any particular merchant being identified as said single merchant;

c) ~~issuing~~ generating a transaction code associated with at least said credit card account and the limits of said selected payment category, and different from said credit card account;

Application No. 11/252, 009  
Amdt. Dated May 13, 2009  
Reply to Office Action dated November 13, 2008

- d) communicating said transaction code to a merchant to consummate a purchase within defined purchase parameters;
- e) verifying that said defined purchase parameters correspond to said designated payment category; and
- f) providing authorization for said purchase so as to confirm at least that said defined purchase parameters are within said designated payment category and complete the purchase; and
- g) associating the purchase with said credit card account.

28. (Currently Amended, Previously Presented as claim 29)  
A method of performing secure credit card purchases, said method comprising:

- a) identifying a pre-established account that can be used to make credit card purchases;
- b) selecting a predetermined payment category which limits a nature, of a series of subsequent purchases to a single ~~unidentified~~ merchant, said single merchant limitation being included in said payment category prior to any particular merchant being identified as said single merchant;
- c) ~~issuing~~ generating a transaction code associated with at least said credit card account and the limits of said

Application No. 11/252, 009

Amdt. Dated May 13, 2009

Reply to Office Action dated November 13, 2008

selected payment category and different from said credit card account;

d) communicating said transaction code to a merchant to consummate a purchase within defined purchase parameters;

e) verifying that said defined purchase parameters correspond to said selected payment category;

f) providing authorization for said purchase so as to confirm at least that said defined purchase parameters are within said selected payment category and complete the purchase; and

g) associating the purchase with said credit card account.

29. (Previously Presented as claim 30) The method of claim 28 wherein said step of selecting said payment category which limits said nature of said series of subsequent purchases to said single merchant further comprises limiting said nature of said series of subsequent purchases to a fixed amount for each of said subsequent purchases.

30. (Previously Presented as claim 31) The method of claim 28 wherein said step of selecting said payment category which limits said nature of said series of subsequent purchases to said single merchant further comprises limiting said nature of said series of subsequent

Application No. 11/252, 009  
Amdt. Dated May 13, 2009  
Reply to Office Action dated November 13, 2008

purchases to a maximum total amount for said subsequent purchases.

31. (Previously Presented as claim 32) The method of claim 28 wherein said step of verifying that said defined purchase parameters correspond to said selected payment category further identifies said merchant as said single merchant.

32. (Currently Amended Previously Presented as claim 33) A method of performing secure credit card purchases, said method comprising the steps of:

a) identifying a pre-established account that can be used to make credit card purchases;

b) selecting a pre-determined payment category which limits a nature of a subsequent purchase to ~~an unidentified~~ a single merchant, said single merchant limitation being included in said payment category prior to any particular merchant being identified as said single merchant;

c) generating a transaction code associated with at least said credit card account and the limits of said selected payment category, and different from said credit card account;

d) designating a merchant as said single merchant;

Application No. 11/252, 009  
Amdt. Dated May 13, 2009  
Reply to Office Action dated November 13, 2008

e) communicating said transaction code to said merchant to consummate a purchase within defined purchase parameters;

f) verifying that said defined purchase parameters correspond to said selected payment category;

g) providing authorization for said purchase so as to confirm at least that said defined purchase parameters are within said selected payment category and complete the purchase; and

h) associating the purchase with said credit card account.

33. (Previously Presented as claim 34) The method of claim 32 wherein said step of verifying that said defined purchase parameters correspond to said selected payment category further identifies said merchant as said single merchant.

34. (Currently Amended Previously Presented as claim 35) A system for performing secure credit card purchases comprising:

a) a custodial authorizing entity, said custodial authorizing entity structured to maintain a pre-established account that can be used to make credit card purchases for at least one user;



Application No. 11/252, 009  
Amdt. Dated May 13, 2009  
Reply to Office Action dated November 13, 2008

b) said custodial authorizing entity further structured to define at least one payment category available for selection by a customer, said payment category structured to limit at least one subsequent transaction to a single merchant, said single merchant limitation being included in said payment category prior to any particular merchant being identified as said single merchant;

c) said custodial authorizing entity further structured to issue a transaction code associated with at least the limits of said payment category selected by the customer and said credit card account of the issuer, said transaction code being different from said credit card account;

d) said custodial authorizing entity further structures to receive said transaction code and designated purchase parameters associated with a purchase from a merchant, and to verify that said designated purchase parameters correspond to said selected payment category; and

e) said custodial authorizing entity structures to provide the merchant with authorization for said purchase that confirms at least that said designated purchase parameters correspond to said selected payment category so that said purchase may be consummated by the merchant.

Application No. 11/252,009  
Amdt. Dated May 13, 2009  
Reply to Office Action dated November 13, 2008

35. (Previously Presented as claim 36) A system for performing secure credit card purchases as recited in claim 34 wherein said single merchant is identified upon selection of said payment category and is associated with said transaction code.

36. (Previously Presented as claim 37) A system for performing secure credit card purchases as recited in claim 34 wherein said custodial authorizing entity is structured to designate a first merchant to provide said transaction code for verification as said single merchant.

37. (Previously Presented as claim 38) A system for performing secure credit card purchases as recited in claim 36 wherein said custodial authorizing entity is structured to designate said first merchant as said single merchant for subsequent transactions utilizing said transaction code.

38. (Previously Presented as claim 39) A system for performing secure credit card purchases as recited in claim 34 wherein said payment category is further structured to limit said at least one subsequent transaction to a specified dollar amount.

39. (Previously Presented as claim 40) A system for performing secure credit card purchases as recited in claim 38 wherein said payment category is further structured to

Application No. 11/252, 009

Amdt. Dated May 13, 2009

Reply to Office Action dated November 13, 2008

limit each of a plurality of subsequent transactions to said specified dollar amount.

40. (Previously Presented as claim 41) A system for performing secure credit card purchases as recited in claim 39 wherein said custodial authorizing entity is structured to designate a dollar amount of a first transaction associated with said transaction code and having said designated purchase parameters that correspond to remaining parameters of said selected payment category, as said specified dollar amount.

41. (Previously Presented as claim 42) A system for performing secure credit card purchases as recited in claim 38 wherein said specified dollar amount is defined upon selection of said payment category and is associated with said transaction code.

42. (Previously Presented as claim 43) A system for performing secure credit card purchases as recited in claim 34 wherein said payment category is further structured to limit said at least one subsequent transaction to a maximum dollar amount.

43. (Previously Presented as claim 44) A system for performing secure credit card purchases as recited in claim 34 wherein said payment category is further structured to

Application No. 11/252,009

Amdt. Dated May 13, 2009

Reply to Office Action dated November 13, 2008

limit said at least one subsequent transaction to a  
predetermined time period.



UNITED STATES PATENT AND TRADEMARK OFFICE

UNITED STATES DEPARTMENT OF COMMERCE  
 United States Patent and Trademark Office  
 Address: COMMISSIONER FOR PATENTS  
 P.O. Box 1450  
 Alexandria, Virginia 22313-1450  
 www.uspto.gov



Bib Data Sheet

CONFIRMATION NO. 4322

<b>SERIAL NUMBER</b> 11/252,009	<b>FILING OR 371(c) DATE</b> 10/17/2005 <b>RULE</b>	<b>CLASS</b> 705	<b>GROUP ART UNIT</b> 3691	<b>ATTORNEY DOCKET NO.</b>
------------------------------------	---	---------------------	-------------------------------	----------------------------

**APPLICANTS**  
 John D'Agostino, Sarasota, FL;

**\*\* CONTINUING DATA \*\*\*\*\***  
 This application is a CON of 10/037,007 11/09/2001 ABN  
 which is a CIP of 09/231,745 01/15/1999 PAT 6,324,526

**\*\* FOREIGN APPLICATIONS \*\*\*\*\***

**IF REQUIRED, FOREIGN FILING LICENSE GRANTED\*\* SMALL ENTITY \*\***  
 \*\* 11/03/2005

Foreign Priority claimed <input type="checkbox"/> yes <input type="checkbox"/> no	<b>STATE OR COUNTRY</b> FL	<b>SHEETS DRAWING</b> 2	<b>TOTAL CLAIMS</b> 44	<b>INDEPENDENT CLAIMS</b> 6	
35 USC 119 (a-d) conditions met <input type="checkbox"/> yes <input type="checkbox"/> no <input type="checkbox"/> Met after Allowance					
Verified and Acknowledged	Examiner's Signature _____	Initials _____			

**ADDRESS**  
 JOHN D'AGOSTINO  
 5168 NORTHRIDGE ROAD #309  
 SARASOTA, FL34238

**TITLE**  
 System and method for performing secure credit card purchases

<b>FILING FEE RECEIVED</b> 1400	FEES: Authority has been given in Paper No. _____ to charge/credit DEPOSIT ACCOUNT No. _____ for following:	<input type="checkbox"/> All Fees
		<input type="checkbox"/> 1.16 Fees ( Filing )
		<input type="checkbox"/> 1.17 Fees ( Processing Ext. of time )
		<input type="checkbox"/> 1.18 Fees ( Issue )
		<input type="checkbox"/> Other _____
		<input type="checkbox"/> Credit



UNITED STATES PATENT AND TRADEMARK OFFICE

UNITED STATES DEPARTMENT OF COMMERCE  
United States Patent and Trademark Office  
Address: COMMISSIONER FOR PATENTS  
P.O. Box 1450  
Alexandria, Virginia 22313-1450  
www.uspto.gov

APPLICATION NUMBER	FILING OR 371(C) DATE	FIRST NAMED APPLICANT	ATTY. DOCKET NO./TITLE
11/252,009	10/17/2005	John D'Agostino	1.706-B.04

MALLOY & MALLOY, P.A.  
2800 S.W. Third Avenue  
Historic Coral Way  
Miami, FL 33129

**CONFIRMATION NO. 4322**  
**POWER OF ATTORNEY NOTICE**



Date Mailed: 03/12/2009

**NOTICE REGARDING CHANGE OF POWER OF ATTORNEY**

This is in response to the Power of Attorney filed 01/26/2009.

- The withdrawal as attorney in this application has been accepted. Future correspondence will be mailed to the new address of record. 37 CFR 1.33.

/dcgoodwyn/

Office of Data Management, Application Assistance Unit (571) 272-4000, or (571) 272-4200, or 1-888-786-0101



UNITED STATES PATENT AND TRADEMARK OFFICE

Commissioner for Patents  
United States Patent and Trademark Office  
P.O. Box 1450  
Alexandria, VA 22313-1450  
www.uspto.gov

MALLOY & MALLOY, P.A.  
2800 S.W. THIRD AVENUE  
HISTORIC CORAL WAY  
MIAMI, FL 33129

**COPY MAILED**

MAR 1 2 2009

**OFFICE OF PETITIONS**

In re Application of	:	
John D'AGOSTINO	:	
Application No. 11/252,009	:	DECISION ON PETITION
Filed: October 17, 2005	:	TO WITHDRAW
Attorney Docket No. 1.706-B.04	:	FROM RECORD
	:	

This is a decision on the Request to Withdraw as attorney or agent of record under 37 C.F.R. § 1.36(b), filed January 26, 2009.

The request is **APPROVED**.

A grantable request to withdraw as attorney/agent of record must be signed by every attorney/agent seeking to withdraw or contain a clear indication that one attorney is signing on behalf of another/others. The Office requires the practitioner(s) requesting withdrawal to certify that he, she, or they have: (1) given reasonable notice to the client, prior to the expiration of the response period, that the practitioner(s) intends to withdraw from employment; (2) delivered to the client or a duly authorized representative of the client all papers and property (including funds) to which the client is entitled; and (3) notified the client of any responses that may be due and the time frame within which the client must respond, pursuant 37 CFR 10.40(c).

The request was signed by Peter A. Matos on behalf of all the attorneys of record.

All the attorneys of record have been withdrawn.

Applicant is reminded that there is no attorney of record at this time.

The correspondence address of record has been changed and the new correspondence address is the address indicated below until otherwise properly notified by the applicant.

Telephone inquiries concerning this decision should be directed to the undersigned at 571-272-6735.



Diane Goodwyn  
Petitions Examiner  
Office of Petitions

cc: JOHN D'AGOSTINO  
5168 NORTHRIDGE ROAD #309  
SARASOTA, FL 34238



DFW

IN THE UNITED STATES PATENT AND TRADEMARK OFFICE

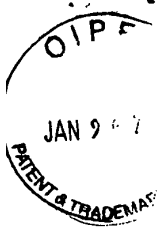

Applicant: John D'Agostino  
 Serial No.: 11/252,009  
 Filing Date: October 17, 2005  
 For: SYSTEM AND METHOD FOR PERFORMING SECURE USER ACCOUNT PURCHASES

Confirmation No. 4322  
 Customer No. 04219  
 Bijendra Shrestha, Examiner  
 Group Art Unit 3691

2800 S.W. Third Avenue  
 Historic Coral Way  
 Miami, Florida 33129

Commissioner for Patents  
 P.O. Box 1450  
 Alexandria, VA 22313-1450

Dear Sir:

CERTIFICATE OF MAILING

I HEREBY CERTIFY that this correspondence is being deposited with the United States Postal Service as first class mail in an envelope addressed to Commissioner for Patents, P.O. Box 1450, Alexandria, VA 22313-1450, this 23 day of January, 2009.

Respectfully submitted,

MALLOY & MALLOY, P.A.  
 2800 S.W. Third Avenue  
 Historic Coral Way  
 Miami, Florida 33129  
 (305) 858-8000

By:   
 Peter A. Matos  
 Reg. No. 37,884

Date: 1/23/09

Doc Code: PET.POA.WDRW

Document Description: Petition to withdraw attorney or agent (SB83)

PTO/SB/83 (04-08)

Approved for use through 12/31/2008. OMB 0651-0035  
U.S. Patent and Trademark Office, U.S. DEPARTMENT OF COMMERCE

Under the Paperwork Reduction Act of 1995, no persons are required to respond to a collection of information unless it displays a valid OMB control number.

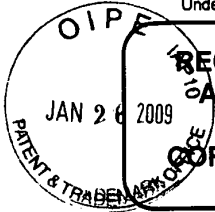

**REQUEST FOR WITHDRAWAL  
AS ATTORNEY OR AGENT  
AND CHANGE OF  
CORRESPONDENCE ADDRESS**

Application Number	11/252,009
Filing Date	October 17, 2005
First Named Inventor	John D'Agostino
Art Unit	4322
Examiner Name	Bijendra K. Shrestha
Attorney Docket Number	1.706-B.04

To: Commissioner for Patents  
P.O. Box 1450  
Alexandria, VA 22313-1450

Please withdraw me as attorney or agent for the above identified patent application, and

- all the practitioners of record;
- the practitioners (with registration numbers) of record listed on the attached paper(s); or
- the practitioners of record associated with Customer Number: \_\_\_\_\_

**NOTE:** The immediately preceding box should only be marked when the practitioners were appointed using the listed Customer Number.

The reason(s) for this request are those described in 37 CFR :

- |   |   |  |  |
|---|---|--|--|
| <input type="checkbox"/> 10.40(b)(1)    | <input type="checkbox"/> 10.40(b)(2)                | <input type="checkbox"/> 10.40(b)(3)                       | <input type="checkbox"/> 10.40(b)(4)     |
| <input type="checkbox"/> 10.40(c)(1)(i) | <input type="checkbox"/> 10.40(c)(1)(ii)            | <input type="checkbox"/> 10.40(c)(1)(iii)                  | <input type="checkbox"/> 10.40(c)(1)(iv) |
| <input type="checkbox"/> 10.40(c)(1)(v) | <input checked="" type="checkbox"/> 10.40(c)(1)(vi) | <input type="checkbox"/> 10.40(c)(2)                       | <input type="checkbox"/> 10.40(c)(3)     |
| <input type="checkbox"/> 10.40(c)(4)    | <input type="checkbox"/> 10.40(c)(5)                | <input type="checkbox"/> 10.40(c)(6) Please explain below: |  |

**Certifications**

**Check each box below that is factually correct. WARNING: If a box is left unchecked, the request will likely not be approved.**

1.  I/We have given reasonable notice to the client, prior to the expiration of the response period, that the practitioner(s) intend to withdraw from employment.
2.  I/We have delivered to the client or a duly authorized representative of the client all papers and property (including funds) to which the client is entitled.
3.  I/We have notified the client of any responses that may be due and the time frame within which the client must respond.

Please provide an explanation, if necessary:

[Page 1 of 2]

This collection of information is required by 37 CFR 1.36. The information is required to obtain or retain a benefit by the public which is to file (and by the USPTO to process) an application. Confidentiality is governed by 35 U.S.C. 122 and 37 CFR 1.11 and 1.14. This collection is estimated to take 12 minutes to complete, including gathering, preparing, and submitting the completed application form to the USPTO. Time will vary depending upon the individual case. Any comments on the amount of time you require to complete this form and/or suggestions for reducing this burden, should be sent to the Chief Information Officer, U.S. Patent and Trademark Office, U.S. Department of Commerce, P.O. Box 1450, Alexandria, VA 22313-1450. DO NOT SEND FEES OR COMPLETED FORMS TO THIS ADDRESS. SEND TO: Commissioner for Patents, P.O. Box 1450, Alexandria, VA 22313-1450.

If you need assistance in completing the form, call 1-800-PTO-9199 and select option 2.

Under the Paperwork Reduction Act of 1995, no persons are required to respond to a collection of information unless it displays a valid OMB control number.

## REQUEST FOR WITHDRAWAL AS ATTORNEY OR AGENT AND CHANGE OF CORRESPONDENCE ADDRESS

Complete the following section only when the correspondence address will change. Changes of address will only be accepted to an inventor or an assignee that has properly made itself of record pursuant to 37 CFR 3.71.

Change the correspondence address and direct all future correspondence to:

A.  The address of the inventor or assignee associated with Customer Number: \_\_\_\_\_

OR

B.  Inventor or  
Assignee name John D'Agostino

Address 5168 Northridge Road #309

City Sarasota State Florida Zip 34238 Country USA

Telephone (941) 922-7007 Email

I am authorized to sign on behalf of myself and all withdrawing practitioners.

Signature



Name Peter A. Matos Registration No. 37,884

Address 2800 S.W. Third Avenue

City Miami State Florida Zip 33129 Country USA

Date 1/23/2009 Telephone No. (305) 858-8000

NOTE: Withdrawal is effective when approved rather than when received.

[Page 2 of 2]

This collection of information is required by 37 CFR 1.36. The information is required to obtain or retain a benefit by the public which is to file (and by the USPTO to process) an application. Confidentiality is governed by 35 U.S.C. 122 and 37 CFR 1.11 and 1.14. This collection is estimated to take 12 minutes to complete, including gathering, preparing, and submitting the completed application form to the USPTO. Time will vary depending upon the individual case. Any comments on the amount of time you require to complete this form and/or suggestions for reducing this burden, should be sent to the Chief Information Officer, U.S. Patent and Trademark Office, U.S. Department of Commerce, P.O. Box 1450, Alexandria, VA 22313-1450. DO NOT SEND FEES OR COMPLETED FORMS TO THIS ADDRESS. SEND TO: Commissioner for Patents, P.O. Box 1450, Alexandria, VA 22313-1450.

If you need assistance in completing the form, call 1-800-PTO-9199 and select option 2.



Telephone inquiries concerning this decision should be directed to the undersigned at 571-272-6735.



Diane Goodwyn  
Petitions Examiner  
Office of Petitions

cc: JOHN D'AGOSTINO  
5168 NORTHRIDGE ROAD #309  
SARASOTA, FL 34238

Under the Paperwork Reduction Act of 1995, no persons are required to respond to a collection of information unless it displays a valid OMB control number.

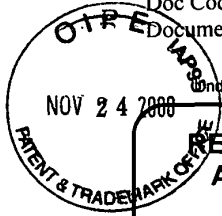

**REQUEST FOR WITHDRAWAL AS ATTORNEY OR AGENT AND CHANGE OF CORRESPONDENCE ADDRESS**

Application Number	11/252,009
Filing Date	October 17, 2005
First Named Inventor	John D'Agostino
Art Unit	4322
Examiner Name	Bijendra K. Shrestha
Attorney Docket Number	1.706-B.04

To: Commissioner for Patents  
P.O. Box 1450  
Alexandria, VA 22313-1450

Please withdraw me as attorney or agent for the above identified patent application, and

- all the practitioners of record;
- the practitioners (with registration numbers) of record listed on the attached paper(s); or
- the practitioners of record associated with Customer Number: 04219

**NOTE:** The immediately preceding box should only be marked when the practitioners were appointed using the listed Customer Number.

The reason(s) for this request are those described in 37 CFR :

- |   |   |  |  |
|---|---|--|--|
| <input type="checkbox"/> 10.40(b)(1)    | <input type="checkbox"/> 10.40(b)(2)                | <input type="checkbox"/> 10.40(b)(3)                       | <input type="checkbox"/> 10.40(b)(4)     |
| <input type="checkbox"/> 10.40(c)(1)(i) | <input type="checkbox"/> 10.40(c)(1)(ii)            | <input type="checkbox"/> 10.40(c)(1)(iii)                  | <input type="checkbox"/> 10.40(c)(1)(iv) |
| <input type="checkbox"/> 10.40(c)(1)(v) | <input checked="" type="checkbox"/> 10.40(c)(1)(vi) | <input type="checkbox"/> 10.40(c)(2)                       | <input type="checkbox"/> 10.40(c)(3)     |
| <input type="checkbox"/> 10.40(c)(4)    | <input type="checkbox"/> 10.40(c)(5)                | <input type="checkbox"/> 10.40(c)(6) Please explain below: |  |

**Certifications**

**Check each box below that is factually correct. WARNING: If a box is left unchecked, the request will likely not be approved.**

1.  I/We have given reasonable notice to the client, prior to the expiration of the response period, that the practitioner(s) intend to withdraw from employment.
2.  I/We have delivered to the client or a duly authorized representative of the client all papers and property (including funds) to which the client is entitled.
3.  I/We have notified the client of any responses that may be due and the time frame within which the client must respond.

Please provide an explanation, if necessary:

[Page 1 of 2]

This collection of information is required by 37 CFR 1.36. The information is required to obtain or retain a benefit by the public which is to file (and by the USPTO to process) an application. Confidentiality is governed by 35 U.S.C. 122 and 37 CFR 1.11 and 1.14. This collection is estimated to take 12 minutes to complete, including gathering, preparing, and submitting the completed application form to the USPTO. Time will vary depending upon the individual case. Any comments on the amount of time you require to complete this form and/or suggestions for reducing this burden, should be sent to the Chief Information Officer, U.S. Patent and Trademark Office, U.S. Department of Commerce, P.O. Box 1450, Alexandria, VA 22313-1450. DO NOT SEND FEES OR COMPLETED FORMS TO THIS ADDRESS. SEND TO: Commissioner for Patents, P.O. Box 1450, Alexandria, VA 22313-1450.

If you need assistance in completing the form, call 1-800-PTO-9199 and select option 2.

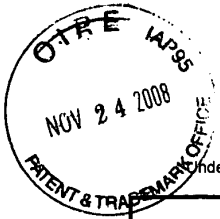

Under the Paperwork Reduction Act of 1995, no persons are required to respond to a collection of information unless it displays a valid OMB control number.

### REQUEST FOR WITHDRAWAL AS ATTORNEY OR AGENT AND CHANGE OF CORRESPONDENCE ADDRESS

Complete the following section only when the correspondence address will change. Changes of address will only be accepted to an inventor or an assignee that has properly made itself of record pursuant to 37 CFR 3.71.

Change the correspondence address and direct all future correspondence to:

A.  The address of the inventor or assignee associated with Customer Number: \_\_\_\_\_

**OR**

B.  Inventor or Assignee name John D'Agostino

Address 5168 Northridge Road #309

City Sarasota	State Florida	Zip 34238	Country USA
---------------	---------------	-----------	-------------

Telephone	(941) 922-7007	Email
-----------	----------------	-------

I am authorized to sign on behalf of myself and all withdrawing practitioners.

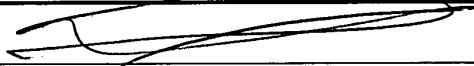
Signature		
Name	Peter A. Matos	Registration No. 37,884

Address 2800 S.W. Third Avenue

City Miami	State Florida	Zip 33129	Country USA
------------	---------------	-----------	-------------

Date	11-21-2008	Telephone No. (305) 858-8000
------	------------	------------------------------

**NOTE: Withdrawal is effective when approved rather than when received.**

[Page 2 of 2]

This collection of information is required by 37 CFR 1.36. The information is required to obtain or retain a benefit by the public which is to file (and by the USPTO to process) an application. Confidentiality is governed by 35 U.S.C. 122 and 37 CFR 1.11 and 1.14. This collection is estimated to take 12 minutes to complete, including gathering, preparing, and submitting the completed application form to the USPTO. Time will vary depending upon the individual case. Any comments on the amount of time you require to complete this form and/or suggestions for reducing this burden, should be sent to the Chief Information Officer, U.S. Patent and Trademark Office, U.S. Department of Commerce, P.O. Box 1450, Alexandria, VA 22313-1450. DO NOT SEND FEES OR COMPLETED FORMS TO THIS ADDRESS. SEND TO: Commissioner for Patents, P.O. Box 1450, Alexandria, VA 22313-1450.

*If you need assistance in completing the form, call 1-800-PTO-9199 and select option 2.*

JFW



IN THE UNITED STATES PATENT AND TRADEMARK OFFICE

Applicant: John D'Agostino  
Serial No.: 11/252,009  
Filing Date: October 17, 2005  
For: SYSTEM AND METHOD FOR PERFORMING SECURE USER ACCOUNT PURCHASES

Confirmation No. 4322  
Customer No. 04219  
Bijendra Shrestha, Examiner  
Group Art Unit 3691

2800 S.W. Third Avenue  
Historic Coral Way  
Miami, Florida 33129

Commissioner for Patents  
P.O. Box 1450  
Alexandria, VA 22313-1450

Dear Sir:

CERTIFICATE OF MAILING

I HEREBY CERTIFY that this correspondence is being deposited with the United States Postal Service as first class mail in an envelope addressed to Commissioner for Patents, P.O. Box 1450, Alexandria, VA 22313-1450, this 21 day of ~~October~~ <sup>NOV.</sup> 2008.

Respectfully submitted,

MALLOY & MALLOY, P.A.  
2800 S.W. Third Avenue  
Historic Coral Way  
Miami, Florida 33129  
(305) 858-8000

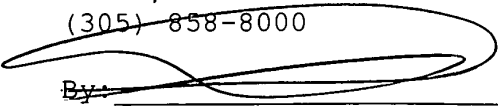
By:   
Peter A. Matos  
Reg. No. 37,884

Date: 11/21/08





UNITED STATES PATENT AND TRADEMARK OFFICE

UNITED STATES DEPARTMENT OF COMMERCE  
United States Patent and Trademark Office  
Address: COMMISSIONER FOR PATENTS  
P.O. Box 1450  
Alexandria, Virginia 22313-1450  
www.uspto.gov

APPLICATION NO.	FILING DATE	FIRST NAMED INVENTOR	ATTORNEY DOCKET NO.	CONFIRMATION NO.
-----------------	-------------	----------------------	---------------------	------------------

11/252,009	10/17/2005	John D'Agostino	1.706-B.04	4322
------------	------------	-----------------	------------	------

<sup>7590</sup>  
MALLOY & MALLOY, P.A.  
2800 S.W. Third Avenue  
Historic Coral Way  
Miami, FL 33129

11/13/2008

EXAMINER
----------

SHRESTHA, BIJENDRA K

ART UNIT	PAPER NUMBER
----------	--------------

3691

MAIL DATE	DELIVERY MODE
-----------	---------------

11/13/2008

PAPER

**Please find below and/or attached an Office communication concerning this application or proceeding.**

The time period for reply, if any, is set in the attached communication.



### **DETAILED ACTION**

Claims 1-44 are presented for examination. Applicant filed an amendment on 08/04/2008 amending claims 1, 27-29, and 32-36. After careful consideration of applicant's arguments and amendments, new grounds of rejections of claims necessitated by Applicant's amendment are established in the instant application as set forth in detail below. Applicant's arguments with respect to claims have been considered but are moot in view of the new ground(s) of rejection.

#### ***Information Disclosure Statement***

Applicant is respectfully requested to cite the references relevant to the instant application so that the Examiner can review it in limited available time.

#### ***Claim Rejections - 35 USC § 103***

1. The following is a quotation of 35 U.S.C. 103(a) which forms the basis for all obviousness rejections set forth in this Office action:

(a) A patent may not be obtained though the invention is not identically disclosed or described as set forth in section 102 of this title, if the differences between the subject matter sought to be patented and the prior art are such that the subject matter as a whole would have been obvious at the time the invention was made to a person having ordinary skill in the art to which said subject matter pertains. Patentability shall not be negated by the manner in which the invention was made.

2. Claims 1-44 are rejected under 35 U.S.C. 103(a) as being unpatentable over Franklin et al., U.S. Patent No. 6,000,832 (reference A in attached PTO-892) in view of Yanagihara et al. U.S. Pub No. 2001/0011249 (reference B in attached PTO-892).

3. As per claim 1, Franklin et al. teach a method of performing secure credit card purchases, said method comprising:

a) contacting a custodial authorizing entity having custodial responsibility of account parameters of customer's account that can be used to make credit card purchases (see Fig. 1; Issuing Bank (26) connected to customer (22) and merchant (24) connected by Internet (34); column 4, lines 3-9; where commerce card is issued by credit card companies or card sponsoring companies);

b) supplying the custodial authorizing entity with at least account identification data (see Fig. 4; Fig. 7);

c) defining a payment category including at least the ability to limit purchases to a single unidentified merchant for at least one transaction (see column 9, lines 52-55); where code specific to a merchant is generated by the software supplied by the issuing bank installed on customer computer as described in column 2, lines 18-37);

e) generating a transaction code and the ability to make a purchase within said designated payment category (see Fig. 4-6; column 10, lines 44-65);

f) communicating the transaction code to a merchant to consummate a purchase with defined purchase parameters (see Fig. 3; column 5, lines 41-58);

g) verifying that said defined purchase parameters are within said designated payment category (see column 5, lines 59-67 to column 6, lines 1-12); and

h) providing authorization for said purchase so as to confirm at least that said defined purchase parameters are within said designated payment category and complete the purchase (see column 12, lines 27-43).

Franklin et al. teach generating a transaction code with transaction specific data (see Fig. 4; Transaction Specific Data which include good identification; column 9, lines 40-43) and but do not teach predefining and associating with the payment categories.

Yanagihara et al. teach predefining and associating the transaction code with the payment categories (see Fig. 2; Fig. 4; paragraph [0019])

Therefore, it would be obvious to one of ordinary skill in the art at the time the invention was made to allow predefining and associating the transaction code with the payment categories of Franklin et al. because Yanagihara et al. teach that including above features would enable user to use usage identification code which indicates purpose of use and usage limit to indicate maximum amount to withdraw (Yanagihara et al., paragraph [0019]).

4. As per claim 2, Franklin et al. in view of Yanagihara et al. teach claim 1 as described above. Franklin et al. further teaches the method comprising

identification of said single merchant upon designation of said payment category (see column 9, lines 40-43; where merchant identification identify the merchant).

5. As per claim 3, Franklin et al. in view of Yanagihara et al. teach claim 1 as described above. Franklin et al. further teaches the method comprising step of designating said single merchant subsequent to generating said transaction code (see Fig. 4; transaction specific data that include merchant identification).

6. As per claim 4, Franklin et al. in view of Yanagihara et al. teach claim 1 as described above. Franklin et al. further teaches the method wherein

step of communicating the transaction code to said merchant to consummate said purchase within defined purchase parameters further comprises designation of said single merchant (see Fig. 4; column 9, lines 18-30; column 49-58).

7. As per claim 5, Franklin et al. in view of Yanagihara et al. teach claim 1 as described above. Franklin et al. further teaches the method wherein

said step of generating said transaction code further comprises said custodial authorizing entity generating said transaction code (see column 3, lines 29-36; 40-45).

8. As per claim 6, Franklin et al. in view of Yanagihara et al. teach claim 1 as described above. Franklin et al. further teaches the method wherein

said step of generating said transaction code further comprises said customer generating said transaction code (see column 3, lines 21-37).

9. As per claim 7, Franklin et al. in view of Yanagihara et al. teach claim 1 as described above. Franklin et al. further teaches the method comprising

obtaining said authorization for said purchase from the custodial authorizing entity (see column 5, lines 59—67).

10. As per claim 8, Franklin et al. in view of Yanagihara et al. teach claim 1 as described above. Franklin et al. further teaches the method comprising

a step of communicating promotional information of offered subject matter to the customer by the merchant, pre-determining the purchase parameters of the purchase, and corresponding said designated payment category to said purchase parameters (see column 9, lines 12-30; where customer surf the web for purchasing; Examiner notes that

customer have access to promotional information of the offered subject matter in the web or merchant website).

11. As per claim 9, Franklin et al. in view of Yanagihara et al. teach claim 1 as described above. Franklin et al. further teaches the method comprising the merchant communicating the transaction code to the custodial authorizing entity for verification (see Fig. 7).

12. As per claims 10-14, Franklin et al. in view of Yanagihara et al. teach claim 1 as described above.

Franklin et al. further teach the method comprising generating a transaction code which reflects at least one of a plurality of said payment categories that include the ability to designate amount parameters for a cost of one or more purchases, ability to designate time parameters during which the purchase can be completed, ability to use said transaction code for a single transaction at a fixed amount for purchase within a predetermined period of time, ability to limit purchases to said single transaction at said fixed amount for purchase within said predetermined period of time (see Fig.4, column 2, lines 30-32; column 9, lines 49-58; column 10, lines 52-65).

13. As per claims 15-24, Franklin et al. in view of Yanagihara et al. teach claim 10 as described above.

Franklin et al. do not teach a) the ability to use said transaction code for a single transaction at a fixed or maximum amount for a purchase within a predetermined period of time, c) the ability to use said transaction code for multiple transactions at a fixed or maximum total amount for purchases within a predetermined time period, d) the ability

to use said transaction code for a repeating transaction at a fixed amount for purchases payable at each of a fixed number of time intervals, and e) the ability to use said transaction code for a repeating transaction at a fixed amount for purchases payable at each of an unspecified number of time intervals.

Yanagihara et al. teach storing a restrictive condition for withdrawal of amount from the money card and application of the predetermined condition during withdrawal of the money from the card ( Yanagihara et al., Fig. 2, Payment Condition (209) and Transaction Record (210); paragraph [0005], [0006] and 0019]; the Examiner notes any above preconditions in claims 5-15 and 19-26 can be set in Payment Condition (209) in Fig. 2).

Therefore, it would be prima facie obvious to one of ordinary skill in the art at the time the invention was made to allow storing a restrictive condition for withdrawal of amount from the money card and application of the predetermined condition during withdrawal of the money from the card of Franklin et al. because Yanagihara et al. teach that including above features would enable user to use usage identification code which indicates purpose of use (Yanagihara et al., paragraph [0019]).

14. As per claim 25, Franklin et al. in view of Yanagihara et al. teach claim 1 as described above.

Franklin et al. further teaches the method comprising generating said transaction code to further reflect an identification of said single merchant (see Fig. 4, column 9, lines 43, 52-55).



15. As per claim 26, Franklin et al. teach claim 25 as described above. Franklin et al. further teaches the method defining said payment category to include the ability to limit purchases to a limited time interval during which said purchase authorization is valid (see column 10, lines 52-65).

16. As per claim 27-29, Franklin et al. teach a method of performing secure credit card purchases, said method comprising

a) identifying a pre-established account that can be used to make credit card purchases; b) designating at least one of a plurality payment categories which limit a nature of a subsequent purchase (see column 2, lines 9-21); column 4, lines 3-9; where commerce card is issued by credit card companies or card sponsoring companies);

c) issuing a transaction code associated with at least said credit card account and said selected payment category, and different from said credit card account (see Fig. 4, column 2, lines 22-35);

d) communicating said transaction code to a merchant to consummate a purchase within defined purchase parameters (see column 2, lines 35-38);

e) verifying that said defined purchase parameters correspond to said designated payment category (see column 2, lines 47-64); and

f) providing authorization for said purchase so as to confirm at least that said defined purchase parameters are within said designated payment category and complete the purchase (see column 2, lines 65-67 to column 3, lines 1-6); and

g) associating the purchase with said credit card account (see column 12, lines 34-43).

Franklin teaches generating a transaction code with transaction specific data (see Fig. 4; Transaction Specific Data which include good identification; column 9, lines 40-43) and but do not teach predefining and associating with the payment categories.

Yanagihara et al. teach predefining and associating the transaction code with the payment categories (see Fig. 2; Fig. 4; paragraph [0019])

Therefore, it would be obvious to one of ordinary skill in the art at the time the invention was made to allow predefining and associating the transaction code with the payment categories of Franklin et al. because Yanagihara et al. teach that including above features would enable user to use usage identification code which indicates purpose of use and usage limit to indicate maximum amount to withdraw (Yanagihara et al., paragraph [0019]).

17. As per claims 30-31, Franklin et al. in view of Yanagihara et al. teach claim 19 as described above.

Franklin et al. do not teach restriction on purchases based on pre-selected payment categories.

Yanagihara et al. teach restriction on purchases based on payment categories such that it limits nature of subsequent purchases in terms of amount (Yanagihara, paragraphs [0006], [0021]).

Therefore, it would be prima facie obvious to one of ordinary skill in the art at the time the invention was made to allow storing a restrictive condition for withdrawal of

amount from the money card and application of the predetermined condition during withdrawal of the money from the card of Franklin et al. because Yanagihara et al. teach that including above features would enable user to use usage identification code which indicates purpose of use (Yanagihara et al., paragraph [0019]).

18. As per claim 32, Franklin et al. in view of Yanagihara et al. teach claim 29 as described above. Franklin et al. further teaches the method wherein

said step of verifying that said defined purchase parameters correspond to said selected payment category further identifies said merchant as said single merchant (see Fig. 4, column 9, lines 43, 52-55).

19. As per claim 33, Franklin et al. teach a method of performing secure card purchases, said method comprising:

a) identifying a pre-established credit card account that can be used to make credit card purchases (see column 2, lines 9-21); column 4, lines 3-9; where commerce card is issued by credit card companies or card sponsoring companies);

b) selecting a payment category which limits a nature of a subsequent purchase to an unidentified single merchant (see Fig. 4, column 9, lines 43, 52-55); where code specific to a merchant is generated by the software supplied by the issuing bank installed on customer computer as described in column 2, lines 18-37);

c) issuing a transaction code associated with at least said credit card account and said selected payment category, and different from said credit card account (see Fig. 4-6; column 10, lines 44-65);

d) designating a merchant as said single merchant (see Fig. 4; column 9, lines 52-55);

e) communicating said transaction code to said merchant to consummate a purchase within defined purchase parameters (see column 2, lines 35-38);

f) verifying that said defined purchase parameters correspond to said selected payment category (see column 2, lines 47-64);

g) providing authorization for said purchase so as to confirm at least that said defined purchase parameters are within said selected payment category and complete the purchase (see column 2, lines 65-67 to column 3, lines 1-6); and

h) associating the purchase with said-credit card account (see column 12, lines 34-43).

Franklin teaches generating a transaction code with transaction specific data (see Fig. 4; Transaction Specific Data which include good identification; column 9, lines 40-43) and but do not teach predefining and associating with the payment categories.

Yanagihara et al. teach predefining and associating the transaction code with the payment categories (see Fig. 2: Fig. 4; paragraph [0019])

Therefore, it would be obvious to one of ordinary skill in the art at the time the invention was made to allow predefining and associating the transaction code with the payment categories of Franklin et al. because Yanagihara et al. teach that including above features would enable user to use usage identification code which indicates purpose of use and usage limit to indicate maximum amount to withdraw (Yanagihara et al., paragraph [0019]).

20. As per claim 34, Franklin et al. teach claim 33 as described above. Franklin et al. further teaches the method wherein said step of verifying that said defined purchase parameters correspond to said selected payment category further identifies said merchant as said single merchant (see column 2, lines 50-64).

21. As per claim 35, Franklin et al. teach a system for performing secure credit\_card purchases (see Fig. 1) comprising:

a) a custodial authorizing entity, said custodial authorizing entity structured to maintain a pre-established account that can be used to make credit card purchases for at least one user (see Fig. 1, Issuing Bank (26); column 2, lines 8-11); column 4, lines 3-9; where commerce card is issued by credit card companies or card sponsoring companies);

b) said custodial authorizing entity further structured to define at least one payment category available for selection by a customer, said payment category structured to limit at least one subsequent transaction to a single merchant (see column 2, lines 11-21);

c) said custodial authorizing entity further structured to issue a transaction code associated with said payment category selected by the customer and said credit card account of the user, said transaction code being different from said credit card account (see Fig. 4-6; column 2, lines 22-35);

d) said custodial authorizing entity further structured to receive said transaction code and designated purchase parameters associated with a purchase from a

merchant, and to verify that said designated purchase parameters correspond to said selected payment category (see Fig. 7; column 2, lines 47-64); and

e) said custodial authorizing entity structured to provide the merchant with authorization for said purchase that confirms at least that said designated purchase parameters correspond to said selected payment category so that said purchase may be consummated by the merchant (see Fig. 7; column 2, lines 65-67 to column 3, lines 1-6).

22. As per claim 36, Franklin et al. teach claim 35 as described above. Franklin et al. further teaches the system wherein

said single merchant is identified upon selection of said payment category and is associated with said transaction code (see column 9, lines 40-43; where merchant identification identifies the merchant).

23. As per claim 37, Franklin et al. teach claim 35 as described above. Franklin et al. further teaches the system wherein

said custodial authorizing entity is structured to designate a first merchant to provide said transaction code for verification as said single merchant (see column 2, lines 18-21; 27-31; where software module supplied by issuing bank generates codes number in digits for customer specific data such as merchant identification).

24. As per claim 38, Franklin et al. teach claim 37 as described above. Franklin et al. further teaches the system wherein

said custodial authorizing entity is structured to designate said first merchant as said single merchant for subsequent transactions utilizing said transaction code

(Examiner interprets that custodial authority supplied software generates identification code for merchant and subsequent transaction could be transacted with the given code for the merchant).

25. As per claim 39-43, Franklin et al. teach claim 35 as described above.

Franklin et al. do not teach defining said payment category as a specific (maximum) dollar amount.

Yanagihara et al. teach defining said payment category as a specific maximum dollar amount (see paragraph [0019]).

Therefore, it would be prima facie obvious to one of ordinary skill in the art at the time the invention was made to allow defining said payment category as a specific maximum dollar amount of Franklin et al. because Yanagihara et al. teach that including above features would enable user to use usage identification code which indicates purpose of use and usage limit to indicate maximum amount to withdraw (Yanagihara et al., Fig. 2; paragraph [0019]).

26. As per claim 44, Franklin et al. teach claim 35 as described above. Franklin et al. further teaches the system wherein

said payment category is further structured to limit said at least one subsequent transaction to a predetermined time period (see column 10, lines 52-65).

### ***Response to Arguments***

27. Applicant's amendment necessitated the new ground(s) of rejection presented in this Office action. Applicant's arguments with respect to claims have been considered but are moot in view of the new ground(s) of rejection.

In response to applicant's argument that the references fail to show certain features of applicant's invention, it is noted that the features upon which applicant relies (i.e., inability to use transaction code for more than one merchant) are not recited in the rejected claim(s). Although the claims are interpreted in light of the specification, limitations from the specification are not read into the claims. See *In re Van Geuns*, 988 F.2d 1181, 26 USPQ2d 1057 (Fed. Cir. 1993). Further the applicant's specification specifically describes "transaction code is precoded to be indicative to specific credit card account, preferably **a merchant or merchant's identification.....**" ( page 15, lines 10-13). Franklin et al. teach generating code number for merchant ID using software module provided by commerce card issuing bank (see column 2, lines 16-38). Examiner notes code thus generated would hide the identity of the merchant.

Examiner agrees that Franklin et al. do not teach disclosing payment category for a transaction. Examiner provided second reference of Yanagihara et al. for meeting this limitation under 103 rejection (Yanagihara et al., Figs. 2 and 4; paragraph [0019]).

### **Conclusion**

28. Accordingly, **THIS ACTION IS MADE FINAL**. See MPEP § 706.07(a). Applicant is reminded of the extension of time policy as set forth in 37 CFR 1.136(a).



A shortened statutory period for reply to this final action is set to expire THREE MONTHS from the mailing date of this action. In the event a first reply is filed within TWO MONTHS of the mailing date of this final action and the advisory action is not mailed until after the end of the THREE-MONTH shortened statutory period, then the shortened statutory period will expire on the date the advisory action is mailed, and any extension fee pursuant to 37 CFR 1.136(a) will be calculated from the mailing date of the advisory action. In no event, however, will the statutory period for reply expire later than SIX MONTHS from the date of this final action.

The prior art made of record and not relied upon is considered pertinent to applicant's disclosures. The following are pertinent to current invention, though not relied upon:

Benson et al. (U.S. Patent No. 5,845,281) teach method and system for managing a data object so as to comply with predetermined conditions for usage.

Demoff et al. (U.S. Patent No. 6,456,984) teach method and system for providing temporary credit authorizations.

Fleming (U.S. Patent No. 5,953,710) teaches children's credit or debit card system.

Foladare et al. (U.S. Patent No. 5,914,472) teach credit card spending authorization control system.

Franco (U.S. Patent No. 4,893,330) teaches method and apparatus for restricting credit card communication calls.

Kravitz (U.S. Patent No. 6,029,150) teaches payment and transactions in electronic commerce system.

Morrill, Jr. (U.S. Patent No. 5,991,749) teaches wireless telephony for collecting tolls, conducting financial transactions, and authorizing other activities.

Watson (U.S. Patent No. 5,991,750) teaches system and method for pre-authorization of individual account transactions.

Watson et al. (U.S. Patent No. 6,226,624) teach system and method for pre-authorization of individual account remote transactions.

Any inquiry concerning this communication or earlier communications from the examiner should be directed to Bijendra K. Shrestha whose telephone number is (571)270-1374. The examiner can normally be reached on 7:00AM-4:30PM (Monday-Friday); 2nd Friday OFF.

If attempts to reach the examiner by telephone are unsuccessful, the examiner's supervisor, Alexander Kalinowski can be reached on (571) 272-6771. The fax phone number for the organization where this application or proceeding is assigned is 571-273-8300.

Information regarding the status of an application may be obtained from the Patent Application Information Retrieval (PAIR) system. Status information for published applications may be obtained from either Private PAIR or Public PAIR. Status information for unpublished applications is available through Private PAIR only. For more information about the PAIR system, see <http://pair-direct.uspto.gov>. Should you have questions on access to the Private PAIR system, contact the Electronic Business Center (EBC) at 866-217-9197 (toll-free). If you would like assistance from a USPTO Customer Service Representative or access to the automated information system, call 800-786-9199 (IN USA OR CANADA) or 571-272-1000.

/Alexander Kalinowski/  
Supervisory Patent Examiner, Art  
Unit 3691

BKS/3691

<b>Notice of References Cited</b>	Application/Control No. 11/252,009	Applicant(s)/Patent Under Reexamination D'AGOSTINO, JOHN	
	Examiner BIJENDRA K. SHRESTHA	Art Unit 3691	Page 1 of 1

**U.S. PATENT DOCUMENTS**

*		Document Number Country Code-Number-Kind Code	Date MM-YYYY	Name	Classification
*	A	US-6,000,832	12-1999	Franklin et al.	700/232
*	B	US-2001/0011249	08-2001	YANAGIHARA et al.	705/41
*	C	US-5,845,281	12-1998	Benson et al.	707/9
*	D	US-6,456,984	09-2002	Demoff et al.	705/40
*	E	US-5,953,710	09-1999	Fleming, Stephen S.	705/38
*	F	US-5,914,472	06-1999	Foladare et al.	235/380
*	G	US-4,893,330	01-1990	Franco, Victor A.	379/91.02
*	H	US-6,029,150	02-2000	Kravitz, David William	705/39
*	I	US-5,991,749	11-1999	Morrill, Jr., Paul H.	705/44
*	J	US-5,991,750	11-1999	Watson, Craig	705/44
*	K	US-6,226,624	05-2001	Watson et al.	705/44
	L	US-			
	M	US-			

**FOREIGN PATENT DOCUMENTS**

*		Document Number Country Code-Number-Kind Code	Date MM-YYYY	Country	Name	Classification
	N					
	O					
	P					
	Q					
	R					
	S					
	T					

**NON-PATENT DOCUMENTS**

*		Include as applicable: Author, Title Date, Publisher, Edition or Volume, Pertinent Pages)
	U	
	V	
	W	
	X	

\*A copy of this reference is not being furnished with this Office action. (See MPEP § 707.05(a).)  
Dates in MM-YYYY format are publication dates. Classifications may be US or foreign.

<b>Index of Claims</b> 	<b>Application/Control No.</b> 11252009	<b>Applicant(s)/Patent Under Reexamination</b> D'AGOSTINO, JOHN
	<b>Examiner</b> Shrestha, Bijendra K	<b>Art Unit</b> 3691

✓	<b>Rejected</b>	-	<b>Cancelled</b>	N	<b>Non-Elected</b>	A	<b>Appeal</b>
=	<b>Allowed</b>	÷	<b>Restricted</b>	I	<b>Interference</b>	O	<b>Objected</b>

Claims renumbered in the same order as presented by applicant
  CPA
  T.D.
  R.1.47

CLAIM		DATE									
Final	Original	11/09/2008									
	1	✓									
	2	✓									
	3	✓									
	4	✓									
	5	✓									
	6	✓									
	7	✓									
	8	✓									
	9	✓									
	10	✓									
	11	✓									
	12	✓									
	13	✓									
	14	✓									
	15	✓									
	16	✓									
	17	✓									
	18	✓									
	19	✓									
	20	✓									
	21	✓									
	22	✓									
	23	✓									
	24	✓									
	25	✓									
	26	✓									
	27	✓									
	28	✓									
	29	✓									
	30	✓									
	31	✓									
	32	✓									
	33	✓									
	34	✓									
	35	✓									
	36	✓									

<b><i>Index of Claims</i></b> 	<b>Application/Control No.</b> 11252009	<b>Applicant(s)/Patent Under Reexamination</b> D'AGOSTINO, JOHN
	<b>Examiner</b> Shrestha, Bijendra K	<b>Art Unit</b> 3691

✓	<b>Rejected</b>	-	<b>Cancelled</b>	N	<b>Non-Elected</b>	A	<b>Appeal</b>
=	<b>Allowed</b>	÷	<b>Restricted</b>	I	<b>Interference</b>	O	<b>Objected</b>

Claims renumbered in the same order as presented by applicant
  CPA
  T.D.
  R.1.47

CLAIM		DATE								
Final	Original	11/09/2008								
	37	✓								
	38	✓								
	39	✓								
	40	✓								
	41	✓								
	42	✓								
	43	✓								
	44	✓								

<b><i>Search Notes</i></b> 	<b>Application/Control No.</b> 11252009	<b>Applicant(s)/Patent Under Reexamination</b> D'AGOSTINO, JOHN
	<b>Examiner</b> Shrestha, Bijendra K	<b>Art Unit</b> 3691

SEARCHED			
Class	Subclass	Date	Examiner

SEARCH NOTES		
Search Notes	Date	Examiner
None	11/09/2008	Bijendra K. Shrestha

INTERFERENCE SEARCH			
Class	Subclass	Date	Examiner

--	--





Application No. 11/252,009  
Amdt. Date July 29, 2008  
Reply to Office Action dated January 29, 2008

*IFU*



IN THE UNITED STATES PATENT AND TRADEMARK OFFICE

Applicant: John D'Agostino  
Serial No.: 11/252,009  
Filing Date: October 17, 2005

For: SYSTEM AND METHOD FOR PERFORMING SECURE CREDIT CARD  
PURCHASES

Confirmation No. 4322  
Customer No. 04219  
Shrestha, B., Examiner  
Group Art Unit 3691

Mail Stop Amendment  
Commissioner for Patents  
P.O. Box 1450  
Alexandria, VA 22313-1450

Sir:

With regard to applicant's response on July 29, 2008, to the office action dated January 29, 2008, applicant wishes to correct several minor typographical errors, made by applicant, and contained within applicants remarks and amended claims. Each error was inadvertent and typographical in nature.

Respectfully Submitted,

John D'Agostino  
5158 Northridge Road, Unit 309  
Sarasota, FL 34238  
(941) 228-2727

By: *John D'Agostino*

Date: 8-11-08

Application No. 11/252,009  
Amdt. Date July 29, 2008  
Reply to Office Action dated January 29, 2008

The errors/corrections are as follows:

1. REMARKS / ARGUMENTS

(As submitted July 29, 2008)

*To the best of applicant's knowledge this single merchant limitation was unknown in the art as of the priority date (January 19, 1999) of this application.*

(Corrected) To the best of applicant's knowledge this single merchant limitation was unknown in the art as of the priority date (January 15, 1999) of this application.

1. Amendments to the Claims

Please note that the words "the steps of" were struck in the previously submitted version of claim 33. The words were inadvertently left in place in the July 29, 2008 response to the office action of January 29, 2008.

(As submitted July 29, 2008)

*33. (Currently Amended) A method of performing secure credit card purchases, said method comprising the steps of:*

(Corrected)

33. (Currently Amended) A method of performing secure credit card purchases, said method comprising:

Application No. 11/252,009  
Amdt. Date July 29, 2008  
Reply to Office Action dated January 29, 2008

Applicant respectfully requests that Examiner note the  
aforementioned corrections.

Respectfully Submitted,

John D'Agostino

5168 Northridge Road Unit 309

Sarasota, FL 34238

(941) 228-1511

By: 

Date: 8-11-08



IN THE UNITED STATES PATENT AND TRADEMARK OFFICE

Applicant: John D'Agostino

Serial No.: 11/252,009

Filing Date: October 17, 2005

For: SYSTEM AND METHOD FOR PERFORMING SECURE CREDIT CARD PURCHASES

Confirmation No. 4322  
Customer No. 04219  
Shrestha, B., Examiner  
Group Art Unit 3691

Mail Stop Amendment  
Commissioner for Patents  
P.O. Box 1450  
Alexandria, VA 22313-1450

CERTIFICATE OF MAILING

I HEREBY CERTIFY that this correspondence is being deposited with the United States Postal Service as first class mail in an envelope addressed to: Mail Stop Amendment, Commissioner for Patents, P.O. Box 1450, Alexandria, VA 22313-1450, this 29 day of July, 2008.

Respectfully Submitted,

By:   
John D'Agostino

Date: 7-29-08



1fw

THE UNITED STATES PATENT AND TRADEMARK OFFICE

Applicant: John D'Agostino

Serial No.: 11/252,009

Filing Date: October 17, 2005

For: SYSTEM AND METHOD FOR PERFORMING SECURE CREDIT CARD PURCHASES

Confirmation No. 4322

Customer No. 04219

Shrestha, B., Examiner

Group Art Unit 3691

Mail Stop Amendment

Commissioner for Patents

P.O. Box 1450

Alexandria, VA 22313-1450

Sir:

REQUEST FOR EXTENSION OF TIME

A three-month extension of time is hereby requested pursuant to 37 CFR, Section 1.136 in order to respond to the Office Action dated January 29, 2008. In accordance with 37 CFR, Section 1.17(a)(3), the amount of \$525.00 for the requested extension of time of three months is enclosed herewith.

Respectfully Submitted,

John D'Agostino  
5158 Northridge Road, Unit 309  
Sarasota, FL 34238  
(941) 228-2727

By: 

Date: 7-29-08

08/05/2008 RNEBRAH1 00000021 11252009

01 FC:2253

525.00 OP



**Amendments to the Claims**

This listing of claims will replace all prior versions, and listings, of the claims in the application:

1. (Currently Amended) A method of performing secure credit card purchases, said method comprising:

a) contacting a custodial authorizing entity having custodial responsibility of account parameters of a customer's ~~credit-card~~ account that can be used to make credit card purchases;

b) supplying the custodial authorizing entity with at least account identification data;

c) Pre-defining a payment category including at least the ability to limit purchases to a single unidentified merchant for at least one transaction;

d) designating said payment category;

e) generating a transaction code reflecting at least said designated payment category and the ability to make a purchase within said designated payment category;

f) communicating the transaction code to a merchant to consummate a purchase with define purchase parameters;

g) verifying that said defined purchase parameters are within said designated payment category; and

h) providing authorization for said purchase so as to confirm at least that said defined purchase parameters are within said designated payment category and complete the purchase.

2. (Original) The method of claim 1 further comprising identification of said single merchant upon designation of said payment category.

3. (Original) The method of claim 1 further comprising the step of designating said single merchant subsequent to generating said transaction code.

4. (Original) The method of claim 1 wherein said step of communicating the transaction code to said merchant to consummate said purchase within defined purchase parameters further comprises designation of said single merchant.

5. (Previously Presented) The method of claim 1 wherein said step of generating said transaction code further comprises said custodial authorizing entity generating said transaction code.

6. (Original) The method of claim 1 wherein said step of generating said transaction code further comprises said customer generating said transaction code.

7. (Original) The method of claim 1 further comprising obtaining said authorization for said purchase from the custodial authorizing entity.

8. (Original) The method of claim 1 further comprising a step of communicating promotional information of offered subject matter to the customer by the merchant, pre-determining the purchase parameters of the purchase, and corresponding said designated payment category to said purchase parameters.

9. (Original) The method of claim 1 further comprising the merchant communicating the transaction code to the custodial authorizing entity for verification.

10. (Original) The method of claim 1 further comprising generating a transaction code which reflects at least one of a plurality of said payment categories.

11. (Original) The method of claim 10 further comprising defining at least one of said plurality of payment categories to include the ability to designate amount parameters for a cost of one or more purchases.

12. (Original) The method of claim 10 further comprising defining at least one of said plurality of payment categories to include the ability to designate time parameters during which the purchase can be completed.



13. (Original) The method of claim 10 further comprising defining at least one of said plurality of payment categories to include the ability to use said transaction code for a single transaction at a fixed amount for purchase within a predetermined period of time.

14. (Original) The method of claim 13 further comprising defining at least one of said plurality of payment categories to transaction at said fixed amount for purchase within said predetermined period of time.

15. (Original) The method of claim 10 further comprising defining at least one of said plurality of payment categories to include the ability to use said transaction code for a single transaction at a maximum amount for purchase within a predetermined period of time.

16. (Original) The method of claim 15 further comprising defining at least one of said plurality of payment categories to include the ability to limit purchases to said single transaction at said maximum amount for purchase within said predetermined period of time.

17. (Original) The method of claim 10 further comprising defining at least one of said plurality of payment categories to include the ability to use said transaction code for at least two purchases at a maximum total amount for items purchased within a predetermined time period.

18. (Original) The method of claim 17 further comprising defining at least one of said plurality of payment categories to include the ability to limit purchases to said at least two purchases at said maximum total amount for items purchased within said predetermined time period.

19. (Original) The method of claim 10 further comprising defining at least one of said plurality of payment categories to include the ability to use said transaction code for at least two purchases for a repeating transaction at a fixed amount payable at each of a fixed number of time intervals.

20. (Original) The method of claim 19 further comprising defining at least one of said plurality of payment categories to include the ability to limit purchases to said repeating transaction at said fixed amount payable at each of said fixed number of time intervals.

21. (Original) The method of claim 10 further comprising defining at least one of said plurality of payment categories to include the ability to use said transaction code for a repeating transaction at a fixed amount payable at each of an unspecified number of time intervals.

22. (Original) The method of claim 21 further comprising defining at least one of said plurality of payment categories to include the ability to limit purchases to

said repeating transaction at said fixed amount payable at each of said unspecified number of time intervals.

23. (Original) The method of claim 10 wherein at least some of said plurality of payment categories to include:

a) the ability to use said transaction code for a single transaction at a fixed amount for a purchase within a predetermined period of time,

b) the ability to use said transaction code for a single transaction at a maximum amount for a purchase within a predetermined period of time,

c) the ability to use said transaction code for multiple transactions at a maximum total amount for purchases within a predetermined time period,

d) the ability to use said transaction code for a repeating transaction at a fixed amount for purchases payable at each of a fixed number of time intervals, and

e) the ability to use said transaction code for a repeating transaction at a fixed amount for purchases payable at each of an unspecified number of time intervals.

24. (Original) The method of claim 10 wherein at least some of said plurality of payment categories include:

a) the ability to use said transaction code for a single transaction at a fixed amount for a purchase,

b) the ability to use said transaction code for a single transaction at a maximum amount for a purchase,

c) the ability to use said transaction code for multiple transactions at a maximum total amount for purchases,

d) the ability to use said transaction code for a repeating transaction at a fixed amount for purchases payable at each of a fixed number of time intervals, and

e) the ability to use said transaction code for a repeating transaction at a fixed amount for purchases payable at each of an unspecified number of time intervals.

25. (Original) The method of claim 1 further comprising generating said transaction code to further reflect an identification of said single merchant.

26. (Original). The method of claim 25 further comprising defining said payment category to include the ability to limit purchases to a limited time interval during which said purchase authorization is valid.

27. (Currently Amended) A method of performing secure credit card purchases, said method comprising:

a) identifying a pre-established ~~credit card~~ account that can be used to make credit card purchases;

b) designating at least one of a plurality of pre-defined payment categories which limit a nature of a subsequent purchase;

c) issuing a transaction code associated with at least said credit card account and said selected payment category, and different from said credit card account;

d) communicating said transaction code to a merchant to consummate a purchase within defined purchase parameters;

e) verifying that said defined purchase parameters correspond to said designated payment category; and

f) providing authorization for said purchase so as to confirm at least that said defined purchase parameters are within said designated payment category and complete the purchase; and

g) associating the purchase with said credit card account.

28. (Currently Amended) A method of performing secure credit card purchases, said method comprising:

a) identifying a pre-established ~~credit card~~ account that can be used to make credit card purchases;

b) designating a pre-defined payment category which limits a nature of a subsequent purchase to a single transaction at a fixed amount;

c) issuing a transaction code associated with at least said credit card account and said selected payment category, and different from said credit card account;

d) communicating said transaction code to a merchant to consummate a purchase within defined purchase parameters;

e) verifying that said defined purchase parameters correspond to said designated payment category; [ [and] ]

f) providing authorization for said purchase so as to confirm at least that said defined purchase parameters are within said designated payment category and complete the purchase;

g) associating the purchase with said credit card account.

29. (Currently amended) A method of performing secure credit card purchases, said method comprising:

a) identifying a pre-established ~~credit card~~ account that can be used to make credit card purchases;

b) selecting a predetermined payment category which limits a nature of a series of subsequent purchases to a single unidentified merchant;

c) issuing a transaction code associated with at least said credit card account and said selected payment category and different from said credit card account;

d) communicating said transaction code to a merchant to consummate a purchase within defined purchase parameters;

e) verifying that said defined purchase parameters correspond to said selected payment category;

f) providing authorization for said purchase so as to confirm at least that said defined purchase parameters are within said selected payment category and complete the purchase; and

g) associating the purchase with said credit card account.

30. (Original) The method of claim 29 wherein said step of selecting said payment category which limits said nature of said series of subsequent purchases to said single merchant further comprises limiting said nature of said series of subsequent purchases to a fixed amount for each of said subsequent purchases.

31. (Original) The method of claim 29 wherein said step of selecting said payment category which limits said nature of said series of subsequent purchases to said single merchant further comprises limiting said nature of said series of subsequent purchases to a maximum total amount for said subsequent purchases.

32. (Currently Amended) The method of claim 29 wherein said step of verifying that said defined purchase parameters correspond to said selected payment category further ~~defines~~ identifies said merchant as said single merchant.

33. (Currently Amended) A method of performing secure credit card purchases, said method comprising the steps of:

a) identifying a pre-established ~~credit card~~ account that can be used to make credit card purchases;

b) selecting a pre-determined payment category which limits a nature of a subsequent purchase to a an unidentified single merchant;

c) issuing a transaction code associated with at least said credit card account and said selected payment category, and different from said credit card account;

d) designating a merchant as said single merchant;

e) communicating said transaction code to said merchant to consummate a purchase within defined purchase parameters;

f) verifying that said defined purchase parameters correspond to said selected payment category;

g) providing authorization for said purchase so as to confirm at least that said defined purchase parameters are within said selected payment category and complete the purchase; and

h) associating the purchase with said credit card account.

34. (Currently Amended) The method of claim 33 wherein said step of verifying that said defined purchase



parameters correspond to said selected payment category further ~~defines~~ identifies said merchant as said single merchant.

35. (Currently Amended) A system for performing secure credit card purchases comprising:

a) a custodial authorizing entity, said custodial authorizing entity structured to maintain a pre-established ~~credit card~~ account that can be used to make credit card purchases for ~~of~~ at least one user;

b) said custodial authorizing entity further structured to define at least one payment category available for selection by a customer, said payment category structured to limit at least one subsequent transaction to a single merchant;

c) said custodial authorizing entity further structured to issue a transaction code associated with said payment category selected by the customer and said credit card account of the sure, said transaction code being different from said credit card account;

d) said custodial authorizing entity further structures to receive said transaction code and designated purchase parameters associated with a purchase from a merchant, and to verify that said designated purchase parameters correspond to said selected payment category; and

e) said custodial authorizing entity structures to provide the merchant with authorization for said purchase that confirms at least that said designated purchase parameters correspond to said selected payment category so that said purchase may be consummated by the merchant.

36. (Currently Amended) A system for performing secure credit card purchases as recited in claim 35 wherein said single merchant is ~~defined~~ identified upon selection of said payment category and is associated with said transaction code.

37. (Previously Presented) A system for performing secure credit card purchases as recited in claim 35 wherein said custodial authorizing entity is structured to designate a first merchant to provide said transaction code for verification as said single merchant.

38. (Previously Presented) A system for performing secure credit card purchases as recited in claim 37 wherein said custodial authorizing entity is structured to designate said first merchant as said single merchant for subsequent transactions utilizing said transaction code.

39. (Previously Presented) A system for performing secure credit card purchases as recited in claim 35 wherein said payment category is further structured to limit said at

least one subsequent transaction to a specified dollar amount.

40. (Previously Presented) A system for performing secure credit card purchases as recited in claim 39 wherein said payment category is further structured to limit each of a plurality of subsequent transactions to said specified dollar amount.

41. (Previously Presented) A system for performing secure credit card purchases as recited in claim 40 wherein said custodial authorizing entity is structured to designate a dollar amount of a first transaction associated with said transaction code and having said designated purchase parameters that correspond to remaining parameters of said selected payment category, as said specified dollar amount.

42. (Previously Presented) A system for performing secure credit card purchases as recited in claim 39 wherein said specified dollar amount is defined upon selection of said payment category and is associated with said transaction code.

43. (Previously Presented) A system for performing secure credit card purchases as recited in claim 35 wherein said payment category is further structured to limit said at least one subsequent transaction to a maximum dollar amount.

Application No. 11/252, 009  
Amdt. Dated July 29, 2008  
Reply to Office Action dated January 29, 2008

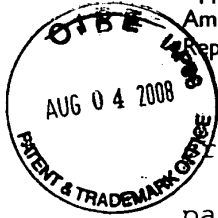

44. (Previously Presented) A system for performing secure credit card purchases as recited in claim 35 wherein said payment category is further structured to limit said at least one subsequent transaction to a predetermined time period.

**REMARKS / ARGUMENTS**

This Amendment is submitted in full response to the Office action dated January 29, 2008, wherein claims 1-44 are rejected under U.S.C. 103(a) as being unpatentable over Franklin et al., U.S. Patent No. 6,000,832 in view of Yanagihara et al. U.S. Pub No. 2001/0011249.

An appropriate Request for an Extension of Time and the corresponding fee are being filed concurrently herewith, and accordingly, Applicant respectfully requests reconsideration of this application in view of the foregoing amendments and the following remarks.

Application No. 11/252, 009  
Amdt. Dated July 29, 2008  
Reply to Office Action dated January 29, 2008

As examiner requested, applicant points out the following with regard to the previously filed information disclosure statements. In view of the ongoing reexamination regarding U.S. patent 6,324,526 which is the grandparent of this application, applicant cites the following references.

U.S. Patent No. 6,422,462 to Cohen

U.S. Patent No. 5,826,243 to Musmanno

U.S. Patent No. 6,298,335 to Burnstein

#### **A. The Franklin Patent**

Generally, the Franklin Patent describes an online commerce card whereby a transaction proxy number is generated *by the customer* and used in substitution of an actual credit card number for online transactions.

It is respectfully pointed out by applicant that the Franklin Patent discloses an invention that is significantly different in several important ways from applicant's invention.

Specifically, the Franklin Patent relates exclusively to a substitute number that is used for a single transaction only (see column 2, lines 31-35, column 3, lines 12-18, column 5, lines 14-17, lines 53-56, column 10, lines 52-

53). Additionally, the Franklin patent describes a transaction code that is generated by the customer on the customer's computer using software previously provided by the issuing bank (see column 1, lines 12-16, column 2, lines 27-34, column 5, lines 28-32, column 9, lines 30-34). It is only after the transaction code has been provided to the merchant by the customer and communicated by the merchant to the issuing bank that the issuing bank uses the same encryption key that was previously provided to the customer to generate a code which makes up a portion of the substitute number for the purpose of verifying that the code matches the one generated by the customer (see column 2, lines 55-64, column 6, lines 3-12, column 12, lines 17-26).

Furthermore, the Franklin patent does not disclose a payment category whereby one or more transactions are limited to a single merchant which has not been identified. Indeed, the Franklin patent does not disclose a payment category which is limited to a single *merchant*, but rather a proxy number that is limited to a single *transaction*. In all cases in which the Franklin patent limits the transaction number with regard to the merchant, it is

Application No. 11/252, 009  
Amdt. Dated July 29, 2008  
Reply to Office Action dated January 29, 2008

based on a *particular* merchant that has been identified prior to generating the substitute number. That is to say the merchant is identified along with other transactions specific data (see column 5, lines 28-32, column 9, lines 30-34, 40-44, 52-55, column 10, lines 9-11). The merchant limitation is not based on the fact that the merchant is a single merchant, but rather that the merchant is a particular (identified) merchant. The distinction between a single merchant limitation (as described in applicant's claims) and a *particular* merchant limitation (as described in the Franklin invention) represents a fundamental difference. A credit card which can only be used with a particular merchant is well known in the art (for example, a Sear's card only works at Sears). However, several of applicant's claims describe a merchant limitation that is based exclusively on the fact that the merchant is a single merchant and not necessarily any particular merchant. This means that the transaction code can be used with any merchant for one or more transactions. However, it can never be used with more than one merchant. For example, the single merchant limitation could be represented by having a card number which could be used anywhere, but once a purchase was made (at Sears, for example) it could only be used at Sears for future purchases. To put it another way, a payment category which limits

Application No. 11/252, 009  
Amdt. Dated July 29, 2008  
Reply to Office Action dated January 29, 2008

transactions to a single merchant is predetermined to limit those transactions *even though said single merchant was not identified when the payment category was created (predetermined)*. Examined application clearly supports this meaning at paragraph 36 which reads in part "The payment category may also include a multi-transaction authorization wherein more than one purchase may be made from one or a plurality of different merchants, each of which *may or may not be identified by the customer and pre-coded in association with the transaction code..*". "Accordingly, in some instances, wherein a customer, or an agent of the customer, such as a child, guardian, or caregiver, must make a number of transactions or purchases which are authorized by the customer, the customer may designate a maximum amount which can be spent utilizing a particular transaction code within a predetermined period of time, and/or can designate that *only one merchant, whether designated or not, can use the transaction code.*" To the best of applicant's knowledge this single merchant limitation was unknown in the art as of the priority date (January 19, 1999) of this application. Applicant respectfully submits that Franklin does not disclose a pre-defined payment category that limits transactions to a single, unidentified merchant.



**B. The Meaning of "Payment Categories"**

Applicant's invention makes clear in multiple references that payment categories refer to sets of predetermined parameters that are offered by the custodial authorizing entity and selectable (can be designated) by the customer. References to the predetermined nature of payment categories are made at least eight times in the specifications. Payment categories offer the advantage of standardizing sets of parameters to accommodate various types of transactions. The customer simply designates a predetermined payment category that has parameters that will accommodate the desired transaction. As such, payment categories do not merely represent "limited use conditions" but rather a simple method whereby the customer can quickly and easily select from one or more predetermined, standardized sets of parameters. The customer may or may not fill in additional details specific to a particular transaction. Please see attached exhibit A in support of the meaning of the term "payment categories". Since payment categories are predetermined, selectable parameters whereby one payment category is designated by the customer to accommodate the desired

Application No. 11/252, 009  
Amdt. Dated July 29, 2008  
Reply to Office Action dated January 29, 2008

transaction. Applicant respectfully submits that Franklin does not disclose a "plurality" of payment categories as required in claim 10-26, and 27(b) of applicant's invention.

**C. Conclusion**

Based on the foregoing remarks and the above amendments to the claims it is respectfully requested that this application be given full and favorable reconsideration. It is believed that upon doing so, this application will be deemed to be in condition for immediate allowance, which action is now respectfully requested.

In addition, a request for an appropriate extension of time is enclosed herewith along with the corresponding PTO fee.

Respectfully Submitted,

John D'Agostino

5168 Northridge Road Unit 309

Sarasota, FL 34238

(941) 228-1511

By: 

7-29-08

**EXHIBIT A**

From Specifications. In Support of the Meaning of "Payment Categories"

Characteristics of Payment Categories	Exemplary Support From Specifications (D'Agostino)	Reference Detail
<p>Payment Categories are predetermined.</p> <p>They are pre-defined and offered to the customer for selection.</p>	<p>[0010]</p>	<p><i>The system and method of the present invention incorporates the advantage of consummating the purchase by the customer through the selection of any one of <u>a plurality of predetermined payment categories</u>.</i></p>
	<p>[0014]</p>	<p><i>Further, a feature of the transaction code is its ability to indicate any one of preferably a plurality of <u>predetermined payment categories</u> which may be either requested by the customer or automatically chosen by the custodial authorizing entity based on the type of account or the type of purchase or other commercial transaction involved.</i></p>
	<p>[0020]</p>	<p><i>It is also an object of the present invention to provide a system and attendant method of accomplishing secure credit card purchases which eliminates the need to disclose or disseminate a given credit card number while providing the customer with the versatility of choosing any one of a plurality of <u>predetermined payment categories</u>.</i></p>
	<p>[0029]</p>	<p><i>Such additional information may preferably include the identification of the merchant or merchants involved, when such information is deemed necessary, and a requested one of a plurality of <u>predetermined payment categories</u> to facilitate consummation of the purchase of the products or services desired. Such <u>predetermined plurality of payment categories</u> will be discussed in greater detail hereinafter.</i></p>
	<p>[0030]</p>	<p><i>More specifically, the transaction code is pre-coded to be indicative of a specific credit card account, preferably a merchant or merchants identification and a designated payment category, selected from the <u>plurality of predetermined payment categories</u> as set forth above.</i></p>
<p><b>COMMENT:</b> In addition to the numerous references cited, the prosecution history of U.S. Patent 6,324,526 (The grandparent to this application) makes clear that the payment categories are presumed to be predefined. In the original application for the D'Agostino patent, the first mention of payment categories—in any of the claims—was in claim 1(c), which simply said: "designate a payment category." Clearly, it was presumed that the category had already been defined and was already available to be designated by the user. The fact that, in some embodiments, the customer provides certain transaction details, does not mean that the customer defines the payment category. This is made even more clear in view of the fact that several of the claims in applicant's invention call for defining a <u>plurality of payment categories</u>. Indeed, it would make no sense for the customer to define more than one payment category in order to make a purchase.</p>		

**EXHIBIT A**

From Specifications. In Support of the Meaning of "Payment Categories"

Characteristics of Payment Categories	Exemplary Support From Specification (D'Agostino)	Reference Detail
<p>Payment Categories are distinct from transaction code.</p> <p>The payment categories are defined prior to the transaction code being generated.</p>	<p>[0030]</p>	<p><i>More specifically, the transaction code is pre-coded to be indicative of a specific credit card account, preferably a merchant or merchants identification and a designated payment category, selected from the plurality of predetermined payment categories as set forth above.</i></p>
	<p>[0030]</p>	<p><i>If the credit card account is in good standing, based at least in part on the requested payment category, (amount of payment), the custodial authorizing entity generates a transaction code as at 20.</i></p>
	<p>[0034]</p>	<p><i>The customer, either directly or through a representative, can then utilize the transaction code to consummate a transaction within the defined parameters of the payment category.</i></p>
	<p>[0035]</p>	<p><i>As emphasized above, an important feature of the present invention is the ability of the customer to request a desired or a required payment category and the ability of the custodial authorizing entity 64 and/or a processing computer 45 of the custodial authorizing entity to issue a transaction code in accordance with the payment category.</i></p>

**EXHIBIT A**

From Specifications. In Support of the Meaning of "Payment Categories"

Characteristics of Payment Categories	Exemplary Support From Specification (D'Agostino)	Reference Detail
<p>Payment Categories are functional</p> <p>ie: The payment categories function to establish, communicate, and efficiently select, in one step, the general parameters of the transaction code)</p>	<p>[0010]</p>	<p><i>Collectively, the payment categories represent a variety of <u>methods for accomplishing payment for a fixed transaction, a multiple transaction and/or a repeating transaction.</u></i></p>
<p>A Payment Category is selectable by the customer in a single step</p>	<p>[0029]</p>	<p><i>Such additional information may preferably include the identification of the merchant or merchants involved, when such information is deemed necessary, and a requested one of a <u>plurality of predetermined payment categories to facilitate consummation of the purchase of the products or services desired.</u></i></p>
<p>A Payment Category is selectable by the customer in a single step</p>	<p>[0032]</p>	<p><i>Such information, as set forth above, is <u>communicated by the requested and subsequently designated payment category as set forth above.</u></i></p>
<p>A Payment Category is selectable by the customer in a single step</p>	<p>[0020]</p>	<p><i>It is also an object of the present invention to provide a system and attendant method of accomplishing secure credit card purchases which eliminates the need to disclose or disseminate a given credit card number while <u>providing the customer with the versatility of choosing any one of a plurality of predetermined payment categories.</u></i></p>
<p>A Payment Category is selectable by the customer in a single step</p>	<p>[0021]</p>	<p><i>It is yet another feature of the present invention to provide a system and method of accomplishing secure credit card payments having the versatility of <u>allowing the customer to select any one of a plurality of payment categories which are indicative of a variance in the amount of a purchase as well as the time in which authorization for such payment is valid.</u></i></p>
<p>A Payment Category is selectable by the customer in a single step</p>	<p>[0030]</p>	<p><i>More specifically, the transaction code is pre-coded to be indicative of a specific credit card account, preferably a merchant or merchants identification and a <u>designated payment category, selected from the plurality of predetermined payment categories as set forth above.</u></i></p>

**EXHIBIT A**

From Specifications. In Support of the Meaning of "Payment Categories"

Characteristics of Payment Categories	Exemplary Support From Specification (D'Agostino)	Reference Detail
Each payment categories can be defined to include one or more different types of transactions.	[0035]	<p><i>The payment categories, may be collectively defined as a variety of different types of transactions.</i></p> <p><b>NOTE:</b> This reference refers to a property of the payment categories. It supports numerous claims and claim elements including claims 10-26 and 27(b), which include the step of "defining a plurality of payment categories to include" various types of transactions. This reference does not equate a transaction type to a payment category. It has been amply demonstrated that payment categories have a variety of characteristics and this reference is simply one of them. The specifications clearly show that a single payment category may include more than one type of transaction.</p> <p><i>Collectively, the payment categories represent a variety of methods for accomplishing payment for a fixed transaction, a multiple transaction and/or a repeating transaction.</i></p>
	[0010]	<p><i>Other alternatives would involve one or more of the categories coded to define multiple transactions involving a maximum dollar amount for purchases, as well as a fixed period of time for authorization of such purchases, and/or a repeating transaction wherein payments may be automatically accessed by a merchant over a predetermined or unspecified time interval (such as every thirty days) for a specific dollar amount or a maximum dollar amount limit. Also, limits solely as to a specific merchant or a given time period can be effectively established for which the transaction code is valid.</i></p>
	[0036]	<p><i>The payment category may also include a multi-transaction authorization wherein more than one purchase may be made from one or a plurality of different merchants, each of which may or may not be identified by the customer and pre-coded in association with the transaction code, and wherein a total cost of the plurality of purchases may not exceed a maximum limit amount.</i></p> <p><b>CONCLUSION:</b> Therefore, claims 10-26 and 27(b), require that at least two functional, selectable categories must be predefined, and that these categories must be distinct from the transaction code and that their functionality must be distinct from the functionality of the transaction code. Specifically, the payment categories function as methods to facilitate the consummation of a variety of transaction types by a). Predefining and standardizing sets of limiting parameters, and b) Communicating the available limiting parameters to the cardholder, and by being designated, communicating the desired parameters to the issuer.</p>

Under the Paperwork Reduction Act of 1995, no persons are required to respond to a collection of information unless it displays a valid OMB control number.

<b>PATENT APPLICATION FEE DETERMINATION RECORD</b> Substitute for Form PTO-875					Application or Docket Number <b>11/252,009</b>	Filing Date <b>10/17/2005</b>	<input type="checkbox"/> To be Mailed			
<b>APPLICATION AS FILED – PART I</b>										
(Column 1)			(Column 2)		SMALL ENTITY <input checked="" type="checkbox"/>	OR	OTHER THAN SMALL ENTITY			
FOR	NUMBER FILED	NUMBER EXTRA	RATE (\$)	FEE (\$)	OR	RATE (\$)	FEE (\$)			
<input type="checkbox"/> BASIC FEE <small>(37 CFR 1.16(a), (b), or (c))</small>	N/A	N/A	N/A			N/A				
<input type="checkbox"/> SEARCH FEE <small>(37 CFR 1.16(k), (l), or (m))</small>	N/A	N/A	N/A			N/A				
<input type="checkbox"/> EXAMINATION FEE <small>(37 CFR 1.16(o), (p), or (q))</small>	N/A	N/A	N/A			N/A				
TOTAL CLAIMS <small>(37 CFR 1.16(i))</small>	minus 20 =	*	X \$ =			X \$ =				
INDEPENDENT CLAIMS <small>(37 CFR 1.16(h))</small>	minus 3 =	*	X \$ =			X \$ =				
<input type="checkbox"/> APPLICATION SIZE FEE <small>(37 CFR 1.16(s))</small>	If the specification and drawings exceed 100 sheets of paper, the application size fee due is \$250 (\$125 for small entity) for each additional 50 sheets or fraction thereof. See 35 U.S.C. 41(a)(1)(G) and 37 CFR 1.16(s).									
<input type="checkbox"/> MULTIPLE DEPENDENT CLAIM PRESENT <small>(37 CFR 1.16(j))</small>										
* If the difference in column 1 is less than zero, enter "0" in column 2.			TOTAL		OR	TOTAL				
<b>APPLICATION AS AMENDED – PART II</b>										
(Column 1)		(Column 2)		(Column 3)		SMALL ENTITY	OR	OTHER THAN SMALL ENTITY		
<b>AMENDMENT</b>	<b>08/04/2008</b>	CLAIMS REMAINING AFTER AMENDMENT		HIGHEST NUMBER PREVIOUSLY PAID FOR	PRESENT EXTRA	RATE (\$)	ADDITIONAL FEE (\$)	RATE (\$)	ADDITIONAL FEE (\$)	
	<small>Total (37 CFR 1.16(i))</small>	* 43	Minus	** 44	= 0	X \$25 =	0	OR	X \$ =	
	<small>Independent (37 CFR 1.16(h))</small>	* 6	Minus	***6	= 0	X \$105 =	0	OR	X \$ =	
	<input type="checkbox"/> Application Size Fee <small>(37 CFR 1.16(s))</small>									
	<input type="checkbox"/> FIRST PRESENTATION OF MULTIPLE DEPENDENT CLAIM <small>(37 CFR 1.16(j))</small>									
					TOTAL ADD'L FEE	<b>0</b>	OR	TOTAL ADD'L FEE		
<b>AMENDMENT</b>		CLAIMS REMAINING AFTER AMENDMENT		HIGHEST NUMBER PREVIOUSLY PAID FOR	PRESENT EXTRA	RATE (\$)	ADDITIONAL FEE (\$)	RATE (\$)	ADDITIONAL FEE (\$)	
	<small>Total (37 CFR 1.16(i))</small>	*	Minus	**	=	X \$ =		OR	X \$ =	
	<small>Independent (37 CFR 1.16(h))</small>	*	Minus	***	=	X \$ =		OR	X \$ =	
	<input type="checkbox"/> Application Size Fee <small>(37 CFR 1.16(s))</small>									
	<input type="checkbox"/> FIRST PRESENTATION OF MULTIPLE DEPENDENT CLAIM <small>(37 CFR 1.16(j))</small>									
					TOTAL ADD'L FEE		OR	TOTAL ADD'L FEE		
* If the entry in column 1 is less than the entry in column 2, write "0" in column 3.					<b>Legal Instrument Examiner:</b> /GAIL D. D. WOOTEN/					
** If the "Highest Number Previously Paid For" IN THIS SPACE is less than 20, enter "20".										
*** If the "Highest Number Previously Paid For" IN THIS SPACE is less than 3, enter "3".										
The "Highest Number Previously Paid For" (Total or Independent) is the highest number found in the appropriate box in column 1.										

This collection of information is required by 37 CFR 1.16. The information is required to obtain or retain a benefit by the public which is to file (and by the USPTO to process) an application. Confidentiality is governed by 35 U.S.C. 122 and 37 CFR 1.14. This collection is estimated to take 12 minutes to complete, including gathering, preparing, and submitting the completed application form to the USPTO. Time will vary depending upon the individual case. Any comments on the amount of time you require to complete this form and/or suggestions for reducing this burden, should be sent to the Chief Information Officer, U.S. Patent and Trademark Office, U.S. Department of Commerce, P.O. Box 1450, Alexandria, VA 22313-1450. DO NOT SEND FEES OR COMPLETED FORMS TO THIS ADDRESS. **SEND TO: Commissioner for Patents, P.O. Box 1450, Alexandria, VA 22313-1450.**

If you need assistance in completing the form, call 1-800-PTO-9199 and select option 2.



UNITED STATES PATENT AND TRADEMARK OFFICE

UNITED STATES DEPARTMENT OF COMMERCE  
United States Patent and Trademark Office  
Address: COMMISSIONER FOR PATENTS  
P.O. Box 1450  
Alexandria, Virginia 22313-1450  
www.uspto.gov

21

APPLICATION NO.	FILING DATE	FIRST NAMED INVENTOR	ATTORNEY DOCKET NO.	CONFIRMATION NO.
11/252,009	10/17/2005	John D'Agostino	1.706-B.04	4322

7590 01/29/2008  
MALLOY & MALLOY, P.A.  
2800 S.W. Third Avenue  
Historic Coral Way  
Miami, FL 33129

EXAMINER

SHRESTHA, BIJENDRA K

ART UNIT	PAPER NUMBER
3691	

3691

MAIL DATE	DELIVERY MODE
01/29/2008	PAPER

01/29/2008

PAPER

Please find below and/or attached an Office communication concerning this application or proceeding.

The time period for reply, if any, is set in the attached communication.





### **DETAILED ACTION**

Claims 1-44 are presented for examination. Applicant filed an amendment on 09/07/2007 amending claims 1, 27-29, 33 and 35-44. The amendment of claims invalidated the reference Paleiov et al. (U.S. Pub No. 2002/0152158) used in the first office action and met the requirement for priority to previously file application 09/231,745 filed on January 15, 1999. The Examiner respectfully withdraws the prior arts Demoff et al. and Paleiov et al. and used new reference Yanagihara et al. and Franklin et al. to prosecute the application.

The Examiner respectfully withdraws double patenting rejection against instant application for submitting terminal disclaimer on U.S. Patent No. 6,324,526 and 11/252,009.

After careful consideration of applicant's arguments and amendments, new grounds of rejections of claims necessitated by Applicant's amendment are established in the instant application as set forth in detail below. Applicant's arguments with respect to claims have been considered but are moot in view of the new ground(s) of rejection.

#### ***Information Disclosure Statement***

Applicant is respectfully requested to cite the references relevant to the instant application so that the Examiner can review it in limited available time.

#### ***Claim Rejections - 35 USC § 103***

Art Unit: 3691

1. The following is a quotation of 35 U.S.C. 103(a) which forms the basis for all obviousness rejections set forth in this Office action:

(a) A patent may not be obtained though the invention is not identically disclosed or described as set forth in section 102 of this title, if the differences between the subject matter sought to be patented and the prior art are such that the subject matter as a whole would have been obvious at the time the invention was made to a person having ordinary skill in the art to which said subject matter pertains. Patentability shall not be negated by the manner in which the invention was made.

2. Claims 1-44 are rejected under 35 U.S.C. 103(a) as being unpatentable over Franklin et al., U.S. Patent No. 6,000,832 (reference A in attached PTO-892) in view of Yanagihara et al. U.S. Pub No. 2001/0011249 (reference B in attached PTO-892).

3. As per claim 1, Franklin et al. teach a method of performing secure credit card purchases, said method comprising:

a) contacting a custodial authorizing entity having custodial responsibility of account parameters of customer's credit card account (see Fig. 1; Issuing Bank (26) connected to customer (22) and merchant (24) connected by Internet (34))

b) supplying the custodial authorizing entity with at least account identification data (see Fig. 4; Fig. 7);

c) defining a payment category including at least the ability to limit purchases to a single merchant for at least one transaction (see column 9, lines 52-55);

e) generating a transaction code and the ability to make a purchase within said designated payment category (see Fig. 4-6; column 10, lines 44-65);

f) communicating the transaction code to a merchant to consummate a purchase with defined purchase parameters (see Fig. 3; column 5, lines 41-58);

g) verifying that said defined purchase parameters are within said designated payment category (see column 5, lines 59-67 to column 6, lines 1-12); and

h) providing authorization for said purchase so as to confirm at least that said defined purchase parameters are within said designated payment category and complete the purchase (see column 12, lines 27-43).

Franklin et al. teach generating a transaction code with transaction specific data (see Fig. 4; Transaction Specific Data which include good identification; column 9, lines 40-43) and but do not teach designating and associating with the payment categories.

Yanagihara et al. teach designating and associating the transaction code with the payment categories (see Fig. 2; Fig. 4; paragraph [0019])

Therefore, it would be obvious to one of ordinary skill in the art at the time the invention was made to allow designating and associating the transaction code with the payment categories of Franklin et al. because Yanagihara et al. teach that including above features would enable user to use usage identification code which indicates purpose of use and usage limit to indicate maximum amount to withdraw (Yanagihara et al., paragraph [0019]).

4. As per claim 2, Franklin et al. in view of Yanagihara et al. teach claim 1 as described above. Franklin et al. further teaches the method comprising identification of said single merchant upon designation of said payment category (see column 9, lines 40-43; where merchant identification identify the merchant).

5. As per claim 3, Franklin et al. in view of Yanagihara et al. teach claim 1 as described above. Franklin et al. further teaches the method comprising step of designating said single merchant subsequent to generating said transaction code (see Fig. 4; transaction specific data that include merchant identification).

6. As per claim 4, Franklin et al. in view of Yanagihara et al. teach claim 1 as described above. Franklin et al. further teaches the method wherein  
step of communicating the transaction code to said merchant to consummate said purchase within defined purchase parameters further comprises designation of said single merchant (see Fig. 4; column 9, lines 18-30; column 49-58).

7. As per claim 5, Franklin et al. in view of Yanagihara et al. teach claim 1 as described above. Franklin et al. further teaches the method wherein  
said step of generating said transaction code further comprises said custodial authorizing entity generating said transaction code (see column 3, lines 29-36; 40-45).

8. As per claim 6, Franklin et al. in view of Yanagihara et al. teach claim 1 as described above. Franklin et al. further teaches the method wherein  
said step of generating said transaction code further comprises said customer generating said transaction code (see column 3, lines 21-37).

9. As per claim 7, Franklin et al. in view of Yanagihara et al. teach claim 1 as described above. Franklin et al. further teaches the method comprising  
obtaining said authorization for said purchase from the custodial authorizing entity (see column 5, lines 59—67).

10. As per claim 8, Franklin et al. in view of Yanagihara et al. teach claim 1 as described above. Franklin et al. further teaches the method comprising  
a step of communicating promotional information of offered subject matter to the customer by the merchant, pre-determining the purchase parameters of the purchase,

and corresponding said designated payment category to said purchase parameters (see column 9, lines 12-30; where customer surf the web for purchasing; Examiner notes that customer have access to promotional information of the offered subject matter in the web or merchant website).

11. As per claim 9, Franklin et al. in view of Yanagihara et al. teach claim 1 as described above. Franklin et al. further teaches the method comprising

the merchant communicating the transaction code to the custodial authorizing entity for verification (see Fig. 7).

12. As per claims 10-14, Franklin et al. in view of Yanagihara et al. teach claim 1 as described above.

Franklin et al. further teach the method comprising generating a transaction code which reflects at least one of a plurality of said payment categories that include the ability to designate amount parameters for a cost of one or more purchases, ability to designate time parameters during which the purchase can be completed, ability to use said transaction code for a single transaction at a fixed amount for purchase within a predetermined period of time, ability to limit purchases to said single transaction at said fixed amount for purchase within said predetermined period of time (see Fig.4, column 2, lines 30-32; column 9, lines 49-58; column 10, lines 52-65).

13. As per claims 15-24, Franklin et al. in view of Yanagihara et al. teach claim 10 as described above.

Franklin et al. do not teach a) the ability to use said transaction code for a single transaction at a fixed or maximum amount for a purchase within a predetermined period

Art Unit: 3691

of time, c) the ability to use said transaction code for multiple transactions at a fixed or maximum total amount for purchases within a predetermined time period, d) the ability to use said transaction code for a repeating transaction at a fixed amount for purchases payable at each of a fixed number of time intervals, and e) the ability to use said transaction code for a repeating transaction at a fixed amount for purchases payable at each of an unspecified number of time intervals.

Yanagihara et al. teach storing a restrictive condition for withdrawal of amount from the money card and application of the predetermined condition during withdrawal of the money from the card ( Yanagihara et al., Fig. 2, Payment Condition (209) and Transaction Record (210); paragraph [0005], [0006] and 0019]; the Examiner notes any above preconditions in claims 5-15 and 19-26 can be set in Payment Condition (209) in Fig. 2).

Therefore, it would be prima facie obvious to one of ordinary skill in the art at the time the invention was made to allow storing a restrictive condition for withdrawal of amount from the money card and application of the predetermined condition during withdrawal of the money from the card of Franklin et al. because Yanagihara et al. teach that including above features would enable user to use usage identification code which indicates purpose of use (Yanagihara et al., paragraph [0019]).

14. As per claim 25, Franklin et al. in view of Yanagihara et al. teach claim 1 as described above.

Franklin et al. further teaches the method comprising comprising generating said transaction code to further reflect an identification of said single merchant (see Fig. 4, column 9, lines 43, 52-55).

15. As per claim 26, Franklin et al. teach claim 25 as described above. Franklin et al. further teaches the method defining said payment category to include the ability to limit purchases to a limited time interval during which said purchase authorization is valid column 10, lines 52-65).

16. As per claim 27-29, Franklin et al. teach a method of performing secure credit card purchases, said method comprising

a) identifying a pre-established credit card account; b) designating at least one of a plurality of pre-defined payment categories which limit a nature of a subsequent purchase (see column 2, lines 9-21);

c) issuing a transaction code associated with at least said credit card account and said selected payment category, and different from said credit card account (see Fig. 4, column 2, lines 22-35);

d) communicating said transaction code to a merchant to consummate a purchase within defined purchase parameters (see column 2, lines 35-38);

e) verifying that said defined purchase parameters correspond to said designated payment category (see column 2, lines 47-64); and



Art Unit: 3691

f) providing authorization for said purchase so as to confirm at least that said defined purchase parameters are within said designated payment category and complete the purchase (see column 2, lines 65-67 to column 3, lines 1-6); and

g) associating the purchase with said credit card account (see column 12, lines 34-43).

Franklin teaches generating a transaction code with transaction specific data (see Fig. 4; Transaction Specific Data which include good identification; column 9, lines 40-43) and but do not teach designating and associating with the payment categories.

Yanagihara et al. teach designating and associating the transaction code with the payment categories (see Fig. 2: Fig. 4; paragraph [0019]

Therefore, it would be obvious to one of ordinary skill in the art at the time the invention was made to allow designating and associating the transaction code with the payment categories of Franklin et al. because Yanagihara et al. teach that including above features would enable user to use usage identification code which indicates purpose of use and usage limit to indicate maximum amount to withdraw (Yanagihara et al., paragraph [0019]).

17. As per claims 30-31, Franklin et al. in view of Yanagihara et al. teach claim 19 as described above.

Franklin et al. do not teach restriction on purchases based on pre-selected payment categories.

Yanagihara et al. teach restriction on purchases based on payment categories such that it limits nature of subsequent purchases in terms of amount (Yanagihara, paragraphs [0006], [0021]).

Therefore, it would be prima facie obvious to one of ordinary skill in the art at the time the invention was made to allow storing a restrictive condition for withdrawal of amount from the money card and application of the predetermined condition during withdrawal of the money from the card of Franklin et al. because Yanagihara et al. teach that including above features would enable user to use usage identification code which indicates purpose of use (Yanagihara et al., paragraph [0019]).

18. As per claim 32, Franklin et al. in view of Yanagihara et al. teach claim 29 as described above. Franklin et al. further teaches the method wherein

said step of verifying that said defined purchase parameters correspond to said selected payment category further defines said merchant as said single merchant (see Fig. 4, column 9, lines 43, 52-55).

19. As per claim 33, Franklin et al. teach a method of performing secure card purchases, said method comprising:

- a) identifying a pre-established credit card account (see column 2, lines 9-21);
- b) selecting a payment category which limits a nature of a subsequent purchase to a single merchant (see Fig. 4, column 9, lines 43, 52-55);

c) issuing a transaction code associated with at least said credit card account and said selected payment category, and different from said credit card account (see Fig. 4-6; column 10, lines 44-65);

d) designating a merchant as said single merchant (see Fig. 4; column 9, lines 52-55);

e) communicating said transaction code to said merchant to consummate a purchase within defined purchase parameters (see column 2, lines 35-38);

f) verifying that said defined purchase parameters correspond to said selected payment category (see column 2, lines 47-64);

g) providing authorization for said purchase so as to confirm at least that said defined purchase parameters are within said selected payment category and complete the purchase (see column 2, lines 65-67 to column 3, lines 1-6); and

h) associating the purchase with said-credit card account (see column 12, lines 34-43).

20. As per claim 34, Franklin et al. teach claim 33 as described above. Franklin et al. further teaches the method wherein said step of verifying that said defined purchase parameters correspond to said selected payment category further defines said merchant as said single merchant (see column 2, lines 50-64).

21. As per claim 35, Franklin et al. teach a system for performing secure credit\_card purchases (see Fig. 1) comprising:

a) a custodial authorizing entity, said custodial authorizing entity structured to maintain a pre-established credit card account of at least one user (see Fig. 1, Issuing Bank (26); column 2, lines 8-11);

b) said custodial authorizing entity further structured to define at least one payment category available for selection by a customer, said payment category structured to limit at least one subsequent transaction to a single merchant (see column 2, lines 11-21);

c) said custodial authorizing entity further structured to issue a transaction code associated with said payment category selected by the customer and said credit card account of the user, said transaction code being different from said credit card account (see Fig. 4-6; column 2, lines 22-35);

d) said custodial authorizing entity further structured to receive said transaction code and designated purchase parameters associated with a purchase from a merchant, and to verify that said designated purchase parameters correspond to said selected payment category (see Fig. 7; column 2, lines 47-64); and

e) said custodial authorizing entity structured to provide the merchant with authorization for said purchase that confirms at least that said designated purchase parameters correspond to said selected payment category so that said purchase may be consummated by the merchant (see Fig. 7; column 2, lines 65-67 to column 3, lines 1-6).

22. As per claim 36, Franklin et al. teach claim 35 as described above. Franklin et al. further teaches the system wherein

said single merchant is defined upon selection of said payment category and is associated with said transaction code (see column 9, lines 40-43; where merchant identification identifies the merchant).

23. As per claim 37, Franklin et al. teach claim 35 as described above. Franklin et al. further teaches the system wherein

said custodial authorizing entity is structured to designate a first merchant to provide said transaction code for verification as said single merchant (see column 2, lines 18-21; 27-31; where software module supplied by issuing bank generates codes number in digits for customer specific data such as merchant identification).

24. As per claim 38, Franklin et al. teach claim 37 as described above. Franklin et al. further teaches the system wherein

said custodial authorizing entity is structured to designate said first merchant as said single merchant for subsequent transactions utilizing said transaction code (Examiner interprets that custodial authority supplied software generates identification code for merchant and subsequent transaction could be transacted with the given code for the merchant).

25. As per claim 39-43, Franklin et al. teach claim 35 as described above.

Franklin et al. do not teach defining said payment category as a specific (maximum) dollar amount.

Yanagihara et al. teach defining said payment category as a specific maximum dollar amount (see paragraph [0019]).

Therefore, it would be prima facie obvious to one of ordinary skill in the art at the time the invention was made to allow defining said payment category as a specific maximum dollar amount of Franklin et al. because Yanagihara et al. teach that including above features would enable user to use usage identification code which indicates purpose of use and usage limit to indicate maximum amount to withdraw (Yanagihara et al., Fig. 2; paragraph [0019]).

26. As per claim 44, Franklin et al. teach claim 35 as described above. Franklin et al. further teaches the system wherein said payment category is further structured to limit said at least one subsequent transaction to a predetermined time period (see column 10, lines 52-65).

### ***Response to Arguments***

27. Applicant's amendment necessitated the new ground(s) of rejection presented in this Office action. Applicant's arguments with respect to claims have been considered but are moot in view of the new ground(s) of rejection. Accordingly, this office action is made **Non-Final**.

### ***Conclusion***

28. The prior art made of record and not relied upon is considered pertinent to applicant's disclosures. The following are pertinent to current invention, though not relied upon:

Benson et al. (U.S. Patent No. 5,845,281) teach method and system for managing a data object so as to comply with predetermined conditions for usage.

Demoff et al. (U.S. Patent No. 6,456,984) teach method and system for providing temporary credit authorizations.

Fleming (U.S. Patent No. 5,953,710) teaches children's credit or debit card system.

Foladare et al. (U.S. Patent No. 5,914,472) teach credit card spending authorization control system.

Franco (U.S. Patent No. 4,893,330) teaches method and apparatus for restricting credit card communication calls.

Kravitz (U.S. Patent No. 6,029,150) teaches payment and transactions in electronic commerce system.

Morrill, Jr. (U.S. Patent No. 5,991,749) teaches wireless telephony for collecting tolls, conducting financial transactions, and authorizing other activities.

Watson (U.S. Patent No. 5,991,750) teaches system and method for pre-authorization of individual account transactions.

Watson et al. (U.S. Patent No. 6,226,624) teach system and method for pre-authorization of individual account remote transactions.

Any inquiry concerning this communication or earlier communications from the examiner should be directed to Bijendra K. Shrestha whose telephone number is

Application/Control Number: 11/252,009  
Art Unit: 3691

Page 16

(571)270-1374. The examiner can normally be reached on 7:00AM-4:30PM (Monday-Friday); 2nd Friday OFF.

If attempts to reach the examiner by telephone are unsuccessful, the examiner's supervisor, Alexander Kalinowski can be reached on (571) 272-6771. The fax phone number for the organization where this application or proceeding is assigned is 571-273-8300.

Information regarding the status of an application may be obtained from the Patent Application Information Retrieval (PAIR) system. Status information for published applications may be obtained from either Private PAIR or Public PAIR. Status information for unpublished applications is available through Private PAIR only. For more information about the PAIR system, see <http://pair-direct.uspto.gov>. Should you have questions on access to the Private PAIR system, contact the Electronic Business Center (EBC) at 866-217-9197 (toll-free). If you would like assistance from a USPTO Customer Service Representative or access to the automated information system, call 800-786-9199 (IN USA OR CANADA) or 571-272-1000.

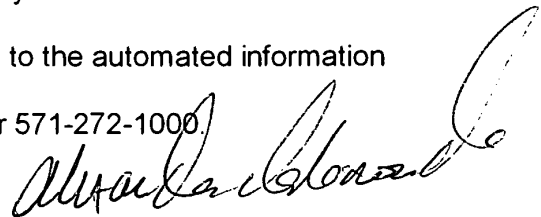

ALEXANDER KALINOWSKI  
SUPERVISORY PATENT EXAMINER

BKS/3691



<b>Notice of References Cited</b>	Application/Control No. 11/252,009	Applicant(s)/Patent Under Reexamination D'AGOSTINO, JOHN	
	Examiner BIJENDRA K. SHRESTHA	Art Unit 3691	Page 1 of 1

**U.S. PATENT DOCUMENTS**

*	Document Number Country Code-Number-Kind Code	Date MM-YYYY	Name	Classification
*	A US-6,000,832	12-1999	Franklin et al.	700/232
*	B US-2001/0011249	08-2001	YANAGIHARA et al.	705/41
*	C US-5,845,281	12-1998	Benson et al.	707/9
*	D US-6,456,984	09-2002	Demoff et al.	705/40
*	E US-5,953,710	09-1999	Fleming, Stephen S.	705/38
*	F US-5,914,472	06-1999	Foladare et al.	235/380
*	G US-4,893,330	01-1990	Franco, Victor A.	379/91.02
*	H US-6,029,150	02-2000	Kravitz, David William	705/39
*	I US-5,991,749	11-1999	Morrill, Jr., Paul H.	705/44
*	J US-5,991,750	11-1999	Watson, Craig	705/44
*	K US-6,226,624	05-2001	Watson et al.	705/44
	L US-			
	M US-			

**FOREIGN PATENT DOCUMENTS**

*	Document Number Country Code-Number-Kind Code	Date MM-YYYY	Country	Name	Classification
	N				
	O				
	P				
	Q				
	R				
	S				
	T				

**NON-PATENT DOCUMENTS**

*	Include as applicable: Author, Title Date, Publisher, Edition or Volume, Pertinent Pages)
U	
V	
W	
X	

\*A copy of this reference is not being furnished with this Office action. (See MPEP § 707.05(a).)  
Dates in MM-YYYY format are publication dates. Classifications may be US or foreign.



UNITED STATES PATENT AND TRADEMARK OFFICE

UNITED STATES DEPARTMENT OF COMMERCE  
 United States Patent and Trademark Office  
 Address: COMMISSIONER FOR PATENTS  
 P.O. Box 1450  
 Alexandria, Virginia 22313-1450  
 www.uspto.gov

BIB DATA SHEET

CONFIRMATION NO. 4322

<b>SERIAL NUMBER</b> 11/252,009	<b>FILING or 371(c) DATE</b> 10/17/2005 <b>RULE</b>	<b>CLASS</b> 705	<b>GROUP ART UNIT</b> 3691	<b>ATTORNEY DOCKET NO.</b> 1.706-B.04		
<b>APPLICANTS</b> John D'Agostino, Sarasota, FL; <b>** CONTINUING DATA *****</b> This application is a CON of 10/037,007 11/09/2001 which is a CIP of 09/231,745 01/15/1999 PAT 6,324,526 <i>BeB</i> <b>** FOREIGN APPLICATIONS *****</b> <b>** IF REQUIRED, FOREIGN FILING LICENSE GRANTED *** SMALL ENTITY **</b> 11/03/2005						
Foreign Priority claimed <input type="checkbox"/> Yes <input checked="" type="checkbox"/> No	35 USC 119(a-d) conditions met <input type="checkbox"/> Yes <input checked="" type="checkbox"/> No	<input type="checkbox"/> Met after Allowance Initials	<b>STATE OR COUNTRY</b> FL	<b>SHEETS DRAWINGS</b> 2	<b>TOTAL CLAIMS</b> 44	<b>INDEPENDENT CLAIMS</b> 6
<b>ADDRESS</b> MALLOY & MALLOY, P.A. 2800 S.W. Third Avenue Historic Coral Way Miami, FL 33129 UNITED STATES						
<b>TITLE</b> System and method for performing secure credit card purchases						
<b>FILING FEE RECEIVED</b> 1400	FEES: Authority has been given in Paper No. _____ to charge/credit DEPOSIT ACCOUNT No. _____ for following:		<input type="checkbox"/> All Fees <input type="checkbox"/> 1.16 Fees (Filing) <input type="checkbox"/> 1.17 Fees (Processing Ext. of time) <input type="checkbox"/> 1.18 Fees (Issue) <input type="checkbox"/> Other _____ <input type="checkbox"/> Credit			

<b>Index of Claims</b>  	<b>Application/Control No.</b> 11252009	<b>Applicant(s)/Patent Under Reexamination</b> D'AGOSTINO, JOHN
	<b>Examiner</b> Shrestha, Bijendra K	<b>Art Unit</b> 3691

✓	<b>Rejected</b>
=	<b>Allowed</b>

-	<b>Cancelled</b>
÷	<b>Restricted</b>

N	<b>Non-Elected</b>
I	<b>Interference</b>

A	<b>Appeal</b>
O	<b>Objected</b>

Claims renumbered in the same order as presented by applicant
  CPA
  T.D.
  R.1.47

CLAIM		DATE							
Final	Original	01/22/2008							
	1	✓							
	2	✓							
	3	✓							
	4	✓							
	5	✓							
	6	✓							
	7	✓							
	8	✓							
	9	✓							
	10	✓							
	11	✓							
	12	✓							
	13	✓							
	14	✓							
	15	✓							
	16	✓							
	17	✓							
	18	✓							
	19	✓							
	20	✓							
	21	✓							
	22	✓							
	23	✓							
	24	✓							
	25	✓							
	26	✓							
	27	✓							
	28	✓							
	29	✓							
	30	✓							
	31	✓							
	32	✓							
	33	✓							
	34	✓							
	35	✓							
	36	✓							

<b>Index of Claims</b> 	<b>Application/Control No.</b> 11252009	<b>Applicant(s)/Patent Under Reexamination</b> D'AGOSTINO, JOHN
	<b>Examiner</b> Shrestha, Bijendra K	<b>Art Unit</b> 3691

✓	<b>Rejected</b>	-	<b>Cancelled</b>	N	<b>Non-Elected</b>	A	<b>Appeal</b>
=	<b>Allowed</b>	÷	<b>Restricted</b>	I	<b>Interference</b>	O	<b>Objected</b>

Claims renumbered in the same order as presented by applicant
  CPA
  T.D.
  R.1.47

CLAIM		DATE							
Final	Original	01/22/2008							
	37	✓							
	38	✓							
	39	✓							
	40	✓							
	41	✓							
	42	✓							
	43	✓							
	44	✓							

<b>Search Notes</b>  	<b>Application/Control No.</b> 11252009	<b>Applicant(s)/Patent Under Reexamination</b> D'AGOSTINO, JOHN
	<b>Examiner</b> Shrestha, Bijendra K	<b>Art Unit</b> 3691

<b>SEARCHED</b>			
<b>Class</b>	<b>Subclass</b>	<b>Date</b>	<b>Examiner</b>
		02/26/2007	Bijendra K. Shrestha

<b>SEARCH NOTES</b>			
<b>Search Notes</b>		<b>Date</b>	<b>Examiner</b>
East, Google/Patents		01/22/2008	Bijendra K. Shrestha

<b>INTERFERENCE SEARCH</b>			
<b>Class</b>	<b>Subclass</b>	<b>Date</b>	<b>Examiner</b>

## EAST Search History

Ref #	Hits	Search Query	DBs	Default Operator	Plurals	Time Stamp
S1	1	"20030055786"	US-PGPUB; USPAT	ADJ	ON	2007/12/06 10:05
S2	19	("20010034703" "20020024906" "20020143647" "20020152158" "20020167947" "20030154168" "4893330" "5566327" "5594227" "5793027" "5914472" "5953710" "5956699" "6021189" "6038552" "6164528" "629019" "6922843" "7124938").PN.	US-PGPUB; USPAT	ADJ	ON	2007/12/05 20:47
S3	40	"6044360"	US-PGPUB; USPAT	ADJ	ON	2007/12/05 20:30
S4	43	card and restriction and spending account	US-PGPUB; USPAT	ADJ	ON	2007/12/05 20:31
S5	86	"5953710"	US-PGPUB; USPAT	ADJ	ON	2007/12/05 20:47
S6	0	credit card and restriction and payment category	US-PGPUB; USPAT	ADJ	ON	2007/12/06 10:06
S7	8050	credit card and restriction	US-PGPUB; USPAT	ADJ	ON	2007/12/06 10:06
S8	10	payment category and maximum amount	US-PGPUB; USPAT	ADJ	ON	2007/12/06 10:08
S9	0	S7 and S8	US-PGPUB; USPAT	ADJ	ON	2007/12/06 10:07
S10	60	payment category	US-PGPUB; USPAT	ADJ	ON	2007/12/06 10:08
S11	0	S7 and S10	US-PGPUB; USPAT	ADJ	ON	2007/12/06 10:08
S12	65	payment categor\$5	US-PGPUB; USPAT	ADJ	ON	2007/12/06 10:10
S13	1	S7 and S12	US-PGPUB; USPAT	ADJ	ON	2007/12/06 10:09
S14	6	credit card and spending restriction	US-PGPUB; USPAT	ADJ	ON	2007/12/06 10:12
S15	6	card and spending restriction	US-PGPUB; USPAT	ADJ	ON	2007/12/06 11:53
S16	1	"20010032184"	US-PGPUB; USPAT	ADJ	ON	2007/12/06 11:53
S17	1	"20020073045"	US-PGPUB; USPAT	ADJ	ON	2007/12/06 11:54
S18	7	"6796497"	US-PGPUB; USPAT	ADJ	ON	2007/12/06 11:58
S19	1	"20060212407"	US-PGPUB; USPAT	ADJ	ON	2007/12/06 11:59
S20	74	"5991750"	US-PGPUB; USPAT	ADJ	ON	2007/12/06 12:12

## EAST Search History

S21	1665	(transaction code) and (payment category\$5 or time or amount or value or repeat\$5 transaction or transaction number)	US-PGPUB; USPAT	ADJ	ON	2007/12/06 12:20
S22	824	authoriz\$5 and S21	US-PGPUB; USPAT	ADJ	ON	2007/12/06 12:16
S23	71734	credit card or smart card or bank card or smart card	US-PGPUB; USPAT	ADJ	ON	2007/12/06 12:17
S24	537	S22 and S23	US-PGPUB; USPAT	ADJ	ON	2007/12/06 12:17
S25	0	rectriction and S24	US-PGPUB; USPAT	ADJ	ON	2007/12/06 12:18
S26	133	restriction and S24	US-PGPUB; USPAT	ADJ	ON	2007/12/06 12:57
S27	4	(transaction code) and (payment category\$5 and time and amount or value and repeat\$5 transaction and transaction number)	US-PGPUB; USPAT	ADJ	ON	2007/12/06 12:36
S28	643	transaction code and credit card	US-PGPUB; USPAT	ADJ	ON	2007/12/06 12:24
S30	49921	category\$6 and restriction	US-PGPUB; USPAT	ADJ	ON	2007/12/06 12:26
S31	102	S28 and S29	US-PGPUB; USPAT	ADJ	ON	2007/12/06 12:30
S32	1	maximum amount	US-PGPUB; USPAT	ADJ	ON	2007/12/06 12:27
S33	27	"6343279"	US-PGPUB; USPAT	ADJ	ON	2007/12/06 12:33
S34	1	"6637648"	US-PGPUB; USPAT	ADJ	ON	2007/12/06 12:35
S35	23	"5349170"	US-PGPUB; USPAT	ADJ	ON	2007/12/06 12:35
S36	4	(transaction code) and (payment category\$5 and time and amount )	US-PGPUB; USPAT	ADJ	ON	2007/12/06 12:36
S37	8	("20010011249" "20020143703" "5621787" "5637845" "5845281" "5953710" "6000608" "6000832").PN.	US-PGPUB; USPAT	ADJ	ON	2007/12/06 12:57
S38	126	"5845281"	US-PGPUB; USPAT	ADJ	ON	2007/12/06 14:40
S39	3	cohen and prent and child	US-PGPUB; USPAT	ADJ	ON	2007/12/06 14:40
S40	12398	cohen and parent and child	US-PGPUB; USPAT	ADJ	ON	2007/12/06 14:40
S41	0	cohen et "al." and parent and child	US-PGPUB; USPAT	ADJ	ON	2007/12/06 14:41
S42	0	("cohen.in.").PN.	US-PGPUB; USPAT	OR	OFF	2007/12/06 14:42
S43	8052	cohen .in.	US-PGPUB; USPAT	ADJ	ON	2007/12/06 14:43

### EAST Search History

S44	1368	(parent or child) and S43	US-PGPUB; USPAT	ADJ	ON	2007/12/06 14:43
S45	64	credit card and S44	US-PGPUB; USPAT	ADJ	ON	2007/12/06 14:44



Application No. 11/252,009  
Amdt. dated September 5, 2007  
Reply to Office Action dated March 5, 2007



F:\MM DOCS\1-PAT\PAT 2004\APP\1706B-01 D'Agostino John\1706-B AMENDMENT FILED.doc

IN THE UNITED STATES PATENT AND TRADEMARK OFFICE

Applicant: John D'Agostino  
Serial No.: 11/252,009  
Filing Date: October 17, 2005  
For: A SYSTEM AND METHOD FOR PERFORMING SECURE CREDIT CARD PURCHASES

Confirmation No. 4322  
Customer No. 04219  
Shrestha, Bijendra K., Examiner  
Group Art Unit 3691

2800 S.W. Third Avenue  
Historic Coral Way  
Miami, Florida 33129  
September 5, 2007

Mail Stop Amendment  
Commissioner for Patents  
P.O. Box 1450  
Alexandria, VA 22313-1450

**A M E N D M E N T**

Sir:

In response to the outstanding Office Action dated March 5, 2007, please amend the above-referenced application as follows:

**Amendments to the Specification** begin on page **2** of this paper.

**Amendments to the Claims** begin on page **3** of this paper.

**Remarks/Arguments** begin on page **19** of this paper.

Application No. 11/252,009  
Amdt. dated September 5, 2007  
Reply to Office Action dated March 5, 2007

F:\MM DOCS\1-PAT\PAT 2004\APP\1706B-01 D'Agostino John\1706-B AMENDMENT FILED.doc

**Amendments to the Specification.**

Please replace the paragraph beginning on page 1 line 5 with the following amended paragraph:

The present application is a Continuation of pending U.S. Patent Application Serial No. 10/037,007, filed November 4, 2001, which is a continuation-in-part of U.S. Patent Application Serial No. 09/231,745, filed on January 15, 1999, now U.S. Patent No. 6,324,526, issued on November 27, 2001.

**Amendments to the Claims.**

This listing of claims will replace all prior versions, and listings, of the claims in the application:

1. (Currently Amended) A method of performing secure credit card purchases, said method comprising ~~the steps of:~~

- a) contacting a custodial authorizing entity having custodial responsibility of account parameters of customer's credit card account;
- b) supplying the custodial authorizing entity with at least account identification data;
- c) defining a payment category including at least the ability to limit purchases to a single merchant for at least one transaction;
- d) designating said payment category;
- e) generating a transaction code reflecting at least said designated payment category and the ability to make a purchase within said designated payment category;
- f) communicating the transaction code to a merchant to consummate a purchase with defined purchase parameters;
- g) verifying that said defined purchase parameters are

within said designated payment category; and

h) providing authorization for said purchase so as to confirm at least that said defined purchase parameters are within said designated payment category and complete the purchase.

2. (Original) The method of claim 1 further comprising identification of said single merchant upon designation of said payment category.

3. (Original) The method of claim 1 further comprising the step of designating said single merchant subsequent to generating said transaction code.

4. (Original) The method of claim 1 wherein said step of communicating the transaction code to said merchant to consummate said purchase within defined purchase parameters further comprises designation of said single merchant.

5. (Previously Presented) The method of claim 1 wherein said step of generating said transaction code further comprises said custodial authorizing entity generating said transaction code.

6. (Original) The method of claim 1 wherein said step of generating said transaction code further comprises said customer generating said transaction code.

7. (Original) The method of claim 1 further comprising obtaining said authorization for said purchase from the custodial authorizing entity.

8. (Original) The method of claim 1 further comprising a step of communicating promotional information of offered subject matter to the customer by the merchant, pre-determining the purchase parameters of the purchase, and corresponding said designated payment category to said purchase parameters.

9. (Original) The method of claim 1 further comprising the merchant communicating the transaction code to the custodial authorizing entity for verification.

10. (Original) The method of claim 1 further comprising generating a transaction code which reflects at least one of a plurality of said payment categories.

11. (Original) The method of claim 10 further comprising defining at least one of said plurality of payment categories to include the ability to designate amount parameters for a cost of one or more purchases.

12. (Original) The method of claim 10 further comprising defining at least one of said plurality of payment categories to

include the ability to designate time parameters during which the purchase can be completed.

13. (Original) The method of claim 10 further comprising defining at least one of said plurality of payment categories to include the ability to use said transaction code for a single transaction at a fixed amount for purchase within a predetermined period of time.

14. (Original) The method of claim 13 further comprising defining at least one of said plurality of payment categories to include the ability to limit purchases to said single transaction at said fixed amount for purchase within said predetermined period of time.

15. (Original) The method of claim 10 further comprising defining at least one of said plurality of payment categories to include the ability to use said transaction code for a single transaction at a maximum amount for purchase within a predetermined period of time.

16. (Original) The method of claim 15 further comprising defining at least one of said plurality of payment categories to include the ability to limit purchases to said single

transaction at said maximum amount for purchase within said predetermined period of time.

17. (Original) The method of claim 10 further comprising defining at least one of said plurality of payment categories to include the ability to use said transaction code for at least two purchases at a maximum total amount for items purchased within a predetermined time period.

18. (Original) The method of claim 17 further comprising defining at least one of said plurality of payment categories to include the ability to limit purchases to said at least two purchases at said maximum total amount for items purchased within said predetermined time period.

19. (Original) The method of claim 10 further comprising defining at least one of said plurality of payment categories to include the ability to use said transaction code for at least two purchases for a repeating transaction at a fixed amount payable at each of a fixed number of time intervals.

20. (Original) The method of claim 19 further comprising defining at least one of said plurality of payment categories to include the ability to limit purchases to said repeating

transaction at said fixed amount payable at each of said fixed number of time intervals.

21. (Original) The method of claim 10 further comprising defining at least one of said plurality of payment categories to include the ability to use said transaction code for a repeating transaction at a fixed amount payable at each of an unspecified number of time intervals.

22. (Original) The method of claim 21 further comprising defining at least one of said plurality of payment categories to include the ability to limit purchases to said repeating transaction at said fixed amount payable at each of said unspecified number of time intervals.

23. (Original) The method of claim 10 wherein at least some of said plurality of payment categories to include:

a) the ability to use said transaction code for a single transaction at a fixed amount for a purchase within a predetermined period of time,

b) the ability to use said transaction code for a single transaction at a maximum amount for a purchase within a predetermined period of time,



c) the ability to use said transaction code for multiple transactions at a maximum total amount for purchases within a predetermined time period,

d) the ability to use said transaction code for a repeating transaction at a fixed amount for purchases payable at each of a fixed number of time intervals, and

e) the ability to use said transaction code for a repeating transaction at a fixed amount for purchases payable at each of an unspecified number of time intervals.

24. (Original) The method of claim 10 wherein at least some of said plurality of payment categories include:

a) the ability to use said transaction code for a single transaction at a fixed amount for a purchase,

b) the ability to use said transaction code for a single transaction at a maximum amount for a purchase,

c) the ability to use said transaction code for multiple transactions at a maximum total amount for purchases,

d) the ability to use said transaction code for a repeating transaction at a fixed amount for purchases payable at each of a fixed number of time intervals, and

e) the ability to use said transaction code for a

repeating transaction at a fixed amount for purchases payable at each of an unspecified number of time intervals.

25. (Original) The method of claim 1 further comprising generating said transaction code to further reflect an identification of said single merchant.

26. (Original) The method of claim 25 further comprising defining said payment category to include the ability to limit purchases to a limited time interval during which said purchase authorization is valid.

27. (Currently Amended) A method of performing secure credit card purchases, said method comprising ~~the steps of:~~

- a) identifying a pre-established ~~financial~~ credit card account;
- b) designating at least one of a plurality of pre-defined payment categories which limit a nature of a subsequent purchase;
- c) issuing a transaction code associated with at least said ~~financial~~ credit card account and said selected payment category, and different from said ~~financial~~ credit card account;

- d) communicating said transaction code to a merchant to consummate a purchase within defined purchase parameters;
- e) verifying that said defined purchase parameters correspond to said designated payment category; and
- f) providing authorization for said purchase so as to confirm at least that said defined purchase parameters are within said designated payment category and complete the purchase; and
- g) associating the purchase with said ~~financial~~ credit card account.

28. (Currently Amended) A method of performing secure credit card purchases, said method comprising ~~the steps of~~:

- a) identifying a pre-established ~~financial~~ credit card account;
- b) designating a payment category which limits a nature of a subsequent purchase to a single transaction at a fixed amount;
- c) issuing a transaction code associated with at least said ~~financial~~ credit card account and said selected payment category, and different from said ~~financial~~ credit card account;

- d) communicating said transaction code to a merchant to consummate a purchase within defined purchase parameters;
- e) verifying that said defined purchase parameters correspond to said designated payment category; [[and]]
- f) providing authorization for said purchase so as to confirm at least that said defined purchase parameters are within said designated payment category and complete the purchase; and
- g) associating the purchase with said ~~financial~~ credit card account.

29. (Currently Amended) A method of performing secure credit card purchases, said method comprising ~~the steps of~~:

- a) identifying a pre-established ~~financial~~ credit card account;
- b) selecting a payment category which limits a nature of a series of subsequent purchases to a single merchant;
- c) issuing a transaction code associated with at least said ~~financial~~ credit card account and said selected payment category and different from said ~~financial~~ credit card account;

- d) communicating said transaction code to a merchant to consummate a purchase within defined purchase parameters;
- e) verifying that said defined purchase parameters correspond to said selected payment category;
- f) providing authorization for said purchase so as to confirm at least that said defined purchase parameters are within said selected payment category and complete the purchase; and
- g) associating the purchase with said ~~financial~~ credit card account.

30. (Original) The method of claim 29 wherein said step of selecting said payment category which limits said nature of said series of subsequent purchases to said single merchant further comprises limiting said nature of said series of subsequent purchases to a fixed amount for each of said subsequent purchases.

31. (Original) The method of claim 29 wherein said step of selecting said payment category which limits said nature of said series of subsequent purchases to said single merchant further comprises limiting said nature of said series of subsequent purchases to a maximum total amount for said subsequent

purchases.

32. (Previously Presented) The method of claim 29 wherein said step of verifying that said defined purchase parameters correspond to said selected payment category further defines said merchant as said single merchant.

33. (Currently Amended) A method of performing secure credit card purchases, said method comprising ~~the steps of~~:

- a) identifying a pre-established ~~financial~~ credit card account;
- b) selecting a payment category which limits a nature of a subsequent purchase to a single merchant;
- c) issuing a transaction code associated with at least said ~~financial~~ credit card account and said selected payment category, and different from said ~~financial~~ credit card account;
- d) designating a merchant as said single merchant;
- e) communicating said transaction code to said merchant to consummate a purchase within defined purchase parameters;
- f) verifying that said defined purchase parameters correspond to said selected payment category;

g) providing authorization for said purchase so as to confirm at least that said defined purchase parameters are within said selected payment category and complete the purchase; and

h) associating the purchase with said ~~financial~~ credit card account.

34. (Previously Presented) The method of claim 33 wherein said step of verifying that said defined purchase parameters correspond to said selected payment category further defines said merchant as said single merchant.

35. (Currently Amended) A system for performing secure credit card purchases comprising:

a) a custodial authorizing entity, said custodial authorizing entity structured to maintain a pre-established ~~financial~~ credit card account of at least one user;

b) said custodial authorizing entity further structured to define at least one payment category available for selection by a customer, said payment category structured to limit at least one subsequent transaction to a single merchant;

c) said custodial authorizing entity further structured

to issue a transaction code associated with said payment category selected by the customer and said ~~financial~~ credit card account of the user, said transaction code being different from said ~~financial~~ credit card account;

d) said custodial authorizing entity further structured to receive said transaction code and designated purchase parameters associated with a purchase from a merchant, and to verify that said designated purchase parameters correspond to said selected payment category; and

e) said custodial authorizing entity structured to provide the merchant with authorization for said purchase that confirms at least that said designated purchase parameters correspond to said selected payment category so that said purchase may be consummated by the merchant.

36. (Currently Amended) A system for performing secure credit card purchases as recited in claim 35 wherein said single merchant is defined upon selection of said payment category and is associated with said transaction code.

37. (Currently Amended) A system for performing secure credit card purchases as recited in claim 35 wherein said custodial authorizing entity is structured to designate a first merchant



to provide said transaction code for verification as said single merchant.

38. (Currently Amended) A system for performing secure credit card purchases as recited in claim 37 wherein said custodial authorizing entity is structured to designate said first merchant as said single merchant for subsequent transactions utilizing said transaction code.

39. (Currently Amended) A system for performing secure credit card purchases as recited in claim 35 wherein said payment category is further structured to limit said at least one subsequent transaction to a specified dollar amount.

40. (Currently Amended) A system for performing secure credit card purchases as recited in claim 39 wherein said payment category is further structured to limit each of a plurality of subsequent transactions to said specified dollar amount.

41. (Currently Amended) A system for performing secure credit card purchases as recited in claim 40 wherein said custodial authorizing entity is structured to designate a dollar amount of a first transaction associated with said transaction code and having said designated purchase parameters that correspond to remaining parameters of said selected payment category, as said

specified dollar amount.

42. (Currently Amended) A system for performing secure credit card purchases as recited in claim 39 wherein said specified dollar amount is defined upon selection of said payment category and is associated with said transaction code.

43. (Currently Amended) A system for performing secure credit card purchases as recited in claim 35 wherein said payment category is further structured to limit said at least one subsequent transaction to a maximum dollar amount.

44. (Currently Amended) A system for performing secure credit card purchases as recited in claim 35 wherein said payment category is further structured to limit said at least one subsequent transaction to a predetermined time period.

**REMARKS / ARGUMENTS**

This Amendment is submitted in full response to the Office Action dated March 5, 2007, wherein claims 1-5, 7-9, 27-29, 32-40, 42, and 43 stand rejected under 35 U.S.C. §102(e) as being anticipated by U.S. Patent No. 6,456,984 issued to Demoff et al. ("Demoff"), and claims 6, 10-26, 30, 31, 41, and 44 stand rejected under 35 U.S.C. §103(a) as being unpatentable by Demoff in view of U.S. Publication No. 2002/0152158 issued to Paleiov et al. ("Paleiov"). In addition, claims 1-44 stand rejected on the ground of non-statutory double patenting over claims 1-16 of U.S. Patent No. 6,324,526 issued to Applicant, and finally, claims 1-44 are provisionally rejected on the ground of non-statutory double patenting over claims 1-26 of Applicant's co-pending Application No. 10/037,007.

An appropriate Request for an Extension of Time and the corresponding fee are being filed concurrently herewith, and accordingly, Applicant respectfully requests reconsideration of this application in view of the foregoing amendments and the following remarks. Applicant also notes that an IDS is being submitted concurrently with the present response for the Examiner's consideration.

Furthermore, Applicant presents herein amended independent claims 1, 27-29, 33, and 35; original dependent claims 2-4, 6-26, and 30-31; previously presented dependent claims 5, 32, and 34; and currently amended dependent claims 36-44.

**A. Priority.**

To begin, it is noted that there are several conditions that must be met for a later-filed application to receive the benefit of the prior-filed application, namely, (1) the prior-filed application must disclose the claimed invention of the later-filed application in the manner provided by the first paragraph of 35 U.S.C. §112, (2) the later-filed application must be co-pending with the prior-filed application, (3) the later-filed application must contain a reference to the prior-filed application, and (4) the later-filed application must be filed by an inventor or inventors named in the prior-filed application. MPEP §201.11. As will be apparent from the following remarks, and in light of the amendments to the claims presented herein, the claimed invention of the present Application has met each of the above-mentioned conditions such that it should now receive the benefit of the filing date of the

first, originally-filed patent Application, filed on January 15, 1999.

As presented in the original specification of the currently pending Application, and acknowledged in the above-referenced outstanding Office Action, this application ("Child Application") is a Continuation application of co-pending patent application Serial No. 10/037,007 ("Parent Application" or "Intermediate Application"), which is a continuation-in-part patent application of previously filed, then-pending application having Serial No. 09/231,745, filed on January 15, 1999 ("Grandparent Application"), now patented as U.S. Patent No. 6,324,526 ("the '526 patent") (Applicant points out in the spirit of full disclosure that as referenced in the IDS, the '526 patent is presently undergoing re-examination, however, it is believed that that proceeding does not in any way impact the priority claims being discussed herein).

As an initial matter, Applicant respectfully notes that although the Parent Application, namely, the continuation-in-part patent application filed on November 9, 2001, may contain additional disclosure not specifically supported by the originally filed specification of the Grandparent Application,

Application No. 11/252,009  
Amdt. dated September 5, 2007  
Reply to Office Action dated March 5, 2007

F:\MM DOCS\1-PAT\PAT 2004\APP\1706B-01 D'Agostino John\1706-B AMENDMENT FILED.doc

filed on January 15, 1999, the disclosure of the present Application (i.e., Child Application) is nearly identical to the originally submitted specification of the Grandparent Application, such that no new matter is presented herein relative to the original specification filed on January 15, 1999.

As explained in more detail below, in accordance with 35 U.S.C. §112, ¶1, the claims as presented herein are supported by the specification of the original Grandparent Application as filed on January 15, 1999, the specification of the continuation-in-part Parent application filed on November 9, 2001, and the specification of the currently pending Child Application, filed on October 17, 2005.<sup>1</sup>

In particular, each of the claims presented herein, namely, currently amended independent claims 1, 27-29, 33, and 35; originally presented dependent claims 2-4, 6-26, and 30-31; previously presented dependent claims 5, 32, and 34; and currently amended dependent claims 36-44 relate to "secure credit card purchases." Specifically, as support for each of

---

<sup>1</sup> It is also noted that the claims presented in the intermediate continuation-in-part Parent Application have been amended via an Amendment dated September 5, 2007 such that the claim therein are also now fully supported by the specification of the Grandparent Application as filed on January 15, 1999. Accordingly, the intermediate continuation-in-part Parent Application is similarly entitled to the benefit of the filing date of the prior application filed on January 15, 1999.

the claims as presented herein, Applicant respectfully directs the PTO's attention to the Grandparent Application at least at page 6, lines 11-16; page 9, line 20 - page 10, line 1; page 11, lines 23-25; page 12, line 22 - page 13, line 13; and Figure 1 (see also the '526 patent, col. 3, lines 7-37; col. 5, lines 17-19; col. 5, lines 42-58; and Figure 1), the Intermediate or Parent Application at least at page 1, lines 9-22; page 12, lines 6-10; and Figure 1, and finally, the present Child Application at least at page 6, lines 19-24; page 10, lines 7-13; page 12, lines 12-23; page 13, line 12 - page 14, line 4; and Figure 1.

In addition, the remaining requirements for the currently pending Child Application to obtain the benefit of the filing date of the Grandparent Application are indeed satisfied. Specifically, the currently pending application was filed during the pendency of the intermediate continuation-in-part Parent Application. Furthermore, the currently pending Child Application contains a reference to the prior filed Parent Application as well as the Grandparent Application, each of which were filed in the name of the exact same inventor, namely, John D'Agostino.

As such, in light of the foregoing, each of the claims presented herein are supported by the specification of the Parent Application filed on November 9, 2001, as well as the Grandparent Application filed on January 15, 1999, such that each claim benefits from the January 15, 1999 filing date.

**B. Rejections Under 35 U.S.C. §§102(e) and 103(a).**

As above, claims 1-5, 7-9, 27-29, 32-40, 42, and 43 stand rejected under 35 U.S.C. §102(e) as being anticipated by Demoff, filed on May 28, 1999, and claims 6, 10-26, 30, 31, 41, and 44 stand rejected under 35 U.S.C. §103(a) as being unpatentable by Demoff in view of Paleiov, filed on April 12, 2001. In light of the foregoing amendments to the claims and remarks thereto, Applicant respectfully notes that claims 1-44, as presented herein, are believed to benefit from the filing date of the Grandparent Application, namely, January 15, 1999, which pre-dates the cited references to Demoff and Paleiov, thereby rendering each of the rejections under 35 U.S.C. §§102(e) and 103(a) moot and overcome.

**C. Terminal Disclaimer.**



Application No. 11/252,009  
Amdt. dated September 5, 2007  
Reply to Office Action dated March 5, 2007

F:\MM DOCS\1-PAT\PAT 2004\APP\1706B-01 D'Agostino John\1706-B AMENDMENT FILED.doc

In addition, two properly executed terminal disclaimers are being filed contemporaneously herewith, thereby eliminating Applicant's U.S. Patent No. 6,324,526 and Applicant's co-pending Application No. 10/037,007 as a basis for the rejection of the claims herein.

**D. Conclusion.**

Based on the foregoing remarks and the above amendments to the claims it is respectfully requested that this application be given full and favorable reconsideration. It is believed that upon doing so, this application will be deemed to be in condition for immediate allowance, which action is now respectfully requested.

In addition, a request for an appropriate extension of time is enclosed herewith along with the corresponding PTO fee. In the event that any additional fee may be required by the filing of this paper, the Commissioner is hereby authorized to charge any fees and/or credits to our **Deposit Account No. 13-1227.**

Application No. 11/252,009  
Amdt. dated September 5, 2007  
Reply to Office Action dated March 5, 2007

F:\MM DOCS\1-PAT\PAT 2004\APP\1706B-01 D'Agostino John\1706-B AMENDMENT FILED.doc

Respectfully Submitted,

MALLOY & MALLOY, P.A.  
Attorneys for Applicant  
2800 S.W. 3<sup>rd</sup> Avenue  
Historic Coral Way  
Miami, Florida 33129  
(305)858-8000

By: 

Peter A. Matos  
Reg. No. 37,884

Date: 9/5/07

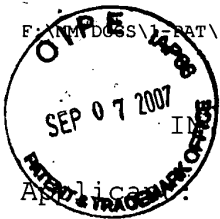

IN THE UNITED STATES PATENT AND TRADEMARK OFFICE

Applicant: John D'Agostino

Serial No.: 11/252,009

Filing Date: October 17, 2005

For: SYSTEM AND METHOD FOR PERFORMING SECURE CREDIT CARD PURCHASES

Confirmation No. 4322  
Customer No. 04219  
Shrestha, B., Examiner  
Group Art Unit 3691

2800 S.W. Third Avenue  
Historic Coral Way  
Miami, Florida 33129

Mail Stop Amendment  
Commissioner for Patents  
P.O. Box 1450  
Alexandria, VA 22313-1450

Dear Sir:

CERTIFICATE OF MAILING

I HEREBY CERTIFY that this correspondence is being deposited with the United States Postal Service as first class mail in an envelope addressed to: Mail Stop Amendment, Commissioner for Patents, P.O. Box 1450, Alexandria, VA 22313-1450, this 5 day of September, 2007.

Respectfully submitted,

MALLOY & MALLOY, P.A.  
2800 S.W. Third Avenue  
Historic Coral Way  
Miami, Florida 33129  
(305) 858-8000

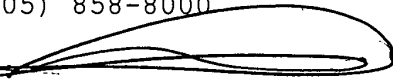
By: 

Peter A. Matos  
Reg. No. 37,884

Date: 9/5/07

IN THE UNITED STATES PATENT AND TRADEMARK OFFICE

Applicant: John D'Agostino  
Serial No.: 11/252,009  
Filing Date: October 17, 2005  
For: SYSTEM AND METHOD FOR PERFORMING SECURE CREDIT CARD PURCHASES



Confirmation No. 4322  
Customer No. 04219  
Shrestha, B., Examiner  
Group Art Unit 3691

2800 S.W. Third Avenue  
Historic Coral Way  
Miami, Florida 33129

Mail Stop Amendment  
Commissioner for Patents  
P.O. Box 1450  
Alexandria, VA 22313-1450

Dear Sir:

INFORMATION DISCLOSURE STATEMENT

In accordance with Applicant's duty of disclosure, the attached information is provided for consideration by the U.S. Patent and Trademark Office ("PTO") in connection with the above-captioned application. The information is identified on attached forms PTO/SB/08A and PTO/SB/08B. In accordance with 37 C.F.R. §1.98(a)(2)(ii), copies of U.S. patents or U.S. patent application publications have not been enclosed.

09/07/2007 ATRINH 00000016 11252009  
04 FC:1006

100.00 OP

Furthermore, in accordance with the duty of disclosure and in an abundance of caution, as reflected on the attached form PTO/SB/08B, Applicant directs the Examiner's attention to Reexamination of U.S. Patent No. 6,324,526 filed on March 28, 2005,

and having Control No. 90/007,481. Said Reexamination is presently under Appeal before the Board of Patent Appeals and Interferences. Additionally, Applicant notes that each of the references cited in said reexamination that have not been previously provided are referenced herein.

The Examiner is respectfully requested to return an initialed copy of each form PTO/SB/08A and PTO/SB/08B evidencing consideration of this information with the next Office Action.

The Applicant points out that this Information Disclosure Statement is being presented after the issuance of a first Office Action, but before the issuance of a Final Office Action, and in accordance with 37 C.F.R. 1.97(c), a check in the amount of \$180.00 is enclosed as the fee under 1.17(p).

In the event that any fee may be required by the filing of this paper, the Commissioner is hereby authorized to charge any fees and/or credit to our **Deposit Account No. 13-1227**.

Respectfully submitted,

MALLOY & MALLOY, P.A.  
Attorneys for Applicant  
2800 S.W. Third Avenue  
Historic Coral Way  
Miami, Florida 33129  
(305) 858-8000

By 

Peter A. Matos  
Reg. No. 37,884

Dated: 9/5/07

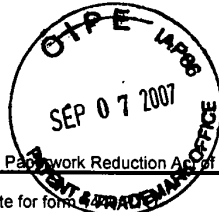

Under the Paperwork Reduction Act of 1995, no persons are required to respond to a collection of information unless it contains a valid OMB control number.

<b>INFORMATION DISCLOSURE          STATEMENT BY APPLICANT</b> <i>(Use as many sheets as necessary)</i>	<b>Complete if Known</b>	
	Application Number	11/252,009
	Filing Date	October 17, 2005
	First Named Inventor	John D'Agostino
	Art Unit	3691
	Examiner Name	Bijendra K. Shrestha
Attorney Docket Number	1.706-B.04	

Sheet 1 of 7

U. S. PATENT DOCUMENTS					
Examiner Initials*	Cite No. <sup>1</sup>	Document Number	Publication Date MM-DD-YYYY	Name of Patentee or Applicant of Cited Document	Pages, Columns, Lines, Where Relevant Passages or Relevant Figures Appear
		Number-Kind Code <sup>2</sup> (if known)			
		US- 3,938,091	02/10/1976	Atalla et al.	
		US- 4,423,316	12/27/1983	Sano et al.	
		US- 4,707,592	11/17/1987	Ware	
		US- 4,720,860	01/19/1988	Weiss	
		US- 4,725,719	02/16/1988	Oncken et al.	
		US- 4,747,050	05/24/1988	Brachtl et al.	
		US- 4,797,920	01/10/1989	Stein	
		US- 5,097,505	03/17/1992	Weiss	
		US- 5,130,519	07/14/1992	Bush et al.	
		US- 5,163,097	11/10/1992	Pegg	
		US- 5,193,114	03/09/1993	Moseley	
		US- 5,196,840	03/23/1993	Leith et al.	
		US- 5,202,826	04/13/1993	McCarthy	
		US- 5,239,583	08/24/1993	Parrillo	
		US- 5,287,268	02/15/1994	McCarthy	
		US- 5,317,636	05/31/1994	Vizcaino	
		US- 5,323,338	06/21/1994	Hawthorne	
		US- 5,326,960	07/05/1994	Tannenbaum	
		US- 5,350,906	09/27/1994	Brody et al.	

FOREIGN PATENT DOCUMENTS						
Examiner Initials*	Cite No. <sup>1</sup>	Foreign Patent Document	Publication Date MM-DD-YYYY	Name of Patentee or Applicant of Cited Document	Pages, Columns, Lines, Where Relevant Passages Or Relevant Figures Appear	T <sup>6</sup>
		Country Code <sup>3</sup> Number <sup>4</sup> Kind Code <sup>5</sup> (if known)				
		EP 0 081 921 A1	06/22/1983	Easterby		
		GB 2 145 265 A	03/20/1985	Miura		
		WO 91/12693	05/08/1992	Hawthorne et al.		
		FR 2 661 996 - A1	11/15/1991	Bremard		
		GB 2 252 270 A	08/05/1992	Wren-Hilton		
		WO 93/14476	07/22/1993	Reinikainen		

Examiner Signature	Date Considered
--------------------	-----------------

\*EXAMINER: Initial if reference considered, whether or not citation is in conformance with MPEP 609. Draw line through citation if not in conformance and not considered. Include copy of this form with next communication to applicant. <sup>1</sup> Applicant's unique citation designation number (optional). <sup>2</sup> See Kinds Codes of USPTO Patent Documents at [www.uspto.gov](http://www.uspto.gov) or MPEP 901.04. <sup>3</sup> Enter Office that issued the document, by the two-letter code (WIPO Standard ST.3). <sup>4</sup> For Japanese patent documents, the indication of the year of the reign of the Emperor must precede the serial number of the patent document. <sup>5</sup> Kind of document by the appropriate symbols as indicated on the document under WIPO Standard ST.16 if possible. <sup>6</sup> Applicant is to place a check mark here if English language Translation is attached.

This collection of information is required by 37 CFR 1.97 and 1.98. The information is required to obtain or retain a benefit by the public which is to file (and by the USPTO to process) an application. Confidentiality is governed by 35 U.S.C. 122 and 37 CFR 1.14. This collection is estimated to take 2 hours to complete, including gathering, preparing, and submitting the completed application form to the USPTO. Time will vary depending upon the individual case. Any comments on the amount of time you require to complete this form and/or suggestions for reducing this burden, should be sent to the Chief Information Officer, U.S. Patent and Trademark Office, P.O. Box 1450, Alexandria, VA 22313-1450. DO NOT SEND FEES OR COMPLETED FORMS TO THIS ADDRESS. SEND TO: Commissioner for Patents, P.O. Box 1450, Alexandria, VA 22313-1450.

If you need assistance in completing the form, call 1-800-PTO-9199 (1-800-786-9199) and select option 2.

Under the Paperwork Reduction Act of 1995, no persons are required to respond to a collection of information unless it contains a valid OMB control number.

Substitute for form 1449/PTO		<b>Complete if Known</b>	
		Application Number	11/252,009
<b>INFORMATION DISCLOSURE STATEMENT BY APPLICANT</b> <i>(Use as many sheets as necessary)</i>		Filing Date	October 17, 2005
		First Named Inventor	John D'Agostino
		Art Unit	3691
		Examiner Name	Bijendra K. Shrestha
		Attorney Docket Number	1.706-B.04
Sheet	2	of	7

U. S. PATENT DOCUMENTS					
Examiner Initials*	Cite No. <sup>1</sup>	Document Number	Publication Date MM-DD-YYYY	Name of Patentee or Applicant of Cited Document	Pages, Columns, Lines, Where Relevant Passages or Relevant Figures Appear
		Number-Kind Code <sup>2</sup> (if known)			
		US- 5,363,449	11/08/1994	Bestock	
		US- 5,428,684	06/27/1995	Akiyama et al.	
		US- 5,466,919	11/14/1995	Hovakimian	
		US- 5,478,994	12/26/1995	Rahman et al.	
		US- 5,485,510	01/16/1996	Colbert	
		US- 5,500,513	03/19/1996	Langhans et al.	
		US- 5,504,808	04/02/1996	Hamrick, Jr.	
		US- 5,555,497	09/10/1996	Helbling	
		US- 5,577,109	11/19/1996	Stimson et al.	
		US- 5,583,918	12/10/1996	Nakagawa	
		US- 5,606,614	02/25/1997	Brady et al.	
		US- 5,621,201	04/15/1997	Langhans et al.	
		US- 5,627,355	05/06/1997	Rahman et al.	
		US- 5,671,279	09/23/1997	Elgamal	
		US- 5,677,955	10/14/1997	Doggett et al.	
		US- 5,694,471	12/02/1997	Chen et al.	
		US- 5,696,908	12/09/1997	Muehlberger et al.	
		US- 5,715,314	02/03/1998	Payne et al.	
		US- 5,721,768	02/24/1998	Stimson et al.	

FOREIGN PATENT DOCUMENTS						
Examiner Initials*	Cite No. <sup>1</sup>	Foreign Patent Document	Publication Date MM-DD-YYYY	Name of Patentee or Applicant of Cited Document	Pages, Columns, Lines, Where Relevant Passages Or Relevant Figures Appear	T <sup>6</sup>
		Country Code <sup>3</sup> Number <sup>4</sup> Kind Code <sup>5</sup> (if known)				
		EP 0 590 861 A2	04/06/1994	Colbert		
		EP 0 590 861 A3	04/06/1994	Colbert		
		EP 0 590 961 A2	04/06/1994	Kazuo et al.		
		WO 95/07512	03/16/1995	Ziamo		
		WO 96/08756	03/21/1996	Hawthorn et al.		
		WO 96/42150	12/27/1996	Pittenger et al.		

Examiner Signature	Date Considered
--------------------	-----------------

\*EXAMINER: Initial if reference considered, whether or not citation is in conformance with MPEP 609. Draw line through citation if not in conformance and not considered. Include copy of this form with next communication to applicant. <sup>1</sup> Applicant's unique citation designation number (optional). <sup>2</sup> See Kinds Codes of USPTO Patent Documents at [www.uspto.gov](http://www.uspto.gov) or MPEP 901.04. <sup>3</sup> Enter Office that issued the document, by the two-letter code (WIPO Standard ST.3). <sup>4</sup> For Japanese patent documents, the indication of the year of the reign of the Emperor must precede the serial number of the patent document. <sup>5</sup> Kind of document by the appropriate symbols as indicated on the document under WIPO Standard ST.16 if possible. <sup>6</sup> Applicant is to place a check mark here if English language Translation is attached.

This collection of information is required by 37 CFR 1.97 and 1.98. The information is required to obtain or retain a benefit by the public which is to file (and by the USPTO to process) an application. Confidentiality is governed by 35 U.S.C. 122 and 37 CFR 1.14. This collection is estimated to take 2 hours to complete, including gathering, preparing, and submitting the completed application form to the USPTO. Time will vary depending upon the individual case. Any comments on the amount of time you require to complete this form and/or suggestions for reducing this burden, should be sent to the Chief Information Officer, U.S. Patent and Trademark Office, P.O. Box 1450, Alexandria, VA 22313-1450. DO NOT SEND FEES OR COMPLETED FORMS TO THIS ADDRESS. SEND TO: Commissioner for Patents, P.O. Box 1450, Alexandria, VA 22313-1450.

If you need assistance in completing the form, call 1-800-PTO-9199 (1-800-786-9199) and select option 2.

Under the Paperwork Reduction Act of 1995, no persons are required to respond to a collection of information unless it contains a valid OMB control number.

<b>INFORMATION DISCLOSURE STATEMENT BY APPLICANT</b> (Use as many sheets as necessary)	Substitute for form 1449/PTO		<b>Complete if Known</b>	
	Application Number	11/252,009		
	Filing Date	October 17, 2005		
	First Named Inventor	John D'Agostino		
	Art Unit	3691		
	Examiner Name	Bijendra K. Shrestha		
Attorney Docket Number	1.706-B.04			
Sheet	3	of	7	

U. S. PATENT DOCUMENTS					
Examiner Initials*	Cite No. <sup>1</sup>	Document Number	Publication Date MM-DD-YYYY	Name of Patentee or Applicant of Cited Document	Pages, Columns, Lines, Where Relevant Passages or Relevant Figures Appear
		Number-Kind Code <sup>2</sup> (if known)			
		US- 5,724,424	03/03/1998	Gifford	
		US- 5,727,163	03/10/1998	Bezos	
		US- 5,729,594	03/17/1998	Klingman	
		US- 5,748,908	05/05/1998	Yu	
		US- 5,757,917	05/26/1998	Rose et al.	
		US- 5,768,381	06/16/1998	Hawthorne	
		US- 5,777,305	07/07/1998	Smith et al.	
		US- 5,777,306	07/07/1998	Masuda	
		US- 5,794,221	08/11/1998	Egendorf	
		US- 5,815,657	09/29/1998	Williams et al.	
		US- 5,822,737	10/13/1998	Ogram	
		US- 5,825,881	10/20/1998	Colvin, Sr.	
		US- 5,826,241	10/20/1998	Stein et al.	
		US- 5,826,243	10/20/1998	Musmanno et al.	
		US- 5,832,087	11/03/1998	Hawthorne	
		US- 5,864,830	01/26/1999	Armetta et al.	
		US- 5,868,236	02/09/1999	Rademacher	
		US- 5,883,810	03/16/1999	Franklin et al.	
		US- 5,890,137	03/30/1999	Koreeda	

FOREIGN PATENT DOCUMENTS						
Examiner Initials*	Cite No. <sup>1</sup>	Foreign Patent Document	Publication Date MM-DD-YYYY	Name of Patentee or Applicant of Cited Document	Pages, Columns, Lines, Where Relevant Passages Or Relevant Figures Appear	T <sup>6</sup>
		Country Code <sup>3</sup> Number <sup>4</sup> Kind Code <sup>5</sup> (if known)				
		WO 97/15893	05/01/1997	Ukuda		
		WO 97/19549	05/29/1997	Beeder et al.		
		CA 2,167,543	07/19/1997	Durward		
		WO 98/26376	06/18/1998	Walker et al.		
		GB 2 327 831 A	02/03/1999	Hawthorne		
		WO 99/49424	09/30/1999	Flitcroft et al.		

Examiner Signature		Date Considered	
--------------------	--	-----------------	--

\*EXAMINER: Initial if reference considered, whether or not citation is in conformance with MPEP 609. Draw line through citation if not in conformance and not considered. Include copy of this form with next communication to applicant. <sup>1</sup> Applicant's unique citation designation number (optional). <sup>2</sup> See Kinds Codes of USPTO Patent Documents at [www.uspto.gov](http://www.uspto.gov) or MPEP 901.04. <sup>3</sup> Enter Office that issued the document, by the two-letter code (WIPO Standard ST.3). <sup>4</sup> For Japanese patent documents, the indication of the year of the reign of the Emperor must precede the serial number of the patent document. <sup>5</sup> Kind of document by the appropriate symbols as indicated on the document under WIPO Standard ST.16 if possible. <sup>6</sup> Applicant is to place a check mark here if English language translation is attached.

This collection of information is required by 37 CFR 1.97 and 1.98. The information is required to obtain or retain a benefit by the public which is to file (and by the USPTO to process) an application. Confidentiality is governed by 35 U.S.C. 122 and 37 CFR 1.14. This collection is estimated to take 2 hours to complete, including gathering, preparing, and submitting the completed application form to the USPTO. Time will vary depending upon the individual case. Any comments on the amount of time you require to complete this form and/or suggestions for reducing this burden, should be sent to the Chief Information Officer, U.S. Patent and Trademark Office, P.O. Box 1450, Alexandria, VA 22313-1450. DO NOT SEND FEES OR COMPLETED FORMS TO THIS ADDRESS. SEND TO: Commissioner for Patents, P.O. Box 1450, Alexandria, VA 22313-1450.

If you need assistance in completing the form, call 1-800-PTO-9199 (1-800-786-9199) and select option 2.



Under the Paperwork Reduction Act of 1995, no persons are required to respond to a collection of information unless it contains a valid OMB control number.

Substitute for form 1449/PTO

**INFORMATION DISCLOSURE  
STATEMENT BY APPLICANT**

(Use as many sheets as necessary)

Sheet 4

of 7

**Complete if Known**

Application Number	11/252,009
Filing Date	October 17, 2005
First Named Inventor	John D'Agostino
Art Unit	3691
Examiner Name	Bijendra K. Shrestha
Attorney Docket Number	1.706-B.04

U. S. PATENT DOCUMENTS					
Examiner Initials*	Cite No. <sup>1</sup>	Document Number	Publication Date MM-DD-YYYY	Name of Patentee or Applicant of Cited Document	Pages, Columns, Lines, Where Relevant Passages or Relevant Figures Appear
		Number-Kind Code <sup>2</sup> (if known)			
		US- 5,893,907	04/13/1999	Ukuda	
		US- 5,903,878	05/11/1999	Talati et al.	
		US- 5,953,710	09/14/1999	Fleming	
		US- 5,956,699	09/21/1999	Wong et al.	
		US- 5,984,180	11/16/1999	Albrecht	
		US- 6,000,832	12/14/1999	Franklin et al.	
		US- 6,029,890	02/29/2000	Austin	
		US- 6,144,948	11/07/2000	Walker et al.	
		US- 6,163,771	12/19/2000	Walker et al.	
		US- 6,188,761 B1	02/13/2001	Dickerman et al.	
		US- 6,240,397 B1	05/29/2001	Sachs	
		US- 6,267,292 B1	07/31/2001	Walker et al.	
		US- 6,298,335 B1	10/02/2001	Bernstein	
		US- 6,324,526 B1	11/27/2001	D'Agostino	
		US- 6,339,766 B1	01/15/2002	Gephart	
		US- 6,341,724 B2	01/29/2002	Campisano	
		US- 6,343,279 B1	01/29/2002	Bissonette et al.	
		US- 6,375,084 B1	04/23/2002	Stanford et al.	
		US- 6,422,462 B1	07/23/2002	Cohen	

FOREIGN PATENT DOCUMENTS						
Examiner Initials*	Cite No. <sup>1</sup>	Foreign Patent Document	Publication Date MM-DD-YYYY	Name of Patentee or Applicant of Cited Document	Pages, Columns, Lines, Where Relevant Passages Or Relevant Figures Appear	T <sup>6</sup>
		Country Code <sup>3</sup> -Number <sup>4</sup> -Kind Code <sup>5</sup> (if known)				
		GB 2 361 790 A	10/31/01	Arndt et al.		
		WO 00/42486	07/20/2000	D'Agostino		

Examiner Signature	Date Considered
--------------------	-----------------

\*EXAMINER: Initial if reference considered, whether or not citation is in conformance with MPEP 609. Draw line through citation if not in conformance and not considered. Include copy of this form with next communication to applicant. <sup>1</sup> Applicant's unique citation designation number (optional). <sup>2</sup> See Kinds Codes of USPTO Patent Documents at [www.uspto.gov](http://www.uspto.gov) or MPEP 901.04. <sup>3</sup> Enter Office that issued the document, by the two-letter code (WIPO Standard ST.3). <sup>4</sup> For Japanese patent documents, the indication of the year of the reign of the Emperor must precede the serial number of the patent document. <sup>5</sup> Kind of document by the appropriate symbols as indicated on the document under WIPO Standard ST.16 if possible. <sup>6</sup> Applicant is to place a check mark here if English language Translation is attached.

This collection of information is required by 37 CFR 1.97 and 1.98. The information is required to obtain or retain a benefit by the public which is to file (and by the USPTO to process) an application. Confidentiality is governed by 35 U.S.C. 122 and 37 CFR 1.14. This collection is estimated to take 2 hours to complete, including gathering, preparing, and submitting the completed application form to the USPTO. Time will vary depending upon the individual case. Any comments on the amount of time you require to complete this form and/or suggestions for reducing this burden, should be sent to the Chief Information Officer, U.S. Patent and Trademark Office, P.O. Box 1450, Alexandria, VA 22313-1450. DO NOT SEND FEES OR COMPLETED FORMS TO THIS ADDRESS. SEND TO: Commissioner for Patents, P.O. Box 1450, Alexandria, VA 22313-1450.

If you need assistance in completing the form, call 1-800-PTO-9199 (1-800-786-9199) and select option 2.

Under the Paperwork Reduction Act of 1995, no persons are required to respond to a collection of information unless it contains a valid OMB control number.

Substitute for form 1449/PTO		<b>Complete if Known</b>	
		Application Number	11/252,009
<b>INFORMATION DISCLOSURE STATEMENT BY APPLICANT</b> <i>(Use as many sheets as necessary)</i>		Filing Date	October 17, 2005
		First Named Inventor	John D'Agostino
		Art Unit	3691
		Examiner Name	Bijendra K. Shrestha
Sheet	5	of	7
		Attorney Docket Number	1.706-B.04

U. S. PATENT DOCUMENTS					
Examiner Initials*	Cite No. <sup>1</sup>	Document Number	Publication Date MM-DD-YYYY	Name of Patentee or Applicant of Cited Document	Pages, Columns, Lines, Where Relevant Passages or Relevant Figures Appear
		Number-Kind Code <sup>2</sup> (if known)			
		US- 6,598,031 B1	07/22/2003	Ice	
		US- 2002/0120587 A1	08/29/2002	D'Agostino	
		US- 2003/0018567 A1	01/23/2003	Flitcroft et al.	
		US- 2003/0028481 A1	02/06/2003	Flitcroft et al.	
		US- 2003/0097331 A1	05/22/2003	Cohen	
		US- 6,636,833 B1	10/21/2003	Flitcroft et al.	
		US- 2003/0216997 A1	11/20/2003	Cohen	
		US-			
		US-			
		US-			
		US-			
		US-			
		US-			
		US-			
		US-			
		US-			
		US-			
		US-			
		US-			

FOREIGN PATENT DOCUMENTS						
Examiner Initials*	Cite No. <sup>1</sup>	Foreign Patent Document	Publication Date MM-DD-YYYY	Name of Patentee or Applicant of Cited Document	Pages, Columns, Lines, Where Relevant Passages Or Relevant Figures Appear	T <sup>6</sup>
		Country Code <sup>3</sup> Number <sup>4</sup> Kind Code <sup>5</sup> (if known)				

Examiner Signature	Date Considered
--------------------	-----------------

\*EXAMINER: Initial if reference considered, whether or not citation is in conformance with MPEP 609. Draw line through citation if not in conformance and not considered. Include copy of this form with next communication to applicant. <sup>1</sup> Applicant's unique citation designation number (optional). <sup>2</sup> See Kinds Codes of USPTO Patent Documents at [www.uspto.gov](http://www.uspto.gov) or MPEP 901.04. <sup>3</sup> Enter Office that issued the document, by the two-letter code (WIPO Standard ST.3). <sup>4</sup> For Japanese patent documents, the indication of the year of the reign of the Emperor must precede the serial number of the patent document. <sup>5</sup> Kind of document by the appropriate symbols as indicated on the document under WIPO Standard ST.16 if possible. <sup>6</sup> Applicant is to place a check mark here if English language Translation is attached.

This collection of information is required by 37 CFR 1.97 and 1.98. The information is required to obtain or retain a benefit by the public which is to file (and by the USPTO to process) an application. Confidentiality is governed by 35 U.S.C. 122 and 37 CFR 1.14. This collection is estimated to take 2 hours to complete, including gathering, preparing, and submitting the completed application form to the USPTO. Time will vary depending upon the individual case. Any comments on the amount of time you require to complete this form and/or suggestions for reducing this burden, should be sent to the Chief Information Officer, U.S. Patent and Trademark Office, P.O. Box 1450, Alexandria, VA 22313-1450. DO NOT SEND FEES OR COMPLETED FORMS TO THIS ADDRESS. SEND TO: Commissioner for Patents, P.O. Box 1450, Alexandria, VA 22313-1450.

If you need assistance in completing the form, call 1-800-PTO-9199 (1-800-786-9199) and select option 2.

Under the Paperwork Reduction Act of 1995, no persons are required to respond to a collection of information unless it contains a valid OMB control number.

Substitute for form 1449/PTO  <b>INFORMATION DISCLOSURE STATEMENT BY APPLICANT</b>  (Use as many sheets as necessary)		<b>Complete if Known</b>	
		Application Number	11/252,009
		Filing Date	October 17, 2005
		First Named Inventor	John D'Agostino
		Art Unit	3691
		Examiner Name	Bijendra K. Shrestha
Sheet 6	of 7	Attorney Docket Number	1.706-B.04

NON PATENT LITERATURE DOCUMENTS			
Examiner Initials*	Cite No. <sup>1</sup>	Include name of the author (in CAPITAL LETTERS), title of the article (when appropriate), title of the item (book, magazine, journal, serial, symposium, catalog, etc.), date, page(s), volume-issue number(s), publisher, city and/or country where published.	T <sup>2</sup>
		ERAN GABBER and ABRAHAM SILBERSCHATZ, A Minimal Distributed Protocol for Electronic Commerce, www.usenix.org/publications (Article), Oakland, USA, November 18-21, 1996	
		CITI.COM, Total Fraud Protection... Solutions for your safety and peace of mind, (printout) CBSD002144-CBSD002153	
		OWEN THOMAS, Money Changers, www.ecompany.com, (Article), October 2000	
		Netchex - a short brief, www.tml.hut.fi/Studies/Tik-110.50/1997/Ecommerce/netchex-5.html, (Article), November 5, 2002	
		GE CAPITAL FINANCIAL INC., GE Pre-Authorization System, (GE's website printout)	
		MATT BARTHEL, Diebold Plans Major Push in Market for Debit-Card Point of Sale Terminals, 09/28/1993, American Banker, PP 1-2	
		BOB WOODS, New Dell E-Commerce Guarantee Called "Weak", 08/13/1998, Newbytes News PP 1-2	
		ANNE FINNIGAN, The Safe Way to Shop Online, Good Housekeeping, 09/1998, PP 1-2	
		PAUL DEMERY, Attaching the Smart Card Fortress, Credit Card Management, 09/1998, PP 1-4	
		LARRY CHASE, Taking Transactions Online, Target Marketing, 10/1998, 1-4	

Examiner Signature		Date Considered	
--------------------	--	-----------------	--

\*EXAMINER: Initial if reference considered, whether or not citation is in conformance with MPEP 609. Draw line through citation if not in conformance and not considered. Include copy of this form with next communication to applicant.  
 1 Applicant's unique citation designation number (optional). 2 Applicant is to place a check mark here if English language Translation is attached.  
 This collection of information is required by 37 CFR 1.98. The information is required to obtain or retain a benefit by the public which is to file (and by the USPTO to process) an application. Confidentiality is governed by 35 U.S.C. 122 and 37 CFR 1.14. This collection is estimated to take 2 hours to complete, including gathering, preparing, and submitting the completed application form to the USPTO. Time will vary depending upon the individual case. Any comments on the amount of time you require to complete this form and/or suggestions for reducing this burden, should be sent to the Chief Information Officer, U.S. Patent and Trademark Office, P.O. Box 1450, Alexandria, VA 22313-1450. DO NOT SEND FEES OR COMPLETED FORMS TO THIS ADDRESS. SEND TO: Commissioner for Patents, P.O. Box 1450, Alexandria, VA 22313-1450.

If you need assistance in completing the form, call 1-800-PTO-9199 (1-800-786-9199) and select option 2.

Under the Paperwork Reduction Act of 1995, no persons are required to respond to a collection of information unless it contains a valid OMB control number.

Substitute for form 1449/PTO		<b>Complete if Known</b>	
<b>INFORMATION DISCLOSURE STATEMENT BY APPLICANT</b>  (Use as many sheets as necessary)		Application Number	11/262,009
		Filing Date	October 17, 2005
		First Named Inventor	John D'Agostino
		Art Unit	3691
		Examiner Name	Bijendra K. Shrestha
Sheet 7	of 7	Attorney Docket Number	1.706-B.04

NON PATENT LITERATURE DOCUMENTS			
Examiner Initials*	Cite No. <sup>1</sup>	Include name of the author (in CAPITAL LETTERS), title of the article (when appropriate), title of the item (book, magazine, journal, serial, symposium, catalog, etc.), date, page(s), volume-issue number(s), publisher, city and/or country where published.	T <sup>2</sup>
		Virtual Credit Card (VCC), www.geocities.com/Eureka/Park/5014/vcc.htm, (printout). June 28, 1999	
		Smart Cards, disc.cba.uh.edu, (printout), November 1, 2001	
		VINCENT MOSCARITOLO & ROBERT HETTINGA, Digital Commerce for the Rest of Us Apple in a Geodesic Economy, www.shipwright.com/rants/rant_15.html, (article), September 4, 1996	
		BLACK IVES & MICHAEL EARL, Mondex International Reengineering Money, London Business School Article, isds.bus.lsu.edu/cases/mondex.html, November 1, 2001	
		Smart Card New Ltd's Information Gateway, www.smartcard.co.uk/articles/electronicmoney.html, November 1, 2001	
		Putting Risk in Perspective, (Article) Internet Outlook (July 20, 1997), Volume 1 No. 3, www.webreference.com, November 1, 2001	
		KEITH LAMOND, Credit Card Transactions Real World and Online. www.virtualschools.edu/mon/ElectronicProperty/klamond/credit_card.htm, September 11, 2001	
		STEVEN P. KETCHPEL & ANDREAS PAEPCKE, Shopping Models: A Flexible Architecture for Information Commerce, dbpubs.stanford.edu:8090, October 1, 2002, (Stanford, USA)	
		Re-examination of U.S. Patent No. 6,324,526 granted to John D'Agostino, assigned Serial No. 90/007,481 filed on March 28, 2005	

Examiner Signature	Date Considered
--------------------	-----------------

\*EXAMINER: Initial if reference considered, whether or not citation is in conformance with MPEP 609. Draw line through citation if not in conformance and not considered. Include copy of this form with next communication to applicant.

<sup>1</sup> Applicant's unique citation designation number (optional). <sup>2</sup> Applicant is to place a check mark here if English language Translation is attached. This collection of information is required by 37 CFR 1.98. The information is required to obtain or retain a benefit by the public which is to file (and by the USPTO to process) an application. Confidentiality is governed by 35 U.S.C. 122 and 37 CFR 1.14. This collection is estimated to take 2 hours to complete, including gathering, preparing, and submitting the completed application form to the USPTO. Time will vary depending upon the individual case. Any comments on the amount of time you require to complete this form and/or suggestions for reducing this burden, should be sent to the Chief Information Officer, U.S. Patent and Trademark Office, P.O. Box 1450, Alexandria, VA 22313-1450. DO NOT SEND FEES OR COMPLETED FORMS TO THIS ADDRESS. SEND TO: Commissioner for Patents, P.O. Box 1450, Alexandria, VA 22313-1450.

If you need assistance in completing the form, call 1-800-PTO-9199 (1-800-786-9199) and select option 2.



Under the Paperwork Reduction Act of 1996, no persons are required to respond to a collection of information unless it contains a valid OMB control number.

Substitute for form 49/PTO

**Complete if Known**

**INFORMATION DISCLOSURE STATEMENT BY APPLICANT**

(Use as many sheets as necessary)

Sheet 1

of 7

Application Number	11/252,009
Filing Date	October 17, 2005
First Named Inventor	John D'Agostino
Art Unit	3691
Examiner Name	Bijendra K. Shrestha
Attorney Docket Number	1.706-B.04

**U. S. PATENT DOCUMENTS**

Examiner Initials*	Cite No. <sup>1</sup>	Document Number	Publication Date MM-DD-YYYY	Name of Patentee or Applicant of Cited Document	Pages, Columns, Lines, Where Relevant Passages or Relevant Figures Appear
		Number-Kind Code <sup>2</sup> (if known)			
		US- 3,938,091	02/10/1976	Atalla et al.	
		US- 4,423,316	12/27/1983	Sano et al.	
		US- 4,707,592	11/17/1987	Ware	
		US- 4,720,860	01/19/1988	Weiss	
		US- 4,725,719	02/16/1988	Oncken et al.	
		US- 4,747,050	05/24/1988	Brachtl et al.	
		US- 4,797,920	01/10/1989	Stein	
		US- 5,097,505	03/17/1992	Weiss	
		US- 5,130,519	07/14/1992	Bush et al.	
		US- 5,163,097	11/10/1992	Pegg	
		US- 5,193,114	03/09/1993	Moseley	
		US- 5,196,840	03/23/1993	Leith et al.	
		US- 5,202,826	04/13/1993	McCarthy	
		US- 5,239,583	08/24/1993	Parillo	
		US- 5,287,268	02/15/1994	McCarthy	
		US- 5,317,636	05/31/1994	Vizcaino	
		US- 5,323,338	06/21/1994	Hawthorne	
		US- 5,326,960	07/05/1994	Tannenbaum	
		US- 5,350,906	09/27/1994	Brody et al.	

**FOREIGN PATENT DOCUMENTS**

Examiner Initials*	Cite No. <sup>1</sup>	Foreign Patent Document	Publication Date MM-DD-YYYY	Name of Patentee or Applicant of Cited Document	Pages, Columns, Lines, Where Relevant Passages Or Relevant Figures Appear	T <sup>6</sup>
		Country Code <sup>3</sup> -Number <sup>4</sup> -Kind Code <sup>5</sup> (if known)				
		EP 0 081 921 A1	06/22/1983	Easterby		
		GB 2 145 265 A	03/20/1985	Miura		
		WO 91/12693	05/08/1992	Hawthorne et al.		
		FR 2 661 996 - A1	11/15/1991	Bremard		
		GB 2 252 270 A	08/05/1992	Wren-Hilton		
		WO 93/14476	07/22/1993	Reinikainen		

Examiner Signature	Date Considered
--------------------	-----------------

\*EXAMINER: Initial if reference considered, whether or not citation is in conformance with MPEP 609. Draw line through citation if not in conformance and not considered. Include copy of this form with next communication to applicant. <sup>1</sup> Applicant's unique citation designation number (optional). <sup>2</sup> See Kinds Codes of USPTO Patent Documents at [www.uspto.gov](http://www.uspto.gov) or MPEP 901.04. <sup>3</sup> Enter Office that issued the document, by the two-letter code (WIPO Standard ST.3). <sup>4</sup> For Japanese patent documents, the indication of the year of the reign of the Emperor must precede the serial number of the patent document. <sup>5</sup> Kind of document by the appropriate symbols as indicated on the document under WIPO Standard ST.16 if possible. <sup>6</sup> Applicant is to place a check mark here if English language Translation is attached.

This collection of information is required by 37 CFR 1.97 and 1.98. The information is required to obtain or retain a benefit by the public which is to file (and by the USPTO to process) an application. Confidentiality is governed by 35 U.S.C. 122 and 37 CFR 1.14. This collection is estimated to take 2 hours to complete, including gathering, preparing, and submitting the completed application form to the USPTO. Time will vary depending upon the individual case. Any comments on the amount of time you require to complete this form and/or suggestions for reducing this burden, should be sent to the Chief Information Officer, U.S. Patent and Trademark Office, P.O. Box 1450, Alexandria, VA 22313-1450. DO NOT SEND FEES OR COMPLETED FORMS TO THIS ADDRESS. SEND TO: Commissioner for Patents, P.O. Box 1450, Alexandria, VA 22313-1450.

If you need assistance in completing the form, call 1-800-PTO-9199 (1-800-786-9199) and select option 2.

Under the Paperwork Reduction Act of 1995, no persons are required to respond to a collection of information unless it contains a valid OMB control number.

Substitute for form 1449/PTO

**INFORMATION DISCLOSURE  
STATEMENT BY APPLICANT**

(Use as many sheets as necessary)

Sheet 3

of 7

**Complete if Known**

Application Number	11/252,009
Filing Date	October 17, 2005
First Named Inventor	John D'Agostino
Art Unit	3691
Examiner Name	Bijendra K. Shrestha
Attorney Docket Number	1.706-B.04

**U. S. PATENT DOCUMENTS**

Examiner Initials*	Cite No. <sup>1</sup>	Document Number	Publication Date MM-DD-YYYY	Name of Patentee or Applicant of Cited Document	Pages, Columns, Lines, Where Relevant Passages or Relevant Figures Appear
		Number-Kind Code <sup>2</sup> (if known)			
		US- 5,724,424	03/03/1998	Gifford	
		US- 5,727,163	03/10/1998	Bezos	
		US- 5,729,594	03/17/1998	Klingman	
		US- 5,748,908	05/05/1998	Yu	
		US- 5,757,917	05/26/1998	Rose et al.	
		US- 5,768,381	06/16/1998	Hawthorne	
		US- 5,777,305	07/07/1998	Smith et al.	
		US- 5,777,306	07/07/1998	Masuda	
		US- 5,794,221	08/11/1998	Egendorf	
		US- 5,815,657	09/29/1998	Williams et al.	
		US- 5,822,737	10/13/1998	Ogram	
		US- 5,825,881	10/20/1998	Colvin, Sr.	
		US- 5,826,241	10/20/1998	Stein et al.	
		US- 5,826,243	10/20/1998	Musmanno et al.	
		US- 5,832,087	11/03/1998	Hawthorne	
		US- 5,864,830	01/26/1999	Armetta et al.	
		US- 5,868,236	02/09/1999	Rademacher	
		US- 5,883,810	03/16/1999	Franklin et al.	
		US- 5,890,137	03/30/1999	Koreeda	

**FOREIGN PATENT DOCUMENTS**

Examiner Initials*	Cite No. <sup>1</sup>	Foreign Patent Document	Publication Date MM-DD-YYYY	Name of Patentee or Applicant of Cited Document	Pages, Columns, Lines, Where Relevant Passages Or Relevant Figures Appear	T <sup>6</sup>
		Country Code <sup>3</sup> -Number <sup>4</sup> -Kind Code <sup>5</sup> (if known)				
		WO 97/15893	05/01/1997	Ukuda		
		WO 97/19549	05/29/1997	Beeder et al.		
		CA 2,167,543	07/19/1997	Durward		
		WO 98/26376	06/18/1998	Walker et al.		
		GB 2 327 831 A	02/03/1999	Hawthorne		
		WO 99/49424	09/30/1999	Flitcroft et al.		

Examiner Signature	Date Considered
--------------------	-----------------

\*EXAMINER: Initial if reference considered, whether or not citation is in conformance with MPEP 609. Draw line through citation if not in conformance and not considered. Include copy of this form with next communication to applicant. <sup>1</sup> Applicant's unique citation designation number (optional). <sup>2</sup> See Kinds Codes of USPTO Patent Documents at [www.uspto.gov](http://www.uspto.gov) or MPEP 901.04. <sup>3</sup> Enter Office that issued the document, by the two-letter code (WIPO Standard ST.3). <sup>4</sup> For Japanese patent documents, the indication of the year of the reign of the Emperor must precede the serial number of the patent document. <sup>5</sup> Kind of document by the appropriate symbols as indicated on the document under WIPO Standard ST.16 if possible. <sup>6</sup> Applicant is to place a check mark here if English language Translation is attached.

This collection of information is required by 37 CFR 1.97 and 1.98. The information is required to obtain or retain a benefit by the public which is to file (and by the USPTO to process) an application. Confidentiality is governed by 35 U.S.C. 122 and 37 CFR 1.14. This collection is estimated to take 2 hours to complete, including gathering, preparing, and submitting the completed application form to the USPTO. Time will vary depending upon the individual case. Any comments on the amount of time you require to complete this form and/or suggestions for reducing this burden, should be sent to the Chief Information Officer, U.S. Patent and Trademark Office, P.O. Box 1450, Alexandria, VA 22313-1450. DO NOT SEND FEES OR COMPLETED FORMS TO THIS ADDRESS. SEND TO: Commissioner for Patents, P.O. Box 1450, Alexandria, VA 22313-1450.

If you need assistance in completing the form, call 1-800-PTO-9199 (1-800-786-9199) and select option 2.

Under the Paperwork Reduction Act of 1995, no persons are required to respond to a collection of information unless it contains a valid OMB control number.

Substitute for form 1449/PTO

**INFORMATION DISCLOSURE  
STATEMENT BY APPLICANT**

(Use as many sheets as necessary)

Sheet 2

of 7

**Complete if Known**

Application Number	11/252,009
Filing Date	October 17, 2005
First Named Inventor	John D'Agostino
Art Unit	3691
Examiner Name	Bijendra K. Shrestha
Attorney Docket Number	1.706-B.04

**U. S. PATENT DOCUMENTS**

Examiner Initials*	Cite No. <sup>1</sup>	Document Number	Publication Date MM-DD-YYYY	Name of Patentee or Applicant of Cited Document	Pages, Columns, Lines, Where Relevant Passages or Relevant Figures Appear
		Number-Kind Code <sup>2</sup> (if known)			
		US- 5,363,449	11/08/1994	Bestock	
		US- 5,428,684	06/27/1995	Akiyama et al.	
		US- 5,466,919	11/14/1995	Hovakimian	
		US- 5,478,994	12/26/1995	Rahman et al.	
		US- 5,485,510	01/16/1996	Colbert	
		US- 5,500,513	03/19/1996	Langhans et al.	
		US- 5,504,808	04/02/1996	Hamrick, Jr.	
		US- 5,555,497	09/10/1996	Helbling	
		US- 5,577,109	11/19/1996	Stimson et al.	
		US- 5,583,918	12/10/1996	Nakagawa	
		US- 5,606,614	02/25/1997	Brady et al.	
		US- 5,621,201	04/15/1997	Langhans et al.	
		US- 5,627,355	05/06/1997	Rahman et al.	
		US- 5,671,279	09/23/1997	Elgamal	
		US- 5,677,955	10/14/1997	Doggett et al.	
		US- 5,694,471	12/02/1997	Chen et al.	
		US- 5,696,908	12/09/1997	Muehlberger et al.	
		US- 5,715,314	02/03/1998	Payne et al.	
		US- 5,721,768	02/24/1998	Stimson et al.	

**FOREIGN PATENT DOCUMENTS**

Examiner Initials*	Cite No. <sup>1</sup>	Foreign Patent Document	Publication Date MM-DD-YYYY	Name of Patentee or Applicant of Cited Document	Pages, Columns, Lines, Where Relevant Passages Or Relevant Figures Appear	T <sup>6</sup>
		Country Code <sup>3</sup> -Number <sup>4</sup> -Kind Code <sup>5</sup> (if known)				
		EP 0 590 861 A2	04/06/1994	Colbert		
		EP 0 590 861 A3	04/06/1994	Colbert		
		EP 0 590 961 A2	04/06/1994	Kazuo et al.		
		WO 95/07512	03/16/1995	Ziarno		
		WO 96/08756	03/21/1996	Hawthorn et al.		
		WO 96/42150	12/27/1996	Pittenger et al.		

Examiner Signature	Date Considered
--------------------	-----------------

\*EXAMINER: Initial if reference considered, whether or not citation is in conformance with MPEP 609. Draw line through citation if not in conformance and not considered. Include copy of this form with next communication to applicant. <sup>1</sup> Applicant's unique citation designation number (optional). <sup>2</sup> See Kinds Codes of USPTO Patent Documents at [www.uspto.gov](http://www.uspto.gov) or MPEP 901.04. <sup>3</sup> Enter Office that issued the document, by the two-letter code (WIPO Standard ST.3). <sup>4</sup> For Japanese patent documents, the indication of the year of the reign of the Emperor must precede the serial number of the patent document. <sup>5</sup> Kind of document by the appropriate symbols as indicated on the document under WIPO Standard ST.16 if possible. <sup>6</sup> Applicant is to place a check mark here if English language Translation is attached.

This collection of information is required by 37 CFR 1.97 and 1.98. The information is required to obtain or retain a benefit by the public which is to file (and by the USPTO to process) an application. Confidentiality is governed by 35 U.S.C. 122 and 37 CFR 1.14. This collection is estimated to take 2 hours to complete, including gathering, preparing, and submitting the completed application form to the USPTO. Time will vary depending upon the individual case. Any comments on the amount of time you require to complete this form and/or suggestions for reducing this burden, should be sent to the Chief Information Officer, U.S. Patent and Trademark Office, P.O. Box 1450, Alexandria, VA 22313-1450. DO NOT SEND FEES OR COMPLETED FORMS TO THIS ADDRESS. SEND TO: Commissioner for Patents, P.O. Box 1450, Alexandria, VA 22313-1450.

If you need assistance in completing the form, call 1-800-PTO-9199 (1-800-786-9199) and select option 2.

Under the Paperwork Reduction Act of 1995, no persons are required to respond to a collection of information unless it contains a valid OMB control number.

Substitute for form 1449/PTO

**INFORMATION DISCLOSURE  
STATEMENT BY APPLICANT**

(Use as many sheets as necessary)

Sheet 4

of 7

**Complete if Known**

Application Number	11/252,009
Filing Date	October 17, 2005
First Named Inventor	John D'Agostino
Art Unit	3691
Examiner Name	Bijendra K. Shrestha
Attorney Docket Number	1.706-B.04

**U. S. PATENT DOCUMENTS**

Examiner Initials*	Cite No. <sup>1</sup>	Document Number	Publication Date MM-DD-YYYY	Name of Patentee or Applicant of Cited Document	Pages, Columns, Lines, Where Relevant Passages or Relevant Figures Appear
		Number-Kind Code <sup>2</sup> (if known)			
		US- 5,893,907	04/13/1999	Ukuda	
		US- 5,903,878	05/11/1999	Talati et al.	
		US- 5,953,710	09/14/1999	Fleming	
		US- 5,956,699	09/21/1999	Wong et al.	
		US- 5,984,180	11/16/1999	Albrecht	
		US- 6,000,832	12/14/1999	Franklin et al.	
		US- 6,029,890	02/29/2000	Austin	
		US- 6,144,948	11/07/2000	Walker et al.	
		US- 6,163,771	12/19/2000	Walker et al.	
		US- 6,188,761 B1	02/13/2001	Dickerman et al.	
		US- 6,240,397 B1	05/29/2001	Sachs	
		US- 6,267,292 B1	07/31/2001	Walker et al.	
		US- 6,298,335 B1	10/02/2001	Bernstein	
		US- 6,324,526 B1	11/27/2001	D'Agostino	
		US- 6,339,766 B1	01/15/2002	Gephart	
		US- 6,341,724 B2	01/29/2002	Campisano	
		US- 6,343,279 B1	01/29/2002	Bissonette et al.	
		US- 6,375,084 B1	04/23/2002	Stanford et al.	
		US- 6,422,462 B1	07/23/2002	Cohen	

**FOREIGN PATENT DOCUMENTS**

Examiner Initials*	Cite No. <sup>1</sup>	Foreign Patent Document	Publication Date MM-DD-YYYY	Name of Patentee or Applicant of Cited Document	Pages, Columns, Lines, Where Relevant Passages Or Relevant Figures Appear	T <sup>6</sup>
		Country Code <sup>3</sup> -Number <sup>4</sup> -Kind Code <sup>5</sup> (if known)				
		GB 2 361 790 A	10/31/01	Arndt et al.		
		WO 00/42486	07/20/2000	D'Agostino		

Examiner Signature	Date Considered
-----------------------	--------------------

\*EXAMINER: Initial if reference considered, whether or not citation is in conformance with MPEP 609. Draw line through citation if not in conformance and not considered. Include copy of this form with next communication to applicant. <sup>1</sup> Applicant's unique citation designation number (optional). <sup>2</sup> See Kinds Codes of USPTO Patent Documents at [www.uspto.gov](http://www.uspto.gov) or MPEP 901.04. <sup>3</sup> Enter Office that issued the document, by the two-letter code (WIPO Standard ST.3). <sup>4</sup> For Japanese patent documents, the indication of the year of the reign of the Emperor must precede the serial number of the patent document. <sup>5</sup> Kind of document by the appropriate symbols as indicated on the document under WIPO Standard ST.16 if possible. <sup>6</sup> Applicant is to place a check mark here if English language Translation is attached.

This collection of information is required by 37 CFR 1.97 and 1.98. The information is required to obtain or retain a benefit by the public which is to file (and by the USPTO to process) an application. Confidentiality is governed by 35 U.S.C. 122 and 37 CFR 1.14. This collection is estimated to take 2 hours to complete, including gathering, preparing, and submitting the completed application form to the USPTO. Time will vary depending upon the individual case. Any comments on the amount of time you require to complete this form and/or suggestions for reducing this burden, should be sent to the Chief Information Officer, U.S. Patent and Trademark Office, P.O. Box 1450, Alexandria, VA 22313-1450. DO NOT SEND FEES OR COMPLETED FORMS TO THIS ADDRESS. SEND TO: Commissioner for Patents, P.O. Box 1450, Alexandria, VA 22313-1450.

If you need assistance in completing the form, call 1-800-PTO-9199 (1-800-786-9199) and select option 2.



Under the Paperwork Reduction Act of 1995, no persons are required to respond to a collection of information unless it contains a valid OMB control number.

<p style="text-align: center;">Substitute for form 1449/PTO</p> <h2 style="text-align: center;">INFORMATION DISCLOSURE STATEMENT BY APPLICANT</h2> <p style="text-align: center;"><i>(Use as many sheets as necessary)</i></p>	<p><b>Complete if Known</b></p> <table border="1" style="width: 100%; border-collapse: collapse;"> <tr> <td>Application Number</td> <td>11/252,009</td> </tr> <tr> <td>Filing Date</td> <td>October 17, 2005</td> </tr> <tr> <td>First Named Inventor</td> <td>John D'Agostino</td> </tr> <tr> <td>Art Unit</td> <td>3691</td> </tr> <tr> <td>Examiner Name</td> <td>Bijendra K. Shrestha</td> </tr> <tr> <td>Attorney Docket Number</td> <td>1.706-B.04</td> </tr> </table>	Application Number	11/252,009	Filing Date	October 17, 2005	First Named Inventor	John D'Agostino	Art Unit	3691	Examiner Name	Bijendra K. Shrestha	Attorney Docket Number	1.706-B.04
Application Number	11/252,009												
Filing Date	October 17, 2005												
First Named Inventor	John D'Agostino												
Art Unit	3691												
Examiner Name	Bijendra K. Shrestha												
Attorney Docket Number	1.706-B.04												
<p>Sheet <b>5</b> of <b>7</b></p>													

U. S. PATENT DOCUMENTS					
Examiner Initials*	Cite No. <sup>1</sup>	Document Number	Publication Date MM-DD-YYYY	Name of Patentee or Applicant of Cited Document	Pages, Columns, Lines, Where Relevant Passages or Relevant Figures Appear
		Number-Kind Code <sup>2</sup> (if known)			
		US- 6,598,031 B1	07/22/2003	Ice	
		US- 2002/0120587 A1	08/29/2002	D'Agostino	
		US- 2003/0018567 A1	01/23/2003	Flitcroft et al.	
		US- 2003/0028481 A1	02/06/2003	Flitcroft et al.	
		US- 2003/0097331 A1	05/22/2003	Cohen	
		US- 6,636,833 B1	10/21/2003	Flitcroft et al.	
		US- 2003/0216997 A1	11/20/2003	Cohen	
		US-			
		US-			
		US-			
		US-			
		US-			
		US-			
		US-			
		US-			
		US-			
		US-			
		US-			
		US-			
		US-			
		US-			

FOREIGN PATENT DOCUMENTS						
Examiner Initials*	Cite No. <sup>1</sup>	Foreign Patent Document	Publication Date MM-DD-YYYY	Name of Patentee or Applicant of Cited Document	Pages, Columns, Lines, Where Relevant Passages Or Relevant Figures Appear	T <sup>6</sup>
		Country Code <sup>3</sup> -Number <sup>4</sup> -Kind Code <sup>5</sup> (if known)				

Examiner Signature	Date Considered
--------------------	-----------------

\*EXAMINER: Initial if reference considered, whether or not citation is in conformance with MPEP 609. Draw line through citation if not in conformance and not considered. Include copy of this form with next communication to applicant. <sup>1</sup> Applicant's unique citation designation number (optional). <sup>2</sup> See Kinds Codes of USPTO Patent Documents at [www.uspto.gov](http://www.uspto.gov) or MPEP 901.04. <sup>3</sup> Enter Office that issued the document, by the two-letter code (WIPO Standard ST.3). <sup>4</sup> For Japanese patent documents, the indication of the year of the reign of the Emperor must precede the serial number of the patent document. <sup>5</sup> Kind of document by the appropriate symbols as indicated on the document under WIPO Standard ST.16 if possible. <sup>6</sup> Applicant is to place a check mark here if English language Translation is attached.

This collection of information is required by 37 CFR 1.97 and 1.98. The information is required to obtain or retain a benefit by the public which is to file (and by the USPTO to process) an application. Confidentiality is governed by 35 U.S.C. 122 and 37 CFR 1.14. This collection is estimated to take 2 hours to complete, including gathering, preparing, and submitting the completed application form to the USPTO. Time will vary depending upon the individual case. Any comments on the amount of time you require to complete this form and/or suggestions for reducing this burden, should be sent to the Chief Information Officer, U.S. Patent and Trademark Office, P.O. Box 1450, Alexandria, VA 22313-1450. DO NOT SEND FEES OR COMPLETED FORMS TO THIS ADDRESS. SEND TO: Commissioner for Patents, P.O. Box 1450, Alexandria, VA 22313-1450.

*If you need assistance in completing the form, call 1-800-PTO-9199 (1-800-786-9199) and select option 2.*

Under the Paperwork Reduction Act of 1995, no persons are required to respond to a collection of information unless it contains a valid OMB control number.

Substitute for form 1449/PTO  <b>INFORMATION DISCLOSURE STATEMENT BY APPLICANT</b>  <i>(Use as many sheets as necessary)</i>		<b>Complete if Known</b>	
		Application Number	11/252,009
		Filing Date	October 17, 2005
		First Named Inventor	John D'Agostino
		Art Unit	3691
		Examiner Name	Bijendra K. Shrestha
Sheet 6	of 7	Attorney Docket Number	1.706-B.04

NON PATENT LITERATURE DOCUMENTS			
Examiner Initials*	Cite No. <sup>1</sup>	Include name of the author (in CAPITAL LETTERS), title of the article (when appropriate), title of the item (book, magazine, journal, serial, symposium, catalog, etc.), date, page(s), volume-issue number(s), publisher, city and/or country where published.	T <sup>2</sup>
		ERAN GABBER and ABRAHAM SILBERSCHATZ, A Minimal Distributed Protocol for Electronic Commerce, www.usenix.org/publications (Article), Oakland, USA, November 18-21, 1996	
		CITI.COM, Total Fraud Protection... Solutions for your safety and peace of mind, (printout) CBSD002144-CBSD002153	
		OWEN THOMAS, Money Changers, www.ecompany.com, (Article), October 2000	
		Netchex - a short brief, www.tml.hut.fi/Studies/Tik-110.50/1997/Ecommerce/netchex-5.html, (Article), November 5, 2002	
		GE CAPITAL FINANCIAL INC., GE Pre-Authorization System, (GE's website printout)	
		MATT BARTHEL, Diebold Plans Major Push in Market for Debit-Card Point of Sale Terminals, 09/28/1993, American Banker, PP 1-2	
		BOB WOODS, New Dell E-Commerce Guarantee Called "Weak", 08/13/1998, Newbytes News PP 1-2	
		ANNE FINNIGAN, The Safe Way to Shop Online, Good Housekeeping, 09/1998, PP 1-2	
		PAUL DEMERY, Attaching the Smart Card Fortress, Credit Card Management, 09/1998, PP 1-4	
		LARRY CHASE, Taking Transactions Online, Target Marketing, 10/1998, 1-4	

Examiner Signature		Date Considered	
--------------------	--	-----------------	--

\*EXAMINER: Initial if reference considered, whether or not citation is in conformance with MPEP 609. Draw line through citation if not in conformance and not considered. Include copy of this form with next communication to applicant.

<sup>1</sup> Applicant's unique citation designation number (optional). <sup>2</sup> Applicant is to place a check mark here if English language Translation is attached. This collection of information is required by 37 CFR 1.98. The information is required to obtain or retain a benefit by the public which is to file (and by the USPTO to process) an application. Confidentiality is governed by 35 U.S.C. 122 and 37 CFR 1.14. This collection is estimated to take 2 hours to complete, including gathering, preparing, and submitting the completed application form to the USPTO. Time will vary depending upon the individual case. Any comments on the amount of time you require to complete this form and/or suggestions for reducing this burden, should be sent to the Chief Information Officer, U.S. Patent and Trademark Office, P.O. Box 1450, Alexandria, VA 22313-1450. DO NOT SEND FEES OR COMPLETED FORMS TO THIS ADDRESS. SEND TO: Commissioner for Patents, P.O. Box 1450, Alexandria, VA 22313-1450.

If you need assistance in completing the form, call 1-800-PTO-9199 (1-800-786-9199) and select option 2.

Under the Paperwork Reduction Act of 1995, no persons are required to respond to a collection of information unless it contains a valid OMB control number.

Substitute for form 1449/PTO  <b>INFORMATION DISCLOSURE STATEMENT BY APPLICANT</b>  (Use as many sheets as necessary)		<b>Complete if Known</b>	
		Application Number	11/262,009
		Filing Date	October 17, 2005
		First Named Inventor	John D'Agostino
		Art Unit	3691
		Examiner Name	Bijendra K. Shrestha
Sheet 7	of 7	Attorney Docket Number	1.706-B.04

NON PATENT LITERATURE DOCUMENTS			
Examiner Initials*	Cite No. <sup>1</sup>	Include name of the author (in CAPITAL LETTERS), title of the article (when appropriate), title of the item (book, magazine, journal, serial, symposium, catalog, etc.), date, page(s), volume-issue number(s), publisher, city and/or country where published.	T <sup>2</sup>
		Virtual Credit Card (VCC), www.geocities.com/Eureka/Park/5014/vcc.htm, (printout). June 28, 1999	
		Smart Cards, disc.cba.uh.edu, (printout), November 1, 2001	
		VINCENT MOSCARITOLO & ROBERT HETTINGA, Digital Commerce for the Rest of Us Apple in a Geodesic Economy, www.shipwright.com/rants/rant_15.html, (article), September 4, 1996	
		BLACK IVES & MICHAEL EARL, Mondex International Reengineering Money, London Business School Article, isds.bus.lsu.edu/cases/mondex.html, November 1, 2001	
		Smart Card New Ltd's Information Gateway, www.smartcard.co.uk/articles/electronicmoney.html, November 1, 2001	
		Putting Risk in Perspective, (Article) Internet Outlook (July 20, 1997), Volume 1 No. 3, www.webreference.com, November 1, 2001	
		KEITH LAMOND, Credit Card Transactions Real World and Online. www.virtualschools.edu/mon/ElectronicProperty/klamond/credit_card.htm, September 11, 2001	
		STEVEN P. KETCHPEL & ANDREAS PAEPCKE, Shopping Models: A Flexible Architecture for Information Commerce, dbpubs.stanford.edu:8090, October 1, 2002, (Stanford, USA)	
		Re-examination of U.S. Patent No. 6,324,526 granted to John D'Agostino, assigned Serial No. 90/007,481 filed on March 28, 2005	

Examiner Signature		Date Considered	
--------------------	--	-----------------	--

\*EXAMINER: Initial if reference considered, whether or not citation is in conformance with MPEP 609. Draw line through citation if not in conformance and not considered. Include copy of this form with next communication to applicant.  
 1 Applicant's unique citation designation number (optional). 2 Applicant is to place a check mark here if English language Translation is attached.  
 This collection of information is required by 37 CFR 1.98. The information is required to obtain or retain a benefit by the public which is to file (and by the USPTO to process) an application. Confidentiality is governed by 35 U.S.C. 122 and 37 CFR 1.14. This collection is estimated to take 2 hours to complete, including gathering, preparing, and submitting the completed application form to the USPTO. Time will vary depending upon the individual case. Any comments on the amount of time you require to complete this form and/or suggestions for reducing this burden, should be sent to the Chief Information Officer, U.S. Patent and Trademark Office, P.O. Box 1450, Alexandria, VA 22313-1450. DO NOT SEND FEES OR COMPLETED FORMS TO THIS ADDRESS. SEND TO: Commissioner for Patents, P.O. Box 1450, Alexandria, VA 22313-1450.

If you need assistance in completing the form, call 1-800-PTO-9199 (1-800-786-9199) and select option 2.

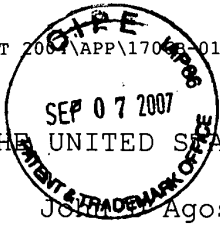

*[Handwritten signature]*

IN THE UNITED STATES PATENT AND TRADEMARK OFFICE

Applicant: John Agostino  
Serial No.: 11/252,009  
Filing Date: October 17, 2005  
For: SYSTEM AND METHOD FOR PERFORMING SECURE CREDIT CARD PURCHASES

Confirmation No. 4322  
Customer No. 04219  
Shrestha, B., Examiner  
Group Art Unit 3691

2800 S.W. Third Avenue  
Historic Coral Way  
Miami, Florida 33129

Mail Stop Amendment  
Commissioner for Patents  
P.O. Box 1450  
Alexandria, VA 22313-1450

Dear Sir:

CERTIFICATE OF MAILING

I HEREBY CERTIFY that this correspondence is being deposited with the United States Postal Service as first class mail in an envelope addressed to: Mail Stop Amendment, Commissioner for Patents, P.O. Box 1450, Alexandria, VA 22313-1450, this 5 day of September, 2007.

Respectfully submitted,

MALLOY & MALLOY, P.A.  
2800 S.W. Third Avenue  
Historic Coral Way  
Miami, Florida 33129  
(305) 858-8000

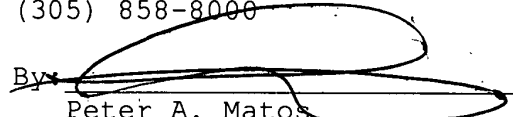
By:   
Peter A. Matos  
Reg. No. 37,884

Date: 9/5/07

IN THE UNITED STATES PATENT AND TRADEMARK OFFICE

Applicant: John D'Agostino

Serial No.: 11/252,009

Filing Date: October 17, 2005

For: SYSTEM AND METHOD FOR PERFORMING SECURE CREDIT CARD PURCHASES



Confirmation No. 4322  
Customer No. 04219  
Shrestha, B., Examiner  
Group Art Unit 3691

2800 S.W. Third Avenue  
Historic Coral Way  
Miami, Florida 33129

Mail Stop Amendment  
Commissioner for Patents  
P.O. Box 1450  
Alexandria, VA 22313-1450

Sir:

REQUEST FOR EXTENSION OF TIME

A three-month extension of time is hereby requested pursuant to 37 CFR, Section 1.136 in order to respond to the Office Action dated March 5, 2007.

In accordance with 37 CFR, Section 1.17(a)(3), the amount of \$510.00 for the requested extension of time of three months is enclosed herewith.

Respectfully Submitted,

MALLOY & MALLOY, P.A. 80000016 11252009  
Attorneys for Applicant 510.00 00  
2800 S.W. 3<sup>rd</sup> Avenue  
Historic Coral Way  
Miami, Florida 33129  
(305)858-8000

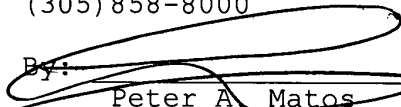
By:   
Peter A. Matos  
Reg. No. 37,884

Date: 9/5/07



**TERMINAL DISCLAIMER TO OBIVIATE A DOUBLE PATENTING REJECTION OVER A "PRIOR" PATENT**

Docket Number (Optional)  
1.708-B.04

In re Application of: John D'Agostino

Application No.: 11/252,009

Filed: October 17, 2005

For: SYSTEM AND METHOD FOR PERFORMING SECURE CREDIT CARD PURCHASES

The owner, John D'Agostino, of 100 percent interest in the instant application hereby disclaims, except as provided below, the terminal part of the statutory term of any patent granted on the instant application which would extend beyond the expiration date of the full statutory term prior patent No. 5,324,526 as the term of said prior patent is defined in 35 U.S.C. 154 and 173, and as the term of said prior patent is presently shortened by any terminal disclaimer. The owner hereby agrees that any patent so granted on the instant application shall be enforceable only for and during such period that it and the prior patent are commonly owned. This agreement runs with any patent granted on the instant application and is binding upon the grantee, its successors or assigns.

In making the above disclaimer, the owner does not disclaim the terminal part of the term of any patent granted on the instant application that would extend to the expiration date of the full statutory term as defined in 35 U.S.C. 154 and 173 of the prior patent, "as the term of said prior patent is presently shortened by any terminal disclaimer," in the event that said prior patent later:

- expires for failure to pay a maintenance fee;
- is held unenforceable;
- is found invalid by a court of competent jurisdiction;
- is statutorily disclaimed in whole or terminally disclaimed under 37 CFR 1.321;
- has all claims canceled by a reexamination certificate;
- is reissued; or
- is in any manner terminated prior to the expiration of its full statutory term as presently shortened by any terminal disclaimer.

Check either box 1 or 2 below, if appropriate.

1.  For submissions on behalf of a business/organization (e.g., corporation, partnership, university, government agency, etc.), the undersigned is empowered to act on behalf of the business/organization.

I hereby declare that all statements made herein of my own knowledge are true and that all statements made on information and belief are believed to be true; and further that these statements were made with the knowledge that willful false statements and the like so made are punishable by fine or imprisonment, or both, under Section 1001 of Title 18 of the United States Code and that such willful false statements may jeopardize the validity of the application or any patent issued thereon.

2.  The undersigned is an attorney or agent of record. Reg. No. \_\_\_\_\_

John D'Agostino  
Signature

9-4-07  
Date

John D'Agostino  
Typed or printed name

(305) 858-8000  
Telephone Number

- Terminal disclaimer fee under 37 CFR 1.20(d) included.

**WARNING: Information on this form may become public. Credit card information should not be included on this form. Provide credit card information and authorization on PTO-2038.**

\*Statement under 37 CFR 3.73(b) is required if terminal disclaimer is signed by the assignee (owner).  
Form PTO/SB/86 may be used for making this certification. See MPEP § 324.

09/07/2007 ATRINH 00000016 11252009

This collection of information is required by 37 CFR 1.321. The information is required to obtain or retain a benefit by the public which is to file (and by the USPTO to process) an application. Confidentiality is governed by 35 U.S.C. 122 and 37 CFR 1.11 and 1.14. This collection is estimated to take 12 minutes to complete, including gathering, preparing, and submitting the completed application form to the USPTO. Time will vary depending upon the individual case. Any comments on the amount of time you require to complete this form and/or suggestions for reducing this burden, should be sent to the Chief Information Officer, U.S. Patent and Trademark Office, U.S. Department of Commerce, P.O. Box 1450, Alexandria, VA 22313-1450. DO NOT SEND FEES OR COMPLETED FORMS TO THIS ADDRESS. SEND TO: Commissioner for Patents, P.O. Box 1450, Alexandria, VA 22313-1450.

If you need assistance in completing the form, call 1-800-PTO-9199 and select option 2.

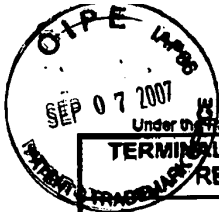

**TERMINAL DISCLAIMER TO OBLIVATE A PROVISIONAL DOUBLE PATENTING REJECTION OVER A PENDING "REFERENCE" APPLICATION**

Docket Number (Optional)  
1.706-B.04

In re Application of: John D'Agostino

Application No.: 11/252,009

Filed: October 17, 2005

For: SYSTEM AND METHOD FOR PERFORMING SECURE CREDIT CARD PURCHASES

The owner, John D'Agostino, of 100 percent interest in the instant application hereby disclaims, except as provided below, the terminal part of the statutory term of any patent granted on the instant application which would extend beyond the expiration date of the full statutory term of any patent granted on pending reference Application Number 10/037,007, filed on November 9, 2001, as such term is defined in 35 U.S.C. 154 and 173, and as the term of any patent granted on said reference application may be shortened by any terminal disclaimer filed prior to the grant of any patent on the pending reference application. The owner hereby agrees that any patent so granted on the instant application shall be enforceable only for and during such period that it and any patent granted on the reference application are commonly owned. This agreement runs with any patent granted on the instant application and is binding upon the grantee, its successors or assigns.

In making the above disclaimer, the owner does not disclaim the terminal part of any patent granted on the instant application that would extend to the expiration date of the full statutory term as defined in 35 U.S.C. 154 and 173 of any patent granted on said reference application, "as the term of any patent granted on said reference application may be shortened by any terminal disclaimer filed prior to the grant of any patent on the pending reference application." In the event that: any such patent: granted on the pending reference application; expires for failure to pay a maintenance fee, is held unenforceable, is found invalid by a court of competent jurisdiction, is statutorily disclaimed in whole or terminally disclaimed under 37 CFR 1.321, has all claims canceled by a reexamination certificate, is released, or is in any manner terminated prior to the expiration of its full statutory term as shortened by any terminal disclaimer filed prior to its grant.

Check either box 1 or 2 below, if appropriate.

- 1.  For submissions on behalf of a business/organization (e.g., corporation, partnership, university, government agency, etc.), the undersigned is empowered to act on behalf of the business/organization.

I hereby declare that all statements made herein of my own knowledge are true and that all statements made on information and belief are believed to be true; and further that these statements were made with the knowledge that willful false statements and the like so made are punishable by fine or imprisonment, or both, under Section 1001 of Title 18 of the United States Code and that such willful false statements may jeopardize the validity of the application or any patent issued thereon.

- 2.  The undersigned is an attorney or agent of record. Reg. No. \_\_\_\_\_

John D'Agostino  
Signature

9-4-07  
Date

John D'Agostino  
Typed or printed name

(305) 858-8000  
Telephone Number

- Terminal disclaimer fee under 37 CFR 1.20(d) is included.

**WARNING: Information on this form may become public. Credit card information should not be included on this form. Provide credit card information and authorization on PTO-2038.**

\*Statement under 37 CFR 3.73(b) is required if terminal disclaimer is signed by the assignee (owner).  
Form PTO/6B/96 may be used for making this statement. See MPEP § 324.

This collection of information is required by 37 CFR 1.321. The information is required to obtain or retain a benefit by the public which is to file (and by the USPTO to process) an application. Confidentiality is governed by 35 U.S.C. 122 and 37 CFR 1.11 and 1.14. This collection is estimated to take 12 minutes to complete, including gathering, preparing, and submitting the completed application form to the USPTO. Time will vary depending upon the individual case. Any comment on the amount of time you require to complete this form and/or suggestions for reducing this burden, should be sent to the Chief Information Officer, U.S. Patent and Trademark Office, U.S. Department of Commerce, P.O. Box 1450, Alexandria, VA 22313-1450. DO NOT SEND FEES OR COMPLETED FORMS TO THIS ADDRESS. SEND TO: Commissioner for Patents, P.O. Box 1450, Alexandria, VA 22313-1450.

If you need assistance in completing the form, call 1-800-PTO-8198 and select option 2.

**PATENT APPLICATION FEE DETERMINATION RECORD**  
Effective December 8, 2004

11/252009

**CLAIMS AS FILED - PART I**

	(Column 1)	(Column 2)
TOTAL CLAIMS		
FOR	NUMBER FILED	NUMBER EXTRA
TOTAL CHARGEABLE CLAIMS	minus 20= *	
INDEPENDENT CLAIMS	minus 3 = *	
MULTIPLE DEPENDENT CLAIM PRESENT <input type="checkbox"/>		

\* If the difference in column 1 is less than zero, enter "0" in column 2

**CLAIMS AS AMENDED - PART II**

	(Column 1)	(Column 2)	(Column 3)
AMENDMENT A 01/29/09	CLAIMS REMAINING AFTER AMENDMENT		HIGHEST NUMBER PREVIOUSLY PAID FOR
	Total	* 44	Minus ** 44 = -
	Independent	* 6	Minus *** 6 = -
FIRST PRESENTATION OF MULTIPLE DEPENDENT CLAIM <input type="checkbox"/>			

	(Column 1)	(Column 2)	(Column 3)
AMENDMENT B 09/07/07	CLAIMS REMAINING AFTER AMENDMENT		HIGHEST NUMBER PREVIOUSLY PAID FOR
	Total	* 44	Minus ** 44 = -
	Independent	* 6	Minus *** 6 = -
FIRST PRESENTATION OF MULTIPLE DEPENDENT CLAIM <input type="checkbox"/>			

	(Column 1)	(Column 2)	(Column 3)
AMENDMENT C	CLAIMS REMAINING AFTER AMENDMENT		HIGHEST NUMBER PREVIOUSLY PAID FOR
	Total	*	Minus ** =
	Independent	*	Minus *** =
FIRST PRESENTATION OF MULTIPLE DEPENDENT CLAIM <input type="checkbox"/>			

SMALL ENTITY TYPE  OR OTHER THAN SMALL ENTITY

RATE	FEE		RATE	FEE
BASIC FEE	150.00	OR	BASIC FEE	300.00
X\$ 25=		OR	X\$50=	
X100=		OR	X200=	
+180=		OR	+360=	
TOTAL		OR	TOTAL	

SMALL ENTITY OR OTHER THAN SMALL ENTITY

RATE	ADDITIONAL FEE		RATE	ADDITIONAL FEE
X\$ 25=		OR	X\$50=	
X100=		OR	X200=	
+180=		OR	+360=	
TOTAL ADDIT. FEE		OR	TOTAL ADDIT. FEE	

RATE	ADDITIONAL FEE		RATE	ADDITIONAL FEE
X\$ 25=		OR	X\$50=	
X100=		OR	X200=	
+180=		OR	+360=	
TOTAL ADDIT. FEE		OR	TOTAL ADDIT. FEE	

RATE	ADDITIONAL FEE		RATE	ADDITIONAL FEE
X\$ 25=		OR	X\$50=	
X100=		OR	X200=	
+180=		OR	+360=	





UNITED STATES PATENT AND TRADEMARK OFFICE

fw

UNITED STATES DEPARTMENT OF COMMERCE  
United States Patent and Trademark Office  
Address: COMMISSIONER FOR PATENTS  
P.O. Box 1450  
Alexandria, Virginia 22313-1450  
www.uspto.gov

APPLICATION NO.	FILING DATE	FIRST NAMED INVENTOR	ATTORNEY DOCKET NO.	CONFIRMATION NO.
11/252,009	10/17/2005	John D'Agostino	1.706-B.04	4322

7590 03/05/2007  
MALLOY & MALLOY, P.A.  
2800 S.W. Third Avenue  
Historic Coral Way  
Miami, FL 33129

EXAMINER

SHRESTHA, BIJENDRA K

ART UNIT PAPER NUMBER

3691

SHORTENED STATUTORY PERIOD OF RESPONSE	MAIL DATE	DELIVERY MODE
3 MONTHS	03/05/2007	PAPER

Please find below and/or attached an Office communication concerning this application or proceeding.

If NO period for reply is specified above, the maximum statutory period will apply and will expire 6 MONTHS from the mailing date of this communication.

<b>Office Action Summary</b>	<b>Application No.</b> 11/252,009	<b>Applicant(s)</b> D'AGOSTINO, JOHN	
	<b>Examiner</b> Bijendra K. Shrestha	<b>Art Unit</b> 3691	

**-- The MAILING DATE of this communication appears on the cover sheet with the correspondence address --**  
**Period for Reply**

A SHORTENED STATUTORY PERIOD FOR REPLY IS SET TO EXPIRE 3 MONTH(S) OR THIRTY (30) DAYS, WHICHEVER IS LONGER, FROM THE MAILING DATE OF THIS COMMUNICATION.

- Extensions of time may be available under the provisions of 37 CFR 1.136(a). In no event, however, may a reply be timely filed after SIX (6) MONTHS from the mailing date of this communication.
- If NO period for reply is specified above, the maximum statutory period will apply and will expire SIX (6) MONTHS from the mailing date of this communication.
- Failure to reply within the set or extended period for reply will, by statute, cause the application to become ABANDONED (35 U.S.C. § 133). Any reply received by the Office later than three months after the mailing date of this communication, even if timely filed, may reduce any earned patent term adjustment. See 37 CFR 1.704(b).

**Status**

- 1)  Responsive to communication(s) filed on \_\_\_\_\_.
- 2a)  This action is **FINAL**.                      2b)  This action is non-final.
- 3)  Since this application is in condition for allowance except for formal matters, prosecution as to the merits is closed in accordance with the practice under *Ex parte Quayle*, 1935 C.D. 11, 453 O.G. 213.

**Disposition of Claims**

- 4)  Claim(s) 1-44 is/are pending in the application.  
4a) Of the above claim(s) \_\_\_\_\_ is/are withdrawn from consideration.
- 5)  Claim(s) \_\_\_\_\_ is/are allowed.
- 6)  Claim(s) 1-44 is/are rejected.
- 7)  Claim(s) \_\_\_\_\_ is/are objected to.
- 8)  Claim(s) \_\_\_\_\_ are subject to restriction and/or election requirement.

**Application Papers**

- 9)  The specification is objected to by the Examiner.
- 10)  The drawing(s) filed on 17 October 2005 is/are: a)  accepted or b)  objected to by the Examiner.  
Applicant may not request that any objection to the drawing(s) be held in abeyance. See 37 CFR 1.85(a).  
Replacement drawing sheet(s) including the correction is required if the drawing(s) is objected to. See 37 CFR 1.121(d).
- 11)  The oath or declaration is objected to by the Examiner. Note the attached Office Action or form PTO-152.

**Priority under 35 U.S.C. § 119**

- 12)  Acknowledgment is made of a claim for foreign priority under 35 U.S.C. § 119(a)-(d) or (f).  
a)  All    b)  Some \*    c)  None of:
1.  Certified copies of the priority documents have been received.
2.  Certified copies of the priority documents have been received in Application No. \_\_\_\_\_.
3.  Copies of the certified copies of the priority documents have been received in this National Stage application from the International Bureau (PCT Rule 17.2(a)).

\* See the attached detailed Office action for a list of the certified copies not received.

**Attachment(s)**

- |  |   |
|--|---|
| 1) <input checked="" type="checkbox"/> Notice of References Cited (PTO-892)                                | 4) <input type="checkbox"/> Interview Summary (PTO-413)<br>Paper No(s)/Mail Date. _____ |
| 2) <input type="checkbox"/> Notice of Draftsperson's Patent Drawing Review (PTO-948)                       | 5) <input type="checkbox"/> Notice of Informal Patent Application                       |
| 3) <input type="checkbox"/> Information Disclosure Statement(s) (PTO/SB/08)<br>Paper No(s)/Mail Date _____ | 6) <input type="checkbox"/> Other: _____  |

## DETAILED ACTION

### *Priority*

1. Acknowledgment is made that this application is a Continuation of copending application # 10/ 037,007 filed on 11/09/2001 which is CIP of 09/231,745 filed on 01/15/1999 which is now patented (U.S. Patent No. 6,324,526).

### *Claim Rejections - 35 USC § 102*

2. The following is a quotation of the appropriate paragraphs of 35 U.S.C. 102 that form the basis for the rejections under this section made in this Office action:

(e) the invention was described in (1) an application for patent, published under section 122(b), by another filed in the United States before the invention by the applicant for patent or (2) a patent granted on an application for patent by another filed in the United States before the invention by the applicant for patent, except that an international application filed under the treaty defined in section 351(a) shall have the effects for purposes of this subsection of an application filed in the United States only if the international application designated the United States and was published under Article 21(2) of such treaty in the English language.

3. Claims 1-5, 7-9, 27-29, 32-40, 42 and 44 are rejected under 35 U.S.C. 102 (e) as being anticipated by Demoff et al., U.S. Patent No. 6,456,984 (reference A in attached PTO-892).

4. As per claim 1 (Original), Demoff et al. teach a method of performing secure credit card purchases, said method comprising the steps of:

a) contacting a custodial authorizing entity having custodial responsibility of account parameters of customer's credit card account (see column 3, line 35-37) ;

b) supplying the custodial authorizing entity with at least account identification data (see Fig. 8, step 314; column 7, lines 13-16);

c) defining a payment category including at least the ability to limit purchases to a single merchant for at least one transaction ( see Fig. 4);

d) designating said payment category ( see Fig. 4; where payment categories are food, entertainment and clothes);

e) generating a transaction code reflecting at least said designated payment category and the ability to make a purchase within said designated payment category (see Fig. 8, step 312; column 15-20; 31-36);

f) communicating the transaction code to a merchant to consummate a purchase with defined purchase parameters (see Fig. 8, step 316; column 2, lines 19-21);

g) verifying that said defined purchase parameters are within said designated payment category (see column 2, lines 43-52); and

h) providing authorization for said purchase so as to confirm at least that said defined purchase parameters are within said designated payment category and complete the purchase (see column 2, lines 52-54).

5. As per claim 2 (Original), Demoff et al. teach claim 1 as described above. Demoff et al. further teach the method comprising identification of said single merchant upon designation of said payment category (see Fig. 3; Fig. 8, step 304).

6. As per claim 3 (Original), Demoff et al. teach claim 1 as described above. Demoff et al. further teach the method comprising

the step of designating said single merchant subsequent to generating said transaction code (see Fig. 8, step 304).

7. As per claim 4 (Original), Demoff et al. teach claim 1 as described above. Demoff et al. further teach the method wherein

said step of communicating the transaction code to said merchant to consummate said purchase within defined purchase parameters further comprises designation of said single merchant (see Fig. 3).

8. As per claim 5 (Currently Amended), Demoff et al. teach claim 1 as described above.

Demoff et al. further teach the method wherein

said step of generating said transaction code further comprises said custodial authorizing entity generating said transaction code (see Fig. 8, step 312; column 3, lines 37-43).

9. As per claim 7 (Original), Demoff et al. teach claim 1 as described above.

Demoff et al. further teach the method comprising

obtaining said authorization for said purchase from the custodial authorizing entity (see column 2, lines 50-54).

10. As per claim 8 (Original), Demoff et al. teach claim 1 as described above.

Demoff et al. further teach the method comprising

a step of communicating promotional information of offered subject matter to the customer by the merchant, pre-determining the purchase parameters of the purchase, and corresponding said designated payment category to said purchase parameters (see Fig. 5; Fig. 6: column 4, lines 66-67; column 5, lines 1-5; where award incentive program is displayed; Examiner interprets the existing system is adaptable to

Art Unit: 3691

communicating promotional information from the merchant about its product purchases).

11. As per claim 9 (Original), Demoff et al. teach claim 1 as described above.

Demoff et al. further teach the method comprising the merchant communicating the transaction code to the custodial authorizing entity for verification (see column 6, lines 15-17).

12. As per claim 27 (Currently Amended), Demoff et al. teach a method of performing secure purchases, said method comprising the steps of:

- a) identifying a pre-established financial account (see column 3, lines 42-48);
- b) designating at least one of a plurality of predefined payment categories which limit a nature of a subsequent purchase (see Fig. 4) ;
- c) issuing a transaction code associated with at least said financial account and said selected payment category, and different from said financial account (see column 2, lines 15-19);
- d) communicating said transaction code to a merchant to consummate a purchase within defined purchase parameters (see Fig. 8, step 316);
- e) verifying that said defined purchase parameters correspond to said designated payment category (see column 2, lines 43-52); and
- f) providing authorization for said purchase so as to confirm at least that said defined purchase parameters are within said designated payment category and complete the purchase (see column 2, lines 52-54); and

Art Unit: 3691

g) associating the purchase with said financial account (see column 2, lines 52-54)

13. As per claim 28 (Currently Amended), Demoff et al. teach a method of performing secure purchases, said method comprising the steps of:

a) identifying a pre-established financial account(see column 3, lines 42-48);

b) designating a payment category which limits a nature of a subsequent purchase to a single transaction at a fixed amount (see Fig. 4);

c) issuing a transaction code associated with at least said financial account and said selected payment category, and different from said financial account (see column 2, lines 15-19);

d) communicating said transaction code to a merchant to consummate a purchase within defined purchase parameters (see Fig. 8, step 316; column 2, lines 39-42);

e) verifying that said defined purchase parameters correspond to said designated payment category (see column 2, lines 43-52);

f) providing authorization for said purchase so as to confirm at least that said defined purchase parameters are within said designated payment category and complete the purchase (see column 2, lines 52-54); and

g) associating the purchase with said financial account (see column 2, lines 52-54)

Art Unit: 3691

14. As per claim 29 (Currently Amended), Demoff et al. teach a method of performing secure purchases, said method comprising the steps of:
- a) identifying a pre-established financial account (see column 3, lines 42-48);
  - b) selecting a payment category which limits a nature of a series of subsequent purchases to a single merchant (see Fig. 3; Fig. 4; Fig. 7);
  - c) issuing a transaction code associated with at least said financial account and said selected payment category and different from said financial account (see column 3, lines 37-43);
  - d) communicating said transaction code to a merchant to consummate a purchase within defined purchase parameters (see Fig. 8, step 316);
  - e) verifying that said defined purchase parameters correspond to said selected payment category (see column 2, lines 43-52);
  - f) providing authorization for said purchase so as to confirm at least that said defined purchase parameters are within said selected payment category and complete the purchase (see column 2, lines 52-54); and
  - g) associating the purchase with said financial account (see column 2, lines 52-54)

15. As per claim 32 (Currently Amended), Demoff et al. teach claim 29 as described above.

Demoff et al. further teach the method wherein



Art Unit: 3691

said step of verifying that said defined purchase parameters correspond to said selected payment category further defines said merchant as said single merchant (see Fig. 3; Fig. 4 and Fig. 7).

16. As per claim 33 (Currently Amended), Demoff et al. teach a method of performing secure purchases, said method comprising the steps of:

- a) identifying a pre-established financial account (see column 7, lines 13-16);
- b) selecting a payment category which limits a nature of a subsequent purchase to a single merchant (see Fig. 4);
- c) issuing a transaction code associated with at least said financial account and said selected payment category, and different from said financial account (see column 3, lines 37-43);
- d) designating a merchant as said single merchant (see Fig. 3);
- e) communicating said transaction code to said merchant to consummate a purchase within defined purchase parameters (see Fig. 8, step 316; column 2, lines 39-42);
- f) verifying that said defined purchase parameters correspond to said selected payment category (see column 2, lines 43-52);
- g) providing authorization for said purchase so as to confirm at least that said defined purchase parameters are within said selected payment category and complete the purchase (see column 2, lines 52-54); and

Art Unit: 3691

h) associating the purchase with said financial account (see column 2, lines 52-54)

17. As per claim 34 (Currently Amended), Demoff et al. claim 33 as described above.

Demoff et al. further teach the method wherein

said step of verifying that said defined purchase parameters correspond to said selected payment category further defines said merchant as said single merchant (see Fig. 3; Fig. 4; and Fig. 7).

18. As per claim 35 (Original), Demoff et al. teach a system for performing secure purchases comprising:

a) a custodial authorizing entity, said custodial authorizing entity structured to maintain a pre-established financial account of at least one user (see Fig. 1; column 3, lines 30-36; 52-55);

b) said custodial authorizing entity further structured to define at least one payment category available for selection by a customer, said payment category structured to limit at least one subsequent transaction to a single merchant (see Fig. 3; Fig. 4; column 4, lines 55-65);

c) said custodial authorizing entity further structured to issue a transaction code associated with said payment category selected by the customer and said financial account of the user, said transaction code being different from said financial account (see Fig. 3; Fig. 4: column 2, lines 15-19; column 3, lines 41-43);

Art Unit: 3691

d) said custodial authorizing entity further structured to receive said transaction code and designated purchase parameters associated with a purchase from a merchant, and to verify that said designated purchase parameters correspond to said selected payment category (see column 6, lines 15-17; 49-53); and

e) said custodial authorizing entity structured to provide the merchant with authorization for said purchase that confirms at least that said designated purchase parameters correspond to said selected payment category so that said purchase may be consummated by the merchant (see column 6, lines 59-63).

19. As per claim 36 (Original), Demoff et al. teach claim 35 as described above.

Demoff et al. further teach a system for performing secure purchases wherein said single merchant is defined upon selection of said payment category and is associated with said transaction code (see Fig. 3; Fig. 4).

20. As per claim 37 (Original), Demoff et al. teach claim 35 as described above.

Demoff et al. further teach a system for performing secure purchases wherein said custodial authorizing entity is structured to designate a first merchant to provide said transaction code for verification as said single merchant (see column 6, lines 15-17; 49-53).

21. As per claim 38 (Original), Demoff et al. teach claim 37 as described above.

Demoff et al. further teach a system for performing secure purchases wherein said custodial authorizing entity is structured to designate said first merchant as said single merchant for subsequent transactions utilizing said transaction code (see Fig. 3; Fig. 4).

Art Unit: 3691

22. As per claim 39 (Original), Demoff et al. teach claim 35 as described above.

Demoff et al. further teach a system for performing secure purchases wherein said payment category is further structured to limit said at least one subsequent transaction to a specified dollar amount (see Fig. 4)

23. As per claim 40 (Original), Demoff et al. teach claim 39 as described above.

Demoff et al. further teach a system for performing secure purchases wherein wherein said payment category is further structured to limit each of a plurality of subsequent transactions to said specified dollar amount (see Fig. 4).

24. As per claim 42 (Original), Demoff et al. teach claim 39 as described above.

Demoff et al. further teach a system for performing secure purchases wherein said specified dollar amount is defined upon selection of said payment category and is associated with said transaction code ( see Fig. 4; where user selected category is clothes (L. L. Bean) for specified dollar amount \$70.09)

25. As per claim 43 (Original), Demoff et al. teach claim 35 as described above.

Demoff et al. further teach a system for performing secure purchases wherein said payment category is further structured to limit said at least one subsequent transaction to a maximum dollar amount (see Fig. 7; where maximum amount of purchase for specified list of product is \$ 40.00).

***Claim Rejections - 35 USC § 103***

26. The following is a quotation of 35 U.S.C. 103(a) which forms the basis for all obviousness rejections set forth in this Office action:

Art Unit: 3691

(a) A patent may not be obtained though the invention is not identically disclosed or described as set forth in section 102 of this title, if the differences between the subject matter sought to be patented and the prior art are such that the subject matter as a whole would have been obvious at the time the invention was made to a person having ordinary skill in the art to which said subject matter pertains. Patentability shall not be negated by the manner in which the invention was made.

27. Claim 6, 10-26, 30, 31, 41 and 44 are rejected under 35 U.S.C. 103(a) as being unpatentable by Demoff et al. U.S. Patent No. 6,456,984 (reference A in attached PTO-892) in view of Paleiov et al., U.S. Pub No. 2002/0152158 (reference B in attached PTO-892).

28. 47. As per claim 6 (Original), Demoff et al. teach claim 1 as described above.

Demoff et al. do not teach the method wherein said step of generating said transaction code further comprises said customer generating said transaction code.

Paleiov et al. teach the method wherein said step of generating said transaction code further comprises said customer generating said transaction code (see page 1, para [0011]).

Therefore, it would be prima facie obvious to one of ordinary skill in the art at the time the invention was made to allow generating transaction code further comprises customer generating transaction code of Demoff et al. because Paleiov et al. teach that allowing customer to generate transaction code would enable to exercise significant control of money spent (Paleiov et al., page 1, para [0012]).

29. As per Claims 10-26, 30, 31, 41 and 44, Paleiov et al. teach "owner or user or another entity adding monetary value and enabling users to designate data to store in at least one of the field, so as to restrict types transaction for which some or all of the value in the token can be used" (see page 1, para[0011]). The restriction includes time-related limitation associated with purchase (para [0057]), amount of financial value

Art Unit: 3691

(para [0064]), frequency of purchase (para [0080]), categorization of purchase of goods and services (para [0012] – [0020]); characteristics of transaction (date, vendor and location (para [0021]) etc. Paleiov et al, therefore, teach limitations of claims 10-26, 30, 31, 41 and 44 cited by the applicant.

Therefore, it would be prima facie obvious to one of ordinary skill in the art at the time the invention was made to allow owner or user or another entity adding monetary value and enabling users to designate data to store in at least one of the field, so as to restrict types transaction for which some or all of the value in the token can be used of Demoff et al. because Paleiov et al. teach that allowing user to generate transaction code would enable to exercise significant control of money spent (Paleiov et al., page 1, para [0012]).

Further, the Examiner notes that data identifying the indicator of field in transaction code is *not functionally* related to substrate of the secured credit card purchases. Thus, this descriptive material will not distinguish the claimed invention from prior art in terms of patentability, see *Cf. In re Gulack*, 703 F.2d 1381, 1385, 217 USPQ 401, 404 (Fed. Cir. 1983), *In re Lowry*, 32 F.3d 1579, 32 USPQ2d 1031 (Fed. Cir. 1994).

### ***Double Patenting***

30. The nonstatutory double patenting rejection is based on a judicially created doctrine grounded in public policy (a policy reflected in the statute) so as to prevent the unjustified or improper timewise extension of the "right to exclude" granted by a patent and to prevent possible harassment by multiple assignees. A nonstatutory obviousness-type double patenting rejection is appropriate where the conflicting claims are not identical, but at least one examined application claim is not patentably distinct

Art Unit: 3691

from the reference claim(s) because the examined application claim is either anticipated by, or would have been obvious over, the reference claim(s). See, e.g., *In re Berg*, 140 F.3d 1428, 46 USPQ2d 1226 (Fed. Cir. 1998); *In re Goodman*, 11 F.3d 1046, 29 USPQ2d 2010 (Fed. Cir. 1993); *In re Longi*, 759 F.2d 887, 225 USPQ 645 (Fed. Cir. 1985); *In re Van Ornum*, 686 F.2d 937, 214 USPQ 761 (CCPA 1982); *In re Vogel*, 422 F.2d 438, 164 USPQ 619 (CCPA 1970); and *In re Thorington*, 418 F.2d 528, 163 USPQ 644 (CCPA 1969).

A timely filed terminal disclaimer in compliance with 37 CFR 1.321(c) or 1.321(d) may be used to overcome an actual or provisional rejection based on a nonstatutory double patenting ground provided the conflicting application or patent either is shown to be commonly owned with this application, or claims an invention made as a result of activities undertaken within the scope of a joint research agreement.

Effective January 1, 1994, a registered attorney or agent of record may sign a terminal disclaimer. A terminal disclaimer signed by the assignee must fully comply with 37 CFR 3.73(b).

31. Claims 1-44 rejected on the ground of nonstatutory double patenting over claims 1-16 of U. S. Patent No. 6,324,526 since the claims, if allowed, would improperly extend the "right to exclude" already granted in the patent.

The subject matter claimed in the instant application is fully disclosed in the patent and is covered by the patent since the patent and the application are claiming common subject matter, as follows: *use of transaction code with purchase parameters and payment categories instead of credit card number.*

Furthermore, there is no apparent reason why applicant was prevented from presenting claims corresponding to those of the instant application during prosecution of the application which matured into a patent. See *In re Schneller*, 397 F.2d 350, 158 USPQ 210 (CCPA 1968). See also MPEP § 804.

32. Claim 1-44 are provisionally rejected on the ground of nonstatutory double patenting over claims 1-26 of copending Application No. 10/037007. This is a

Art Unit: 3691

provisional double patenting rejection since the conflicting claims have not yet been patented.

The subject matter claimed in the instant application is fully disclosed in the referenced copending application and would be covered by any patent granted on that copending application since the referenced copending application and the instant application are claiming common subject matter, as follows: *use of transaction code with purchase parameters and payment categories instead of credit card number.*

Furthermore, there is no apparent reason why applicant would be prevented from presenting claims corresponding to those of the instant application in the other copending application. See *In re Schneller*, 397 F.2d 350, 158 USPQ 210 (CCPA 1968). See also MPEP § 804.

33. The prior art made of record and not relied upon is considered pertinent to applicant's disclosures. The following are pertinent to current invention, though not relied upon:

Kravitz (U.S. Patent No. 6,029,150) teaches payment and transactions in electronic commerce system.

Morrill, Jr. (U.S. Patent No. 5,991,749) teaches wireless telephony for collecting tolls, conducting financial transactions, and authorizing other activities.

Watson (U.S. Patent No. 5,991,750) teaches system and method for pre-authorization of individual account transactions.



Watson et al. (U.S. Patent No. 6,226,624) teach system and method for pre-authorization of individual account remote transactions.

Zampese (U.S. Patent No. 6,014,650) teaches purchase management system and method.

Any inquiry concerning this communication or earlier communications from the examiner should be directed to Bijendra K. Shrestha whose telephone number is (571)270-1374. The examiner can normally be reached on 7:00AM-4:30PM (Monday-Friday); 2nd Friday OFF.

If attempts to reach the examiner by telephone are unsuccessful, the examiner's supervisor, Alexander Kalinowski can be reached on (571)272-6771. The fax phone number for the organization where this application or proceeding is assigned is 571-273-8300.

Information regarding the status of an application may be obtained from the Patent Application Information Retrieval (PAIR) system. Status information for published applications may be obtained from either Private PAIR or Public PAIR. Status information for unpublished applications is available through Private PAIR only. For more information about the PAIR system, see <http://pair-direct.uspto.gov>. Should you have questions on access to the Private PAIR system, contact the Electronic Business Center (EBC) at 866-217-9197 (toll-free). If you would like assistance from a USPTO Customer Service Representative or access to the automated information system, call 800-786-9199 (IN USA OR CANADA) or 571-272-1000.

Application/Control Number: 11/252,009  
Art Unit: 3691

Page 17

BKS

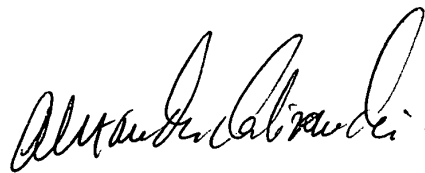
A handwritten signature in black ink, appearing to read "Alexander Kaminowski". The signature is written in a cursive style with a large, prominent initial "A".

**ALEXANDER KAMINOWSKI**  
**SUPERVISORY PATENT EXAMINER**

<b>Notice of References Cited</b>	Application/Control No. 11/252,009	Applicant(s)/Patent Under Reexamination D'AGOSTINO, JOHN	
	Examiner Bijendra K. Shrestha	Art Unit 3691	Page 1 of 1

**U.S. PATENT DOCUMENTS**

*		Document Number Country Code-Number-Kind Code	Date MM-YYYY	Name	Classification
*	A	US-6,456,984	09-2002	Demoff et al.	705/40
*	B	US-2002/0152158	10-2002	Paleiov et al.	705/39
*	C	US-6,029,150	02-2000	Kravitz, David William	705/39
*	D	US-5,991,749	11-1999	Morrill, Jr., Paul H.	705/44
*	E	US-5,991,750	11-1999	Watson, Craig	705/44
*	F	US-6,226,624	05-2001	Watson et al.	705/44
*	G	US-6,014,650	01-2000	Zampese, David	705/44
	H	US-			
	I	US-			
	J	US-			
	K	US-			
	L	US-			
	M	US-			

**FOREIGN PATENT DOCUMENTS**

*		Document Number Country Code-Number-Kind Code	Date MM-YYYY	Country	Name	Classification
	N					
	O					
	P					
	Q					
	R					
	S					
	T					

**NON-PATENT DOCUMENTS**

*		Include as applicable: Author, Title Date, Publisher, Edition or Volume, Pertinent Pages)
	U	
	V	
	W	
	X	

\*A copy of this reference is not being furnished with this Office action. (See MPEP § 707.05(a).)  
Dates in MM-YYYY format are publication dates. Classifications may be US or foreign.

<b>Index of Claims</b>  	<b>Application/Control No.</b> 11252009	<b>Applicant(s)/Patent Under Reexamination</b> D'AGOSTINO, JOHN
	<b>Examiner</b> Shrestha, Bijendra K	<b>Art Unit</b> 3691

✓	<b>Rejected</b>	-	<b>Cancelled</b>	N	<b>Non-Elected</b>	A	<b>Appeal</b>
=	<b>Allowed</b>	÷	<b>Restricted</b>	I	<b>Interference</b>	O	<b>Objected</b>

<input type="checkbox"/> Claims renumbered in the same order as presented by applicant		<input type="checkbox"/> CPA	<input type="checkbox"/> T.D.	<input type="checkbox"/> R.1.47					
CLAIM		DATE							
Final	Original	02/26/2007							
	1	✓							
	2	✓							
	3	✓							
	4	✓							
	5	✓							
	6	✓							
	7	✓							
	8	✓							
	9	✓							
	10	✓							
	11	✓							
	12	✓							
	13	✓							
	14	✓							
	15	✓							
	16	✓							
	17	✓							
	18	✓							
	19	✓							
	20	✓							
	21	✓							
	22	✓							
	23	✓							
	24	✓							
	25	✓							
	26	✓							
	27	✓							
	28	✓							
	29	✓							
	30	✓							
	31	✓							
	32	✓							
	33	✓							
	34	✓							
	35	✓							
	36	✓							

<b>Index of Claims</b>  	<b>Application/Control No.</b>  11252009	<b>Applicant(s)/Patent Under Reexamination</b>  D'AGOSTINO, JOHN
	<b>Examiner</b>  Shrestha, Bijendra K	<b>Art Unit</b>  3691

✓	<b>Rejected</b>	-	<b>Cancelled</b>	N	<b>Non-Elected</b>	A	<b>Appeal</b>
=	<b>Allowed</b>	÷	<b>Restricted</b>	I	<b>Interference</b>	O	<b>Objected</b>

<input type="checkbox"/> Claims renumbered in the same order as presented by applicant		<input type="checkbox"/> CPA		<input type="checkbox"/> T.D.		<input type="checkbox"/> R.1.47			
CLAIM		DATE							
Final	Original	02/26/2007							
	37	✓							
	38	✓							
	39	✓							
	40	✓							
	41	✓							
	42	✓							
	43	✓							
	44	✓							

<b>Search Notes</b>  	<b>Application/Control No.</b>  11252009	<b>Applicant(s)/Patent Under Reexamination</b>  D'AGOSTINO, JOHN
	<b>Examiner</b>  Shrestha, Bijendra K	<b>Art Unit</b>  3691

SEARCHED			
Class	Subclass	Date	Examiner
705	39, 40 , 44	02/26/2007	Bijendra K. Shrestha

SEARCH NOTES		
Search Notes	Date	Examiner
East, Google/Patents and Inventors search in PALM (see attached)	02/26/2007	Bijendra K. Shrestha

INTERFERENCE SEARCH			
Class	Subclass	Date	Examiner



UNITED STATES PATENT AND TRADEMARK OFFICE

UNITED STATES DEPARTMENT OF COMMERCE  
 United States Patent and Trademark Office  
 Address: COMMISSIONER FOR PATENTS  
 P.O. Box 1450  
 Alexandria, Virginia 22313-1450  
 www.uspto.gov



Bib Data Sheet

CONFIRMATION NO. 4322

<b>SERIAL NUMBER</b> 11/252,009	<b>FILING OR 371(c) DATE</b> 10/17/2005 <b>RULE</b>	<b>CLASS</b> 705	<b>GROUP ART UNIT</b> 3691	<b>ATTORNEY DOCKET NO.</b> 1.706-B.04	
<b>APPLICANTS</b> John D'Agostino, Sarasota, FL;					
<b>** CONTINUING DATA *****</b> This application is a CON of 10/037,007 11/09/2001 which is a CIP of 09/231,745 01/15/1999 PAT 6,324,526					
<b>** FOREIGN APPLICATIONS *****</b>					
<b>IF REQUIRED, FOREIGN FILING LICENSE GRANTED ** SMALL ENTITY **</b> ** 11/03/2005					
Foreign Priority claimed <input type="checkbox"/> yes <input checked="" type="checkbox"/> no		<b>STATE OR COUNTRY</b> FL	<b>SHEETS DRAWING</b> 2	<b>TOTAL CLAIMS</b> 44	<b>INDEPENDENT CLAIMS</b> 6
35 USC 119 (a-d) conditions met <input type="checkbox"/> yes <input checked="" type="checkbox"/> no <input type="checkbox"/> Met after Allowance					
Verified and Acknowledged Examiner's Signature: <i>Supendra K. Sheth</i> Initials: <i>BS</i>					
<b>ADDRESS</b> MALLOY & MALLOY, P.A. 2800 S.W. Third Avenue Historic Coral Way Miami, FL33129					
<b>TITLE</b> System and method for performing secure credit card purchases					
<b>FILING FEE RECEIVED</b> 1400	FEES: Authority has been given in Paper No. _____ to charge/credit DEPOSIT ACCOUNT No. _____ for following:		<input type="checkbox"/> All Fees <input type="checkbox"/> 1.16 Fees ( Filing ) <input type="checkbox"/> 1.17 Fees ( Processing Ext. of time ) <input type="checkbox"/> 1.18 Fees ( Issue ) <input type="checkbox"/> Other _____ <input type="checkbox"/> Credit		

Day : Monday  
Date: 2/26/2007

Time: 10:08:02

# PALM INTRANET

## Inventor Information for 11/252009

<b>Inventor Name</b>	<b>City</b>	<b>State/Country</b>
D'AGOSTINO, JOHN	SARASOTA	FLORIDA

Appln Info	Contents	Petition Info	Atty/Agent Info	Continuity/Reexam	Foreign I
------------	----------	---------------	-----------------	-------------------	-----------

**Search Another: Application#**  **Search**
**or Patent#**  **Search**  
**PCT /**  **/**  **Search**
**or PG PUBS #**  **Search**  
**Attorney Docket #**  **Search**  
**Bar Code #**  **Search**

To go back use Back button on your browser toolbar.

Back to [PALM](#) | [ASSIGNMENT](#) | [OASIS](#) | [Home page](#)



Day : Monday  
Date: 2/26/2007

**PALM INTRANET**

Time: 10:08:12

**Inventor Name Search Result**

Your Search was:

Last Name = D'AGOSTINO

First Name = JOHN

Application#	Patent#	Status	Date Filed	Title	Inventor Name
<a href="#">90007481</a>	Not Issued	425	03/28/2005	SYSTEM AND METHOD FOR PERFORMING SECURE CREDIT CARD PURCHASES	D'AGOSTINO (OWNER), JOHN
<a href="#">10037007</a>	Not Issued	30	11/09/2001	System and method for performing secure user account purchases	D'AGOSTINO, JOHN
<a href="#">10260594</a>	<a href="#">7021660</a>	150	09/30/2002	ADJUSTABLE STEERING COLUMN FOR MOTOR VEHICLES	D'AGOSTINO, JOHN
<a href="#">11252009</a>	Not Issued	30	10/17/2005	System and method for performing secure credit card purchases	D'AGOSTINO, JOHN
<a href="#">60442935</a>	Not Issued	159	01/27/2003	Beverage flavoring system	D'AGOSTINO, JOHN
<a href="#">06261839</a>	<a href="#">4634293</a>	150	05/08/1981	BATTLEFIELD ENVIRONMENT THERMAL ANALYZER	D'AGOSTINO, JOHN A.
<a href="#">60540279</a>	Not Issued	159	01/29/2004	E-pitcard wireless trade entry device	D'AGOSTINO, JOHN J.

Inventor Search Completed: No Records to Display.

**Search Another: Inventor**

To go back use Back button on your browser toolbar.

Back to [PALM](#) | [ASSIGNMENT](#) | [OASIS](#) | [Home page](#)

### EAST Search History

Ref #	Hits	Search Query	DBs	Default Operator	Plurals	Time Stamp
S1	56	"5991750"	US-PGPUB; USPAT	ADJ	ON	2007/02/16 17:04
S2	13	"6014650"	US-PGPUB; USPAT	ADJ	ON	2007/02/19 13:51
S3	9	"6456984"	US-PGPUB; USPAT	ADJ	ON	2007/02/16 17:01
S4	9	"6282523"	US-PGPUB; USPAT	ADJ	ON	2007/02/16 17:10
S5	3872	transaction (code or identifier)	US-PGPUB; USPAT	ADJ	ON	2007/02/16 17:11
S6	2493	establish\$6 account	US-PGPUB; USPAT	ADJ	ON	2007/02/16 17:11
S7	118	S5 and S6	US-PGPUB; USPAT	ADJ	ON	2007/02/16 18:04
S8	134	payment near1 categor\$5	US-PGPUB; USPAT	ADJ	ON	2007/02/16 17:12
S9	1	S7 and S8	US-PGPUB; USPAT	ADJ	ON	2007/02/16 17:13
S10	237434	categor\$5	US-PGPUB; USPAT	ADJ	ON	2007/02/16 17:13
S11	56	S7 and S10	US-PGPUB; USPAT	ADJ	ON	2007/02/16 18:00
S12	61	merchant and user and (authorizing entity)	US-PGPUB; USPAT	ADJ	ON	2007/02/16 18:02
S13	5	S5 and S12	US-PGPUB; USPAT	ADJ	ON	2007/02/16 18:02
S14	1	Us "20020152158"	US-PGPUB; USPAT	ADJ	ON	2007/02/19 13:57
S15	2	"20010034703"	US-PGPUB; USPAT	ADJ	ON	2007/02/19 13:58
S16	1	"20020143647"	US-PGPUB; USPAT	ADJ	ON	2007/02/19 13:59
S17	2	"6922843"	US-PGPUB; USPAT	ADJ	ON	2007/02/19 14:00
S18	2	"6629019"	US-PGPUB; USPAT	ADJ	ON	2007/02/19 14:00

SPW



IN THE UNITED STATES PATENT AND TRADEMARK OFFICE

Applicant: John D'Agostino  
Serial No.: 11/252,009  
Filing Date: October 17, 2005  
For: SYSTEM AND METHOD FOR PERFORMING SECURE CREDIT CARD PURCHASES

Confirmation No. 4322  
Group Art Unit 3622  
Customer No. 4219

2800 S.W. Third Avenue  
Historic Coral Way  
Miami, Florida 33129

Mail Stop Amendment  
Commissioner for Patents  
P.O. Box 1450  
Alexandria, VA 22313-1450

Dear Sir:

CERTIFICATE OF MAILING

I HEREBY CERTIFY that this correspondence is being deposited with the United States Postal Service as first class mail in an envelope addressed to: Mail Stop Amendment, Commissioner for Patents, P.O. Box 1450, Alexandria, VA 22313-1450, this 18 day of Jan, 2006.

Respectfully submitted,

MALLOY & MALLOY, P.A.  
2800 S.W. Third Avenue  
Historic Coral Way  
Miami, Florida 33129  
(305) 858-8000

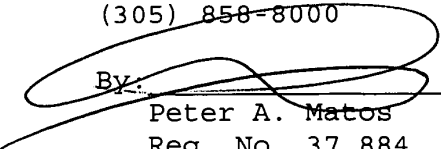
By:   
Peter A. Matos  
Reg. No. 37,884

Date: 1/18/06

Application No. 11/252,009  
Amdt. dated January 18, 2006

F:\MM DOCS\1-PAT\PAT 2004\APP\1706B-0177\Agostino\John\1706B Preliminary -AMD.doc

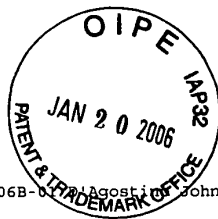

IN THE UNITED STATES PATENT AND TRADEMARK OFFICE

Applicant: John D'Agostino  
Serial No.: 11/252,009  
Filing Date: October 17, 2005  
For: SYSTEM AND METHOD FOR PERFORMING SECURE CREDIT CARD PURCHASES

Confirmation No. 4322  
Group Art Unit 3622  
Customer No. 4219

2800 S.W. Third Avenue  
Historic Coral Way  
Miami, Florida 33129  
January 18, 2006

Mail Stop Amendment  
Commissioner for Patents  
P.O. Box 1450  
Alexandria, VA 22313-1450

P R E L I M I N A R Y A M E N D M E N T

Sir:

Please amend the above-identified patent application as follows:

**Amendments to the Specification** begin on page 2 of this paper.

**Amendments to the Claims** are reflected in the listing of claims which begins on page 6 of this paper.

**Remarks/Arguments** begin on page 20 of this paper.

**Amendments to the Specification:**

Please replace the paragraph beginning on page 9 line 5 with the following amended paragraph:

A further feature of the present invention to be described in greater detail[[s]] hereinafter, is the requirement that the transaction code, once received by the customer is transmitted to the merchant by the customer or a person specifically authorized by the customer. Only minimal contact by the merchant and the custodial authorizing entity is provided for purposes of the merchant verifying the validity of the transaction code utilizing a conventional process electronically or otherwise similar to the verification of a credit card number normally offered to a merchant for the purchase of goods or services. There is, therefore, no disclosure, publication or other dissemination of the specific credit card number of a given customer account beyond those entities who already know the information, and the transaction code is transmitted exclusively to the customer by the custodial authorizing entity who has the ability to better identify whether the customer is properly authorized to use the account. Moreover, the transaction code, once given out by the customer, only has a limited usefulness, thereby limiting the risk of misuse and minimizing the potential losses to be experienced by the credit

card company and/or the account holder.

Please replace the paragraph beginning on page 11 line 1 with the following amended paragraph:

It is also an object of the present invention to provide a system and attendant method of accomplishing secure credit card purchases which eliminate[[s]] the need to disclose or disseminate a given credit card number while providing the customer with the versatility of choosing any one of a plurality of predetermined payment categories.

Please replace the paragraph beginning on page 12 line 12 with the following amended paragraph:

As shown in the accompanying Figures, the present invention is directed towards a system and method for accomplishing secure credit card purchases. Moreover, these purchases can be "in person", but preferably include remote commercial transactions such as mail order, purchases over the internet, television solicitations, telephone solicitations, etc. Security is established by virtue of the elimination of the need to disclose an active credit card number and expiration date to the merchant or any other party other than the original credit card company,

issuing bank or like financial institution which already has custodial responsibilities for the financial or account data associated with a given customer's credit card account.

Please replace the paragraph beginning on page 18 line 3 with the following amended paragraph:

Figures 3 and 4 are representative of the versatility of the system and method of the present invention wherein the customer 54 may receive the aforementioned promotional information from the merchant 56 by any appropriate means such as television solicitation as at 58, phone solicitation as at 60 and/or personal solicitation as at 62. Once the customer receives the promotional information, which may include the viewing of the product itself, or in advance if a general estimate as to the ultimate cost of an anticipated purchase(s) can be made prior to viewing promotional information, the customer contacts the custodial authorizing entity 64 by any appropriate electronic or conventional facilities such as direct phone to phone contact as at 66 and 66' or direct computer contact as at 42', 45'. Once the customer's authorization is confirmed, details of the anticipated transaction are established so as to determine a payment category, and [[the]] a transaction code is issued to the customer. The customer, either directly or

through a representative, can then utilize the transaction code to consummate a transaction within the defined parameters of the payment category. Moreover, the merchant 56, through a conventional, yet restricted communication with the custodial authorizing entity 64 by any of a plurality of conventional or electronic methods using computer to computer linking as at 44', 45' or by telephone transmission as at 56', 66', can obtain a verification and subsequent payment utilizing the transaction code only.



**Amendments to the Claims:**

This listing of claims will replace all prior versions, and listings, of claims in the application:

**Listing of Claims:**

1. (Original) A method of performing secure credit card purchases, said method comprising the steps of:
  - a) contacting a custodial authorizing entity having custodial responsibility of account parameters of customer's credit card account;
  - b) supplying the custodial authorizing entity with at least account identification data;
  - c) defining a payment category including at least the ability to limit purchases to a single merchant for at least one transaction;
  - d) designating said payment category;
  - e) generating a transaction code reflecting at least said designated payment category and the ability to make a purchase within said designated payment category;
  - f) communicating the transaction code to a merchant to consummate a purchase with defined purchase parameters;
  - g) verifying that said defined purchase parameters are

within said designated payment category; and

h) providing authorization for said purchase so as to confirm at least that said defined purchase parameters are within said designated payment category and complete the purchase.

2. (Original) The method of claim 1 further comprising identification of said single merchant upon designation of said payment category.

3. (Original) The method of claim 1 further comprising the step of designating said single merchant subsequent to generating said transaction code.

4. (Original) The method of claim 1 wherein said step of communicating the transaction code to said merchant to consummate said purchase within defined purchase parameters further comprises designation of said single merchant.

5. (Currently Amended) The method of claim 1 wherein said step of generating said transaction code further comprises said custodial authority authorizing entity generating said transaction code.

6. (Original) The method of claim 1 wherein said step of generating said transaction code further comprises said customer generating said transaction code.

7. (Original) The method of claim 1 further comprising obtaining said authorization for said purchase from the custodial authorizing entity.

8. (Original) The method of claim 1 further comprising a step of communicating promotional information of offered subject matter to the customer by the merchant, pre-determining the purchase parameters of the purchase, and corresponding said designated payment category to said purchase parameters.

9. (Original) The method of claim 1 further comprising the merchant communicating the transaction code to the custodial authorizing entity for verification.

10. (Original) The method of claim 1 further comprising generating a transaction code which reflects at least one of a plurality of said payment categories.

11. (Original) The method of claim 10 further comprising defining at least one of said plurality of payment categories to include the ability to designate amount parameters for a cost of one or more purchases.

12. (Original) The method of claim 10 further comprising defining at least one of said plurality of payment categories to include the ability to designate time parameters during which the purchase can be completed.

13. (Original) The method of claim 10 further comprising defining at least one of said plurality of payment categories to include the ability to use said transaction code for a single transaction at a fixed amount for purchase within a predetermined period of time.

14. (Original) The method of claim 13 further comprising defining at least one of said plurality of payment categories to include the ability to limit purchases to said single transaction at said fixed amount for purchase within said predetermined period of time.

15. (Original) The method of claim 10 further comprising defining at least one of said plurality of payment categories to include the ability to use said transaction code for a single transaction at a maximum amount for purchase within a predetermined period of time.

16. (Original) The method of claim 15 further comprising defining at least one of said plurality of payment categories to include the ability to limit purchases to said single transaction at said maximum amount for purchase within said predetermined period of time.

17. (Original) The method of claim 10 further comprising defining at least one of said plurality of payment categories to include the ability to use said transaction code for at least two purchases at a maximum total amount for items purchased within a predetermined time period.

18. (Original) The method of claim 17 further comprising defining at least one of said plurality of payment categories to include the ability to limit purchases to said at least two purchases at said maximum total amount for items purchased within said predetermined time period.

19. (Original) The method of claim 10 further comprising defining at least one of said plurality of payment categories to include the ability to use said transaction code for at least two purchases for a repeating transaction at a fixed amount payable at each of a fixed number of time intervals.

20. (Original) The method of claim 19 further comprising defining at least one of said plurality of payment categories to include the ability to limit purchases to said repeating transaction at said fixed amount payable at each of said fixed number of time intervals.

21. (Original) The method of claim 10 further comprising defining at least one of said plurality of payment categories to include the ability to use said transaction code for a repeating transaction at a fixed amount payable at each of an unspecified number of time intervals.

22. (Original) The method of claim 21 further comprising defining at least one of said plurality of payment categories to include the

ability to limit purchases to said repeating transaction at said fixed amount payable at each of said unspecified number of time intervals.

23. (Original) The method of claim 10 wherein at least some of said plurality of payment categories to include:

a) the ability to use said transaction code for a single transaction at a fixed amount for a purchase within a predetermined period of time,

b) the ability to use said transaction code for a single transaction at a maximum amount for a purchase within a predetermined period of time,

c) the ability to use said transaction code for multiple transactions at a maximum total amount for purchases within a predetermined time period,

d) the ability to use said transaction code for a repeating transaction at a fixed amount for purchases payable at each of a fixed number of time intervals, and

e) the ability to use said transaction code for a repeating transaction at a fixed amount for purchases payable at each of an unspecified number of time intervals.

24. (Original) The method of claim 10 wherein at least some of said plurality of payment categories include:

a) the ability to use said transaction code for a single transaction at a fixed amount for a purchase,

b) the ability to use said transaction code for a single transaction at a maximum amount for a purchase,

c) the ability to use said transaction code for multiple transactions at a maximum total amount for purchases,

d) the ability to use said transaction code for a repeating transaction at a fixed amount for purchases payable at each of a fixed number of time intervals, and

e) the ability to use said transaction code for a repeating transaction at a fixed amount for purchases payable at each of an unspecified number of time intervals.

25. (Original) The method of claim 1 further comprising generating said transaction code to further reflect an identification of said single merchant.

26. (Original) The method of claim 25 further comprising defining said payment category to include the ability to limit purchases to a limited time interval during which said purchase authorization is valid.

27. (Currently Amended) A method of performing secure purchases, said method comprising the steps of:

a) identifying a pre-established financial account;

- b) ~~selecting~~ designating at least one of a plurality of pre-defined payment categories which limit a nature of a subsequent purchase;
- c) issuing a transaction code associated with at least said financial account and said selected payment category, and different from said financial account;
- d) communicating said transaction code to a merchant to consummate a purchase within defined purchase parameters;
- e) verifying that said defined purchase parameters correspond to said designated payment category; and
- f) providing authorization for said purchase so as to confirm at least that said defined purchase parameters are within said designated payment category and complete the purchase; and
- g) associating the purchase with said financial account.

28. (Currently Amended) A method of performing secure purchases, said method comprising the steps of:

- a) identifying a pre-established financial account;
- b) ~~selecting~~ designating a payment category which limits a nature of a subsequent purchase to a single transaction at a fixed amount;
- c) issuing a transaction code associated with at least said



financial account and said selected payment category, and different from said financial account;

d) communicating said transaction code to a merchant to consummate a purchase within defined purchase parameters;

e) verifying that said defined purchase parameters correspond to said designated payment category; [[and]]

f) providing authorization for said purchase so as to confirm at least that said defined purchase parameters are within said designated payment category and complete the purchase; and

g) associating the purchase with said financial account.

29. (Currently Amended) A method of performing secure purchases, said method comprising the steps of:

a) identifying a pre-established financial account;

b) selecting a payment category which limits a nature of a series of subsequent purchases to a single merchant;

c) issuing a transaction code associated with at least said financial account and said selected payment category[[,]] and different from said financial account;

d) communicating said transaction code to a merchant to consummate a purchase within defined purchase parameters;

e) verifying that said defined purchase parameters correspond to said ~~designated~~ selected payment category;  
[[and]]

f) providing authorization for said purchase so as to confirm at least that said defined purchase parameters are within said ~~designated~~ selected payment category and complete the purchase; and

g) associating the purchase with said financial account.

30. (Original) The method of claim 29 wherein said step of selecting said payment category which limits said nature of said series of subsequent purchases to said single merchant further comprises limiting said nature of said series of subsequent purchases to a fixed amount for each of said subsequent purchases.

31. (Original) The method of claim 29 wherein said step of selecting said payment category which limits said nature of said series of subsequent purchases to said single merchant further comprises limiting said nature of said series of subsequent purchases to a maximum total amount for said subsequent purchases.

32. (Currently Amended) The method of claim 29 wherein said step of verifying that said defined purchase parameters correspond to said ~~designated~~ selected payment category further defines said merchant as said single merchant..

33. (Currently Amended) A method of performing secure purchases, said method comprising the steps of:

- a) identifying a pre-established financial account;
- b) selecting a payment category which limits a nature of a subsequent purchase to a single merchant;
- c) issuing a transaction code associated with at least said financial account and said selected payment category, and different from said financial account;
- d) designating a merchant as said single merchant;
- e) communicating said transaction code to said merchant to consummate a purchase within defined purchase parameters;
- f) verifying that said defined purchase parameters correspond to said ~~designated~~ selected payment category; [[and]]
- g) providing authorization for said purchase so as to confirm at least that said defined purchase parameters are within said ~~designated~~ selected payment category and complete the purchase; and
- h) associating the purchase with said financial account.

34. (Currently Amended) The method of claim 33 wherein said step of verifying that said defined purchase parameters correspond to said ~~designated~~ selected payment category further defines said

merchant as said single merchant.

35. (Original) A system for performing secure purchases comprising:

- a) a custodial authorizing entity, said custodial authorizing entity structured to maintain a pre-established financial account of at least one user;
- b) said custodial authorizing entity further structured to define at least one payment category available for selection by a customer, said payment category structured to limit at least one subsequent transaction to a single merchant;
- c) said custodial authorizing entity further structured to issue a transaction code associated with said payment category selected by the customer and said financial account of the user, said transaction code being different from said financial account;
- d) said custodial authorizing entity further structured to receive said transaction code and designated purchase parameters associated with a purchase from a merchant, and to verify that said designated purchase parameters correspond to said selected payment category; and
- e) said custodial authorizing entity structured to provide the merchant with authorization for said purchase that

confirms at least that said designated purchase parameters correspond to said selected payment category so that said purchase may be consummated by the merchant.

36. (Original) A system for performing secure purchases as recited in claim 35 wherein said single merchant is defined upon selection of said payment category and is associated with said transaction code.

37. (Original) A system for performing secure purchases as recited in claim 35 wherein said custodial authorizing entity is structured to designate a first merchant to provide said transaction code for verification as said single merchant.

38. (Original) A system for performing secure purchases as recited in claim 37 wherein said custodial authorizing entity is structured to designate said first merchant as said single merchant for subsequent transactions utilizing said transaction code.

39. (Original) A system for performing secure purchases as recited in claim 35 wherein said payment category is further structured to limit said at least one subsequent transaction to a specified dollar amount.

40. (Original) A system for performing secure purchases as recited in claim 39 wherein said payment category is further structured to limit each of a plurality of subsequent transactions to said

specified dollar amount.

41. (Original) A system for performing secure purchases as recited in claim 40 wherein said custodial authorizing entity is structured to designate a dollar amount of a first transaction associated with said transaction code and having said designated purchase parameters that correspond to remaining parameters of said selected payment category, as said specified dollar amount.

42. (Original) A system for performing secure purchases as recited in claim 39 wherein said specified dollar amount is defined upon selection of said payment category and is associated with said transaction code.

43. (Original) A system for performing secure purchases as recited in claim 35 wherein said payment category is further structured to limit said at least one subsequent transaction to a maximum dollar amount.

44. (Original) A system for performing secure purchases as recited in claim 35 wherein said payment category is further structured to limit said at least one subsequent transaction to a predetermined time period.

Application No. 11/252,009  
Amdt. dated January 18, 2006

F:\MM DOCS\1-PAT\PAT 2004\APP\1706B-01 D'Agostino John\1706B Preliminary -AMD.doc

REMARKS / ARGUMENTS

This amendment is submitted on a preliminary basis prior to Applicant receiving any action on the merits regarding the prosecution of this application.

The purpose of the amendment is to overcome any informalities and inconsistencies in the language of the specification and claims. As clearly indicated above, the changes made to the specification and claims are of a minor nature and care was taken not to include any new subject matter.

The Commissioner is hereby authorized to charge all additional filing fees that may be required by the filing of this paper to our **Deposit Account No. 13-1227.**

Respectfully submitted,

MALLOY & MALLOY, P.A.  
Attorneys for Applicant  
2800 S.W. Third Avenue  
Historic Coral Way  
Miami, Florida 33129  
(305) 858-8000

By: 

Peter A. Matos  
Reg. No. 37,884

Dated: 1/18/06

**PATENT APPLICATION FEE DETERMINATION RECORD**  
Effective December 8, 2004

11/252009

**CLAIMS AS FILED - PART I**

	(Column 1)	(Column 2)
TOTAL CLAIMS		
FOR	NUMBER FILED	NUMBER EXTRA
TOTAL CHARGEABLE CLAIMS	minus 20=	*
INDEPENDENT CLAIMS	minus 3 =	*
MULTIPLE DEPENDENT CLAIM PRESENT <input type="checkbox"/>		

\* If the difference in column 1 is less than zero, enter "0" in column 2

SMALL ENTITY TYPE  OR

OTHER THAN SMALL ENTITY

RATE	FEE
BASIC FEE	150.00
X\$ 25=	
X100=	
+180=	
TOTAL	

RATE	FEE
BASIC FEE	300.00
X\$50=	
X200=	
+360=	
TOTAL	

**CLAIMS AS AMENDED - PART II**

	(Column 1)	(Column 2)	(Column 3)
AMENDMENT A	07/20/00	CLAIMS REMAINING AFTER AMENDMENT	HIGHEST NUMBER PREVIOUSLY PAID FOR
	Total	* 44	Minus ** 44
	Independent	* 6	Minus *** 6
FIRST PRESENTATION OF MULTIPLE DEPENDENT CLAIM <input type="checkbox"/>			

SMALL ENTITY OR

OTHER THAN SMALL ENTITY

RATE	ADDITIONAL FEE
X\$ 25=	
X100=	
+180=	
TOTAL ADDIT. FEE	

RATE	ADDITIONAL FEE
X\$50=	
X200=	
+360=	
TOTAL ADDIT. FEE	

	(Column 1)	(Column 2)	(Column 3)
AMENDMENT B		CLAIMS REMAINING AFTER AMENDMENT	HIGHEST NUMBER PREVIOUSLY PAID FOR
	Total	*	Minus **
	Independent	*	Minus ***
FIRST PRESENTATION OF MULTIPLE DEPENDENT CLAIM <input type="checkbox"/>			

RATE	ADDITIONAL FEE
X\$ 25=	
X100=	
+180=	
TOTAL ADDIT. FEE	

RATE	ADDITIONAL FEE
X\$50=	
X200=	
+360=	
TOTAL ADDIT. FEE	

	(Column 1)	(Column 2)	(Column 3)
AMENDMENT C		CLAIMS REMAINING AFTER AMENDMENT	HIGHEST NUMBER PREVIOUSLY PAID FOR
	Total	*	Minus **
	Independent	*	Minus ***
FIRST PRESENTATION OF MULTIPLE DEPENDENT CLAIM <input type="checkbox"/>			

RATE	ADDITIONAL FEE
X\$ 25=	
X100=	
+180=	

RATE	ADDITIONAL FEE
X\$50=	
X200=	
+360=	



IFW



IN THE UNITED STATES PATENT AND TRADEMARK OFFICE

Applicant: John D'Agostino  
Serial No.: 11/252,009  
Filing Date: October 17, 2005  
For: SYSTEM AND METHOD FOR PERFORMING SECURE CREDIT CARD PURCHASES

Group Art Unit 3622  
2800 S.W. Third Avenue  
Historic Coral Way  
Miami, Florida 33129

Commissioner for Patents  
P.O. Box 1450  
Alexandria, VA 22313-1450

Dear Sir:

CERTIFICATE OF MAILING

I HEREBY CERTIFY that this correspondence is being deposited with the United States Postal Service as first class mail in an envelope addressed to: Commissioner for Patents, P.O. Box 1450, Alexandria, VA 22313-1450, this 6 day of December, 2005.

Respectfully submitted,

MALLOY & MALLOY, P.A.  
2800 S.W. Third Avenue  
Historic Coral Way  
Miami, Florida 33129  
(305) 858-8000

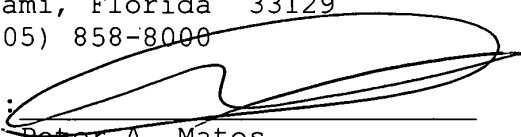
By: 

Peter A. Matos  
Reg. No. 37,884

Date: 12/6/05



IN THE UNITED STATES PATENT AND TRADEMARK OFFICE

Applicant: John D'Agostino
Serial No.: 11/252,009
Filing Date: October 17, 2005
For: SYSTEM AND METHOD FOR PERFORMING SECURE CREDIT CARD PURCHASES

2800 S.W. Third Avenue
Historic Coral Way
Miami, Florida 33129

Commissioner for Patents
P.O. Box 1450
Alexandria, VA. 22313-1450

Dear Sir:

REQUEST TO CORRECT FILING RECEIPT

This notice is a request for the U.S. Patent and Trademark Office ("PTO") to make certain corrections under the clause "Domestic Priority data as claimed by application" in the filing receipt.

Upon review of the Filing Receipt we note that the PTO made a typographical error in the priority data. Therefore, please remove the asterisk, specifically please delete the following: --(\*)Data provided by applicant is not consistent with PTO records.-

We have reviewed the priority data in the first page of the specification and the inventorship papers and confirm that the data thereon is indeed correct.

Once this correction is made, we ask that you please forward a corrected filing receipt for this application.

Respectfully submitted,

MALLOY & MALLOY, P.A.
Attorneys for Applicant
2800 S.W. Third Avenue
Historic Coral Way
Miami, Florida 33129
(305) 858-8000

By: [Signature]
Peter A. Matos
Reg. No. 37,884

Date: 12/6/05

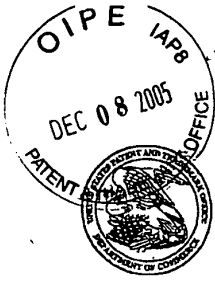

UNITED STATES PATENT AND TRADEMARK OFFICE

UNITED STATES DEPARTMENT OF COMMERCE
United States Patent and Trademark Office
Address: COMMISSIONER FOR PATENTS
P.O. Box 1450
Alexandria, Virginia 22313-1450
www.uspto.gov

Table with 8 columns: APPL NO., FILING OR 371 (c) DATE, ART UNIT, FIL FEE REC'D, ATTY. DOCKET NO., DRAWINGS, TOT CLMS, IND CLMS. Row 1: 11/252,009, 10/17/2005, 3622, 1400, 1.706-B.04, 2, 44, 6

MALLOY & MALLOY, P.A.
2800 S.W. Third Avenue
Historic Coral Way
Miami, FL 33129

CONFIRMATION NO. 4322

FILING RECEIPT



\*OC000000017397319\*

Date Mailed: 11/04/2005

Receipt is acknowledged of this regular Patent Application. It will be considered in its order and you will be notified as to the results of the examination. Be sure to provide the U.S. APPLICATION NUMBER, FILING DATE, NAME OF APPLICANT, and TITLE OF INVENTION when inquiring about this application. Fees transmitted by check or draft are subject to collection. Please verify the accuracy of the data presented on this receipt. If an error is noted on this Filing Receipt, please mail to the Commissioner for Patents P.O. Box 1450 Alexandria Va 22313-1450. Please provide a copy of this Filing Receipt with the changes noted thereon. If you received a "Notice to File Missing Parts" for this application, please submit any corrections to this Filing Receipt with your reply to the Notice. When the USPTO processes the reply to the Notice, the USPTO will generate another Filing Receipt incorporating the requested corrections (if appropriate).

Applicant(s)

John D'Agostino, Sarasota, FL;

Power of Attorney:

John Malloy--19531
Jennie Malloy--37670
Peter Matos--37884
John Fulton Jr--46716

Domestic Priority data as claimed by applicant

This application is a CON of 10/037,007 11/09/2001\* which is a CIP of 09/231,745 01/15/1999 PAT 6,324,526\*
(\*)Data provided by applicant is not consistent with PTO records.

Handwritten note: this information is correct so please delete asterisk and

Foreign Applications

If Required, Foreign Filing License Granted: 11/03/2005

The country code and number of your priority application, to be used for filing abroad under the Paris Convention, is US11/252,009

Projected Publication Date: 02/09/2006

Non-Publication Request: No

Early Publication Request: No

**\*\* SMALL ENTITY \*\***

Title

System and method for performing secure credit card purchases

Preliminary Class

705

## PROTECTING YOUR INVENTION OUTSIDE THE UNITED STATES

Since the rights granted by a U.S. patent extend only throughout the territory of the United States and have no effect in a foreign country, an inventor who wishes patent protection in another country must apply for a patent in a specific country or in regional patent offices. Applicants may wish to consider the filing of an international application under the Patent Cooperation Treaty (PCT). An international (PCT) application generally has the same effect as a regular national patent application in each PCT-member country. The PCT process **simplifies** the filing of patent applications on the same invention in member countries, but **does not result** in a grant of "an international patent" and does not eliminate the need of applicants to file additional documents and fees in countries where patent protection is desired.

Almost every country has its own patent law, and a person desiring a patent in a particular country must make an application for patent in that country in accordance with its particular laws. Since the laws of many countries differ in various respects from the patent law of the United States, applicants are advised to seek guidance from specific foreign countries to ensure that patent rights are not lost prematurely.

Applicants also are advised that in the case of inventions made in the United States, the Director of the USPTO must issue a license before applicants can apply for a patent in a foreign country. The filing of a U.S. patent application serves as a request for a foreign filing license. The application's filing receipt contains further information and guidance as to the status of applicant's license for foreign filing.

Applicants may wish to consult the USPTO booklet, "General Information Concerning Patents" (specifically, the section entitled "Treaties and Foreign Patents") for more information on timeframes and deadlines for filing foreign patent applications. The guide is available either by contacting the USPTO Contact Center at 800-786-9199, or it can be viewed on the USPTO website at <http://www.uspto.gov/web/offices/pac/doc/general/index.html>.

For information on preventing theft of your intellectual property (patents, trademarks and copyrights), you may wish to consult the U.S. Government website, <http://www.stopfakes.gov>. Part of a Department of Commerce initiative, this website includes self-help "toolkits" giving innovators guidance on how to protect intellectual property in specific countries such as China, Korea and Mexico. For questions regarding patent enforcement issues, applicants may call the U.S. Government hotline at 1-866-999-HALT (1-866-999-4158).

---

### LICENSE FOR FOREIGN FILING UNDER Title 35, United States Code, Section 184 Title 37, Code of Federal Regulations, 5.11 & 5.15

#### **GRANTED**

The applicant has been granted a license under 35 U.S.C. 184, if the phrase "IF REQUIRED, FOREIGN FILING LICENSE GRANTED" followed by a date appears on this form. Such licenses are issued in all applications where the conditions for issuance of a license have been met, regardless of whether or not a license may be required as set forth in 37 CFR 5.15. The scope and limitations of this license are set forth in 37 CFR 5.15(a) unless an earlier

license has been issued under 37 CFR 5.15(b). The license is subject to revocation upon written notification. The date indicated is the effective date of the license, unless an earlier license of similar scope has been granted under 37 CFR 5.13 or 5.14.

This license is to be retained by the licensee and may be used at any time on or after the effective date thereof unless it is revoked. This license is automatically transferred to any related applications(s) filed under 37 CFR 1.53(d). This license is not retroactive.

The grant of a license does not in any way lessen the responsibility of a licensee for the security of the subject matter as imposed by any Government contract or the provisions of existing laws relating to espionage and the national security or the export of technical data. Licensees should apprise themselves of current regulations especially with respect to certain countries, of other agencies, particularly the Office of Defense Trade Controls, Department of State (with respect to Arms, Munitions and Implements of War (22 CFR 121-128)); the Bureau of Industry and Security, Department of Commerce (15 CFR parts 730-774); the Office of Foreign Assets Control, Department of Treasury (31 CFR Parts 500+) and the Department of Energy.

**NOT GRANTED**

No license under 35 U.S.C. 184 has been granted at this time, if the phrase "IF REQUIRED, FOREIGN FILING LICENSE GRANTED" DOES NOT appear on this form. Applicant may still petition for a license under 37 CFR 5.12, if a license is desired before the expiration of 6 months from the filing date of the application. If 6 months has lapsed from the filing date of this application and the licensee has not received any indication of a secrecy order under 35 U.S.C. 181, the licensee may foreign file the application pursuant to 37 CFR 5.15(b).

**NON-PROVISIONAL UTILITY PATENT APPLICATION TRANSMITTAL LETTER**

Commissioner for Patent  
 P.O. Box 1450  
 Alexandria, VA 22313-1450

Docket No. 1.706-B.04  
 Customer No. 04219

101705

Transmitted herewith for filing are papers related to the patent application of:

Inventor(s): **JOHN D'AGOSTINO**

**A SYSTEM AND METHOD FOR PERFORMING SECURE CREDIT CARD PURCHASES**

112960 U.S. PTO  
 11/252009  
 101705

Enclosed are:

- XX 22 pages of specification (including Abstract).
- X 2 sheet(s) of drawings.
- X A Declaration and Power of Attorney.
- X A verified statement to establish small entity status under 37 CFR 1.27.
- Nonpublication Request Under 35 U.S.C. 122(b)(2)(B)(i).
- An assignment of the invention to: \_\_\_\_\_.
- Certified copy(s) of the following application(s) the priority of which is hereby claimed under 35 USC §119: \_\_\_\_\_.

The filing fee has been calculated as shown below:

			Small Entity	Large Entity
			Rate	Rate
Basic Filing, Search, and Examination Fees:			\$500	\$1000
Total Claims:	44	- 20=	x 25 = 600	x 50 =
Independent Claims:	6	- 3=	x 100 = 300	x 200 =
Total Sheets (if >100):		-100=	x 125 =	x 250 =
Multiple Dependent Claims:			x 180 =	x 360 =
Non-English Specification			+ 130 =	+ 130 =
<b>Total Fees:</b>			<b>\$1,500</b>	<b>\$ 0</b>

- A check in the amount of **\$1,500.00** to cover the filing fee is enclosed.
- Please charge Deposit Account No. \_\_\_\_\_ in the amount of \$\_\_\_\_\_.
- A duplicate copy of this sheet is enclosed.
- The Commissioner is hereby authorized to charge payment of the following fees associated with this communication or credit any overpayment to Deposit Account No. \_\_\_\_\_. A duplicate copy of this sheet is enclosed.
  - Any additional filing fees required under 37 CFR 1.16.
  - Any patent application processing fees under 37 CFR 1.17.
- The Commissioner is hereby authorized to charge payment of the following fees during the pendency of this application or credit any overpayment to Deposit Account No. \_\_\_\_\_. A duplicate copy of this sheet is enclosed.
  - A duplicate copy of this sheet is enclosed.
  - Any filing fees under 37 CFR 1.16 for presentation of extra claims.
  - Any patent application processing fees under 37 CFR 1.17.
  - The issue fee set in 37 CFR 1.18 at or before mailing of the Notice of Allowance pursuant to 37 CFR 1.311(b).

Date

10/17/05

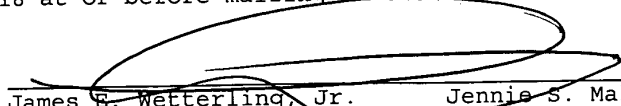
  
 James E. Wetterling, Jr.      Jennie S. Malloy  
 Reg. No. 31,440                  Reg. No. 37,670  
 Peter A. Matos                  John Fulton, Jr.  
 Reg. No. 37,884                  Reg. No. 46,716

FOR: MALLOY & MALLOY, P.A.  
 2800 S.W. Third Avenue  
 Historic Coral Way  
 Miami, Florida 33129  
 (305) 858-8000

1706-B PTO Utility Fee Transmittal

IN THE UNITED STATES PATENT AND TRADEMARK OFFICE

Applicant: John D'Agostino

Serial No.:

Filing Date:

For: A SYSTEM AND METHOD FOR PERFORMING SECURE CREDIT  
CARD PURCHASES

Customer Number 04219

2800 S.W. Third Avenue  
Historic Coral Way  
Miami, Florida 33129

Commissioner for Patents  
P.O. Box 1450  
Alexandria, VA 22313-1450

Dear Sir:

CERTIFICATE OF EXPRESS MAILING

I HEREBY CERTIFY that this correspondence is being deposited by United States Express Mail, Label No. EV-560-874-818-US, in an envelope addressed to: *Commissioner for Patents, P.O. Box 1450, Alexandria, VA 22313-1450*, this 17 day of October, 2005.

Respectfully submitted,

MALLOY & MALLOY, P.A.  
2800 S.W. Third Avenue  
Historic Coral Way  
Miami, Florida 33129  
(305) 858-8000

By: 

Peter A. Matos  
Reg. No. 37,884

Date: 10/17/05

1                   A SYSTEM AND METHOD FOR PERFORMING SECURE  
2                                   CREDIT CARD PURCHASES

3  
4   BACKGROUND OF THE INVENTION

5           The present application is a Continuation of pending U.S.  
6 Patent Application Serial No. 10/037,007, filed November 4,  
7 2001, which is a continuation in part of U.S. Patent No.  
8 6,324,526, issued on November 27, 2001.

9  
10 Field of the Invention

11           This invention relates to a system and method of performing  
12 secure credit card purchases in connection with remote  
13 commercial transactions, wherein a credit card holder does not  
14 have to reveal their credit card number to a merchant or a  
15 mechanism controlled by the merchant in order to accomplish a  
16 purchase, and wherein the merchant is still assured of the  
17 necessary credit verifications and approvals prior to  
18 authorizing and/or completing a credit card transaction, thereby  
19 increasing overall security by minimizing any access to credit  
20 card numbers without having to substantially modify or deviate  
21 from existing, accepted credit card transaction practices.

22  
23 Description of the Related Art

24           The utilization of credit and debit cards to conduct



1 transactions is ever increasing. This is especially the case  
2 with remote or "mail-order" transactions wherein merchants  
3 desire to be assured of a payment prior to shipping a product.  
4 For example, recent years have seen a substantial increase in  
5 the popularity of televised shopping networks to further  
6 supplement the popularity of catalogue type sales. Moreover,  
7 the increasing use and popularity of distributed computer  
8 networks such as the internet has also contributed to the  
9 dramatic increase in the number of remote commercial  
10 transactions conducted every day.

11 One primary reason associated with the rapid growth of  
12 remote commercial transactions is the ability of a merchant to  
13 reach an almost limitless number of potential customers at a  
14 substantially insignificant cost and with little or no operating  
15 overhead since an actual store is not required. Additionally,  
16 such sales techniques permit customers to view the products and  
17 services in a greatly expanded marketplace, representing a great  
18 number of vendors, without extensive travel and without  
19 foregoing the privacy and convenience of their home or other  
20 predetermined computer site in some cases. Simply put, a  
21 telephone or like communication avenue is all that is needed to  
22 place the consumer in contact with the merchant and complete the  
23 transaction.

24 The vast increase in popularity of remote commercial

1 transactions conducted over the telephone or internet is further  
2 facilitated by the relatively simple protocols and procedures  
3 necessary to conduct such transactions. In particular, in order  
4 to complete a valid transaction, a merchant need not physically  
5 see the customer or the credit card, but must merely accept and  
6 enter a customer's credit card account number and an expiration  
7 date thereof to obtain authorization. This same convenience,  
8 however, is the primary disadvantage and/or problem associated  
9 with conducting commerce in the manners set forth above.  
10 Specifically, there is a great reluctance on the part of the  
11 customer to transmit the credit card account information,  
12 including the credit card number, because of the proliferation  
13 of fraud, and a well recognized lack of security directed to the  
14 protection of such account information. Indeed, it has been  
15 established that security and privacy concerns are realistic due  
16 to the fact that credit card account data is easily readable or  
17 interceptable by unauthorized parties, and can be readily used  
18 for all types of remote transactions with minimal risk of being  
19 physically caught. In fact, unscrupulous individuals have many  
20 ways of gaining access to a consumer's legitimate remote  
21 transactions and thereby obtaining the credit card information.  
22 This information can be obtained from old credit card receipts  
23 or even from the unauthorized notation and use of the  
24 information by merchants or their employees after a legitimate

1 transaction is made. Naturally, the latter is the most  
2 difficult to prevent utilizing known methods and systems unless  
3 a consumer is willing to completely forego the use of a credit  
4 card for purchases.

5 In the case of computerized remote transactions, as  
6 messages, including account data or other confidential  
7 information, move across the internet, they can easily pass  
8 through numerous computers, any one of which can be utilized to  
9 copy such confidential information or data, thereby leading to a  
10 further risk of potential fraud when conducting such  
11 transactions. Presently, some companies currently seek to  
12 address such security and privacy concerns by the employment of  
13 encryption programs and techniques. To this end there is an  
14 extensive facility associated with both public and private  
15 encryption schemes being deployed in order to guard the private  
16 or secured information being transmitted across the internet or  
17 like world wide networks. Unfortunately, however, even with  
18 such encryption techniques, the account information must usually  
19 still ultimately be transmitted to a third party who did not  
20 previously have access to that information previously. Even  
21 some more sophisticated systems which seek to interpose a  
22 separate computer or encryption entity between the consumer and  
23 the merchant so as to obtain authorization and forward it to the  
24 merchant, that information must still be made available to

1 and/or transmitted to that third party, thereby leaving open an  
2 avenue for fraud or theft. Further, such encryption techniques,  
3 even if minimally effective for computerized remote  
4 transactions, are not truly useable for other conventional types  
5 of remote transactions, or even normal in person transactions.

6 Based on the above, there is an obvious need in the field  
7 of art associated with remote commercial transactions for a  
8 system and method of performing secure credit card purchases of  
9 goods and services which truly reduces the risk of potential  
10 fraud and theft by eliminating outside access to a consumer's  
11 private credit card information without requiring complex  
12 encryption equipment or significantly altering the ease and  
13 convenience of current transaction techniques. Further, such a  
14 system and method should also be effective for use in  
15 conventional, "in person" transactions as well, thereby  
16 providing an added measure of security and minimizing the  
17 hazards associated with the passing on of account information by  
18 unscrupulous merchants. Also, such a system should provide  
19 limits to potential loss or liability in a manner which does not  
20 impede the transaction.

21

## 22 Summary of the Invention

23 The present invention is directed towards a system and  
24 method of performing secure credit card purchases, wherein

1 payment for goods or services purchased is efficiently  
2 accomplished while eliminating the necessity of disclosure or  
3 dissemination of a consumers specific credit card number or  
4 other account data which the customer or other individual may  
5 wish to maintain in confidence. The system and method of the  
6 present invention incorporates the advantage of consummating the  
7 purchase by the customer through the selection of any one of a  
8 plurality of predetermined payment categories. Collectively,  
9 the payment categories represent a variety of methods for  
10 accomplishing payment for a fixed transaction, a multiple  
11 transaction and/or a repeating transaction.

12 One embodiment of the system and method of the present  
13 invention comprises a customer receiving information, including  
14 specific data necessary for the purchase of any given product or  
15 service. This promotional information generated by the merchant  
16 can be received by any of a plurality of conventional means  
17 including advertisements, catalogues, computer network  
18 connections, direct person to person customer and merchant  
19 contact, telephone solicitation, mail orders, etc. Once the  
20 customer has identified the product or services which he/she  
21 wishes to purchase, the customer contacts and supplies a  
22 custodial authorizing entity with the requisite information  
23 concerning both the identification of a specific credit card or  
24 debit card account and a requested payment category.

1 Additionally, security against unauthorized use of confidential  
2 account data may also preferably include information relating to  
3 the merchant's identification and/or location.

4 The custodial authorizing entity is preferably defined as  
5 the entity which has or has been assigned the custodial  
6 responsibility for the financial account data of a customer's  
7 credit card account, including a previous knowledge of the  
8 credit card number and other information such as credit limits,  
9 payment history, available credit amounts and other information  
10 which will determine the status of a given credit card account  
11 in terms of authorizing a requested payment for a current  
12 purchase.

13 As part of the security system for accomplishing a  
14 commercial transaction utilizing credit card or debit card  
15 payment, the custodial authorizing entity includes sufficient  
16 facilities, preferably including a processing computer or like  
17 applicable hardware for the generation of an exclusive  
18 transaction code. The transaction code is to be used in  
19 substitution for the credit card number and when utilized as  
20 authorized, will issue the merchant a credit approval, and will  
21 accomplish payment for the goods or services desired in the  
22 normal fashion normally associated with a credit or debit card  
23 transaction, without the publication or dissemination of an  
24 identifying credit card number for a specific customer's account

1 to any entity that is not already aware of that information.

2 Further, a feature of the transaction code is its ability  
3 to indicate any one of preferably a plurality of predetermined  
4 payment categories which may be either requested by the customer  
5 or automatically chosen by the custodial authorizing entity  
6 based on the type of account or the type of purchase or other  
7 commercial transaction involved. Each of the payment categories  
8 are reflective of a different type of payment desired or  
9 required to consummate the intended purchase. More  
10 specifically, the plurality of payment categories may include a  
11 single transaction involving a specific dollar amount for a  
12 purchase within a specific time period, such as twenty four  
13 hours, during which authorization of the purchase remains valid.  
14 Alternately, a single transaction may be involved wherein a  
15 maximum limit or a dollar amount is determined above which the  
16 purchase will become invalidated and further wherein a fixed  
17 period of time is preferably established for maintaining  
18 authorization of such purchase. Other alternatives would  
19 involve one or more of the categories coded to define multiple  
20 transactions involving a maximum dollar amount for purchases, as  
21 well as a fixed period of time for authorization of such  
22 purchases, and/or a repeating transaction wherein payments may  
23 be automatically accessed by a merchant over a predetermined or  
24 unspecified time interval (such as every thirty days) for a

1 specific dollar amount or a maximum dollar amount limit. Also,  
2 limits solely as to a specific merchant or a given time period  
3 can be effectively established for which the transaction code is  
4 valid.

5 A further feature of the present invention to be described  
6 in greater details hereinafter, is the requirement that the  
7 transaction code, once received by the customer is transmitted  
8 to the merchant by the customer or a person specifically  
9 authorized by the customer. Only minimal contact by the  
10 merchant and the custodial authorizing entity is provided for  
11 purposes of the merchant verifying the validity of the  
12 transaction code utilizing a conventional process electronically  
13 or otherwise similar to the verification of a credit card number  
14 normally offered to a merchant for the purchase of goods or  
15 services. There is, therefore, no disclosure, publication or  
16 other dissemination of the specific credit card number of a  
17 given customer account beyond those entities who already know  
18 the information, and the transaction code is transmitted  
19 exclusively to the customer by the custodial authorizing entity  
20 who has the ability to better identify whether the customer is  
21 properly authorized to use the account. Moreover, the  
22 transaction code, once given out by the customer, only has a  
23 limited usefulness, thereby limiting the risk of misuse and  
24 minimizing the potential losses to be experienced by the credit



1 card company and/or the account holder.

2 Accordingly, it is an object of the present invention to  
3 provide a system and attendant method for performing remote  
4 commercial transactions utilizing credit cards, which maximizes  
5 the security of the transaction and limits the potential  
6 liability to be experienced from a fraudulent transaction.

7 Yet another object of the present invention is to provide a  
8 secure system and method for establishing credit card purchases  
9 which eliminate the disclosure or dissemination of the actual  
10 credit card number to anyone other than a custodial authorizing  
11 entity which normally has custodial responsibilities for account  
12 information including the previously established credit card  
13 number.

14 It is another object of the present invention to provide a  
15 system and method of establishing secure credit card purchases  
16 through the generation of a transaction code which renders it  
17 extremely difficult or impossible to access or infiltrate a  
18 customer's credit card account by unauthorized means.

19 It is yet another object of the present invention to  
20 provide a secure method of completing a remote commercial  
21 transaction which eliminates the need to convey actual account  
22 information to a merchant, but which allows the merchant to  
23 conduct a normal verification of information needed to  
24 consummate a given purchase.

1           It is also an object of the present invention to provide a  
2 system and attendant method of accomplishing secure credit card  
3 purchases which eliminates the need to disclose or disseminate a  
4 given credit card number while providing the customer with the  
5 versatility of choosing any one of a plurality of predetermined  
6 payment categories.

7           It is yet another feature of the present invention to  
8 provide a system and method of accomplishing secure credit card  
9 payments having the versatility of allowing the customer to  
10 select any one of a plurality of payment categories which are  
11 indicative of a variance in the amount of a purchase as well as  
12 the time in which authorization for such payment is valid.

13           These and other objects, features and advantages of the  
14 present invention will become more clear when the drawings as  
15 well as the detailed description are taken into consideration.

16

17 Brief Description of the Drawings

18           For a fuller understanding of the nature of the present  
19 invention, reference should be had to the following detailed  
20 description taken in connection with the accompanying drawings  
21 in which:

22           Figure 1 is a schematic representation of a flow chart  
23 showing various steps involved in the performance of the system  
24 and method of the present invention for the secure credit card

1 purchasing;

2 Figure 2 is a schematic representation similar to that of  
3 Figure 1 wherein customer to merchant contact is accomplished by  
4 conventional facilities such as television; and

5 Figure 3 is a schematic representation similar that of  
6 Figure 2 wherein customer to merchant contact is established  
7 either by phone or in person.

8 Like reference numerals refer to like parts throughout the  
9 several views of the drawings.

10

11 Detailed Description of the Preferred Embodiment

12 As shown in the accompanying Figures, the present invention  
13 is directed towards a system and method for accomplishing secure  
14 credit card purchases. Moreover, these purchases can be "in  
15 person", but preferably include remote commercial transactions  
16 such as mail order, purchases over the internet, television  
17 solicitations, telephone solicitations, etc. Security is  
18 establish by virtue of the elimination of the need to disclose  
19 an active credit card number and expiration date to the merchant  
20 or any other party other than the original credit card company,  
21 issuing bank or like financial institution which already has  
22 custodial responsibilities for the financial or account data  
23 associated with a given customer's credit card account.

24 More specifically and with reference to Figure 1 the system

1 as well as an attendant method is preferably instigated by the  
2 customer viewing a product, identifying a desired amount for a  
3 transaction and/or receiving promotional information as at 10,  
4 either in person or by any of the electronic or more  
5 conventional techniques which will be described in greater  
6 detail with reference to Figures 2 through 3. Once the customer  
7 reviews the product or promotional information and has  
8 sufficient information, such as including price, product or  
9 service identification, payment requirement, etc., regarding the  
10 remote commercial transaction to be conducted, the customer  
11 contacts, either by computer, telephone or in person, a  
12 custodial authorizing entity as at 12. The custodial  
13 authorizing entity may herein be defined as comprising that  
14 entity or institution which has or has been designated by the  
15 entity which has custodial responsibility for the financial data  
16 and security of a given credit card account of a customer. As  
17 set forth above such custodial authorizing entity can be  
18 represented by the credit card company issuing a credit card to  
19 a given customer or alternately can be represented by a bank or  
20 other financial institution serving to sponsor a credit card or  
21 debit card to the extent of processing the debits and credit  
22 associated therewith. The authorizing entity's custodial  
23 responsibilities of course includes the previous knowledge  
24 and/or storage of the credit card number serving to identify a

1 specific customer's credit card account. Once contacted, the  
2 customer then supplies appropriate identification data to inform  
3 the custodial authorizing entity of a specific customer's credit  
4 card account as at 14. In addition, the customer will supply  
5 the custodial authorizing entity with additional required  
6 information needed to consummate the purchase as well as ensure  
7 the security of the account in order to prevent its unauthorized  
8 use. Such additional information may preferably include the  
9 identification of the merchant or merchants involved, when such  
10 information is deemed necessary, and a requested one of a  
11 plurality of predetermined payment categories to facilitate  
12 consummation of the purchase of the products or services  
13 desired. Such predetermined plurality of payment categories  
14 will be discussed in greater detail hereinafter.

15       Once the appropriate information has been received from the  
16 customer as indicated at 16, the custodial authorizing entity  
17 verifies the credit card status and account identification of  
18 the customer to determine the viability of the account in terms  
19 of dollar amount limits, payment history, available credit  
20 balance, etc. If the accessed credit card account is not in  
21 good standing, the custodial authorizing entity will permanently  
22 or temporarily terminate the transaction as at 18 and/or  
23 communicate to the customer directly as at 18' by any applicable

1 means for purposes of informing the customer of the unacceptable  
2 status of the accessed credit card account. If the credit card  
3 account is in good standing, based at least in part on the  
4 requested payment category, (amount of payment), the custodial  
5 authorizing entity generates a transaction code as at 20. The  
6 transaction code is used in substitution for the specific credit  
7 card number which would normally identify a customer's credit  
8 card account and would allow access thereto by any entity having  
9 possession of the credit card number whether or not such  
10 possession was authorized or unauthorized. More specifically,  
11 the transaction code is pre-coded to be indicative of a specific  
12 credit card account, preferably a merchant or merchants  
13 identification and a designated payment category, selected from  
14 the plurality of predetermined payment categories as set forth  
15 above. Once generated, the transaction code is communicated  
16 exclusively to the authorized and verified customer by the  
17 custodial authorizing entity as at 22, wherein the system and  
18 method of the present invention preferably restricts  
19 communication between the custodial authorizing entity and the  
20 merchant except to conduct a normal verification as will be  
21 explained.

22       The verified customer thereafter and preferably within a  
23 time limit to be determined by the customer and pre-coded in  
24 association with the transaction code, will directly or through

1 an authorized representative communicate the transaction code to  
2 the merchant as at 24. The system and method of the preferred  
3 embodiment of the present invention contemplates that only the  
4 verified customer will transmit the generated transaction code  
5 to the merchant in the case of a remote commercial transaction,  
6 thereby limiting knowledge of the transaction code to those  
7 parties having a need to know. Of course, however, as the  
8 transaction code will generally have a limited value as defined  
9 by the verified customer when obtained, the verified customer  
10 may designate an agent or other entity to act as the customer on  
11 his/her behalf, with the amount of potential liability to be  
12 experienced by such a transaction to be limited to the amount  
13 defined by the verified customer when obtaining the transaction  
14 code.

15 At this point the purchase is consummated at least from the  
16 customer standpoint in that the customer has previously  
17 established the acceptable status of the account. Therefore the  
18 customer feels free to disclose the transaction code to the  
19 merchant or merchants instead of the actual credit card number  
20 as at 22, 24 and is relatively unconcerned if the transaction  
21 code is published or otherwise disseminated to unauthorized  
22 entities. In a preferred embodiment wherein a merchant  
23 identifier is pre-coded in association with the transaction  
24 code, the pre-coding of the transaction code will prohibit an

1 unauthorized use due at least in part to the fact that the  
2 merchant is specifically identified and any attempt to use the  
3 transaction code other than by the identified merchant will be  
4 prohibited. In addition, the merchant is prevented from  
5 "overcharging" or "extending" the purchase by fixing the dollar  
6 amount to satisfy the specific cost or limit of the purchase as  
7 well as a specific time limit or time parameters in which the  
8 authorization for payment is valid. Such information, as set  
9 forth above, is communicated by the requested and subsequently  
10 designated payment category as set forth above. Restricted  
11 communication between the merchant and the custodial authorizing  
12 entity as at 26 is permitted exclusively for purposes of  
13 verification of the transaction code in a manner, which may  
14 utilize, at least to some extent, conventional facilities for  
15 the verification of a credit card number by most merchants or  
16 like commercial establishments. As a result, the merchant also  
17 has a desired verification as to the validity of a transaction  
18 and can effectively make arrangements to be paid by the credit  
19 card company.

20 If for some reason the transaction code is refused  
21 verification, the customer may be informed directly by the  
22 merchant as at 28 and or the transaction may be terminated as at  
23 30. Assuming verification of the transaction code by the  
24 custodial authorizing entity, the merchant proceeds to



1 consummate the purchase and send the order, as at 32, in the  
2 case of a remote commercial transaction.

3        Figures 3 and 4 are representative of the versatility of  
4 the system and method of the present invention wherein the  
5 customer 54 may receive the aforementioned promotional  
6 information from the merchant 56 by any appropriate means such  
7 as television solicitation as at 58, phone solicitation as at 60  
8 and/or personal solicitation as at 62. Once the customer  
9 receives the promotional information, which may include the  
10 viewing of the product itself, or in advance if a general  
11 estimate as to the ultimate cost of an anticipate purchase(s)  
12 can be made prior to viewing promotional information, the  
13 customer contacts the custodial authorizing entity 64 by any  
14 appropriate electronic or conventional facilities such as direct  
15 phone to phone contact as at 66 and 66' or direct computer  
16 contact as at 42', 45'. Once the customer's authorization is  
17 confirmed, details of the anticipated transaction are  
18 established so as to determine a payment category, and the a  
19 transaction code is issued to the customer. The customer,  
20 either directly or through a representative, can then utilize  
21 the transaction code to consummate a transaction within the  
22 defined parameters of the payment category. Moreover, the  
23 merchant 56, through a conventional, yet restricted  
24 communication with the custodial authorizing entity 64 by any of

1 a plurality of conventional or electronic methods using computer  
2 to computer linking as at 44', 45' or by telephone transmission  
3 as at 56', 66', can obtain a verification and subsequent payment  
4 utilizing the transaction code only.

5 As emphasized above, an important feature of the present  
6 invention is the ability of the customer to request a desired or  
7 a required payment category and the ability of the custodial  
8 authorizing entity 64 and/or a processing computer 45 of the  
9 custodial authorizing entity to issue a transaction code in  
10 accordance with the payment category. The payment categories,  
11 may be collectively defined as a variety of different types of  
12 transactions. Such transactions may include a single  
13 transaction for a specific amount of a purchase to be  
14 consummated. Alternatively, the payment category may include a  
15 single transaction defined by a single purchase having a maximum  
16 limit amount, wherein the specific or precise cost of the  
17 purchase has not been determined for a variety of reasons, and  
18 as such, the customer desires to set a maximum amount for which  
19 the single transaction may be made. Accordingly, with such a  
20 payment category, the exact amount may not be known in advance,  
21 but the customer is assured of not paying over the specifically  
22 designated maximum limit. In addition, the transactions are  
23 preferably, but not necessarily, authorized to be conducted only  
24 over a fixed life period of time, such as within twenty four

1 hours, thereby ensuring that an outstanding transaction code  
2 does not remain valid if not used as generally intended. This  
3 limited time period can, of course be varied or omitted  
4 depending upon the wishes of the customer and/or the policies of  
5 the custodial authorizing entity. Also, these or any other  
6 payment category transactions may include a specific merchant  
7 identification to further restrict use of the transaction code.

8       The payment category may also include a multi-transaction  
9 authorization wherein more than one purchase may be made from  
10 one or a plurality of different merchants, each of which may or  
11 may not be identified by the customer and pre-coded in  
12 association with the transaction code, and wherein a total cost  
13 of the plurality of purchases may not exceed a maximum limit  
14 amount. This transaction can also be limited to having to take  
15 place within a predetermined, designated fixed life span, such  
16 as but not limited to twenty four hours. Accordingly, in some  
17 instances wherein a customer, or an agent of the customer, such  
18 as a child, guardian, or care giver, must make a number of  
19 transactions or purchases which are authorized by the customer,  
20 the customer may designate a maximum amount which can be spent  
21 utilizing a particular transaction code within a predetermined  
22 period of time, and/or can designate that only one merchant,  
23 whether designated or not, can use the transaction code.

24       As yet another alternative, the payment category may

1 include a repeating transaction for a specific amount to be paid  
2 in each of a fixed number of intervals. For example, the  
3 customer may wish to join a gym or receive services or products  
4 over a fixed number of payment intervals, such as every thirty  
5 days. Accordingly, the merchant will be authorized to charge  
6 the credit card account designated by the corresponding  
7 transaction code a fixed monthly payment. Similarly, a  
8 repeating transaction for a stated minimum interval such as  
9 every thirty days may be authorized for a specific amount for an  
10 unspecified number of intervals wherein the merchant will be  
11 authorized to continuously obtain payment on a "monthly" basis  
12 until the customer decides to cancel such authorization.

13       Since many modifications, variations and changes in detail  
14 can be made to the described preferred embodiment of the  
15 invention, it is intended that all matters in the foregoing  
16 description and shown in the accompanying drawings be  
17 interpreted as illustrative and not in a limiting sense. Thus,  
18 the scope of the invention should be determined by the appended  
19 claims and their legal equivalents.

20       Now that the invention has been described,

1       What is claimed is:

2       1.   A method of performing secure credit card purchases, said  
3       method comprising the steps of:

4           a)   contacting a custodial authorizing entity having  
5           custodial responsibility of account parameters of  
6           customer's credit card account;

7           b)   supplying the custodial authorizing entity with at  
8           least account identification data;

9           c)   defining a payment category including at least the  
10          ability to limit purchases to a single merchant for at  
11          least one transaction;

12          d)   designating said payment category;

13          e)   generating a transaction code reflecting at least said  
14          designated payment category and the ability to make a  
15          purchase within said designated payment category;

16          f)   communicating the transaction code to a merchant to  
17          consummate a purchase with defined purchase parameters;

18          g)   verifying that said defined purchase parameters are  
19          within said designated payment category; and

20          h)   providing authorization for said purchase so as to  
21          confirm at least that said defined purchase parameters are  
22          within said designated payment category and complete the  
23          purchase.

1 2. The method of claim 1 further comprising identification of  
2 said single merchant upon designation of said payment category.

3 3. The method of claim 1 further comprising the step of  
4 designating said single merchant subsequent to generating said  
5 transaction code.

6 4. The method of claim 1 wherein said step of communicating  
7 the transaction code to said merchant to consummate said  
8 purchase within defined purchase parameters further comprises  
9 designation of said single merchant.

10 5. The method of claim 1 wherein said step of generating said  
11 transaction code further comprises said custodial authority  
12 generating said transaction code.

13 6. The method of claim 1 wherein said step of generating said  
14 transaction code further comprises said customer generating said  
15 transaction code.

16 7. The method of claim 1 further comprising obtaining said  
17 authorization for said purchase from the custodial authorizing  
18 entity.

19 8. The method of claim 1 further comprising a step of  
20 communicating promotional information of offered subject matter  
21 to the customer by the merchant, pre-determining the purchase  
22 parameters of the purchase, and corresponding said designated  
23 payment category to said purchase parameters.

1 9. The method of claim 1 further comprising the merchant  
2 communicating the transaction code to the custodial authorizing  
3 entity for verification.

4 10. The method of claim 1 further comprising generating a  
5 transaction code which reflects at least one of a plurality of  
6 said payment categories.

7 11. The method of claim 10 further comprising defining at least  
8 one of said plurality of payment categories to include the  
9 ability to designate amount parameters for a cost of one or  
10 more purchases.

11 12. The method of claim 10 further comprising defining at least  
12 one of said plurality of payment categories to include the  
13 ability to designate time parameters during which the purchase  
14 can be completed.

15 13. The method of claim 10 further comprising defining at least  
16 one of said plurality of payment categories to include the  
17 ability to use said transaction code for a single transaction at  
18 a fixed amount for purchase within a predetermined period of  
19 time.

20 14. The method of claim 13 further comprising defining at least  
21 one of said plurality of payment categories to include the  
22 ability to limit purchases to said single transaction at said  
23 fixed amount for purchase within said predetermined period of  
24 time.

1 15. The method of claim 10 further comprising defining at least  
2 one of said plurality of payment categories to include the  
3 ability to use said transaction code for a single transaction at  
4 a maximum amount for purchase within a predetermined period of  
5 time.

6 16. The method of claim 15 further comprising defining at least  
7 one of said plurality of payment categories to include the  
8 ability to limit purchases to said single transaction at said  
9 maximum amount for purchase within said predetermined period of  
10 time.

11 17. The method of claim 10 further comprising defining at least  
12 one of said plurality of payment categories to include the  
13 ability to use said transaction code for at least two purchases  
14 at a maximum total amount for items purchased within a  
15 predetermined time period.

16 18. The method of claim 17 further comprising defining at least  
17 one of said plurality of payment categories to include the  
18 ability to limit purchases to said at least two purchases at  
19 said maximum total amount for items purchased within said  
20 predetermined time period.

21 19. The method of claim 10 further comprising defining at least  
22 one of said plurality of payment categories to include the  
23 ability to use said transaction code for at least two purchases



1 for a repeating transaction at a fixed amount payable at each of  
2 a fixed number of time intervals.

3 20. The method of claim 19 further comprising defining at least  
4 one of said plurality of payment categories to include the  
5 ability to limit purchases to said repeating transaction at said  
6 fixed amount payable at each of said fixed number of time  
7 intervals.

8 21. The method of claim 10 further comprising defining at least  
9 one of said plurality of payment categories to include the  
10 ability to use said transaction code for a repeating transaction  
11 at a fixed amount payable at each of an unspecified number of  
12 time intervals.

13 22. The method of claim 21 further comprising defining at least  
14 one of said plurality of payment categories to include the  
15 ability to limit purchases to said repeating transaction at said  
16 fixed amount payable at each of said unspecified number of time  
17 intervals.

18 23. The method of claim 10 wherein at least some of said  
19 plurality of payment categories to include:

20 a) the ability to use said transaction code for a single  
21 transaction at a fixed amount for a purchase within a  
22 predetermined period of time,

1           b)    the ability to use said transaction code for a single  
2 transaction at a maximum amount for a purchase within a  
3 predetermined period of time,

4           c)    the ability to use said transaction code for multiple  
5 transactions at a maximum total amount for purchases within a  
6 predetermined time period,

7           d)    the ability to use said transaction code for a  
8 repeating transaction at a fixed amount for purchases payable at  
9 each of a fixed number of time intervals, and

10          e)    the ability to use said transaction code for a  
11 repeating transaction at a fixed amount for purchases payable at  
12 each of an unspecified number of time intervals.

13       24. The method of claim 10 wherein at least some of said  
14 plurality of payment categories include:

15          a)    the ability to use said transaction code for a single  
16 transaction at a fixed amount for a purchase,

17          b)    the ability to use said transaction code for a single  
18 transaction at a maximum amount for a purchase,

19          c)    the ability to use said transaction code for multiple  
20 transactions at a maximum total amount for purchases,

21          d)    the ability to use said transaction code for a  
22 repeating transaction at a fixed amount for purchases payable at  
23 each of a fixed number of time intervals, and

24          e)    the ability to use said transaction code for a

1 repeating transaction at a fixed amount for purchases payable at  
2 each of an unspecified number of time intervals.

3 25. The method of claim 1 further comprising generating said  
4 transaction code to further reflect an identification of said  
5 single merchant.

6 26. The method of claim 25 further comprising defining said  
7 payment category to include the ability to limit purchases to a  
8 limited time interval during which said purchase authorization  
9 is valid.

10 27. A method of performing secure purchases, said method  
11 comprising the steps of:

- 12 a) identifying a pre-established financial account;
- 13 b) selecting at least one of a plurality of pre-defined  
14 payment categories which limit a nature of a subsequent  
15 purchase;
- 16 c) issuing a transaction code associated with at least  
17 said financial account and said selected payment category,  
18 and different from said financial account;
- 19 d) communicating said transaction code to a merchant to  
20 consummate a purchase within defined purchase parameters;
- 21 e) verifying that said defined purchase parameters  
22 correspond to said designated payment category; and
- 23 f) providing authorization for said purchase so as to  
24 confirm at least that said defined purchase parameters are

1 within said designated payment category and complete the  
2 purchase; and

3 g) associating the purchase with said financial account.

4 28. A method of performing secure purchases, said method  
5 comprising the steps of:

6 a) identifying a pre-established financial account;

7 b) selecting a payment category which limits a nature of  
8 a subsequent purchase to a single transaction at a fixed  
9 amount;

10 c) issuing a transaction code associated with at least  
11 said financial account and said selected payment category,  
12 and different from said financial account;

13 d) communicating said transaction code to a merchant to  
14 consummate a purchase within defined purchase parameters;

15 e) verifying that said defined purchase parameters  
16 correspond to said designated payment category; and

17 f) providing authorization for said purchase so as to  
18 confirm at least that said defined purchase parameters are  
19 within said designated payment category and complete the  
20 purchase; and

21 g) associating the purchase with said financial account.

22 29. A method of performing secure purchases, said method  
23 comprising the steps of:

24 a) identifying a pre-established financial account;

- 1        b)    selecting a payment category which limits a nature of
- 2        a series of subsequent purchases to a single merchant;
- 3        c)    issuing a transaction code associated with at least
- 4        said financial account and said selected payment category,
- 5        and different from said financial account;
- 6        d)    communicating said transaction code to a merchant to
- 7        consummate a purchase within defined purchase parameters;
- 8        e)    verifying that said defined purchase parameters
- 9        correspond to said designated payment category; and
- 10      f)    providing authorization for said purchase so as to
- 11      confirm at least that said defined purchase parameters are
- 12      within said designated payment category and complete the
- 13      purchase; and
- 14      g)    associating the purchase with said financial account.

15 30. The method of claim 29 wherein said step of selecting said  
16 payment category which limits said nature of said series of  
17 subsequent purchases to said single merchant further comprises  
18 limiting said nature of said series of subsequent purchases to a  
19 fixed amount for each of said subsequent purchases.

20 31. The method of claim 29 wherein said step of selecting said  
21 payment category which limits said nature of said series of  
22 subsequent purchases to said single merchant further comprises  
23 limiting said nature of said series of subsequent purchases to a  
24 maximum total amount for said subsequent purchases.

1 32. The method of claim 29 wherein said step of verifying that  
2 said defined purchase parameters correspond to said designated  
3 payment category further defines said merchant as said single  
4 merchant.

5 33. A method of performing secure purchases, said method  
6 comprising the steps of:

- 7 a) identifying a pre-established financial account;
- 8 b) selecting a payment category which limits a nature of  
9 a subsequent purchase to a single merchant;
- 10 c) issuing a transaction code associated with at least  
11 said financial account and said selected payment category,  
12 and different from said financial account;
- 13 d) designating a merchant as said single merchant;
- 14 e) communicating said transaction code to said merchant  
15 to consummate a purchase within defined purchase  
16 parameters;
- 17 f) verifying that said defined purchase parameters  
18 correspond to said designated payment category; and
- 19 g) providing authorization for said purchase so as to  
20 confirm at least that said defined purchase parameters are  
21 within said designated payment category and complete the  
22 purchase; and
- 23 h) associating the purchase with said financial account.

24 34. The method of claim 33 wherein said step of verifying that

1 said defined purchase parameters correspond to said designated  
2 payment category further defines said merchant as said single  
3 merchant.

4 35. A system for performing secure purchases comprising:

5 a) a custodial authorizing entity, said custodial  
6 authorizing entity structured to maintain a pre-established  
7 financial account of at least one user;

8 b) said custodial authorizing entity further structured  
9 to define at least one payment category available for  
10 selection by a customer, said payment category structured  
11 to limit at least one subsequent transaction to a single  
12 merchant;

13 c) said custodial authorizing entity further structured  
14 to issue a transaction code associated with said payment  
15 category selected by the customer and said financial  
16 account of the user, said transaction code being different  
17 from said financial account;

18 d) said custodial authorizing entity further structured  
19 to receive said transaction code and designated purchase  
20 parameters associated with a purchase from a merchant, and  
21 to verify that said designated purchase parameters  
22 correspond to said selected payment category; and

23 e) said custodial authorizing entity structured to  
24 provide the merchant with authorization for said purchase

1           that confirms at least that said designated purchase  
2           parameters correspond to said selected payment category so  
3           that said purchase may be consummated by the merchant.

4   36. A system for performing secure purchases as recited in  
5   claim 35 wherein said single merchant is defined upon selection  
6   of said payment category and is associated with said transaction  
7   code.

8   37. A system for performing secure purchases as recited in  
9   claim 35 wherein said custodial authorizing entity is structured  
10  to designate a first merchant to provide said transaction code  
11  for verification as said single merchant.

12  38. A system for performing secure purchases as recited in  
13  claim 37 wherein said custodial authorizing entity is structured  
14  to designate said first merchant as said single merchant for  
15  subsequent transactions utilizing said transaction code.

16  39. A system for performing secure purchases as recited in  
17  claim 35 wherein said payment category is further structured to  
18  limit said at least one subsequent transaction to a specified  
19  dollar amount.

20  40. A system for performing secure purchases as recited in  
21  claim 39 wherein said payment category is further structured to  
22  limit each of a plurality of subsequent transactions to said  
23  specified dollar amount.

24  41. A system for performing secure purchases as recited in



1 claim 40 wherein said custodial authorizing entity is structured  
2 to designate a dollar amount of a first transaction associated  
3 with said transaction code and having said designated purchase  
4 parameters that correspond to remaining parameters of said  
5 selected payment category, as said specified dollar amount.

6 42. A system for performing secure purchases as recited in  
7 claim 39 wherein said specified dollar amount is defined upon  
8 selection of said payment category and is associated with said  
9 transaction code.

10 43. A system for performing secure purchases as recited in  
11 claim 35 wherein said payment category is further structured to  
12 limit said at least one subsequent transaction to a maximum  
13 dollar amount.

14 44. A system for performing secure purchases as recited in  
15 claim 35 wherein said payment category is further structured to  
16 limit said at least one subsequent transaction to a  
17 predetermined time period.

1

ABSTRACT OF THE INVENTION

2           A method and system of performing secure credit card  
3 purchases in the context of a remote commercial transaction,  
4 such as over the telephone, wherein only the customer, once  
5 generally deciding upon a product or service to be purchased,  
6 communicates with a custodial authorizing entity, such as a  
7 credit card company or issuing bank wherein such entity has  
8 previous knowledge of the credit card number as well as  
9 custodial control of other account parameters such as interest  
10 rate, payment history, available credit limit etc. The customer  
11 supplies the custodial authorizing entity with the account  
12 identification data such as the credit card number and a  
13 requested one of a possible plurality of predetermined payment  
14 categories which define the dollar amount for the purchase and  
15 specific, predetermined time parameters within which  
16 authorization by the custodial authorizing entity will remain in  
17 effect. The custodial authorizing entity then generates a  
18 transaction code which is communicated exclusively to the  
19 customer wherein the customer in turn communicates only the  
20 transaction code to the merchant instead of a credit card  
21 number. The transaction code is indicative of merchant  
22 identification, credit card account identification and a  
23 designated one of the plurality of predetermined payment  
24 categories.

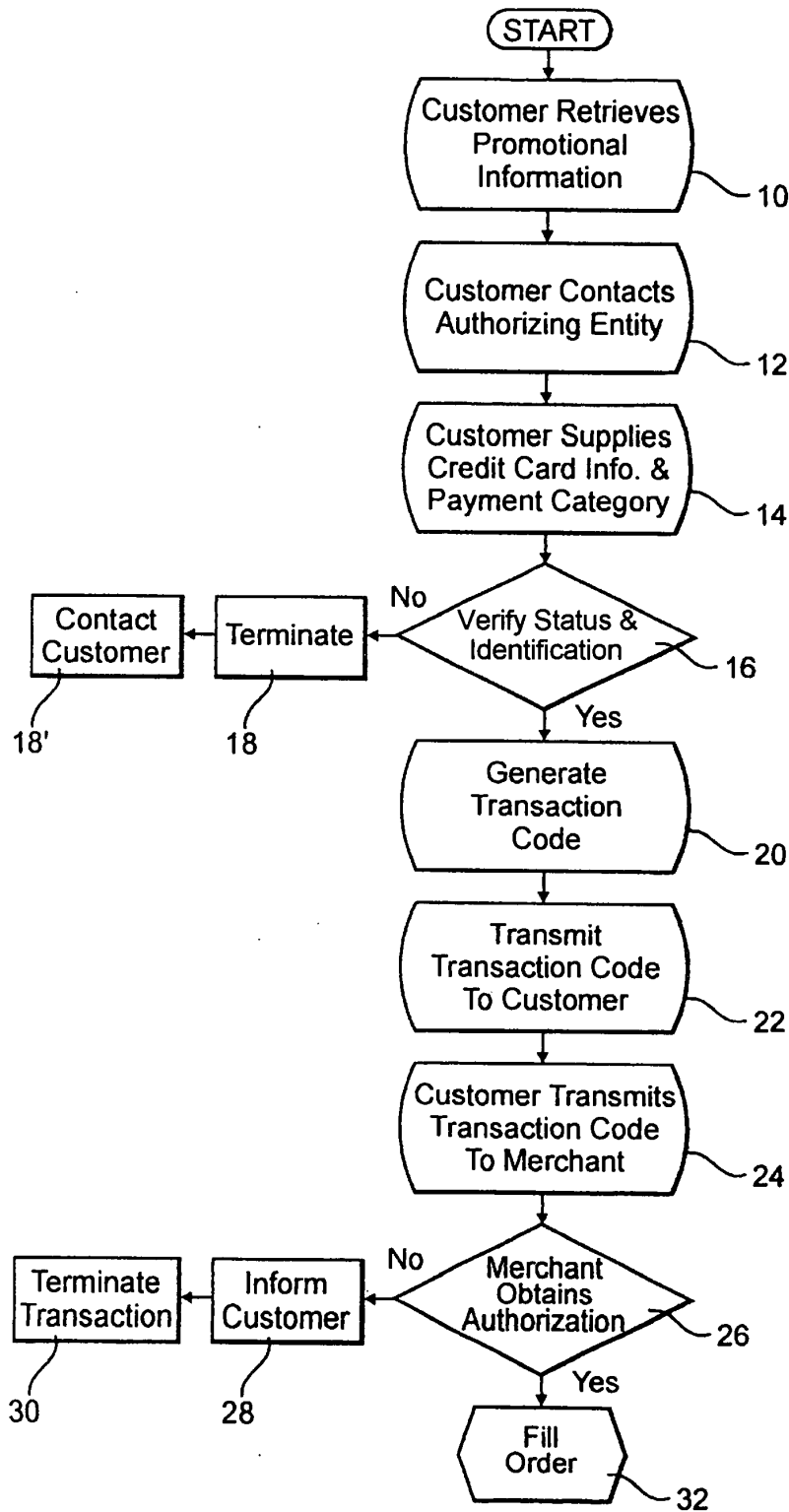

FIG. 1

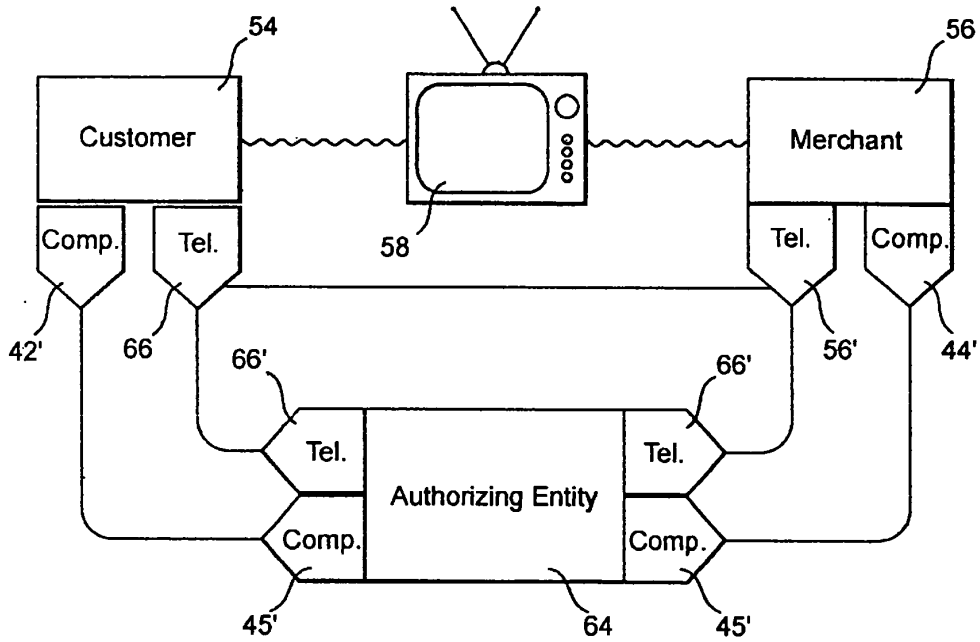

FIG. 2

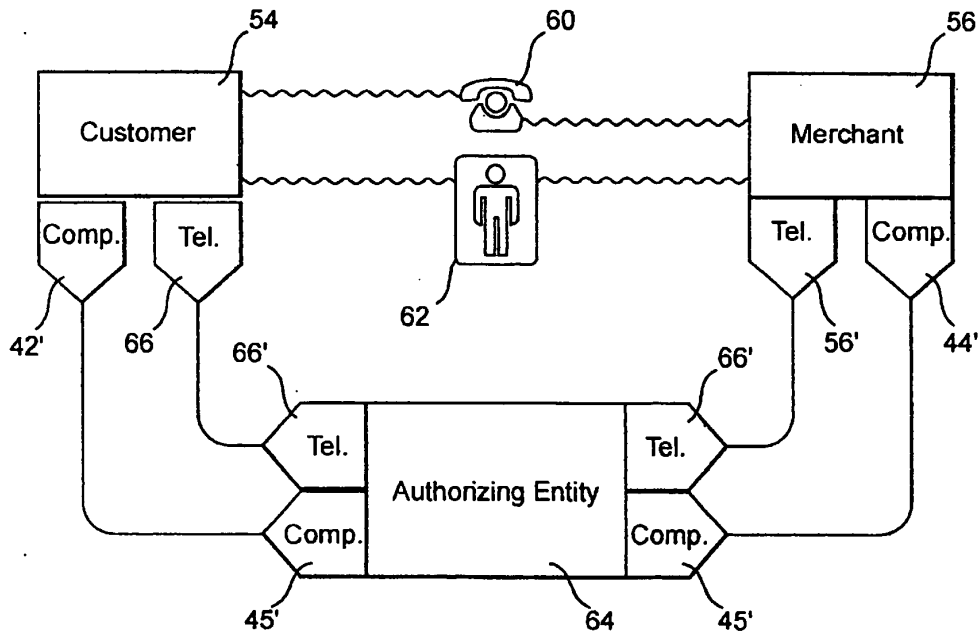

FIG. 3

MALLOY & MALLOY, P.A.

DECLARATION AND POWER OF ATTORNEY FOR PATENT APPLICATION  
English Language Division

As a below named inventor, I hereby declare that:

My residence, post office address and citizenship are as stated below, next to my name.

I believe I am the original, first and sole inventor (if only one name is listed below) or an original, first and joint inventor (if plural names are listed below) of the subject matter which is claimed and for which a patent is sought on the invention entitled

**A SYSTEM AND METHOD FOR PERFORMING SECURE CREDIT CARD PURCHASES**

the specification of which

(check one)

is attached hereto

was filed on

Application Serial No.

and was amended on and

(if applicable)

I hereby state that I have reviewed and understand the contents of the above-identified specification, including the claims, as amended by any amendment referred to above.

I acknowledge the duty to disclose information which is material to the examination of this application in accordance with Title 37, Code of Federal Regulations §1.56(a).

I hereby claim foreign priority benefits under Title 35, United States Code, §119 of any foreign application(s) for patent or inventor's certificate listed below and have also identified below any foreign application for patent or inventor's certificate have a filing date before that of the application on which priority is claimed:

Prior Foreign Application(s):

			Priority Claimed	
(Number)	(Country)	(Day/Month/Year Filed)	Yes	No
_____	_____	_____	Yes	No
_____	_____	_____	Yes	No
_____	_____	_____	Yes	No

I hereby claim the benefit under Title 35, United States Code, §120 of any United States application(s) listed below and, insofar as the subject matter of each of the claims of this application is not disclosed in the prior United application in the manner provided by the first paragraph of Title 35, United States Code, §112, I acknowledge the duty to disclose material information as defined in Title 37, Code of Federal Regulations, §1.56(a) which occurred between the filing date of the prior application and the national PCT international filing date of this application:

BEST AVAILABLE COPY

10/037,007

November 4, 2001

Pending

(Application Serial No.)

(Filing Date)

(Status)  
(patented, pending, abandoned)

09/231,745

January 15, 1999

Patented

(Application Serial No.)

(Filing Date)

(Status)  
(patented, pending, abandoned)

I hereby declare that all statements made herein of my own knowledge are true and that all statements made of information and belief are believed to be true; and further, that these statements were made with the knowledge that willful false statements and the like so made are punishable by fine or imprisonment, or both, under Section 1001 of Title 18 of the United States Code and that such willful false statements may jeopardize the validity of the application or any patent issued thereon.

POWER OF ATTORNEY: As a named inventor, I hereby appoint the following attorney(s) and/or agent(s) to prosecute this application and transact all business in the Patent and Trademark Office connected therewith. (list name and registration number)

James E. Wetterling - Reg. No. 31,440  
Peter A. Matos - Reg. No. 37,884  
John Fulton, Jr. - Reg. No. 46,716

Jennie S. Malloy - Reg. No. 37,670  
John Cyril Malloy - Reg. No. 19,531

Send correspondence to: MALLOY & MALLOY, P.A.  
2800 S.W. Third Avenue  
Historic Coral Way  
Miami, Florida 33129

Direct telephone calls to: (305) 858-8000

Full name of sole or first inventor

JOHN D'AGOSTINO

Inventor's signature

Date

*John D'Agostino*

10/17/05

Residence (City, State)

Sarasota, Florida

Citizenship (Country)

U.S.A.

Post Office Address (complete mailing address)

6237 Weymouth Drive Sarasota, FL 34238

Full name of second joint inventor, if any

Inventor's signature

Date

Residence (City, State)

Citizenship (Country)

Post Office Address (complete mailing address)

(Supply similar information and signature for third and subsequent joint inventors.)

BEST AVAILABLE COPY

INDEPENDENT INVENTOR - SMALL ENTITY STATUS

Applicant(s) or Patentee(s): JOHN D'AGOSTINO

Serial or Patent No.:

Attorney's Docket No.: 1.706-B.04

Filed or Issued:

For: A SYSTEM AND METHOD FOR PERFORMING SECURE CREDIT CARD PURCHASES

VERIFIED STATEMENT (DECLARATION) CLAIMING SMALL ENTITY STATUS (37 CFR 1.9(f) and 1.27(b) - INDEPENDENT INVENTOR

As a below named inventor, I hereby declare that I qualify as an independent inventor as defined in 37 CFR 1.9(c) for purposes of paying reduced fees under Section 41(a) and (b) of Title 35, United States Code, to the Patent and Trademark Office with regard to the invention entitled,

A SYSTEM AND METHOD FOR PERFORMING SECURE CREDIT CARD PURCHASES described in

- [ X ] the specification filed herewith.
[ ] application serial no.
[ ] patent no. filed issued

I have not assigned, granted, conveyed or licensed and am under no obligation under contract or law to assign, grant, convey or license, any rights in the invention to any person who could not be classified as an independent inventor under 37 CFR 1.9(c) if that person had made the invention, or to any concern which would not qualify as a small business concern under 37 CFR 1.9(d) or a nonprofit organization under 37 CFR 1.9(e).

Each person, concern or organization to which I have assigned, granted, conveyed, or licensed or am under obligation under contract or law to assign, grant, convey, or license any rights in the invention is listed below:

- [ X ] no such person, concern or organization
[ ] person, concerns, or organization listed below

Note: Separate verified statements are required from each named person, concern or organization having rights to the invention averring to their status as small entities. (37 CFR 1.27)

FULL NAME ADDRESS [ ] INDIVIDUAL [ ] SMALL BUSINESS CONCERN [ ] NONPROFIT ORGANIZATION

FULL NAME ADDRESS [ ] INDIVIDUAL [ ] SMALL BUSINESS CONCERN [ ] NONPROFIT ORGANIZATION

FULL NAME ADDRESS [ ] INDIVIDUAL [ ] SMALL BUSINESS CONCERN [ ] NONPROFIT ORGANIZATION

I acknowledge the duty to file, in this application or patent, notification of any change in status resulting in loss of entitlement to small entity status prior to paying, or at the time of paying, the earliest of the issue fee or any maintenance fee due after the date on which status as a small entity is no longer appropriate. (37 CFR 1.28(b))

I hereby declare that all statements made herein of my own knowledge are true and that all statements made on information and belief are believed to be true, and further, that these statements were made with the under Section 1001 of Title 18 of the United States Code, and that such willful false statements may jeopardize the validity of the application, any patent issuing thereon, or any patent to which this verified statement is directed.

NAME OF INVENTOR JOHN D'AGOSTINO NAME OF INVENTOR NAME OF INVENTOR

Signature of Inventor Signature of Inventor Signature of Inventor

Date Date Date

10/17/05

BEST AVAILABLE COPY

PATENT APPLICATION SERIAL NO \_\_\_\_\_

U.S. DEPARTMENT OF COMMERCE  
PATENT AND TRADEMARK OFFICE  
FEE RECORD SHEET

10/20/2005 JBALINAN 00000048 11252009

01 FC:2011	150.00 OP
02 FC:2111	250.00 OP
03 FC:2311	100.00 OP
04 FC:2201	300.00 OP
05 FC:2202	600.00 OP

Refund Ref:  
10/20/2005 JBALINAN 0000148229

CHECK Refund Total: \$100.00

PTO-1556  
(5/87)

U.S. Government Printing Office: 2002 — 498-267/88033



Under the Paperwork Reduction Act of 1995, no persons are required to respond to a collection of information unless it displays a valid OMB control number.

**PATENT APPLICATION FEE DETERMINATION RECORD**  
 Substitute for Form PTO-875 Effective December 8, 2004

Application or Docket Number  
11252009

APPLICATION AS FILED - PART I			SMALL ENTITY		OTHER THAN SMALL ENTITY	
FOR	NUMBER FILED	NUMBER EXTRA	RATE (\$)	FEE (\$)	RATE (\$)	FEE (\$)
BASIC FEE (37 CFR 1.16(a), (b), or (c))	N/A	N/A	N/A	150.00	N/A	300.00
SEARCH FEE (37 CFR 1.16(k), (l), or (m))	N/A	N/A	N/A	250	N/A	500
EXAMINATION FEE (37 CFR 1.16(o), (p), or (q))	N/A	N/A	N/A	100	N/A	200
TOTAL CLAIMS (37 CFR 1.16(i))	44 minus 20 =	24	X\$ 25 =	600	X\$50 =	1200
INDEPENDENT CLAIMS (37 CFR 1.16(h))	6 minus 3 =	3	X100 =	300	X200 =	600
APPLICATION SIZE FEE (37 CFR 1.16(s))	If the specification and drawings exceed 100 sheets of paper, the application size fee due is \$250 (\$125 for small entity) for each additional 50 sheets or fraction thereof. See 35 U.S.C. 41(a)(1)(G) and 37 CFR 1.16(s).					
MULTIPLE DEPENDENT CLAIM PRESENT (37 CFR 1.16(j))			+180=		+360=	
			<b>330</b> TOTAL	<b>1400</b>	TOTAL	

\* If the difference in column 1 is less than zero, enter "0" in column 2.

APPLICATION AS AMENDED - PART II					SMALL ENTITY		OTHER THAN SMALL ENTITY	
AMENDMENT A	CLAIMS REMAINING AFTER AMENDMENT	HIGHEST NUMBER PREVIOUSLY PAID FOR	PRESENT EXTRA	RATE (\$)	ADDITIONAL FEE (\$)	RATE (\$)	ADDITIONAL FEE (\$)	
	Total (37 CFR 1.16(i))	Minus **	=	X\$ 25 =		X\$50 =		
	Independent (37 CFR 1.16(h))	Minus ***	=	X100 =		X200 =		
	Application Size Fee (37 CFR 1.16(s))							
	FIRST PRESENTATION OF MULTIPLE DEPENDENT CLAIM (37 CFR 1.16(j))				+180=		+360=	
				TOTAL ADD'L FEE		TOTAL ADD'L FEE		

\* If the entry in column 1 is less than the entry in column 2, write "0" in column 3.  
 \*\* If the "Highest Number Previously Paid For" IN THIS SPACE is less than 20, enter "20".  
 \*\*\* If the "Highest Number Previously Paid For" IN THIS SPACE is less than 3, enter "3".

APPLICATION AS AMENDED - PART II					SMALL ENTITY		OTHER THAN SMALL ENTITY	
AMENDMENT B	CLAIMS REMAINING AFTER AMENDMENT	HIGHEST NUMBER PREVIOUSLY PAID FOR	PRESENT EXTRA	RATE (\$)	ADDITIONAL FEE (\$)	RATE (\$)	ADDITIONAL FEE (\$)	
	Total (37 CFR 1.16(i))	Minus **	=	X\$ 25 =		X\$50 =		
	Independent (37 CFR 1.16(h))	Minus ***	=	X100 =		X200 =		
	Application Size Fee (37 CFR 1.16(s))							
	FIRST PRESENTATION OF MULTIPLE DEPENDENT CLAIM (37 CFR 1.16(j))				+180=		+360=	
				TOTAL ADD'L FEE		TOTAL ADD'L FEE		

\* If the entry in column 1 is less than the entry in column 2, write "0" in column 3.  
 \*\* If the "Highest Number Previously Paid For" IN THIS SPACE is less than 20, enter "20".  
 \*\*\* If the "Highest Number Previously Paid For" IN THIS SPACE is less than 3, enter "3".  
 The "Highest Number Previously Paid For" (Total or Independent) is the highest number found in the appropriate box in column 1.

This collection of information is required by 37 CFR 1.16. The information is required to obtain or retain a benefit by the public which is to file (and by the USPTO to process) an application. Confidentiality is governed by 35 U.S.C. 122 and 37 CFR 1.14. This collection is estimated to take 12 minutes to complete, including gathering, preparing, and submitting the completed application form to the USPTO. Time will vary depending upon the individual case. Any comments on the amount of time you require to complete this form and/or suggestions for reducing this burden, should be sent to the Chief Information Officer, U.S. Patent and Trademark Office, U.S. Department of Commerce, P.O. Box 1450, Alexandria, VA 22313-1450. DO NOT SEND FEES OR COMPLETED FORMS TO THIS ADDRESS. SEND TO: Commissioner for Patents, P.O. Box 1450, Alexandria, VA 22313-1450.

If you need assistance in completing the form, call 1-800-PTO-9199 and select option 2.