

Exhibit 1022

[54] METHOD AND APPARATUS FOR SELECTING BETWEEN A PLURALITY OF COMMUNICATION PATHS

[75] Inventors: Christopher J. Burke, Maple Valley; Janice M. Chaffee, Auburn; Erez Nir, Bellevue; Thomas E. Kee, Lynnwood, all of Wash.

[73] Assignee: Motorola, Inc., Schaumburg, Ill.

[21] Appl. No.: 991,892

[22] Filed: Feb. 11, 1993

[51] Int. Cl.⁶ H04Q 11/04; H04J 3/26

[52] U.S. Cl. 395/200; 370/94.1; 364/DIG. 1; 364/284; 364/284.3; 364/284.4; 364/242.94; 364/229; 364/229.3; 364/229.4; 364/229.5

[58] Field of Search 395/200, 700, 650, 800; 370/94, 94.1, 94.3, 60.1

[56] References Cited

U.S. PATENT DOCUMENTS

4,736,363	4/1988	Aubin et al.	370/60
4,825,206	4/1989	Brice, Jr. et al.	340/825.02
5,088,032	2/1992	Bosack	395/200
5,115,495	5/1992	Tsuchiya et al.	395/200
5,142,622	8/1992	Owens	395/200
5,168,572	12/1992	Perkins	395/800

Primary Examiner—Kevin A. Kriess

Attorney, Agent, or Firm—Val Jean F. Hillman

[57] ABSTRACT

In a data communication system (100), a method is provided to distinguish between and select from multiple communication paths (4,6,and 8) to a designated end point (10). The communications path selection is done locally, on a portable subscriber unit (2). The communications path is transparent to requesting software application (30). The method manages a plurality of communications devices (42,44) using existing communications infrastructure.

19 Claims, 9 Drawing Sheets

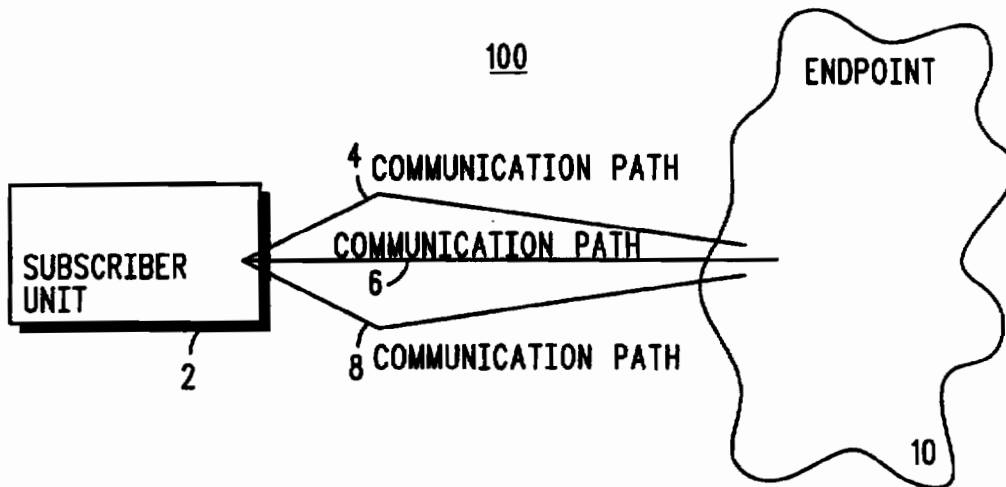

FIG. 1

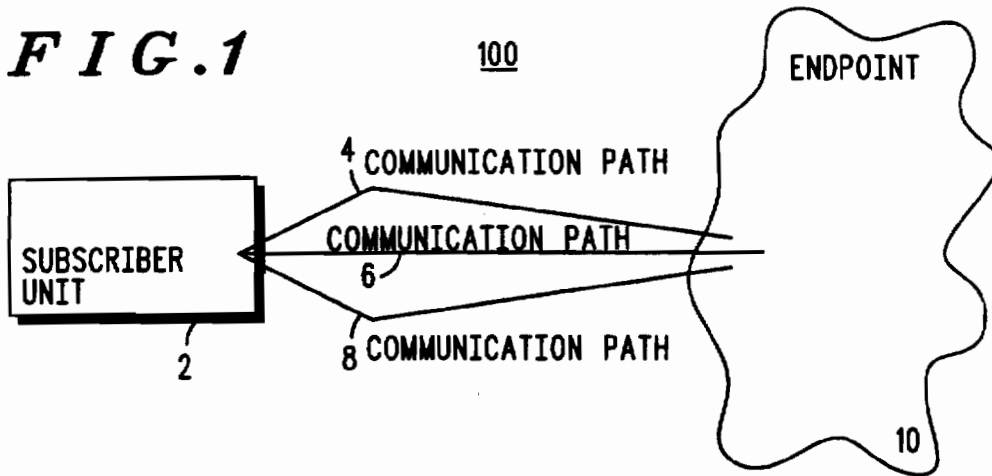

FIG. 2

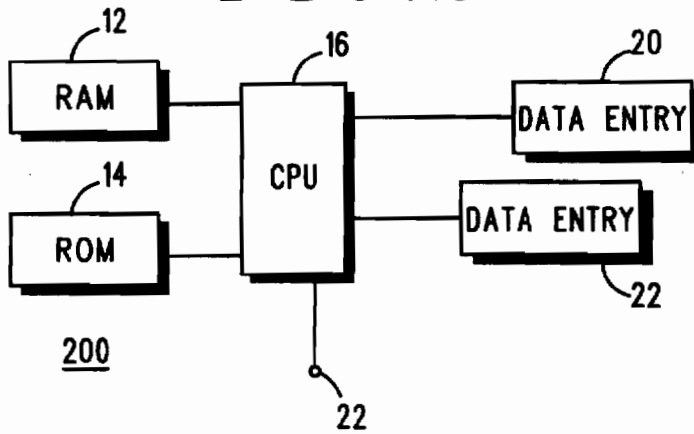
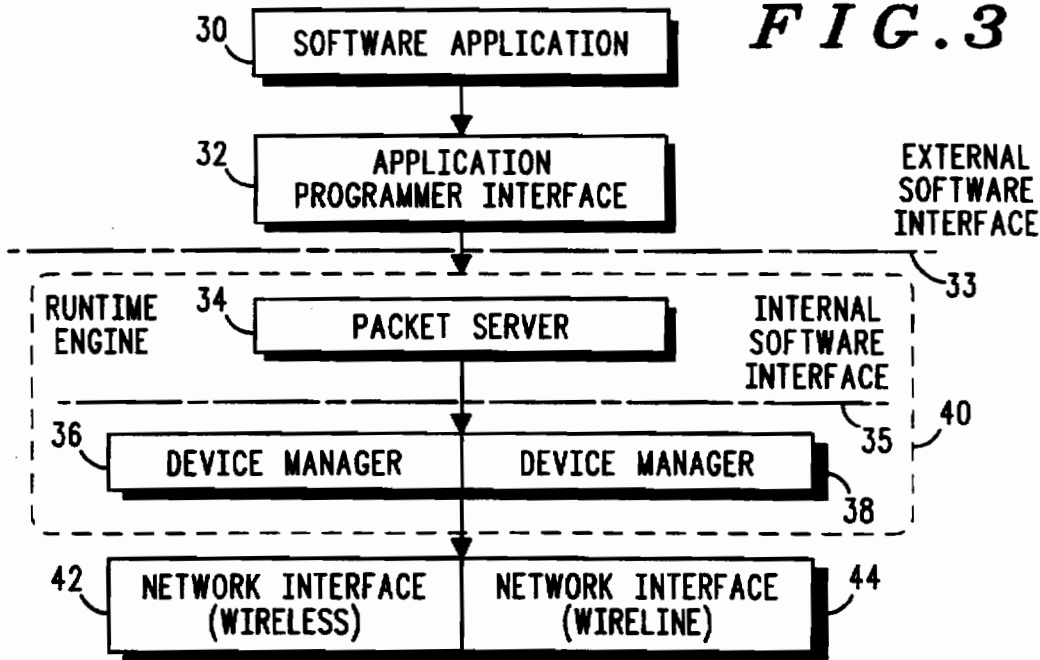

FIG. 3



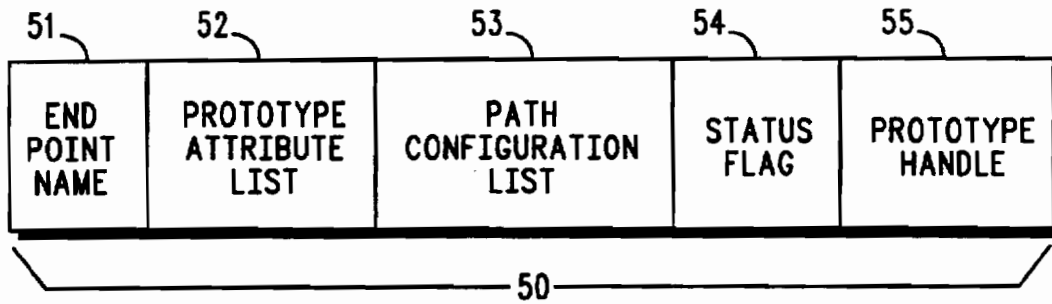

FIG. 4

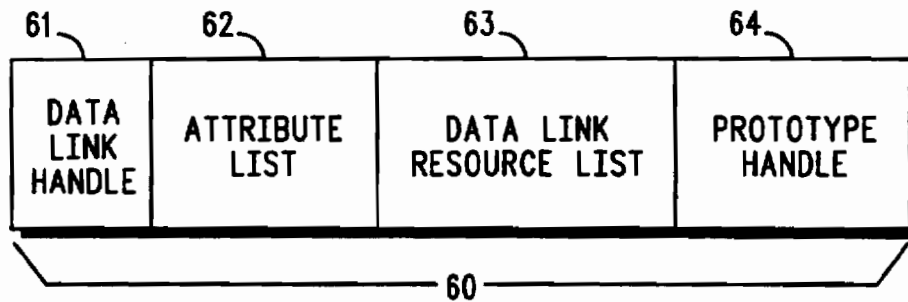

FIG. 5

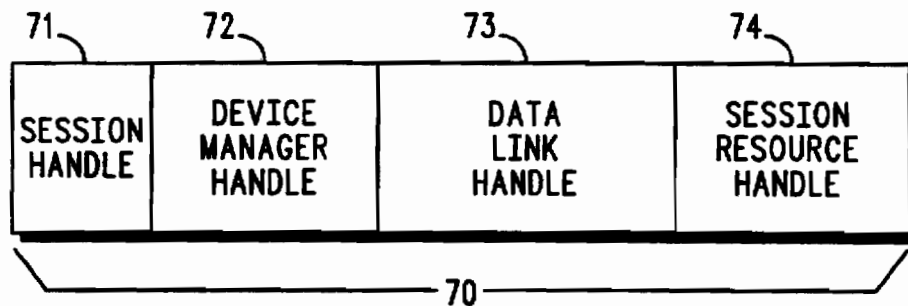
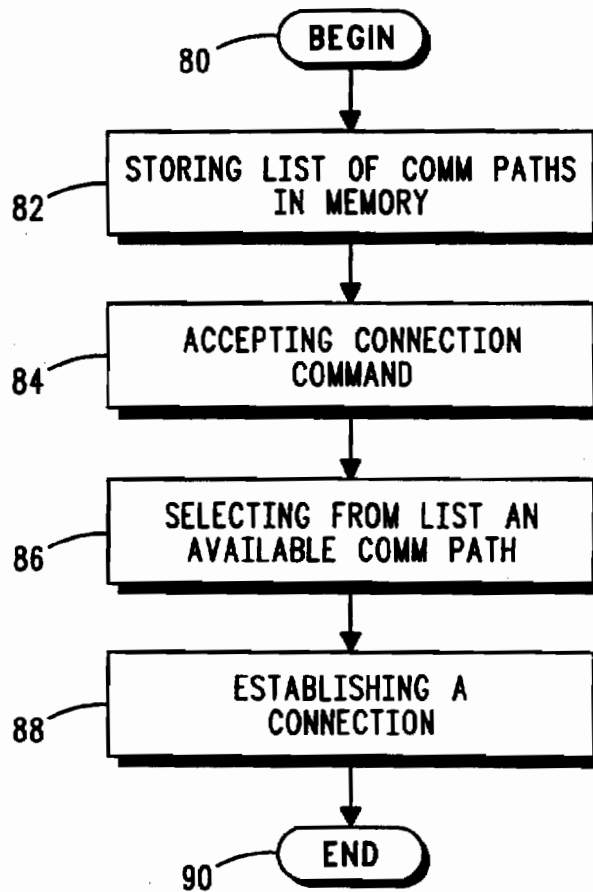

FIG. 6

*FIG. 7*

Explore Litigation Insights

Docket Alarm provides insights to develop a more informed litigation strategy and the peace of mind of knowing you're on top of things.

Real-Time Litigation Alerts



Keep your litigation team up-to-date with **real-time alerts** and advanced team management tools built for the enterprise, all while greatly reducing PACER spend.

Our comprehensive service means we can handle Federal, State, and Administrative courts across the country.

Advanced Docket Research



With over 230 million records, Docket Alarm's cloud-native docket research platform finds what other services can't. Coverage includes Federal, State, plus PTAB, TTAB, ITC and NLRB decisions, all in one place.

Identify arguments that have been successful in the past with full text, pinpoint searching. Link to case law cited within any court document via Fastcase.

Analytics At Your Fingertips



Learn what happened the last time a particular judge, opposing counsel or company faced cases similar to yours.

Advanced out-of-the-box PTAB and TTAB analytics are always at your fingertips.

API

Docket Alarm offers a powerful API (application programming interface) to developers that want to integrate case filings into their apps.

LAW FIRMS

Build custom dashboards for your attorneys and clients with live data direct from the court.

Automate many repetitive legal tasks like conflict checks, document management, and marketing.

FINANCIAL INSTITUTIONS

Litigation and bankruptcy checks for companies and debtors.

E-DISCOVERY AND LEGAL VENDORS

Sync your system to PACER to automate legal marketing.