

(12) **United States Patent**
Bremer

(10) **Patent No.:** **US 6,614,838 B1**
(45) **Date of Patent:** **Sep. 2, 2003**

(54) **SYSTEM AND METHOD OF COMMUNICATION VIA EMBEDDED MODULATION**

Primary Examiner—Phuong Phu
(74) *Attorney, Agent, or Firm*—Thomas, Kayden, Horstemeyer & Risley LLP

(75) **Inventor:** **Gordon Bremer**, Clearwater, FL (US)

(57) **ABSTRACT**

(73) **Assignee:** **Paradyne Corporation**, Largo, FL (US)

A communication system includes a master transceiver in communication with one or more transceivers, for example, a first tributary transceiver and a second tributary transceiver over a communication medium. The first tributary transceiver uses a primary modulation method for communication while the second tributary transceiver uses a secondary or embedded modulation method for communication. The master transceiver and tributary transceivers each include a processor, memory, and control logic for controlling their operation. While the primary modulation method is normally used for transmissions on the communication medium, the master transceiver can communicate with the second tributary transceiver by notifying the first tributary transceiver that the primary modulation method is being temporarily replaced by the secondary or embedded modulation method. The master transceiver can then exchange information with the second tributary transceiver while the first tributary transceiver ignores any secondary modulation transmissions. In the meantime, the first tributary transceiver conditions itself to look for a trailing sequence from the master transceiver indicating that communication with the second tributary transceiver is complete. When the master transceiver transmits the trailing sequence using the primary modulation method, the first tributary transceiver conditions itself to look for primary modulation transmissions while the second tributary transceiver conditions itself to ignore primary modulation transmissions.

(*) **Notice:** Subject to any disclaimer, the term of this patent is extended or adjusted under 35 U.S.C. 154(b) by 0 days.

(21) **Appl. No.:** **09/205,205**

(22) **Filed:** **Dec. 4, 1998**

Related U.S. Application Data

(60) **Provisional application No.** 60/067,562, filed on Dec. 5, 1997.

(51) **Int. Cl.⁷** **H04B 1/38; H04L 5/16**

(52) **U.S. Cl.** **375/220; 375/222; 375/219; 370/453**

(58) **Field of Search** **375/261, 222, 375/219, 220; 370/328, 338, 389, 449, 452, 453, 457**

(56) **References Cited**

U.S. PATENT DOCUMENTS

- 5,563,883 A * 10/1996 Cheng
- 5,936,949 A * 8/1999 Pasternak et al.
- 5,999,563 A * 12/1999 Polley et al.
- 6,021,158 A * 2/2000 Schurr et al. 375/211
- 6,067,297 A * 5/2000 Beach

* cited by examiner

18 Claims, 7 Drawing Sheets

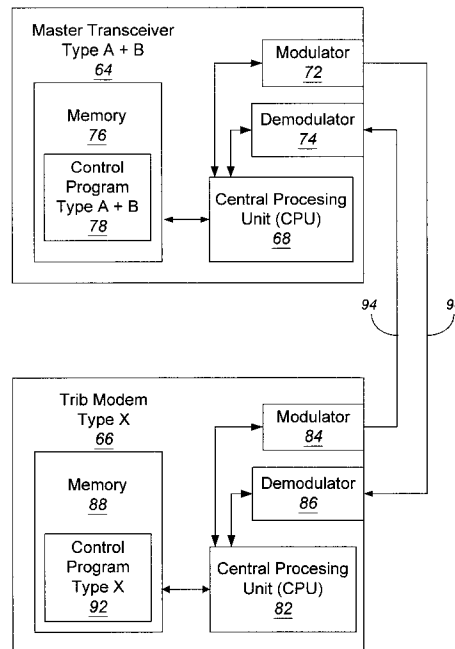

Samsung Ex. 1314
(Samsung v. Rembrandt)

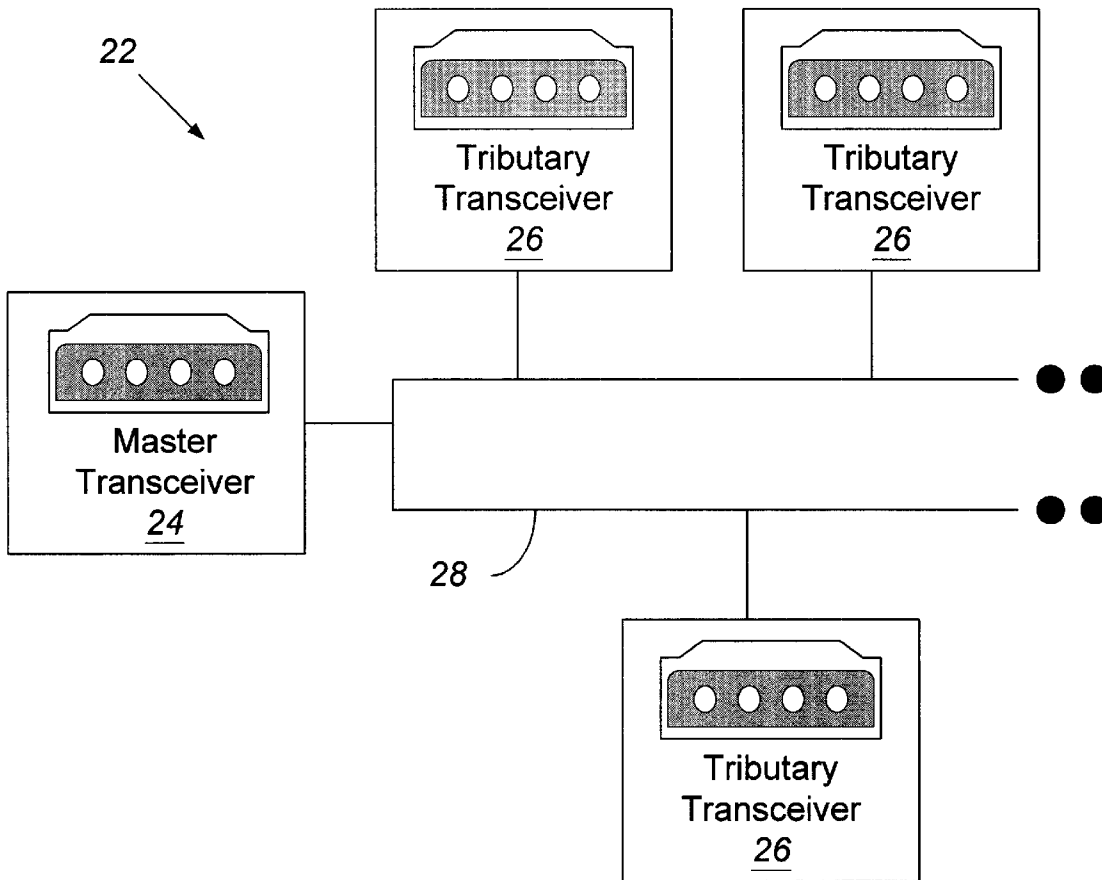

FIG. 1
Prior Art

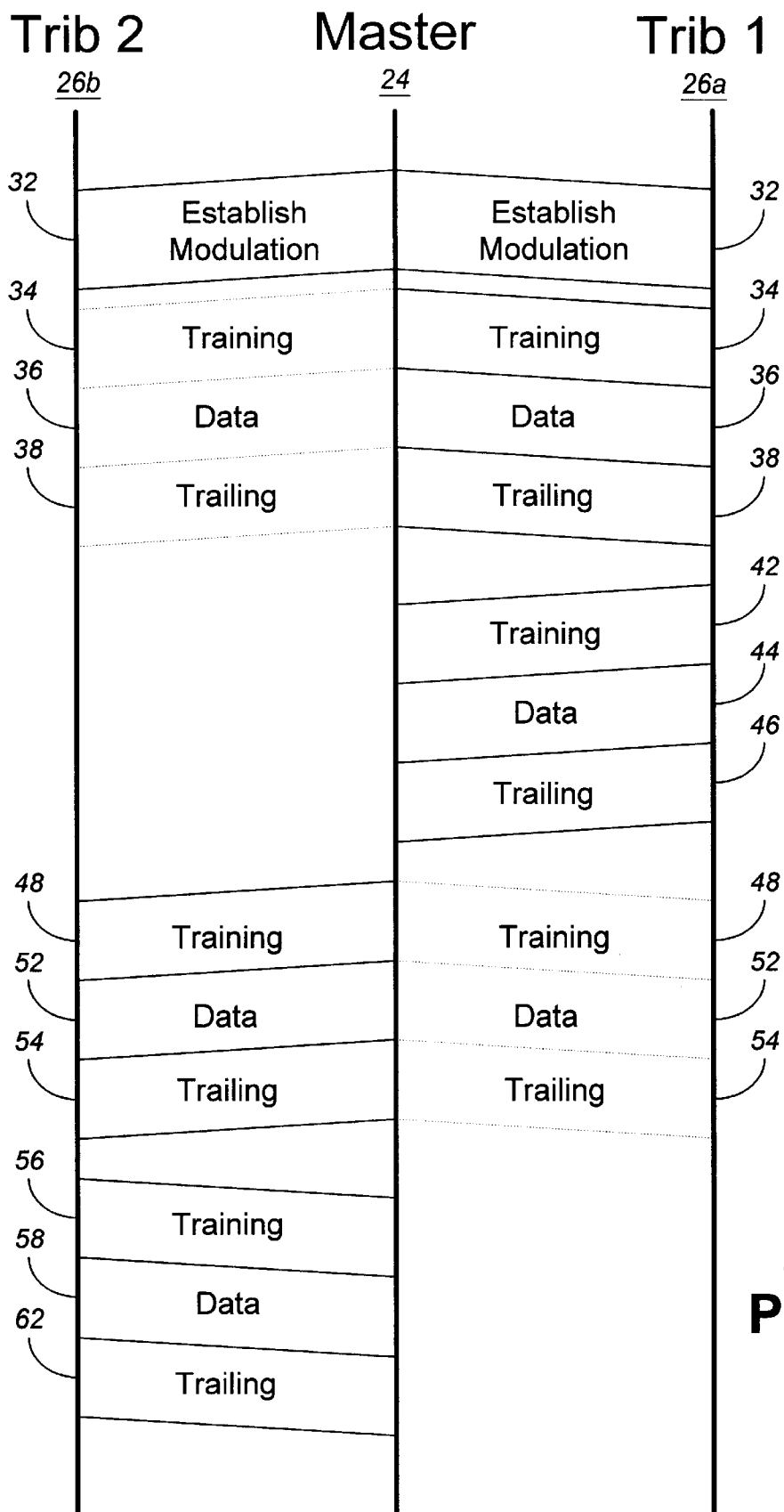

FIG. 2
Prior Art

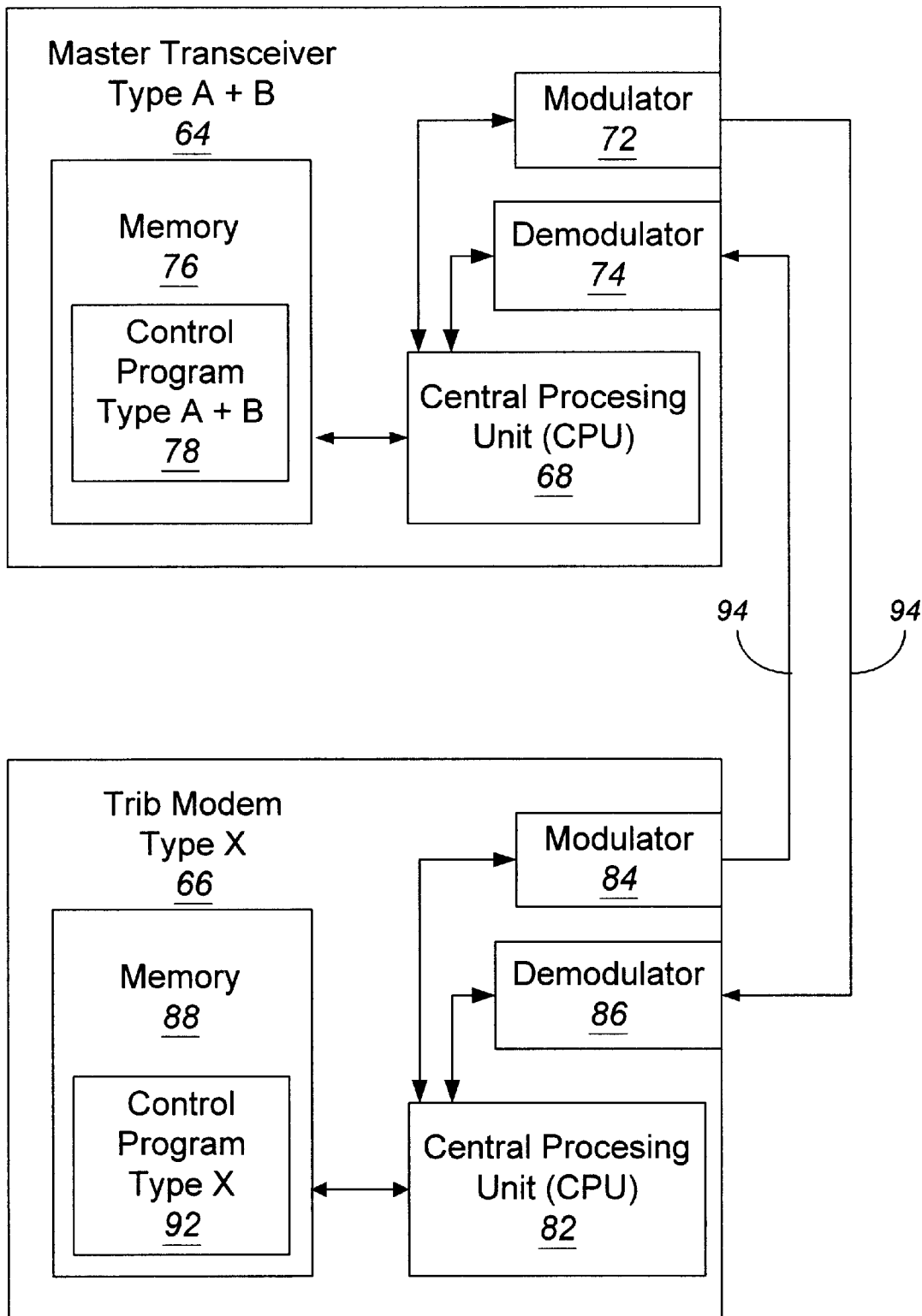

FIG. 3

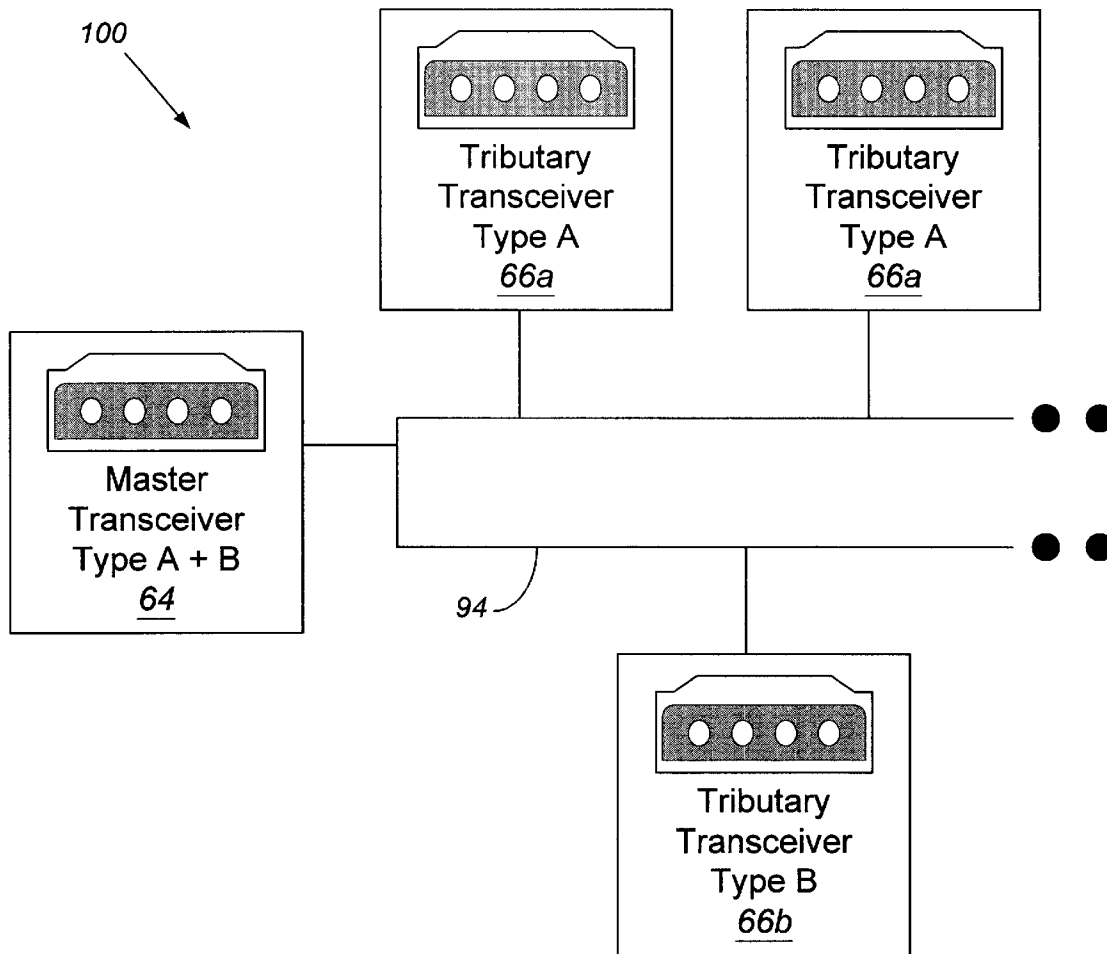

FIG. 4

Explore Litigation Insights

Docket Alarm provides insights to develop a more informed litigation strategy and the peace of mind of knowing you're on top of things.

Real-Time Litigation Alerts



Keep your litigation team up-to-date with **real-time alerts** and advanced team management tools built for the enterprise, all while greatly reducing PACER spend.

Our comprehensive service means we can handle Federal, State, and Administrative courts across the country.

Advanced Docket Research



With over 230 million records, Docket Alarm's cloud-native docket research platform finds what other services can't. Coverage includes Federal, State, plus PTAB, TTAB, ITC and NLRB decisions, all in one place.

Identify arguments that have been successful in the past with full text, pinpoint searching. Link to case law cited within any court document via Fastcase.

Analytics At Your Fingertips



Learn what happened the last time a particular judge, opposing counsel or company faced cases similar to yours.

Advanced out-of-the-box PTAB and TTAB analytics are always at your fingertips.

API

Docket Alarm offers a powerful API (application programming interface) to developers that want to integrate case filings into their apps.

LAW FIRMS

Build custom dashboards for your attorneys and clients with live data direct from the court.

Automate many repetitive legal tasks like conflict checks, document management, and marketing.

FINANCIAL INSTITUTIONS

Litigation and bankruptcy checks for companies and debtors.

E-DISCOVERY AND LEGAL VENDORS

Sync your system to PACER to automate legal marketing.