

418 F.3d 1282, 75 U.S.P.Q.2d 1763
(Cite as: 418 F.3d 1282)



United States Court of Appeals,
 Federal Circuit.
 NTP, INC., Plaintiff–Appellee,
 v.

RESEARCH IN MOTION, LTD., Defendant–Appellant.

No. 03–1615.

Aug. 2, 2005.

Rehearing and Rehearing En Banc Denied Oct. 7, 2005.

Background: Owner of patents for method of enabling mobile users to receive e-mail over wireless network sued competitor for infringement. The United States District Court for the Eastern District of Virginia, [James R. Spencer, J.](#), 2003 WL 23100881, entered judgment on jury verdict for owner, and competitor appealed.

Holdings: The Court of Appeals, [Linn](#), Circuit Judge, held that:

- (1) “originating processor” was separate from gateway or interface switches;
- (2) accused system was used within United States, for purpose of determining whether system claims were infringed; and
- (3) accused system was not used within United States, for purpose of determining whether method claims were infringed.

Affirmed in part, reversed in part, vacated in part, and remanded.

Prior opinion, [392 F.3d 1336](#), withdrawn.

West Headnotes

[1] Patents 291 [165\(5\)](#)

291 Patents

[291IX](#) Construction and Operation of Letters Patent

[291IX\(B\)](#) Limitation of Claims

[291k165](#) Operation and Effect of Claims in General

[291k165\(5\)](#) k. Construction of particular claims as affected by other claims. [Most Cited Cases](#)

Claims in multiple patents, which derive from same parent application and share many common terms, must be interpreted consistently.

[2] Patents 291 [324.5](#)

291 Patents

[291XII](#) Infringement

[291XII\(B\)](#) Actions

[291k324](#) Appeal

[291k324.5](#) k. Scope and extent of review in general. [Most Cited Cases](#)

Patent claim construction presents question of law, reviewed de novo.

[3] Patents 291 [165\(2\)](#)

291 Patents

[291IX](#) Construction and Operation of Letters Patent

[291IX\(B\)](#) Limitation of Claims

[291k165](#) Operation and Effect of Claims in General

[291k165\(2\)](#) k. Claims as measure of patentee's rights. [Most Cited Cases](#)

Claims of patent define invention to which patentee is entitled right to exclude.

418 F.3d 1282, 75 U.S.P.Q.2d 1763

(Cite as: 418 F.3d 1282)

[4] Patents 291  157(1)

291 Patents

291IX Construction and Operation of Letters Patent

291IX(A) In General

291k157 General Rules of Construction

291k157(1) k. In general. [Most Cited Cases](#)

Patents 291  161

291 Patents

291IX Construction and Operation of Letters Patent

291IX(A) In General

291k161 k. State of the art. [Most Cited Cases](#)

Words of patent claim are generally given their ordinary and customary meaning, which is meaning that term would have to person of ordinary skill in the art in question at time of invention.

[5] Patents 291  159

291 Patents

291IX Construction and Operation of Letters Patent

291IX(A) In General

291k159 k. Extrinsic evidence in general. [Most Cited Cases](#)

Patents 291  165(3)

291 Patents

291IX Construction and Operation of Letters Patent

291IX(B) Limitation of Claims

291k165 Operation and Effect of Claims in General

291k165(3) k. Construction of language of claims in general. [Most Cited Cases](#)

Patents 291  167(1)

291 Patents

291IX Construction and Operation of Letters Patent

291IX(B) Limitation of Claims

291k167 Specifications, Drawings, and Models

291k167(1) k. In general. [Most Cited Cases](#)

Patents 291  168(2.1)

291 Patents

291IX Construction and Operation of Letters Patent

291IX(B) Limitation of Claims

291k168 Proceedings in Patent Office in General

291k168(2) Rejection and Amendment of Claims

291k168(2.1) k. In general. [Most Cited Cases](#)

To ascertain meaning of patent claim term, court looks to those sources available to public that show what person of ordinary skill in the art would have understood disputed claim language to mean; such sources include words of claims themselves, remainder of specification, prosecution history, and extrinsic evidence concerning relevant scientific principles, meaning of technical terms, and state of art.

[6] Patents 291  101(2)

291 Patents

291IV Applications and Proceedings Thereon

291k101 Claims

291k101(2) k. Construction in general. [Most Cited Cases](#)

“Electronic mail system,” referred to in patents for method of enabling mobile users to receive e-mail over wireless network, was type of communication system which included plurality of processors running electronic mail programming, wherein such processors and programming were configured to permit communication by way of electronic mail messages among recognized users of system.

[7] Patents 291  324.1

418 F.3d 1282, 75 U.S.P.Q.2d 1763

(Cite as: 418 F.3d 1282)

291 Patents

291XII Infringement

291XII(B) Actions

291k324 Appeal

291k324.1 k. In general. [Most Cited Cases](#)

Patent infringement defendant waived claim construction argument raised for first time on appeal by failing to raise it before district court.

[8] Patents 291 101(2)

291 Patents

291IV Applications and Proceedings Thereon

291k101 Claims

291k101(2) k. Construction in general. [Most Cited Cases](#)

“Gateway switch,” called for in patent for method of enabling mobile users to receive e-mail over wireless network, was processor in electronic mail system that connected other processors in system and had additional functions for supporting other conventional aspects of system such as receiving, storing, routing, or forwarding electronic mail messages.

[9] Patents 291 101(2)

291 Patents

291IV Applications and Proceedings Thereon

291k101 Claims

291k101(2) k. Construction in general. [Most Cited Cases](#)

“Originating processor,” called for in patents for method of enabling mobile users to receive e-mail over wireless network, was processor in electronic mail system that initiated transmission of message into system, and was separate from gateway or interface switches.

[10] Patents 291 101(2)

291 Patents

291IV Applications and Proceedings Thereon

291k101 Claims

291k101(2) k. Construction in general. [Most Cited Cases](#)

“Originated information,” called for in patents for method of enabling mobile users to receive e-mail over wireless network, was message text of electronic mail message.

[11] Patents 291 314(5)

291 Patents

291XII Infringement

291XII(B) Actions

291k314 Hearing

291k314(5) k. Questions of law or fact. [Most Cited Cases](#)

Although district court is not required to adhere to specific timeline in making its patent claim construction rulings, court has power and obligation to construe meaning of claims as matter of law and should not give such task to jury as factual matter.

[12] Patents 291 165(4)

291 Patents

291IX Construction and Operation of Letters Patent

291IX(B) Limitation of Claims

291k165 Operation and Effect of Claims in General

291k165(4) k. Reading limitations or elements into claims, or disregarding limitations or elements. [Most Cited Cases](#)

Patent claim preamble generally limits claimed invention if it recites essential structure or steps, or if it is

418 F.3d 1282, 75 U.S.P.Q.2d 1763

(Cite as: 418 F.3d 1282)

necessary to give life, meaning, and vitality to claim.

[13] Patents 291  **165(4)**

291 Patents

291IX Construction and Operation of Letters Patent

291IX(B) Limitation of Claims

291k165 Operation and Effect of Claims in General

291k165(4) k. Reading limitations or elements into claims, or disregarding limitations or elements.

[Most Cited Cases](#)

When limitations in body of patent claim rely upon and derive antecedent basis from preamble, then preamble may act as necessary component of claimed invention.

[14] Patents 291  **165(4)**

291 Patents

291IX Construction and Operation of Letters Patent

291IX(B) Limitation of Claims

291k165 Operation and Effect of Claims in General

291k165(4) k. Reading limitations or elements into claims, or disregarding limitations or elements.

[Most Cited Cases](#)

Reference to “plurality of destination processors in the electronic mail system,” in preamble to patent claim for method of enabling mobile users to receive e-mail over wireless network, was necessary to provide context for claim reference to “the processors” and thus was includable as limitation of claim.

[15] Patents 291  **101(2)**

291 Patents

291IV Applications and Proceedings Thereon

291k101 Claims

291k101(2) k. Construction in general. [Most](#)

[Cited Cases](#)

Requirement in patents for method of enabling mobile users to receive e-mail over wireless network, that at least one destination processor must be in electronic mail system and accessible by radio frequency information transmission network, did not mean that single processor had to be accessible through both wireline and radio frequency transmission systems.

[16] Patents 291  **167(1.1)**

291 Patents

291IX Construction and Operation of Letters Patent

291IX(B) Limitation of Claims

291k167 Specifications, Drawings, and Models

291k167(1.1) k. Specification as limiting or enlarging claims. [Most Cited Cases](#)

Generally, party wishing to use statements in written description to confine or otherwise affect patent's scope must, at very least, point to term or terms in claim with which to draw in those statements; without any claim term that is susceptible of clarification by written description, there is no legitimate way to narrow property right.

[17] Patents 291  **101(2)**

291 Patents

291IV Applications and Proceedings Thereon

291k101 Claims

291k101(2) k. Construction in general. [Most Cited Cases](#)

Requirements in patents for method of enabling mobile users to receive e-mail over wireless network, that radio frequency receiver “transfer” information to destination processor, or that wireless receiver be “connected to” mobile processor, did not mean that receiver and processor had to be physically disposed in separate housings.

418 F.3d 1282, 75 U.S.P.Q.2d 1763

(Cite as: 418 F.3d 1282)

[18] Patents 291 ↪ 324.1

291 Patents

291XII Infringement

291XII(B) Actions

291k324 Appeal

291k324.1 k. In general. [Most Cited Cases](#)

Terms not used in patent claims in controversy on appeal need not be construed.

[19] Patents 291 ↪ 226.6

291 Patents

291XII Infringement

291XII(A) What Constitutes Infringement

291k226.5 Substantial Identity of Subject Matter

291k226.6 k. Comparison with claims of patent. [Most Cited Cases](#)

Determination of patent infringement is two-step process: court must first correctly construe asserted claims, and then compare properly construed claims to allegedly infringing devices, systems, or methods.

[20] Federal Courts 170B ↪ 3703(1)

170B Federal Courts

170BXVII Courts of Appeals

170BXVII(K) Scope and Extent of Review

170BXVII(K)4 Harmless and Reversible Error

170Bk3686 Particular Errors as Harmless or

Prejudicial

170Bk3703 Instructions

170Bk3703(1) k. In general. [Most](#)

[Cited Cases](#)

(Formerly 170Bk908.1)

Party seeking to alter judgment based on erroneous jury instructions must establish that: (1) it made proper and timely objection to instructions, (2) instructions were le-

gally erroneous, (3) errors had prejudicial effect, and (4) it requested alternative instructions that would have remedied error.

[21] Federal Courts 170B ↪ 3703(1)

170B Federal Courts

170BXVII Courts of Appeals

170BXVII(K) Scope and Extent of Review

170BXVII(K)4 Harmless and Reversible Error

170Bk3686 Particular Errors as Harmless or

Prejudicial

170Bk3703 Instructions

170Bk3703(1) k. In general. [Most](#)

[Cited Cases](#)

(Formerly 170Bk908.1)

When error in jury instruction could not have changed result, erroneous instruction is harmless. [Fed.Rules Civ.Proc.Rule 61, 28 U.S.C.A.](#)

[22] Federal Courts 170B ↪ 3574

170B Federal Courts

170BXVII Courts of Appeals

170BXVII(K) Scope and Extent of Review

170BXVII(K)2 Standard of Review

170Bk3574 k. Statutes, regulations, and

ordinances, questions concerning in general. [Most Cited Cases](#)

(Formerly 170Bk776)

District court's statutory construction is reviewed de novo.

[23] Statutes 361 ↪ 1091

361 Statutes

361III Construction

361III(B) Plain Language; Plain, Ordinary, or Common Meaning

418 F.3d 1282, 75 U.S.P.Q.2d 1763

(Cite as: **418 F.3d 1282**)

[361k1091 k](#). In general. [Most Cited Cases](#)
(Formerly 361k188)

Interpreting court gives words of statute their ordinary, contemporary, common meaning, absent indication Congress intended them to bear some different import.

[24] Statutes 361  **1181**

361 Statutes

[361III Construction](#)

[361III\(F\) Extrinsic Aids to Construction](#)

[361k1179 Treatises and Reference Works](#)

[361k1181 k](#). Dictionaries. [Most Cited Cases](#)

(Formerly 361k188)

Statutes 361  **1241**

361 Statutes

[361III Construction](#)

[361III\(H\) Legislative History](#)

[361k1241 k](#). In general. [Most Cited Cases](#)

(Formerly 361k217.4)

Court construing statute begins with words of statute, but may consult dictionaries and legislative history if necessary.

[25] Patents 291  **226**

291 Patents

[291XII Infringement](#)

[291XII\(A\) What Constitutes Infringement](#)

[291k226 k](#). Nature and elements of injury. [Most](#)

[Cited Cases](#)

Situs of patent infringement is wherever offending act of infringement is committed. [35 U.S.C.A. § 271\(a\)](#).

[26] Patents 291  **226**

291 Patents

[291XII Infringement](#)

[291XII\(A\) What Constitutes Infringement](#)

[291k226 k](#). Nature and elements of injury. [Most Cited Cases](#)

Patented system is directly infringed at place where system as a whole is put into service, i.e., place where control of system is exercised and beneficial use of system is obtained. [35 U.S.C.A. § 271\(a\)](#).

[27] Patents 291  **189**

291 Patents

[291X Title, Conveyances, and Contracts](#)

[291X\(A\) Rights of Patentees in General](#)

[291k189 k](#). Territorial extent of rights. [Most Cited Cases](#)

Accused wireless e-mail system was used within United States, for purpose of determining whether system claims in United States patent were directly infringed, even though relay component of accused system was located in Canada; fact that messages exchanged between two United States users of system were transmitted outside of United States at some point along their wireless journey was irrelevant. [35 U.S.C.A. § 271\(a\)](#).

[28] Patents 291  **189**

291 Patents

[291X Title, Conveyances, and Contracts](#)

[291X\(A\) Rights of Patentees in General](#)

[291k189 k](#). Territorial extent of rights. [Most Cited Cases](#)

Accused wireless e-mail system was not used within United States, for purpose of determining whether method claims in United States patent were directly infringed, where essential relay component of accused system was located in Canada. [35 U.S.C.A. § 271\(a\)](#).

418 F.3d 1282, 75 U.S.P.Q.2d 1763

(Cite as: 418 F.3d 1282)

[29] Patents 291  **229**

291 Patents

291XII Infringement

291XII(A) What Constitutes Infringement

291k228 Patents for Processes

291k229 k. Identity in general. **Most Cited**

Cases

Patent for method or process is not infringed unless all steps or stages of claimed process are utilized. 35 U.S.C.A. § 271(a).

[30] Patents 291  **229**

291 Patents

291XII Infringement

291XII(A) What Constitutes Infringement

291k228 Patents for Processes

291k229 k. Identity in general. **Most Cited**

Cases

Patented process cannot be used “within” United States, as required to establish direct infringement, unless each of its claimed steps is performed within this country. 35 U.S.C.A. § 271(a).

[31] Patents 291  **226**

291 Patents

291XII Infringement

291XII(A) What Constitutes Infringement

291k226 k. Nature and elements of injury. **Most**

Cited Cases

Statute defining direct patent infringement was merely codification of common law of infringement that had developed up to time of its enactment; it was not meant to change law of infringement. 35 U.S.C.A. § 271(a).

[32] Patents 291  **189**

291 Patents

291X Title, Conveyances, and Contracts

291X(A) Rights of Patentees in General

291k189 k. Territorial extent of rights. **Most Cited Cases**

Accused wireless e-mail system was not sold or offered for sale within United States, for purpose of determining whether method claims in United States patent were directly infringed, where essential relay component of accused system was located in Canada; sale of method could not occur in United States where contemplated performance of that method would not be wholly within United States. 35 U.S.C.A. § 271(a).

[33] Patents 291  **258**

291 Patents

291XII Infringement

291XII(A) What Constitutes Infringement

291k258 k. Importation and sale or use of imported article. **Most Cited Cases**

Accused wireless e-mail system was not imported into United States, for purpose of determining whether method claims in United States patent were directly infringed, where essential relay component of accused system was located in Canada; method could not be imported into United States where contemplated performance of that method would not be wholly within United States. 35 U.S.C.A. § 271(a).

[34] Patents 291  **259(3)**

291 Patents

291XII Infringement

291XII(A) What Constitutes Infringement

291k259 Contributory Infringement; Inducement

291k259(3) k. Manufacture and sale of articles to be used in manufacture of patented articles. **Most**

418 F.3d 1282, 75 U.S.P.Q.2d 1763

(Cite as: 418 F.3d 1282)

Cited Cases

Supply of wireless e-mail system components to users in United States did not constitute infringing supply of any component steps for combination into patented method for wireless delivery of e-mails. 35 U.S.C.A. § 271(f).

[35] Patents 291 101(11)

291 Patents

291IV Applications and Proceedings Thereon

291k101 Claims

291k101(11) k. Process or method claims. [Most Cited Cases](#)

Cited Cases

Invention recited in method claim of patent is performance of recited steps.

[36] Patents 291 258

291 Patents

291XII Infringement

291XII(A) What Constitutes Infringement

291k258 k. Importation and sale or use of imported article. [Most Cited Cases](#)

Statute proscribing importation, sale, or use within the United States of product made by process patented in United States was not applicable to wireless e-mail system that allegedly infringed patented method for wirelessly delivering e-mails; patented process was not for manufacture of physical object. 35 U.S.C.A. § 271(g).

[37] Courts 106 96(7)

106 Courts

106II Establishment, Organization, and Procedure

106II(G) Rules of Decision

106k88 Previous Decisions as Controlling or as Precedents

106k96 Decisions of United States Courts as

Authority in Other United States Courts

106k96(7) k. Particular questions or subject matter. [Most Cited Cases](#)

Grant or denial of motion for judgment as matter of law (JMOL) in patent case is procedural issue not unique to patent law, and thus is reviewed under law of regional circuit in which appeal from district court would usually lie.

[38] Federal Courts 170B 3605

170B Federal Courts

170BXVII Courts of Appeals

170BXVII(K) Scope and Extent of Review

170BXVII(K)2 Standard of Review

170Bk3576 Procedural Matters

170Bk3605 k. Taking case or question from jury; judgment as a matter of law. [Most Cited Cases](#) (Formerly 170Bk776)

Under law of Fourth Circuit, denial of motion for judgment as matter of law (JMOL) is reviewed de novo.

[39] Patents 291 323.3

291 Patents

291XII Infringement

291XII(B) Actions

291k323 Final Judgment or Decree

291k323.3 k. Relief from judgment or decree. [Most Cited Cases](#)

Judgment as matter of law (JMOL) of patent noninfringement was properly denied in light of expert testimony and other evidence from which jury could have found that patent for wireless e-mail system was infringed.

[40] Patents 291 323.3

291 Patents

418 F.3d 1282, 75 U.S.P.Q.2d 1763

(Cite as: 418 F.3d 1282)

291XII Infringement

291XII(B) Actions

291k323 Final Judgment or Decree

291k323.3 k. Relief from judgment or decree. [Most Cited Cases](#)

Judgment as matter of law (JMOL) of patent invalidity on grounds of anticipation and obviousness was properly denied, given conclusory nature of expert testimony on which patent challenger relied.

Patents 291 328(2)

291 Patents

291XIII Decisions on the Validity, Construction, and Infringement of Particular Patents

291k328 Patents Enumerated

291k328(2) k. Original utility. [Most Cited Cases](#)

4,644,351. Cited as Prior Art.

Patents 291 328(2)

291 Patents

291XIII Decisions on the Validity, Construction, and Infringement of Particular Patents

291k328 Patents Enumerated

291k328(2) k. Original utility. [Most Cited Cases](#)

5,436,960, 5,838,906. Cited.

Patents 291 328(2)

291 Patents

291XIII Decisions on the Validity, Construction, and Infringement of Particular Patents

291k328 Patents Enumerated

291k328(2) k. Original utility. [Most Cited Cases](#)

5,625,670. Construed.

Patents 291 328(2)

291 Patents

291XIII Decisions on the Validity, Construction, and Infringement of Particular Patents

291k328 Patents Enumerated

291k328(2) k. Original utility. [Most Cited Cases](#)

5,819,172. Not Infringed.

Patents 291 328(2)

291 Patents

291XIII Decisions on the Validity, Construction, and Infringement of Particular Patents

291k328 Patents Enumerated

291k328(2) k. Original utility. [Most Cited Cases](#)

6,067,451. Infringed in Part.

Patents 291 328(2)

291 Patents

291XIII Decisions on the Validity, Construction, and Infringement of Particular Patents

291k328 Patents Enumerated

291k328(2) k. Original utility. [Most Cited Cases](#)

6,317,592. Infringed.

*1286 [Henry C. Bunsow](#), Howrey Simon Arnold & White, LLP, of San Francisco, California, filed a combined petition for panel rehearing and rehearing en banc for defendant-appellant. With him on the petition were [Robert C. Laurenson](#), of Irvine, California, and [David W. Long](#), of Washington, DC.

[James H. Wallace, Jr.](#), Wiley, Rein & Fielding LLP, of Washington, DC, filed a response to the petition for plaintiff-appellee. With him on the response were [John B. Wyss](#), [Gregory R. Lyons](#), [Scott E. Bain](#), [Floyd B. Chap-](#)

418 F.3d 1282, 75 U.S.P.Q.2d 1763

(Cite as: 418 F.3d 1282)

man, and Kevin P. Anderson.

Philip C. Swain, Foley Hoag LLP, of Boston, Massachusetts, filed an amicus curiae brief for the Canadian Chamber of Commerce. With him on the brief was Carla Miriam Levy.

Homer E. Moyer, Jr., Miller & Chevalier, Chartered, of Washington, DC, filed an amicus curiae brief for The Government of Canada. With him on the brief was Michael T. Brady.

Linda S. Resh, Kirkland & Ellis LLP, of Chicago, Illinois, filed an amicus curiae brief for the Information Technology Association of Canada. With her on the brief was Craig D. Leavell.

Susan A. Cahoon, Kilpatrick Stockton LLP, of Atlanta, Georgia, filed an amicus curiae brief for Earthlink, Inc. With her on the brief was Kristin J. Doyle.

Before MICHEL,^{FN*} Chief Judge, SCHALL, and LINN, Circuit Judges.^{FN1}

FN* Paul R. Michel assumed the position of Chief Judge on December 25, 2004.

FN1. The earlier opinion in this case, reported at 392 F.3d 1336 (Fed.Cir.2004), is withdrawn, and this opinion is substituted therefor. See Order in this case issued this date.

ORDER

A combined petition for panel rehearing and rehearing en banc was filed by Research In Motion, Ltd. (“RIM”). A response*1287 thereto was invited by the court and filed by NTP, Inc. (“NTP”). Briefs of *amicus curiae* were filed by Earthlink, Inc.; The Canadian Chamber of Commerce; Information Technology Association of Canada; and The Government of Canada. Thereafter, these filings were referred to the merits panel that heard the appeal.

Upon consideration thereof,

IT IS ORDERED THAT:

(1) the petition for panel rehearing is granted for the limited purpose of revising portions of the opinion treating Section 271, and

(2) the previous opinion of the court in this appeal, issued on December 14, 2004 and reported at 392 F.3d 1336, is withdrawn. The new opinion accompanies this order.

LINN, Circuit Judge.

Research In Motion, Ltd. (“RIM”) appeals from a judgment of the U.S. District Court for the Eastern District of Virginia (“district court”) entered in favor of NTP, Inc. (“NTP”) following a jury verdict that RIM’s BlackBerry™ system infringed NTP’s U.S. Patents Nos. 5,436,960 (“the ‘960 patent”); 5,625,670 (“the ‘670 patent”); 5,819,172 (“the ‘172 patent”); 6,067,451 (“the ‘451 patent”); and 6,317,592 (“the ‘592 patent”) (collectively, “the patents-in-suit”) and awarding damages to NTP in the amount of \$53,704,322.69. *NTP, Inc. v. Research in Motion, Ltd.*, No. 3:01CV767, 2003 WL 23325540 (E.D.Va. Aug.5, 2003) (“*Final Judgment*”). The court, in a final order also appealed by RIM, permanently enjoined any further infringement by RIM, but stayed the injunction pending this appeal. We conclude that the district court erred in construing the claim term “originating processor,” but did not err in construing any of the other claim terms on appeal. We also conclude that the district court correctly denied RIM’s motion for judgment as a matter of law (“JMOL”), and did not abuse its discretion in denying evidentiary motions. Finally, we conclude that the district court was correct in sending the question of infringement of the system and apparatus claims to the jury, but erred as a matter of law in entering judgment of infringement of the method claims. Thus, we affirm-in-part, reverse-in-part, vacate-in-part, and remand for further proceedings consistent with this opinion.

418 F.3d 1282, 75 U.S.P.Q.2d 1763

(Cite as: 418 F.3d 1282)

I. BACKGROUND

The technology at issue relates to systems for integrating existing electronic mail systems (“wireline” systems) with radio frequency (“RF”) wireless communication networks, to enable a mobile user to receive email over a wireless network.

A. Overview of Electronic Mail Technology

Traditional email systems operate in the following manner: To send an email, a user begins by composing a message in his or her email client. An “email client” is a user interface, such as Microsoft Outlook™, Eudora™, or Hotmail™, that organizes and displays a user's email messages and provides the user with a means of creating and sending email messages. The message begins with a specific destination address, *i.e.*, `jdoe@* *.com`, that corresponds to the recipient's user identification, “jdoe,” and his or her internet service provider (“ISP” or “host”), “* *.com.” See generally Andrew S. Tanenbaum, *Computer Networks* 592–611 (4th ed.2003). When the message is sent, it is transferred first from the sender's machine to his or her ISP. *Id.* at 607. The sender's host then uses a domain name server to identify the recipient's ISP mail *1288 server and its associated internet protocol (“IP”) address. *Id.* A connection is then established by the sender's host with the recipient's ISP mail server, facilitating transfer of the message. *Id.* at 607–08. The message is next sorted by the recipient's ISP mail server into the recipient's particular “mailbox,” where it is stored until the recipient initiates a connection with the server and downloads the message off the server onto his or her personal machine. This configuration is commonly referred to as a “pull” system because emails cannot be distributed to the user's machine without a connection being initiated by the user to “pull” the messages from the mail server.

B. Problems With the Prior Art Systems

As societal dependence on email and computers increased throughout the 1990s, so did the demand for mobile internet access. See generally Richard Duffy & Denis Gross, *World Without Wires*, 22 *Communications Int'l* 72 (June 1995) (describing “user demand” as “one of the most

important driving factors behind the mobile data market”). The increased portability of computers via laptop machines exacerbated this demand. See *id.*; '960 patent, col. 4, ll. 19–39. Available methods of remote internet access were cumbersome and inefficient for the traveling businessperson, however, as the patents-in-suit explain:

As personal computers are used more frequently by business travellers, the problem of electronic mail delivery becomes considerably more difficult. A business traveler carrying a portable PC has great difficulty in finding a telephone jack to connect the PC to fetch electronic mail from either a host computer or a gateway switch. Connections for a PC's modem are difficult to find in airports Hotels and motels often have internal PABX's that prevent calls from automatically being placed by the user's PC to electronic mail gateway switches to receive information.... The inability to find an appropriate connection to connect the PC modem when travelling has contributed to the degradation of electronic mail reception when the recipient is travelling.

'960 patent, col. 3, l. 60—col. 4, l. 12. RIM's technical documentation for its BlackBerry products echoes the undesirability of these constraints:

Typically, mobile professionals use a laptop when traveling and dial-in to the corporate email server from a hotel room to manage an inbox full of email. The more adventurous use special software to send email notification to a pager or cell phone so they know what is in their inbox before spending the time and effort to dial-in. Focus groups and market research on mobile email revealed common complaints with dialing-in—the inconvenience of lugging a laptop around just for email; the trouble of finding a connection and dialing-out of the hotel; the difficulty of negotiating corporate dial-in security; and the cost of phone charges when dialing-in to the corporate server.

Research in Motion Ltd., *Technical White Paper BlackBerry Enterprise Edition*™ 3 (2001) (“White Paper”).

418 F.3d 1282, 75 U.S.P.Q.2d 1763

(Cite as: 418 F.3d 1282)

C. *The Patents-in-Suit*

Inventors Thomas J. Campana, Jr.; Michael P. Ponschke; and Gary F. Thelen (collectively “Campana”) developed an electronic mail system that was claimed in the '960, '670, '172, '451, and '592 patents. The '960 patent, filed on May 20, 1991, is the parent of a string of continuation applications. The most recent patent, the '592 patent, filed December 6, 1999, is a continuation*1289 of the '451 patent, filed September 28, 1998. The '451 patent, in turn, is a continuation of the '172 patent, which itself originates from the '670 patent, a direct continuation of the parent '960 patent. As continuations of that single parent application, these patents contain the same written descriptions as the '960 patent. NTP now owns these five patents-in-suit.

Campana's particular innovation was to integrate existing electronic mail systems with RF wireless communications networks. See '960 patent, col. 18, ll. 32–39. In simplified terms, the Campana invention operates in the following manner: A message originating in an electronic mail system may be transmitted not only by wireline but also via RF, in which case it is received by the user and stored on his or her mobile RF receiver. The user can view the message on the RF receiver and, at some later point, connect the RF receiver to a fixed destination processor, *i.e.*, his or her personal desktop computer, and transfer the stored message. *Id.* at col. 18, ll. 39–66. Intermediate transmission to the RF receiver is advantageous because it “eliminat[es] the requirement that the destination processor [be] turned on and carried with the user” to receive messages. *Id.* at col. 18, ll. 44–46. Instead, a user can access his or her email stored on the RF receiver and “review ... its content without interaction with the destination processor,” *id.* at col. 18, l. 67—col. 19, l. 1, while reserving the ability to transfer the stored messages automatically to the destination processor, *id.* at col. 19, ll. 1–2. The patents-in-suit do not disclose a method for composing and sending messages from the RF receiver.

D. *The Accused System*

RIM is a Canadian corporation with its principal place

of business in Waterloo, Ontario. RIM sells the accused BlackBerry system, which allows out-of-office users to continue to receive and send electronic mail, or “email” communications, using a small wireless device. The system utilizes the following components: (1) the BlackBerry handheld unit (also referred to as the “BlackBerry Pager”); (2) email redirector software (such as the BlackBerry Enterprise Server (“BES”), the Desktop Redirector, or the Internet Redirector); and (3) access to a nationwide wireless network (such as Mobitex, DataTAC, or GPRS).

The BlackBerry system uses “push” email technology to route messages to the user's handheld device without a user-initiated connection. There are multiple BlackBerry email “solutions” that interface with different levels of the user's email system. In the Desktop solution, the BlackBerry email redirector software, the Desktop Redirector, is installed on the user's personal computer. In the Corporate solution, different BlackBerry email redirector software, the BES program, is installed on the organizational user's mail server, where it can function for the benefit of the multiple users of that server. Also at issue in this case is RIM's Internet solution of the BlackBerry system. The Internet solution operates in a manner similar to the Corporate solution, but it executes a different email redirector software, Internet Redirector. In either version, the BlackBerry email redirector software merges seamlessly with the user's existing email system. The operation of the email redirector software is transparent to the user's desktop email client and the organizational user's mail server. That is, the user's email system does not recognize or incorporate the BlackBerry wireless system into its operation. No modification of the underlying email system is required to run RIM's wireless email extension. When new mail is detected in the Desktop solution, the Desktop *1290 Redirector is notified and retrieves the message from the mail server. It then copies, encrypts, and routes the message to the BlackBerry “Relay” component of RIM's wireless network, which is located in Canada. In the Corporate solution, the BES software performs this same function but intercepts the email before the message reaches the individual user's personal computer. The individual user's personal computer need not be turned on for

418 F.3d 1282, 75 U.S.P.Q.2d 1763

(Cite as: 418 F.3d 1282)

the BES software to properly redirect the user's emails. However, the user retains some control over message forwarding by using the BlackBerry "Desktop Manager." This additional software permits the user to specify his or her email redirection preferences. In both systems, the message travels through the BlackBerry Relay, where it is translated and routed from the processors in the user's email system to a partner wireless network. That partner network delivers the message to the user's BlackBerry handheld, and the user is "notified virtually instantly" of new email messages. *White Paper* at 6. This process, accomplished without any command from the BlackBerry user, is an example of "push" email architecture. *Id.* There are significant advantages to "push" email architecture. Most importantly, the user is no longer required to initiate a connection with the mail server to determine if he or she has new email. As RIM's technical literature explains, "[b]y having the desktop connect to the user, time spent dialing-up and connecting to the desktop (possibly to find that there is no new email) is eliminated as users ... are notified virtually instantly of important messages, enabling the user to respond immediately." *Id.*

RIM's system also permits users to send email messages over the wireless network from their handhelds. This functionality is achieved through the integration of an RF transmitter and a processor in the BlackBerry handheld unit. The processor allows the user to manipulate, view, and respond to email on his or her BlackBerry handheld. Sending a message from the handheld requires the same steps as the process for receiving email, only in reverse. When the user composes a message on his or her handheld, it is sent back to that user's desktop machine over the partner and BlackBerry wireless networks. The BlackBerry email redirector software then retrieves the outgoing message from the user's mail server and places it in the user's desktop email software, where it is dispersed through normal channels. In this way, messages sent from the BlackBerry handheld are identical to messages sent from the user's desktop email—they originate from the same address and also appear in the "sent mail" folder of the user's email client.

E. Procedural History

On November 13, 2001, NTP filed suit against RIM in the U.S. District Court for the Eastern District of Virginia. NTP alleged that over forty system and method claims from its several patents-in-suit had been infringed by various configurations of the BlackBerry system (comprised of the numerous handheld units; the BES, the Desktop Redirector, and the ISP Redirector software; and the associated wireless networks).

In an Order dated August 14, 2002, the district court construed thirty-one disputed claim terms. *NTP, Inc. v. Research in Motion, Ltd.*, No. 3:01CV767 (E.D.Va. Aug.14, 2002) ("*Claim Construction Order*"). In that Order, the district court "construed the disputed terms according to their plain and ordinary meaning, as supported by the specification and prosecution history." *Id.*, slip op. at 3. The Order listed the claim terms in contention and their corresponding constructions without additional reasoning or analysis. *See id.*, slip op. at 4–9. A series of summary judgment motions followed the court's *Markman* decision. Setting forth several alternate theories, RIM asked for summary judgment of both non-infringement and invalidity. The issues raised in two of RIM's summary judgment motions remain relevant on appeal: RIM argued (1) that the asserted claims, properly construed, did not read on the accused RIM systems, *see NTP, Inc. v. Research in Motion, Ltd.*, No. 3:01CV767, 2003 WL 23325540 (E.D.Va. Aug.5, 2003) (*nunc pro tunc* Oct. 23, 2002) ("*Non-infringement Order*"), and (2) that the physical location of the "Relay" component of the BlackBerry system put RIM's allegedly infringing conduct outside the reach of 35 U.S.C. § 271, *see NTP, Inc. v. Research in Motion, Ltd.*, No. 3:01CV767, 2003 WL 23325540 (E.D.Va. Aug.5, 2002) (*nunc pro tunc* Oct. 23, 2002) ("*Section 271 Order*"). The district court denied all of RIM's summary judgment motions.

For its part, NTP asked the district court to grant partial summary judgment of infringement on four claims of the patents-in-suit. In its motion, NTP argued: (1) that the 800 and 900 series BlackBerry handheld units infringed claim 248 of the '451 patent and claim 150 of the '592

418 F.3d 1282, 75 U.S.P.Q.2d 1763

(Cite as: 418 F.3d 1282)

patent; (2) that the BES software infringed claim 653 of the '592 patent; and (3) that the BlackBerry system, software, and handhelds infringed claim 15 of the '960 patent. See *NTP, Inc. v. Research in Motion, Ltd.*, 261 F.Supp.2d 423 (E.D.Va. 2002) (“*Order Granting Summary Judgment of Infringement*”). RIM cross-moved for summary judgment of non-infringement, arguing that its products lacked certain limitations required by the asserted claims. *Id.*, at 425. The district court agreed with NTP, holding that “no genuine issue of material fact” existed as to infringement of the four claims. *Id.* at 427. Accordingly, the district court granted summary judgment, except as to the issue of infringement of claim 15 of the '960 patent or claim 248 of the '451 patent by the BlackBerry series 5810 handheld device. That issue was reserved for the jury.

The case proceeded to trial on fourteen claims. The fourteen claims submitted to the jury were: claims 15 (with respect to the series 5810 handheld devices only), 32, and 34 of the '960 patent; claim 8 of the '670 patent; claim 199 of the '172 patent; claims 28, 248 (with respect to the series 5810 handheld devices only), 309, 313, and 317 of the '451 patent; and claims 40, 278, 287,^{FN2} and 654 of the '592 patent. A verdict was rendered on November 21, 2002. On every issue presented, the jury found in favor of the plaintiff, NTP. The jury found direct, induced, and contributory infringement by RIM on all asserted claims of the patents-in-suit. The jury also found that the infringement was willful. It rejected every defense proposed by RIM. Adopting a reasonable royalty rate of 5.7%, the jury awarded damages to NTP in the amount of approximately \$23 million.

FN2. Claim 287 is a multiple dependent claim. While the record is unclear, it appears to have been presented to the jury as dependent from claim 150 only.

Following the jury verdict, RIM moved the court for JMOL or, in the alternative, for a new trial.^{FN3} The court denied these motions. *1292 *NTP, Inc. v. Research in Motion, Ltd.*, 270 F.Supp.2d 751 (E.D.Va. 2003) (“*JMOL Order*”). On August 5, 2003, the district court entered

final judgment in favor of NTP. The court awarded monetary damages totaling \$53,704,322.69, with the following approximate division: (1) compensatory damages of \$33 million; (2) attorneys' fees of \$4 million; (3) prejudgment interest of \$2 million; and (4) enhanced damages of \$14 million. *Final Judgment*, slip op. at 1. The court also entered a permanent injunction against RIM, enjoining it from further manufacture, use, importation, and/or sale of all accused BlackBerry systems, software, and handhelds. *Id.* at 2–3. The injunction has been stayed pending this appeal.

FN3. After the jury verdict, the United States Patent and Trademark Office initiated re-examination of the '670, '172, '451, and '592 patents, and granted RIM's petition for re-examination of the '960 patent. The re-examination process has yet to be completed.

RIM timely appealed from the district court's final judgment and injunction. We have jurisdiction pursuant to 28 U.S.C. § 1295(a)(1).

II. ANALYSIS

A. Claim Construction

In the district court, NTP ultimately asserted against RIM, and RIM was found to have infringed, sixteen system and method claims of five different patents owned by NTP. This includes both the claims resolved by the court in NTP's favor on summary judgment and the claims submitted to the jury for a determination of infringement. These claims are: claims 15, 32, and 34 of the '960 patent; claim 8 of the '670 patent; claim 199 of the '172 patent; claims 28, 248, 309, 313, and 317 of the '451 patent; and claims 40, 150, 278, 287, 653, and 654 of the '592 patent.^{FN4} All of these claims, with the exception of claim 150 of the '592 patent, are dependent claims. The parental lineage of the adjudicated claims is indicated in the following table:

FN4. We note that the injunction lists only fifteen claims, omitting claim 287 of the '592 patent.

418 F.3d 1282, 75 U.S.P.Q.2d 1763

(Cite as: 418 F.3d 1282)

Final Judgment, slip op. at 3. Based on the record before us, we cannot determine why the jury's finding of infringement as to claim 287 was not included in the injunction. Even though claim 287

is not listed in the injunction, it was before the jury and presumptively was factored into the jury's calculation of damages, which is part of the judgment before us on appeal.

Pa- tent	Disputed claim Parental Lineage					
'960	15	11		1		
	32	28		18		
	34	18				
'670	8	4		1		
'172	199	194				
'451	28	26		1		
	248	247		246		
	309	308		250		
	313	311				
	317	313		311		
'592	40	25	10	4	1	
	150					
	278	232	186	171	156	150
	287	150				
	653	652				
	654	653		652		

*1293 On appeal, RIM challenges the judgment of infringement with respect to each of the asserted claims. RIM argues that the district court erred in construing the claim terms: (a) “electronic mail system” (appearing in the '960, '670, and '172 patents); (b) “gateway switch” (appearing in the '960 patent); and (c) “originating processor” and “originated information” (appearing in the '960, '670, and '592 patents). Further, RIM argues that the district court erred in failing to impose general restrictions on certain asserted claims and in failing to construe certain terms relating to asserted claims; specifically: (d) a “dual pathways” limitation, requiring that at least one destination

processor be accessible through *both* a wireline and an RF pathway (relating to asserted claims of the '960 and '670 patents); (e) a limitation requiring that the RF receiver and destination processor be “separate and distinct” entities (relating to asserted claims of the '960, '670, and '592 patents, and to certain asserted claims of the '451 patent); and (f) the term “processor outside any electronic mail system” (relating to the '960 patent). We consider each, in turn.

1. Claim Construction Precedent

[1] Because NTP's patents all derive from the same parent application and share many common terms, we must interpret the claims consistently across all asserted

418 F.3d 1282, 75 U.S.P.Q.2d 1763

(Cite as: 418 F.3d 1282)

patents. See, e.g., *Microsoft Corp. v. Multi-Tech Sys., Inc.*, 357 F.3d 1340, 1350 (Fed.Cir.2004) (holding that statements made in prosecution of one patent are relevant to the scope of all sibling patents); *Laitram Corp. v. Morehouse Indus., Inc.*, 143 F.3d 1456, 1460 & n. 2 (Fed.Cir.1998) (noting that it was proper to consider the prosecution histories of two related re-examination patents originating from the same parent, to determine the meaning of a term used in both patents). We thus draw distinctions between the various patents only where necessary.

[2][3][4][5] Claim construction presents a question of law that this court reviews *de novo*. *Cybor Corp. v. FAS Techs., Inc.*, 138 F.3d 1448, 1456 (Fed.Cir.1998) (en banc). “It is a bedrock principle of patent law that the claims of a patent define the invention to which the patentee is entitled the right to exclude.” *Phillips v. AWH Corp.*, 415 F.3d 1303, 1312 (Fed.Cir.2005) (en banc) (internal quotations omitted). The words of a claim are generally given their ordinary and customary meaning, which is “the meaning that the term would have to a person of ordinary skill in the art in question at the time of the invention.” *Id.* To ascertain the meaning of a claim term, “the court looks to those sources available to the public that show what a person of ordinary skill in the art would have understood disputed claim language to mean. Those sources include the words of the claims themselves, the remainder of the specification, the prosecution history, and extrinsic evidence concerning relevant scientific principles, the meaning of technical terms, and the state of the art.” *Id.* at 1314 (internal quotations and citations omitted). In consulting the relevant claim construction sources, we must “attach the appropriate weight ... to those sources.” *Id.* at 1324. Once the court has construed the claim limitations, the second step in the analysis is to compare the properly construed claims to the accused device. *Cybor Corp.*, 138 F.3d at 1454.

*1294 With these general principles in mind, we turn now to RIM's specific challenges to the district court's claim construction determinations.

2. Disputed Terms

a. “Electronic Mail System”

[6] The term “electronic mail system” appears in all of the asserted claims of the '960, '670, and '172 patents. For simplicity, we will use system claim 1 (from which disputed claim 15 depends) and method claim 18 (from which disputed claims 32 and 34 depend) of the '960 patent as exemplars. Claim 1 of the '960 patent reads as follows:

1. A system for transmitting originated information from one of a plurality of originating processors in an *electronic mail system* to at least one of a plurality of destination processors in the *electronic mail system* comprising:

at least one gateway switch in the *electronic mail system*, one of the at least one gateway switch receiving the originated information and storing the originated information prior to transmission of the originated information to the at least one of the plurality of destination processors;

a RF information transmission network for transmitting the originated information to at least one RF receiver which transfers the originated information to the at least one of the plurality of destination processors;

at least one interface switch, one of the at least one interface switch connecting at least one of the at least one gateway switch to the RF information transmission network and transmitting the originated information received from the gateway switch to the RF information transmission network; and wherein

the originated information is transmitted to the one interface switch by the one gateway switch in response to an address of the one interface switch added to the originated information at the one of the plurality of originating processors or by the *electronic mail system* and the originated information is transmitted from the one interface switch to the RF information transmission network with an address

418 F.3d 1282, 75 U.S.P.Q.2d 1763

(Cite as: 418 F.3d 1282)

of the at least one of the plurality of destination processors to receive the originated information added at the originating processor, or by either the *electronic mail system* or the one interface switch; and

the *electronic mail system* transmits other originated information from one of the plurality of originating processors in the *electronic mail system* to at least one of the plurality of destination processors in the *electronic mail system* through a wireline without transmission using the RF information transmission network.

'960 patent, col. 49, ll. 2–45 (emphases added). Claim 18 of the '960 patent reads as follows:

18. A method for transmitting originated information from one of a plurality of originating processors in an *electronic mail system* to at least one of a plurality of destination processors in the *electronic mail system* comprising:

transmitting the originated information originating from the one of the plurality of originating processors to a gateway switch within the electronic mail system;

transmitting the originated information from the gateway switch to an interface switch;

*1295 transmitting the originated information received from the gateway switch from the interface switch to a RF information transmission network;

transmitting the originated information by using the RF information transmission network to at least one RF receiver which transfers the originated information to the at least one of the plurality of destination processors; and

transmitting other originated information with the *electronic mail system* from one of the plurality originating processors in the *electronic mail system* to at

least one of the plurality of destination processors in the *electronic mail system* through a wireline without transmission using the RF information transmission network; and wherein

the originated information is transmitted to the interface switch by the gateway switch in response to an address of the interface switch which has been added to the originated information at the one of the plurality of originating processors or by the *electronic mail system* and the originated information is transmitted from the interface switch to the RF information transmission network with an address of the at least one of the plurality of destination processors to receive the originated information which has been added at the originating processor or by either the *electronic mail system* or the interface switch.

'960 patent, col. 52, ll. 11–49 (emphases added).

The district court construed “electronic mail system” as:

A type of communication system which includes a plurality of processors running electronic mail programming wherein the processors and the electronic mail programming are configured to permit communication by way of electronic mail messages among recognized users of the electronic mail system. The various constituent processors in the electronic mail system typically function as both “originating processors” and “destination processors.[”]

Claim Construction Order, slip op. at 4.

RIM argues there are two ordinary meanings of “electronic mail system”: a broad definition that encompasses “communicating word processors, PCs, telex, facsimile, videotex, voicemail and radio paging systems (beepers)” and a narrow definition that defines the term in the context of “pull” technology. Asserting that Campana

418 F.3d 1282, 75 U.S.P.Q.2d 1763

(Cite as: 418 F.3d 1282)

endorsed the pull technology definition during prosecution, RIM argues that “electronic mail system” includes a pull technology requirement. RIM also argues that during prosecution Campana characterized an “electronic mail system” as a wireline system to distinguish over the Zabarisky reference. Thus, RIM argues that “electronic mail system” requires a processor interconnected with other processors to serve the common purpose of providing electronic mail services to end users through pull technology while utilizing wireline, point-to-point connections.

NTP responds that the district court's claim construction of “electronic mail system” is correct and is consistent with the written description. NTP contends that RIM's proposed construction of “electronic mail system” as requiring pull technology contravenes the plain language of the claim and is inconsistent with Campana's disclosure. Further, NTP argues that RIM never raised its pull technology claim construction at the *Markman* hearing, but in fact argued the opposite. Finally, NTP argues that RIM's requirement that “electronic mail system” be limited to a wireline *1296 only system simply cites the prior art description of those terms, and not Campana's use of the term as including wireless connections.

[7] At the outset, we note that NTP correctly points out that RIM did not argue its pull technology construction before the district court, instead arguing that an electronic mail system is limited to a wireline only system. See J.A. at 2821–22 (arguing that “electronic mail system” should be construed as “a system of single processors or groups of processors linked by a wire line system, such as the PSTN [‘Public Switch Telephone Network’], that provides a system for transmitting information between at least two computers.” We have previously held that presenting proposed claim constructions which alter claim scope for the first time on appeal invokes the doctrine of waiver as to the new claim constructions. See *CCS Fitness, Inc. v. Brunswick Corp.*, 288 F.3d 1359, 1370 (Fed.Cir.2002) (“[A] waiver may occur if a party raises a new issue on appeal, as by, e.g., presenting a new question of claim scope” (internal quotation marks omitted)); *Interactive*

Gift Express, 256 F.3d at 1346 (“As it relates to claim construction, the doctrine [of waiver] has been applied to preclude a party from adopting a new claim construction position on appeal.”). For the first time on appeal, RIM is attempting to add a pull technology limitation to the claim that it did not raise before the district court. Because RIM failed to raise before the district court the argument that the claim should be limited to pull technology, the argument was waived, and we decline to address it on the merits.

The district court's claim construction, which includes various architectures of single processors and groups of processors, is correct. The claims themselves recite that an “electronic mail system” includes various configurations of originating processors and destination processors that communicate via wireline connections or over an RF transmission network. See, e.g., '960 patent, claim 1. Moreover, the written description recognizes that electronic mail systems may have various processor architectures. See, e.g., *id.* at col. 1, l. 60—col. 2, l. 22; *id.* at col. 2, ll. 13–17 (“It should be understood that the illustrated architecture of the single and associated groups of processors is only representative of the state of the art with numerous variations being utilized.”); see also '670 patent, col. 1, l. 64—col. 2, l. 25; '172 patent, col. 1, l. 65—col. 2, l. 25.

RIM's premise that the “electronic mail system” is limited to a wireline only system is flawed. The plain language of the claim 1 preamble recites that the claimed system transmits originated information “from one of a plurality of originating processors in an electronic mail system to at least one of a plurality of destination processors in the electronic mail system.” '960 patent, claim 1. Thus, all of the originating and destination processors are recited in the claims as being contained in the “electronic mail system.” This language, however, is not helpful in determining whether the “electronic mail system” may include wireless connections. Accordingly, we turn to the written description.

The written description expressly indicates that the “electronic mail system” in the patent claims may include

418 F.3d 1282, 75 U.S.P.Q.2d 1763

(Cite as: 418 F.3d 1282)

wireless connections. Campana described prior art “[e]lectronic mail services” as “*basically* a wire line-to-wire line, point-to-point type of communications” system. *Id.* at col. 1, ll. 52–54 (emphasis added). The use of the term “basically” suggests that an electronic mail system may include other types of connections, including wireless connections. Moreover, Campana provided an example of one prior art electronic mail *1297 system in commercial use, stating “FIG. 1 illustrates a block diagram of a typical electronic mail system in commercial use such as by AT & T Corporation.” *Id.* at col. 1, ll. 60–62. In this prior art electronic mail system, “groups of processors ... may be distributed at locations which are linked by the [PSTN]. The individual processors may be portable computers with a modem which are linked to the [PSTN] *through wired or RF communications* as indicated by a dotted line.” *Id.* at col. 1, l. 66—col. 2, l. 4 (emphasis added). Figure 1 depicts various processors that are all connected to the PSTN via either wired or wireless links. The prior art electronic mail system depicted in Figure 1 is incorporated into Figure 8, which Campana describes as a “block diagram of an electronic mail system in accordance with the present invention.” ^{FNS} *Id.* at col. 22, ll. 60–61. Accordingly, because RIM’s argument that the term “electronic mail system” cannot include wireless connections contradicts the text and figures of the written description, it must be rejected.

FNS. We concede that the wireless connections disclosed in the written description appear to involve “pull” access. This has no impact on our analysis, however, for two reasons. First, as we held above, RIM has waived any argument for adding a “pull” limitation. Second, RIM argues that the term “electronic mail system” as used in the patents-in-suit is limited to an all “‘wireline’ system.” Thus, any wireless connection, even a pull connection, suffices to defeat RIM’s argument.

Our review of the prosecution history reveals no disclaimers or disavowals limiting an “electronic mail system” to a wireline only system. RIM cobbles together

statements from the prosecution history that refer to an electronic mail system as having wireline connections. While it is true that Campana often focused on wireline connections in describing electronic mail systems, this focus is understandable given his acknowledgment that electronic mail systems are “basically a wire line-to-wire line, point-to-point type of communications” system. *Id.* at col. 1, ll. 52–54. Contrary to RIM’s assertions, however, Campana did not accept a narrow definition of “electronic mail system” or disclaim subject matter, so as to limit the term “electronic mail system” to a wireline only system. Instead, Campana expressly stated that information sent between the originating and destination processors located in “an electronic mail system” in his invention could be accomplished either through the RF transmission network or a wireline. *See* Amendment Pursuant to 37 C.F.R. § 1.116, at 19–20 (Nov. 7, 1994).

Because we discern no error, we affirm the district court’s claim construction of “electronic mail system.”

b. “Gateway Switch”

[8] The term “gateway switch” appears only in the asserted claims 15, 32, and 34 of the ‘960 patent. As before the district court, RIM bases its construction of the term on its argument that Campana’s “electronic mail system” implemented a “pull” email architecture. RIM contends that “a gateway switch is the mechanism for maintaining the mailboxes needed to implement the pull technology.” The district court construed the term differently, as “[a] processor in an electronic mail system which connects other processors in that system and has additional functions for supporting other conventional aspects of the electronic mail system such as receiving, storing, routing, and/or forwarding electronic mail messages.” *Claim Construction Order*, slip op. at 6. As we have previously rejected RIM’s argument that “pull” email architecture is required, *see* Section II.A.2.a, *supra* (construing “electronic mail system”), we are similarly compelled*1298 to reject its suggestion that “gateway switches” must enable this technology. In short, we agree with the district court’s claim construction of “gateway switch.”

418 F.3d 1282, 75 U.S.P.Q.2d 1763

(Cite as: 418 F.3d 1282)

c. “*Originating Processor*” and “*Originated Information*”

The parties dispute the construction of the term “originating processor” recited in the claims of the '960, '670, and '592 patents^{FN6} and “originated information” recited in the claims of the '960, '670, '592, and '451 patents.^{FN7} Claim 1 of the '960 patent, from which claim 15 ultimately depends, again is exemplary and states in pertinent part:

FN6. This term appears in all of the asserted claims of the '960 and '670 patents, and in parent claim 25 of asserted claim 40 of the '592 patent. A variation, “originating device,” is used in claims 40, 150, 278, 287, 653, and 654 of the '592 patent. “Originating device” was separately construed by the district court and that construction has not been appealed.

FN7. This term appears in all of the asserted claims of the '960 and '670 patents. A variation, “originating electronic mail,” is used in claims 313 and 317 (both depending from independent claim 311) of the '451 patent. A slightly different variation, “originate the electronic mail,” is used in claims 40 (depending from independent claim 1), 150, 278, and 287 of the '592 patent. We treat these variations as being of identical scope and meaning to the term “originating information” as discussed in our opinion.

1. A system for transmitting *originated information* from one of a plurality of *originating processors* in an electronic mail system to at least one of a plurality of destination processors in the electronic mail system comprising:

at least one gateway switch in the electronic mail system, one of the at least one gateway switch receiving the *originated information* and storing the *originated information* prior to transmission of the originated information to the at least one of the plurality of destination processors;

a RF information transmission network for transmitting the *originated information* to at least one RF receiver which transfers the *originated information* to the at least one of the plurality of destination processors;

at least one interface switch, one of the at least one interface switch connecting at least one of the at least one gateway switch to the RF information transmission network and transmitting the *originated information* received from the gateway switch to the RF information transmission network; and wherein

the *originated information* is transmitted to the one interface switch by the one gateway switch in response to an address of the one interface switch added to the originated information at the one of the plurality of *originating processors* or by the electronic mail system and the *originated information* is transmitted from the one interface switch to the RF information transmission network with an address of the at least one of the plurality of destination processors to receive the originated information added at the *originating processor*, or by either the electronic mail system or the one interface switch

'960 patent, col. 49, ll. 2–38 (emphases added).

The district court construed “originating processor” as “[a]ny one of the constituent processors in an electronic mail system that prepares data for transmission through the system.” *Claim Construction Order*, slip op. at 5. The court construed “originated information” as “[t]he message *1299 text of an electronic mail message.” *Id.*, slip op. at 6 (noting an exception for the term as used in a patent which is not disputed on appeal).

RIM argues that “originating processor” is correctly construed to mean a processor that initiates or starts the transmission of data through the system, thereby excluding any of the “constituent processors” in the system which

418 F.3d 1282, 75 U.S.P.Q.2d 1763

(Cite as: 418 F.3d 1282)

subsequently handle the data. It argues that “originated information” is the electronic mail message generated by an “originating processor.” RIM argues that its constructions are supported by dictionary definitions of the term “originating” and “originate” which impose an “initiating” requirement on the claims. RIM argues that the '960 patent specification supports this construction, because it describes an “originating processor” as a processor at which an electronic mail message is composed by a person or inputted by a machine.

NTP responds that this dispute centers on whether an “originating processor” can include gateway switches. Before the district court, NTP urged that “originating processor” be construed to include not only “that processor upon which the sender types the message,” but also “all of the constituent processors in an electronic mail system that run electronic mail programming to format and initiate transmission of electronic mail messages.” *NTP's Claim Construction Mem.* at 37. NTP argues that RIM's proposed construction is erroneous because it ignores language in the written description specifying that a gateway switch can originate information, and thus would exclude embodiments in the written description. NTP argues that a construction which limited “originating processor” to only processors upon which senders actually type the electronic mail message is not required by RIM's dictionary definitions.

[9] As we shall explain, we conclude that the district court erred in its claim construction of the term “originating processor.” The term “originating processor” is properly construed as “a processor in an electronic mail system that initiates the transmission of a message into the system.” We do not hold that the “originating processor” is always the processor on which text of the email message was created. As a practical matter this will probably be the case. However, there could be a situation where someone composes an email message on one processor, then perhaps transfers the message from the creating processor to the “originating processor” that initiates the message into the electronic mail system; *e.g.*, by copying onto a disk.

[10] Further, we conclude that the district court did not err in construing “originated information” as “[t]he message text of an electronic mail message.” RIM focuses its argument on the term “originating processor.” Indeed, RIM presents no independent argument that “originated information” means anything other than the text of an electronic mail message to be transmitted in the electronic mail system. We see no reason to disturb the district court's claim construction of the term “originating information.”

We begin with the language of the claims. *See PSC Computer Prods., Inc. v. Foxconn Int'l*, 355 F.3d 1353, 1359 (Fed.Cir.2004). Claim 1 of the '960 patent recites:

1. A system for transmitting originated information from one of a plurality of *originating processors* in an electronic mail system to at least one of a plurality of destination processors in the electronic mail system comprising: ...

at least one *gateway switch* in the electronic mail system ...

*1300 at least one *interface switch*

'960 patent, col. 49, ll. 2–19 (emphases added). Construing “originating processor” to mean the processor that is the origin of the email message text comports with the goal of the system—to move “originated information” from the processor where the email message text originated to the processor(s) where it is intended to be received. Moreover, that construction is consistent with the overall context of the claim language. Claim 1 of the '960 patent contains a number of limitations relating to devices that process data, including, *inter alia*: “a plurality of originating processors,” “at least one gateway switch,” and “at least one interface switch.” *See* '960 patent, col. 49, ll. 2–25. Nothing in the claim suggests that “a plurality of originating processors” defines a genus which includes the claimed “gateway switch” or “interface switch” as a species. Instead, these limitations are used as three separate, independent limitations to describe the various constituent

418 F.3d 1282, 75 U.S.P.Q.2d 1763

(Cite as: 418 F.3d 1282)

components in an electronic mail system that prepares and transmits electronic mail messages. There is no antecedent basis in the claim language to signify that “at least one gateway switch” conceptually is contained within “a plurality of originating processors.” See *Innova/Pure Water, Inc. v. Safari Water Filtration Sys.*, 381 F.3d 1111, 1119 (Fed.Cir.2004) (“While not an absolute rule, all claim terms are presumed to have meaning in a claim.”).

In addition, as claim 1 above recites, the “originated information” *originates from* the “originating processor.” ‘960 patent, col. 49, ll. 2–3. Thus, the plain language of the claims indicates that “originating processor” is not referring to *every* component that initiates data. Rather the “originating processor” is, more precisely, the processor that is the source of the “originated information”—the text of the electronic mail message.

Also, the claim language shows how a gateway switch is not included within the larger term “originating processor,” but is rather a separate component from an “originating processor.” That is because the “originated information” is *transmitted from* an “originating processor” to a gateway switch. Indeed, the “originating processor” and the gateway switch initiate different types of data. “Originated information”—the electronic mail message—originates with the “originating processor.” By contrast, the gateway switch is never described as being the origin of the “originated information.” Rather, it merely “receives” the “originated information” from the “originating processor.” See, e.g., *id.* at col. 49, ll. 8–9; ‘611 patent, col. 19, ll. 60–63, col. 47, ll. 52–54. A gateway switch may sometimes *add* or initiate address information such as an address of an interface switch to the “originated information” that it receives from the “originating processor.” See, e.g., ‘960 patent, col. 49, ll. 26–37. However, a gateway switch is not the origin of the “originated information” itself. According to the language of the claims, gateway switches are components that receive “originated information” from an “originating processor” and then sometimes append additional data to the information received from an “originating processor.”

The written description is consistent with this interpretation and reveals that two different types of information are “originated” and transmitted within the claimed invention. First, there is “originated information.” As the district court correctly held, “originated information” refers to the text of the electronic mail message being transmitted. One could analogize this to the contents of a physical letter one mails to a recipient via the postal system. Second, in the claimed invention *1301 there is also what one might call address information or destination information. This refers to an identifier of the intermediate components and/or the destination processor(s) to which the electronic message text should be delivered. See, e.g., ‘960 patent, col. 24, ll. 31–46 (discussing “address of the interface switch” and “identification number of the RF receiver”). Address information originated from a gateway switch or interface switch is never described as itself the “originated information” or the “other originated information.” Rather, it is described as separate information which is added to the “originated information” which came from an originating processor. See, e.g., *id.* at col. 21, ll. 54–56 (text notes that the address of the interface switch can be added “to the information originating from the originating processor”); *id.* at col. 22, ll. 24–26 (text notes that the destination address can be “added to the information from the originating processor”); *id.* at col. 26, ll. 39–41 (text notes adding information to the “information from the originating processor”); *id.* at col. 49, ll. 27–29 (claims describe “adding” address information to “originated information”); *id.* at col. 50, ll. 7–10 (text describes movement of both “originated information” and identification number in the RF transmission network); *id.* at col. 54, ll. 49–51 (text notes identification number “added to the originated information”). This address information can be analogized to the address contained on the outside of an envelope that one mails with the post office, as well as information added by the post office, such as a barcode, which may direct the envelope through the myriad routes in the postal system. Thus, just as one physically mails a letter with two types of information—the text of the actual letter itself within the envelope and the address information on the outside of the envelope—the claimed invention “originates” two types of information.

418 F.3d 1282, 75 U.S.P.Q.2d 1763

(Cite as: 418 F.3d 1282)

From the written description, one skilled in the art would understand an “originating processor” to refer to a processor where “originated information”—the electronic mail message text—is introduced into the electronic mail system. In some cases, this “originating processor” is the point at which some or all of the second type of information, the address information, is added. In other cases, after the “originating processor” sends the “originated information” to a gateway switch, the gateway switch then “originates” and appends additional address information onto the “originated information.” A user typing at the originating processor does need to provide at least some address destination information—for example, that the email message is intended for “John Doe.” *See, e.g., id.* at col. 24, ll. 29–30. However, the user need not know precisely through which switches the email message needs to travel within the system to get to John Doe (or even whether John Doe’s destination processor is a wireless or wireline processor). In the “most user friendly form” of the invention, the user need only indicate the intended recipient, and the proper address information can be added to the text of the electronic mail message either by the originating processor itself or by later components in the electronic mail system, such as gateway switches and/or interface switches. *See, e.g., id.* at col. 24, ll. 25–30. This is analogous to how, in the postal system, one need only indicate a destination address, and the postal system sometimes adds barcode information to envelopes which

help indicate through which routes within the postal network the letter needs to travel to get to the proper destination.

The term “originating processor” does not encompass every constituent processor *1302 that initiates data into the system. “Originating processor” refers more precisely to the processor that initiates the electronic message text into the system. It is correct to conclude that other components besides an “originating processor” “originate” information. For example, components such as the gateway switches originate some of the address information to get the electronic message from the “originating processor” to the proper destination processor(s). However, there is nothing in the written description to suggest that one skilled in the art would blur the distinction between a component such as a gateway switch that sometimes “originates” address information, and an “originating processor,” which is a separately labeled and separately claimed component than a gateway switch or an interface switch.

Referring specifically to the written description, Figure 1 of the '960 patent discloses a prior art electronic mail system in which the “originating processor” is depicted as the processor which originates the email message, which is separate and distinct from other constituent components such as gateway switches:

418 F.3d 1282, 75 U.S.P.Q.2d 1763

(Cite as: 418 F.3d 1282)

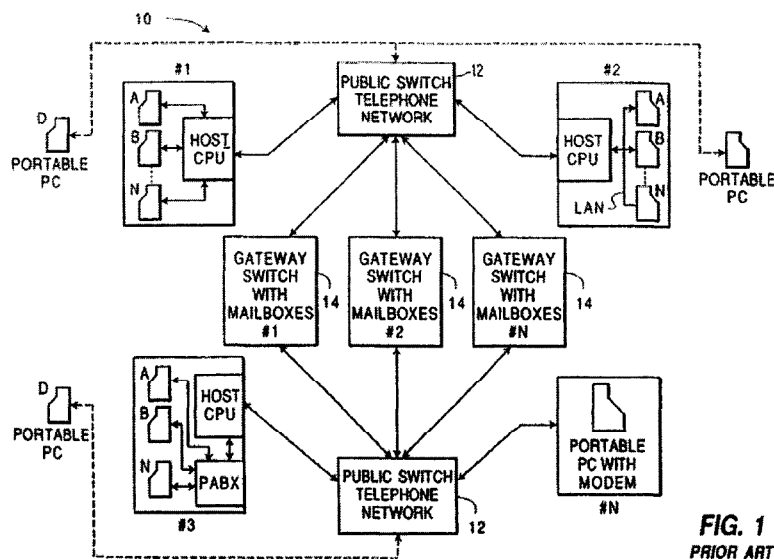

FIG. 1
PRIOR ART

The specification states that Figure 1 shows that “[c]ommunications between an *originating processor A–N*, which may be any of the processors within the groups of associated processors # 1–# 3 or processor # N and a destination processor A–N are completed through the public switch telephone network 12 to one or more gateway switches ... 14.” ’960 patent, col. 2, ll. 23–28 (emphases added). This passage explains that the electronic mail message originates from the “originating processor” and then moves “to” an associated gateway switch. Thus, the “originating processor” is not a generic term referring to all data-generating constituent processors in a system, but more precisely refers to a processor that is separate from the gateway switches. Moreover, the written description repeatedly refers to the “originating processor” where the electronic mail message text is generated. See, e.g., *id.* at col. 3, ll. 12–21 (“Finally, the message or message text must be entered which is the information that is inputted by the person or machine which is originating the message at the originating processor A–N. Upon completion of the message text, the user ... enters a series of commands or keystrokes on the originating processor to *1303 transmit the message to the gateway switch” (emphasis added)); *id.* at col. 19, ll. 29–30 (explaining how, in the claimed invention, the “originating processor” might be associated with “an icon driven display” and a computer “mouse” for the user). There is no corresponding

discussion of the electronic mail message text being generated with, or the use of “an icon driven display” with, a gateway or interface switch.

Components other than an “originating processor” can initiate data. The written description describes how, for example, “the identification of the RF receiver 119 and the address of the interface switch may be implemented by the originating processor A–N of one of the computing systems # 1–# N, a gateway switch 14 or an interface switch 304” *Id.* at col. 24, ll. 42–46. This shows that three different components can initiate address information: (1) an “originating processor” A–N; (2) a gateway switch 14; or (3) an interface switch 304. However, simply because the “originating processor” is but one of three separate, differently named and labeled components that can serve as the initiator of address information, does not mean that the term “originating processor” covers *all* of these different components. If “originating processor” referred to all three components, then the specification would simply read “the identification of the RF receiver 119 may be implemented by an originating processor.”

The specification makes clear that it may take several processors in Campana’s claimed invention to successfully initiate an electronic mail message. As Campana teaches in his written description, to initiate an electronic mail message, the message text must be entered, then the addresses

418 F.3d 1282, 75 U.S.P.Q.2d 1763

(Cite as: 418 F.3d 1282)

of various interface switches and the receiving destination processor must be entered and appended to the message. See *id.* at col. 19, ll. 26–39. The written description also teaches that entering the addresses of the interface switches, RF receivers, and destination processors may be accomplished by various components, including the originating processor or a gateway switch. See *id.* at col. 21, ll. 54–56, 65–66 (noting that the address of the receiving interface switch may be added by the originating processor or a gateway switch); *id.* at col. 22, ll. 10–15, 24–26 (noting that the address of the destination processor may be added by “the originating processor by an operator or a machine using the originating processor” or the gateway switch). However, the mere fact that a constituent component may tack on destination address information to the “originated information” coming from the “originating processor” does not turn that constituent processor into an “originating processor.” Gateway switches are separate components from the “originating processor” that can also add address information after receiving the message text from the “originating processor.” This is why Campana asserts that the invention is “user friendly” because only a

“minimum amount of information ... must be provided to initiate the transmission of electronic mail *from an originating processor* to at least one destination processor.” *Id.* at col. 19, ll. 20–25.

The written description further describes how either the “originating processor,” “gateway switch,” or “interface switch” can be used to add information needed to transmit the electronic mail message, such as addressing data. See *id.* at col. 22, ll. 24–26 (“The address of the destination processor may also be added to the information originated by the originating processor by the gateway switch.”). Figure 11 of the '960 patent visually demonstrates various steps by which the “originating processor,” “gateway switch 14,” and “interface switch 304” could operate *1304 together to add address information to the text of the electronic mail message, *i.e.*, the “originated information”:

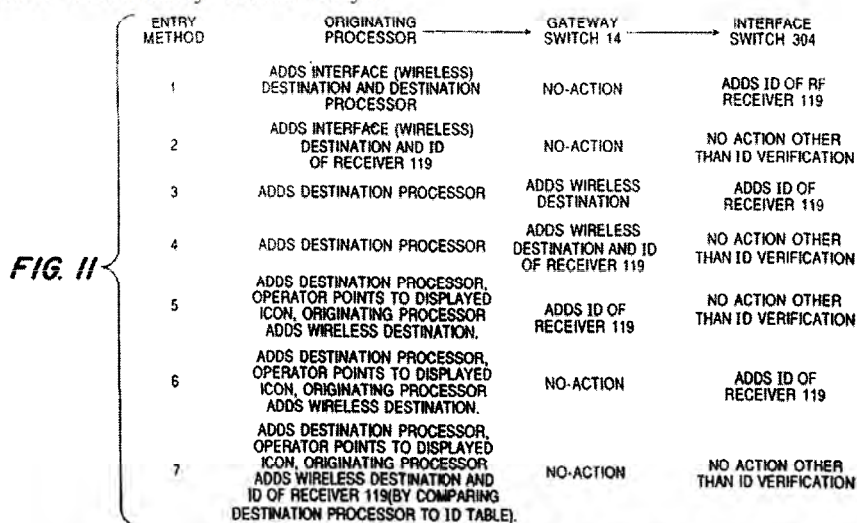

See '960 patent, col. 28, ll. 10–13 (“Fig[ure] 11 summarizes electronic mail message entry methods for messages (*information*) originating from originating processors within an electronic mail system.” (emphasis added)). The arrows show the flow of the “originated information” from the “originating processor,” the first processor in the

system where the information is originated, to a gateway switch 14, and then to an interface switch 304. Campana describes the flow of data in the various entry methods. For example, in “entry method 1” the “originating processor” itself adds the appropriate destination address data. *Id.* at col. 28, ll. 13–17. When the “originated information” then reaches a gateway switch 14, the gateway switch takes no

418 F.3d 1282, 75 U.S.P.Q.2d 1763

(Cite as: 418 F.3d 1282)

action, because all of the address data necessary at that point has already been added by the “originating processor.” By contrast, in “entry method 3,” a gateway switch, after receiving the “originated information” from the “originating processor,” adds the wireless destination address. *Id.* at col. 28, ll. 24–29. Although under the various methods enumerated in Figure 11 either the “originating processor,” “gateway switch,” or “interface switch” may add address information to the electronic mail message, the gateway and interface switches do not initiate the message text of an electronic mail message and, thus, are not “originating processors.”

This shows how the “originating processor” merely refers to the first (initiating) processor of the “originated information.” A gateway switch is *not* an “originating processor.” While the gateway switch serves as an initiator of address information, as in entry methods 3, 4, and 5, a gateway switch only does this after it gets the “originated information” from the “originating processor.” “Originating processor” is not an umbrella term referring to all of the processors that add data into the system, but rather would be understood to one skilled in the art to be the first processor, or the initial source of the “originated information” or email message text. All three different components in Figure 11, an “originating processor,” a “gateway *1305 switch,” and an “interface switch,” are initiating address information. “Originating processor” refers to one of these components—the first processor, and not all three. Thus, the “originating processor” is the sole processor that initiates the transmission of the electronic mail message text into the electronic mail system and is separate from the gateway or interface switches.

d. “Dual Pathways”

RIM argues that claim 8 of the '670 patent and claims 15, 32, and 34 of the '960 patent, when properly construed, require “ ‘dual pathways’ ... whereby at least one of the destination processors in the system must be reachable through two independent pathways, one through the email system, and the other through the RF system.” Appellant’s Br. at 20.

[11] We begin our analysis with the words of the claims.^{FN8} *Vitronics*, 90 F.3d at 1582. We refer again to claim 1 of the '960 patent, from which claim 15 ultimately depends, which is illustrative and states in pertinent part:

FN8. The district court addressed the “dual pathways” limitation on at least two occasions. On the first occasion, the district court rejected the “dual pathways” limitation, describing RIM’s argument as an “attempt [] to read a limitation into the claim that is not supported by the plain meaning of the claim.” On the second occasion, the court discussed the parties arguments, but declined to resolve the issue after finding a “genuine dispute of material fact.” *Non-Infringement Order*, slip op. at 4–11. The district court erred in refusing on the second occasion to resolve a claim construction issue due to a factual dispute. Although the district court is not required to adhere to a specific timeline in making its claim construction rulings, “in a case tried to a jury, the court has the power and obligation to construe as a matter of law the meaning of language used in the patent claim” and “should not give such task to the jury as a factual matter.” *Markman v. Westview Instruments, Inc.*, 52 F.3d 967, 978–79 (Fed.Cir.1995) (en banc).

1. A system for transmitting originated information from one of a plurality of originating processors in an electronic mail system *to at least one of a plurality of destination processors in the electronic mail system comprising: ...*

a RF information transmission network for transmitting the originated information to at least one RF receiver which transfers the originated information *to the at least one of the plurality of destination processors; ...*

the electronic mail system transmits other originated information from one of the plurality of originating

418 F.3d 1282, 75 U.S.P.Q.2d 1763

(Cite as: 418 F.3d 1282)

processors in the electronic mail system *to at least one of the plurality of destination processors* in the electronic mail system through a wireline without transmission using the RF information transmission network.

'960 patent, col. 49, ll. 2–45 (emphases added).

[12][13] In considering RIM's proposed “dual pathways” limitation, we begin by noting that the preamble of claim 1 of the '960 patent limits the claim. Under our precedent, a preamble generally limits the claimed invention if it “recites essential structure or steps, or if it is necessary to give life, meaning, and vitality to the claim.” *Catalina Mktg. Int'l, Inc. v. Coolsavings.com, Inc.*, 289 F.3d 801, 808 (Fed.Cir.2002) (internal quotation marks omitted). Thus, if the preamble helps to determine the scope of the patent claim, then it is construed as part of the claimed invention. *Bell Communications Research, Inc. v. Vitalink Communications Corp.*, 55 F.3d 615, 620 (Fed.Cir.1995) (“[W]hen the claim drafter chooses to use both the preamble and the body to define the subject matter of the claimed invention, the *1306 invention so defined, and not some other, is the one the patent protects.”). “When limitations in the body of the claim rely upon and derive antecedent basis from the preamble, then the preamble may act as a necessary component of the claimed invention.” *Eaton Corp. v. Rockwell Int'l Corp.*, 323 F.3d 1332, 1339 (Fed.Cir.2003); see also *C.R. Bard, Inc. v. M3 Sys., Inc.*, 157 F.3d 1340, 1350 (Fed.Cir.1998) (“[A] preamble usually does not limit the scope of the claim unless the preamble provides antecedents for ensuing claim terms and limits the claim accordingly.”).

[14] Because these limitations of claim 1 of the '960 patent derive their antecedent basis from the claim 1 preamble and are necessary to provide context for the claim limitations, the use of these limitations in the preamble limits the claim. *Eaton*, 323 F.3d at 1339; *Catalina Mktg.*, 289 F.3d at 808. The limitations of claim 1 “at least one of a plurality of destination processors” and “electronic mail system” are first recited in the preamble. '960 patent, col. 49, ll. 2–45 (claim 1). The antecedent basis of

the disputed claim limitation “to *the* at least one of the plurality of destination processors,” *id.* at col. 49, ll. 17–18 (emphasis added) (claim 1), is the destination processor recited in the preamble.

RIM's assertion that claim 1 of the '960 patent requires that “[t]he same destination processor must therefore simultaneously be ‘in an electronic mail system’ and reachable through an ‘RF information transmission network’ ” is well-supported. RIM correctly argues that the claim language “a RF information transmission network for transmitting ... originated information to *the* at least one of the plurality of destination processors,” which employs the definite article “the,” refers to the antecedent “at least one of a plurality of destination processors in the electronic mail system.” '960 patent, claim 1 (emphasis added). RIM also correctly argues that, based on this antecedent relationship, a destination processor accessible by RF transmission must also be “in an electronic mail system.” See generally *Warner–Lambert Co. v. Apotex Corp.*, 316 F.3d 1348, 1356 (Fed.Cir.2003) (“[I]t is a rule of law well established that the definite article ‘the’ particularizes the subject which it precedes. It is a word of limitation as opposed to the indefinite or generalizing force of ‘a’ or ‘an.’ ” (internal quotation omitted)).

However, the conclusions RIM seeks to advance do not follow from its assertion. One conclusion RIM advances, at least at one point in its briefing, is that this “dual pathways” assertion suffices to demonstrate non-infringement, arguing that “[t]he Blackberry[®] system avoids this requirement since the Blackberry[®] handhelds are only reachable through an RF pathway.” That sentence, which is the extent of RIM's analysis on this point, is simply insufficient to support a non-infringement determination. The argument relies on the implied premise that the BlackBerry handhelds are not in the electronic mail system. As defined by the district court, and approved above, an “electronic mail system” includes “a plurality of processors running electronic mail programming wherein the processors and the electronic mail programming are configured to permit communication by way of electronic mail messages among recognized users of the electronic

418 F.3d 1282, 75 U.S.P.Q.2d 1763

(Cite as: 418 F.3d 1282)

mail system.” RIM has cited nothing in the record to suggest that BlackBerry handhelds do not contain “processors running electronic mail programming” or are not “configured to permit communication by way of electronic mail messages among recognized *1307 users of the electronic mail system.”^{FN9} Accordingly, RIM’s argument that the claim limitation requires that at least one destination processor must be in the electronic mail system and accessible by the RF information transmission network is not, by itself, sufficient to demonstrate non-infringement.

FN9. As explained in more detail below, the RF receiver and the destination processor need not be physically separate and distinct. Similarly, it is of no importance that BlackBerry handhelds, which contain an RF receiver and a destination processor in a single unit, have access to both the RF information transmission network and the electronic mail system from the same device.

[15] Another conclusion RIM attempts to draw from its assertion that at least one destination processor must be in the electronic mail system and accessible by the RF information transmission network is that there must be a “dual pathway” to the same destination processor. The term “dual pathways” is not a claim term, but the notion of dual communication paths was argued by Campana during the prosecution of the ‘960 patent and incorporated into the structure of the claims of the patent. In distinguishing his invention over a prior art reference, Zabarsky, Campana argued that Zabarsky “would *not* meet the claims because of the recited dual communication paths involving telephonic and wireless communications which use the claimed interface switch between the electronic mail system and the RF information transmission system.” The dual pathways distinction was mentioned during several exchanges between Campana and the examiner and was included in the recited structure of the claims. The first pathway is a pathway using both wireless connections in the RF information transmission network and either wireline or wireless connections in the email system (“wireline-and-wireless pathway”). This pathway is recited in the second paragraph after the preamble in claim 1. ‘960 pa-

tent, col. 49, ll. 13–17 (reciting transmission through an “RF information transmission network”). The second pathway is a pathway using only wireline connections in the email system (“wireline-only pathway”). This pathway is recited in the final paragraph of claim 1, which was added explicitly to incorporate a dual pathways limitation into the claims. See *id.* at col. 49, ll. 41–45 (reciting the transmission of information “to at least one of the plurality of destination processors in the electronic mail system through a wireline without transmission using the RF information transmission network”).

RIM’s correct assertion that at least one destination processor must be in the electronic mail system and accessible by the RF information transmission network does not, by itself, yield the conclusion that at least one destination processor must be accessible by dual pathways, that is, by a wireline-only pathway as well as a wireline-and-wireless pathway. RIM concedes that the final paragraph of claim 1 does not establish that a single destination processor must be accessible by dual pathways.

RIM does argue, however, that during the prosecution of the ‘960 patent, Campana “urged a narrow definition of ‘electronic mail system’ to distinguish over the wireless messaging system of Zabarsky.” Thus, RIM ties its proposed “narrow definition” of “electronic mail system” to its dual pathways claim construction argument. RIM makes the following argument. First, at least one destination processor must be in the email system and accessible by the wireline-and-wireless pathway. Second, if a destination processor is in the email system, then it is *1308 accessible by a wireline-only pathway. Therefore, at least one destination processor must be accessible by dual pathways. This argument fails, however, because as we have concluded in section II.A.2.a, *supra*, the term “electronic mail system” as used in the patent is not limited to wireline-only pathways.

RIM also points to other statements Campana made in distinguishing the claimed invention over the Zabarsky reference. RIM argues that Campana’s repeated reliance on a dual pathways requirement to distinguish over Zabarsky

418 F.3d 1282, 75 U.S.P.Q.2d 1763

(Cite as: 418 F.3d 1282)

acted as a disclaimer of any claim interpretation that avoids a dual pathways requirement. NTP responds that there was no disavowal or disclaimer limiting Campana's invention to a system having dual pathways to the same destination processor. NTP argues that, instead, Campana simply distinguished Zabarsky as a purely wireless system, and noted that Zabarsky did not teach the claimed combination of a wireless system and an electronic mail system. Further, NTP contends that the examiner clearly stated his understanding that no “dual pathways” requirement exists.

RIM emphasizes the following passage from the prosecution history:

[T]he claims as described above ... define the combination of an electronic mail system and an RF information transmission system which transmits originated information from an originating processor to at least one destination processor using *both an electronic mail system* including a telephone network and *an RF information transmission network* which transmits originated information to at least one receiver which transfers the information to at least one destination processor. Thus, it is seen that the Examiner has *not* provided a teaching in the prior art or reasoning justifying a conclusion of obviousness with regard to the claimed system and method of operation of the electronic mail system and the RF information transmission system which define *dual* transmission paths of originated information with one of the paths being in the electronic mail system using a telephone network and the other of the paths being from the electronic mail system through an interface switch and through the RF information transmission system to the at least one destination processor.

Second Supplemental Amendment, May 13, 1994, at 23. RIM argues that Campana's statement that the “claimed system ... define[s] *dual* transmission paths,” *id.*, serves to disclaim systems where the same destination processor cannot be reached through both wireline and RF transmissions. This characterization of the prosecution history is in error. Campana made these statements in the prosecution history to demonstrate how its combination of a

wireline system and RF transmission system is distinguishable from the Zabarsky messaging system, which did not have the capacity to send a message using only wireline connections. *Id.* at 21–23. Although Campana clearly contemplated that various destination processors could be accessed through either a wireline system or the RF transmission network (or both), Campana did not limit his invention in these prosecution history passages to require that the same destination processor be accessible through both the wireline system and the RF transmission system. *See Gemstar–TV Guide Int'l, Inc. v. Int'l Trade Comm'n*, 383 F.3d 1352, 1364 (Fed.Cir.2004) (noting that “the presumption of ordinary meaning will be ‘rebutted if the inventor has disavowed or disclaimed scope of coverage, by using words or expressions of manifest exclusion or restriction, representing a clear disavowal of *1309 claim scope.’” (quoting *ACTV, Inc. v. Walt Disney Co.*, 346 F.3d 1082, 1091 (Fed.Cir.2003))). The required words or expressions of manifest exclusion or restriction representing a clear disavowal of claim scope are not present in these passages from the prosecution history.

As NTP correctly points out, the examiner's “Reasons for Allowance” confirm that no requirement of “dual” transmission pathways to the same destination processor was required for the claims to be patentable:

The prior art of record fails to teach or fairly suggest a system for transmitting originated information from an originating processor in an electronic mail system to a destination processor in the electronic mail system comprising an RF information transmission network ... with an address of the destination processor added at the originating processor [and] the electronic mail system transmits other originated information from an originating processor to a destination processor in the electronic mail system through a wireline without transmission using the RF information transmission network.

Notice of Allowability, Feb. 7, 1995, at 2. Although information is transmitted to various destination processors via RF or wireline transmission systems, there is no requirement that there must be “dual” transmission path-

418 F.3d 1282, 75 U.S.P.Q.2d 1763

(Cite as: 418 F.3d 1282)

ways to the same destination processor. Thus, we conclude that the asserted claims of the '960 and '670 patents do not include the “dual pathways” limitation contended by RIM.

e. “Separate and Distinct” RF Receiver and Destination Processor

In its summary judgment motion, RIM argued to the district court that certain of the asserted claims required that the RF receiver be distinct and separable from the destination processor. This “separate and distinct” limitation is, in RIM’s view, applicable to all claims of the '960, '670, and '592 patents, and to claims 248, 309, 313, and 317 of the '451 patent. The court declined to impose this limitation, stating that “while it appears that Campana envisioned a portable and mobile RF receiver that is physically separate from the bulkier destination processor (*i.e.*, laptop or desktop computer) the claims do not impose this requirement.” *Non-Infringement Order*, slip op. at 10–11. We agree with the district court.

As RIM correctly notes, the specification does indicate that Campana contemplated a separate housing as a way of achieving increased mobility and portability. For example, the specification suggests that an advantage of the invention is that the RF receiver may be carried with the user, while the location of the destination processor remains fixed. '960 patent, col. 18, ll. 60–66. But the specification also states that “a preferred embodiment of the invention is with portable destination processors.” *Id.* at col. 18, ll. 57–58.

RIM focuses its argument as to this alleged claim limitation on two claim terms, “transfer,” which can be found in the asserted claims of the '960 and '670 patents, and “connected to” or “coupled to,” which can be found in claims 150, 278, and 287 of the '592 patent and claims 248, 309, 313, and 317 of the '451 patent. Repeated statements in the specification echo these claim terms. *See, e.g., id.* at col. 18, ll. 50–53 (“The RF receiver automatically transfer [sic] the information to the destination processor upon connection of the RF receiver to the destination processor.” (emphasis added)); *id.* at col. 20, l. 66—col. 21, l. 1 (“The RF receiver may be detached from the destination

processor during reception of the information with a memory *1310 of the RF receiver storing the information.” (emphasis added)).

[16] Our case law requires a textual “hook” in the claim language for a limitation of this nature to be imposed. Generally, “a party wishing to use statements in the written description to confine or otherwise affect a patent’s scope must, at the very least, point to a term or terms in the claim with which to draw in those statements. Without any claim term that is susceptible of clarification by the written description, there is no legitimate way to narrow the property right.” *Renishaw PLC v. Marposs Societa’ per Azioni*, 158 F.3d 1243, 1248 (Fed.Cir.1998). In other words, “there must be a textual reference in the actual language of the claim with which to associate a proffered claim construction.” *Johnson Worldwide Assocs., Inc. v. Zebeo Corp.*, 175 F.3d 985, 990 (Fed.Cir.1999); *see also, e.g., McCarty v. Lehigh Valley R. Co.*, 160 U.S. 110, 116, 16 S.Ct. 240, 40 L.Ed. 358 (1895) (“[I]f we once begin to include elements not mentioned in the claim in order to limit such claim ... we should never know where to stop.”).

[17] In an effort to justify the limitation it urges, RIM first points to the claim term, “transfer.” In the '960 patent, for example, claim 1 requires that the “RF receiver ... transfer[] the originated information to the at least one of the plurality of destination processors.” '960 patent, col. 49, ll. 15–18. According to RIM, the fact that information must be “transferred,” *i.e.*, moved from one place to another, implies that the RF receiver and destination processor are separately housed. This reading stretches the meaning of “transfer.” As NTP points out, a “transfer” of information can equally occur between two entities that are physically housed together. The suggestion that information will be “transferred” between these two entities does not require the physical separation of those entities.

RIM also cites the claim terms “connected to” and “coupled to” used in the '592 patent. In that patent, independent claim 150 (from which asserted claims 278 and 287 depend) describes

418 F.3d 1282, 75 U.S.P.Q.2d 1763

(Cite as: 418 F.3d 1282)

a wireless receiver *connected* to the one mobile processor with the one mobile processor receiving the information contained in the electronic mail after the identification of the wireless device is detected by the wireless receiver in a broadcast by the wireless system.

'592 patent, col. 41, ll. 18–22 (emphasis added). Independent claim 301 of the '592 patent, from which asserted claims 309, 313, and 317 depend, recites similar requirements:

301. A communication system comprising:

mobile devices, each mobile device comprising a wireless device *connected* to a mobile processor which executes electronic mail programming to function as a destination of electronic mail, the wireless device after receiving a broadcast of information contained in the electronic mail and an identification of the wireless device transmits the information to the *connected* mobile processor

Id. at col. 53, ll. 32–40. *Webster's Third New International Dictionary* 480 (1993) defines “connected” as “to join, fasten, or link together.” Although “connected” more strongly connotes a physical link between the mobile processor and the wireless receiver than does the term “transfer,” it still does not require that the mobile processor and wireless receiver be physically disposed in separate housings. A “connection” can occur between these two devices regardless of whether they are housed separately or together. Indeed, the two components could *1311 be connected, joined, or linked together by wires or other electrical conductors and still be located in the same housing or even on the same circuit board. Because the claim language does not support RIM's interpretation, we agree with the district court and decline to impose this additional restriction on the claims.

f. “*Additional Processor Outside an Electronic Mail System*”

[18] RIM challenges the district court's construction of

the term “additional processor outside an electronic mail system.” As NTP correctly points out, this term is not present in any of the claims currently before us on appeal. RIM's principal justification for this court to construe the “additional processor” limitation is simply that the district court below construed the claim term. That is not a sufficient basis for this court to construe this claim term. Terms not used in claims in controversy on appeal need not be construed. *See Vivid Techs., Inc. v. Am. Sci. & Eng'g, Inc.*, 200 F.3d 795, 803 (Fed.Cir.1999) (“[O]nly those [claim] terms need be construed that are in controversy, and only to the extent necessary to resolve the controversy.”); *U.S. Surgical Corp. v. Ethicon, Inc.*, 103 F.3d 1554, 1568 (Fed.Cir.1997) (“Claim construction is a matter of resolution of disputed meanings and technical scope, to clarify and when necessary to explain what the patentee covered by the claims, for use in the determination of infringement. It is not an obligatory exercise in redundancy.”). We therefore decline to reach the question of whether the district court's construction of “additional processor outside of an electronic mail system” was correct.

B. Infringement

RIM makes three arguments challenging the district court's judgment of infringement. First, RIM argues that the district court erred in its claim constructions, and under the correct claim constructions RIM's products do not infringe. Second, RIM contends that because the BlackBerry Relay is located in Canada, as a matter of law RIM cannot be held liable for infringement under 35 U.S.C. § 271. Finally, RIM argues that the jury verdict of infringement lacked substantial evidence, and thus the district court should have granted RIM's motion for JMOL of non-infringement. We will discuss each argument in turn.

1. Claim Construction

[19] A determination of infringement is a two-step process. The court must first correctly construe the asserted claims, and then compare the properly construed claims to the allegedly infringing devices, systems, or methods. *Ethicon Endo-Surgery, Inc. v. U.S. Surgical Corp.*, 149 F.3d 1309, 1315 (Fed.Cir.1998). We have determined that the district court's jury instructions contained

418 F.3d 1282, 75 U.S.P.Q.2d 1763

(Cite as: 418 F.3d 1282)

an erroneous claim construction of the term “originating processor.” Thus, we are presented with the question of whether the jury verdict of infringement must be set aside as to the affected claims.

[20][21] A jury verdict will be set aside, based on erroneous jury instructions, if the party seeking to set aside the verdict can establish that “those instructions were legally erroneous,” and that “the errors had prejudicial effect.” *Advanced Display Sys., Inc. v. Kent State Univ.*, 212 F.3d 1272, 1281 (Fed.Cir.2000); see also *Ecolab Inc. v. Paraclype, Inc.*, 285 F.3d 1362, 1373 (Fed.Cir.2002). More specifically, “a party seeking to alter a judgment based on erroneous jury instructions must establish that (1) it made a proper and timely objection to the jury instructions, (2) those instructions were legally erroneous, (3) the *1312 errors had prejudicial effect, and (4) it requested alternative instructions that would have remedied the error.” *Advanced Display*, 212 F.3d at 1281 (internal citations omitted). “Prejudicial legal error exists when it ‘appears to the court [that the error is] inconsistent with substantial justice.’ ” *Id.* at 1283 (quoting Fed.R.Civ.P. 61). However, when the error in a jury instruction “could not have changed the result, the erroneous instruction is harmless.” *Environ Prods., Inc. v. Furon Co.*, 215 F.3d 1261, 1266–67 (Fed.Cir.2000) (citing 11 Charles Alan Wright & Arthur R. Miller, *Federal Practice and Procedure* § 2886 (2d ed. 1995) (“Errors in instructions are routinely ignored if ... the error could not have changed the result.”)); *Weinar v. Rollform Inc.*, 744 F.2d 797, 808 (Fed.Cir.1984) (“[A] reversal ... is not available to an appellant who merely establishes error in instructions Where the procedural error was ‘harmless,’ *i.e.*, where the evidence in support of the verdict was so overwhelming that the same verdict would necessarily be reached absent the error, or the error was cured by an instruction, a new trial would be mere waste and affirmance of the judgment is required.”).

At trial, RIM made a timely objection to the jury instructions pertaining to the district court's claim constructions, including its erroneous construction of the term “originating processor.” See J.A. at 14102–03. RIM also

requested alternative instructions that would have remedied the error, including specifically an alternative jury instruction embodying its proposed claim construction of the term “originating processor.” See J.A. at 8368–73 (instruction 16). But to set aside the jury verdict, RIM must also establish that the error was prejudicial. *Advanced Display*, 212 F.3d at 1281.

Prior to trial, RIM proffered a declaration by its expert Dr. Reed arguing that the accused BlackBerry products and services do not infringe under RIM's proposed claim constructions as contained in RIM's proposed jury instructions. See J.A. at 10115–71 (Reed declaration). This proffer addressed, *inter alia*, infringement as it relates to the “originating processor” limitation. However, the district court did not admit the Reed declaration into evidence or address the merits of the contentions in the Reed declaration. While RIM asserts that the court excluded all testimony arguing claim limitations different than or inconsistent with the court's claim construction, the court's actual ruling appears to have been directed only to the “separate and distinct physical housing argument [and] the RF indicator argument.” See J.A. at 12047–48. At the trial, testimony was presented with respect to infringement of the claims as construed by the district court. However, the extent to which the trial testimony and the exhibits actually admitted into evidence might relate to the issue of infringement under the correct construction of the term “originating processor” is unclear on the record before us. What is clear is that in the briefing of this appeal, the parties have not fully vetted the evidentiary record as it might relate to the correct construction of the term “originating processor.” Because the district court has a more direct understanding of the full record of trial proceedings in this case and is, thus, in a better position to make an informed determination of prejudicial error relating to the erroneous claim construction of the term “originating processor,” we decline to make that determination in the first instance on appeal and, instead, remand the same to the district court for proper resolution.

On remand, if RIM can establish that the erroneous claim construction prejudiced*1313 the jury's verdict as to

418 F.3d 1282, 75 U.S.P.Q.2d 1763

(Cite as: 418 F.3d 1282)

the affected claims, the district court will have to set aside the verdict of infringement as to those claims. The affected claims are those that include the term “originating processor;” namely, claim 15 of the '960 patent; claim 8 of the '670 patent; and claim 40 of the '592 patent (through its parent claim 25).^{FN10}

FN10. Method claims 32 and 34 of the '960 patent also contain the term “originating processor” but are not infringed by RIM as a matter of law, as we conclude, *infra*.

2. Section 271(a)

Section 271(a) of title 35 sets forth the requirements for a claim of direct infringement of a patent. It provides:

Except as otherwise provided in this title, whoever without authority makes, uses, offers to sell, or sells any patented invention, within the United States or imports into the United States any patented invention during the term of the patent therefor, infringes the patent.

35 U.S.C. § 271(a) (2000). The territorial reach of section 271 is limited. Section 271(a) is only actionable against patent infringement that occurs within the United States. See *Pellegrini v. Analog Devices, Inc.*, 375 F.3d 1113, 1117 (Fed.Cir.2004) (“[As] the U.S. Supreme Court explained nearly 150 years ago in *Brown v. Duchesne*, 60 U.S. (19 How.) 183, 15 L.Ed. 595 (1856), ... the U.S. patent laws ‘do not, and were not intended to, operate beyond the limits of the United States.’ ”); *Rotec Indus., Inc. v. Mitsubishi Corp.*, 215 F.3d 1246, 1251 (Fed.Cir.2000) (stating that “extraterritorial activities ... are irrelevant to the case before us, because ‘the right conferred by a patent under our law is confined to the United States and its territories, and infringement of this right cannot be predicated on acts wholly done in a foreign country’ ” (emphasis added) (quoting *Dowagiac Mfg. Co. v. Minn. Moline Plow Co.*, 235 U.S. 641, 650, 35 S.Ct. 221, 59 L.Ed. 398 (1915))).

Ordinarily, whether an infringing activity under sec-

tion 271(a) occurs within the United States can be determined without difficulty. This case presents an added degree of complexity, however, in that: (1) the “patented invention” is not one single device, but rather a system comprising multiple distinct components or a method with multiple distinct steps; and (2) the nature of those components or steps permits their function and use to be separated from their physical location.

In its complaint, NTP alleged that RIM had infringed its patents by “making, using, selling, offering to sell and importing into the United States products and services, including the Defendant's BlackBerry™ products and their related software” Compl. ¶ 19. NTP's theory of infringement tracks the language of section 271(a). In the district court, RIM moved for summary judgment of non-infringement, arguing that it could not be held liable as a direct infringer under section 271(a). According to RIM, the statutory requirement that the allegedly infringing activity occur “within the United States” was not satisfied because the BlackBerry Relay component of the accused system is located in Canada.^{FN11} The Relay component is alleged to meet the “interface” or the “interface switch” limitation in the '960, '670, '172, and '451 patents. *1314 RIM's argument based on the location of its Relay outside the United States does not apply to the asserted claims of the '592 patent (claims 40, 150, 278, 287, 653, and 654) because those claims do not include the “interface” or “interface switch” limitation.^{FN12}

FN11. There was a question below as to whether the Relay was also operated out of Virginia. This question appears to have been resolved in RIM's favor; on appeal, NTP does not contest the location of the BlackBerry Relay in Canada. For the purposes of our discussion, we assume that the BlackBerry Relay is located only in Canada. If, in fact, a Relay is also located in the United States, the need for this analysis would of course be obviated.

FN12. RIM argues that certain preamble recitations of the asserted claims of the '451 and the

418 F.3d 1282, 75 U.S.P.Q.2d 1763

(Cite as: 418 F.3d 1282)

'592 patents are affirmative limitations. For the purpose of the infringement analysis, we have assumed without deciding that the preamble of each of the asserted claims limits the claimed invention as it "recites essential structure or steps, or ... is necessary to give life, meaning, and vitality to the claim." *Catalina Mktg. Int'l, Inc. v. Coolsavings.com, Inc.*, 289 F.3d 801, 808 (Fed.Cir.2002) (internal quotation marks omitted).

The district court declined to grant summary judgment in RIM's favor. The court agreed that "to establish direct infringement under § 271(a), NTP must show that RIM practiced all of the steps of the process patented in the Campana inventions in the United States." *Section 271 Order*, slip op. at 6. However, because there remained "a genuine dispute ... with regards to whether RIM operates a Relay facility in Virginia," the court decided it could not resolve this issue on summary judgment. *Id.* at 9. Subsequently, during trial, the court changed its position and specifically held that "the fact that the BlackBerry relay is located in Canada is not a bar to infringement in this matter." The court therefore instructed the jury that "the location of RIM's Relay in Canada does not preclude infringement." In the district court, the jury found direct, induced, and contributory infringement by RIM on all asserted claims. The asserted claims included both systems and methods for transmitting an email message between an originating processor and a destination processor. By holding RIM liable for contributory infringement and inducing infringement, the jury necessarily found that its customers are direct infringers of the claimed systems and methods. *Dynacore Holdings Corp. v. U.S. Philips Corp.*, 363 F.3d 1263, 1272 (Fed.Cir.2004) ("Indirect infringement, whether inducement to infringe or contributory infringement, can only arise in the presence of direct infringement, though the direct infringer is typically someone other than the defendant accused of indirect infringement.").

On appeal, RIM argues that the district court erred in its interpretation of the infringement statute. RIM does not

appeal the jury's finding that its customers use, *i.e.*, put into service, its systems and methods for transmitting email messages. RIM has, however, appealed whether any direct infringement, by it or its customers, can be considered "within the United States" for purposes of section 271(a). Citing the Supreme Court's decision in *Deepsouth*, RIM contends that an action for infringement under section 271(a) may lie only if the allegedly infringing activity occurs within the United States. RIM urges that, in this case, that standard is not met because the BlackBerry Relay component, described by RIM as the "control point" of the accused system, is housed in Canada. For section 271(a) to apply, RIM asserts that the entire accused system and method must be contained or conducted within the territorial bounds of the United States. RIM thus contends that there can be no direct infringement as a matter of law because the location of RIM's Relay outside the United States precludes a finding of an infringing act occurring within the United States.

[22][23][24] This court reviews the statutory construction of a district court *de novo*. *Merck & Co. v. Kessler*, 80 F.3d 1543, 1549 (Fed.Cir.1996). In our interpretation of the statute, we "give the words of a statute their ordinary, contemporary, common *1315 meaning, absent an indication Congress intended them to bear some different import." *Williams v. Taylor*, 529 U.S. 420, 431, 120 S.Ct. 1479, 146 L.Ed.2d 435 (2000) (internal quotation marks omitted). We begin with the words of the statute, *see Trayco, Inc. v. United States*, 994 F.2d 832, 836 (Fed.Cir.1993), but may consult dictionaries, *see Bayer AG v. Housey Pharms., Inc.*, 340 F.3d 1367, 1371 (Fed.Cir.2003), and legislative history, *see Neptune Mut. Ass'n Ltd. of Bermuda v. United States*, 862 F.2d 1546, 1549 (Fed.Cir.1988), if necessary to construe the statute.

The question before us is whether the using, offering to sell, or selling of a patented invention is an infringement under section 271(a) if a component or step of the patented invention is located or performed abroad. The jury also was instructed on infringement by importation, which we discuss separately *infra*. Pursuant to section 271(a), whoever without authority "uses, offers to sell, or sells any

418 F.3d 1282, 75 U.S.P.Q.2d 1763

(Cite as: 418 F.3d 1282)

patented invention, within the United States ... during the term of the patent therefor, infringes the patent.” 35 U.S.C. § 271(a). The grammatical structure of the statute indicates that “within the United States” is a separate requirement from the infringing acts clause. Thus, it is unclear from the statutory language how the territoriality requirement limits direct infringement where the location of at least a part of the “patented invention” is not the same as the location of the infringing act.

RIM argues that *Deepsouth* answers this question. However, *Deepsouth* did not address this issue. In *Deepsouth*, the Supreme Court considered whether section 271(a) prevented, as direct infringement, the domestic production of all component parts of a patented combination for export, assembly, and use abroad. 406 U.S. at 527, 92 S.Ct. 1700. The Court held that the export of unassembled components of an invention could not infringe the patent. *Id.* at 529, 92 S.Ct. 1700. The Court said that it could not “endorse the view that the ‘substantial manufacture of the constituent parts of a machine’ constitutes direct infringement when we have so often held that a combination patent protects only against the operable assembly of the whole and not the manufacture of its parts.” *Id.* at 528, 92 S.Ct. 1700. Thus, the Court concluded that the complete manufacture of the operable assembly of the whole within the United States was required for infringement by making under section 271(a). In that case, however, both the act of making and the resulting patented invention were wholly outside the United States. By contrast, this case involves a system that is partly within and partly outside the United States and relates to acts that may be occurring within or outside the United States.

Although *Deepsouth* does not resolve these issues, our predecessor court's decision in *Decca Ltd. v. United States*, 210 Ct.Cl. 546, 544 F.2d 1070 (1976), is instructive. In *Decca*, the plaintiff sued the United States for use and manufacture of its patented invention under 28 U.S.C. § 1498. The claimed invention was a radio navigation system requiring stations transmitting signals that are received by a receiver, which then calculates position by the time difference in the signals. At the time of the suit, the United

States was operating three such transmitting stations, one of which was located in Norway and thus was outside the territorial limits of the United States. Only asserted claim 11 required three transmitting stations. Thus, in considering infringement of claim 11, the court considered the extraterritorial reach of the patent laws as applied to a system in which a component was located outside the United States. The court recognized that *Deepsouth* did not address this issue. *Id.* at 1081. In analyzing whether such a system*1316 was “made” in the United States, however, the court focused on the “operable assembly of the whole” language from *Deepsouth* and concluded that “[t]he plain fact is that one of the claimed elements is outside of the United States so that the combination, as an operable assembly, simply is not to be found solely within the territorial limits of this country.” *Id.* at 1082. The court recognized that what was located within the United States was as much of the system as was possible, but the court reached no clear resolution of whether the accused system was “made” within the United States. Nevertheless, the court said, “Analyzed from the standpoint of a use instead of a making by the United States, a somewhat clearer picture emerges.” *Id.* The court concluded that “it is obvious that, although the Norwegian station is located on Norwegian soil, a navigator employing signals from that station is, in fact, ‘using’ that station and such use occurs wherever the signals are received and used in the manner claimed.” *Id.* at 1083. In reaching its decision, the court found particularly significant “the ownership of the equipment by the United States, the control of the equipment from the United States and ... the actual beneficial use of the system within the United States.” *Id.* Although *Decca* was decided within the context of section 1498, which raises questions of use by the United States, the question of use *within* the United States also was implicated because direct infringement under section 271(a) is a necessary predicate for government liability under section 1498. *Motorola, Inc. v. United States*, 729 F.2d 765, 768 n. 3 (Fed.Cir.1984).

Decca provides a legal framework for analyzing this case. As our predecessor court concluded, infringement under section 271(a) is not necessarily precluded even though a component of a patented system is located outside

418 F.3d 1282, 75 U.S.P.Q.2d 1763

(Cite as: 418 F.3d 1282)

the United States. However, as is also evident from *Decca*, the effect of the extraterritorial component may be different for different infringing acts. In *Decca*, the court found it difficult to conclude that the system had been made within the United States but concluded that the system had been used in the United States even though one of the claim limitations was only met by including a component located in Norway. Not only will the analysis differ for different types of infringing acts, it will also differ as the result of differences between different types of claims. See *Minton v. Nat'l Ass'n of Sec. Dealers, Inc.*, 336 F.3d 1373, 1378 (Fed.Cir.2003) (“It is not correct that nothing in § 102(b) compels different treatment between an invention that is a tangible item and an invention that describes a series of steps in a process. The very nature of the invention may compel a difference.” (quotation marks omitted)). Because the analytical frameworks differ, we will separately analyze the alleged infringing acts, considering first the system claims and then the claimed methods.

a. “uses ... within the United States”

[25] The situs of the infringement “is wherever an offending act [of infringement] is committed.” *N. Am. Philips Corp. v. Am. Vending Sales, Inc.*, 35 F.3d 1576, 1579 (Fed.Cir.1994) (“[Section 271] on its face clearly suggests the conception that the ‘tort’ of patent infringement occurs where the offending act is committed and not where the injury is felt.”). The situs of the infringing act is a “purely physical occurrence[.]” *Id.* In terms of the infringing act of “use,” courts have interpreted the term “use” broadly. In *Bauer & Cie v. O'Donnell*, 229 U.S. 1, 33 S.Ct. 616, 57 L.Ed. 1041 (1913), the Supreme Court stated that “use,” as used in a predecessor to title 35, is a “comprehensive*1317 term and embraces within its meaning the right to put into service any given invention.” *Id.* at 10–11, 33 S.Ct. 616. The ordinary meaning of “use” is to “put into action or service.” *Webster's Third New International Dictionary* 2523 (1993). The few court decisions that address the meaning of “use” have consistently followed the Supreme Court's lead in giving the term a broad interpretation. *E.g.*, *Roche Prods., Inc. v. Bolar Pharm. Co.*, 733 F.2d 858, 863 (Fed.Cir.1984), *superseded-in-part by* 35 U.S.C. § 271(e) (holding that testing is a “use”).

[26][27] The use of a claimed system under section 271(a) is the place at which the system as a whole is put into service, *i.e.*, the place where control of the system is exercised and beneficial use of the system obtained. See *Decca*, 544 F.2d at 1083. Based on this interpretation of section 271(a), it was proper for the jury to have found that use of NTP's asserted system claims occurred within the United States.^{FN13} RIM's customers located within the United States controlled the transmission of the originated information and also benefited from such an exchange of information. Thus, the location of the Relay in Canada did not, as a matter of law, preclude infringement of the asserted system claims in this case.

FN13. As noted *supra*, the jury found that RIM's customers are direct infringers of the patented system, and RIM has not appealed the determination that the customers are directly putting into action the system that is the subject of NTP's claim limitations. RIM only appeals whether any such use occurs within the United States, in light of the location of the Relay within Canada.

RIM argues that the BlackBerry system is distinguishable from the system in *Decca* because the RIM Relay, which controls the accused systems and is necessary for the other components of the system to function properly, is not located within the United States. While this distinction recognizes technical differences between the two systems, it fails to appreciate the way in which the claimed NTP system is actually used by RIM's customers. When RIM's United States customers send and receive messages by manipulating the handheld devices in their possession in the United States, the location of the use of the communication system as a whole occurs in the United States. This satisfactorily establishes that the situs of the “use” of RIM's system by RIM's United States customers for purposes of section 271(a) is the United States. Therefore, we conclude that the jury was properly presented with questions of infringement as to NTP's system claims containing the “interface” or “interface switch” limitation; namely, claim 15 of the '960 patent; claim 8 of

418 F.3d 1282, 75 U.S.P.Q.2d 1763

(Cite as: 418 F.3d 1282)

the '670 patent; and claims 28 and 248 of the '451 patent.

[28][29] We reach a different conclusion as to NTP's asserted method claims. Under section 271(a), the concept of “use” of a patented method or process is fundamentally different from the use of a patented system or device. *In re Kollar*, 286 F.3d 1326, 1332 (Fed.Cir.2002) (recognizing “the distinction between a claim to a product, device, or apparatus, all of which are tangible items, and a claim to a process, which consists of a series of acts or steps.... [A process] consists of doing something, and therefore has to be carried out or performed.”); see *Joy Techs., Inc. v. Flakt, Inc.*, 6 F.3d 770, 773 (Fed.Cir.1993) (“The law is unequivocal that the sale of equipment to perform a process is not a sale of the process within the meaning of section 271(a).”). Although the Supreme Court focused on the whole operable assembly of a system claim for infringement in *Deepsouth*, there is no corresponding whole operable assembly of a process *1318 claim. A method or process consists of one or more operative steps, and, accordingly, “[i]t is well established that a patent for a method or process is not infringed unless all steps or stages of the claimed process are utilized.” *Roberts Dairy Co. v. United States*, 208 Ct.Cl. 830, 530 F.2d 1342, 1354 (1976).

[30] Because a process is nothing more than the sequence of actions of which it is comprised, the use of a process necessarily involves doing or performing each of the steps recited. This is unlike use of a system as a whole, in which the components are used collectively, not individually. We therefore hold that a process cannot be used “within” the United States as required by section 271(a) unless each of the steps is performed within this country. In the present case, each of the asserted method claims of the '960, '172, and '451 patents recites a step that utilizes an “interface” or “interface switch,” which is only satisfied by the use of RIM's Relay located in Canada. Therefore, as a matter of law, these claimed methods could not be infringed by use of RIM's system. See *Eli Lilly & Co. v. Am. Cyanamid Co.*, 82 F.3d 1568, 1571 (Fed.Cir.1996) (discussing the enactment of section 271(g) and stating that “[p]rior to the enactment of the [Process Patents Amendments Act of 1988], a patentee holding a process patent

could sue for infringement if others used the process in this country, but had no cause of action if such persons used the patented process abroad to manufacture products, and then imported, used, or sold the products in this country”); see also *Zoltek Corp. v. United States*, 51 Fed.Cl. 829, 836 (2002) (stating that “if a private party practiced even one step of a patented process outside the United States, it avoided infringement liability, as [section 271(a)] was limited to acts committed within the United States”).

Thus, we agree with RIM that a finding of direct infringement by RIM's customers under section 271(a) of the method claims reciting an “interface switch”^{FN14} or an “interface”^{FN15} is precluded by the location of RIM's Relay in Canada. As a consequence, RIM cannot be liable for induced or contributory infringement of the asserted method claims, as a matter of law.

FN14. Claims 32 and 34 of the '960 patent recite “transmitting ... from the interface switch.”

FN15. Claim 199 of the '172 patent recites “receiving ... at the interface”; claim 309 of the '451 patent recites “receiving with one of the at least one interface”; and claims 313 and 317 of the '451 patent recite “receiving the originated electronic mail at the interface.”

b. “offers to sell, or sells”

Because we conclude that RIM's customers could not have infringed the asserted method claims of the '960, '172, and '451 patents under the “use” prong of section 271(a), and thus, could not have provided the necessary predicate for the charges of induced or contributory infringement of those claims, we must consider whether RIM could have directly infringed the method claims under the “sell” or “offer to sell” prongs of section 271(a). The cases cited by RIM are concerned primarily with the “use” and “make” prongs of section 271(a) and do not directly address the issue of whether a method claim may be infringed by selling or offering to sell within the meaning of section 271(a).

418 F.3d 1282, 75 U.S.P.Q.2d 1763

(Cite as: 418 F.3d 1282)

[31] Because the relevant precedent does not address the issue of whether a sale of a claimed method can occur in the United States, even though the contemplated performance of that method would not be wholly within the United States, the issue is one of first impression. We begin *1319 with the language of the statute. Section 271(a) does not define “sells” or “offers to sell,” nor does the statute specify which infringing acts apply to which types of claims. Section 271(a) was merely a codification of the common law of infringement that had developed up to the time of passage of the 1952 Patent Act. It was not meant to change the law of infringement. *DeepSouth*, 406 U.S. at 530 n. 10, 92 S.Ct. 1700. A claim directed to a method or process, although somewhat controversial in the Nineteenth Century, is now a well-established form of claiming. See *In re Tarczy-Hornoch*, 55 C.C.P.A. 1441, 397 F.2d 856, 857–65 (1968) (describing the evolution of Supreme Court precedent concerning process claims). Nevertheless, the precise contours of infringement of a method claim have not been clearly established.

In *Enercon GmbH v. International Trade Commission*, 151 F.3d 1376 (Fed.Cir.1998), this court considered the meaning of the phrase “sale for importation” in the international Trade Commission’s governing statute, 19 U.S.C. § 1337. Because the term “sale” was not defined in the statute, we assumed that Congress intended to give the term its ordinary meaning. *Id.* at 1381. In considering the ordinary meaning, we looked to dictionaries and to the Uniform Commercial Code. *Id.* at 1382. We employ a similar methodology here, looking to the ordinary meaning of the term “sale.” The definition of “sale” is: “1. The transfer of property or title for a price. 2. The agreement by which such a transfer takes place. The four elements are (1) parties competent to contract, (2) mutual assent, (3) a thing capable of being transferred, and (4) a price in money paid or promised.” *Black’s Law Dictionary* 1337 (7th ed.1999). Thus, the ordinary meaning of a sale includes the concept of a transfer of title or property. The definition also requires as the third element “a thing capable of being transferred.” It is difficult to apply this concept to a method claim consisting of a series of acts. See *Minton v. Nat’l*

Ass’n of Sec. Dealers, Inc., 336 F.3d 1373, 1378 (Fed.Cir.2003) (“[A] process is a series of acts, and the concept of sale as applied to those acts is ambiguous.”). It is difficult to envision what property is transferred merely by one party performing the steps of a method claim in exchange for payment by another party. Moreover, performance of a method does not necessarily require anything that is capable of being transferred.

Congress has consistently expressed the view that it understands infringement of method claims under section 271(a) to be limited to use. The committee reports surrounding the passage of the Process Patents Amendments Act of 1987 indicate that Congress did not understand all of the infringing acts in section 271(a) to apply to method claims. The Senate Report explains, “Under our current patent laws, a patent on a process gives the patentholder the right to exclude others from using that process in the United States without authorization from the patentholder. The other two standard aspects of the patent right—the exclusive right to make or sell the invention—are not directly applicable to a patented process.” S.Rep. No. 100–83, at 30 (1987). The House Report expresses a similar view: “With respect to process patents, courts have reasoned that the only act of infringement is the act of making through the use of a patented process” H.R.Rep. No. 99–807, at 5 (1986). Although this issue has not been directly addressed, this court expressed a similar view in *Joy Technologies, Inc. v. Flakt, Inc.*, 6 F.3d 770 (Fed.Cir.1993). In that case, we said, “A method claim is *directly* infringed only by one practicing the patented method.” *Id.* at 775.

*1320 In 1994, Congress passed legislation to implement the Uruguay Round of the General Agreement on Tariffs and Trade. Uruguay Round Agreements Act, Pub.L. No. 103–465, 108 Stat. 4809 (1994). That legislation modified section 271(a) to include the infringing acts of offering to sell and importing into the United States. *Id.* § 533, 108 Stat. at 4988. The portion of the Uruguay Round being implemented in the modification of section 271(a) was the Agreement on Trade-Related Aspects of Intellectual Property Rights. That agreement clearly spells out

418 F.3d 1282, 75 U.S.P.Q.2d 1763

(Cite as: 418 F.3d 1282)

the rights to be protected. It states:

I. A patent shall confer on its owner the following exclusive rights:

(a) where the subject matter of a patent is a product, to prevent third parties not having the owner's consent from the acts of: making, using, offering for sale, selling or importing for these purposes that product;

(b) where the subject matter of a patent is a process, to prevent third parties not having the owner's consent from the act of using the process, and from the acts of: using, offering for sale, selling, or importing for these purposes at least the product obtained directly by that process.

Agreement on Trade-Related Aspects of Intellectual Property Rights, Apr. 15, 1994, art. 28, H.R. Doc. No. 103-316, at 1634 (1994) (footnote omitted). The agreement makes clear that claimed processes are to be directly protected only from “the act of using the process.” The joint committee report from the Senate reflects the same understanding: “The list of exclusive rights granted to patent owners is expanded to preclude others from offering to sell or importing products covered by a U.S. patent or offering to sell the products of patented processes.” *S. Rep. 103-412, at 230 (1994)*, U.S. Code Cong. & Admin. News 1994 at pp. 3773, 4002. Thus, the legislative history of [section 271\(a\)](#) indicates Congress's understanding that method claims could only be directly infringed by use.

In the context of the on sale bar, we have held that a method claim may be invalid if an offer to perform the method was made prior to the critical date. *Scaltech, Inc. v. Retec/Tetra, LLC*, 269 F.3d 1321, 1328 (Fed.Cir.2001) (“The on sale bar rule applies to the sale of an ‘invention,’ and in this case, the invention was a process, as permitted by § 101. As a result, the process involved in this case is subject to § 102(b).”); see also *Robotic Vision Sys., Inc. v. View Eng'g, Inc.*, 249 F.3d 1307 (Fed.Cir.2001) (affirming invalidity of claimed method under on sale bar where

device capable of performing claimed method was sold). Nevertheless, we have previously “decline[d] to import the authority construing the ‘on sale’ bar of § 102(b) into the ‘offer to sell’ provision of § 271(a).” *3D Sys., Inc. v. Aarotech Labs., Inc.*, 160 F.3d 1373, 1379 n. 4 (Fed.Cir.1998). As the Supreme Court cautioned in *Deepsouth*, 406 U.S. at 531, 92 S.Ct. 1700: “We would require a clear and certain signal from Congress before approving the position of a litigant who, as respondent here, argues that the beachhead of privilege is wider, and the area of public use narrower, than courts had previously thought.” The indication we have from Congress on infringement by selling or offering to sell method claims shows that it believes the beachhead is narrow.

[32] In this case, we conclude that the jury could not have found that RIM infringed the asserted method claims under the “sells” or “offers to sell” prongs of [section 271\(a\)](#). We need not and do not hold that method claims may not be infringed*1321 under the “sells” and “offers to sell” prongs of [section 271\(a\)](#). Rather, we conclude only that RIM's performance of at least some of the recited steps of the asserted method claims as a service for its customers cannot be considered to be selling or offering to sell the invention covered by the asserted method claims. The sale or offer to sell handheld devices is not, in and of itself, enough. Thus, we conclude as a matter of law that RIM did not sell or offer to sell the invention covered by NTP's method claims within the United States.

c. “imports into the United States”

[33] Because the jury's instruction on direct infringement by RIM included the act of importing, we must consider next whether the jury could have found that RIM imported any of the processes covered by the asserted method claims in violation of [section 271\(a\)](#). Like the sell and offer to sell provisions discussed *supra*, the question of whether a method claim can be infringed by importation is a difficult one conceptually. The legislative history cited with respect to the sell and offer to sell provisions indicates that Congress did not consider the “import” prong of [section 271\(a\)](#) to apply to method claims. However, we need not decide that broad issue. We hold only that for the same

418 F.3d 1282, 75 U.S.P.Q.2d 1763

(Cite as: 418 F.3d 1282)

reasons that the jury could not have found that RIM infringed the method claims under the sale or offer for sale prongs, it could not have found infringement by importation under the facts of this case.

3. *Section 271(f)*

[34] RIM argues that it could not infringe under [section 271\(f\)\(1\)](#) as a matter of law because it did not reship the handhelds and software components from the United States to induce combination in Canada. RIM argues that it could not infringe under [section 271\(f\)\(2\)](#) because it did not intend to reship the components from the United States to Canada for combination. RIM also asserts that it could not intend or induce any combination “outside the United States” because no component combined with the Relay in Canada was shipped to Canada from the United States.

NTP counters that the claimed system is formed somewhere and that RIM induced or intended that formation by supplying components in the United States. NTP argues that RIM infringes under [section 271\(f\)](#), regardless of whether components supplied in the United States move across borders.

The arguments of the parties are directed to the system claims but do not address infringement of the method claims under [section 271\(f\)](#). Because we have determined that the system claims are infringed under [section 271\(a\)](#), we need not consider infringement of the system claims under [section 271\(f\)](#) and will limit our infringement analysis under [section 271\(f\)](#) to the method claims at issue.

The statute provides:

(1) Whoever without authority supplies or causes to be supplied in or from the United States all or a substantial portion of the *components of a patented invention*, where such components are uncombined in whole or in part, in such manner as to actively induce the combination of such components outside of the United States in a manner that would infringe the patent if such combination occurred within the United States, shall be liable as

an infringer.

(2) Whoever without authority supplies or causes to be supplied in or from the United States *any component of a patented invention* that is especially made or especially adapted for use in the invention and not a staple article or commodity***1322** of commerce suitable for substantial non-infringing use, where such component is uncombined in whole or in part, knowing that such component is so made or adapted and intending that such component will be combined outside of the United States in a manner that would infringe the patent if such combination occurred within the United States, shall be liable as an infringer.

[35 U.S.C. § 271\(f\) \(2000\)](#) (emphases added).

As discussed *supra*, [section 271\(f\)](#) was Congress's response to *Deepsouth*, which involved an article of manufacture and not a process. [406 U.S. at 519–20, 92 S.Ct. 1700](#). During the legislative debates, Congress discussed components of a “product” but did not refer to components of a “process.” S.Rep. No. 98–663, at 3, 6 (1984); 130 Cong. Rec. 28,069 (1984).

[35] Recently, the court in *Eolas Technologies Inc. v. Microsoft Corp.*, [399 F.3d 1325, 1338–41 \(Fed.Cir.2005\)](#), addressed [section 271\(f\)](#) in the context of a suit for infringement of claim to an article of manufacture. In *Eolas*, the issue was whether software code exported on a “golden master” disk could be “a component[] of a patented invention” under [section 271\(f\)](#). *Id.* at 1338–39. The claim was directed to a software product, comprising (1) “a computer usable medium having computer readable program code physically embodied therein” and (2) “computer readable program code.” [U.S. Patent No. 5,838,906](#), col. 17, l. 58–col. 18, l. 30. *Eolas* held that software code—even if intangible—is a component of a patented product within the meaning of [§ 271\(f\)](#). *Eolas*, [399 F.3d at 1338–41](#). The holding does not impact the application of [section 271\(f\)](#) to the method claims in the present appeal. Although *Eolas* was correct to observe that Congress did

418 F.3d 1282, 75 U.S.P.Q.2d 1763

(Cite as: 418 F.3d 1282)

not expressly limit section 271(f) to a specific type of invention, we have held that “[t]he very nature of the invention may compel a difference.” *Minton v. Nat’l Ass’n of Sec. Dealers, Inc.*, 336 F.3d 1373, 1378 (Fed.Cir.2003). A method, by its very nature, is nothing more than the steps of which it is comprised. The invention recited in a method claim is the performance of the recited steps. *In re Kollar*, 286 F.3d at 1332 (recognizing “the distinction between a claim to a product, device, or apparatus, all of which are tangible items, and a claim to a process, which consists of a series of acts or steps [A process] consists of doing something, and therefore has to be carried out or performed”).

While it is difficult to conceive of how one might supply or cause to be supplied all or a substantial portion of the steps of a patented method in the sense contemplated by the phrase “components of a patented invention” in section 271(f), it is clear that RIM’s supply of the BlackBerry handheld devices and Redirector products to its customers in the United States is not the statutory “supply” of any “component” steps for combination into NTP’s patented methods. See *Standard Havens Prods., Inc. v. Gencor Indus., Inc.*, 953 F.2d 1360, 1374 (Fed.Cir.1991) (holding that the sale in the United States of an apparatus for carrying out a claimed process did not infringe the process claim under § 271(f) where the customer practiced the process abroad); cf. *Joy Techs.*, 6 F.3d at 773 (stating that “[t]he law is unequivocal that the sale of equipment to perform a process is not a sale of the process within the meaning of section 271(a)”). By merely supplying products to its customers in the United States, RIM is not supplying or causing to be supplied in this country any steps of a patented process invention for combination outside the United States and cannot infringe NTP’s asserted method *1323 claims under section 271(f) as a matter of law.

4. Section 271(g)

[36] The next question is whether RIM can be said to “import[] into ... or offer[] to sell, sell[], or use[] within the United States a product which is made by a process patented in the United States” and thus infringe under 35 U.S.C. § 271(g). The district court held that “wireless

electronic mail” specially formatted by a patented process can be a “product” under section 271(g). *Section 271 Order* at 13–14. The district court compared the breadth of “product” to the breadth of patentable subject matter, cited to *Diamond v. Chakrabarty*, 447 U.S. 303, 100 S.Ct. 2204, 65 L.Ed.2d 144 (1980), and explained that specially formatted wireless e-mail is not naturally occurring, an abstract idea, or a physical phenomenon. *Section 271 Order* at 14.

RIM argues that the product created by the NTP process is data or information, and that *Bayer AG v. Housey Pharmaceuticals, Inc.*, 340 F.3d 1367 (Fed.Cir.2003), held that section 271(g) does not cover the production of intangible items. NTP counters that *Bayer* held only that a “product” cannot be “information in the abstract.” NTP asserts that the “email packets” flowing from the BES, to the interface, and back to the RF receiver, have a “tangible” structure which includes the interface address, an RF address, and the inputted message. NTP argues that *AT & T Corp. v. Excel Communications, Inc.*, 172 F.3d 1352 (Fed.Cir.1999); *State Street Bank & Trust Co. v. Signature Financial Group*, 149 F.3d 1368 (Fed.Cir.1998); and *In re Alappat*, 33 F.3d 1526 (Fed.Cir.1994), illustrate that the transformation of data can produce a tangible result, that RIM transforms data by moving email through the network, and that the tangible result of the transformation is a product under section 271(g). NTP adds that RIM “manufactures” email into its tangible structure and “imports” email using patented methods, in part, by replacing the interface address with the RF receiver address at the interface Relay. RIM responds that the email packets that it may transfer into the United States are not manufactured, physical goods, and therefore are not “products” under section 271(g).

In *Bayer*, we considered whether research data from the performance of a method to identify substances, which inhibit or activate a protein affecting characteristics of the cell, was “a product which is made by a process.” 340 F.3d at 1370. We held that “the production of information is not covered” by section 271(g), explaining that the process must be for the “manufacturing” of “a physical article.” *Id.*

418 F.3d 1282, 75 U.S.P.Q.2d 1763

(Cite as: 418 F.3d 1282)

at 1377. In this case, the relevant claims are directed to methods for the transmission of information in the form of email messages. See '960 patent, col. 52, ll. 12–50; col. 54, ll. 31–36, 59–68; col. 55, ll. 10–14 (claiming methods for “transmitting” information from an originating processor to a destination processor); '172 patent, col. 82, ll. 11–33, 57–64 (claiming a method for “transmitting and distributing an inputted message” through an email system and an RF system); '451 patent, col. 51, ll. 41–60; col. 58, ll. 8–26, 34–63; col. 59, ll. 1–6, 24–30 (claiming methods for “transmitting information” contained in email using a communication system and RF system, and for “transmitting and distributing inputted information through a distributed system”). Because the “transmission of information,” like the “production of information,” does not entail the manufacturing of a physical product, section 271(g) does not apply to the asserted method claims in this case any more than it did in *Bayer*.

*1324 *AT & T, State Street Bank, Alappat, and Chakrabarty* do not command a different result because sections 101 and 271(g) are not coextensive in their coverage of process inventions. Although section 101 extends to “a [ny] process that applies an equation to a new and useful end,” *AT & T*, 172 F.3d at 1357, section 271(g) does not cover every patented process and its purported result, *Bayer*, 340 F.3d at 1370. In *Bayer*, we expressed no doubt that a process producing research data is patentable under section 101. See 340 F.3d at 1371–78. However, we held that section 271(g) was inapplicable because research data is not a physical product. *Id.* at 1378. NTP's argument that the transformation of data and the manipulation of addresses qualify the asserted processes for section 271(g) protection is unpersuasive. The requirement that a process transform data and produce a “tangible result” was a standard devised to prevent patenting of mathematical abstractions. *AT & T*, 172 F.3d at 1359. We rejected this “tangible result” test for section 271(g) in *Bayer* when we held that research data—a “tangible result” for section 101 purposes—did not garner the protection of section 271(g).

For the foregoing reasons, the district court erred in not holding as a matter of law that § 271(g) was inappli-

able to the asserted method claims.

5. Denial of Judgment as a Matter of Law

[37][38] “The grant or denial of a motion for judgment as a matter of law is a procedural issue not unique to patent law, reviewed under the law of the regional circuit in which the appeal from the district court would usually lie.” *Summit Tech., Inc. v. Nidek Co.*, 363 F.3d 1219, 1223 (Fed.Cir.2004). Under the law of the Fourth Circuit, the denial of a motion for judgment as a matter of law is reviewed *de novo*. *Johnson v. MBNA Am. Bank, NA*, 357 F.3d 426, 431 (4th Cir.2004). “We must view the evidence in the light most favorable to ... the nonmovant, and draw all reasonable inferences in [the non-movant's] favor without weighing the evidence or assessing the witnesses' credibility.” *Id.* “The question is whether a jury, viewing the evidence in the light most favorable to [the non-movant], could have properly reached the conclusion reached by this jury.” *Baynard v. Malone*, 268 F.3d 228, 235 (4th Cir.2001). “We must reverse [the denial of a motion for JMOL] if a reasonable jury could only rule in favor of [the movant]; if reasonable minds could differ, we must affirm.” *Id.*

[39] To establish that no reasonable jury could have found infringement, RIM challenges the testimony of NTP's expert, Dr. Vernon Rhyne, who opined during trial that the BlackBerry Corporate and Internet solutions met the limitations of asserted claims from the '960, '670, '172, and '451 patents. According to RIM, Dr. Rhyne's testimony was inconsistent with that of Alan Lewis, a RIM employee, though it was Lewis's testimony on which Dr. Rhyne, in part, based his conclusions. This inconsistency, argues RIM, prevented the testimony from amounting to substantial evidence on which a jury could deliver a verdict of infringement. We disagree. As NTP correctly notes, (1) Dr. Rhyne's testimony was not based exclusively on Lewis's testimony, and (2) the jury had before it evidence other than Dr. Rhyne's testimony that demonstrated infringement. We conclude that the district court did not err in denying RIM's JMOL motion of non-infringement.

[40] RIM next contends no reasonable jury could have

418 F.3d 1282, 75 U.S.P.Q.2d 1763

(Cite as: 418 F.3d 1282)

found the asserted claims to be not invalid over certain “AlohaNet” prior art, either alone or in combination with a 1975 article by the AlohaNet inventor,***1325** Dr. Abramson. AlohaNet was a pioneering network system developed at the University of Hawaii. According to RIM, the AlohaNet system facilitated communications over both wireline and wireless networks as early as 1973. At trial, RIM’s expert, Dr. Reed, testified that the AlohaNet system met each of the asserted claim limitations. On appeal, RIM attempts to rebut the three distinctions drawn by NTP at trial to differentiate the Campana invention from the prior art. In response, NTP emphasizes that RIM’s invalidity argument was premised on the testimony of Dr. Reed, which the jury found not to be credible. In its JMOL order, the district court reached this same conclusion: “[M]uch of Dr. Reed’s direct testimony was conclusory and failed to analyze and explain the claim language and which components of the prior art embodied each element of the asserted claims.” *JMOL Order*, slip op. at 6. We agree with the district court that “[s]uch conclusory evidence is hardly enough to meet RIM’s high burden of clear and convincing evidence with respect to anticipation and obviousness.” *Id.* We thus affirm the district court’s denial of JMOL on the validity issue.

C. Evidentiary Rulings

Finally, RIM contests three evidentiary rulings made by the court: (1) the exclusion of the testimony of Larry Nixon, a patent attorney who would have testified on behalf of RIM that under the district court’s claim construction, the claims were invalid for want of an adequate written description, *see* 35 U.S.C. § 112; ^{FN16} (2) the exclusion of the testimony of RIM employee Alan Lewis, who was to opine on certain aspects of the BES system; and (3) the exclusion of the demonstration of a “TekNow” prior art system and related testimony after doubt was cast on the authenticity of that evidence. In reviewing a district court’s evidentiary rulings, we apply the law of the relevant regional circuit. *Sulzer Textil A.G. v. Picanol N.V.*, 358 F.3d 1356, 1363 (Fed.Cir.2004). Under the law of the Fourth Circuit, the district court’s exclusion of expert testimony is reviewed under an abuse of discretion standard. *United States v. Wilkerson*, 84 F.3d 692, 696 (4th

Cir.1996). We have reviewed RIM’s arguments in connection with these evidentiary rulings and have concluded that the court acted within its discretion.

FN16. Our decision that the district court did not abuse its discretion in excluding the particular testimony in this case should not be read as expressing a view on the propriety of the use of patent attorneys as experts on patent law issues generally.

III. CONCLUSION

In conclusion, we alter the district court’s construction of the claim term “originating processor.” We affirm the remainder of the district court’s claim constructions. We conclude that the district court correctly denied RIM’s motion for judgment as a matter of law (“JMOL”), and did not abuse its discretion in denying evidentiary motions. We further conclude that the district court was correct in sending the question of infringement of the system and apparatus claims to the jury, but erred as a matter of law in entering judgment of infringement of the method claims. Accordingly, we reverse the judgment of infringement as to the asserted method claims, namely, claims 32 and 34 of the '960 patent; claim 199 of the '172 patent; and claims 309, 313, 317 of the '451 patent. We affirm the judgment of infringement with respect to the system and apparatus claims that do not contain an “originating processor” limitation, namely, claims 28 and 248 of the '451 patent, and ***1326** claims 150, 278, 287, 653, and 654 of the '592 patent. We vacate the judgment of infringement of the system claims that contain the “originating processor” limitation, namely, claim 15 of the '960 patent; claim 8 of the '670 patent; and claim 40 of the '592 patent (through its parent claim 25), and remand to the district court the questions of whether and to what extent the jury verdict of infringement should be set aside, based on the prejudicial effect, if any, of the district court’s erroneous claim construction of the term “originating processor.” We vacate the damage award and the injunction and affirm the district court’s judgment in all other respects.

On remand, if prejudice is shown with respect to the

418 F.3d 1282, 75 U.S.P.Q.2d 1763

(Cite as: 418 F.3d 1282)

claims containing the “originating processor” limitation, and because the jury verdict did not specify the amount of infringing sales attributed to each individual patent claim, or the specific devices and services determined by the jury to infringe each separately asserted claim, the district court will have to determine the effect of any alteration of the jury verdict on the district court's damage award and on the scope of the district court's injunction. We thus affirm-in-part, reverse-in-part, vacate-in-part, and remand for further proceedings consistent with this opinion.

IV. COSTS

Each party shall bear its own costs.

AFFIRMED-IN-PART, REVERSED-IN-PART, VACATED-IN-PART, AND REMANDED

C.A.Fed. (Va.),2005.

NTP, Inc. v. Research In Motion, Ltd.

418 F.3d 1282, 75 U.S.P.Q.2d 1763

END OF DOCUMENT