

[54] AUTOMATIC OPENING AND CLOSING DEVICE FOR A WINDOW

[75] Inventors: Takeshi Itoh, Katsuta; Akihiko Tsukahara, Fujisawa, both of Japan

[73] Assignee: Jidosha Denki Kogyo Kabushiki Kaisha, Kanagawa, Japan

[21] Appl. No.: 103,767

[22] Filed: Oct. 2, 1987

[30] Foreign Application Priority Data

Oct. 3, 1986 [JP] Japan ..... 61-234658
Oct. 9, 1986 [JP] Japan ..... 61-240378

[51] Int. Cl.<sup>4</sup> ..... H02P 1/22

[52] U.S. Cl. .... 318/286; 318/266; 318/466

[58] Field of Search ..... 318/256, 265, 266, 466, 318/467, 468, 469, 470, 603, 280, 286; 29/26, 28, 199

[56] References Cited

U.S. PATENT DOCUMENTS

4,035,702 7/1977 Pettersen et al. .... 318/467 X
4,234,833 11/1980 Barrett ..... 318/468 X
4,514,670 4/1985 Fassel et al. .... 318/266 X
4,529,920 7/1985 Yoshida et al. .... 318/466

4,563,625 1/1986 Kornbrekke et al. .... 318/603
4,608,637 8/1986 Okuyama et al. .... 318/466

FOREIGN PATENT DOCUMENTS

2580717 10/1986 France ..... 49/199

Primary Examiner—Bentsu Ro
Attorney, Agent, or Firm—Sughrue, Mion, Zinn, Macpeak & Seas

[57] ABSTRACT

An automatic opening and closing device for a window which has a forwardly and reversely rotatable motor for opening and closing the window, switching means which instructs said motor to rotate, pulse-detecting means which detects a pulse generated along with a rotation of said motor, counting means which counts a pulse number detected by said pulse-detecting means and rotation-controlling means which performs rotation-control to said motor on basis of a count number counted by said counting means and a predetermined count number is disclosed, by which it is possible to stop the opening or closing action of the window at a halfway, or possible to convert the action of the window in the reverse direction.

5 Claims, 12 Drawing Sheets

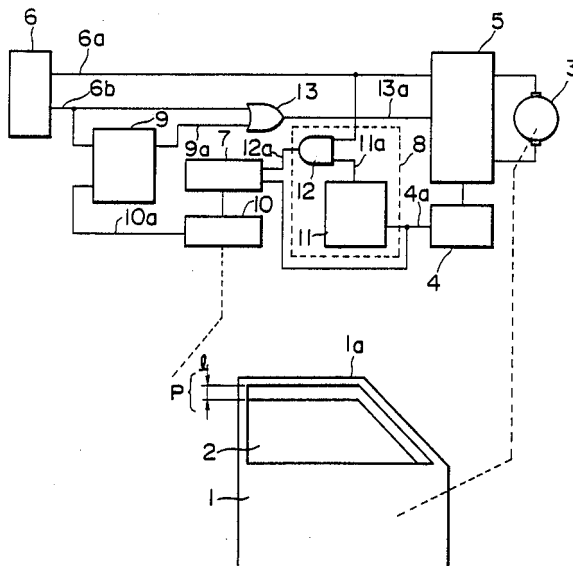

FIG. 1

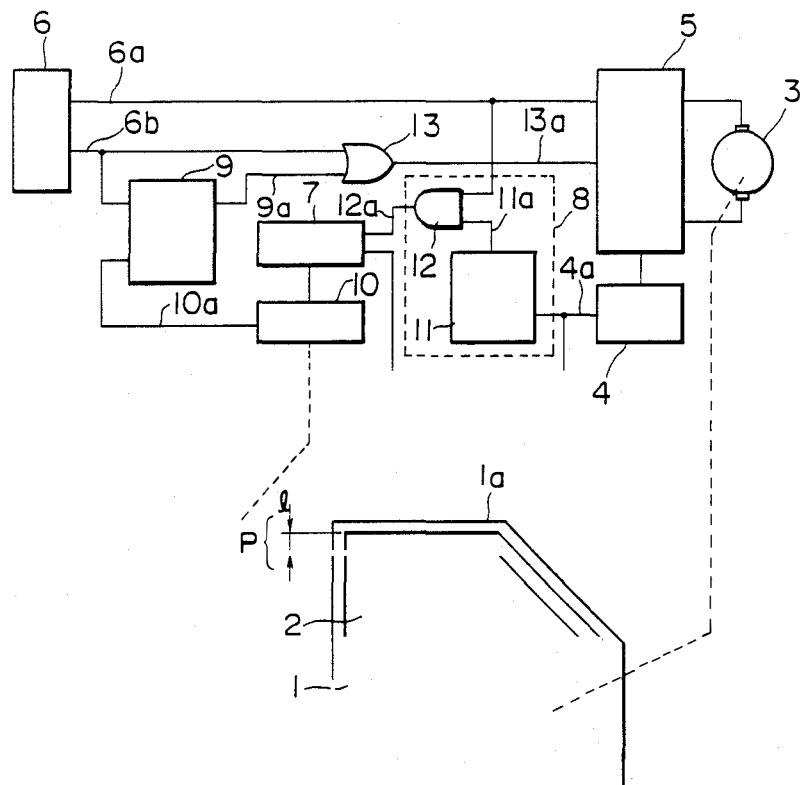

FIG.2 (a)

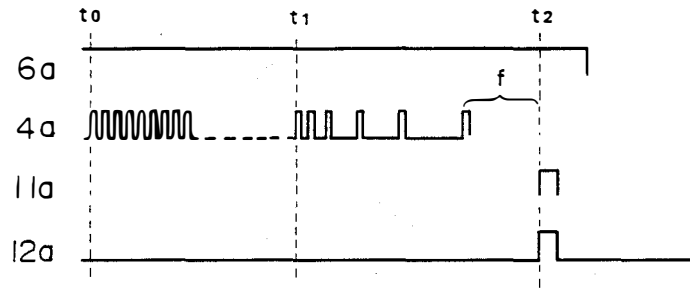

FIG.2 (b)

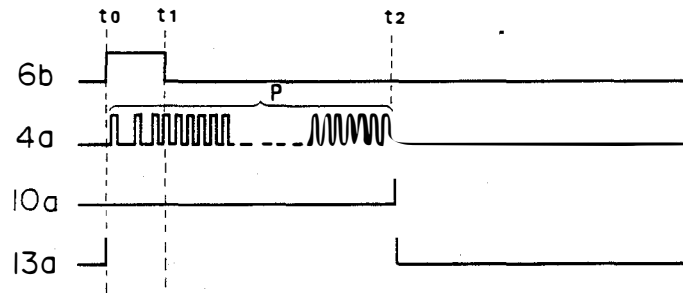

FIG.2 (c)

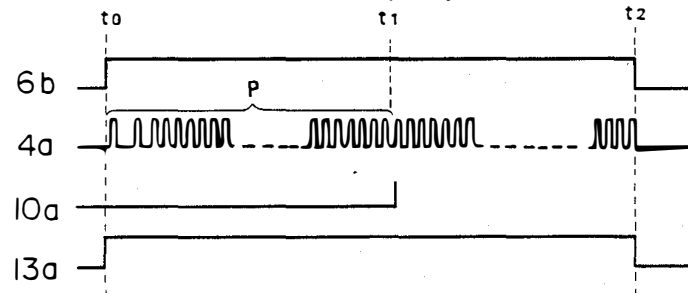

FIG. 3

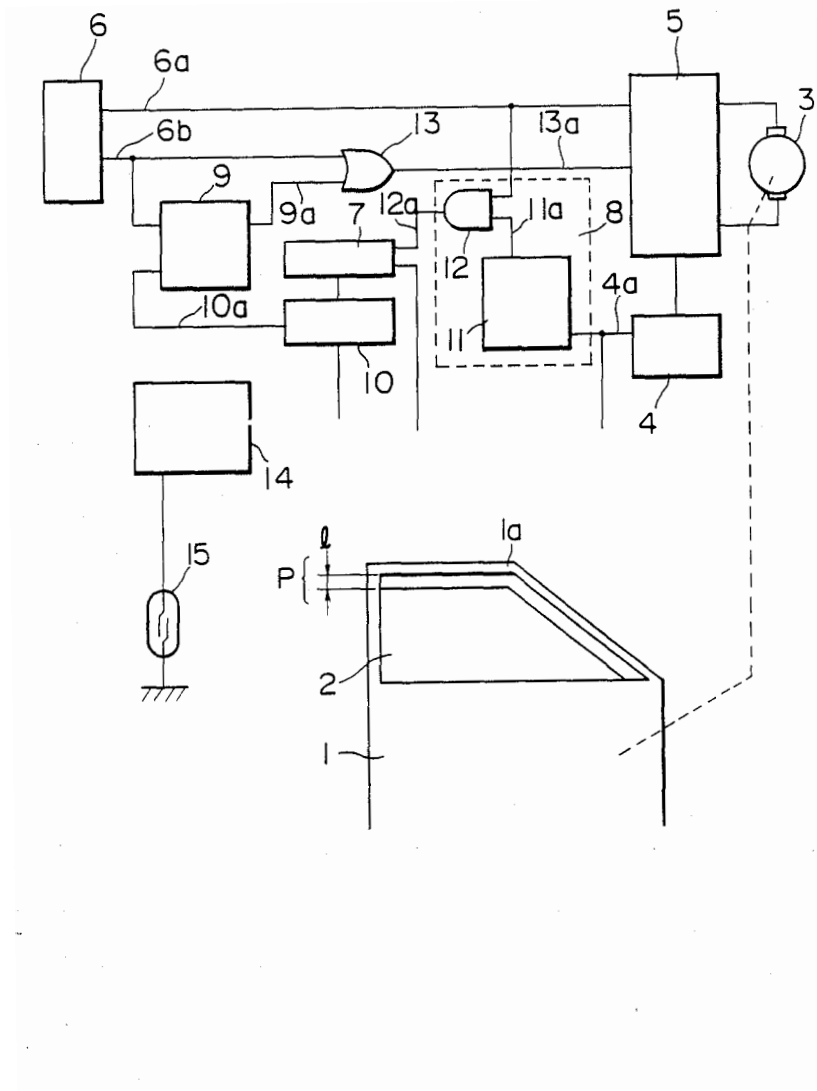
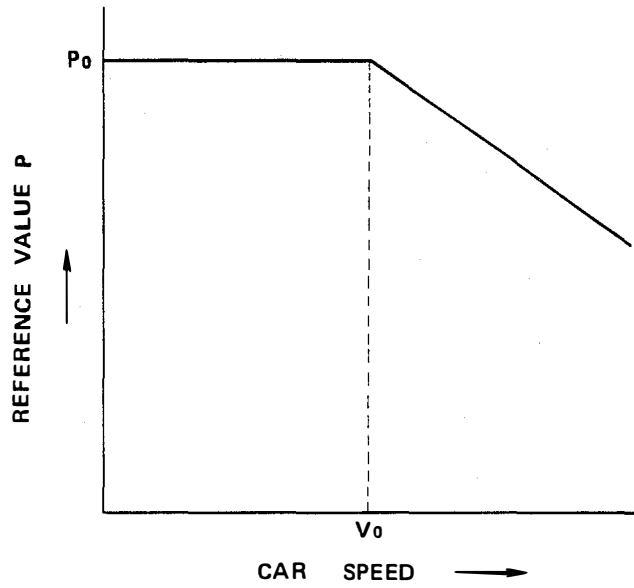

FIG. 4



# Explore Litigation Insights

Docket Alarm provides insights to develop a more informed litigation strategy and the peace of mind of knowing you're on top of things.

## Real-Time Litigation Alerts



Keep your litigation team up-to-date with **real-time alerts** and advanced team management tools built for the enterprise, all while greatly reducing PACER spend.

Our comprehensive service means we can handle Federal, State, and Administrative courts across the country.

## Advanced Docket Research



With over 230 million records, Docket Alarm's cloud-native docket research platform finds what other services can't. Coverage includes Federal, State, plus PTAB, TTAB, ITC and NLRB decisions, all in one place.

Identify arguments that have been successful in the past with full text, pinpoint searching. Link to case law cited within any court document via Fastcase.

## Analytics At Your Fingertips



Learn what happened the last time a particular judge, opposing counsel or company faced cases similar to yours.

Advanced out-of-the-box PTAB and TTAB analytics are always at your fingertips.

## API

Docket Alarm offers a powerful API (application programming interface) to developers that want to integrate case filings into their apps.

## LAW FIRMS

Build custom dashboards for your attorneys and clients with live data direct from the court.

Automate many repetitive legal tasks like conflict checks, document management, and marketing.

## FINANCIAL INSTITUTIONS

Litigation and bankruptcy checks for companies and debtors.

## E-DISCOVERY AND LEGAL VENDORS

Sync your system to PACER to automate legal marketing.