

CA (US); **Ana R. Menk**, Minneapolis, MN (US); **Mark J. Capps**, Mission Viejo, CA (US); **Billie J. Millwee**, Fullerton, CA (US); **Janice Lynn Shay**, Lake Forest, CA (US); **Debra Ann Taitague**, Orange, CA (US); **Joseph C. Morrow**, Fridley, MN (US); **Jerald Redmond**, Blaine, MN (US)

7,635,386	B1 *	12/2009	Gammie	623/2.11
7,704,277	B2	4/2010	Zakay et al.	
2004/0210303	A1 *	10/2004	Sedransk	623/2.1
2004/0210304	A1 *	10/2004	Seguin et al.	623/2.11
2005/0203616	A1	9/2005	Cribier	
2006/0195183	A1 *	8/2006	Navia et al.	623/2.18
2007/0118154	A1 *	5/2007	Crabtree	606/151

(Continued)

FOREIGN PATENT DOCUMENTS

DE 200 03 874 6/2000
(Continued)

OTHER PUBLICATIONS

Bolling, et al., "Mitral Valve Reconstruction in the Patient with Heart Failure," Heart Failure Reviews, 6, 177-185, 2001.
(Continued)

Primary Examiner — Christopher D Koharski
Assistant Examiner — Rebecca Straszheim

(57) **ABSTRACT**

A stented valve of two or more leaflets made of pericardium or other material having a relatively thin profile at the annulus. The leaflet surfaces are attached via chords to a stent frame, where the chords are positioned to mimic the native valve anatomy and functionality. In particular, the valves of one exemplary embodiment of the invention are sized to replace a mitral valve and therefore the chords are arranged to prevent prolapse of the leaflets into the atrium. The stented valve has a relatively short height at its annulus due to the positioning of the chords. In addition, the stented valve is capable of being crimped to a small enough size that it can be delivered to the implantation site via transcatheter delivery systems and methods.

15 Claims, 3 Drawing Sheets

- (73) Assignee: **Medtronic, Inc.**, Minneapolis, MN (US)
- (*) Notice: Subject to any disclaimer, the term of this patent is extended or adjusted under 35 U.S.C. 154(b) by 342 days.
- (21) Appl. No.: **12/429,054**
- (22) Filed: **Apr. 23, 2009**
- (65) **Prior Publication Data**
US 2009/0281618 A1 Nov. 12, 2009
- Related U.S. Application Data**
- (60) Provisional application No. 61/125,235, filed on Apr. 23, 2008.
- (51) **Int. Cl.**
A61F 2/24 (2006.01)
- (52) **U.S. Cl.** 623/2.14; 623/1.24
- (58) **Field of Classification Search** None
See application file for complete search history.

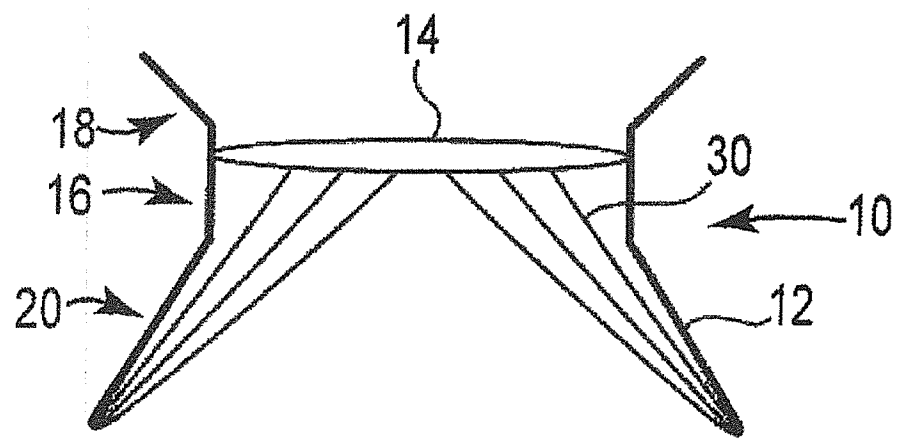

2009/0919337 A1 12/2009 Rowe et al.
2010/0030330 A1 2/2010 Bobo et al.
2010/0036479 A1 2/2010 Hill et al.
2010/0042147 A1 2/2010 Janowsky et al.
2010/0217382 A1 8/2010 Chau et al.

FOREIGN PATENT DOCUMENTS

DE 100 10 074 4/2005
DE 102007043830 4/2009

Bozonseni, et al., "Transparent Mitral Valved Stent Implantation,"
Ann. Thorac. Surg., 2008;86:745-8.
Ma, et al., "Double-crowned valved stents for off-pump mitral valve
replacement," Europ. J. of Cardio-thoracic Surg., 28 (2005) 194-199.
Massana, et al., "Conservative Surgery of the Mitral Valve.
Annuloplasty on a new Adjustable Ring," Cardiovascular Surgery
1980, 1987: 30-37.

* cited by examiner

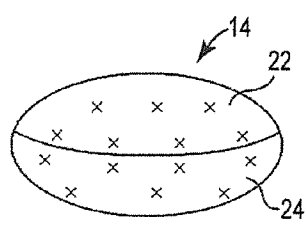

Fig. 1

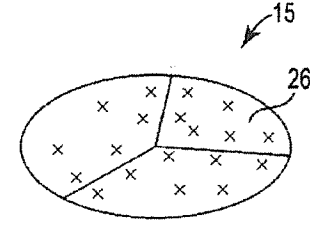

Fig. 2

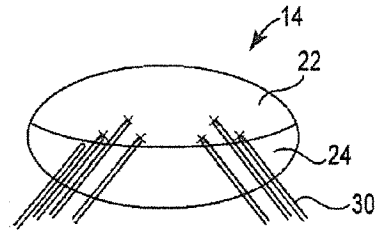

Fig. 3

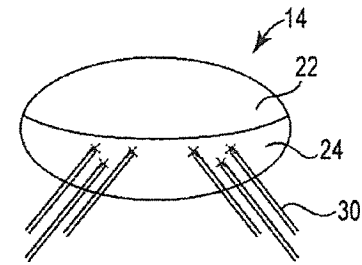

Fig. 4

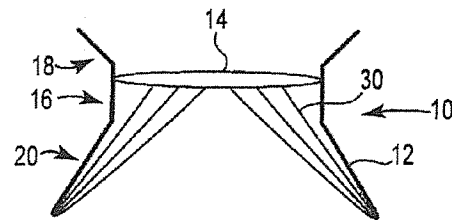

Fig. 5

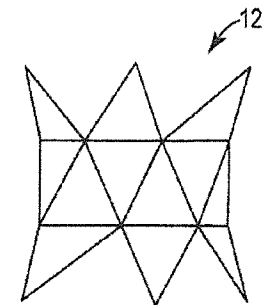

Fig. 6

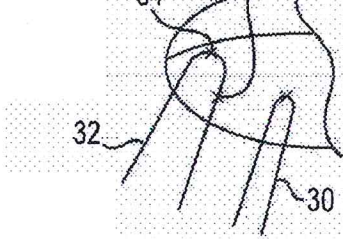

Fig. 7

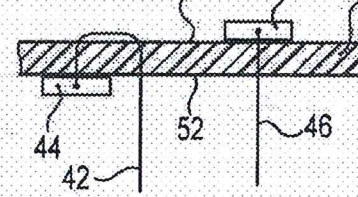

Fig. 8

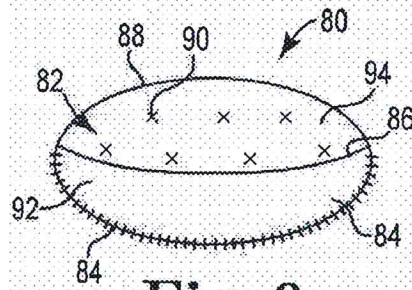

Fig. 9

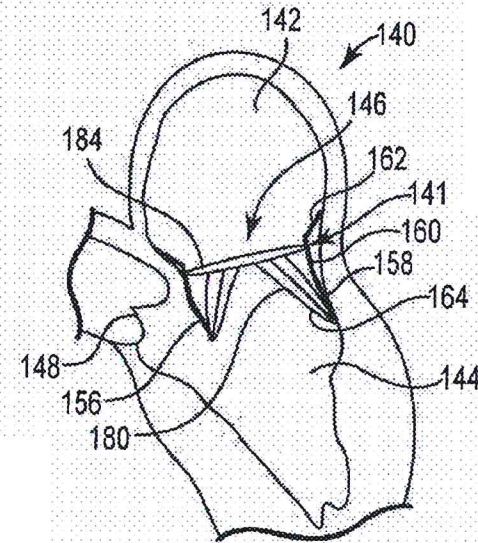

Fig. 10

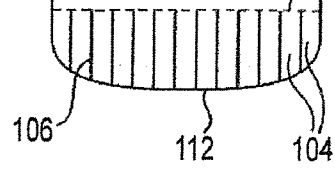

Fig. 11

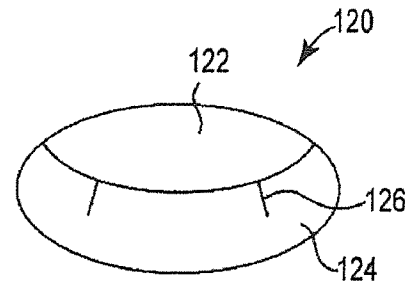

Fig. 12

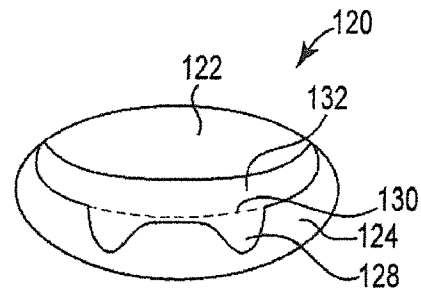

Fig. 13

Explore Litigation Insights

Docket Alarm provides insights to develop a more informed litigation strategy and the peace of mind of knowing you're on top of things.

Real-Time Litigation Alerts



Keep your litigation team up-to-date with **real-time alerts** and advanced team management tools built for the enterprise, all while greatly reducing PACER spend.

Our comprehensive service means we can handle Federal, State, and Administrative courts across the country.

Advanced Docket Research



With over 230 million records, Docket Alarm's cloud-native docket research platform finds what other services can't. Coverage includes Federal, State, plus PTAB, TTAB, ITC and NLRB decisions, all in one place.

Identify arguments that have been successful in the past with full text, pinpoint searching. Link to case law cited within any court document via Fastcase.

Analytics At Your Fingertips



Learn what happened the last time a particular judge, opposing counsel or company faced cases similar to yours.

Advanced out-of-the-box PTAB and TTAB analytics are always at your fingertips.

API

Docket Alarm offers a powerful API (application programming interface) to developers that want to integrate case filings into their apps.

LAW FIRMS

Build custom dashboards for your attorneys and clients with live data direct from the court.

Automate many repetitive legal tasks like conflict checks, document management, and marketing.

FINANCIAL INSTITUTIONS

Litigation and bankruptcy checks for companies and debtors.

E-DISCOVERY AND LEGAL VENDORS

Sync your system to PACER to automate legal marketing.