



US005716417A

United States Patent [19]

Girard et al.

[11] Patent Number: **5,716,417**

[45] Date of Patent: **Feb. 10, 1998**

[54] **INTEGRAL SUPPORTING STRUCTURE FOR BIOPROSTHETIC HEART VALVE**

4,851,000	7/1989	Gupta	623/2
5,258,023	11/1993	Reger	623/900
5,411,552	5/1995	Andersen et al.	623/900

[75] Inventors: **Michael J. Girard**, Lino Lakes; **Todd D. Campbell**, White Bear; **M. William Mirsch, II**, Roseville; **Kristen Swanson**, St. Paul, all of Minn.

FOREIGN PATENT DOCUMENTS

1264471	2/1972	United Kingdom	623/2
2279134	12/1994	United Kingdom	623/2

[73] Assignee: **St. Jude Medical, Inc.**, St. Paul, Minn.

Primary Examiner—John G. Weiss
Assistant Examiner—Bruce E. Snow
Attorney, Agent, or Firm—Hallie A. Finucane

[21] Appl. No.: **472,744**

[22] Filed: **Jun. 7, 1995**

[57] ABSTRACT

[51] Int. Cl.⁶ **A61F 2/24**

[52] U.S. Cl. **623/900; 623/2**

[58] Field of Search **623/900, 2, 3, 623/66**

A stent for receiving and supporting a tissue heart valve for ultimate implantation into a human, the heart valve including tissue leaflets joined at circumferentially spaced commissures, wherein the stent includes at least one commissure support post and at least one sinus support structure each sinus support structure being disposed between but not functionally connected to an adjacent commissure support post.

[56] References Cited

U.S. PATENT DOCUMENTS

3,570,014	3/1971	Hancock	623/900
4,626,255	12/1986	Reichart et al.	623/900

3 Claims, 4 Drawing Sheets

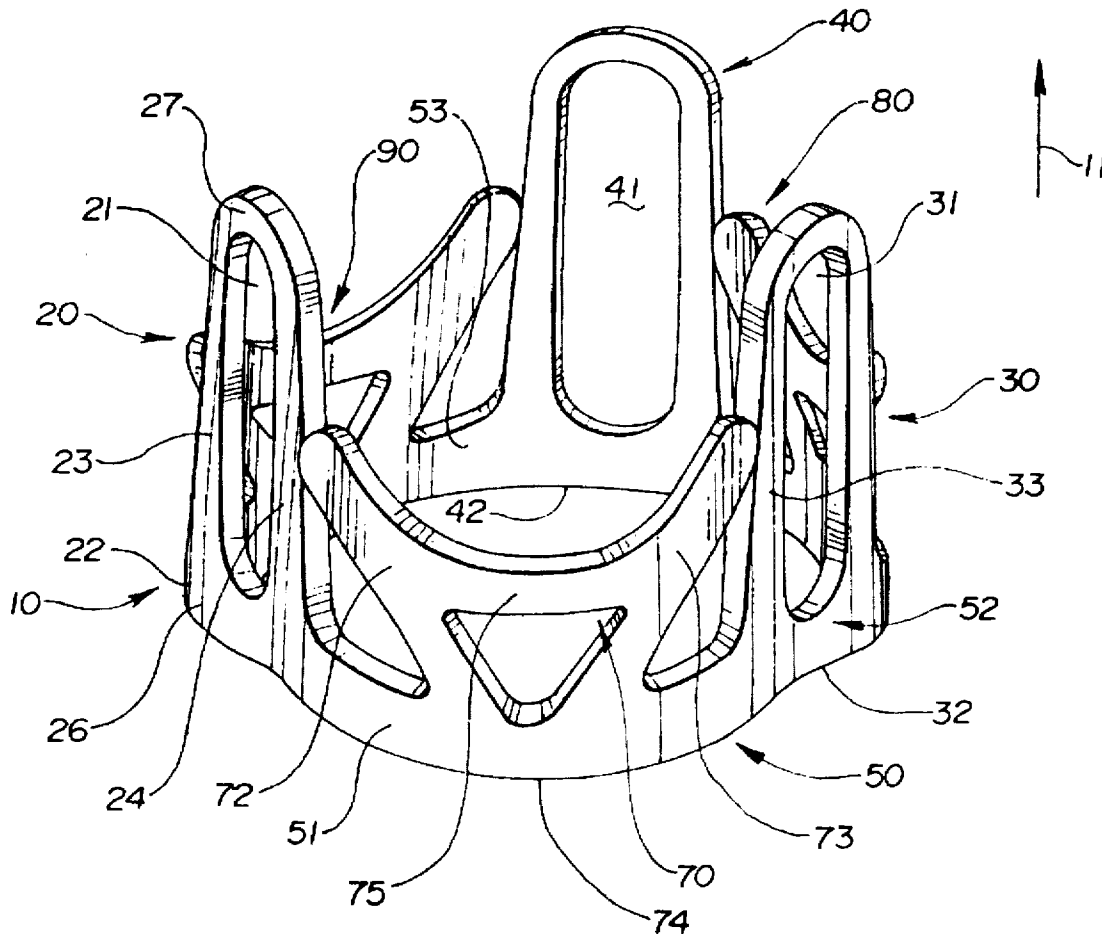

NORRED EXHIBIT 2224 - Page 1

Medtronic, Inc., Medtronic Vascular, Inc., & Medtronic

Fig. 1

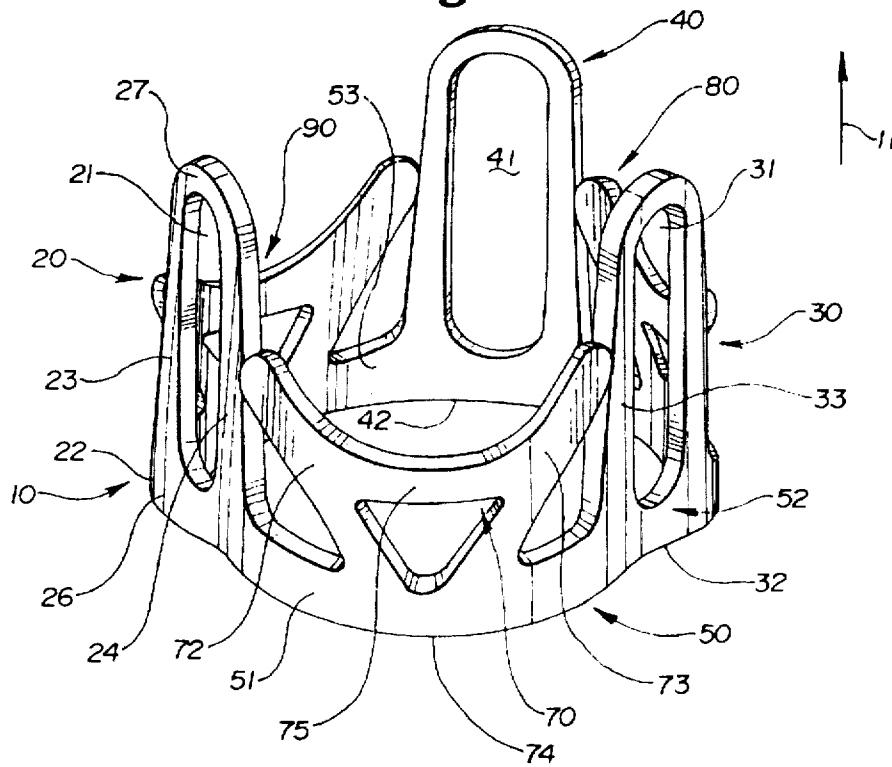

Fig. 2

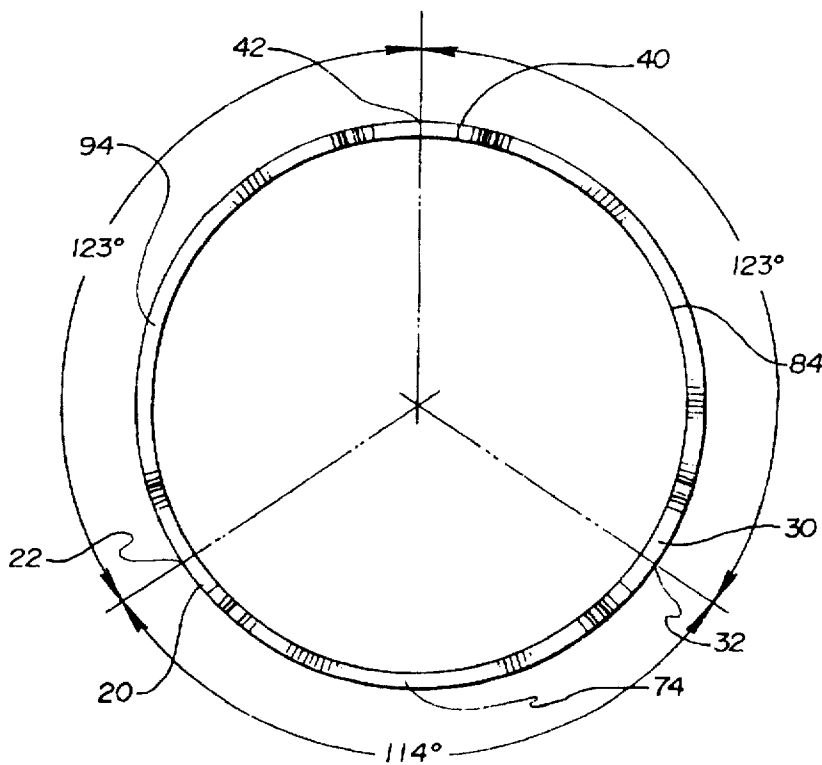

Fig. 3

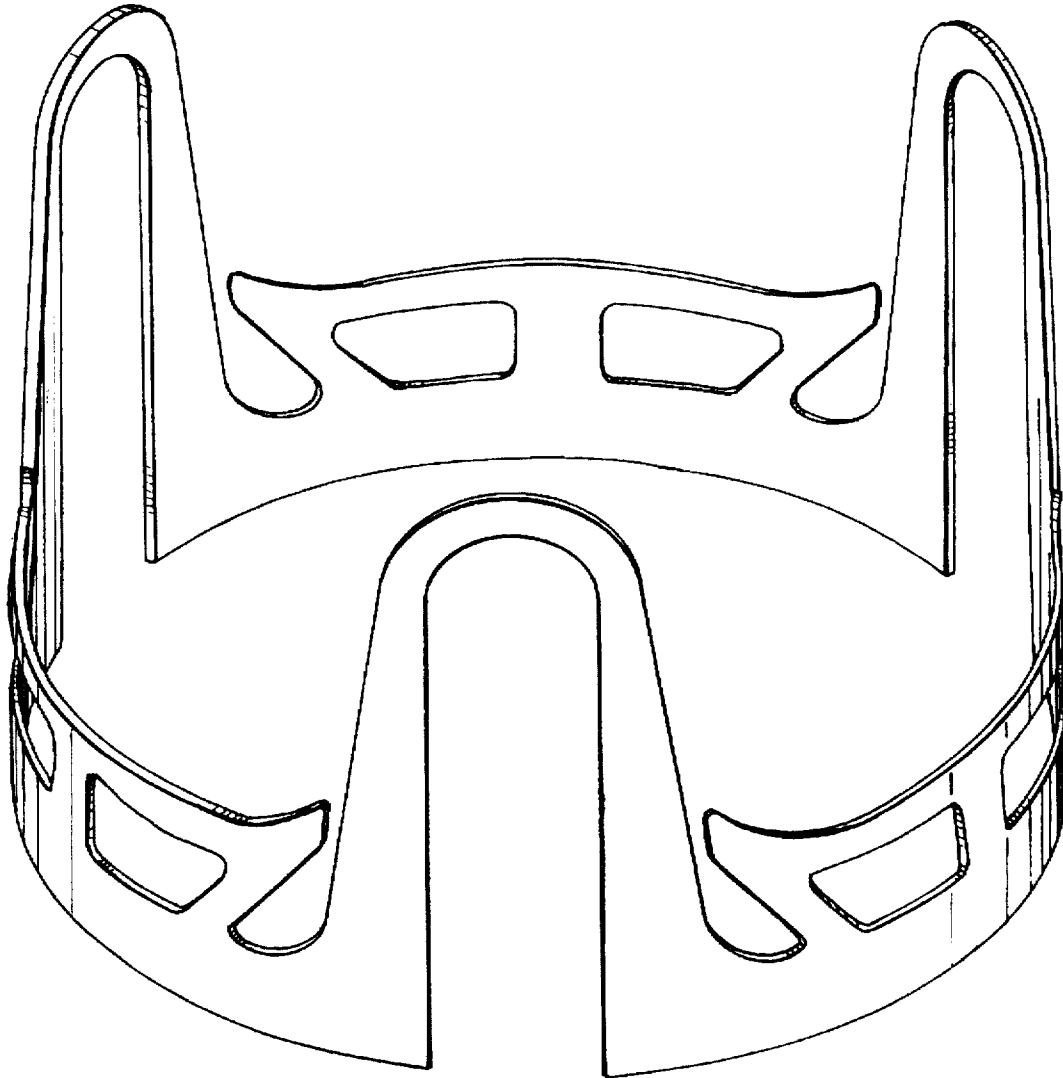

Fig. 4

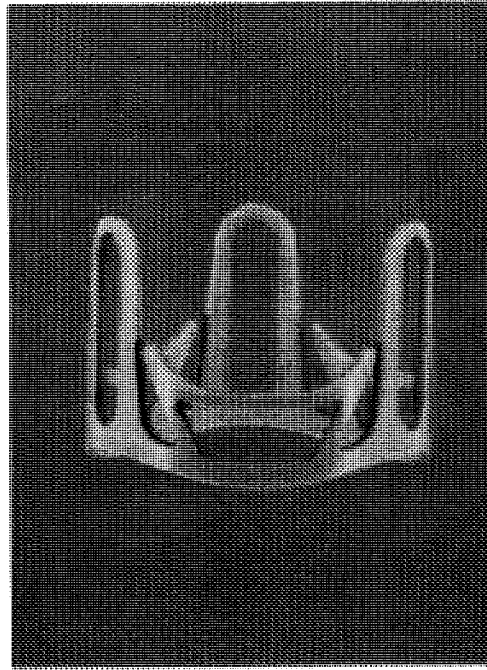

Fig. 5

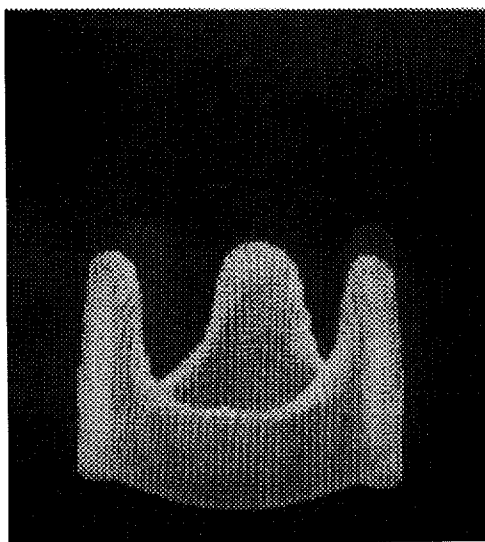
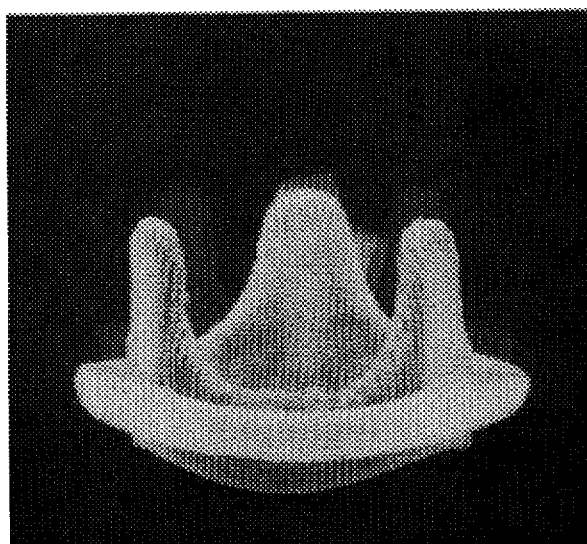

Fig. 6



Explore Litigation Insights

Docket Alarm provides insights to develop a more informed litigation strategy and the peace of mind of knowing you're on top of things.

Real-Time Litigation Alerts



Keep your litigation team up-to-date with **real-time alerts** and advanced team management tools built for the enterprise, all while greatly reducing PACER spend.

Our comprehensive service means we can handle Federal, State, and Administrative courts across the country.

Advanced Docket Research



With over 230 million records, Docket Alarm's cloud-native docket research platform finds what other services can't. Coverage includes Federal, State, plus PTAB, TTAB, ITC and NLRB decisions, all in one place.

Identify arguments that have been successful in the past with full text, pinpoint searching. Link to case law cited within any court document via Fastcase.

Analytics At Your Fingertips



Learn what happened the last time a particular judge, opposing counsel or company faced cases similar to yours.

Advanced out-of-the-box PTAB and TTAB analytics are always at your fingertips.

API

Docket Alarm offers a powerful API (application programming interface) to developers that want to integrate case filings into their apps.

LAW FIRMS

Build custom dashboards for your attorneys and clients with live data direct from the court.

Automate many repetitive legal tasks like conflict checks, document management, and marketing.

FINANCIAL INSTITUTIONS

Litigation and bankruptcy checks for companies and debtors.

E-DISCOVERY AND LEGAL VENDORS

Sync your system to PACER to automate legal marketing.