



(12) **United States Patent**
DiMatteo et al.

(10) **Patent No.:** **US 6,440,164 B1**
(45) **Date of Patent:** **Aug. 27, 2002**

- (54) **IMPLANTABLE PROSTHETIC VALVE**
- (75) Inventors: **Kristian DiMatteo**, Watertown; **Peter Marshall**, Newburyport, both of MA (US)
- (73) Assignee: **Scimed Life Systems, Inc.**, Natick, MA (US)
- (*) Notice: Subject to any disclaimer, the term of this patent is extended or adjusted under 35 U.S.C. 154(b) by 0 days.

- (21) Appl. No.: **09/425,142**
- (22) Filed: **Oct. 21, 1999**
- (51) **Int. Cl.**⁷ **A61F 2/06**; A61F 2/04
- (52) **U.S. Cl.** **623/1.24**; 623/2.18
- (58) **Field of Search** 623/1.24, 1.25, 623/1.26, 2.16, 2.17, 2.18; 604/9

(56) **References Cited**

U.S. PATENT DOCUMENTS

15,192 A	6/1856	Peale	
4,759,759 A	7/1988	Walker et al.	
4,851,001 A	7/1989	Taheri	
5,123,919 A	6/1992	Sauter et al.	
5,358,518 A	10/1994	Camilli	
5,409,019 A	* 4/1995	Wilk	128/898
5,413,599 A	* 5/1995	Imachi et al.	623/1.24
5,500,014 A	* 3/1996	Quijano et al.	623/1.24
5,545,214 A	8/1996	Stevens	
5,759,830 A	6/1998	Vacanti et al.	
5,770,193 A	6/1998	Vacanti et al.	
5,770,417 A	6/1998	Vacanti et al.	
5,840,081 A	11/1998	Anderson et al.	
5,843,180 A	12/1998	Jaffe et al.	
5,851,232 A	12/1998	Lois	
5,855,597 A	1/1999	Jayaraman	

5,855,601 A	1/1999	Bessler et al.	
5,855,602 A	1/1999	Angell	
5,863,531 A	1/1999	Naughton et al.	
5,954,766 A	* 9/1999	Zadno-Azizi et al.	623/1.24
5,957,949 A	9/1999	Leonhardt et al.	
6,015,431 A	* 1/2000	Thornton et al.	623/1.24
6,027,525 A	* 2/2000	Suh et al.	623/1.24
6,110,201 A	* 8/2000	Quijano et al.	623/2.1
6,126,686 A	10/2000	Badylak et al.	
6,254,564 B1	* 7/2001	Wilk et al.	604/9

FOREIGN PATENT DOCUMENTS

EP	0 520 126 A1	12/1992	
EP	0 850 607 A1	7/1998	
FR	2 788 217	7/2000	
SU	1371701a1	* 3/1986	623/2.1
WO	WO 94/04099	3/1994	
WO	WO 98/32400	7/1998	

* cited by examiner

Primary Examiner—David H. Willse
Assistant Examiner—Suzette J. Jackson
(74) *Attorney, Agent, or Firm*—Hoffmann & Baron, LLP

(57) **ABSTRACT**

A prosthetic valve for implantation within a fluid conducting lumen within a body includes an elongate generally cylindrical radially collapsible valve body scaffold defining a fluid passageway therethrough for retentive positioning within the lumen. A radially collapsible leaf valve member is supported by the scaffold includes a number of valve leafs deflectable between a closed position restricting fluid flow through the passageway and an open position permitting fluid flow through the passageway. The leaf valve member includes an interior leaf valve frame defining a valve leaf aperture which is sealed by a fluid impermeable non-thrombogenic lining to prevent fluid flow therethrough.

48 Claims, 7 Drawing Sheets

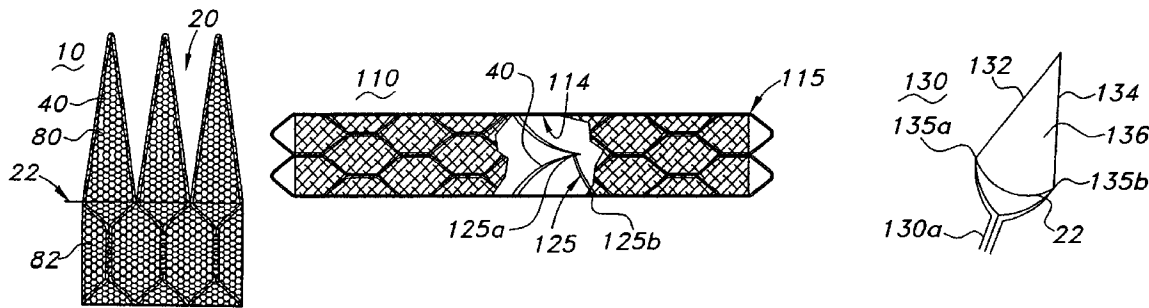

NORRED EXHIBIT 2198 - Page 1
Medtronic, Inc., Medtronic Vascular, Inc.,
& Medtronic Corevalve, LLC

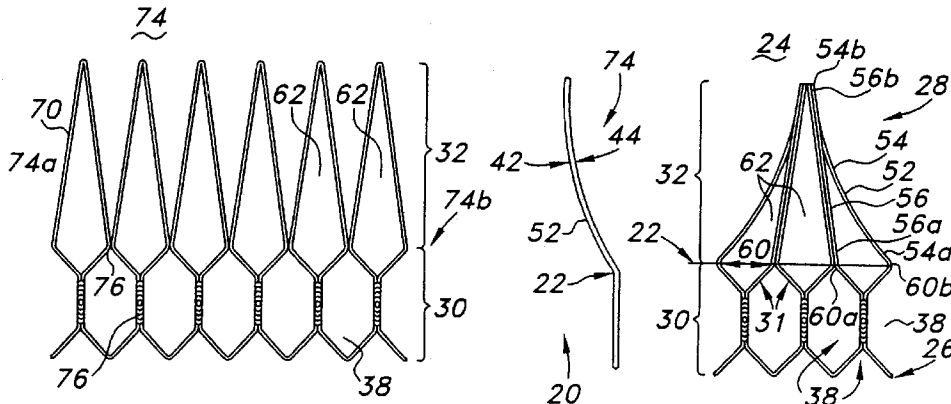

FIG 6

FIG 7

FIG 5

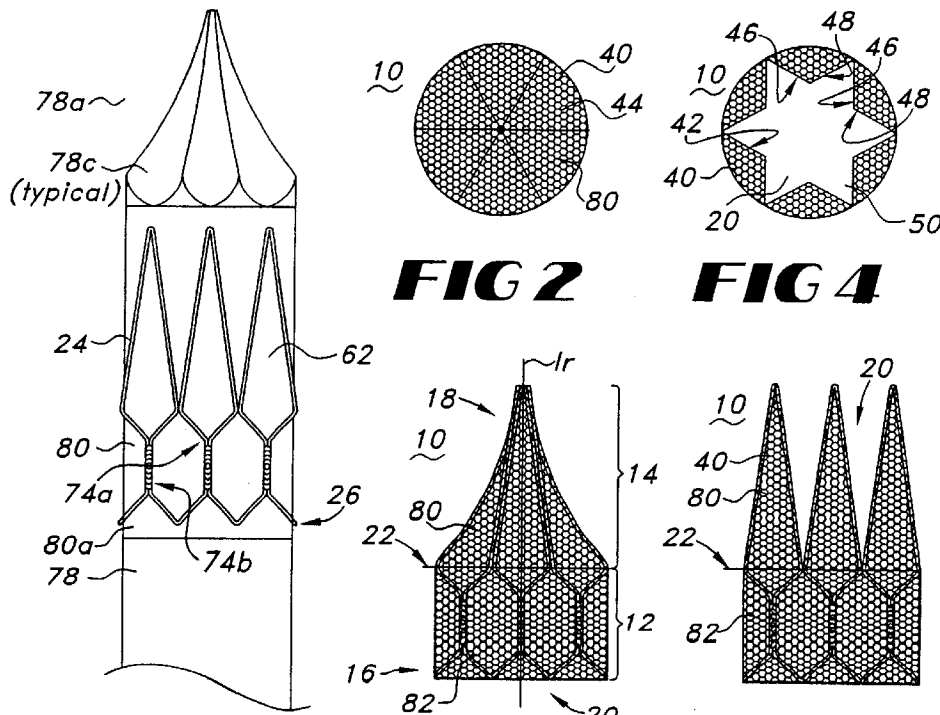

FIG 2

FIG 4

FIG 8

FIG 1

FIG 3

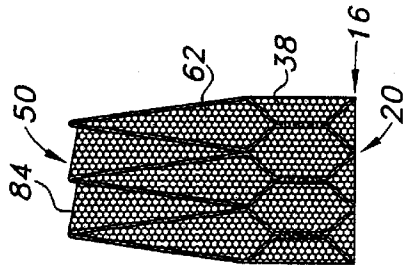

FIG 16

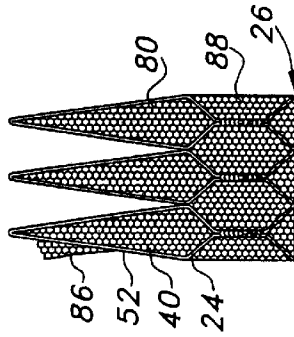

FIG 15

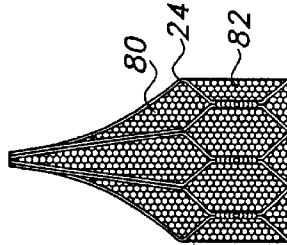

FIG 14

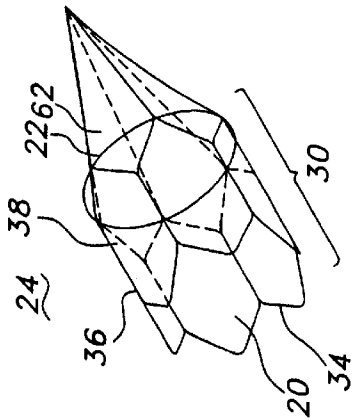

FIG 9

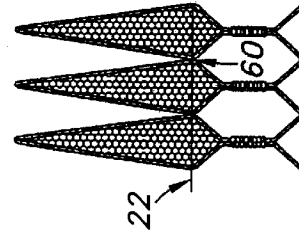

FIG 12

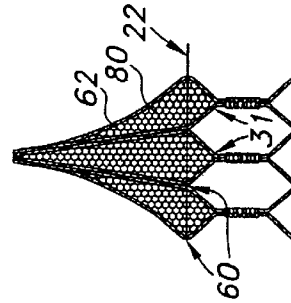

FIG 11

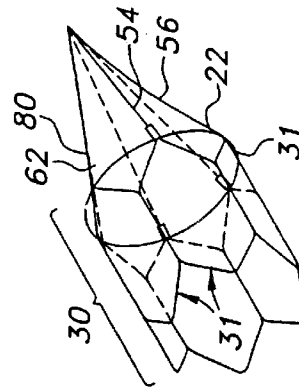

FIG 10

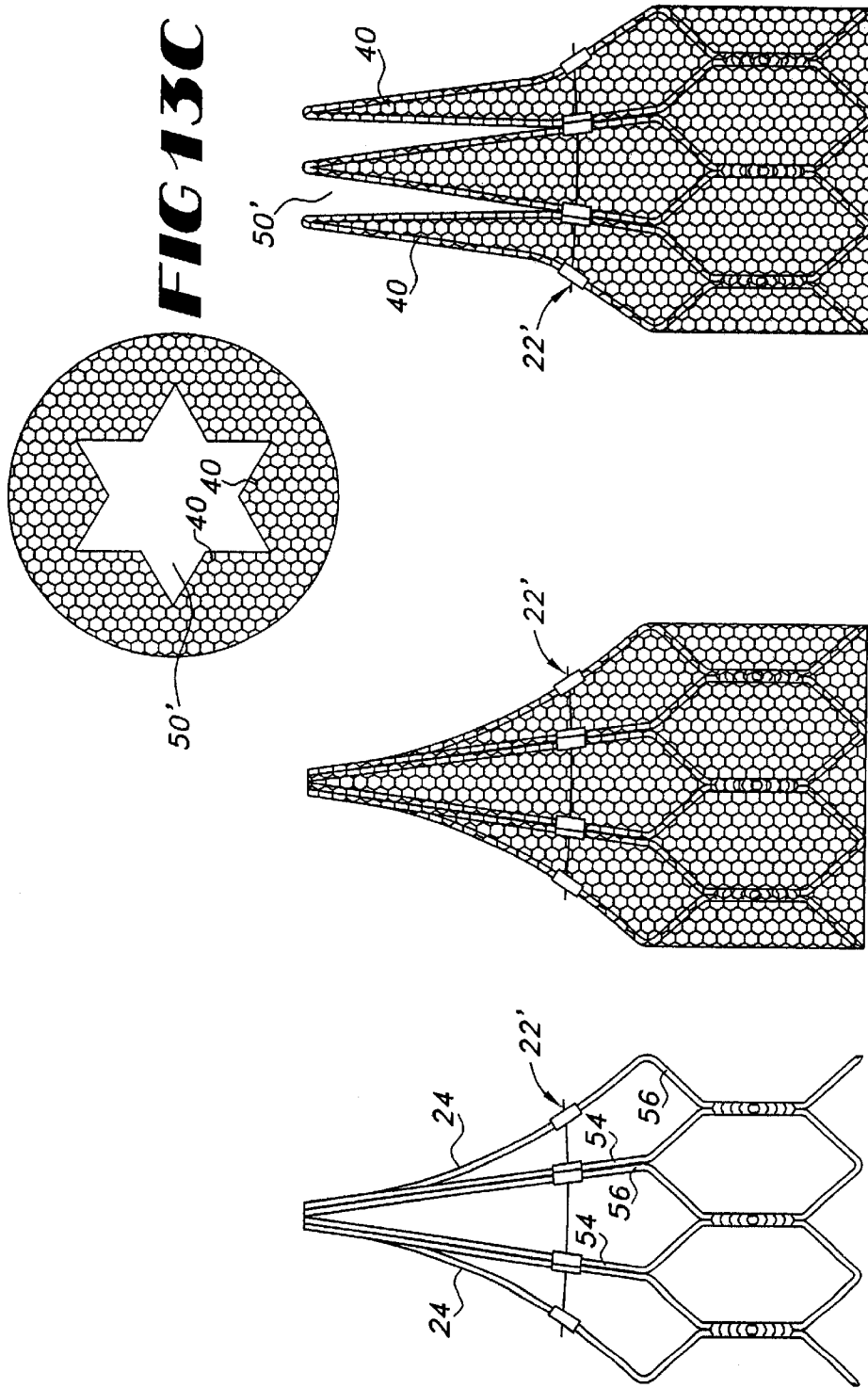

FIG 13C

FIG 13B

FIG 13A

FIG 13D

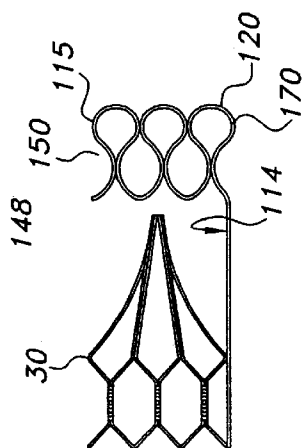

FIG 17

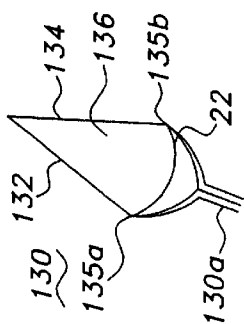

FIG 21

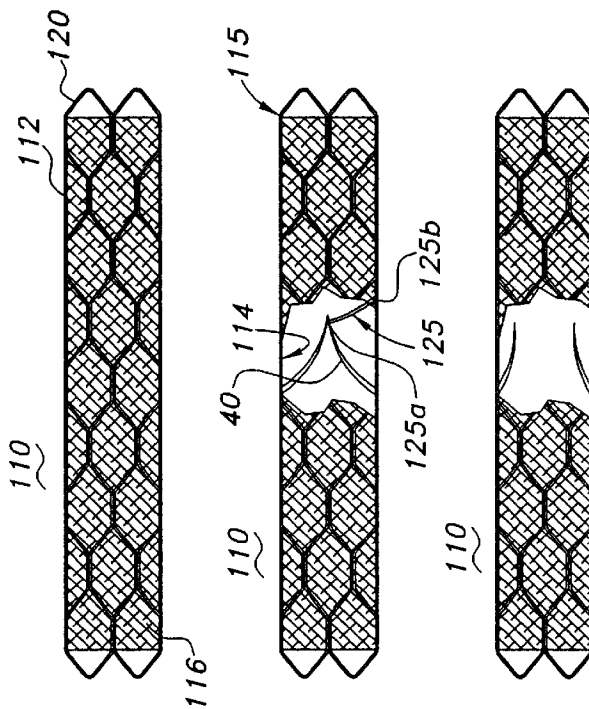

FIG 18

FIG 19

FIG 20

Explore Litigation Insights

Docket Alarm provides insights to develop a more informed litigation strategy and the peace of mind of knowing you're on top of things.

Real-Time Litigation Alerts



Keep your litigation team up-to-date with **real-time alerts** and advanced team management tools built for the enterprise, all while greatly reducing PACER spend.

Our comprehensive service means we can handle Federal, State, and Administrative courts across the country.

Advanced Docket Research



With over 230 million records, Docket Alarm's cloud-native docket research platform finds what other services can't. Coverage includes Federal, State, plus PTAB, TTAB, ITC and NLRB decisions, all in one place.

Identify arguments that have been successful in the past with full text, pinpoint searching. Link to case law cited within any court document via Fastcase.

Analytics At Your Fingertips



Learn what happened the last time a particular judge, opposing counsel or company faced cases similar to yours.

Advanced out-of-the-box PTAB and TTAB analytics are always at your fingertips.

API

Docket Alarm offers a powerful API (application programming interface) to developers that want to integrate case filings into their apps.

LAW FIRMS

Build custom dashboards for your attorneys and clients with live data direct from the court.

Automate many repetitive legal tasks like conflict checks, document management, and marketing.

FINANCIAL INSTITUTIONS

Litigation and bankruptcy checks for companies and debtors.

E-DISCOVERY AND LEGAL VENDORS

Sync your system to PACER to automate legal marketing.