

(12) **United States Patent**
Jawa et al.(10) **Patent No.:** **US 6,728,729 B1**
(45) **Date of Patent:** **Apr. 27, 2004**

- (54) **ACCESSING MEDIA ACROSS NETWORKS**
- (75) Inventors: **Amandeep Jawa**, San Francisco, CA (US); **Jeffrey L. Robbin**, Los Altos, CA (US); **David Heller**, San Jose, CA (US)
- (73) Assignee: **Apple Computer, Inc.**, Cupertino, CA (US)
- (*) Notice: Subject to any disclaimer, the term of this patent is extended or adjusted under 35 U.S.C. 154(b) by 0 days.
- (21) Appl. No.: **10/423,638**
- (22) Filed: **Apr. 25, 2003**
- (51) **Int. Cl.**⁷ **G06F 17/30**
- (52) **U.S. Cl.** **707/104; 707/3; 707/203**
- (58) **Field of Search** **707/104, 3, 4, 707/5, 203**

(56) **References Cited**

U.S. PATENT DOCUMENTS

5,920,856 A	*	7/1999	Syeda-Mahmood	707/3
5,983,218 A	*	11/1999	Syeda-Mahmood	707/3
6,243,713 B1	*	6/2001	Nelson et al.	707/104.1
6,523,022 B1	*	2/2003	Hobbs	707/3

OTHER PUBLICATIONS

"Apple Introduces iTunes—World's Best and Easiest To Use Jukebox Software," Macworld Expo, San Francisco, Jan. 9, 2001, downloaded from <http://www.apple.com/pr/library/2001/jan/09itunes.html>, on Jul. 10, 2002, 2 pages.

iTunes, Playlist Related Help Screens, iTunes v1.0, Apple Computer, Inc., Jan. 2001.

"Apple Announces iTunes 2," Press Release, Apple Computer, Inc., Oct. 23, 2001, downloaded from: <http://www.apple.com/pr/library/2001/oct/23itunes.html>, on Jul. 10, 2002, 2 pages.

Specification Sheet, iTunes 2, Apple Computer, Inc., Oct. 31, 2001.

iTunes 2, Playlist Related Help Screens, iTunes v2.0, Apple Computer, Inc., Oct. 23, 2001.

SoundJam MP Plus, Representative Screens, published by Casady & Greene, Inc., Salinas, CA, 2000.

"SoundJam MP Plus Manual, version 2.0"—MP3 Player and Encoder for Macintosh by Jeffrey Robbin, bill Kincaid and Dave Heller, manual by Tom Negrino, published by Casady & Greene, Inc., 2000.

"WWDC 2002 Keynote Coverage," MacCentral Staff, May 6, 2002, downloaded from: <http://naccentral.macworld.com/news/2002/05/06/wwdckeynote> on Nov. 12, 2003, 8 pages.

"WWDC Keynote Coverage," MacCentral Staff, May 6, 2002, downloaded from: <http://maccentral.macworld.com/news/2002/05/06/wwdckeynote> on Nov. 12, 2003, 8 pages.

"Review: SoundJam MP Plus 2.5.1," Daniel Chvatik, Oct. 2000, downloaded from: <http://www.atpm.com/6.10/soundjam.shtml> on Nov. 12, 2003, 8 pages.

"iHam on iRye: 2.0—VersionTracker," downloaded from: <http://www.versiontracker.com/dyn/moreinfo/macosex/13021> on Nov. 12, 2003, 3 pages.

"iCommune—Share your music over a network," downloaded from <http://www.icommune.sourceforge.net/> on Nov. 12, 2003, 1 page.

* cited by examiner

Primary Examiner—Sanjiv Shah(74) *Attorney, Agent, or Firm*—Beyer Weaver & Thomas LLP(57) **ABSTRACT**

Method and apparatus for accessing media across networks. The present invention generally allows for media to be provided across a network. A client requests media information from a server so the client can create a local representation of the server's database. The client is then able to manage the media information locally. When the client selects the desired media, it requests the selection from across the network. The server then delivers the selected media.

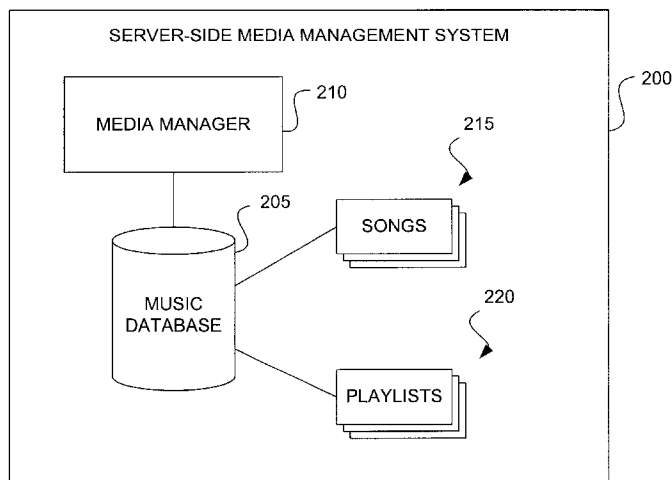
15 Claims, 11 Drawing Sheets

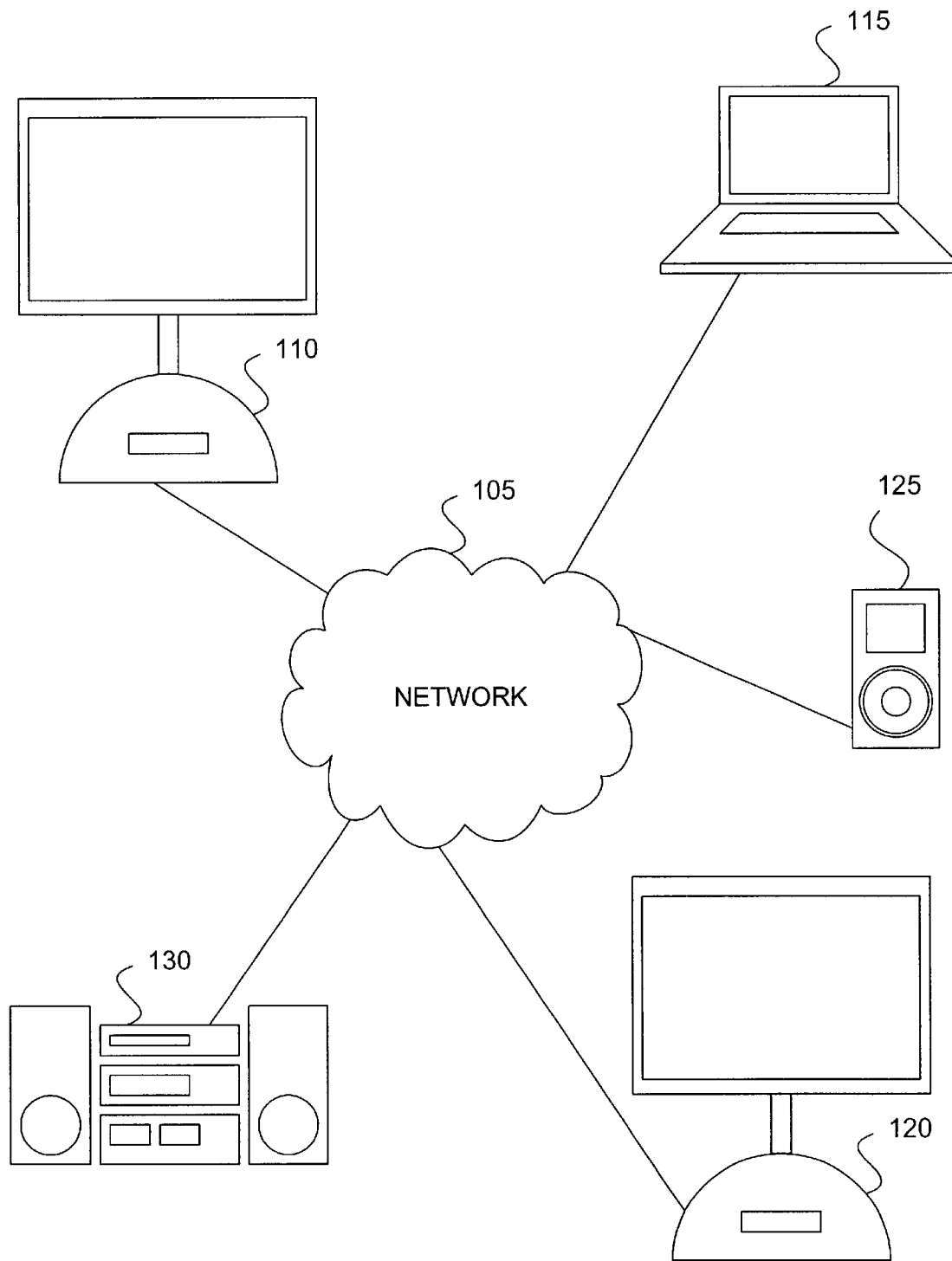

FIGURE 1

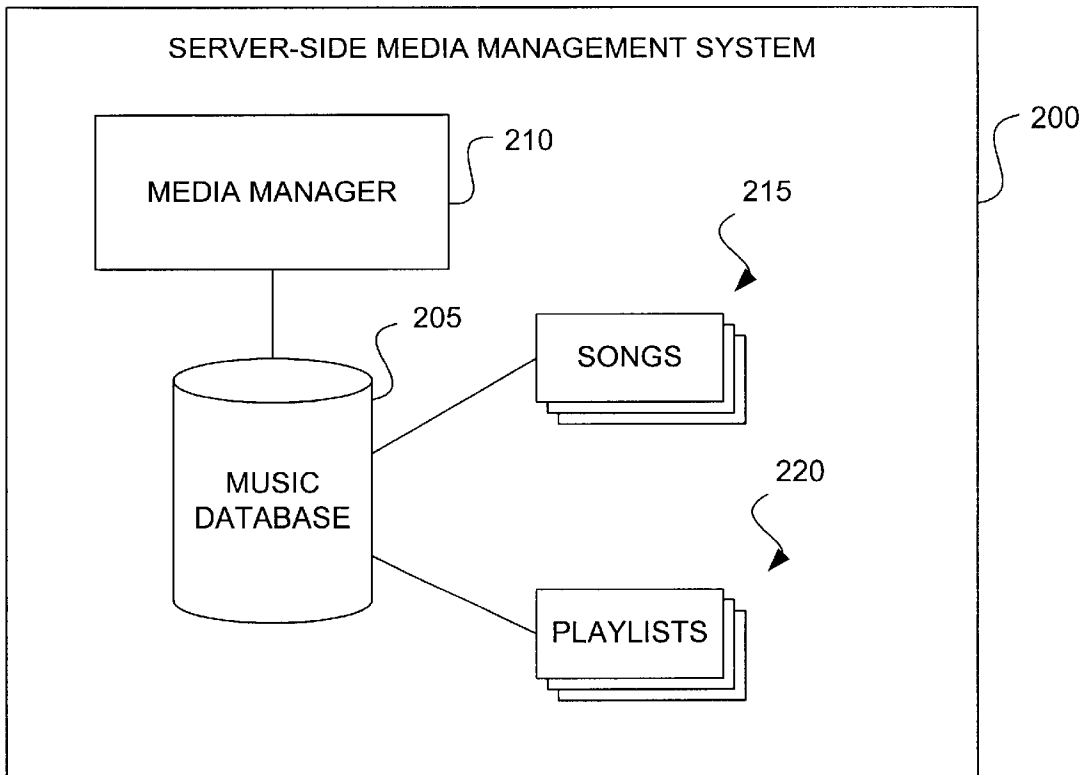

FIGURE 2

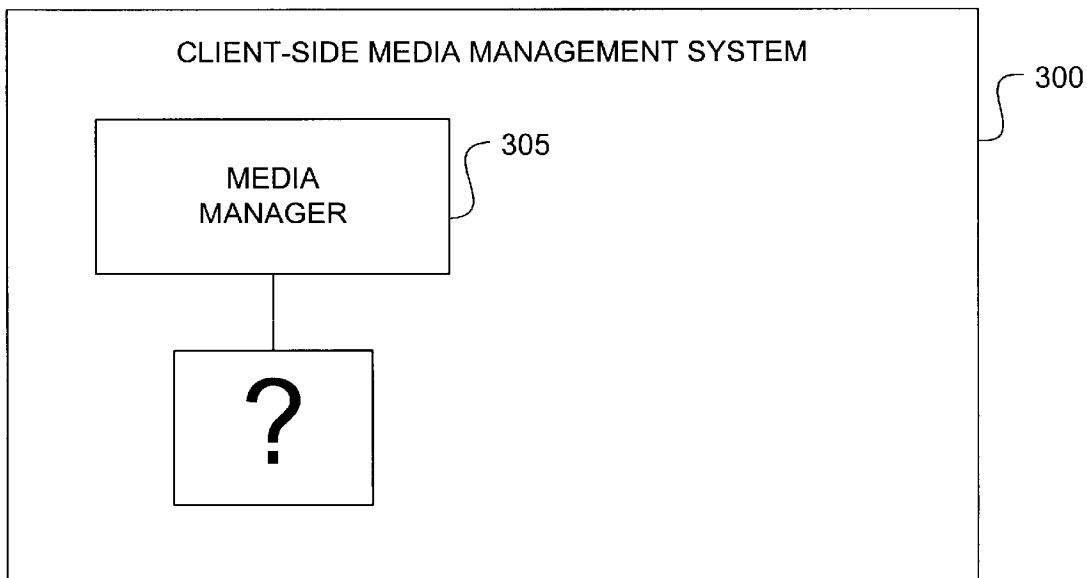

FIGURE 3

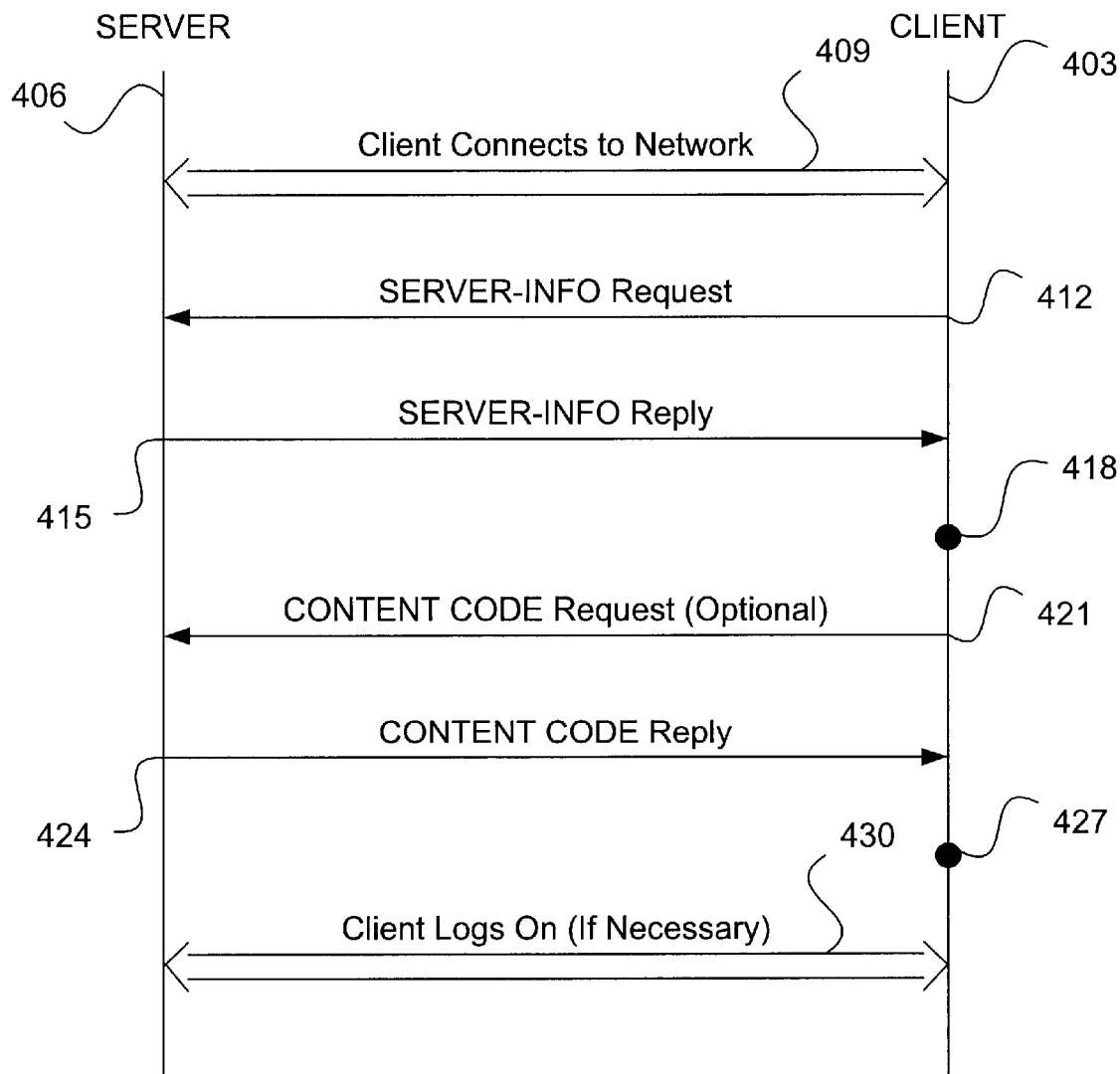

FIGURE 4A

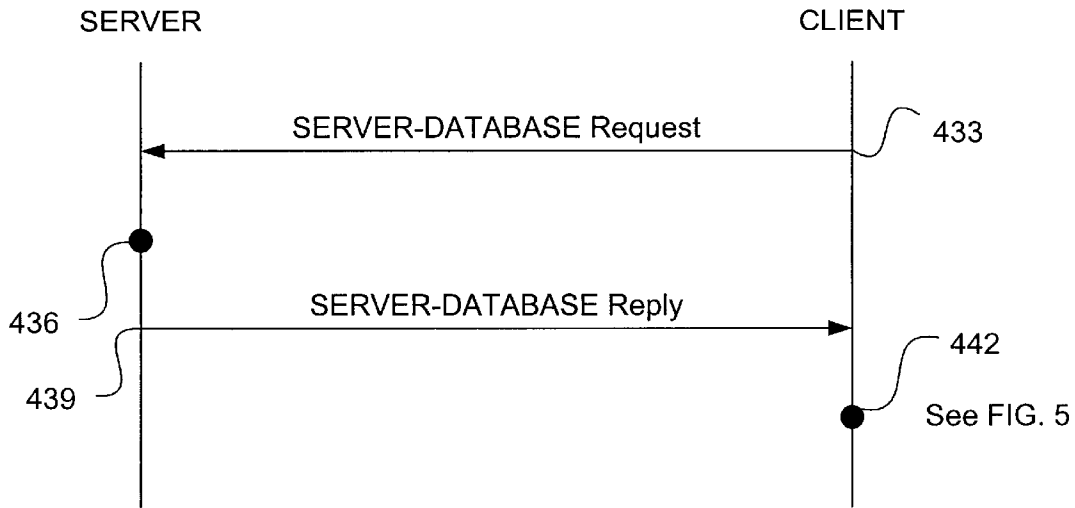

FIGURE 4B

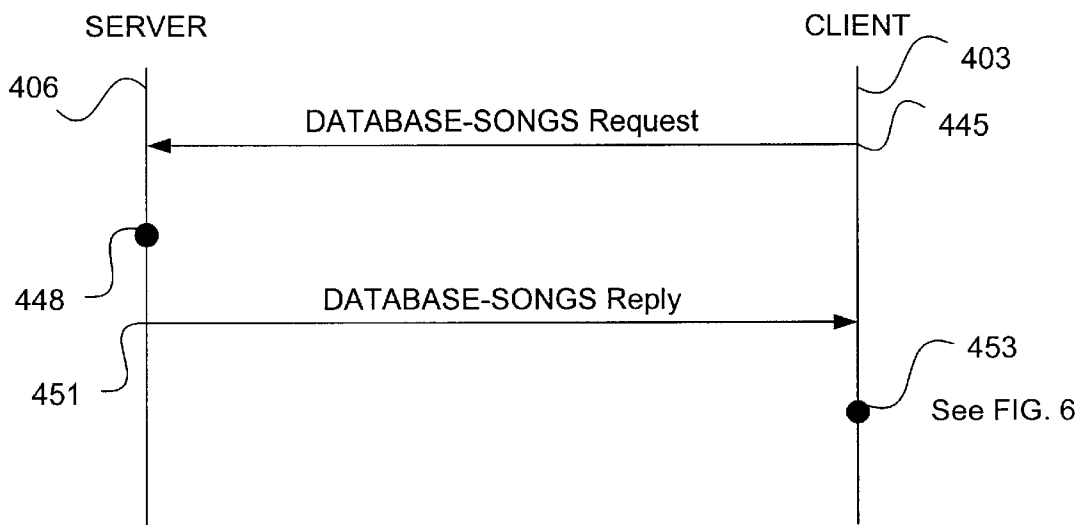

FIGURE 4C

Explore Litigation Insights

Docket Alarm provides insights to develop a more informed litigation strategy and the peace of mind of knowing you're on top of things.

Real-Time Litigation Alerts



Keep your litigation team up-to-date with **real-time alerts** and advanced team management tools built for the enterprise, all while greatly reducing PACER spend.

Our comprehensive service means we can handle Federal, State, and Administrative courts across the country.

Advanced Docket Research



With over 230 million records, Docket Alarm's cloud-native docket research platform finds what other services can't. Coverage includes Federal, State, plus PTAB, TTAB, ITC and NLRB decisions, all in one place.

Identify arguments that have been successful in the past with full text, pinpoint searching. Link to case law cited within any court document via Fastcase.

Analytics At Your Fingertips



Learn what happened the last time a particular judge, opposing counsel or company faced cases similar to yours.

Advanced out-of-the-box PTAB and TTAB analytics are always at your fingertips.

API

Docket Alarm offers a powerful API (application programming interface) to developers that want to integrate case filings into their apps.

LAW FIRMS

Build custom dashboards for your attorneys and clients with live data direct from the court.

Automate many repetitive legal tasks like conflict checks, document management, and marketing.

FINANCIAL INSTITUTIONS

Litigation and bankruptcy checks for companies and debtors.

E-DISCOVERY AND LEGAL VENDORS

Sync your system to PACER to automate legal marketing.