

Under the Paperwork Reduction Act of 1995, no persons are required to respond to a collection of information unless it displays a valid OMB control number.

UTILITY PATENT APPLICATION TRANSMITTAL

(Only for new nonprovisional applications under 37 CFR 1.53(b))

Attorney Docket No.	D8114-00369
First Inventor	Lisa A. Hendrickson
Title	Belly Covering Garment
Express Mail Label No.	being e-filed

APPLICATION ELEMENTS

See MPEP chapter 600 concerning utility patent application contents.

1. **Fee Transmittal Form** (e.g., PTO/SB/17)
(Submit an original and a duplicate for fee processing)
2. **Applicant claims small entity status.**
See 37 CFR 1.27.
3. **Specification** [Total Pages 9]
Both the claims and abstract must start on a new page
(For information on the preferred arrangement, see MPEP 608.01(a))
4. **Drawing(s)** (35 U.S.C. 113) [Total Sheets 8]
5. **Oath or Declaration** unexecuted [Total Sheets 3]
 - a. Newly executed (original or copy)
 - b. A copy from a prior application (37 CFR 1.63(d))
(for continuation/divisional with Box 18 completed)
 - i. **DELETION OF INVENTOR(S)**
Signed statement attached deleting inventor(s)
name in the prior application, see 37 CFR 1.63(d)(2) and 1.33(b).
6. **Application Data Sheet.** See 37 CFR 1.76
7. **CD-ROM or CD-R** in duplicate, large table or
Computer Program (Appendix)
 Landscape Table on CD
8. **Nucleotide and/or Amino Acid Sequence Submission**
(if applicable, items a. - c. are required)
 - a. Computer Readable Form (CRF)
 - b. **Specification Sequence Listing on:**
 - i. CD-ROM or CD-R (2 copies); or
 - ii. Paper
 - c. Statements verifying identity of above copies

ADDRESS TO: Commissioner for Patents
P.O. Box 1450
Alexandria VA 22313-1450

ACCOMPANYING APPLICATION PARTS

9. **Assignment Papers** (cover sheet & document(s))
Name of Assignee Mothers Work, Inc.
10. **37 CFR 3.73(b) Statement** (when there is an assignee) **Power of Attorney**
11. **English Translation Document** (if applicable)
12. **Information Disclosure Statement** (PTO/SB/08 or PTO-1449)
 Copies of citations attached
13. **Preliminary Amendment**
14. **Return Receipt Postcard** (MPEP 503)
(Should be specifically itemized)
15. **Certified Copy of Priority Document(s)**
(if foreign priority is claimed)
16. **Nonpublication Request** under 35 U.S.C. 122(b)(2)(B)(i).
Applicant must attach form PTO/SB/35 or equivalent.
17. Other: _____

18. If a CONTINUING APPLICATION, check appropriate box, and supply the requisite information below and in the first sentence of the specification following the title, or in an Application Data Sheet under 37 CFR 1.76:

Continuation Divisional Continuation-in-part (CIP) of prior application No.: _____

Prior application information: Examiner: _____ Art Unit: _____

19. CORRESPONDENCE ADDRESS

The address associated with Customer Number: 08933 OR Correspondence address below

Name		State		Zip Code	
Address		Telephone		Fax	
City					
Country					

Signature	<i>Gerald K. Kita</i>	Date	<i>May 30, 2007</i>
Name (Print/Type)	Gerald K. Kita	Registration No. (Attorney/Agent)	24,125

This collection of information is required by 37 CFR 1.53(b). The information is required to obtain or retain a benefit by the public which is to file (and by the USPTO to process) an application. Confidentiality is governed by 35 U.S.C. 122 and 37 CFR 1.11 and 1.14. This collection is estimated to take 12 minutes to complete, including gathering, preparing, and submitting the completed application form to the USPTO. Time will vary depending upon the individual case. Any comments on the amount of time you require to complete this form and/or suggestions for reducing this burden, should be sent to the Chief Information Officer, U.S. Patent and Trademark Office, U.S. Department of Commerce, P.O. Box 1450, Alexandria, VA 22313-1450. DO NOT SEND FEES OR COMPLETED FORMS TO THIS ADDRESS. SEND TO: Commissioner for Patents, P.O. Box 1450, Alexandria, VA 22313-1450.

If you need assistance in completing the form, call 1-800-PTO-9199 and select option 2.

Under the Paperwork Reduction Act of 1995 no persons are required to respond to a collection of information unless it displays a valid OMR control number

Effective on 12/08/2004.
Fees pursuant to the Consolidated Appropriations Act, 2005 (H.R. 4818).**FEE TRANSMITTAL
For FY 2005** Applicant claims small entity status. See 37 CFR 1.27**TOTAL AMOUNT OF PAYMENT** (\$) 1,000.00**Complete if Known**

Application Number	NOT YET ASSIGNED
Filing Date	HEREWITH
First Named Inventor	LISA A. HENDRICKSON
Examiner Name	NOT YET ASSIGNED
Art Unit	NOT YET ASSIGNED
Attorney Docket No.	D8114-00369

METHOD OF PAYMENT (check all that apply) Check Credit Card Money Order None Other (please identify): _____ Deposit Account Deposit Account Number: 04-1679 Deposit Account Name: Duane Morris LLP

For the above-identified deposit account, the Director is hereby authorized to: (check all that apply)

 Charge fee(s) indicated below Charge fee(s) indicated below, except for the filing fee Charge any additional fee(s) or underpayments of fee(s) under 37 CFR 1.16 and 1.17 Credit any overpayments**WARNING: Information on this form may become public. Credit card information should not be included on this form. Provide credit card information and authorization on PTO-2038.****FEE CALCULATION****1. BASIC FILING, SEARCH, AND EXAMINATION FEES**

Application Type	FILING FEES		SEARCH FEES		EXAMINATION FEES		Fees Paid (\$)
	Fee (\$)	Small Entity Fee (\$)	Fee (\$)	Small Entity Fee (\$)	Fee (\$)	Small Entity Fee (\$)	
Utility	300	150	500	250	200	100	1,000.00
Design	200	100	100	50	130	65	
Plant	200	100	300	150	160	80	
Reissue	300	150	500	250	600	300	
Provisional	200	100	0	0	0	0	

2. EXCESS CLAIM FEES

Fee Description	Fee (\$)	Small Entity Fee (\$)
Each claim over 20 or, for Reissues, each claim over 20 and more than in the original patent	50	25
Each independent claim over 3 or, for Reissues, each independent claim more than in the original patent	200	100
Multiple dependent claims	360	180

Total Claims	Extra Claims	Fee (\$)	Fee Paid (\$)	Multiple Dependent Claims	Fee (\$)	Fee Paid (\$)
11	- 20 or HP = 0	x	=			

HP = highest number of total claims paid for, if greater than 20

Indep. Claims	Extra Claims	Fee (\$)	Fee Paid (\$)
1	- 3 or HP = 0	x	=

HP = highest number of independent claims paid for, if greater than 3

3. APPLICATION SIZE FEE

If the specification and drawings exceed 100 sheets of paper, the application size fee due is \$250 (\$125 for small entity) for each additional 50 sheets or fraction thereof. See 35 U.S.C. 41(a)(1)(G) and 37 CFR 1.16(s).

Total Sheets	Extra Sheets	Number of each additional 50 or fraction thereof	Fee (\$)	Fee Paid (\$)
- 100 =	/ 50 =	(round up to a whole number) x	=	

4. OTHER FEE(S)

Non-English Specification, \$130 fee (no small entity discount)

Other: _____

SUBMITTED BY

Signature		Registration No. (Attorney/Agent) 24,125	Telephone 215.979.1863
Name (Print/Type)	GERALD K. KITA	Date	May 31, 2007

This collection of information is required by 37 CFR 1.136. The information is required to obtain or retain a benefit by the public which is to file (and by the USPTO to process) an application. Confidentiality is governed by 35 U.S.C. 122 and 37 CFR 1.14. This collection is estimated to take 30 minutes to complete, including gathering, preparing, and submitting the completed application form to the USPTO. Time will vary depending upon the individual case. Any comments on the amount of time you require to complete this form and/or suggestions for reducing this burden, should be sent to the Chief Information Officer, U.S. Patent and Trademark Office, U.S. Department of Commerce, P.O. Box 1450, Alexandria, VA 22313-1450. DO NOT SEND FEES OR COMPLETED FORMS TO THIS ADDRESS. SEND TO: Commissioner for Patents, P.O. Box 1450, Alexandria, VA 22313-1450.

If you need assistance in completing the form, call 1-800-PTO-9199 and select option 2.

BELLY COVERING GARMENT

FIELD OF THE INVENTION

[0001] The present invention relates to a garment worn during different stages of pregnancy and different stages of postpartum body changes.

BACKGROUND OF THE INVENTION

[0002] Garments intended to cover a wearer's body below the abdomen or belly during various stages of pregnancy have been manufactured as knits or woven fabrics. Some of the knits or woven fabric garments are constructed with an elastic belt or waist band which caused discomfort when tightened about the body. Some of the garments have stretchable fabric panels sewn into place with sewn seams. Such garments cause discomfort due to the presence of the sewn seams, urged by elastic stretching of the panels pressing against the torso. Moreover, women have complained that such garments are difficult to keep in place, as they gradually slip downward while they are being worn.

[0003] Denim jeans or trousers have been recycled by removing the waistband at the front of the jeans and replacing the same with an elastic band that cradles a growing abdomen. Alternatively, denim jeans or trousers are manufactured without a waistband at the front so that a separate band can be attached at the front.

[0004] Accordingly, a need exists for a garment that covers and fits a growing abdomen during different stages of pregnancy. Such a garment is required to stay up, and desirably would fit comfortably while being worn. Moreover, such a garment would stay up when worn over different body types.

SUMMARY OF THE INVENTION

[0005] A purpose of the invention is to provide a garment that adapts to cover and fit a growing abdomen during pregnancy, wherein the garment stays up when worn.

[0006] A garment comprises a garment upper portion and a garment lower portion. The garment upper portion has a belly panel that is expansible to cover and fit over a growing

abdomen during different stages of pregnancy. The garment lower portion has a first torso encircling circumference that recedes downward to make way for expansion of the belly panel. The garment upper portion has a second torso encircling circumference to hold the garment up and in place over the torso.

- 5 [0007] An embodiment of the garment is adjustable to encircle different body types. Another embodiment of the invention provides a garment that fits comfortably while being worn.
- [0008] An embodiment of the garment comprises an adjustable torso encircling circumference that is adjustable in girth to encircle different body types.
- [0009] An embodiment of the upper portion of the garment comprises a seamless tubular
10 elastic fabric to stretch elastically and fit different body types.
- [0010] An embodiment of the abdomen covering area comprises an elastic fabric.
- [0011] An embodiment of the abdomen covering area comprises an elastic fabric that is contractible elastically to cover an abdomen during different stages of post partum body changes.
- [0012] According to an embodiment of the invention, an expansible tubular upper portion
15 of the garment is seamless to fit comfortably while being worn.

BRIEF DESCRIPTION OF THE DRAWINGS

- [0013] Fig. 1 is a front view of a garment according to the present invention.
- [0014] Fig. 1A is a view similar to Fig. 1, and discloses a body panel covering a growing
abdomen.
- 20 [0015] Fig. 2 is a view of a backside portion of the garment disclosed by Fig. 1.
- [0016] Fig. 3 is view of a front portion of another embodiment of a garment.
- [0017] Fig. 4 is view of a backside portion of another embodiment of a garment.
- [0018] Fig. 5 is a view of a backside portion of yet another embodiment of a garment.
- [0019] Fig. 6 is front view of a portion of another embodiment of a garment.
- 25 [0020] Fig. 7 is front view of a portion of yet another embodiment of a garment.

DETAILED DESCRIPTION OF THE INVENTION

[0021] Fig. 1 discloses a garment 100 for encircling a lower torso portion of a wearer of the garment 100. The garment 100 comprises a garment upper portion 102 and a garment lower portion 104. A lower end perimeter 106 of the garment upper portion 102 is attached to a

corresponding upper end perimeter 108 of the garment lower portion 104. The garment lower portion 104 comprises, for example, a pair of trousers, such as, denim jeans. Alternatively, the garment lower portion 104 comprises a skirt depicted in Fig. 1 in phantom outline.

[0022] With reference to Figs. 1 and 2, each leg of the pair of trousers is constructed with
5 sewn seams. Outer side seams 110, 112 extend continuously from top to bottom of the trousers, or garment lower portion 104. Further, each leg is constructed with inner side seams 114, 116 joining a front center seam 118 of the trousers and a back side, curved center seam 200, Fig. 2, of the trousers. For example, the front center seam 106 defines a sewn “zipper less” fly front. The back side of the trousers, Fig. 2, is sewn with a back side perimeter seam 202 extending
10 horizontally across the back side of the trousers from the outer side seams 110, 112 to the back side center seam 200. If pockets are desired, the legs of the trousers are constructed, for example, with a front pockets 120, 122 and back pockets 204, 206.

[0023] Fig. 2 discloses an embodiment of the trousers, or garment lower portion 104, having a partial waistband 208 joining and extending from the side seams 110, 112 of the
15 trousers and extending across a back side of the trousers or garment lower portion 104. The waistband 208 is sewn onto the perimeter seam 202 on the back side. The waistband 208 tapers toward the side seams 110, 112 and widens across the back side, and has a center seam 210 to shape the waistband 208 with a curvature above a wearer’s pelvis, and for torso coverage especially when sitting or bending.

[0024] In Fig. 1, the garment upper portion 102 has a belly panel 124 to provide an
20 abdomen covering area. The belly panel 124 is expansible, for example, when made of a stretchable fabric, to cover and fit over a growing abdomen during different stages of pregnancy, Fig. 1A. The belly panel 124 has a bottom portion 128 that projects downward with a parabolic shape, especially when covering a growing abdomen, Fig. 1A. The perimeter 108 of the garment
25 lower portion 104 provides a first torso encircling circumference 126 that recedes downward with a parabolic shape adjacent to and below the bottom portion 128 of the belly panel 124 to make way for expansion of the belly panel 124 when covering a growing abdomen during various stages of pregnancy. The parabolic shape includes a shallow curvature, or, alternatively includes a more pronounced curvature. The belly panel 124 extends at least partially under the
30 abdomen of the garment wearer to meet and join the bottom portion 128 of the belly panel 124 with the parabolic receding circumference 126 of the garment lower portion 104.

[0025] According to an embodiment of the invention, at least the belly panel 124 comprises a stretchable fabric that is woven or knitted with elastic, stretchable strands. The stretchable fabric is expansible by stretching elastically to cover and fit over the growing abdomen, Fig. 1A. Further, the stretchable fabric is contractible elastically to cover a shrinking abdomen during different stages of post partum body changes. The belly panel 124 also has foreseeable alternative functions, for example, to cover an abdomen during different stages of torso weight gains and losses, or to fit over respective torsos of different body types.

[0026] In Figs. 1 and 2, the garment upper portion has a top tubular perimeter hem 130 made by folding over a top edge margin of the stretchable fabric, and either tubular knitting or sewing the folded fabric to the inside surface of the fabric, and to create a top perimeter knitted hem stitch 132 as disclosed in Fig. 1. The perimeter of the garment upper portion 102 has a torso encircling circumference 134 to hold the garment 100 up and in place over the torso.

Advantageously, the entire garment 100 is held up and in place. An embodiment of the garment upper portion 102 comprises stretchable fabric to adjust the girth of the second torso encircling circumference 134 in conformance with different body types. According to an embodiment of the invention, the torso encircling circumference 134 extends along the upper end of the belly panel 124. In Fig. 1A, the belly panel 124 extends at least somewhat above the maximum girth of the abdomen, even during a later stage of pregnancy, such that the belly panel 124 positions the torso encircling circumference 134 at least somewhat above the location of maximum girth to resist slipping down over the abdomen.

[0027] An embodiment of the garment upper portion 102 comprises a tubular structure to encircle a torso of a wearer of the garment 100. The tubular structure comprises a stretchable fabric woven or knitted with elastic, stretchable strands. The belly panel 124 comprises a portion of the stretchable fabric. The tubular structure is adaptable to cover and fit different body types by being elastically expansible and contractible. Different body types have different muscle mass distributions and spinal columns of different curvatures, which make the tubular structure conform to the different body types by expanding and contracting in different locations and amounts when worn by the different body types. The tubular structure is elastically expansible to widen the tubular girth at selected locations and amounts where needed to fit a body type, and is elastically contractible to narrow the tubular girth at selected locations and amounts where needed to fit the body type.

[0028] In Figs. 1 and 2, the tubular structure is shaped and formed as a one-sheet hyperboloid cylinder to fit a body type having a tapered torso that tapers approximately from shoulder to waist. The perimeter profile of the one-sheet hyperboloid cylinder has hyperbolic shaped sides. Alternatively, the tubular structure is shaped and formed as a straight-sided cylinder, for example, as disclosed in Fig. 6. The perimeter profile of the straight sided cylinder has substantially straight sides.

[0029] Preferably, the stretchable fabric is woven or knitted to form a continuous, seamless tubular structure, such that the garment 100 is comfortable to wear due to the absence of seams that would tend to press against the torso.

[0030] Fig. 3 discloses an alternative embodiment in which the garment upper portion 102 is provided with belly cradling support in the form of a series of sewn stitches or knitted tension at 300, 302, 304, 306, 308, 310, 312, and 314 in the belly panel 124. The knitted tension or stitches extend along multiple stitch paths grouped in an elliptical pattern that curves so as to cradle a curved growing abdomen, Fig. 1A, during various stages of pregnancy.

[0031] Fig. 4 discloses an alternative embodiment in which the backside of the garment upper portion 102 is provided with spinal column and back support for a wearer of the garment, in the form of a series of sewn supporting stitches or knitted tension at 400, 402, 404, 406, 408, 410, 412, 414, 416, 418 in the fabric, wherein the supporting knitted tension or stitches stiffen the fabric at the backside of the garment upper portion 102 to provide spinal and back support of the wearer of the garment 100. For example, the series of supporting stitches are arranged along multiple stitch paths grouped in a hyperbolic pattern or other curved pattern along an axis extending substantially vertically along a spinal supporting section of the fabric. Fig. 5 discloses an alternative pattern of supporting stitches 500, 502, 504, 506, 508, 510, 512, 514 in the fabric, wherein the supporting stitches are arranged along multiple stitch paths. For example, the stitch paths are shown as being grouped in a truncated, v-shaped pattern.

[0032] Fig. 6 discloses the garment upper portion 102 comprising a fabric woven or knitted to form a tubular structure, wherein the fabric of the tubular structure is doubled back on itself downward from the top circumference 134 thereof to form a double-layer tubular structure 600 that extends downward at least for a portion of the garment upper portion 102. The layers of the double-layer tubular structure 600 are sewn together with a tubular perimeter drop stitch 602. The layers are further sewn with a top, tubular perimeter hem stitch 132 as described in Fig. 1.

In an alternative embodiment disclosed by Fig. 6, the fabric is doubled back over an inner tubular layer of stretchable fabric 604, shown in phantom outline by and between the stitches 132, 602, that is flatly layered and sewn in between the two tubular layers of the double layer fabric. The three tubular layers are sewn together with the top, tubular perimeter drop stitch 602 and the top, tubular perimeter hem stitch 132 as described in Fig. 1. The inner layer 604 of stretchable fabric provides the belly panel 124 with the capability for resilient expansion. In another embodiment, the double layer fabric comprises a stretch fabric woven or knitted with elastically stretchable and contractible yarns, providing the belly panel with the capability for resilient expansion.

[0033] Fig. 7 discloses that the garment 100 of Fig. 6 is convertible to comprise a bottom garment without a top, the garment upper portion 102 is foldable toward the garment lower portion 104 to provide a folded band 700 on the garment lower portion 104, which is to be worn solely as a garment bottom 104 having the folded band 700, and having no top. Each of the other embodiments of the garment 100 is similarly convertible by adding the stretchable fabric 604 to the upper garment portion 102 of the other embodiment of the garment 100, and folding the garment upper portion 102 toward the garment lower portion 104 to provide a folded band 700 on the garment lower portion 104 of the other embodiment of the garment 100.

[0034] This description of the exemplary embodiments is intended to be read in connection with the accompanying drawings, which are to be considered part of the entire written description. In the description, relative terms such as "lower," "upper," "horizontal," "vertical," "above," "below," "up," "down," "top" and "bottom" as well as derivatives thereof (e.g., "horizontally," "downwardly," "upwardly," etc.) should be construed to refer to the orientation as then described or as shown in the drawing under discussion. These relative terms are for convenience of description and do not require that the apparatus be constructed or operated in a particular orientation. Terms concerning attachments, coupling and the like, such as "connected" and "interconnected," refer to a relationship wherein structures are secured or attached to one another either directly or indirectly through intervening structures, as well as both movable or rigid attachments or relationships, unless expressly described otherwise.

[0035] Although the invention has been described in terms of exemplary embodiments, it is not limited thereto. Rather, the appended claims should be construed broadly, to include other variants and embodiments of the invention, which may be made by those skilled in the art without departing from the scope and range of equivalents of the invention.

What is claimed is:

1. A garment, comprising:
a garment upper portion having a belly panel that is expansible to cover and fit over a
5 growing abdomen during different stages of pregnancy;
a garment lower portion having a first torso encircling circumference that recedes
downward to make way for expansion of the belly panel; and
the garment upper portion having a second torso encircling circumference to hold the
garment up and in place over the torso.
10
2. The garment of claim 1, wherein the second torso encircling circumference is
adjustable in girth to encircle different body types.
3. The garment of claim 1, wherein the garment upper portion comprises a seamless
15 tubular structure that fits comfortably while being worn, and the belly panel comprises a portion
of the tubular structure.
4. The garment of claim 1, wherein the garment upper portion comprises a seamless
tubular elastic fabric to stretch elastically.
20
5. The garment of claim 1, wherein the garment upper portion comprises an elastic fabric
that is contractible elastically to cover an abdomen during different stages of postpartum body
changes.
- 25 6. The garment of claim 1, wherein the garment lower portion has a partial waistband
extending from side seams of the garment lower portion and extending across a back side of the
garment lower portion.
- 30 7. The garment of claim 1, further comprising a series of belly cradling stitches or
knitted tension in the belly panel, wherein the knitted tension or stitches extend along multiple

paths arranged in an elliptical pattern that curves, so as to cradle a curved growing abdomen during various stages of pregnancy.

5 8. The garment of claim 1, further comprising a series of stitches or knitted tension in the
backside of the garment upper portion to provide spinal and back support against the wearer of
the garment.

10 9. The garment of claim 8, wherein the series of stitches or knitted tension in the
backside of the garment upper portion extends along a pattern of multiple stitch paths.

10 10. The garment of claim 8, wherein the series of stitches or knitted tension in the
backside of the garment upper portion extends along a pattern of multiple stitch paths.

15 11. The garment of claim 1, wherein the garment upper portion is foldable toward the
garment lower portion to comprise a folded band on the garment lower portion.

ABSTRACT OF THE DISCLOSURE

The present invention relates to a garment worn during different stages of pregnancy and different stages of postpartum body changes. A garment upper portion has a belly panel that is expandible to cover and fit over a growing abdomen during different stages of pregnancy, and a garment lower portion having a first torso encircling circumference that recedes downward to make way for expansion of the belly panel. The garment upper portion has a second torso encircling circumference to hold the garment up and in place over the torso.

COMBINED DECLARATION AND POWER OF ATTORNEY

As a below-named inventor, I hereby declare that:

My residence, post office address, and citizenship are as stated below next to my name; and

I verily believe that I am the original, first and joint inventor of the subject matter which is claimed and for which a patent is sought on the invention entitled: "Belly Covering Garment" the specification of which:

[XX] is attached hereto.

[] was filed on _____ as Application Serial No. _____, and was amended on _____. (If applicable.)

I hereby state that I have reviewed and understand the contents of the above-identified specification, including the claims, as amended by any Amendment referred to above.

I acknowledge the duty to disclose information which is material to the patentability of this application in accordance with 37 C.F.R. § 1.56.

I hereby claim foreign priority benefits under 35 U.S.C. § 119 of any foreign application(s) for patent or inventor's certificate listed below and have also identified below any foreign application for patent or inventor's certificate having a filing date before that of any application on which priority is claimed:

Country	Number	Date Filed	Priority Claimed ?
_____	_____	_____	_____
_____	_____	_____	_____

I hereby claim the benefit under 35 U.S.C. § 119(e) of any United States provisional application listed below:

Application

Filed

I hereby appoint all of the attorneys associated with **Customer No. 08933**, the law firm Duane Morris LLP, 30 South 17th Street, Philadelphia, PA 19103-4196 to prosecute this application and to transact all business in the United States Patent and Trademark Office connected therewith:

Address all written correspondence and telephone calls to:

Gerald K. Kita
DUANE MORRIS LLP
30 South 17th Street
Philadelphia, PA 19103-4196
(215) 979-1863

I hereby declare that all statements made herein of my own knowledge are true, and that all statements made on information and belief are believed to be true, and further that these statements were made with the knowledge that willful false statements and the like so made are punishable by fine or imprisonment, or both, under 18 U.S.C. § 1001 and that such willful false statements may jeopardize the validity of the application or any patent issued thereon.

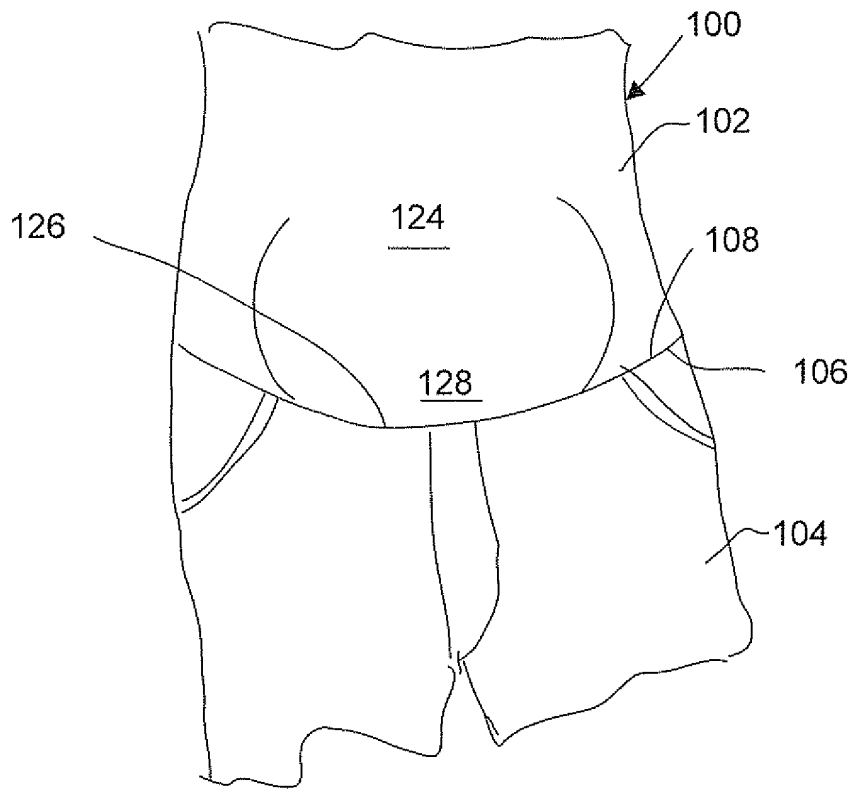

FIG. 1A

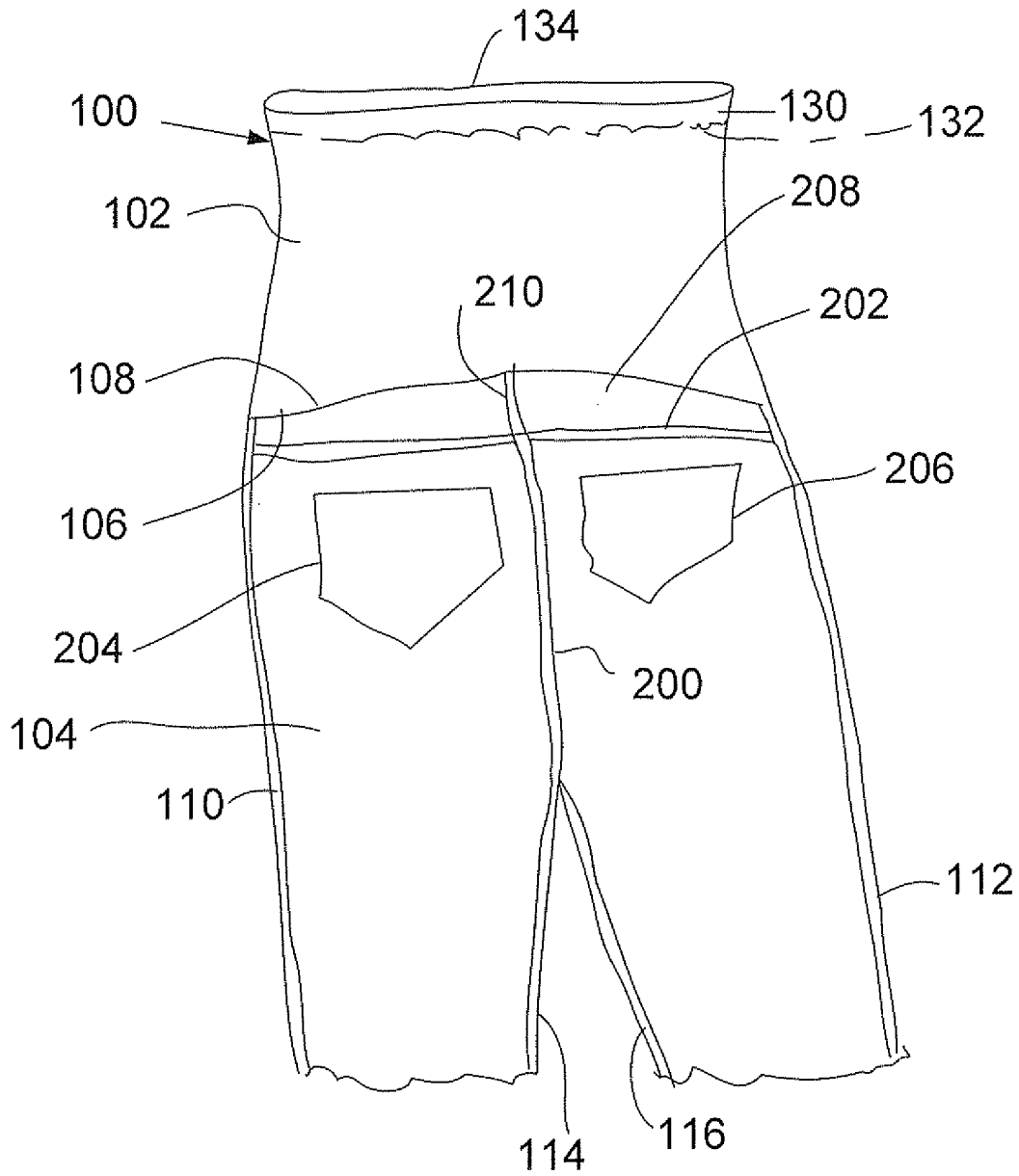

FIG. 2

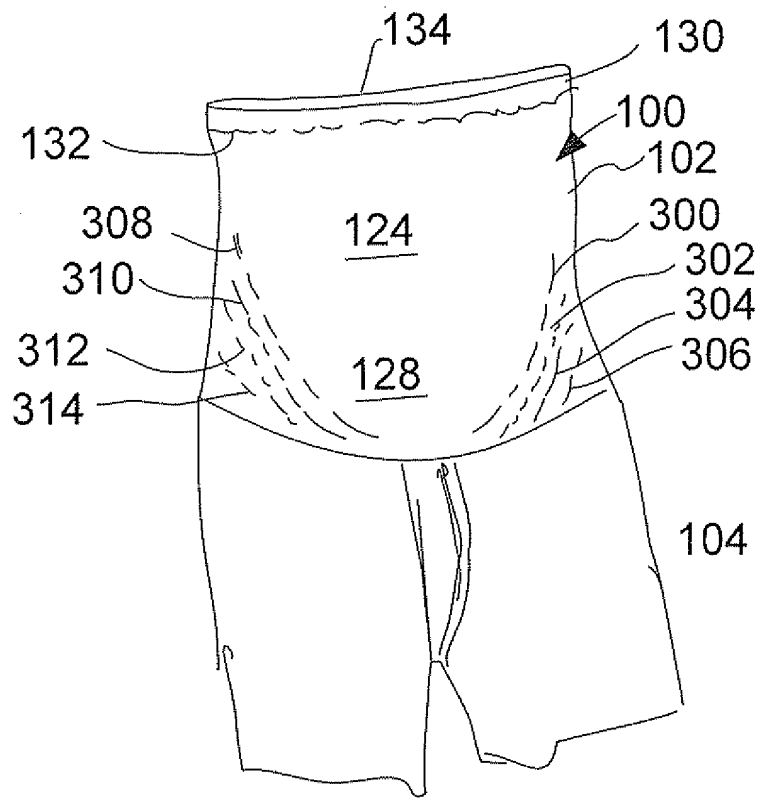

FIG. 3

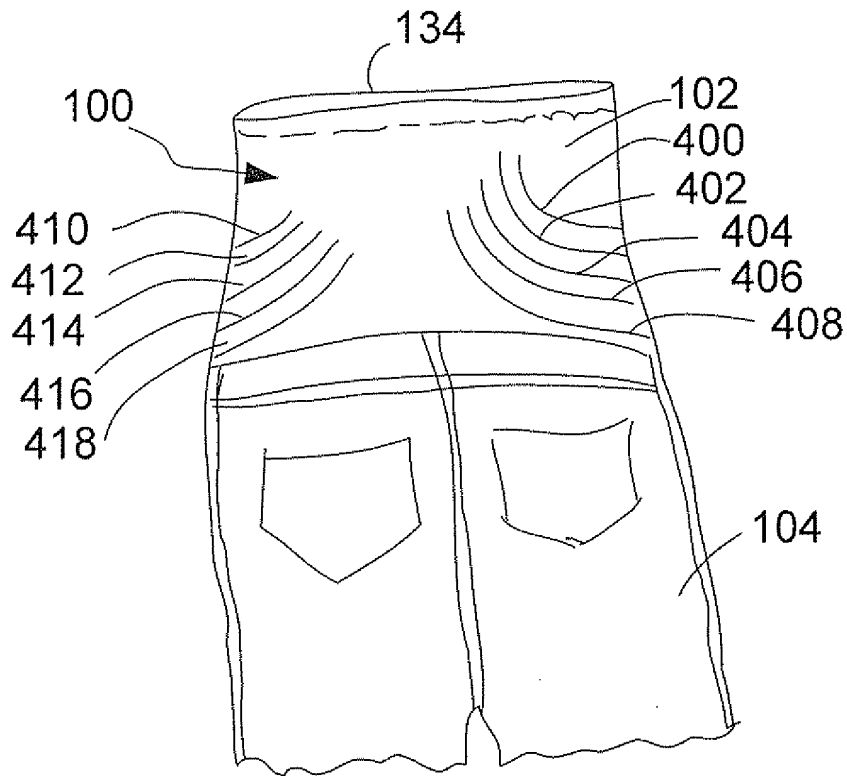

FIG. 4

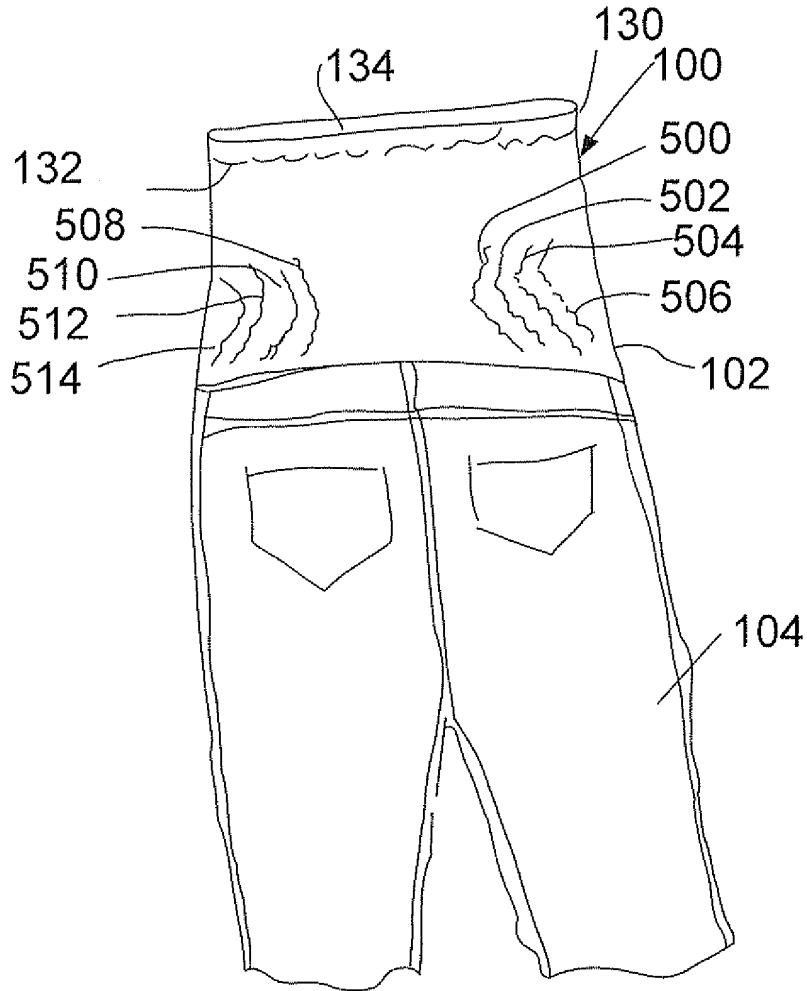

FIG. 5

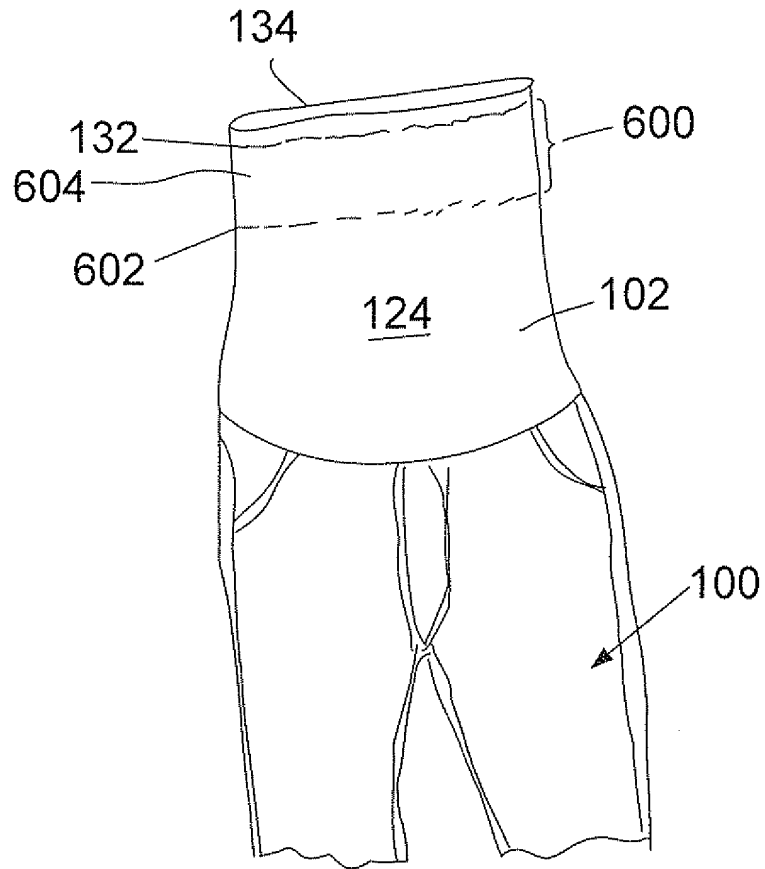

FIG. 6

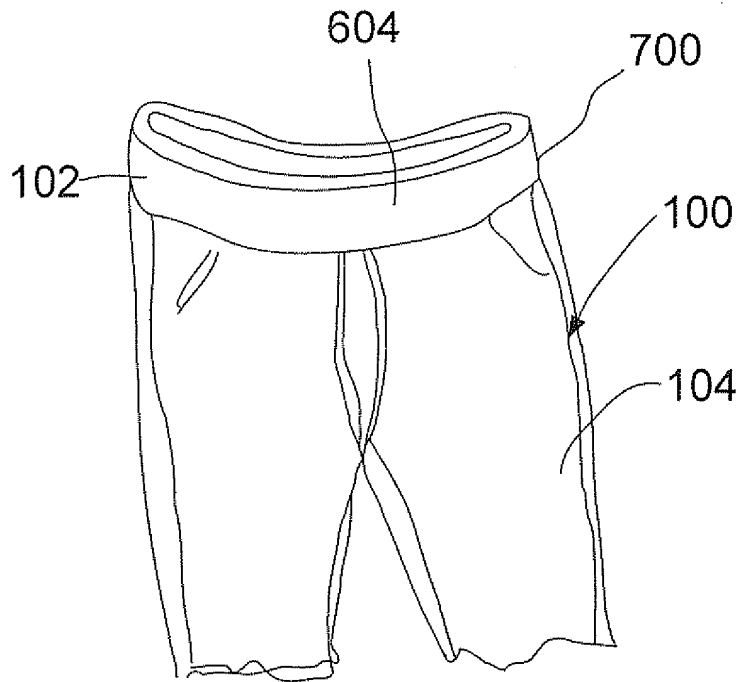

FIG. 7

Electronic Acknowledgement Receipt

EFS ID:	1827427
Application Number:	11756242
International Application Number:	
Confirmation Number:	1512
Title of Invention:	BELLY COVERING GARMENT
First Named Inventor/Applicant Name:	LISA A. HENDRICKSON
Customer Number:	08933
Filer:	Gerald K. Kita./MARY LA GRANGE
Filer Authorized By:	Gerald K. Kita.
Attorney Docket Number:	D8114-00369
Receipt Date:	31-MAY-2007
Filing Date:	
Time Stamp:	16:36:23
Application Type:	Utility

Payment information:

Submitted with Payment	yes
Payment was successfully received in RAM	\$ 1000
RAM confirmation Number	1334
Deposit Account	041679

File Listing:

Document Number	Document Description	File Name	File Size(Bytes)	Multi Part /.zip	Pages (if appl.)
-----------------	----------------------	-----------	------------------	------------------	------------------

1		369UtilApp.pdf	1042168	yes	22
Multipart Description/PDF files in .zip description					
		Document Description	Start	End	
		Transmittal of New Application	1	1	
		Fee Worksheet (PTO-06)	2	2	
		Specification	3	8	
		Claims	9	10	
		Abstract	11	11	
		Oath or Declaration filed	12	14	
		Drawings	15	22	

Warnings:

Information:

2	Fee Worksheet (PTO-06)	fee-info.pdf	8360	no	2
---	------------------------	--------------	------	----	---

Warnings:

Information:

Total Files Size (in bytes):	1050528
-------------------------------------	---------

This Acknowledgement Receipt evidences receipt on the noted date by the USPTO of the indicated documents, characterized by the applicant, and including page counts, where applicable. It serves as evidence of receipt similar to a Post Card, as described in MPEP 503.

New Applications Under 35 U.S.C. 111

If a new application is being filed and the application includes the necessary components for a filing date (see 37 CFR 1.53(b)-(d) and MPEP 506), a Filing Receipt (37 CFR 1.54) will be issued in due course and the date shown on this Acknowledgement Receipt will establish the filing date of the application.

National Stage of an International Application under 35 U.S.C. 371

If a timely submission to enter the national stage of an international application is compliant with the conditions of 35 U.S.C. 371 and other applicable requirements a Form PCT/DO/EO/903 indicating acceptance of the application as a national stage submission under 35 U.S.C. 371 will be issued in addition to the Filing Receipt, in due course.

New International Application Filed with the USPTO as a Receiving Office

If a new international application is being filed and the international application includes the necessary components for an international filing date (see PCT Article 11 and MPEP 1810), a Notification of the International Application Number and of the International Filing Date (Form PCT/RO/105) will be issued in due course, subject to prescriptions concerning national security, and the date shown on this Acknowledgement Receipt will establish the international filing date of the application.

Electronic Patent Application Fee Transmittal

Application Number:				
Filing Date:				
Title of Invention:	BELLY COVERING GARMENT			
First Named Inventor/Applicant Name:	LISA A. HENDRICKSON			
Filer:	Gerald K. Kita./MARY LA GRANGE			
Attorney Docket Number:	D8114-00369			
Filed as Large Entity				
Utility Filing Fees				
Description	Fee Code	Quantity	Amount	Sub-Total in USD(\$)
Basic Filing:				
Utility application filing	1011	1	300	300
Utility Search Fee	1111	1	500	500
Utility Examination Fee	1311	1	200	200
Pages:				
Claims:				
Miscellaneous-Filing:				
Petition:				
Patent-Appeals-and-Interference:				

Description	Fee Code	Quantity	Amount	Sub-Total in USD(\$)
Post-Allowance-and-Post-Issuance:				
Extension-of-Time:				
Miscellaneous:				
Total in USD (\$)				1000

05/31/07

Approved for use through 7/31/2006. OMB 0651-0032
 U.S. Patent and Trademark Office; U.S. DEPARTMENT OF COMMERCE

Under the Paperwork Reduction Act of 1995, no persons are required to respond to a collection of information unless it displays a valid OMB control number.

PATENT APPLICATION FEE DETERMINATION RECORD Substitute for Form PTO-875	Application or Docket Number 11/756,242
---	---

APPLICATION AS FILED – PART I			SMALL ENTITY		OR	OTHER THAN SMALL ENTITY	
FOR	NUMBER FILED (Column 1)	NUMBER EXTRA (Column 2)	RATE (\$)	FEE (\$)		RATE (\$)	FEE (\$)
BASIC FEE (37 CFR 1.16(a), (b), or (c))							300
SEARCH FEE (37 CFR 1.16(k), (l), or (m))							500
EXAMINATION FEE (37 CFR 1.16(o), (p), or (q))							200
TOTAL CLAIMS (37 CFR 1.16(i))	11	minus 20 =	X\$ 25		OR	X\$50	0
INDEPENDENT CLAIMS (37 CFR 1.16(h))	1	minus 3 =	X\$100			X\$200	0
APPLICATION SIZE FEE (37 CFR 1.16(s))							
MULTIPLE DEPENDENT CLAIM PRESENT (37 CFR 1.16(j))			180			360	
			TOTAL	0		TOTAL	1000

* If the difference in column 1 is less than zero, enter "0" in column 2.

APPLICATION AS AMENDED – PART II					SMALL ENTITY		OR	OTHER THAN SMALL ENTITY		
AMENDMENT A	CLAIMS REMAINING AFTER AMENDMENT	HIGHEST NUMBER PREVIOUSLY PAID FOR	PRESENT EXTRA		RATE (\$)	ADDITIONAL FEE (\$)		RATE (\$)	ADDITIONAL FEE (\$)	
	Total (37 CFR 1.16(i))	*	Minus	**	=	X =		OR	X =	
	Independent (37 CFR 1.16(h))	*	Minus	***	=	X =		OR	X =	
	Application Size Fee (37 CFR 1.16(s))							OR		
	FIRST PRESENTATION OF MULTIPLE DEPENDENT CLAIM (37 CFR 1.16(j))					180		OR	360	
					TOTAL ADD'T FEE		OR	TOTAL ADD'T FEE		

APPLICATION AS AMENDED – PART II					SMALL ENTITY		OR	OTHER THAN SMALL ENTITY		
AMENDMENT B	CLAIMS REMAINING AFTER AMENDMENT	HIGHEST NUMBER PREVIOUSLY PAID FOR	PRESENT EXTRA		RATE (\$)	ADDITIONAL FEE (\$)		RATE (\$)	ADDITIONAL FEE (\$)	
	Total (37 CFR 1.16(i))	*	Minus	**	=	X =		OR	X =	
	Independent (37 CFR 1.16(h))	*	Minus	***	=	X =		OR	X =	
	Application Size Fee (37 CFR 1.16(s))							OR		
	FIRST PRESENTATION OF MULTIPLE DEPENDENT CLAIM (37 CFR 1.16(j))					N/A		OR	N/A	
					TOTAL ADD'T FEE		OR	TOTAL ADD'T FEE		

- * If the entry in column 1 is less than the entry in column 2, write "0" in column 3.
- ** If the "Highest Number Previously Paid For" IN THIS SPACE is less than 20, enter "20".
- *** If the "Highest Number Previously Paid For" IN THIS SPACE is less than 3, enter "3".
The "Highest Number Previously Paid For" (Total or Independent) is the highest number found in the appropriate box in column 1.

This collection of information is required by 37 CFR 1.16. The information is required to obtain or retain a benefit by the public which is to file (and by the USPTO to process) an application. Confidentiality is governed by 35 U.S.C. 122 and 37 CFR 1.14. This collection is estimated to take 12 minutes to complete, including gathering, preparing, and submitting the completed application form to the USPTO. Time will vary depending upon the individual case. Any comments on the amount of time you require to complete this form and/or suggestions for reducing this burden, should be sent to the Chief Information Officer, U.S. Patent and Trademark Office, U.S. Department of Commerce, P.O. Box 1450, Alexandria, VA 22313-1450. DO NOT SEND FEES OR COMPLETED FORMS TO THIS ADDRESS. **SEND TO: Commissioner for Patents, P.O. Box 1450, Alexandria, VA 22313-1450.**

If you need assistance in completing the form, call 1-800-PTO-9199 and select option 2.



UNITED STATES PATENT AND TRADEMARK OFFICE

UNITED STATES DEPARTMENT OF COMMERCE
United States Patent and Trademark Office
Address: COMMISSIONER FOR PATENTS
P.O. Box 1450
Alexandria, Virginia 22313-1450
www.uspto.gov

Table with 7 columns: APPLICATION NUMBER, FILING or 371(c) DATE, GRP ART UNIT, FIL FEE REC'D, ATTY.DOCKET.NO, TOT CLAIMS, IND CLAIMS. Row 1: 11/756,242, 05/31/2007, 3765, 1000, D8114-00369, 11, 1

CONFIRMATION NO. 1512

FILING RECEIPT

8933
DUANE MORRIS, LLP
IP DEPARTMENT
30 SOUTH 17TH STREET
PHILADELPHIA, PA19103-4196

Date Mailed: 06/13/2007

Receipt is acknowledged of this regular Patent Application. It will be considered in its order and you will be notified as to the results of the examination. Be sure to provide the U.S. APPLICATION NUMBER, FILING DATE, NAME OF APPLICANT, and TITLE OF INVENTION when inquiring about this application. Fees transmitted by check or draft are subject to collection. Please verify the accuracy of the data presented on this receipt. If an error is noted on this Filing Receipt, please mail to the Commissioner for Patents P.O. Box 1450 Alexandria Va 22313-1450. Please provide a copy of this Filing Receipt with the changes noted thereon. If you received a "Notice to File Missing Parts" for this application, please submit any corrections to this Filing Receipt with your reply to the Notice. When the USPTO processes the reply to the Notice, the USPTO will generate another Filing Receipt incorporating the requested corrections (if appropriate).

Applicant(s)

LISA A. HENDRICKSON, Mount Laurel, NJ;
James H. Gardner III, Ambler, PA;
Richard Adelman, Greensboro, NC;

Assignment For Published Patent Application

Mothers Work, Inc.

Power of Attorney: None

Domestic Priority data as claimed by applicant

Foreign Applications

If Required, Foreign Filing License Granted: 06/12/2007

The country code and number of your priority application, to be used for filing abroad under the Paris Convention, is US11/756,242

Projected Publication Date: To Be Determined - pending completion of Missing Parts

Non-Publication Request: No

Early Publication Request: No

Title

BELLY COVERING GARMENT

Preliminary Class

002

PROTECTING YOUR INVENTION OUTSIDE THE UNITED STATES

Since the rights granted by a U.S. patent extend only throughout the territory of the United States and have no effect in a foreign country, an inventor who wishes patent protection in another country must apply for a patent in a specific country or in regional patent offices. Applicants may wish to consider the filing of an international application under the Patent Cooperation Treaty (PCT). An international (PCT) application generally has the same effect as a regular national patent application in each PCT-member country. The PCT process **simplifies** the filing of patent applications on the same invention in member countries, but **does not result** in a grant of "an international patent" and does not eliminate the need of applicants to file additional documents and fees in countries where patent protection is desired.

Almost every country has its own patent law, and a person desiring a patent in a particular country must make an application for patent in that country in accordance with its particular laws. Since the laws of many countries differ in various respects from the patent law of the United States, applicants are advised to seek guidance from specific foreign countries to ensure that patent rights are not lost prematurely.

Applicants also are advised that in the case of inventions made in the United States, the Director of the USPTO must issue a license before applicants can apply for a patent in a foreign country. The filing of a U.S. patent application serves as a request for a foreign filing license. The application's filing receipt contains further information and guidance as to the status of applicant's license for foreign filing.

Applicants may wish to consult the USPTO booklet, "General Information Concerning Patents" (specifically, the section entitled "Treaties and Foreign Patents") for more information on timeframes and deadlines for filing foreign patent applications. The guide is available either by contacting the USPTO Contact Center at 800-786-9199, or it can be viewed on the USPTO website at <http://www.uspto.gov/web/offices/pac/doc/general/index.html>.

For information on preventing theft of your intellectual property (patents, trademarks and copyrights), you may wish to consult the U.S. Government website, <http://www.stopfakes.gov>. Part of a Department of Commerce initiative, this website includes self-help "toolkits" giving innovators guidance on how to protect intellectual property in specific countries such as China, Korea and Mexico. For questions regarding patent enforcement issues, applicants may call the U.S. Government hotline at 1-866-999-HALT (1-866-999-4158).

LICENSE FOR FOREIGN FILING UNDER

Title 35, United States Code, Section 184

Title 37, Code of Federal Regulations, 5.11 & 5.15

GRANTED

The applicant has been granted a license under 35 U.S.C. 184, if the phrase "IF REQUIRED, FOREIGN FILING LICENSE GRANTED" followed by a date appears on this form. Such licenses are issued in all applications where the conditions for issuance of a license have been met, regardless of whether or not a license may be required as set forth in 37 CFR 5.15. The scope and limitations of this license are set forth in 37 CFR 5.15(a) unless an earlier license has been issued under 37 CFR 5.15(b). The license is subject to revocation upon written notification. The date indicated is the effective date of the license, unless an earlier license of similar scope has been granted under 37 CFR 5.13 or 5.14.

This license is to be retained by the licensee and may be used at any time on or after the effective date thereof unless it is revoked. This license is automatically transferred to any related applications(s) filed under 37 CFR 1.53(d). This license is not retroactive.

The grant of a license does not in any way lessen the responsibility of a licensee for the security of the

subject matter as imposed by any Government contract or the provisions of existing laws relating to espionage and the national security or the export of technical data. Licensees should apprise themselves of current regulations especially with respect to certain countries, of other agencies, particularly the Office of Defense Trade Controls, Department of State (with respect to Arms, Munitions and Implements of War (22 CFR 121-128)); the Bureau of Industry and Security, Department of Commerce (15 CFR parts 730-774); the Office of Foreign Assets Control, Department of Treasury (31 CFR Parts 500+) and the Department of Energy.

NOT GRANTED

No license under 35 U.S.C. 184 has been granted at this time, if the phrase "IF REQUIRED, FOREIGN FILING LICENSE GRANTED" DOES NOT appear on this form. Applicant may still petition for a license under 37 CFR 5.12, if a license is desired before the expiration of 6 months from the filing date of the application. If 6 months has lapsed from the filing date of this application and the licensee has not received any indication of a secrecy order under 35 U.S.C. 181, the licensee may foreign file the application pursuant to 37 CFR 5.15(b).

UNITED STATES PATENT AND TRADEMARK OFFICE

UNITED STATES DEPARTMENT OF COMMERCE
 United States Patent and Trademark Office
 Address: COMMISSIONER FOR PATENTS
 P.O. Box 1450
 Alexandria, Virginia 22313-1450
 www.uspto.gov

APPLICATION NUMBER	FILING OR 371 (c) DATE	FIRST NAMED APPLICANT	ATTORNEY DOCKET NUMBER
11/756,242	05/31/2007	LISA A. HENDRICKSON	D8114-00369

CONFIRMATION NO. 1512

8933
 DUANE MORRIS, LLP
 IP DEPARTMENT
 30 SOUTH 17TH STREET
 PHILADELPHIA, PA 19103-4196

**FORMALITIES
 LETTER**

Date Mailed: 06/13/2007

NOTICE TO FILE MISSING PARTS OF NONPROVISIONAL APPLICATION
FILED UNDER 37 CFR 1.53(b)
Filing Date Granted
Items Required To Avoid Abandonment:

An application number and filing date have been accorded to this application. The item(s) indicated below, however, are missing. Applicant is given **TWO MONTHS** from the date of this Notice within which to file all required items and pay any fees required below to avoid abandonment. Extensions of time may be obtained by filing a petition accompanied by the extension fee under the provisions of 37 CFR 1.136(a).

- The oath or declaration is unsigned.

The applicant needs to satisfy supplemental fees problems indicated below.

The required item(s) identified below must be timely submitted to avoid abandonment:

- To avoid abandonment, a surcharge (for late submission of filing fee, search fee, examination fee or oath or declaration) as set forth in 37 CFR 1.16(f) of \$130 for a non-small entity, must be submitted with the missing items identified in this letter.

SUMMARY OF FEES DUE:

Total additional fee(s) required for this application is **\$130** for a non-small entity

- **\$130** Surcharge.

Replies should be mailed to: Mail Stop Missing Parts
 Commissioner for Patents
 P.O. Box 1450
 Alexandria VA 22313-1450

Registered users of EFS-Web may alternatively submit their reply to this notice via EFS-Web.
<https://sportal.uspto.gov/authenticate/AuthenticateUserLocalEPF.html>

For more information about EFS-Web please call the USPTO Electronic Business Center at **1-866-217-9197** or visit our website at <http://www.uspto.gov/ebc>.

If you are not using EFS-Web to submit your reply, you must include a copy of this notice.

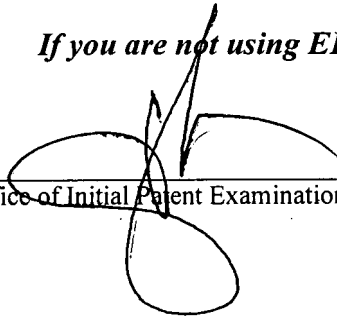
A handwritten signature in black ink, consisting of several loops and a long vertical stroke, positioned above a horizontal line.

Office of Initial Patent Examination (571) 272-4000, or 1-800-PTO-9199
PART 3 - OFFICE COPY

IN THE UNITED STATES PATENT AND TRADEMARK OFFICE

In Re Application of: Hendrickson, Lisa

Confirmation No: 1512

Serial No. 11/756,242

Group Art Unit: 3727

Filed: May 31, 2007

Examiner: n/a

For: Belly Covering Garment

M.S. Amendment
Commissioner for Patents
P.O. Box 1450
Alexandria, VA 22313-1450

Dear Sir:

INFORMATION DISCLOSURE STATEMENT TRANSMITTAL LETTER

Enclosed herewith is an Information Disclosure Statement pursuant to 37 CFR. § 1.56 in connection with the above-identified application, which statement is being filed:

Together with the present application.

Before the first Office Action on the merits or three (3) months from the filing date of this application, whichever occurs last. **[37 CFR § 1.97(b)]**

After the first Office Action on the merits, but before a Final Office Action under §1.113 or Notice of Allowance under §1.311, whichever occurs first. **[37 CFR §1.97(c)].** *(Either the fee or certification is provided, as set forth below).*

After a Final Office Action under §1.113 or Notice of Allowance under §1.311, but prior to or with payment of the Issue Fee. **[37 CFR §1.97(d)].** *The fee and certification are provided, as set forth below).*

Consistent with Applicant's obligations pursuant to 37 CFR §§1.97 and 1.98, the following requirements have been met:

No separate requirements are needed.

No additional fee is required.

Fee Under 37 CFR § 1.97(c) or 1.97(d)

The fee of \$180.00 for submission of an IDS under § 1.97(c) as set forth in § 1.17(p) accompanies this statement.

Please charge the fee of \$180.00 for submission of an IDS under § 1.97(c) or (d) as set forth in § 1.17(p) to Deposit Account 04-1679.

Certification Under 37 CFR § 1.97(e)

The undersigned certifies:

1 that each item of information contained in the information disclosure statement was first cited in a communication from a foreign patent office in a counterpart foreign application not more than three months prior to the filing of the information disclosure statement; or

2 that no item of information contained in the information disclosure statement was cited in a communication from a foreign patent office in a counterpart foreign application, and, to the knowledge of the person signing the statement after making reasonable inquiry, no item of information contained in the information disclosure statement was known to any individual designated in §1.56(c) more than three months prior to the filing of the information disclosure statement.

Provision of Copies of References

A copy of each of the Foreign and Other references listed on the attached Form PTO-1449 is enclosed herewith and forms a part hereof.

Partial Translations of References are enclosed herewith and form a part hereof.

A copy of the European Search Report from a corresponding or related EPO application is enclosed herewith.

A copy of the International Search Report from a corresponding or related PCT application is enclosed herewith.

Identification of Prior Application(s) In Which Listed Information Was Already Cited And For Which No Copies Are Submitted Or Need Be Submitted

[X] This application relies, under 35 U.S.C. § 120, on the earlier filing date of prior U.S. Application No(s). filed . Some or all of the references were submitted to, and/or cited by, the Office in the prior application(s) and therefore are not required to be provided in this application.

The Commissioner is hereby authorized to charge any fees associated with this communication or credit any overpayment to Deposit Account No. 04-1679.

Respectfully submitted,

Date: June 26, 2007



Gerald K. Kita
Registration No. 24,125

Customer No. 08933
DUANE MORRIS LLP
30 South 17th Street
Philadelphia, PA 19103-4196
215-979-1863 tel
215-979-1020 fax

SUBSTITUTE for form 1449A/PTO			<i>Complete if Known</i>		
INFORMATION DISCLOSURE STATEMENT BY APPLICANT (use as many sheets as necessary)			Application Number	11/756,242	
			Filing Date	May 31, 2007	
			First Named Inventor	Hendrickson, Lisa	
			Art Unit	3765	
			Examiner Name	n/a	
Sheet	1	of	1	Attorney Docket Number	D8114-00369

U.S. PATENT DOCUMENTS						
Examiner Initials	Cite No.	Document Number		Publication Date MM-DD-YYYY	Name of Patentee or Applicant of Cited Document	Pages, Columns, Lines, Where Relevant Passages or Relevant Figures Appear
		Number-Kind Code (if known)				
	A	US2006/0010571		01/09/2006	Oakley	

FOREIGN PATENT DOCUMENTS							
Examiner Initials	Cite No.	Foreign Patent Document		Publication Date MM-DD-YYY	Name of Patentee or Applicant of Cited Document	Pages, Columns, Lines Where Relevant Passages or Figures Appear	T
		Country Code - Number - Kind Code (if known)					

OTHER PRIOR ART - NON PATENT LITERATURE DOCUMENTS			
Examiner Initials	Cite No.	Include name of the author (in CAPITAL LETTERS), title of the article (when appropriate), title of the Item (book, magazine, journal, serial, symposium, catalog, etc.), date, page(s), volume-issue number(s), publisher city and/or country where published	T

Examiner Signature		Date Considered	
-----------------------	--	--------------------	--

*Examiner: Initial if reference considered, whether or not citation is in conformance with MPEP 609. Draw line through citation if not in conformance and not considered. Include copy of this form with next communication to applicant.
DM2\1186338.1

Electronic Acknowledgement Receipt

EFS ID:	1911533
Application Number:	11756242
International Application Number:	
Confirmation Number:	1512
Title of Invention:	BELLY COVERING GARMENT
First Named Inventor/Applicant Name:	LISA A. HENDRICKSON
Customer Number:	8933
Filer:	Gerald K. Kita./MARY LA GRANGE
Filer Authorized By:	Gerald K. Kita.
Attorney Docket Number:	D8114-00369
Receipt Date:	26-JUN-2007
Filing Date:	31-MAY-2007
Time Stamp:	15:30:50
Application Type:	Utility

Payment information:

Submitted with Payment	no
------------------------	----

File Listing:

Document Number	Document Description	File Name	File Size(Bytes)	Multi Part /.zip	Pages (if appl.)
1		369IDS.pdf	284728	yes	5

Multipart Description/PDF files in .zip description			
Document Description		Start	End
Miscellaneous Incoming Letter		1	1
Information Disclosure Statement (IDS) Filed		2	5

Warnings:

Information:

Total Files Size (in bytes):	284728
-------------------------------------	--------

This Acknowledgement Receipt evidences receipt on the noted date by the USPTO of the indicated documents, characterized by the applicant, and including page counts, where applicable. It serves as evidence of receipt similar to a Post Card, as described in MPEP 503.

New Applications Under 35 U.S.C. 111

If a new application is being filed and the application includes the necessary components for a filing date (see 37 CFR 1.53(b)-(d) and MPEP 506), a Filing Receipt (37 CFR 1.54) will be issued in due course and the date shown on this Acknowledgement Receipt will establish the filing date of the application.

National Stage of an International Application under 35 U.S.C. 371

If a timely submission to enter the national stage of an international application is compliant with the conditions of 35 U.S.C. 371 and other applicable requirements a Form PCT/DO/EO/903 indicating acceptance of the application as a national stage submission under 35 U.S.C. 371 will be issued in addition to the Filing Receipt, in due course.

New International Application Filed with the USPTO as a Receiving Office

If a new international application is being filed and the international application includes the necessary components for an international filing date (see PCT Article 11 and MPEP 1810), a Notification of the International Application Number and of the International Filing Date (Form PCT/RO/105) will be issued in due course, subject to prescriptions concerning national security, and the date shown on this Acknowledgement Receipt will establish the international filing date of the application.

Under the Paperwork Reduction Act of 1995, no persons are required to respond to a collection of information unless it displays a valid OMB control number.

TRANSMITTAL FORM <i>(to be used for all correspondence after initial filing)</i>	Application Number	11/756,242
	Filing Date	May 31, 2007
	First Named Inventor	Hendrickson, Lisa
	Art Unit	3765
	Examiner Name	n/a
Total Number of Pages in This Submission	Attorney Docket Number	D8114-00369

ENCLOSURES (Check all that apply)		
<input type="checkbox"/> Fee(s) Transmittal Form	<input type="checkbox"/> Drawing(s)	<input type="checkbox"/> After Allowance communication to Technology Center (TC)
<input type="checkbox"/> Fee Attached	<input type="checkbox"/> Licensing-related Papers	<input type="checkbox"/> Appeal Communication to Board of Appeals and Interferences
<input type="checkbox"/> Amendment/Reply	<input type="checkbox"/> Petition	<input type="checkbox"/> Appeal Communication to TC (Appeal Notice, Brief, Reply Brief)
<input type="checkbox"/> After Allowance	<input type="checkbox"/> Petition to Convert to a Provisional Application	<input type="checkbox"/> Proprietary Information
<input type="checkbox"/> Affidavits/declaration(s)	<input type="checkbox"/> Power of Attorney, Revocation	<input type="checkbox"/> Status Letter
<input type="checkbox"/> Extension of Time Request	<input type="checkbox"/> Change of Correspondence Address	<input type="checkbox"/> Other Enclosure(s) (please identify below):
<input type="checkbox"/> Express Abandonment Request	<input type="checkbox"/> Terminal Disclaimer	
<input checked="" type="checkbox"/> Information Disclosure Statement	<input type="checkbox"/> Request for Refund	
<input type="checkbox"/> Certified Copy of Priority Document(s)	<input type="checkbox"/> CD, Number of CD(s) _____	
<input type="checkbox"/> Response to Missing Parts/ Incomplete Application	Remarks	
<input type="checkbox"/> Response to Missing Parts under 37 CFR 1.52 or 1.53	The Commissioner is hereby authorized to charge any fees associated with this communication or credit any overpayment to Deposit Account No. 04-1679.	

SIGNATURE OF APPLICANT, ATTORNEY, OR AGENT

Firm or Individual name	Gerald K. Kita, Reg. No. 24,125 Duane Morris LLP, Customer Number 08933	
Signature	<i>Gerald K. Kita</i>	
Date	<i>June 26, 2007</i>	

CERTIFICATE UNDER 37 CFR 1.10

I hereby certify that this correspondence and the documents referred to therein are being electronically filed in the United States Patent and Trademark Office on the date indicated below		
Typed or printed name	Mary La Grange	
Signature	<i>Mary La Grange</i>	Date <i>6.26.07</i>

This collection of information is required by 37 CFR 1.5. The information is required to obtain or retain a benefit by the public which is to file (and by the USPTO to process) an application. Confidentiality is governed by 35 U.S.C. 122 and 37 CFR 1.14. This collection is estimated to 2 hours to complete, including gathering, preparing, and submitting the completed application form to the USPTO. Time will vary depending upon the individual case. Any comments on the amount of time you require to complete this form and/or suggestions for reducing this burden, should be sent to the Chief Information Officer, U.S. Patent and Trademark Office, U.S. Department of Commerce, P.O. Box 1450, Alexandria, VA 22313-1450. DO NOT SEND FEES OR COMPLETED FORMS TO THIS ADDRESS. SEND TO: **Commissioner for Patents, P.O. Box 1450, Alexandria, VA 22313-1450.**

If you need assistance in completing the form, call 1-800-PTO-9199 and select option 2.

Electronic Patent Application Fee Transmittal

Application Number:	11756242
Filing Date:	31-May-2007
Title of Invention:	BELLY COVERING GARMENT
First Named Inventor/Applicant Name:	LISA A. HENDRICKSON
Filer:	Gerald K. Kita./Mary La Grange
Attorney Docket Number:	D8114-00369

Filed as Large Entity

Utility Filing Fees

Description	Fee Code	Quantity	Amount	Sub-Total in USD(\$)
Basic Filing:				
Pages:				
Claims:				
Miscellaneous-Filing:				
Late filing fee for oath or declaration	1051	1	130	130

Petition:

Patent-Appeals-and-Interference:

Post-Allowance-and-Post-Issuance:

Extension-of-Time:

Description	Fee Code	Quantity	Amount	Sub-Total in USD(\$)
Miscellaneous:				
Total in USD (\$)				130

COMBINED DECLARATION AND POWER OF ATTORNEY

As a below-named inventor, I hereby declare that:

My residence, post office address, and citizenship are as stated below next to my name; and

I verily believe that I am the original, first and joint inventor of the subject matter which is claimed and for which a patent is sought on the invention entitled: "Belly Covering Garment" the specification of which:

[] is attached hereto.

[xx] was filed on May 31, 2007, as Application Serial No. 11/756,242, and was amended on _____. (If applicable.)

I hereby state that I have reviewed and understand the contents of the above-identified specification, including the claims, as amended by any Amendment referred to above.

I acknowledge the duty to disclose information which is material to the patentability of this application in accordance with 37 C.F.R. § 1.56.

I hereby claim foreign priority benefits under 35 U.S.C. § 119 of any foreign application(s) for patent or inventor's certificate listed below and have also identified below any foreign application for patent or inventor's certificate having a filing date before that of any application on which priority is claimed:

Country	Number	Date Filed	Priority Claimed ?
_____	_____	_____	_____
_____	_____	_____	_____

I hereby claim the benefit under 35 U.S.C. § 119(e) of any United States provisional application listed below:

Application

Filed

I hereby appoint all of the attorneys associated with **Customer No. 08933**, the law firm Duane Morris LLP, 30 South 17th Street, Philadelphia, PA 19103-4196 to prosecute this application and to transact all business in the United States Patent and Trademark Office connected therewith:

Address all written correspondence and telephone calls to:

Gerald K. Kita
DUANE MORRIS LLP
30 South 17th Street
Philadelphia, PA 19103-4196
(215) 979-1863

I hereby declare that all statements made herein of my own knowledge are true, and that all statements made on information and belief are believed to be true, and further that these statements were made with the knowledge that willful false statements and the like so made are punishable by fine or imprisonment, or both, under 18 U.S.C. § 1001 and that such willful false statements may jeopardize the validity of the application or any patent issued thereon.

1	Full Name Lisa A. Hendrickson	Inventor's Signature <i>Lisa A. Hendrickson</i>	Date 7/30/07 ✓
	Residence 791 Cornwallis Drive Mount Laurel, NJ 08054 Citizenship: U.S.A.		
	Post Office Address: Same as above		
2	Full Name James H. Gardner, III	Inventor's Signature	Date
	Residence 1329 Squire Drive Ambler, PA 19002 Citizenship: U.S.A.		
	Post Office Address: Same as above		
3	Full Name Richard Adelman	Inventor's Signature	Date
	Residence 5 Sunfish Point Greensboro, NC 27455 Citizenship: U.S.A.		
	Post Office Address: Same as above		

1	Full Name Lisa A. Hendrickson	Inventor's Signature	Date
	Residence 791 Cornwallis Drive Mount Laurel, NJ 08054		Citizenship: U.S.A.
	Post Office Address: Same as above		
2	Full Name James H. Gardner, III	Inventor's Signature <i>James H. Gardner</i>	Date 7/30/07
	Residence 1329 Squire Drive Ambler, PA 19002		Citizenship: U.S.A.
	Post Office Address: Same as above		
3	Full Name Richard Adelman	Inventor's Signature	Date
	Residence 5 Sunfish Point Greensboro, NC 27455		Citizenship: U.S.A.
	Post Office Address: Same as above		

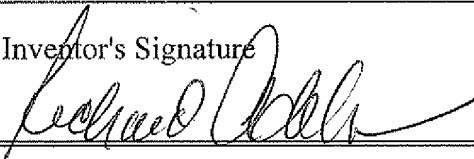
1	Full Name Lisa A. Hendrickson	Inventor's Signature	Date
	Residence 791 Cornwallis Drive Mount Laurel, NJ 08054		Citizenship: U.S.A.
	Post Office Address: Same as above		
2	Full Name James H. Gardner, III	Inventor's Signature	Date
	Residence 1329 Squire Drive Ambler, PA 19002		Citizenship: U.S.A.
	Post Office Address: Same as above		
3	Full Name Richard Adelman	Inventor's Signature 	Date 7/20/07 ✓
	Residence 5 Sunfish Point Greensboro, NC 27455		Citizenship: U.S.A.
	Post Office Address: Same as above		

Under the Paperwork Reduction Act of 1995, no persons are required to respond to a collection of information unless it displays a valid OMB control number.

TRANSMITTAL FORM (to be used for all correspondence after initial filing)	Application Number	11/756,242
	Filing Date	May 31, 2007
	First Named Inventor	Hendrickson, Lisa et al.
	Art Unit	3765
	Examiner Name	n/a
Total Number of Pages in This Submission	Attorney Docket Number	D8114-00369

ENCLOSURES (Check all that apply)		
<input type="checkbox"/> Fee(s) Transmittal Form	<input type="checkbox"/> Drawing(s)	<input type="checkbox"/> After Allowance communication to Technology Center (TC)
<input type="checkbox"/> Fee Attached	<input type="checkbox"/> Licensing-related Papers	<input type="checkbox"/> Appeal Communication to Board of Appeals and Interferences
<input type="checkbox"/> Amendment/Reply	<input type="checkbox"/> Petition	<input type="checkbox"/> Appeal Communication to TC (Appeal Notice, Brief, Reply Brief)
<input type="checkbox"/> After Allowance	<input type="checkbox"/> Petition to Convert to a Provisional Application	<input type="checkbox"/> Proprietary Information
<input type="checkbox"/> Affidavits/declaration(s)	<input type="checkbox"/> Power of Attorney, Revocation	<input type="checkbox"/> Status Letter
<input type="checkbox"/> Extension of Time Request	<input type="checkbox"/> Change of Correspondence Address	<input type="checkbox"/> Other Enclosure(s) (please identify below):
<input type="checkbox"/> Express Abandonment Request	<input type="checkbox"/> Terminal Disclaimer	<input checked="" type="checkbox"/> Executed Combined Declaration and Power of Attorney
<input type="checkbox"/> Information Disclosure Statement	<input type="checkbox"/> Request for Refund	
<input type="checkbox"/> Certified Copy of Priority Document(s)	<input type="checkbox"/> CD, Number of CD(s) _____	
<input type="checkbox"/> Response to Missing Parts/ Incomplete Application	Remarks	
<input checked="" type="checkbox"/> Response to Missing Parts under 37 CFR 1.52 or 1.53	The Commissioner is hereby authorized to charge any fees associated with this communication or credit any overpayment to Deposit Account No. 04-1679.	

SIGNATURE OF APPLICANT, ATTORNEY, OR AGENT

Firm or Individual name	Gerald K. Kita, Registration No. 24,125 Customer Number 08933
Signature	<i>Gerald K. Kita</i>
Date	<i>August 8, 2007</i>

CERTIFICATE UNDER 37 CFR 1.10

I hereby certify that this correspondence and the documents referred to therein are being electronically filed in the United States Patent and Trademark Office on the date indicated below		
Typed or printed name	Mary La Grange	
Signature	<i>Mary La Grange</i>	Date <i>8-8-07</i>

This collection of information is required by 37 CFR 1.5. The information is required to obtain or retain a benefit by the public which is to file (and by the USPTO to process) an application. Confidentiality is governed by 35 U.S.C. 122 and 37 CFR 1.14. This collection is estimated to 2 hours to complete, including gathering, preparing, and submitting the completed application form to the USPTO. Time will vary depending upon the individual case. Any comments on the amount of time you require to complete this form and/or suggestions for reducing this burden, should be sent to the Chief Information Officer, U.S. Patent and Trademark Office, U.S. Department of Commerce, P.O. Box 1450, Alexandria, VA 22313-1450. DO NOT SEND FEES OR COMPLETED FORMS TO THIS ADDRESS. SEND TO: **Commissioner for Patents, P.O. Box 1450, Alexandria, VA 22313-1450.**

If you need assistance in completing the form, call 1-800-PTO-9199 and select option 2.

Electronic Acknowledgement Receipt

EFS ID:	2059642
Application Number:	11756242
International Application Number:	
Confirmation Number:	1512
Title of Invention:	BELLY COVERING GARMENT
First Named Inventor/Applicant Name:	LISA A. HENDRICKSON
Customer Number:	8933
Filer:	Gerald K. Kita./Mary La Grange
Filer Authorized By:	Gerald K. Kita.
Attorney Docket Number:	D8114-00369
Receipt Date:	08-AUG-2007
Filing Date:	31-MAY-2007
Time Stamp:	10:55:46
Application Type:	Utility under 35 USC 111(a)

Payment information:

Submitted with Payment	yes
Payment was successfully received in RAM	\$ 130
RAM confirmation Number	4527
Deposit Account	041679

File Listing:

Document Number	Document Description	File Name	File Size(Bytes) /Message Digest	Multi Part /.zip	Pages (if appl.)
-----------------	----------------------	-----------	-------------------------------------	------------------	------------------

1		369MissPts.pdf	291972 2f4f350b3645c304ab7129a7c9e96858 b00ea41f	yes	6
Multipart Description/PDF files in .zip description					
		Document Description	Start	End	
		Miscellaneous Incoming Letter	1	1	
		Oath or Declaration filed	2	6	
Warnings:					
Information:					
2	Fee Worksheet (PTO-06)	fee-info.pdf	8155 273e5e94ed69eebe33070ac8a2dff952 3c904aac	no	2
Warnings:					
Information:					
Total Files Size (in bytes):			300127		
<p>This Acknowledgement Receipt evidences receipt on the noted date by the USPTO of the indicated documents, characterized by the applicant, and including page counts, where applicable. It serves as evidence of receipt similar to a Post Card, as described in MPEP 503.</p> <p><u>New Applications Under 35 U.S.C. 111</u> If a new application is being filed and the application includes the necessary components for a filing date (see 37 CFR 1.53(b)-(d) and MPEP 506), a Filing Receipt (37 CFR 1.54) will be issued in due course and the date shown on this Acknowledgement Receipt will establish the filing date of the application.</p> <p><u>National Stage of an International Application under 35 U.S.C. 371</u> If a timely submission to enter the national stage of an international application is compliant with the conditions of 35 U.S.C. 371 and other applicable requirements a Form PCT/DO/EO/903 indicating acceptance of the application as a national stage submission under 35 U.S.C. 371 will be issued in addition to the Filing Receipt, in due course.</p> <p><u>New International Application Filed with the USPTO as a Receiving Office</u> If a new international application is being filed and the international application includes the necessary components for an international filing date (see PCT Article 11 and MPEP 1810), a Notification of the International Application Number and of the International Filing Date (Form PCT/RO/105) will be issued in due course, subject to prescriptions concerning national security, and the date shown on this Acknowledgement Receipt will establish the international filing date of the application.</p>					



UNITED STATES PATENT AND TRADEMARK OFFICE

UNITED STATES DEPARTMENT OF COMMERCE
United States Patent and Trademark Office
Address: COMMISSIONER FOR PATENTS
P.O. Box 1450
Alexandria, Virginia 22313-1450
www.uspto.gov

Table with 7 columns: APPLICATION NUMBER, FILING or 371(c) DATE, GRP ART UNIT, FIL FEE REC'D, ATTY.DOCKET.NO, TOT CLAIMS, IND CLAIMS. Row 1: 11/756,242, 05/31/2007, 3765, 1130, D8114-00369, 11, 1

CONFIRMATION NO. 1512

UPDATED FILING RECEIPT

8933
DUANE MORRIS, LLP
IP DEPARTMENT
30 SOUTH 17TH STREET
PHILADELPHIA, PA19103-4196

Date Mailed: 08/14/2007

Receipt is acknowledged of this non-provisional patent application. The application will be taken up for examination in due course. Applicant will be notified as to the results of the examination. Any correspondence concerning the application must include the following identification information: the U.S. APPLICATION NUMBER, FILING DATE, NAME OF APPLICANT, and TITLE OF INVENTION. Fees transmitted by check or draft are subject to collection. Please verify the accuracy of the data presented on this receipt. If an error is noted on this Filing Receipt, please write to the Office of Initial Patent Examination's Filing Receipt Corrections. Please provide a copy of this Filing Receipt with the changes noted thereon. If you received a "Notice to File Missing Parts" for this application, please submit any corrections to this Filing Receipt with your reply to the Notice. When the USPTO processes the reply to the Notice, the USPTO will generate another Filing Receipt incorporating the requested corrections

Applicant(s)

LISA A. HENDRICKSON, Mount Laurel, NJ;
James H. Gardner III, Ambler, PA;
Richard Adelman, Greensboro, NC;

Assignment For Published Patent Application

Mothers Work, Inc.

Power of Attorney: The patent practitioners associated with Customer Number 08933

Domestic Priority data as claimed by applicant

Foreign Applications

If Required, Foreign Filing License Granted: 06/12/2007

The country code and number of your priority application, to be used for filing abroad under the Paris Convention, is US11/756,242

Projected Publication Date: 12/04/2008

Non-Publication Request: No

Early Publication Request: No

Title

BELLY COVERING GARMENT

Preliminary Class

002

PROTECTING YOUR INVENTION OUTSIDE THE UNITED STATES

Since the rights granted by a U.S. patent extend only throughout the territory of the United States and have no effect in a foreign country, an inventor who wishes patent protection in another country must apply for a patent in a specific country or in regional patent offices. Applicants may wish to consider the filing of an international application under the Patent Cooperation Treaty (PCT). An international (PCT) application generally has the same effect as a regular national patent application in each PCT-member country. The PCT process **simplifies** the filing of patent applications on the same invention in member countries, but **does not result** in a grant of "an international patent" and does not eliminate the need of applicants to file additional documents and fees in countries where patent protection is desired.

Almost every country has its own patent law, and a person desiring a patent in a particular country must make an application for patent in that country in accordance with its particular laws. Since the laws of many countries differ in various respects from the patent law of the United States, applicants are advised to seek guidance from specific foreign countries to ensure that patent rights are not lost prematurely.

Applicants also are advised that in the case of inventions made in the United States, the Director of the USPTO must issue a license before applicants can apply for a patent in a foreign country. The filing of a U.S. patent application serves as a request for a foreign filing license. The application's filing receipt contains further information and guidance as to the status of applicant's license for foreign filing.

Applicants may wish to consult the USPTO booklet, "General Information Concerning Patents" (specifically, the section entitled "Treaties and Foreign Patents") for more information on timeframes and deadlines for filing foreign patent applications. The guide is available either by contacting the USPTO Contact Center at 800-786-9199, or it can be viewed on the USPTO website at <http://www.uspto.gov/web/offices/pac/doc/general/index.html>.

For information on preventing theft of your intellectual property (patents, trademarks and copyrights), you may wish to consult the U.S. Government website, <http://www.stopfakes.gov>. Part of a Department of Commerce initiative, this website includes self-help "toolkits" giving innovators guidance on how to protect intellectual property in specific countries such as China, Korea and Mexico. For questions regarding patent enforcement issues, applicants may call the U.S. Government hotline at 1-866-999-HALT (1-866-999-4158).

LICENSE FOR FOREIGN FILING UNDER

Title 35, United States Code, Section 184

Title 37, Code of Federal Regulations, 5.11 & 5.15

GRANTED

The applicant has been granted a license under 35 U.S.C. 184, if the phrase "IF REQUIRED, FOREIGN FILING LICENSE GRANTED" followed by a date appears on this form. Such licenses are issued in all applications where the conditions for issuance of a license have been met, regardless of whether or not a license may be required as set forth in 37 CFR 5.15. The scope and limitations of this license are set forth in 37 CFR 5.15(a) unless an earlier license has been issued under 37 CFR 5.15(b). The license is subject to revocation upon written notification. The date indicated is the effective date of the license, unless an earlier license of similar scope has been granted under 37 CFR 5.13 or 5.14.

This license is to be retained by the licensee and may be used at any time on or after the effective date thereof unless it is revoked. This license is automatically transferred to any related application(s) filed under 37 CFR 1.53(d). This license is not retroactive.

The grant of a license does not in any way lessen the responsibility of a licensee for the security of the subject matter as imposed by any Government contract or the provisions of existing laws relating to espionage and the national security or the export of technical data. Licensees should apprise themselves of current regulations especially with respect to certain countries, of other agencies, particularly the Office of Defense Trade Controls, Department of State (with respect to Arms, Munitions and Implements of War (22 CFR 121-128)); the Bureau of Industry and Security, Department of Commerce (15 CFR parts 730-774); the Office of Foreign Assets Control, Department of Treasury (31 CFR Parts 500+) and the Department of Energy.

NOT GRANTED

No license under 35 U.S.C. 184 has been granted at this time, if the phrase "IF REQUIRED, FOREIGN FILING LICENSE GRANTED" DOES NOT appear on this form. Applicant may still petition for a license under 37 CFR 5.12, if a license is desired before the expiration of 6 months from the filing date of the application. If 6 months has lapsed from the filing date of this application and the licensee has not received any indication of a secrecy order under 35 U.S.C. 181, the licensee may foreign file the application pursuant to 37 CFR 5.15(b).

IN THE UNITED STATES PATENT AND TRADEMARK OFFICE

In Re Application of: Lisa A. Hendrickson et al.

Confirmation No. 1512

Serial No. 11/756,242

Examiner: n/a

Filed: May 31, 2007

Group Art Unit: 3765

For: BELLY COVERING GARMENT

M.S. Amendment
Commissioner for Patents
P.O. Box 1450
Alexandria, VA 22313-1450

Dear Sir:

PRELIMINARY AMENDMENT

I. Introductory Comments

Prior to examination, please enter this Preliminary Amendment to add new claims 12-17 to the referenced application.

Amendments to the Claims are reflected in the listing of claims which begins on page 2 of this Amendment.

Remarks begin on page 5 of this Amendment.

II. Amendments to the Claims

1. (Original) A garment, comprising:
a garment upper portion having a belly panel that is expansible to cover and fit over a growing abdomen during different stages of pregnancy;
a garment lower portion having a first torso encircling circumference that recedes downward to make way for expansion of the belly panel; and
the garment upper portion having a second torso encircling circumference to hold the garment up and in place over the torso.

2. (Original) The garment of claim 1, wherein the second torso encircling circumference is adjustable in girth to encircle different body types.

3. (Original) The garment of claim 1, wherein the garment upper portion comprises a seamless tubular structure that fits comfortably while being worn, and the belly panel comprises a portion of the tubular structure.

4. (Original) The garment of claim 1, wherein the garment upper portion comprises a seamless tubular elastic fabric to stretch elastically.

5. (Original) The garment of claim 1, wherein the garment upper portion comprises an elastic fabric that is contractible elastically to cover an abdomen during different stages of postpartum body changes.

6. (Original) The garment of claim 1, wherein the garment lower portion has a partial waistband extending from side seams of the garment lower portion and extending across a back side of the garment lower portion.

7. (Original) The garment of claim 1, further comprising a series of belly cradling stitches or knitted tension in the belly panel, wherein the knitted tension or stitches

extend along multiple paths arranged in an elliptical pattern that curves, so as to cradle a curved growing abdomen during various stages of pregnancy.

8. (Original) The garment of claim 1, further comprising a series of stitches or knitted tension in the backside of the garment upper portion to provide spinal and back support against the wearer of the garment.

9. (Original) The garment of claim 8, wherein the series of stitches or knitted tension in the backside of the garment upper portion extends along a pattern of multiple stitch paths.

10. (Original) The garment of claim 8, wherein the series of stitches or knitted tension in the backside of the garment upper portion extends along a pattern of multiple stitch paths.

11. (Original) The garment of claim 1, wherein the garment upper portion is foldable toward the garment lower portion to comprise a folded band on the garment lower portion.

12. (New) The garment of claim 1, wherein the garment upper portion comprises a seamless tubular structure having a top edge margin folded over and knitted to the inside surface of the fabric to provide a top hem.

13. (New) The garment of claim 12, wherein the garment upper portion comprises a seamless tubular structure.

14. wherein the garment upper portion comprises a seamless tubular elastic fabric to stretch elastically.

15. (New) The garment of claim 1, wherein the garment upper portion comprises a seamless tubular structure having a top edge margin folded over and sewn to the inside surface of the fabric.

16. (New) The garment of claim 15, wherein the garment upper portion comprises a seamless tubular structure.

17. (New) The garment of claim 15, wherein the garment upper portion comprises a seamless tubular elastic fabric to stretch elastically.

III. **Remarks**

Claims 1-17 are pending in the application following entry of this Amendment. Claims 12-17 have been added. Claim 1 is the only independent claim pending. No new matter is added by the amendments and additions made herein. Antecedent basis for the new claims 12-17 is found in the specification at paragraphs [0026] and [0029]. Examination of Claims 1-17 is requested.

In view of the Amendment of the Claims, allowance is requested. The Examiner is invited to telephone the undersigned for any reason to advance the prosecution of the application.

Respectfully submitted,

Date: February 20, 2008 By: Gerald K. Kita
Gerald K. Kita
Registration No. 24,125

Customer No. 08933
DUANE MORRIS LLP
30 South 17th Street
Philadelphia, PA 19103-4196
Direct Dial: 215-979-1863
Facsimile: 215-979-1020
E-Mail: GKKita@DuaneMorris.com

Electronic Acknowledgement Receipt

EFS ID:	2884174
Application Number:	11756242
International Application Number:	
Confirmation Number:	1512
Title of Invention:	BELLY COVERING GARMENT
First Named Inventor/Applicant Name:	LISA A. HENDRICKSON
Customer Number:	8933
Filer:	Gerald K. Kita./Mary La Grange
Filer Authorized By:	Gerald K. Kita.
Attorney Docket Number:	D8114-00369
Receipt Date:	20-FEB-2008
Filing Date:	31-MAY-2007
Time Stamp:	12:35:25
Application Type:	Utility under 35 USC 111(a)

Payment information:

Submitted with Payment	no
------------------------	----

File Listing:

Document Number	Document Description	File Name	File Size(Bytes) /Message Digest	Multi Part /.zip	Pages (if appl.)
1		369prelimAmend.pdf	264119 <small>99721dd316742a652f1238a7d13d12f03ceb8621</small>	yes	6

Multipart Description/PDF files in .zip description			
Document Description		Start	End
Miscellaneous Incoming Letter		1	1
Preliminary Amendment		2	2
Claims		3	5
Applicant Arguments/Remarks Made in an Amendment		6	6

Warnings:

Information:

Total Files Size (in bytes):	264119
-------------------------------------	--------

This Acknowledgement Receipt evidences receipt on the noted date by the USPTO of the indicated documents, characterized by the applicant, and including page counts, where applicable. It serves as evidence of receipt similar to a Post Card, as described in MPEP 503.

New Applications Under 35 U.S.C. 111

If a new application is being filed and the application includes the necessary components for a filing date (see 37 CFR 1.53(b)-(d) and MPEP 506), a Filing Receipt (37 CFR 1.54) will be issued in due course and the date shown on this Acknowledgement Receipt will establish the filing date of the application.

National Stage of an International Application under 35 U.S.C. 371

If a timely submission to enter the national stage of an international application is compliant with the conditions of 35 U.S.C. 371 and other applicable requirements a Form PCT/DO/EO/903 indicating acceptance of the application as a national stage submission under 35 U.S.C. 371 will be issued in addition to the Filing Receipt, in due course.

New International Application Filed with the USPTO as a Receiving Office

If a new international application is being filed and the international application includes the necessary components for an international filing date (see PCT Article 11 and MPEP 1810), a Notification of the International Application Number and of the International Filing Date (Form PCT/RO/105) will be issued in due course, subject to prescriptions concerning national security, and the date shown on this Acknowledgement Receipt will establish the international filing date of the application.

Under the Paperwork Reduction Act of 1995, no persons are required to respond to a collection of information unless it displays a valid OMB control number.

TRANSMITTAL FORM <i>(to be used for all correspondence after initial filing)</i>	Application Number	11/756,242
	Filing Date	May 31, 2007
	First Named Inventor	Hendrickson, Lisa et al.
	Art Unit	3765
	Examiner Name	n/a
Total Number of Pages in This Submission	Attorney Docket Number	D8114-00369

ENCLOSURES <i>(Check all that apply)</i>		
<input type="checkbox"/> Fee(s) Transmittal Form <input type="checkbox"/> Fee Attached <input type="checkbox"/> Amendment/Reply <input type="checkbox"/> After Allowance <input type="checkbox"/> Affidavits/declaration(s) <input type="checkbox"/> Extension of Time Request <input type="checkbox"/> Express Abandonment Request <input type="checkbox"/> Information Disclosure Statement <input type="checkbox"/> Certified Copy of Priority Document(s) <input type="checkbox"/> Response to Missing Parts/ Incomplete Application <input type="checkbox"/> Response to Missing Parts under 37 CFR 1.52 or 1.53	<input type="checkbox"/> Drawing(s) <input type="checkbox"/> Licensing-related Papers <input type="checkbox"/> Petition <input type="checkbox"/> Petition to Convert to a Provisional Application <input type="checkbox"/> Power of Attorney, Revocation Change of Correspondence Address <input type="checkbox"/> Terminal Disclaimer <input type="checkbox"/> Request for Refund <input type="checkbox"/> CD, Number of CD(s) _____	<input type="checkbox"/> After Allowance communication to Technology Center (TC) <input type="checkbox"/> Appeal Communication to Board of Appeals and Interferences <input type="checkbox"/> Appeal Communication to TC (Appeal Notice, Brief, Reply Brief) <input type="checkbox"/> Proprietary Information <input type="checkbox"/> Status Letter <input checked="" type="checkbox"/> Other Enclosure(s) (please identify below): PRELIMINARY AMENDMENT
Remarks The Commissioner is hereby authorized to charge any fees associated with this communication or credit any overpayment to Deposit Account No. 04-1679.		

SIGNATURE OF APPLICANT, ATTORNEY, OR AGENT	
Firm or Individual name	Gerald K. Kita, Registration No. 24,125 Customer Number 08933
Signature	<i>Gerald K. Kita</i>
Date	<i>February 20, 2008</i>

CERTIFICATE UNDER 37 CFR 1.10	
I hereby certify that this correspondence and the documents referred to therein are being electronically filed in the United States Patent and Trademark Office on the date indicated below	
Typed or printed name	Mary La Grange
Signature	<i>Mary La Grange</i>
Date	<i>2-20-08</i>

This collection of information is required by 37 CFR 1.5. The information is required to obtain or retain a benefit by the public which is to file (and by the USPTO to process) an application. Confidentiality is governed by 35 U.S.C. 122 and 37 CFR 1.14. This collection is estimated to 2 hours to complete, including gathering, preparing, and submitting the completed application form to the USPTO. Time will vary depending upon the individual case. Any comments on the amount of time you require to complete this form and/or suggestions for reducing this burden, should be sent to the Chief Information Officer, U.S. Patent and Trademark Office, U.S. Department of Commerce, P.O. Box 1450, Alexandria, VA 22313-1450. DO NOT SEND FEES OR COMPLETED FORMS TO THIS ADDRESS. SEND TO: Commissioner for Patents, P.O. Box 1450, Alexandria, VA 22313-1450.

If you need assistance in completing the form, call 1-800-PTO-9199 and select option 2.

05/31/07

Approved for use through 7/31/2006. OMB 0651-0032
 U.S. Patent and Trademark Office; U.S. DEPARTMENT OF COMMERCE

Under the Paperwork Reduction Act of 1995, no persons are required to respond to a collection of information unless it displays a valid OMB control number.

PATENT APPLICATION FEE DETERMINATION RECORD
 Substitute for Form PTO-875

Application or Docket Number
11/756,242

APPLICATION AS FILED - PART I

FOR	NUMBER FILED	NUMBER EXTRA
BASIC FEE (37 CFR 1.16(a), (b), or (c))		
SEARCH FEE (37 CFR 1.16(k), (l), or (m))		
EXAMINATION FEE (37 CFR 1.16(o), (p), or (q))		
TOTAL CLAIMS (37 CFR 1.16(i))	11 minus 20 =	0
INDEPENDENT CLAIMS (37 CFR 1.16(h))	1 minus 3 =	0
APPLICATION SIZE FEE (37 CFR 1.16(s))		
MULTIPLE DEPENDENT CLAIM PRESENT (37 CFR 1.16(j))		

SMALL ENTITY

RATE (\$)	FEE (\$)
X\$ 25	
X\$100	
180	
TOTAL	0

OR OTHER THAN SMALL ENTITY

RATE (\$)	FEE (\$)
	300
	500
	200
X\$50	0
X\$200	0
360	
TOTAL	1000

* If the difference in column 1 is less than zero, enter "0" in column 2.

APPLICATION AS AMENDED - PART II

2/21/08

AMENDMENT A	CLAIMS REMAINING AFTER AMENDMENT	HIGHEST NUMBER PREVIOUSLY PAID FOR	PRESENT EXTRA
Total (37 CFR 1.16(i))	11	20	1
Independent (37 CFR 1.16(h))	1	3	1
Application Size Fee (37 CFR 1.16(s))			
FIRST PRESENTATION OF MULTIPLE DEPENDENT CLAIM (37 CFR 1.16(j))			

SMALL ENTITY

RATE (\$)	ADDITIONAL FEE (\$)
X =	
X =	
180	
TOTAL ADD'T FEE	

OR OTHER THAN SMALL ENTITY

RATE (\$)	ADDITIONAL FEE (\$)
X =	
X =	
360	
TOTAL ADD'T FEE	

AMENDMENT B	CLAIMS REMAINING AFTER AMENDMENT	HIGHEST NUMBER PREVIOUSLY PAID FOR	PRESENT EXTRA
Total (37 CFR 1.16(i))			
Independent (37 CFR 1.16(h))			
Application Size Fee (37 CFR 1.16(s))			
FIRST PRESENTATION OF MULTIPLE DEPENDENT CLAIM (37 CFR 1.16(j))			

SMALL ENTITY

RATE (\$)	ADDITIONAL FEE (\$)
X =	
X =	
N/A	
TOTAL ADD'T FEE	

OR OTHER THAN SMALL ENTITY

RATE (\$)	ADDITIONAL FEE (\$)
X =	
X =	
N/A	
TOTAL ADD'T FEE	

- * If the entry in column 1 is less than the entry in column 2, write "0" in column 3.
 - ** If the "Highest Number Previously Paid For" IN THIS SPACE is less than 20, enter "20".
 - *** If the "Highest Number Previously Paid For" IN THIS SPACE is less than 3, enter "3".
- The "Highest Number Previously Paid For" (Total or Independent) is the highest number found in the appropriate box in column 1.

This collection of information is required by 37 CFR 1.16. The information is required to obtain or retain a benefit by the public which is to file (and by the USPTO to process) an application. Confidentiality is governed by 35 U.S.C. 122 and 37 CFR 1.14. This collection is estimated to take 12 minutes to complete, including gathering, preparing, and submitting the completed application form to the USPTO. Time will vary depending upon the individual case. Any comments on the amount of time you require to complete this form and/or suggestions for reducing this burden, should be sent to the Chief Information Officer, U.S. Patent and Trademark Office, U.S. Department of Commerce, P.O. Box 1450, Alexandria, VA 22313-1450. DO NOT SEND FEES OR COMPLETED FORMS TO THIS ADDRESS. SEND TO: Commissioner for Patents, P.O. Box 1450, Alexandria, VA 22313-1450.

If you need assistance in completing the form, call 1-800-PTO-9199 and select option 2.

Under the Paperwork Reduction Act of 1995, no persons are required to respond to a collection of information unless it displays a valid OMB control number.

TRANSMITTAL FORM <i>(to be used for all correspondence after initial filing)</i>	Application Number	11/756,242
	Filing Date	May 31, 2007
	First Named Inventor	Hendrickson, Lisa et al.
	Art Unit	3765
	Examiner Name	n/a
Total Number of Pages in This Submission	Attorney Docket Number	D8114-00369

ENCLOSURES (Check all that apply)		
<input type="checkbox"/> Fee(s) Transmittal Form	<input type="checkbox"/> Drawing(s)	<input type="checkbox"/> After Allowance communication to Technology Center (TC)
<input type="checkbox"/> Fee Attached	<input type="checkbox"/> Licensing-related Papers	<input type="checkbox"/> Appeal Communication to Board of Appeals and Interferences
<input type="checkbox"/> Amendment/Reply	<input type="checkbox"/> Petition	<input type="checkbox"/> Appeal Communication to TC (Appeal Notice, Brief, Reply Brief)
<input type="checkbox"/> After Allowance	<input type="checkbox"/> Petition to Convert to a Provisional Application	<input type="checkbox"/> Proprietary Information
<input type="checkbox"/> Affidavits/declaration(s)	<input type="checkbox"/> Power of Attorney, Revocation	<input type="checkbox"/> Status Letter
<input type="checkbox"/> Extension of Time Request	<input type="checkbox"/> Change of Correspondence Address	<input type="checkbox"/> Other Enclosure(s) (please identify below):
<input type="checkbox"/> Express Abandonment Request	<input type="checkbox"/> Terminal Disclaimer	
<input checked="" type="checkbox"/> Information Disclosure Statement	<input type="checkbox"/> Request for Refund	
<input type="checkbox"/> Certified Copy of Priority Document(s)	<input type="checkbox"/> CD, Number of CD(s) _____	
<input type="checkbox"/> Response to Missing Parts/Incomplete Application	Remarks	
<input type="checkbox"/> Response to Missing Parts under 37 CFR 1.52 or 1.53	The Commissioner is hereby authorized to charge any fees associated with this communication or credit any overpayment to Deposit Account No. 04-1679.	

SIGNATURE OF APPLICANT, ATTORNEY, OR AGENT

Firm or Individual name	Gerald K. Kita, Registration No. 24,125 Customer Number 08933		
Signature	<i>Gerald K. Kita</i>		
Date	<i>February 26, 2008</i>		

CERTIFICATE UNDER 37 CFR 1.10

I hereby certify that this correspondence and the documents referred to therein are being electronically filed in the United States Patent and Trademark Office on the date indicated below			
Typed or printed name		Mary La Grange	
Signature	<i>Mary La Grange</i>	Date	<i>2-26-08</i>

This collection of information is required by 37 CFR 1.5. The information is required to obtain or retain a benefit by the public which is to file (and by the USPTO to process) an application. Confidentiality is governed by 35 U.S.C. 122 and 37 CFR 1.14. This collection is estimated to 2 hours to complete, including gathering, preparing, and submitting the completed application form to the USPTO. Time will vary depending upon the individual case. Any comments on the amount of time you require to complete this form and/or suggestions for reducing this burden, should be sent to the Chief Information Officer, U.S. Patent and Trademark Office, U.S. Department of Commerce, P.O. Box 1450, Alexandria, VA 22313-1450. DO NOT SEND FEES OR COMPLETED FORMS TO THIS ADDRESS. SEND TO: **Commissioner for Patents, P.O. Box 1450, Alexandria, VA 22313-1450.**

If you need assistance in completing the form, call 1-800-PTO-9199 and select option 2.

Electronic Acknowledgement Receipt

EFS ID:	2911260
Application Number:	11756242
International Application Number:	
Confirmation Number:	1512
Title of Invention:	BELLY COVERING GARMENT
First Named Inventor/Applicant Name:	LISA A. HENDRICKSON
Customer Number:	8933
Filer:	Gerald K. Kita./Mary La Grange
Filer Authorized By:	Gerald K. Kita.
Attorney Docket Number:	D8114-00369
Receipt Date:	26-FEB-2008
Filing Date:	31-MAY-2007
Time Stamp:	15:09:10
Application Type:	Utility under 35 USC 111(a)

Payment information:

Submitted with Payment	no
------------------------	----

File Listing:

Document Number	Document Description	File Name	File Size(Bytes) /Message Digest	Multi Part /.zip	Pages (if appl.)
1		369ids2.pdf	1215191 <small>b1c102de27703251dc13a97a064f0e113bf4ff91</small>	yes	10

Multipart Description/PDF files in .zip description			
Document Description		Start	End
Miscellaneous Incoming Letter		1	1
Information Disclosure Statement Letter		2	5
NPL Documents		6	10

Warnings:

Information:

Total Files Size (in bytes):	1215191
-------------------------------------	---------

This Acknowledgement Receipt evidences receipt on the noted date by the USPTO of the indicated documents, characterized by the applicant, and including page counts, where applicable. It serves as evidence of receipt similar to a Post Card, as described in MPEP 503.

New Applications Under 35 U.S.C. 111

If a new application is being filed and the application includes the necessary components for a filing date (see 37 CFR 1.53(b)-(d) and MPEP 506), a Filing Receipt (37 CFR 1.54) will be issued in due course and the date shown on this Acknowledgement Receipt will establish the filing date of the application.

National Stage of an International Application under 35 U.S.C. 371

If a timely submission to enter the national stage of an international application is compliant with the conditions of 35 U.S.C. 371 and other applicable requirements a Form PCT/DO/EO/903 indicating acceptance of the application as a national stage submission under 35 U.S.C. 371 will be issued in addition to the Filing Receipt, in due course.

New International Application Filed with the USPTO as a Receiving Office

If a new international application is being filed and the international application includes the necessary components for an international filing date (see PCT Article 11 and MPEP 1810), a Notification of the International Application Number and of the International Filing Date (Form PCT/RO/105) will be issued in due course, subject to prescriptions concerning national security, and the date shown on this Acknowledgement Receipt will establish the international filing date of the application.

1 In The Oven



[shop online](#)

[about us](#)

[stores](#)

[contact](#)

[press](#)

[email a friend](#)

<http://www.1intheoven.com/>

Jump To:

1 in the Oven's InvisiBelly™ Jeans

[Email this Product](#)

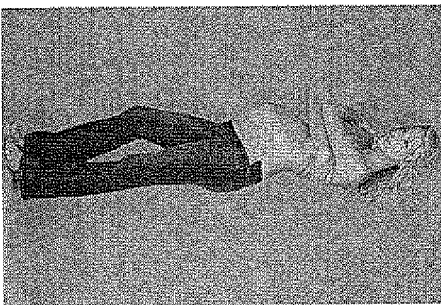

[More Images](#)

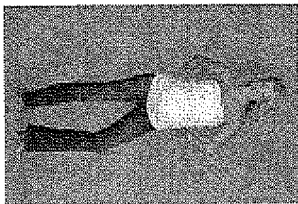

You wont want to miss out on these hot new jeans! Our Original InvisiBelly™ Jeans are the very first maternity denim to have a nude belly band, so no more big dark elastic waist peeking through your white tees. Roll down to wear under the belly or up for mid belly fit. Waistband made of super soft, breathable Tactel nylon. Boot cut. Made in LOS ANGELES, USA. FEATURED IN THIS MONTHS FIT PREGNANCY! Sizing: XS(0-2) S(2-4) M(6-8) L(8-10) XL(10-12)

price: **\$128.00**

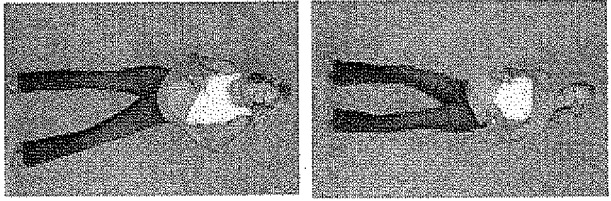

Item URL: <http://www.1intheoven.com/index.php?p=product&id=88&parent=26>

Powered by 1 In The Oven

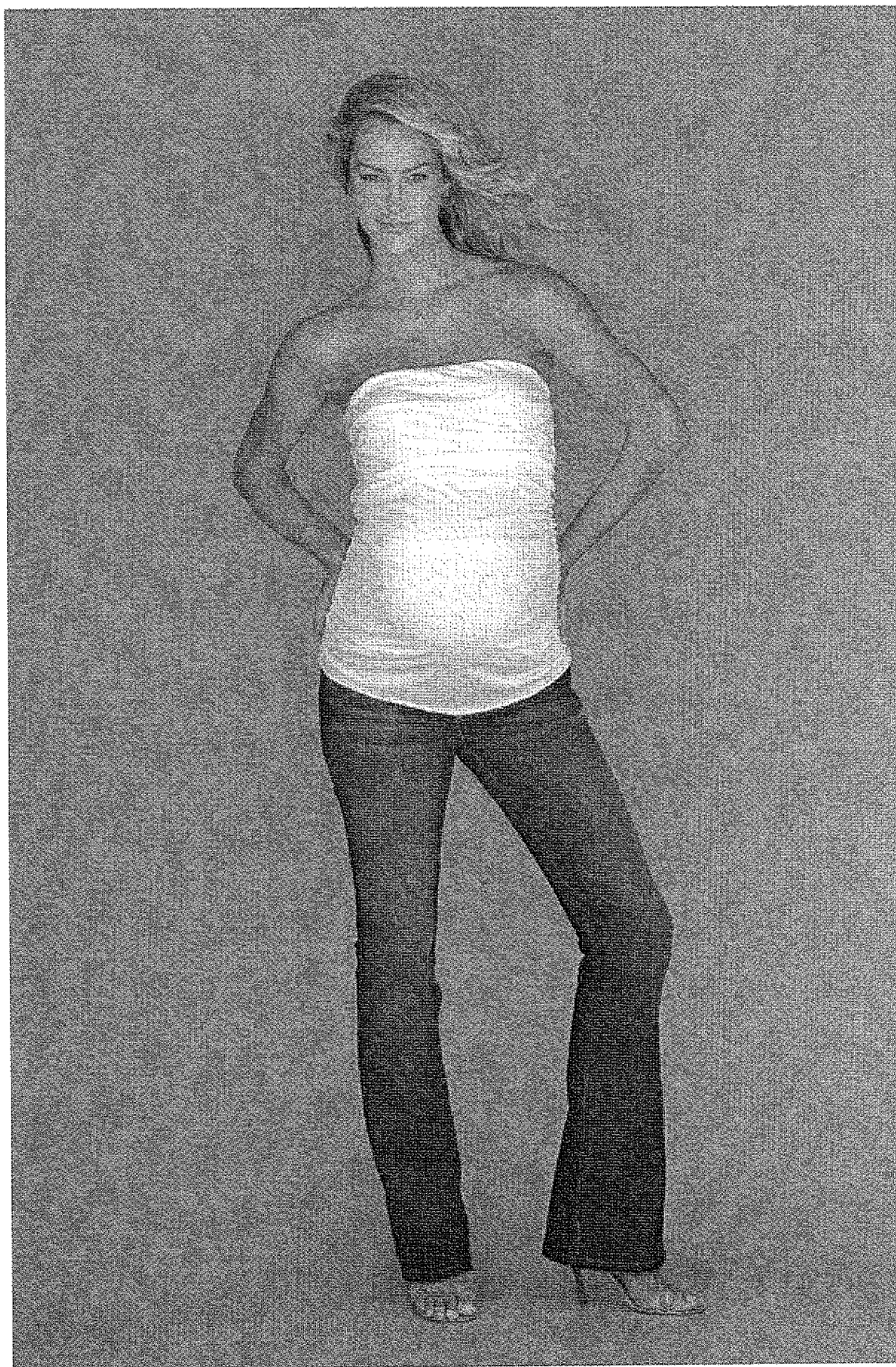



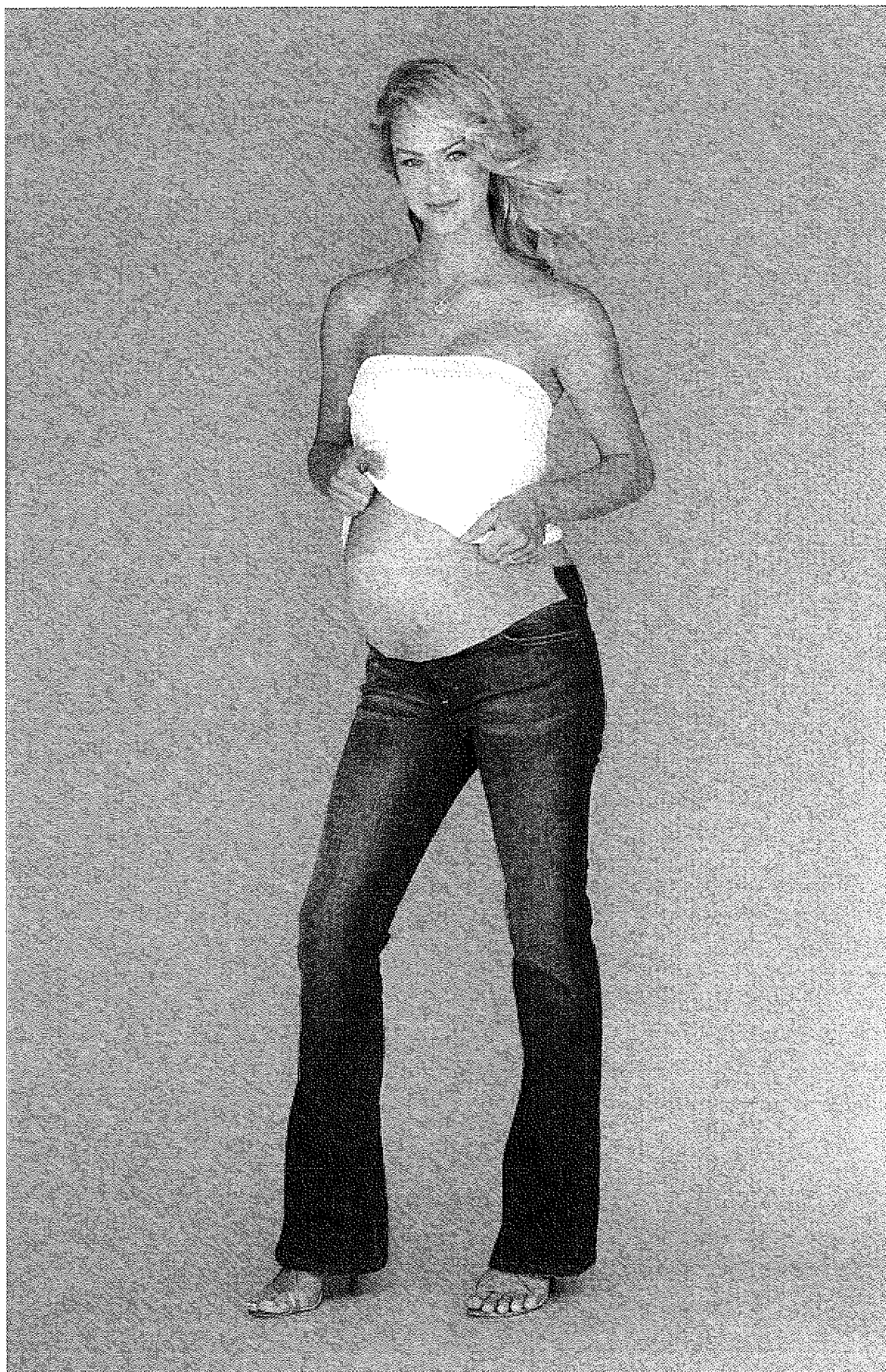

IN THE UNITED STATES PATENT AND TRADEMARK OFFICE

In re Application of: Henderson et al.

Confirmation No. 1512

Serial No: 11/756,242

Group Art Unit: 3765

Filed: May 21, 2007

Examiner: n/a

For: Belly Covering Garment

M.S. Amendment
Commissioner for Patents
P.O. Box 1450
Alexandria, VA 22313-1450

Dear Sir:

INFORMATION DISCLOSURE STATEMENT TRANSMITTAL LETTER

Enclosed herewith is an Information Disclosure Statement pursuant to 37 CFR. § 1.56 in connection with the above-identified application, which statement is being filed:

Together with the present application.

Before the first Office Action on the merits or three (3) months from the filing date of this application, whichever occurs last. **[37 CFR § 1.97(b)]**

After the first Office Action on the merits, but before a Final Office Action under §1.113 or Notice of Allowance under §1.311, whichever occurs first. **[37 CFR §1.97(c)]**. *(Either the fee or certification is provided, as set forth below).*

After a Final Office Action under §1.113 or Notice of Allowance under §1.311, but prior to or with payment of the Issue Fee. **[37 CFR §1.97(d)]**. *The fee and certification are provided, as set forth below).*

Consistent with Applicant's obligations pursuant to 37 CFR §§1.97 and 1.98, the following requirements have been met:

- No separate requirements are needed.
- No additional fee is required.

Fee Under 37 CFR § 1.97(c) or 1.97(d)

The fee of \$180.00 for submission of an IDS under § 1.97(c) as set forth in § 1.17(p) accompanies this statement.

Please charge the fee of \$180.00 for submission of an IDS under § 1.97(c) or (d) as set forth in § 1.17(p) to Deposit Account 04-1679.

Certification Under 37 CFR § 1.97(e)

The undersigned certifies:

1 that each item of information contained in the information disclosure statement was first cited in a communication from a foreign patent office in a counterpart foreign application not more than three months prior to the filing of the information disclosure statement; or

2 that no item of information contained in the information disclosure statement was cited in a communication from a foreign patent office in a counterpart foreign application, and, to the knowledge of the person signing the statement after making reasonable inquiry, no item of information contained in the information disclosure statement was known to any individual designated in §1.56(c) more than three months prior to the filing of the information disclosure statement.

Provision of Copies of References

- A copy of each of the "Foreign" and "Other" references listed on the attached Form PTO-1449 is enclosed herewith and forms a part hereof.
- Partial Translations of References are enclosed herewith and form a part hereof.
- A copy of the European Search Report from a corresponding or related EPO application is enclosed herewith.
- A copy of the International Search Report from a corresponding or related PCT application is enclosed herewith.

Identification of Prior Application(s) In Which Listed Information Was Already Cited And For Which No Copies Are Submitted Or Need Be Submitted

This application relies, under 35 U.S.C. § 120, on the earlier filing date of prior U.S. Application No(s). _____, filed _____. Some or all of the references were submitted to, and/or cited by, the Office in the prior application(s) and therefore are not required to be provided in this application.

The Commissioner is hereby authorized to charge any fees associated with this communication or credit any overpayment to Deposit Account No. 04-1679.

Respectfully submitted,

Date:

February 26, 2008



Gerald K. Kita

Registration No. 24,125

Customer No. 08933

DUANE MORRIS LLP
One Liberty Place
Philadelphia, PA 19103-7396
215-979-1863 tel
215-979-1020 fax

THJ
SEL



IN THE UNITED STATES PATENT AND TRADEMARK OFFICE

In Re Application of: Hendrickson, Lisa

Confirmation No: 1512

Serial No. 11/756,242

Group Art Unit: 3727

Filed: May 31, 2007

Examiner: n/a

For: Belly Covering Garment

CERTIFICATE OF FIRST CLASS MAIL

I hereby certify that the enclosed correspondence, listed below, is being deposited with the United States Postal Service on the date shown below with sufficient postage as first class mail and addressed to: Commissioner for Patents, P.O. Box 1450, Alexandria, VA 22313-1450

Date: July 24, 2008
By: Mary La Grange

M.S. Amendment
Commissioner for Patents
P.O. Box 1450
Alexandria, VA 22313-1450

Dear Sir:

INFORMATION DISCLOSURE STATEMENT TRANSMITTAL LETTER

Enclosed herewith is an Information Disclosure Statement pursuant to 37 CFR. § 1.56 in connection with the above-identified application, which statement is being filed:

Together with the present application.

Before the first Office Action on the merits or three (3) months from the filing date of this application, whichever occurs last. **[37 CFR § 1.97(b)]**

After the first Office Action on the merits, but before a Final Office Action under §1.113 or Notice of Allowance under §1.311, whichever occurs first. **[37 CFR §1.97(c)]**. *(Either the fee or certification is provided, as set forth below).*

After a Final Office Action under §1.113 or Notice of Allowance under §1.311, but prior to or with payment of the Issue Fee. **[37 CFR §1.97(d)]**. *The fee and certification are provided, as set forth below).*

Consistent with Applicant's obligations pursuant to 37 CFR §§1.97 and 1.98, the following requirements have been met:

No separate requirements are needed.

No additional fee is required.

Fee Under 37 CFR § 1.97(c) or 1.97(d)

The fee of \$180.00 for submission of an IDS under § 1.97(c) as set forth in § 1.17(p) accompanies this statement.

Please charge the fee of \$180.00 for submission of an IDS under § 1.97(c) or (d) as set forth in § 1.17(p) to Deposit Account 04-1679.

Certification Under 37 CFR § 1.97(e)

The undersigned certifies:

1 that each item of information contained in the information disclosure statement was first cited in a communication from a foreign patent office in a counterpart foreign application not more than three months prior to the filing of the information disclosure statement; or

2 that no item of information contained in the information disclosure statement was cited in a communication from a foreign patent office in a counterpart foreign application, and, to the knowledge of the person signing the statement after making reasonable inquiry, no item of information contained in the information disclosure statement was known to any individual designated in §1.56(c) more than three months prior to the filing of the information disclosure statement.

Provision of Copies of References

A copy of each of the Foreign and Other references listed on the attached Form PTO-1449 is enclosed herewith and forms a part hereof.

Partial Translations of References are enclosed herewith and form a part hereof.

A copy of the European Search Report from a corresponding or related EPO application is enclosed herewith.

A copy of the International Search Report from a corresponding or related PCT application is enclosed herewith.

Identification of Prior Application(s) In Which Listed Information Was Already Cited And For Which No Copies Are Submitted Or Need Be Submitted

[X] This application relies, under 35 U.S.C. § 120, on the earlier filing date of prior U.S. Application No(s). filed . Some or all of the references were submitted to, and/or cited by, the Office in the prior application(s) and therefore are not required to be provided in this application.

The Commissioner is hereby authorized to charge any fees associated with this communication or credit any overpayment to Deposit Account No. 04-1679.

Respectfully submitted,

Date: July 24, 2008



Gerald K. Kita
Registration No. 24,125

Customer No. 08933
DUANE MORRIS LLP
30 South 17th Street
Philadelphia, PA 19103-4196
215-979-1863 tel
215-979-1020 fax

UNITED STATES PATENT AND TRADEMARK OFFICE

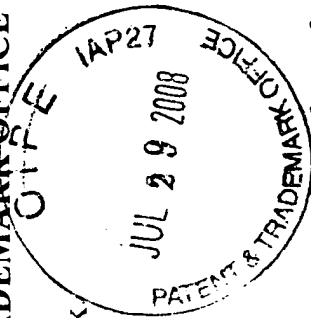

Docket No.: D8114-00369 Mothers Work
Applicant(s): Hendrickson et al.
Serial No.: 11/756,242
Filed: May 31, 2007
For: Belly Covering Garment

The Patent Office acknowledges and has stamped hereon the date of receipt of the following items:

ADS transmittal; form 1449; DVD of NPL reference; all via First Class Mail.

Date: July 24, 2008

ARTIFACT SHEET

Enter artifact number below. Artifact number is application number + artifact type code (see list below) + sequential letter (A, B, C ...). The first artifact folder for an artifact type receives the letter A, the second B, etc.. Examples: 59123456PA, 59123456PB, 59123456ZA, 59123456ZB

11756242ZA

Indicate quantity of a single type of artifact received but not scanned. Create individual artifact folder/box and artifact number for each Artifact Type.

CD(s) containing:

computer program listing

Doc Code: Computer

pages of specification

and/or sequence listing

and/or table

Doc Code: Artifact

content unspecified or combined

Doc Code: Artifact

Artifact Type Code: P

Artifact Type Code: S

Artifact Type Code: U

Stapled Set(s) Color Documents or B/W Photographs

Doc Code: Artifact Artifact Type Code: C

Microfilm(s)

Doc Code: Artifact Artifact Type Code: F

Video tape(s)

Doc Code: Artifact Artifact Type Code: V

Model(s)

Doc Code: Artifact Artifact Type Code: M

Bound Document(s)

Doc Code: Artifact Artifact Type Code: B

Confidential Information Disclosure Statement or Other Documents marked Proprietary, Trade Secrets, Subject to Protective Order, Material Submitted under MPEP 724.02, etc.

Doc Code: Artifact Artifact Type Code X

Other, description: **DVD**

Doc Code: Artifact Artifact Type Code: Z

PATENT COOPERATION TREATY

GKK
RECEIVED
AUG 22 2008

From the INTERNATIONAL SEARCHING AUTHORITY

DOCKETED
PCT BY:

To: GERALD KITA DUANE MORRIS LLP 30 S. 17TH STREET PHILADELPHIA, PA 19103-4196	NOTIFICATION OF TRANSMITTAL OF THE INTERNATIONAL SEARCH REPORT AND THE WRITTEN OPINION OF THE INTERNATIONAL SEARCHING AUTHORITY, OR THE DECLARATION (PCT Rule 44.1)
	Date of mailing (day/month/year) 18 AUG 2008
Applicant's or agent's file reference D8114-00486	FOR FURTHER ACTION See paragraphs 1 and 4 below
International application No. PCT/US2008/061739	International filing date (day/month/year) 28 April 2008
Applicant MOTHERS WORK, INC.	

1. The applicant is hereby notified that the international search report and the written opinion of the International Searching Authority have been established and are transmitted herewith.

Filing of amendments and statement under Article 19:
 The applicant is entitled, if he so wishes, to amend the claims of the international application (see Rule 46):

When? The time limit for filing such amendments is normally two months from the date of transmittal of the international search report.

Where? Directly to the International Bureau of WIPO, 34 chemin des Colombettes
 1211 Geneva 20, Switzerland, Facsimile No.: +41 22 740 14 35

For more detailed instructions, see the notes on the accompanying sheet.

2. The applicant is hereby notified that no international search report will be established and that the declaration under Article 17(2)(a) to that effect and the written opinion of the International Searching Authority are transmitted herewith.

3. **With regard to the protest** against payment of (an) additional fee(s) under Rule 40.2, the applicant is notified that:

the protest together with the decision thereon has been transmitted to the International Bureau together with the applicant's request to forward the texts of both the protest and the decision thereon to the designated Offices.

no decision has been made yet on the protest; the applicant will be notified as soon as a decision is made.

4. **Reminders**

Shortly after the expiration of **18 months** from the priority date, the international application will be published by the International Bureau. If the applicant wishes to avoid or postpone publication, a notice of withdrawal of the international application, or of the priority claim, must reach the International Bureau as provided in Rules 90bis.1 and 90bis.3, respectively, before the completion of the technical preparations for international publication.

The applicant may submit comments on an informal basis on the written opinion of the International Searching Authority to the International Bureau. The International Bureau will send a copy of such comments to all designated Offices unless an international preliminary examination report has been or is to be established. These comments would also be made available to the public but not before the expiration of 30 months from the priority date.

Within **19 months** from the priority date, but only in respect of some designated Offices, a demand for international preliminary examination must be filed if the applicant wishes to postpone the entry into the national phase **until 30 months** from the priority date (in some Offices even later); otherwise, the applicant must, **within 20 months** from the priority date, perform the prescribed acts for entry into the national phase before those designated Offices.

In respect of other designated Offices, the time limit of **30 months** (or later) will apply even if no demand is filed within 19 months.

See the Annex to Form PCT/IB/301 and, for details about the applicable time limits, Office by Office, see the *PCT Applicant's Guide*, Volume II, National Chapters and the WIPO Internet site.

Name and mailing address of the ISA/US Mail Stop PCT, Attn: ISA/US Commissioner for Patents P.O. Box 1450, Alexandria, Virginia 22313-1450 Facsimile No. 571-273-3201	Authorized officer: Blaine R. Copenheaver Telephone No. 571-272-7774
---	--

PATENT COOPERATION TREATY

From the INTERNATIONAL SEARCHING AUTHORITY

PCT

NOTIFICATION OF TRANSMITTAL OF
THE INTERNATIONAL SEARCH REPORT AND
THE WRITTEN OPINION OF THE INTERNATIONAL
SEARCHING AUTHORITY, OR THE DECLARATION

(PCT Rule 44.1)

To: GERALD KITA DUANE MORRIS LLP 30 S. 17TH STREET PHILADELPHIA, PA 19103-4196		Date of mailing (day/month/year) 18 AUG 2008
Applicant's or agent's file reference D8114-00486	FOR FURTHER ACTION See paragraphs 1 and 4 below	
International application No. PCT/US2008/061739	International filing date (day/month/year) 28 April 2008	
Applicant MOTHERS WORK, INC.		

1. The applicant is hereby notified that the international search report and the written opinion of the International Searching Authority have been established and are transmitted herewith.

Filing of amendments and statement under Article 19:
 The applicant is entitled, if he so wishes, to amend the claims of the international application (see Rule 46):

When? The time limit for filing such amendments is normally two months from the date of transmittal of the international search report.

Where? Directly to the International Bureau of WIPO, 34 chemin des Colombettes
 1211 Geneva 20, Switzerland, Facsimile No.: +41 22 740 14 35

For more detailed instructions, see the notes on the accompanying sheet.

2. The applicant is hereby notified that no international search report will be established and that the declaration under Article 17(2)(a) to that effect and the written opinion of the International Searching Authority are transmitted herewith.

3. **With regard to the protest** against payment of (an) additional fee(s) under Rule 40.2, the applicant is notified that:

the protest together with the decision thereon has been transmitted to the International Bureau together with the applicant's request to forward the texts of both the protest and the decision thereon to the designated Offices.

no decision has been made yet on the protest; the applicant will be notified as soon as a decision is made.

4. **Reminders**

Shortly after the expiration of **18 months** from the priority date, the international application will be published by the International Bureau. If the applicant wishes to avoid or postpone publication, a notice of withdrawal of the international application, or of the priority claim, must reach the International Bureau as provided in Rules 90bis.1 and 90bis.3, respectively, before the completion of the technical preparations for international publication.

The applicant may submit comments on an informal basis on the written opinion of the International Searching Authority to the International Bureau. The International Bureau will send a copy of such comments to all designated Offices unless an international preliminary examination report has been or is to be established. These comments would also be made available to the public but not before the expiration of 30 months from the priority date.

Within **19 months** from the priority date, but only in respect of some designated Offices, a demand for international preliminary examination must be filed if the applicant wishes to postpone the entry into the national phase **until 30 months** from the priority date (in some Offices even later); otherwise, the applicant must, **within 20 months** from the priority date, perform the prescribed acts for entry into the national phase before those designated Offices.

In respect of other designated Offices, the time limit of **30 months** (or later) will apply even if no demand is filed within 19 months.

See the Annex to Form PCT/IB/301 and, for details about the applicable time limits, Office by Office, see the *PCT Applicant's Guide*, Volume II, National Chapters and the WIPO Internet site.

Name and mailing address of the ISA/US Mail Stop PCT, Attn: ISA/US Commissioner for Patents P.O. Box 1450, Alexandria, Virginia 22313-1450 Facsimile No. 571-273-3201	Authorized officer: Blaine R. Copenheaver Telephone No. 571-272-7774
---	--

PATENT COOPERATION TREATY

PCT

INTERNATIONAL SEARCH REPORT

(PCT Article 18 and Rules 43 and 44)

Applicant's or agent's file reference D8114-00486	FOR FURTHER ACTION	see Form PCT/ISA/220 as well as, where applicable, item 5 below.
International application No. PCT/US2008/061739	International filing date (day/month/year) 28 April 2008	(Earliest) Priority Date (day/month/year) 31 May 2007
Applicant MOTHERS WORK, INC.		

This international search report has been prepared by this International Searching Authority and is transmitted to the applicant according to Article 18. A copy is being transmitted to the International Bureau.

This international search report consists of a total of 2 sheets.

It is also accompanied by a copy of each prior art document cited in this report.

1. Basis of the report

a. With regard to the **language**, the international search was carried out on the basis of:

the international application in the language in which it was filed

a translation of the international application into _____, which is the language of a translation furnished for the purposes of international search (Rules 12.3(a) and 23.1(b))

b. With regard to any **nucleotide and/or amino acid sequence** disclosed in the international application, see Box No. I.

2. **Certain claims were found unsearchable** (see Box No. II)

3. **Unity of invention is lacking** (see Box No. III)

4. With regard to the **title**,

the text is approved as submitted by the applicant

the text has been established by this Authority to read as follows:

5. With regard to the **abstract**,

the text is approved as submitted by the applicant

the text has been established, according to Rule 38.2(b), by this Authority as it appears in Box No. IV. The applicant may, within one month from the date of mailing of this international search report, submit comments to this Authority

6. With regard to the **drawings**,

a. the figure of the **drawings** to be published with the abstract is Figure No. 1

as suggested by the applicant

as selected by this Authority, because the applicant failed to suggest a figure

as selected by this Authority, because this figure better characterizes the invention

b. none of the figures is to be published with the abstract

INTERNATIONAL SEARCH REPORT

International application No.
PCT/US2008/061739

A. CLASSIFICATION OF SUBJECT MATTER
IPC(8) - A41D 1/20 (2008.04)
USPC - 2/221
According to International Patent Classification (IPC) or to both national classification and IPC

B. FIELDS SEARCHED
Minimum documentation searched (classification system followed by classification symbols)
IPC(8) - A41C 1/10; A41D 1/20 (2008.04)
USPC - 2/69, 76, 220, 221, 227, 228, 236, 237, 239, 240, 309, 311; 450/95, 116, 118, 123, 130, 131, 132, 155, 309

Documentation searched other than minimum documentation to the extent that such documents are included in the fields searched

Electronic data base consulted during the international search (name of data base and, where practicable, search terms used)
PatBase

C. DOCUMENTS CONSIDERED TO BE RELEVANT

Category*	Citation of document, with indication, where appropriate, of the relevant passages	Relevant to claim No.
X	US 4,506,390 A (STERN) 26 March 1985 (26.03.1985) entire document	1, 2, 4-6, 8
Y		3, 7, 9, 10
Y	US 2004/0210987 A1 (CARNEY) 28 October 2004 (28.10.2004) entire document	3
Y	US 2006/0010571 A1 (OAKLEY) 19 January 2006 (19.01.2006) entire document	7
Y	US 6,311,333 B1 (BATRA) 06 November 2001 (06.11.2001) entire document	9
Y	US 3,045,678 A (GEIMER) 24 July 1962 (24.07.1962) entire document	10
A	US 4,280,229 A (STEIN) 28 July 1981 (28.07.1981) entire document	1-10

Further documents are listed in the continuation of Box C.

* Special categories of cited documents:
 "A" document defining the general state of the art which is not considered to be of particular relevance
 "E" earlier application or patent but published on or after the international filing date
 "L" document which may throw doubts on priority claim(s) or which is cited to establish the publication date of another citation or other special reason (as specified)
 "O" document referring to an oral disclosure, use, exhibition or other means
 "P" document published prior to the international filing date but later than the priority date claimed
 "T" later document published after the international filing date or priority date and not in conflict with the application but cited to understand the principle or theory underlying the invention
 "X" document of particular relevance; the claimed invention cannot be considered novel or cannot be considered to involve an inventive step when the document is taken alone
 "Y" document of particular relevance; the claimed invention cannot be considered to involve an inventive step when the document is combined with one or more other such documents, such combination being obvious to a person skilled in the art
 "&" document member of the same patent family

Date of the actual completion of the international search 06 August 2008	Date of mailing of the international search report 18 AUG 2008
---	--

Name and mailing address of the ISA/US Mail Stop PCT, Attn: ISA/US, Commissioner for Patents P.O. Box 1450, Alexandria, Virginia 22313-1450 Facsimile No. 571-273-3201	Authorized officer: Blaine R. Copenheaver PCT Helpdesk: 571-272-4300 PCT OSP: 571-272-7774
---	---

GKK

PATENT COOPERATION TREATY

DOCKETED Lis
PCT

From the
INTERNATIONAL SEARCHING AUTHORITY

To: GERALD KITA
DUANE MORRIS LLP
30 S. 17TH STREET
PHILADELPHIA, PA 19103-4196

WRITTEN OPINION OF THE
INTERNATIONAL SEARCHING AUTHORITY

(PCT Rule 43bis.1)

Date of mailing
(day/month/year) 18 AUG 2008

Applicant's or agent's file reference
D8114-00486

FOR FURTHER ACTION
See paragraph 2 below

International application No.
PCT/US2008/061739

International filing date (day/month/year)
28 April 2008

Priority date (day/month/year)
31 May 2007

International Patent Classification (IPC) or both national classification and IPC
IPC(8) - A41D 1/20 (2008.04)
USPC - 2/221

Applicant
MOTHERS WORK, INC.

1. This opinion contains indications relating to the following items:

- Box No. I Basis of the opinion
- Box No. II Priority
- Box No. III Non-establishment of opinion with regard to novelty, inventive step and industrial applicability
- Box No. IV Lack of unity of invention
- Box No. V Reasoned statement under Rule 43bis.1(a)(i) with regard to novelty, inventive step or industrial applicability; citations and explanations supporting such statement
- Box No. VI Certain documents cited
- Box No. VII Certain defects in the international application
- Box No. VIII Certain observations on the international application

2. FURTHER ACTION

If a demand for international preliminary examination is made, this opinion will be considered to be a written opinion of the International Preliminary Examining Authority ("IPEA") except that this does not apply where the applicant chooses an Authority other than this one to be the IPEA and the chosen IPEA has notified the International Bureau under Rule 66.1bis(b) that written opinions of this International Searching Authority will not be so considered.

If this opinion is, as provided above, considered to be a written opinion of the IPEA, the applicant is invited to submit to the IPEA a written reply together, where appropriate, with amendments, before the expiration of 3 months from the date of mailing of Form PCT/ISA/220 or before the expiration of 22 months from the priority date, whichever expires later.

For further options, see Form PCT/ISA/220.

3. For further details, see notes to Form PCT/ISA/220.

Name and mailing address of the ISA/US Mail Stop PCT, Attn: ISA/US Commissioner for Patents P.O. Box 1450, Alexandria, Virginia 22313-1450 Facsimile No. 571-273-3201	Date of completion of this opinion 06 August 2008	Authorized officer: Blaine Copenheaver PCT Helpdesk: 571-272-4300 PCT OSP: 571-272-7774
---	--	--

WRITTEN OPINION OF THE
INTERNATIONAL SEARCHING AUTHORITY

International application No.
PCT/US2008/061739

Box No. I Basis of this opinion

1. With regard to the **language**, this opinion has been established on the basis of:
 - the international application in the language in which it was filed.
 - a translation of the international application into _____ which is the language of a translation furnished for the purposes of international search (Rules 12.3(a) and 23.1(b)).
2. This opinion has been established taking into account the **rectification of an obvious mistake** authorized by or notified to this Authority under Rule 91 (Rule 43*bis*.1(a))
3. With regard to any **nucleotide and/or amino acid sequence** disclosed in the international application, this opinion has been established on the basis of:
 - a. type of material
 - a sequence listing
 - table(s) related to the sequence listing
 - b. format of material
 - on paper
 - in electronic form
 - c. time of filing/furnishing
 - contained in the international application as filed
 - filed together with the international application in electronic form
 - furnished subsequently to this Authority for the purposes of search
4. In addition, in the case that more than one version or copy of a sequence listing and/or table(s) relating thereto has been filed or furnished, the required statements that the information in the subsequent or additional copies is identical to that in the application as filed or does not go beyond the application as filed, as appropriate, were furnished.
5. Additional comments:

WRITTEN OPINION OF THE
INTERNATIONAL SEARCHING AUTHORITY

International application No.
PCT/US2008/061739

Box No. V Reasoned statement under Rule 43bis.1(a)(i) with regard to novelty, inventive step or industrial applicability; citations and explanations supporting such statement

1. Statement

Novelty (N)	Claims	<u>3, 7, 9, 10</u>	YES
	Claims	<u>1, 2, 4-6, 8</u>	NO
Inventive step (IS)	Claims	<u>None</u>	YES
	Claims	<u>1-10</u>	NO
Industrial applicability (IA)	Claims	<u>1-10</u>	YES
	Claims	<u>None</u>	NO

2. Citations and explanations:

Claims 1, 2, 4-6, and 8 lack novelty under PCT Article 33(2) as being anticipated by Stern.

Referring to Claim 1, Stern discloses a garment, comprising: a garment upper portion having a belly panel (Fig. 1, waist portion 11), wherein the belly panel is expansible (Col. 3, Lns. 30-31 regarding the waistband portion is radially expandable) to cover and fit over a growing abdomen (Fig. 2, ref. 19); and a garment lower portion (Fig. 1, body portion 13) having a torso encircling circumference (Fig. 1, unnumbered waistline of body portion 13), wherein the torso encircling circumference recedes downward (Figs. 1 and 2, unnumbered intersection of waist portion 11 and body portion 13) to make way for expansion of the belly panel.

Referring to Claim 2, Stern discloses the garment of claim 1 wherein the belly panel (Fig. 1, waist portion 11) is contractible elastically to cover a shrinking abdomen (Figs. 1 and 2, waist portion 11 and pocket 19; Col. 4, lines 28-30 regarding "natural automatic contraction" of 11).

Referring to Claim 4, Stern discloses the garment of claim 1 with a garment upper portion (Fig. 1, waist portion 11) having the belly panel which is foldable toward the garment lower portion to comprise a folded band (Fig. 4, top hem stitching 15; Col. 3, Lns. 34-36 regarding a hem is formed along a top edge by folding the top edge and stitching along line 15).

Referring to Claim 5, Stern discloses the garment of claim 1 wherein the belly panel (Fig. 1, front panel 11) is woven or knitted with elastic, stretchable strands (Col. 4, lines 45-47 regarding elastically woven or knitted material).

Referring to Claim 6, Stern discloses the garment of claim 1 wherein a top edge margin of the garment upper portion is folded over and sewn or knitted to an inside of the fabric (Fig. 4, top hem stitching 15; Col. 3, Lns. 34-36 regarding a hem is formed along a top edge by folding the top edge and stitching along line 15).

Referring to Claim 8, Stern discloses the garment of claim 1 wherein the garment upper portion has a further torso encircling circumference (Fig. 1, unnumbered top of waist portion 11) to hold the garment up and in place over the torso.

Claim 3 lacks an inventive step under PCT Article 33(3) as being obvious over Stern in view of Carney.

Referring to Claim 3, Stern discloses the garment of claim 1 with an expandable garment upper portion (Fig. 1, waist portion 11; Col. 3, Lns. 30-31 regarding the waistband portion is radially expandable) wherein the garment upper portion is an expansible tubular upper portion (Fig. 3, waistband portion 11 which fits around the waist of the user and is tubular in shape). Stern fails to explicitly disclose wherein the garment upper portion is seamless to fit comfortably while being worn. Carney teaches a garment upper portion which is an expansible (Abstract regarding elastic band) tubular (Fig. 1, garment band 10, Abstract regarding tube top) upper portion that is seamless (Para. [0029] regarding garment may be seamless) to fit comfortably while being worn. It would have been obvious to one having ordinary skill in the art at the time the invention was made to further provide wherein the garment upper portion is an expansible tubular upper portion that is seamless to fit comfortably while being worn as taught by Carney with the system of Stern in order to eliminate seams which may cause discomfort to the user.

(Continued in Supplemental Box)

WRITTEN OPINION OF THE
INTERNATIONAL SEARCHING AUTHORITY

International application No.
PCT/US2008/061739

Supplemental Box

In case the space in any of the preceding boxes is not sufficient.

Continuation of:

Box V

Claim 7 lacks an inventive step under PCT Article 33(3) as being obvious over Stern in view of Oakley.

Referring to Claim 7, Stern discloses the garment of claim 1 wherein the garment upper portion is a tubular structure (Fig. 3, waistband portion 11 which fits around the waist of the user and is tubular in shape). Stern fails to explicitly disclose wherein the garment upper portion is a double layer tubular structure. Oakley teaches a double layer structure (Fig. 1C, lower component 110; where lower component 110 has an inner surface and an outer surface, forming a double layer structure of two different materials; Abstract regarding the lower component has an outer surface and an inner surface; Para. [0013] regarding knit inside fabric stretches more than stretch woven outer fabric to accommodate a growing stomach). It would have been obvious to one having ordinary skill in the art at the time the invention was made to further provide a double layer structure as taught by Oakley with the system of Stern in order to slightly increase the tension on the belly of the user providing additional support.

Claim 9 lacks an inventive step under PCT Article 33(3) as being obvious over Stern in view of Batra.

Referring to Claim 9, Stern discloses the garment of claim 1. Stern fails to explicitly disclose wherein the garment lower portion has a partial waistband extending from side seams of the garment lower portion and extending across a back side of the garment lower portion. Batra teaches wherein the garment lower portion has a partial waistband (Fig. 2, yoke area 21) extending from side seams (30, 31; Fig. 1 and col. 2, lines 47-50) of the garment lower portion and extending across a back side of the garment lower portion (Fig. 2). It would have been obvious to one having ordinary skill in the art at the time the invention was made to further provide wherein the garment lower portion has a partial waistband extending from side seams of the garment lower portion and extending across a back side of the garment lower portion as taught by Batra with the system of Stern in order to provide additional support for the back.

Claim 10 lacks an inventive step under PCT Article 33(3) as being obvious over Stern in view of Geimer.

Referring to Claim 10, Stern discloses the garment of claim 1. Stern fails to explicitly disclose a series of belly cradling stitches or knitted tension in the belly panel to cradle a growing abdomen during various stages of pregnancy. Geimer teaches a series of belly cradling stitches or knitted tension in the belly panel to cradle a growing abdomen during various stages of pregnancy (Fig. 2, panel 20; Col. 3, Lns. 25-28 regarding shirred elastic material of panel 20 to ensure desired comfort and adequate support). It would have been obvious to one having ordinary skill in the art at the time the invention was made to further provide a series of belly cradling stitches or knitted tension in the belly panel to cradle a growing abdomen during various stages of pregnancy as taught by Geimer with the system of Stern in order to provide additional support and comfort.

Claims 1-10 meet the criteria set out in PCT Article 33(4), and thus have industrial applicability because the subject matter claimed can be made or used in industry.

Electronic Acknowledgement Receipt

EFS ID:	3963860
Application Number:	11756242
International Application Number:	
Confirmation Number:	1512
Title of Invention:	BELLY COVERING GARMENT
First Named Inventor/Applicant Name:	LISA A. HENDRICKSON
Customer Number:	08933
Filer:	Gerald K. Kita./MARY LA GRNGE
Filer Authorized By:	Gerald K. Kita.
Attorney Docket Number:	D8114-00369
Receipt Date:	18-SEP-2008
Filing Date:	31-MAY-2007
Time Stamp:	12:52:03
Application Type:	Utility under 35 USC 111(a)

Payment information:

Submitted with Payment	no
------------------------	----

File Listing:

Document Number	Document Description	File Name	File Size(Bytes)/ Message Digest	Multi Part /.zip	Pages (if appl.)
1		369IDS3.pdf	1496792 e197d007d1bea2593b8ebcc8a00cc0364cd1da188	yes	13

Multipart Description/PDF files in .zip description			
Document Description		Start	End
Miscellaneous Incoming Letter		1	1
Information Disclosure Statement (IDS) Filed (SB/08)		2	5
NPL Documents		6	13

Warnings:

Information:

Total Files Size (in bytes):	1496792
-------------------------------------	---------

This Acknowledgement Receipt evidences receipt on the noted date by the USPTO of the indicated documents, characterized by the applicant, and including page counts, where applicable. It serves as evidence of receipt similar to a Post Card, as described in MPEP 503.

New Applications Under 35 U.S.C. 111

If a new application is being filed and the application includes the necessary components for a filing date (see 37 CFR 1.53(b)-(d) and MPEP 506), a Filing Receipt (37 CFR 1.54) will be issued in due course and the date shown on this Acknowledgement Receipt will establish the filing date of the application.

National Stage of an International Application under 35 U.S.C. 371

If a timely submission to enter the national stage of an international application is compliant with the conditions of 35 U.S.C. 371 and other applicable requirements a Form PCT/DO/EO/903 indicating acceptance of the application as a national stage submission under 35 U.S.C. 371 will be issued in addition to the Filing Receipt, in due course.

New International Application Filed with the USPTO as a Receiving Office

If a new international application is being filed and the international application includes the necessary components for an international filing date (see PCT Article 11 and MPEP 1810), a Notification of the International Application Number and of the International Filing Date (Form PCT/RO/105) will be issued in due course, subject to prescriptions concerning national security, and the date shown on this Acknowledgement Receipt will establish the international filing date of the application.

SUBSTITUTE for form 1449A/PTO INFORMATION DISCLOSURE STATEMENT BY APPLICANT (use as many sheets as necessary)				<i>Complete if Known</i>	
				Application Number	11/756,242
				Filing Date	May 31, 2007
				First Named Inventor	Hendrickson, Lisa
				Art Unit	3765
				Examiner Name	n/a
Sheet	1	of	1	Attorney Docket Number	D8114-00369

U.S. PATENT DOCUMENTS						
Examiner Initials	Cite No.	Document Number		Publication Date MM-DD-YYYY	Name of Patentee or Applicant of Cited Document	Pages, Columns, Lines, Where Relevant Passages or Relevant Figures Appear
		Number-Kind Code (if known)				
	A	3,045,678		07/24/1962	Geimer	
	B	4,280,229		07/28/1981	Stein	
	C	4,506,390		03/26/1985	Stern	
	D	6,311,333		11/06/2001	Batra	
	E	US2004/021987		10/28/2004	Carney	
	F	US2006/0010571		01/19/2006	Oakley	

FOREIGN PATENT DOCUMENTS							
Examiner Initials	Cite No.	Foreign Patent Document		Publication Date MM-DD-YYY	Name of Patentee or Applicant of Cited Document	Pages, Columns, Lines Where Relevant Passages or Figures Appear	T
		Country Code - Number - Kind Code (if known)					

OTHER PRIOR ART - NON PATENT LITERATURE DOCUMENTS			
Examiner Initials	Cite No.	Include name of the author (in CAPITAL LETTERS), title of the article (when appropriate), title of the item (book, magazine, journal, serial, symposium, catalog, etc.), date, page(s), volume-issue number(s), publisher city and/or country where published	T
	G	International Search Report and Written Opinion dated 18 AUG 2008 in PCT/US2008/061739 (D8114-00486)	

Examiner Signature	Date Considered
--------------------	-----------------

*Examiner: Initial if reference considered, whether or not citation is in conformance with MPEP 609. Draw line through citation if not in conformance and not considered. Include copy of this form with next communication to applicant.
DM2\1576453.1

IN THE UNITED STATES PATENT AND TRADEMARK OFFICE

In Re Application of: Hendrickson, Lisa

Confirmation No: 1512

Serial No. 11/756,242

Group Art Unit: 3765

Filed: May 31, 2007

Examiner: n/a

For: Belly Covering Garment

M.S. Amendment
Commissioner for Patents
P.O. Box 1450
Alexandria, VA 22313-1450

Dear Sir:

INFORMATION DISCLOSURE STATEMENT TRANSMITTAL LETTER

Enclosed herewith is an Information Disclosure Statement pursuant to 37 CFR. § 1.56 in connection with the above-identified application, which statement is being filed:

Together with the present application.

Before the first Office Action on the merits or three (3) months from the filing date of this application, whichever occurs last. **[37 CFR § 1.97(b)]**

After the first Office Action on the merits, but before a Final Office Action under §1.113 or Notice of Allowance under §1.311, whichever occurs first. **[37 CFR §1.97(c)]**. *(Either the fee or certification is provided, as set forth below).*

After a Final Office Action under §1.113 or Notice of Allowance under §1.311, but prior to or with payment of the Issue Fee. **[37 CFR §1.97(d)]**. *The fee and certification are provided, as set forth below).*

Consistent with Applicant's obligations pursuant to 37 CFR §§1.97 and 1.98, the following requirements have been met:

No separate requirements are needed.

No additional fee is required.

Fee Under 37 CFR § 1.97(c) or 1.97(d)

The fee of \$180.00 for submission of an IDS under § 1.97(c) as set forth in § 1.17(p) accompanies this statement.

Please charge the fee of \$180.00 for submission of an IDS under § 1.97(c) or (d) as set forth in § 1.17(p) to Deposit Account 04-1679.

Certification Under 37 CFR § 1.97(e)

The undersigned certifies:

1 that each item of information contained in the information disclosure statement was first cited in a communication from a foreign patent office in a counterpart foreign application not more than three months prior to the filing of the information disclosure statement; or

2 that no item of information contained in the information disclosure statement was cited in a communication from a foreign patent office in a counterpart foreign application, and, to the knowledge of the person signing the statement after making reasonable inquiry, no item of information contained in the information disclosure statement was known to any individual designated in § 1.56(c) more than three months prior to the filing of the information disclosure statement.

Provision of Copies of References

A copy of each of the Foreign and Other references listed on the attached Form PTO-1449 is enclosed herewith and forms a part hereof.

Partial Translations of References are enclosed herewith and form a part hereof.

A copy of the European Search Report from a corresponding or related EPO application is enclosed herewith.

A copy of the International Search Report from a corresponding or related PCT application is enclosed herewith.

Identification of Prior Application(s) In Which Listed Information Was Already Cited And For Which No Copies Are Submitted Or Need Be Submitted

[X] This application relies, under 35 U.S.C. § 120, on the earlier filing date of prior U.S. Application No(s). filed . Some or all of the references were submitted to, and/or cited by, the Office in the prior application(s) and therefore are not required to be provided in this application.

The Commissioner is hereby authorized to charge any fees associated with this communication or credit any overpayment to Deposit Account No. 04-1679.

Respectfully submitted,

Date: September 18 2008

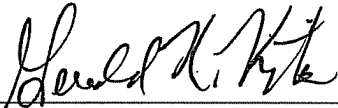

Gerald K. Kita
Registration No. 24,125

Customer No. 08933
DUANE MORRIS LLP
30 South 17th Street
Philadelphia, PA 19103-4196
215-979-1863 tel
215-979-1020 fax

Under the Paperwork Reduction Act of 1995, no persons are required to respond to a collection of information unless it displays a valid OMB control number.

TRANSMITTAL FORM (to be used for all correspondence after initial filing)	Application Number	11/756,242
	Filing Date	May 31, 2007
	First Named Inventor	Hendrickson, Lisa et al.
	Art Unit	3765
	Examiner Name	n/a
Total Number of Pages in This Submission	Attorney Docket Number	D8114-00369

ENCLOSURES (Check all that apply)		
<input type="checkbox"/> Fee(s) Transmittal Form	<input type="checkbox"/> Drawing(s)	<input type="checkbox"/> After Allowance communication to Technology Center (TC)
<input type="checkbox"/> Fee Attached	<input type="checkbox"/> Licensing-related Papers	<input type="checkbox"/> Appeal Communication to Board of Appeals and Interferences
<input type="checkbox"/> Amendment/Reply	<input type="checkbox"/> Petition	<input type="checkbox"/> Appeal Communication to TC (Appeal Notice, Brief, Reply Brief)
<input type="checkbox"/> After Allowance	<input type="checkbox"/> Petition to Convert to a Provisional Application	<input type="checkbox"/> Proprietary Information
<input type="checkbox"/> Affidavits/declaration(s)	<input type="checkbox"/> Power of Attorney, Revocation Change of Correspondence Address	<input type="checkbox"/> Status Letter
<input type="checkbox"/> Extension of Time Request	<input type="checkbox"/> Terminal Disclaimer	<input type="checkbox"/> Other Enclosure(s) (please identify below):
<input type="checkbox"/> Express Abandonment Request	<input type="checkbox"/> Request for Refund	
<input checked="" type="checkbox"/> Information Disclosure Statement	<input type="checkbox"/> CD, Number of CD(s) _____	
<input type="checkbox"/> Certified Copy of Priority Document(s)	Remarks	
<input type="checkbox"/> Response to Missing Parts/Incomplete Application	The Commissioner is hereby authorized to charge any fees associated with this communication or credit any overpayment to Deposit Account No. 04-1679.	
<input type="checkbox"/> Response to Missing Parts under 37 CFR 1.52 or 1.53		

SIGNATURE OF APPLICANT, ATTORNEY, OR AGENT

Firm or Individual name	Gerald K. Kita, Registration No. 24,125 Customer Number 08933	
Signature	<i>Gerald K. Kita</i>	
Date	<i>September 18, 2008</i>	

CERTIFICATE UNDER 37 CFR 1.10

I hereby certify that this correspondence and the documents referred to therein are being electronically filed in the United States Patent and Trademark Office on the date indicated below			
Typed or printed name	Mary La Grange		
Signature	<i>Mary La Grange</i>	Date	<i>9-18-08</i>

This collection of information is required by 37 CFR 1.5. The information is required to obtain or retain a benefit by the public which is to file (and by the USPTO to process) an application. Confidentiality is governed by 35 U.S.C. 122 and 37 CFR 1.14. This collection is estimated to 2 hours to complete, including gathering, preparing, and submitting the completed application form to the USPTO. Time will vary depending upon the individual case. Any comments on the amount of time you require to complete this form and/or suggestions for reducing this burden, should be sent to the Chief Information Officer, U.S. Patent and Trademark Office, U.S. Department of Commerce, P.O. Box 1450, Alexandria, VA 22313-1450. DO NOT SEND FEES OR COMPLETED FORMS TO THIS ADDRESS. SEND TO: **Commissioner for Patents, P.O. Box 1450, Alexandria, VA 22313-1450.**

If you need assistance in completing the form, call 1-800-PTO-9199 and select option 2.

III. Remarks

Claims 1-25 are pending. Claim 1 is the sole independent claim.

Each of Claims 1-25 is independently patentable. A discussion follows that will determine the differences between the claimed invention and the prior art references cited in the International Search Report (ISR) of PCT Application No. PCT/US08/61739. The ISR is furnished by an Information Disclosure Statement filed in the present application on September 18, 2008.

Claim 1 claims an invention that differs patentably from Stern US 4,506,390 under 35 USC 102 and 35 USC 103.

Claim 1 is amended to recite, a garment upper portion having a second torso encircling circumference along the upper end of the belly panel above a location of maximum girth of the abdomen to hold the garment up and in place over the torso. Antecedent basis is in paragraph [0022], page 3, line 33, to page 4, line 9. This differs from Stern US 4,506,390. Stern US 4,506,390 repeatedly describes and claims a waistband portion 11. (See column 3, lines 25, 31; column 4, lines 7, 10, 11, 18, 28, 45, 63 and Claims 1, 2 and 4) Amended Claim 1 recites more than a waistband portion, since a waistband portion is not reasonably expected to extend above a maximum girth of an abdomen, especially a distended abdomen.

The description in Stern US 4,506,390 of a waistband portion 11 does not encompass the claimed invention including a garment upper portion having a second torso encircling circumference along the upper end of the belly panel above a location of maximum girth of the abdomen to hold the garment up and in place over the torso. Instead, Stern discloses (column 3, lines 56-59) "The resultant waistband material is expandable horizontally (in the radial direction) when fastened to a garment but not vertically." [Underline emphasis added] Further, Stern states

(column 2, lines 55-58) “The waistband portion [11] is constructed to be width-wise expandable and contractable, but not vertically expandable.” [Underline emphasis added]

Fig. 2 of Stern US 4,506,390 shows a garment having a horizontal hem level. In Fig. 2, a horizontal dotted line depicts the horizontal hem level extending further outward toward the left, in Fig. 2. Below the horizontal dotted line are dotted lines 19, which are described according to Stern (column 4, lines 31-35) “...the pouch 19 cups the lower portion of a woman’s stomach and contours itself to fit it, and acts as a sling-like support which provides added comfort to a wearer.” Further, (column 4, lines 37-44) “The cup-like action of the pouch [19] permits the body of the garment to always hang from the same position below the bulge of the stomach, close to the legs... Additionally, the garment maintains an even horizontal hem level with no hike-up in the front [shown by horizontal dotted line in Fig. 2].”

Thus, Fig. 2 of Stern US 4,506,390 discloses a horizontal hem line of a waistband portion [11] with a pouch 19 (column 4, lines 37-44) “below the bulge of the stomach” and “an even horizontal hem level with no hike-up in the front.” Thus, the waistband portion 11 described by Stern with reference to Fig. 2 of Stern teaches away from Applicant’s amended Claim 1 reciting, a garment upper portion having a second torso encircling circumference along the upper end of the belly panel above a location of maximum girth of the abdomen to hold the garment up and in place over the torso.

Applicant’s claimed invention includes the structure of a second torso encircling circumference along the upper end of the belly panel above a location of maximum girth of the abdomen, which differs patentably from the waistband portion 11 of Stern US 4,506,390.

Further, Applicant’s claimed invention includes a difference in function or operation of a second torso encircling circumference above a location of maximum girth of the abdomen to hold the

garment up and in place over the torso. To negate obviousness under 35 USC 103, *In re Horton et al.*, 151 F.2d 210, 67 USPQ 105 (1945) establishes a legal precedent that a structural limitation reciting a difference in function or a difference in operation from prior art is proper, and can be patentable. In other words, patentability of the claimed structural limitation can depend on the difference in function or the difference in operation from prior art.

Exhibit A is respectfully submitted as copied (09/11/2008) from the website, <http://www.motherhood.com>. Exhibit A comprises photographed garments commercially available from the Assignee of the present application. The photographed garments incorporate the features recited in amended Claim 1. The photographed garments are demonstrate on photographed persons, which distinguish from the waistband on the garment of Stern US 4,506,390.

Claim 1 claims an invention that differs patentably from Oakley US 2006/0010571 under 35 USC 102 and 35 USC 103.

Oakley US 2006/0010571 discloses (paragraph [0007]) and claims in Claim 1, a double waistband component 108 having a lower, non-elastic portion 110 and an upper, elastic portion 112. Further, "a five or six-inch elastic portion 112 may rise too high." (paragraph [0008])

Thus, the five or six-inch elastic portion 112 of Oakley is even shorter compared to Stern US 4,506,390 that teaches (column 3, lines 60-66) "... a central portion at the center is cut on a curve from each of the end portions to form a pouch 19 having a maximum height T of approximately 7 ¼". Both are too short to encompass the claimed invention that includes, a garment upper portion having a second torso encircling circumference along the upper end of the belly panel above a location of maximum girth of the abdomen to hold the garment up and in place over the torso.

Each of Claims 2 and 18 claims an invention that differs patentably from Stern US 4,506,390 under 35 USC 102 and 35 USC 103.

Claim 2 is amended to recite, the second torso encircling circumference is adjustable in girth in conformance with different body types. Antecedent basis is in paragraph [0022], page 4, lines 1-3. The waistband of Stern adjusts for pregnancy stages at the waist, but does not adjust for conformance with different body types above the maximum girth. It is above the maximum girth of the abdomen that different body types are prevalent and require fitting conformance of a garment. Applicant's claimed invention in Claim 2 adjusts for both pregnancy stages and body types above the maximum girth to distinguish patentably from Stern.

Each of Claims 1, 3, 4 and 5 claims an invention that differs patentably from Carney US 2004/0210987 under 35 USC 102 and 35 USC 103.

Carney US 2004/021087 discloses (FIG. 4, paragraph [0032]) a band garment 10, which is a stretchable band 10 that engages over the top of a woman's skirt or pants 14 in the opened condition. The pants (Fig. 5, paragraphs [0034] and [0035]) have an open front and a stretchable expansion panel in the front as shown at 28. The stretchable band 10 is described as covering the open front of the skirt or pants to hold the same against a woman's body. However, the stretchable band 10 of Carney US 2004/021087 does not supply the deficiencies of Stern US 4,506,290 previously discussed.

Carney's stretchable band 10 does not encompass the Applicant's amended Claim 1 reciting, a garment upper portion having a second torso encircling circumference along the upper end of the belly panel above a location of maximum girth of the abdomen to hold the garment up and in place over the torso. Instead, the stretchable band 10 of Carney is described as covering and holding the open front of the skirt or pants against a person. Further, in Exhibit A the

features of Applicant's Claim 1 are worn by persons depicted in the photographs, and distinguish from Figs. 4, 7 and 7C of Carney US 2004/021087, which depict a stretchable band 10 against a skirt or pants worn by a person.

Each of amended Claim 6 and new Claim 12 claims an invention that differs patentably from Batra US 6,311,333 under 35 USC 102 and 35 USC 103

Each of Claims 6 and 12 recites an alternative embodiment of the invention. Antecedent basis for amending claim 6 is in paragraph [0019] "The waistband 208 tapers toward the side seams 110, 112 and widens across the back side, and has a center seam 210 to shape the waist band 10 with a curvature above the wearer's pelvis, and for torso coverage especially when sitting or bending."

Batra teaches (column 2, lines 61-63) "Directly below the rear portion 16 of waistband 12 is the yoke area 21 of the pant seat which is slightly triangular in shape." Thus, Batra teaches a pants seat which is slightly triangular in shape. Thus, in Batra, the yoke area 21 is below the waistband 12 and is part of the pants seat (below a pelvis), which does not encompass a waistband with curvature above the wearer's pelvis.

Stern US 4,506,390 teaches (Claim 1) "a tube-like waistband portion having a front and a back and a vertical extend which is narrower at said back...". Thus, Stern teaches away from the waistband in each of Claims 6 and 12 that widens across the back side.

In Oakley US 2006/0010571, Figs. 1A, 1B, 7A and 7B the waistband 110 appears to be of constant vertical height, which does not widen across the back side, and which does not taper toward side seams of the pants.

In Carney US 2004/021087, Figs. and 5, the waistband of the pants appears to be of constant vertical height, which does not widen across the back side, and which does not taper toward side seams of the pants.

Claim 7 claims an invention that differs patentably from Geimer US 3,045,678 under 35 USC 102 and 35 USC 103.

Claim 7 recites an alternative embodiment of the invention in which belly cradling stitches or knitting extend along multiple paths arranged in an elliptical pattern that curves.

Geimer US 3,045,678 discloses a girdle with garter loops, which is not suitable for being combined with a garment lower portion such as denim jeans. Three panels 19, 20 and 21 of the girdle are shirred in different directions. The three panels 19, 20 and 21 are stitched together to provide stretchability in a longitudinal sense. "For the purpose of further identifying the longitudinality, the panels 19, 20 and 21 may be said to uniformly embody longitudinal zones 22 of relatively loosely shirred netting, connected by more compactly shirred lines or zones 23, the zones 22 and 23 in all cases being considered to extend longitudinally, in so far as the particular panel in question is concerned." (column 2, lines 49-56)

However, this longitudinal sense described by Geimer does not encompass Claim 7 that recites stitches in an elliptical pattern that curves. Further, see Fig. 6 of Stern, Fig 1C of Oakley and Fig. 1 of Carney, none of which depicts an elliptical pattern.

Each of Claims 8, 9, 10 and 13-15 claims an invention that differs patentably from Stern US 4,506,390 and/or Oakley US 2006/0010571 and/or Carney US 2004/021087 and/or Batra US 6,311,333, under 35 USC 102 and 35 USC 103.

Each of Claim 8, 9, 10 and 13-15 recites a corresponding alternative embodiment of the invention in which a series of stitches or knitted tension in the backside of the garment upper

portion provide spinal and back support against the wearer of the garment. None of the references discloses such a structure or the function or operation of such structure, to provide spinal and back support.

Each of Claims 11 and 25 claims an invention that differs patentably from Carney US 2004/0210987 under 35 USC 102 and 35 USC 103

Each of Claims 11 and 25 recite the structure of a garment upper portion having a second torso encircling circumference along the upper end of the belly panel above a location of maximum girth of the abdomen. Each of the Claims 11 and 25 recites the structure having a dual function or dual operation, to hold the garment up and in place over the torso, and foldable toward the garment lower portion to comprise a folded band on the garment lower portion. In Carney, the elastic band 10 is worn exclusively over the pants or skirt, unfolded or folded in half as a double layer (paragraph [0013]), but which does not encompass the structure having the dual function or dual operation of the claimed invention.

Each of Claims 16, 17, 23 and 24 claims an invention that differs patentably from Carney US 2004/0210987 under 35 USC 102 and 35 USC 103

New claim 16 recites, an edge margin of the garment upper portion is folded over and knitted to an inside of the fabric to provide a perimeter hem stitch. Antecedent basis is in paragraph [0028]. Each of Claims 17, 23 and 24 is similar to claim 16. Claims 16, 17, 23 and 24 are intended to claim a garment upper portion made by knitting and knitting a folded over edge margin having a perimeter hem stitch.

Carney does not expressly disclose such a structure. Carney describes a plainly disclosed and simple structure of a tubular band 10, which can not inherently anticipate the specific structure recited in Claims 16 and 17 that distinguishes from a simple tubular band.

Further, Stern US 4,506,390 describes (column 2, lines 66-68) “The stitching of the elastically shirred waistband portion is also arranged to prevent fold-over or ruffling of the upper edge of the garment.” Accordingly, Stern expressly prevents fold-over.

Additionally, Stern US 4,506,390 teaches (column 3, lines 33-51) “A hem is formed along a top edge thereof by folding the top edge and stitching along line 15 (FIG. 4) so that the material strip is reduce to a size X-x-Y of about 60” x 80”. This material is then elastically shirred (stitched longitudinally) with stretched elastic thread to form the waistband material shown in FIG. 5, having a X-x-Y dimension of approximately 28” x 8”. ... The smaller spacing between the first four rows of stitching prevents ruffling or “fold over” of the upper edge of the garment during use.” There is no teaching, suggestion or motivation in the prior art to modify the waistband of Stern that prevents fold-over, so as to make it foldable.

Each of Claims 19 and 20 claims an invention that differs patentably from Carney US 2004/0210987 under 35 USC 102 and 35 USC 103.

Each of Claims 19 and 20 recite a garment upper portion that extends above a maximum girth, and as a tubular structure with a corresponding shape to fit a certain body type. The tubular band 10 of Carney fits over a skirt or pants that is too small to close, but does not include a garment upper portion that extends above a maximum girth and with a corresponding shape to fit a certain body type.

Claim 21 claims an invention that differs patentably from Stern US 4,506,390 and/or Oakley US 2006/0010571 and/or Carney US 2004/021087 and/or Batra US 6,311,333, under 35 USC 102 and 35 USC 103.

Claim 21 recites a double-layer tubular structure and an inner layer between two layers of the double-layer tubular structure. Antecedent basis is in paragraph [0028]. Each of the references discloses a single layer structure.

Each of Claims 22, 23 and 24 claims an invention that differs patentably from Stern US 4,506,390 and/or Oakley US 2006/0010571 and/or Carney US 2004/021087 and/or Batra US 6,311,333, under 35 USC 102 and 35 USC 103

The claimed invention in each of Claims 22, 23 and 24 intends to cover an upper garment portion that is doubled back on itself to form a double-layer tubular structure with a corresponding hem. Each of the references disclose a hem on a single layer of fabric.

In view of the Preliminary Amendment of the Claims and the Remarks in support of patentability, allowance is requested. The Examiner is invited to telephone the undersigned for any reason to advance the prosecution of the application.

Respectfully submitted,

Date November 3, 2008

By: Gerald K. Kita

Gerald K. Kita
Registration No. 24,12

Customer No. 08933
DUANE MORRIS LLP
30 South 17th Street
Philadelphia, PA 19103-4196
Direct Dial: 215-979-1863
Facsimile: 215-979-1020
E-Mail: GKKita@DuaneMorris.com

Enclosure: Exhibit A, pages 1-5.

EXHIBIT A

Espanol

Also Visit : DestinationMaternity.com

Motherhood

MOTHERHOOD
MATERNITY
hot fashion, low prices

[store locator](#)

[my account](#)

[log in](#)

0 items in my bag

[home](#) | [size chart](#) | [customer service](#) |

CONTACT BY PHONE 1.800.4r

search

Shop By :

ALL OUR MATERNITY SECRET FIT BELLY

new arrivals

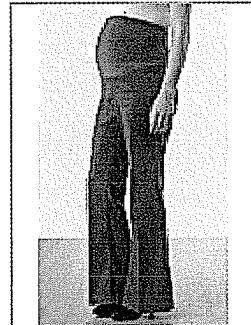

tech twill pant with secret fit belly(tm)
3 colors
\$29.98

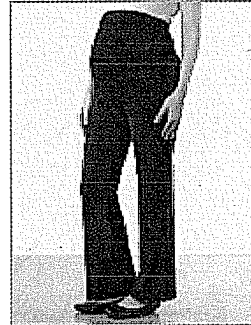

gaberdine pinstripe pant
\$34.98

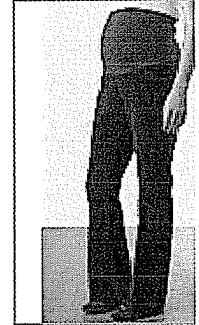

16 wale corduroy v secret fit belly(tm)
3 colors
\$34.98

jeans

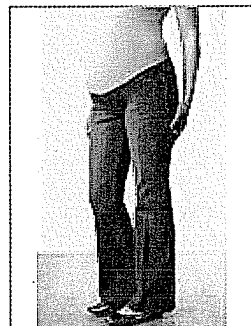

5 pocket stretch denim with the secret fit belly (tm)
2 colors
\$24.98

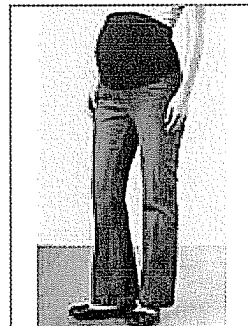

short length basic jean with secret fit belly(tm)
\$24.98



stretch jean with secret fit belly(tm)
\$24.98

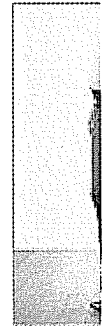

petite str the secre
\$24.98

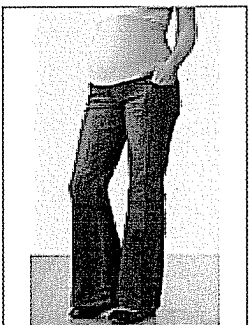

curvy stitch jean with the

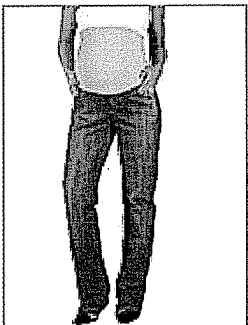

short length american

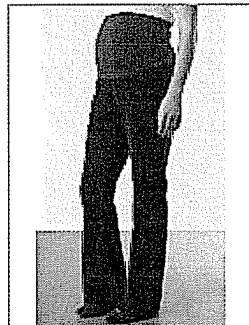

16 wale corduroy with

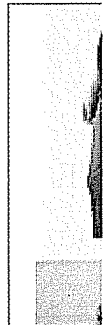

super stre

Maternity Shops
Motherhood Plus®
Motherhood Nursing®

the gift card

Shop All

secret fit belly

view all

new arrivals

jeans

pants

skirts

shorts

crops and capris

sale

new arrivals

fall looks

denim and jeans

pants

dresses

skirts

shorts

sweaters

blouses and shirts

tees and tanks

sets

suiting collection

outerwear

activewear

bras and camisoles

panties

sleepwear

special occasion

swim

accessories

nursing accessories

skin care

for baby

hosiery

gift cards

Shop Sale

Maternity Features

5 Reasons to Wear The Secret Fit Belly™

The Bra Shop

Fall Preview

secret fit belly(tm)
\$44.98



plus basic jean with
secret fit belly(tm)
\$29.98

star secret fit belly(tm)
jean
\$44.98



american star jean with
secret fit belly(tm)
\$44.98

secret fit belly(tm)
3 colors
\$34.98



plus bootcut jean with
secret fit belly(tm)
\$44.98

with secre
\$29.98



plus dark
belly(tm) j
\$49.98

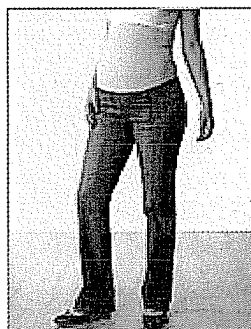

long length american
star with the secret fit
belly(tm)
\$44.98

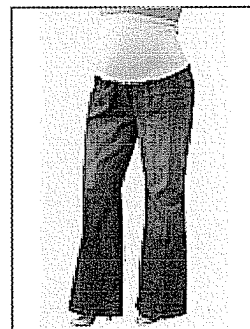

plus curvy stitch with
secret fit belly(tm)
\$49.98

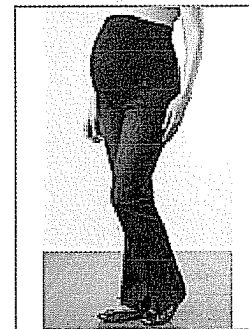

basic stretch jean with
secret fit belly(tm)
2 colors
\$24.98 - \$29.98



crosshatch
secret fit t
~~\$29.98~~ \$

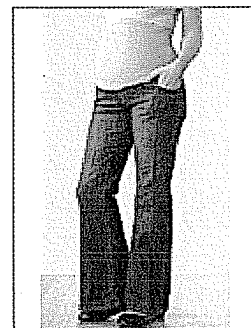

short length curvy stitch
jean with secret fit belly
(tm)
~~\$44.98~~ \$34.99

pants

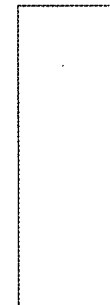
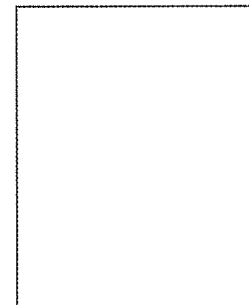
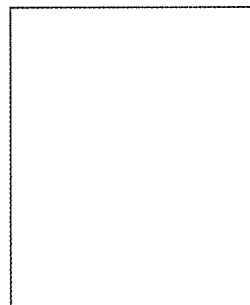
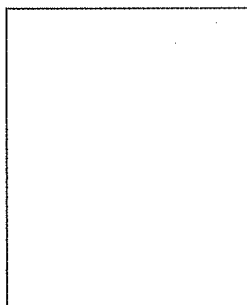



short basic stretch twill pant with secret fit belly (tm)
\$24.98

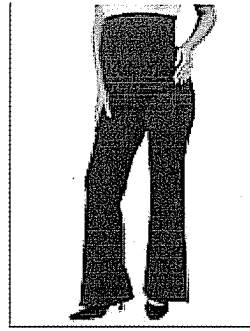

fit and flare pants with secret fit belly(tm)
3 colors
\$29.98

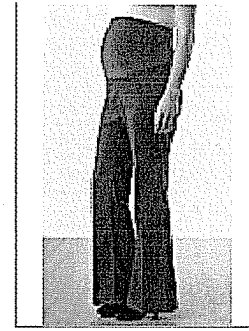

tech twill pant with secret fit belly(tm)
3 colors
\$29.98

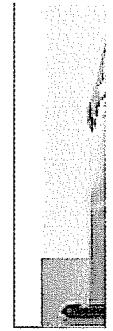

basic stre with secre
4 colors
\$24.98

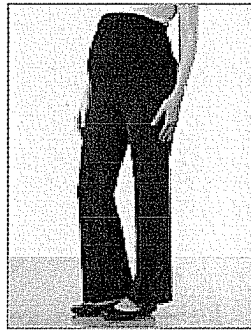

gaberdine pinstripe pant
\$34.98

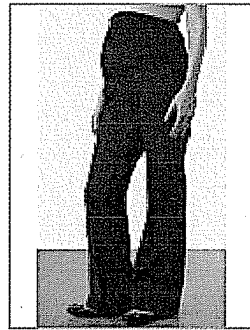

light weight stretch twill pant with secret fit belly (tm)
2 colors
\$29.98

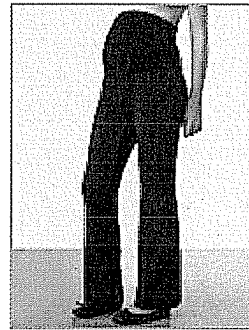

ponte pant with secret fit belly(tm)
2 colors
\$29.98



petite pon secret fit l
\$29.98

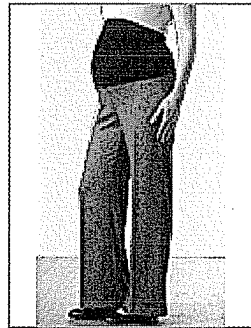

tweed wide leg secret fit belly pant
\$34.98

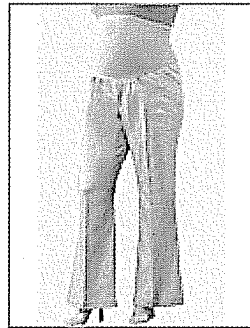

plus stretch twill pant with the secret fit belly (tm)
2 colors
\$34.98



petite fit and flare bistretch pant
\$29.98

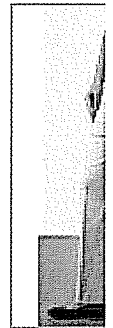

stretch tw secret fit l
\$24.98

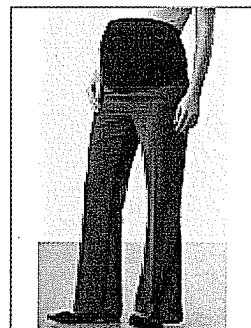

fit and flare bistretch pant
\$29.98

skirts

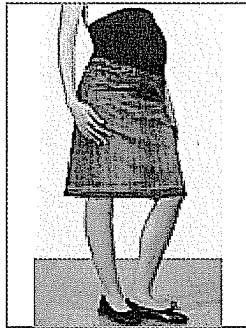

american star skirt with secret fit belly(tm) \$34.98

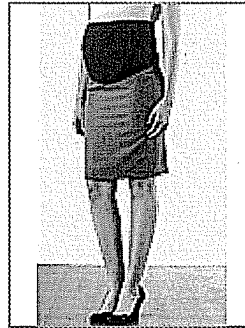

straight skirt with secret fit belly(tm) \$19.98



border embroidery: ~~\$24.98~~ \$19.99

shorts

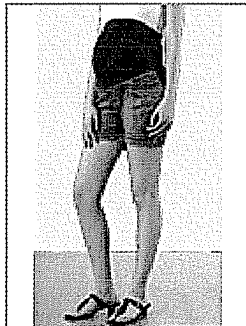

american star denim short with secret fit belly (tm) \$29.98

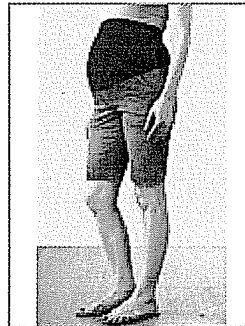

dark denim bermuda short with secret fit belly (tm) \$34.98

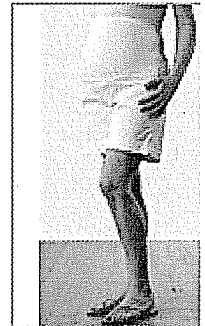

walk short with the secret fit belly(tm) ~~\$29.98~~ \$19.99

crops and capris

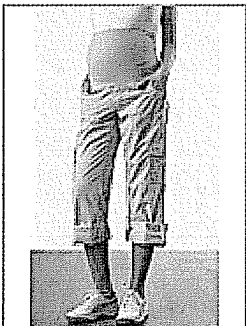

poplin convertible crop with secret fit belly(tm) 3 colors \$39.98



secret fit belly(tm) basic crop \$19.98

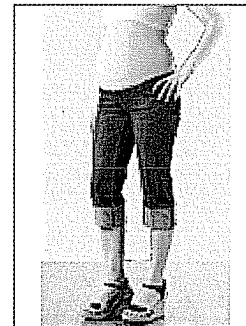

american star crop with secret fit belly(tm) \$44.98

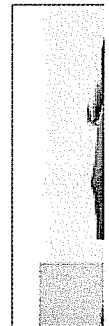

super stre with secret fit belly(tm) \$29.98

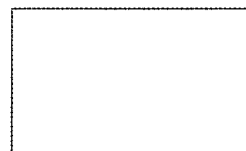
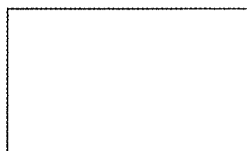

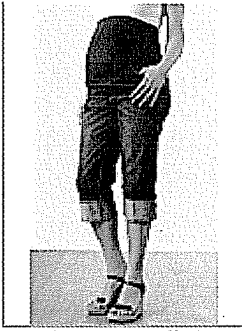

american star cuffed capri with secret fit belly (tm)
\$39.98

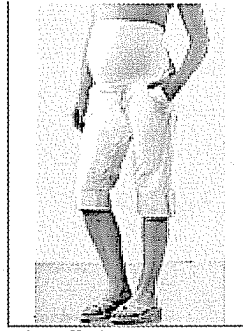

tab cuffed crop
\$29.98

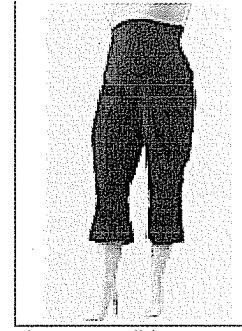

plus convertible pant with the secret fit belly (tm)
\$44.98

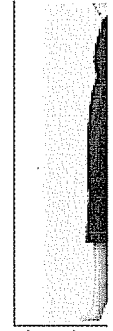

plus size secret fit t
\$29.98

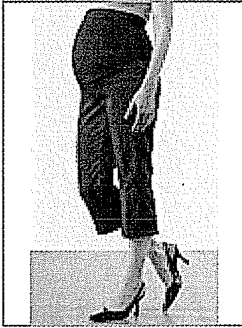

textured crop with secret fit belly(tm)
2 colors
\$14.99 - \$24.98

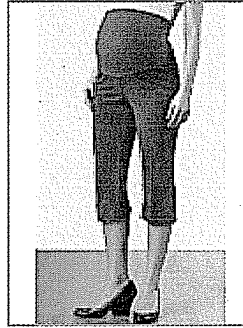

cuffed crop pant with secret fit belly(tm)
2 colors
\$19.99 - \$24.98

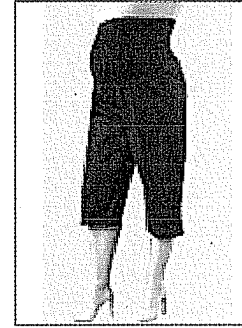

plus stretch twill capri with the secret fit belly (tm)
2 colors
\$26.98 - \$29.98

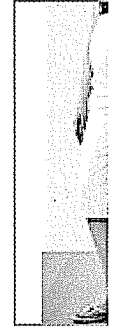

basic stre with secre
5 colors
~~\$24.98~~ \$19.99

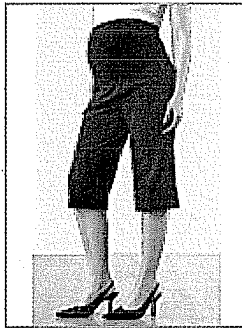

pinstripe cuffed crop with secret fit belly(tm)
~~\$24.98~~ \$19.99

contact by phone | 1.800.4mom2be | EMAIL: click here

FREE GIFT BAG : For New Customers

\$1000 Sweepstakes

Get on Our E-mail List by clicking submit y
enter your email address



| CUSTOMER SERVICE | PRIVACY POLICY | HOME | SITE MAP |

Copyright © 2008 Motherhood Maternity. All Rights Reserved

II. Amendments to the Claims

Please amend the claims to read as follows:

1. (Currently amended) A garment, comprising:

a garment upper portion having a belly panel that is expansible to cover and fit over a growing abdomen during different stages of pregnancy;

a garment lower portion having a first torso encircling circumference that recedes downward to make way for expansion of the belly panel; and

the garment upper portion having a second torso encircling circumference along the upper end of the belly panel above a location of maximum girth of the abdomen to hold the garment up and in place over the torso.

2. (Currently amended) The garment of claim 1, wherein the second torso encircling circumference is adjustable in girth ~~to encircle~~ in conformance with different body types.

3. (Currently amended) The garment of claim 1, wherein the garment upper portion comprises a seamless tubular structure that fits comfortably while being worn, and the belly panel comprises a an expansible portion of the tubular structure.

4. (Original) The garment of claim 1, wherein the garment upper portion comprises a seamless tubular elastic fabric to stretch elastically.

5. (Original) The garment of claim 1, wherein the garment upper portion comprises an elastic fabric that is contractible elastically to cover an abdomen during different stages of postpartum body changes.
6. (Currently amended) The garment of claim 1, wherein the garment lower portion has a partial waistband extending from side seams of the garment lower portion and extending across a back side of the garment lower portion where the partial waistband widens above a wearer's pelvis.
7. (Original) The garment of claim 1, further comprising a series of belly cradling stitches or knitted tension in the belly panel and extending along multiple paths arranged in an elliptical pattern that curves, so as to cradle a curved growing abdomen during various stages of pregnancy.
8. (Original) The garment of claim 1, further comprising a series of stitches or knitted tension in the backside of the garment upper portion to provide spinal and back support against the wearer of the garment.
9. (Original) The garment of claim 8, wherein the series of stitches or knitted tension in the backside of the garment upper portion extends along a pattern of multiple stitch paths.
10. (Original) The garment of claim 8, wherein the series of stitches or knitted tension in the backside of the garment upper portion extends along a pattern of multiple stitch paths.

11. (New) The garment of claim 1, wherein the garment upper portion is foldable toward the garment lower portion to comprise a folded band on the garment lower portion.

12. (New) The garment of claim 1, wherein the garment lower portion has a partial waistband extending from side seams of the garment lower portion wherein the partial waistband tapers toward the side seams and widens above a wearer's pelvis across a back side of the garment lower portion.

13. (New) The garment of claim 1, comprising:

knitted tension in the backside of the garment upper portion providing spinal column and back support for a wearer of the garment.

14. (New) The garment of claim 1, comprising:

a series of sewn supporting stitches in the backside of the garment upper portion providing spinal column and back support for a wearer of the garment.

15. (New) The garment of claim 1, comprising:

a series of sewn supporting stitches in the backside of the garment upper portion providing spinal column and back support for a wearer of the garment, wherein the stitches are arranged along multiple stitch paths grouped in a hyperbolic pattern, a curved pattern or a truncated, v-shaped pattern along an axis extending substantially vertically along a spinal supporting section of the fabric.

16. (New) The garment of claim 1, wherein an edge margin of the garment upper portion is folded over and knitted to an inside of the fabric to provide a perimeter hem stitch.
17. (New) The garment of claim 1, wherein an edge margin of the garment upper portion is folded over and sewn or knitted to an inside of the fabric to provide a perimeter hem stitch.
18. (New) The garment of claim 1, wherein the second torso encircling circumference comprises stretchable fabric to adjust the girth in conformance with different body types.
19. (New) The garment of claim 1, wherein the garment upper portion is a tubular structure, wherein the tubular structure is shaped and formed as a hyperboloid cylinder to fit a body type having a tapered torso.
20. (New) The garment of claim 1, wherein the garment upper portion is a tubular structure, wherein the tubular structure is shaped and formed as a straight sided cylinder to fit a body type having a corresponding shaped torso.
21. (New) The garment of claim 1, wherein the garment upper portion comprises a double layer tubular structure, and an inner layer of stretchable fabric between two layers of the double-layer tubular structure.
22. (New) The garment of claim 1, wherein the garment upper portion comprises a fabric, and the fabric is doubled back on itself downward to form a double-layer tubular structure that

extends downward for at least a portion of the garment upper portion, and the layers of the double-layer tubular structure are sewn together with a tubular perimeter drop stitch.

23. (New) The garment of claim 1, wherein the garment upper portion comprises a fabric doubled back on itself downward to form a double-layer tubular structure that extends downward for at least a portion of the garment upper portion, the layers of the double-layer tubular structure are sewn together with a tubular perimeter drop stitch, and an edge margin of the garment upper portion is knitted to an inside of the fabric to provide a perimeter hem stitch.

24. (New) The garment of claim 3, wherein the seamless tubular structure comprises a fabric doubled back on itself downward to form a double-layer tubular structure that extends downward for at least a portion of the garment upper portion, the layers of the double-layer tubular structure are sewn together with a tubular perimeter drop stitch, and an edge margin of the garment upper portion is folded over and sewn or knitted to an inside of the fabric to provide a perimeter hem stitch.

25. (New) The garment of claim 1, wherein the garment upper portion is foldable toward the garment lower portion to provide a folded band on the garment lower portion to be worn as a garment bottom having no top.

IN THE UNITED STATES PATENT AND TRADEMARK OFFICE

In Re Application of: Hendrickson, Lisa

Confirmation No. 1512

Serial No. 11/756,242

Examiner: n/a

Filed: May 31, 2007

Group Art Unit: 3765

For: Belly Covering Garment

M.S. Amendment
Commissioner for Patents
P.O. Box 1450
Alexandria, VA 22313-1450

Dear Sir:

PRELIMINARY AMENDMENT

I. Introductory Comments

Prior to Examination, please amend the application with this Preliminary Amendment.

Amendments to the Claims are reflected in the listing of claims which begins on page 2 of this Preliminary Amendment.

Remarks begin on page 7 of this Preliminary amendment.

Electronic Acknowledgement Receipt

EFS ID:	4221573
Application Number:	11756242
International Application Number:	
Confirmation Number:	1512
Title of Invention:	BELLY COVERING GARMENT
First Named Inventor/Applicant Name:	LISA A. HENDRICKSON
Customer Number:	08933
Filer:	Gerald K. Kita./MARY LA GRANGE
Filer Authorized By:	Gerald K. Kita.
Attorney Docket Number:	D8114-00369
Receipt Date:	03-NOV-2008
Filing Date:	31-MAY-2007
Time Stamp:	15:03:27
Application Type:	Utility under 35 USC 111(a)

Payment information:

Submitted with Payment	no
------------------------	----

File Listing:

Document Number	Document Description	File Name	File Size(Bytes)/ Message Digest	Multi Part /.zip	Pages (if appl.)
1		369PrelAmen.pdf	2723599 <small>75b1f0185acb8a7d7b4dcb32ad0277254803b162</small>	yes	22

Multipart Description/PDF files in .zip description			
Document Description		Start	End
Miscellaneous Incoming Letter		1	1
Preliminary Amendment		2	2
Claims		3	7
Applicant Arguments/Remarks Made in an Amendment		8	22

Warnings:

Information:

Total Files Size (in bytes):	2723599
-------------------------------------	---------

This Acknowledgement Receipt evidences receipt on the noted date by the USPTO of the indicated documents, characterized by the applicant, and including page counts, where applicable. It serves as evidence of receipt similar to a Post Card, as described in MPEP 503.

New Applications Under 35 U.S.C. 111

If a new application is being filed and the application includes the necessary components for a filing date (see 37 CFR 1.53(b)-(d) and MPEP 506), a Filing Receipt (37 CFR 1.54) will be issued in due course and the date shown on this Acknowledgement Receipt will establish the filing date of the application.

National Stage of an International Application under 35 U.S.C. 371

If a timely submission to enter the national stage of an international application is compliant with the conditions of 35 U.S.C. 371 and other applicable requirements a Form PCT/DO/EO/903 indicating acceptance of the application as a national stage submission under 35 U.S.C. 371 will be issued in addition to the Filing Receipt, in due course.

New International Application Filed with the USPTO as a Receiving Office

If a new international application is being filed and the international application includes the necessary components for an international filing date (see PCT Article 11 and MPEP 1810), a Notification of the International Application Number and of the International Filing Date (Form PCT/RO/105) will be issued in due course, subject to prescriptions concerning national security, and the date shown on this Acknowledgement Receipt will establish the international filing date of the application.

Under the Paperwork Reduction Act of 1995, no persons are required to respond to a collection of information unless it displays a valid OMB control number.

TRANSMITTAL FORM (to be used for all correspondence after initial filing)	Application Number	11/756,242
	Filing Date	May 31, 2007
	First Named Inventor	Hendrickson, Lisa et al.
	Art Unit	3765
	Examiner Name	n/a
Total Number of Pages in This Submission	Attorney Docket Number	D8114-00369

ENCLOSURES (Check all that apply)		
<input type="checkbox"/> Fee(s) Transmittal Form <input type="checkbox"/> Fee Attached <input checked="" type="checkbox"/> Amendment/Reply <input type="checkbox"/> After Allowance <input type="checkbox"/> Affidavits/declaration(s) <input type="checkbox"/> Extension of Time Request <input type="checkbox"/> Express Abandonment Request <input type="checkbox"/> Information Disclosure Statement <input type="checkbox"/> Certified Copy of Priority Document(s) <input type="checkbox"/> Response to Missing Parts/ Incomplete Application <input type="checkbox"/> Response to Missing Parts under 37 CFR 1.52 or 1.53	<input type="checkbox"/> Drawing(s) <input type="checkbox"/> Licensing-related Papers <input type="checkbox"/> Petition <input type="checkbox"/> Petition to Convert to a Provisional Application <input type="checkbox"/> Power of Attorney, Revocation Change of Correspondence Address <input type="checkbox"/> Terminal Disclaimer <input type="checkbox"/> Request for Refund <input type="checkbox"/> CD, Number of CD(s) _____	<input type="checkbox"/> After Allowance communication to Technology Center (TC) <input type="checkbox"/> Appeal Communication to Board of Appeals and Interferences <input type="checkbox"/> Appeal Communication to TC (Appeal Notice, Brief, Reply Brief) <input type="checkbox"/> Proprietary Information <input type="checkbox"/> Status Letter <input type="checkbox"/> Other Enclosure(s) (please Identify below): <input checked="" type="checkbox"/> Executed Combined Declaration and Power of Attorney
Remarks The Commissioner is hereby authorized to charge any fees associated with this communication or credit any overpayment to Deposit Account No. 04-1679.		
SIGNATURE OF APPLICANT, ATTORNEY, OR AGENT		
Firm or Individual name	Gerald K. Kita, Registration No. 24,125 Customer Number 08933	
Signature	<i>Gerald K. Kita</i>	
Date	<i>November 3, 2008</i>	

CERTIFICATE UNDER 37 CFR 1.10		
I hereby certify that this correspondence and the documents referred to therein are being electronically filed in the United States Patent and Trademark Office on the date indicated below		
Typed or printed name	Mary La Grange	
Signature	<i>Mary La Grange</i>	Date <i>11.3.08</i>

This collection of information is required by 37 CFR 1.5. The information is required to obtain or retain a benefit by the public which is to file (and by the USPTO to process) an application. Confidentiality is governed by 35 U.S.C. 122 and 37 CFR 1.14. This collection is estimated to 2 hours to complete, including gathering, preparing, and submitting the completed application form to the USPTO. Time will vary depending upon the individual case. Any comments on the amount of time you require to complete this form and/or suggestions for reducing this burden, should be sent to the Chief Information Officer, U.S. Patent and Trademark Office, U.S. Department of Commerce, P.O. Box 1450, Alexandria, VA 22313-1450. DO NOT SEND FEES OR COMPLETED FORMS TO THIS ADDRESS. SEND TO: Commissioner for Patents, P.O. Box 1450, Alexandria, VA 22313-1450.

If you need assistance in completing the form, call 1-800-PTO-9199 and select option 2.

Electronic Patent Application Fee Transmittal

Application Number:	11756242
Filing Date:	31-May-2007
Title of Invention:	BELLY COVERING GARMENT
First Named Inventor/Applicant Name:	LISA A. HENDRICKSON
Filer:	Gerald K. Kita./MARY LA GRANGE
Attorney Docket Number:	D8114-00369

Filed as Large Entity

Utility under 35 USC 111(a) Filing Fees

Description	Fee Code	Quantity	Amount	Sub-Total in USD(\$)
Basic Filing:				
Pages:				
Claims:				
Claims in excess of 20	1202	14	52	728

Miscellaneous-Filing:

Petition:

Patent-Appeals-and-Interference:

Post-Allowance-and-Post-Issuance:

Extension-of-Time:

Description	Fee Code	Quantity	Amount	Sub-Total in USD(\$)
Miscellaneous:				
Total in USD (\$)				728

Electronic Acknowledgement Receipt

EFS ID:	4221625
Application Number:	11756242
International Application Number:	
Confirmation Number:	1512
Title of Invention:	BELLY COVERING GARMENT
First Named Inventor/Applicant Name:	LISA A. HENDRICKSON
Customer Number:	08933
Filer:	Gerald K. Kita./MARY LA GRANGE
Filer Authorized By:	Gerald K. Kita.
Attorney Docket Number:	D8114-00369
Receipt Date:	03-NOV-2008
Filing Date:	31-MAY-2007
Time Stamp:	15:07:07
Application Type:	Utility under 35 USC 111(a)

Payment information:

Submitted with Payment	yes
Payment Type	Deposit Account
Payment was successfully received in RAM	\$728
RAM confirmation Number	339
Deposit Account	041679
Authorized User	

The Director of the USPTO is hereby authorized to charge indicated fees and credit any overpayment as follows:

Charge any Additional Fees required under 37 C.F.R. Section 1.16 (National application filing, search, and examination fees)

Charge any Additional Fees required under 37 C.F.R. Section 1.17 (Patent application and reexamination processing fees)

File Listing:

Document Number	Document Description	File Name	File Size(Bytes)/ Message Digest	Multi Part /.zip	Pages (if appl.)
1	Fee Worksheet (PTO-06)	fee-info.pdf	30273 9bfd74655fbd551329529dfdd2d23d9173257521	no	2

Warnings:**Information:**

Total Files Size (in bytes):	30273
-------------------------------------	-------

This Acknowledgement Receipt evidences receipt on the noted date by the USPTO of the indicated documents, characterized by the applicant, and including page counts, where applicable. It serves as evidence of receipt similar to a Post Card, as described in MPEP 503.

New Applications Under 35 U.S.C. 111

If a new application is being filed and the application includes the necessary components for a filing date (see 37 CFR 1.53(b)-(d) and MPEP 506), a Filing Receipt (37 CFR 1.54) will be issued in due course and the date shown on this Acknowledgement Receipt will establish the filing date of the application.

National Stage of an International Application under 35 U.S.C. 371

If a timely submission to enter the national stage of an international application is compliant with the conditions of 35 U.S.C. 371 and other applicable requirements a Form PCT/DO/EO/903 indicating acceptance of the application as a national stage submission under 35 U.S.C. 371 will be issued in addition to the Filing Receipt, in due course.

New International Application Filed with the USPTO as a Receiving Office

If a new international application is being filed and the international application includes the necessary components for an international filing date (see PCT Article 11 and MPEP 1810), a Notification of the International Application Number and of the International Filing Date (Form PCT/RO/105) will be issued in due course, subject to prescriptions concerning national security, and the date shown on this Acknowledgement Receipt will establish the international filing date of the application.

Under the Paperwork Reduction Act of 1995, no persons are required to respond to a collection of information unless it displays a valid OMB control number.

PATENT APPLICATION FEE DETERMINATION RECORD Substitute for Form PTO-875	Application or Docket Number 11/756,242	Filing Date 05/31/2007	<input type="checkbox"/> To be Mailed
---	---	----------------------------------	---------------------------------------

APPLICATION AS FILED – PART I			OTHER THAN SMALL ENTITY				
(Column 1)		(Column 2)	SMALL ENTITY <input type="checkbox"/>		OR	SMALL ENTITY	
FOR	NUMBER FILED	NUMBER EXTRA	RATE (\$)	FEE (\$)		RATE (\$)	FEE (\$)
<input type="checkbox"/> BASIC FEE <small>(37 CFR 1.16(a), (b), or (c))</small>	N/A	N/A	N/A			N/A	
<input type="checkbox"/> SEARCH FEE <small>(37 CFR 1.16(k), (l), or (m))</small>	N/A	N/A	N/A			N/A	
<input type="checkbox"/> EXAMINATION FEE <small>(37 CFR 1.16(o), (p), or (q))</small>	N/A	N/A	N/A			N/A	
TOTAL CLAIMS <small>(37 CFR 1.16(i))</small>	minus 20 =	*	X \$ =		OR	X \$ =	
INDEPENDENT CLAIMS <small>(37 CFR 1.16(h))</small>	minus 3 =	*	X \$ =			X \$ =	
<input type="checkbox"/> APPLICATION SIZE FEE <small>(37 CFR 1.16(s))</small>	If the specification and drawings exceed 100 sheets of paper, the application size fee due is \$250 (\$125 for small entity) for each additional 50 sheets or fraction thereof. See 35 U.S.C. 41(a)(1)(G) and 37 CFR 1.16(s).						
<input type="checkbox"/> MULTIPLE DEPENDENT CLAIM PRESENT <small>(37 CFR 1.16(j))</small>							
* If the difference in column 1 is less than zero, enter "0" in column 2.			TOTAL			TOTAL	

APPLICATION AS AMENDED – PART II					OTHER THAN SMALL ENTITY				
(Column 1)		(Column 2)	(Column 3)		SMALL ENTITY		OR	SMALL ENTITY	
AMENDMENT	11/03/2008	CLAIMS REMAINING AFTER AMENDMENT	HIGHEST NUMBER PREVIOUSLY PAID FOR	PRESENT EXTRA	RATE (\$)	ADDITIONAL FEE (\$)		RATE (\$)	ADDITIONAL FEE (\$)
	Total <small>(37 CFR 1.16(i))</small>	* 25	Minus	** 20 = 5	X \$ =		OR	X \$52=	260
	Independent <small>(37 CFR 1.16(h))</small>	* 1	Minus	***3 = 0	X \$ =		OR	X \$220=	0
<input type="checkbox"/> Application Size Fee <small>(37 CFR 1.16(s))</small>									
<input type="checkbox"/> FIRST PRESENTATION OF MULTIPLE DEPENDENT CLAIM <small>(37 CFR 1.16(j))</small>							OR		
					TOTAL ADD'L FEE		OR	TOTAL ADD'L FEE	260

APPLICATION AS AMENDED – PART II					OTHER THAN SMALL ENTITY				
(Column 1)		(Column 2)	(Column 3)		SMALL ENTITY		OR	SMALL ENTITY	
AMENDMENT	CLAIMS REMAINING AFTER AMENDMENT	HIGHEST NUMBER PREVIOUSLY PAID FOR	PRESENT EXTRA	RATE (\$)	ADDITIONAL FEE (\$)		RATE (\$)	ADDITIONAL FEE (\$)	
	Total <small>(37 CFR 1.16(i))</small>	*	Minus	** =	X \$ =		OR	X \$ =	
	Independent <small>(37 CFR 1.16(h))</small>	*	Minus	*** =	X \$ =		OR	X \$ =	
<input type="checkbox"/> Application Size Fee <small>(37 CFR 1.16(s))</small>									
<input type="checkbox"/> FIRST PRESENTATION OF MULTIPLE DEPENDENT CLAIM <small>(37 CFR 1.16(j))</small>							OR		
					TOTAL ADD'L FEE		OR	TOTAL ADD'L FEE	

* If the entry in column 1 is less than the entry in column 2, write "0" in column 3.
 ** If the "Highest Number Previously Paid For" IN THIS SPACE is less than 20, enter "20".
 *** If the "Highest Number Previously Paid For" IN THIS SPACE is less than 3, enter "3".
 The "Highest Number Previously Paid For" (Total or Independent) is the highest number found in the appropriate box in column 1.

Legal Instrument Examiner:
 /KELLY D. HARRIS/

This collection of information is required by 37 CFR 1.16. The information is required to obtain or retain a benefit by the public which is to file (and by the USPTO to process) an application. Confidentiality is governed by 35 U.S.C. 122 and 37 CFR 1.14. This collection is estimated to take 12 minutes to complete, including gathering, preparing, and submitting the completed application form to the USPTO. Time will vary depending upon the individual case. Any comments on the amount of time you require to complete this form and/or suggestions for reducing this burden, should be sent to the Chief Information Officer, U.S. Patent and Trademark Office, U.S. Department of Commerce, P.O. Box 1450, Alexandria, VA 22313-1450. DO NOT SEND FEES OR COMPLETED FORMS TO THIS ADDRESS. **SEND TO: Commissioner for Patents, P.O. Box 1450, Alexandria, VA 22313-1450.**
 If you need assistance in completing the form, call 1-800-PTO-9199 and select option 2.



UNITED STATES PATENT AND TRADEMARK OFFICE

UNITED STATES DEPARTMENT OF COMMERCE
United States Patent and Trademark Office
Address: COMMISSIONER FOR PATENTS
P.O. Box 1450
Alexandria, Virginia 22313-1450
www.uspto.gov

Table with 4 columns: APPLICATION NUMBER (11/756,242), FILING OR 371(C) DATE (05/31/2007), FIRST NAMED APPLICANT (LISA A. HENDRICKSON), ATTY. DOCKET NO./TITLE (D8114-00369)

CONFIRMATION NO. 1512

PUBLICATION NOTICE



8933
DUANE MORRIS LLP - Philadelphia
IP DEPARTMENT
30 SOUTH 17TH STREET
PHILADELPHIA, PA 19103-4196

Title:BELLY COVERING GARMENT

Publication No.US-2008-0295225-A1
Publication Date:12/04/2008

NOTICE OF PUBLICATION OF APPLICATION

The above-identified application will be electronically published as a patent application publication pursuant to 37 CFR 1.211, et seq. The patent application publication number and publication date are set forth above.

The publication may be accessed through the USPTO's publically available Searchable Databases via the Internet at www.uspto.gov. The direct link to access the publication is currently http://www.uspto.gov/patft/.

The publication process established by the Office does not provide for mailing a copy of the publication to applicant. A copy of the publication may be obtained from the Office upon payment of the appropriate fee set forth in 37 CFR 1.19(a)(1). Orders for copies of patent application publications are handled by the USPTO's Office of Public Records. The Office of Public Records can be reached by telephone at (703) 308-9726 or (800) 972-6382, by facsimile at (703) 305-8759, by mail addressed to the United States Patent and Trademark Office, Office of Public Records, Alexandria, VA 22313-1450 or via the Internet.

In addition, information on the status of the application, including the mailing date of Office actions and the dates of receipt of correspondence filed in the Office, may also be accessed via the Internet through the Patent Electronic Business Center at www.uspto.gov using the public side of the Patent Application Information and Retrieval (PAIR) system. The direct link to access this status information is currently http://pair.uspto.gov/. Prior to publication, such status information is confidential and may only be obtained by applicant using the private side of PAIR.

Further assistance in electronically accessing the publication, or about PAIR, is available by calling the Patent Electronic Business Center at 1-866-217-9197.

Office of Data Management, Application Assistance Unit (571) 272-4000, or (571) 272-4200, or 1-888-786-0101

Document code: WFEE

United States Patent and Trademark Office
Sales Receipt for Accounting Date: 03/03/2009

SZIMMERM	ADJ #00000003	Mailroom Dt: 02/02/2009		
	Seq No: 12	Sales Acctg Dt: 02/02/2009	081394	11756242
	01 FC : 1806	180.00 CR		

Approved.
JAB
3/9/09

IN THE UNITED STATES PATENT AND TRADEMARK OFFICE

In re application of:
Hendrickson et al.

Serial No.: 11/756,242

Filed: May 31, 2007

For: BELLY COVERING GARMENT

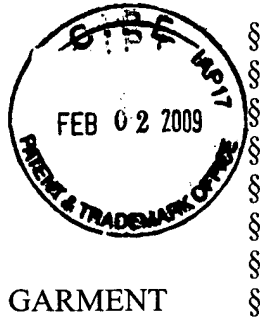

Publication No.: US 2008/0295225 A1

Publication Date: Dec. 4, 2008

Commissioner for Patents
P.O. Box 1450
Alexandria, VA 22313-1450

**THIRD PARTY SUBMISSION OF PRIOR ART
UNDER 37 C.F.R. § 1.99**

Sir:

Please accept this submission of prior art:

1. Selected pages from the *JCPenney Catalog Maternity Collection*, published 1Q 2004, front and back cover pages, and pages 4, 22, 30, and 32.
2. Selected pages from the *JCPenney Catalog Maternity Collection*, dated Fall/Winter 2005, front and back cover pages, and pages 14, 15, and 28.

The undersigned hereby certifies that, consistent with 37 C.F.R. § 1.248(b), a copy of this correspondence and the attached prior art references was deposited with the United States Postal Service as first class mail in an envelope addressed to:

Duane Morris LLP - Philadelphia
IP Department
30 South 17th Street
Philadelphia, PA 19103-4196

Signature

Date

02/02/2009 CNGUYEN2 00000012 001394 11756242
01 FC:1006 100.00 DA

Third Party Submission of Prior Art
Mailed January 29, 2008

Appl. No. 11/756,242
Publication No. US 2008/0295225 A1

The Commissioner is hereby authorized to charge to Deposit Account No. 08-1394 of Haynes and Boone, LLP the PTO fee of \$180.00 (Fee Code 1806) for submission of an Information Disclosure Statement under §1.99. The Commissioner is hereby authorized to charge any other fees necessary in association with papers submitted herewith or to credit any overpayment to Deposit Account No. 08-1394. A self-addressed postcard is included herewith to acknowledge receipt by the Patent Office.

Respectfully submitted,

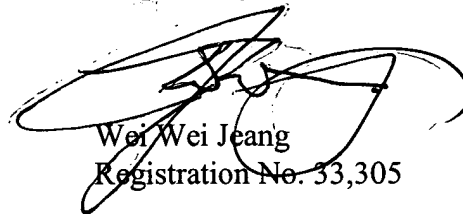

Wei Wei Jeang
Registration No. 33,305

Dated: January 29, 2009

HAYNES AND BOONE, LLP
2323 Victory Avenue Suite 700
Dallas TX 75219
Telephone: 972-739-8631
File: 40612.6

R-221012_1.DOC

I hereby certify that this correspondence is being deposited with the United States Postal Service as first class mail in an envelope addressed to: Commissioner For Patents, P.O. Box 1450, Alexandria, VA 22313-1450 on January 29, 2009.

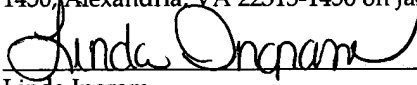

Linda Ingram

ARTIFACT SHEET

Enter artifact number below. Artifact number is application number + artifact type code (see list below) + sequential letter (A, B, C ...). The first artifact folder for an artifact type receives the letter A, the second B, etc..
Examples: 59123456PA, 59123456PB, 59123456ZA, 59123456ZB

11756242ZB

Indicate quantity of a single type of artifact received but not scanned. Create individual artifact folder/box and artifact number for each Artifact Type.

CD(s) containing:

computer program listing

Doc Code: Computer

pages of specification

and/or sequence listing

and/or table

Doc Code: Artifact

content unspecified or combined

Doc Code: Artifact

Artifact Type Code: P

Artifact Type Code: S

Artifact Type Code: U

Stapled Set(s) Color Documents or B/W Photographs

Doc Code: Artifact Artifact Type Code: C

Microfilm(s)

Doc Code: Artifact Artifact Type Code: F

Video tape(s)

Doc Code: Artifact Artifact Type Code: V

Model(s)

Doc Code: Artifact Artifact Type Code: M

Bound Document(s)

Doc Code: Artifact Artifact Type Code: B

Confidential Information Disclosure Statement or Other Documents
marked Proprietary, Trade Secrets, Subject to Protective Order,
Material Submitted under MPEP 724.02, etc.

Doc Code: Artifact Artifact Type Code X

Other, description: **NPL**

Doc Code: Artifact Artifact Type Code: Z

Electronic Acknowledgement Receipt

EFS ID:	4853513
Application Number:	11756242
International Application Number:	
Confirmation Number:	1512
Title of Invention:	BELLY COVERING GARMENT
First Named Inventor/Applicant Name:	LISA A. HENDRICKSON
Customer Number:	08933
Filer:	Gerald K. Kita./MARY LA GRANGE
Filer Authorized By:	Gerald K. Kita.
Attorney Docket Number:	D8114-00369
Receipt Date:	25-FEB-2009
Filing Date:	31-MAY-2007
Time Stamp:	11:33:53
Application Type:	Utility under 35 USC 111(a)

Payment information:

Submitted with Payment	no
------------------------	----

File Listing:

Document Number	Document Description	File Name	File Size(Bytes)/ Message Digest	Multi Part /.zip	Pages (if appl.)
1		369ids4.pdf	512910 <small>477c2df4f462253f5c1abe120baa8fe1877020d4</small>	yes	5

Multipart Description/PDF files in .zip description			
Document Description		Start	End
Miscellaneous Incoming Letter		1	1
Information Disclosure Statement (IDS) Filed (SB/08)		2	5

Warnings:

Information:

Total Files Size (in bytes):	512910
-------------------------------------	--------

This Acknowledgement Receipt evidences receipt on the noted date by the USPTO of the indicated documents, characterized by the applicant, and including page counts, where applicable. It serves as evidence of receipt similar to a Post Card, as described in MPEP 503.

New Applications Under 35 U.S.C. 111

If a new application is being filed and the application includes the necessary components for a filing date (see 37 CFR 1.53(b)-(d) and MPEP 506), a Filing Receipt (37 CFR 1.54) will be issued in due course and the date shown on this Acknowledgement Receipt will establish the filing date of the application.

National Stage of an International Application under 35 U.S.C. 371

If a timely submission to enter the national stage of an international application is compliant with the conditions of 35 U.S.C. 371 and other applicable requirements a Form PCT/DO/EO/903 indicating acceptance of the application as a national stage submission under 35 U.S.C. 371 will be issued in addition to the Filing Receipt, in due course.

New International Application Filed with the USPTO as a Receiving Office

If a new international application is being filed and the international application includes the necessary components for an international filing date (see PCT Article 11 and MPEP 1810), a Notification of the International Application Number and of the International Filing Date (Form PCT/RO/105) will be issued in due course, subject to prescriptions concerning national security, and the date shown on this Acknowledgement Receipt will establish the international filing date of the application.

Under the Paperwork Reduction Act of 1995, no persons are required to respond to a collection of information unless it displays a valid OMB control number.

TRANSMITTAL FORM <i>(to be used for all correspondence after initial filing)</i>	Application Number	11/756,242
	Filing Date	May 31, 2007
	First Named Inventor	Hendrickson, Lisa et al.
	Art Unit	3765
	Examiner Name	n/a
Total Number of Pages in This Submission	Attorney Docket Number	D8114-00369

ENCLOSURES (Check all that apply)		
<input type="checkbox"/> Fee(s) Transmittal Form <input type="checkbox"/> Fee Attached <input type="checkbox"/> Amendment/Reply <input type="checkbox"/> After Allowance <input type="checkbox"/> Affidavits/declaration(s) <input type="checkbox"/> Extension of Time Request <input type="checkbox"/> Express Abandonment Request <input checked="" type="checkbox"/> Information Disclosure Statement <input type="checkbox"/> Certified Copy of Priority Document(s) <input type="checkbox"/> Response to Missing Parts/Incomplete Application <input type="checkbox"/> Response to Missing Parts under 37 CFR 1.52 or 1.53	<input type="checkbox"/> Drawing(s) <input type="checkbox"/> Licensing-related Papers <input type="checkbox"/> Petition <input type="checkbox"/> Petition to Convert to a Provisional Application <input type="checkbox"/> Power of Attorney, Revocation <input type="checkbox"/> Change of Correspondence Address <input type="checkbox"/> Terminal Disclaimer <input type="checkbox"/> Request for Refund <input type="checkbox"/> CD, Number of CD(s) _____	<input type="checkbox"/> After Allowance communication to Technology Center (TC) <input type="checkbox"/> Appeal Communication to Board of Appeals and Interferences <input type="checkbox"/> Appeal Communication to TC (Appeal Notice, Brief, Reply Brief) <input type="checkbox"/> Proprietary Information <input type="checkbox"/> Status Letter <input type="checkbox"/> Other Enclosure(s) (please identify below):
Remarks The Commissioner is hereby authorized to charge any fees associated with this communication or credit any overpayment to Deposit Account No. 04-1679.		

SIGNATURE OF APPLICANT, ATTORNEY, OR AGENT

Firm or Individual name	Gerald K. Kita, Registration No. 24,125 Customer Number 08933		
Signature	<i>Gerald K. Kita</i>		
Date	<i>February 25, 2009</i>		

CERTIFICATE UNDER 37 CFR 1.10

I hereby certify that this correspondence and the documents referred to therein are being electronically filed in the United States Patent and Trademark Office on the date indicated below

Typed or printed name	Mary La Grange		
Signature		Date	

This collection of information is required by 37 CFR 1.5. The information is required to obtain or retain a benefit by the public which is to file (and by the USPTO to process) an application. Confidentiality is governed by 35 U.S.C. 122 and 37 CFR 1.14. This collection is estimated to 2 hours to complete, including gathering, preparing, and submitting the completed application form to the USPTO. Time will vary depending upon the individual case. Any comments on the amount of time you require to complete this form and/or suggestions for reducing this burden, should be sent to the Chief Information Officer, U.S. Patent and Trademark Office, U.S. Department of Commerce, P.O. Box 1450, Alexandria, VA 22313-1450. DO NOT SEND FEES OR COMPLETED FORMS TO THIS ADDRESS. SEND TO: Commissioner for Patents, P.O. Box 1450, Alexandria, VA 22313-1450.

If you need assistance in completing the form, call 1-800-PTO-9199 and select option 2.

IN THE UNITED STATES PATENT AND TRADEMARK OFFICE

In Re Application of: Hendrickson, Lisa

Confirmation No: 1512

Serial No. 11/756,242

Group Art Unit: 3765

Filed: May 31, 2007

Examiner: n/a

For: Belly Covering Garment

M.S. Amendment
Commissioner for Patents
P.O. Box 1450
Alexandria, VA 22313-1450

Dear Sir:

INFORMATION DISCLOSURE STATEMENT TRANSMITTAL LETTER

Enclosed herewith is an Information Disclosure Statement pursuant to 37 CFR. § 1.56 in connection with the above-identified application, which statement is being filed:

Together with the present application.

Before the first Office Action on the merits or three (3) months from the filing date of this application, whichever occurs last. **[37 CFR § 1.97(b)]**

After the first Office Action on the merits, but before a Final Office Action under §1.113 or Notice of Allowance under §1.311, whichever occurs first. **[37 CFR §1.97(c)]**. *(Either the fee or certification is provided, as set forth below).*

After a Final Office Action under §1.113 or Notice of Allowance under §1.311, but prior to or with payment of the Issue Fee. **[37 CFR §1.97(d)]**. *The fee and certification are provided, as set forth below).*

Consistent with Applicant's obligations pursuant to 37 CFR §§1.97 and 1.98, the following requirements have been met:

- No separate requirements are needed.
- No additional fee is required.

Fee Under 37 CFR § 1.97(c) or 1.97(d)

The fee of \$180.00 for submission of an IDS under § 1.97(c) as set forth in § 1.17(p) accompanies this statement.

Please charge the fee of \$180.00 for submission of an IDS under § 1.97(c) or (d) as set forth in § 1.17(p) to Deposit Account 04-1679.

Certification Under 37 CFR § 1.97(e)

The undersigned certifies:

1 that each item of information contained in the information disclosure statement was first cited in a communication from a foreign patent office in a counterpart foreign application not more than three months prior to the filing of the information disclosure statement; or

2 that no item of information contained in the information disclosure statement was cited in a communication from a foreign patent office in a counterpart foreign application, and, to the knowledge of the person signing the statement after making reasonable inquiry, no item of information contained in the information disclosure statement was known to any individual designated in §1.56(c) more than three months prior to the filing of the information disclosure statement.

Provision of Copies of References

- A copy of each of the Foreign and Other references listed on the attached Form PTO-1449 is enclosed herewith and forms a part hereof.
- Partial Translations of References are enclosed herewith and form a part hereof.
- A copy of the European Search Report from a corresponding or related EPO application is enclosed herewith.
- A copy of the International Search Report from a corresponding or related PCT application is enclosed herewith.

Identification of Prior Application(s) In Which Listed Information Was Already Cited And For Which No Copies Are Submitted Or Need Be Submitted

[X] This application relies, under 35 U.S.C. § 120, on the earlier filing date of prior U.S. Application No(s) _____ filed _____. Some or all of the references were submitted to, and/or cited by, the Office in the prior application(s) and therefore are not required to be provided in this application.

The Commissioner is hereby authorized to charge any fees associated with this communication or credit any overpayment to Deposit Account No. 04-1679.

Respectfully submitted,

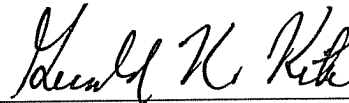

Gerald K. Kita
Registration No. 24,125

Date: February 25, 2009

Customer No. 08933
DUANE MORRIS LLP
30 South 17th Street
Philadelphia, PA 19103-4196
215-979-1863 tel
215-979-1020 fax

Electronic Acknowledgement Receipt

EFS ID:	4918476
Application Number:	11756242
International Application Number:	
Confirmation Number:	1512
Title of Invention:	BELLY COVERING GARMENT
First Named Inventor/Applicant Name:	LISA A. HENDRICKSON
Customer Number:	08933
Filer:	Gerald K. Kita./MARY LA GRANGE
Filer Authorized By:	Gerald K. Kita.
Attorney Docket Number:	D8114-00369
Receipt Date:	06-MAR-2009
Filing Date:	31-MAY-2007
Time Stamp:	13:43:06
Application Type:	Utility under 35 USC 111(a)

Payment information:

Submitted with Payment	no
------------------------	----

File Listing:

Document Number	Document Description	File Name	File Size(Bytes)/ Message Digest	Multi Part /.zip	Pages (if appl.)
1		369ids5.pdf	527569 465590f1a2f4fbfb65bfff8a6a6d383a4d2cdd72d	yes	5

Multipart Description/PDF files in .zip description			
Document Description		Start	End
Miscellaneous Incoming Letter		1	1
Information Disclosure Statement (IDS) Filed (SB/08)		2	5

Warnings:

Information:

Total Files Size (in bytes):	527569
-------------------------------------	--------

This Acknowledgement Receipt evidences receipt on the noted date by the USPTO of the indicated documents, characterized by the applicant, and including page counts, where applicable. It serves as evidence of receipt similar to a Post Card, as described in MPEP 503.

New Applications Under 35 U.S.C. 111

If a new application is being filed and the application includes the necessary components for a filing date (see 37 CFR 1.53(b)-(d) and MPEP 506), a Filing Receipt (37 CFR 1.54) will be issued in due course and the date shown on this Acknowledgement Receipt will establish the filing date of the application.

National Stage of an International Application under 35 U.S.C. 371

If a timely submission to enter the national stage of an international application is compliant with the conditions of 35 U.S.C. 371 and other applicable requirements a Form PCT/DO/EO/903 indicating acceptance of the application as a national stage submission under 35 U.S.C. 371 will be issued in addition to the Filing Receipt, in due course.

New International Application Filed with the USPTO as a Receiving Office

If a new international application is being filed and the international application includes the necessary components for an international filing date (see PCT Article 11 and MPEP 1810), a Notification of the International Application Number and of the International Filing Date (Form PCT/RO/105) will be issued in due course, subject to prescriptions concerning national security, and the date shown on this Acknowledgement Receipt will establish the international filing date of the application.

Under the Paperwork Reduction Act of 1995, no persons are required to respond to a collection of information unless it displays a valid OMB control number.

TRANSMITTAL FORM (to be used for all correspondence after initial filing)	Application Number	11/756,242
	Filing Date	May 31, 2007
	First Named Inventor	Hendrickson, Lisa et al.
	Art Unit	3765
	Examiner Name	n/a
Total Number of Pages in This Submission	Attorney Docket Number	D8114-00369

ENCLOSURES (Check all that apply)		
<input type="checkbox"/> Fee(s) Transmittal Form	<input type="checkbox"/> Drawing(s)	<input type="checkbox"/> After Allowance communication to Technology Center (TC)
<input type="checkbox"/> Fee Attached	<input type="checkbox"/> Licensing-related Papers	<input type="checkbox"/> Appeal Communication to Board of Appeals and Interferences
<input type="checkbox"/> Amendment/Reply	<input type="checkbox"/> Petition	<input type="checkbox"/> Appeal Communication to TC (Appeal Notice, Brief, Reply Brief)
<input type="checkbox"/> After Allowance	<input type="checkbox"/> Petition to Convert to a Provisional Application	<input type="checkbox"/> Proprietary Information
<input type="checkbox"/> Affidavits/declaration(s)	<input type="checkbox"/> Power of Attorney, Revocation	<input type="checkbox"/> Status Letter
<input type="checkbox"/> Extension of Time Request	<input type="checkbox"/> Change of Correspondence Address	<input type="checkbox"/> Other Enclosure(s) (please identify below):
<input type="checkbox"/> Express Abandonment Request	<input type="checkbox"/> Terminal Disclaimer	<input type="checkbox"/> XX Executed Combined Declaration and Power of Attorney
<input checked="" type="checkbox"/> Information Disclosure Statement	<input type="checkbox"/> Request for Refund	
<input type="checkbox"/> Certified Copy of Priority Document(s)	<input type="checkbox"/> CD, Number of CD(s) _____	
<input type="checkbox"/> Response to Missing Parts/Incomplete Application	Remarks The Commissioner is hereby authorized to charge any fees associated with this communication or credit any overpayment to Deposit Account No. 04-1679.	
<input type="checkbox"/> Response to Missing Parts under 37 CFR 1.52 or 1.53		

SIGNATURE OF APPLICANT, ATTORNEY, OR AGENT	
Firm or Individual name	Gerald K. Kita, Registration No. 24,125 Customer Number 08933
Signature	<i>Gerald K. Kita</i>
Date	March 6, 2007

CERTIFICATE UNDER 37 CFR 1.10	
I hereby certify that this correspondence and the documents referred to therein are being electronically filed in the United States Patent and Trademark Office on the date indicated below	
Typed or printed name	Mary La Grange
Signature	<i>Mary La Grange</i>
Date	3609

This collection of information is required by 37 CFR 1.5. The information is required to obtain or retain a benefit by the public which is to file (and by the USPTO to process) an application. Confidentiality is governed by 35 U.S.C. 122 and 37 CFR 1.14. This collection is estimated to 2 hours to complete, including gathering, preparing, and submitting the completed application form to the USPTO. Time will vary depending upon the individual case. Any comments on the amount of time you require to complete this form and/or suggestions for reducing this burden, should be sent to the Chief Information Officer, U.S. Patent and Trademark Office, U.S. Department of Commerce, P.O. Box 1450, Alexandria, VA 22313-1450. DO NOT SEND FEES OR COMPLETED FORMS TO THIS ADDRESS. SEND TO: Commissioner for Patents, P.O. Box 1450, Alexandria, VA 22313-1450.

If you need assistance in completing the form, call 1-800-PTO-9199 and select option 2.

IN THE UNITED STATES PATENT AND TRADEMARK OFFICE

In Re Application of: Hendrickson, Lisa

Confirmation No: 1512

Serial No. 11/756,242

Group Art Unit: 3765

Filed: May 31, 2007

Examiner: n/a

For: Belly Covering Garment

M.S. Amendment
Commissioner for Patents
P.O. Box 1450
Alexandria, VA 22313-1450

Dear Sir:

INFORMATION DISCLOSURE STATEMENT TRANSMITTAL LETTER

Enclosed herewith is a revised Information Disclosure Statement, pursuant to 37 CFR. § 1.56, which Applicant is submitting in order to correct the Publication No. of the Carney reference originally submitted in the Information Disclosure Statement filed on September 18 2008. This Statement is being filed:

Together with the present application.

Before the first Office Action on the merits or three (3) months from the filing date of this application, whichever occurs last. **[37 CFR § 1.97(b)]**

After the first Office Action on the merits, but before a Final Office Action under §1.113 or Notice of Allowance under §1.311, whichever occurs first. **[37 CFR §1.97(c)]**. *(Either the fee or certification is provided, as set forth below).*

After a Final Office Action under §1.113 or Notice of Allowance under §1.311, but prior to or with payment of the Issue Fee. **[37 CFR §1.97(d)]**. *The fee and certification are provided, as set forth below).*

Consistent with Applicant's obligations pursuant to 37 CFR §§1.97 and 1.98, the following requirements have been met:

No separate requirements are needed.

No additional fee is required.

Fee Under 37 CFR § 1.97(c) or 1.97(d)

The fee of \$180.00 for submission of an IDS under § 1.97(c) as set forth in § 1.17(p) accompanies this statement.

Please charge the fee of \$180.00 for submission of an IDS under § 1.97(c) or (d) as set forth in § 1.17(p) to Deposit Account 04-1679.

Certification Under 37 CFR § 1.97(e)

The undersigned certifies:

1 that each item of information contained in the information disclosure statement was first cited in a communication from a foreign patent office in a counterpart foreign application not more than three months prior to the filing of the information disclosure statement; or

2 that no item of information contained in the information disclosure statement was cited in a communication from a foreign patent office in a counterpart foreign application, and, to the knowledge of the person signing the statement after making reasonable inquiry, no item of information contained in the information disclosure statement was known to any individual designated in §1.56(c) more than three months prior to the filing of the information disclosure statement.

Provision of Copies of References

A copy of each of the Foreign and Other references listed on the attached Form PTO-1449 is enclosed herewith and forms a part hereof.

Partial Translations of References are enclosed herewith and form a part hereof.

A copy of the European Search Report from a corresponding or related EPO application is enclosed herewith.

A copy of the International Search Report from a corresponding or related PCT application is enclosed herewith.

Identification of Prior Application(s) In Which Listed Information Was Already Cited And For Which No Copies Are Submitted Or Need Be Submitted

[X] This application relies, under 35 U.S.C. § 120, on the earlier filing date of prior U.S. Application No(s). filed . Some or all of the references were submitted to, and/or cited by, the Office in the prior application(s) and therefore are not required to be provided in this application.

The Commissioner is hereby authorized to charge any fees associated with this communication or credit any overpayment to Deposit Account No. 04-1679.

Respectfully submitted,

Date: March 6, 2009

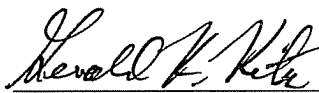

Gerald K. Kita
Registration No. 24,125

Customer No. 08933
DUANE MORRIS LLP
30 South 17th Street
Philadelphia, PA 19103-4196
215-979-1863 tel
215-979-1020 fax

Electronic Acknowledgement Receipt

EFS ID:	6433564
Application Number:	11756242
International Application Number:	
Confirmation Number:	1512
Title of Invention:	BELLY COVERING GARMENT
First Named Inventor/Applicant Name:	LISA A. HENDRICKSON
Customer Number:	08933
Filer:	David Lee May/Donald Sias
Filer Authorized By:	David Lee May
Attorney Docket Number:	D8114-00369
Receipt Date:	11-NOV-2009
Filing Date:	31-MAY-2007
Time Stamp:	15:13:32
Application Type:	Utility under 35 USC 111(a)

Payment information:

Submitted with Payment	no
------------------------	----

File Listing:

Document Number	Document Description	File Name	File Size(Bytes)/ Message Digest	Multi Part /.zip	Pages (if appl.)
1	Power of Attorney	043174_014000_Power_of_Attorney_and_Statement.pdf	144076 <small>e78f1fa07c7a15c3c5a6bb9de5990060417a2959</small>	no	2

Warnings:

Information:

This Acknowledgement Receipt evidences receipt on the noted date by the USPTO of the indicated documents, characterized by the applicant, and including page counts, where applicable. It serves as evidence of receipt similar to a Post Card, as described in MPEP 503.

New Applications Under 35 U.S.C. 111

If a new application is being filed and the application includes the necessary components for a filing date (see 37 CFR 1.53(b)-(d) and MPEP 506), a Filing Receipt (37 CFR 1.54) will be issued in due course and the date shown on this Acknowledgement Receipt will establish the filing date of the application.

National Stage of an International Application under 35 U.S.C. 371

If a timely submission to enter the national stage of an international application is compliant with the conditions of 35 U.S.C. 371 and other applicable requirements a Form PCT/DO/EO/903 indicating acceptance of the application as a national stage submission under 35 U.S.C. 371 will be issued in addition to the Filing Receipt, in due course.

New International Application Filed with the USPTO as a Receiving Office

If a new international application is being filed and the international application includes the necessary components for an international filing date (see PCT Article 11 and MPEP 1810), a Notification of the International Application Number and of the International Filing Date (Form PCT/RO/105) will be issued in due course, subject to prescriptions concerning national security, and the date shown on this Acknowledgement Receipt will establish the international filing date of the application.

POWER OF ATTORNEY OR REVOCAION OF POWER OF ATTORNEY WITH A NEW POWER OF ATTORNEY AND CHANGE OF CORRESPONDENCE ADDRESS	Application Number	11/756,242
	Filing Date	May 31, 2007
	First Named Inventor	Lisa A. Hendrickson
	Title	BELLY COVERING GARMENT
	Art Unit	3765
	Examiner Name	Not Yet Assigned
	Attorney Docket Number	043174-014000

I hereby revoke all previous powers of attorney given in the above-identified application.

A Power of Attorney is submitted herewith.

OR

I hereby appoint Practitioner(s) associated with the following Customer Number as my/our attorney(s) or agent(s) to prosecute the application identified above, and to transact all business in the United States Patent and Trademark Office connected therewith:

22204

OR

I hereby appoint Practitioner(s) named below as my/our attorney(s) or agent(s) to prosecute the application identified above, and to transact all business in the United States Patent and Trademark Office connected therewith:

Practitioner(s) Name	Registration Number

Please recognize or change the correspondence address for the above-identified application to:

The address associated with the above-mentioned Customer Number.

OR

The address associated with Customer Number:

Firm or Individual Name

Address

City _____ State _____ Zip _____

Country _____

Telephone _____ Email _____

I am the:

Applicant/Inventor.

OR

Assignee of record of the entire interest. See 37 CFR 3.71. Statement under 37 CFR 3.73(b) (Form PTO/SB/96) submitted herewith or filed on _____ herewith.

SIGNATURE of Applicant or Assignee of Record

Signature 	Date	11/4/2009
Name	Telephone	(215)400-2532
Title and Company: Vice President and General Counsel I, Destination Maternity Corporation		

NOTE: Signatures of all the inventors or assignees of record of the entire interest or their representative(s) are required. Submit multiple forms if more than one signature is required, see below*.

*Total of 1 forms are submitted.

This collection of information is required by 37 CFR 1.31, 1.32 and 1.33. The information is required to obtain or retain a benefit by the public which is to file (and by the USPTO to process) an application. Confidentiality is governed by 35 U.S.C. 122 and 37 CFR 1.11 and 1.14. This collection is estimated to take 3 minutes to complete, including gathering, preparing, and submitting the completed application form to the USPTO. Time will vary depending upon the individual case. Any comments on the amount of time you require to complete this form and/or suggestions for reducing this burden, should be sent to the Chief Information Officer, U.S. Patent and Trademark Office, U.S. Department of Commerce, P.O. Box 1450, Alexandria, VA 22313-1450. DO NOT SEND FEES OR COMPLETED FORMS TO THIS ADDRESS. SEND TO: Commissioner for Patents, P.O. Box 1450, Alexandria, VA 22313-1450.

If you need assistance in completing the form, call 1-800-PTO-9199 and select option 2.

STATEMENT UNDER 37 CFR 3.73(b)

Applicant/Patent Owner: Lisa A. HENDRICKSON, James H. GARDNER, III and Richard ADELMAN

Application No./Patent No.: 11/756,242 Filed/Issue Date: May 31, 2007

Titled: BELLY COVERING GARMENT

DESTINATION MATERNITY CORPORATION, a corporation

(Name of Assignee) (Type of Assignee, e.g., corporation, partnership, university, government agency, etc.)

states that it is:

- 1. the assignee of the entire right, title, and interest in;
- 2. an assignee of less than the entire right, title, and interest in (The extent (by percentage) of its ownership interest is _____ %); or
- 3. the assignee of an undivided interest in the entirety of (a complete assignment from one of the joint inventors was made) the patent application/patent identified above, by virtue of either:

A. An assignment from the inventor(s) of the patent application/patent identified above. The assignment was recorded in the United States Patent and Trademark Office at Reel _____, Frame _____, or for which a copy therefore is attached.

OR

B. A chain of title from the inventor(s), of the patent application/patent identified above, to the current assignee as follows:

1. From: Inventors To: Mothers Work, Inc.

The document was recorded in the United States Patent and Trademark Office at Reel 019670, Frame 0495, or for which a copy thereof is attached.

2. From: Mothers Work, Inc. To: Destination Maternity Corporation

The document was recorded in the United States Patent and Trademark Office at Reel 023390, Frame 0079, or for which a copy thereof is attached.

3. From: _____ To: _____

The document was recorded in the United States Patent and Trademark Office at Reel _____, Frame _____, or for which a copy thereof is attached.

Additional documents in the chain of title are listed on a supplemental sheet(s).

As required by 37 CFR 3.73(b)(1)(i), the documentary evidence of the chain of title from the original owner to the assignee was, or concurrently is being, submitted for recordation pursuant to 37 CFR 3.11.

[NOTE: A separate copy (i.e., a true copy of the original assignment document(s)) must be submitted to Assignment Division in accordance with 37 CFR Part 3, to record the assignment in the records of the USPTO. See MPEP 302.08]

The undersigned (whose title is supplied below) is authorized to act on behalf of the assignee.

Signature

Date

Ronald J. Masciantonio
Printed or Typed Name

11/4/2009
Vice President + General Counsel
Title

This collection of information is required by 37 CFR 3.73(b). The information is required to obtain or retain a benefit by the public which is to file (and by the USPTO to process) an application. Confidentiality is governed by 35 U.S.C. 122 and 37 CFR 1.11 and 1.14. This collection is estimated to take 12 minutes to complete, including gathering, preparing, and submitting the completed application form to the USPTO. Time will vary depending upon the individual case. Any comments on the amount of time you require to complete this form and/or suggestions for reducing this burden, should be sent to the Chief Information Officer, U.S. Patent and Trademark Office, U.S. Department of Commerce, P.O. Box 1450, Alexandria, VA 22313-1450. DO NOT SEND FEES OR COMPLETED FORMS TO THIS ADDRESS. SEND TO: Commissioner for Patents, P.O. Box 1450, Alexandria, VA 22313-1450.



UNITED STATES PATENT AND TRADEMARK OFFICE

UNITED STATES DEPARTMENT OF COMMERCE
United States Patent and Trademark Office
Address: COMMISSIONER FOR PATENTS
P.O. Box 1450
Alexandria, Virginia 22313-1450
www.uspto.gov

APPLICATION NUMBER	FILING OR 371(C) DATE	FIRST NAMED APPLICANT	ATTY. DOCKET NO./TITLE
11/756,242	05/31/2007	LISA A. HENDRICKSON	D8114-00369

CONFIRMATION NO. 1512

POWER OF ATTORNEY NOTICE



8933
DUANE MORRIS LLP - Philadelphia
IP DEPARTMENT
30 SOUTH 17TH STREET
PHILADELPHIA, PA 19103-4196

Date Mailed: 11/18/2009

NOTICE REGARDING CHANGE OF POWER OF ATTORNEY

This is in response to the Power of Attorney filed 11/11/2009.

- The Power of Attorney to you in this application has been revoked by the assignee who has intervened as provided by 37 CFR 3.71. Future correspondence will be mailed to the new address of record(37 CFR 1.33).

/mayalew/

Office of Data Management, Application Assistance Unit (571) 272-4000, or (571) 272-4200, or 1-888-786-0101



UNITED STATES PATENT AND TRADEMARK OFFICE

UNITED STATES DEPARTMENT OF COMMERCE
United States Patent and Trademark Office
Address: COMMISSIONER FOR PATENTS
P.O. Box 1450
Alexandria, Virginia 22313-1450
www.uspto.gov

APPLICATION NUMBER	FILING OR 371(C) DATE	FIRST NAMED APPLICANT	ATTY. DOCKET NO./TITLE
11/756,242	05/31/2007	LISA A. HENDRICKSON	043174-014000

CONFIRMATION NO. 1512

POA ACCEPTANCE LETTER



22204
NIXON PEABODY, LLP
401 9TH STREET, NW
SUITE 900
WASHINGTON, DC 20004-2128

Date Mailed: 11/18/2009

NOTICE OF ACCEPTANCE OF POWER OF ATTORNEY

This is in response to the Power of Attorney filed 11/11/2009.

The Power of Attorney in this application is accepted. Correspondence in this application will be mailed to the above address as provided by 37 CFR 1.33.

/mayalew/

Office of Data Management, Application Assistance Unit (571) 272-4000, or (571) 272-4200, or 1-888-786-0101

SUBSTITUTE for form 1449A/PTO INFORMATION DISCLOSURE STATEMENT BY APPLICANT (use as many sheets as necessary)			<i>Complete if Known</i>		
			Application Number	11/756,242	
Sheet 1 of 1			Filing Date	May 31, 2007	
			First Named Inventor	Hendrickson, Lisa	
			Art Unit	3765	
			Examiner Name	n/a	
			Attorney Docket Number	D8114-00369	

U.S. PATENT DOCUMENTS					
Examiner Initials	Cite No.	Document Number	Publication Date MM-DD-YYYY	Name of Patentee or Applicant of Cited Document	Pages, Columns, Lines, Where Relevant Passages or Relevant Figures Appear
		Number-Kind Code (If known)			
	A	US2004/0210987	10/28/2004	Carney	

FOREIGN PATENT DOCUMENTS						
Examiner Initials	Cite No.	Foreign Patent Document	Publication Date MM-DD-YYY	Name of Patentee or Applicant of Cited Document	Pages, Columns, Lines Where Relevant Passages or Figures Appear	T
		Country Code - Number - Kind Code (if known)				

OTHER PRIOR ART - NON PATENT LITERATURE DOCUMENTS			
Examiner Initials	Cite No.	Include name of the author (in CAPITAL LETTERS), title of the article (when appropriate), title of the item (book, magazine, journal, serial, symposium, catalog, etc.), date, page(s), volume-issue number(s), publisher city and/or country where published	T

Examiner Signature	/Gloria Hale/	Date Considered	12/21/2009
--------------------	---------------	-----------------	------------

*Examiner: Initial if reference considered, whether or not citation is in conformance with MPEP 609. Draw line through citation if not in conformance and not considered. Include copy of this form with next communication to applicant.
DM2\1722398.1

IN THE UNITED STATES PATENT AND TRADEMARK OFFICE

In Re Application of: Hendrickson, Lisa

Confirmation No: 1512

Serial No. 11/756,242

Group Art Unit: 3727

Filed: May 31, 2007

Examiner: n/a

For: Belly Covering Garment

M.S. Amendment
Commissioner for Patents
P.O. Box 1450
Alexandria, VA 22313-1450

Dear Sir:

INFORMATION DISCLOSURE STATEMENT TRANSMITTAL LETTER

Enclosed herewith is an Information Disclosure Statement pursuant to 37 CFR. § 1.56 in connection with the above-identified application, which statement is being filed:

Together with the present application.

Before the first Office Action on the merits or three (3) months from the filing date of this application, whichever occurs last. **[37 CFR § 1.97(b)]**

After the first Office Action on the merits, but before a Final Office Action under §1.113 or Notice of Allowance under §1.311, whichever occurs first. **[37 CFR §1.97(c)].** *(Either the fee or certification is provided, as set forth below).*

After a Final Office Action under §1.113 or Notice of Allowance under §1.311, but prior to or with payment of the Issue Fee. **[37 CFR §1.97(d)].** *The fee and certification are provided, as set forth below).*

Consistent with Applicant's obligations pursuant to 37 CFR §§1.97 and 1.98, the following requirements have been met:

No separate requirements are needed.

No additional fee is required.

Fee Under 37 CFR § 1.97(c) or 1.97(d)

The fee of \$180.00 for submission of an IDS under § 1.97(c) as set forth in § 1.17(p) accompanies this statement.

Please charge the fee of \$180.00 for submission of an IDS under § 1.97(c) or (d) as set forth in § 1.17(p) to Deposit Account 04-1679.

Certification Under 37 CFR § 1.97(e)

The undersigned certifies:

1 that each item of information contained in the information disclosure statement was first cited in a communication from a foreign patent office in a counterpart foreign application not more than three months prior to the filing of the information disclosure statement; or

2 that no item of information contained in the information disclosure statement was cited in a communication from a foreign patent office in a counterpart foreign application, and, to the knowledge of the person signing the statement after making reasonable inquiry, no item of information contained in the information disclosure statement was known to any individual designated in §1.56(c) more than three months prior to the filing of the information disclosure statement.

Provision of Copies of References

A copy of each of the Foreign and Other references listed on the attached Form PTO-1449 is enclosed herewith and forms a part hereof.

Partial Translations of References are enclosed herewith and form a part hereof.

A copy of the European Search Report from a corresponding or related EPO application is enclosed herewith.

A copy of the International Search Report from a corresponding or related PCT application is enclosed herewith.

Identification of Prior Application(s) In Which Listed Information Was Already Cited And For Which No Copies Are Submitted Or Need Be Submitted

[X] This application relies, under 35 U.S.C. § 120, on the earlier filing date of prior U.S. Application No(s). filed . Some or all of the references were submitted to, and/or cited by, the Office in the prior application(s) and therefore are not required to be provided in this application.

The Commissioner is hereby authorized to charge any fees associated with this communication or credit any overpayment to Deposit Account No. 04-1679.

Respectfully submitted,

Date: June 26, 2007



Gerald K. Kita
Registration No. 24,125

Customer No. 08933
DUANE MORRIS LLP
30 South 17th Street
Philadelphia, PA 19103-4196
215-979-1863 tel
215-979-1020 fax

SUBSTITUTE for form 1449A/PTO		Complete if Known	
INFORMATION DISCLOSURE STATEMENT BY APPLICANT (use as many sheets as necessary)		Application Number	11/756,242
		Filing Date	May 31, 2007
		First Named Inventor	Hendrickson, Lisa
		Art Unit	3765
		Examiner Name	n/a
Sheet	1 of 1	Attorney Docket Number	D8114-00369

U.S. PATENT DOCUMENTS						
Examiner Initials	Cite No.	Document Number		Publication Date MM-DD-YYYY	Name of Patentee or Applicant of Cited Document	Pages, Columns, Lines, Where Relevant Passages or Relevant Figures Appear
		Number-Kind Code (if known)				
	A	US2006/0010571		01/09/2006	Oakley	

FOREIGN PATENT DOCUMENTS							
Examiner Initials	Cite No.	Foreign Patent Document		Publication Date MM-DD-YYY	Name of Patentee or Applicant of Cited Document	Pages, Columns, Lines Where Relevant Passages or Figures Appear	T
		Country Code - Number - Kind Code (if known)					

OTHER PRIOR ART - NON PATENT LITERATURE DOCUMENTS			
Examiner Initials	Cite No.	Include name of the author (in CAPITAL LETTERS), title of the article (when appropriate), title of the item (book, magazine, journal, serial, symposium, catalog, etc.), date, page(s), volume-issue number(s), publisher city and/or country where published	T

Examiner Signature	/Gloria Hale/	Date Considered	12/21/2009
---------------------------	---------------	------------------------	------------

*Examiner: Initial if reference considered, whether or not citation is in conformance with MPEP 609. Draw line through citation if not in conformance and not considered. Include copy of this form with next communication to applicant.
DM2\1186338.1

SUBSTITUTE for form 1449A/PTO			Complete if Known	
			Application Number	11/756,242
INFORMATION DISCLOSURE STATEMENT BY APPLICANT (use as many sheets as necessary)			Filing Date	May 31, 2007
			First Named Inventor	Hendrickson, Lisa
			Art Unit	3765
			Examiner Name	n/a
			Attorney Docket Number	D8114-00369
Sheet	1	of	1	

U.S. PATENT DOCUMENTS						
Examiner Initials	Cite No.	Document Number		Publication Date MM-DD-YYYY	Name of Patentee or Applicant of Cited Document	Pages, Columns, Lines, Where Relevant Passages or Relevant Figures Appear
		Number-Kind Code (if known)				
	A	3,045,678		07/24/1962	Geimer	
	B	4,280,229		07/28/1981	Stein	
	C	4,506,390		03/26/1985	Stern	
	D	6,311,333		11/06/2001	Batra	
	E	US2004/021987		10/28/2004	Carney	
	F	US2006/0010571		01/19/2006	Oakley	

FOREIGN PATENT DOCUMENTS							
Examiner Initials	Cite No.	Foreign Patent Document		Publication Date MM-DD-YYY	Name of Patentee or Applicant of Cited Document	Pages, Columns, Lines Where Relevant Passages or Figures Appear	T
		Country Code - Number - Kind Code (if known)					

OTHER PRIOR ART - NON PATENT LITERATURE DOCUMENTS			
Examiner Initials	Cite No.	Include name of the author (in CAPITAL LETTERS), title of the article (when appropriate), title of the item (book, magazine, journal, serial, symposium, catalog, etc.), date, page(s), volume-issue number(s), publisher city and/or country where published	T
	G	International Search Report and Written Opinion dated 18 AUG 2008 in PCT/US2008/061739 (D8114-00486)	

Examiner Signature	/Gloria Hale/	Date Considered	12/21/2009
--------------------	---------------	-----------------	------------

*Examiner: Initial if reference considered, whether or not citation is in conformance with MPEP 609. Draw line through citation if not in conformance and not considered. Include copy of this form with next communication to applicant.
DM2\1576453.1

Search Notes 	Application/Control No. 11756242	Applicant(s)/Patent Under Reexamination HENDRICKSON ET AL.
	Examiner Gloria Hale	Art Unit 3765

SEARCHED			
Class	Subclass	Date	Examiner
2	69,228,227,238,236,237,211,212,214	12-15-09	gh
450	155,96-100		

SEARCH NOTES		
Search Notes	Date	Examiner
INV NAME SRCH;IDS FLAG CLRED	12-19-09	gh

INTERFERENCE SEARCH			
Class	Subclass	Date	Examiner

	/Gloria Hale/ Primary Examiner.Art Unit 3765
--	---

Index of Claims 	Application/Control No. 11756242	Applicant(s)/Patent Under Reexamination HENDRICKSON ET AL.
	Examiner Gloria Hale	Art Unit 3765

✓	Rejected
=	Allowed

-	Cancelled
÷	Restricted

N	Non-Elected
I	Interference

A	Appeal
O	Objected

Claims renumbered in the same order as presented by applicant
 CPA
 T.D.
 R.1.47

CLAIM		DATE							
Final	Original	12/19/2009							
	1	✓							
	2	✓							
	3	✓							
	4	✓							
	5	✓							
	6	✓							
	7	✓							
	8	✓							
	9	✓							
	10	✓							
	11	✓							
	12	✓							
	13	✓							
	14	✓							
	15	✓							
	16	✓							
	17	✓							
	18	✓							
	19	✓							
	20	✓							
	21	✓							
	22	✓							
	23	✓							
	24	✓							
	25	✓							

Notice of References Cited	Application/Control No. 11/756,242	Applicant(s)/Patent Under Reexamination HENDRICKSON ET AL.	
	Examiner Gloria Hale	Art Unit 3765	Page 1 of 1

U.S. PATENT DOCUMENTS

*		Document Number Country Code-Number-Kind Code	Date MM-YYYY	Name	Classification
*	A	US-4,506,390	03-1985	Stern, Marilyn M.	2/221
*	B	US-6,311,333	11-2001	Batra, Sachin	2/237
*	C	US-3,045,678	07-1962	GEIMER CORNELIUS J	450/130
*	D	US-4,280,229	07-1981	Stein, Paul	2/221
	E	US-			
	F	US-			
	G	US-			
	H	US-			
	I	US-			
	J	US-			
	K	US-			
	L	US-			
	M	US-			

FOREIGN PATENT DOCUMENTS

*		Document Number Country Code-Number-Kind Code	Date MM-YYYY	Country	Name	Classification
	N					
	O					
	P					
	Q					
	R					
	S					
	T					

NON-PATENT DOCUMENTS

*		Include as applicable: Author, Title Date, Publisher, Edition or Volume, Pertinent Pages)
	U	
	V	
	W	
	X	

*A copy of this reference is not being furnished with this Office action. (See MPEP § 707.05(a).)
Dates in MM-YYYY format are publication dates. Classifications may be US or foreign.



UNITED STATES PATENT AND TRADEMARK OFFICE

UNITED STATES DEPARTMENT OF COMMERCE
United States Patent and Trademark Office
Address: COMMISSIONER FOR PATENTS
P.O. Box 1450
Alexandria, Virginia 22313-1450
www.uspto.gov

Table with 5 columns: APPLICATION NO., FILING DATE, FIRST NAMED INVENTOR, ATTORNEY DOCKET NO., CONFIRMATION NO.
11/756,242 05/31/2007 LISA A. HENDRICKSON 043174-014000 1512

22204 7590 12/30/2009
NIXON PEABODY, LLP
401 9TH STREET, NW
SUITE 900
WASHINGTON, DC 20004-2128

EXAMINER

HALE, GLORIA M

ART UNIT PAPER NUMBER

3765

MAIL DATE DELIVERY MODE

12/30/2009

PAPER

Please find below and/or attached an Office communication concerning this application or proceeding.

The time period for reply, if any, is set in the attached communication.

Office Action Summary	Application No.	Applicant(s)	
	11/756,242	HENDRICKSON ET AL.	
	Examiner	Art Unit	
	Gloria Hale	3765	

-- The MAILING DATE of this communication appears on the cover sheet with the correspondence address --

Period for Reply

A SHORTENED STATUTORY PERIOD FOR REPLY IS SET TO EXPIRE 3 MONTH(S) OR THIRTY (30) DAYS, WHICHEVER IS LONGER, FROM THE MAILING DATE OF THIS COMMUNICATION.

- Extensions of time may be available under the provisions of 37 CFR 1.136(a). In no event, however, may a reply be timely filed after SIX (6) MONTHS from the mailing date of this communication.
- If NO period for reply is specified above, the maximum statutory period will apply and will expire SIX (6) MONTHS from the mailing date of this communication.
- Failure to reply within the set or extended period for reply will, by statute, cause the application to become ABANDONED (35 U.S.C. § 133). Any reply received by the Office later than three months after the mailing date of this communication, even if timely filed, may reduce any earned patent term adjustment. See 37 CFR 1.704(b).

Status

- 1) Responsive to communication(s) filed on ____.
- 2a) This action is **FINAL**. 2b) This action is non-final.
- 3) Since this application is in condition for allowance except for formal matters, prosecution as to the merits is closed in accordance with the practice under *Ex parte Quayle*, 1935 C.D. 11, 453 O.G. 213.

Disposition of Claims

- 4) Claim(s) 1-25 is/are pending in the application.
4a) Of the above claim(s) ____ is/are withdrawn from consideration.
- 5) Claim(s) ____ is/are allowed.
- 6) Claim(s) 1-25 is/are rejected.
- 7) Claim(s) ____ is/are objected to.
- 8) Claim(s) ____ are subject to restriction and/or election requirement.

Application Papers

- 9) The specification is objected to by the Examiner.
- 10) The drawing(s) filed on 31 May 2007 is/are: a) accepted or b) objected to by the Examiner.
Applicant may not request that any objection to the drawing(s) be held in abeyance. See 37 CFR 1.85(a).
Replacement drawing sheet(s) including the correction is required if the drawing(s) is objected to. See 37 CFR 1.121(d).
- 11) The oath or declaration is objected to by the Examiner. Note the attached Office Action or form PTO-152.

Priority under 35 U.S.C. § 119

- 12) Acknowledgment is made of a claim for foreign priority under 35 U.S.C. § 119(a)-(d) or (f).
a) All b) Some * c) None of:
1. Certified copies of the priority documents have been received.
2. Certified copies of the priority documents have been received in Application No. ____.
3. Copies of the certified copies of the priority documents have been received in this National Stage application from the International Bureau (PCT Rule 17.2(a)).

* See the attached detailed Office action for a list of the certified copies not received.

Attachment(s)

- | | |
|---|---|
| 1) <input checked="" type="checkbox"/> Notice of References Cited (PTO-892) | 4) <input type="checkbox"/> Interview Summary (PTO-413)
Paper No(s)/Mail Date. ____. |
| 2) <input type="checkbox"/> Notice of Draftperson's Patent Drawing Review (PTO-948) | 5) <input type="checkbox"/> Notice of Informal Patent Application |
| 3) <input checked="" type="checkbox"/> Information Disclosure Statement(s) (PTO/SB/08)
Paper No(s)/Mail Date <u>See Continuation Sheet</u> . | 6) <input type="checkbox"/> Other: ____. |

Continuation of Attachment(s) 3). Information Disclosure Statement(s) (PTO/SB/08), Paper No(s)/Mail Date :2-5-09&3-6-09;9-18-08,7-29-08,2-26-08; and 6-26-07.

DETAILED ACTION

Claim Rejections - 35 USC § 102

The following is a quotation of the appropriate paragraphs of 35 U.S.C. 102 that form the basis for the rejections under this section made in this Office action:

A person shall be entitled to a patent unless –

(b) the invention was patented or described in a printed publication in this or a foreign country or in public use or on sale in this country, more than one year prior to the date of application for patent in the United States.

Claims 1, 11,16-20 and 25 are rejected under 35 U.S.C. 102(b) as being anticipated by Stern (US 4,506,390).

Stern discloses a garment comprising an upper portion having a belly panel (as seen in figure 1, ref. 11) wherein the belly panel is expandable (see col. 3,lines 30-31) wherein the waistband portion 1 is radially expandable to cover and fit over the growing abdomen (See figure 2, 19) and a garment lower portion 13 in figure 1 having a torso encircling circumference as seen in figure 1- the unnumbered waistline of body portion 13 wherein the torso encircling circumference recedes downwardly as seen in figures 1 and 2, unnumbered intersection of waist portion 11 and body portion 13, to make way for the expansion of the belly panel. Stern discloses the garment wherein the belly panel, figure 1, waist portion 11 is contractible elastically to cover a shrinking abdomen(See figures 1 and 2, waist portion 11 and pocket 19, col. 4,lines 28-30 in regard to the automatic contraction of 11. Stern also discloses the garment with a garment upper portion as seen in figure 1 waist portion 11 having the belly panel which is foldable toward the garment lower portion to comprise a folded band.(See figure 4, top hem stitching 15; col. 3,lines 34-36 in regard to the hem being formed along a top

Art Unit: 3765

edge by folding the top edge and stitching along line 15. Stern further discloses the garment with the belly panel of figure 1, 11 as being woven or knitted with elastic, stretchable strands(See col. 4,lines 45-47) in regard to the elastically woven or knitted material. Stern discloses the garment with the garment upper portion having a further torso encircling circumference as seen in figure 1, unnumbered waist portion 11 to hold the garment up and in place over the torso. Stern also discloses the garment wherein atop edge margin of the garment upper portion is folded over and sewn or knitted to an inside of the fabric, figure 4, top hem stitching, 15 in col. 3,lines 34-36 wherein the hem is formed along a top edge by folding over the top edge and stitching it.

Claim Rejections - 35 USC § 103

The following is a quotation of 35 U.S.C. 103(a) which forms the basis for all obviousness rejections set forth in this Office action:

(a) A patent may not be obtained though the invention is not identically disclosed or described as set forth in section 102 of this title, if the differences between the subject matter sought to be patented and the prior art are such that the subject matter as a whole would have been obvious at the time the invention was made to a person having ordinary skill in the art to which said subject matter pertains. Patentability shall not be negated by the manner in which the invention was made.

Claims 3 and 4 are rejected under 35 U.S.C. 103(a) as being unpatentable over Stern in view of Carney (US 2004/0210987 A1)

Stern discloses the garment as claimed in claim 1 in addition to an expandable upper portion as seen in figure 1, waist portion 11;col. 3,lines 30-31 regarding the waistband portion as being radially expandable wherein the garment upper portion is an expandable tubular upper portion as seen in figure 3, 11 which is around the waist of the user and is tubular. Stern does not disclose the upper portion as being seamless to fit comfortably while worn. Carney

Art Unit: 3765

teaches a garment upper portion which is an expandable (See Abstract-elastic band) tubular (figure 1, garment band 10, Abstract in regard to tube top) upper portion that is seamless (para.29) in regard to the garment may be seamless to fit comfortably while being worn. Accordingly, it would have been obvious to one having ordinary skill in the art at the time the invention was made to modify the expandable waist portion to construct it in an expandable tubular and seamless design to fit comfortably while worn as taught by Carney with the system of Stern in order to eliminate seams which may dig in a cause discomfort to the user.

Claims 21-24 are rejected under 35 U.S.C. 103(a) as being unpatentable over Stern in view of Oakley (US 2006/0010571).

Stern discloses the invention substantially as claimed except for the double layer tubular structure. Oakley teaches a double layer structure (Fig.1C, lower component 110, where lower component 110 has an inner surface and an outer surface, forming a double layer structure of two different materials. See the Abstract in regard to the lower component as having an outer surface and an inner surface. Para.0013 in regard to the knit inside fabric stretches more than the stretch woven outer fabric to accommodate a growing stomach. It would have been obvious to one having ordinary skill in the art at the time the invention was made to modify the garment of Stern with the teaching of Oakley to provide the double layer structure as taught by Oakley in order to slightly increase the tension on the body of the user providing additional support thereto.

Art Unit: 3765

.Claims 6 and 12 are rejected under 35 U.S.C. 103(a) as being unpatentable over Stern in view of Batra (US 6311333)

Stern discloses the invention substantially as claimed except for the garment lower portion has having a partial waistband(fig. 2,yoke 21) extending from the side seams(30,31;fig.1 and col. 2,lines 47-50) of the garment lower portion and extending across the back side of the garment lower portion.(figure 2). Batra teaches wherein the garment lower portion has a partial waistband extending from side seams of the garment lower portion and extending across a back side of the garment lower portion. . Accordingly it would have been obvious to one having ordinary skill in the art at the time the invention was made to further provide wherein the garment lower portion has a partial waistband extending from the side seams of the garment lower portion and extending across a back side of the garment lower portion as taught by Batra with the system of Stern in order to provide additional support for the back.

Claims 7-10,13,14 and 15 are rejected under 35 U.S.C. 103(a) as being unpatentable over Stern in view of Geimer (US 3045678).

Stern discloses the garment substantially as claimed except for the series of belly cradling stitches or knitted tension in the belly panel or in the back panel for further support to the wearer during various stages of pregnancy to provide more or less support to the wearer during different stages. Geimer teaches a series of belly cradling stitches or knitted tension in the belly panel to cradle a growing abdomen during various stages of pregnancy(See figure 2, panel 20;col.

Art Unit: 3765

1,lines 25-28 regarding shirred elastic material of panel 20 to ensure the desired comfort and adequate support. It would have been obvious to one having ordinary skill in the art at the time the invention was made to modify the panel to include the belly cradling stitches or knitted tension in the belly panel to cradle a growing abdomen and to include such support stitches in the back panel along the spine to add more support to the wearer as taught by Geimer within the garment of Stern in order to provide additional support and comfort to the wearer.

Conclusion

The prior art made of record and not relied upon is considered pertinent to applicant's disclosure.

Any inquiry concerning this communication or earlier communications from the examiner should be directed to Gloria Hale whose telephone number is 571-272-4984. The examiner can normally be reached on Mon.-Thurs.,...

If attempts to reach the examiner by telephone are unsuccessful, the examiner's supervisor, Gary Welch can be reached on 571-272-4996. The fax phone number for the organization where this application or proceeding is assigned is 571-273-8300.

Art Unit: 3765

Information regarding the status of an application may be obtained from the Patent Application Information Retrieval (PAIR) system. Status information for published applications may be obtained from either Private PAIR or Public PAIR. Status information for unpublished applications is available through Private PAIR only. For more information about the PAIR system, see <http://pair-direct.uspto.gov>. Should you have questions on access to the Private PAIR system, contact the Electronic Business Center (EBC) at 866-217-9197 (toll-free). If you would like assistance from a USPTO Customer Service Representative or access to the automated information system, call 800-786-9199 (IN USA OR CANADA) or 571-272-1000.

/Gloria Hale/
Primary Examiner, Art Unit 3765

IN THE UNITED STATES PATENT AND TRADEMARK OFFICE

In re Patent Application of:) Confirmation No.: 1512
Lisa HENDRICKSON, et al.) Group Art Unit: 3765
Serial No. 11/756,242) Examiner: Hale, Gloria M.
Filed: May 31, 2007)
For: BELLY COVERING GARMENT) Date: March 9, 2010
)

AMENDMENT

Mail Stop Amendment
Commissioner for Patents
P.O. Box 1450
Alexandria, VA 22313-1450

Sir:

In response to the Office Action mailed December 30, 2009, Applicants respectfully request reconsideration and allowance of the above-identified application in view of the following remarks.

Amendments to the Claims begins on page 2 of this paper.

Remarks begin on page 6 of this paper.

Amendments to the Claims:

1. (Previously Presented) A garment, comprising:
a garment upper portion having a belly panel that is expansible to cover and fit over a growing abdomen during different stages of pregnancy;
a garment lower portion having a first torso encircling circumference that recedes downward to make way for expansion of the belly panel; and
the garment upper portion having a second torso encircling circumference along the upper end of the belly panel above a location of maximum girth of the abdomen to hold the garment up and in place over the torso.
2. (Previously Presented) The garment of claim 1, wherein the second torso encircling circumference is adjustable in girth in conformance with different body types.
3. (Previously Presented) The garment of claim 1, wherein the garment upper portion comprises a seamless tubular structure that fits comfortably while being worn, and the belly panel comprises an expansible portion of the tubular structure.
4. (Original) The garment of claim 1, wherein the garment upper portion comprises a seamless tubular elastic fabric to stretch elastically.
5. (Original) The garment of claim 1, wherein the garment upper portion comprises an elastic fabric that is contractible elastically to cover an abdomen during different stages of postpartum body changes.
6. (Previously Presented) The garment of claim 1, wherein the garment lower portion has a partial waistband extending from side seams of the garment lower portion and extending across a back side of the garment lower portion where the partial waistband widens above a wearer's pelvis.

7. (Original) The garment of claim 1, further comprising a series of belly cradling stitches or knitted tension in the belly panel, wherein the knitted tension or stitches extend along multiple paths arranged in an elliptical pattern that curves, so as to cradle a curved growing abdomen during various stages of pregnancy.

8. (Original) The garment of claim 1, further comprising a series of stitches or knitted tension in the backside of the garment upper portion to provide spinal and back support against the wearer of the garment.

9. (Original) The garment of claim 8, wherein the series of stitches or knitted tension in the backside of the garment upper portion extends along a pattern of multiple stitch paths.

10. (Canceled)

11. (Previously Presented) The garment of claim 1, wherein the garment upper portion is foldable toward the garment lower portion to comprise a folded band on the garment lower portion.

12. (Previously Presented) The garment of claim 1, wherein the garment lower portion has a partial waistband extending from side seams of the garment lower portion wherein the partial waistband tapers toward the side seams and widens above a wearer's pelvis across a back side of the garment lower portion.

13. (Previously Presented) The garment of claim 1, comprising:
knitted tension in the backside of the garment upper portion providing spinal column and back support for a wearer of the garment.

14. (Previously Presented) The garment of claim 1, comprising:
a series of sewn supporting stitches in the backside of the garment upper portion providing spinal column and back support for a wearer of the garment.

15. (Previously Presented) The garment of claim 1, comprising:
a series of sewn supporting stitches in the backside of the garment upper portion providing spinal column and back support for a wearer of the garment, wherein the stitches are arranged along multiple stitch paths grouped in a hyperbolic pattern, a curved pattern or a truncated, v-shaped pattern along an axis extending substantially vertically along a spinal supporting section of the fabric.
16. (Previously Presented) The garment of claim 1, wherein an edge margin of the garment upper portion is folded over and knitted to an inside of the fabric to provide a perimeter hem stitch.
17. (Previously Presented) The garment of claim 1, wherein an edge margin of the garment upper portion is folded over and sewn or knitted to an inside of the fabric to provide a perimeter hem stitch.
18. (Previously Presented) The garment of claim 1, wherein the second torso encircling circumference comprises stretchable fabric to adjust the girth in conformance with different body types.
19. (Previously Presented) The garment of claim 1, wherein the garment upper portion is a tubular structure, wherein the tubular structure is shaped and formed as a hyperboloid cylinder to fit a body type having a tapered torso.
20. (Previously Presented) The garment of claim 1, wherein the garment upper portion is a tubular structure, wherein the tubular structure is shaped and formed as a straight sided cylinder to fit a body type having a corresponding shaped torso.

21. (Previously Presented) The garment of claim 1, wherein the garment upper portion comprises a double layer tubular structure, and an inner layer of stretchable fabric between two layers of the double-layer tubular structure.
22. (Previously Presented) The garment of claim 1, wherein the garment upper portion comprises a fabric, and the fabric is doubled back on itself downward to form a double-layer tubular structure that extends downward for at least a portion of the garment upper portion, and the layers of the double-layer tubular structure are sewn together with a tubular perimeter drop stitch.
23. (Previously Presented) The garment of claim 1, wherein the garment upper portion comprises a fabric doubled back on itself downward to form a double-layer tubular structure that extends downward for at least a portion of the garment upper portion, the layers of the double-layer tubular structure are sewn together with a tubular perimeter drop stitch, and an edge margin of the garment upper portion is knitted to an inside of the fabric to provide a perimeter hem stitch.
24. (Previously Presented) The garment of claim 3, wherein the seamless tubular structure comprises a fabric doubled back on itself downward to form a double-layer tubular structure that extends downward for at least a portion of the garment upper portion, the layers of the double-layer tubular structure are sewn together with a tubular perimeter drop stitch, and an edge margin of the garment upper portion is folded over and sewn or knitted to an inside of the fabric to provide a perimeter hem stitch.
25. (Previously Presented) The garment of claim 1, wherein the garment upper portion is foldable toward the garment lower portion to provide a folded band on the garment lower portion to be worn as a garment bottom having no top.

REMARKS

Claims 1-25 were pending in this application prior to the Office Action. By this amendment, claim 10 has been canceled to correct an inadvertent duplication of claim 9. Thus, claims 1-9 and 11-25 are now pending. In view of the following remarks, Applicants respectfully request reconsideration and allowance of the present application.

A. Claim Rejections Under 35 U.S.C. § 102

Claims 1, 2, 5, 11, 16-20 and 25 stand rejected under 35 U.S.C. § 102(b) as being anticipated by U.S. Pat. No. 4,506,390 to Stern (“Stern”). In view of the comments below, Applicants respectfully request reconsideration and withdrawal of this rejection because Stern fails to teach, disclose, or suggest each and every feature recited in the claims.

Independent claim 1 of the present invention requires, “the garment upper portion having a second torso encircling circumference along the upper end of the belly panel above a location of maximum girth of the abdomen to hold the garment up and in place over the torso” (underline emphasis added). Applicants respectfully draw the Examiner’s attention to Exhibit A of the Preliminary Amendment submitted on November 3, 2008, which was copied from the website, <http://www.motherhood.com> on September 11, 2008. Exhibit A shows photographed garments commercially available from the Assignee of the present application. The photographed garments incorporate the features recited in claim 1, including positioning of the second torso encircling circumference extending above a location of maximum girth, and demonstrate an exemplary garment of claim 1 on photographed persons.

Unlike the present application, Stern relates to a maternity garment with an expandable waistband portion arranged to prevent fold-over or ruffling of the upper edge of the garment. See Stern, col. 2, lines 66-68. The waistband portion is constructed to form a pouch which “cups and supports the lower part of a woman’s stomach,” and is “width-wise expandable and contractable, but not vertically expandable” (underline emphasis added). See Stern, col. 2, lines 50-57. Further, “[t]he cup-like action of the pouch permits the body of the garment to always hang [...] below the bulge of the stomach, close to the legs” and “[maintain] an even horizontal

hem level with no hike-up in the front” (underline emphasis added). See Stern, col. 4, lines 37-44.

Thus, the waistband of Stern that covers only a lower portion of the stomach cannot physically be expanded to extend further vertically, for example, onto an upper portion of a distended abdomen above a location of maximum girth. In fact, the disclosure of Stern teaches away from a circumference positioned above a location of maximum girth of the abdomen, as required by claim 1 of the Applicants’ invention.

For at least the above reasons, Stern fails to disclose each and every feature recited in independent claim 1, as is required for a proper rejection under 35 U.S.C. § 102. Accordingly, Applicants respectfully request reconsideration and withdrawal of the rejection of claim 1. Dependent claims 2, 5, 11, 16-20 and 25 are also believed to be patentable at least for the reasons discussed above with respect to claim 1 by virtue of their dependency thereon, and also on their own merits.

Furthermore, with respect to dependent claim 25, the present invention requires a “garment upper portion [that] is foldable toward the garment lower portion to provide a folded band on the garment lower portion to be worn as a garment bottom having no top.” See Application Publication, FIG. 7. Stern neither discloses a garment lower portion that can be worn as a garment bottom having no top, nor foldable upper portion. In fact, Stern teaches away from this limitation, providing that “[t]he stitching of the elastically shirred waistband portion is arranged to prevent fold-over or ruffling of the upper edge of the garment” (underline emphasis added). See Stern, col. 2, lines 66-68. As a result, Stern neither anticipates nor renders obvious the subject matter of claim 25.

B. Claim Rejections Under 35 U.S.C. § 103

Claims 3 and 4 stand rejected under 35 U.S.C. § 103(a) over Stern in view of US 2004/0210987 to Carney (“Carney”). Carney fails to overcome the above-stated deficiencies of Stern. Furthermore, Carney discloses a band garment, which is a stretchable band that engages over the top of a woman’s skirt or pants in the opened position, and is not attached to the skirt or

pants. See Carney, paragraph [0032], and Carney, FIG. 4. This “stretchable band” of Carney has an entirely different purpose and principle of operation than that of the claimed invention, which has a second torso encircling element attached to the garment lower portion and used to hold a garment lower portion up and in place over the torso.

Claims 21-24 stand rejected under 35 U.S.C. § 103(a) over Stern in view of US 2006/0010571 to Oakley (“Oakley”). Oakley also fails to overcome the above-stated deficiencies of Stern. For example, Oakley discloses and claims a double waistband component having a lower, non-elastic portion and an upper elastic portion. See Oakley, paragraph [0007]. Further, Oakley provides that “a five or six-inch portion 112 may rise too high.” See Oakley, paragraph [0008]. This portion is too short to encompass the claimed invention, whose second torso encircling circumference along the upper end of the belly panel rises above a location of maximum girth of the abdomen. In fact, Oakley teaches away from this feature of the claimed invention.

With respect to claim 21, the claimed invention requires that “the garment upper portion comprises a double layer tubular structure, and an inner layer of stretchable fabric between two layers of the double-layer tubular structure” (underline emphasis added). On the other hand, the double-layer structure of Oakley comprises only an inner surface and an outer surface, with no layer in between. See Oakley, FIG. 1C.

Claims 6 and 12 stand rejected under 35 U.S.C. § 103(a) over Stern in view of US 6,311,333 to Batra (“Batra”). Claims 6 and 12 recite an alternative embodiment of the invention wherein, with respect to claim 6, the waistband tapers toward the side seams and widens across the back side, and has a center seam to shape the waist band with a curvature above the wearer’s pelvis, and for torso coverage especially when sitting or bending. See Application Publication, paragraph [0019]. On the other hand, Batra teaches that “[d]irectly below the rear portion 16 of waistband 12 is the yoke area 21 of the pant seat which is slight triangular in shape.” See Batra, col. 12, lines 61-63. Thus, Batra discloses that the yoke area is below the waistband and is part of the pants seat (below the pelvis), which does not encompass a waistband with curvature above the wearer’s pelvis, as required by claims 6 and 12. See, for example, Batra, FIG. 3.

Claims 7-10 and 13-15 are rejected under 35 U.S.C. § 103(a) over Stern in view of US 3,045,678 to Geimer (“Geimer”). Geimer also fails to overcome the above-stated deficiencies of Stern. Claim 7 of the present application recites an alternative embodiment of the invention in which belly cradling stitches or knitting extends along multiple paths arranged in an elliptical pattern that curves. Geimer, on the other hand, discloses a girdle with garter loops, which is not suitable for being combined with a garment lower portion such as denim jeans. Three panels are stitched together to provide stretchability in a longitudinal sense. See Geimer, col. 2, lines 49-56. However, this longitudinal sense described by Geimer does not encompass stitches in an elliptical pattern that curves.

Each of claims 8-10 and 13-15 recite a series of stitches and/or knitted tension in the backside of the garment upper portion. Claims 8 and 13-15 specify that the purpose of this feature is to provide spinal and back support for the wearer of the garment. Geimer provides little, if any, stitching features along the backside of the garment. See, for example, Geimer, FIG. 3, reference numeral 10. Instead, the stitching features of Geimer are concentrated about the lower front abdomen in order to provide support for the abdomen. See Geimer, col. 1, lines 12-15 and 40-43.

Furthermore, each of the dependent claims rejected rely upon independent claim 1, which recites a specific combination of features that distinguishes the invention from Stern. As discussed above, these claims are patentable over Stern, because Stern fails to teach, nor does it suggest, a garment comprising a garment upper portion having a second torso encircling circumference along the upper end of the belly panel above a location of maximum girth of the abdomen to hold the garment up and in place over the torso, as recited in claim 1. Therefore, Stern does not teach or suggest each and every element, limitation, and/or feature of independent claim 1 and, therefore, the dependencies thereon.

Applicants’ claimed invention also includes a difference in function and principle operation than Stern. Claim 1 recites “a second torso encircling circumference along the upper end of the belly panel above a location of maximum girth of the abdomen to hold the garment up and in place over the torso” (underline emphasis added). Stern recites no such function or operation.

See, for example, Stern, col. 2, lines 25-44. To negate obviousness under 35 U.S.C. § 103, *In re Horton* establishes a legal precedent that a structural limitation reciting a difference in function or a difference in operation from prior art is proper, and can be patentable. 151 F.2d 210, 67 USPQ 105 (1945). In other words, patentability of the claimed structural limitation can depend on the difference in function or the difference in operation from prior art.

Thus, for at least the above reasons, Stern and the above-mentioned references, taken alone or in combination, fail to disclose, suggest, or render obvious the invention recited in claims 3, 4, 6-10, 12-15, and 21-24, as is required for a proper rejection under 35 U.S.C. § 103(a). The rejection of claim 10 has been rendered moot by virtue of its cancelled herein. Accordingly, Applicants respectfully request reconsideration and withdrawal of this rejection.

C. Conclusion

In view of the foregoing, it is submitted that the present application is in condition for allowance and a notice to that effect is respectfully requested. If, however, the Examiner deems that any issue remains after considering this response, the Examiner is invited to contact the undersigned attorney to expedite the prosecution and engage in a joint effort to work out a mutually satisfactory solution.

Respectfully submitted,

NIXON PEABODY, LLP

/David L. May, Reg. No. 58,760/

David L. May

Reg. No. 58,760

NIXON PEABODY LLP
CUSTOMER NO.: 22204
401 9th Street, N.W., Suite 900
Washington, DC 20004
Tel: 202-585-8000
Fax: 202-585-8080

Electronic Acknowledgement Receipt

EFS ID:	7172274
Application Number:	11756242
International Application Number:	
Confirmation Number:	1512
Title of Invention:	BELLY COVERING GARMENT
First Named Inventor/Applicant Name:	LISA A. HENDRICKSON
Customer Number:	22204
Filer:	David Lee May/Amanda Baker
Filer Authorized By:	David Lee May
Attorney Docket Number:	043174-014000
Receipt Date:	09-MAR-2010
Filing Date:	31-MAY-2007
Time Stamp:	15:51:54
Application Type:	Utility under 35 USC 111(a)

Payment information:

Submitted with Payment	no
------------------------	----

File Listing:

Document Number	Document Description	File Name	File Size(Bytes)/ Message Digest	Multi Part /.zip	Pages (if appl.)
1		014000_Response_to_OA.pdf	51231 cb1293fd9d7436ef5be514d0be268b2e9ed e60fb	yes	10

Multipart Description/PDF files in .zip description			
Document Description		Start	End
Amendment/Req. Reconsideration-After Non-Final Reject		1	1
Claims		2	5
Applicant Arguments/Remarks Made in an Amendment		6	10

Warnings:

Information:

Total Files Size (in bytes):

51231

This Acknowledgement Receipt evidences receipt on the noted date by the USPTO of the indicated documents, characterized by the applicant, and including page counts, where applicable. It serves as evidence of receipt similar to a Post Card, as described in MPEP 503.

New Applications Under 35 U.S.C. 111

If a new application is being filed and the application includes the necessary components for a filing date (see 37 CFR 1.53(b)-(d) and MPEP 506), a Filing Receipt (37 CFR 1.54) will be issued in due course and the date shown on this Acknowledgement Receipt will establish the filing date of the application.

National Stage of an International Application under 35 U.S.C. 371

If a timely submission to enter the national stage of an international application is compliant with the conditions of 35 U.S.C. 371 and other applicable requirements a Form PCT/DO/EO/903 indicating acceptance of the application as a national stage submission under 35 U.S.C. 371 will be issued in addition to the Filing Receipt, in due course.

New International Application Filed with the USPTO as a Receiving Office

If a new international application is being filed and the international application includes the necessary components for an international filing date (see PCT Article 11 and MPEP 1810), a Notification of the International Application Number and of the International Filing Date (Form PCT/RO/105) will be issued in due course, subject to prescriptions concerning national security, and the date shown on this Acknowledgement Receipt will establish the international filing date of the application.

Under the Paperwork Reduction Act of 1995, no persons are required to respond to a collection of information unless it displays a valid OMB control number.

PATENT APPLICATION FEE DETERMINATION RECORD Substitute for Form PTO-875	Application or Docket Number 11/756,242	Filing Date 05/31/2007	<input type="checkbox"/> To be Mailed
---	---	----------------------------------	---------------------------------------

APPLICATION AS FILED – PART I			OTHER THAN SMALL ENTITY				
(Column 1)		(Column 2)	SMALL ENTITY <input type="checkbox"/>		OR	SMALL ENTITY	
FOR	NUMBER FILED	NUMBER EXTRA	RATE (\$)	FEE (\$)		RATE (\$)	FEE (\$)
<input type="checkbox"/> BASIC FEE <small>(37 CFR 1.16(a), (b), or (c))</small>	N/A	N/A	N/A		OR	N/A	
<input type="checkbox"/> SEARCH FEE <small>(37 CFR 1.16(k), (l), or (m))</small>	N/A	N/A	N/A			N/A	
<input type="checkbox"/> EXAMINATION FEE <small>(37 CFR 1.16(o), (p), or (q))</small>	N/A	N/A	N/A			N/A	
TOTAL CLAIMS <small>(37 CFR 1.16(i))</small>	minus 20 =	*	X \$ =			X \$ =	
INDEPENDENT CLAIMS <small>(37 CFR 1.16(h))</small>	minus 3 =	*	X \$ =			X \$ =	
<input type="checkbox"/> APPLICATION SIZE FEE <small>(37 CFR 1.16(s))</small>	If the specification and drawings exceed 100 sheets of paper, the application size fee due is \$250 (\$125 for small entity) for each additional 50 sheets or fraction thereof. See 35 U.S.C. 41(a)(1)(G) and 37 CFR 1.16(s).						
<input type="checkbox"/> MULTIPLE DEPENDENT CLAIM PRESENT <small>(37 CFR 1.16(j))</small>							
* If the difference in column 1 is less than zero, enter "0" in column 2.			TOTAL			TOTAL	

APPLICATION AS AMENDED – PART II					OTHER THAN SMALL ENTITY				
(Column 1)		(Column 2)	(Column 3)		SMALL ENTITY		OR	SMALL ENTITY	
AMENDMENT	03/09/2010	CLAIMS REMAINING AFTER AMENDMENT	HIGHEST NUMBER PREVIOUSLY PAID FOR	PRESENT EXTRA	RATE (\$)	ADDITIONAL FEE (\$)		RATE (\$)	ADDITIONAL FEE (\$)
	Total <small>(37 CFR 1.16(i))</small>	* 24	Minus	** 25 = 0	X \$ =		OR	X \$52=	0
	Independent <small>(37 CFR 1.16(h))</small>	* 1	Minus	***3 = 0	X \$ =		OR	X \$220=	0
	<input type="checkbox"/> Application Size Fee <small>(37 CFR 1.16(s))</small>								
	<input type="checkbox"/> FIRST PRESENTATION OF MULTIPLE DEPENDENT CLAIM <small>(37 CFR 1.16(j))</small>						OR		
					TOTAL ADD'L FEE		OR	TOTAL ADD'L FEE	0

APPLICATION AS AMENDED – PART II					OTHER THAN SMALL ENTITY				
(Column 1)		(Column 2)	(Column 3)		SMALL ENTITY		OR	SMALL ENTITY	
AMENDMENT	CLAIMS REMAINING AFTER AMENDMENT	HIGHEST NUMBER PREVIOUSLY PAID FOR	PRESENT EXTRA	RATE (\$)	ADDITIONAL FEE (\$)		RATE (\$)	ADDITIONAL FEE (\$)	
	Total <small>(37 CFR 1.16(i))</small>	*	Minus	** =	X \$ =		OR	X \$ =	
	Independent <small>(37 CFR 1.16(h))</small>	*	Minus	*** =	X \$ =		OR	X \$ =	
	<input type="checkbox"/> Application Size Fee <small>(37 CFR 1.16(s))</small>								
	<input type="checkbox"/> FIRST PRESENTATION OF MULTIPLE DEPENDENT CLAIM <small>(37 CFR 1.16(j))</small>						OR		
					TOTAL ADD'L FEE		OR	TOTAL ADD'L FEE	

* If the entry in column 1 is less than the entry in column 2, write "0" in column 3.
 ** If the "Highest Number Previously Paid For" IN THIS SPACE is less than 20, enter "20".
 *** If the "Highest Number Previously Paid For" IN THIS SPACE is less than 3, enter "3".
 The "Highest Number Previously Paid For" (Total or Independent) is the highest number found in the appropriate box in column 1.

Legal Instrument Examiner:
 /PATRICIA WARNER/

This collection of information is required by 37 CFR 1.16. The information is required to obtain or retain a benefit by the public which is to file (and by the USPTO to process) an application. Confidentiality is governed by 35 U.S.C. 122 and 37 CFR 1.14. This collection is estimated to take 12 minutes to complete, including gathering, preparing, and submitting the completed application form to the USPTO. Time will vary depending upon the individual case. Any comments on the amount of time you require to complete this form and/or suggestions for reducing this burden, should be sent to the Chief Information Officer, U.S. Patent and Trademark Office, U.S. Department of Commerce, P.O. Box 1450, Alexandria, VA 22313-1450. DO NOT SEND FEES OR COMPLETED FORMS TO THIS ADDRESS. **SEND TO: Commissioner for Patents, P.O. Box 1450, Alexandria, VA 22313-1450.**

If you need assistance in completing the form, call 1-800-PTO-9199 and select option 2.



UNITED STATES PATENT AND TRADEMARK OFFICE

UNITED STATES DEPARTMENT OF COMMERCE
United States Patent and Trademark Office
Address: COMMISSIONER FOR PATENTS
P.O. Box 1450
Alexandria, Virginia 22313-1450
www.uspto.gov

Table with 5 columns: APPLICATION NO., FILING DATE, FIRST NAMED INVENTOR, ATTORNEY DOCKET NO., CONFIRMATION NO.
11/756,242 05/31/2007 LISA A. HENDRICKSON 043174-014000 1512

22204 7590 06/08/2010
NIXON PEABODY, LLP
401 9TH STREET, NW
SUITE 900
WASHINGTON, DC 20004-2128

EXAMINER

HALE, GLORIA M

ART UNIT PAPER NUMBER

3765

MAIL DATE DELIVERY MODE

06/08/2010

PAPER

Please find below and/or attached an Office communication concerning this application or proceeding.

The time period for reply, if any, is set in the attached communication.

DETAILED ACTION

Claim Rejections - 35 USC § 103

The following is a quotation of 35 U.S.C. 103(a) which forms the basis for all obviousness rejections set forth in this Office action:

(a) A patent may not be obtained though the invention is not identically disclosed or described as set forth in section 102 of this title, if the differences between the subject matter sought to be patented and the prior art are such that the subject matter as a whole would have been obvious at the time the invention was made to a person having ordinary skill in the art to which said subject matter pertains. Patentability shall not be negated by the manner in which the invention was made.

Claims 1,11,16-20 and 25 are rejected under 35 U.S.C. 103(a) as being unpatentable over Stern (US 4,506,390)

Stern discloses a garment comprising an upper portion having a belly panel(as seen in figure 1, ref 11) wherein the belly panel is expandable (See col. 3,lines 30-31) wherein the waistband portion is radially expandable to cover and fit over the growing abdomen (See figure 2, 19) and a garment lower portion 13 in figure 1 having a torso encircling circumference as seen in figure 1- the unnumbered waistline of body portion 13 wherein the torso encircling circumference recedes downwardly as seen in figure 1 and 2, non- numbered intersection of waist portion 11 and body portion 13, to make way for the expansion of the belly panel. Stern discloses the garment wherein the belly panel, figure 1, waist portion 11 is contractible elastically to cover a shrinking abdomen(See figures 1 and 2, waist portion 11 and pocket 19, col. 4, lines 28-30 in regard to the automatic contraction of 11. Stern also discloses the garment with a garment upper portion as seen in figure 1 waist portion 11 having the belly panel which is foldable toward the garment lower portion to comprise a folded

Art Unit: 3765

band. (See figure 4, top hem stitching 15; col. 3, lines 34-36 in regard to the hem being formed along a top edge by folding the top edge and stitching along line 15. Stern further discloses the garment with the belly panel of figure 1, 11 as being woven or knitted with elastic, stretchable strands (See col 4, lines 45-47) in regard to the elastically woven or knitted material. The limitation that the upper edge of the waistband lies "above a location of maximum girth of the abdomen" is intended use and also subjective because this location is different on all wearers and the structure cannot be defined by this subjective functional limitation that is indefinite. Applicant needs to better define this location and state that the belly panel covers the "Entire" growing abdomen. Stern discloses the garment with the garment upper portion having a further torso encircling circumference as seen in figure 1, unnumbered waist portion 11 to hold the garment up and in place over the torso. Stern also discloses the garment wherein a top edge margin of the garment upper portion is folded over and sewn or knitted to an inside of the fabric, figure 4, top hem stitching, 15 in col. 3, lines 34-36 wherein the hem is formed along a top edge by folding over the top edge and stitching it.

Claims 3 and 4 are rejected under 35 U.S.C. 103(a) as being unpatentable over Stern in view of Carney (US 2004/0210987 A1).

Stern discloses the garment as claimed in claim 1 in addition to an expandable upper portion as seen in figure 1, waist portion 11; col. 3, lines 30-31 regarding the waistband portion as being radially expandable wherein the

Art Unit: 3765

garment upper portion is expandable tubular upper portion as seen in figure 3, 11 which his around the waist of the user and is tubular. Stern doe snot disclose the upper portion as being seamless to fit comfortably while worn. Carney teaches a garment that is placed at a garment upper portion which is expandable and tubular and seamless (See Abstract- elastic band, figure 1 garment band 10 and the Abstract in regard to tube top) upper portion that is seamless(para. 29) in regard to the garment maybe seamless to fit comfortably while being worn. Accordingly it would have been obvious to one having ordinary skill in the art at the time the invention was made to modify the expandable waist portion to construct it in an expandable tubular and seamless design to fit comfortably while worn as taught by Carney with the system of Stern in order to eliminate seams which may dig in and cause discomfort to the user.

Claims 21-24 are rejected under 35 USC 103(a) as being unpatentable over Stern in view of Oakley (US 2006/0010571).

Stern discloses the invention substantially as claimed except fdoor the double layer tubular structure. Oakley teaches a double layer structure (Fig. 1C, lower component 110,where lower component 110 has an inner surface and an outer surface, forking a double layer structure of two different materials. See the Abstract in regard to the lower component as having an outer surface and an inner surface. See Para 13, in regard to the knit inside fabric as stretching more than the stretch woven outer fabric to accommodate a growing stomach. It would have been obvious to one

Art Unit: 3765

having ordinary skill in the art at the time the invention was made to modify the garment of Stern with the teaching of Oakley to provide the double layer structure as taught by Oakley in order to slightly increase the tension on the body of the user providing additional support thereto in addition to including within the two layers an elastic band to provide a better securement of the waistband onto the wearer. Such elastic bands within the two layers formed by one layer folded over to form two layers about the elastic is well known in the art of garment manufacturing and waistbands. Such garment waistband structures are well known in the art and not new.

Claims 6 and 12 are rejected under 35 USC 103(a) as being unpatentable over Stern in view of Batra (US 8311333).

Stern discloses the invention substantially as claimed except for the garment lower portion as having a partial waistband (Figure 2, yoke 21) extending from the side seams (30,31; fig. 1 and col. 2, lines 47-50) of the garment lower portion and extending across the back side of the garment lower portion (figure 2). Batra teaches wherein the garment lower portion has a partial waistband extending from side seams of the garment lower portion and extending across the back side of the garment lower portion above the pelvis. The waistband and the triangular portion are one piece and unitary and structured as seen in applicant's figures. Accordingly it would have been obvious to one having ordinary skill in the art at the time the invention was made to

Art Unit: 3765

modify the garment lower portion to include the partial waistband extending from the side seams of the garment lower portion and extending across the back side of the garment lower portion as taught by Batra with the system of Stern in order to provide additional support for the back.

Claims 7-9, 13,14 and 15 are rejected under 35 USC 103(a) as being unpatentable over Stern in view of Geimer (US 3045678)

Stern discloses the garment substantially as claimed except for the series of belly cradling stitches or knitted tension in the belly panel or in the back panel for further support to the wearer during various stages of pregnancy to provide more or less support to the wearer during various stages of pregnancy to provide more or less support to the wearer during different stages of Pregnancy. Geimer teaches a series of belly cradling stitches or knitted tension in the belly panel to cradle a growing abdomen during various stages of pregnancy. (See figure 2, panel 20; col. 1, lines 25-28 regarding shirred elastic material of panel 20 to ensure the desired comfort and adequate support. It would have been obvious to one having ordinary skill in the art at the time the invention was made to modify the panel to include the belly cradling having stitches or knitted tension in the belly panel to cradle a growing abdomen and to include such support stitches in the back panel along the spine or any other areas where support is needed since this method of adding such stitching is well known in the art to provide support areas to garments to add more support to the wearer as

Art Unit: 3765

taught by Geimer within the garment of Stern in order to provide additional support and comfort to the wearer.

Claim Rejections - 35 USC § 112

The following is a quotation of the second paragraph of 35 U.S.C. 112:

The specification shall conclude with one or more claims particularly pointing out and distinctly claiming the subject matter which the applicant regards as his invention.

Claims 1-9 and 11-25 are rejected under 35 U.S.C. 112, second paragraph, as being indefinite for failing to particularly point out and distinctly claim the subject matter which applicant regards as the invention.

In regard to claim 1, line 7 in regard to “ the belly panel above a location of maximum girth of the abdomen” is indefinite since this location would be different on each wearer and is a subjective limitation. The location needs to be defined in regard to the garment itself and not the wearer or the location needs to be defined in regard to the wearer according to a body location that would not be different on each wearer so that the location is clear and definite. Especially since this location is what defines and differentiates applicant’s invention from the prior art.

Response to Arguments

Applicant's arguments filed 3-9-10 have been fully considered but they are not persuasive.

Applicant’s invention needs to be better defined in claim 1 as stated above. The Stern structure includes the limitations of claim 1 and ‘depends on the size of the wearer. The area above the location of maximum girth is different

Art Unit: 3765

on each wearer and is intended use. Applicant has not clearly defined the invention in structural terms as sated above in regard to the rejection under 35 USC 112, para 2. Applicant is also only claiming a general garment and not their invention of a pant or skirt waistband portion. Claim 1 is too broad and the claim does not define that the belly panel is to fit over an entire pregnant abdomen of a wearer expanding vertically and circumferentially with the upper edge about the circumference of the wearer just between the breast area whereby the entire pregnant belly is covered. Applicant has argued that stern only cups the lower belly but applicant's claim did not define that the entire belly is covered as they are intending to argue in their remarks.

IN response to the remarks on page 6 of the response applicant is arguing in regard to the "maximum girth" as sated above but the structure has not been clearly claimed as sated above. IN regard to the statement on page 7 of the remarks that Stern prevents fold over and ruffling of the upper edge when a wearer is wearing the belly panel upright and not folded over this non-fold over is the unintentional rollover when the garment is worn with out being folded over. However, if the garment is intentionally worn with the upper perimeter folded over by the wearer, the structure will fold over and can be worn as such intentionally. The statements in Stern are in regard for unintentional foldover when a wearer does not intend to wear it folded over.

IN regard to the rejection of Carney, Carney is only relied upon for the seamless tubular structure and not that it is not attached to the garment. Carney

Art Unit: 3765

is used in the same fashion as an attached waistband and that function is not being relied upon. Carney is only relied upon for the seamless tubular structure and the modification of Stern to construct it in a seamless tubular fashion. The references are analogous art because they are worn at the waist and at the top of a pant garment.

Applicant is arguing parts of Carney that were not relied upon in the rejection.

Oakley is relied upon for the double layer construction. Such double layers constructions with elastic in between the layers are well known in elastic waistbands on pants and skirts and are obvious.

Batra includes the yoke area 21 that is integrally formed with the rear waistband and is part of waistband 116 and triangularly shaped and extending from the waistband. The Batra figures show the element above the pelvis.

Geimer is relied upon for the use of elastic support yarns in the configuration as claimed in the front of a garment and wherein such yarns can be utilized in any garment areas desired to provide the same support such as the back, side of garments etc. The provision of such elastic yarns in garments to provide support is well known such as in swimsuits and even in brassiere cups. Anyone of ordinary skill in the art would have the skill and knowledge to include such yarns in any areas of the garment where they want to provide support such as the back. This is well known to be done with the knitted stitches themselves and elastic yarns.

Art Unit: 3765

Stern does teach the broadly claimed elements of claim 1 and applicant has not differentiated the structure of the invention especially in claim 1 in regard to the intended use location of the belly panel. The maximum girth area needs to be better defined as stated above.

Therefore, the rejection stands.

Conclusion

THIS ACTION IS MADE FINAL. Applicant is reminded of the extension of time policy as set forth in 37 CFR 1.136(a).

A shortened statutory period for reply to this final action is set to expire THREE MONTHS from the mailing date of this action. In the event a first reply is filed within TWO MONTHS of the mailing date of this final action and the advisory action is not mailed until after the end of the THREE-MONTH shortened statutory period, then the shortened statutory period will expire on the date the advisory action is mailed, and any extension fee pursuant to 37 CFR 1.136(a) will be calculated from the mailing date of the advisory action. In no event, however, will the statutory period for reply expire later than SIX MONTHS from the mailing date of this final action.

Any inquiry concerning this communication or earlier communications from the examiner should be directed to Gloria Hale whose telephone number is 571-272-4984. The examiner can normally be reached on Mon.-Thurs.,...

If attempts to reach the examiner by telephone are unsuccessful, the examiner's supervisor, Gary Welch can be reached on 571-272-4996. The fax phone number for the organization where this application or proceeding is assigned is 571-273-8300.

Art Unit: 3765

Information regarding the status of an application may be obtained from the Patent Application Information Retrieval (PAIR) system. Status information for published applications may be obtained from either Private PAIR or Public PAIR. Status information for unpublished applications is available through Private PAIR only. For more information about the PAIR system, see <http://pair-direct.uspto.gov>. Should you have questions on access to the Private PAIR system, contact the Electronic Business Center (EBC) at 866-217-9197 (toll-free). If you would like assistance from a USPTO Customer Service Representative or access to the automated information system, call 800-786-9199 (IN USA OR CANADA) or 571-272-1000.

/Gloria Hale/
Primary Examiner, Art Unit 3765

Search Notes 	Application/Control No. 11756242	Applicant(s)/Patent Under Reexamination HENDRICKSON ET AL.
	Examiner Gloria Hale	Art Unit 3765

SEARCHED			
Class	Subclass	Date	Examiner
2	69,228,227,238,236,237,211,212,214	12-15-09	gh
450	155,96-100		
updated		6-4-10	gh

SEARCH NOTES		
Search Notes	Date	Examiner
INV NAME SRCH;IDS FLAG CLRED	12-19-09	gh

INTERFERENCE SEARCH			
Class	Subclass	Date	Examiner

	/Gloria Hale/ Primary Examiner.Art Unit 3765
--	---

Index of Claims 	Application/Control No. 11756242	Applicant(s)/Patent Under Reexamination HENDRICKSON ET AL.
	Examiner Gloria Hale	Art Unit 3765

✓	Rejected
=	Allowed

-	Cancelled
÷	Restricted

N	Non-Elected
I	Interference

A	Appeal
O	Objected

Claims renumbered in the same order as presented by applicant
 CPA
 T.D.
 R.1.47

CLAIM		DATE							
Final	Original	12/19/2009	06/04/2010						
	1	✓	✓						
	2	✓	✓						
	3	✓	✓						
	4	✓	✓						
	5	✓	✓						
	6	✓	✓						
	7	✓	✓						
	8	✓	✓						
	9	✓	✓						
	10	✓	-						
	11	✓	✓						
	12	✓	✓						
	13	✓	✓						
	14	✓	✓						
	15	✓	✓						
	16	✓	✓						
	17	✓	✓						
	18	✓	✓						
	19	✓	✓						
	20	✓	✓						
	21	✓	✓						
	22	✓	✓						
	23	✓	✓						
	24	✓	✓						
	25	✓	✓						

Electronic Acknowledgement Receipt

EFS ID:	7882806
Application Number:	11756242
International Application Number:	
Confirmation Number:	1512
Title of Invention:	BELLY COVERING GARMENT
First Named Inventor/Applicant Name:	LISA A. HENDRICKSON
Customer Number:	22204
Filer:	Paul A. Taufer/Nancy Nunez
Filer Authorized By:	Paul A. Taufer
Attorney Docket Number:	043174-014000
Receipt Date:	24-JUN-2010
Filing Date:	31-MAY-2007
Time Stamp:	11:45:27
Application Type:	Utility under 35 USC 111(a)

Payment information:

Submitted with Payment	yes
Payment Type	Deposit Account
Payment was successfully received in RAM	\$130
RAM confirmation Number	8668
Deposit Account	502719
Authorized User	

The Director of the USPTO is hereby authorized to charge indicated fees and credit any overpayment as follows:

Charge any Additional Fees required under 37 C.F.R. Section 1.16 (National application filing, search, and examination fees)

Charge any Additional Fees required under 37 C.F.R. Section 1.17 (Patent application and reexamination processing fees)

Target Corporation

Charge any Additional Fees required under 37 C.F.R. Section 1.19 (Document supply fees)

Charge any Additional Fees required under 37 C.F.R. Section 1.20 (Post Issuance fees)

Charge any Additional Fees required under 37 C.F.R. Section 1.21 (Miscellaneous fees and charges)

File Listing:

Document Number	Document Description	File Name	File Size(Bytes)/ Message Digest	Multi Part /.zip	Pages (if appl.)
1	Power of Attorney	POA.pdf	264576 c5e800ea5e30cc2906787e24f2183f94787c 332	no	4
Warnings:					
Information:					
2	Petition for review by the Office of Petitions.	Petition.pdf	45965 24f88613a186cbc5e2b248e1839f3be9da4 4b04a	no	2
Warnings:					
Information:					
3	Fee Worksheet (PTO-875)	fee-info.pdf	30147 becca8cef60a13455ade05d0295ce1706dd 500b1	no	2
Warnings:					
Information:					
Total Files Size (in bytes):			340688		

This Acknowledgement Receipt evidences receipt on the noted date by the USPTO of the indicated documents, characterized by the applicant, and including page counts, where applicable. It serves as evidence of receipt similar to a Post Card, as described in MPEP 503.

New Applications Under 35 U.S.C. 111

If a new application is being filed and the application includes the necessary components for a filing date (see 37 CFR 1.53(b)-(d) and MPEP 506), a Filing Receipt (37 CFR 1.54) will be issued in due course and the date shown on this Acknowledgement Receipt will establish the filing date of the application.

National Stage of an International Application under 35 U.S.C. 371

If a timely submission to enter the national stage of an international application is compliant with the conditions of 35 U.S.C. 371 and other applicable requirements a Form PCT/DO/EO/903 indicating acceptance of the application as a national stage submission under 35 U.S.C. 371 will be issued in addition to the Filing Receipt, in due course.

New International Application Filed with the USPTO as a Receiving Office

If a new international application is being filed and the international application includes the necessary components for an international filing date (see PCT Article 11 and MPEP 1810), a Notification of the International Application Number and of the International Filing Date (Form PCT/RO/105) will be issued in due course, subject to prescriptions concerning national security, and the date shown on this Acknowledgement Receipt will establish the international filing date of the application.

Electronic Patent Application Fee Transmittal

Application Number:	11756242
Filing Date:	31-May-2007
Title of Invention:	BELLY COVERING GARMENT
First Named Inventor/Applicant Name:	LISA A. HENDRICKSON
Filer:	Paul A. Taufer/Nancy Nunez
Attorney Docket Number:	043174-014000

Filed as Large Entity

Utility under 35 USC 111(a) Filing Fees

Description	Fee Code	Quantity	Amount	Sub-Total in USD(\$)
Basic Filing:				
Pages:				
Claims:				
Miscellaneous-Filing:				
Petition:				
Petition fee- 37 CFR 1.17(h) (Group III)	1464	1	130	130

Patent-Appeals-and-Interference:

Post-Allowance-and-Post-Issuance:

Extension-of-Time:

Description	Fee Code	Quantity	Amount	Sub-Total in USD(\$)
Miscellaneous:				
Total in USD (\$)				130

IN THE UNITED STATES PATENT AND TRADEMARK OFFICE

Art Unit : 3765 Customer No. 035811
Examiner : Gloria M. Hale
Serial No. : 11/756,242 Docket No.: DMC-10-1220
Filed : May 31, 2007
Inventors : Lisa A. Hendrickson
: James H. Gardner III
: Richard Adelman Confirmation No.: 1512
Title : BELLY COVERING GARMENT

PETITION TO MAKE SPECIAL UNDER 37 C.F.R. §1.102(d)

Commissioner for Patents
PO Box 1450
Alexandria, VA 22313-1450

Sir:

Applicants hereby petition under 37 CFR §1.102(d) and MPEP §708.02(II) that the subject application be accorded special status and advanced in order of examination.

The requirements of 37 CFR §1.102 and MPEP §708.02 are fulfilled as follows:

1. Please charge Deposit Account No. 50-2719 in the amount of \$130.00 to cover the official Petition fee. The Commissioner is hereby authorized to charge fees under 37 CFR §1.16 and §1.17 which may be required, or credit any overpayment, to Deposit Account No. 50-2719.
2. In support of its Petition to Make Special, the Applicants allege the following:
 - a.) there are infringing products currently on the market;
 - b.) a rigid comparison of the alleged infringing products has been made, and in the Applicants' opinion, at least some of the claims are unquestionably infringed by said products; and
 - c.) the Applicants have a good knowledge of the pertinent prior art.
3. The references deemed most closely related to the subject matter encompassed by the claims are already on the record.

4. In view of that set forth above, Applicants respectfully solicit favorable consideration and grant of this Petition, so that examination of the present application may be expedited.

Respectfully submitted,

DESTINATION MATERNITY CORPORATION

Date: 6/23/10

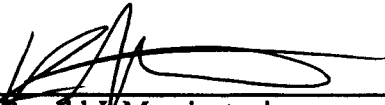
By: 

Ronald J. Masciantonio
Senior Vice President & General Counsel

Under the Paperwork Reduction Act of 1995, no persons are required to respond to a collection of information unless it displays a valid OMB control number.

POWER OF ATTORNEY OR REVOCATION OF POWER OF ATTORNEY WITH A NEW POWER OF ATTORNEY AND CHANGE OF CORRESPONDENCE ADDRESS	Application Number	11/756,242
	Filing Date	May 31, 2007
	First Named Inventor	Lisa A. Hendrickson
	Title	BELLY COVERING GARMENT
	Art Unit	3765
	Examiner Name	Gloria M. Hale
	Attorney Docket Number	DMC-10-1220

I hereby revoke all previous powers of attorney given in the above-identified application.

A Power of Attorney is submitted herewith.

OR

I hereby appoint Practitioner(s) associated with the following Customer Number as my/our attorney(s) or agent(s) to prosecute the application identified above, and to transact all business in the United States Patent and Trademark Office connected therewith:

35811

OR

I hereby appoint Practitioner(s) named below as my/our attorney(s) or agent(s) to prosecute the application identified above, and to transact all business in the United States Patent and Trademark Office connected therewith:

Practitioner(s) Name	Registration Number

Please recognize or change the correspondence address for the above-identified application to:

The address associated with the above-mentioned Customer Number.

OR

The address associated with Customer Number:

<input type="checkbox"/> Firm or Individual Name			
Address			
City	State	Zip	
Country			
Telephone	Email		

I am the:

Applicant/Inventor.

OR

Assignee of record of the entire interest. See 37 CFR 3.71. Statement under 37 CFR 3.73(b) (Form PTO/SB/96) submitted herewith or filed on _____.

SIGNATURE of Applicant or Assignee of Record

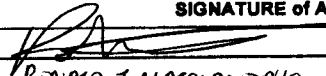
Signature		Date	6/23/10
Name	RONALD J. MASCIANDRO	Telephone	215-873-2200
Title and Company	SVP IGC DESTINADIVA MATERNITY CORPORATION		

NOTE: Signatures of all the inventors or assignees of record of the entire interest or their representative(s) are required. Submit multiple forms if more than one signature is required, see below.

*Total of _____ forms are submitted.

This collection of information is required by 37 CFR 1.31, 1.32 and 1.33. The information is required to obtain or retain a benefit by the public which is to file (and by the USPTO to process) an application. Confidentiality is governed by 35 U.S.C. 122 and 37 CFR 1.11 and 1.14. This collection is estimated to take 3 minutes to complete, including gathering, preparing, and submitting the completed application form to the USPTO. Time will vary depending upon the individual case. Any comments on the amount of time you require to complete this form and/or suggestions for reducing this burden, should be sent to the Chief Information Officer, U.S. Patent and Trademark Office, U.S. Department of Commerce, P.O. Box 1450, Alexandria, VA 22313-1450. DO NOT SEND FEES OR COMPLETED FORMS TO THIS ADDRESS. SEND TO: Commissioner for Patents, P.O. Box 1450, Alexandria, VA 22313-1450.

If you need assistance in completing the form, call 1-800-PTO-9199 and select option 2.

Privacy Act Statement

The Privacy Act of 1974 (P.L. 93-579) requires that you be given certain information in connection with your submission of the attached form related to a patent application or patent. Accordingly, pursuant to the requirements of the Act, please be advised that: (1) the general authority for the collection of this information is 35 U.S.C. 2(b)(2); (2) furnishing of the information solicited is voluntary; and (3) the principal purpose for which the information is used by the U.S. Patent and Trademark Office is to process and/or examine your submission related to a patent application or patent. If you do not furnish the requested information, the U.S. Patent and Trademark Office may not be able to process and/or examine your submission, which may result in termination of proceedings or abandonment of the application or expiration of the patent.

The information provided by you in this form will be subject to the following routine uses:

1. The information on this form will be treated confidentially to the extent allowed under the Freedom of Information Act (5 U.S.C. 552) and the Privacy Act (5 U.S.C. 552a). Records from this system of records may be disclosed to the Department of Justice to determine whether disclosure of these records is required by the Freedom of Information Act.
2. A record from this system of records may be disclosed, as a routine use, in the course of presenting evidence to a court, magistrate, or administrative tribunal, including disclosures to opposing counsel in the course of settlement negotiations.
3. A record in this system of records may be disclosed, as a routine use, to a Member of Congress submitting a request involving an individual, to whom the record pertains, when the individual has requested assistance from the Member with respect to the subject matter of the record.
4. A record in this system of records may be disclosed, as a routine use, to a contractor of the Agency having need for the information in order to perform a contract. Recipients of information shall be required to comply with the requirements of the Privacy Act of 1974, as amended, pursuant to 5 U.S.C. 552a(m).
5. A record related to an International Application filed under the Patent Cooperation Treaty in this system of records may be disclosed, as a routine use, to the International Bureau of the World Intellectual Property Organization, pursuant to the Patent Cooperation Treaty.
6. A record in this system of records may be disclosed, as a routine use, to another federal agency for purposes of National Security review (35 U.S.C. 181) and for review pursuant to the Atomic Energy Act (42 U.S.C. 218(c)).
7. A record from this system of records may be disclosed, as a routine use, to the Administrator, General Services, or his/her designee, during an inspection of records conducted by GSA as part of that agency's responsibility to recommend improvements in records management practices and programs, under authority of 44 U.S.C. 2904 and 2906. Such disclosure shall be made in accordance with the GSA regulations governing inspection of records for this purpose, and any other relevant (i.e., GSA or Commerce) directive. Such disclosure shall not be used to make determinations about individuals.
8. A record from this system of records may be disclosed, as a routine use, to the public after either publication of the application pursuant to 35 U.S.C. 122(b) or issuance of a patent pursuant to 35 U.S.C. 151. Further, a record may be disclosed, subject to the limitations of 37 CFR 1.14, as a routine use, to the public if the record was filed in an application which became abandoned or in which the proceedings were terminated and which application is referenced by either a published application, an application open to public inspection or an issued patent.
9. A record from this system of records may be disclosed, as a routine use, to a Federal, State, or local law enforcement agency, if the USPTO becomes aware of a violation or potential violation of law or regulation.

Under the Paperwork Reduction Act of 1995, no persons are required to respond to a collection of information unless it displays a valid OMB control number.

STATEMENT UNDER 37 CFR 3.73(b)

Applicant/Patent Owner: Destination Maternity Corporation

Application No./Patent No.: 11/756,242 Filed/Issue Date: May 31, 2007

Titled: BELLY COVERING GARMENT

Destination Maternity Corporation, a corporation of Delaware
(Name of Assignee) (Type of Assignee, e.g., corporation, partnership, university, government agency, etc.)

states that it is:

- 1. the assignee of the entire right, title, and interest in;
- 2. an assignee of less than the entire right, title, and interest in
(The extent (by percentage) of its ownership interest is _____ %); or
- 3. the assignee of an undivided interest in the entirety of (a complete assignment from one of the joint inventors was made)

the patent application/patent identified above, by virtue of either:

A. An assignment from the inventor(s) of the patent application/patent identified above. The assignment was recorded in the United States Patent and Trademark Office at Reel 023390, Frame 0079, or for which a copy therefore is attached.

OR

B. A chain of title from the inventor(s), of the patent application/patent identified above, to the current assignee as follows:

1. From: _____ To: _____

The document was recorded in the United States Patent and Trademark Office at
Reel _____, Frame _____, or for which a copy thereof is attached.

2. From: _____ To: _____

The document was recorded in the United States Patent and Trademark Office at
Reel _____, Frame _____, or for which a copy thereof is attached.

3. From: _____ To: _____

The document was recorded in the United States Patent and Trademark Office at
Reel _____, Frame _____, or for which a copy thereof is attached.

Additional documents in the chain of title are listed on a supplemental sheet(s).

As required by 37 CFR 3.73(b)(1)(i), the documentary evidence of the chain of title from the original owner to the assignee was, or concurrently is being, submitted for recordation pursuant to 37 CFR 3.11.

[NOTE: A separate copy (i.e., a true copy of the original assignment document(s)) must be submitted to Assignment Division in accordance with 37 CFR Part 3, to record the assignment in the records of the USPTO. See MPEP 302.08]

The undersigned (whose title is supplied below) is authorized to act on behalf of the assignee.

Signature

Paul A. Tauber, Reg. No. 35,703

Printed or Typed Name

June 24, 2010

Date

Attorney of Record

Title

This collection of information is required by 37 CFR 3.73(b). The information is required to obtain or retain a benefit by the public which is to file (and by the USPTO to process) an application. Confidentiality is governed by 35 U.S.C. 122 and 37 CFR 1.11 and 1.14. This collection is estimated to take 12 minutes to complete, including gathering, preparing, and submitting the completed application form to the USPTO. Time will vary depending upon the individual case. Any comments on the amount of time you require to complete this form and/or suggestions for reducing this burden, should be sent to the Chief Information Officer, U.S. Patent and Trademark Office, U.S. Department of Commerce, P.O. Box 1450, Alexandria, VA 22313-1450. DO NOT SEND FEES OR COMPLETED FORMS TO THIS ADDRESS. SEND TO: Commissioner for Patents, P.O. Box 1450, Alexandria, VA 22313-1450.

If you need assistance in completing the form, call 1-800-PTO-9199 and select option 2.

Privacy Act Statement

The **Privacy Act of 1974 (P.L. 93-579)** requires that you be given certain information in connection with your submission of the attached form related to a patent application or patent. Accordingly, pursuant to the requirements of the Act, please be advised that: (1) the general authority for the collection of this information is 35 U.S.C. 2(b)(2); (2) furnishing of the information solicited is voluntary; and (3) the principal purpose for which the information is used by the U.S. Patent and Trademark Office is to process and/or examine your submission related to a patent application or patent. If you do not furnish the requested information, the U.S. Patent and Trademark Office may not be able to process and/or examine your submission, which may result in termination of proceedings or abandonment of the application or expiration of the patent.

The information provided by you in this form will be subject to the following routine uses:

1. The information on this form will be treated confidentially to the extent allowed under the Freedom of Information Act (5 U.S.C. 552) and the Privacy Act (5 U.S.C. 552a). Records from this system of records may be disclosed to the Department of Justice to determine whether disclosure of these records is required by the Freedom of Information Act.
2. A record from this system of records may be disclosed, as a routine use, in the course of presenting evidence to a court, magistrate, or administrative tribunal, including disclosures to opposing counsel in the course of settlement negotiations.
3. A record in this system of records may be disclosed, as a routine use, to a Member of Congress submitting a request involving an individual, to whom the record pertains, when the individual has requested assistance from the Member with respect to the subject matter of the record.
4. A record in this system of records may be disclosed, as a routine use, to a contractor of the Agency having need for the information in order to perform a contract. Recipients of information shall be required to comply with the requirements of the Privacy Act of 1974, as amended, pursuant to 5 U.S.C. 552a(m).
5. A record related to an International Application filed under the Patent Cooperation Treaty in this system of records may be disclosed, as a routine use, to the International Bureau of the World Intellectual Property Organization, pursuant to the Patent Cooperation Treaty.
6. A record in this system of records may be disclosed, as a routine use, to another federal agency for purposes of National Security review (35 U.S.C. 181) and for review pursuant to the Atomic Energy Act (42 U.S.C. 218(c)).
7. A record from this system of records may be disclosed, as a routine use, to the Administrator, General Services, or his/her designee, during an inspection of records conducted by GSA as part of that agency's responsibility to recommend improvements in records management practices and programs, under authority of 44 U.S.C. 2904 and 2906. Such disclosure shall be made in accordance with the GSA regulations governing inspection of records for this purpose, and any other relevant (*i.e.*, GSA or Commerce) directive. Such disclosure shall not be used to make determinations about individuals.
8. A record from this system of records may be disclosed, as a routine use, to the public after either publication of the application pursuant to 35 U.S.C. 122(b) or issuance of a patent pursuant to 35 U.S.C. 151. Further, a record may be disclosed, subject to the limitations of 37 CFR 1.14, as a routine use, to the public if the record was filed in an application which became abandoned or in which the proceedings were terminated and which application is referenced by either a published application, an application open to public inspection or an issued patent.
9. A record from this system of records may be disclosed, as a routine use, to a Federal, State, or local law enforcement agency, if the USPTO becomes aware of a violation or potential violation of law or regulation.



UNITED STATES PATENT AND TRADEMARK OFFICE

UNITED STATES DEPARTMENT OF COMMERCE
United States Patent and Trademark Office
Address: COMMISSIONER FOR PATENTS
P.O. Box 1450
Alexandria, Virginia 22313-1450
www.uspto.gov

APPLICATION NUMBER	FILING OR 371(C) DATE	FIRST NAMED APPLICANT	ATTY. DOCKET NO./TITLE
11/756,242	05/31/2007	LISA A. HENDRICKSON	DMC-10-1220

CONFIRMATION NO. 1512

POA ACCEPTANCE LETTER

35811
IP GROUP OF DLA PIPER LLP (US)
ONE LIBERTY PLACE
1650 MARKET ST, SUITE 4900
PHILADELPHIA, PA 19103



Date Mailed: 07/02/2010

NOTICE OF ACCEPTANCE OF POWER OF ATTORNEY

This is in response to the Power of Attorney filed 06/24/2010.

The Power of Attorney in this application is accepted. Correspondence in this application will be mailed to the above address as provided by 37 CFR 1.33.

/qtran/

Office of Data Management, Application Assistance Unit (571) 272-4000, or (571) 272-4200, or 1-888-786-0101



UNITED STATES PATENT AND TRADEMARK OFFICE

UNITED STATES DEPARTMENT OF COMMERCE
United States Patent and Trademark Office
Address: COMMISSIONER FOR PATENTS
P.O. Box 1450
Alexandria, Virginia 22313-1450
www.uspto.gov

APPLICATION NUMBER	FILING OR 371(C) DATE	FIRST NAMED APPLICANT	ATTY. DOCKET NO./TITLE
11/756,242	05/31/2007	LISA A. HENDRICKSON	043174-014000

CONFIRMATION NO. 1512

POWER OF ATTORNEY NOTICE



22204
NIXON PEABODY, LLP
401 9TH STREET, NW
SUITE 900
WASHINGTON, DC 20004-2128

Date Mailed: 07/02/2010

NOTICE REGARDING CHANGE OF POWER OF ATTORNEY

This is in response to the Power of Attorney filed 06/24/2010.

- The Power of Attorney to you in this application has been revoked by the assignee who has intervened as provided by 37 CFR 3.71. Future correspondence will be mailed to the new address of record(37 CFR 1.33).

/qtran/

Office of Data Management, Application Assistance Unit (571) 272-4000, or (571) 272-4200, or 1-888-786-0101

AUG 03 2010

PTOL-413A (07-07)
Approved for use through 08/30/2007. OMB 0631-0031
U.S. Patent and Trademark Office: U.S. DEPARTMENT OF COMMERCE

Applicant Initiated Interview Request Form

Application No.: 11/756,242 First Named Applicant: LISA A. HENDRICKSON
Examiner: GLORIA HALE Art Unit: 3765 Status of Application: PENDING

Tentative Participants:

(1) EXAMINER HALE (2) RICHARD CRUE, ESQ.
(3) _____ (4) _____

Proposed Date of Interview: ANY Proposed Time: ANY (AM/PM)

Type of Interview Requested:

(1) Telephonic (2) Personal (3) Video Conference

Exhibit To Be Shown or Demonstrated: YES NO

If yes, provide brief description: _____

Issues To Be Discussed

Issues (Rej., Obj., etc)	Claims/ Fig. #s	Prior Art	Discussed	Agreed	Not Agreed
(1) <u>RES.</u>	<u>1-9, 11-25</u>	<u>STERN</u>	<input type="checkbox"/>	<input type="checkbox"/>	<input type="checkbox"/>
(2) _____	_____	_____	<input type="checkbox"/>	<input type="checkbox"/>	<input type="checkbox"/>
(3) _____	_____	_____	<input type="checkbox"/>	<input type="checkbox"/>	<input type="checkbox"/>
(4) _____	_____	_____	<input type="checkbox"/>	<input type="checkbox"/>	<input type="checkbox"/>

Continuation Sheet Attached

Brief Description of Arguments to be Presented:

STERN'S FAILURE TO DISCLOSE A BELLY PANEL CONFIGURED TO FIT OVER
SUBSTANTIALLY AN ENTIRE ABDOMEN BY EXPANDING VERTICALLY AND CIRCUMFERENTIALLY

An interview was conducted on the above-identified application on _____

NOTE: This form should be completed by applicant and submitted to the examiner in advance of the interview (see MPEP § 713.01).

This application will not be delayed from issue because of applicant's failure to submit a written record of this interview. Therefore, applicant is advised to file a statement of the substance of this interview (37 CFR 1.133(b)) as soon as possible.

Applicant/Applicant's Representative Signature

Examiner/SPE Signature

RICHARD CRUE

Typed/Printed Name of Applicant or Representative

52783

Registration Number, if applicable

This collection of information is required by 37 CFR 1.133. The information is required to obtain or retain a benefit by the public which is to file (and by the USPTO to process) an application. Confidentiality is governed by 35 U.S.C. 122 and 37 CFR 1.11 and 1.14. This collection is estimated to take 31 minutes to complete, including gathering, preparing, and submitting the completed application form to the USPTO. Time will vary depending upon the individual case. Any comments on the amount of time you require to complete this form and/or suggestions for reducing this burden, should be sent to the Chief Information Officer, U.S. Patent and Trademark Office, U.S. Department of Commerce, P.O. Box 1450, Alexandria, VA 22313-1450. DO NOT SEND FEES OR COMPLETED FORMS TO THIS ADDRESS. SEND TO: Commissioner for Patents, P.O. Box 1450, Alexandria, VA 22313-1450.

If you need assistance in completing the form, call 1-800-PTO-9199 and select option 2.



MAILED AUG 06 2010

IP GROUP OF DLA PIPER LLP (US)
ONE LIBERTY PLACE
1650 MARKET ST, SUITE 4900
PHILADELPHIA PA 19103

In re Application of: Hendrickson et al.	:	DECISION ON PETITION TO
Application No.: 11/756242	:	MAKE SPECIAL FOR NEW
Filed: May 31, 2007	:	APPLICATION UNDER 37
Title: BELLY COVERING GARMENT	:	C.F.R. § 1.102 & M.P.E.P. §
	:	708.02
	:	

This is a decision on the petition filed on June 24, 2010 to make the above-identified application special for accelerated examination procedure under 37 C.F.R. § 1.102(d).

The petition to make the application special is **DENIED**.

REGULATION AND PRACTICE

To be eligible for accelerated examination under 37 C.F.R. § 1.102(d) and pursuant to the "Change to Practice for Petitions in Patent Applications to Make Special and for Accelerated Examination" published in the Federal Register on June 26, 2006 (71 Fed. Reg. 36323), the following conditions must be satisfied:

1. The application must be a non-reissue utility or design application filed under 37 CFR 1.111(a);
2. The application, the petition and the required fees must be filed electronically using the USPTO's electronic filing system (EFS), or EFS-web; if not filed electronically, a statement asserting that EFS and EFS-web were not available during the normal business hours;
3. The application, at the time of filing, must be complete under 37 CFR 1.51 and in condition for examination;
4. The application must contain three or fewer independent claims and twenty or fewer total claims and the claims must be directed to a single invention.
5. The petition must be filed with the application.

The application as filed is not eligible for the accelerated examination under 37 C.F.R. § 1.102(d) because the petition was not filed with the application. As noted in the policy

statement referenced above, any petition to make special filed on or after the effective date must meet the new requirements set forth in the 71 Fed. Reg. 36323 notice. Applications filed before the effective date will not be eligible for the revised accelerated examination program. The effective date of the change in practice was August 25, 2006. Thus the instant petition must be reviewed under the revised practice and the instant application is ineligible.

The petition appears on its face to have been filed without recognition of the August 25, 2006 policy change to the petition to make special program. The changes to the program are substantial. The Notice of Federal Register on June 26, 2006 (71 Fed. Reg. 36323) can be accessed on the internet at <http://www.uspto.gov/web/offices/com/sol/notices/71fr36323.pdf>

Further guidance may be found website of the USPTO at <http://www.uspto.gov/web/patents/accelerated>

under the accelerated examination link.

For the above-stated reasons, the petition is **DENIED**. The application will therefore be taken up by the examiner for action in its regular turn.

Any inquiry regarding this decision should be directed to Linda Sholl, TC 3700 Special Program Examiner, at (571) 272-4391.



Linda Sholl
Special Program Examiner
Technology Center 3700

Search Notes 	Application/Control No. 11756242	Applicant(s)/Patent Under Reexamination HENDRICKSON ET AL.
	Examiner Gloria Hale	Art Unit 3765

SEARCHED			
Class	Subclass	Date	Examiner
2	69,228,227,238,236,237,211,212,214	12-15-09	gh
450	155,96-100		
updated		6-4-10	gh
		8-12-10	gh

SEARCH NOTES		
Search Notes	Date	Examiner
INV NAME SRCH;IDS FLAG CLRED	12-19-09	gh

INTERFERENCE SEARCH			
Class	Subclass	Date	Examiner
EAST BRS SRCH HIST IN FILE		8-14-10	gh

	/Gloria Hale/ Primary Examiner.Art Unit 3765
--	---



UNITED STATES PATENT AND TRADEMARK OFFICE

UNITED STATES DEPARTMENT OF COMMERCE
 United States Patent and Trademark Office
 Address: COMMISSIONER FOR PATENTS
 P.O. Box 1450
 Alexandria, Virginia 22313-1450
 www.uspto.gov

BIB DATA SHEET

CONFIRMATION NO. 1512

SERIAL NUMBER 11/756,242	FILING or 371(c) DATE 05/31/2007 RULE	CLASS 002	GROUP ART UNIT 3765	ATTORNEY DOCKET NO. DMC-10-1220	
APPLICANTS LISA A. HENDRICKSON, Mount Laurel, NJ; James H. Gardner III, Ambler, PA; Richard Adelman, Greensboro, NC; ** CONTINUING DATA ***** ** FOREIGN APPLICATIONS ***** ** IF REQUIRED, FOREIGN FILING LICENSE GRANTED ** 06/12/2007					
Foreign Priority claimed <input type="checkbox"/> Yes <input checked="" type="checkbox"/> No 35 USC 119(a-d) conditions met <input type="checkbox"/> Yes <input checked="" type="checkbox"/> No Verified and Acknowledged / <u>GLORIA HALE</u> / Examiner's Signature	<input type="checkbox"/> Met after Allowance Initials	STATE OR COUNTRY NJ	SHEETS DRAWINGS 8	TOTAL CLAIMS 11	INDEPENDENT CLAIMS 1
ADDRESS IP GROUP OF DLA PIPER LLP (US) ONE LIBERTY PLACE 1650 MARKET ST, SUITE 4900 PHILADELPHIA, PA 19103 UNITED STATES					
TITLE BELLY COVERING GARMENT					
FILING FEE RECEIVED 1858	FEES: Authority has been given in Paper No. _____ to charge/credit DEPOSIT ACCOUNT No. _____ for following:		<input type="checkbox"/> All Fees <input type="checkbox"/> 1.16 Fees (Filing) <input type="checkbox"/> 1.17 Fees (Processing Ext. of time) <input type="checkbox"/> 1.18 Fees (Issue) <input type="checkbox"/> Other _____ <input type="checkbox"/> Credit		

Index of Claims 	Application/Control No. 11756242	Applicant(s)/Patent Under Reexamination HENDRICKSON ET AL.
	Examiner Gloria Hale	Art Unit 3765

✓	Rejected
=	Allowed

-	Cancelled
÷	Restricted

N	Non-Elected
I	Interference

A	Appeal
O	Objected

Claims renumbered in the same order as presented by applicant
 CPA
 T.D.
 R.1.47

CLAIM		DATE							
Final	Original	12/19/2009	06/04/2010	08/12/2010					
1	1	✓	✓	=					
2	2	✓	✓	=					
3	3	✓	✓	=					
4	4	✓	✓	=					
5	5	✓	✓	=					
6	6	✓	✓	=					
7	7	✓	✓	=					
8	8	✓	✓	=					
9	9	✓	✓	=					
	10	✓	-	-					
10	11	✓	✓	=					
11	12	✓	✓	=					
12	13	✓	✓	=					
13	14	✓	✓	=					
14	15	✓	✓	=					
15	16	✓	✓	=					
16	17	✓	✓	=					
17	18	✓	✓	=					
18	19	✓	✓	=					
19	20	✓	✓	=					
20	21	✓	✓	=					
21	22	✓	✓	=					
22	23	✓	✓	=					
23	24	✓	✓	=					
24	25	✓	✓	=					
25	26			=					

EXAMINER'S AMENDMENT

An examiner's amendment to the record appears below. Should the changes and/or additions be unacceptable to applicant, an amendment may be filed as provided by 37 CFR 1.312. To ensure consideration of such an amendment, it MUST be submitted no later than the payment of the issue fee.

Authorization for this examiner's amendment was given in a telephone interview with Richard Cruz on 8-10-10.

The application has been amended as follows:

In claim 1 delete lines 6-10 and insert therein :

- the garment upper portion having a second torso encircling circumference defining an upper edge of the belly panel that encircles a wearer's torso just beneath the wearer's breast area configured to hold the garment up and in place about the torso in a position of a location of maximum girth of the abdomen thereby substantially covering the wearer's entire pregnant abdomen during all stages of pregnancy. - -

Add new claim 26 as follows:

26(NEW) The garment of claim 1, wherein the garment lower portion comprises one of a pair of trousers and a skirt. - - .

/Gloria Hale/

Application/Control Number: 11/756,242
Art Unit: 3765

Page 3

Primary Examiner, Art Unit 3765

EAST Search History**EAST Search History (I nterference)**

Ref #	Hits	Search Query	DBs	Default Operator	Plurals	Time Stamp
L1	2	garment and belly and panel and expansible and cover and abdomen and torso and encircling and circumference and expansion	US-PGPUB	OR	OFF	2010/08/16 01:24
L2	2	garment and belly and panel and expansible and cover and abdomen and torso and encircling and circumference	US-PGPUB	OR	OFF	2010/08/16 01:24
L3	2	garment and belly and panel and expansible and cover and abdomen and encircling and circumference	US-PGPUB	OR	OFF	2010/08/16 01:24
L4	2	garment and belly and panel and expansible and cover and abdomen and circumference	US-PGPUB	OR	OFF	2010/08/16 01:24
L5	2	garment and belly and panel and expansible and abdomen and circumference	US-PGPUB	OR	OFF	2010/08/16 01:24

8/ 16/ 2010 1:25:05 AM



NOTICE OF ALLOWANCE AND FEE(S) DUE

35811 7590 08/31/2010

IP GROUP OF DLA PIPER LLP (US)
ONE LIBERTY PLACE
1650 MARKET ST, SUITE 4900
PHILADELPHIA, PA 19103

EXAMINER
HALE, GLORIA M
ART UNIT PAPER NUMBER

3765
DATE MAILED: 08/31/2010

Table with 5 columns: APPLICATION NO., FILING DATE, FIRST NAMED INVENTOR, ATTORNEY DOCKET NO., CONFIRMATION NO.

11/756,242 05/31/2007 LISA A. HENDRICKSON DMC-10-1220 1512

TITLE OF INVENTION: BELLY COVERING GARMENT

Table with 7 columns: APPLN. TYPE, SMALL ENTITY, ISSUE FEE DUE, PUBLICATION FEE DUE, PREV. PAID ISSUE FEE, TOTAL FEE(S) DUE, DATE DUE

nonprovisional NO \$1510 \$300 \$0 \$1810 11/30/2010

THE APPLICATION IDENTIFIED ABOVE HAS BEEN EXAMINED AND IS ALLOWED FOR ISSUANCE AS A PATENT. PROSECUTION ON THE MERITS IS CLOSED. THIS NOTICE OF ALLOWANCE IS NOT A GRANT OF PATENT RIGHTS. THIS APPLICATION IS SUBJECT TO WITHDRAWAL FROM ISSUE AT THE INITIATIVE OF THE OFFICE OR UPON PETITION BY THE APPLICANT. SEE 37 CFR 1.313 AND MPEP 1308.

THE ISSUE FEE AND PUBLICATION FEE (IF REQUIRED) MUST BE PAID WITHIN THREE MONTHS FROM THE MAILING DATE OF THIS NOTICE OR THIS APPLICATION SHALL BE REGARDED AS ABANDONED. THIS STATUTORY PERIOD CANNOT BE EXTENDED. SEE 35 U.S.C. 151. THE ISSUE FEE DUE INDICATED ABOVE DOES NOT REFLECT A CREDIT FOR ANY PREVIOUSLY PAID ISSUE FEE IN THIS APPLICATION. IF AN ISSUE FEE HAS PREVIOUSLY BEEN PAID IN THIS APPLICATION (AS SHOWN ABOVE), THE RETURN OF PART B OF THIS FORM WILL BE CONSIDERED A REQUEST TO REAPPLY THE PREVIOUSLY PAID ISSUE FEE TOWARD THE ISSUE FEE NOW DUE.

HOW TO REPLY TO THIS NOTICE:

I. Review the SMALL ENTITY status shown above.

If the SMALL ENTITY is shown as YES, verify your current SMALL ENTITY status:

A. If the status is the same, pay the TOTAL FEE(S) DUE shown above.

B. If the status above is to be removed, check box 5b on Part B - Fee(s) Transmittal and pay the PUBLICATION FEE (if required) and twice the amount of the ISSUE FEE shown above, or

If the SMALL ENTITY is shown as NO:

A. Pay TOTAL FEE(S) DUE shown above, or

B. If applicant claimed SMALL ENTITY status before, or is now claiming SMALL ENTITY status, check box 5a on Part B - Fee(s) Transmittal and pay the PUBLICATION FEE (if required) and 1/2 the ISSUE FEE shown above.

II. PART B - FEE(S) TRANSMITTAL, or its equivalent, must be completed and returned to the United States Patent and Trademark Office (USPTO) with your ISSUE FEE and PUBLICATION FEE (if required). If you are charging the fee(s) to your deposit account, section "4b" of Part B - Fee(s) Transmittal should be completed and an extra copy of the form should be submitted. If an equivalent of Part B is filed, a request to reapply a previously paid issue fee must be clearly made, and delays in processing may occur due to the difficulty in recognizing the paper as an equivalent of Part B.

III. All communications regarding this application must give the application number. Please direct all communications prior to issuance to Mail Stop ISSUE FEE unless advised to the contrary.

IMPORTANT REMINDER: Utility patents issuing on applications filed on or after Dec. 12, 1980 may require payment of maintenance fees. It is patentee's responsibility to ensure timely payment of maintenance fees when due.

PART B - FEE(S) TRANSMITTAL

**Complete and send this form, together with applicable fee(s), to: Mail Mail Stop ISSUE FEE
 Commissioner for Patents
 P.O. Box 1450
 Alexandria, Virginia 22313-1450
 or Fax (571)-273-2885**

INSTRUCTIONS: This form should be used for transmitting the ISSUE FEE and PUBLICATION FEE (if required). Blocks 1 through 5 should be completed where appropriate. All further correspondence including the Patent, advance orders and notification of maintenance fees will be mailed to the current correspondence address as indicated unless corrected below or directed otherwise in Block 1, by (a) specifying a new correspondence address; and/or (b) indicating a separate "FEE ADDRESS" for maintenance fee notifications.

CURRENT CORRESPONDENCE ADDRESS (Note: Use Block 1 for any change of address)

35811 7590 08/31/2010

IP GROUP OF DLA PIPER LLP (US)
 ONE LIBERTY PLACE
 1650 MARKET ST, SUITE 4900
 PHILADELPHIA, PA 19103

Note: A certificate of mailing can only be used for domestic mailings of the Fee(s) Transmittal. This certificate cannot be used for any other accompanying papers. Each additional paper, such as an assignment or formal drawing, must have its own certificate of mailing or transmission.

Certificate of Mailing or Transmission

I hereby certify that this Fee(s) Transmittal is being deposited with the United States Postal Service with sufficient postage for first class mail in an envelope addressed to the Mail Stop ISSUE FEE address above, or being facsimile transmitted to the USPTO (571) 273-2885, on the date indicated below.

(Depositor's name)
(Signature)
(Date)

APPLICATION NO.	FILING DATE	FIRST NAMED INVENTOR	ATTORNEY DOCKET NO.	CONFIRMATION NO.
11/756,242	05/31/2007	LISA A. HENDRICKSON	DMC-10-1220	1512

TITLE OF INVENTION: BELLY COVERING GARMENT

APPLN. TYPE	SMALL ENTITY	ISSUE FEE DUE	PUBLICATION FEE DUE	PREV. PAID ISSUE FEE	TOTAL FEE(S) DUE	DATE DUE
nonprovisional	NO	\$1510	\$300	\$0	\$1810	11/30/2010

EXAMINER	ART UNIT	CLASS-SUBCLASS
HALE, GLORIA M	3765	002-237000

<p>1. Change of correspondence address or indication of "Fee Address" (37 CFR 1.363).</p> <p><input type="checkbox"/> Change of correspondence address (or Change of Correspondence Address form PTO/SB/122) attached.</p> <p><input type="checkbox"/> "Fee Address" indication (or "Fee Address" Indication form PTO/SB/47; Rev 03-02 or more recent) attached. Use of a Customer Number is required.</p>	<p>2. For printing on the patent front page, list</p> <p>(1) the names of up to 3 registered patent attorneys or agents OR, alternatively, 1 _____</p> <p>(2) the name of a single firm (having as a member a registered attorney or agent) and the names of up to 2 registered patent attorneys or agents. If no name is listed, no name will be printed. 2 _____</p> <p>3 _____</p>
---	---

3. ASSIGNEE NAME AND RESIDENCE DATA TO BE PRINTED ON THE PATENT (print or type)

PLEASE NOTE: Unless an assignee is identified below, no assignee data will appear on the patent. If an assignee is identified below, the document has been filed for recordation as set forth in 37 CFR 3.11. Completion of this form is NOT a substitute for filing an assignment.

(A) NAME OF ASSIGNEE _____ (B) RESIDENCE: (CITY AND STATE OR COUNTRY) _____

Please check the appropriate assignee category or categories (will not be printed on the patent) : Individual Corporation or other private group entity Government

<p>4a. The following fee(s) are submitted:</p> <p><input type="checkbox"/> Issue Fee</p> <p><input type="checkbox"/> Publication Fee (No small entity discount permitted)</p> <p><input type="checkbox"/> Advance Order - # of Copies _____</p>	<p>4b. Payment of Fee(s); (Please first reapply any previously paid issue fee shown above)</p> <p><input type="checkbox"/> A check is enclosed.</p> <p><input type="checkbox"/> Payment by credit card. Form PTO-2038 is attached.</p> <p><input type="checkbox"/> The Director is hereby authorized to charge the required fee(s), any deficiency, or credit any overpayment, to Deposit Account Number _____ (enclose an extra copy of this form).</p>
---	--

5. Change in Entity Status (from status indicated above)

a. Applicant claims SMALL ENTITY status. See 37 CFR 1.27. b. Applicant is no longer claiming SMALL ENTITY status. See 37 CFR 1.27(g)(2).

NOTE: The Issue Fee and Publication Fee (if required) will not be accepted from anyone other than the applicant; a registered attorney or agent; or the assignee or other party in interest as shown by the records of the United States Patent and Trademark Office.

Authorized Signature _____ Date _____

Typed or printed name _____ Registration No. _____

This collection of information is required by 37 CFR 1.311. The information is required to obtain or retain a benefit by the public which is to file (and by the USPTO to process) an application. Confidentiality is governed by 35 U.S.C. 122 and 37 CFR 1.14. This collection is estimated to take 12 minutes to complete, including gathering, preparing, and submitting the completed application form to the USPTO. Time will vary depending upon the individual case. Any comments on the amount of time you require to complete this form and/or suggestions for reducing this burden, should be sent to the Chief Information Officer, U.S. Patent and Trademark Office, U.S. Department of Commerce, P.O. Box 1450, Alexandria, Virginia 22313-1450. DO NOT SEND FEES OR COMPLETED FORMS TO THIS ADDRESS. SEND TO: Commissioner for Patents, P.O. Box 1450, Alexandria, Virginia 22313-1450.

Under the Paperwork Reduction Act of 1995, no persons are required to respond to a collection of information unless it displays a valid OMB control number.



UNITED STATES PATENT AND TRADEMARK OFFICE

UNITED STATES DEPARTMENT OF COMMERCE
United States Patent and Trademark Office
Address: COMMISSIONER FOR PATENTS
P. O. Box 1450
Alexandria, Virginia 22313-1450
www.uspto.gov

Table with 5 columns: APPLICATION NO., FILING DATE, FIRST NAMED INVENTOR, ATTORNEY DOCKET NO., CONFIRMATION NO.
11/756,242 05/31/2007 LISA A. HENDRICKSON DMC-10-1220 1512

35811 7590 08/31/2010
IP GROUP OF DLA PIPER LLP (US)
ONE LIBERTY PLACE
1650 MARKET ST, SUITE 4900
PHILADELPHIA, PA 19103

EXAMINER

HALE, GLORIA M

ART UNIT PAPER NUMBER

3765

DATE MAILED: 08/31/2010

Determination of Patent Term Adjustment under 35 U.S.C. 154 (b)

(application filed on or after May 29, 2000)

The Patent Term Adjustment to date is 517 day(s). If the issue fee is paid on the date that is three months after the mailing date of this notice and the patent issues on the Tuesday before the date that is 28 weeks (six and a half months) after the mailing date of this notice, the Patent Term Adjustment will be 517 day(s).

If a Continued Prosecution Application (CPA) was filed in the above-identified application, the filing date that determines Patent Term Adjustment is the filing date of the most recent CPA.

Applicant will be able to obtain more detailed information by accessing the Patent Application Information Retrieval (PAIR) WEB site (http://pair.uspto.gov).

Any questions regarding the Patent Term Extension or Adjustment determination should be directed to the Office of Patent Legal Administration at (571)-272-7702. Questions relating to issue and publication fee payments should be directed to the Customer Service Center of the Office of Patent Publication at 1-(888)-786-0101 or (571)-272-4200.

Notice of Allowability

Application No. 11/756,242	Applicant(s) HENDRICKSON ET AL.	
Examiner Gloria Hale	Art Unit 3765	

-- The MAILING DATE of this communication appears on the cover sheet with the correspondence address--

All claims being allowable, PROSECUTION ON THE MERITS IS (OR REMAINS) CLOSED in this application. If not included herewith (or previously mailed), a Notice of Allowance (PTOL-85) or other appropriate communication will be mailed in due course. **THIS NOTICE OF ALLOWABILITY IS NOT A GRANT OF PATENT RIGHTS.** This application is subject to withdrawal from issue at the initiative of the Office or upon petition by the applicant. See 37 CFR 1.313 and MPEP 1308.

- 1. This communication is responsive to the Interview of 8-10-10.
- 2. The allowed claim(s) is/are 1-9 and 11-26.
- 3. Acknowledgment is made of a claim for foreign priority under 35 U.S.C. § 119(a)-(d) or (f).
 - a) All b) Some* c) None of the:
 - 1. Certified copies of the priority documents have been received.
 - 2. Certified copies of the priority documents have been received in Application No. _____.
 - 3. Copies of the certified copies of the priority documents have been received in this national stage application from the International Bureau (PCT Rule 17.2(a)).

* Certified copies not received: _____.

Applicant has THREE MONTHS FROM THE "MAILING DATE" of this communication to file a reply complying with the requirements noted below. Failure to timely comply will result in ABANDONMENT of this application.
THIS THREE-MONTH PERIOD IS NOT EXTENDABLE.

- 4. A SUBSTITUTE OATH OR DECLARATION must be submitted. Note the attached EXAMINER'S AMENDMENT or NOTICE OF INFORMAL PATENT APPLICATION (PTO-152) which gives reason(s) why the oath or declaration is deficient.
 - 5. CORRECTED DRAWINGS (as "replacement sheets") must be submitted.
 - (a) including changes required by the Notice of Draftsperson's Patent Drawing Review (PTO-948) attached
 - 1) hereto or 2) to Paper No./Mail Date _____.
 - (b) including changes required by the attached Examiner's Amendment / Comment or in the Office action of Paper No./Mail Date _____.
- Identifying indicia such as the application number (see 37 CFR 1.84(c)) should be written on the drawings in the front (not the back) of each sheet. Replacement sheet(s) should be labeled as such in the header according to 37 CFR 1.121(d).**
- 6. DEPOSIT OF and/or INFORMATION about the deposit of BIOLOGICAL MATERIAL must be submitted. Note the attached Examiner's comment regarding REQUIREMENT FOR THE DEPOSIT OF BIOLOGICAL MATERIAL.

Attachment(s)

- 1. Notice of References Cited (PTO-892)
- 2. Notice of Draftsperson's Patent Drawing Review (PTO-948)
- 3. Information Disclosure Statements (PTO/SB/08), Paper No./Mail Date _____
- 4. Examiner's Comment Regarding Requirement for Deposit of Biological Material
- 5. Notice of Informal Patent Application
- 6. Interview Summary (PTO-413), Paper No./Mail Date 8-12-10 .
- 7. Examiner's Amendment/Comment
- 8. Examiner's Statement of Reasons for Allowance
- 9. Other _____.

/Gloria Hale/
Primary Examiner, Art Unit 3765

Interview Summary	Application No. 11/756,242	Applicant(s) HENDRICKSON ET AL.	
	Examiner Gloria Hale	Art Unit 3765	

All participants (applicant, applicant's representative, PTO personnel):

(1) Gloria Hale. (3)_____.

(2) Richard Cruz, Applicant's Attorney. (4)_____.

Date of Interview: 10 August 2010.

Type: a) Telephonic b) Video Conference
c) Personal [copy given to: 1) applicant 2) applicant's representative]

Exhibit shown or demonstration conducted: d) Yes e) No.
If Yes, brief description: _____.

Claim(s) discussed: 1.

Identification of prior art discussed: all of record.

Agreement with respect to the claims f) was reached. g) was not reached. h) N/A.

Substance of Interview including description of the general nature of what was agreed to if an agreement was reached, or any other comments: The Examiner will amend claim 1 by an Examiner's Amendment to delete lines 6-10 and insert the following:

- - the garment upper portion having a second torso encircling circumference defining an upper edge of the belly panel that encircles a wearer's torso just beneath the wearer's breast area configured to hold the garment up and in place about the torso in a position of a location of maximum girth of the abdomen thereby substantially covering the wearer's entire pregnant abdomen during all stages of pregnancy- - .

(A fuller description, if necessary, and a copy of the amendments which the examiner agreed would render the claims allowable, if available, must be attached. Also, where no copy of the amendments that would render the claims allowable is available, a summary thereof must be attached.)

THE FORMAL WRITTEN REPLY TO THE LAST OFFICE ACTION MUST INCLUDE THE SUBSTANCE OF THE INTERVIEW. (See MPEP Section 713.04). If a reply to the last Office action has already been filed, APPLICANT IS GIVEN A NON-EXTENDABLE PERIOD OF THE LONGER OF ONE MONTH OR THIRTY DAYS FROM THIS INTERVIEW DATE, OR THE MAILING DATE OF THIS INTERVIEW SUMMARY FORM, WHICHEVER IS LATER, TO FILE A STATEMENT OF THE SUBSTANCE OF THE INTERVIEW. See Summary of Record of Interview requirements on reverse side or on attached sheet.

/Gloria Hale/
Primary Examiner, Art Unit 3765

Summary of Record of Interview Requirements

Manual of Patent Examining Procedure (MPEP), Section 713.04, Substance of Interview Must be Made of Record

A complete written statement as to the substance of any face-to-face, video conference, or telephone interview with regard to an application must be made of record in the application whether or not an agreement with the examiner was reached at the interview.

Title 37 Code of Federal Regulations (CFR) § 1.133 Interviews Paragraph (b)

In every instance where reconsideration is requested in view of an interview with an examiner, a complete written statement of the reasons presented at the interview as warranting favorable action must be filed by the applicant. An interview does not remove the necessity for reply to Office action as specified in §§ 1.111, 1.135. (35 U.S.C. 132)

37 CFR §1.2 Business to be transacted in writing.

All business with the Patent or Trademark Office should be transacted in writing. The personal attendance of applicants or their attorneys or agents at the Patent and Trademark Office is unnecessary. The action of the Patent and Trademark Office will be based exclusively on the written record in the Office. No attention will be paid to any alleged oral promise, stipulation, or understanding in relation to which there is disagreement or doubt.

The action of the Patent and Trademark Office cannot be based exclusively on the written record in the Office if that record is itself incomplete through the failure to record the substance of interviews.

It is the responsibility of the applicant or the attorney or agent to make the substance of an interview of record in the application file, unless the examiner indicates he or she will do so. It is the examiner's responsibility to see that such a record is made and to correct material inaccuracies which bear directly on the question of patentability.

Examiners must complete an Interview Summary Form for each interview held where a matter of substance has been discussed during the interview by checking the appropriate boxes and filling in the blanks. Discussions regarding only procedural matters, directed solely to restriction requirements for which interview recordation is otherwise provided for in Section 812.01 of the Manual of Patent Examining Procedure, or pointing out typographical errors or unreadable script in Office actions or the like, are excluded from the interview recordation procedures below. Where the substance of an interview is completely recorded in an Examiners Amendment, no separate Interview Summary Record is required.

The Interview Summary Form shall be given an appropriate Paper No., placed in the right hand portion of the file, and listed on the "Contents" section of the file wrapper. In a personal interview, a duplicate of the Form is given to the applicant (or attorney or agent) at the conclusion of the interview. In the case of a telephone or video-conference interview, the copy is mailed to the applicant's correspondence address either with or prior to the next official communication. If additional correspondence from the examiner is not likely before an allowance or if other circumstances dictate, the Form should be mailed promptly after the interview rather than with the next official communication.

The Form provides for recordation of the following information:

- Application Number (Series Code and Serial Number)
- Name of applicant
- Name of examiner
- Date of interview
- Type of interview (telephonic, video-conference, or personal)
- Name of participant(s) (applicant, attorney or agent, examiner, other PTO personnel, etc.)
- An indication whether or not an exhibit was shown or a demonstration conducted
- An identification of the specific prior art discussed
- An indication whether an agreement was reached and if so, a description of the general nature of the agreement (may be by attachment of a copy of amendments or claims agreed as being allowable). Note: Agreement as to allowability is tentative and does not restrict further action by the examiner to the contrary.
- The signature of the examiner who conducted the interview (if Form is not an attachment to a signed Office action)

It is desirable that the examiner orally remind the applicant of his or her obligation to record the substance of the interview of each case. It should be noted, however, that the Interview Summary Form will not normally be considered a complete and proper recordation of the interview unless it includes, or is supplemented by the applicant or the examiner to include, all of the applicable items required below concerning the substance of the interview.

A complete and proper recordation of the substance of any interview should include at least the following applicable items:

- 1) A brief description of the nature of any exhibit shown or any demonstration conducted,
- 2) an identification of the claims discussed,
- 3) an identification of the specific prior art discussed,
- 4) an identification of the principal proposed amendments of a substantive nature discussed, unless these are already described on the Interview Summary Form completed by the Examiner,
- 5) a brief identification of the general thrust of the principal arguments presented to the examiner,
(The identification of arguments need not be lengthy or elaborate. A verbatim or highly detailed description of the arguments is not required. The identification of the arguments is sufficient if the general nature or thrust of the principal arguments made to the examiner can be understood in the context of the application file. Of course, the applicant may desire to emphasize and fully describe those arguments which he or she feels were or might be persuasive to the examiner.)
- 6) a general indication of any other pertinent matters discussed, and
- 7) if appropriate, the general results or outcome of the interview unless already described in the Interview Summary Form completed by the examiner.

Examiners are expected to carefully review the applicant's record of the substance of an interview. If the record is not complete and accurate, the examiner will give the applicant an extendable one month time period to correct the record.

Examiner to Check for Accuracy

If the claims are allowable for other reasons of record, the examiner should send a letter setting forth the examiner's version of the statement attributed to him or her. If the record is complete and accurate, the examiner should place the indication, "Interview Record OK" on the paper recording the substance of the interview along with the date and the examiner's initials.

In the Claims

1. (Currently Amended) A garment, comprising:
 - a garment upper portion having a belly panel that is expansible to cover and fit over a growing abdomen during different stages of pregnancy;
 - a garment lower portion having a first torso encircling circumference that recedes downward to make way for expansion of the belly pane; and
 - the garment upper portion having a second torso encircling circumference defining an upper edge of the belly panel that encircles a wearer's torso just beneath the wearer's breast area configured to hold the garment up and in ~~place~~place about the torso in a position of a location of maximum girth of the abdomen, thereby substantially covering the wearer's entire pregnant abdomen during all stages of pregnancy.

2. (Previously Presented) The garment of claim 1, wherein the second torso encircling circumference is adjustable in girth in conformance with different body types.

3. (Previously Presented) The garment of claim 1, wherein the garment upper portion comprises a seamless tubular structure that fits comfortably while being worn, and the belly panel comprises an expansible portion of the tubular structure.

4. (Original) The garment of claim 1, wherein the garment upper portion comprises a seamless tubular elastic fabric to stretch elastically.

5. (Original) The garment of claim 1, wherein the garment upper portion comprises an elastic fabric that is contractible elastically to cover an abdomen during different stages of postpartum body changes.

6. (Previously Presented) The garment of claim 1, wherein the garment lower portion has a partial waistband extending from side seams of the garment lower portion and extending across a back side of the garment lower portion where the partial waistband widens above a wearer's pelvis.

7. (Original) The garment of claim 1, further comprising a series of belly cradling stitches or knitted tension in the belly panel, wherein the knitted tension or stitches extend along multiple paths arranged in an elliptical pattern that curves, so as to cradle a curved growing abdomen during various stages of pregnancy.

8. (Original) The garment of claim 1, further comprising a series of stitches or knitted tension in the backside of the garment upper portion to provide spinal and back support against the wearer of the garment.

9. (Original) The garment of claim 8, wherein the series of stitches or knitted tension in the backside of the garment upper portion extends along a pattern of multiple stitch paths.

10. (Canceled)

11. (Previously Presented) The garment of claim 1, wherein the garment upper portion is foldable toward the garment lower portion to comprise a folded band on the garment lower portion.

12. (Previously Presented) The garment of claim 1, wherein the garment lower portion has a partial waistband extending from the side seams of the garment lower portion wherein the partial waistband tapers toward the side seams and widens above a wearer's pelvis across a back side of the garment lower portion.

13. (Previously Presented) The garment of claim 1, comprising:
knitted tension in the backside of the garment upper portion providing spinal column and back support for a wearer of the garment.

14. (Previously Presented) The garment of claim 1, comprising:
a series of sewn supporting stitches in the backside of the garment upper portion providing spinal column and back support for a wearer of the garment.

15. (Previously Presented) The garment of claim 1, comprising:
A series of sewn supporting stitches in the backside of the garment upper portion providing spinal column and back support for a wearer of the garment, wherein the stitches are arranged along multiple stitch paths grouped in a hyperbolic pattern, a curved pattern or a truncated, v-shaped pattern along an axis extending substantially vertically along a spinal supporting section of the fabric.

16. (Previously Presented) The garment of claim 1, wherein an edge margin of the garment upper portion is folded over and knitted to an inside of the fabric to provide a perimeter hem stitch.

17. (Previously Presented) The garment of claim 1, wherein an edge margin of the garment upper portion is folded over and sewn or knitted to an inside of the fabric to provide a perimeter hem stitch.
18. (Previously Presented) The garment of claim 1, wherein the second torso encircling circumference comprises stretchable fabric to adjust the girth in conformance with different body types.
19. (Previously Presented) The garment of claim 1, wherein the garment upper portion is a tubular structure, wherein the tubular structure is shaped and formed as a hyperboloid cylinder to fit a body type having a tapered torso.
20. (Previously Presented) The garment of claim 1, wherein the garment upper portion is a tubular structure, wherein the tubular structure is shaped and formed as a straight sided cylinder to fit a body type having a corresponding shaped torso.
21. (Previously Presented) The garment of claim 1, wherein the garment upper portion comprises a double layer tubular structure, and an inner layer of stretchable fabric between two layers of the double-layer tubular structure.
22. (Previously Presented) The garment of claim 1, wherein the garment upper portion comprises a fabric, and the fabric is doubled back on itself downward to form a double-layer tubular structure that extends downward for at least a portion of the garment upper portion, and the layers of the double-layer tubular structure are sewn together with a tubular perimeter drop stitch.

23. (Previously Presented) The garment of claim 1, wherein the garment upper portion comprises a fabric doubled back on itself downward to form a double-layer tubular structure that extends downward for at least a portion of the garment upper portion, the layers of the double-layer tubular structure are sewn together with a tubular perimeter drop stitch, and an edge margin of the garment upper portion is knitted to an inside of the fabric to provide a perimeter hem stitch.

24. (Previously Presented) The garment of claim 3, wherein the seamless tubular structure comprises a fabric doubled back on itself downward to form a double-layer tubular structure that extends downward for at least a portion of the garment upper portion, the layers of the double-layer tubular structure are sewn together with a tubular perimeter drop stitch, and an edge margin of the garment upper portion is folded over and sewn or knitted to an inside of the fabric to provide a perimeter hem stitch.

25. (Previously Presented) The garment of claim 1, wherein the garment upper portion is foldable toward the garment lower portion to provide a folded band on the garment lower portion to be worn as a garment bottom having no top.

26. (Previously Presented) The garment of claim 1, wherein the garment lower portion comprises one of a pair of trousers and a skirt.

Remarks

The Applicants note with appreciation the interview with the Examiner on August 10, 2010 including discussion about an Examiner's Amendment to Claim 1 and the addition of new Claim 26.

The Applicants have further amended Claim 1 to correct a typographical error in line 4 of the Examiner's Amendment. The Applicants respectfully request that the correction be entered into the official file.

Respectfully submitted,



Paul A. Tauffer
Reg. No. 35,703
Richard L. Cruz
Reg. No. 52,783
Attorneys for Applicants

PAT/RLC/mn
(215) 656-3385

IN THE UNITED STATES PATENT AND TRADEMARK OFFICE

Art Unit	: 3765	Customer No. 035811
Examiner	: Gloria M. Hale	
Serial No.	: 11/756,242	Docket No.: DMC-10-1220
Filed	: May 31, 2007	
Inventors	: Lisa A. Hendrickson	Confirmation No.: 1512
	: James H. Gardner III	
	: Richard Adelman	
Title	: BELLY COVERING GARMENT	Date: September 7, 2010

AMENDMENT PURSUANT TO 37 CFR §1.312

Mail Stop Issue Fee
Commissioner for Patents
P.O. Box 1450
Alexandria, VA 22313-1450

Sir:

Responsive to the Notice of Allowance and Notice of Allowability mailed on August 31, 2010, entry of the following amendment to Claim 1 is respectfully requested.

Electronic Acknowledgement Receipt

EFS ID:	8362592
Application Number:	11756242
International Application Number:	
Confirmation Number:	1512
Title of Invention:	BELLY COVERING GARMENT
First Named Inventor/Applicant Name:	LISA A. HENDRICKSON
Customer Number:	35811
Filer:	Paul A. Taufer/Nancy Nunez
Filer Authorized By:	Paul A. Taufer
Attorney Docket Number:	DMC-10-1220
Receipt Date:	07-SEP-2010
Filing Date:	31-MAY-2007
Time Stamp:	13:17:37
Application Type:	Utility under 35 USC 111(a)

Payment information:

Submitted with Payment	no
------------------------	----

File Listing:

Document Number	Document Description	File Name	File Size(Bytes)/ Message Digest	Multi Part /.zip	Pages (if appl.)
1	Amendment after Notice of Allowance (Rule 312)	Amendmt.pdf	202055 <small>12fd809367dfe63a16246e13d22a630e4f8ad3a5</small>	no	7

Warnings:

Information:

This Acknowledgement Receipt evidences receipt on the noted date by the USPTO of the indicated documents, characterized by the applicant, and including page counts, where applicable. It serves as evidence of receipt similar to a Post Card, as described in MPEP 503.

New Applications Under 35 U.S.C. 111

If a new application is being filed and the application includes the necessary components for a filing date (see 37 CFR 1.53(b)-(d) and MPEP 506), a Filing Receipt (37 CFR 1.54) will be issued in due course and the date shown on this Acknowledgement Receipt will establish the filing date of the application.

National Stage of an International Application under 35 U.S.C. 371

If a timely submission to enter the national stage of an international application is compliant with the conditions of 35 U.S.C. 371 and other applicable requirements a Form PCT/DO/EO/903 indicating acceptance of the application as a national stage submission under 35 U.S.C. 371 will be issued in addition to the Filing Receipt, in due course.

New International Application Filed with the USPTO as a Receiving Office

If a new international application is being filed and the international application includes the necessary components for an international filing date (see PCT Article 11 and MPEP 1810), a Notification of the International Application Number and of the International Filing Date (Form PCT/RO/105) will be issued in due course, subject to prescriptions concerning national security, and the date shown on this Acknowledgement Receipt will establish the international filing date of the application.

PART B - FEE(S) TRANSMITTAL

Complete and send this form, together with applicable fee(s), to: **Mail** Mail Stop ISSUE FEE
 Commissioner for Patents
 P.O. Box 1450
 Alexandria, Virginia 22313-1450
 or **Fax** (571)-273-2885

INSTRUCTIONS: This form should be used for transmitting the ISSUE FEE and PUBLICATION FEE (if required). Blocks 1 through 8 should be completed where appropriate. All further correspondence including the Patent, advance orders and notification of maintenance fees will be mailed to the current correspondence address as indicated unless corrected below or directed otherwise in Block 1, by (a) specifying a new correspondence address; and/or (b) indicating a separate "FEE ADDRESS" for maintenance fee notifications.

CURRENT CORRESPONDENCE ADDRESS (Note: Use Block 1 for any change of address)

Note: A certificate of mailing can only be used for domestic mailings of the Fee(s) Transmittal. This certificate cannot be used for any other accompanying papers. Each additional paper, such as an assignment or formal drawing, must have its own certificate of mailing or transmission.

35811 7590 08/31/2010

IP GROUP OF DLA PIPER LLP (US)
 ONE LIBERTY PLACE
 1650 MARKET ST, SUITE 4900
 PHILADELPHIA, PA 19103

Certificate of Mailing or Transmission
 I hereby certify that this Fee(s) Transmittal is being deposited with the United States Postal Service with sufficient postage for first class mail in an envelope addressed to the Mail Stop ISSUE FEE address above, or being facsimile transmitted to the USPTO (571) 273-2885, on the date indicated below.

	(Depositor's name)
	(Signature)
	(Date)

APPLICATION NO.	FILING DATE	FIRST NAMED INVENTOR	ATTORNEY DOCKET NO.	CONFIRMATION NO.
11756242	05/31/2007	LISA A. HENDRICKSON	DMC-10-1220	1512

TITLE OF INVENTION: BELLY COVERING GARMENT

APPLN. TYPE	SMALL ENTITY	ISSUE FEE DUE	PUBLICATION FEE DUE	PREV. PAID ISSUE FEE	TOTAL FEE(S) DUE	DATE DUE
nonprovisional	NO	\$1510	\$300	\$0	\$1810	11/30/2010

EXAMINER	ART UNIT	CLASS-SUBCLASS
HALE, GLORIA M	3765	002-237000

1. Change of correspondence address or indication of "Fee Address" (37 CFR 1.363).

Change of correspondence address (or Change of Correspondence Address form PTO/SB/122) attached.

"Fee Address" indication (or "Fee Address" Indication form PTO/SB/47; Rev 03-02 or more recent) attached. Use of a Customer Number is required.

2. For printing on the patent front page, list

(1) the names of up to 3 registered patent attorneys or agents OR, alternatively, 1 DLA Piper LLP (US)

(2) the name of a single firm (having as a member a registered attorney or agent) and the names of up to 2 registered patent attorneys or agents. If no name is listed, no name will be printed. 2 _____

3 _____

3. ASSIGNEE NAME AND RESIDENCE DATA TO BE PRINTED ON THE PATENT (print or type)

PLEASE NOTE: Unless an assignee is identified below, no assignee data will appear on the patent. If an assignee is identified below, the document has been filed for recordation as set forth in 37 CFR 3.11. Completion of this form is NOT a substitute for filing an assignment.

(A) NAME OF ASSIGNEE: Destination Maternity Corporation

(B) RESIDENCE: (CITY and STATE OR COUNTRY) Wilmington, Delaware

Please check the appropriate assignee category or categories (will not be printed on the patent): Individual Corporation or other private group entity Government

4a. The following fee(s) are submitted:

Issue Fee

Publication Fee (No small entity discount permitted)

Advance Order - # of Copies _____

4b. Payment of Fee(s): (Please first reapply any previously paid issue fee shown above)

A check is enclosed.

Payment by credit card. Form PTO-2038 is attached.

The Director is hereby authorized to charge the required fee(s), any deficiency, or credit any overpayment, to Deposit Account Number 50-2719 (enclose an extra copy of this form).

5. Change in Entity Status (from status indicated above)

a. Applicant claims SMALL ENTITY status. See 37 CFR 1.27.

b. Applicant is no longer claiming SMALL ENTITY status. See 37 CFR 1.27(g)(2).

NOTE: The Issue Fee and Publication Fee (if required) will not be accepted from anyone other than the applicant, a registered attorney or agent, or the assignee or other party in interest as shown by the records of the United States Patent and Trademark Office.

Authorized Signature _____ Date September 8, 2010

Typed or printed name Paul A. Taufer Registration No. 35,703

This collection of information is required by 37 CFR 1.311. The information is required to obtain or retain a benefit by the public which is to file (and by the USPTO to process) an application. Confidentiality is governed by 35 U.S.C. 122 and 37 CFR 1.14. This collection is estimated to take 12 minutes to complete, including gathering, preparing, and submitting the completed application form to the USPTO. Time will vary depending upon the individual case. Any comments on the amount of time you require to complete this form and/or suggestions for reducing this burden, should be sent to the Chief Information Officer, U.S. Patent and Trademark Office, U.S. Department of Commerce, P.O. Box 1450, Alexandria, Virginia 22313-1450. DO NOT SEND FEES OR COMPLETED FORMS TO THIS ADDRESS. SEND TO: Commissioner for Patents, P.O. Box 1450, Alexandria, Virginia 22313-1450.

Under the Paperwork Reduction Act of 1995, no persons are required to respond to a collection of information unless it displays a valid OMB control number.

Electronic Patent Application Fee Transmittal

Application Number:	11756242
Filing Date:	31-May-2007
Title of Invention:	BELLY COVERING GARMENT
First Named Inventor/Applicant Name:	LISA A. HENDRICKSON
Filer:	Thomas Daniel Christenbury/Carol Coney
Attorney Docket Number:	DMC-10-1220

Filed as Large Entity

Utility under 35 USC 111(a) Filing Fees

Description	Fee Code	Quantity	Amount	Sub-Total in USD(\$)
Basic Filing:				
Pages:				
Claims:				
Miscellaneous-Filing:				
Petition:				
Patent-Appeals-and-Interference:				
Post-Allowance-and-Post-Issuance:				
Utility Appl issue fee	1501	1	1510	1510
Publ. Fee- early, voluntary, or normal	1504	1	300	300

Target Corporation

Description	Fee Code	Quantity	Amount	Sub-Total in USD(\$)
Extension-of-Time:				
Miscellaneous:				
Total in USD (\$)				1810

Electronic Acknowledgement Receipt

EFS ID:	8376157
Application Number:	11756242
International Application Number:	
Confirmation Number:	1512
Title of Invention:	BELLY COVERING GARMENT
First Named Inventor/Applicant Name:	LISA A. HENDRICKSON
Customer Number:	35811
Filer:	Thomas Daniel Christenbury/Carol Coney
Filer Authorized By:	Thomas Daniel Christenbury
Attorney Docket Number:	DMC-10-1220
Receipt Date:	08-SEP-2010
Filing Date:	31-MAY-2007
Time Stamp:	16:10:55
Application Type:	Utility under 35 USC 111(a)

Payment information:

Submitted with Payment	yes
Payment Type	Deposit Account
Payment was successfully received in RAM	\$1810
RAM confirmation Number	2665
Deposit Account	502719
Authorized User	

The Director of the USPTO is hereby authorized to charge indicated fees and credit any overpayment as follows:

Charge any Additional Fees required under 37 C.F.R. Section 1.16 (National application filing, search, and examination fees)

Charge any Additional Fees required under 37 C.F.R. Section 1.17 (Patent application and reexamination processing fees)

Target Corporation

Charge any Additional Fees required under 37 C.F.R. Section 1.19 (Document supply fees)

Charge any Additional Fees required under 37 C.F.R. Section 1.20 (Post Issuance fees)

Charge any Additional Fees required under 37 C.F.R. Section 1.21 (Miscellaneous fees and charges)

File Listing:

Document Number	Document Description	File Name	File Size(Bytes)/ Message Digest	Multi Part /.zip	Pages (if appl.)
1	Issue Fee Payment (PTO-85B)	FormPTOL85.pdf	581990 58f6cbfd953c365c33ad5b2889a6c313b22c064	no	1

Warnings:

Information:

2	Miscellaneous Incoming Letter	transmittalletter.pdf	205935 cbcd691fbcc7d6f4f234ed4b50a7ee8f925c961a	no	1
---	-------------------------------	-----------------------	--	----	---

Warnings:

Information:

3	Fee Worksheet (PTO-875)	fee-info.pdf	31867 a2a042f15245f7584cd81f955a33351b25d6011e	no	2
---	-------------------------	--------------	---	----	---

Warnings:

Information:

Total Files Size (in bytes):

819792

This Acknowledgement Receipt evidences receipt on the noted date by the USPTO of the indicated documents, characterized by the applicant, and including page counts, where applicable. It serves as evidence of receipt similar to a Post Card, as described in MPEP 503.

New Applications Under 35 U.S.C. 111

If a new application is being filed and the application includes the necessary components for a filing date (see 37 CFR 1.53(b)-(d) and MPEP 506), a Filing Receipt (37 CFR 1.54) will be issued in due course and the date shown on this Acknowledgement Receipt will establish the filing date of the application.

National Stage of an International Application under 35 U.S.C. 371

If a timely submission to enter the national stage of an international application is compliant with the conditions of 35 U.S.C. 371 and other applicable requirements a Form PCT/DO/EO/903 indicating acceptance of the application as a national stage submission under 35 U.S.C. 371 will be issued in addition to the Filing Receipt, in due course.

New International Application Filed with the USPTO as a Receiving Office

If a new international application is being filed and the international application includes the necessary components for an international filing date (see PCT Article 11 and MPEP 1810), a Notification of the International Application Number and of the International Filing Date (Form PCT/RO/105) will be issued in due course, subject to prescriptions concerning national security, and the date shown on this Acknowledgement Receipt will establish the international filing date of the application.

IN THE UNITED STATES PATENT AND TRADEMARK OFFICE

Art Unit	: 3765	Customer No.	035811
Examiner	: Gloria M. Hale	Docket No.:	DMC-10-1220
Serial No.	: 11/756,242	Confirmation No.:	1512
Filed	: May 31, 2007	Not. Of Allow.:	08/31/10
Inventors	: Lisa A. Hendrickson	Date:	September 8, 2010
	: James H. Gardner III		
	: Richard Adelman		
Title	: BELLY COVERING GARMENT		

TRANSMITTAL LETTER

Commissioner for Patents
P.O. Box 1450
Alexandria, VA 22313-1450

Sir:

Applicants submit herewith Form PTOL-85B.

The Commissioner is authorized to charge the \$1810.00 fee to Deposit Account No. 50-2719 to cover the fee for payment of the issue fee and the publication fee.

The Commissioner is also authorized to charge any additional fees to Deposit Account No. 50-2719.

Respectfully submitted,

Paul A. Tauger
Reg. No. 35,703

PAT/cc
(215)656-3385

Receipt date: 09/18/2008

11756242 - GAU: 3765

SUBSTITUTE for form 1449A/PTO INFORMATION DISCLOSURE STATEMENT BY APPLICANT (use as many sheets as necessary)		Complete if Known			
		Application Number	11756,242		
		Filing Date	May 31, 2007		
		First Named Inventor	Hendrickson, Lisa		
		Art Unit	3765		
		Examiner Name	n/a		
Sheet	1	of	1	Attorney Docket Number	D8114-00369

U.S. PATENT DOCUMENTS						
Examiner Initials	Cite No.	Document Number		Publication Date MM-DD-YYYY	Name of Patentee or Applicant of Cited Document	Pages, Columns, Lines, Where Relevant Passages or Relevant Figures Appear
		Number-Kind Code (if known)				
	A	3,045,678		07/24/1962	Geimer	
	B	4,280,229		07/28/1981	Stein	
	C	4,506,390		03/26/1985	Stern	
	D	6,311,333		11/06/2001	Batra	
	E	US2004/021987		10/28/2004	Carney	20040210987
	F	US2006/0010571		01/19/2006	Oakley	

FOREIGN PATENT DOCUMENTS							
Examiner Initials	Cite No.	Foreign Patent Document		Publication Date MM-DD-YYY	Name of Patentee or Applicant of Cited Document	Pages, Columns, Lines Where Relevant Passages or Figures Appear	T
		Country Code - Number - Kind Code (if known)					

OTHER PRIOR ART - NON PATENT LITERATURE DOCUMENTS			
Examiner Initials	Cite No.	Include name of the author (in CAPITAL LETTERS), title of the article (when appropriate), title of the item (book, magazine, journal, serial, symposium, catalog, etc.), date, page(s), volume-issue number(s), publisher city and/or country where published	T
	G	International Search Report and Written Opinion dated 18 AUG 2008 in PCT/US2008/061739 (D8114-00486)	

Examiner Signature	/Gloria Hale/	Date Considered	12/21/2009
--------------------	---------------	-----------------	------------

*Examiner: Initial if reference considered, whether or not citation is in conformance with MPEP 609. Draw line through citation if not in conformance and not considered. Include copy of this form with next communication to applicant.
DM2\1576453.1

ALL REFERENCES CONSIDERED EXCEPT WHERE LINED THROUGH. /G.H./



UNITED STATES PATENT AND TRADEMARK OFFICE

UNITED STATES DEPARTMENT OF COMMERCE
United States Patent and Trademark Office
Address: COMMISSIONER FOR PATENTS
P.O. Box 1450
Alexandria, Virginia 22313-1450
www.uspto.gov

Table with 5 columns: APPLICATION NO., FILING DATE, FIRST NAMED INVENTOR, ATTORNEY DOCKET NO., CONFIRMATION NO.
11/756,242 05/31/2007 LISA A. HENDRICKSON DMC-10-1220 1512

35811 7590 09/17/2010
IP GROUP OF DLA PIPER LLP (US)
ONE LIBERTY PLACE
1650 MARKET ST, SUITE 4900
PHILADELPHIA, PA 19103

EXAMINER

HALE, GLORIA M

ART UNIT PAPER NUMBER

3765

NOTIFICATION DATE DELIVERY MODE

09/17/2010

ELECTRONIC

Please find below and/or attached an Office communication concerning this application or proceeding.

The time period for reply, if any, is set in the attached communication.

Notice of the Office communication was sent electronically on above-indicated "Notification Date" to the following e-mail address(es):

pto.phil@dlapiper.com

Response to Rule 312 Communication	Application No.	Applicant(s)
	11/756,242	HENDRICKSON ET AL.
	Examiner	Art Unit
	Gloria Hale	3765

-- The MAILING DATE of this communication appears on the cover sheet with the correspondence address --

1. The amendment filed on 07 September 2010 under 37 CFR 1.312 has been considered, and has been:
- a) entered.
 - b) entered as directed to matters of form not affecting the scope of the invention.
 - c) disapproved because the amendment was filed after the payment of the issue fee.
Any amendment filed after the date the issue fee is paid must be accompanied by a petition under 37 CFR 1.313(c)(1) and the required fee to withdraw the application from issue.
 - d) disapproved. See explanation below.
 - e) entered in part. See explanation below.

/Gloria Hale/
Primary Examiner, Art Unit 3765

OK TO ENTER: /G.H. IN THE UNITED STATES PATENT AND TRADEMARK OFFICE

Art Unit	: 3765	Customer No. 035811
Examiner	: Gloria M. Hale	
Serial No.	: 11/756,242	Docket No.: DMC-10-1220
Filed	: May 31, 2007	
Inventors	: Lisa A. Hendrickson	Confirmation No.: 1512
	: James H. Gardner III	
	: Richard Adelman	
Title	: BELLY COVERING GARMENT	Date: September 7, 2010

AMENDMENT PURSUANT TO 37 CFR §1.312

Mail Stop Issue Fee
Commissioner for Patents
P.O. Box 1450
Alexandria, VA 22313-1450

Sir:

Responsive to the Notice of Allowance and Notice of Allowability mailed on August 31, 2010, entry of the following amendment to Claim 1 is respectfully requested.



APPLICATION NO.	ISSUE DATE	PATENT NO.	ATTORNEY DOCKET NO.	CONFIRMATION NO.
11/756,242	10/19/2010	7814575	DMC-10-1220	1512

35811 7590 09/29/2010
IP GROUP OF DLA PIPER LLP (US)
ONE LIBERTY PLACE
1650 MARKET ST, SUITE 4900
PHILADELPHIA, PA 19103

ISSUE NOTIFICATION

The projected patent number and issue date are specified above.

Determination of Patent Term Adjustment under 35 U.S.C. 154 (b) (application filed on or after May 29, 2000)

The Patent Term Adjustment is 647 day(s). Any patent to issue from the above-identified application will include an indication of the adjustment on the front page.

If a Continued Prosecution Application (CPA) was filed in the above-identified application, the filing date that determines Patent Term Adjustment is the filing date of the most recent CPA.

Applicant will be able to obtain more detailed information by accessing the Patent Application Information Retrieval (PAIR) WEB site (<http://pair.uspto.gov>).

Any questions regarding the Patent Term Extension or Adjustment determination should be directed to the Office of Patent Legal Administration at (571)-272-7702. Questions relating to issue and publication fee payments should be directed to the Application Assistance Unit (AAU) of the Office of Data Management (ODM) at (571)-272-4200.

APPLICANT(s) (Please see PAIR WEB site <http://pair.uspto.gov> for additional applicants):

LISA A. HENDRICKSON, Mount Laurel, NJ;
James H. Gardner III, Ambler, PA;
Richard Adelman, Greensboro, NC;