

Under the Paperwork Reduction Act of 1995, no persons are required to respond to a collection of information unless it displays a valid OMB control number.

REISSUE PATENT APPLICATION TRANSMITTAL

Address to: Mail Stop Reissue Commissioner for Patents P.O. Box 1450 Alexandria, VA 22313-1450	Attorney Docket No.	DMC-10-1220RE
	First Named Inventor	Lisa A. Hendrickson
	Original Patent Number	7,814,675
	Original Patent Issue Date (Month/Day/Year)	10/19/2010
	Express Mail Label No.	

APPLICATION FOR REISSUE OF: Utility Patent Design Patent Plant Patent

(Check applicable box)

APPLICATION ELEMENTS (37 CFR 1.173)	ACCOMPANYING APPLICATION PARTS
1. <input checked="" type="checkbox"/> Fee Transmittal Form (PTO/SB/06) 2. <input type="checkbox"/> Applicant claims small-entity status. See 37 CFR 1.27. 3. <input checked="" type="checkbox"/> Specification and Claims in double column copy of patent format (amended, if appropriate) 4. <input checked="" type="checkbox"/> Drawing(s) (proposed amendments, if appropriate) 5. <input checked="" type="checkbox"/> Reissue Oath/Declaration (original or copy) (37 C.F.R. 1.176) (PTO/SB/01 or 02) 6. <input type="checkbox"/> Power of Attorney 7. <input checked="" type="checkbox"/> Original U.S. Patent currently assigned? <input checked="" type="checkbox"/> Yes <input type="checkbox"/> No (If Yes, check applicable box(es)) <input checked="" type="checkbox"/> Written Consent of all Assignees (PTO/SB/03) <input checked="" type="checkbox"/> 37 CFR 2.75(b) Statement (PTO/SB/06) 8. <input type="checkbox"/> CD-ROM or CD-R in duplicate, Computer Program (Appendix) or large table <input type="checkbox"/> Landscape Table on CD 9. Nucleotide and/or Amino Acid Sequence Submission (if applicable, items a. - c. are required) a. <input type="checkbox"/> Computer Readable Form (CRF) b. Specification Sequence Listing on: i. <input type="checkbox"/> CD-ROM (2 copies) or CD-R (2 copies); or ii. <input type="checkbox"/> paper c. <input type="checkbox"/> Statements verifying identity of above copies	10. <input checked="" type="checkbox"/> Statement of status and support for all changes to the claims. See 37 CFR 1.173(c). 11. <input type="checkbox"/> Foreign Priority Claim (35 U.S.C. 119) (if applicable) 12. <input checked="" type="checkbox"/> Information Disclosure Statement (IDS) (PTO/SB/08 or PTO-1443) <input checked="" type="checkbox"/> Copies of citations attached 13. <input type="checkbox"/> English Translation of Reissue Oath/Declaration (if applicable) 14. <input checked="" type="checkbox"/> Preliminary Amendment 15. <input type="checkbox"/> Return Receipt Postcard (MPEP 200) (Should be specifically itemized) 16. <input type="checkbox"/> Other:

17. CORRESPONDENCE ADDRESS

The address associated with Customer Number: 35811 OR Correspondence address below

Name			
Address			
City	State	Zip Code	
Country	Telephone	Email	
Signature:			Date: June 15, 2011
Name (Print/Type): Richard L. Cruz		Registration No. (Attorney/Agent): 52780	

This collection of information is required by 37 CFR 1.173. The information is required to obtain or retain a benefit by the public which is to file (and by the USPTO to process) an application. Confidentiality is governed by 35 U.S.C. 122 and 37 CFR 1.11 and 1.14. This collection is estimated to take 10 minutes to complete, including gathering, preparing, and submitting the completed application form to the USPTO. Time will vary depending upon the individual case. Any comments on the amount of time you require to complete this form and/or suggestions for reducing this burden, should be sent to the Chief Information Officer, U.S. Patent and Trademark Office, U.S. Department of Commerce, P.O. Box 1460, Alexandria, VA 22313-1450. DO NOT SEND FEES OR COMPLETED FORMS TO THIS ADDRESS. SEND TO: Mail Stop Reissues, Commissioner for Patents, P.O. Box 1450, Alexandria, VA 22313-1450.

If you need assistance in completing the form, call 1-800-PTO-9199 and select option 2.

Privacy Act Statement

The Privacy Act of 1974 (P.L. 93-579) requires that you be given certain information in connection with your submission of the attached form related to a patent application or patent. Accordingly, pursuant to the requirements of the Act, please be advised that: (1) the general authority for the collection of this information is 35 U.S.C. 2(b)(2); (2) furnishing of the information solicited is voluntary; and (3) the principal purpose for which the information is used by the U.S. Patent and Trademark Office is to process and/or examine your submission related to a patent application or patent. If you do not furnish the requested information, the U.S. Patent and Trademark Office may not be able to process and/or examine your submission, which may result in termination of proceedings or abandonment of the application or expiration of the patent.

The information provided by you in this form will be subject to the following routine uses:

1. The information on this form will be treated confidentially to the extent allowed under the Freedom of Information Act (5 U.S.C. 552) and the Privacy Act (5 U.S.C. 552a). Records from this system of records may be disclosed to the Department of Justice to determine whether disclosure of these records is required by the Freedom of Information Act.
2. A record from this system of records may be disclosed, as a routine use, in the course of presenting evidence to a court, magistrate, or administrative tribunal, including disclosures to opposing counsel in the course of settlement negotiations.
3. A record in this system of records may be disclosed, as a routine use, to a Member of Congress submitting a request involving an individual, to whom the record pertains, when the individual has requested assistance from the Member with respect to the subject matter of the record.
4. A record in this system of records may be disclosed, as a routine use, to a contractor of the Agency having need for the information in order to perform a contract. Recipients of information shall be required to comply with the requirements of the Privacy Act of 1974, as amended, pursuant to 5 U.S.C. 552a(m).
5. A record related to an international Application filed under the Patent Cooperation Treaty in this system of records may be disclosed, as a routine use, to the International Bureau of the World Intellectual Property Organization, pursuant to the Patent Cooperation Treaty.
6. A record in this system of records may be disclosed, as a routine use, to another federal agency for purposes of National Security review (35 U.S.C. 181) and for review pursuant to the Atomic Energy Act (42 U.S.C. 218(c)).
7. A record from this system of records may be disclosed, as a routine use, to the Administrator, General Services, or his/her designee, during an inspection of records conducted by GSA as part of that agency's responsibility to recommend improvements in records management practices and programs, under authority of 44 U.S.C. 2904 and 2906. Such disclosure shall be made in accordance with the GSA regulations governing inspection of records for this purpose, and any other relevant (i.e., GSA or Commerce) directive. Such disclosure shall not be used to make determinations about individuals.
8. A record from this system of records may be disclosed, as a routine use, to the public after either publication of the application pursuant to 35 U.S.C. 122(b) or issuance of a patent pursuant to 35 U.S.C. 151. Further, a record may be disclosed, subject to the limitations of 37 CFR 1.14, as a routine use, to the public if the record was filed in an application which became abandoned or in which the proceedings were terminated and which application is referenced by either a published application, an application open to public inspection or an issued patent.
9. A record from this system of records may be disclosed, as a routine use, to a Federal, State, or local law enforcement agency, if the USPTO becomes aware of a violation or potential violation of law or regulation.

IN THE UNITED STATES PATENT AND TRADEMARK OFFICE

Art Unit : Customer No. 035811
Examiner :
Serial No. : Docket No.: DMC-10-1220RE
Filed : Herewith
Reissue of Patent : 7,814,575
Issued : October 19, 2010
Inventor : Lisa A. Hendrickson
: James H. Gardner, III
: Richard Adelman
Title : BELLY COVERING
: GARMENT Date: June 15, 2011

PRELIMINARY AMENDMENT

Mail Stop REISSUE
Commissioner for Patents
P.O. Box 1450
Alexandria, VA 22313-1450

Sir:

The following is a Preliminary Amendment being filed with a reissue application relating to U.S. Patent No. 7,814,575 ("the '575 Patent").

Accompanying this Preliminary Amendment is a Reissue Application Oath and Consent by Assignee, an Information Disclosure Statement and a copy of the issued '575 Patent.

The Commissioner is authorized to charge the reissue filing fees of \$1728.00 to Deposit Account 50-2719. The Commissioner is also authorized to charge any insufficiency or credit any overpayment to the same account.

5

either directly or indirectly through intervening structures, as well as both movable or rigid attachments or relationships, unless expressly described otherwise.

Although the invention has been described in terms of exemplary embodiments, it is not limited thereto. Rather, the appended claims should be construed broadly, to include other variants and embodiments of the invention, which may be made by those skilled in the art without departing from the scope and range of equivalents of the invention.

What is claimed is:

1. A garment, comprising:

a garment upper portion having a belly panel that is expandable to cover and fit over a growing abdomen during different stages of pregnancy;

a garment lower portion having a first torso encircling circumference that recedes downward to make way for expansion of the belly panel; and

the garment upper portion having a second torso encircling circumference defining an upper edge of the belly panel that encircles a wearer's torso just beneath the wearer's breast area configured to hold the garment up and in place about the torso in a position of a location of maximum girth of the abdomen thereby substantially covering the wearer's entire pregnant abdomen during all stages of pregnancy.

2. The garment of claim 1, wherein the second torso encircling circumference is adjustable in girth in conformance with different body types.

3. The garment of claim 1, wherein the garment upper portion comprises a seamless tubular structure that fits comfortably while being worn, and the belly panel comprises an expandable portion of the tubular structure.

4. The garment of claim 1, wherein the garment upper portion comprises a seamless tubular elastic fabric to stretch elastically.

5. The garment of claim 1, wherein the garment upper portion comprises an elastic fabric that is contractible elastically to cover an abdomen during different stages of postpartum body changes.

6. The garment of claim 1, wherein the garment lower portion has a partial waistband extending from side seams of the garment lower portion and extending across a back side of the garment lower portion where the partial waistband widens above a wearer's pelvis.

7. The garment of claim 1, further comprising a series of belly cradling stitches or knitted tension in the belly panel, wherein the knitted tension or stitches extend along multiple paths arranged in an elliptical pattern that curves, so as to cradle a curved growing abdomen during various stages of pregnancy.

8. The garment of claim 1, further comprising a series of stitches or knitted tension in the backside of the garment upper portion to provide spinal and back support against the wearer of the garment.

9. The garment of claim 8, wherein the series of stitches or knitted tension in the backside of the garment upper portion extends along a pattern of multiple stitch paths.

10. The garment of claim 1, wherein the garment upper portion is foldable toward the garment lower portion to comprise a folded band on the garment lower portion.

11. The garment of claim 1, wherein the garment lower portion has a partial waistband extending from side seams of the garment lower portion wherein the partial waistband tapers toward the side seams and widens above a wearer's pelvis across a back side of the garment lower portion.

6

12. The garment of claim 1, comprising:

knitted tension in the backside of the garment upper portion providing spinal column and back support for a wearer of the garment.

13. The garment of claim 1, comprising:

a series of sewn supporting stitches in the backside of the garment upper portion providing spinal column and back support for a wearer of the garment.

14. The garment of claim 1, comprising:

a series of sewn supporting stitches in the backside of the garment upper portion providing spinal column and back support for a wearer of the garment, wherein the stitches are arranged along multiple stitch paths grouped in a hyperbolic pattern, a curved pattern or a truncated, v-shaped pattern along an axis extending substantially vertically along a spinal supporting section of the fabric.

15. The garment of claim 1, wherein an edge margin of the garment upper portion is folded over and knitted to an inside of the fabric to provide a perimeter hem stitch.

16. The garment of claim 1, wherein an edge margin of the garment upper portion is folded over and sewn or knitted to an inside of the fabric to provide a perimeter hem stitch.

17. The garment of claim 1, wherein the second torso encircling circumference comprises stretchable fabric to adjust the girth in conformance with different body types.

18. The garment of claim 1, wherein the garment upper portion is a tubular structure, wherein the tubular structure is shaped and formed as a hyperboloid cylinder to fit a body type having a tapered torso.

19. The garment of claim 1, wherein the garment upper portion is a tubular structure, wherein the tubular structure is shaped and formed as a straight sided cylinder to fit a body type having a corresponding shaped torso.

20. The garment of claim 1, wherein the garment upper portion comprises a double layer tubular structure, and an inner layer of stretchable fabric between two layers of the double-layer tubular structure.

21. The garment of claim 1, wherein the garment upper portion comprises a fabric, and the fabric is doubled back on itself downward to form a double-layer tubular structure that extends downward for at least a portion of the garment upper portion, and the layers of the double-layer tubular structure are sewn together with a tubular perimeter drop stitch.

22. The garment of claim 1, wherein the garment upper portion comprises a fabric doubled back on itself downward to form a double-layer tubular structure that extends downward for at least a portion of the garment upper portion, the layer of the double-layer tubular structure are sewn together with a tubular perimeter drop stitch, and an edge margin of the garment upper portion is knitted to an inside of the fabric to provide a perimeter hem stitch.

23. The garment of claim 3, wherein the seamless tubular structure comprises a fabric doubled back on itself downward to form a double-layer tubular structure that extends downward for at least a portion of the garment upper portion, the layers of the double-layer tubular structure are sewn together with a tubular perimeter drop stitch, and an edge margin of the garment upper portion is folded over and sewn or knitted to an inside of the fabric to provide a perimeter hem stitch.

24. The garment of claim 1, wherein the garment upper portion is foldable toward the garment lower portion to provide a folded band on the garment lower portion to be worn as a garment bottom having no top.

25. The garment of claim 1, wherein the garment lower portion comprises one of a pair of trousers and a skirt.

* * * * *

IN THE UNITED STATES PATENT AND TRADEMARK OFFICE

Art Unit : Customer No. 035811
Examiner :
Serial No. : Docket No.: DMC-10-1220RE
Filed : Herewith
Reissue of Patent : 7,814,575
Issued : October 19, 2010
Inventor : Lisa A. Hendrickson
: James H. Gardner, III
: Richard Adelman
Title : BELLY COVERING
: GARMENT Date: June 15, 2011

REISSUE APPLICATION TRANSMITTAL LETTER

Mail Stop REISSUE
Commissioner for Patents
P.O. Box 1450
Washington, D.C. 20231-1450

Sir:

The Applicants submit herewith the following documents in connection with the reissue application of Lisa A. Hendrickson, James H. Gardner, III and Richard Adelman entitled BELLY COVERING GARMENT:

- 1) a Preliminary Amendment;
- 2) an Information Disclosure Statement with Form PTO-1449 and a copy of each of the eight (8) non-US publications;
- 3) an executed Oath and Consent by Assignee to the Filing of the Reissue Application; and
- 6) a copy of the issued patent.

It is respectfully requested that a reissue patent be granted to Destination Maternity Corporation, which is the assignee.

The Commissioner is authorized to charge the reissue filing fee of \$1728.00 to deposit account 50-2719. The Commissioner is also authorized to charge any insufficiency or credit any overpayment to the same account.

An early and favorable action on the merits of the case is respectfully requested.

Respectfully submitted,



Richard L. Cruz
Reg. No. 52,783
Attorney for Applicants

RLC/nn
(215) 656-2446

1**BELLY COVERING GARMENT**

FIELD OF THE INVENTION

The present invention relates to a garment worn during different stages of pregnancy and different stages of postpartum body changes.

BACKGROUND OF THE INVENTION

Garments intended to cover a wearer's body below the abdomen or belly during various stages of pregnancy have been manufactured as knits or woven fabrics. Some of the knits or woven fabric garments are constructed with an elastic belt or waist band which caused discomfort when tightened about the body. Some of the garments have stretchable fabric panels sewn into place with sewn seams. Such garments cause discomfort due to the presence of the sewn seams, urged by elastic stretching of the panels pressing against the torso. Moreover, women have complained that such garments are difficult to keep in place, as they gradually slip downward while they are being worn.

Denim jeans or trousers have been recycled by removing the waistband at the front of the jeans and replacing the same with an elastic band that cradles a growing abdomen. Alternatively, denim jeans or trousers are manufactured without a waistband at the front so that a separate band can be attached at the front.

Accordingly, a need exists for a garment that covers and fits a growing abdomen during different stages of pregnancy. Such a garment is required to stay up, and desirably would fit comfortably while being worn. Moreover, such a garment would stay up when worn over different body types.

SUMMARY OF THE INVENTION

A purpose of the invention is to provide a garment that adapts to cover and fit a growing abdomen during pregnancy, wherein the garment stays up when worn.

A garment comprises a garment upper portion and a garment lower portion. The garment upper portion has a belly panel that is expansible to cover and fit over a growing abdomen during different stages of pregnancy. The garment lower portion has a first torso encircling circumference that recedes downward to make way for expansion of the belly panel. The garment upper portion has a second torso encircling circumference to hold the garment up and in place over the torso.

An embodiment of the garment is adjustable to encircle different body types. Another embodiment of the invention provides a garment that fits comfortably while being worn.

An embodiment of the garment comprises an adjustable torso encircling circumference that is adjustable in girth to encircle different body types.

An embodiment of the upper portion of the garment comprises a seamless tubular elastic fabric to stretch elastically and fit different body types.

An embodiment of the abdomen covering area comprises an elastic fabric.

An embodiment of the abdomen covering area comprises an elastic fabric that is contractible elastically to cover an abdomen during different stages of post partum body changes.

According to an embodiment of the invention, an expansible tubular upper portion of the garment is seamless to fit comfortably while being worn.

2

BRIEF DESCRIPTION OF THE DRAWINGS

FIG. 1 is a front view of a garment according to the present invention.

FIG. 1A is a view similar to FIG. 1, and discloses a body panel covering a growing abdomen.

FIG. 2 is a view of a backside portion of the garment disclosed by FIG. 1.

FIG. 3 is view of a front portion of another embodiment of a garment.

FIG. 4 is view of a backside portion of another embodiment of a garment.

FIG. 5 is a view of a backside portion of yet another embodiment of a garment.

FIG. 6 is front view of a portion of another embodiment of a garment.

FIG. 7 is front view of a portion of yet another embodiment of a garment.

DETAILED DESCRIPTION OF THE INVENTION

FIG. 1 discloses a garment **100** for encircling a lower torso portion of a wearer of the garment **100**. The garment **100** comprises a garment upper portion **102** and a garment lower portion **104**. A lower end perimeter **106** of the garment upper portion **102** is attached to a corresponding upper end perimeter **108** of the garment lower portion **104**. The garment lower portion **104** comprises, for example, a pair of trousers, such as, denim jeans. Alternatively, the garment lower portion **104** comprises a skirt depicted in FIG. 1 in phantom outline.

With reference to FIGS. 1 and 2, each leg of the pair of trousers is constructed with sewn seams. Outer side seams **110**, **112** extend continuously from top to bottom of the trousers, or garment lower portion **104**. Further, each leg is constructed with inner side seams **114**, **116** joining a front center seam **118** of the trousers and a back side, curved center seam **200**, FIG. 2, of the trousers. For example, the front center seam **106** defines a sewn "zipper less" fly front. The back side of the trousers, FIG. 2, is sewn with a back side perimeter seam **202** extending horizontally across the back side of the trousers from the outer side seams **110**, **112** to the back side center seam **200**. If pockets are desired, the legs of the trousers are constructed, for example, with a front pockets **120**, **122** and back pockets **204**, **206**.

FIG. 2 discloses an embodiment of the trousers, or garment lower portion **104**, having a partial waistband **208** joining and extending from the side seams **110**, **112** of the trousers and extending across a back side of the trousers or garment lower portion **104**. The waistband **208** is sewn onto the perimeter seam **202** on the back side. The waistband **208** tapers toward the side seams **110**, **112** and widens across the back side, and has a center seam **210** to shape the waistband **208** with a curvature above a wearer's pelvis, and for torso coverage especially when sitting or bending.

In FIG. 1, the garment upper portion **102** has a belly panel **124** to provide an abdomen covering area. The belly panel **124** is expansible, for example, when made of a stretchable fabric, to cover and fit over a growing abdomen during different stages of pregnancy, FIG. 1A. The belly panel **124** has a bottom portion **128** that projects downward with a parabolic shape, especially when covering a growing abdomen, FIG. 1A. The perimeter **108** of the garment lower portion **104** provides a first torso encircling circumference **126** that recedes downward with a parabolic shape adjacent to and below the bottom portion **128** of the belly panel **124** to make way for expansion of the belly panel **124** when covering a growing abdomen during various stages of pregnancy. The

3

parabolic shape includes a shallow curvature, or, alternatively includes a more pronounced curvature. The belly panel 124 extends at least partially under the abdomen of the garment wearer to meet and join the bottom portion 128 of the belly panel 124 with the parabolic receding circumference 126 of the garment lower portion 104.

According to an embodiment of the invention, at least the belly panel 124 comprises a stretchable fabric that is woven or knitted with elastic, stretchable strands. The stretchable fabric is expansible by stretching elastically to cover and fit over the growing abdomen, FIG. 1A. Further, the stretchable fabric is contractible elastically to cover a shrinking abdomen during different stages of post partum body changes. The belly panel 124 also has foreseeable alternative functions, for example, to cover an abdomen during different stages of torso weight gains and losses, or to fit over respective torsos of different body types.

In FIGS. 1 and 2, the garment upper portion has a top tubular perimeter hem 130 made by folding over a top edge margin of the stretchable fabric, and either tubular knitting or sewing the folded fabric to the inside surface of the fabric, and to create a top perimeter knitted hem stitch 132 as disclosed in FIG. 1. The perimeter of the garment upper portion 102 has a torso encircling circumference 134 to hold the garment 100 up and in place over the torso. Advantageously, the entire garment 100 is held up and in place. An embodiment of the garment upper portion 102 comprises stretchable fabric to adjust the girth of the second torso encircling circumference 134 in conformance with different body types. According to an embodiment of the invention, the torso encircling circumference 134 extends along the upper end of the belly panel 124. In FIG. 1A, the belly panel 124 extends at least somewhat above the maximum girth of the abdomen, even during a later stage of pregnancy, such that the belly panel 124 positions the torso encircling circumference 134 at least somewhat above the location of maximum girth to resist slipping down over the abdomen.

An embodiment of the garment upper portion 102 comprises a tubular structure to encircle a torso of a wearer of the garment 100. The tubular structure comprises a stretchable fabric woven or knitted with elastic, stretchable strands. The belly panel 124 comprises a portion of the stretchable fabric. The tubular structure is adaptable to cover and fit different body types by being elastically expansible and contractible. Different body types have different muscle mass distributions and spinal columns of different curvatures, which make the tubular structure conform to the different body types by expanding and contracting in different locations and amounts when worn by the different body types. The tubular structure is elastically expansible to widen the tubular girth at selected locations and amounts where needed to fit a body type, and is elastically contractible to narrow the tubular girth at selected locations and amounts where needed to fit the body type.

In FIGS. 1 and 2, the tubular structure is shaped and formed as a one-sheet hyperboloid cylinder to fit a body type having a tapered torso that tapers approximately from shoulder to waist. The perimeter profile of the one-sheet hyperboloid cylinder has hyperbolic shaped sides. Alternatively, the tubular structure is shaped and formed as a straight-sided cylinder, for example, as disclosed in FIG. 6. The perimeter profile of the straight sided cylinder has substantially straight sides.

Preferably, the stretchable fabric is woven or knitted to form a continuous, seamless tubular structure, such that the garment 100 is comfortable to wear due to the absence of seams that would tend to press against the torso.

FIG. 3 discloses an alternative embodiment in which the garment upper portion 102 is provided with belly cradling support in the form of a series of sewn stitches or knitted tension at 300, 302, 304, 306, 308, 310, 312, and 314 in the belly panel 124. The knitted tension or stitches extend along

4

multiple stitch paths grouped in an elliptical pattern that curves so as to cradle a curved growing abdomen, FIG. 1A, during various stages of pregnancy.

FIG. 4 discloses an alternative embodiment in which the backside of the garment upper portion 102 is provided with spinal column and back support for a wearer of the garment, in the form of a series of sewn supporting stitches or knitted tension at 400, 402, 404, 406, 408, 410, 412, 414, 416, 418 in the fabric, wherein the supporting knitted tension or stitches stiffen the fabric at the backside of the garment upper portion 102 to provide spinal and back support of the wearer of the garment 100. For example, the series of supporting stitches are arranged along multiple stitch paths grouped in a hyperbolic pattern or other curved pattern along an axis extending substantially vertically along a spinal supporting section of the fabric. FIG. 5 discloses an alternative pattern of supporting stitches 500, 502, 504, 506, 508, 510, 512, 514 in the fabric, wherein the supporting stitches are arranged along multiple stitch paths. For example, the stitch paths are shown as being grouped in a truncated, v-shaped pattern.

FIG. 6 discloses the garment upper portion 102 comprising a fabric woven or knitted to form a tubular structure, wherein the fabric of the tubular structure is doubled back on itself downward from the top circumference 134 thereof to form a double-layer tubular structure 600 that extends downward at least for a portion of the garment upper portion 102. The layers of the double-layer tubular structure 600 are sewn together with a tubular perimeter drop stitch 602. The layers are further sewn with a top, tubular perimeter hem stitch 132 as described in FIG. 1. In an alternative embodiment disclosed by FIG. 6, the fabric is doubled back over an inner tubular layer of stretchable fabric 604, shown in phantom outline by and between the stitches 132, 602, that is flatly layered and sewn in between the two tubular layers of the double layer fabric. The three tubular layers are sewn together with the top, tubular perimeter drop stitch 602 and the top, tubular perimeter hem stitch 132 as described in FIG. 1. The inner layer 604 of stretchable fabric provides the belly panel 124 with the capability for resilient expansion. In another embodiment, the double layer fabric comprises a stretch fabric woven or knitted with elastically stretchable and contractible yarns, providing the belly panel with the capability for resilient expansion.

FIG. 7 discloses that the garment 100 of FIG. 6 is convertible to comprise a bottom garment without a top, the garment upper portion 102 is foldable toward the garment lower portion 104 to provide a folded band 700 on the garment lower portion 104, which is to be worn solely as a garment bottom 104 having the folded band 700, and having no top. Each of the other embodiments of the garment 100 is similarly convertible by adding the stretchable fabric 604 to the upper garment portion 102 of the other embodiment of the garment 100, and folding the garment upper portion 102 toward the garment lower portion 104 to provide a folded band 700 on the garment lower portion 104 of the other embodiment of the garment 100.

This description of the exemplary embodiments is intended to be read in connection with the accompanying drawings, which are to be considered part of the entire written description. In the description, relative terms such as "lower," "upper," "horizontal," "vertical," "above," "below," "up," "down," "top" and "bottom" as well as derivatives thereof (e.g., "horizontally," "downwardly," "upwardly," etc.) should be construed to refer to the orientation as then described or as shown in the drawing under discussion. These relative terms are for convenience of description and do not require that the apparatus be constructed or operated in a particular orientation. Terms concerning attachments, coupling and the like, such as "connected" and "interconnected," refer to a relationship wherein structures are secured or attached to one another



US007814575B2

(12) **United States Patent**
Hendrickson et al.

(10) **Patent No.:** **US 7,814,575 B2**
(45) **Date of Patent:** **Oct. 19, 2010**

(54) **BELLY COVERING GARMENT**

(75) Inventors: **Lisa A. Hendrickson**, Mount Laurel, NJ (US); **James H. Gardner, III**, Ambler, PA (US); **Richard Adelman**, Greensboro, NC (US)

4,506,390 A * 3/1985 Stern 2/221
5,946,730 A 9/1999 Blair
6,311,333 B1 * 11/2001 Batra 2/237
2004/0210987 A1 10/2004 Carney
2006/0010571 A1 1/2006 Oakley

(73) Assignee: **Destination Maternity Corporation**,
Wilmington, DE (US)

OTHER PUBLICATIONS

(*) Notice: Subject to any disclaimer, the term of this patent is extended or adjusted under 35 U.S.C. 154(b) by 647 days.

1 in the Oven's InvisiBelly™ Jeans, Trade Literature, Feb. 26, 2008, http://wwwv.1intheoven.com/index.php?p=product&id=88&parent=26&is_print_version=true.
International Search Report and Written Opinion dated Aug. 18, 2008 in PCT/US2008/061739.
Cody, Diablo, *Juno*, DVD, Fox Searchlight Pictures screenplay, Feb. 2, 2008, Newmarket Press, Newmarket Publishing and Communications company, New York, NY.

(21) Appl. No.: **11/756,242**

* cited by examiner

(22) Filed: **May 31, 2007**

(65) **Prior Publication Data**
US 2008/0295225 A1 Dec. 4, 2008

Primary Examiner—Gloria Hale
(74) *Attorney, Agent, or Firm*—DLA Piper LLP (US)

(51) **Int. Cl.**
A41D 13/00 (2006.01)
A41D 9/00 (2006.01)

(57) **ABSTRACT**

(52) **U.S. Cl.** 2/227; 450/155
(58) **Field of Classification Search** 2/69,
2/228, 227, 238, 236, 237, 211, 212, 214;
450/155, 96-100
See application file for complete search history.

The present invention relates to a garment worn during different stages of pregnancy and different stages of postpartum body changes. A garment upper portion has a belly panel that is expansible to cover and fit over a growing abdomen during different stages of pregnancy, and a garment lower portion having a first torso encircling circumference that recedes downward to make way for expansion of the belly panel. The garment upper portion has a second torso encircling circumference to hold the garment up and in place over the torso.

(56) **References Cited**
U.S. PATENT DOCUMENTS
3,045,678 A * 7/1962 Geimer 450/130
4,280,229 A * 7/1981 Stein 2/221

25 Claims, 8 Drawing Sheets

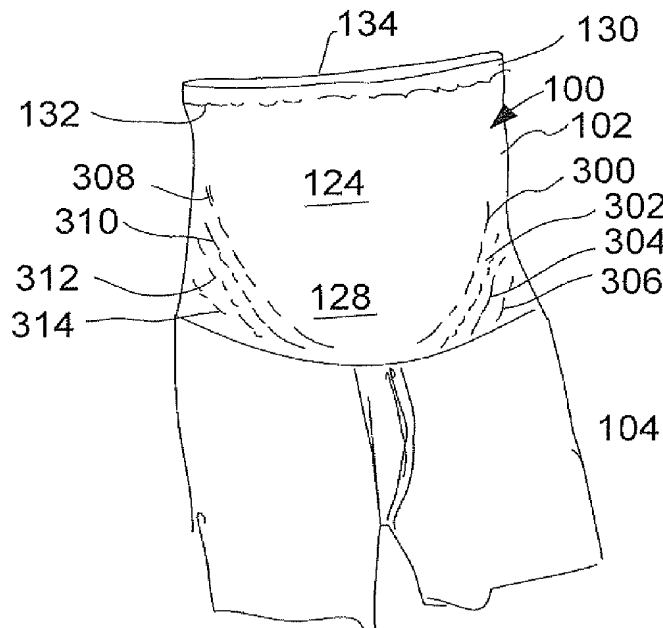

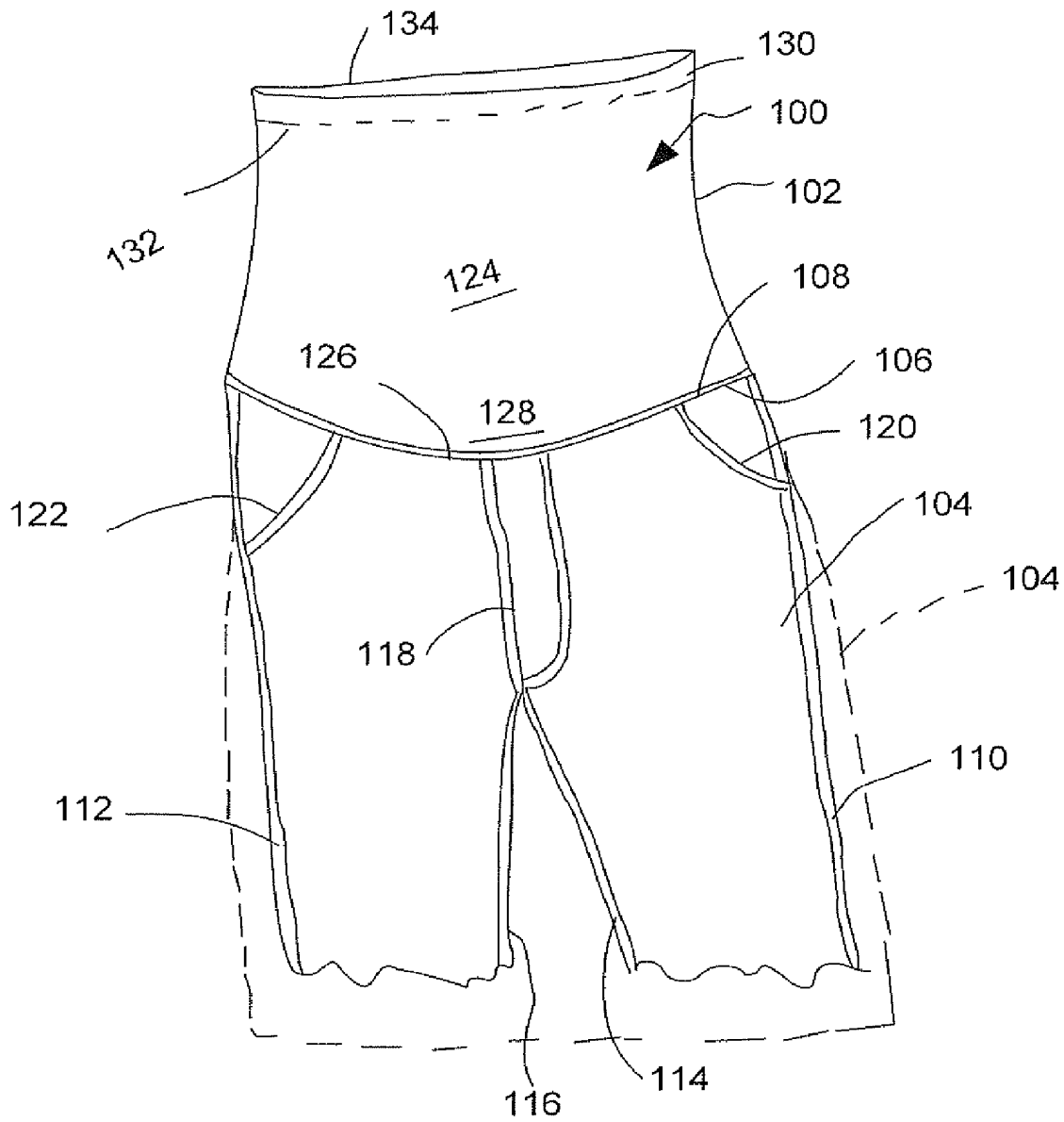

FIG. 1

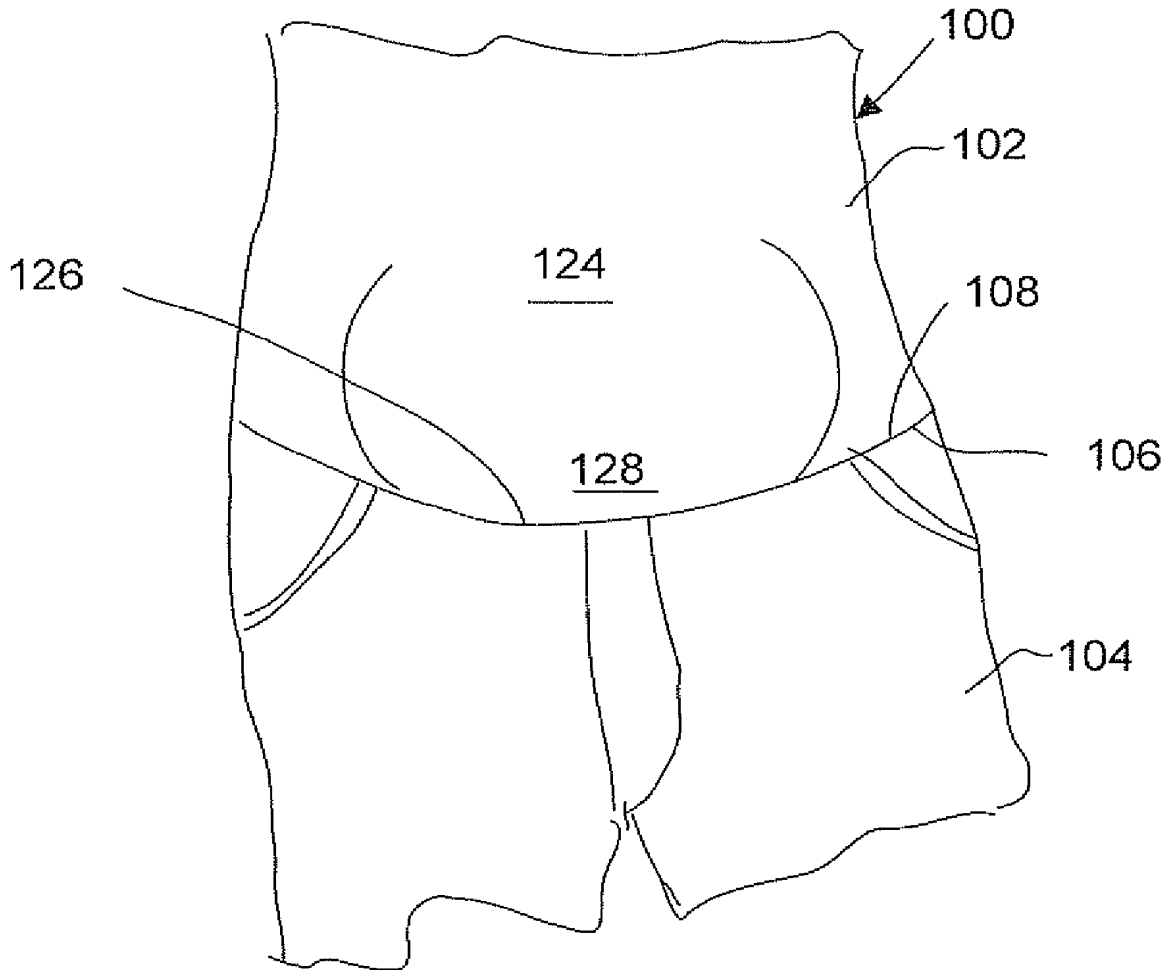

FIG. 1A

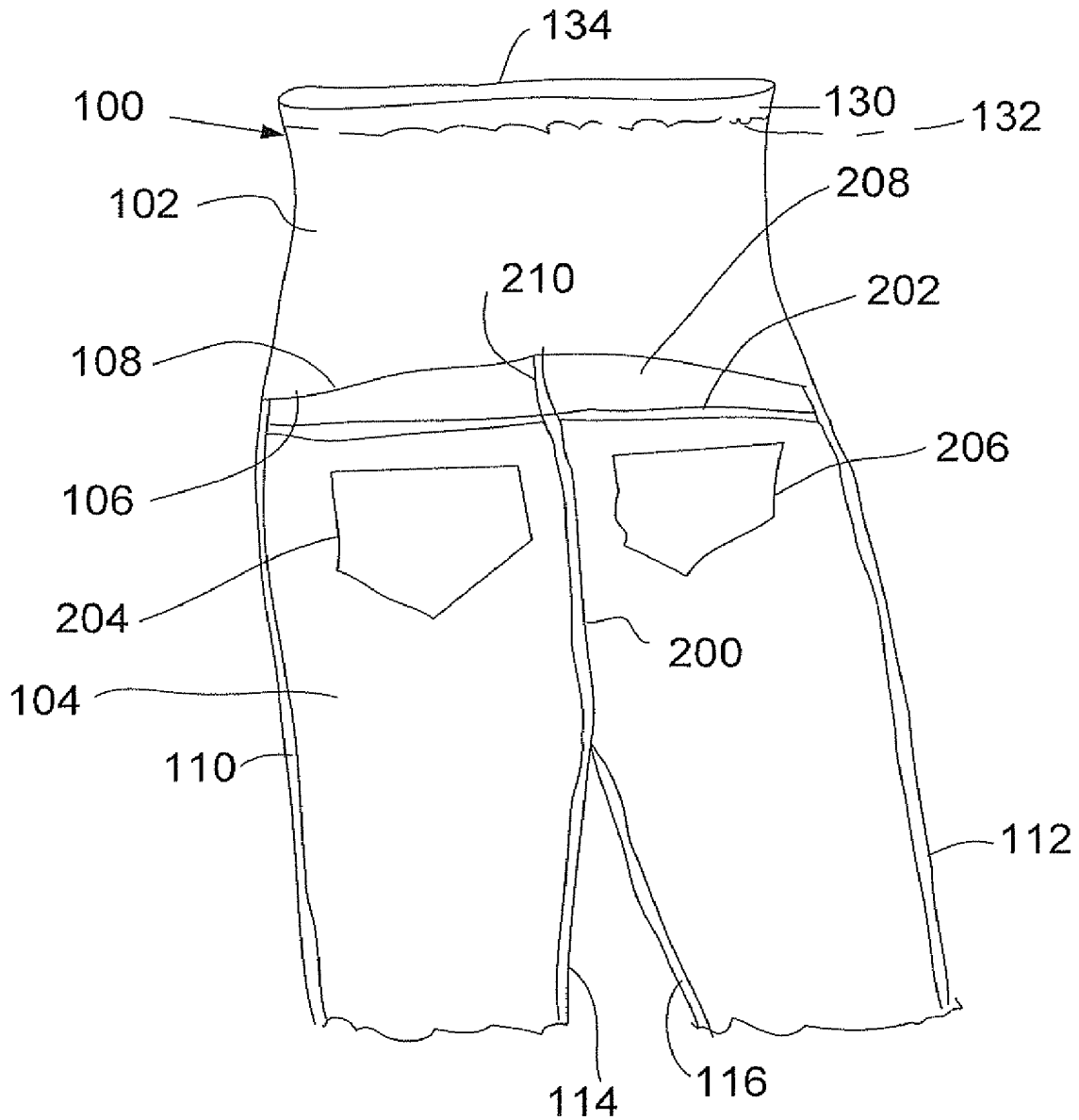

FIG. 2

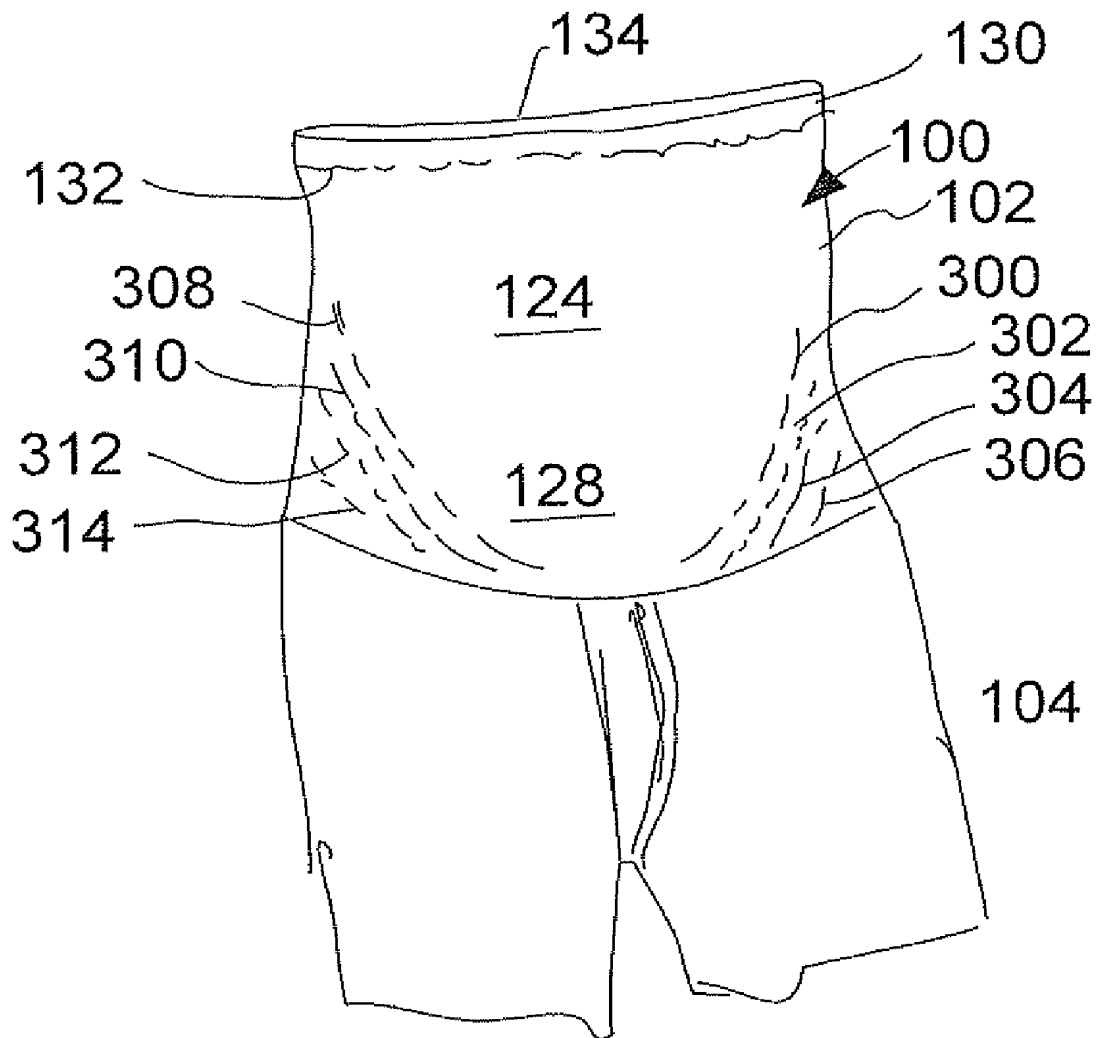

FIG. 3

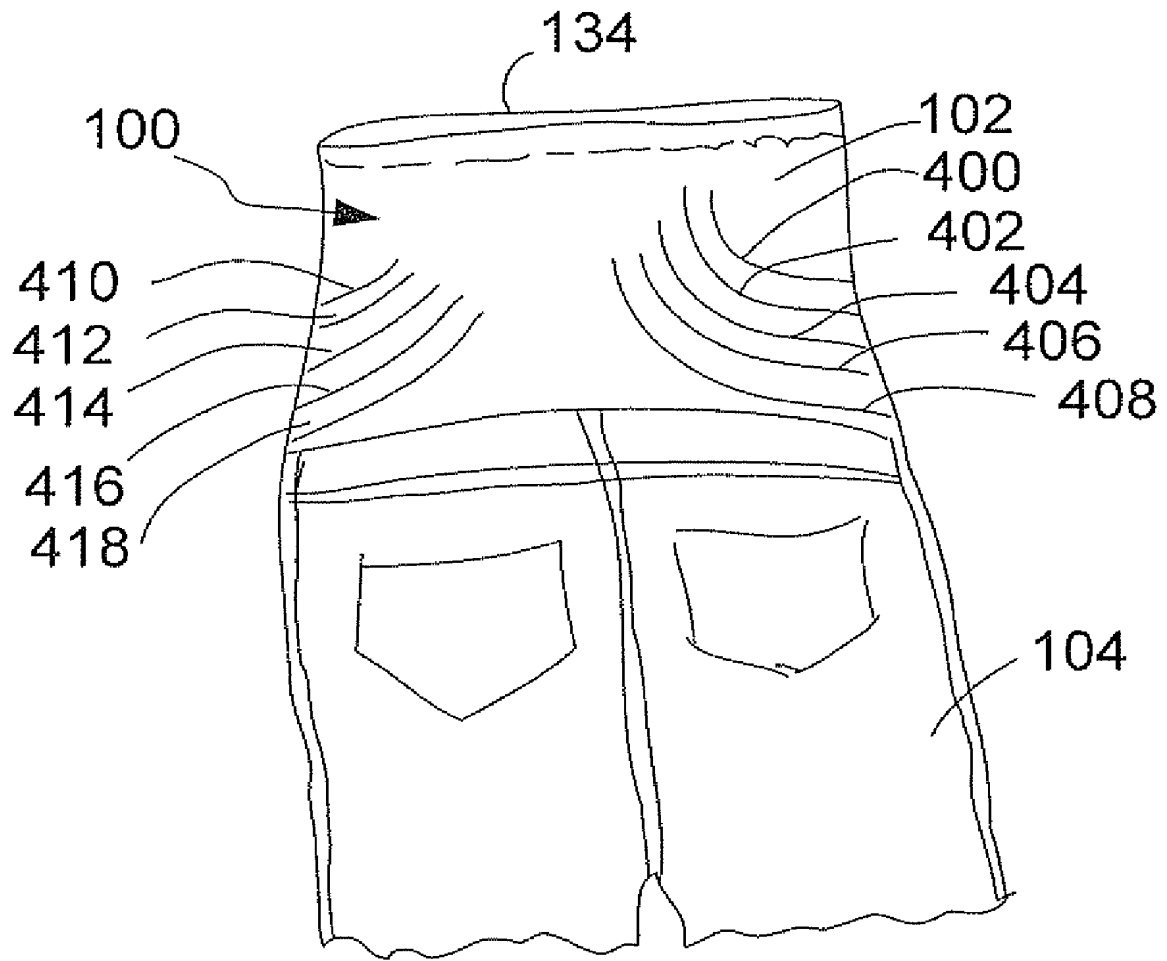

FIG. 4

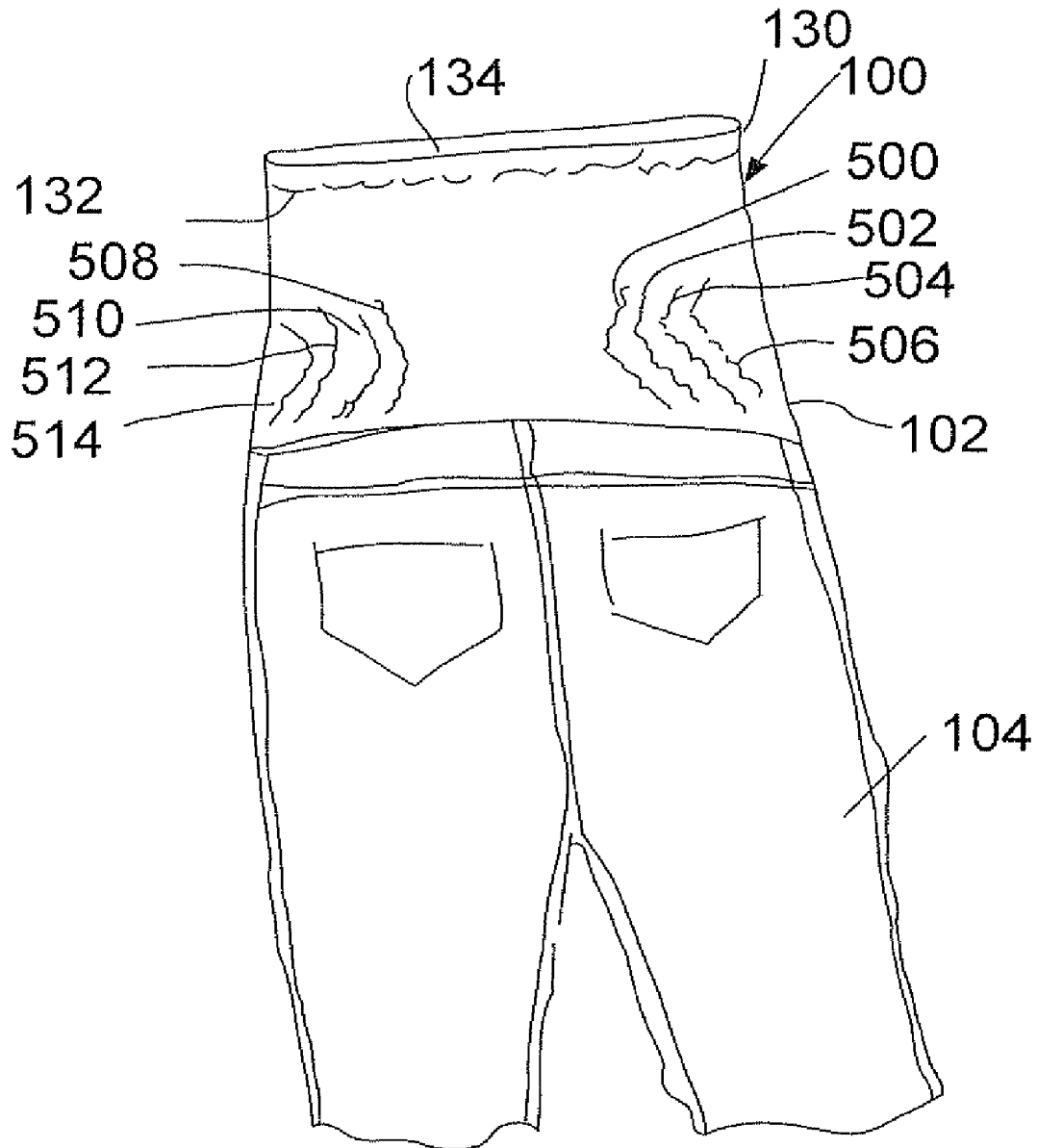

FIG. 5

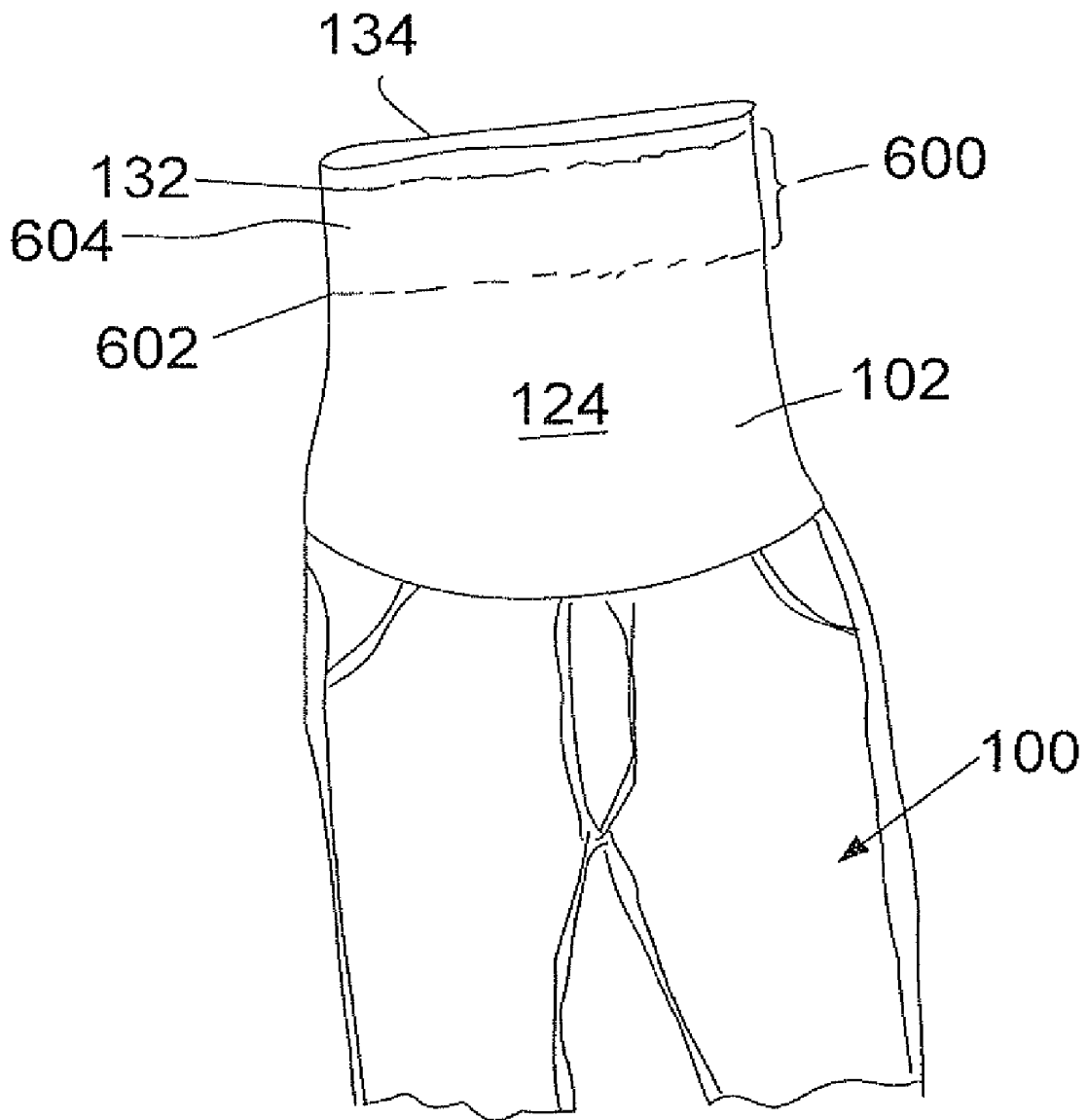

FIG. 6

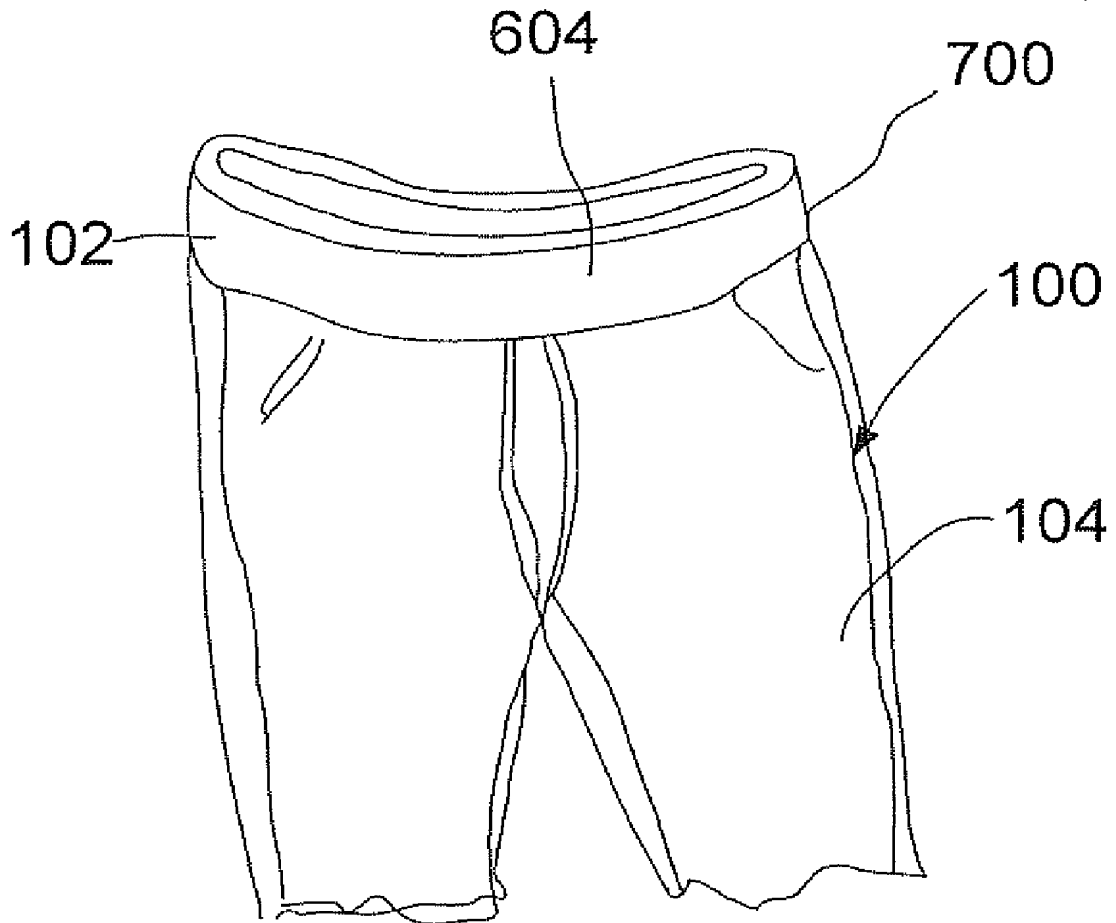

FIG. 7

Remarks

The claims as issued in the '575 Patent remain unchanged by this Preliminary Amendment. New Claims 26-29 are added. The newly added claims are directed to additional features of the contemplated invention. Support for the new claims can be found in the specification of the '575 Patent (and its originally filed application). No new matter is added by these amendments.

Pursuant to 37 CFR §1.173(c), the following is an identification of the support for the added claims as found in the specification of the '575 Patent.

Newly Added Claim 26

26. The garment of claim 1, wherein the garment lower portion comprises denim jeans.

Column 2, lines 27-29 of the '575 Patent (for which reissue is sought) describes the claimed feature as follows: "The garment lower portion 104 comprises, for example, a pair of trousers, such as, denim jeans."

Newly Added Claim 27

27. The garment of claim 1, wherein the garment lower portion comprises a zipperless fly.

Column 2, lines 37-38 of the '575 Patent (for which reissue is sought) describes the claimed feature as follows: "For example, the front center seam 106 defines a sewn 'zipper less' fly front."

Newly Added Claim 28

28. The garment of claim 1, wherein the first torso-encircling circumference recedes downward with a parabolic shape, said parabolic shape including a shallow curvature.

Column 2, line 62 through column 3, line 2 of the '575 Patent (for which reissue is sought) describes the claimed feature as follows: "...the garment lower portion 104 provides a first torso encircling circumference 126 that recedes downward with a parabolic shape...The parabolic shape includes a shallow curvature..."

Newly Added Claim 29

29. The garment of claim 28, wherein the belly panel extends at least partially under the abdomen of the wearer to meet the parabolic receding circumference of the garment lower portion.

Column 3, lines 2-6 of the '575 Patent (for which reissue is sought) describes the claimed feature as follows: "The belly panel 124 extends at least partially under the abdomen of the garment wearer to meet and join the bottom portion 128 of the belly panel 124 with the parabolic receding circumference 126 of the garment lower portion 104."

Conclusion

As indicated above, there is support for each of the features of the claims as added by this Preliminary Amendment in the specification of US Patent No. 7,814,575 (for which reissue is now sought).

It is respectfully submitted that the claims as pending in this reissue application are in allowable form. Acceptance of all amendments and a notice of allowance are requested, followed by publication of the reissue patent.

Respectfully submitted,

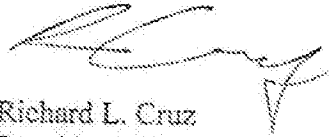

Richard L. Cruz
Reg. No. 52,783
Attorney for Applicants

RLC/mn
(215) 656-2446

IN THE UNITED STATES PATENT AND TRADEMARK OFFICE

Art Unit : Customer No. 035811
Examiner :
Serial No. :
Filed : Herewith Docket No.: DMC-10-1220RE
Reissue of Patent : 7,814,575
Issued : October 19, 2010
Inventor : Lisa A. Hendrickson
: James H. Gardner, III
: Richard Adelman
Title : BELLY COVERING
: GARMENT Date: June 15, 2011

INFORMATION DISCLOSURE STATEMENT
SUBMITTED WITH REISSUE APPLICATION

Mail Stop REISSUE
Commissioner for Patents
P.O. Box 1450
Washington, D.C. 20231-1450

Sir:

The Applicants submit herewith Form PTO-1449 together with a copy of each of the eight (8) listed non-US publications. The documents are submitted under 37 CFR §1.56 and are believed related to this application.

The Applicants respectfully request that this Information Disclosure Statement be officially entered into the file and that appropriate notification be made that it was considered by the Examiner.

Respectfully submitted,

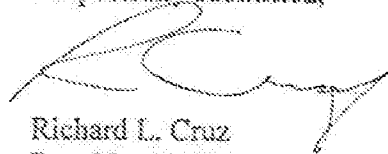

Richard L. Cruz
Reg. No. 52,783
Attorney for Applicants

RLC/nn
(215) 656-2446

IN THE UNITED STATES PATENT AND TRADEMARK OFFICE

Art Unit	:		Customer No. 035811
Examiner	:		
Serial No.	:		Docket No.: DMC-10-1220RE
Filed	:	Herewith	
<i>Reissue of Patent</i>	:	7,814,575	
<i>Issued</i>	:	October 19, 2010	
Inventor	:	Lisa A. Hendrickson	
	:	James H. Gardner, III	
	:	Richard Adelman	
Title	:	BELLY COVERING	
	:	GARMENT	

REISSUE APPLICATION OATH AND CONSENT BY THE ASSIGNEE
(Pursuant to 37 C.F.R. §1.172)

I, Ronald J. Masciantonio, a citizen of the United States, am the Senior Vice President and General Counsel of Destination Maternity Corporation ("DMC"), and as such, am authorized to act on behalf of DMC.

To the best of my knowledge and understanding, DMC is the sole assignee of the entire right, title, and interest in and to U.S. Patent No. 7,814,575 (the '575 Patent), issued on October 19, 2010.

Documentary evidence of a chain of title of the '575 Patent from the original owners to DMC is recorded in the assignment records of the US Patent and Trademark Office at Reel 019670, Frame 0495 which shows an assignment from the inventors to Mothers Work, Inc., and at Reel 023390, Frame 0079 which shows an assignment from Mothers Work, Inc. to Destination Maternity Corporation.

To the best of my knowledge and understanding, the inventors listed below to be the original and first inventors of the subject matter which is described and claimed in the '575 Patent, for which a reissue patent is sought, on the invention entitled BELLY COVERING GARMENT, the specification of which is attached hereto together with a Preliminary Amendment that includes newly added claims:

1. Lisa A. Hendrickson, a citizen of the United States, residing at 791 Cornwallis Drive, Mount Laurel, New Jersey 08054;
2. James H. Gardner, III, a citizen of the United States, residing at 1329 Squire Drive, Ambler, Pennsylvania 19002; and

3. Richard Adelman, a citizen of the United States, residing at 5 Sunfish Point, Greensboro, North Carolina 27455.

I have reviewed and understand the contents of the above-identified specification, including the claims as amended by the newly added claims referred to above.

By this declaration, DMC, assignee of the '575 Patent, hereby consents to the filing of the present application for the reissue of U.S. Patent No. 7,814,575.

To the best of my knowledge and understanding, the original '575 Patent to be wholly or partly inoperative by the reason of the patentee claiming less than it had the right to claim. For instance, the issued claims of the '575 Patent fail to explicitly recite features such as a lower garment portion that comprises denim jeans and/or a zipperless fly. All errors being corrected in the reissue application up to the time of this declaration arose without deceptive intent.

Direct all communications about the application to the address associated with Customer No. 035811. Direct all telephone calls regarding the application to Richard L. Cruz at 215-656-2446.

I acknowledge the duty to disclose information which is material to patentability as defined in 37 C.F.R. §1.56.

I hereby declare that all statements made herein of my own knowledge are true and that all statements made on information and belief are believed to be true; and further that these statements were made with the knowledge that willful false statements and the like so made are punishable by fine and imprisonment, or both, under 18 USC §1001, and that such willful false statements may jeopardize the validity of the application, any patent issuing thereon, or any patent to which this declaration is directed.

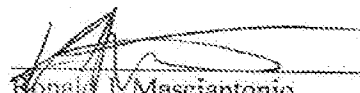

Ronald J. Masciantonio,
Senior Vice President & General Counsel
Destination Maternity Corporation
456 North 5th Street
Philadelphia, PA 19123

6/15/11

Date

Form PTO-1449 US DEPARTMENT OF COMMERCE PATENT AND TRADEMARK OFFICE	ATTY. DOCKET NO. DMC-10-1220RE	SERIAL NO.
APPLICANT Lisa A. Hendrickson, et al.		
LIST OF PUBLICATIONS CITED BY APPLICANT <i>(Use several sheets if necessary)</i>	FILING DATE herewith	GROUP

US PATENT DOCUMENTS							
EXAMINER INITIAL*		DOCUMENT NUMBER	DATE	NAME	CLASS	SUBCLASS	FILING DATE IF APPROPRIATE
	AA						
	AB						
	AC						
	AD						
	AE						
	AF						
	AG						
	AH						
	AI						
	AJ						
	AK						

FOREIGN PATENT DOCUMENTS								
		DOCUMENT NUMBER	DATE	COUNTRY	CLASS	SUBCLASS	TRANSLATION	
							YES	NO
	AL							
	AM							
	AN							
	AO							
	AP							

OTHER PUBLICATIONS (including Author, Title, Date, Pertinent Pages, Etc.)		
AR	"BOM Spring 2006" - Sketch and measurements of Gap Full Panel Long and Lean pant, Style # 376586, Gap Maternity Denim, Spring 2006.	
AS	"BOM Fall 2003" - Sketch and measurements of Old Navy Bootcut Jean w/Panel Non-Stretch pant, Style # 200963-00, Old Navy Women's Maternity, Fall 2003.	
AT	"BOM Fall 2005" - Sketch and measurements of Gap Roll Panel Modern Chino pant, Style # 313773, Gap Maternity Wovens, Fall 2005.	

EXAMINER	DATE CONSIDERED
*EXAMINER: Initial if publication considered, whether or not citation is in conformance with MPEP 609; Draw line through citation if not in conformance and not considered. Include copy of this form with next communication to Applicant.	

Form PTO-1449 US DEPARTMENT OF COMMERCE PATENT AND TRADEMARK OFFICE	ATTY. DOCKET NO. DMC-10-1226RE	SERIAL NO.
LIST OF PUBLICATIONS CITED BY APPLICANT <i>(Use several sheets if necessary)</i>		
US PATENT DOCUMENTS		

EXAMINER INITIAL*	DOCUMENT NUMBER	DATE	NAME	CLASS	SUBCLASS	FILING DATE IF APPROPRIATE
AA						
AB						
AC						
AD						
AE						
AF						
AG						
AH						
AI						
AJ						
AK						

FOREIGN PATENT DOCUMENTS							
EXAMINER INITIAL*	DOCUMENT NUMBER	DATE	COUNTRY	CLASS	SUBCLASS	TRANSLATION	
						YES	NO
AL							
AM							
AN							
AO							
AP							

OTHER PUBLICATIONS (Including Author, Title, Date, Pertinent Pages, Etc.)		
AR	"Garment Diagrams" - Sketches and measurements of various Gap and Old Navy garments, Style Nos.: 324282, 256229, 281008, 205224Su05, Fall 2004-Summer 2005.	
AS	"Poplin Pant" et al. - Maternity Print Str. Crisp Ctn. Poplin pant, Style # MBT414A (Ultra Clean Ankle Overbelly), 8/9/2002.	
AT	"Jean Pant" et al. - GAP Women's Full Panel Bootcut Jean, Style # 207095, 4/30/2003.	

EXAMINER	DATE CONSIDERED
*EXAMINER: Initial if publication considered, whether or not citation is in conformance with MPEP 609; Draw line through citation if not in conformance and not considered. Include copy of this form with next communication to Applicant.	

Form PTO-1449 US DEPARTMENT OF COMMERCE
PATENT AND TRADEMARK OFFICE

ATTY. DOCKET NO.
DMC-16-1229RE

SERIAL NO.

APPLICANT
Lisa A. Hendrickson, et al.

LIST OF PUBLICATIONS CITED BY APPLICANT
(Use several sheets if necessary)

FILING DATE
herewith

GROUP

US PATENT DOCUMENTS

EXAMINER INITIAL*	DOCUMENT NUMBER	DATE	NAME	CLASS	SUBCLASS	FILING DATE IF APPROPRIATE
AA						
AB						
AC						
AD						
AE						
AF						
AG						
AH						
AI						
AJ						
AK						

FOREIGN PATENT DOCUMENTS

	DOCUMENT NUMBER	DATE	COUNTRY	CLASS	SUBCLASS	TRANSLATION	
						YES	NO
AL							
AM							
AN							
AO							
AP							

OTHER PUBLICATIONS (Including Author, Title, Date, Pertinent Pages, Etc.)

AR	"Artifact color" - Selected pages from the JCPenney Catalog Maternity Collection, published 1Q 2004, front and back cover pages, and pages 4, 22, 30, and 32; and Selected pages from the JCPenney Catalog Maternity Collection, dated Fall/Winter 2005, front and back cover pages, and pages 14, 15, and 28.
AS	"Images from un-identified documents," (2 sheets)
AT	

EXAMINER

DATE CONSIDERED

*EXAMINER: Initial if publication considered, whether or not citation is in conformance with MPEP 609; Draw line through citation if not in conformance and not considered. Include copy of this form with next communication to Applicant.

Under the Paperwork Reduction Act of 1995, no persons are required to respond to a collection of information unless it displays a valid OMB control number.

REISSUE APPLICATION FEE TRANSMITTAL FORM

Director Number (Optional)
DMC-10-1220RE

Application as Filed - Part 1									
	(1) Claims in Patent	(2) Claims Filed in Reissue Application	(3) Number Extra	Small Entity		Other than a Small Entity		or	
				Rate (\$)	Fee (\$)	Rate (\$)	Fee (\$)		
Total Claims (37 CFR 1.18(b))	(A) 25	(B) 29	9	x	=			52.00	468.00
Independent Claims (37 CFR 1.16(b))	(C) 1	(D) 1	0	x	=			0.00	0.00
Application Size Fee (37 CFR 1.16(s))	If the specification and drawings exceed 100 sheets of paper, the application size fee due is \$270 (\$135 for small entity) for each additional 50 sheets or fraction thereof. See 35 U.S.C. 41(a)(1)(G) and 37 CFR 1.16(s).								
			Filing Fee (37 CFR 1.16(e))						330.00
			Search Fee (37 CFR 1.16(h))						540.00
			Examination Fee (37 CFR 1.16(i))						69.00
			Total Filing Fee						1988.00

Application as Amended - Part 2									
	(1) Claims Remaining After Amendment	(2) Highest Number Previously Paid For	(3) Extra Claims Present	Small Entity		Other than a Small Entity		or	
				Rate (\$)	Fee (\$)	Rate (\$)	Fee (\$)		
Total Claims (37 CFR 1.16(b))	***	MINUS	**	x	=				
Independent Claims (37 CFR 1.16(b))	***	MINUS	****	x	=				
Application Size Fee (37 CFR 1.16(s))	If the specification and drawings exceed 100 sheets of paper, the application size fee due is \$270 (\$135 for small entity) for each additional 50 sheets or fraction thereof. See 35 U.S.C. 41(a)(1)(G) and 37 CFR 1.16(s).								
			Total Additional Fee						

* Enter (D) minus 3, or enter "0" if (D) is less than 3.
 ** If the "Highest Number of Total Claims Previously Paid For" is less than 20, enter "20" in this space.
 *** After any cancellation of claims.
 **** Enter (B) - 20, or enter "0" if (B) is less than 20.
 ***** If the "Highest Number of Independent Claims Previously Paid For" is less than 3, enter "3" in this space.

- Applicant claims small entity status. See 37 CFR 1.27.
- Please charge Deposit Account No. 50-2719 in the amount of \$1988.00
- The Director is hereby authorized to charge any additional fees under 37 CFR 1.16 or 1.17 which may be required, or credit any overpayment to Deposit Account No. same
- A check in the amount of \$ _____ to cover the filing/additional fee is enclosed.
- Payment by credit card. Form PTO-2038 is attached. **WARNING:** Information on this form may become public. Credit card information should not be included on this form. Provide credit card information and authorization on PTO-2038.

Signature: [Signature] Date: June 15, 2011
 Richard L. Cruz TYPED OR PRINTED NAME: _____ Registration Number, if applicable: 52783
 Telephone Number: 215-656-2446

The collection of information is required by 37 CFR 1.06. The information is required to obtain or return a benefit by the patent, which is to be filed by the USPTO to process an application. Confidentiality is governed by 35 U.S.C. 122 and 37 CFR 1.11 and 1.14. This collection is estimated to take 12 minutes to complete, including gathering, preparing, and submitting the completed application form to the USPTO. Time will vary depending upon the individual case. Any comments on the amount of time you require to complete this form and/or suggestions for reducing this burden, should be sent to the Chief Information Officer, U.S. Patent and Trademark Office, U.S. Department of Commerce, P.O. Box 1450, Alexandria, VA 22313-1450. DO NOT SEND FEES OR COMPLETED FORMS TO THIS ADDRESS. SEND TO: Commissioner for Patents, P.O. Box 1450, Alexandria, VA 22313-1450.
 If you need assistance in completing the form, call 1-800-PTO-9199 and select option 2.

Privacy Act Statement

The Privacy Act of 1974 (P.L. 93-579) requires that you be given certain information in connection with your submission of the attached form related to a patent application or patent. Accordingly, pursuant to the requirements of the Act, please be advised that: (1) the general authority for the collection of this information is 35 U.S.C. 2(b)(2); (2) furnishing of the information solicited is voluntary; and (3) the principal purpose for which the information is used by the U.S. Patent and Trademark Office is to process and/or examine your submission related to a patent application or patent. If you do not furnish the requested information, the U.S. Patent and Trademark Office may not be able to process and/or examine your submission, which may result in termination of proceedings or abandonment of the application or expiration of the patent.

The information provided by you in this form will be subject to the following routine uses:

1. The information on this form will be treated confidentially to the extent allowed under the Freedom of Information Act (5 U.S.C. 552) and the Privacy Act (5 U.S.C. 552a). Records from this system of records may be disclosed to the Department of Justice to determine whether disclosure of these records is required by the Freedom of Information Act.
2. A record from this system of records may be disclosed, as a routine use, in the course of presenting evidence to a court, magistrate, or administrative tribunal, including disclosures to opposing counsel in the course of settlement negotiations.
3. A record in this system of records may be disclosed, as a routine use, to a Member of Congress submitting a request involving an individual, to whom the record pertains, when the individual has requested assistance from the Member with respect to the subject matter of the record.
4. A record in this system of records may be disclosed, as a routine use, to a contractor of the Agency having need for the information in order to perform a contract. Recipients of information shall be required to comply with the requirements of the Privacy Act of 1974, as amended, pursuant to 5 U.S.C. 552a(m).
5. A record related to an International Application filed under the Patent Cooperation Treaty in this system of records may be disclosed, as a routine use, to the International Bureau of the World Intellectual Property Organization, pursuant to the Patent Cooperation Treaty.
6. A record in this system of records may be disclosed, as a routine use, to another federal agency for purposes of National Security review (35 U.S.C. 181) and for review pursuant to the Atomic Energy Act (42 U.S.C. 218(c)).
7. A record from this system of records may be disclosed, as a routine use, to the Administrator, General Services, or his/her designee, during an inspection of records conducted by GSA as part of that agency's responsibility to recommend improvements in records management practices and programs, under authority of 44 U.S.C. 2904 and 2906. Such disclosure shall be made in accordance with the GSA regulations governing inspection of records for this purpose, and any other relevant (*i.e.*, GSA or Commerce) directive. Such disclosure shall not be used to make determinations about individuals.
8. A record from this system of records may be disclosed, as a routine use, to the public after either publication of the application pursuant to 35 U.S.C. 122(b) or issuance of a patent pursuant to 35 U.S.C. 151. Further, a record may be disclosed, subject to the limitations of 37 CFR 1.14, as a routine use, to the public if the record was filed in an application which became abandoned or in which the proceedings were terminated and which application is referenced by either a published application, an application open to public inspection or an issued patent.
9. A record from this system of records may be disclosed, as a routine use, to a Federal, State, or local law enforcement agency, if the USPTO becomes aware of a violation or potential violation of law or regulation.

Electronic Patent Application Fee Transmittal

Application Number:				
Filing Date:				
Title of Invention:	Belly Covering Garment			
First Named Inventor/Applicant Name:	Lisa A. Hendrickson			
Filer:	Paul A. Taufer/Nancy Nunez			
Attorney Docket Number:	DMC-10-1220RE			
Filed as Large Entity				
Reissue (Utility) Filing Fees				
Description	Fee Code	Quantity	Amount	Sub-Total in USD(\$)
Basic Filing:				
Utility Reissue Basic	1014	1	330	330
Design and utility Reissue Basic	1114	1	540	540
Design and utility Reissue Basic	1314	1	650	650
Pages:				
Claims:				
Reissue claims in excess of 20 for large	1205	9	52	468
Miscellaneous-Filing:				
Petition:				

Description	Fee Code	Quantity	Amount	Sub-Total in USD(\$)
Patent-Appeals-and-Interference:				
Post-Allowance-and-Post-Issuance:				
Extension-of-Time:				
Miscellaneous:				
Total in USD (\$)				1988

Electronic Acknowledgement Receipt

EFS ID:	10312468
Application Number:	13161138
International Application Number:	
Confirmation Number:	4808
Title of Invention:	Belly Covering Garment
First Named Inventor/Applicant Name:	Lisa A. Hendrickson
Customer Number:	35811
Filer:	Paul A. Taufer/Nancy Nunez
Filer Authorized By:	Paul A. Taufer
Attorney Docket Number:	DMC-10-1220RE
Receipt Date:	15-JUN-2011
Filing Date:	
Time Stamp:	16:48:48
Application Type:	Reissue (Utility)

Payment information:

Submitted with Payment	yes
Payment Type	Deposit Account
Payment was successfully received in RAM	\$1988
RAM confirmation Number	3666
Deposit Account	502719
Authorized User	

The Director of the USPTO is hereby authorized to charge indicated fees and credit any overpayment as follows:

Charge any Additional Fees required under 37 C.F.R. Section 1.16 (National application filing, search, and examination fees)

Charge any Additional Fees required under 37 C.F.R. Section 1.17 (Patent application and reexamination processing fees)

Target Corporation

Charge any Additional Fees required under 37 C.F.R. Section 1.19 (Document supply fees)

Charge any Additional Fees required under 37 C.F.R. Section 1.20 (Post Issuance fees)

Charge any Additional Fees required under 37 C.F.R. Section 1.21 (Miscellaneous fees and charges)

File Listing:

Document Number	Document Description	File Name	File Size(Bytes)/ Message Digest	Multi Part /.zip	Pages (if appl.)
1	Transmittal Reissue Application	ReissuePatentApplnTrans.pdf	605534 4ff93990ea0cafab974c307684c2ec83320b06b	no	2

Warnings:

Information:

2	Transmittal Reissue Application	ReissueApplnTransLet.pdf	242781 6c2a36d1aebb393144e970bc0adb40898eafffe85	no	2
---	---------------------------------	--------------------------	-----------------------------------------------------	----	---

Warnings:

Information:

3		7814575.pdf	512437 7cd00f21b21dafc12f4384c2e92bce26b61c4d8	yes	12
---	--	-------------	---------------------------------------------------	-----	----

Multipart Description/PDF files in .zip description

Document Description	Start	End
Abstract	1	1
Drawings-only black and white line drawings	2	9
Specification	10	11
Claims	12	12

Warnings:

Information:

4		PreliminaryAmendmt.pdf	1438762 9d8239bc1e168b914df685753335f2e985e6bc73	yes	9
---	--	------------------------	-----------------------------------------------------	-----	---

Multipart Description/PDF files in .zip description

Document Description	Start	End
Preliminary Amendment	1	1
Claims	2	6
Applicant Arguments/Remarks Made in an Amendment	7	9

Warnings:

Information:					
5	Consent of Assignee accompanying the declaration	ReissueApplnOathandConsent.pdf	443210 b1e7388080b00c2ce93da03709e3d043712f8e76	no	2
Warnings:					
Information:					
6		IDSand1449.pdf	857836 7bac500133871981d08b709c5fe0473b02e3e8d	yes	4
	Multipart Description/PDF files in .zip description				
	Document Description		Start	End	
	Transmittal Letter		1	1	
	Information Disclosure Statement (IDS) Form (SB08)		2	4	
Warnings:					
Information:					
7	Non Patent Literature	Artifactcolor.pdf	1225962 1e38e630d1574ffb58b79b25e109a57216dbac12	no	11
Warnings:					
Information:					
8	Non Patent Literature	ImagesUnidentifiedDocs.pdf	178121 4cae254f71b44278adcd7e306d460275bfd99e36	no	2
Warnings:					
Information:					
9	Non Patent Literature	JeanPant.pdf	1081215 304d78ed3ef63d17d717f1177ce2c22e1f691950	no	3
Warnings:					
Information:					
10	Non Patent Literature	PoplinPant.pdf	1029203 e3dd5f0edb07442d476ee9fc28ff84694aafc084	no	3
Warnings:					
Information:					
11	Non Patent Literature	GarmentDiagrams.pdf	674938 57d28ee396ba73828709bd28d6f2074dbf8c1df5	no	5
Warnings:					
Information:					

12	Non Patent Literature	BOMFall2003.pdf	755998 a486fbd23a580d7a4931e09c90c633070e1394d4	no	5
Warnings:					
Information:					
13	Non Patent Literature	BOMFall2005.pdf	146206 aca7798fa18d908efa126f220209edb8f7874402	no	1
Warnings:					
Information:					
14	Non Patent Literature	BOMSpring2006.pdf	1104613 d2a248183d736434549e76b31d9a56b3d79c160b	no	9
Warnings:					
Information:					
15	Fee Worksheet (SB06)	ReissueApplnFeeTransForm.pdf	603442 d110f7de510904bf3265258e19a8ee3faed84415	no	2
Warnings:					
Information:					
16	Fee Worksheet (SB06)	fee-info.pdf	36400 a905d8396bd46bb9f650e89bcef12c03f462de35	no	2
Warnings:					
Information:					
Total Files Size (in bytes):				10936658	

This Acknowledgement Receipt evidences receipt on the noted date by the USPTO of the indicated documents, characterized by the applicant, and including page counts, where applicable. It serves as evidence of receipt similar to a Post Card, as described in MPEP 503.

New Applications Under 35 U.S.C. 111

If a new application is being filed and the application includes the necessary components for a filing date (see 37 CFR 1.53(b)-(d) and MPEP 506), a Filing Receipt (37 CFR 1.54) will be issued in due course and the date shown on this Acknowledgement Receipt will establish the filing date of the application.

National Stage of an International Application under 35 U.S.C. 371

If a timely submission to enter the national stage of an international application is compliant with the conditions of 35 U.S.C. 371 and other applicable requirements a Form PCT/DO/EO/903 indicating acceptance of the application as a national stage submission under 35 U.S.C. 371 will be issued in addition to the Filing Receipt, in due course.

New International Application Filed with the USPTO as a Receiving Office

If a new international application is being filed and the international application includes the necessary components for an international filing date (see PCT Article 11 and MPEP 1810), a Notification of the International Application Number and of the International Filing Date (Form PCT/RO/105) will be issued in due course, subject to prescriptions concerning national security, and the date shown on this Acknowledgement Receipt will establish the international filing date of the application.

Production

Sketch Page-Back

Gap	Style #: 376586	Description: FULL PANEL LONG AND LEAN	
Maternity	Pattern #:		
Denim	NY Design # TGD515F4	Date Created: Jul 29-2005	
Spring 2006	Delivery:	Date Modified: Nov 16-2005	

Comment:

Sketch: Gap Maternity/Denim/Spring 2006/Production/376586.dwg

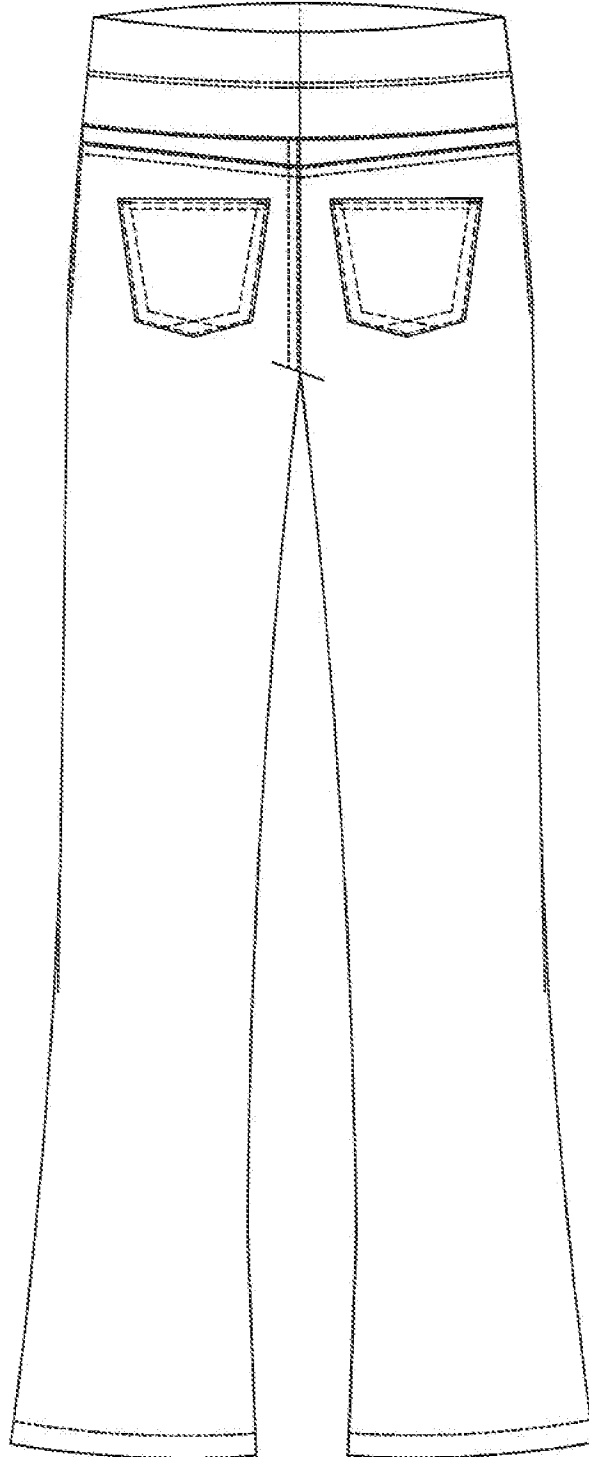

Production

Measurement WorkSheet (2)

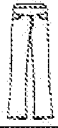
Gap	Style #: 376586	Description: FULL PANEL LONG AND LEAN	
Maternity	Pattern #:		
Denim	NY Design # TGD515F4	Date Created: Jul 29-2005	
Spring 2006	Delivery:	Date Modified: Nov 16-2005	

Sketch: nity/Denim/Spring 2006/Production/376586.dwg | Sketch: nity/Denim/Spring 2006/Production/376586.dwg | Sketch: nity/Wovens/Ongoing/Production/full Panel.dwg

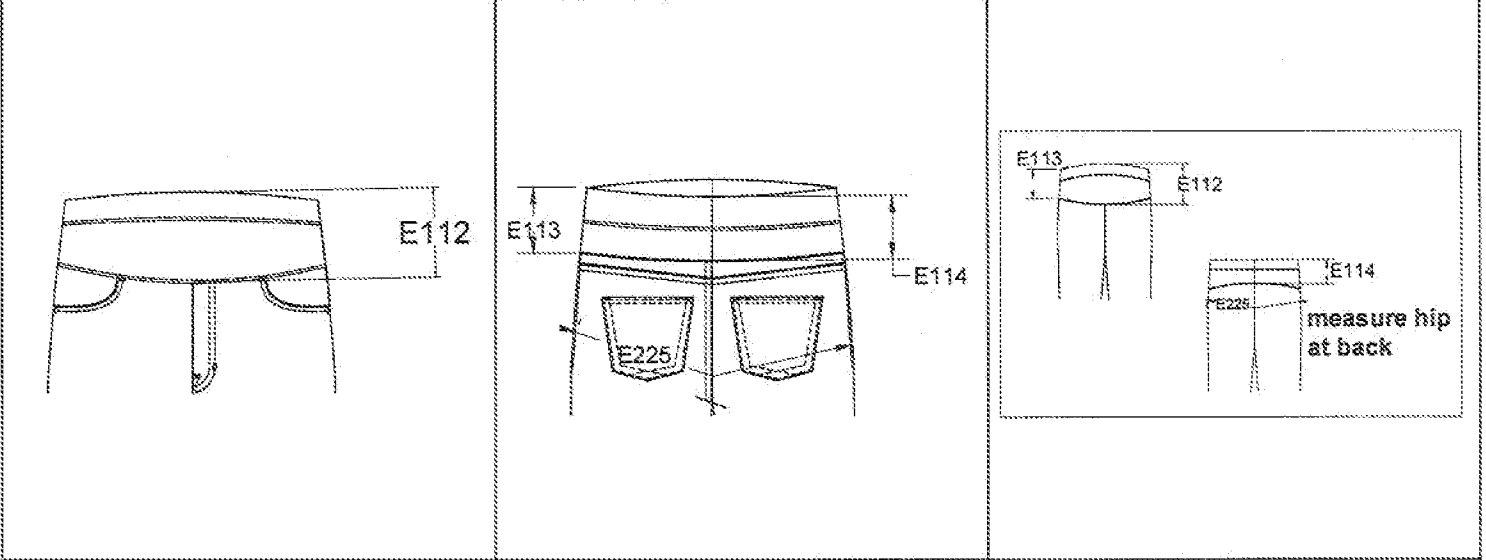

Size Class: Gap Maternity Numeric Sample Size: 8
 Size Range: 0-20 UOM: Inch
 Product Type: Gap Woven Bottoms Measurement Type: Finished Garment Measurements

POM	DESCRIPTION	TOL (+)	TOL (-)	00	0	1	2	4	6	8	10
-----	-------------	---------	---------	----	---	---	---	---	---	---	----

E112	*Panel Height at CF from Top Edge	1/4	1/4	0	0	0	0	0	0	9	0
E113	*Panel Height at SS from Top Edge	1/4	1/4	0	0	0	0	0	0	4 1/2	0
E114	*Panel Height at CB from Top Edge	1/4	1/4	0	0	0	0	0	0	3 3/4	0

Measurement WorkSheet (2)

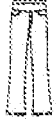
Production	Gap	Style #: 376586	Description: FULL PANEL LONG AND LEAN	
Maternity		Pattern #:		
Denim		NY Design # TGD515F4	Date Created: Jul 29-2005	
Spring 2006		Delivery:	Date Modified: Nov 16-2005	

Sketch: nity/Denim/Spring 2006/Production/376586.dwg Sketch: nity/Denim/Spring 2006/Production/376586.dwg Sketch: nity/Wovens/Ongoing/Production/full Panel.dwg

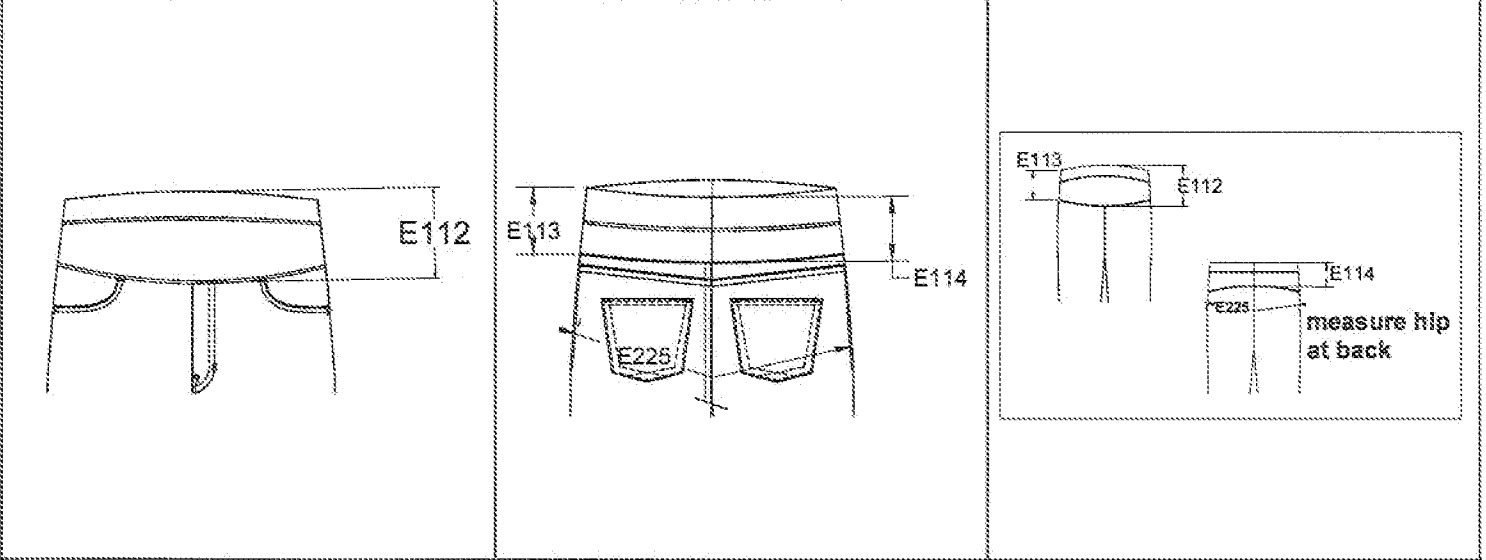

Size Class: Gap Maternity Numeric **Sample Size:** 8
Size Range: 0-20 **UOM:** Inch
Product Type: Gap Woven Bottoms **Measurement Type:** Finished Garment Measurements

POM	DESCRIPTION	TOL (+)	TOL (-)	12	14	16	18	20	22	24
-----	-------------	---------	---------	----	----	----	----	----	----	----

E112	*Panel Height at CF from Top Edge	1/4	1/4	0	0	0	0	0	0	0
E113	*Panel Heights at SS from Top Edge	1/4	1/4	0	0	0	0	0	0	0
E114	*Panel Height at CB from Top Edge	1/4	1/4	0	0	0	0	0	0	0

Production

Calculated Measurement (2)

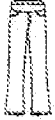
Gap	Style #: 376586	Description: FULL PANEL LONG AND LEAN	
Maternity	Pattern #:		
Denim	NY Design # TGD515F4	Date Created: Jul 29-2005	
Spring 2006	Delivery:	Date Modified: Nov 16-2005	

POM	DESCRIPTION	TOL (+)	TOL (-)	0	1	2	4	6	8	10	12
-----	-------------	---------	---------	---	---	---	---	---	---	----	----

E112	*Panel Height at CF from Top Edge	1/4	1/4	9	9	9	9	9	9	9	9
E113	*Panel Height at SS from Top Edge	1/4	1/4	4 1/2	4 1/2	4 1/2	4 1/2	4 1/2	4 1/2	4 1/2	4 1/2
E114	*Panel Height at CB from Top Edge	1/4	1/4	3 1/4	3 1/4	3 1/4	3 1/4	3 1/4	3 1/4	3 1/4	3 1/4

Production

Calculated Measurement (2)

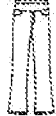
Gap	Style #: 376586	Description: FULL PANEL LONG AND LEAN	
Maternity	Pattern #:		
Denim	NY Design # TGD515F4	Date Created: Jul 29-2005	
Spring 2006	Delivery:	Date Modified: Nov 16-2005	

POM	DESCRIPTION	TOL (+)	TOL (-)	14	16	18	20
-----	-------------	---------	---------	----	----	----	----

E112	*Panel Height at CF from Top Edge	1/4	1/4	9	9	9	9
E113	*Panel Height at SS from Top Edge	1/4	1/4	4 1/2	4 1/2	4 1/2	4 1/2
E114	*Panel Height at CB from Top Edge	1/4	1/4	3 1/4	3 1/4	3 1/4	3 1/4

Production

Measurement Verification (2) - 1st Fit

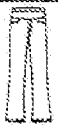
Gap	Style #: 376586	Description: FULL PANEL LONG AND LEAN	
Maternity	Pattern #:		
Denim	NY Design # TGD515P4	Date Created: Jul 29-2005	
Spring 2006	Delivery:	Date Modified: Nov 16-2005	

Sketch: nity/Denim/Spring 2006/Production/376586.dwg Sketch: nity/Denim/Spring 2006/Production/376586.dwg Sketch: nity/Wovens/Ongoing/Production/full Panel.dwg

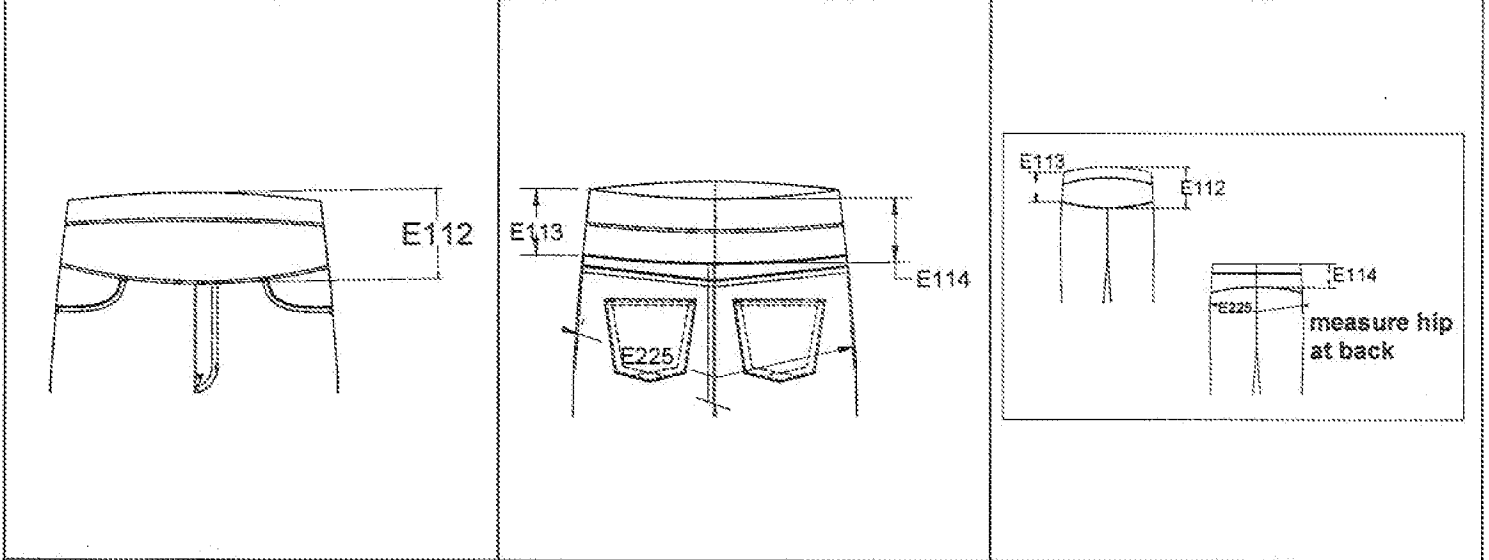

Size Class: Gap Maternity Numeric Sample Size: 8
 Size Range: 0-20 UOM: inch
 Product Type: Gap Woven Bottoms Measurement Type: Finished Garment Measurements

POM	DESCRIPTION	TOL (+)	TOL (-)	0	1	2	4
-----	-------------	---------	---------	---	---	---	---

E112	*Panel Height at CF from Top Edge	1/4	1/4	9	9	9	9
E113	*Panel Height at SS from Top Edge	1/4	1/4	4 1/2	4 1/2	4 1/2	4 1/2
E114	*Panel Height at CB from Top Edge	1/4	1/4	3 1/4	3 1/4	3 1/4	3 1/4

Production

Measurement Verification (2) - 1st Fit

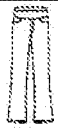
Gap	Style #: 376586	Description: FULL PANEL LONG AND LEAN	
Maternity	Pattern #:		
Denim	NY Design # TGD515F4	Date Created: Jul 29-2005	
Spring 2006	Delivery:	Date Modified: Nov 16-2005	

Sketch: nity/Denim/Spring 2006/Production/376586.dwg | Sketch: nity/Denim/Spring 2006/Production/376586.dwg | Sketch: mity/Wovens/Ongoing/Production/full Panel.dwg

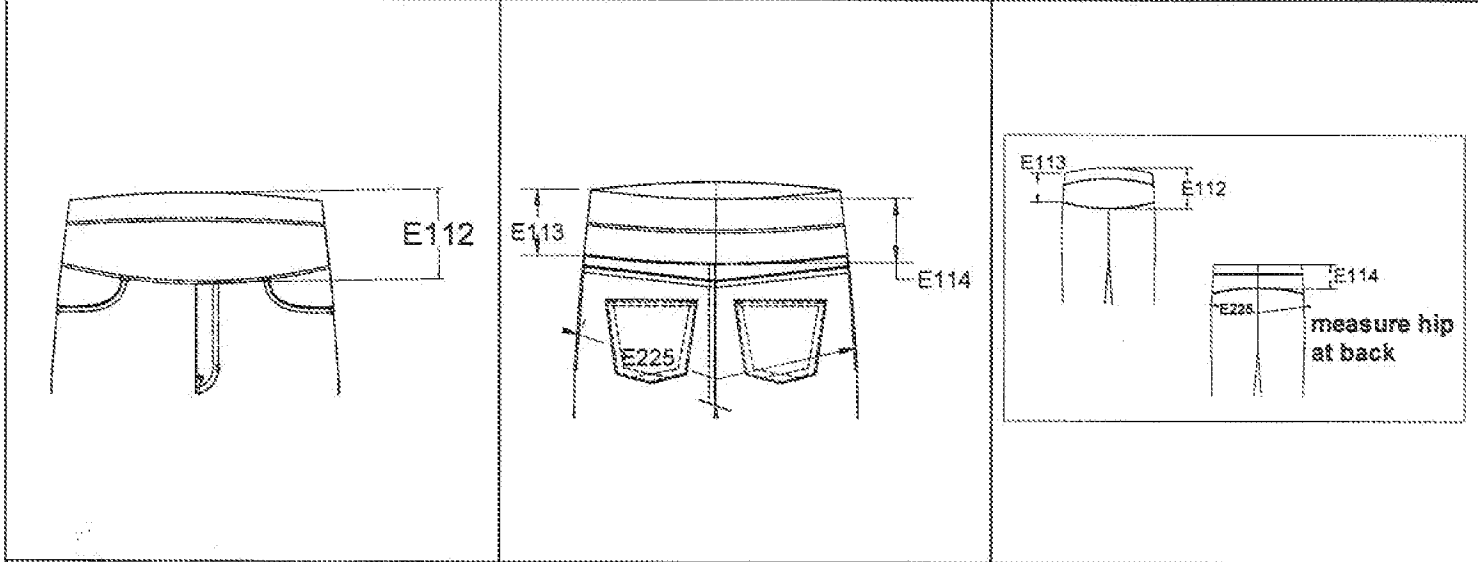

Size Class: Gap Maternity Numeric	Sample Size: 8
Size Range: 0-20	UOM: Inch
Product Type: Gap Woven Bottoms	Measurement Type: Finished Garment Measurements

POM	DESCRIPTION	TOL (+)	TOL (-)	6	8	10	12
-----	-------------	---------	---------	---	---	----	----

E112	*Panel Height at CF from Top Edge	1/4	1/4	9	9	9	9
E113	*Panel Height at SS from Top Edge	1/4	1/4	4 1/2	4 1/2	4 1/2	4 1/2
E114	*Panel Height at CB from Top Edge	1/4	1/4	3 1/4	3 1/4	3 1/4	3 1/4

Production **Measurement Verification (2) - 1st Fit**

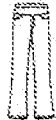
Gap	Style #: 376586	Description: FULL PANEL LONG AND LEAN	
Maternity	Pattern #:		
Denim	NY Design # TGD515F4	Date Created: Jul 29-2005	
Spring 2006	Delivery:	Date Modified: Nov 16-2005	

Sketch: nity/Denim/Spring 2006/Production/376586.dwg | Sketch: nity/Denim/Spring 2006/Production/376586.dwg | Sketch: nity/Wovens/Ongoing/Production/full Panel dw

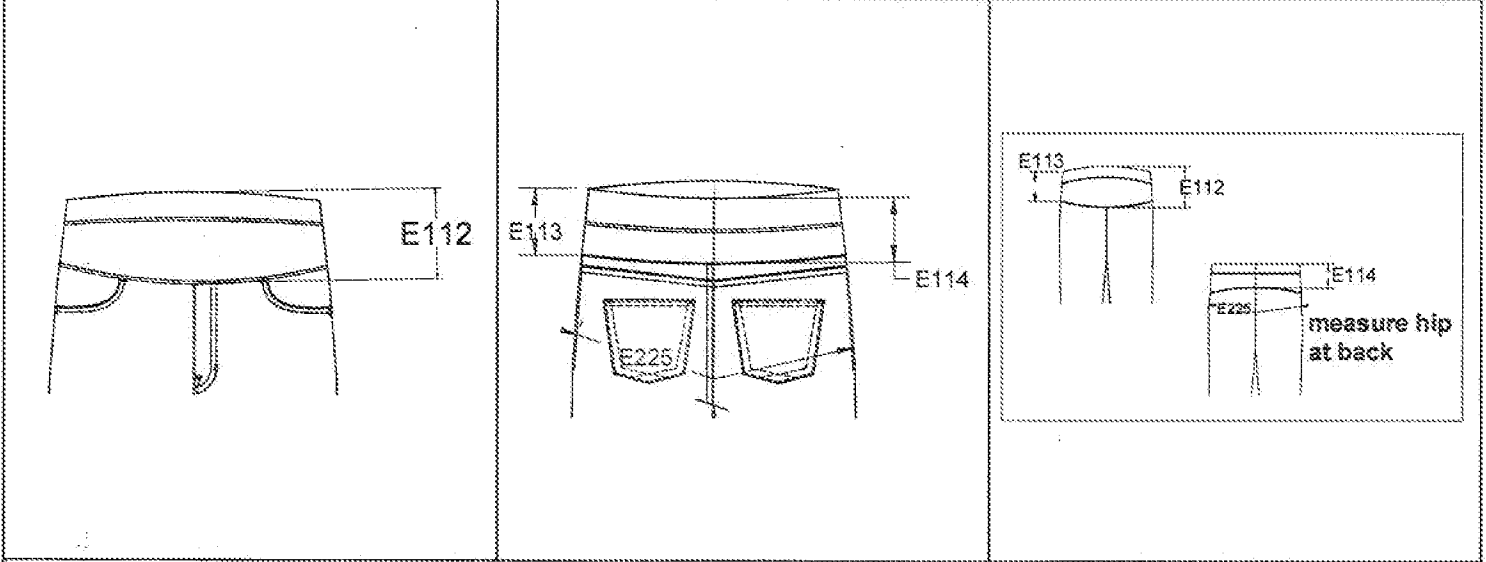

Size Class: Gap Maternity Numeric Sample Size: 8
 Size Range: 0-20 UOM: Inch
 Product Type: Gap Woven Bottoms Measurement Type: Finished Garment Measurements

POM	DESCRIPTION	TOL (+)	TOL (-)	14	16	18
-----	-------------	---------	---------	----	----	----

E112	*Panel Height at CF from Top Edge	1/4	1/4	9	9	9
E113	*Panel Height at SS from Top Edge	1/4	1/4	4.5	4.5	4.5
E114	*Panel Height at CB from Top Edge	1/4	1/4	3 1/4	3 1/4	3 1/4

Production

Calculated Measurement (2)

Gap	Style #: 313773	Description: Roll Panel Modern Chino	
Maternity	Pattern #: 313773		
Wovens	NY Design # TGB014F3	Date Created: Feb 08-2005	
Fall 2005	Delivery:	Date Modified: Mar 25-2005	

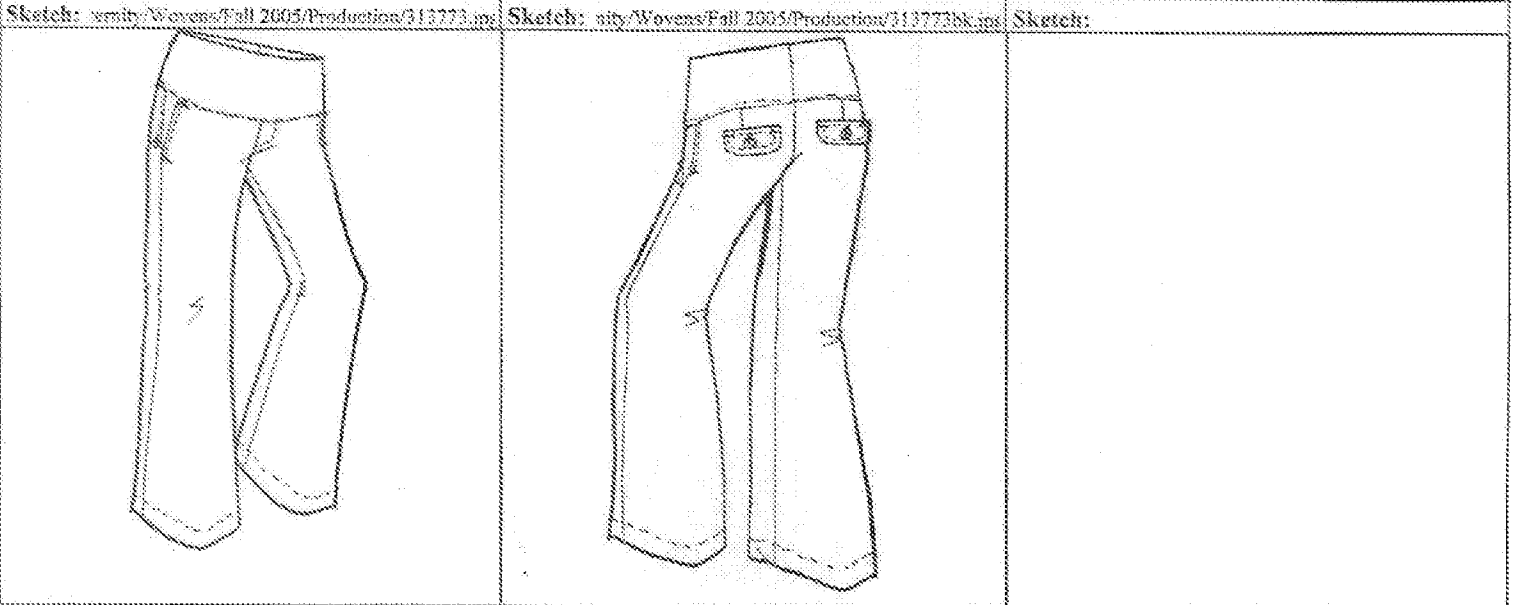

Size Class: Gap Maternity Numeric	Sample Size: 8
Size Range: 0-20	UOM: Inch
Product Type: Gap Woven Bottoms	Measurement Type: Finished Garment Measurements

POM	DESCRIPTION	TOL (+)	TOL (-)	0	1	2	4	6	8	10	12
E112	*Panel Height at CF from Top Edge	1/4	1/4	6	6	6	6	6	6	6	6
E113	*Panel Height at Sideseam from Top Edge	1/4	1/4	6	6	6	6	6	6	6	6
E114	*Panel Height at CB from Top Edge	1/4	1/4	6	6	6	6	6	6	6	6

Sketch Page-Front

Production

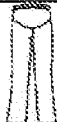
Old_Navy	Style #: 200963-00	Description: BOOYCUT JEAN W/ PANEL NON-STRETCH	
Womens	Pattern #: 200963		
Maternity	NY Design # GPM03M	Date Created: Dec 27-2002	
Fall 2003	Delivery:	Date Modified: Nov 17-2003	

Comment:		BestSeller
----------	--	------------

Vendor	Status	Date	Vendor	Status	Date
TAINAN ENTERPRISES CO LTD	Final	Mar 05-03			
TAINAN ENTERPRISES CO LTD	Final	Nov 17-03			

Sketch: Old_Navy_Womens/Maternity/Fall 2003/Production/200963-00.dwg

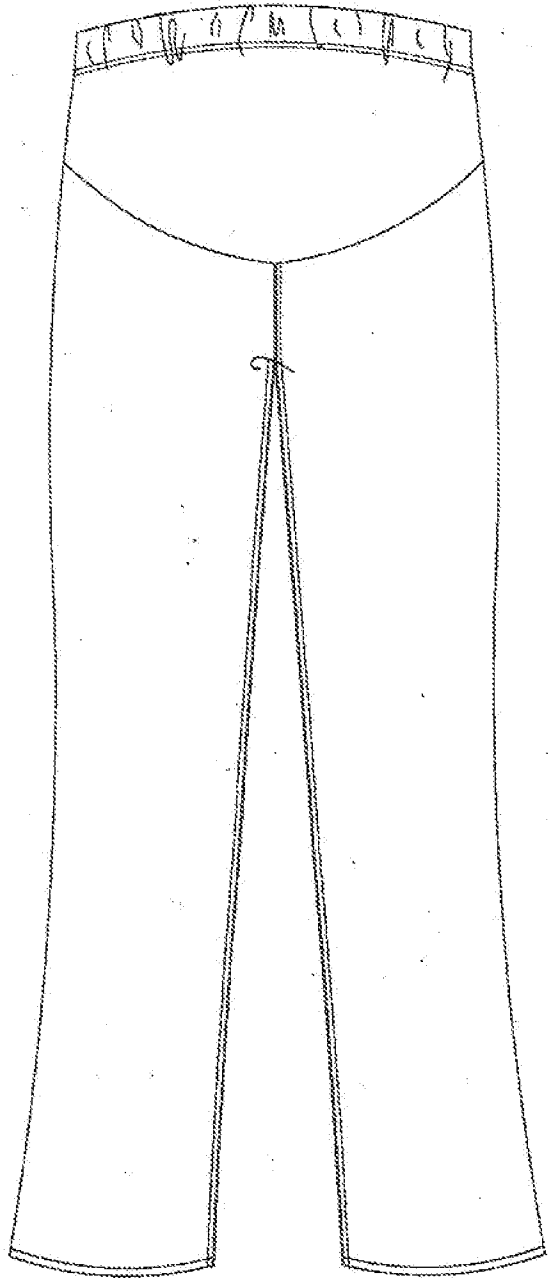

Production

Measurement WorkSheet (2)

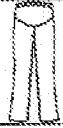
Old_Navy	Style #: 200963-00	Description: BOOTCUT JEAN W/PANEL NON-STRETCH	
Womens	Pattern #: 200963		
Maternity	NY Design # GPM03M	Date Created: Dec 27-2002	
Fall 2003	Delivery:	Date Modified: Nov 17-2003	

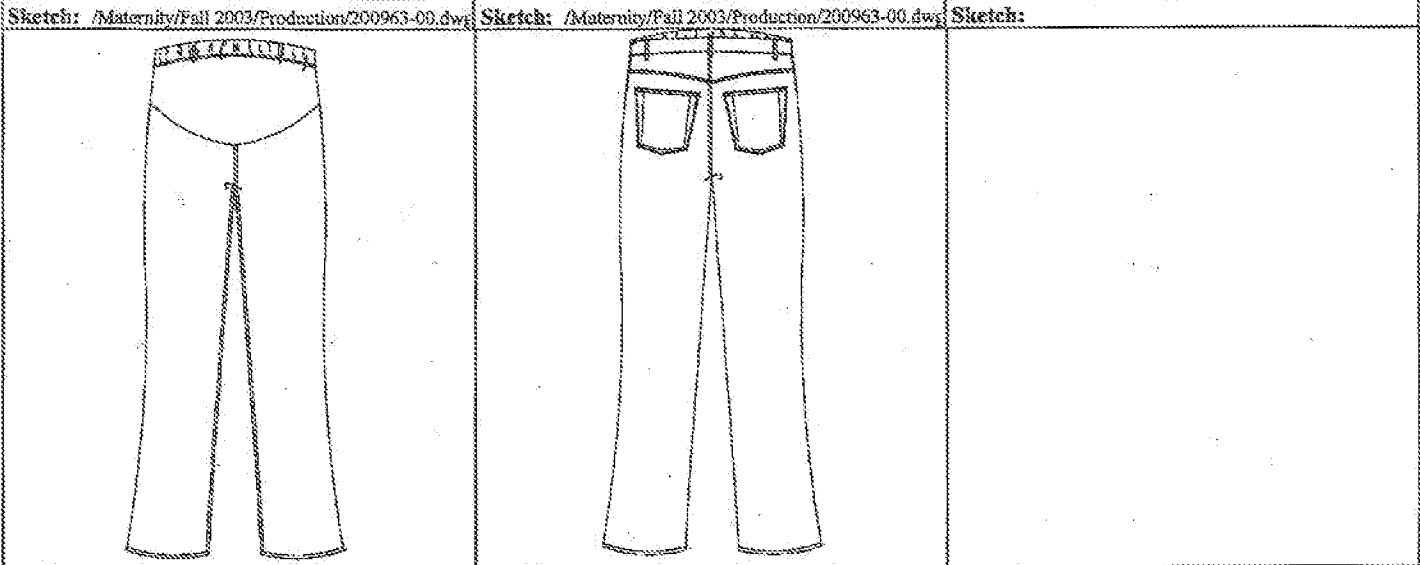

Size Class: Old Navy Women's Alpha	Sample Size: M
Size Range: XS-XL	UOM: Inch
Product Type: Old Navy Woven Bottoms	Measurement Type: Finished Garment Measurements

POM	DESCRIPTION	TOL (+)	TOL (-)	XXS	XS	S	M	L	XL	XXL	XXXL
E112	*Panel Height at CF from Top Edge-Maternity	1/4	1/4		- 3/8	- 3/8	9 1/2	3/8	3/8	3/8	
E113	Panel Height at Side Seam frm Top Edge-Mat	1/4	1/4		0	0	2 1/2	0	0	0	

Production

Calculated Measurement (2)

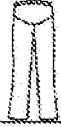
Old Navy	Style #: 200963-00	Description: BOGTCUT JEAN W/PANEL NON-STRETCH	
Womens	Pattern #: 200963		
Maternity	NY Design # GPM03M	Date Created: Dec 27-2002	
Fall 2003	Delivery:	Date Modified: Nov 17-2003	

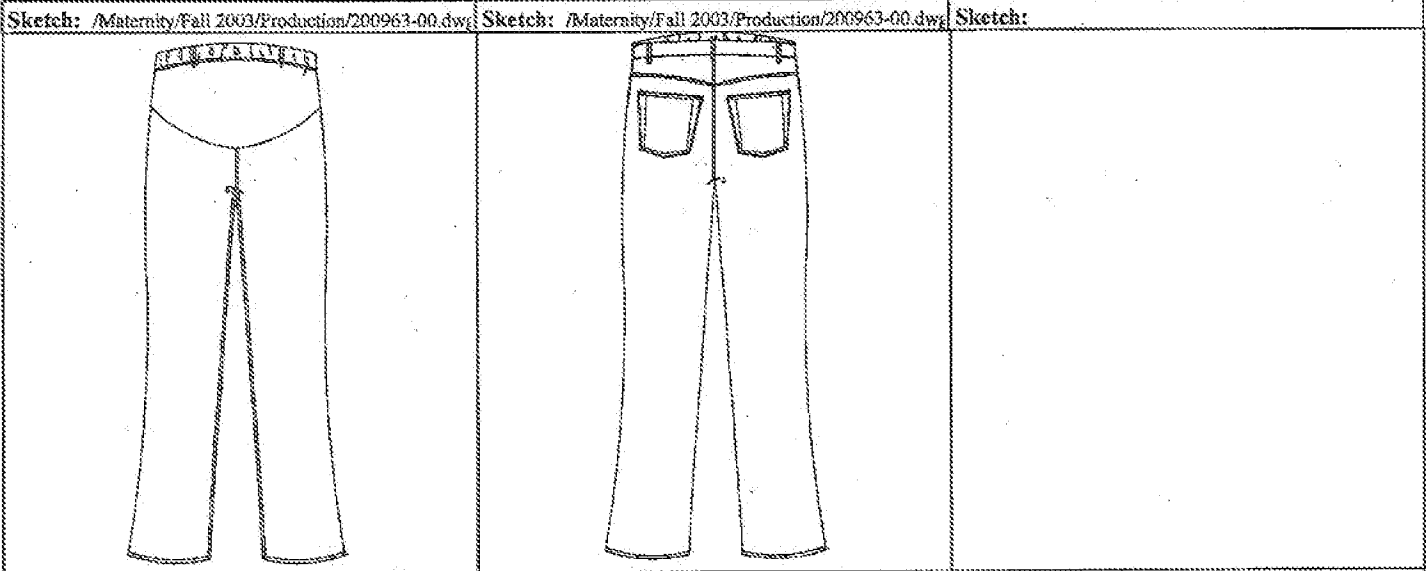

Size Class: Old Navy Women's Alpha	Sample Size: M
Size Range: XS-XL	UOM: Inch
Product Type: Old Navy Woven Bottoms	Measurement Type: Finished Garment Measurements

POM	DESCRIPTION	TOL (+)	TOL (-)	XS	S	M	L	XL
-----	-------------	---------	---------	----	---	---	---	----

E112	*Panel Height at CF from Top Edge-Maternity	1/4	1/4	8 3/4	9 1/8	9 1/2	9 7/8	10 1/4
E113	Panel Height at Side Seam from Top Edge-Mat	1/4	1/4	2 1/2	2 1/2	2 1/2	2 1/2	2 1/2

Measurement Verification (2) - 1st Fit

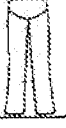
Production	Style #: 200963-00	Description: BOOTCUT JEAN W/ PANEL NON-STRETCH	
Old_Navy	Pattern #: 200963	Date Created: Dec 27-2002	
Womens	NY Design # GPM03M	Date Modified: Nov 17-2003	
Maternity	Delivery:		
Fall 2003			

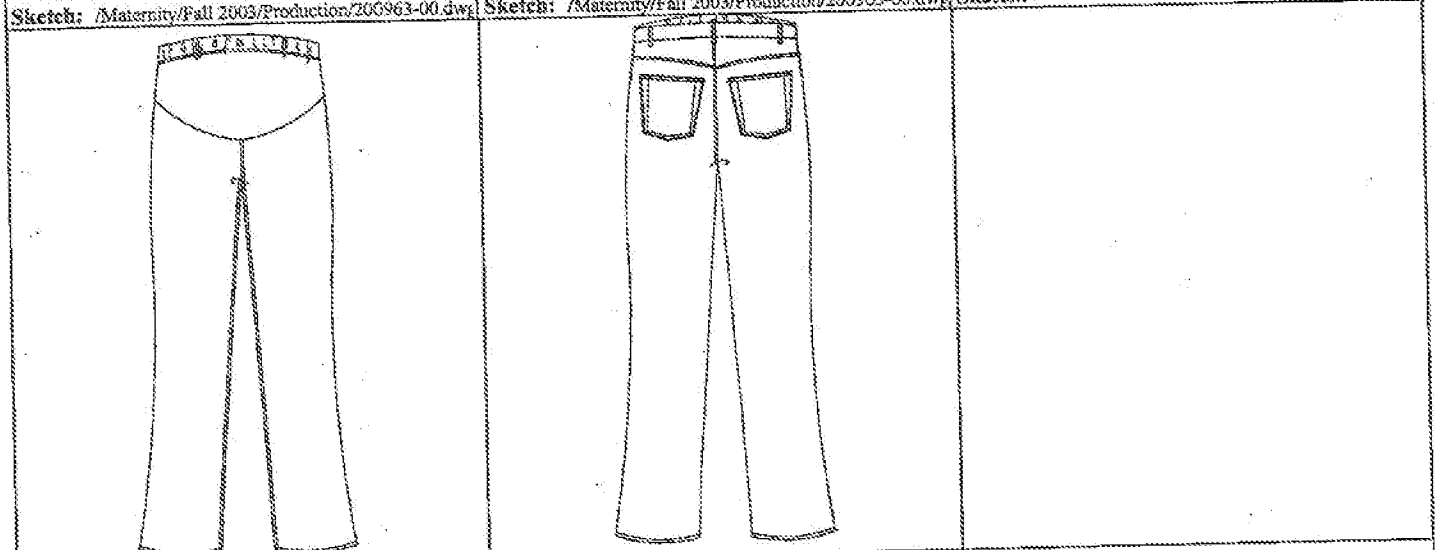

Size Class: Old Navy Women's Alpha Sample Size: M
 Size Range: XS-XL UOM: Inch
 Product Type: Old Navy Woven Bottoms Measurement Type: Finished Garment Measurements

POM	DESCRIPTION	TOL (+)	TOL (-)	XS	S	M	L
E112	*Panel Height at CF from Top Edge-Maternity	1/4	1/4	8 3/4	9 1/8	9 1/2	9 7/8
E113	Panel Height at Side Seam from Top Edge-Mat	1/4	1/4	2 1/2	2 1/2	2 1/2	2 1/2

Measurement Verification (2) - 1st Fit

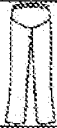
Production Old_Navy Womens Maternity Fall 2003	Style #: 200963-00 Pattern #: 200963 NY Design # GPM03M Delivery:	Description: BOOTCUT JEAN W/PANEL NON-STRETCH Date Created: Dec 27-2002 Date Modified: Nov 17-2003	
-------------------------------------------------------------------	----------------------------------------------------------------------------	-------------------------------------------------------------------------------------------------------------	-------------------------------------------------------------------------------------

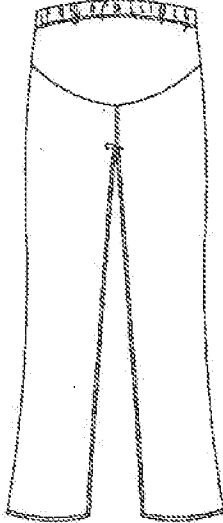
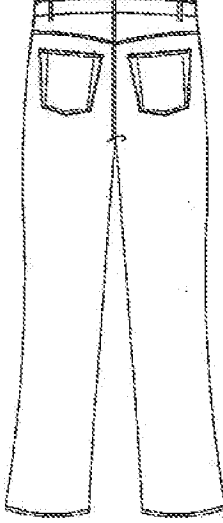
Sketch: /Maternity/Fall 2003/Production/200963-00.dwg	Sketch: /Maternity/Fall 2003/Production/200963-00.dwg	Sketch:
		

Size Class: Old Navy Women's Alpha	Sample Size: M
Size Range: XS-XL	UOM: Inch
Product Type: Old Navy Woven Bottoms	Measurement Type: Finished Garment Measurements

POM	DESCRIPTION	TOL (+)	TOL (-)	XL
E112	*Panel Height at CF from Top Edge-Maternity	1/4	1/4	10 1/4
E113	Panel Height at Side Seam from Top Edge-Mate	1/4	1/4	2 1/2





Division

MPA Technology

GIS

NY

288

Mill

620 7006 5

Article Number/Name

Print Str Crisp Chn. Poplin
Color Name/Number: WHITE / BLACK

Fusible

Factory

Syng MDT 1144

City Dimension Ultra (USA)

PAKED OVERBLEN

Mill

620 7006 5 8/9/03



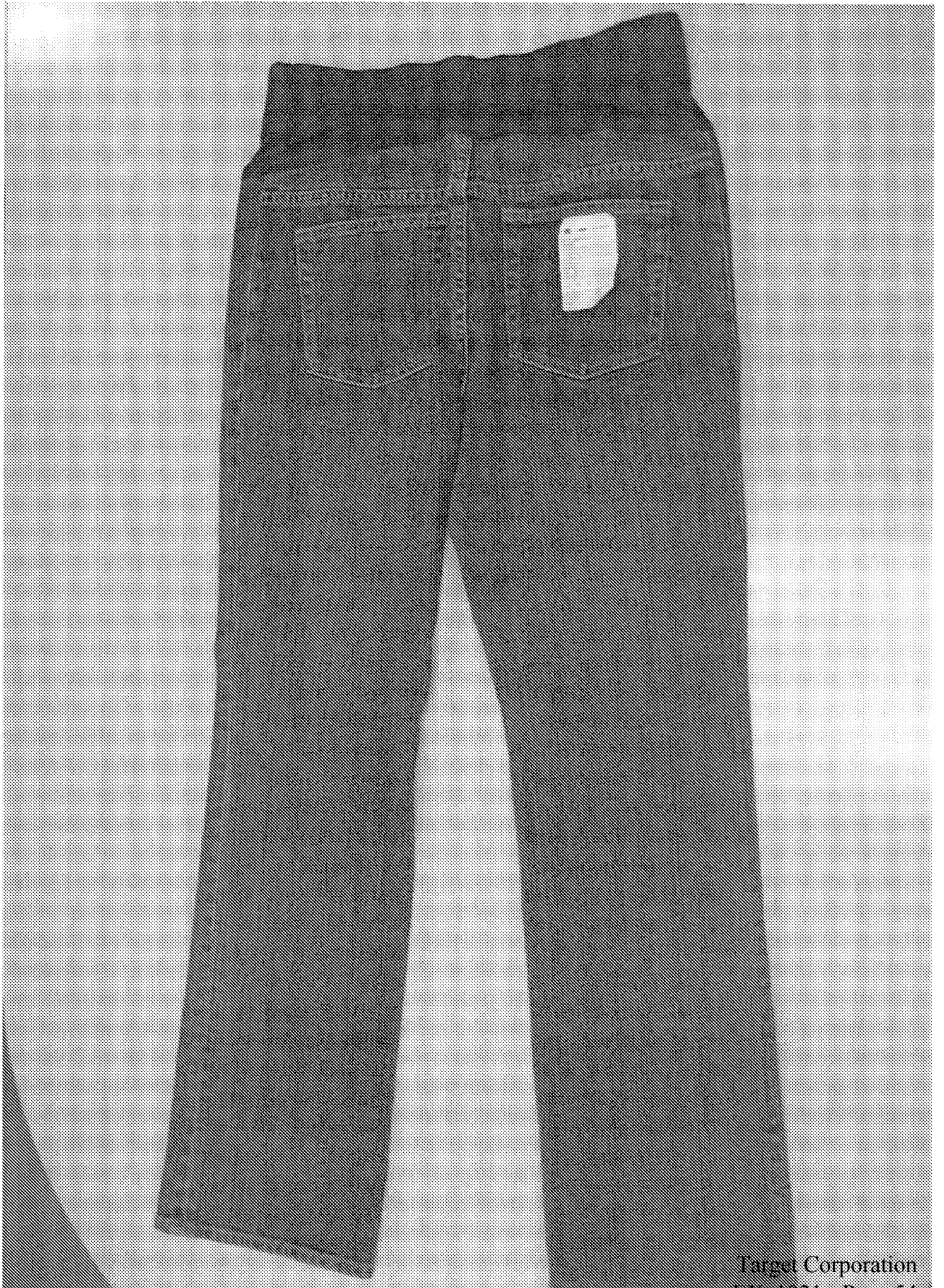

MINI **OLD NAVY** **HANNAH REPUBLIC**

DEPT WOMEN

VENDOR _____

SEASON FALL

STYLE NO 207075

DESC FULL PANEL BOOTCUT JEAN

COLOR _____

WEIGHT _____

SIZE 4

REMARKS NY PR

DATE 20 APR 03

- CONFIRMATION SAMPLE
- DEVELOPMENT
- FIT TRIAL SAMPLE
- PROTO
- SHIPMENT
- AD

OTHERS _____

Designed by 1102

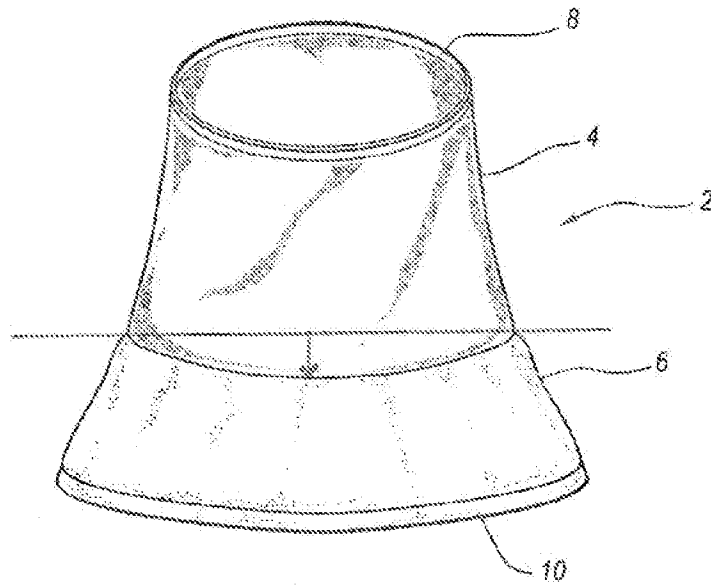

FIG. 1

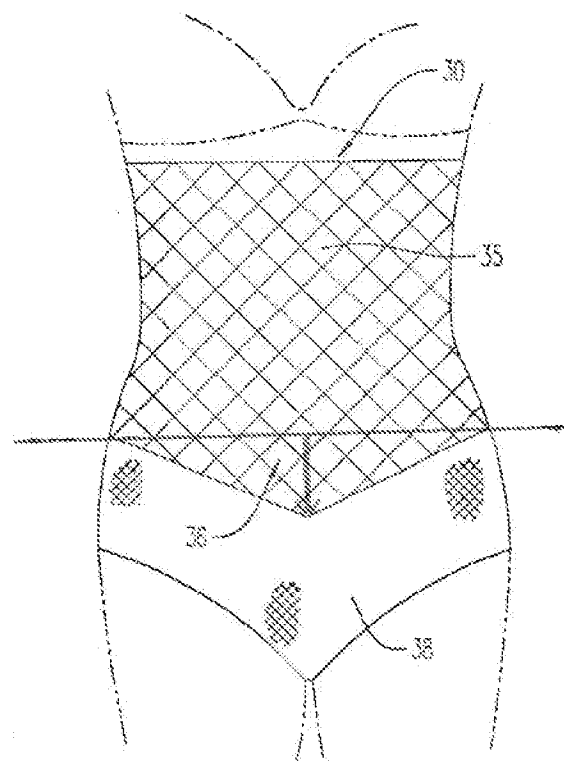
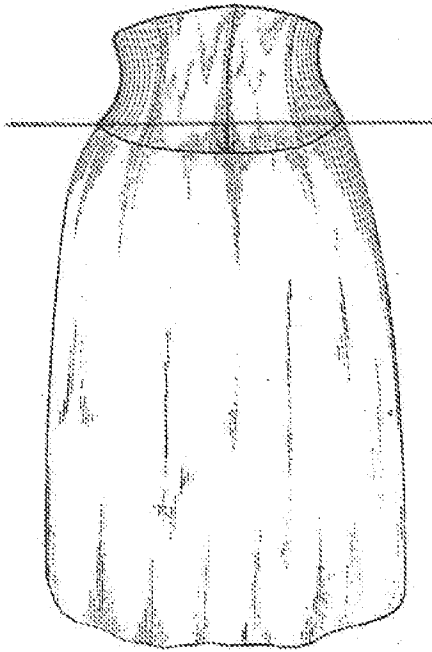
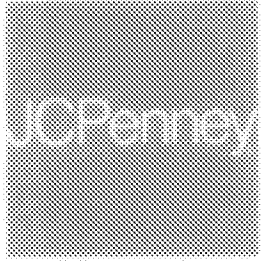

FIG. 3

Fig. 1.



It's all inside.



catalog | .com

CATALOG 2004

Featuring Misses, Petites,
Tall and Women's Plus.
For our entire assortment
visit jcpenney.com

maternity COLLECTION

showing your style

You're showing congratulations!
Look your absolute best and
feel your most comfortable
with all the must-haves for the
modern mom-to-be.

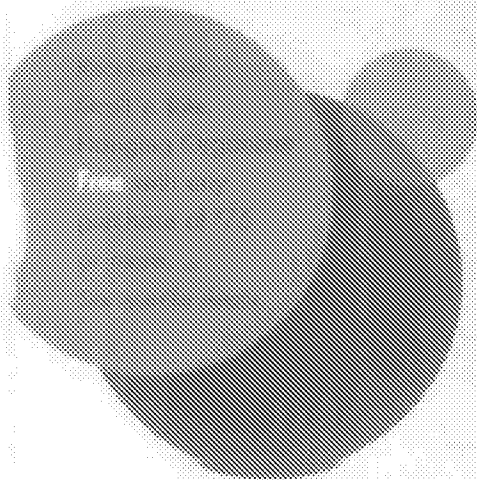

jean-ealogy

Your genes never had it so good! Trace your denim options with low-rise, mid-rise or boot cut. Underbelly style or classic panel. With or without stretch.

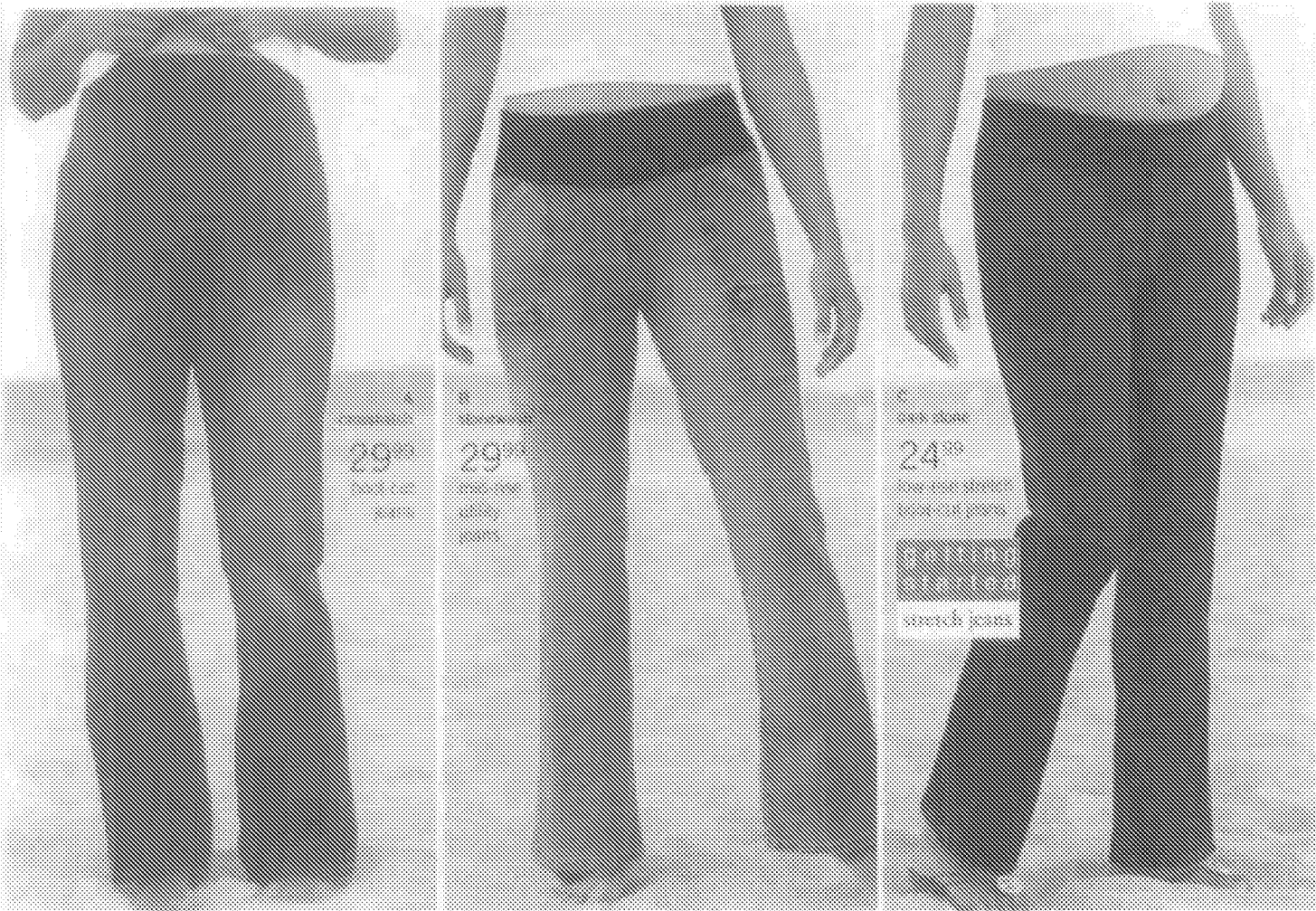

A. BOOT-CUT JEANS

Intriguingly, low-rise bootcut denim with multi-adjustable button tabs. Hold for a customized fit. Flare classic panel along with you. Provides maximum comfort in your key flex zones. Updated finishes will make this a favorite with your night crew and cowboys. Back-Kick. Great contemporary skinny-panel. Washable. Made in USA or imported or domestic fabric. Inseam: Misses 31".

Men's 29", 30", 32", Women's 31".

Condition:

Misses 4-16	US 285-2810	29.99
Misses 2-16	US 285-2811	29.99
Men's 4-16	US 285-2812	34.99
Women's 18W-20W	US 285-2813	34.99
3+ adjust		
Men's 4-16	US 285-2814	29.99
Men's 2-16	US 285-2815	29.99
Men's 4-16	US 285-2816	34.99
Women's 18W-20W	US 285-2817	34.99

B. MID-RISE UTILITY JEANS

In conversation denim and chinos built. Easy pull-on style with wide elastic waistband and contemporary panel. Front zip pocket. Washable. Inseam: Misses 31", Men's 32", Women's 31".

Stretch: Cotton/polyester/spandex. Made in USA or imported fabric.

Misses 31"	US 285-2116	orig 100	new 29.99
Men's 32"	US 285-2118	orig 140	new 34.99
Women's 31"	US 285-2119	orig 100	new 34.99
Model: 5'00" - custom USA.			
Misses 5-16	US 285-2117	orig 135	new 29.99
Men's 32"	US 285-2115	orig 140	new 34.99
Women's 31"	US 285-2118	orig 140	new 34.99

Shop for more styles and sizes for the men's date at target.com/menstyle.

C. STRETCH BODY-CUT JEANS

The style you wore before you were expecting. One with an all-around elastic waist and contemporary low-rise panel for a comfortable fit. Cotton/polyester. Washable. USA Inseam 31". Dark denim. Wash: Misses 3-16, US 285-2014.

Orig 135	new 34.99
Women's 18-36	US 285-2015
Orig 140	new 31.99

larger size? no way!

Your body is changing. Get your size right. Be sure to order your pre-pregnancy size.

Category & brand only flow.

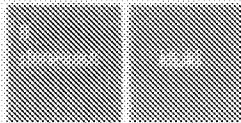
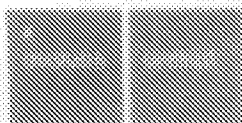

A
pink

21⁹⁹

Knit top has flat back
of two stripes in each

A. DOUBLE LAYERED RUCHED TEE

Double-knit top shows top is reinforced by an attached flat back section. Cotton. Machine wash, dry flat. USA.

Wick, black, button-up
Misses S-XL VP 285-0603 21.99
Women's 1X-3X VP 285-0619 23.99

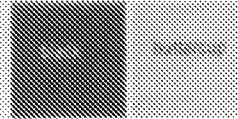

B. RUCHED-KNIT CAPRIS

Directed front allows adjustment over or under crotch for two crotch-mouth wear.

Elastic waist. Cotton/spandex.
Washable. USA. Imported. Misses 22"
Women's 24" Black
Misses S-XL VP 285-2642
Orig. \$22.99 now 21.99
Women's 1X-3X VP 285-2643
Orig. \$22.99 now 21.99

C. FOLD-OVER CAPRIS

Flap-over waist for comfortable wear throughout the changing months.

Cotton/spandex. Washable. USA. Women 24" Black.
Misses S-XL VP 285-2644
Orig. \$22.99 now 21.99
Women's 1X-3X VP 285-2645
Orig. \$22.99 now 21.99

D. SHINY PARENT TOTE

Parent Tote bag with extra dot lining. Toddler bag handles. Can phone pocket. Machine wash. Dry with proper detergent and hot ironing. Easy bag for your parent. Use flat as bottom. No ties. Imported from China. Fashion white. Pink, black.
VP 285-0606 28.00
\$28.00 each bag.

E. KNIT TOP

Flat top bands and stripes for attention. Flattering knit detail at bodice.

Cotton/spandex. Washable. USA. Color, white, aqua.
Misses S-XL VP 285-0613 21.99
Women's 1X-3X VP 285-0616 23.99

F. CRINKLE TOP

Scrunchneck with 1/2 button sleeves has flat back. Softness-edge hem and side slit.

Polyester/cotton/spandex. Machine wash, line dry. Imported. White.
Misses S-XL VP 285-0602
Orig. \$22.99 now 21.99
Women's 1X-3X VP 285-0603
Orig. \$22.99 now 21.99

G. PRINT HALTER TOP

Same wash print empire bodice has back neck tie for "just right" adjustment.

Polyester/spandex. Washable. Made in USA of imported fabric. Pink print.
Misses S-XL VP 285-0617 21.99
Women's 1X-3X VP 285-0620 23.99

H. ZIP-UP RUCHED TOP

Side-zip opening adds extra adjustment to the shapely capris empire top.

Cotton. Washable. USA. Dark lavender, pink, creamily peach, aqua.
Misses S-XL VP 285-0607 21.99
Women's 1X-3X VP 285-0608 23.99

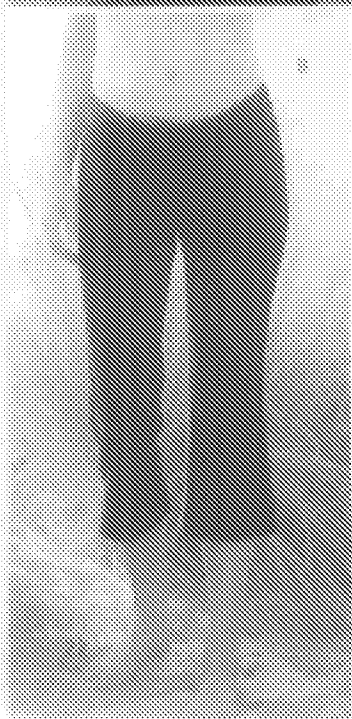
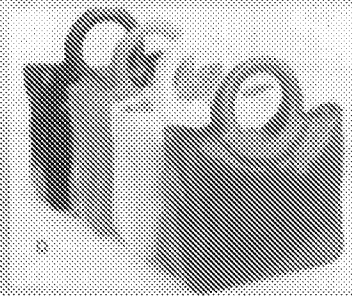

19⁹⁹

Ruched knit
capris



19⁹⁹

Knit top



A. dress
 B. earrings

Dots with dash show off your new curves wrapped in a pretty ribbon.

29⁹⁹

A. DRESS WITH ABBON

Simple enough to wear to the office yet sophisticated enough to carry you through a special event. This versatile wrap dress features a flattering empire waistline and stylish 37-degree cotton belt. Polyester/nylon. No-iron. USA. Black.

Misses S-XL VN 285-6112 29.99
 Women's L-XL VN 285-6113 34.99

B. NO-WAIST PANTS

Hidden belt elastic waist carries over the body to distract coverage and all-day comfort. A touch of stretch moves with you and maintains a crisp look throughout the day. Backed legs offer a more contemporary fit. Polyester/cotton/polyester. Washable. USA of imported fabric. 11" inseam.

Black/white stripe

Misses S-XL VN 285-2108

Orig. 19.99 now 14.99

Women's L-XL VN 285-2109

Orig. 19.99 now 14.99

Black, leather gray

Misses S-XL VN 285-2105

Orig. 19.99 now 14.99

Women's L-XL VN 285-2107

Orig. 19.99 now 14.99

C. OFF THE SHOULDER TOP

Flattering shoulder-baring top with a pretty delicately frayed hem. Cotton. Hand wash. Dry flat. USA. Black/taupe flower.

Misses S-XL VN 285-0605 21.99

Women's L-XL VN 285-0606 23.99

D. FLOWER PRINT SKIRT

Bring your length A-line skirt with elastic waist. Cotton/spandex. Machine wash, line dry. Made in USA of imported fabric.

Black print

Misses S-XL VN 285-2640 28.99

Women's L-XL VN 285-2641 38.99

24⁹⁹

NO-WAIST PANTS

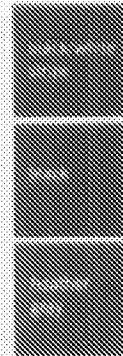

NO-WAIST PANTS

C. top
 D. skirt



denim and twill for the long haul

Our bottom basics fit and flatter the whole 9 months with snaps, spandex and Velcro®.

A

\$28

snap-to-fit pants grow with you

- snap-to-fit elastic waist pants conveniently grow with you from the beginning stages...
- through mid-to-late pregnancy...
- and even through post-pregnancy!

B

26⁹⁹

classic fit jeans

- cotton/spandex classic pants grows with you
- traditional straight leg styling for a classic look
- available in 5 sizes

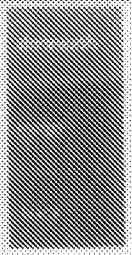
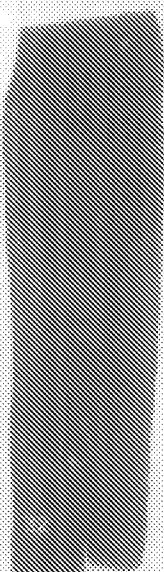

19⁹⁹

elastic pants

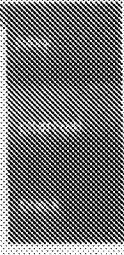
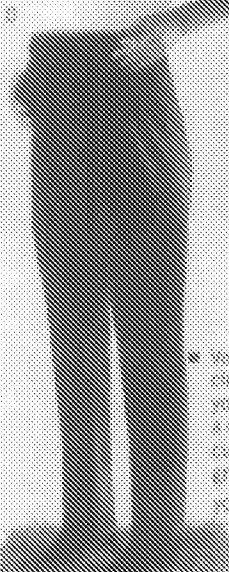

19⁹⁹

Velcro® waist and pants

- Velcro® brand closure allows you to create a comfortable custom fit that grows with you

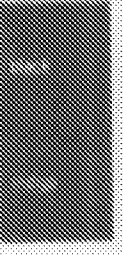

24⁹⁹

denim leggings

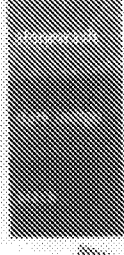
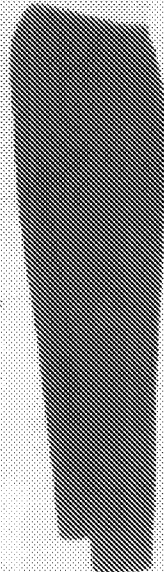

19⁹⁹

classic shorts

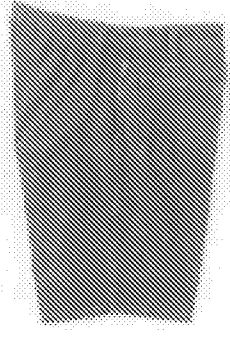

UP-4226

Vol. V8 04

Order through July 6, 2004.

tee for two 19⁹⁹

Literally! Our double
layered-look tee
adds touches of
white knit
peeking out
of colorful
mesh.

DOUBLE LAYER TEE 
Colorful mesh outer layer
with white knit at V-neck
and hem. Cotton/polyester.
Washable. Imported.
Short-sleeved, crew
neckline, ribbed,
hem/ cuffs.
Women's. **UP-285-0202 19.99**

 **Caring & cleaning**
see tag

duo
MATERNITY



order anytime 1.800.222.6161 or jcpenney.com

it's all inside:

FALL/WINTER CATALOG 2005

JCPenney

catalog | .com

on trend
misses • petites • plus • women's
maternity

Shop for more at jcpenny.com

classic bootcut 26™

- elastic over-the-belly panel
- hidden adjustable drawcord
- embroidered back pockets

low-rise bootcut 29™

- elastic underbelly waistband
- hidden adjustable drawcord
- stretch for comfort

welt pocket 29™

- elastic underbelly band
- flattening pockets
- stretch for comfort

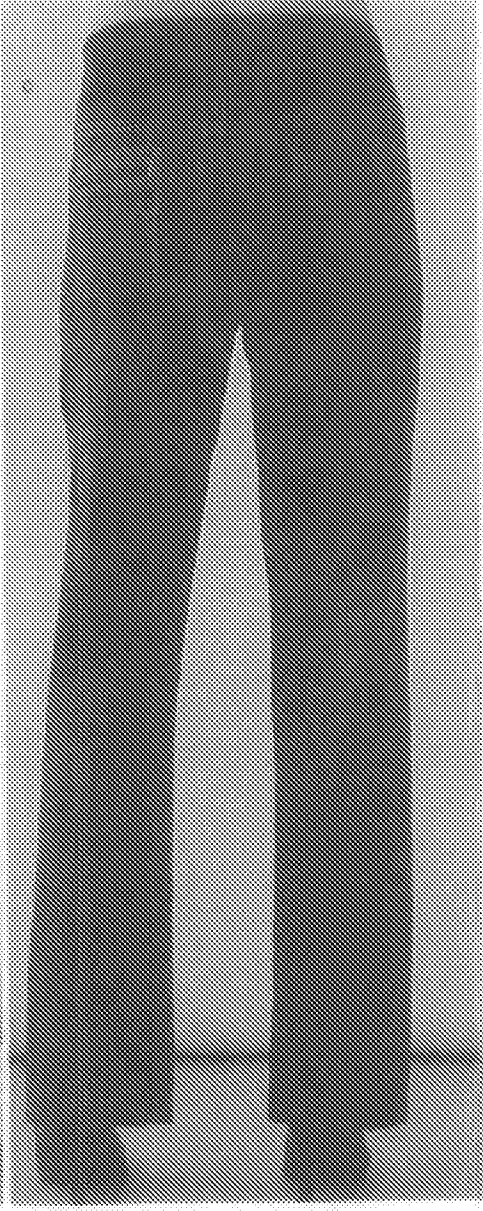
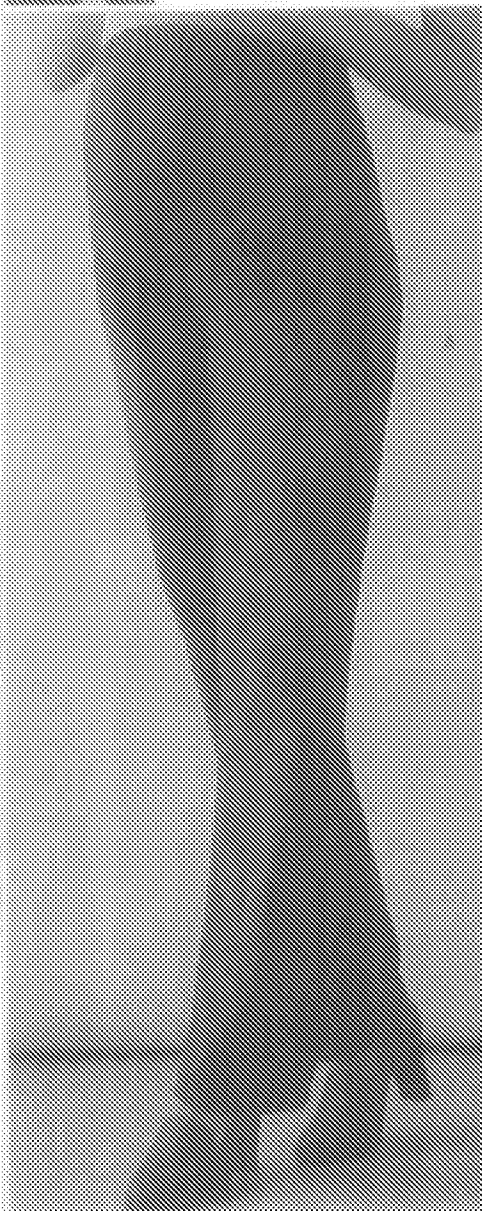

find your favorite fit from our most flattering styles ever!

A. CLASSIC BOOTCUT JEANS

Classic styling updated with a touch of leg. Embroidered back pockets. Elastic over-the-belly panel with hidden adjustable drawcord. Cotton twill fabric. Made in USA or imported of domestic fabric. Machine. Average 31W, Inseam 29W. Leg 14.5". Women's 26™. Vintage washable featured. Care: Hang to dry or tumble dry.

Average Size	05 265-2900	26.99
Size 25 x	05 265-2970	28.99
Leg 14.5"	05 265-2971	31.99
Women's 26™	05 265-2979	31.99

B. LOW-RISE STRETCH BOOTCUT JEANS

Five-pocket styling with stretch for all-day comfort. Embroidered back pockets. Elastic underbelly waistband with hidden adjustable drawcord. Fabric by Undergarments. Machine. Made in USA or imported of domestic fabric. Machine. Average 31W, Inseam 29W, Leg 14.5". Women's 29™. Care: Hang to dry.

Average Size	05 265-2904	29.99
Size 29 x	05 265-2907	29.99
Leg 14.5"	05 265-2934	34.99
Women's 29™	05 265-2937	34.99

C. WELT POCKET JEANS

Straight-leg jeans with low rise under the belly waistband. Front and back welt pockets. Cotton/polyester/spandex. Washable. Imported. Machine. Women's 29™, Inseam 29W, Leg 14.5". Stone bleach.

Women's 29™	05 265-2901	29.99
Leg 14.5"	05 265-2902	34.99
Women's 29™	05 265-2904	34.99

Under your size pregnancy size. Details on return.

5. SWEAT TOP 28

Soft with side ruffling to fit and shape your new curves. Long raglan sleeves. Cotton/spandex. Machine wash. Imported.

Misses 2-4L — \$5.99-9.99
 Reg. 2L — now \$7.99
 Misses 2-4L — \$5.99-9.99
 Reg. 2L — now \$7.99

6. FOLD-OVER PANTS JEANS 28

Great fitting jeans are a must — especially when you're expecting. These jeans have fold-over pants design that allows you to wear them before, during and after your pregnancy. See more photos. Soft stretch twill with two side pockets. Side seam pockets. Cotton/polyester/cotton. Machine wash. Imported.

Misses 2-4L — \$19.99-29.99
 Reg. 2L — now \$15.99
 Misses 2-4L — \$19.99-29.99
 Reg. 2L — now \$15.99



Join our Target Circle program. Find more apps and offers at [target.com/circle](#)

29⁹⁹

At Target, pants, jeans, you decide the fit you want.

- Soft stretch twill with side seam pockets
- Fold-over pants design
- Cotton/polyester/cotton

Your new wardrobe gets you adapt to the comfort you require:

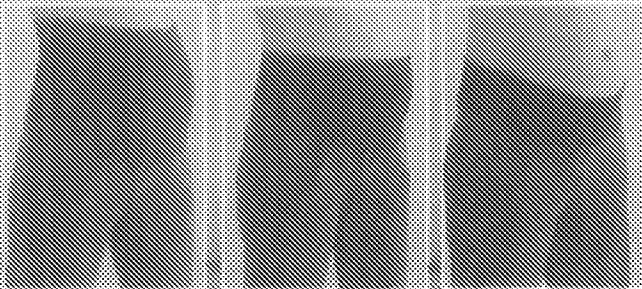

1. Fold-over pants for the ultimate comfort and support.

29⁹⁹
 29⁹⁹
 29⁹⁹

9 months of comfort: from full tummy panel

19^{1/2}"
stretch-panel
jeans

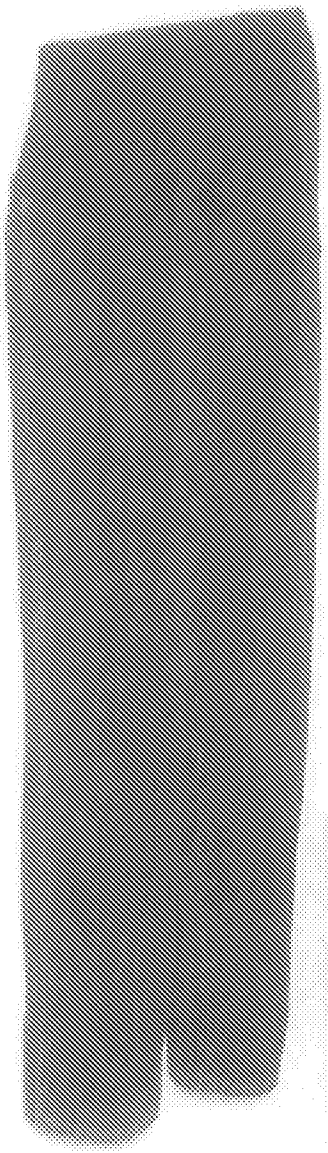

\$28
snap-to-fit
pants

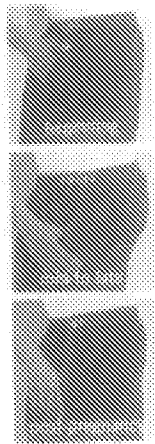
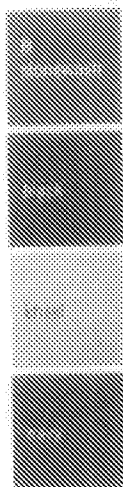
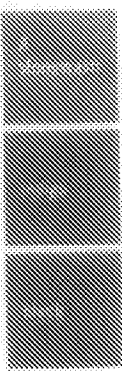
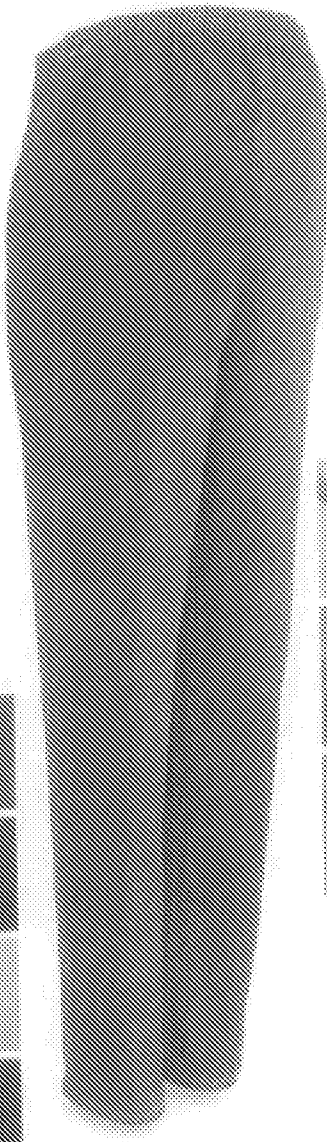

A. STRETCH-PANEL JEANS

19 1/2" inseam, light-blue cotton-jeans fabric with an all-around stretch-panel for comfort. Straight-leg, washable. 100% cotton. Machine washable. Imported. Model: 285-2133, women's fit.

Women's S-XL	05 285-2133	\$9.99
Women's 14-40	05 285-2132	\$4.99

Target Circle member only item

B. SNAP-TO-FIT PANTS

Ultra-comfortable no-iron fabric with elastic waist. Cotton. Washable. USA. Imported. Women's S-XL, Petite S-P, Size S-P, Women's 28-30.

Women's S-XL	05 285-2179	\$8.00
Petite S-XL	05 285-2186	\$8.00
Size S-XL	05 285-2187	\$4.00
Women's 14-40	05 285-2185	\$4.00

Twill. Black, navy, grey.

Women's S-XL	05 285-2190	\$8.00
Petite S-XL	05 285-2477	\$8.00
Size S-XL	05 285-2391	\$4.00
Women's 14-40	05 285-2391	\$4.00

Order your pre-programmed card (available online)

Target Circle member only item
www.target.com/circle

06 9382

WI 05-05

Order through January 31, 2006

Please recycle All JCPenney catalogs are recyclable
Visit recyclepaper.org for more information



12.99 essential stretch tee,

perfect for going from work to dinner or dressy up or down with ease. In 7 autumn-inspired solids and 3 easy stripes.

• 100% cotton
 • Machine washable
 • Imported
 • Available in sizes XS, S, M, L, XL
 • Colors: Black, Navy, Burgundy, Red, Olive, Grey, White, and Stripes



order anytime 1.800.222.6161 or jcpenney.com

Sketch Page-Front

Production	Style #: 324282	Description: Full Panel Stretch Twill Boot Cut	
Old_Navy	Pattern #: ownwdipp.dg1		
Womens	NY Design # 324282SF	Date Created: Jan 17-2005	
Maternity			

Comment:		BestSeller
----------	--	------------

Vendor	Status	Date	Vendor	Status	Date
	Final	Apr 04-05			

Sketch: Old_Navy_Womens/Maternity/Fall 2005/Production/324282.dwg

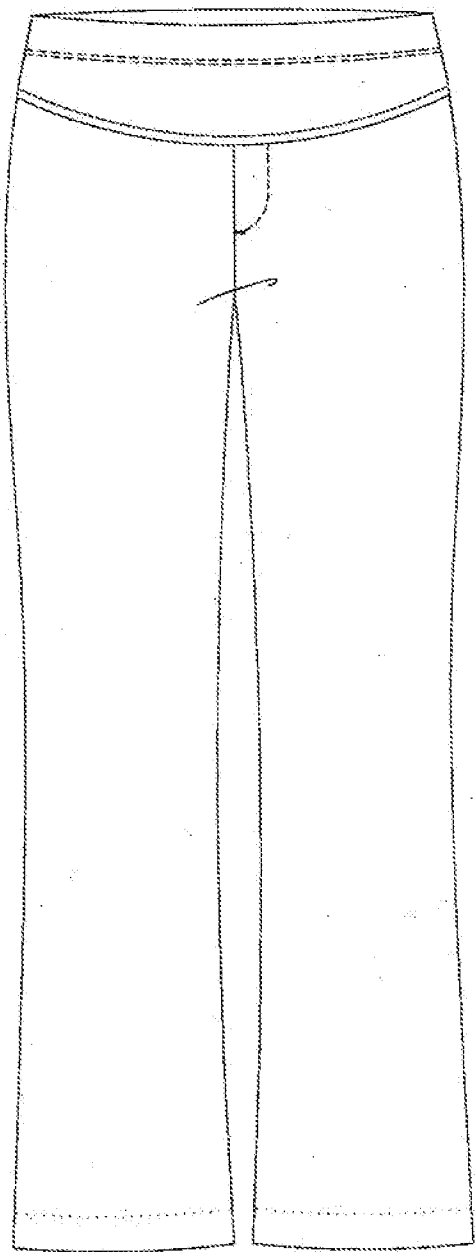

Sketch Page-Back

Production

Old Navy
Womens
Maternity

Style #: 324282
Pattern #: ownwdfpp.dg1
NY Design # 324282SF

Description: Full Panel Stretch Twill Boot Cut
Date Created: Jan 17-2005

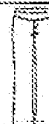

Comment:

Sketch: Old Navy Womens/Maternity/Fall 2005/Production/324282.dwg

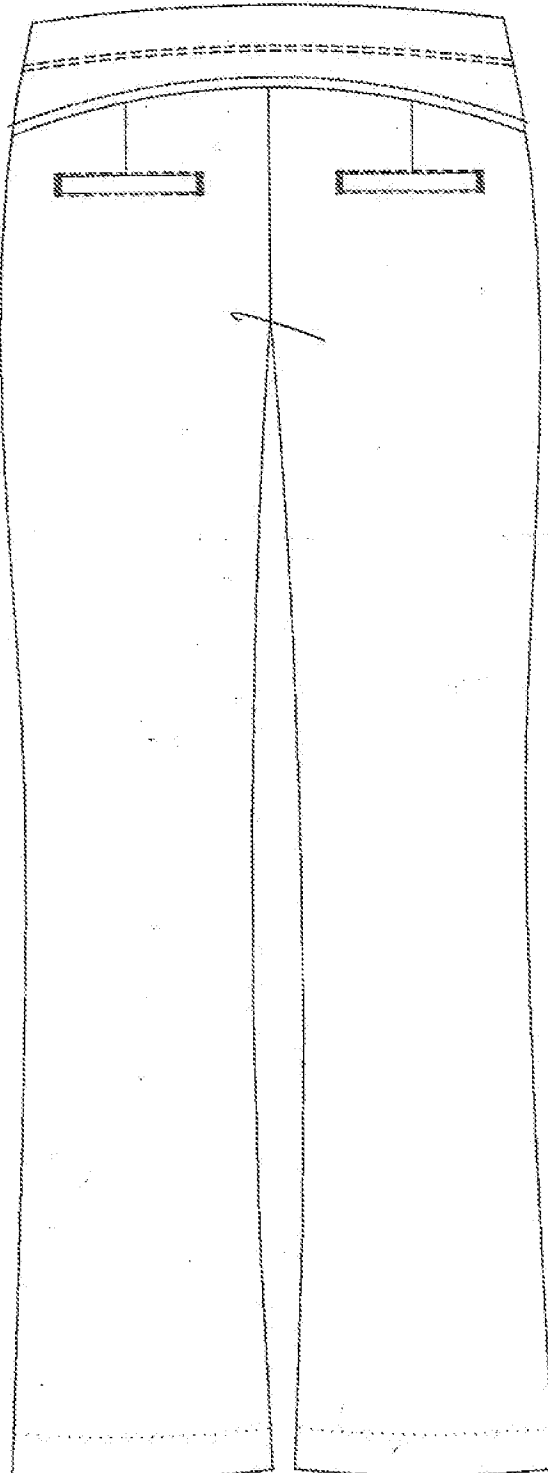

Production

Calculated Measurement (3)

Gap

Style #: 256229

Description: ESSENTIAL TROUSER WITH FULL PANEL

Materiality

Pattern #: 256229

Wovens

NY Design # TGB020F-4

Date Created: Feb 23-2004

Fall 2004

Delivery:

Date Modified: Feb 08-2005

Sketch: rmbv/Wovens/Fall 2004/Production/246229.dwg

Sketch: rmbv/Wovens/Fall 2004/Production/256229.dwg

Sketch:

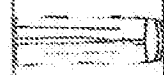
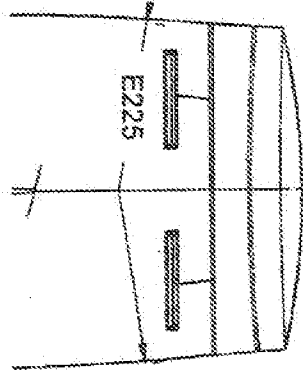
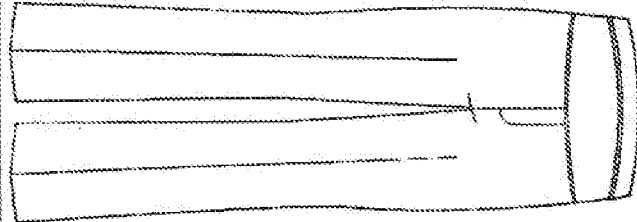

Size Class: Gap Maternity Numeric

Size Range: 0-20

Product Type: Gap Woven Bottoms

Sample Size: 8

UOM: Inch

Measurement Type: Finished Garment Measurements

Production

Calculated Measurement (1)

Gap

Style #: 281008

Description: RP - FLUTTER SKIRT

Maternity

Pattern #: WQW312S5

Wovens

NY Design # WQW312S5

Spring 2005

Delivery:

Date Created: Jul 21-2004

Sketch: by:Wovens/Spring 2005/Production/281008.dwg

Sketch: by:Wovens/Spring 2005/Production/281008.dwg

Sketch:

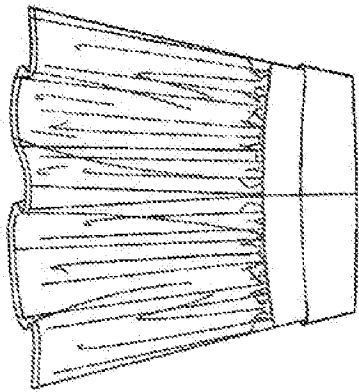
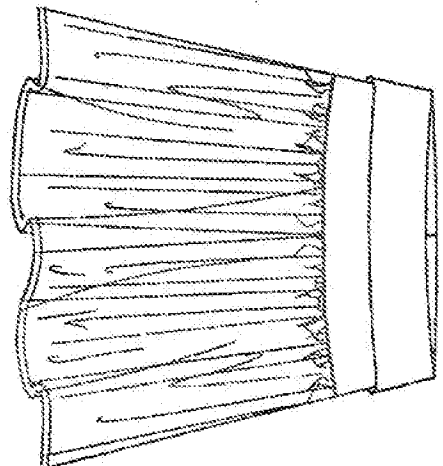
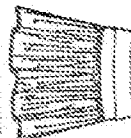

Size Class: Gap Maternity Numeric

Size Range: 0-20

Product Type: Gap Woven Bottoms

Sample Size: 8

UOM: Inch

Measurement Type: Finished Garment Measurements

Production

Calculated Measurement (1)

Gap

Style #: 205224Su05

Description: BOOTCUT PANT WITH FULL PANEL

Material:

Pattern #: 205222

Wovens

NY Design # MBT415A

Date Created: Dec 02-2004

Summer 2005

Delivery:

Date Modified: Jan 17-2005

Sketch: /Wovens/Summer 2005/Production/205224.dwg

Sketch: /Wovens/Summer 2005/Production/205224.dwg

Sketch:

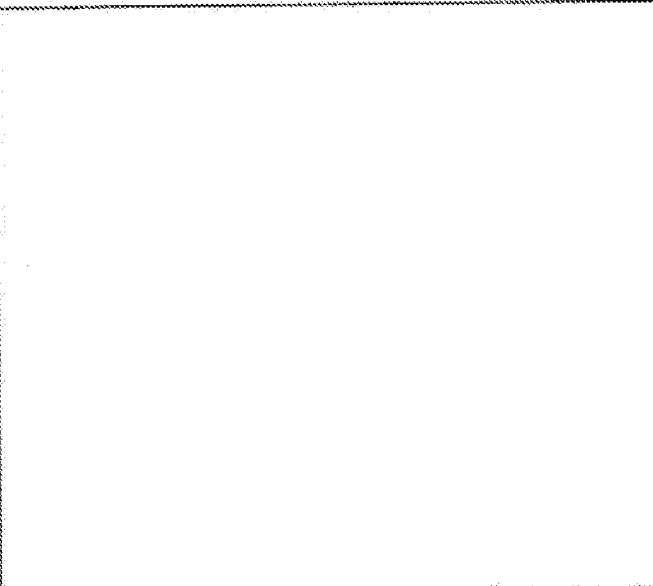
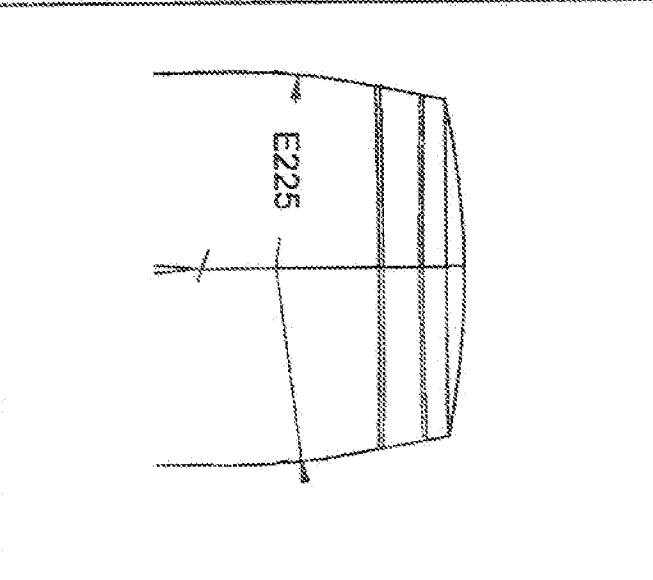
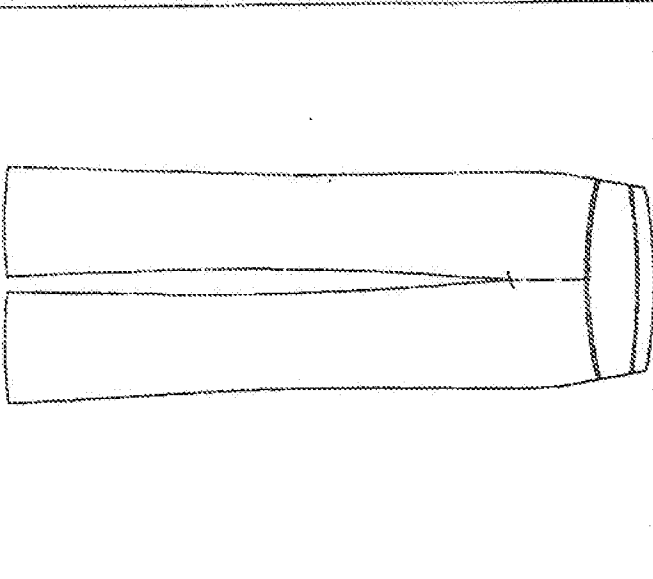

Size Class: Gap Women's Numeric

Size Range: 0-20

Product Type: Gap Woven Bottoms

Sample Size: 8

LOM: Inch

Measurement Type: Finished Garment Measurements

In the Claims:

Please amend the claims of the '575 Patent as indicated below:

1. (Original) A garment, comprising: a garment upper portion having a belly panel that is expansible to cover and fit over a growing abdomen during different stages of pregnancy; a garment lower portion having a first torso encircling circumference that recedes downward to make way for expansion of the belly panel; and the garment upper portion having a second torso encircling circumference defining an upper edge of the belly panel that encircles a wearer's torso just beneath the wearer's breast area configured to hold the garment up and in place about the torso in a position of a location of maximum girth of the abdomen thereby substantially covering the wearer's entire pregnant abdomen during all stages of pregnancy.

2. (Original) The garment of claim 1, wherein the second torso encircling circumference is adjustable in girth in conformance with different body types.

3. (Original) The garment of claim 1, wherein the garment upper portion comprises a seamless tubular structure that fits comfortably while being worn, and the belly panel comprises an expansible portion of the tubular structure.

4. (Original) The garment of claim 1, wherein the garment upper portion comprises a seamless tubular elastic fabric to stretch elastically.

5. (Original) The garment of claim 1, wherein the garment upper portion comprises an elastic fabric that is contractible elastically to cover an abdomen during different stages of postpartum body changes.

6. (Original) The garment of claim 1, wherein the garment lower portion has a partial waistband extending from side seams of the garment lower portion and extending

across a back side of the garment lower portion where the partial waistband widens above a wearer's pelvis.

7. (Original) The garment of claim 1, further comprising a series of belly cradling stitches or knitted tension in the belly panel, wherein the knitted tension or stitches extend along multiple paths arranged in an elliptical pattern that curves, so as to cradle a curved growing abdomen during various stages of pregnancy.

8. (Original) The garment of claim 1, further comprising a series of stitches or knitted tension in the backside of the garment upper portion to provide spinal and back support against the wearer of the garment.

9. (Original) The garment of claim 8, wherein the series of stitches or knitted tension in the backside of the garment upper portion extends along a pattern of multiple stitch paths.

10. (Original) The garment of claim 1, wherein the garment upper portion is foldable toward the garment lower portion to comprise a folded band on the garment lower portion.

11. (Original) The garment of claim 1, wherein the garment lower portion has a partial waistband extending from side seams of the garment lower portion wherein the partial waistband tapers toward the side seams and widens above a wearer's pelvis across a back side of the garment lower portion.

12. (Original) The garment of claim 1, comprising: knitted tension in the backside of the garment upper portion providing spinal column and back support for a wearer of the garment.

13. (Original) The garment of claim 1, comprising: a series of sewn supporting stitches in the backside of the garment upper portion providing spinal column and back support for a wearer of the garment.

14. (Original) The garment of claim 1, comprising: a series of sewn supporting stitches in the backside of the garment upper portion providing spinal column and back support for a wearer of the garment, wherein the stitches are arranged along multiple stitch paths grouped in a hyperbolic pattern, a curved pattern or a truncated, v-shaped pattern along an axis extending substantially vertically along a spinal supporting section of the fabric.

15. (Original) The garment of claim 1, wherein an edge margin of the garment upper portion is folded over and knitted to an inside of the fabric to provide a perimeter hem stitch.

16. (Original) The garment of claim 1, wherein an edge margin of the garment upper portion is folded over and sewn or knitted to an inside of the fabric to provide a perimeter hem stitch.

17. (Original) The garment of claim 1, wherein the second torso encircling circumference comprises stretchable fabric to adjust the girth in conformance with different body types.

18. (Original) The garment of claim 1, wherein the garment upper portion is a tubular structure, wherein the tubular structure is shaped and formed as a hyperboloid cylinder to fit a body type having a tapered torso.

19. (Original) The garment of claim 1, wherein the garment upper portion is a tubular structure, wherein the tubular structure is shaped and formed as a straight sided cylinder to fit a body type having a corresponding shaped torso.

20. (Original) The garment of claim 1, wherein the garment upper portion comprises a double layer tubular structure, and an inner layer of stretchable fabric between two layers of the double-layer tubular structure.

21. (Original) The garment of claim 1, wherein the garment upper portion comprises a fabric, and the fabric is doubled back on itself downward to form a double-layer tubular structure that extends downward for at least a portion of the garment upper portion, and the layers of the double-layer tubular structure are sewn together with a tubular perimeter drop stitch.

22. (Original) The garment of claim 1, wherein the garment upper portion comprises a fabric doubled back on itself downward to form a double-layer tubular structure that extends downward for at least a portion of the garment upper portion, the layer of the double-layer tubular structure are sewn together with a tubular perimeter drop stitch, and an edge margin of the garment upper portion is knitted to an inside of the fabric to provide a perimeter hem stitch.

23. (Original) The garment of claim 3, wherein the seamless tubular structure comprises a fabric doubled back on itself downward to form a double-layer tubular structure that extends downward for at least a portion of the garment upper portion, the layers of the double-layer tubular structure are sewn together with a tubular perimeter drop stitch, and an edge margin of the garment upper portion is folded over and sewn or knitted to an inside of the fabric to provide a perimeter hem stitch.

24. (Original) The garment of claim 1, wherein the garment upper portion is foldable toward the garment lower portion to provide a folded band on the garment lower portion to be worn as a garment bottom having no top.

25. (Original) The garment of claim 1, wherein the garment lower portion comprises one of a pair of trousers and a skirt.

26. (New) The garment of claim 1, wherein the garment lower portion comprises denim jeans.

27. (New) The garment of claim 1, wherein the garment lower portion comprises a zipperless fly.

28. (New) The garment of claim 1, wherein the first torso-encircling circumference recedes downward with a parabolic shape, said parabolic shape including a shallow curvature.

29. (New) The garment of claim 28, wherein the belly panel extends at least partially under the abdomen of the wearer to meet the parabolic receding circumference of the garment lower portion.

PATENT APPLICATION FEE DETERMINATION RECORD

Substitute for Form PTO-875

Application or Docket Number
13/161,138

APPLICATION AS FILED - PART I

(Column 1) (Column 2)

FOR	NUMBER FILED	NUMBER EXTRA
BASIC FEE (37 CFR 1.16(a), (b), or (c))	N/A	N/A
SEARCH FEE (37 CFR 1.16(k), (l), or (m))	N/A	N/A
EXAMINATION FEE (37 CFR 1.16(o), (p), or (q))	N/A	N/A
TOTAL CLAIMS (37 CFR 1.16(j))	29 minus 20 = *	9
INDEPENDENT CLAIMS (37 CFR 1.16(h))	1 minus 3 = *	
APPLICATION SIZE FEE (37 CFR 1.16(s))	If the specification and drawings exceed 100 sheets of paper, the application size fee due is \$270 (\$135 for small entity) for each additional 50 sheets or fraction thereof. See 35 U.S.C. 41(a)(1)(G) and 37 CFR 1.16(s).	
MULTIPLE DEPENDENT CLAIM PRESENT (37 CFR 1.16(j))		

SMALL ENTITY

RATE(\$)	FEE(\$)
N/A	
N/A	
N/A	
TOTAL	

OR OTHER THAN SMALL ENTITY

RATE(\$)	FEE(\$)
N/A	330
N/A	540
N/A	650
x 52 =	468
x 220 =	0.00
	0.00
	0.00
TOTAL	1988

* If the difference in column 1 is less than zero, enter "0" in column 2.

APPLICATION AS AMENDED - PART II

(Column 1) (Column 2) (Column 3)

AMENDMENT A		CLAIMS REMAINING AFTER AMENDMENT		HIGHEST NUMBER PREVIOUSLY PAID FOR	PRESENT EXTRA
	Total (37 CFR 1.16(i))	*	Minus	**	=
	Independent (37 CFR 1.16(h))	*	Minus	***	=
	Application Size Fee (37 CFR 1.16(s))				
FIRST PRESENTATION OF MULTIPLE DEPENDENT CLAIM (37 CFR 1.16(j))					

SMALL ENTITY

RATE(\$)	ADDITIONAL FEE(\$)
x =	
x =	
TOTAL ADD'L FEE	

OR OTHER THAN SMALL ENTITY

RATE(\$)	ADDITIONAL FEE(\$)
x =	
x =	
TOTAL ADD'L FEE	

(Column 1) (Column 2) (Column 3)

AMENDMENT B		CLAIMS REMAINING AFTER AMENDMENT		HIGHEST NUMBER PREVIOUSLY PAID FOR	PRESENT EXTRA
	Total (37 CFR 1.16(i))	*	Minus	**	=
	Independent (37 CFR 1.16(h))	*	Minus	***	=
	Application Size Fee (37 CFR 1.16(s))				
FIRST PRESENTATION OF MULTIPLE DEPENDENT CLAIM (37 CFR 1.16(j))					

RATE(\$)	ADDITIONAL FEE(\$)
x =	
x =	
TOTAL ADD'L FEE	

OR OTHER THAN SMALL ENTITY

RATE(\$)	ADDITIONAL FEE(\$)
x =	
x =	
TOTAL ADD'L FEE	

* If the entry in column 1 is less than the entry in column 2, write "0" in column 3.

** If the "Highest Number Previously Paid For" IN THIS SPACE is less than 20, enter "20".

*** If the "Highest Number Previously Paid For" IN THIS SPACE is less than 3, enter "3".

The "Highest Number Previously Paid For" (Total or Independent) is the highest found in the appropriate box in column 1.



UNITED STATES PATENT AND TRADEMARK OFFICE

UNITED STATES DEPARTMENT OF COMMERCE
United States Patent and Trademark Office
Address: COMMISSIONER FOR PATENTS
P.O. Box 1450
Alexandria, Virginia 22313-1450
www.uspto.gov

Table with 7 columns: APPLICATION NUMBER, FILING or 371(c) DATE, GRP ART UNIT, FIL FEE REC'D, ATTY. DOCKET NO, TOT CLAIMS, IND CLAIMS. Row 1: 13/161,138, 06/15/2011, 3765, 1988, DMC-10-1220RE, 29, 1

CONFIRMATION NO. 4808

FILING RECEIPT

35811
IP GROUP OF DLA PIPER LLP (US)
ONE LIBERTY PLACE
1650 MARKET ST, SUITE 4900
PHILADELPHIA, PA 19103



Date Mailed: 06/21/2011

Receipt is acknowledged of this reissue patent application. The application will be taken up for examination in due course. Applicant will be notified as to the results of the examination. Any correspondence concerning the application must include the following identification information: the U.S. APPLICATION NUMBER, FILING DATE, NAME OF APPLICANT, and TITLE OF INVENTION. Fees transmitted by check or draft are subject to collection. Please verify the accuracy of the data presented on this receipt. If an error is noted on this Filing Receipt, please submit a written request for a Filing Receipt Correction. Please provide a copy of this Filing Receipt with the changes noted thereon. If you received a "Notice to File Missing Parts" for this application, please submit any corrections to this Filing Receipt with your reply to the Notice. When the USPTO processes the reply to the Notice, the USPTO will generate another Filing Receipt incorporating the requested corrections

Applicant(s)

Lisa A. Hendrickson, Mount Laurel, NJ;
James H. Gardner III, Ambler, PA;
Richard Adelman, Greensboro, NC;

Assignment For Published Patent Application

Destination Maternity Corporation, Philadelphia, PA

Power of Attorney: The patent practitioners associated with Customer Number 35811

Domestic Priority data as claimed by applicant

This application is a REI of 11/756,242 05/31/2007 PAT 7,814,575

Foreign Applications (You may be eligible to benefit from the Patent Prosecution Highway program at the USPTO. Please see http://www.uspto.gov for more information.)

If Required, Foreign Filing License Granted: 06/20/2011

The country code and number of your priority application, to be used for filing abroad under the Paris Convention, is US 13/161,138

Projected Publication Date: None, application is not eligible for pre-grant publication

Non-Publication Request: No

Early Publication Request: No

Title

Belly Covering Garment

Preliminary Class

002

PROTECTING YOUR INVENTION OUTSIDE THE UNITED STATES

Since the rights granted by a U.S. patent extend only throughout the territory of the United States and have no effect in a foreign country, an inventor who wishes patent protection in another country must apply for a patent in a specific country or in regional patent offices. Applicants may wish to consider the filing of an international application under the Patent Cooperation Treaty (PCT). An international (PCT) application generally has the same effect as a regular national patent application in each PCT-member country. The PCT process **simplifies** the filing of patent applications on the same invention in member countries, but **does not result** in a grant of "an international patent" and does not eliminate the need of applicants to file additional documents and fees in countries where patent protection is desired.

Almost every country has its own patent law, and a person desiring a patent in a particular country must make an application for patent in that country in accordance with its particular laws. Since the laws of many countries differ in various respects from the patent law of the United States, applicants are advised to seek guidance from specific foreign countries to ensure that patent rights are not lost prematurely.

Applicants also are advised that in the case of inventions made in the United States, the Director of the USPTO must issue a license before applicants can apply for a patent in a foreign country. The filing of a U.S. patent application serves as a request for a foreign filing license. The application's filing receipt contains further information and guidance as to the status of applicant's license for foreign filing.

Applicants may wish to consult the USPTO booklet, "General Information Concerning Patents" (specifically, the section entitled "Treaties and Foreign Patents") for more information on timeframes and deadlines for filing foreign patent applications. The guide is available either by contacting the USPTO Contact Center at 800-786-9199, or it can be viewed on the USPTO website at <http://www.uspto.gov/web/offices/pac/doc/general/index.html>.

For information on preventing theft of your intellectual property (patents, trademarks and copyrights), you may wish to consult the U.S. Government website, <http://www.stopfakes.gov>. Part of a Department of Commerce initiative, this website includes self-help "toolkits" giving innovators guidance on how to protect intellectual property in specific countries such as China, Korea and Mexico. For questions regarding patent enforcement issues, applicants may call the U.S. Government hotline at 1-866-999-HALT (1-866-999-4158).

LICENSE FOR FOREIGN FILING UNDER**Title 35, United States Code, Section 184****Title 37, Code of Federal Regulations, 5.11 & 5.15****GRANTED**

The applicant has been granted a license under 35 U.S.C. 184, if the phrase "IF REQUIRED, FOREIGN FILING LICENSE GRANTED" followed by a date appears on this form. Such licenses are issued in all applications where the conditions for issuance of a license have been met, regardless of whether or not a license may be required as

set forth in 37 CFR 5.15. The scope and limitations of this license are set forth in 37 CFR 5.15(a) unless an earlier license has been issued under 37 CFR 5.15(b). The license is subject to revocation upon written notification. The date indicated is the effective date of the license, unless an earlier license of similar scope has been granted under 37 CFR 5.13 or 5.14.

This license is to be retained by the licensee and may be used at any time on or after the effective date thereof unless it is revoked. This license is automatically transferred to any related applications(s) filed under 37 CFR 1.53(d). This license is not retroactive.

The grant of a license does not in any way lessen the responsibility of a licensee for the security of the subject matter as imposed by any Government contract or the provisions of existing laws relating to espionage and the national security or the export of technical data. Licensees should apprise themselves of current regulations especially with respect to certain countries, of other agencies, particularly the Office of Defense Trade Controls, Department of State (with respect to Arms, Munitions and Implements of War (22 CFR 121-128)); the Bureau of Industry and Security, Department of Commerce (15 CFR parts 730-774); the Office of Foreign Assets Control, Department of Treasury (31 CFR Parts 500+) and the Department of Energy.

NOT GRANTED

No license under 35 U.S.C. 184 has been granted at this time, if the phrase "IF REQUIRED, FOREIGN FILING LICENSE GRANTED" DOES NOT appear on this form. Applicant may still petition for a license under 37 CFR 5.12, if a license is desired before the expiration of 6 months from the filing date of the application. If 6 months has lapsed from the filing date of this application and the licensee has not received any indication of a secrecy order under 35 U.S.C. 181, the licensee may foreign file the application pursuant to 37 CFR 5.15(b).



UNITED STATES PATENT AND TRADEMARK OFFICE

UNITED STATES DEPARTMENT OF COMMERCE
United States Patent and Trademark Office
Address: COMMISSIONER FOR PATENTS
P.O. Box 1450
Alexandria, Virginia 22313-1450
www.uspto.gov

Table with 5 columns: APPLICATION NO., FILING DATE, FIRST NAMED INVENTOR, ATTORNEY DOCKET NO., CONFIRMATION NO. Includes details for application 13/161,138 filed 06/15/2011 by Lisa A. Hendrickson, attorney DMC-10-1220RE, examiner HALE, GLORIA M, art unit 3765, notification date 12/15/2011, delivery mode ELECTRONIC.

Please find below and/or attached an Office communication concerning this application or proceeding.

The time period for reply, if any, is set in the attached communication.

Notice of the Office communication was sent electronically on above-indicated "Notification Date" to the following e-mail address(es):

pto.phil@dlapiper.com

DETAILED ACTION

The reissue oath/declaration filed with this application is defective because it fails to identify at least one proper error which is relied upon to support the reissue application. See 37 CFR 1.175(a)(1) and MPEP § 1414.

The reissue oath/declaration filed with this application is defective because the error which is relied upon to support the reissue application is not an error upon which a reissue can be based. See 37 CFR 1.175(a)(1) and MPEP § 1414.

The reissue oath/declaration filed with this application is defective (see 37 CFR 1.175 and MPEP § 1414) because of the following:

Because it did not identify the specific claim which is defective. Applicant has only broadly listed unclaimed features. However, they did not state as to which claims were in error.

Claims 1-29 are rejected as being based upon a defective reissue declaration under 35 U.S.C. 251 as set forth above. See 37 CFR 1.175.

The nature of the defect(s) in the declaration is set forth in the discussion above in this Office action.

However, the claims, as best understood, have been examined on their merits.

Double Patenting

The nonstatutory double patenting rejection is based on a judicially created doctrine grounded in public policy (a policy reflected in the statute) so as to prevent the unjustified or improper timewise extension of the “right to exclude” granted by a patent and to prevent possible harassment by multiple assignees. A nonstatutory obviousness-type double patenting rejection is appropriate where the conflicting claims are not identical, but at least one examined application claim is not patentably distinct from the reference claim(s) because the examined application claim is either anticipated by, or would have been obvious over, the reference claim(s). See, e.g., *In re Berg*, 140 F.3d 1428, 46 USPQ2d 1226 (Fed. Cir. 1998); *In re Goodman*, 11 F.3d 1046, 29 USPQ2d 2010 (Fed. Cir. 1993); *In re Longi*, 759 F.2d 887, 225 USPQ 645 (Fed. Cir. 1985); *In re Van Ornum*, 686 F.2d 937, 214 USPQ 761 (CCPA 1982); *In re Vogel*, 422 F.2d 438, 164 USPQ 619 (CCPA 1970); and *In re Thorington*, 418 F.2d 528, 163 USPQ 644 (CCPA 1969).

A timely filed terminal disclaimer in compliance with 37 CFR 1.321(c) or 1.321(d) may be used to overcome an actual or provisional rejection based on a nonstatutory double patenting ground provided the conflicting application or patent either is shown to be commonly owned with this application, or claims an invention made as a result of activities undertaken within the scope of a joint research agreement.

Effective January 1, 1994, a registered attorney or agent of record may sign a terminal disclaimer. A terminal disclaimer signed by the assignee must fully comply with 37 CFR 3.73(b).

Claims 1-29 are provisionally rejected on the ground of nonstatutory obviousness-type double patenting as being unpatentable over claims 1-21 of copending Application No. 13/161169. Although the conflicting claims are not identical, they are not patentably distinct from each other because they claim the same pant garment with the belly panel structure as claimed in claims 1-21.

This is a provisional obviousness-type double patenting rejection because the conflicting claims have not in fact been patented.

Applicant is notified that any subsequent amendment to the specification and/or claims must comply with 37 CFR 1.173(b). In addition, when any substantive amendment is filed in the reissue application, which amendment otherwise places the reissue application in condition for allowance, a supplemental oath/declaration will be required. See MPEP § 1414.01.

Claims 1-29 would be allowable upon the filing of a proper declaration/oath and Terminal Disclaimer as outlined above.

None of the cited references, alone or in combination, disclose the garment with the belly panel that has an upper edge portion located as claimed in claim 1.

Conclusion

The prior art made of record and not relied upon is considered pertinent to applicant's disclosure.

Art Unit: 3765

Any inquiry concerning this communication or earlier communications from the examiner should be directed to GLORIA HALE whose telephone number is (571)272-4984. The examiner can normally be reached on Mon.-Thurs..

If attempts to reach the examiner by telephone are unsuccessful, the examiner's supervisor, KHOA HUYNH can be reached on 571-272-4888. The fax phone number for the organization where this application or proceeding is assigned is 571-273-8300.

Information regarding the status of an application may be obtained from the Patent Application Information Retrieval (PAIR) system. Status information for published applications may be obtained from either Private PAIR or Public PAIR. Status information for unpublished applications is available through Private PAIR only. For more information about the PAIR system, see <http://pair-direct.uspto.gov>. Should you have questions on access to the Private PAIR system, contact the Electronic Business Center (EBC) at 866-217-9197 (toll-free). If you would like assistance from a USPTO Customer Service Representative or access to the automated information system, call 800-786-9199 (IN USA OR CANADA) or 571-272-1000.

/Gloria Hale/
Primary Examiner, Art Unit 3765

Notice of References Cited	Application/Control No. 13/161,138	Applicant(s)/Patent Under Reexamination HENDRICKSON ET AL.	
	Examiner GLORIA HALE	Art Unit 3765	Page 1 of 1

U.S. PATENT DOCUMENTS

*	Document Number Country Code-Number-Kind Code	Date MM-YYYY	Name	Classification
*	A US-3,045,676	07-1962	SLATEN JOHN M	606/159
*	B US-4,280,229	07-1981	Stein, Paul	2/221
*	C US-4,506,390	03-1985	Stern, Marilyn M.	2/221
*	D US-5,946,730	09-1999	Blair, Vivia M.	2/227
*	E US-6,311,333	11-2001	Batra, Sachin	2/237
*	F US-2004/0210987	10-2004	Carney, Ingrid	002/236
*	G US-2006/0010571	01-2006	Oakley, Joh	002/227
*	H US-7,814,575	10-2010	Hendrickson et al.	2/227
*	I US-7,900,276	03-2011	Hendrickson et al.	2/237
	J US-			
	K US-			
	L US-			
	M US-			

FOREIGN PATENT DOCUMENTS

*	Document Number Country Code-Number-Kind Code	Date MM-YYYY	Country	Name	Classification
	N				
	O				
	P				
	Q				
	R				
	S				
	T				

NON-PATENT DOCUMENTS

*	Document Number Country Code-Number-Kind Code	Date MM-YYYY	Country	Name	Classification
	Include as applicable: Author, Title Date, Publisher, Edition or Volume, Pertinent Pages)				
	U				
	V				
	W				
	X				

*A copy of this reference is not being furnished with this Office action. (See MPEP § 707.05(a).)
Dates in MM-YYYY format are publication dates. Classifications may be US or foreign.

Search Notes 	Application/Control No. 13161138	Applicant(s)/Patent Under Reexamination HENDRICKSON ET AL.
	Examiner GLORIA HALE	Art Unit 3765

SEARCHED			
Class	Subclass	Date	Examiner
2	69,227,228,238,236-238,211,212,214,243.1		
450	155,96-100	12-3-11	gh

SEARCH NOTES		
Search Notes	Date	Examiner
inv name srch;ids flag clred;review related apps for DP	12-3-11	gh
litigation srch in file		

INTERFERENCE SEARCH			
Class	Subclass	Date	Examiner

	/GLORIA HALE/ Primary Examiner.Art Unit 3765
--	-------------------------------------------------

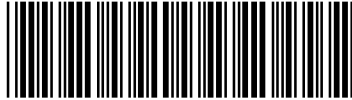
Index of Claims 	Application/Control No. 13161138	Applicant(s)/Patent Under Reexamination HENDRICKSON ET AL.
	Examiner GLORIA HALE	Art Unit 3765

✓	Rejected
=	Allowed

-	Cancelled
÷	Restricted

N	Non-Elected
I	Interference

A	Appeal
O	Objected

Claims renumbered in the same order as presented by applicant
 CPA
 T.D.
 R.1.47

CLAIM		DATE							
Final	Original	12/04/2011							
	1	✓							
	2	✓							
	3	✓							
	4	✓							
	5	✓							
	6	✓							
	7	✓							
	8	✓							
	9	✓							
	10	✓							
	11	✓							
	12	✓							
	13	✓							
	14	✓							
	15	✓							
	16	✓							
	17	✓							
	18	✓							
	19	✓							
	20	✓							
	21	✓							
	22	✓							
	23	✓							
	24	✓							
	25	✓							
	26	✓							
	27	✓							
	28	✓							
	29	✓							

Form PTO-1449 US DEPARTMENT OF COMMERCE PATENT AND TRADEMARK OFFICE	ATTY. DOCKET NO. DMC-10-1220RE	SERIAL NO.
APPLICANT Lisa A. Hendrickson, et al.		
LIST OF PUBLICATIONS CITED BY APPLICANT <i>(Use several sheets if necessary)</i>	FILING DATE herewith	GROUP

US PATENT DOCUMENTS							
EXAMINER INITIAL*		DOCUMENT NUMBER	DATE	NAME	CLASS	SUBCLASS	FILING DATE IF APPROPRIATE
	AA						
	AB						
	AC						
	AD						
	AE						
	AF						
	AG						
	AH						
	AI						
	AJ						
	AK						

FOREIGN PATENT DOCUMENTS								
		DOCUMENT NUMBER	DATE	COUNTRY	CLASS	SUBCLASS	TRANSLATION	
							YES	NO
	AL							
	AM							
	AN							
	AO							
	AP							

OTHER PUBLICATIONS (including Author, Title, Date, Pertinent Pages, Etc.)		
AR		"BOM Spring 2006" - Sketch and measurements of Gap Full Panel Long and Lean pant, Style # 376586, Gap Maternity Denim, Spring 2006.
AS		"BOM Fall 2003" - Sketch and measurements of Old Navy Bootcut Jean w/Panel Non-Stretch pant, Style # 200963-00, Old Navy Women's Maternity, Fall 2003.
AT		"BOM Fall 2005" - Sketch and measurements of Gap Roll Panel Modern Chino pant, Style # 313773, Gap Maternity Wovens, Fall 2005.

EXAMINER <u>(Gloria Hale)</u>	DATE CONSIDERED <u>12/04/2011</u>
-------------------------------	-----------------------------------

*EXAMINER: Initial if publication considered, whether or not citation is in conformance with MPEP 609; Draw line through citation if not in conformance and not considered. Include copy of this form with next communication to Applicant.

Form PTO-1449 US DEPARTMENT OF COMMERCE PATENT AND TRADEMARK OFFICE	ATTY. DOCKET NO. DMC-10-1226RE	SERIAL NO.
APPLICANT Lisa A. Hendrickson, et al.		
LIST OF PUBLICATIONS CITED BY APPLICANT <i>(Use several sheets if necessary)</i>	FILING DATE herewith	GROUP

US PATENT DOCUMENTS							
EXAMINER INITIAL*		DOCUMENT NUMBER	DATE	NAME	CLASS	SUBCLASS	FILING DATE IF APPROPRIATE
	AA						
	AB						
	AC						
	AD						
	AE						
	AF						
	AG						
	AH						
	AI						
	AJ						
	AK						

FOREIGN PATENT DOCUMENTS								
		DOCUMENT NUMBER	DATE	COUNTRY	CLASS	SUBCLASS	TRANSLATION	
							YES	NO
	AL							
	AM							
	AN							
	AO							
	AP							

OTHER PUBLICATIONS (Including Author, Title, Date, Pertinent Pages, Etc.)		
AR	"Garment Diagrams" - Sketches and measurements of various Gap and Old Navy garments, Style Nos.: 324282, 256229, 281008, 205224Su05, Fall 2004-Summer 2005.	
AS	"Poplin Pant" et al. - Maternity Print Str. Crisp Ctn. Poplin pant, Style # MBT414A (Ultra Clean Ankle Overbelly), 8/9/2002.	
AT	"Jean Pant" et al. - GAP Women's Full Panel Bootcut Jean, Style # 207095, 4/30/2003.	

EXAMINER /Gloria Hale/	DATE CONSIDERED 12/04/2011
*EXAMINER: Initial if publication considered, whether or not citation is in conformance with MPEP 609; Draw line through number if not in conformance and not considered. Include copy of this form with next communication to Applicant.	

Form PTO-1449 US DEPARTMENT OF COMMERCE PATENT AND TRADEMARK OFFICE	ATTY. DOCKET NO. DMC-16-1229RE	SERIAL NO.
	APPLICANT Lisa A. Hendrickson, et al.	
	FILING DATE herewith	GROUP

LIST OF PUBLICATIONS CITED BY APPLICANT
(Use several sheets if necessary)

US PATENT DOCUMENTS

EXAMINER INITIAL*	DOCUMENT NUMBER	DATE	NAME	CLASS	SUBCLASS	FILING DATE IF APPROPRIATE
AA						
AB						
AC						
AD						
AE						
AF						
AG						
AH						
AI						
AJ						
AK						

FOREIGN PATENT DOCUMENTS

	DOCUMENT NUMBER	DATE	COUNTRY	CLASS	SUBCLASS	TRANSLATION	
						YES	NO
AL							
AM							
AN							
AO							
AP							

OTHER PUBLICATIONS (Including Author, Title, Date, Pertinent Pages, Etc.)

AR	"Artifact color" - Selected pages from the JCPenney Catalog Maternity Collection, published 1Q 2004, front and back cover pages, and pages 4, 22, 30, and 32; and Selected pages from the JCPenney Catalog Maternity Collection, dated Fall/Winter 2005, front and back cover pages, and pages 14, 15, and 28.	
AS	Images from un-identified documents, (2 sheets) ----- NODATE	
AT		

EXAMINER /Gloria Hale/	DATE CONSIDERED 12/04/2011
---------------------------	-------------------------------

*EXAMINER: Initial if publication considered, whether or not citation is in conformance with MPEP 609; Draw line through citation if not in conformance and not considered. Include copy of this form with next communication to Applicant.

IN THE UNITED STATES PATENT AND TRADEMARK OFFICE

Art Unit : 3765 Customer No. 035811
Examiner : Gloria M. Hale
Serial No. : 13/161,138 Docket No.: DMC-10-1220RE
Filed : June 15, 2011
Inventor : Lisa A. Hendrickson
: James H. Gardner, III
: Richard Adelman
Title : BELLY COVERING
: GARMENT

TERMINAL DISCLAIMER

Commissioner for Patents
P.O. Box 1450
Alexandria, VA 22313-1450

Sir:

Your Petitioner, Richard L. Cruz, represents that he is patent counsel for Destination Maternity Corporation, which is the owner of the entire interest in the instant application (Serial No. 13/161,138) filed June 15, 2011 for BELLY COVERING GARMENT, as evidenced by an Assignment recorded at Reel 023390, Frame 0079 of the US Patent and Trademark Office records, and is also the owner of US Application No. 13/161,169 filed June 15, 2011 for BELLY COVERING GARMENT as evidenced by an Assignment recorded at Reel 023390, Frame 0079 of the US Patent and Trademark Office records.

Your Petitioner, on behalf of the patent owner, hereby disclaims the terminal part of the statutory term of any patent to be issued on said instant application which would extend beyond the expiration date of the full statutory term of any patent granted on US Application No. 13/161,169,

and hereby agrees that any patent so granted on the instant application shall be enforceable only for and during such period that the instant application is commonly owned with US Application No. 13/161,169 and any patent granted thereon, this agreement to run with any patent granted on the instant application and to be binding upon the grantee, its successors or assigns.

Respectfully submitted,

Richard L. Cruz

Date: 12/22/2011

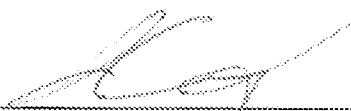
By: 
Richard L. Cruz, Patent Counsel
Reg. No. 52,783

IN THE UNITED STATES PATENT AND TRADEMARK OFFICE

Art Unit : 3765 Customer No. 035811
Examiner : Gloria M. Hale
Serial No. : 13/161,138 Docket No.: DMC-10-1220RE
Filed : June 15, 2011
Inventor : Lisa A. Hendrickson
: James H. Gardner, III
: Richard Adelman
Title : BELLY COVERING
: GARMENT

SUPPLEMENTAL REISSUE APPLICATION OATH AND
CONSENT BY THE ASSIGNEE
(Pursuant to 37 C.F.R. §1.172)

I, Ronald J. Masciantonio, a citizen of the United States, am the Executive Vice President and General Counsel of Destination Maternity Corporation ("DMC"), and as such, am authorized to act on behalf of DMC.

To the best of my knowledge and understanding, DMC is the sole assignee of the entire right, title, and interest in and to U.S. Patent No. 7,814,575 (the '575 Patent), issued on October 19, 2010.

Documentary evidence of a chain of title of the '575 Patent from the original owners to DMC is recorded in the assignment records of the US Patent and Trademark Office at Reel 019670, Frame 0495 which shows an assignment from the inventors to Mothers Work, Inc., and at Reel 023390, Frame 0079 which shows an assignment from Mothers Work, Inc. to Destination Maternity Corporation.

To the best of my knowledge and understanding, the inventors listed below are the original and first inventors of the subject matter which is described and claimed in the '575 Patent, for which a reissue patent is sought, on the invention entitled BELLY COVERING GARMENT, the specification of which was filed with the US Patent and Trademark Office on June 15, 2011 together with a Preliminary Amendment that included newly added claims:

1. Lisa A. Hendrickson, a citizen of the United States, residing at 791 Cornwallis Drive, Mount Laurel, New Jersey 08054;

2. James H. Gardner, III, a citizen of the United States, residing at 1329 Squire Drive, Ambler, Pennsylvania 19002; and

EAST47639083.1

3. Richard Adelman, a citizen of the United States, residing at 5 Suntuish Point, Greensboro, North Carolina 27455.

I have reviewed and understand the contents of the above-identified specification, including the claims as amended by the newly added claims referred to above.

By this declaration, DMC, assignee of the '575 Patent, hereby consents to the filing of the present application for the reissue of U.S. Patent No. 7,814,575.

To the best of my knowledge and understanding, the original '575 Patent to be wholly or partly inoperative by the reason of the patentee claiming less than it had the right to claim. In particular, issued Claims 2 – 25 of the '575 Patent are believed to be wholly or partly inoperative for failing to explicitly recite features such as a lower garment portion comprising denim jeans and/or a zipperless fly. All errors being corrected in the reissue application up to the time of this declaration arose without deceptive intent.

Direct all communications about the application to the address associated with Customer No. 035811. Direct all telephone calls regarding the application to Richard L. Cruz at 215-656-2446.

I acknowledge the duty to disclose information which is material to patentability as defined in 37 C.F.R. §1.56.

I hereby declare that all statements made herein of my own knowledge are true and that all statements made on information and belief are believed to be true; and further that those statements were made with the knowledge that willful false statements and the like so made are punishable by fine and imprisonment, or both, under 18 USC §1001, and that such willful false statements may jeopardize the validity of the application, any patent issuing thereon, or any patent to which this declaration is directed.



Ronald J. Stasiobantoni,
Executive Vice President & General Counsel
Destination Maternity Corporation
456 North 5th Street
Philadelphia, PA 19123

12/21/11

Date

Electronic Patent Application Fee Transmittal

Application Number:	13161138
Filing Date:	15-Jun-2011
Title of Invention:	Belly Covering Garment
First Named Inventor/Applicant Name:	Lisa A. Hendrickson
Filer:	Paul A. Taufer/Nancy Nunez
Attorney Docket Number:	DMC-10-1220RE

Filed as Large Entity

Utility under 35 USC 111(a) Filing Fees

Description	Fee Code	Quantity	Amount	Sub-Total in USD(\$)
Basic Filing:				
Pages:				
Claims:				
Miscellaneous-Filing:				
Petition:				
Patent-Appeals-and-Interference:				
Post-Allowance-and-Post-Issuance:				
Extension-of-Time:				

Description	Fee Code	Quantity	Amount	Sub-Total in USD(\$)
Miscellaneous:				
Statutory or terminal disclaimer	1814	1	160	160
Total in USD (\$)				160

Electronic Acknowledgement Receipt

EFS ID:	11686749
Application Number:	13161138
International Application Number:	
Confirmation Number:	4808
Title of Invention:	Belly Covering Garment
First Named Inventor/Applicant Name:	Lisa A. Hendrickson
Customer Number:	35811
Filer:	Paul A. Taufer/Nancy Nunez
Filer Authorized By:	Paul A. Taufer
Attorney Docket Number:	DMC-10-1220RE
Receipt Date:	22-DEC-2011
Filing Date:	15-JUN-2011
Time Stamp:	11:44:54
Application Type:	Utility under 35 USC 111(a)

Payment information:

Submitted with Payment	yes
Payment Type	Deposit Account
Payment was successfully received in RAM	\$160
RAM confirmation Number	12691
Deposit Account	502719
Authorized User	

The Director of the USPTO is hereby authorized to charge indicated fees and credit any overpayment as follows:

Charge any Additional Fees required under 37 C.F.R. Section 1.16 (National application filing, search, and examination fees)

Charge any Additional Fees required under 37 C.F.R. Section 1.17 (Patent application and reexamination processing fees)

Target Corporation

Charge any Additional Fees required under 37 C.F.R. Section 1.19 (Document supply fees)

Charge any Additional Fees required under 37 C.F.R. Section 1.20 (Post Issuance fees)

Charge any Additional Fees required under 37 C.F.R. Section 1.21 (Miscellaneous fees and charges)

File Listing:

Document Number	Document Description	File Name	File Size(Bytes)/ Message Digest	Multi Part /.zip	Pages (if appl.)
1	Terminal Disclaimer Filed	TerminalDisclaimer.pdf	400528 636da7579eb50595657a3bb035ce80cc8964fea1	no	2

Warnings:

Information:

2	Consent of Assignee accompanying the declaration	SupplementalOathandConsent.pdf	583892 34aca4fbbb434c91c32346e859857e18c83f8a80	no	2
---	--------------------------------------------------	--------------------------------	----------------------------------------------------	----	---

Warnings:

Information:

3	Fee Worksheet (SB06)	fee-info.pdf	30089 ff61cba70273f58179f43d923b5aa434f6719337	no	2
---	----------------------	--------------	---------------------------------------------------	----	---

Warnings:

Information:

Total Files Size (in bytes):

1014509

This Acknowledgement Receipt evidences receipt on the noted date by the USPTO of the indicated documents, characterized by the applicant, and including page counts, where applicable. It serves as evidence of receipt similar to a Post Card, as described in MPEP 503.

New Applications Under 35 U.S.C. 111

If a new application is being filed and the application includes the necessary components for a filing date (see 37 CFR 1.53(b)-(d) and MPEP 506), a Filing Receipt (37 CFR 1.54) will be issued in due course and the date shown on this Acknowledgement Receipt will establish the filing date of the application.

National Stage of an International Application under 35 U.S.C. 371

If a timely submission to enter the national stage of an international application is compliant with the conditions of 35 U.S.C. 371 and other applicable requirements a Form PCT/DO/EO/903 indicating acceptance of the application as a national stage submission under 35 U.S.C. 371 will be issued in addition to the Filing Receipt, in due course.

New International Application Filed with the USPTO as a Receiving Office

If a new international application is being filed and the international application includes the necessary components for an international filing date (see PCT Article 11 and MPEP 1810), a Notification of the International Application Number and of the International Filing Date (Form PCT/RO/105) will be issued in due course, subject to prescriptions concerning national security, and the date shown on this Acknowledgement Receipt will establish the international filing date of the application.

IN THE UNITED STATES PATENT AND TRADEMARK OFFICE

Art Unit	: 3765	Customer No. 035811
Examiner	: Gloria M. Hale	
Serial No.	: 13/161,138	Docket No.: DMC-10-1220RE
Filed	: June 15, 2011	
Inventor	: Lisa A. Hendrickson	
	: James H. Gardner, III	
	: Richard Adelman	Confirmation No.: 4808
Title	: BELLY COVERING	
	: GARMENT	Date: December 22, 2011

RESPONSE

Commissioner for Patents
P.O. Box 1450
Alexandria, VA 22313-1450

Sir:

In response to the Official Action of December 15, 2011, the Applicants hereby simultaneously submit a Supplemental Reissue Application Oath and Consent by the Assignee and a Terminal Disclaimer. Entry into the Official Record is respectfully requested.

As a result of this Response and the documents referenced above, the Applicants submit that the instant Application is now in condition for allowance, which action is respectfully requested.

Respectfully submitted,

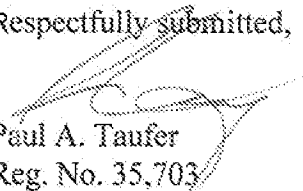

Paul A. Taufer
Reg. No. 35,703
Richard L. Cruz
Reg. No. 52,783
Attorneys for Applicants

PAT/RLC/mn
(215) 656-3385

Electronic Acknowledgement Receipt

EFS ID:	11690018
Application Number:	13161138
International Application Number:	
Confirmation Number:	4808
Title of Invention:	Belly Covering Garment
First Named Inventor/Applicant Name:	Lisa A. Hendrickson
Customer Number:	35811
Filer:	Paul A. Taufer/Nancy Nunez
Filer Authorized By:	Paul A. Taufer
Attorney Docket Number:	DMC-10-1220RE
Receipt Date:	22-DEC-2011
Filing Date:	15-JUN-2011
Time Stamp:	14:32:39
Application Type:	Utility under 35 USC 111(a)

Payment information:

Submitted with Payment	no
------------------------	----

File Listing:

Document Number	Document Description	File Name	File Size(Bytes)/ Message Digest	Multi Part /.zip	Pages (if appl.)
1	Amendment/Req. Reconsideration-After Non-Final Reject	Response.pdf	149690 <small>a1550b9ac6ee8146a7b7cdade3f5201a99d1fd7c</small>	no	1

Warnings:

Information:

This Acknowledgement Receipt evidences receipt on the noted date by the USPTO of the indicated documents, characterized by the applicant, and including page counts, where applicable. It serves as evidence of receipt similar to a Post Card, as described in MPEP 503.

New Applications Under 35 U.S.C. 111

If a new application is being filed and the application includes the necessary components for a filing date (see 37 CFR 1.53(b)-(d) and MPEP 506), a Filing Receipt (37 CFR 1.54) will be issued in due course and the date shown on this Acknowledgement Receipt will establish the filing date of the application.

National Stage of an International Application under 35 U.S.C. 371

If a timely submission to enter the national stage of an international application is compliant with the conditions of 35 U.S.C. 371 and other applicable requirements a Form PCT/DO/EO/903 indicating acceptance of the application as a national stage submission under 35 U.S.C. 371 will be issued in addition to the Filing Receipt, in due course.

New International Application Filed with the USPTO as a Receiving Office

If a new international application is being filed and the international application includes the necessary components for an international filing date (see PCT Article 11 and MPEP 1810), a Notification of the International Application Number and of the International Filing Date (Form PCT/RO/105) will be issued in due course, subject to prescriptions concerning national security, and the date shown on this Acknowledgement Receipt will establish the international filing date of the application.

Form PTO-1449 US DEPARTMENT OF COMMERCE PATENT AND TRADEMARK OFFICE	ATTY. DOCKET NO. DMC-10-1220RE	SERIAL NO. 13/161,138
	APPLICANT Lisa A. Hendrickson, et al.	
	FILING DATE June 15, 2011	GROUP 3465

LIST OF PUBLICATIONS CITED BY APPLICANT
(Use several sheets if necessary)

US PATENT DOCUMENTS

EXAMINER INITIAL*	DOCUMENT NUMBER	DATE	NAME	CLASS	SUBCLASS	FILING DATE IF APPROPRIATE
AA	3,045,678	07/24/62	C. J. Geimer			
AB	5,946,730	09/07/99	Blair			
AC						
AD						
AE						
AF						
AG						
AH						
AI						
AJ						
AK						

FOREIGN PATENT DOCUMENTS

	DOCUMENT NUMBER	DATE	COUNTRY	CLASS	SUBCLASS	TRANSLATION	
						YES	NO
AL							
AM							
AN							
AO							
AP							

OTHER PUBLICATIONS (Including Author, Title, Date, Pertinent Pages, Etc.)

AR	
AS	
AT	

EXAMINER	DATE CONSIDERED
----------	-----------------

*EXAMINER: Initial if publication considered, whether or not citation is in conformance with MPEP 609; Draw line through citation if not in conformance and not considered. Include copy of this form with next communication to Applicant.

12/27/10

53

EXAMINATION REPORT

NAME OF THE EXAMINATION OFFICE: AUSTRIAN PATENT OFFICE

Applicant's or agent's file reference		
Application No. GCC/P/2008/10911	Application filing date 28 May 2008 (28.05.2008)	(earliest) Priority date 31 May 2007 (31.05.2007)

Applicant
BELLY COVERING GARMENT

1. This is the first second third examination report on this application
2. This REPORT consists of a total of 6 sheets.
3. This report contains indications relating to the following items:
 - I. Basis of the report..... (page Ex. R 2/2)
 - II. Priority..... (page Ex. R 2/2)
 - III. Non-establishment of opinion with regard to novelty, inventive step, industrial applicability; (page Ex. R 2/3)
 - IV. Lack of unity of invention (page Ex. R 2/4)
 - V. Reasoned statement with regard to novelty, inventive step or industrial applicability; Citation and explanation supporting such statement (page Ex. R 2/5)
 - VI. Certain documents cited (page Ex. R 2/6)
 - VII. Certain defects in the application (page Ex. R 2/7)
 - VIII. Certain observations of the application..... (page Ex. R 2/8)
4. The search report used was issued by the ISA/US and the date of completion is 6 August 2008. The search report(s) used to prepare this Examination Report is a previous report(s) (enclosed) new search report prepared by the Austrian Patent Office

Date of request submission to the Austrian Patent Office 3 April 2011 (03.04.2011)	Date of completion of the examination report 11 August 2011 (11.08.2011)	Date of mailing of the examination report 20 September 2011 (20.09.2011)
------------------------------------------------------------------------------------------	-----------------------------------------------------------------------------	--------------------------------------------------------------------------------

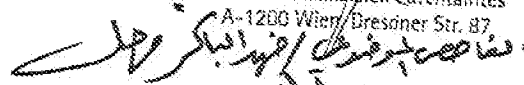
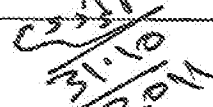
Name and mailing address	Patent Expert: Name: Schäfer Edith	Authorized Officer Name: Roman Strauss Title: Mag. Signature:  & serv.ip - ein privatrechtliches Unternehmen Seal: des Österreichischen Patentamtes A-1200 Wien / Dresdner Str. 87
Facsimile No.: 0043 / 53424 / 733	 	

I. Basis of the report (Exam. R 2/1)

1. This report has been drawn on the basis of

- the application as transmitted with the request from the GCC Office
- the description, page(s) 1-6, 9(abstract), as originally filed
page(s) , filed with the request from the GCC to the Austrian Patent Office
page(s) , filed with the letter of
page(s) , filed with the letter of
- the claim(s), number(s) 1-10, as originally filed
number(s) , filed with the request from the GCC to the Austrian Patent Office
number(s) , filed with the letter of
number(s) , filed with the letter of
- the drawings, figs. 1,1A,2-7, as originally filed
page(s) , filed with the request from the GCC to the Austrian Patent Office
page(s) , filed with the letter of
page(s) , filed with the letter of

2. The amendments have resulted in the cancellation of page(s)

sheet(s) of drawings/figures No(s):

- This report has been established as if (some of) the amendments had not been made, since they have been considered to go beyond the disclosure as filed, as indicated in the Supplemental Box

3. Additional observations, if necessary:

II. Priority (See page Exam. R. 2/1)

1. Accepted, as mentioned on page Exam. R 2/1 according to

- Request Form Priority Certificate

2. This report has been established as if no priority had been claimed.

- This report has been established as if no priority had been claimed due to failure to furnish:

- copy of the earlier application whose priority has been claimed.
- translation thereof if the earlier application whose priority has been claimed.

3. This report has been established as if no priority had been claimed due to the fact that the priority claim has been found invalid.

- Thus for the purposes of this report, the filing date indicated above is considered to be the relevant date.

Examination Report
Application No.: GCC/P/2008/10911
V. Reasoned statement with regard to novelty, inventive step or industrial applicability: citation and explanations supporting such statement (See page Exam. R. 2/1)
1. STATEMENT:

Novelty (N)	Claim(s)	9	YES
	Claim(s)	1-8,10	NO
Inventive step (IS)	Claim(s)	---	YES
	Claim(s)	1-10	NO
Industrial applicability (IA)	Claim(s)	1-10	YES
	Claim(s)	---	NO

2. CITATIONS AND EXPLANATIONS:

In the Search Report, established by ISA/US, the following documents are cited:

D1 : US 4506390 A
 D2 : US 2004/0210987 A1
 D3 : US 2006/0010571 A1
 D4 : US 6311333 B1
 D5 : US 3045678 A
 D6 : US 4280229 A

D1 describes a maternity garment comprising a tube-like waistband portion and a body portion, the waistband portion having a pouch-like vertical extension at the front and being elastic and expandable and contractible only in a radial direction, the body portion forming the configuration of the garment and being connected with and extending downward from the waistband portion. The waistband portion is formed of an elastically shirred material, which is stitched circumferentially of the garment with elastic thread. The waistband portion and the body portion may be formed of the same woven or knitted material. A hem is formed along a top edge of the waistband portion by folding the top edge and stitching. The center of the elastically shirred waistband material is cut on a curve and the panel is sewn into a tube with the back edges being joined together. (See D1, e.g. claims 1-4; col.2, l.45-61; col.3, l.31-40, 60-68; col.4, l.3-15,45-49; Figs.)

D2 refers to a stretchable generally cylindrical seamless maternity garment, similar to a tube top to be worn around a pregnant woman's torso at the waist. A portion of the height of the band resides over the pants, while an upper portion of the band's height extends above the upper portion of the pants and engages against the torso. The elastic band may be worn as a single layer or folded as a double layer, is formed of knit fabric and hugs a woman's lower abdomen. (See D2, e.g. claims; paragraphs 10-14,27,29; Figs.)

D3 discloses a maternity pant having two waistband components sewn together to form a contiguous single waistband, the first waistband component having an outer surface of low stretchiness and an inner surface of high stretchiness, the second waistband component being made of elastic fabric. (See D3, e.g. claims; paragraphs 2,13,14; Figs.)

D4 is directed towards a pants garment having incorporated a stretchable material in the yoke and the rear section of the waistband. The front portion of the waistband may be of different material

than the rear portion. (See D4, e.g. abstract; claim 1; col.2, l.47-50; col.3, l.1-24; Figs. 1,2.)

D5 relates to maternity garments comprising a rear and side encircling panel unit of elastic fabric connected across the lower front portion of the garment by a lower abdomen supporting portion and an upper front abdomen supporting panel unit. The upper panel unit is formed to provide a forward looseness and pocketing thereof and is made of two-way stretch material having predetermined lines of major stretchability in one direction. (See D5, e.g. claims; col.1, l.32-63; Figs.)

D6 reveals a maternity garment including a waist portion, having a larger front and a vertically optionally smaller rear panel of elastically expansible ribbed knitted material extending circumferentially along the waist, and a body portion integral with the waist portion forming the shape of the garment. The elastically deformable panels arranged around the waist enables the waist region to expand as the wearer expands, thus enabling the garment to be worn through all stages of pregnancy. (See D6, e.g. claims; col.3, l.6-10; Figs.)

Novelty and Inventive Step:

In present claim 1, the terms "garment", "garment upper portion", "garment lower portion", "recedes downward" appear to be unclear and so allow many interpretations, in particular, D1-D6 refer to garments having upper and lower portions.

The subject matters of present claims 1-8,10 do not appear to be novel or to involve an inventive step, since the given features appear to be described e.g. in D1,D2,D4,D5.

Garments with elastic expansible contractible belly panels holding the garment in place and having downward receding circumferences according to present claims 1,2,8 appear to be disclosed e.g. in D1,D2,D4,D5 (see e.g. D1, claim 1, col.4, l.3-15, Figs. 1-3; D2, claim 1, Fig. 4; D4, claim 1, Fig.2; D5, claim 1, Fig. 1).

Seamless tubular garment upper portions according to present claim 3 appear to be shown e.g. in D2,D5,D6 (see e.g. D2, claim 1, Fig. 1, paragraph 10; D5, Fig. 1; D6, claim 1, Figs.).

Foldable belly panels also representing a double layer structure according to present claims 4,6,7 appear to be found e.g. in D1-D3 (see e.g. D1, col.3, l.31-40; D2, claims 4,9; D3, claim 1).

Belly panels being woven or knitted with elastic strands according to present claim 5 are disclosed e.g. in D1-D6 (see e.g. D1, claim 2; D2, paragraph 29; D3, paragraph 13; D4, col.3, l.14-24; D5, col.1, l.53-63; D6, col.2, l.7-12).

Cradling stitches or knitted tension in the belly panel according to present claim 10 appear to be disclosed e.g. in D1,D2,D5 (see e.g. D1, claim 3, col.2, l.45-61; D2, paragraph 14, Fig. 4.; D5, claim 1, Fig. 1).

The subject matter of present claim 9, comprising a garment lower portion having a partial waistband across the back side appears to be novel, since the combination of all features could not be found in one of documents D1-D6 cited in the Search Report, but said subject matter does not appear to bear inventive matter, since partial waistbands as claimed in present claim 9 are shown e.g. in D4,D6 and so appear to belong to the general state of the art, may be applied without difficulty and appear to yield expectable effects (see D4, e.g. col.3, l.5-9; D6, e.g. claims; Fig. 1a).

Summing up, the subject matters of present claims 1-8,10 do not appear to be novel or to involve an inventive step, since said subject matters appear to be described and shown in documents

D1, D2, D4, D5 cited in the Search Report. In particular, unclear general terms in present claim 1 allow multiple interpretations of the claimed subject matters.

The subject matter of present claim 9 appears to be novel, since the combination of all features of said claim could not be found in one of documents D1-D6 cited in the Search Report, but said subject matter does not appear to bear inventive matter, since it appears to be obvious to an artisan to use features known in the art, e.g. by the disclosures of D4, D6, and the effect obtained by said combination of features appears to be expectable.

Industrial Applicability:

The subject matters of all present claims 1-10 appear to be industrially applicable, since they can be produced industrially.

VIII. Certain observations on the application (See page Exam. R, 2/1)-

The following observations on the clarity of the claims, description and drawings of on the question whether the claims are fully supported by the description are made:

In present claim 1, the terms "garment", "garment upper portion", "garment lower portion" appear to be unclear, comprising a huge number of possible embodiments (see e.g. present description, paragraphs 17-20; Figs.).

In present claim 1, last line, the term "recedes downward" appears to be unclear (configuration, extent, place, area ? etc.) and so is open for different interpretations (see e.g. present description, paragraph 20).

Electronic Acknowledgement Receipt

EFS ID:	11745538
Application Number:	13161138
International Application Number:	
Confirmation Number:	4808
Title of Invention:	Belly Covering Garment
First Named Inventor/Applicant Name:	Lisa A. Hendrickson
Customer Number:	35811
Filer:	Paul A. Taufer/Nancy Nunez
Filer Authorized By:	Paul A. Taufer
Attorney Docket Number:	DMC-10-1220RE
Receipt Date:	03-JAN-2012
Filing Date:	15-JUN-2011
Time Stamp:	13:46:13
Application Type:	Utility under 35 USC 111(a)

Payment information:

Submitted with Payment	no
------------------------	----

File Listing:

Document Number	Document Description	File Name	File Size(Bytes)/ Message Digest	Multi Part /.zip	Pages (if appl.)
1		IDS1449.pdf	396058 4a7f087f96b87a07bdf985aeca2a048599d5bb28	yes	2

Multipart Description/PDF files in .zip description			
Document Description	Start	End	
Transmittal Letter	1	1	
Information Disclosure Statement (IDS) Form (SB08)	2	2	

Warnings:

Information:

2	Non Patent Literature	AustrianOA.pdf	1468833	no	6
			4bf9707f48da4874003df8c88f7ebf1a0038af18		

Warnings:

Information:

Total Files Size (in bytes):	1864891
-------------------------------------	---------

This Acknowledgement Receipt evidences receipt on the noted date by the USPTO of the indicated documents, characterized by the applicant, and including page counts, where applicable. It serves as evidence of receipt similar to a Post Card, as described in MPEP 503.

New Applications Under 35 U.S.C. 111

If a new application is being filed and the application includes the necessary components for a filing date (see 37 CFR 1.53(b)-(d) and MPEP 506), a Filing Receipt (37 CFR 1.54) will be issued in due course and the date shown on this Acknowledgement Receipt will establish the filing date of the application.

National Stage of an International Application under 35 U.S.C. 371

If a timely submission to enter the national stage of an international application is compliant with the conditions of 35 U.S.C. 371 and other applicable requirements a Form PCT/DO/EO/903 indicating acceptance of the application as a national stage submission under 35 U.S.C. 371 will be issued in addition to the Filing Receipt, in due course.

New International Application Filed with the USPTO as a Receiving Office

If a new international application is being filed and the international application includes the necessary components for an international filing date (see PCT Article 11 and MPEP 1810), a Notification of the International Application Number and of the International Filing Date (Form PCT/RO/105) will be issued in due course, subject to prescriptions concerning national security, and the date shown on this Acknowledgement Receipt will establish the international filing date of the application.

IN THE UNITED STATES PATENT AND TRADEMARK OFFICE

Art Unit : 3765 Customer No. 035811
Examiner : Gloria M. Hale
Serial No. : 13/161,138 Docket No.: DMC-10-1220RE
Filed : June 15, 2011
Inventor : Lisa A. Hendrickson
: James H. Gardner, III
: Richard Adelman Confirmation No.: 4808
Title : BELLY COVERING
: GARMENT Date: January 3, 2012

SUPPLEMENTAL INFORMATION DISCLOSURE STATEMENT

Commissioner for Patents
P.O. Box 1450
Washington, D.C. 20231-1450

Sir:

The Applicants enclose Form PTO-1449 which lists relevant US publications. A copy of the Examination Report from corresponding Gulf Cooperation Council Application No. 2008/10911 issued by the Austrian Patent Office is also enclosed. The documents are submitted under 37 CFR §1.56. The publications are believed related in view of their mention in the Examination Report and the Official Action issued in corresponding US Application No. 13/161,169 for the reasons stated.

The Applicants respectfully request that this Supplemental Information Disclosure Statement be officially entered into the file of this case and that appropriate notification be made that it was considered by the Examiner.

Respectfully submitted,



Richard L. Cruz
Reg. No. 52,783
Attorney for Applicants

RLC/nn
(215) 656-2446

Application Number 	Application/Control No. 13/161,138	Applicant(s)/Patent under Reexamination HENDRICKSON ET AL.

Document Code - DISQ	Internal Document – DO NOT MAIL
-----------------------------	----------------------------------------

TERMINAL DISCLAIMER	<input checked="" type="checkbox"/> APPROVED	<input type="checkbox"/> DISAPPROVED
Date Filed : 1/13/12	This patent is subject to a Terminal Disclaimer	

Approved/Disapproved by:

ANDRE ROBINSON
 2 TDS WERE APPRVD.

Application Number 	Application/Control No. 13/161,138	Applicant(s)/Patent under Reexamination HENDRICKSON ET AL.

Document Code - DISQ	Internal Document – DO NOT MAIL
-----------------------------	----------------------------------------

TERMINAL DISCLAIMER	<input type="checkbox"/> APPROVED	<input checked="" type="checkbox"/> DISAPPROVED
Date Filed : 12/22/11	This patent is subject to a Terminal Disclaimer	

Approved/Disapproved by:

ANDRE ROBINSON

[X] The person who signed the terminal disclaimer:

[] has failed to state his/her capacity to sign for the business entity. (See FP 14.28)

[] is not recognized as an officer of the assignee. (See FP 14.29)

[X] does not have power of attorney. (FP 14.29.01)

Electronic Acknowledgement Receipt

EFS ID:	12633250
Application Number:	13161138
International Application Number:	
Confirmation Number:	4808
Title of Invention:	Belly Covering Garment
First Named Inventor/Applicant Name:	Lisa A. Hendrickson
Customer Number:	35811
Filer:	Paul A. Taufer/Nancy Nunez
Filer Authorized By:	Paul A. Taufer
Attorney Docket Number:	DMC-10-1220RE
Receipt Date:	26-APR-2012
Filing Date:	15-JUN-2011
Time Stamp:	09:56:47
Application Type:	Utility under 35 USC 111(a)

Payment information:

Submitted with Payment	no
------------------------	----

File Listing:

Document Number	Document Description	File Name	File Size(Bytes)/ Message Digest	Multi Part /.zip	Pages (if appl.)
1	Miscellaneous Incoming Letter	TL.pdf	137319 <small>c18f1c707edef3c51f920b79567b551dd8f9787a</small>	no	1

Warnings:

Information:

2	Oath or Declaration filed	SupDEC.pdf	471385 aa47e873d441505734dfcb1d1bbd99684007 aa097	no	2
---	---------------------------	------------	---------------------------------------------------------	----	---

Warnings:

Information:

Total Files Size (in bytes):	608704
-------------------------------------	--------

This Acknowledgement Receipt evidences receipt on the noted date by the USPTO of the indicated documents, characterized by the applicant, and including page counts, where applicable. It serves as evidence of receipt similar to a Post Card, as described in MPEP 503.

New Applications Under 35 U.S.C. 111

If a new application is being filed and the application includes the necessary components for a filing date (see 37 CFR 1.53(b)-(d) and MPEP 506), a Filing Receipt (37 CFR 1.54) will be issued in due course and the date shown on this Acknowledgement Receipt will establish the filing date of the application.

National Stage of an International Application under 35 U.S.C. 371

If a timely submission to enter the national stage of an international application is compliant with the conditions of 35 U.S.C. 371 and other applicable requirements a Form PCT/DO/EO/903 indicating acceptance of the application as a national stage submission under 35 U.S.C. 371 will be issued in addition to the Filing Receipt, in due course.

New International Application Filed with the USPTO as a Receiving Office

If a new international application is being filed and the international application includes the necessary components for an international filing date (see PCT Article 11 and MPEP 1810), a Notification of the International Application Number and of the International Filing Date (Form PCT/RO/105) will be issued in due course, subject to prescriptions concerning national security, and the date shown on this Acknowledgement Receipt will establish the international filing date of the application.

IN THE UNITED STATES PATENT AND TRADEMARK OFFICE

Art Unit	: 3765	Customer No. 035811
Examiner	: Gloria M. Hale	
Serial No.	: 13/161,138	Docket No.: DMC-10-1220RE
Filed	: June 15, 2011	
Inventor	: Lisa A. Hendrickson	
	: James H. Gardner, III	
	: Richard Adelman	
Title	: BELLY COVERING	
	: GARMENT	

SUPPLEMENTAL REISSUE APPLICATION OATH AND
CONSENT BY THE ASSIGNEE
(Pursuant to 37 C.F.R. §1.172)

I, Ronald J. Masciantonio, a citizen of the United States, am the Executive Vice President and General Counsel of Destination Maternity Corporation ("DMC"), and as such, am authorized to act on behalf of DMC.

To the best of my knowledge and understanding, DMC is the sole assignee of the entire right, title, and interest in and to U.S. Patent No. 7,814,575 (the '575 Patent), issued on October 19, 2010.

Documentary evidence of a chain of title of the '575 Patent from the original owners to DMC is recorded in the assignment records of the US Patent and Trademark Office at Reel 019670, Frame 0495 which shows an assignment from the inventors to Mothers Work, Inc., and at Reel 023390, Frame 0079 which shows an assignment from Mothers Work, Inc. to Destination Maternity Corporation.

To the best of my knowledge and understanding, the inventors listed below are the original and first inventors of the subject matter which is described and claimed in the '575 Patent, for which a reissue patent is sought, on the invention entitled BELLY COVERING GARMENT, the specification of which was filed with the US Patent and Trademark Office on June 15, 2011 together with a Preliminary Amendment that included newly added claims:

1. Lisa A. Hendrickson, a citizen of the United States, residing at 791 Cornwallis Drive, Mount Laurel, New Jersey 08054;

2. James H. Gardner, III, a citizen of the United States, residing at 1329 Squire Drive, Ambler, Pennsylvania 19002; and

3. Richard Adelman, a citizen of the United States, residing at 5 Sunfish Point, Greensboro, North Carolina 27455.

I have reviewed and understand the contents of the above-identified specification, including the claims as amended by the newly added claims referred to above.

By this declaration, DMC, assignee of the '575 Patent, hereby consents to the filing of the present application for the reissue of U.S. Patent No. 7,814,575.

To the best of my knowledge and understanding, the original '575 Patent to be wholly or partly inoperative by the reason of the patentee claiming less than it had the right to claim. In particular, issued Claims 2 - 25 of the '575 Patent are believed to be wholly or partly inoperative for failing to explicitly recite features such as a lower garment portion comprising denim jeans and/or a zipperless fly. All errors being corrected in the reissue application up to the time of this declaration arose without deceptive intent. Every error in the patent which was corrected in the present reissue application, and is not covered by the prior declaration submitted in this application, arose without any deceptive intention on the part of the Applicant.

Direct all communications about the application to the address associated with Customer No. 035811. Direct all telephone calls regarding the application to Richard L. Cruz at 215-656-2446.

I acknowledge the duty to disclose information which is material to patentability as defined in 37 C.F.R. §1.56.

I hereby declare that all statements made herein of my own knowledge are true and that all statements made on information and belief are believed to be true; and further that these statements were made with the knowledge that willful false statements and the like so made are punishable by fine and imprisonment, or both, under 18 USC §1001, and that such willful false statements may jeopardize the validity of the application, any patent issuing thereon, or any patent to which this declaration is directed.



Ronald J. Masciantonio,
Executive Vice President & General Counsel
Destination Maternity Corporation
456 North 5th Street
Philadelphia, PA 19123

4/25/12

Date

IN THE UNITED STATES PATENT AND TRADEMARK OFFICE

Art Unit	: 3765	Customer No. 035811
Examiner	: Gloria M. Hale	
Serial No.	: 13/161,138	Docket No.: DMC-10-1220RE
Filed	: June 15, 2011	
Inventor	: Lisa A. Hendrickson	
	: James H. Gardner, III	
	: Richard Adelman	Confirmation No.: 4808
Title	: BELLY COVERING	
	: GARMENT	Date: April 26, 2012

TRANSMITTAL LETTER

Commissioner for Patents
P.O. Box 1450
Alexandria, VA 22313-1450

Sir:

Applicants hereby submit an executed Supplemental Reissue Application Oath and Consent by the Assignee. Entry into the Official Record is respectfully requested.

As a result of this submission, the Applicants submit that the instant Application is now in condition for allowance, which action is respectfully requested.

Respectfully submitted,



Richard L. Cruz
Reg. No. 52,783
Attorney for Applicants

RLC/nn
(215) 656-2446



NOTICE OF ALLOWANCE AND FEE(S) DUE

35811 7590 06/05/2012
IP GROUP OF DLA PIPER LLP (US)
ONE LIBERTY PLACE
1650 MARKET ST, SUITE 4900
PHILADELPHIA, PA 19103

EXAMINER
HALE, GLORIA M
ART UNIT PAPER NUMBER

3765
DATE MAILED: 06/05/2012

Table with 5 columns: APPLICATION NO., FILING DATE, FIRST NAMED INVENTOR, ATTORNEY DOCKET NO., CONFIRMATION NO.

13/161,138 06/15/2011 Lisa A. Hendrickson DMC-10-1220RE 4808
TITLE OF INVENTION: BELLY COVERING GARMENT

Table with 7 columns: APPLN. TYPE, SMALL ENTITY, ISSUE FEE DUE, PUBLICATION FEE DUE, PREV. PAID ISSUE FEE, TOTAL FEE(S) DUE, DATE DUE

THE APPLICATION IDENTIFIED ABOVE HAS BEEN EXAMINED AND IS ALLOWED FOR ISSUANCE AS A PATENT. PROSECUTION ON THE MERITS IS CLOSED. THIS NOTICE OF ALLOWANCE IS NOT A GRANT OF PATENT RIGHTS. THIS APPLICATION IS SUBJECT TO WITHDRAWAL FROM ISSUE AT THE INITIATIVE OF THE OFFICE OR UPON PETITION BY THE APPLICANT. SEE 37 CFR 1.313 AND MPEP 1308.

THE ISSUE FEE AND PUBLICATION FEE (IF REQUIRED) MUST BE PAID WITHIN THREE MONTHS FROM THE MAILING DATE OF THIS NOTICE OR THIS APPLICATION SHALL BE REGARDED AS ABANDONED. THIS STATUTORY PERIOD CANNOT BE EXTENDED. SEE 35 U.S.C. 151. THE ISSUE FEE DUE INDICATED ABOVE DOES NOT REFLECT A CREDIT FOR ANY PREVIOUSLY PAID ISSUE FEE IN THIS APPLICATION. IF AN ISSUE FEE HAS PREVIOUSLY BEEN PAID IN THIS APPLICATION (AS SHOWN ABOVE), THE RETURN OF PART B OF THIS FORM WILL BE CONSIDERED A REQUEST TO REAPPLY THE PREVIOUSLY PAID ISSUE FEE TOWARD THE ISSUE FEE NOW DUE.

HOW TO REPLY TO THIS NOTICE:

I. Review the SMALL ENTITY status shown above.
If the SMALL ENTITY is shown as YES, verify your current SMALL ENTITY status:
A. If the status is the same, pay the TOTAL FEE(S) DUE shown above.
B. If the status above is to be removed, check box 5b on Part B - Fee(s) Transmittal and pay the PUBLICATION FEE (if required) and twice the amount of the ISSUE FEE shown above, or

If the SMALL ENTITY is shown as NO:
A. Pay TOTAL FEE(S) DUE shown above, or
B. If applicant claimed SMALL ENTITY status before, or is now claiming SMALL ENTITY status, check box 5a on Part B - Fee(s) Transmittal and pay the PUBLICATION FEE (if required) and 1/2 the ISSUE FEE shown above.

II. PART B - FEE(S) TRANSMITTAL, or its equivalent, must be completed and returned to the United States Patent and Trademark Office (USPTO) with your ISSUE FEE and PUBLICATION FEE (if required). If you are charging the fee(s) to your deposit account, section "4b" of Part B - Fee(s) Transmittal should be completed and an extra copy of the form should be submitted. If an equivalent of Part B is filed, a request to reapply a previously paid issue fee must be clearly made, and delays in processing may occur due to the difficulty in recognizing the paper as an equivalent of Part B.

III. All communications regarding this application must give the application number. Please direct all communications prior to issuance to Mail Stop ISSUE FEE unless advised to the contrary.

IMPORTANT REMINDER: Utility patents issuing on applications filed on or after Dec. 12, 1980 may require payment of maintenance fees. It is patentee's responsibility to ensure timely payment of maintenance fees when due.

PART B - FEE(S) TRANSMITTAL

**Complete and send this form, together with applicable fee(s), to: Mail Mail Stop ISSUE FEE
 Commissioner for Patents
 P.O. Box 1450
 Alexandria, Virginia 22313-1450
 or Fax (571)-273-2885**

INSTRUCTIONS: This form should be used for transmitting the ISSUE FEE and PUBLICATION FEE (if required). Blocks 1 through 5 should be completed where appropriate. All further correspondence including the Patent, advance orders and notification of maintenance fees will be mailed to the current correspondence address as indicated unless corrected below or directed otherwise in Block 1, by (a) specifying a new correspondence address; and/or (b) indicating a separate "FEE ADDRESS" for maintenance fee notifications.

CURRENT CORRESPONDENCE ADDRESS (Note: Use Block 1 for any change of address)

Note: A certificate of mailing can only be used for domestic mailings of the Fee(s) Transmittal. This certificate cannot be used for any other accompanying papers. Each additional paper, such as an assignment or formal drawing, must have its own certificate of mailing or transmission.

35811 7590 06/05/2012
IP GROUP OF DLA PIPER LLP (US)
 ONE LIBERTY PLACE
 1650 MARKET ST, SUITE 4900
 PHILADELPHIA, PA 19103

Certificate of Mailing or Transmission

I hereby certify that this Fee(s) Transmittal is being deposited with the United States Postal Service with sufficient postage for first class mail in an envelope addressed to the Mail Stop ISSUE FEE address above, or being facsimile transmitted to the USPTO (571) 273-2885, on the date indicated below.

_____ (Depositor's name)
_____ (Signature)
_____ (Date)

APPLICATION NO.	FILING DATE	FIRST NAMED INVENTOR	ATTORNEY DOCKET NO.	CONFIRMATION NO.
13/161,138	06/15/2011	Lisa A. Hendrickson	DMC-10-1220RE	4808

TITLE OF INVENTION: BELLY COVERING GARMENT

APPLN. TYPE	SMALL ENTITY	ISSUE FEE DUE	PUBLICATION FEE DUE	PREV. PAID ISSUE FEE	TOTAL FEE(S) DUE	DATE DUE
nonprovisional	NO	\$1740	\$0	\$0	\$1740	09/05/2012

EXAMINER	ART UNIT	CLASS-SUBCLASS
HALE, GLORIA M	3765	002-227000

<p>1. Change of correspondence address or indication of "Fee Address" (37 CFR 1.363).</p> <p><input type="checkbox"/> Change of correspondence address (or Change of Correspondence Address form PTO/SB/122) attached.</p> <p><input type="checkbox"/> "Fee Address" indication (or "Fee Address" Indication form PTO/SB/47; Rev 03-02 or more recent) attached. Use of a Customer Number is required.</p>	<p>2. For printing on the patent front page, list</p> <p>(1) the names of up to 3 registered patent attorneys or agents OR, alternatively, 1 _____</p> <p>(2) the name of a single firm (having as a member a registered attorney or agent) and the names of up to 2 registered patent attorneys or agents. If no name is listed, no name will be printed. 2 _____</p> <p>3 _____</p>
-------------------------------------------------------------------------------------------------------------------------------------------------------------------------------------------------------------------------------------------------------------------------------------------------------------------------------------------------------------------------------------------------------------------	---------------------------------------------------------------------------------------------------------------------------------------------------------------------------------------------------------------------------------------------------------------------------------------------------------------------------------------------------------------------------------------

3. ASSIGNEE NAME AND RESIDENCE DATA TO BE PRINTED ON THE PATENT (print or type)

PLEASE NOTE: Unless an assignee is identified below, no assignee data will appear on the patent. If an assignee is identified below, the document has been filed for recordation as set forth in 37 CFR 3.11. Completion of this form is NOT a substitute for filing an assignment.

(A) NAME OF ASSIGNEE _____ (B) RESIDENCE: (CITY and STATE OR COUNTRY) _____

Please check the appropriate assignee category or categories (will not be printed on the patent) : Individual Corporation or other private group entity Government

<p>4a. The following fee(s) are submitted:</p> <p><input type="checkbox"/> Issue Fee</p> <p><input type="checkbox"/> Publication Fee (No small entity discount permitted)</p> <p><input type="checkbox"/> Advance Order - # of Copies _____</p>	<p>4b. Payment of Fee(s); (Please first reapply any previously paid issue fee shown above)</p> <p><input type="checkbox"/> A check is enclosed.</p> <p><input type="checkbox"/> Payment by credit card. Form PTO-2038 is attached.</p> <p><input type="checkbox"/> The Director is hereby authorized to charge the required fee(s), any deficiency, or credit any overpayment, to Deposit Account Number _____ (enclose an extra copy of this form).</p>
-------------------------------------------------------------------------------------------------------------------------------------------------------------------------------------------------------------------------------------------------	----------------------------------------------------------------------------------------------------------------------------------------------------------------------------------------------------------------------------------------------------------------------------------------------------------------------------------------------------------------------------------------------------------------------------------------------------------

5. Change in Entity Status (from status indicated above)

a. Applicant claims SMALL ENTITY status. See 37 CFR 1.27. b. Applicant is no longer claiming SMALL ENTITY status. See 37 CFR 1.27(g)(2).

NOTE: The Issue Fee and Publication Fee (if required) will not be accepted from anyone other than the applicant; a registered attorney or agent; or the assignee or other party in interest as shown by the records of the United States Patent and Trademark Office.

Authorized Signature _____ Date _____

Typed or printed name _____ Registration No. _____

This collection of information is required by 37 CFR 1.311. The information is required to obtain or retain a benefit by the public which is to file (and by the USPTO to process) an application. Confidentiality is governed by 35 U.S.C. 122 and 37 CFR 1.14. This collection is estimated to take 12 minutes to complete, including gathering, preparing, and submitting the completed application form to the USPTO. Time will vary depending upon the individual case. Any comments on the amount of time you require to complete this form and/or suggestions for reducing this burden, should be sent to the Chief Information Officer, U.S. Patent and Trademark Office, U.S. Department of Commerce, P.O. Box 1450, Alexandria, Virginia 22313-1450. DO NOT SEND FEES OR COMPLETED FORMS TO THIS ADDRESS. SEND TO: Commissioner for Patents, P.O. Box 1450, Alexandria, Virginia 22313-1450.

Under the Paperwork Reduction Act of 1995, no persons are required to respond to a collection of information unless it displays a valid OMB control number.



UNITED STATES PATENT AND TRADEMARK OFFICE

UNITED STATES DEPARTMENT OF COMMERCE
United States Patent and Trademark Office
Address: COMMISSIONER FOR PATENTS
P.O. Box 1450
Alexandria, Virginia 22313-1450
www.uspto.gov

Table with 5 columns: APPLICATION NO., FILING DATE, FIRST NAMED INVENTOR, ATTORNEY DOCKET NO., CONFIRMATION NO.
13/161,138 06/15/2011 Lisa A. Hendrickson DMC-10-1220RE 4808

35811 7590 06/05/2012
IP GROUP OF DLA PIPER LLP (US)
ONE LIBERTY PLACE
1650 MARKET ST, SUITE 4900
PHILADELPHIA, PA 19103

EXAMINER

HALE, GLORIA M

ART UNIT PAPER NUMBER

3765

DATE MAILED: 06/05/2012

Determination of Patent Term Extension or Adjustment under 35 U.S.C. 154 (b)

A reissue patent is for "the unexpired part of the term of the original patent." See 35 U.S.C. 251. Accordingly, the above-identified reissue application is not eligible for Patent Term Extension or Adjustment under 35 U.S.C. 154(b).

Any questions regarding the Patent Term Extension or Adjustment determination should be directed to the Office of Patent Legal Administration at (571)-272-7702. Questions relating to issue and publication fee payments should be directed to the Customer Service Center of the Office of Patent Publication at 1-(888)-786-0101 or (571)-272-4200.

Privacy Act Statement

The Privacy Act of 1974 (P.L. 93-579) requires that you be given certain information in connection with your submission of the attached form related to a patent application or patent. Accordingly, pursuant to the requirements of the Act, please be advised that: (1) the general authority for the collection of this information is 35 U.S.C. 2(b)(2); (2) furnishing of the information solicited is voluntary; and (3) the principal purpose for which the information is used by the U.S. Patent and Trademark Office is to process and/or examine your submission related to a patent application or patent. If you do not furnish the requested information, the U.S. Patent and Trademark Office may not be able to process and/or examine your submission, which may result in termination of proceedings or abandonment of the application or expiration of the patent.

The information provided by you in this form will be subject to the following routine uses:

1. The information on this form will be treated confidentially to the extent allowed under the Freedom of Information Act (5 U.S.C. 552) and the Privacy Act (5 U.S.C. 552a). Records from this system of records may be disclosed to the Department of Justice to determine whether disclosure of these records is required by the Freedom of Information Act.
2. A record from this system of records may be disclosed, as a routine use, in the course of presenting evidence to a court, magistrate, or administrative tribunal, including disclosures to opposing counsel in the course of settlement negotiations.
3. A record in this system of records may be disclosed, as a routine use, to a Member of Congress submitting a request involving an individual, to whom the record pertains, when the individual has requested assistance from the Member with respect to the subject matter of the record.
4. A record in this system of records may be disclosed, as a routine use, to a contractor of the Agency having need for the information in order to perform a contract. Recipients of information shall be required to comply with the requirements of the Privacy Act of 1974, as amended, pursuant to 5 U.S.C. 552a(m).
5. A record related to an International Application filed under the Patent Cooperation Treaty in this system of records may be disclosed, as a routine use, to the International Bureau of the World Intellectual Property Organization, pursuant to the Patent Cooperation Treaty.
6. A record in this system of records may be disclosed, as a routine use, to another federal agency for purposes of National Security review (35 U.S.C. 181) and for review pursuant to the Atomic Energy Act (42 U.S.C. 218(c)).
7. A record from this system of records may be disclosed, as a routine use, to the Administrator, General Services, or his/her designee, during an inspection of records conducted by GSA as part of that agency's responsibility to recommend improvements in records management practices and programs, under authority of 44 U.S.C. 2904 and 2906. Such disclosure shall be made in accordance with the GSA regulations governing inspection of records for this purpose, and any other relevant (i.e., GSA or Commerce) directive. Such disclosure shall not be used to make determinations about individuals.
8. A record from this system of records may be disclosed, as a routine use, to the public after either publication of the application pursuant to 35 U.S.C. 122(b) or issuance of a patent pursuant to 35 U.S.C. 151. Further, a record may be disclosed, subject to the limitations of 37 CFR 1.14, as a routine use, to the public if the record was filed in an application which became abandoned or in which the proceedings were terminated and which application is referenced by either a published application, an application open to public inspection or an issued patent.
9. A record from this system of records may be disclosed, as a routine use, to a Federal, State, or local law enforcement agency, if the USPTO becomes aware of a violation or potential violation of law or regulation.

Notice of Allowability

Application No.

13/161,138

Examiner

GLORIA HALE

Applicant(s)

HENDRICKSON ET AL.

Art Unit

3765

-- The MAILING DATE of this communication appears on the cover sheet with the correspondence address--

All claims being allowable, PROSECUTION ON THE MERITS IS (OR REMAINS) CLOSED in this application. If not included herewith (or previously mailed), a Notice of Allowance (PTOL-85) or other appropriate communication will be mailed in due course. **THIS NOTICE OF ALLOWABILITY IS NOT A GRANT OF PATENT RIGHTS.** This application is subject to withdrawal from issue at the initiative of the Office or upon petition by the applicant. See 37 CFR 1.313 and MPEP 1308.

- 1. This communication is responsive to 1-3-12Amendment/T.D and 4/26/12 OATH.
- 2. An election was made by the applicant in response to a restriction requirement set forth during the interview on _____; the restriction requirement and election have been incorporated into this action.
- 3. The allowed claim(s) is/are 1-29.
- 4. Acknowledgment is made of a claim for foreign priority under 35 U.S.C. § 119(a)-(d) or (f).
 - a) All b) Some* c) None of the:
 - 1. Certified copies of the priority documents have been received.
 - 2. Certified copies of the priority documents have been received in Application No. _____ .
 - 3. Copies of the certified copies of the priority documents have been received in this national stage application from the International Bureau (PCT Rule 17.2(a)).
 - * Certified copies not received: _____.

Applicant has THREE MONTHS FROM THE "MAILING DATE" of this communication to file a reply complying with the requirements noted below. Failure to timely comply will result in ABANDONMENT of this application.
THIS THREE-MONTH PERIOD IS NOT EXTENDABLE.

- 5. A SUBSTITUTE OATH OR DECLARATION must be submitted. Note the attached EXAMINER'S AMENDMENT or NOTICE OF INFORMAL PATENT APPLICATION (PTO-152) which gives reason(s) why the oath or declaration is deficient.
- 6. CORRECTED DRAWINGS (as "replacement sheets") must be submitted.
 - (a) including changes required by the Notice of Draftsperson's Patent Drawing Review (PTO-948) attached
 - 1) hereto or 2) to Paper No./Mail Date _____.
 - (b) including changes required by the attached Examiner's Amendment / Comment or in the Office action of Paper No./Mail Date _____.

Identifying indicia such as the application number (see 37 CFR 1.84(c)) should be written on the drawings in the front (not the back) of each sheet. Replacement sheet(s) should be labeled as such in the header according to 37 CFR 1.121(d).
- 7. DEPOSIT OF and/or INFORMATION about the deposit of BIOLOGICAL MATERIAL must be submitted. Note the attached Examiner's comment regarding REQUIREMENT FOR THE DEPOSIT OF BIOLOGICAL MATERIAL.

Attachment(s)

- 1. Notice of References Cited (PTO-892)
- 2. Notice of Draftsperson's Patent Drawing Review (PTO-948)
- 3. Information Disclosure Statements (PTO/SB/08), Paper No./Mail Date 1-03-12
- 4. Examiner's Comment Regarding Requirement for Deposit of Biological Material
- 5. Notice of Informal Patent Application
- 6. Interview Summary (PTO-413), Paper No./Mail Date _____ .
- 7. Examiner's Amendment/Comment
- 8. Examiner's Statement of Reasons for Allowance
- 9. Other _____.

/Gloria Hale/
Primary Examiner, Art Unit 3765

Search Notes 	Application/Control No. 13161138	Applicant(s)/Patent Under Reexamination HENDRICKSON ET AL.
	Examiner GLORIA HALE	Art Unit 3765

SEARCHED			
Class	Subclass	Date	Examiner
2	69,227,228,238,236-238,211,212,214,243.1		
450	155,96-100	12-3-11	gh
all updated		1-16-12	gh

SEARCH NOTES		
Search Notes	Date	Examiner
inv name srch;ids flag clred;review related apps for DP	12-3-11	gh
litigation srch in file		

INTERFERENCE SEARCH			
Class	Subclass	Date	Examiner
east brs srch hist in file		1-16-12	gh

	/GLORIA HALE/ Primary Examiner.Art Unit 3765
--	-------------------------------------------------

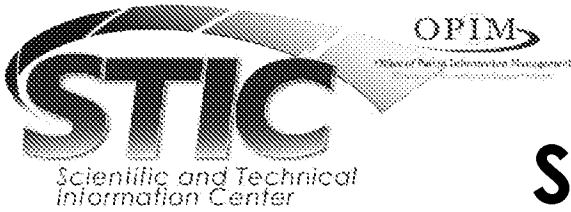

EIC 3700

SEARCH REPORT

STIC Database Tracking Number: 378913

To: GLORIA HALE
Location: RND-7D79
Art Unit: 3765
Monday, November 21, 2011

Case Serial Number: 13/161138

From: TERRENCE SOLOMON
Location: EIC3700
RND-8B31
Phone: (571)272-3509

terrence.solomon@uspto.gov

Search Notes

US Pat. 7814575 was not involved in any current or past federal court cases.

Sources:

- Lexis (0)
- Courtlink (0)
- Lit Alert (0)

756242 (11) 7814575 October 19, 2010

UNITED STATES PATENT AND TRADEMARK OFFICE GRANTED PATENT

7814575

Get Drawing Sheet 1 of 8
Access PDF of Official Patent *
Order Patent File History / Wrapper from REEDFAX®
Link to Claims Section

October 19, 2010

Belly covering garment

REISSUE:

June 15, 2011 - Reissue Application filed, Ex. Gp.: 3765; Re. S.N.: 13/161,138 , (O.G. July 12, 2011)

APPL-NO: 756242 (11)

FILED-DATE: May 31, 2007

GRANTED-DATE: October 19, 2010

LEGAL-REP: DLA Piper LLP (US)

LEGAL-STATUS:

August 8, 2007 - ASSIGNMENT
October 19, 2009 - ASSIGNMENT

PRIM-EXMR: Hale, Gloria

CORE TERMS: garment, fabric, tubular, belly, panel, torso, abdomen, stitch, stretchable, seam, perimeter, body types, trousers, sewn, circumference, encircling, pregnancy, knitted, worn, elastically, elastic, layer, expansible, downward, wearer, woven, waistband, covering, girth, band

Source: [Legal > / . . . / > Utility, Design and Plant Patents](#) [x]

Terms: **patno=7814575** (Suggest Terms for My Search)

View: Custom

Segments: Asst-exmr, Cert-correction, Exmr, Legal-rep, Legal-status, Lit-reex, Prim-exmr, Reexam-litigate, Reissue, Reissue-comment

Date/Time: Monday, November 21, 2011 - 9:34 AM EST

in

[About LexisNexis](#) | [Privacy Policy](#) | [Terms & Conditions](#) | [Contact Us](#)
Copyright © 2011 LexisNexis, a division of Reed Elsevier Inc. All rights reserved.

Patent Search 7,814,575 11/21/2011

No cases found.

File 670:LitAlert 1973-2011/UD=201139
(c) 2011 Thomson Reuters

Set	Items	Description
---	-----	-----

? s pn= us 7814575

S1	0	PN=US 7814575
----	---	---------------

Form PTO-1449 US DEPARTMENT OF COMMERCE PATENT AND TRADEMARK OFFICE	ATTY. DOCKET NO. DMC-10-1220RE	SERIAL NO. 13/161,138
	APPLICANT Lisa A. Hendrickson, et al.	
LIST OF PUBLICATIONS CITED BY APPLICANT <i>(Use several sheets if necessary)</i>	FILING DATE June 15, 2011	GROUP 3465

US PATENT DOCUMENTS							
EXAMINER INITIAL*	DOCUMENT NUMBER	DATE	NAME	CLASS	SUBCLASS	FILING DATE IF APPROPRIATE	
AA	3,045,678	07/24/62	C. J. Geimer				
AB	5,946,730	09/07/99	Blair				
AC							
AD							
AE							
AF							
AG							
AH							
AI							
AJ							
AK							

FOREIGN PATENT DOCUMENTS							
	DOCUMENT NUMBER	DATE	COUNTRY	CLASS	SUBCLASS	TRANSLATION	
						YES	NO
AL							
AM							
AN							
AO							
AP							

OTHER PUBLICATIONS (Including Author, Title, Date, Pertinent Pages, Etc.)		
AR		
AS		
AT		

EXAMINER	/Gloria Hale/	DATE CONSIDERED	01/17/2012
----------	---------------	-----------------	------------

*EXAMINER: Initial if publication considered, whether or not citation is in conformance with MPEP 609; Draw line through citation if not in conformance and not considered. Include copy of this form with next communication to Applicant.



UNITED STATES PATENT AND TRADEMARK OFFICE

UNITED STATES DEPARTMENT OF COMMERCE
 United States Patent and Trademark Office
 Address: COMMISSIONER FOR PATENTS
 P.O. Box 1450
 Alexandria, Virginia 22313-1450
 www.uspto.gov

BIB DATA SHEET

CONFIRMATION NO. 4808

SERIAL NUMBER 13/161,138	FILING or 371(c) DATE 06/15/2011	CLASS 002	GROUP ART UNIT 3765	ATTORNEY DOCKET NO. DMC-10-1220RE	
APPLICANTS Lisa A. Hendrickson, Mount Laurel, NJ; James H. Gardner III, Ambler, PA; Richard Adelman, Greensboro, NC; ** CONTINUING DATA ***** This application is a REI of 11/756,242 05/31/2007 PAT 7,814,575 ** FOREIGN APPLICATIONS ***** ** IF REQUIRED, FOREIGN FILING LICENSE GRANTED ** 06/20/2011					
Foreign Priority claimed <input type="checkbox"/> Yes <input checked="" type="checkbox"/> No 35 USC 119(a-d) conditions met <input type="checkbox"/> Yes <input checked="" type="checkbox"/> No Verified and Acknowledged <u>/ Gloria Hale /</u> Examiner's Signature	<input type="checkbox"/> Met after Allowance Initials	STATE OR COUNTRY NJ	SHEETS DRAWINGS 8	TOTAL CLAIMS 29	INDEPENDENT CLAIMS 1
ADDRESS IP GROUP OF DLA PIPER LLP (US) ONE LIBERTY PLACE 1650 MARKET ST, SUITE 4900 PHILADELPHIA, PA 19103 UNITED STATES					
TITLE Belly Covering Garment					
FILING FEE RECEIVED 1988	FEES: Authority has been given in Paper No. _____ to charge/credit DEPOSIT ACCOUNT No. _____ for following:		<input type="checkbox"/> All Fees <input type="checkbox"/> 1.16 Fees (Filing) <input type="checkbox"/> 1.17 Fees (Processing Ext. of time) <input type="checkbox"/> 1.18 Fees (Issue) <input type="checkbox"/> Other _____ <input type="checkbox"/> Credit		

IN THE UNITED STATES PATENT AND TRADEMARK OFFICE

Art Unit : 3765 Customer No. 035811
Examiner : Gloria M. Hale
Serial No. : 13/161,138 Docket No.: DMC-10-1220RE
Filed : June 15, 2011
Inventor : Lisa A. Hendrickson
: James H. Gardner, III
: Richard Adelman Confirmation No.: 4808
Title : BELLY COVERING
: GARMENT Date: January 3, 2012

SUPPLEMENTAL INFORMATION DISCLOSURE STATEMENT

Commissioner for Patents
P.O. Box 1450
Washington, D.C. 20231-1450

Sir:

The Applicants enclose Form PTO-1449 which lists relevant US publications. A copy of the Examination Report from corresponding Gulf Cooperation Council Application No. 2008/10911 issued by the Austrian Patent Office is also enclosed. The documents are submitted under 37 CFR §1.56. The publications are believed related in view of their mention in the Examination Report and the Official Action issued in corresponding US Application No. 13/161,169 for the reasons stated.

The Applicants respectfully request that this Supplemental Information Disclosure Statement be officially entered into the file of this case and that appropriate notification be made that it was considered by the Examiner.

Respectfully submitted,



Richard L. Cruz
Reg. No. 52,783
Attorney for Applicants

RLC/nn
(215) 656-2446

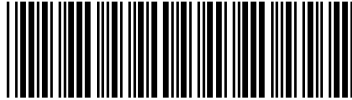
Index of Claims 	Application/Control No. 13161138	Applicant(s)/Patent Under Reexamination HENDRICKSON ET AL.
	Examiner GLORIA HALE	Art Unit 3765

✓	Rejected
=	Allowed

-	Cancelled
÷	Restricted

N	Non-Elected
I	Interference

A	Appeal
O	Objected

Claims renumbered in the same order as presented by applicant
 CPA
 T.D.
 R.1.47

CLAIM		DATE							
Final	Original	12/04/2011	01/16/2012						
	1	✓	=						
	2	✓	=						
	3	✓	=						
	4	✓	=						
	5	✓	=						
	6	✓	=						
	7	✓	=						
	8	✓	=						
	9	✓	=						
	10	✓	=						
	11	✓	=						
	12	✓	=						
	13	✓	=						
	14	✓	=						
	15	✓	=						
	16	✓	=						
	17	✓	=						
	18	✓	=						
	19	✓	=						
	20	✓	=						
	21	✓	=						
	22	✓	=						
	23	✓	=						
	24	✓	=						
	25	✓	=						
	26	✓	=						
	27	✓	=						
	28	✓	=						
	29	✓	=						

Electronic Acknowledgement Receipt

EFS ID:	12937540
Application Number:	13161138
International Application Number:	
Confirmation Number:	4808
Title of Invention:	BELLY COVERING GARMENT
First Named Inventor/Applicant Name:	Lisa A. Hendrickson
Customer Number:	35811
Filer:	Thomas Daniel Christenbury/Carol Coney
Filer Authorized By:	Thomas Daniel Christenbury
Attorney Docket Number:	DMC-10-1220RE
Receipt Date:	05-JUN-2012
Filing Date:	15-JUN-2011
Time Stamp:	14:42:07
Application Type:	Utility under 35 USC 111(a)

Payment information:

Submitted with Payment	yes
Payment Type	Deposit Account
Payment was successfully received in RAM	\$1740
RAM confirmation Number	1089
Deposit Account	502719
Authorized User	

The Director of the USPTO is hereby authorized to charge indicated fees and credit any overpayment as follows:

Charge any Additional Fees required under 37 C.F.R. Section 1.16 (National application filing, search, and examination fees)

Charge any Additional Fees required under 37 C.F.R. Section 1.17 (Patent application and reexamination processing fees)

Target Corporation

Charge any Additional Fees required under 37 C.F.R. Section 1.19 (Document supply fees)

Charge any Additional Fees required under 37 C.F.R. Section 1.20 (Post Issuance fees)

Charge any Additional Fees required under 37 C.F.R. Section 1.21 (Miscellaneous fees and charges)

File Listing:

Document Number	Document Description	File Name	File Size(Bytes)/ Message Digest	Multi Part /.zip	Pages (if appl.)
1	Miscellaneous Incoming Letter	transmittalletter.pdf	223106 719657c9c5feb74278cd5655f4a8e6b4e17f64ec	no	2

Warnings:

Information:

2	Issue Fee Payment (PTO-85B)	FormPTOL85.pdf	170059 83a01077e5e22a89a0b908198edcb08ce24237d	no	1
---	-----------------------------	----------------	---------------------------------------------------	----	---

Warnings:

Information:

3	Fee Worksheet (SB06)	fee-info.pdf	30350 c165fef0b8df15418ea2931558552c4d0084b135	no	2
---	----------------------	--------------	---------------------------------------------------	----	---

Warnings:

Information:

Total Files Size (in bytes):

423515

This Acknowledgement Receipt evidences receipt on the noted date by the USPTO of the indicated documents, characterized by the applicant, and including page counts, where applicable. It serves as evidence of receipt similar to a Post Card, as described in MPEP 503.

New Applications Under 35 U.S.C. 111

If a new application is being filed and the application includes the necessary components for a filing date (see 37 CFR 1.53(b)-(d) and MPEP 506), a Filing Receipt (37 CFR 1.54) will be issued in due course and the date shown on this Acknowledgement Receipt will establish the filing date of the application.

National Stage of an International Application under 35 U.S.C. 371

If a timely submission to enter the national stage of an international application is compliant with the conditions of 35 U.S.C. 371 and other applicable requirements a Form PCT/DO/EO/903 indicating acceptance of the application as a national stage submission under 35 U.S.C. 371 will be issued in addition to the Filing Receipt, in due course.

New International Application Filed with the USPTO as a Receiving Office

If a new international application is being filed and the international application includes the necessary components for an international filing date (see PCT Article 11 and MPEP 1810), a Notification of the International Application Number and of the International Filing Date (Form PCT/RO/105) will be issued in due course, subject to prescriptions concerning national security, and the date shown on this Acknowledgement Receipt will establish the international filing date of the application.

Electronic Patent Application Fee Transmittal

Application Number:	13161138
Filing Date:	15-Jun-2011
Title of Invention:	BELLY COVERING GARMENT
First Named Inventor/Applicant Name:	Lisa A. Hendrickson
Filer:	Thomas Daniel Christenbury/Carol Coney
Attorney Docket Number:	DMC-10-1220RE

Filed as Large Entity

Utility under 35 USC 111(a) Filing Fees

Description	Fee Code	Quantity	Amount	Sub-Total in USD(\$)
Basic Filing:				
Pages:				
Claims:				
Miscellaneous-Filing:				
Petition:				
Patent-Appeals-and-Interference:				
Post-Allowance-and-Post-Issuance:				
Utility Appl issue fee	1501	1	1740	1740

Extension-of-Time:

Description	Fee Code	Quantity	Amount	Sub-Total in USD(\$)
Miscellaneous:				
Total in USD (\$)				1740

PART B - FEE(S) TRANSMITTAL

Complete and send this form, together with applicable fee(s), to: **Mail** Mail Stop ISSUE FEE
Commissioner for Patents
P.O. Box 1450
Alexandria, Virginia 22313-1450
 or **Fax** (571)-273-2885

INSTRUCTIONS: This form should be used for transmitting the ISSUE FEE and PUBLICATION FEE (if required). Blocks 1 through 5 should be completed where appropriate. All further correspondence including the Patent, advance orders and notification of maintenance fees will be mailed to the current correspondence address as indicated unless corrected below or directed otherwise in Block 1, by (a) specifying a new correspondence address; and/or (b) indicating a separate "FEE ADDRESS" for maintenance fee notifications.

CURRENT CORRESPONDENCE ADDRESS (Note: Use Block 1 for any change of address)

Note: A certificate of mailing can only be used for domestic mailings of the Fee(s) Transmittal. This certificate cannot be used for any other accompanying papers. Each additional paper, such as an assignment or formal drawing, must have its own certificate of mailing or transmission.

35811 7590 06/05/2012
 IP GROUP OF DLA PIPER LLP (US)
 ONE LIBERTY PLACE
 1650 MARKET ST, SUITE 4900
 PHILADELPHIA, PA 19103

Certificate of Mailing or Transmission

I hereby certify that this Fee(s) Transmittal is being deposited with the United States Postal Service with sufficient postage for first class mail in an envelope addressed to the Mail Stop ISSUE FEE address above, or being facsimile transmitted to the USPTO (571) 273-2885, on the date indicated below.

_____ (Depositor's name)
_____ (Signature)
_____ (Date)

APPLICATION NO.	FILING DATE	FIRST NAMED INVENTOR	ATTORNEY DOCKET NO.	CONFIRMATION NO.
13/161,138	06/15/2011	Lisa A. Hendrickson	DMC-10-1220RE	4808

TITLE OF INVENTION: BELLY COVERING GARMENT

APPLN. TYPE	SMALL ENTITY	ISSUE FEE DUE	PUBLICATION FEE DUE	PREV. PAID ISSUE FEE	TOTAL FEE(S) DUE	DATE DUE
nonprovisional	NO	\$1740	\$0	\$0	\$1740	09/05/2012

EXAMINER	ART UNIT	CLASS-SUBCLASS
HALE, GLORIA M	3765	002-227000

1. Change of correspondence address or indication of "Fee Address" (37 CFR 1.363).
 Change of correspondence address (or Change of Correspondence Address form PTO/SB/122) attached.
 "Fee Address" indication (or "Fee Address" Indication form PTO/SB/47; Rev 03-02 or more recent) attached. Use of a Customer Number is required.

2. For printing on the patent front page, list
 (1) the names of up to 3 registered patent attorneys or agents OR, alternatively,
 (2) the name of a single firm (having as a member a registered attorney or agent) and the names of up to 2 registered patent attorneys or agents. If no name is listed, no name will be printed.

1. DLA Piper LLP (US)
 2. _____
 3. _____

3. ASSIGNEE NAME AND RESIDENCE DATA TO BE PRINTED ON THE PATENT (print or type)
 PLEASE NOTE: Unless an assignee is identified below, no assignee data will appear on the patent. If an assignee is identified below, the document has been filed for recordation as set forth in 37 CFR 3.11. Completion of this form is NOT a substitute for filing an assignment.

(A) NAME OF ASSIGNEE: Destination Maternity Corporation
 (B) RESIDENCE: (CITY and STATE OR COUNTRY) Philadelphia, PA

Please check the appropriate assignee category or categories (will not be printed on the patent): Individual Corporation or other private group entity Government

4a. The following fee(s) are submitted:
 Issue Fee
 Publication Fee (No small entity discount permitted)
 Advance Order - # of Copies _____

4b. Payment of Fee(s): (Please first reapply any previously paid issue fee shown above)
 A check is enclosed.
 Payment by credit card. Form PTO-2038 is attached.
 The Director is hereby authorized to charge the required fee(s), any deficiency, or credit any overpayment, to Deposit Account Number 50-2719 (enclose an extra copy of this form).

5. Change in Entity Status (from status indicated above)
 a. Applicant claims SMALL ENTITY status. See 37 CFR 1.27. b. Applicant is no longer claiming SMALL ENTITY status. See 37 CFR 1.27(g)(2).

NOTE: The Issue Fee and Publication Fee (if required) will not be accepted from anyone other than the applicant; a registered attorney or agent; or the assignee or other party in interest as shown by the records of the United States Patent and Trademark Office.

Authorized Signature _____ Date June 5, 2012
 Typed or printed name Paul A. Taufer Registration No. 35,703

This collection of information is required by 37 CFR 1.301. The information is required to obtain or retain a benefit by the public which is to file (and by the USPTO to process) an application. Confidentiality is governed by 35 U.S.C. 42 and 37 CFR 1.14. This collection is estimated to take 12 minutes to complete, including gathering, preparing, and submitting the completed application form to the USPTO. Time will vary depending upon the individual case. Any comments on the amount of time you require to complete this form and/or suggestions for reducing this burden, should be sent to the Chief Information Officer, U.S. Patent and Trademark Office, U.S. Department of Commerce, P.O. Box 1450, Alexandria, Virginia 22313-1450. DO NOT SEND FEES OR COMPLETED FORMS TO THIS ADDRESS. SEND TO: Commissioner for Patents, P.O. Box 1450, Alexandria, Virginia 22313-1450.

Under the Paperwork Reduction Act of 1995, no persons are required to respond to a collection of information unless it displays a valid OMB control number.

PART B - FEE(S) TRANSMITTAL

Complete and send this form, together with applicable fee(s), to: **Mail** **Mail Stop ISSUE FEE**
Commissioner for Patents
P.O. Box 1450
Alexandria, Virginia 22313-1450
 or **Fax** **(571)-273-2885**

INSTRUCTIONS: This form should be used for transmitting the ISSUE FEE and PUBLICATION FEE (if required). Blocks 1 through 5 should be completed where appropriate. All further correspondence including the Patent, advance orders and notification of maintenance fees will be mailed to the current correspondence address as indicated unless corrected below or directed otherwise in Block 1, by (a) specifying a new correspondence address; and/or (b) indicating a separate "FEE ADDRESS" for maintenance fee notifications.

CURRENT CORRESPONDENCE ADDRESS (Note: Use Block 1 for any change of address)

Note: A certificate of mailing can only be used for domestic mailings of the Fee(s) Transmittal. This certificate cannot be used for any other accompanying papers. Each additional paper, such as an assignment or formal drawing, must have its own certificate of mailing or transmission.

35811 7590 06/05/2012
IP GROUP OF DLA PIPER LLP (US)
ONE LIBERTY PLACE
1650 MARKET ST, SUITE 4900
PHILADELPHIA, PA 19103

Certificate of Mailing or Transmission

I hereby certify that this Fee(s) Transmittal is being deposited with the United States Postal Service with sufficient postage for first class mail in an envelope addressed to the Mail Stop ISSUE FEE address above, or being facsimile transmitted to the USPTO (571) 273-2885, on the date indicated below.

_____ (Depositor's name)
_____ (Signature)
_____ (Date)

APPLICATION NO.	FILING DATE	FIRST NAMED INVENTOR	ATTORNEY DOCKET NO.	CONFIRMATION NO.
13/161,138	06/15/2011	Lisa A. Hendrickson	DMC-10-1220RE	4808

TITLE OF INVENTION: BELLY COVERING GARMENT

APPLN. TYPE	SMALL ENTITY	ISSUE FEE DUE	PUBLICATION FEE DUE	PREV. PAID ISSUE FEE	TOTAL FEE(S) DUE	DATE DUE
nonprovisional	NO	\$1740	\$0	\$0	\$1740	09/05/2012

EXAMINER	ART UNIT	CLASS-SUBCLASS
HALE, GLORIA M	3765	002-227000

<p>1. Change of correspondence address or indication of "Fee Address" (37 CFR 1.363).</p> <p><input type="checkbox"/> Change of correspondence address (or Change of Correspondence Address form PTO/SB/122) attached.</p> <p><input type="checkbox"/> "Fee Address" indication (or "Fee Address" Indication form PTO/SB/47; Rev 03-02 or more recent) attached. Use of a Customer Number is required.</p>	<p>2. For printing on the patent front page, list</p> <p>(1) the names of up to 3 registered patent attorneys or agents OR, alternatively,</p> <p>(2) the name of a single firm (having as a member a registered attorney or agent) and the names of up to 2 registered patent attorneys or agents. If no name is listed, no name will be printed.</p>
	<p>1 <u>DLA Piper LLP (US)</u></p> <p>2 _____</p> <p>3 _____</p>

3. ASSIGNEE NAME AND RESIDENCE DATA TO BE PRINTED ON THE PATENT (print or type)

PLEASE NOTE: Unless an assignee is identified below, no assignee data will appear on the patent. If an assignee is identified below, the document has been filed for recordation as set forth in 37 CFR 3.11. Completion of this form is NOT a substitute for filing an assignment.

(A) NAME OF ASSIGNEE (B) RESIDENCE: (CITY and STATE OR COUNTRY)

Destination Maternity Corporation **Philadelphia, PA**

Please check the appropriate assignee category or categories (will not be printed on the patent): Individual Corporation or other private group entity Government

<p>4a. The following fee(s) are submitted:</p> <p><input checked="" type="checkbox"/> Issue Fee</p> <p><input type="checkbox"/> Publication Fee (No small entity discount permitted)</p> <p><input type="checkbox"/> Advance Order - # of Copies _____</p>	<p>4b. Payment of Fee(s): (Please first reapply any previously paid issue fee shown above)</p> <p><input type="checkbox"/> A check is enclosed.</p> <p><input type="checkbox"/> Payment by credit card. Form PTO-2038 is attached.</p> <p><input checked="" type="checkbox"/> The Director is hereby authorized to charge the required fee(s), any deficiency, or credit any overpayment, to Deposit Account Number <u>50-2719</u> (enclose an extra copy of this form).</p>
------------------------------------------------------------------------------------------------------------------------------------------------------------------------------------------------------------------------------------------------------------	------------------------------------------------------------------------------------------------------------------------------------------------------------------------------------------------------------------------------------------------------------------------------------------------------------------------------------------------------------------------------------------------------------------------------------------------------------------------------

5. Change in Entity Status (from status indicated above)

a. Applicant claims SMALL ENTITY status. See 37 CFR 1.27. b. Applicant is no longer claiming SMALL ENTITY status. See 37 CFR 1.27(g)(2).

NOTE: The Issue Fee and Publication Fee (if required) will not be accepted from anyone other than the applicant; a registered attorney or agent; or the assignee or other party in interest as shown by the records of the United States Patent and Trademark Office.

Authorized Signature _____ Date June 5, 2012

Typed or printed name Paul A. Taufer Registration No. 35,703

This collection of information is required by 37 CFR 1.301. The information is required to obtain or retain a benefit by the public which is to file (and by the USPTO to process) an application. Confidentiality is governed by 35 U.S.C. 122 and 37 CFR 1.14. This collection is estimated to take 12 minutes to complete, including gathering, preparing, and submitting the completed application form to the USPTO. Time will vary depending upon the individual case. Any comments on the amount of time you require to complete this form and/or suggestions for reducing this burden, should be sent to the Chief Information Officer, U.S. Patent and Trademark Office, U.S. Department of Commerce, P.O. Box 1450, Alexandria, Virginia 22313-1450. DO NOT SEND FEES OR COMPLETED FORMS TO THIS ADDRESS. SEND TO: Commissioner for Patents, P.O. Box 1450, Alexandria, Virginia 22313-1450.

Under the Paperwork Reduction Act of 1995, no persons are required to respond to a collection of information unless it displays a valid OMB control number.

IN THE UNITED STATES PATENT AND TRADEMARK OFFICE

Art Unit	: 3765	Customer No. 035811
Examiner	: Gloria M. Hale	
Serial No.	: 13/161,138	Docket No.: DMC-10-1220RE
Filed	: June 15, 2011	
Inventor	: Lisa A. Hendrickson	
	: James H. Gardner, III	
	: Richard Adelman	Confirmation No.: 4808
Title	: BELLY COVERING	Not. of Allow.: 06/05/12
	: GARMENT	Date: June 5, 2012

TRANSMITTAL LETTER

Commissioner for Patents
P.O. Box 1450
Alexandria, VA 22313-1450

Sir:

Applicants submit herewith Form PTOL-85B.

The Commissioner is authorized to charge the \$1740.00 fee to Deposit Account No. 50-2719 to cover the fee for payment of the issue fee.

The Commissioner is also authorized to charge any additional fees to Deposit Account No. 50-2719.

Respectfully submitted,

Paul A. Tauffer
Reg. No. 35,703

PAT/cc
(215)656-3385



APPLICATION NO.	ISSUE DATE	PATENT NO.	ATTORNEY DOCKET NO.	CONFIRMATION NO.
13/161,138	07/24/2012	RE43531	DMC-10-1220RE	4808

35811 7590 07/04/2012
 IP GROUP OF DLA PIPER LLP (US)
 ONE LIBERTY PLACE
 1650 MARKET ST, SUITE 4900
 PHILADELPHIA, PA 19103

ISSUE NOTIFICATION

The projected patent number and issue date are specified above.

Determination of Patent Term Extension or Adjustment under 35 U.S.C. 154 (b)

A reissue patent is for "the unexpired part of the term of the original patent." See 35 U.S.C. 251. Accordingly, the above-identified reissue application is not eligible for Patent Term Extension or Adjustment under 35 U.S.C. 154(b).

Any questions regarding the Patent Term Extension or Adjustment determination should be directed to the Office of Patent Legal Administration at (571)-272-7702. Questions relating to issue and publication fee payments should be directed to the Application Assistance Unit (AAU) of the Office of Data Management (ODM) at (571)-272-4200.

APPLICANT(s) (Please see PAIR WEB site <http://pair.uspto.gov> for additional applicants):

Lisa A. Hendrickson, Mount Laurel, NJ;
 James H. Gardner III, Ambler, PA;
 Richard Adelman, Greensboro, NC;

The United States represents the largest, most dynamic marketplace in the world and is an unparalleled location for business investment, innovation, and commercialization of new technologies. The USA offers tremendous resources and advantages for those who invest and manufacture goods here. Through SelectUSA, our nation works to encourage and facilitate business investment. To learn more about why the USA is the best country in the world to develop technology, manufacture products, and grow your business, visit SelectUSA.gov.