



US005214408A

United States Patent [19]

[11] Patent Number: **5,214,408**

Asayama

[45] Date of Patent: **May 25, 1993**

[54] **DISTANCE DETECTING APPARATUS FOR A VEHICLE**

- 57-49841 10/1982 Japan .
- 63-18122 4/1988 Japan .
- 63-38085 7/1988 Japan .
- 63-64363 12/1988 Japan .
- 1-12221 4/1989 Japan .

[75] Inventor: **Yoshiaki Asayama, Himeji, Japan**

[73] Assignee: **Mitsubishi Denki Kabushiki Kaisha, Tokyo, Japan**

[21] Appl. No.: **782,110**

[22] Filed: **Oct. 24, 1991**

[30] Foreign Application Priority Data

- Oct. 25, 1990 [JP] Japan 2-290469
- Nov. 28, 1990 [JP] Japan 2-335430

[51] Int. Cl.⁵ **B60Q 1/00; G08G 1/16**

[52] U.S. Cl. **340/435; 340/436; 340/901; 340/903; 340/939; 340/555; 340/942; 358/105; 358/125; 180/169; 180/167; 342/55; 342/66; 342/69**

[58] Field of Search **340/435, 903, 937, 901, 340/436, 555, 556, 937, 961; 358/107-113, 125; 180/167-169, 271; 342/47, 55, 66, 126, 118, 69, 450, 451**

[56] References Cited

U.S. PATENT DOCUMENTS

- 4,539,590 9/1985 Gage 358/107
- 4,709,264 11/1987 Tamura et al. 358/93
- 4,779,095 10/1988 Guerreri 340/904
- 4,908,704 3/1990 Fujioka et al. 358/108
- 5,026,153 6/1991 Suzuki et al. 340/903

FOREIGN PATENT DOCUMENTS

- 55-15337 4/1980 Japan .

Primary Examiner—Donnie L. Crosland
Attorney, Agent, or Firm—Sughrue, Mion, Zinn, Macpeak and Seas

[57] ABSTRACT

A distance detecting apparatus enables the driver of a vehicle to readily and concurrently recognize the location and direction of each of a plurality of objects present in the driver's field of view, in daylight or darkness, and at the same time determine whether each of the objects is an obstacle to the vehicle travel. The objects sensed by a pair of first and second image sensors 3, 4 are displayed on a screen 11 in a plurality of windows 15-19. Deviations between the images of the objects within the respective windows are electrically detected so that the distance to an object within each window is individually calculated based on the deviations. Obstacles to the travel of the vehicle can be discriminated on the basis of the positions of the windows on the screen and the distances to the objects in the respective windows as detected. Infrared light can be projected onto objects present within the fields of view of the image sensors when natural visible light is insufficient for the image sensors which, in this case, are sensitive to infrared light.

8 Claims, 6 Drawing Sheets

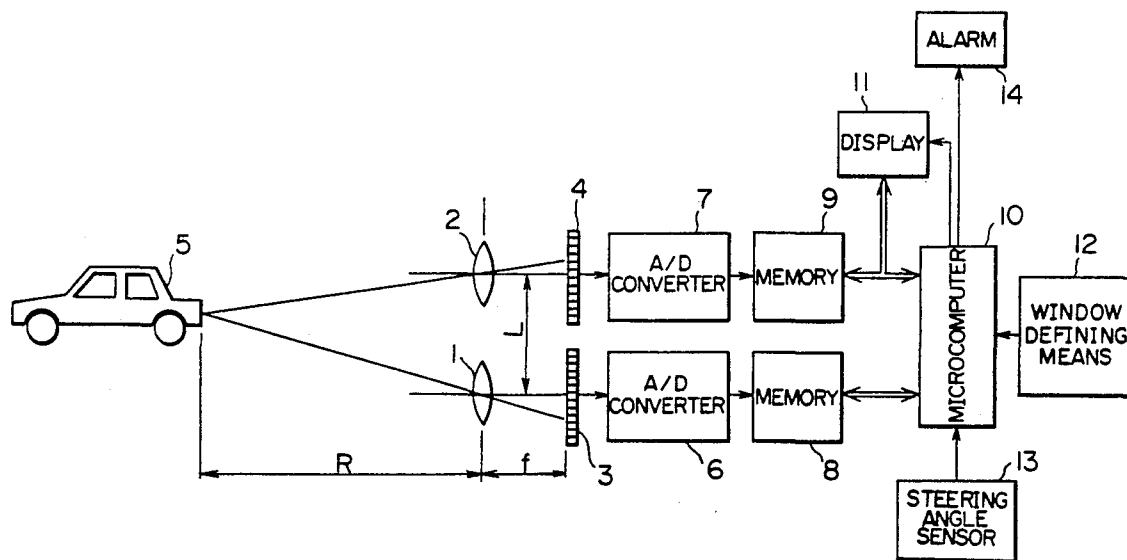

FIG. 1

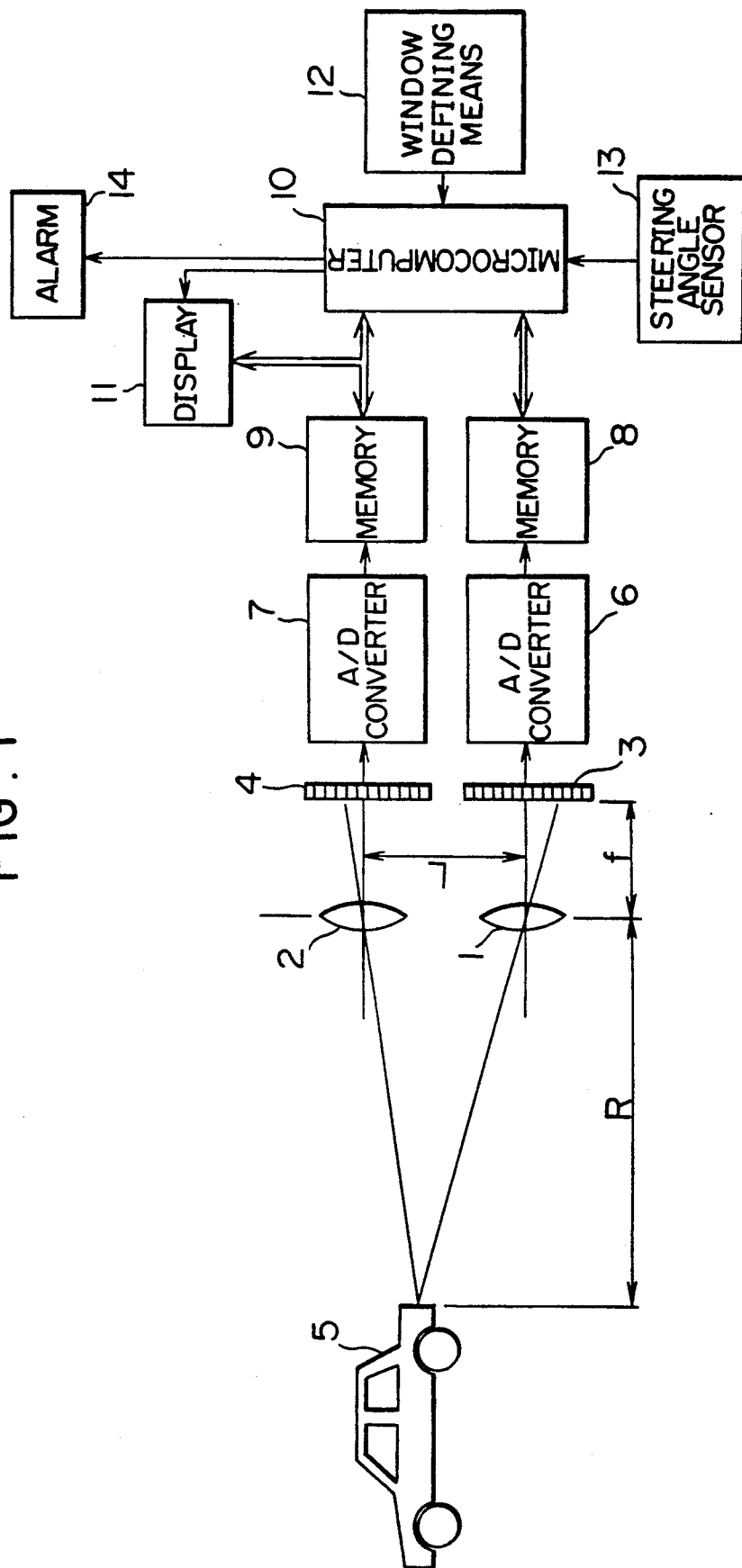

FIG. 2

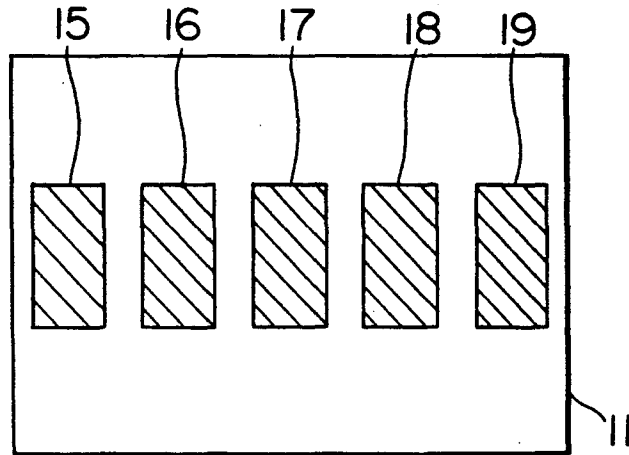

FIG. 3

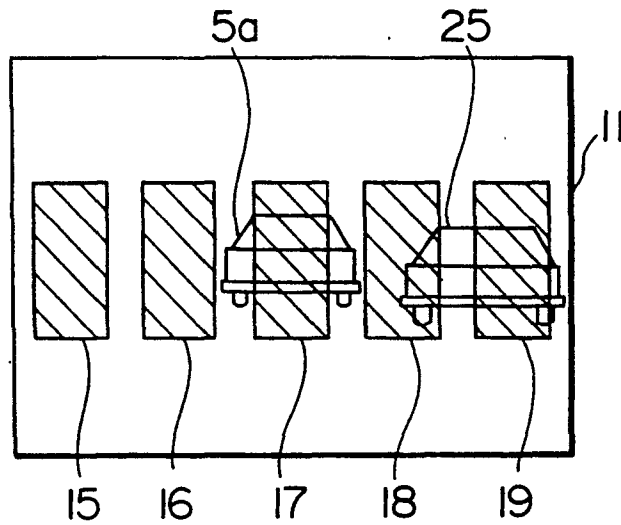

FIG. 4(a)

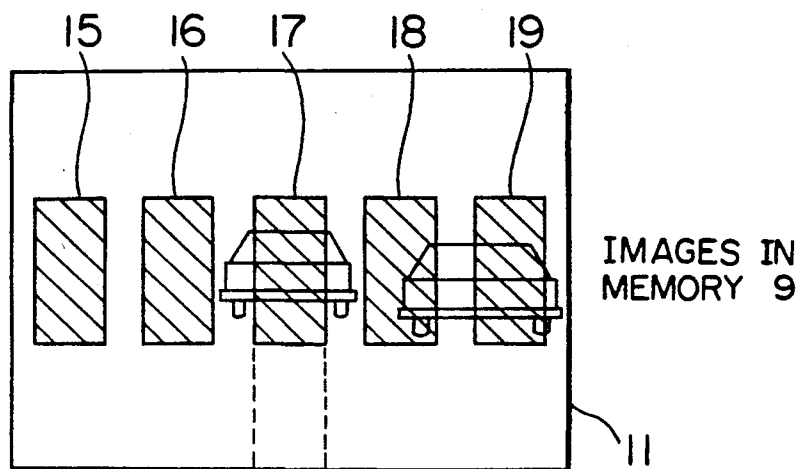

FIG. 4(b)

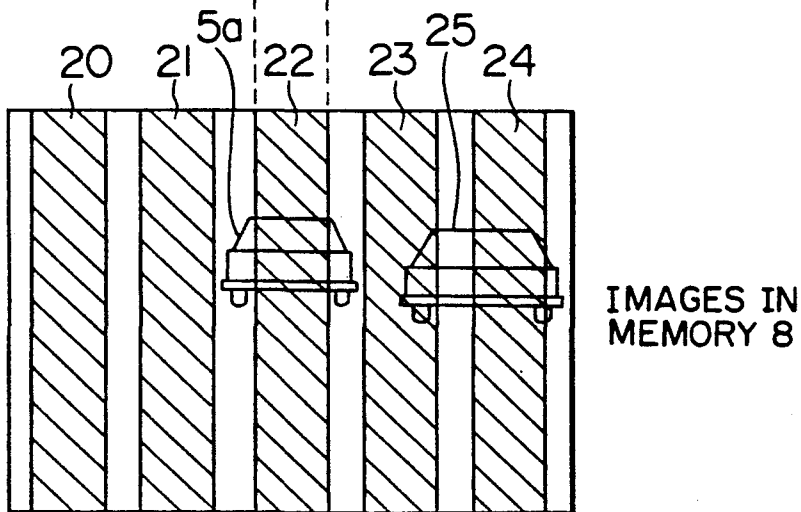

FIG. 5

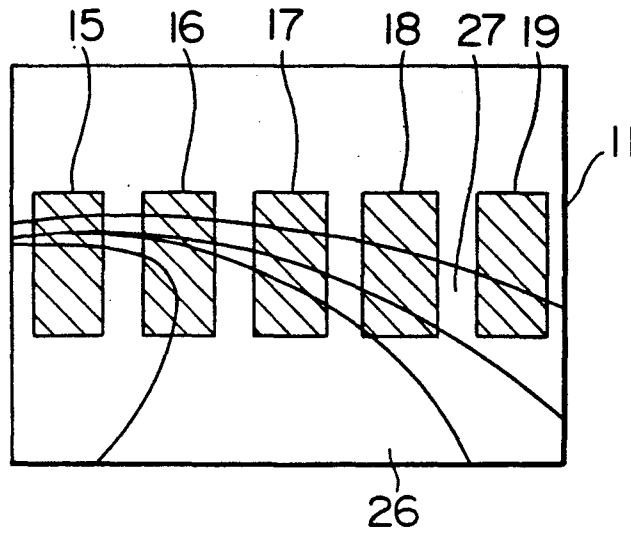
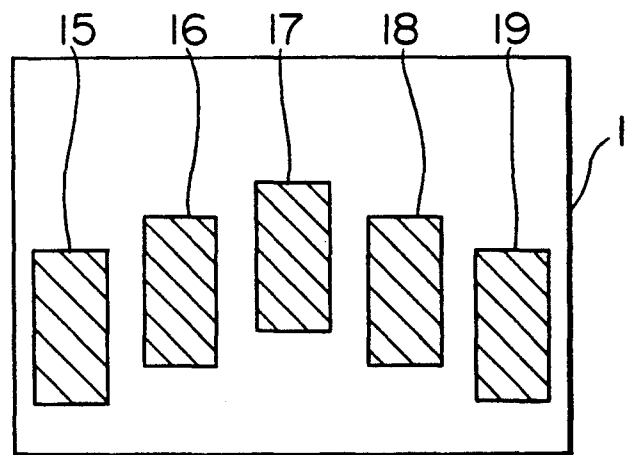

FIG. 6



Explore Litigation Insights

Docket Alarm provides insights to develop a more informed litigation strategy and the peace of mind of knowing you're on top of things.

Real-Time Litigation Alerts



Keep your litigation team up-to-date with **real-time alerts** and advanced team management tools built for the enterprise, all while greatly reducing PACER spend.

Our comprehensive service means we can handle Federal, State, and Administrative courts across the country.

Advanced Docket Research



With over 230 million records, Docket Alarm's cloud-native docket research platform finds what other services can't. Coverage includes Federal, State, plus PTAB, TTAB, ITC and NLRB decisions, all in one place.

Identify arguments that have been successful in the past with full text, pinpoint searching. Link to case law cited within any court document via Fastcase.

Analytics At Your Fingertips



Learn what happened the last time a particular judge, opposing counsel or company faced cases similar to yours.

Advanced out-of-the-box PTAB and TTAB analytics are always at your fingertips.

API

Docket Alarm offers a powerful API (application programming interface) to developers that want to integrate case filings into their apps.

LAW FIRMS

Build custom dashboards for your attorneys and clients with live data direct from the court.

Automate many repetitive legal tasks like conflict checks, document management, and marketing.

FINANCIAL INSTITUTIONS

Litigation and bankruptcy checks for companies and debtors.

E-DISCOVERY AND LEGAL VENDORS

Sync your system to PACER to automate legal marketing.