

United States Patent [19]

[11] **Patent Number:** **5,691,802**

Takahashi

[45] **Date of Patent:** **Nov. 25, 1997**

[54] **CATADIOPTRIC OPTICAL SYSTEM AND EXPOSURE APPARATUS HAVING THE SAME**
 5,303,001 4/1994 Jeong et al. 355/53
 5,402,205 3/1995 Markle et al. 355/53
 5,467,166 11/1995 Shiraishi 355/71

[75] **Inventor:** Tomowaki Takahashi, Yokohama, Japan

Primary Examiner—R. L. Moses
Attorney, Agent, or Firm—Pennie & Edmonds LLP

[73] **Assignee:** Nikon Corporation, Japan

[57] **ABSTRACT**

[21] **Appl. No.:** 552,453

It is an object of the invention to provide a catadioptric optical system with an arrangement for realizing a large numerical aperture and reducing the diameter of a concave mirror while ensuring a sufficient working distance on the image side, and also an exposure apparatus using this catadioptric optical system.

[22] **Filed:** Nov. 3, 1995

[30] **Foreign Application Priority Data**

Nov. 7, 1994 [JP] Japan 6-271631
 Mar. 7, 1995 [JP] Japan 7-047142
 Jul. 14, 1995 [JP] Japan 7-177858

[51] **Int. Cl.⁶** **G03B 27/42**

[52] **U.S. Cl.** **355/53; 355/77; 355/60; 355/43; 359/727; 359/730; 359/366**

[58] **Field of Search** **355/53, 71, 43, 355/77, 57, 60; 359/366, 727, 730, 731**

[56] **References Cited**

U.S. PATENT DOCUMENTS

3,917,399 11/1975 Buzawa et al. 355/43
 4,669,866 6/1987 Phillips 355/53 X
 4,704,027 11/1987 Phillips 355/53 X
 4,742,376 5/1988 Phillips 355/77
 4,779,966 10/1988 Friedman 350/442
 5,052,763 10/1991 Singh et al. 359/355
 5,274,420 12/1993 Chastang 355/53 X

A catadioptric optical system according to the invention includes a first imaging optical system for forming an intermediate image of a pattern on a first plane, a second imaging optical system for forming a reduced image of the intermediate image on a second plane, and an optical path deflecting member for guiding a light beam from the first imaging optical system to the second imaging optical system. The first imaging optical system has at least a first optical element group having a positive refracting power, and a second optical element group having a concave mirror and a meniscus lens component with a concave surface facing the first imaging optical system. In particular, the first optical element group having a positive refracting power is arranged to guide a light beam from the first plane to the second optical element group.

35 Claims, 20 Drawing Sheets

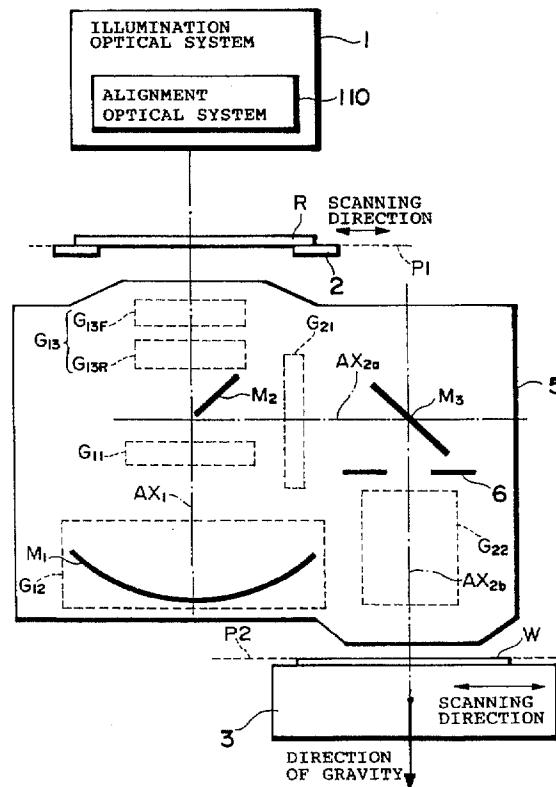

Fig. 1

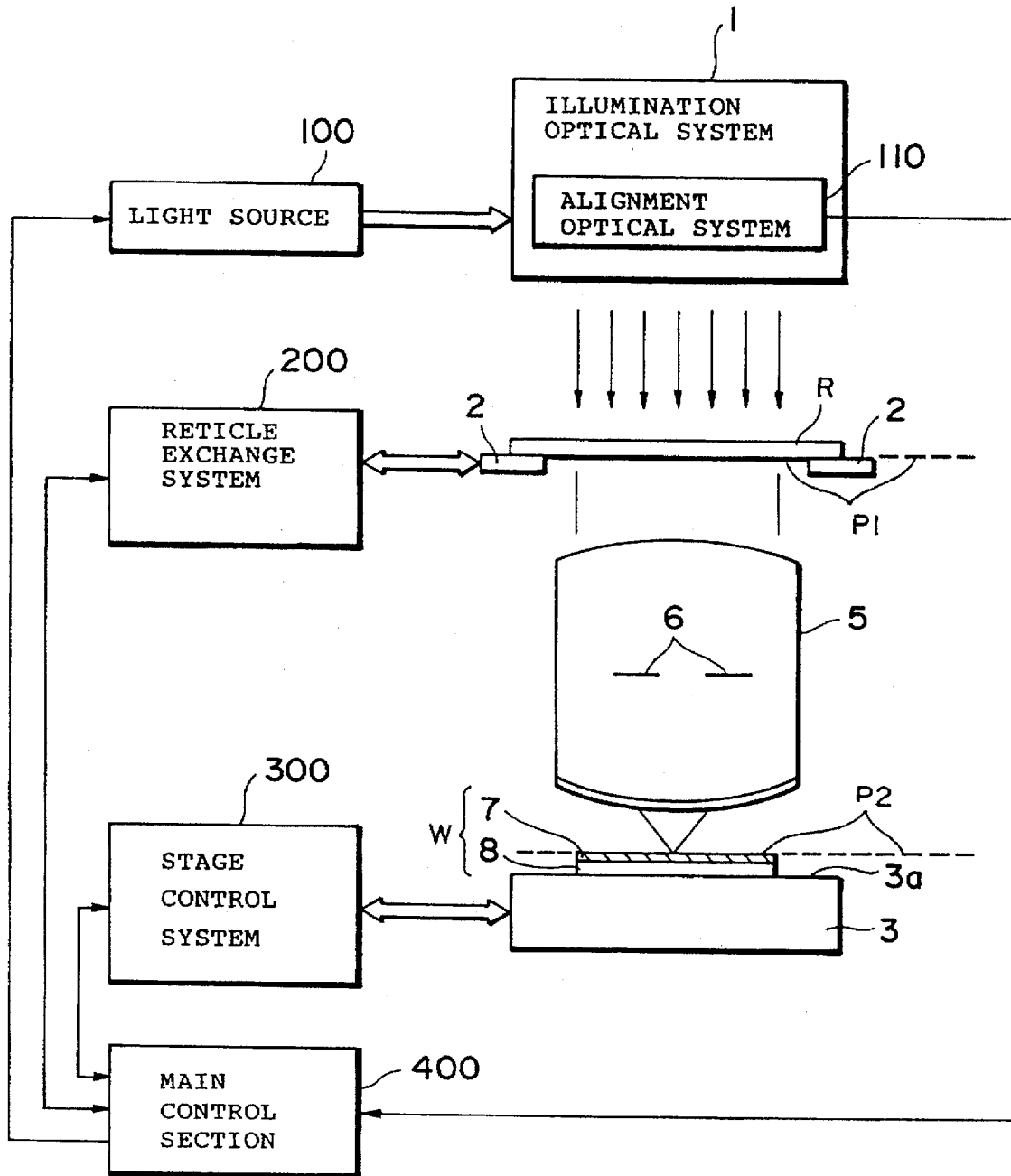

Fig. 2

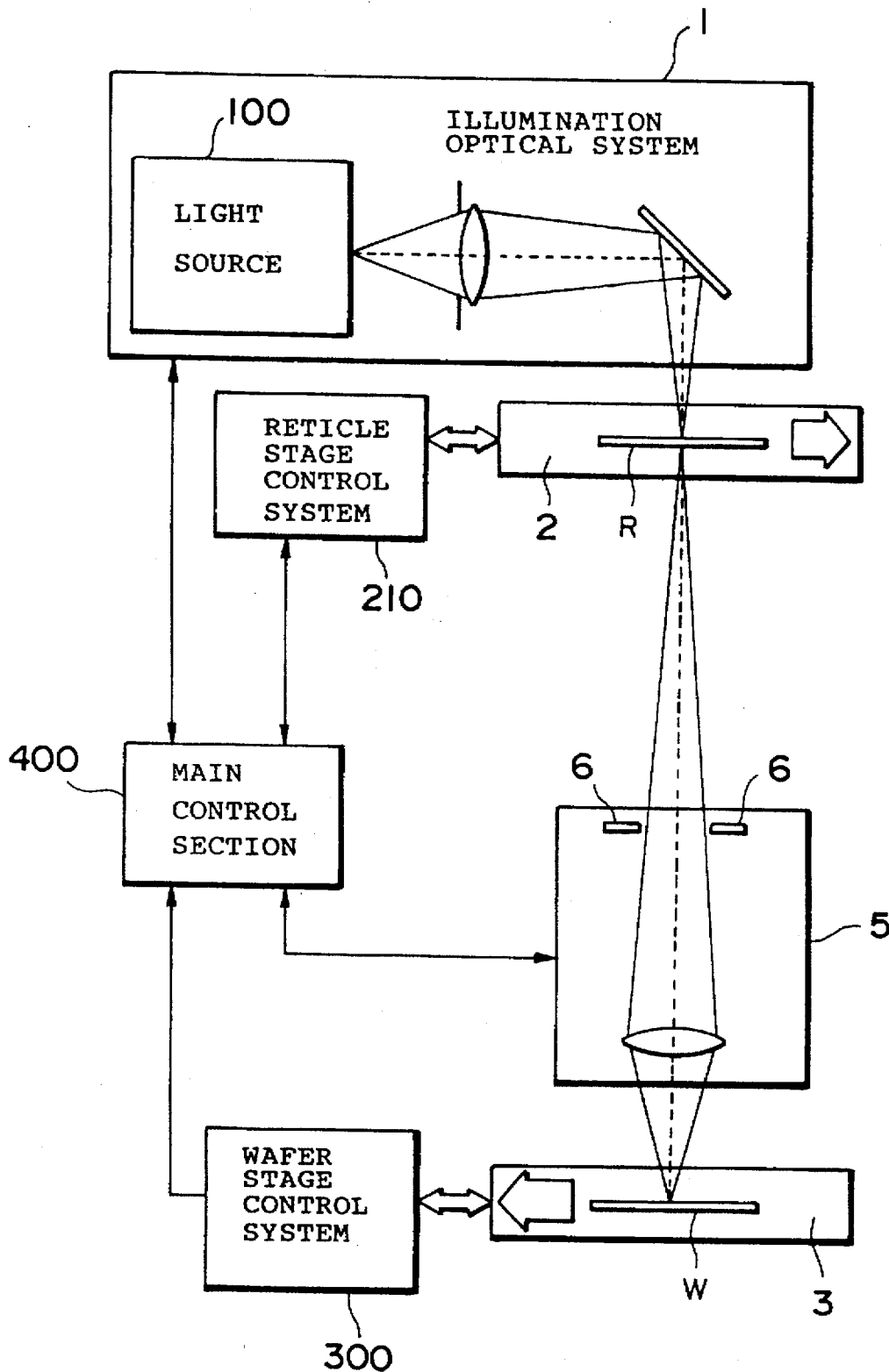

Fig. 3

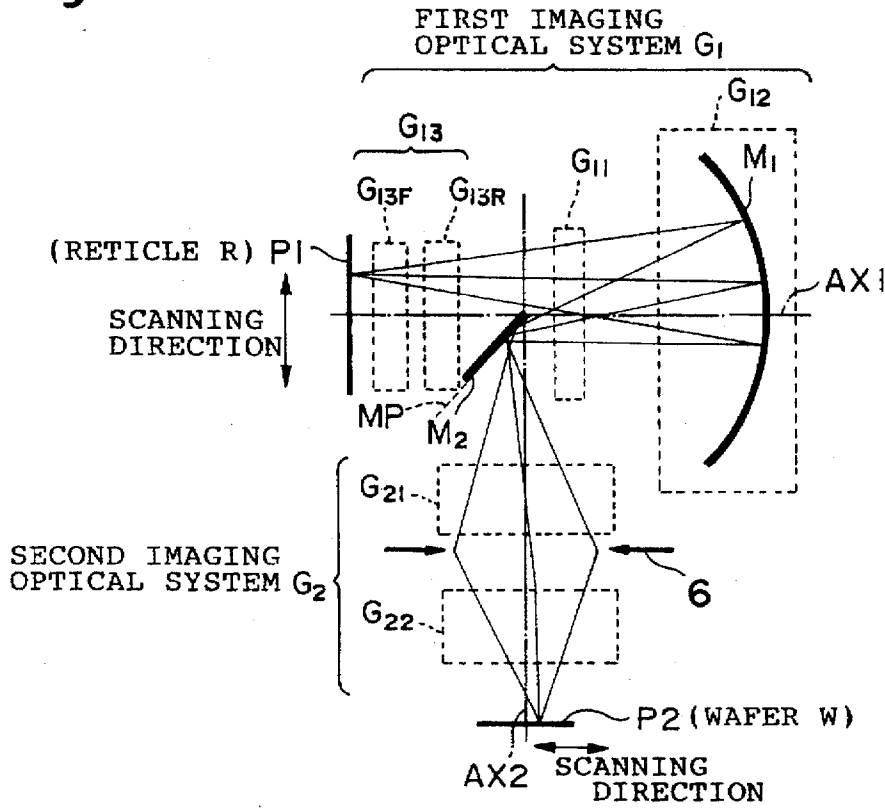

Fig. 4

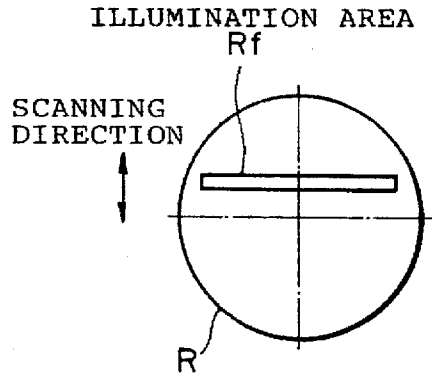

Fig. 5

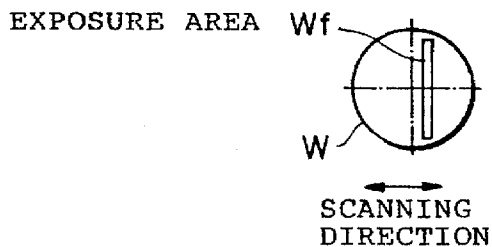

Fig. 6

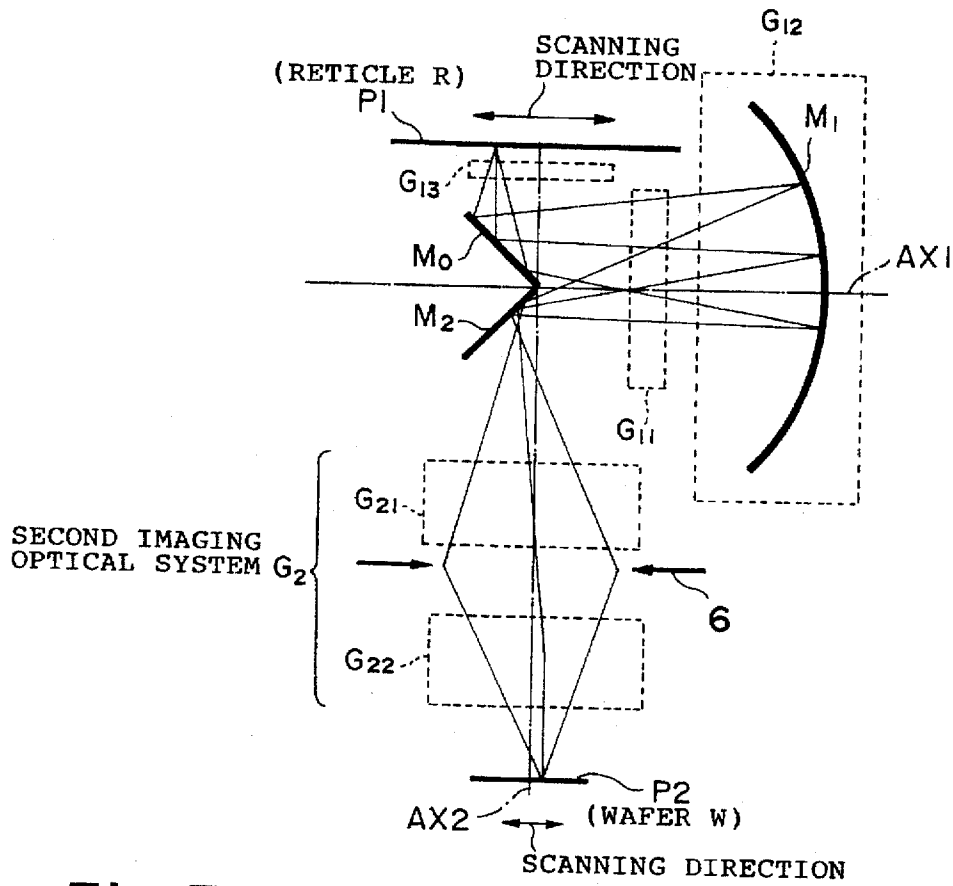

Fig. 7

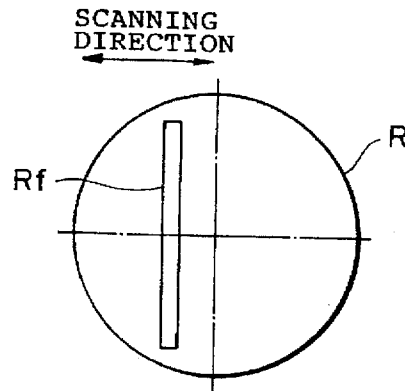
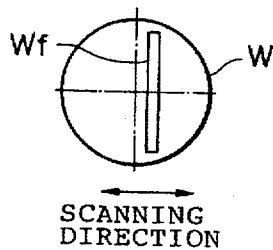

Fig. 8



Explore Litigation Insights

Docket Alarm provides insights to develop a more informed litigation strategy and the peace of mind of knowing you're on top of things.

Real-Time Litigation Alerts



Keep your litigation team up-to-date with **real-time alerts** and advanced team management tools built for the enterprise, all while greatly reducing PACER spend.

Our comprehensive service means we can handle Federal, State, and Administrative courts across the country.

Advanced Docket Research



With over 230 million records, Docket Alarm's cloud-native docket research platform finds what other services can't. Coverage includes Federal, State, plus PTAB, TTAB, ITC and NLRB decisions, all in one place.

Identify arguments that have been successful in the past with full text, pinpoint searching. Link to case law cited within any court document via Fastcase.

Analytics At Your Fingertips



Learn what happened the last time a particular judge, opposing counsel or company faced cases similar to yours.

Advanced out-of-the-box PTAB and TTAB analytics are always at your fingertips.

API

Docket Alarm offers a powerful API (application programming interface) to developers that want to integrate case filings into their apps.

LAW FIRMS

Build custom dashboards for your attorneys and clients with live data direct from the court.

Automate many repetitive legal tasks like conflict checks, document management, and marketing.

FINANCIAL INSTITUTIONS

Litigation and bankruptcy checks for companies and debtors.

E-DISCOVERY AND LEGAL VENDORS

Sync your system to PACER to automate legal marketing.