

**IN THE UNITED STATES DISTRICT COURT  
FOR THE WESTERN DISTRICT OF PENNSYLVANIA**

CENTRIA,

Plaintiff,

v.

ATAS INTERNATIONAL, INC.,

Defendant.

Civil Action No.

**JURY TRIAL DEMANDED**

**COMPLAINT AND DEMAND FOR JURY TRIAL**

Plaintiff Centria (hereinafter, “Centria”), by and through its undersigned counsel, hereby alleges the following against Defendant ATAS International, Inc. (hereinafter, “ATAS”):

**THE PARTIES**

1. Centria is a Pennsylvania partnership having its principal place of business located at 1005 Beaver Grade Road, Moon Township, PA 15108.

2. Upon information and belief, ATAS is a Pennsylvania corporation having its principal place of business located at 6612 Snowdrift Road, Allentown, PA 18106.

**JURISDICTION AND VENUE**

3. Centria brings this action under the Patent Laws of the United States, Title 35 of the United States Code. This Court has jurisdiction pursuant to 28 U.S.C. § 1331 and § 1338.

4. Centria is the owner of all right, title, and interest in and to United States Patent No. D527,834 (“the ’834 Patent”). A true and correct copy of the ’834 Patent is attached hereto as Exhibit A.

5. Upon information and belief, ATAS has and continues to manufacture, use, sell, and/or offer for sale building panels in the United States and in this judicial district that infringe the ’834 Patent, including at least its MFR-161 and MFR-162 wall panel products.

6. ATAS offers for sale its products via its website, [www.atas.com](http://www.atas.com), which is accessible over the Internet all over the United States including in this judicial district and does not purport to preclude prospective customers within this judicial district from obtaining any of ATAS’s products or services. On information and belief, ATAS regularly conducts business in this district—indeed, ATAS’s website identifies multiple “Projects of the Year” wherein its panels were used on buildings located in this judicial district.

7. Upon being notified of the ’834 Patent and ATAS’s infringement thereof and being given a reasonable opportunity to respond, ATAS did not agree to cease its infringing activity or provide any legal justification for its infringement. This infringing activity causes injury to Centria in this district, is believed to be directed at causing harm to Centria in this district, and subjects ATAS to personal jurisdiction in this judicial district.

8. Venue is proper pursuant to 28 U.S.C. § 1391 and § 1400.

**SUMMARY OF FACTS**

9. Centria manufactures, uses, sells, and offers for sale building panels in the United States including its Concept Series line of building panels, certain of which building panels embody the designs covered by the '834 Patent, including Centria's CS-610 and CS-610 panels.

10. Upon information and belief, ATAS manufactures, uses, sells, and offers to sell various building panels in the United States and within this district, including the MFR-161 and MFR-162 wall panels in ATAS's Rigid Wall product line. A true and correct copy of an engineering specification showing ATAS's MFR-161 wall panel, as obtained from ATAS's website, is attached hereto as Exhibit B. A true and correct copy of an engineering specification showing ATAS's MFR-162 wall panel, as obtained from ATAS's website, is attached hereto as Exhibit C.

11. Upon information and belief, Centria has lost sales due to ATAS's sales of its MFR-161 and MFR-162 products, including via ATAS's sales to ATAS's customer, Merchant & Evans, Inc., which offers the ATAS MFR-161 and MFR-162 products under its own "Expression Series" private label as products EX-161 and EX-162.

12. On January 24, 2013, Centria directly notified ATAS of Centria's belief that ATAS's MFR-161 and MFR-162 building panels infringed the '834 Patent. In this correspondence, Centria requested further discussions with ATAS regarding the infringement to reach an amicable resolution of the dispute. Centria and ATAS engaged in subsequent discussions concerning the dispute, but no resolution was reached by the parties.

13. On or about February 6, 2013, ATAS informed Centria that it was going to discuss the infringement issue with its counsel. Centria and its counsel have not heard from ATAS since that conversation.

14. Notwithstanding the direct notification of infringement from Centria, upon information and belief, ATAS continues to manufacture, use, sell, and offer for sale building panels that infringe the '834 Patent.

**COUNT I:**  
**INFRINGEMENT OF THE '834 PATENT**

15. Centria repeats and re-alleges each and every averment contained in paragraphs 1-14 hereof as if fully set forth herein.

16. ATAS has infringed the '834 Patent at least by making, using, selling or offering to sell, and by inducing, aiding and abetting, actively inducing, and encouraging and contributing to others' use, sales, and offers to sell at least the following building panels within its Rigid Wall product line: (1) the MFR-162 Rigid Wall panel; and (2) the MFR-162 Rigid Wall panel. ATAS received notice of the '834 Patent and ATAS's infringement thereof at least as early as January 24, 2013.

17. ATAS's infringement has injured Centria, and Centria is entitled to recover damages adequate to compensate for the infringement that has occurred, including Centria's lost profits, but in no event less than a reasonable royalty pursuant to 35 U.S.C. § 284. Centria is additionally and alternatively entitled to recover ATAS's total profit attributable to the infringing building panels pursuant to 35 U.S.C. § 289.



18. ATAS has infringed the '834 Patent with knowledge of the patent and without legal justification or excuse. ATAS's infringement has been and is willful.

19. Centria has been injured and is being injured by ATAS's infringement of the '834 Patent, and Centria will continue to suffer irreparable harm unless ATAS's infringement of the '834 Patent is enjoined by this Court.

**WHEREFORE**, Centria respectfully requests judgment be entered against ATAS as follows:

A. An award of damages adequate to compensate Centria for the infringement that has occurred, in the form of lost profits, a reasonable royalty, and/or ATAS's total profit, together with prejudgment interest from the date the infringement began;

B. Any other damages permitted in the Court's equitable discretion, including increased damages for willful infringement under 35 U.S.C. § 284;

C. A finding that this case is exceptional and an award to Centria of its attorneys' fees and expenses as provided by 35 U.S.C. § 285;

D. An injunction permanently enjoining ATAS, and all persons in active concert or participation with ATAS, from further acts of infringement of the '834 Patent; and

E. Such other and further relief as this Court deems proper.

**DEMAND FOR JURY TRIAL**

Pursuant to Rule 38 of the Federal Rules of Civil Procedure, Centria hereby demands a trial by jury of all issues triable by jury.

Respectfully submitted,

Dated: March 1, 2013

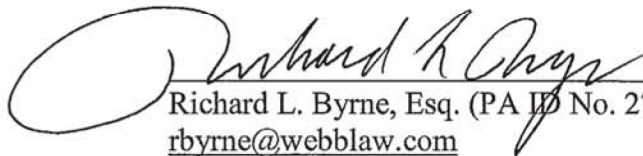
  
Richard L. Byrne, Esq. (PA ID No. 27913)  
[rbyrne@webblaw.com](mailto:rbyrne@webblaw.com)

  
Daniel H. Brean, Esq. (PA ID No. 208711)  
[dbrean@webblaw.com](mailto:dbrean@webblaw.com)

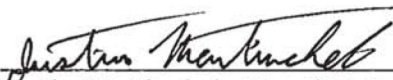
  
Justin Martinchek, Esq. (PA ID No. 311471)  
[jmartinchek@webblaw.com](mailto:jmartinchek@webblaw.com)

THE WEBB LAW FIRM  
One Gateway Center  
420 Fort Duquesne Blvd., Suite 1200  
(412) 471-8815

*Counsel for Plaintiff Centria*

# **EXHIBIT A**



US00D527834S

(12) **United States Design Patent** (10) **Patent No.:** **US D527,834 S**  
**Thimons et al.** (45) **Date of Patent:** **\*\* Sep. 5, 2006**

(54) **BUILDING PANEL**

(75) Inventors: **Mark A. Thimons**, Natrona Heights, PA (US); **Mark J. Klos**, West Mifflin, PA (US)

(73) Assignee: **Centria**, Moon Township, PA (US)

(\*\*) Term: **14 Years**

(21) Appl. No.: **29/203,806**

(22) Filed: **Apr. 20, 2004**

(51) **LOC (8) Cl.** ..... **25-01**

(52) **U.S. Cl.** ..... **D25/119**

(58) **Field of Classification Search** ..... D25/119, D25/138; 52/519, 520, 537, 478, 311.2, 588.1  
 See application file for complete search history.

(56) **References Cited**

**U.S. PATENT DOCUMENTS**

D259,143 S	*	5/1981	Aktinson	.....	D25/119
5,524,409 A	*	6/1996	Kaiser	.....	52/588.1
5,775,042 A	*	7/1998	Mowery et al.	.....	52/520
D449,120 S	*	10/2001	Kulik	.....	D25/138

**OTHER PUBLICATIONS**

“Commercial & Industrial Metal Wall Systems” Robertson Product Brochure, p. 9 (1994).

\* cited by examiner

*Primary Examiner*—Doris Clark

(74) *Attorney, Agent, or Firm*—Buchanan Ingersoll PC

(57) **CLAIM**

The ornamental design for a building panel, as shown and described.

**DESCRIPTION**

FIG. 1 is a perspective view of a building panel showing our new design;  
 FIG. 2 is a left side elevational view thereof;  
 FIG. 3 is a front elevational view thereof;

FIG. 4 is a bottom plan view thereof;  
 FIG. 5 is a top plan view thereof;  
 FIG. 6 is a perspective view of two building panels attached together;  
 FIG. 7 is a perspective view of a second embodiment of our new design;  
 FIG. 8 is a left side elevational view thereof;  
 FIG. 9 is a front elevational view thereof;  
 FIG. 10 is a bottom plan view thereof;  
 FIG. 11 is a top plan view thereof;  
 FIG. 12 is a perspective view of two building panels attached together;  
 FIG. 13 is a perspective view of a third embodiment of our new design;  
 FIG. 14 is a left side elevational view thereof;  
 FIG. 15 is a front elevational view thereof;  
 FIG. 16 is a bottom plan view thereof;  
 FIG. 17 is a top plan view thereof;  
 FIG. 18 is a perspective view of two building panels attached together;  
 FIG. 19 is a perspective view of a fourth embodiment of our new design;  
 FIG. 20 is a left side elevational view thereof;  
 FIG. 21 is a front elevational view thereof;  
 FIG. 22 is a bottom plan view thereof;  
 FIG. 23 is a top plan view thereof;  
 FIG. 24 is a perspective view of two building panels attached together;  
 FIG. 25 is a perspective view of a fifth embodiment of our new design;  
 FIG. 26 is a left side elevational view thereof;  
 FIG. 27 is a front elevational view thereof;  
 FIG. 28 is a bottom plan view thereof;  
 FIG. 29 is a top plan view thereof;  
 FIG. 30 is a perspective view of two building panels attached together;  
 FIG. 31 is a perspective view of a sixth embodiment of our new design;  
 FIG. 32 is a left side elevational view thereof;  
 FIG. 33 is a front elevational view thereof;  
 FIG. 34 is a bottom plan view thereof;  
 FIG. 35 is a top plan view thereof;  
 FIG. 36 is a perspective view of two building panels attached together;

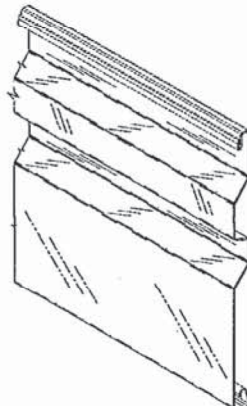

**US D527,834 S**

Page 2

---

FIG. 37 is a perspective view of a seventh embodiment of our new design;  
FIG. 38 is a left side elevational view thereof;  
FIG. 39 is a front elevational view thereof;  
FIG. 40 is a bottom plan view thereof;  
FIG. 41 is a top plan view thereof;  
FIG. 42 is a perspective view of two building panels attached together.

The broken lines are for illustrative purposes only and form no part of the claimed design. The claimed design is broken on one side to indicate indefinite length.

**1 Claim, 28 Drawing Sheets**



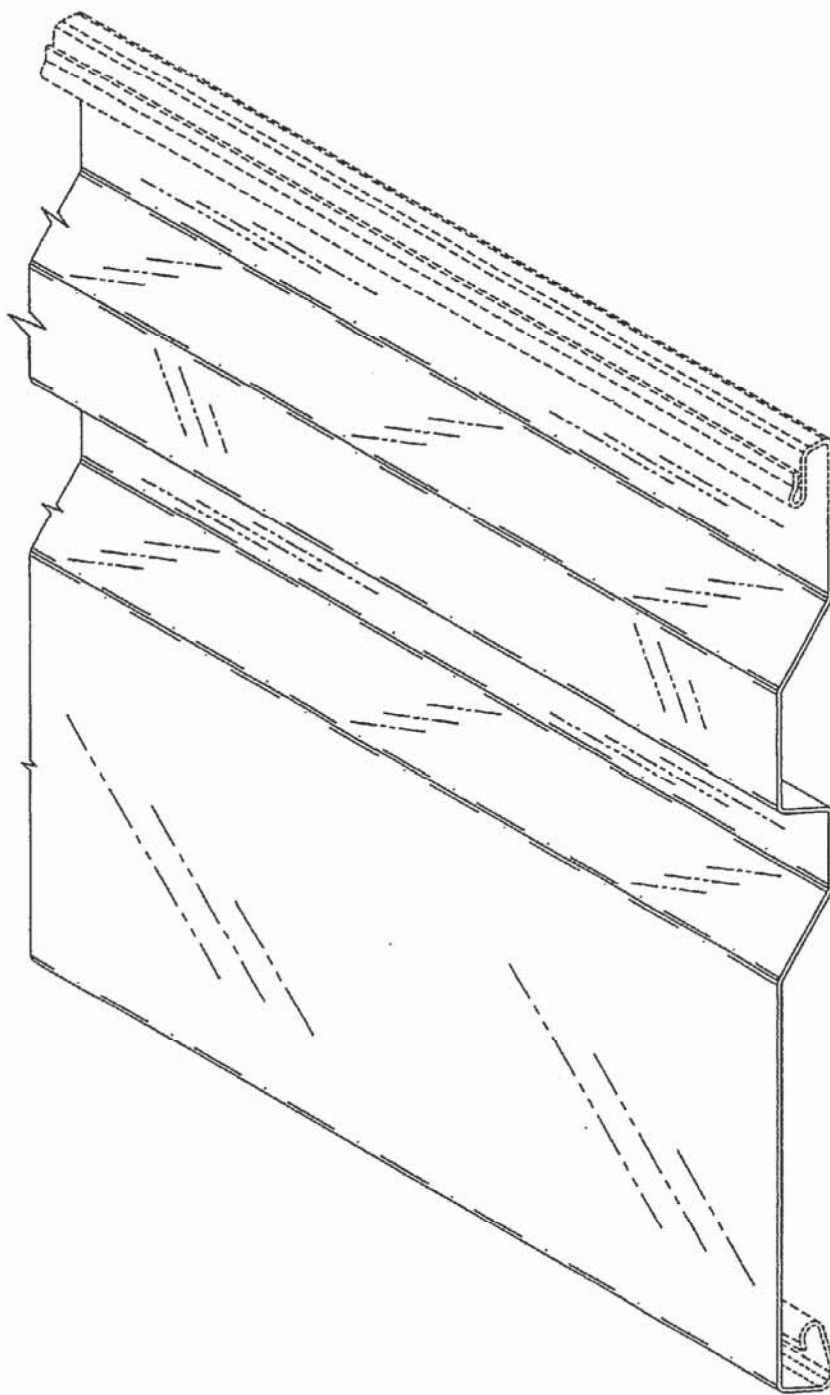

FIG. 1



FIG. 2



FIG. 5

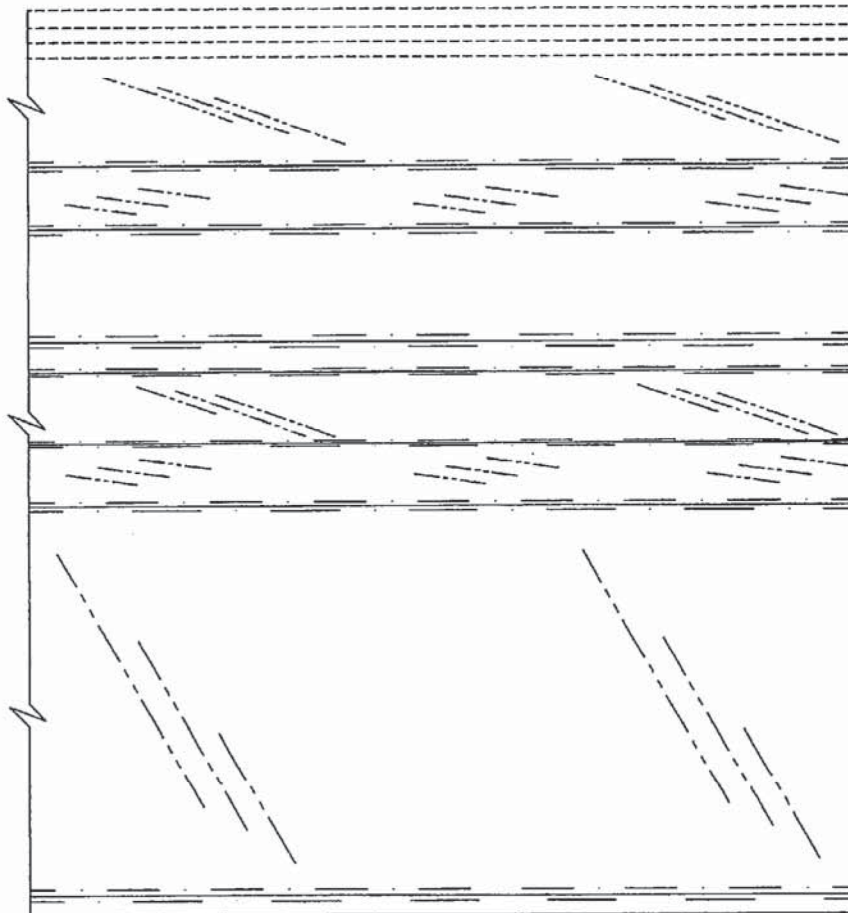

FIG. 3

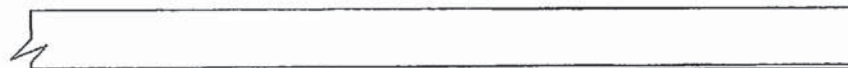

FIG. 4

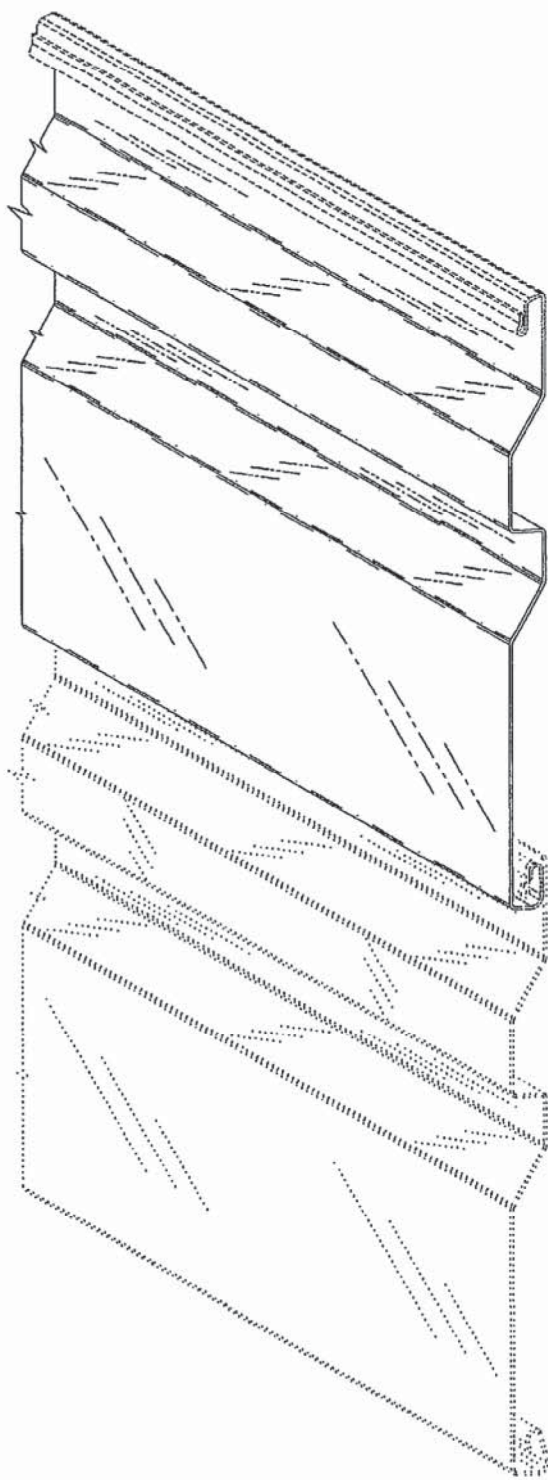

FIG. 6

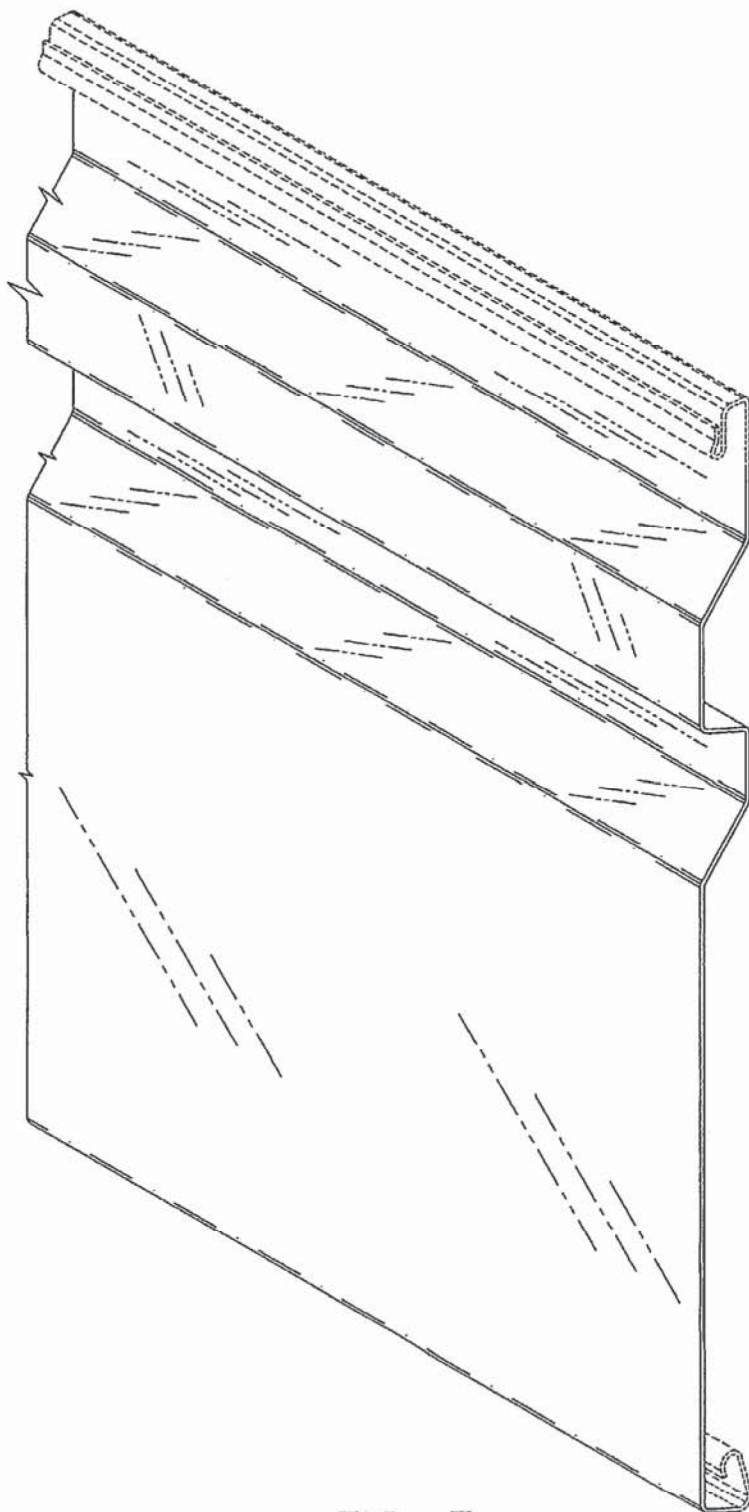

FIG. 7





FIG. 8

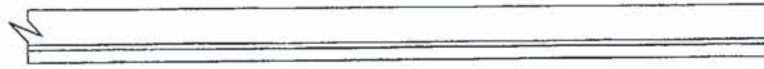

FIG. 11

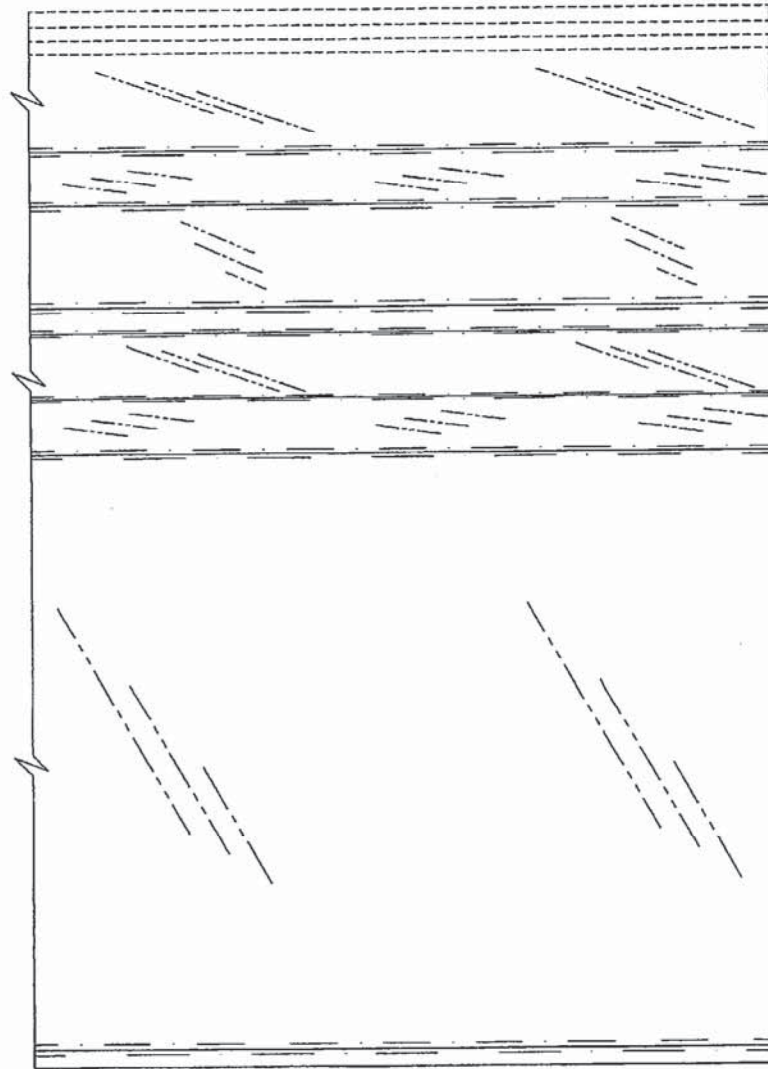

FIG. 9

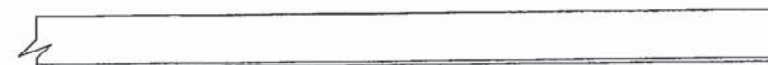

FIG. 10

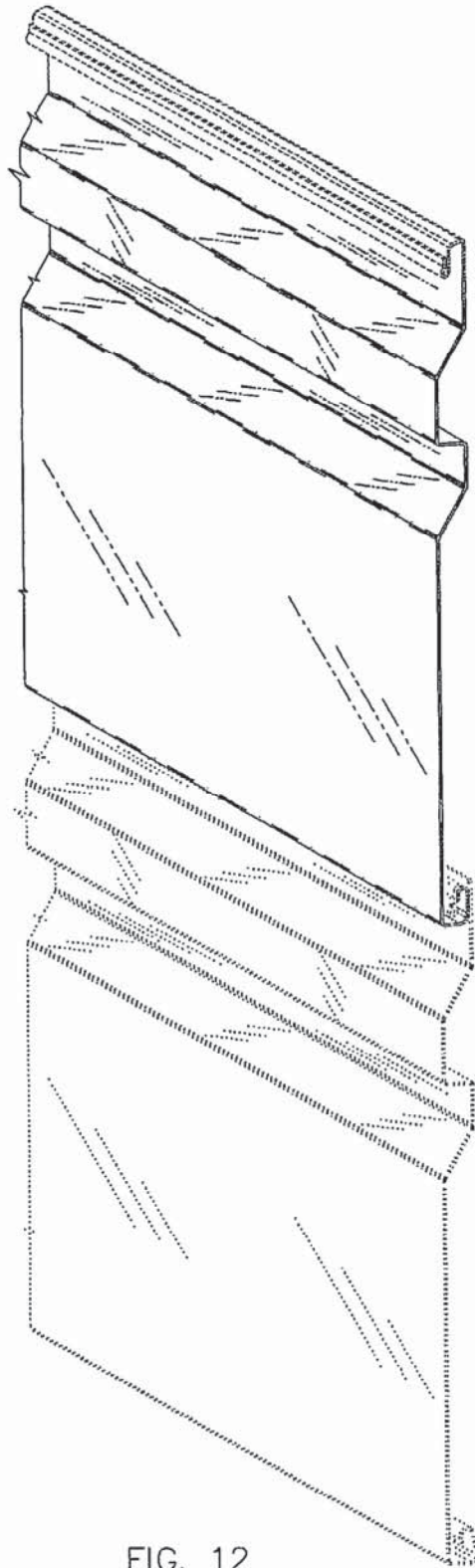

FIG. 12

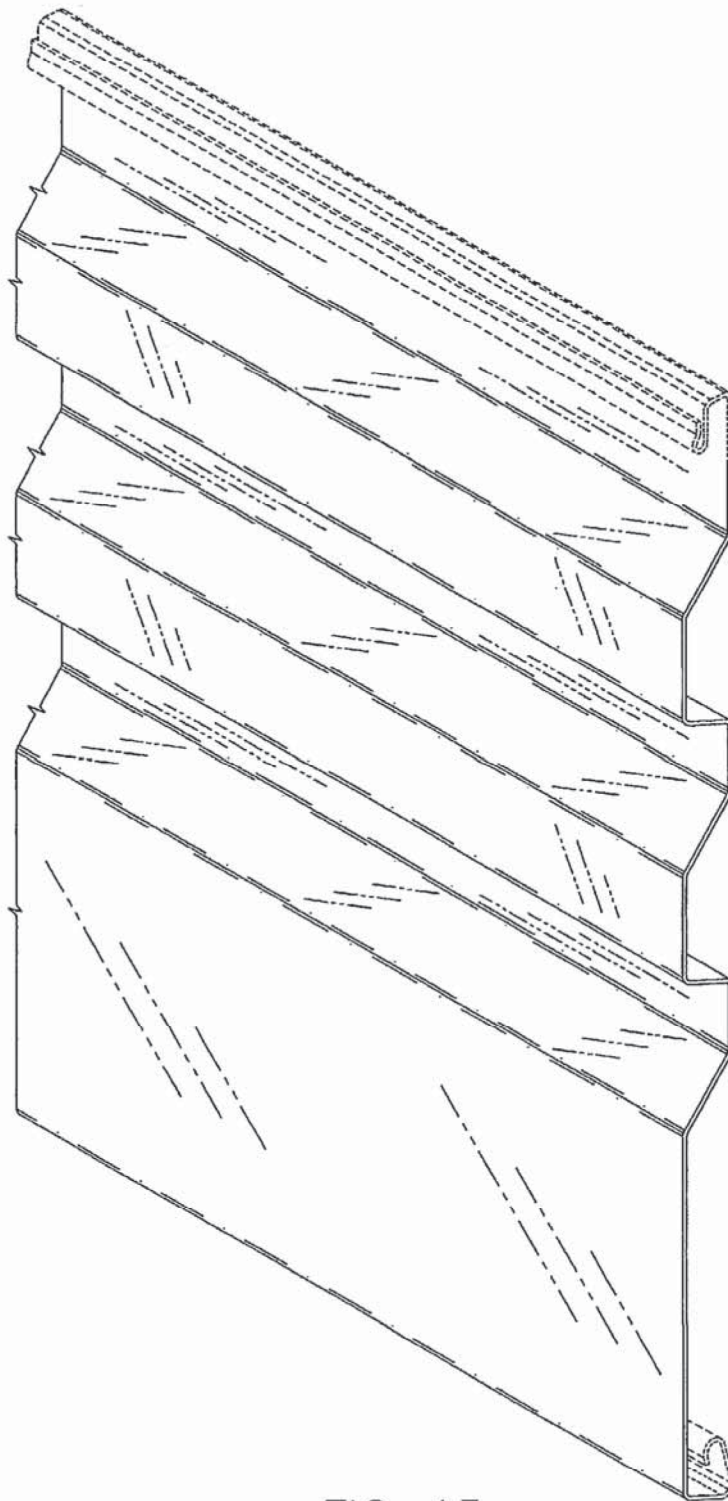

FIG. 13



FIG. 14





FIG. 17

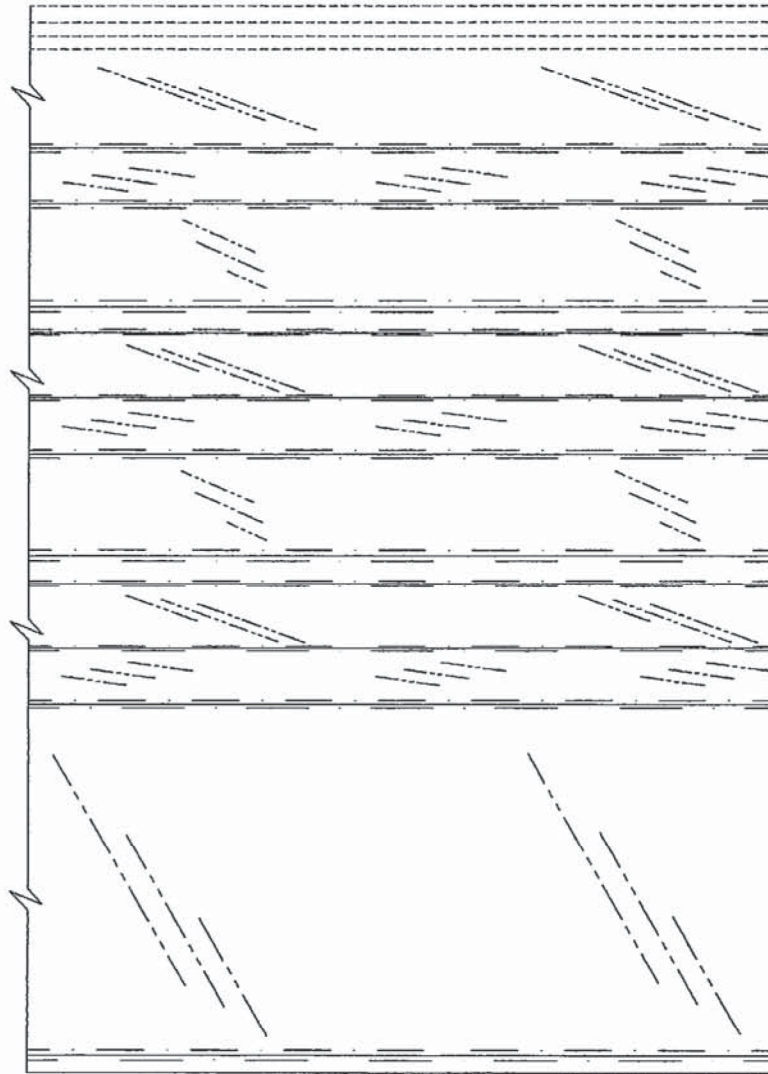

FIG. 15



FIG. 16

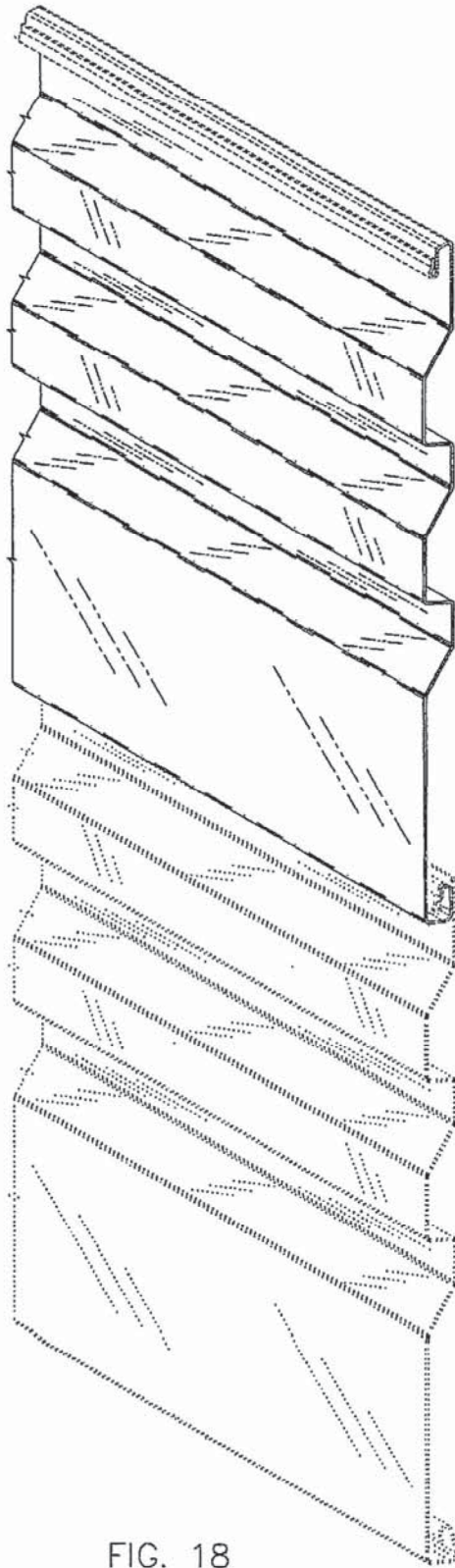

FIG. 18

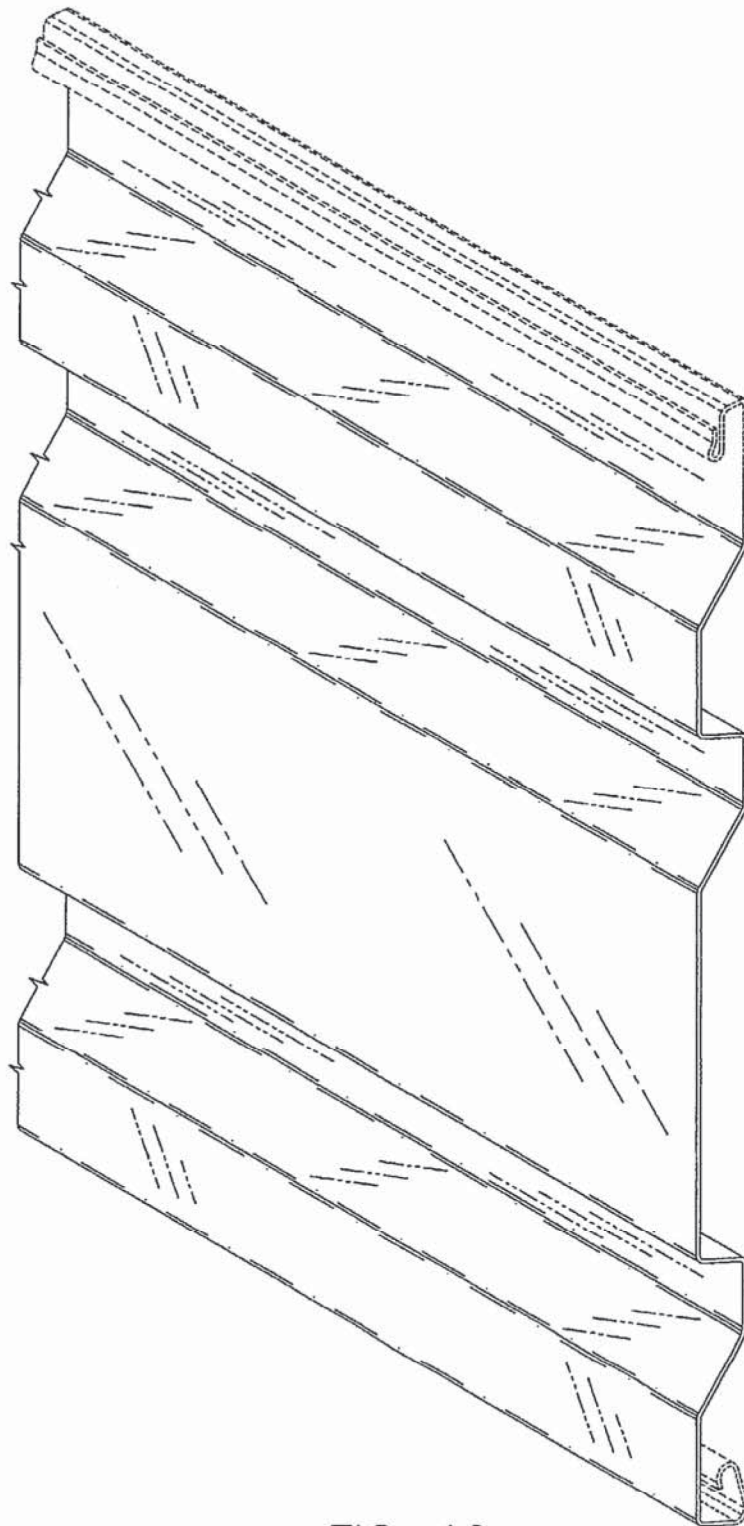

FIG. 19



FIG. 20



FIG. 23

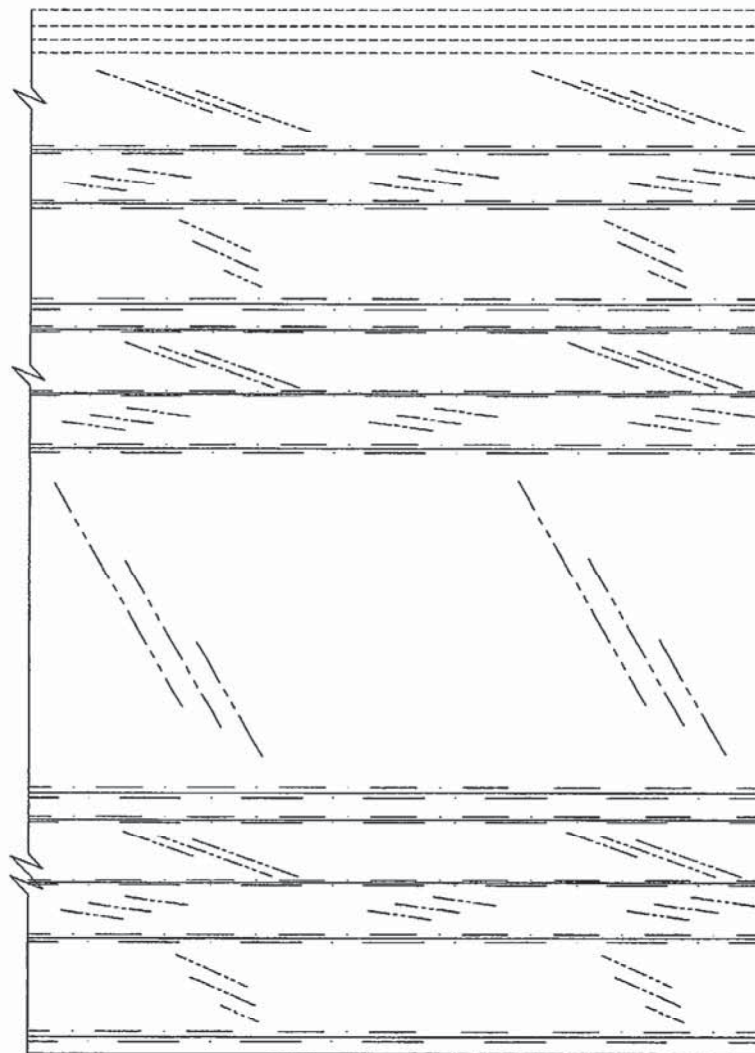

FIG. 21

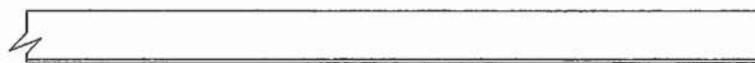

FIG. 22



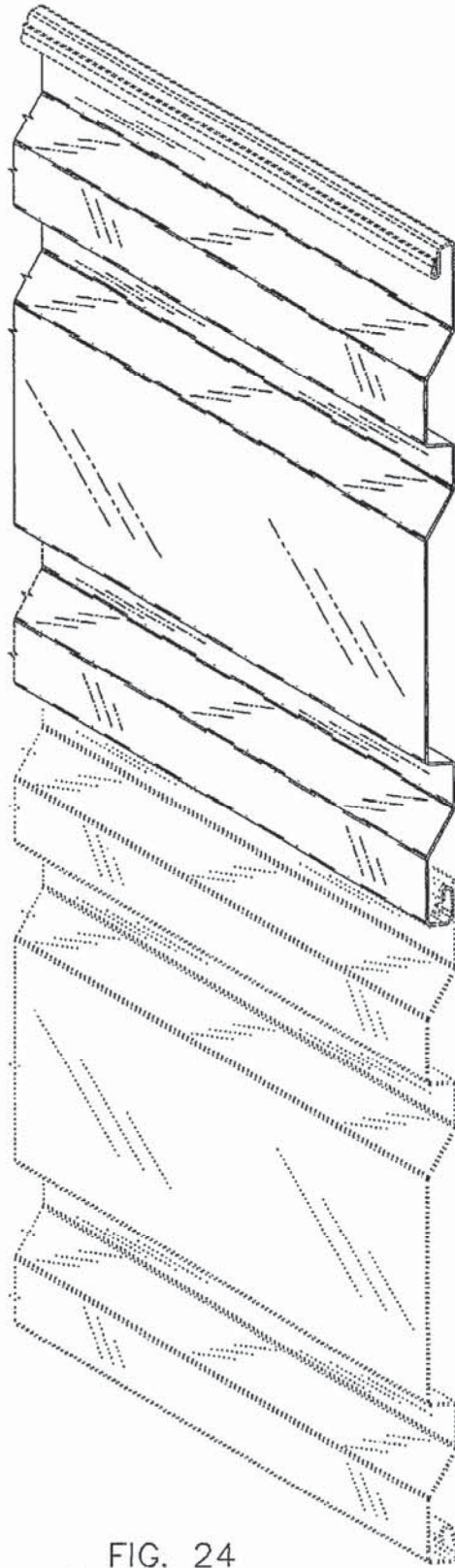

FIG. 24

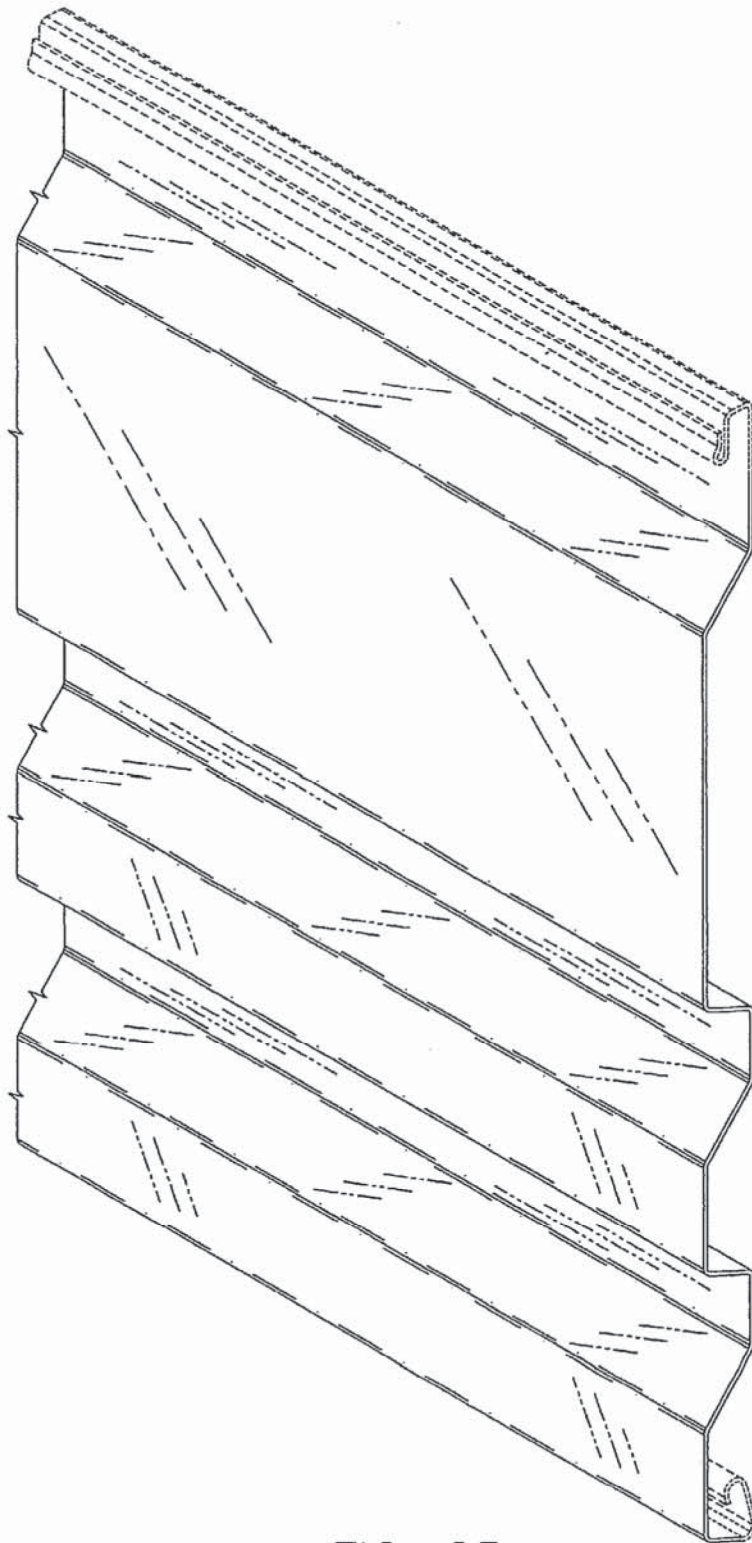

FIG. 25



FIG. 26

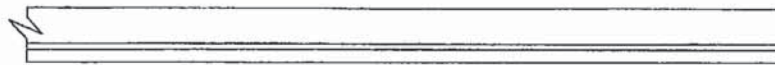

FIG. 29

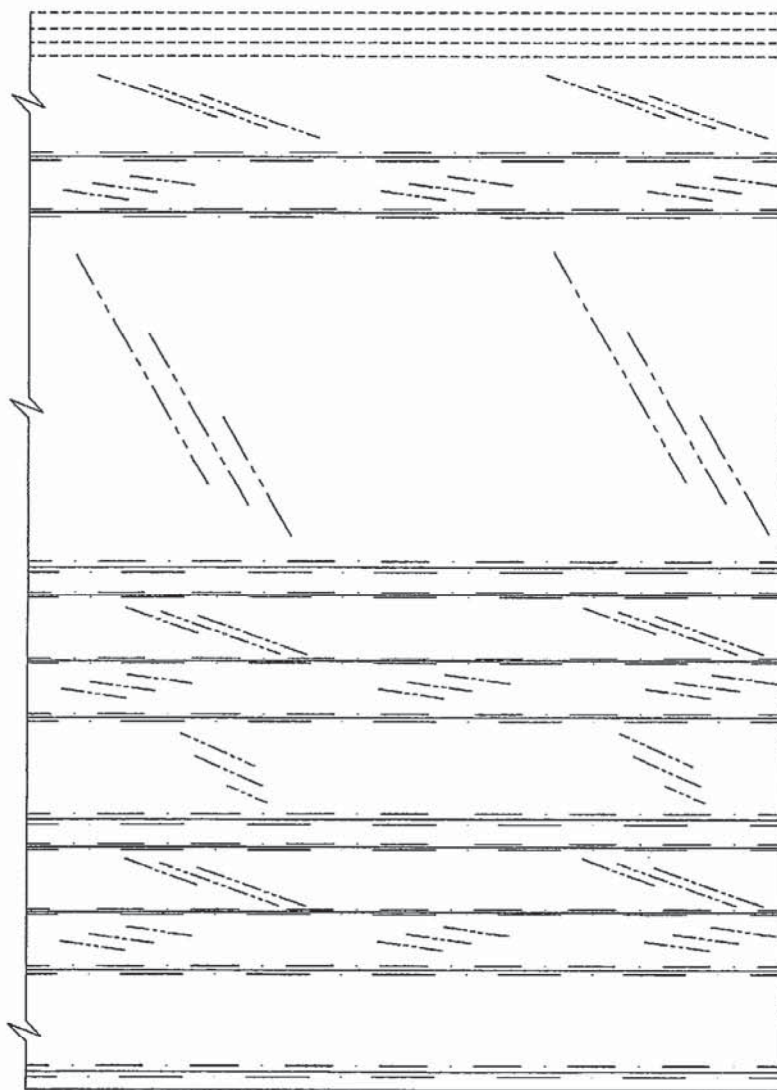

FIG. 27

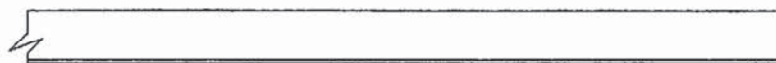

FIG. 28

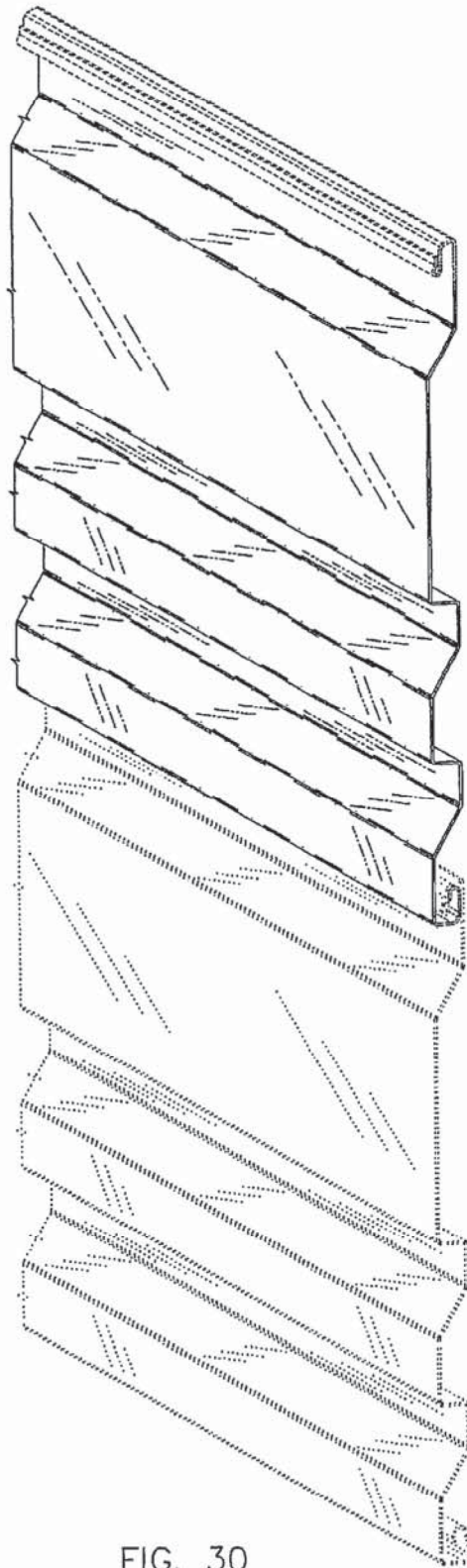

FIG. 30



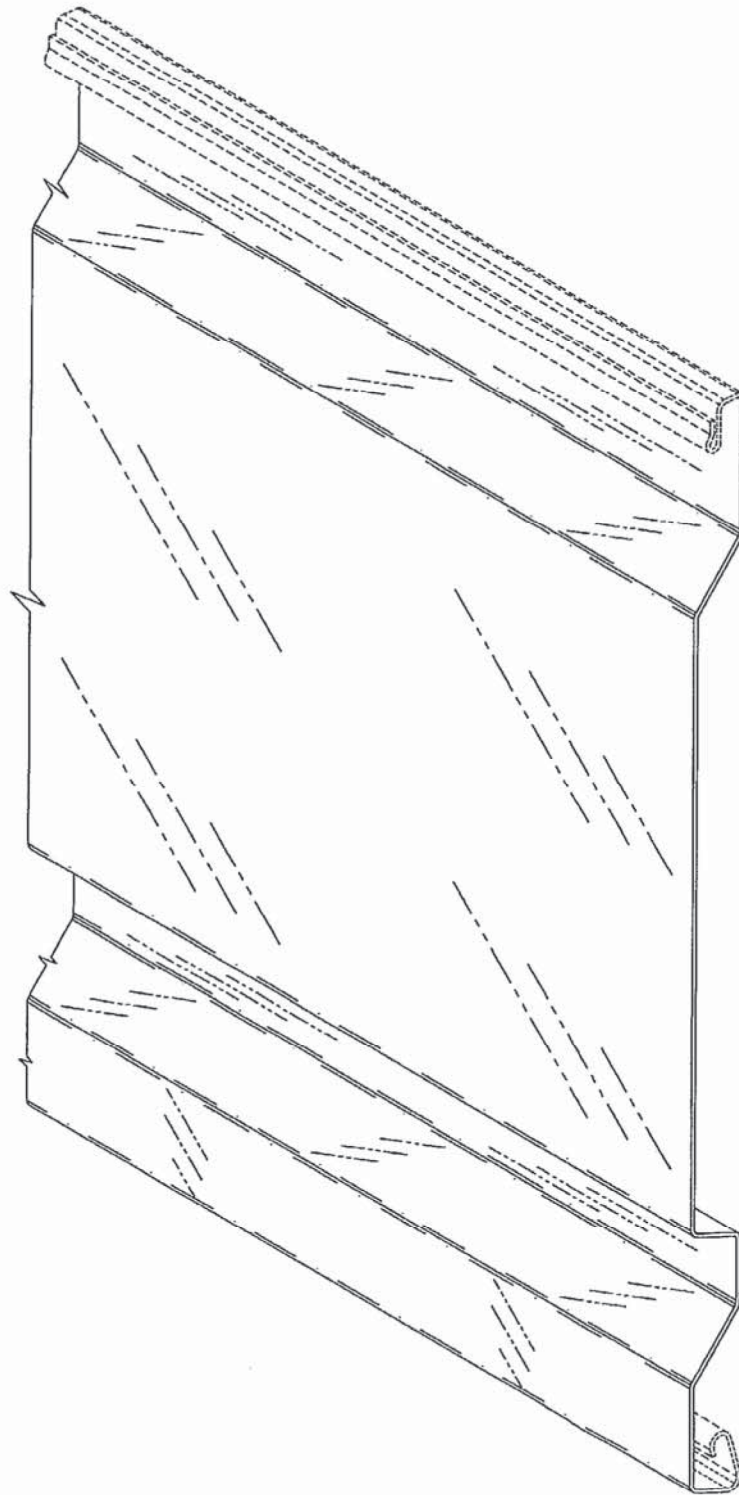

FIG. 31





FIG. 32

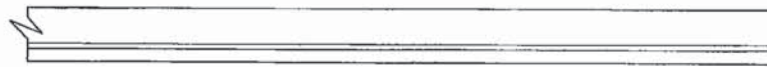

FIG. 35

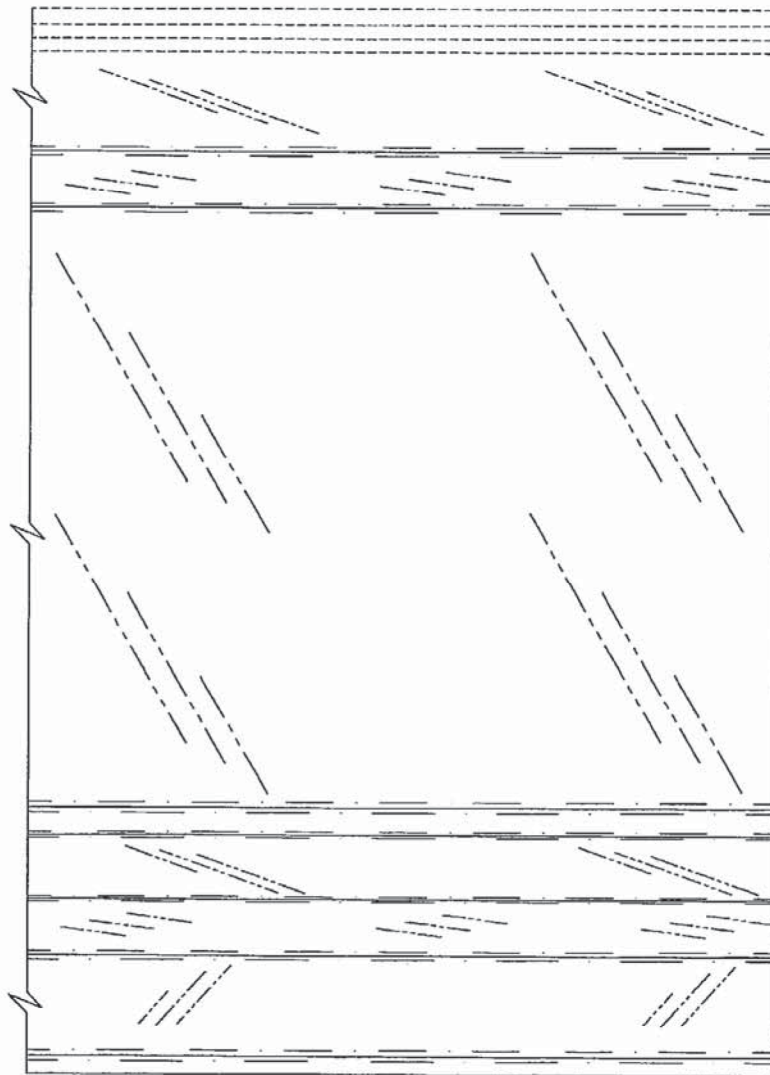

FIG. 33

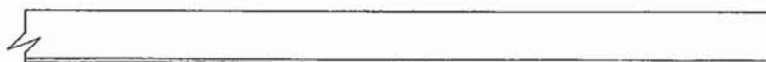

FIG. 34

**U.S. Patent**

Sep. 5, 2006

Sheet 24 of 28

**US D527,834 S**

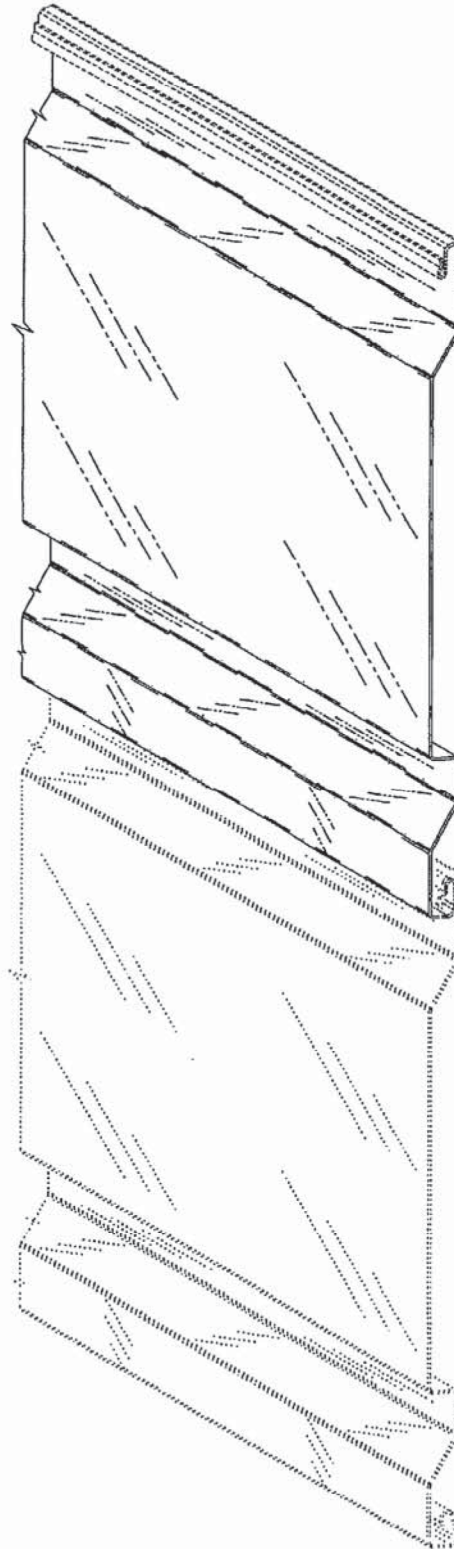

FIG. 36

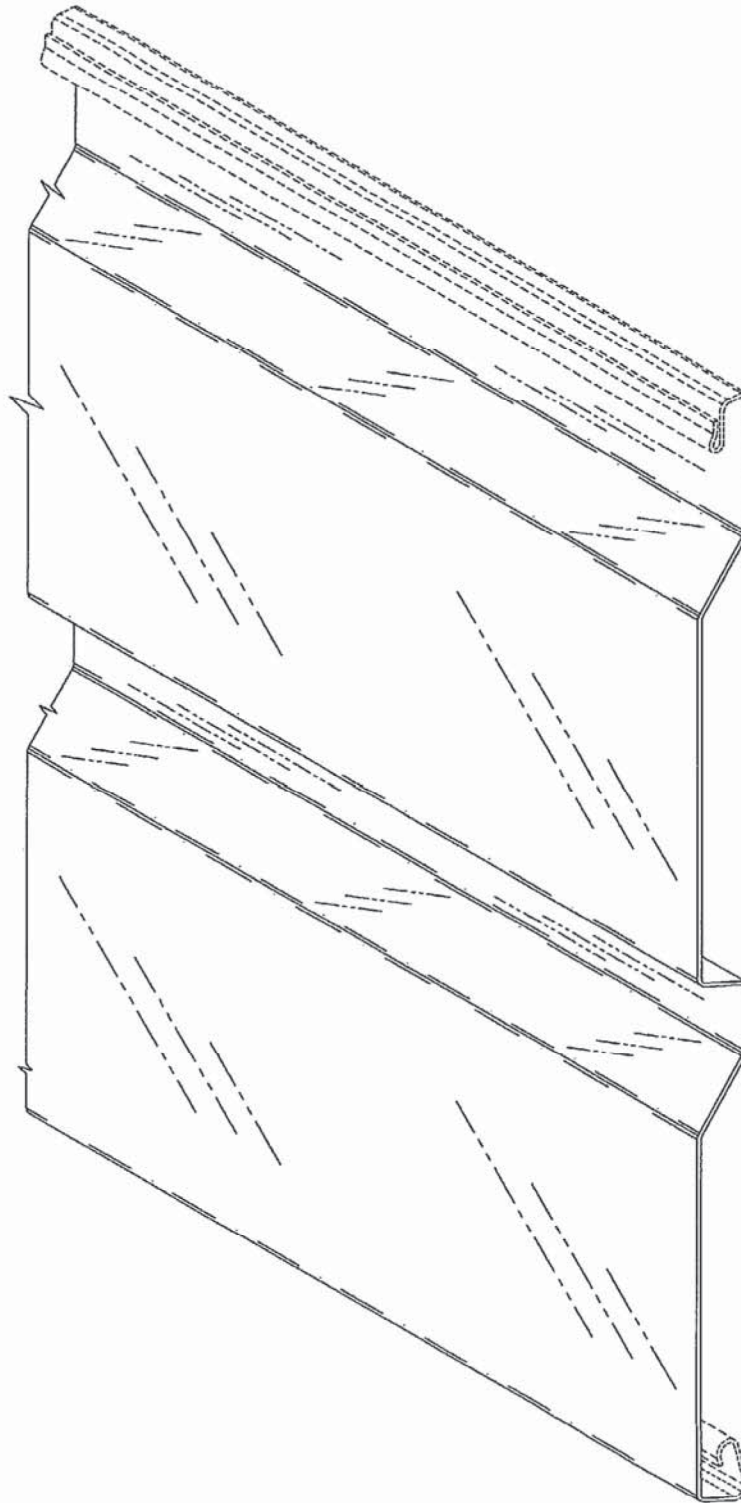

FIG. 37

**U.S. Patent**

**Sep. 5, 2006**

**Sheet 26 of 28**

**US D527,834 S**



FIG. 38



FIG. 41

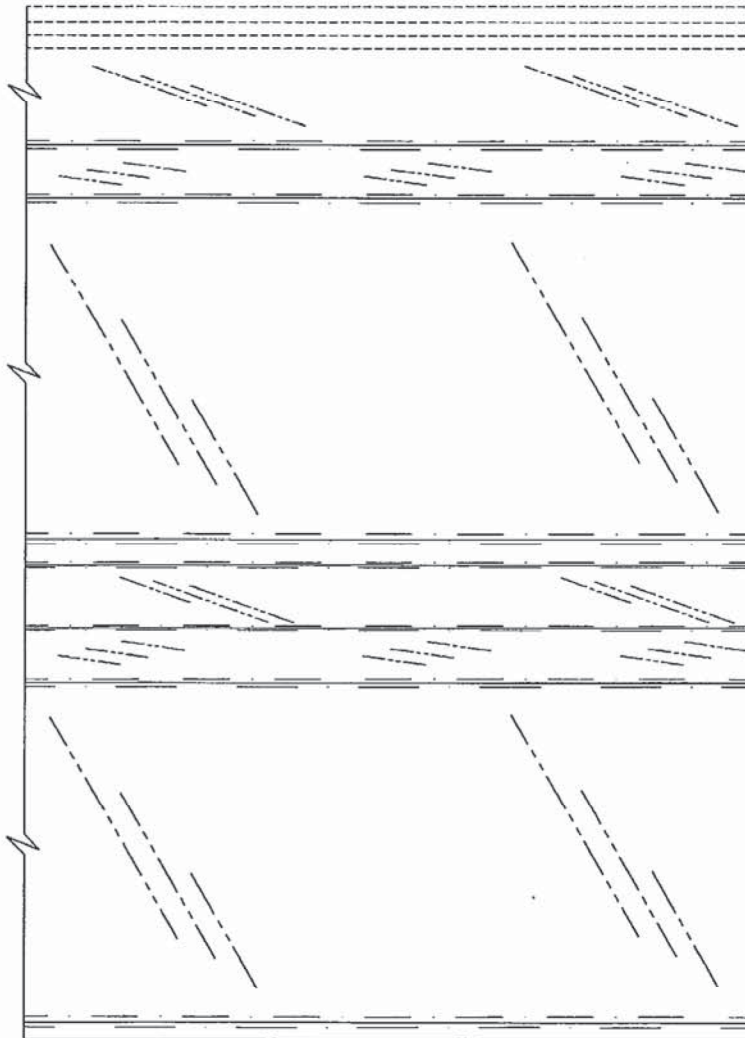

FIG. 39

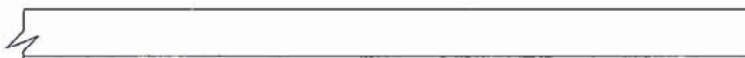

FIG. 40



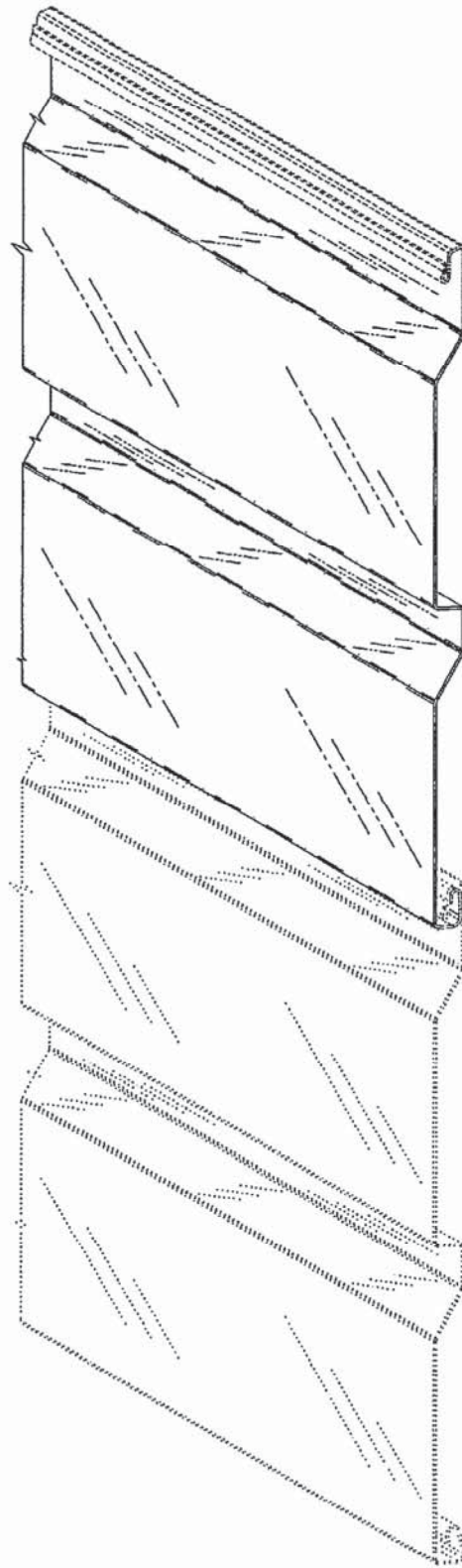
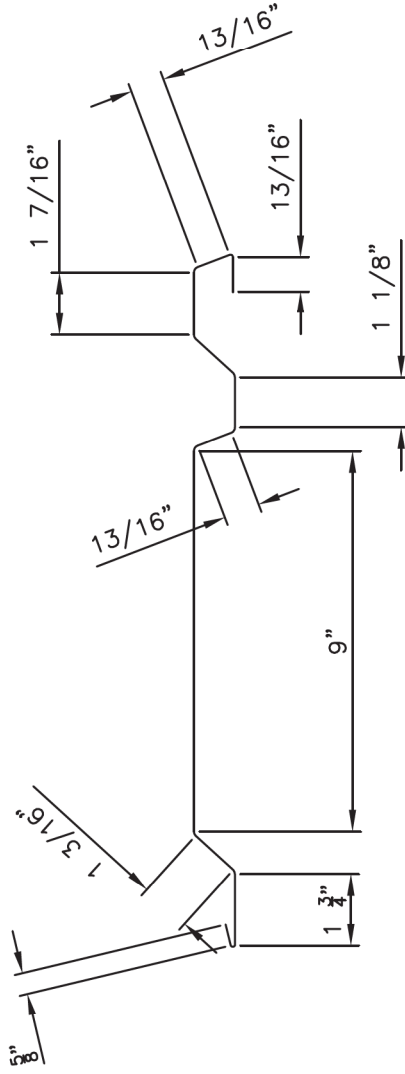
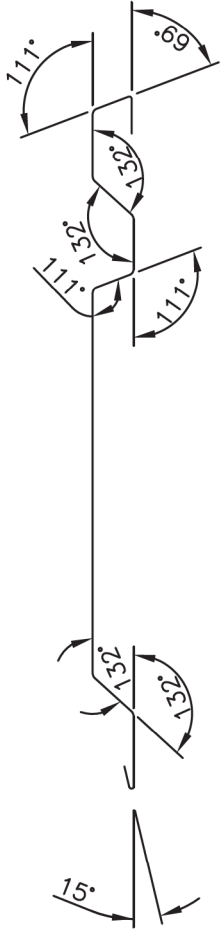



FIG. 42

# **EXHIBIT B**



 ATAS INTERNATIONAL, INC. Allentown PA 610-395-8445 Mesa AZ 480-558-7210		TITLE		MFR161		SCALE	3"=1'-0"
		DWG NO. / FILE NO.	MFR161		DATE	7-15-10	DATE
REVISION NO.	REVISION DATE	REVISION DATE	REVISION DATE	APP. BY	APP. BY	APP. DATE	APP. DATE
0	7-15-10	XXXX	XXXX	DAS	JEB	XXXX	MM/DD/YY
Drawn By	DAS	DATE	DATE	APP. BY	JEB	DATE	DATE
Description of Revision							
MFR161							

# **EXHIBIT C**

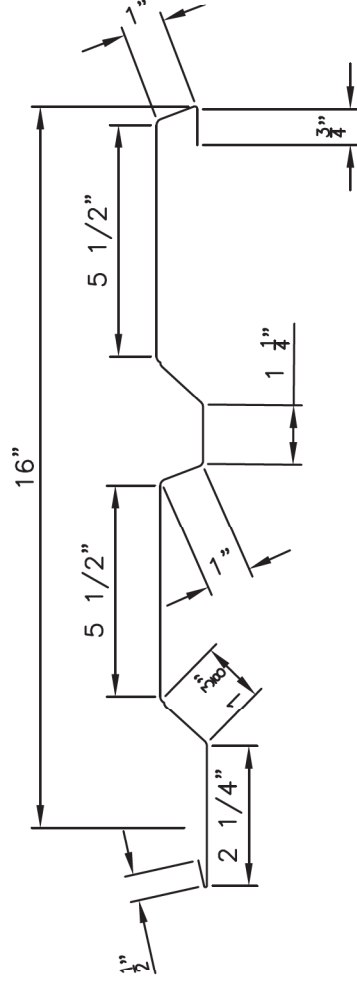
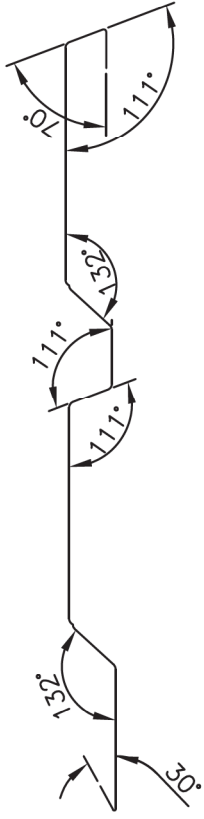

 ATAS INTERNATIONAL, INC. Allentown PA 610-395-8445 Mesa AZ 480-558-7210		MFR161		SCALE	3"=1'-0"
		MFR161		DWG NO./FILE NO.	
REVISION NO.	DAS	DATE	APPR. BY	JEB	DATE
0	DAS	7-15-10	XXXX	XXXX	7-15-10
Description of Revision		REVISION DATE	APPR. BY	XXXX	MM/DD/YY
					MM/DD/YY
MFR161					

**IN THE UNITED STATES DISTRICT COURT  
FOR THE WESTERN DISTRICT OF PENNSYLVANIA**

CENTRIA,

Plaintiff,

v.

ATAS INTERNATIONAL, INC.,

Defendant.

Civil Action No.

**JURY TRIAL DEMANDED**

**PRAECIPE TO ISSUE SUMMONS**

To The Clerk of the United States District Court for the Western District of Pennsylvania:

Plaintiff filed its Complaint in this action on March 1, 2013. You are now requested to issue a Summons directed to the Defendants in this action:

ATAS INTERNATIONAL, INC.,

A pre-populated form Summons is attached.

Respectfully submitted,



Richard L. Byrne, Esq. (PA ID No. 27913)  
Daniel H. Brean, Esq. (PA ID No. 208711)  
Justin Martinchek, Esq. (PA ID No. 311471)  
The Webb Law Firm  
One Gateway Center  
420 Fort Duquesne Blvd., Suite 1200  
(412) 471-8815  
[rbyrne@webblaw.com](mailto:rbyrne@webblaw.com)  
[dbrean@webblaw.com](mailto:dbrean@webblaw.com)  
[jmartinchek@webblaw.com](mailto:jmartinchek@webblaw.com)



AO 440 (Rev. 06/12) Summons in a Civil Action

UNITED STATES DISTRICT COURT

for the

Western District of Pennsylvania

CENTRIA

Plaintiff(s)

v.

ATAS INTERNATIONAL, INC.,

Defendant(s)

Civil Action No.

SUMMONS IN A CIVIL ACTION

To: (Defendant's name and address) ATAS INTERNATIONAL, INC.,
6612 Snowdrift Road
Allentown, PA 18106

A lawsuit has been filed against you.

Within 21 days after service of this summons on you (not counting the day you received it) — or 60 days if you are the United States or a United States agency, or an officer or employee of the United States described in Fed. R. Civ. P. 12 (a)(2) or (3) — you must serve on the plaintiff an answer to the attached complaint or a motion under Rule 12 of the Federal Rules of Civil Procedure. The answer or motion must be served on the plaintiff or plaintiff's attorney, whose name and address are:

Richard L. Byrne
The Webb Law Firm
One Gateway Center
420 Ft. Duquesne Blvd.
Suite 1200
Pittsburgh, PA 15222

If you fail to respond, judgment by default will be entered against you for the relief demanded in the complaint. You also must file your answer or motion with the court.

CLERK OF COURT

Date:

Signature of Clerk or Deputy Clerk