

EXHIBIT 1017:

U.S. PATENT NUMBER D354,416 TO CAUTEREELS.

(“CAUTEREELS (‘416)’)

Munchkin, Inc. & Toys “R” Us, Inc.: 1017



US00D354416S

**United States Patent** [19]  
**Cautereels et al.**

[11] **Patent Number: Des. 354,416**  
[45] **Date of Patent: \*\* Jan. 17, 1995**

- [54] **DRINKING TUMBLER WITH BASE AND SIPPER**
- [75] Inventors: **Victor J. J. Cautereels**, Borsbeek, Belgium; **Ian Ferris**, Wokingham, United Kingdom
- [73] Assignee: **Dart Industries Inc.**, Deerfield, Ill.
- [\*\*] Term: **14 Years**
- [21] Appl. No.: **932,859**
- [22] Filed: **Aug. 20, 1992**
- [52] U.S. Cl. .... **D7/507; D7/510; D7/511; D7/534**
- [58] **Field of Search** ..... **D7/509, 510, 511, 512, D7/513, 514, 507, 530, 532, 528, 533, 317, 536, 584, 545, 548, 392, 543, 534; D9/560, 533, 538, 539, 564, 551, 542, 307; D24/199, 197; D12/114; 220/630, 912, 669, 675, 755, 771; 65/66, DIG. 10**

- D. 253,216 10/1979 Trombly .
- D. 255,858 7/1980 Ashton ..... D7/536
- D. 256,645 9/1980 Keough .
- D. 259,231 5/1981 Kozlow, Sr. .
- D. 270,039 8/1983 Lipscombe ..... D9/307 X
- D. 279,752 7/1985 Jagger .
- D. 298,717 11/1988 Nichols et al. .
- D. 310,567 9/1990 Fitzpatrick .
- D. 316,652 5/1991 Hunter .
- D. 327,818 7/1992 Haralson et al. .... D7/534
- D. 334,869 4/1993 Mills ..... D7/536 X
- D. 343,763 2/1994 Zimmerman ..... D7/545 X
- 2,169,426 8/1939 Morton ..... 65/66
- 4,756,440 7/1988 Gartner .

*Primary Examiner*—Alan P. Douglas  
*Assistant Examiner*—M. N. Pandozzi  
*Attorney, Agent, or Firm*—John A. Doninger

[57] **CLAIM**

The ornamental design for a drinking tumbler with base and sipper, as shown and described.

**DESCRIPTION**

FIG. 1 is a top perspective view of a drinking tumbler with base and sipper, showing our new design;  
FIG. 2 is an exploded elevational view thereof;  
FIG. 3 is a top plan view thereof;  
FIG. 4 is a bottom plan view thereof;  
FIG. 5 is a rear elevational view thereof;  
FIG. 6 is a front elevational view thereof;  
FIG. 7 is a side elevational view thereof, the opposite side being a mirror image;  
FIG. 8 is an enlarged cross-sectional view thereof on line 8—8 in FIG. 7; and,  
FIG. 9 is an enlarged cross-sectional view thereof on line 9—9 in FIG. 5.

[56] **References Cited**  
**U.S. PATENT DOCUMENTS**

- D. 69,133 12/1925 Haviland ..... D7/536
- D. 77,281 12/1928 Bartlett .
- D. 90,060 6/1933 Barbiers ..... D7/530
- D. 104,342 5/1937 Duncan, 3D, et al. .
- D. 104,343 5/1937 Duncan, 3D et al. .
- D. 162,085 2/1951 Rogers .
- D. 163,673 6/1951 Bliss .
- D. 165,249 11/1951 Soyster .
- D. 165,778 1/1952 Olsen .
- D. 196,271 9/1963 Edwards .
- D. 216,730 3/1970 Carslaw .
- D. 223,999 6/1972 Klose .
- D. 233,972 12/1974 Juhlin .

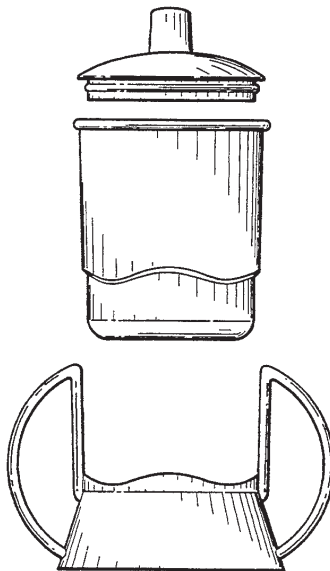

FIG. 1

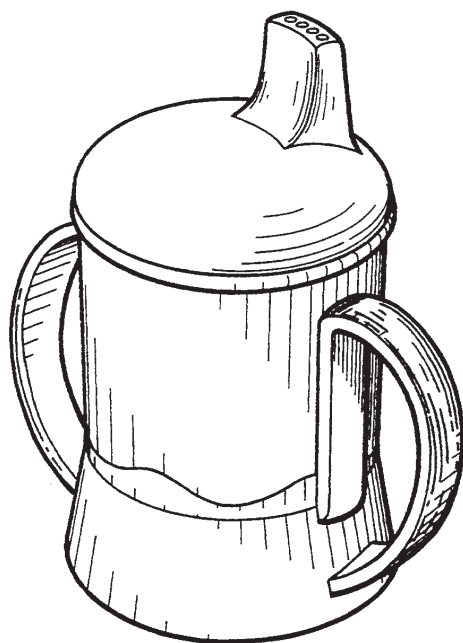

FIG. 3

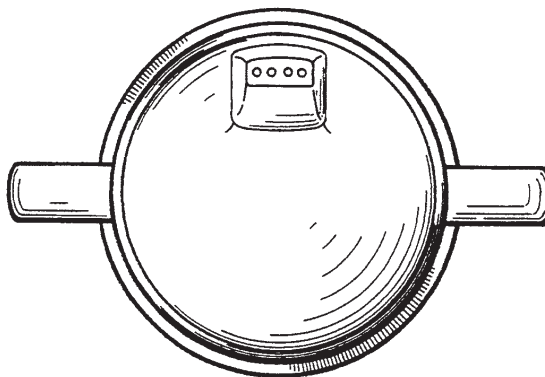
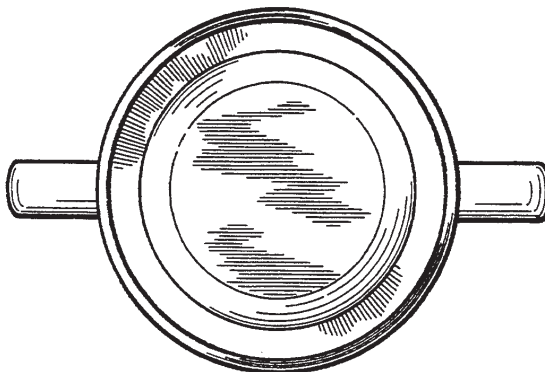
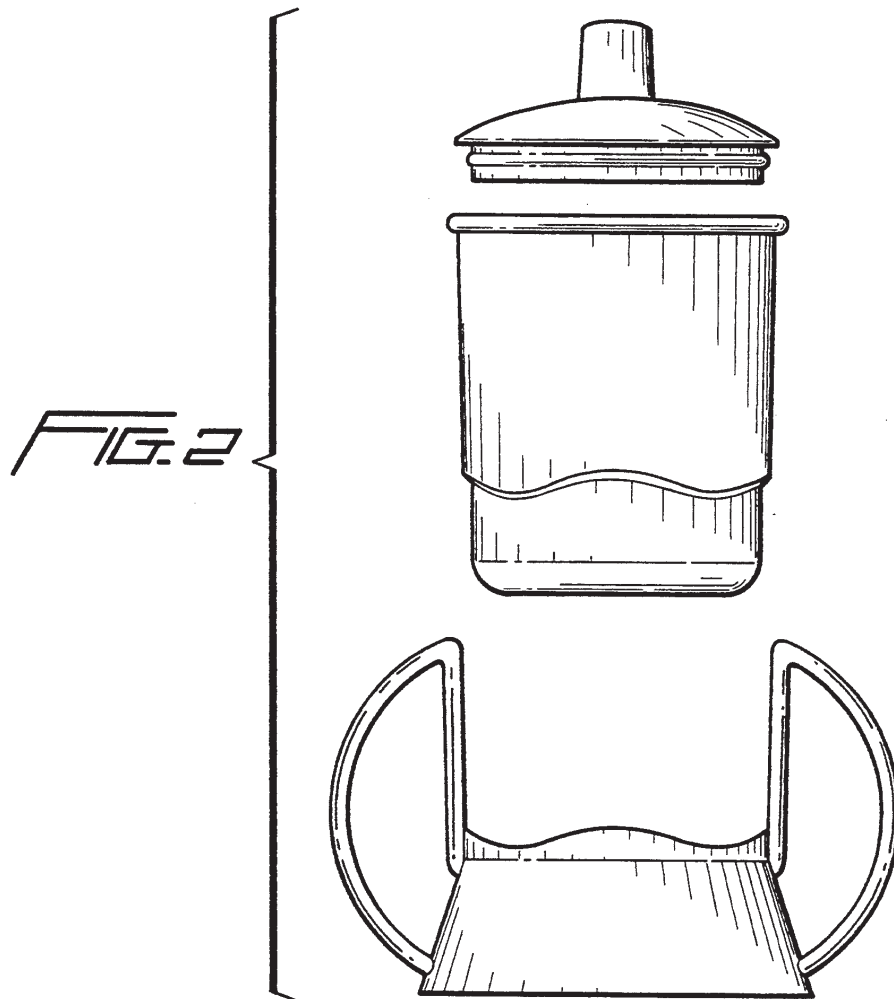
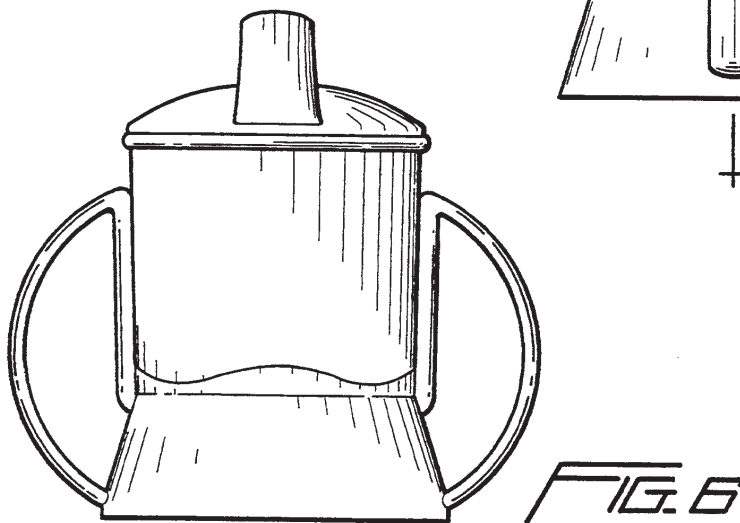
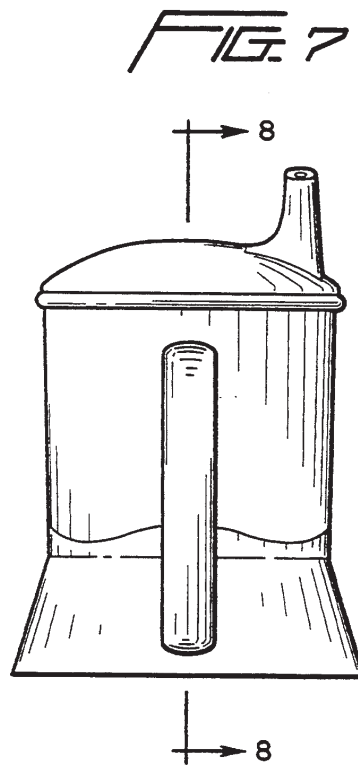
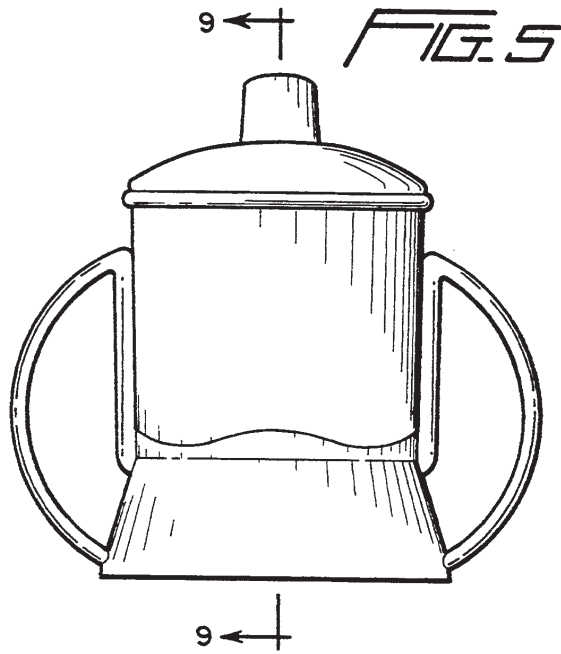

FIG. 4







# Explore Litigation Insights

Docket Alarm provides insights to develop a more informed litigation strategy and the peace of mind of knowing you're on top of things.

## Real-Time Litigation Alerts



Keep your litigation team up-to-date with **real-time alerts** and advanced team management tools built for the enterprise, all while greatly reducing PACER spend.

Our comprehensive service means we can handle Federal, State, and Administrative courts across the country.

## Advanced Docket Research



With over 230 million records, Docket Alarm's cloud-native docket research platform finds what other services can't. Coverage includes Federal, State, plus PTAB, TTAB, ITC and NLRB decisions, all in one place.

Identify arguments that have been successful in the past with full text, pinpoint searching. Link to case law cited within any court document via Fastcase.

## Analytics At Your Fingertips



Learn what happened the last time a particular judge, opposing counsel or company faced cases similar to yours.

Advanced out-of-the-box PTAB and TTAB analytics are always at your fingertips.

## API

Docket Alarm offers a powerful API (application programming interface) to developers that want to integrate case filings into their apps.

## LAW FIRMS

Build custom dashboards for your attorneys and clients with live data direct from the court.

Automate many repetitive legal tasks like conflict checks, document management, and marketing.

## FINANCIAL INSTITUTIONS

Litigation and bankruptcy checks for companies and debtors.

## E-DISCOVERY AND LEGAL VENDORS

Sync your system to PACER to automate legal marketing.