



US005742820A

# United States Patent [19]

[11] Patent Number: **5,742,820**

Perlman et al.

[45] Date of Patent: **Apr. 21, 1998**

[54] **MECHANISM FOR EFFICIENTLY SYNCHRONIZING INFORMATION OVER A NETWORK**

[75] Inventors: **Radia J. Perlman**, Acton, Mass.; **Neal D. Castagnoli**, Morgan Hill, Calif.

[73] Assignee: **Novell, Inc.**, Orem, Utah

[21] Appl. No.: **499,029**

[22] Filed: **Jul. 6, 1995**

[51] Int. Cl.<sup>6</sup> ..... **G06F 17/30**

[52] U.S. Cl. .... **395/617; 395/610; 395/200.03; 395/200.09**

[58] Field of Search ..... **395/610, 617, 395/200.03, 200.09**

[56] **References Cited**

**U.S. PATENT DOCUMENTS**

5,129,082	7/1992	Tirfling et al. ....	395/600
5,249,268	9/1993	Doucet .....	395/200
5,265,092	11/1993	Soloway et al. ....	370/60
5,276,871	1/1994	Howarth .....	395/600
5,280,498	1/1994	Tymes et al. ....	375/1
5,479,654	12/1995	Squibb .....	395/617

**FOREIGN PATENT DOCUMENTS**

0 348 331	12/1989	European Pat. Off. .
0 447 725 A2	9/1991	European Pat. Off. .

**OTHER PUBLICATIONS**

Ramabadran et al., "A Tutorial on CRC Computations", IEEE Micro, vol. 8, No. 4, Aug., 1988, pp. 62-75.

Radia Perlman, Interconnections Bridges and Routers, Addison-Wesley Professional Computing Series, Jul. 1992, pp. 242-245 and 272-275.

Computer Communications Review, 21 (1991) Jan., No. 1, New York, US, Inter Domain Policy Routing: Overview of Architecture and Protocols, Deborah Estin et al., pp. 71-79.

Primary Examiner—Paul R. Lintz  
Attorney, Agent, or Firm—Cesari and McKenna

[57] **ABSTRACT**

A novel mechanism efficiently synchronizes the contents of databases stored on nodes of a computer network to ensure that those contents are consistent. The mechanism comprises a database identifier generated by a node of the computer network and distributed to other receiving nodes coupled to the network. The database identifier is uniquely representative of the contents of the distributing node's database and the receiving nodes compare this unique identifier with their own generated database identifiers to determine if the identifiers, and thus their databases, are consistent and synchronized.

**18 Claims, 6 Drawing Sheets**

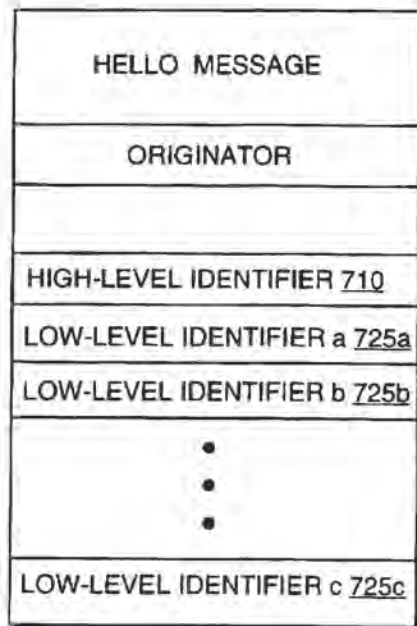
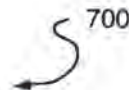

MICROSOFT  
Dem. Ex. 1031  
IPR2012-00026  
IPR2013-00109

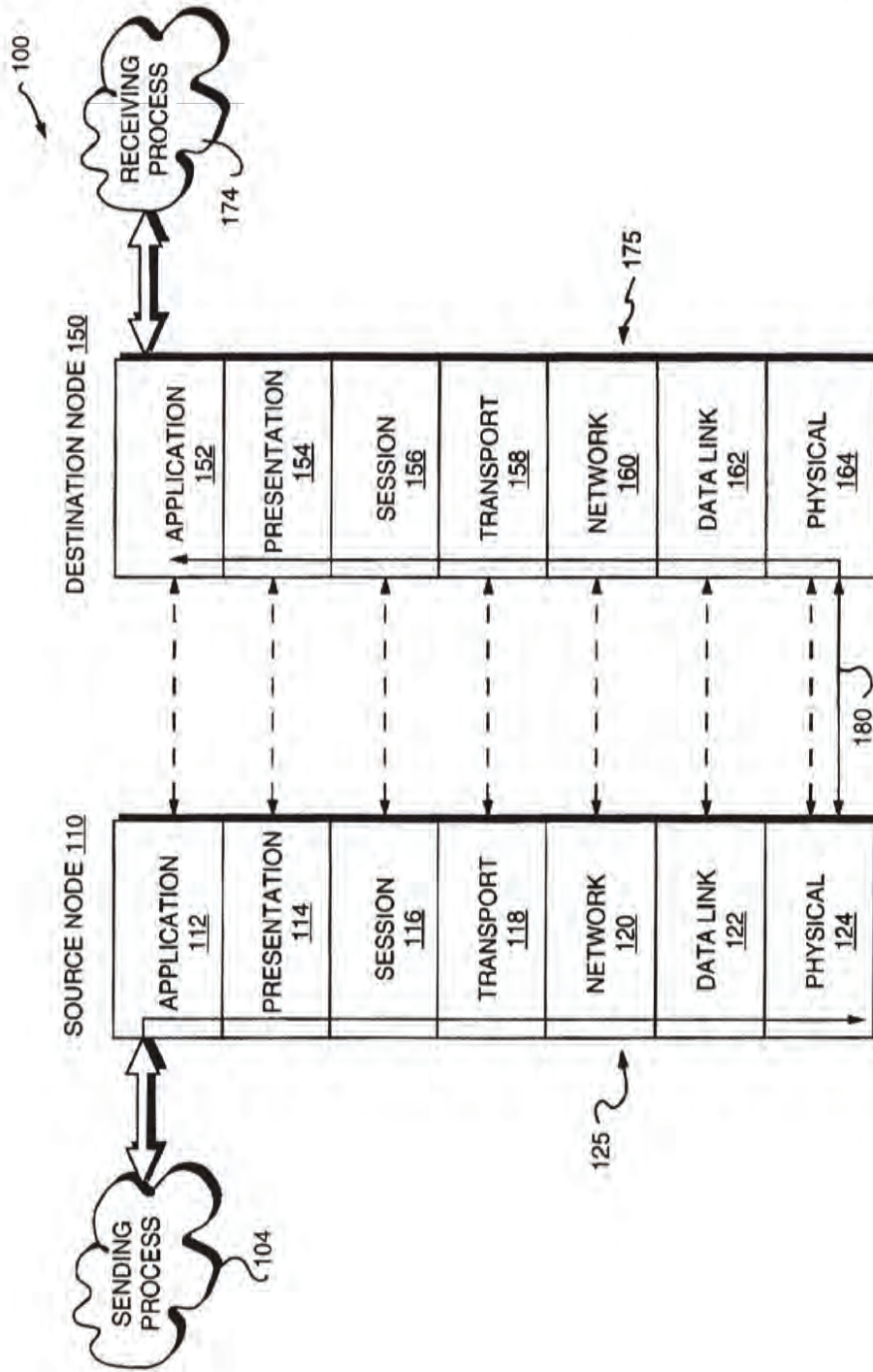

FIG. 1  
PRIOR ART

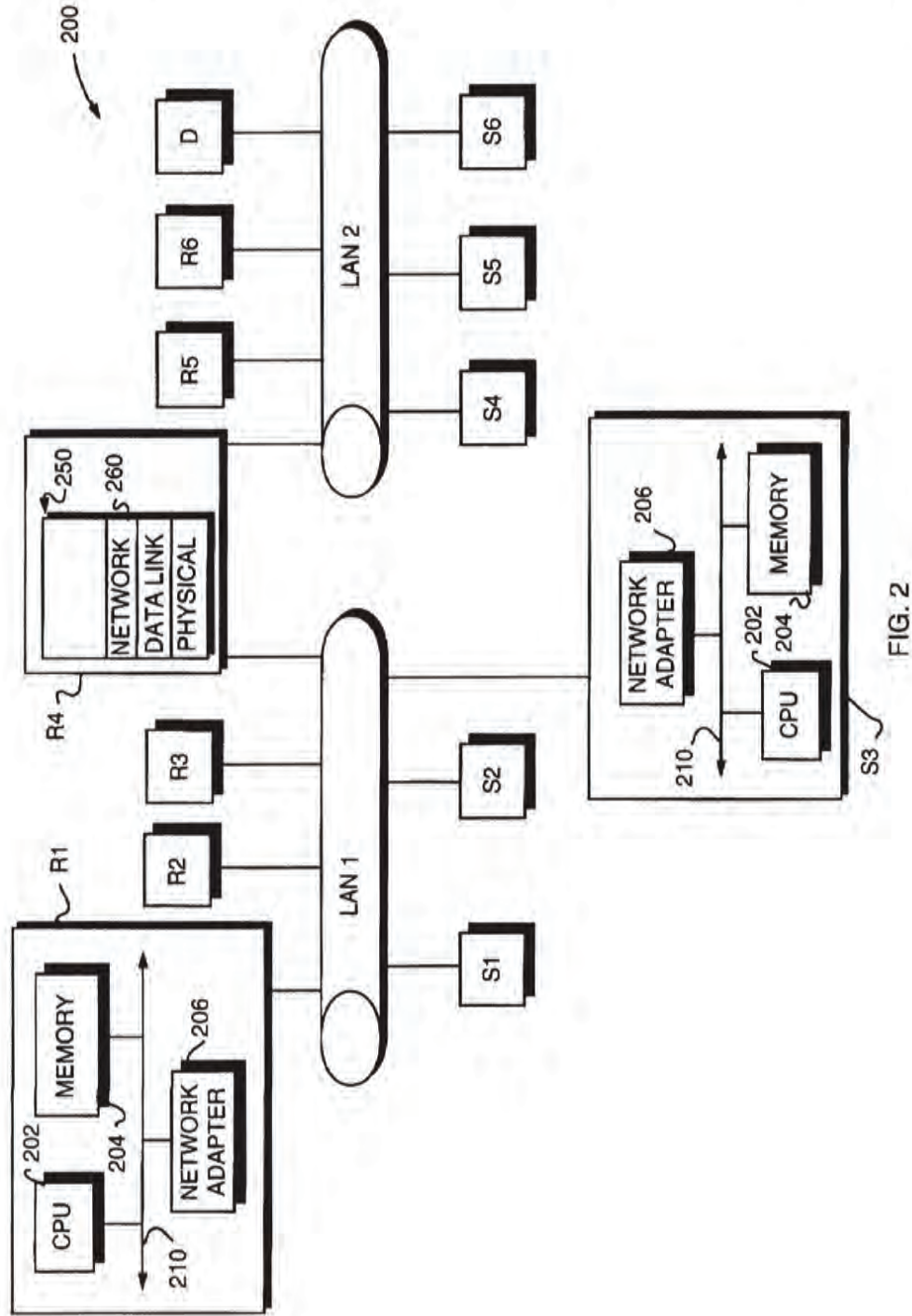

FIG. 2

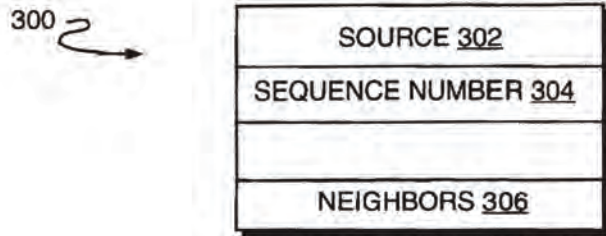

FIG. 3

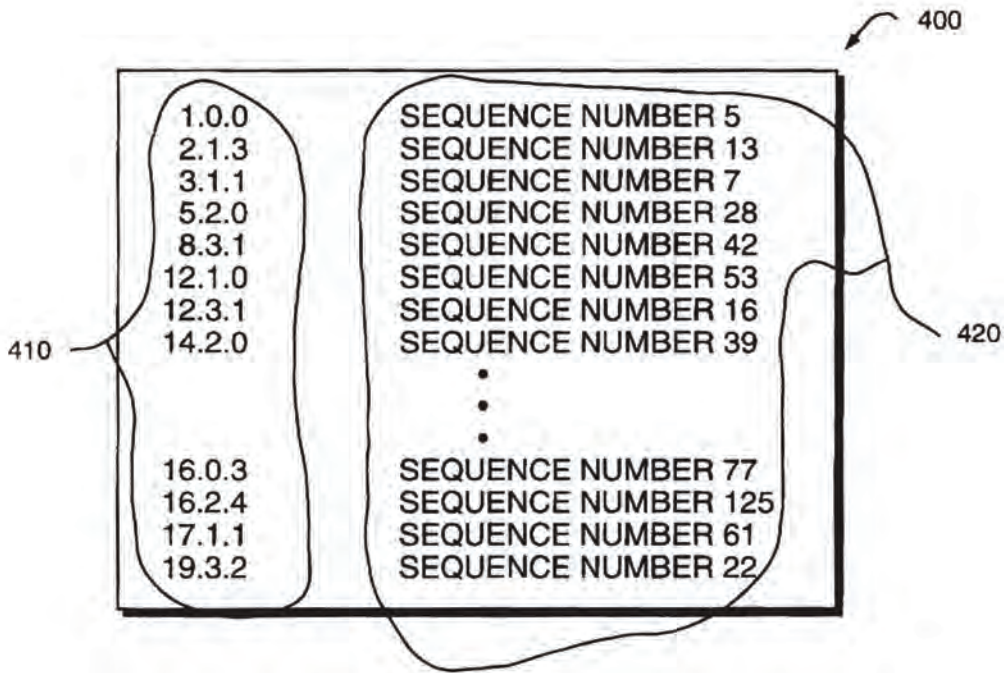

FIG. 4A



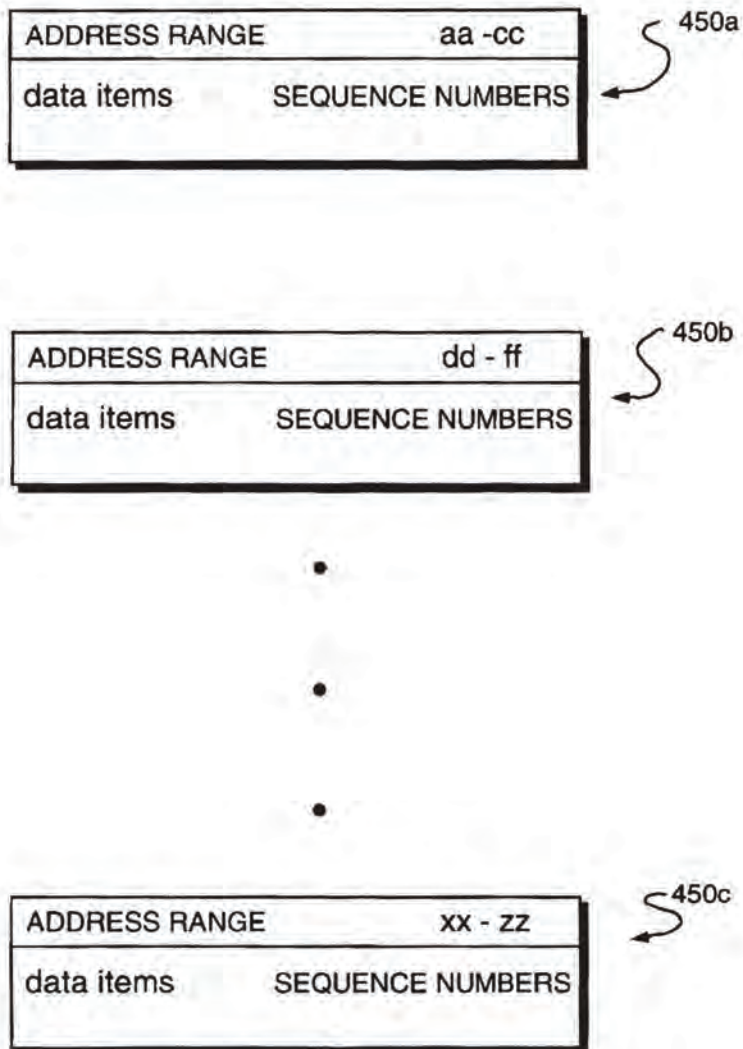

FIG. 4B

# Explore Litigation Insights

Docket Alarm provides insights to develop a more informed litigation strategy and the peace of mind of knowing you're on top of things.

## Real-Time Litigation Alerts



Keep your litigation team up-to-date with **real-time alerts** and advanced team management tools built for the enterprise, all while greatly reducing PACER spend.

Our comprehensive service means we can handle Federal, State, and Administrative courts across the country.

## Advanced Docket Research



With over 230 million records, Docket Alarm's cloud-native docket research platform finds what other services can't. Coverage includes Federal, State, plus PTAB, TTAB, ITC and NLRB decisions, all in one place.

Identify arguments that have been successful in the past with full text, pinpoint searching. Link to case law cited within any court document via Fastcase.

## Analytics At Your Fingertips



Learn what happened the last time a particular judge, opposing counsel or company faced cases similar to yours.

Advanced out-of-the-box PTAB and TTAB analytics are always at your fingertips.

## API

Docket Alarm offers a powerful API (application programming interface) to developers that want to integrate case filings into their apps.

## LAW FIRMS

Build custom dashboards for your attorneys and clients with live data direct from the court.

Automate many repetitive legal tasks like conflict checks, document management, and marketing.

## FINANCIAL INSTITUTIONS

Litigation and bankruptcy checks for companies and debtors.

## E-DISCOVERY AND LEGAL VENDORS

Sync your system to PACER to automate legal marketing.