



US005636122A

United States Patent [19]

Shah et al.

[11] Patent Number: **5,636,122**

[45] Date of Patent: **Jun. 3, 1997**

[54] **METHOD AND APPARATUS FOR TRACKING VEHICLE LOCATION AND COMPUTER AIDED DISPATCH**

[75] Inventors: **Mukesh C. Shah**, Lake Oswego, Oreg.;
Sanjiv Prabhakaran, San Jose, Calif.

5,155,689 10/1992 Wortham 364/460
 5,243,530 9/1993 Stanifer et al. 364/452
 5,272,638 12/1993 Martin et al. 364/444
 5,334,974 8/1994 Simms et al. 340/990
 5,428,546 6/1995 Shah et al. 364/449
 5,487,139 1/1996 Saylor et al. 395/135

[73] Assignee: **Mobile Information Systems, Inc.**,
Sunnyvale, Calif.

OTHER PUBLICATIONS

Allen, David P., "Here Be Dragons . . .," *CD-ROM EndUser*, Mar. 1990.
 Sena, Michael L., "Computer-Aided Dispatching," *Computer Graphics World*, PennWell (publ.), May 1990.

[21] Appl. No.: **443,062**
 [22] Filed: **May 17, 1995**

Primary Examiner—Michael Zanelli
Attorney, Agent, or Firm—Townsend and Townsend and Crew LLP

Related U.S. Application Data

[63] Continuation-in-part of Ser. No. 961,736, Oct. 16, 1992, Pat. No. 5,428,546.
 [51] Int. Cl.⁶ **G08G 1/13; G01S 7/10; G06F 17/60**
 [52] U.S. Cl. **364/449.1; 364/400; 340/990**
 [58] Field of Search 364/449, 460, 364/400, 401 R; 340/990, 995, 991; 342/357, 457; 395/153, 600

[57] ABSTRACT

A computer aided dispatch apparatus including a first memory portion, a second memory portion, and a third memory portion. The computer aided dispatch apparatus also includes a display **510, 626** with a first display segment **530**. The first display segment includes a digitized representation of a selected geographical area **530**, street data, and a user locatable mark **520**. The user locatable mark **520** defines a mobile unit position for a mobile unit based upon a first value and a second value. The computer aided dispatch apparatus includes a dispatch system **811** operably coupled to the display **510, 626**. The dispatch system includes order data from customers. A portion of the order data is transferred from a data acquisition device **801, 808** to the mobile unit **610**.

[56] References Cited

U.S. PATENT DOCUMENTS

4,660,037 4/1987 Nakamura et al. 340/990
 4,924,402 5/1990 Ando et al. 364/449
 4,954,959 9/1990 Moroto et al. 364/449
 5,003,317 3/1991 Gray et al. 342/457
 5,067,081 11/1991 Person 364/444
 5,140,532 8/1992 Beckwith, Jr. et al. 395/101

20 Claims, 10 Drawing Sheets

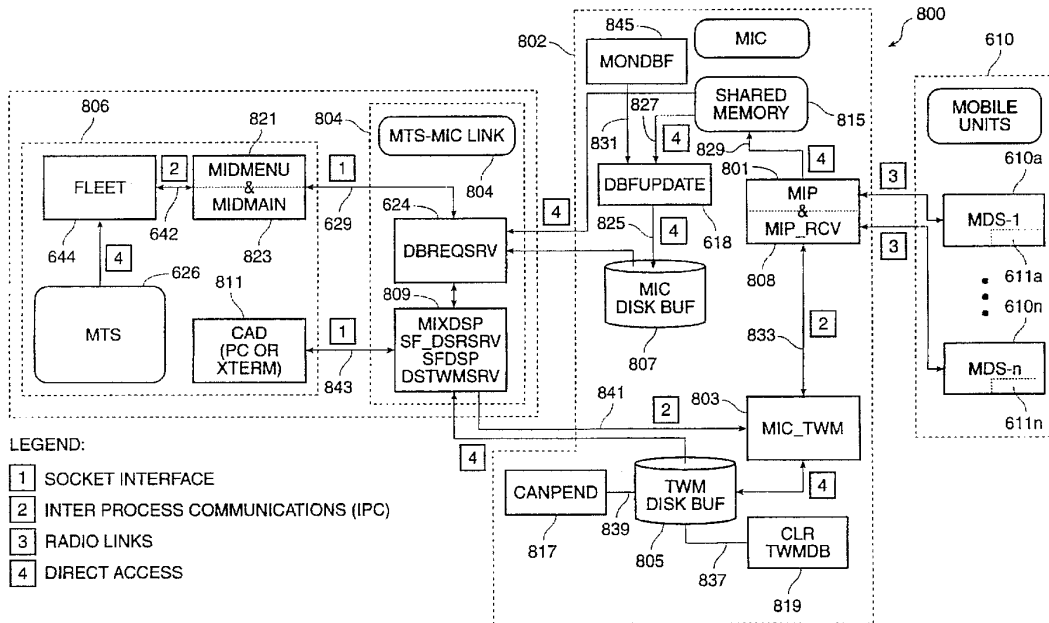

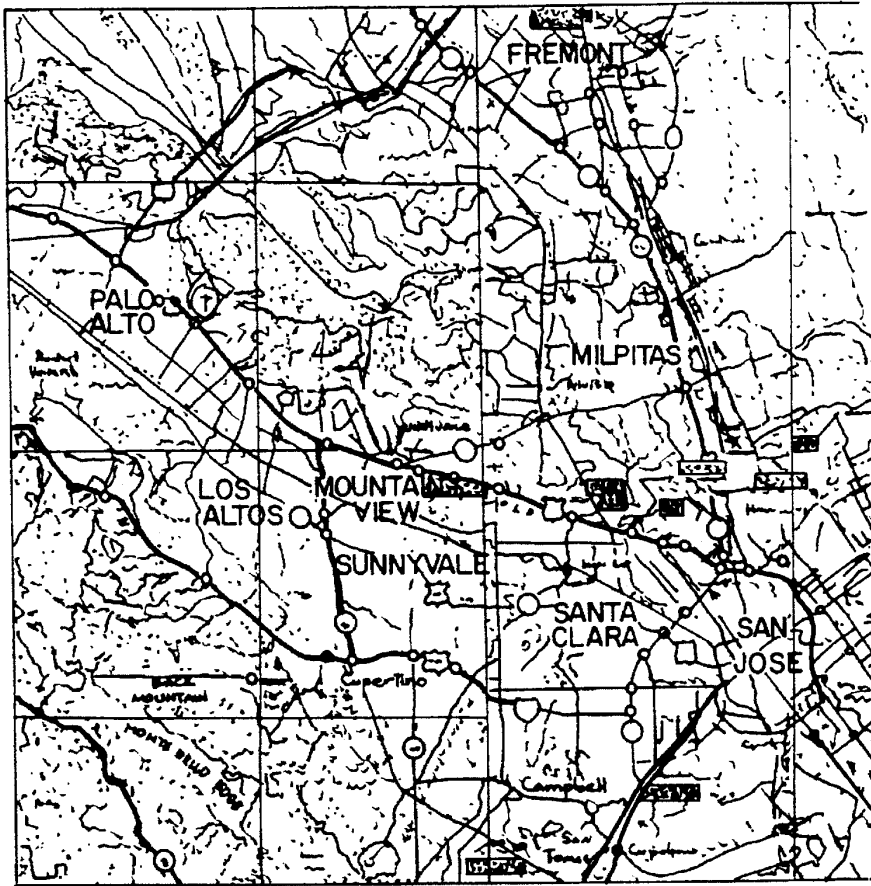

FIG. 1. PRIOR ART

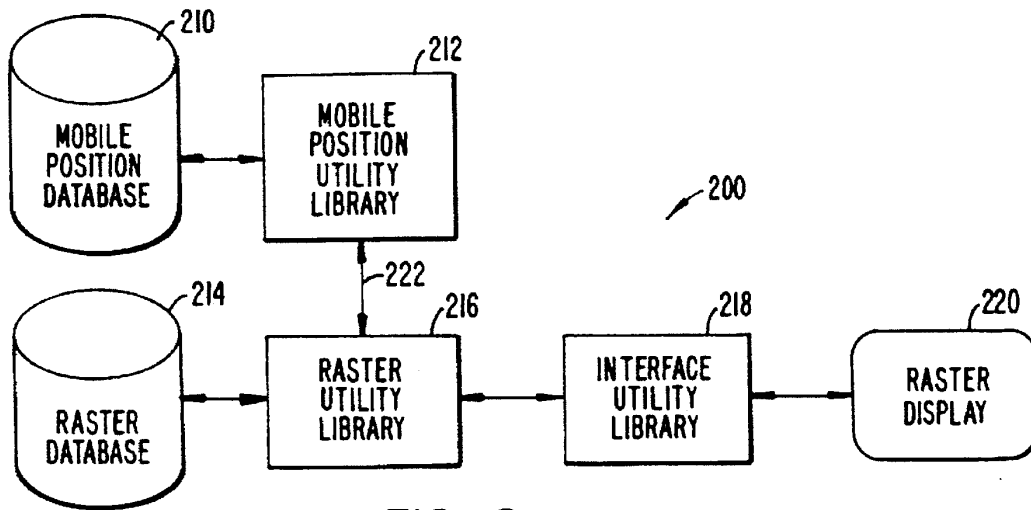

FIG. 2. PRIOR ART

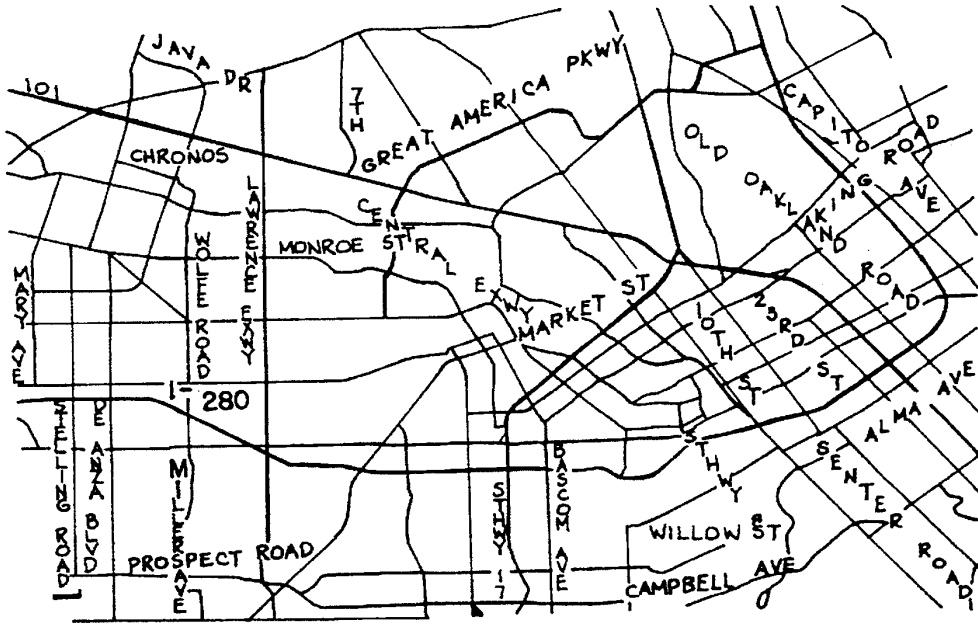

FIG. 3. PRIOR ART

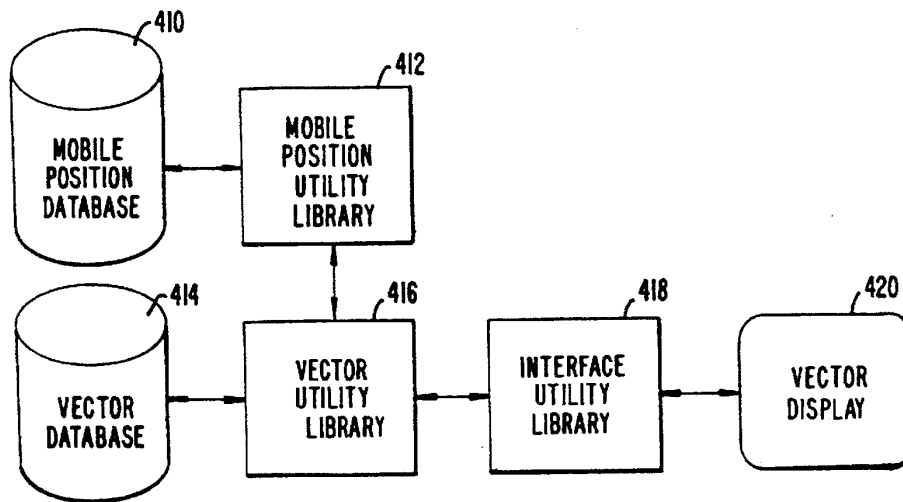

FIG. 4. PRIOR ART

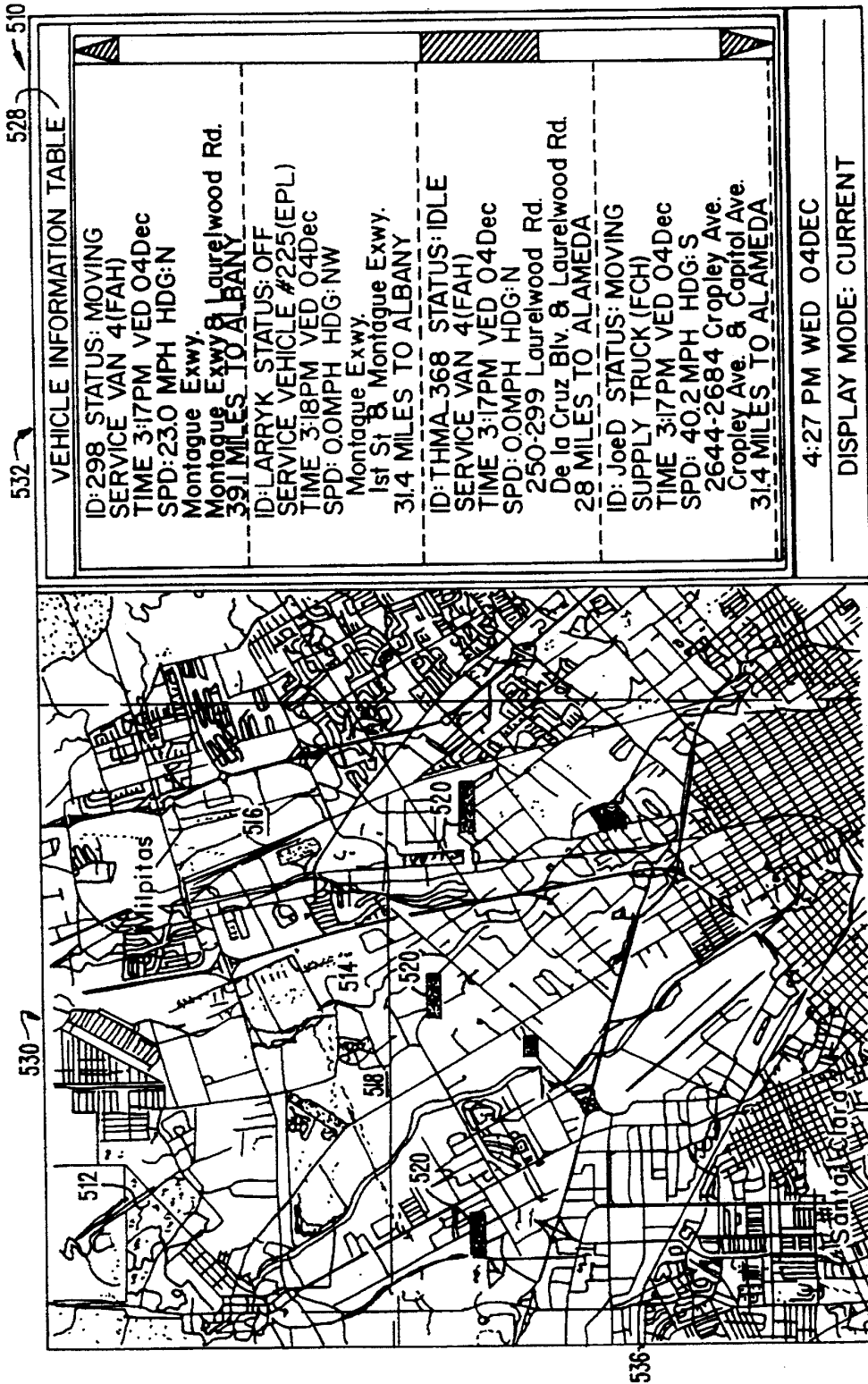

FIG. 5.

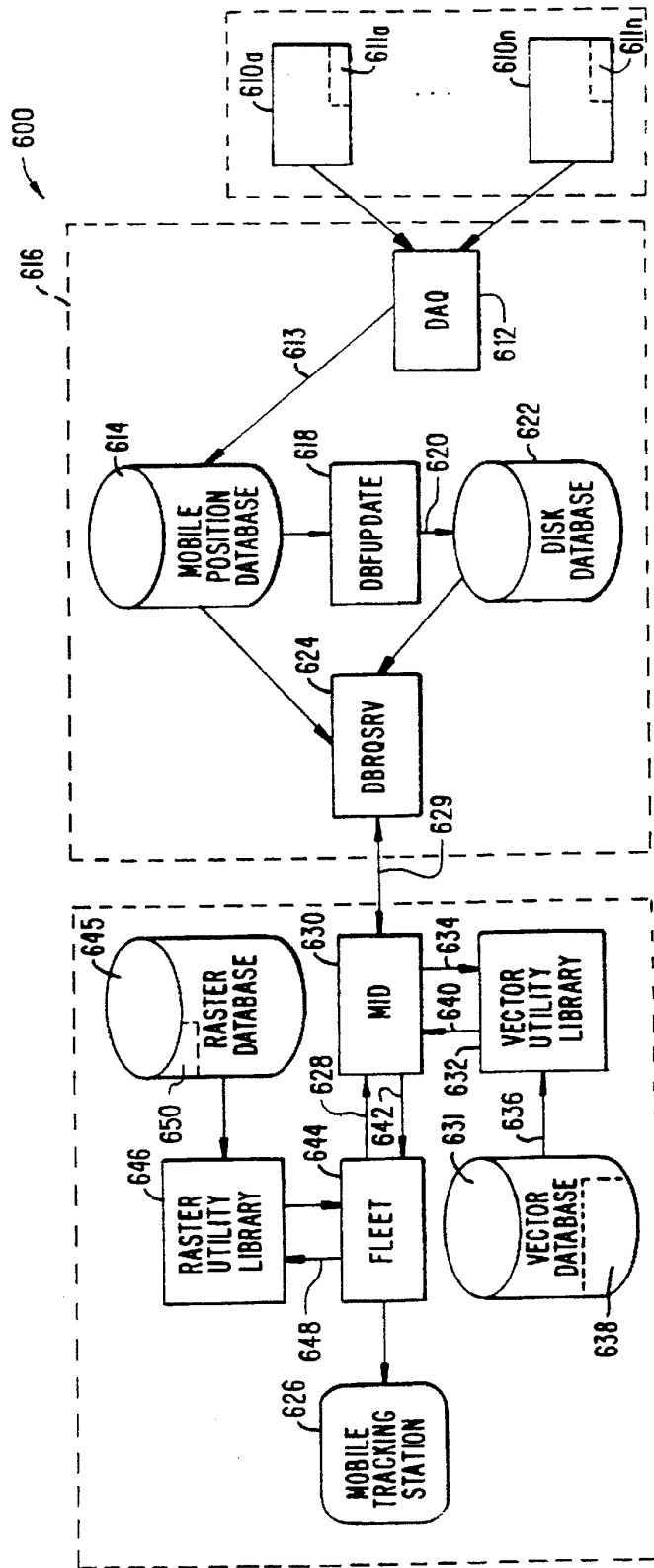

FIG. 6.

Explore Litigation Insights

Docket Alarm provides insights to develop a more informed litigation strategy and the peace of mind of knowing you're on top of things.

Real-Time Litigation Alerts



Keep your litigation team up-to-date with **real-time alerts** and advanced team management tools built for the enterprise, all while greatly reducing PACER spend.

Our comprehensive service means we can handle Federal, State, and Administrative courts across the country.

Advanced Docket Research



With over 230 million records, Docket Alarm's cloud-native docket research platform finds what other services can't. Coverage includes Federal, State, plus PTAB, TTAB, ITC and NLRB decisions, all in one place.

Identify arguments that have been successful in the past with full text, pinpoint searching. Link to case law cited within any court document via Fastcase.

Analytics At Your Fingertips



Learn what happened the last time a particular judge, opposing counsel or company faced cases similar to yours.

Advanced out-of-the-box PTAB and TTAB analytics are always at your fingertips.

API

Docket Alarm offers a powerful API (application programming interface) to developers that want to integrate case filings into their apps.

LAW FIRMS

Build custom dashboards for your attorneys and clients with live data direct from the court.

Automate many repetitive legal tasks like conflict checks, document management, and marketing.

FINANCIAL INSTITUTIONS

Litigation and bankruptcy checks for companies and debtors.

E-DISCOVERY AND LEGAL VENDORS

Sync your system to PACER to automate legal marketing.