

EXHIBIT 1027

**TO PETITIONER GOOGLE INC.'S
PETITION FOR COVERED BUSINESS
METHOD REVIEW OF
U.S. PATENT NO. 8,794,516**



US007334720B2

(12) **United States Patent**
Hulst et al.

(10) **Patent No.:** **US 7,334,720 B2**
(45) **Date of Patent:** **Feb. 26, 2008**

(54) **DATA STORAGE AND ACCESS SYSTEMS**

(75) Inventors: **Hermen-ard Hulst**, Amsterdam (NL);
Patrick Sandor Racz, St. Heller (GB)

(73) Assignee: **Smart-Flash Limited**, East Sussex
(GB)

5,457,746 A 10/1995 Dolphin
5,588,146 A 12/1996 Leroux
5,677,953 A 10/1997 Dolphin
5,703,951 A 12/1997 Dolphin
5,754,654 A * 5/1998 Hiroya et al. 705/76
5,794,202 A 8/1998 Kim

(*) Notice: Subject to any disclaimer, the term of this patent is extended or adjusted under 35 U.S.C. 154(b) by 0 days.

(Continued)

FOREIGN PATENT DOCUMENTS

(21) Appl. No.: **11/336,758**

EP 0195098 10/1990

(22) Filed: **Jan. 19, 2006**

(65) **Prior Publication Data**

(Continued)

US 2006/0118619 A1 Jun. 8, 2006

Related U.S. Application Data

Primary Examiner—Steven S. Paik

(74) *Attorney, Agent, or Firm*—Townsend and Townsend and Crew LLP

(63) Continuation of application No. 10/111,716, filed as application No. PCT/GB00/04110 on Oct. 25, 2000, now abandoned.

(57) **ABSTRACT**

(30) **Foreign Application Priority Data**

Nov. 25, 1999 (GB) 9925227.2

Data storage and access systems are described for downloading and paying for data such as audio and video data, text, software, games and other types of data. A portable data carrier has an interface for sending and receiving data, non-volatile data memory for storing received content data and non-volatile payment validation memory for providing payment validation data to an external device. The carrier may also store a record of access made to the stored content, and content use rules for controlling access to the stored content. Preferred embodiments store further access control data and supplementary data such as hot links to web sites and/or advertising data. A complementary data access terminal, data supply computer system and data access device are also described. The combination of payment data and stored content data and, in preferred embodiments, use rule data, helps reduce the risk of unauthorized access to data such as compressed music and video data, especially over the Internet.

(51) **Int. Cl.**
G06K 5/00 (2006.01)

(52) **U.S. Cl.** **230/380**; 235/382; 235/492;
235/451

(58) **Field of Classification Search** 235/380,
235/382, 492, 451; 711/100, 101, 103
See application file for complete search history.

(56) **References Cited**

U.S. PATENT DOCUMENTS

5,226,145 A 7/1993 Moronaga et al.
5,367,150 A 11/1994 Kitta et al.
5,406,619 A * 4/1995 Akhteruzzaman
et al. 379/93.02

18 Claims, 17 Drawing Sheets

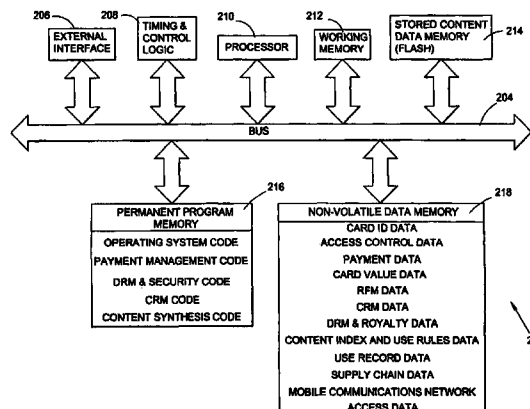

US 7,334,720 B2

Page 2

U.S. PATENT DOCUMENTS

5,809,241 A 9/1998 Hanel et al.
5,847,372 A 12/1998 Kreft
5,889,860 A 3/1999 Eller et al.
5,901,330 A 5/1999 Sun et al.
5,918,213 A 6/1999 Bernard et al.
5,923,884 A 7/1999 Peyret et al.
6,012,634 A 1/2000 Brogan et al.
6,078,917 A 6/2000 Paulsen et al.
6,119,945 A 9/2000 Muller et al.
6,202,056 B1 3/2001 Nuttall
6,385,731 B2 5/2002 Ananda
6,424,975 B1 7/2002 Walter et al.
6,442,570 B1 8/2002 Wu
6,473,829 B1 10/2002 Dahman et al.
6,510,236 B1 1/2003 Crane et al.
6,553,413 B1 4/2003 Leighton et al.
6,574,643 B2 6/2003 Walter et al.
6,999,936 B2* 2/2006 Sehr 705/5

7,044,362 B2* 5/2006 Yu 235/375
7,083,081 B2* 8/2006 McGee et al. 235/375

FOREIGN PATENT DOCUMENTS

EP 0713198 5/1996
EP 0823694 2/1998
EP 0823694 A1 2/1998
EP 0542298 4/1998
EP 0713198 A2 5/1998
EP 0843449 5/1998
EP 0843449 A2 5/1998
EP 0914001 5/1999
EP 0914001 A1 5/1999
WO 98/19237 5/1998
WO 98/19237 A1 5/1998
WO 98/33343 7/1998
WO 98/37526 8/1998

* cited by examiner

Fig. 1

A

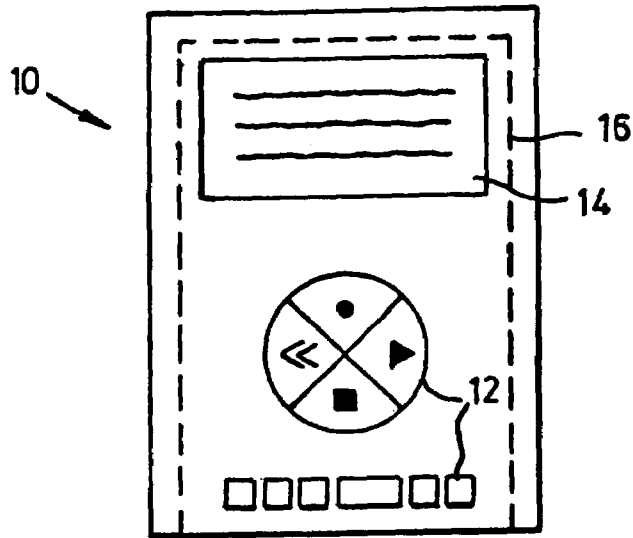

B



C

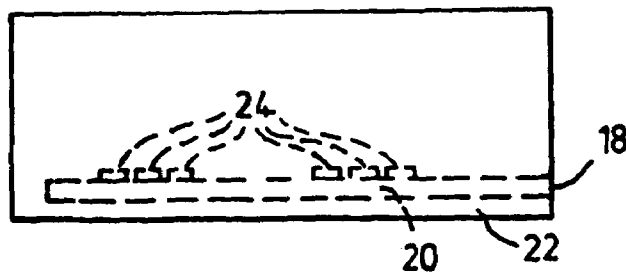

Fig. 2

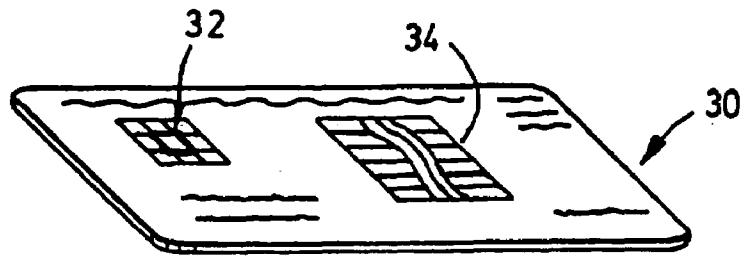
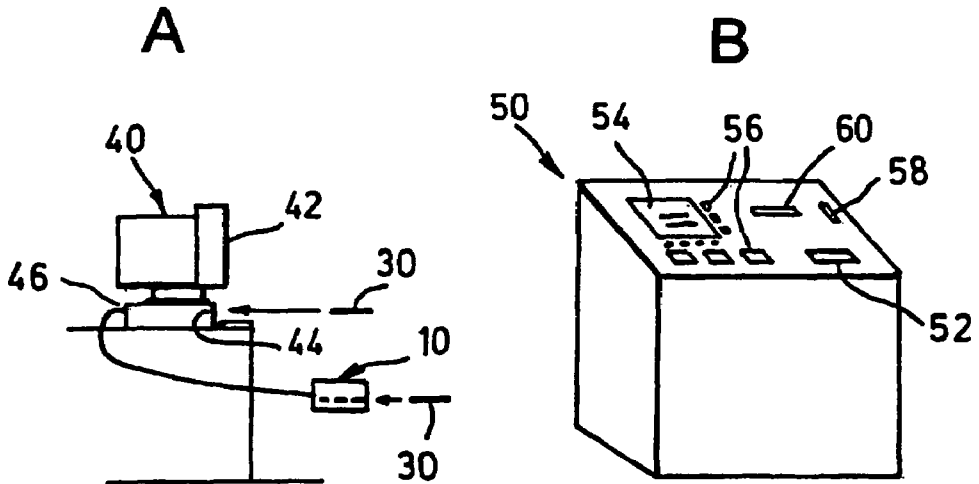

Fig. 3



Explore Litigation Insights

Docket Alarm provides insights to develop a more informed litigation strategy and the peace of mind of knowing you're on top of things.

Real-Time Litigation Alerts



Keep your litigation team up-to-date with **real-time alerts** and advanced team management tools built for the enterprise, all while greatly reducing PACER spend.

Our comprehensive service means we can handle Federal, State, and Administrative courts across the country.

Advanced Docket Research



With over 230 million records, Docket Alarm's cloud-native docket research platform finds what other services can't. Coverage includes Federal, State, plus PTAB, TTAB, ITC and NLRB decisions, all in one place.

Identify arguments that have been successful in the past with full text, pinpoint searching. Link to case law cited within any court document via Fastcase.

Analytics At Your Fingertips



Learn what happened the last time a particular judge, opposing counsel or company faced cases similar to yours.

Advanced out-of-the-box PTAB and TTAB analytics are always at your fingertips.

API

Docket Alarm offers a powerful API (application programming interface) to developers that want to integrate case filings into their apps.

LAW FIRMS

Build custom dashboards for your attorneys and clients with live data direct from the court.

Automate many repetitive legal tasks like conflict checks, document management, and marketing.

FINANCIAL INSTITUTIONS

Litigation and bankruptcy checks for companies and debtors.

E-DISCOVERY AND LEGAL VENDORS

Sync your system to PACER to automate legal marketing.