

<b>UTILITY PATENT APPLICATION TRANSMITTAL</b>  <i>(Only for new nonprovisional applications under 37 CFR 1.53(b))</i>	Attorney Docket No.	080379-000130US
	First Inventor	RACZ, Patrick
	Title	DATA STORAGE AND ACCESS SYSTEMS
	Express Mail Label No.	VIA EFS

<b>APPLICATION ELEMENTS</b> <i>See MPEP chapter 600 concerning utility patent application contents.</i>	<b>ADDRESS TO:</b> Commissioner for Patents P.O. Box 1450 Alexandria, VA 22313-1450
--	--

1. <input type="checkbox"/> Fee Transmittal Form (e.g., PTO/SB/17) 2. <input checked="" type="checkbox"/> Applicant claims small entity status. See 37 CFR 1.27. 3. <input checked="" type="checkbox"/> Specification [Total Pages <u>42</u> ] Both the claims and abstract must start on a new page (For information on the preferred arrangement, see MPEP 608.01(a)) 4. <input checked="" type="checkbox"/> Drawing(s) (35 U.S.C.113) [Total Sheets <u>17</u> ] 5. Oath or Declaration [Total Sheets <u>2</u> ] a. <input type="checkbox"/> Newly executed (original or copy) b. <input checked="" type="checkbox"/> A copy from a prior application (37 CFR 1.63 (d)) (for a continuation/divisional with Box 18 completed) i. <input type="checkbox"/> DELETION OF INVENTOR(S) Signed statement attached deleting inventor(s) named in the prior application, see 37 CFR 1.63(d)(2) and 1.33(b). 6. <input checked="" type="checkbox"/> Application Data Sheet. See 37 CFR 1.76 7. <input type="checkbox"/> CD-ROM or CD-R in duplicate, large table or Computer Program (Appendix) <input type="checkbox"/> Landscape Table on CD 8. Nucleotide and/or Amino Acid Sequence Submission (if applicable, items a. - c. are required) a. <input type="checkbox"/> Computer Readable Form (CRF) b. Specification Sequence Listing on: i. <input type="checkbox"/> CD-ROM or CD-R (2 copies); or ii. <input type="checkbox"/> Paper c. <input type="checkbox"/> Statements verifying identity of above copies	<b>ACCOMPANYING APPLICATION PARTS</b> 9. <input type="checkbox"/> Assignment Papers (cover sheet & document(s)) Name of Assignee _____ 10. <input type="checkbox"/> 37 CFR 3.73(b) Statement <input type="checkbox"/> Power of Attorney (when there is an assignee) 11. <input type="checkbox"/> English Translation Document (if applicable) 12. <input checked="" type="checkbox"/> Information Disclosure Statement (PTO/SB/08 or PTO-1449) <input type="checkbox"/> Copies of citations attached 13. <input type="checkbox"/> Preliminary Amendment 14. <input type="checkbox"/> Return Receipt Postcard (MPEP 503) (Should be specifically itemized) 15. <input type="checkbox"/> Certified Copy of Priority Document(s) (if foreign priority is claimed) 16. <input type="checkbox"/> Nonpublication Request under 35 U.S.C. 122 (b)(2)(B)(i). Applicant must attach form PTO/SB/35 or equivalent. 17. <input checked="" type="checkbox"/> Other: <u>Communication</u>
--	---

18. If a CONTINUING APPLICATION, check appropriate box, and supply the requisite information below and in the first sentence of the specification following the title, or in an Application Data Sheet under 37 CFR 1.76:

Continuation     Divisional     Continuation-in-part (CIP)    of prior application No: 12/014,558

Prior application information:    Examiner THEIN MIN LE    Art Unit: 2887

**19. CORRESPONDENCE ADDRESS**

The address associated with Customer Number: 20350    OR     Correspondence address below

Name		Address	
City	State	Zip Code	
Country	Telephone	Email	

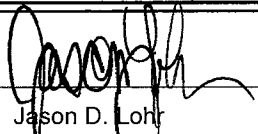
Signature		Date	<u>11/10/2010</u>
Name (Print/Type)	Jason D. Lohr	Registration No. (Attorney/Agent)	48,163

62989773 v1

## **Application Data Sheet**

### **Application Information**

Application number:: Not Yet Assigned  
Filing Date:: 11/10/2010  
Application Type:: Regular  
Subject Matter:: Utility  
Title:: DATA STORAGE AND ACCESS SYSTEMS  
Attorney Docket Number:: 080379-000130US  
Request for Early Publication:: No  
Request for Non-Publication:: No  
Suggested Drawing Figure::  
Total Drawing Sheets:: 17  
Small Entity?:: Yes  
Petition included?:: No  
Secrecy Order in Parent Appl.:: No

### **Applicant Information**

Applicant Authority Type:: Inventor  
Primary Citizenship Country:: United Kingdom  
Status:: Full Capacity  
Given Name:: Patrick  
Middle Name::  
Family Name:: RACZ  
Name Suffix::  
City of Residence:: Saint Heller  
State or Province of Residence::  
Country of Residence:: Jersey  
Street of Mailing Address:: 19 Royal Street  
City of Mailing Address:: Saint Heller

State or Province of mailing address::  
Country of mailing address:: Jersey  
Postal or Zip Code of mailing address:: JE1 4WA

Applicant Authority Type:: Inventor  
Primary Citizenship Country:: Netherlands  
Status:: Full Capacity  
Given Name:: Hermen-ard  
Middle Name::  
Family Name:: Hulst  
Name Suffix::  
City of Residence:: Amsterdam  
State or Province of Residence::  
Country of Residence:: Netherlands  
Street of Mailing Address:: Van Tuyll van Serooskerweg 75hs  
City of Mailing Address:: Amsterdam  
State or Province of mailing address::  
Country of mailing address:: Netherlands  
Postal or Zip Code of mailing address:: 1076 JG

### **Correspondence Information**

Correspondence Customer Number:: 20350

### **Representative Information**

Representative Customer Number:: 20350

### **Domestic Priority Information**

Application::	Continuity Type::	Parent Application::	Parent Filing Date::
This Application	Continuation of	12/014,558	01/15/08
12/014,558	Continuation of	11/336,758	01/19/06
11/336,758	Continuation of	10/111,716	09/17/02

**Foreign Priority Information**

Country::	Application number::	Filing Date::
PCT	GB00104110	10/25/00
United Kingdom	9925227.2	10/25/99

**Assignee Information**

Assignee Name::	Smartflash Technologies Limited
Street of mailing address::	1070908 Palm Grove House, P.O. Box 438
City of mailing address::	Wickhams' Cay, Road Town
State or Province of mailing address::	Tortola
Country of mailing address::	British Virgin Islands
Postal or Zip Code of mailing address::	

Submitted by:

Signature

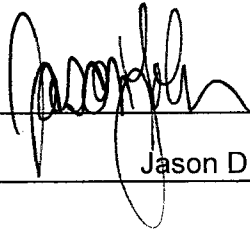

Date

11/10/10

Printed Name

Jason D. Lohr

Registration Number

48,163



I hereby certify that this correspondence is being filed via  
EFS-Web with the United States Patent and Trademark Office  
on November 10, 2010

PATENT  
Docket No.: 080379-000130US  
Client Ref. No.: PN759544USD

TOWNSEND and TOWNSEND and CREW LLP

By: 

**IN THE UNITED STATES PATENT AND TRADEMARK OFFICE**

In re application of:

Patrick RACZ, et al.

Application No.: Not Yet Assigned

Filed: Concurrently Herewith

For: DATA STORAGE AND ACCESS  
SYSTEMS

Customer No.: 20350

Confirmation No.: Not Yet Assigned

Examiner: Not Yet Assigned

Art Unit: Not Yet Assigned

COMMUNICATION

Commissioner for Patents  
P.O. Box 1450  
Alexandria, VA 22313-1450

Commissioner:

In accordance with the accompanying continuation application, please  
enter the following remarks:

**Remarks/Arguments** begin on page 2 of this paper.

REMARKS/ARGUMENTS

This continuation application presents claims that are substantially similar in scope to claims originally presented in parent case 11/336,758, and in some cases presented again in parent case 12/014,558. While in many cases these claims were canceled or not elected in these parent cases, Applicants respectfully submit that the Examiner should be aware that claims presented herein may be similar to at least some of the claims prosecuted in the parent cases, and the Examiner might want to consider art cited in the parent for relevance. The art cited in these parent cases will be cited in an Information Disclosure Statement, but in order to comply with the duty of disclosure Applicants submit that the Examiner might also want to look to the Office Actions in the parent cases.

CONCLUSION

If the Examiner believes a telephone conference would expedite prosecution of this application, please telephone the undersigned at 925-472-5000.

Respectfully submitted,



Jason D. Lohr  
Reg. No. 48,163

TOWNSEND and TOWNSEND and CREW LLP  
Two Embarcadero Center, Eighth Floor  
San Francisco, California 94111-3834  
Tel: (415) 576-0200  
Fax: (415) 576-0300  
JDL:sep

62989780 v1

I hereby certify that this correspondence is being filed via EFS-Web with the United States Patent and Trademark Office on November 10, 2010

PATENT  
Attorney Docket No.: 080379-000130US  
Client Reference No.: PN759544USD

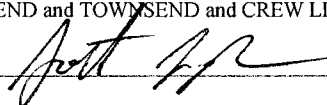
TOWNSEND and TOWNSEND and CREW LLP  
By: 

**IN THE UNITED STATES PATENT AND TRADEMARK OFFICE**

In re application of:  
  
Patrick RACZ, et al.  
  
Application No.: Not Yet Assigned  
  
Filed: November 10, 2010  
  
For: DATA STORAGE AND ACCESS SYSTEMS  
  
Customer No.: 20350

Confirmation No.: Not Yet Assigned  
  
Examiner: Not Yet Assigned  
  
Art Unit: Not Yet Assigned  
  
INFORMATION DISCLOSURE STATEMENT UNDER 37 CFR §1.97 and §1.98

Mail Stop Amendment  
Commissioner for Patents  
P.O. Box 1450  
Alexandria, VA 22313-1450

Commissioner:

The references cited on attached form PTO/SB/08A and PTO/SB/08B are being called to the attention of the Examiner. In accordance with 37 CFR §1.98(d), copies of the references can be found in Application No. 12/014,558, filed January 15, 2008 (Attorney Docket No. 080379-000110US) and Application No. 11/336,758, filed January 19, 2006 (Attorney Docket No. 080379-000100US). It is respectfully requested that the cited references be expressly considered during the prosecution of this application, and the references be made of record therein and appear among the "references cited" on any patent to issue therefrom.

Some of the references cited in this IDS were cited in an Office Action mailed on September 1, 2010 in related U.S. Patent Application No. 12/014,558. Copies of the Office Actions in 12/014,558 are available on PAIR and are believed to be readily accessible to the Examiner.

Some of the references cited in this IDS were cited in an Office Action mailed on November 6, 2006, in related U.S. Patent Application No. 11/336,758. Copies of the Office Actions in U.S. Patent Application No. 11/336,758 are available on PAIR and are believed to be readily accessible to the Examiner.

Some of the references cited in this IDS were cited in Office Actions mailed on July 19, 2005 and February 28, 2004, in related U.S. Patent Application No. 10/111,716. Copies of the Office Actions in U.S. Patent Application No. 10/111,716 are available on PAIR and are believed to be readily accessible to the Examiner.

As provided for by 37 CFR §1.97(g) and (h), no inference should be made that the information and references cited are prior art merely because they are in this statement and no representation is being made that a search has been conducted or that this statement encompasses all the possible relevant information.

Applicant believes that no fee is required for submission of this statement. However, if a fee is required, the Commissioner is authorized to deduct such fee from the undersigned's Deposit Account No. 20-1430. Please deduct any additional fees from, or credit any overpayment to, the above-noted Deposit Account.

Respectfully submitted,

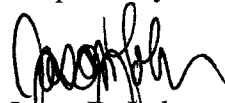
  
Jason D. Lohr  
Reg. No. 48,163

TOWNSEND and TOWNSEND and CREW LLP  
Two Embarcadero Center, Eighth Floor  
San Francisco, California 94111-3834  
Tel: 925-472-5000  
Fax: 925-472-8895  
JDL:sep  
62992256 v1

Substitute for form 1449/PTO				<b>Complete if Known</b>	
				Application Number	
<b>INFORMATION DISCLOSURE STATEMENT BY APPLICANT</b>  <i>(Use as many sheets as necessary)</i>				Filing Date	
				First Named Inventor	RACZ, Patrick
				Art Unit	
				Examiner Name	
				Attorney Docket Number	080379-000130US
Sheet	1	of	3		

U.S. PATENT DOCUMENTS					
Examiner Initials*	Cite No. <sup>1</sup>	Document Number	Publication Date MM-DD-YYYY	Name of Patentee or Applicant of Cited Document	Pages, Columns, Lines, Where Relevant Passages or Relevant Figures Appear
		Number Kind Code <sup>2</sup> (if known)			
	AA	US 4,341,951	07-1982	Benton	
	AB	US 5,226,145	07-06-1993	Moronaga et al.	
	AC	US 5,367,150	11-22-1994	Kitta et al.	
	AD	US 5,406,619	04-11-1995	Akhteruzzaman et al.	
	AE	US 5,457,746	10-10-1995	Dolphin	
	AF	US 5,532,466	07-02-1996	Konno et al.	
	AG	US 5,588,146	12-24-1996	Leroux	
	AH	US 5,677,953	10-14-1997	Dolphin	
	AI	US 5,703,951	12-30-1997	Dolphin	
	AJ	US 5,740,369	04-14-1998	Yokozawa et al.	
	AK	US 5,744,787	04-28-1998	Teicher	
	AL	US 5,754,654	05-19-1998	Hiroya et al.	
	AM	US 5,794,202	08-11-1998	Kim	
	AN	US 5,809,241	09-15-1998	Hanel et al.	
	AO	US 5,845,281 A	12-01-1998	Benson et al.	
	AP	US 5,847,372	12-08-1998	Kreft	
	AQ	US 5,889,860	03-30-1999	Eller et al.	
	AR	US 5,901,330	05-04-1999	Sun et al.	
	AS	US 5,918,213	06-29-1999	Bernard et al.	
	AT	US 5,923,884	07-13-1999	Peyret et al.	
	AU	US 5,933,498 A	08-03-1999	Schneck et al.	
	AV	US 5,936,220	08-10-1999	Hoshino et al.	
	AW	US 6,012,634	01-11-2000	Brogan et al.	
	AX	US 6,018,720 A	01-25-2000	Fujimoto	Corresponds to JP 11-53184
	AY	US 6,078,917	06-20-2000	Paulsen et al.	
	AZ	US 6,119,945	09-19-2000	Muller et al.	
	BA	US 6,142,369	11-2000	Jonstromer	
	BB	US 6,202,056	03-13-2001	Nuttall	
	BC	US 6,385,731	05-07-2002	Ananda	
	BD	US 6,424,975	07-23-2002	Walter et al.	
	BE	US 6,442,570	08-27-2002	Wu	
	BF	US 6,473,829	10-29-2002	Dahman et al.	
	BG	US 6,510,236	01-21-2003	Crane et al.	
	BH	US 6,553,413	04-22-2003	Leighton et al.	
	BI	US 6,554,192	04-29-2003	Tingl	

Examiner Signature		Date Considered	
--------------------	--	-----------------	--

\*EXAMINER: Initial if reference considered, whether or not citation is in conformance with MPEP 609. Draw line through citation if not in conformance and not considered. Include copy of this form with next communication to applicant. <sup>1</sup> Applicant's unique citation designation number (optional). <sup>2</sup> See Kind Codes of U.S. Patent Documents at [www.uspto.gov](http://www.uspto.gov) or MPEP 901.04. <sup>3</sup> Enter Office that issued the document, by the two-letter code (WIPO Standard ST.3). <sup>4</sup> For Japanese patent documents, the indication of the year of the reign of the Emperor must precede the serial number of the patent document. <sup>5</sup> Kind of document by the appropriate symbols as indicated on the document under WIPO Standard ST. 16 if possible. <sup>6</sup> Applicant is to place a check mark here if English language Translation is attached.

Substitute for form 1449/PTO  <b>INFORMATION DISCLOSURE STATEMENT BY APPLICANT</b>  <i>(Use as many sheets as necessary)</i>			<b>Complete if Known</b>			
			Application Number			
			Filing Date			
			First Named Inventor		RACZ, Patrick	
			Art Unit			
			Examiner Name			
Sheet	2	of	3	Attorney Docket Number	080379-000130US	

U.S. PATENT DOCUMENTS						
Examiner Initials*	Cite No. <sup>1</sup>	Document Number		Publication Date MM-DD-YYYY	Name of Patentee or Applicant of Cited Document	Pages, Columns, Lines, Where Relevant Passages or Relevant Figures Appear
		Number	Kind Code <sup>2</sup> (if known)			
	BJ	US 6,574,643		06-03-2003	Walter et al.	
	BK	US 6,993,507		01-31-2006	Meyer et al.	
	BL	US 6,999,936		02-14-2006	Sehr	
	BM	US 7,044,362		05-16-2006	Yu	
	BN	US 7,083,081		08-01-2006	McGee et al.	
	BO	US 7,334,720		02-26-2008	Hulst et al.	
	BP	US 7,677,446		03-16-2010	Wise	
	BQ	US-2006/0249570		11-09-2006	Seifert et al.	
	BR	US-2008/0041938		02-21-2008	Wise	
	BS	US 4,341,951		07-1982	Benton	
	BT	US 5,226,145		07-06-1993	Moronaga et al.	

FOREIGN PATENT DOCUMENTS								
Examiner Initials*	Cite No. <sup>1</sup>	Foreign Patent Document			Publication Date MM-DD-YYYY	Name of Patentee or Applicant of Cited Document	Pages, Columns, Lines, Where Relevant Passages or Relevant Figures Appear	T <sup>6</sup>
		Country Code <sup>3</sup>	Number <sup>4</sup>	Kind Code <sup>5</sup> (if known)				
	BU	EP	0 195 098		10-03-1990	FPDC, Inc.		
	BV	EP	0 542 298		04-22-1998	Hitachi, Ltd.		
	BW	EP	0 713 198	A2	05-22-1996	Nederland PTT		
	BX	EP	0 823 694	A1	02-11-1998	Citibank NA		
	BY	EP	0 843 449	A2	05-07-1998	Sunhawk Corp. Inc.		
	BZ	EP	0 914 001	A1	05-06-1999	Canal Plus SA		
	CA	JP	10-269291	A	10-09-1998	Sony Corp.		
	CB	JP	11-212785	A	08-06-1999	Casio Comput. Co. Ltd.		
	CC	JP	11-213010	A	08-06-1999	Planet Computer:KK		
	CD	JP	11-272762	A	10-08-1999	Hitachi Ltd.		
	CE	JP	11-53184	A	02-26-1999	Seta:KK	Corresponds to US 6,018,720	
	CF	WO	98/19237	A1	05-07-1998	Schulumberger Technologies, Inc.		
	CG	WO	98/33343		07-30-1998	Sonera OY et al.		
	CH	WO	98/37526		08-27-1998	Mondex Int. Ltd.		

Examiner Signature		Date Considered	
--------------------	--	-----------------	--

\*EXAMINER: Initial if reference considered, whether or not citation is in conformance with MPEP 609. Draw line through citation if not in conformance and not considered. Include copy of this form with next communication to applicant. <sup>1</sup> Applicant's unique citation designation number (optional). <sup>2</sup> See Kind Codes of U.S. Patent Documents at [www.uspto.gov](http://www.uspto.gov) or MPEP 901.04. <sup>3</sup> Enter Office that issued the document, by the two-letter code (WIPO Standard ST.3). <sup>4</sup> For Japanese patent documents, the indication of the year of the reign of the Emperor must precede the serial number of the patent document. <sup>5</sup> Kind of document by the appropriate symbols as indicated on the document under WIPO Standard ST. 16 if possible. <sup>6</sup> Applicant is to place a check mark here if English language Translation is attached.

Substitute for form 1449/PTO				<b>Complete if Known</b>	
<b>INFORMATION DISCLOSURE STATEMENT BY APPLICANT</b>  <i>(Use as many sheets as necessary)</i>				Application Number	
				Filing Date	
				First Named Inventor	RACZ, Patrick
				Art Unit	
				Examiner Name	
Sheet	3	of	3	Attorney Docket Number	080379-000120US

NON PATENT LITERATURE DOCUMENTS			
Examiner Initials *	Cite No. <sup>1</sup>	Include name of the author (in CAPITAL LETTERS), title of the article (when appropriate), title of the item (book, magazine, journal, serial, symposium, catalog, etc.), date, page(s), volume-issue number(s), publisher, city and/or country where published.	T <sup>2</sup>
	CI		<input type="checkbox"/>

Examiner Signature		Date Considered	
-----------------------	--	--------------------	--

\*EXAMINER: Initial if reference considered, whether or not citation is in conformance with MPEP 609. Draw line through citation if not in conformance and not considered. Include copy of this form with next communication to applicant.

<sup>1</sup> Applicant's unique citation designation number (optional). <sup>2</sup> Applicant is to place a check mark here if English language Translation is attached.

Under the Paperwork Reduction Act of 1995, no persons are required to respond to a collection of information unless it contains a valid OMB control number.

<b>DECLARATION FOR UTILITY OR DESIGN PATENT APPLICATION (37 CFR 1.63)</b>  <input type="checkbox"/> Declaration Submitted With Initial Filing <input checked="" type="checkbox"/> Declaration Submitted after Initial Filing (surcharge (37 CFR 1.16(e)) required)	Attorney Docket Number	080379-000000US
	First Named Inventor	HULST, Hermen-ard
	<b>COMPLETE IF KNOWN</b>	
	Application Number	10/111,716
	Filing Date	October 25, 2000
	Art Unit	
Examiner Name		

As the below named inventor, I hereby declare that:

My residence, mailing address, and citizenship are as stated below next to my name.

I believe I am the original and first inventor of the subject matter which is claimed and for which a patent is sought on the invention entitled:

DATA STORAGE AND ACCESS SYSTEMS

(Title of the Invention)

the specification of which

 is attached hereto

OR

 was filed on (MM/DD/YYYY)

10/25/00

as United States Application Number; or PCT International

Application Number 10/111,716 and was amended on (MM/DD/YYYY)                      (if applicable).

I hereby state that I have reviewed and understand the contents of the above identified specification, including the claims, as amended by any amendment specifically referred to above.

I acknowledge the duty to disclose information which is material to patentability as defined in 37 CFR 1.56, including for continuation-in-part applications, material information which became available between the filing date of the prior application and the national or PCT international filing date of the continuation-in-part application.

I hereby claim foreign priority benefits under 35 U.S.C. 119(a)-(d) or (f), or 365(b) of any foreign application(s) for patent, inventor's or plant breeder's rights certificate(s), or 365(a) of any PCT international application which designated at least one country other than the United States of America, listed below and have also identified below, by checking the box, any foreign application for patent, inventor's or plant breeder's rights certificate(s), or of any PCT international application having a filing date before that of the application on which priority is claimed.

Prior Foreign Application Number(s)	Country	Foreign Filing Date (MM/DD/YYYY)	Priority Not Claimed	Certified Copy Attached?	
				YES	NO
9925227.2	Great Britain	10/25/1999	<input type="checkbox"/>	<input type="checkbox"/>	<input checked="" type="checkbox"/>
			<input type="checkbox"/>	<input type="checkbox"/>	<input type="checkbox"/>
			<input type="checkbox"/>	<input type="checkbox"/>	<input type="checkbox"/>
			<input type="checkbox"/>	<input type="checkbox"/>	<input type="checkbox"/>

 Additional foreign application numbers are listed on a supplemental priority data sheet PTO/SB/02B attached hereto:

[Page 1 of 2]

Burden Hour Statement: This form is estimated to take 21 minutes to complete. Time will vary depending upon the needs of the individual case. Any comments on the amount of time you are required to complete this form should be sent to the Chief Information Officer, U.S. Patent and Trademark Office, Washington, DC 20231. DO NOT SEND FEES OR COMPLETED FORMS TO THIS ADDRESS. SEND TO: Assistant Commissioner for Patents, Washington, DC 20231.



Under the Paperwork Reduction Act of 1995, no persons are required to respond to a collection of information unless it contains a valid OMB control number.

## DECLARATION — Utility or Design Patent Application

Direct all correspondence to: <input checked="" type="checkbox"/> Customer Number or Bar Code Label		20350	OR <input type="checkbox"/> Correspondence address below	
Name				
Address				
City			State	ZIP
Country		Telephone		Fax
I hereby declare that all statements made herein of my own knowledge are true and that all statements made on information and belief are believed to be true; and further that these statements were made with the knowledge that willful false statements and the like so made are punishable by fine or imprisonment, or both, under 18 U.S.C. 1001 and that such willful false statements may jeopardize the validity of the application or any patent issued thereon.				
NAME OF SOLE OR FIRST INVENTOR:		<input type="checkbox"/> A petition has been filed for this unsigned inventor		
Hermen-ard Given Name (first and middle (if any))		HULST Family Name or Surname		
Inventor's Signature			Date June 12 <sup>th</sup> 2002	
Amsterdam Residence: City	State	Netherlands Country	Dutch Citizenship	
Van Tuyll van Serooskerkenweg 75h <sup>s</sup>				
Mailing Address				
Amsterdam City	State	1076 JG ZIP	Netherlands Country	
NAME OF SECOND INVENTOR:		<input type="checkbox"/> A petition has been filed for this unsigned inventor		
Patrick Sandor Given Name (first and middle (if any))		RACZ Family Name or Surname		
Inventor's Signature			Date 12/5/02	
St. Heller, Jersey Residence: City	State	Great Britain Country	GB Citizenship	
19 Royal Square				
Mailing Address				
St. Heller, Jersey City	State	JE1 4WA ZIP	Great Britain Country	
<input type="checkbox"/> Additional inventors are being named on the _____ supplemental Additional Inventor(s) sheet(s) PTO/SB/02A attached hereto.				

Fig. 1  
A

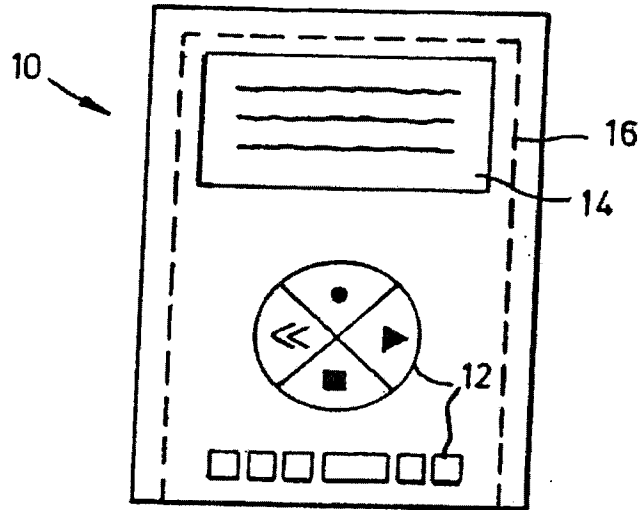

B

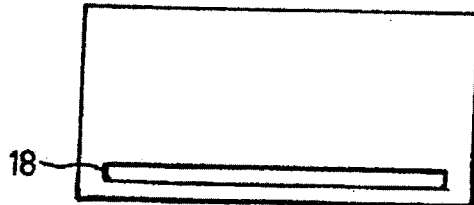

C

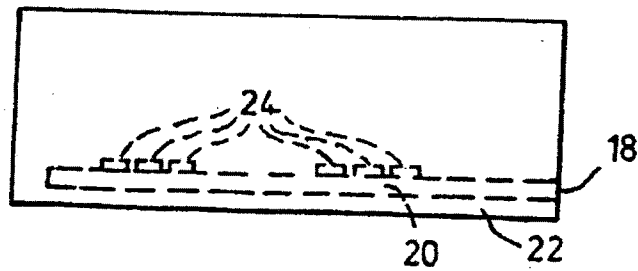

Fig. 2

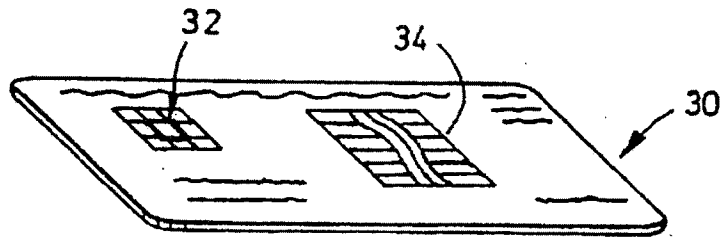

Fig. 3

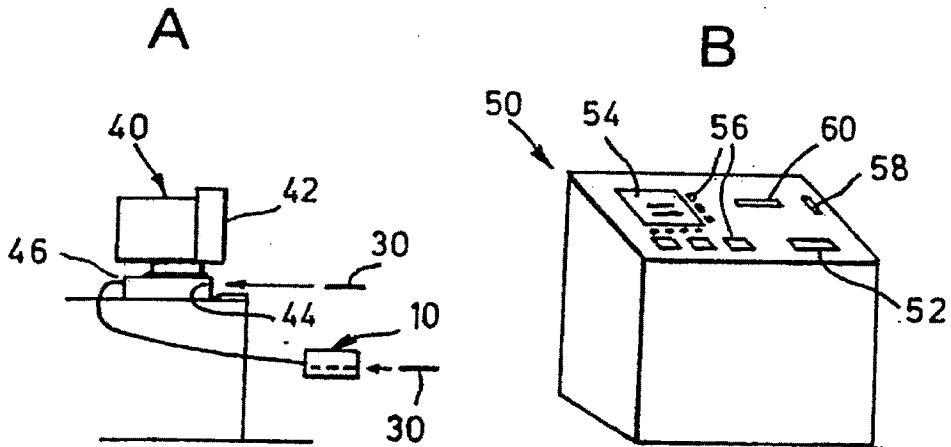
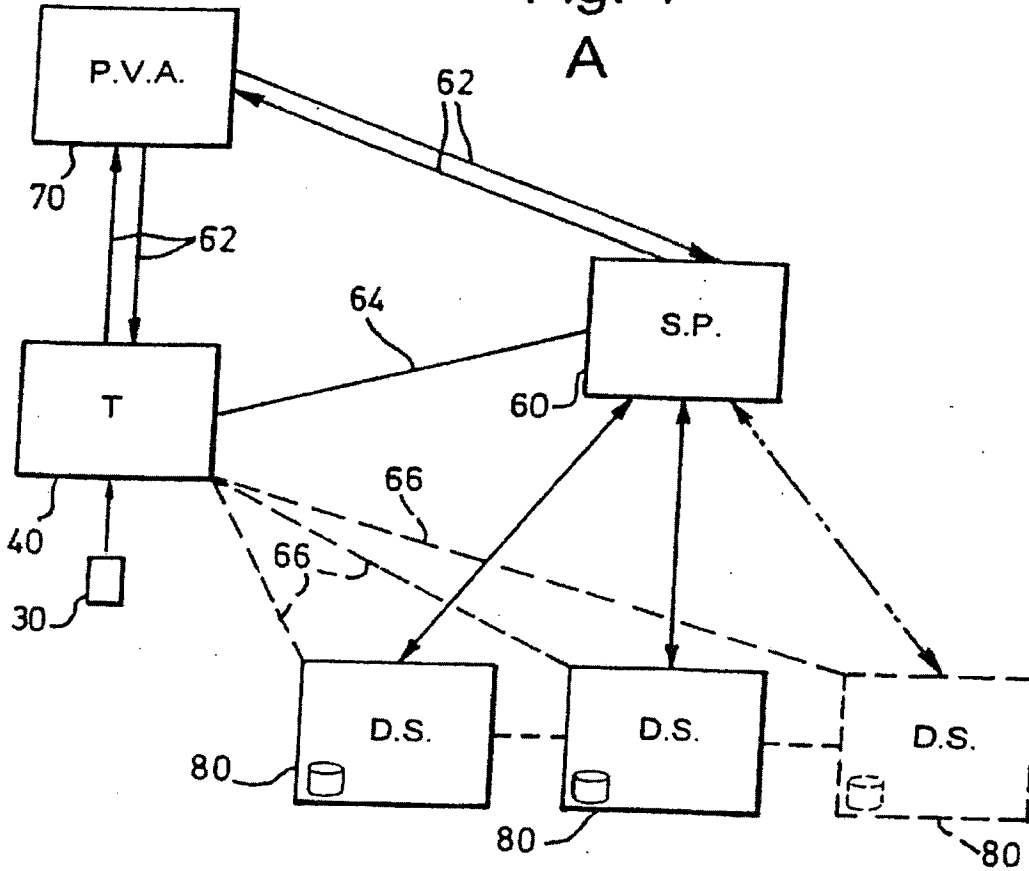
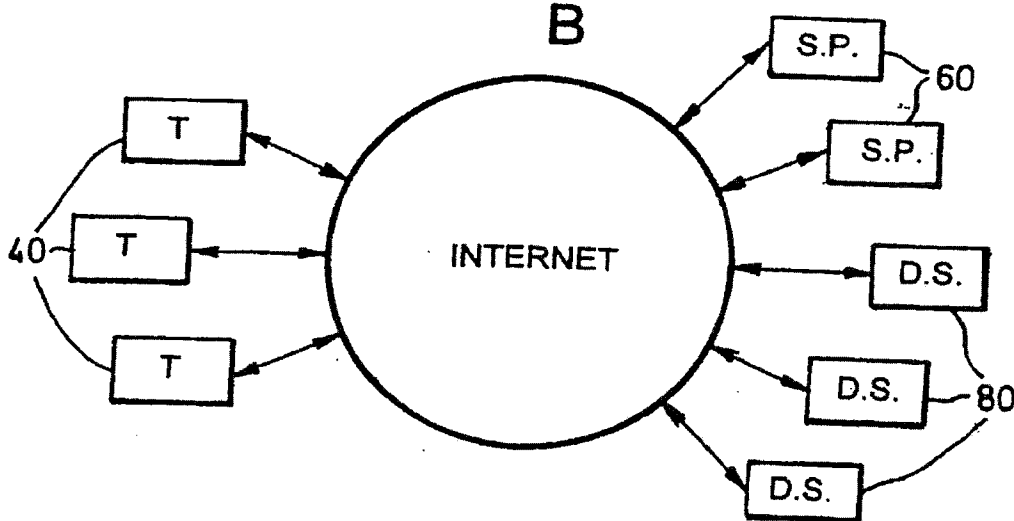

Fig. 4  
A



B



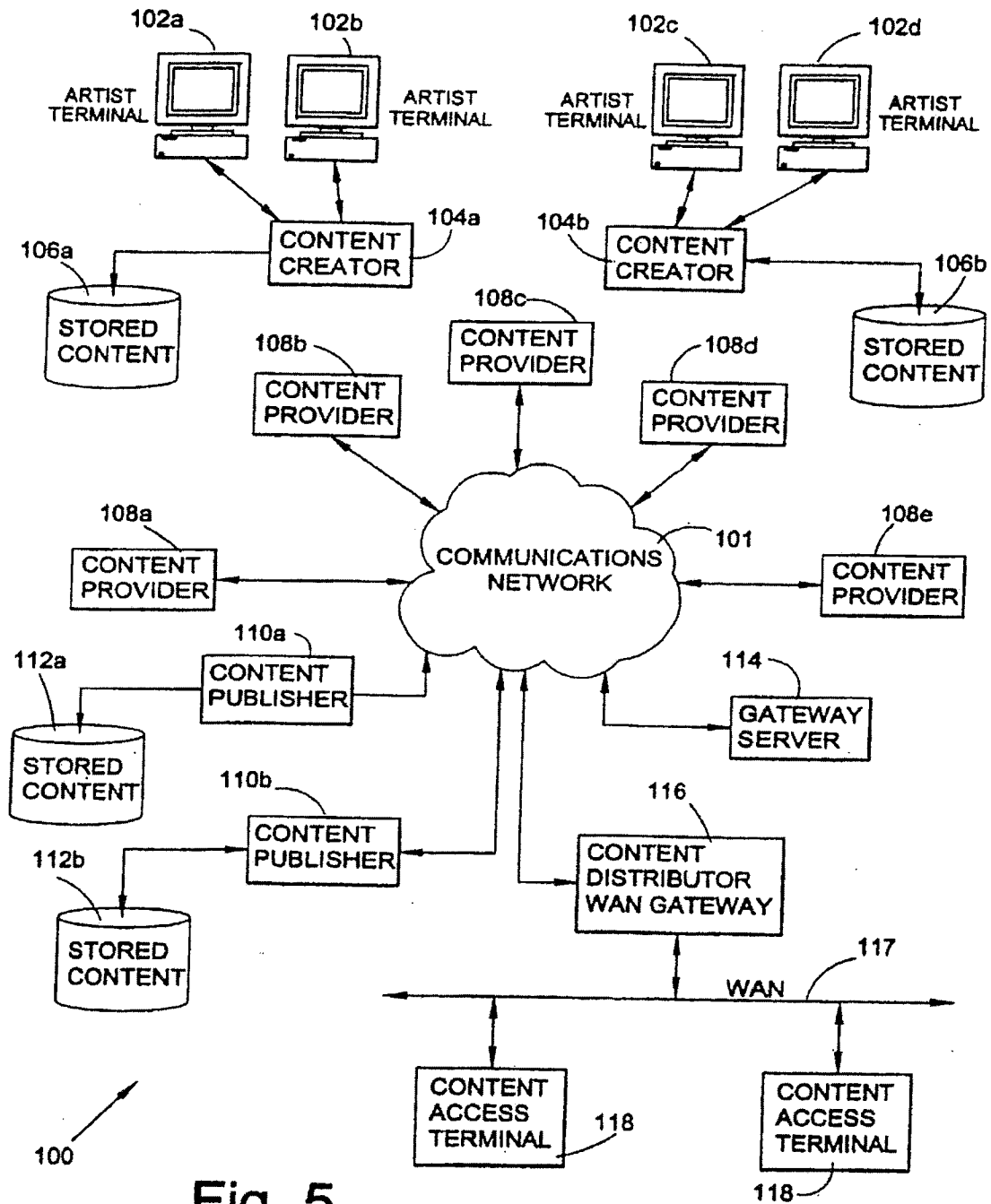

Fig. 5

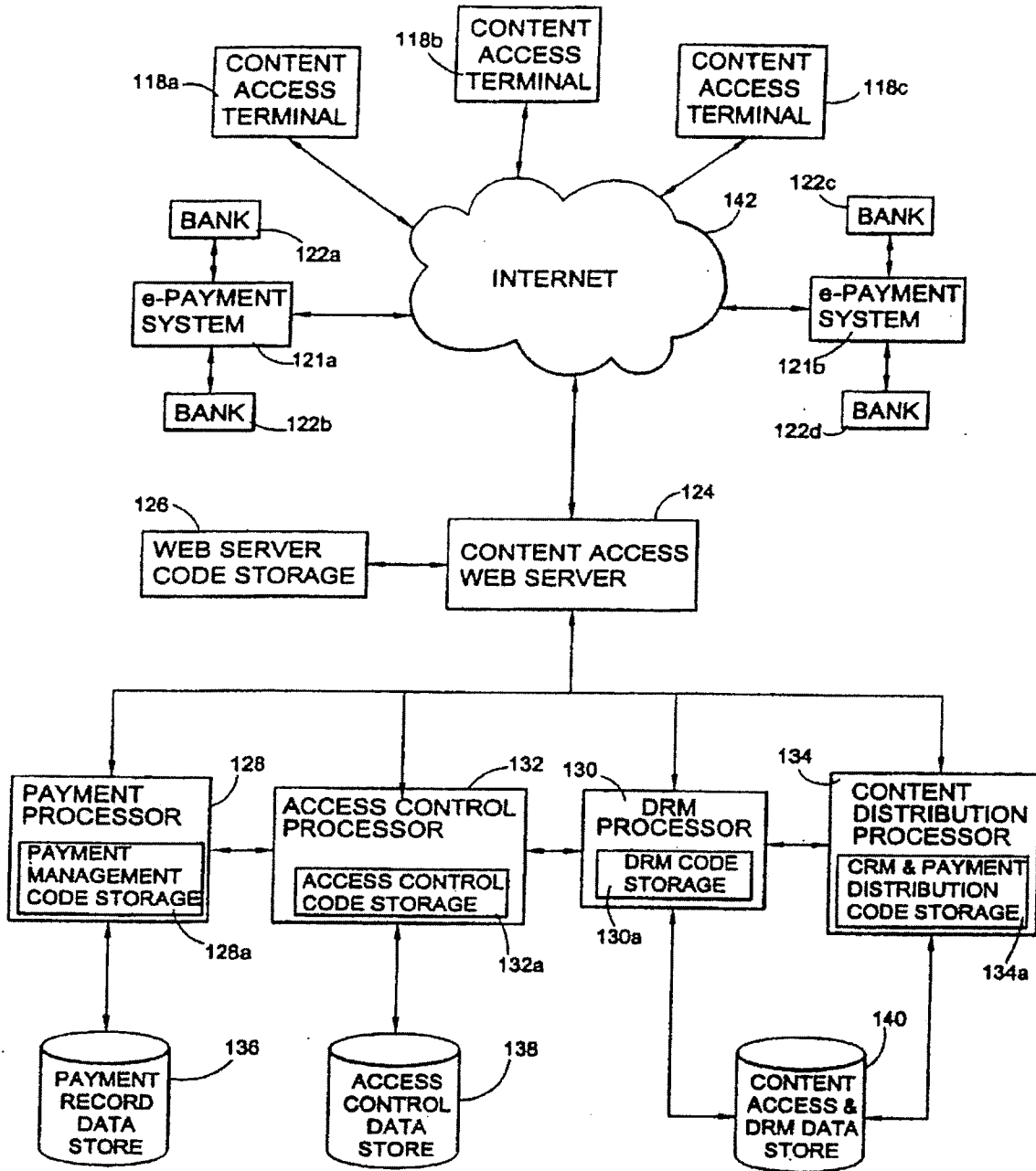

Fig.6

120

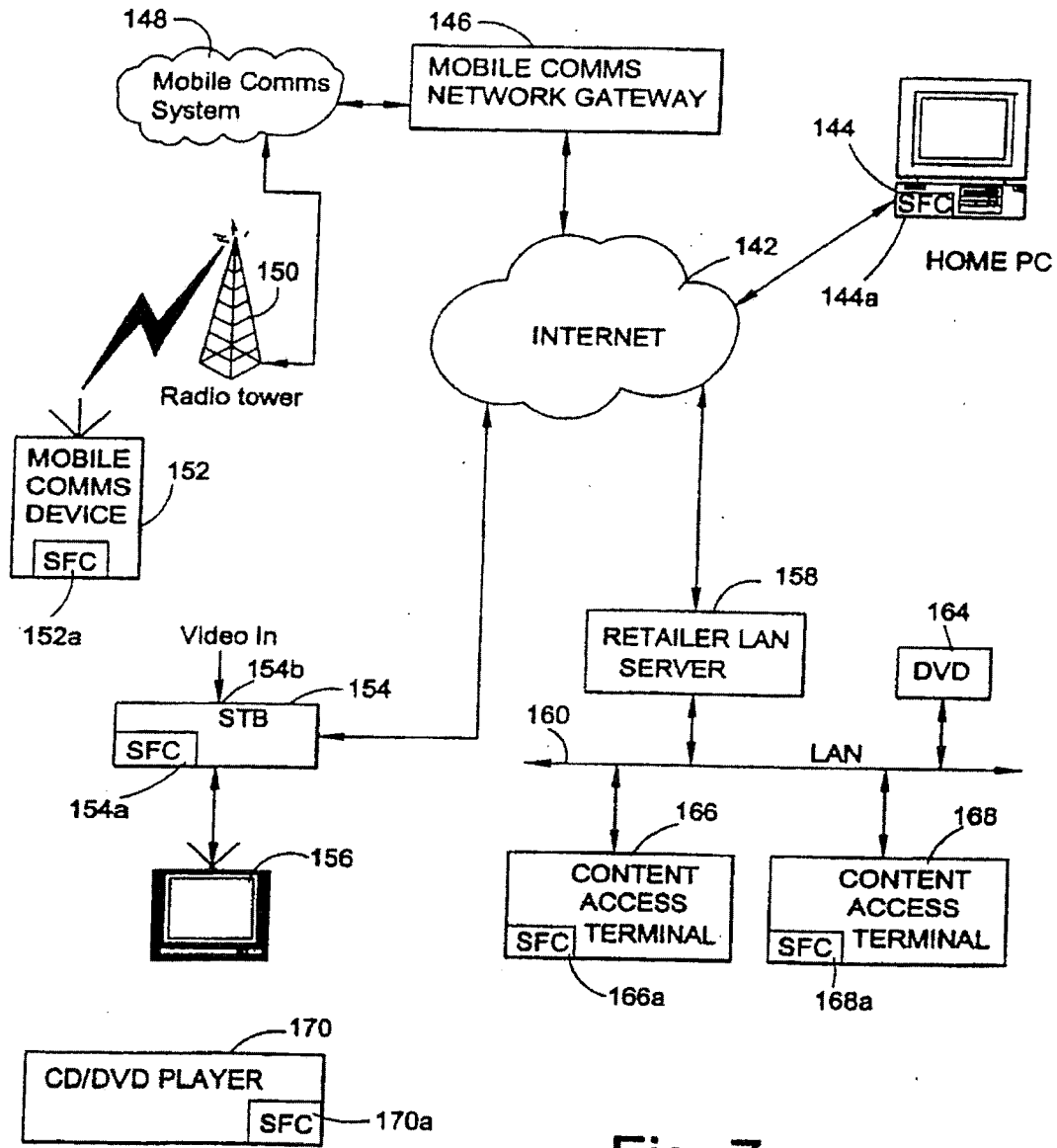

Fig. 7

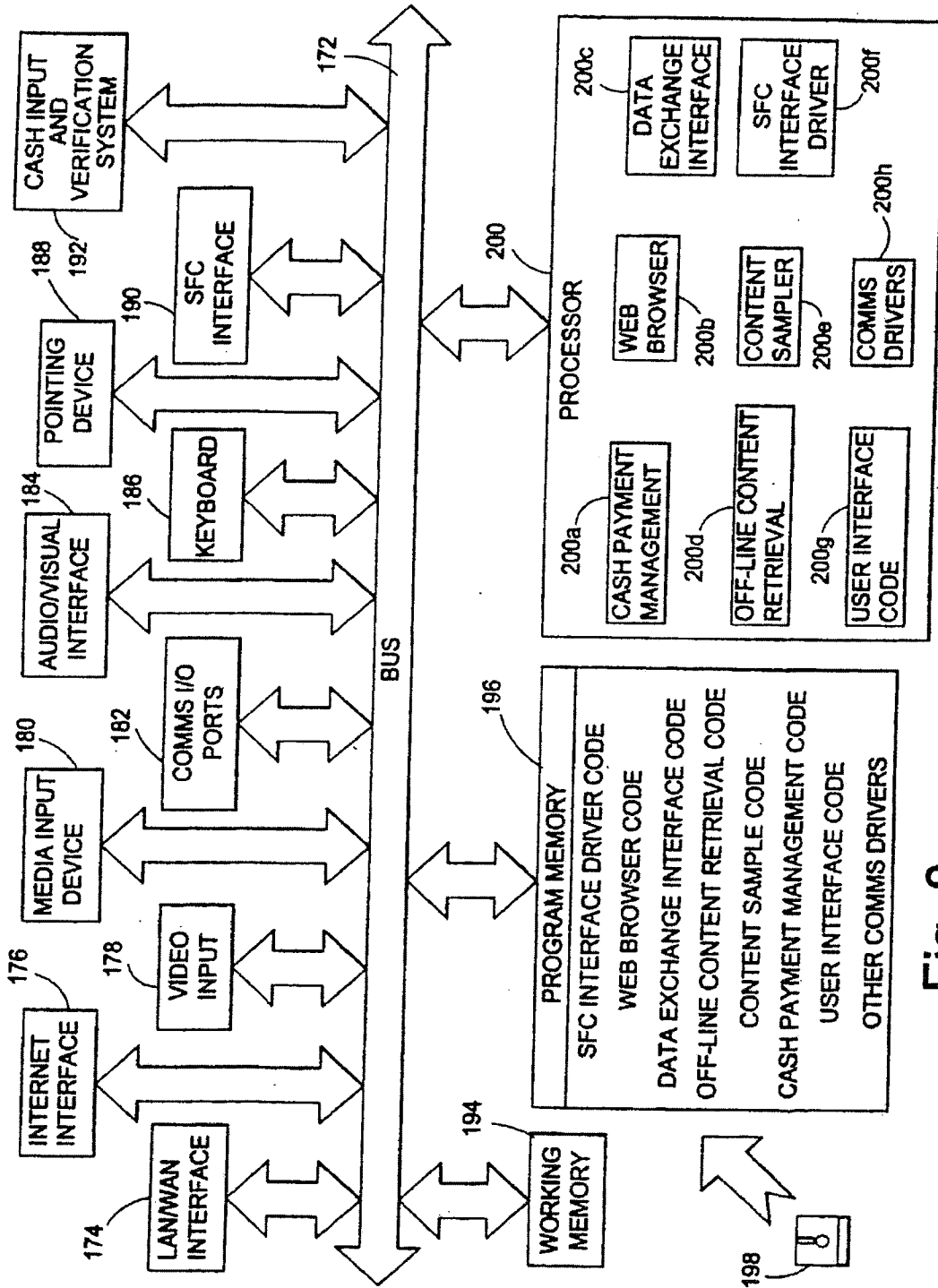

Fig. 8



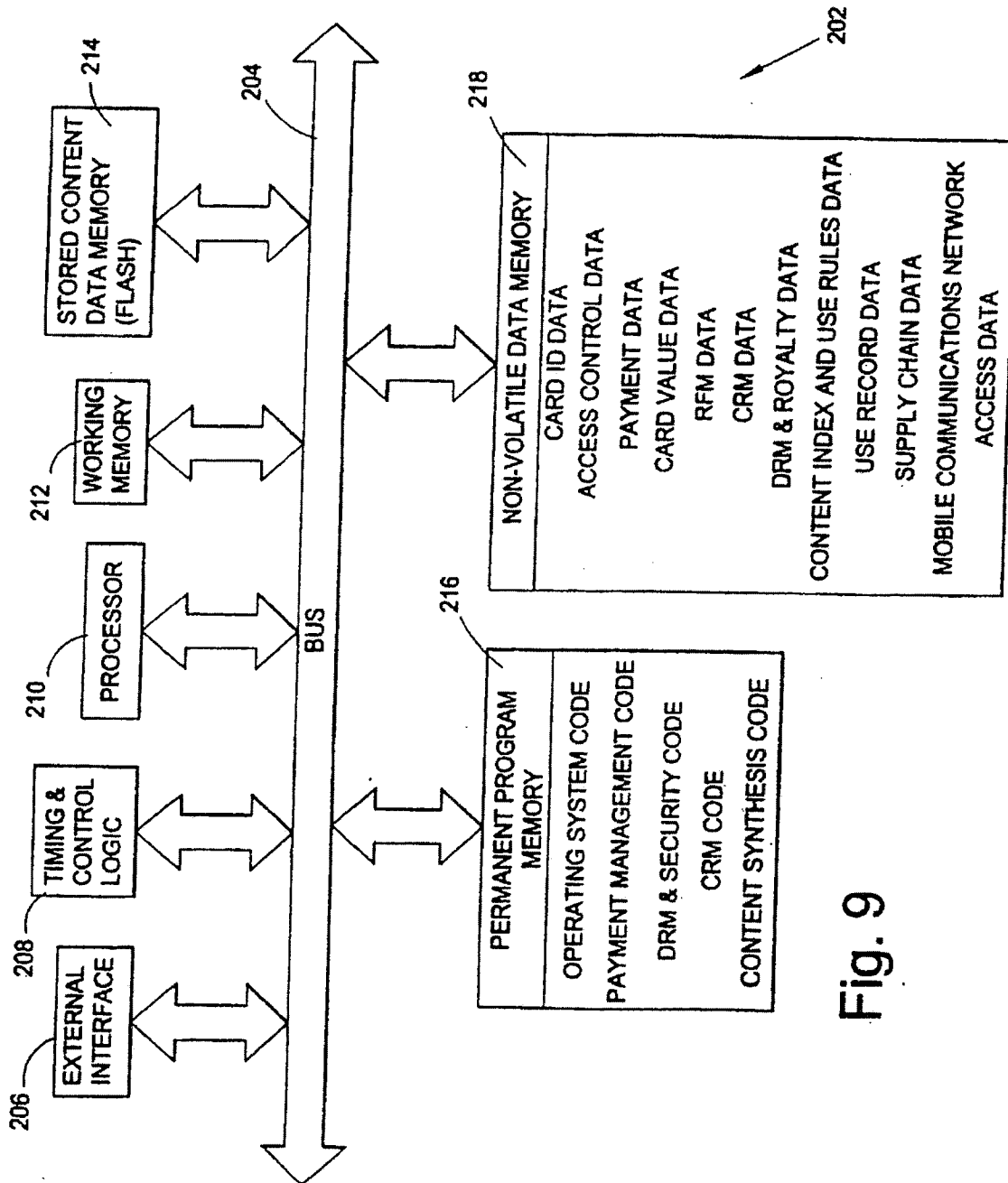

Fig. 9

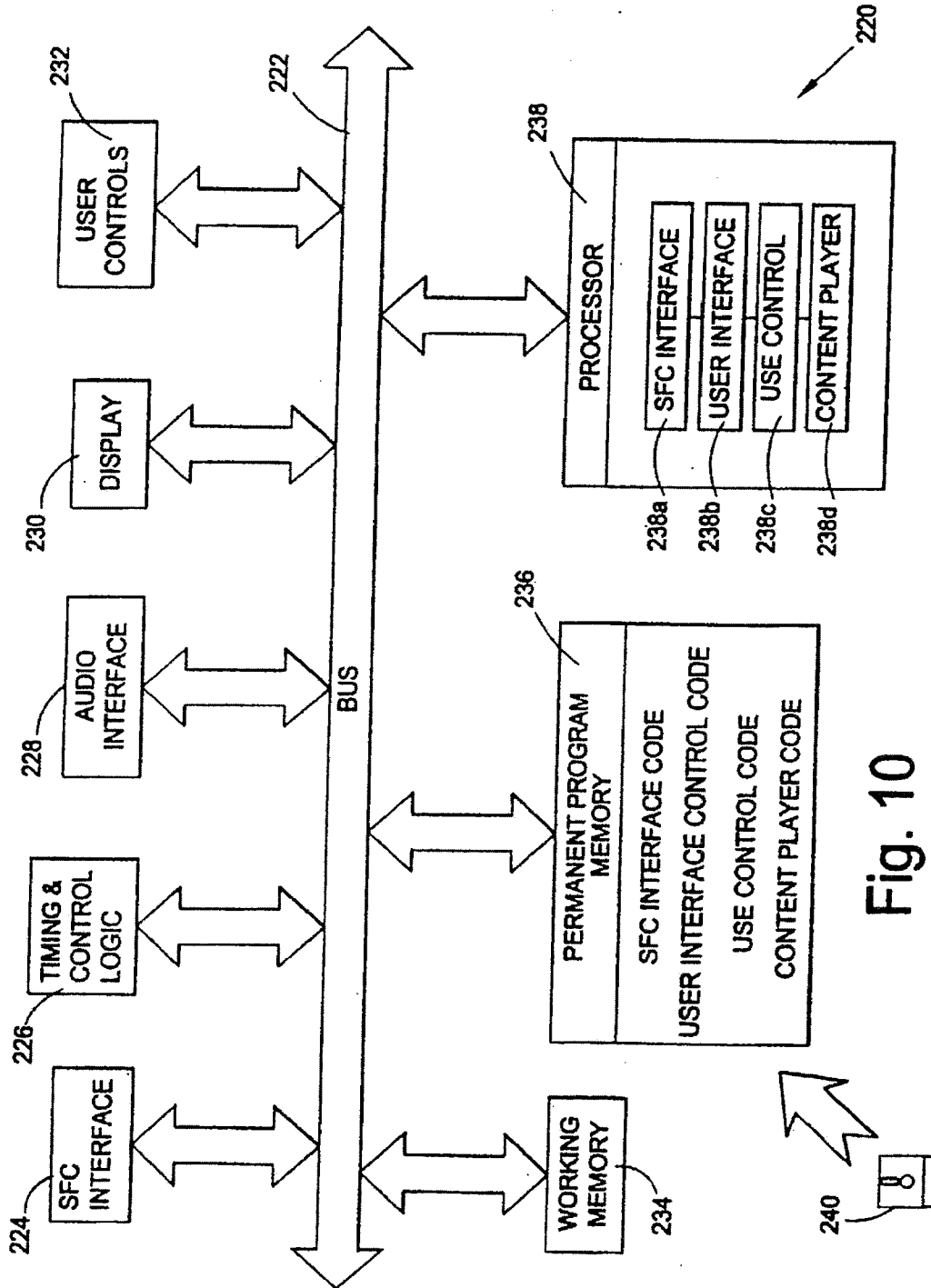

Fig. 10

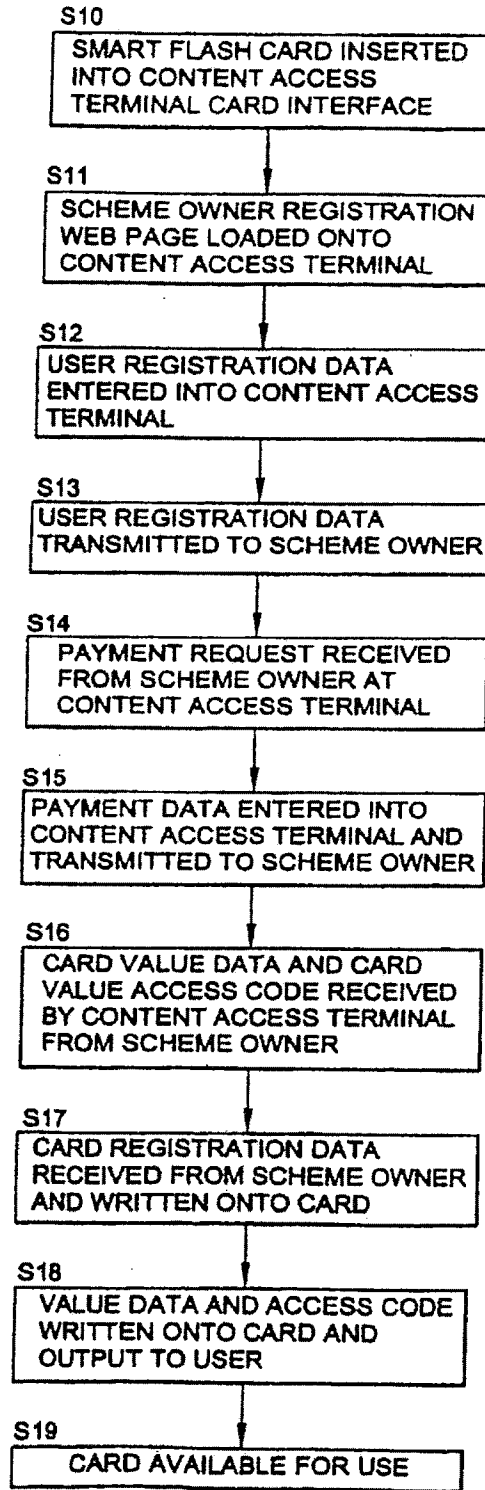

Fig11a

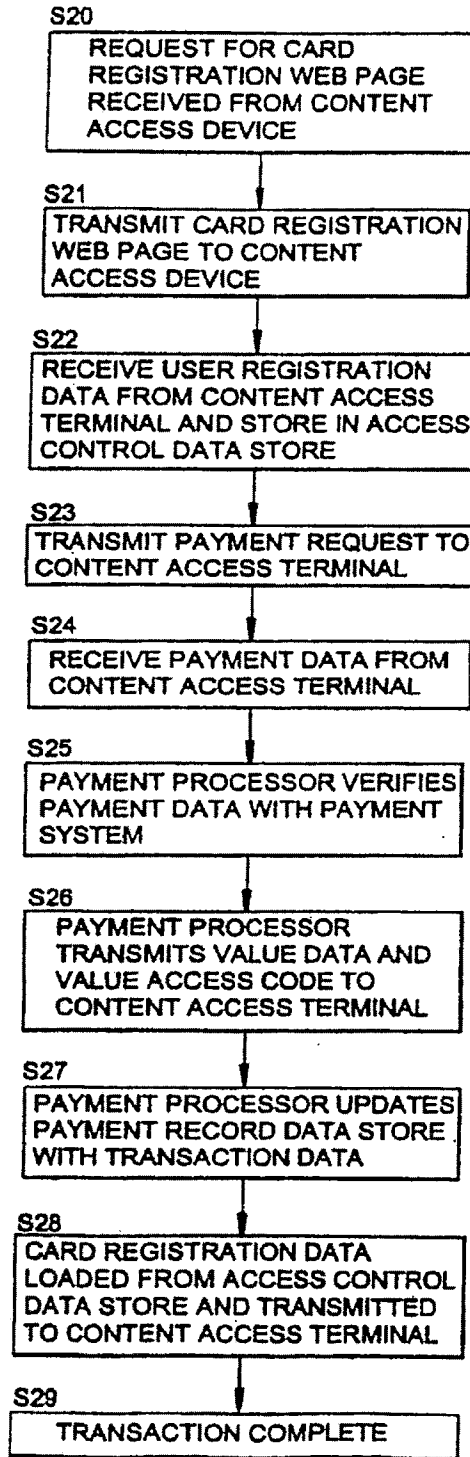

Fig.11b

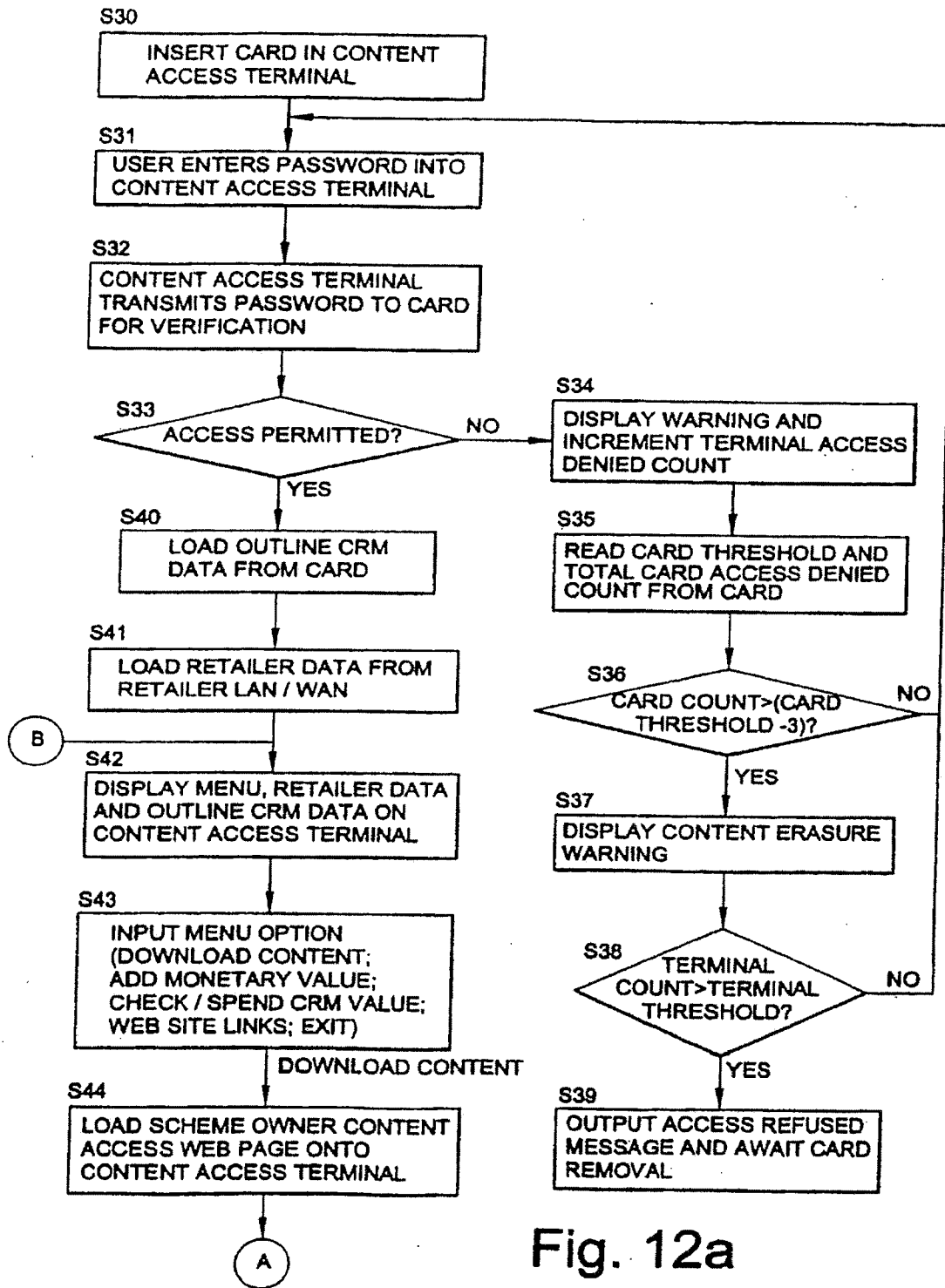
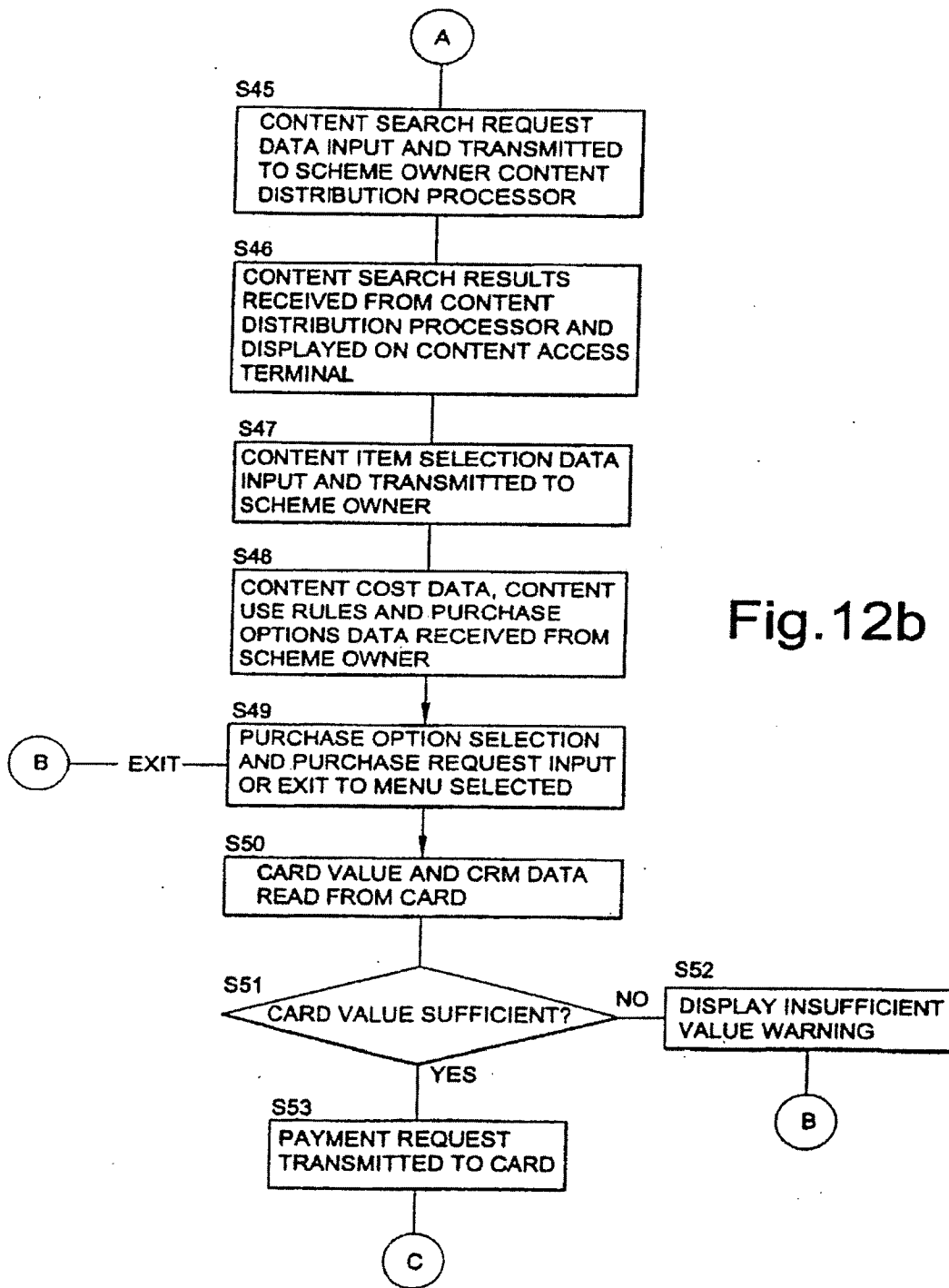

Fig. 12a



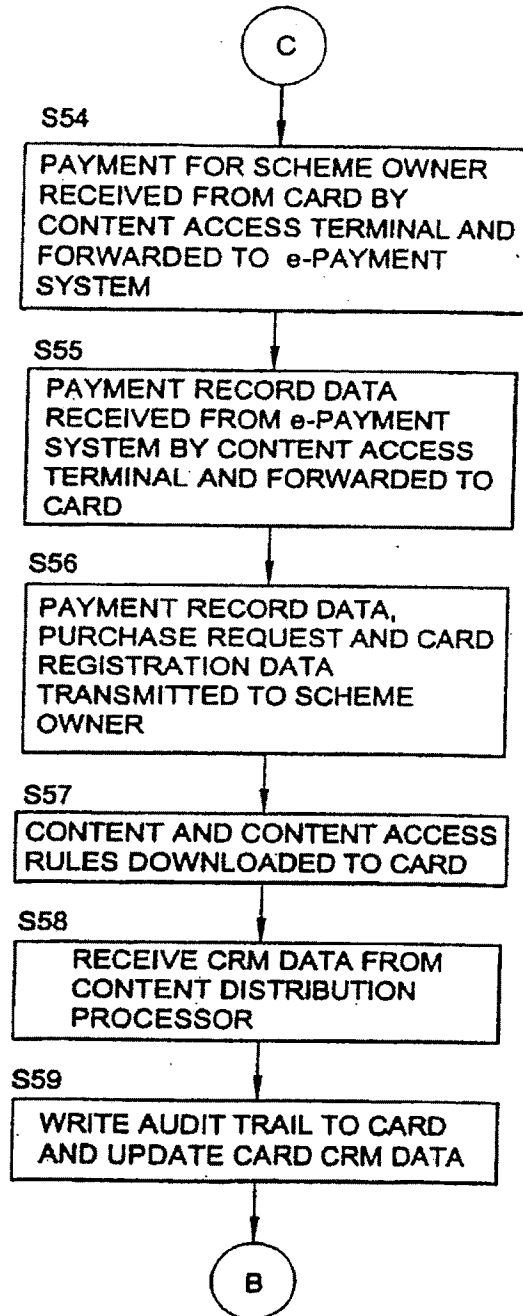

Fig.12c

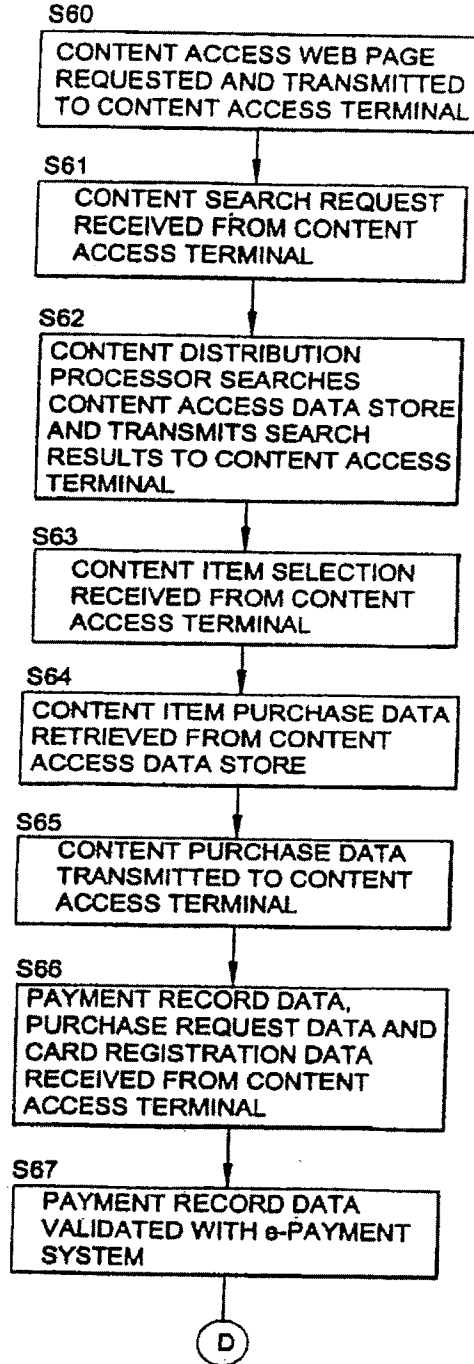

Fig. 12d



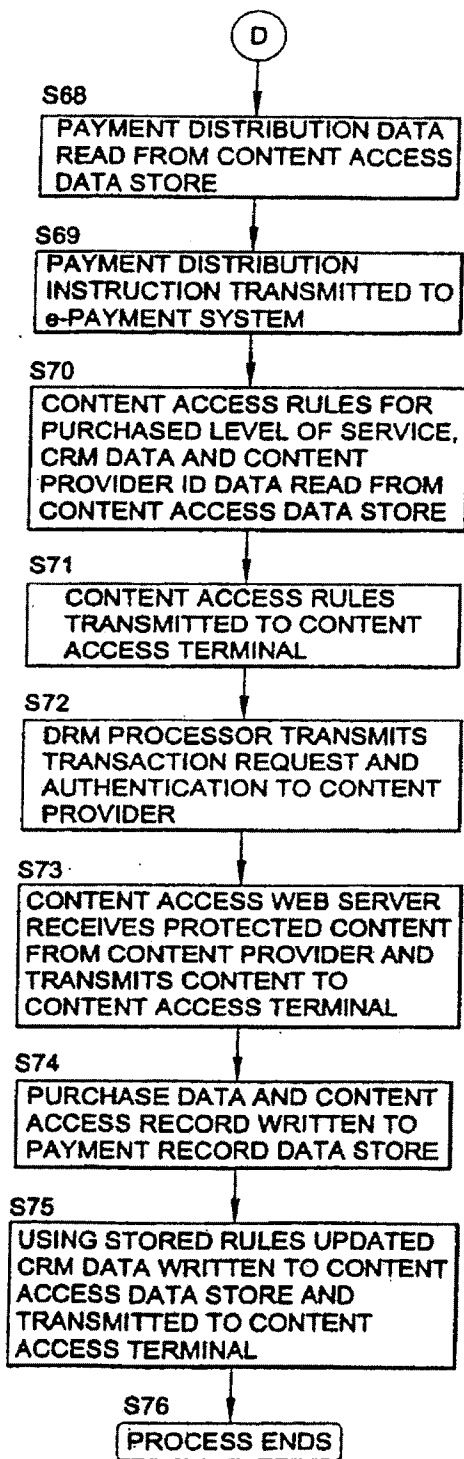

Fig. 12e

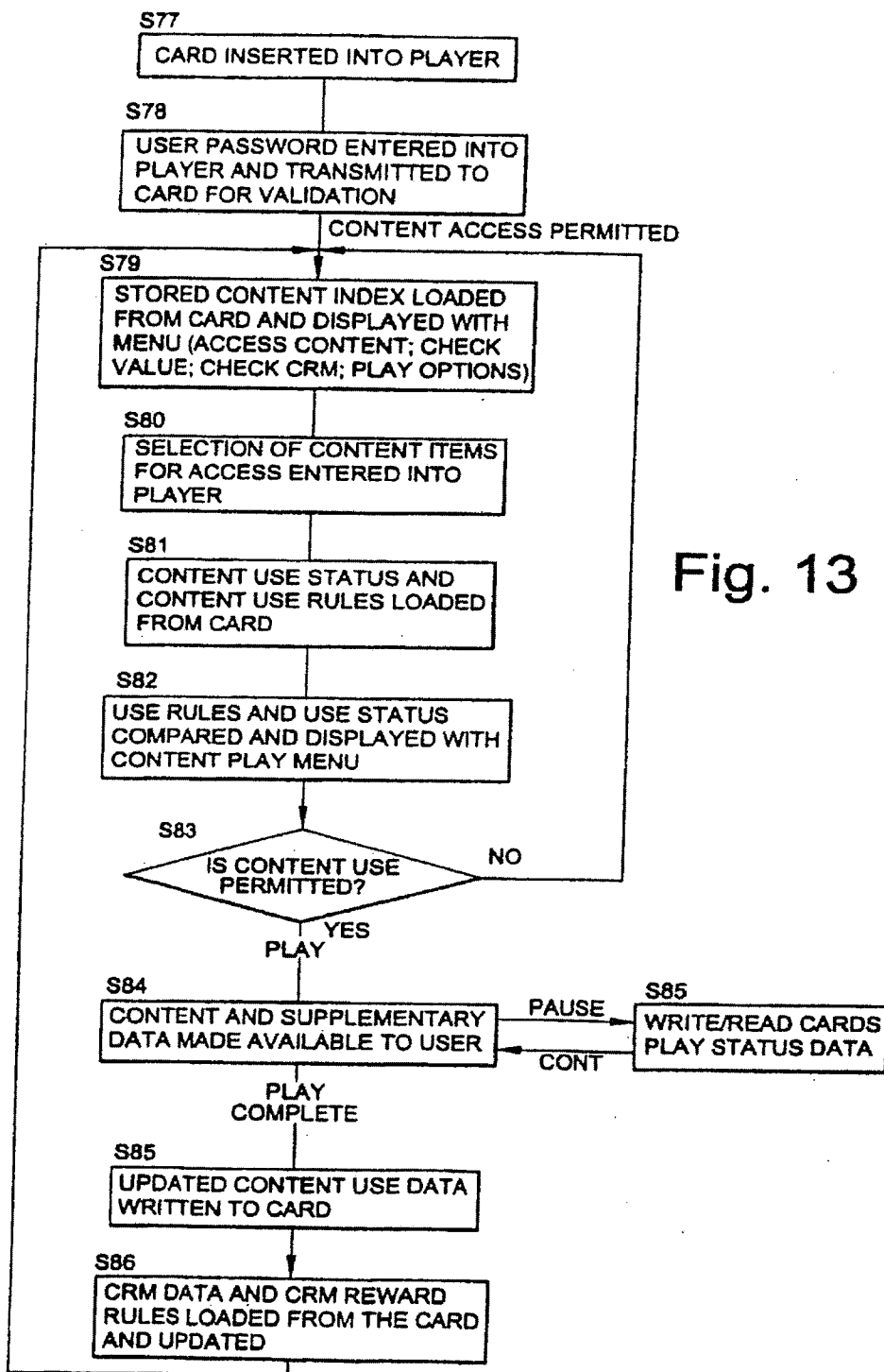

Fig. 13

## Electronic Patent Application Fee Transmittal

<b>Application Number:</b>	
<b>Filing Date:</b>	
<b>Title of Invention:</b>	DATA STORAGE AND ACCESS SYSTEMS
<b>First Named Inventor/Applicant Name:</b>	Patrick RACZ
<b>Filer:</b>	Jason Donald Lohr/Scott Pugh
<b>Attorney Docket Number:</b>	080379-000130US

Filed as Small Entity

### Utility under 35 USC 111(a) Filing Fees

Description	Fee Code	Quantity	Amount	Sub-Total in USD(\$)
<b>Basic Filing:</b>				
Utility filing Fee (Electronic filing)	4011	1	82	82
Utility Search Fee	2111	1	270	270
Utility Examination Fee	2311	1	110	110

### Pages:

### Claims:

Claims in excess of 20	2202	5	26	130
Independent claims in excess of 3	2201	1	110	110

### Miscellaneous-Filing:

Description	Fee Code	Quantity	Amount	Sub-Total in USD(\$)
<b>Petition:</b>				
<b>Patent-Appeals-and-Interference:</b>				
<b>Post-Allowance-and-Post-Issuance:</b>				
<b>Extension-of-Time:</b>				
<b>Miscellaneous:</b>				
			<b>Total in USD (\$)</b>	<b>702</b>

## Electronic Acknowledgement Receipt

<b>EFS ID:</b>	8813795
<b>Application Number:</b>	12943847
<b>International Application Number:</b>	
<b>Confirmation Number:</b>	4513
<b>Title of Invention:</b>	DATA STORAGE AND ACCESS SYSTEMS
<b>First Named Inventor/Applicant Name:</b>	Patrick RACZ
<b>Customer Number:</b>	20350
<b>Filer:</b>	Jason Donald Lohr/Scott Pugh
<b>Filer Authorized By:</b>	Jason Donald Lohr
<b>Attorney Docket Number:</b>	080379-000130US
<b>Receipt Date:</b>	10-NOV-2010
<b>Filing Date:</b>	
<b>Time Stamp:</b>	19:35:47
<b>Application Type:</b>	Utility under 35 USC 111(a)

### Payment information:

Submitted with Payment	yes
Payment Type	Deposit Account
Payment was successfully received in RAM	\$702
RAM confirmation Number	7260
Deposit Account	201430
Authorized User	

The Director of the USPTO is hereby authorized to charge indicated fees and credit any overpayment as follows:

Charge any Additional Fees required under 37 C.F.R. Section 1.16 (National application filing, search, and examination fees)

Charge any Additional Fees required under 37 C.F.R. Section 1.17 (Patent application and reexamination processing fees)

Charge any Additional Fees required under 37 C.F.R. Section 1.19 (Document supply fees)

Charge any Additional Fees required under 37 C.F.R. Section 1.20 (Post Issuance fees)

Charge any Additional Fees required under 37 C.F.R. Section 1.21 (Miscellaneous fees and charges)

**File Listing:**

Document Number	Document Description	File Name	File Size(Bytes)/ Message Digest	Multi Part /.zip	Pages (if appl.)
1	Specification	Specification_080379_000130US.pdf	2475680 9079b1e750888ad7e82f6c5e7f9e8f3bbd0b1563	no	42

**Warnings:**

**Information:**

2		ApplicationDocs_080379_000130US.pdf	1045147 7f66db175d0477c514a8fa45796326b38fd734a8	yes	30
---	--	-------------------------------------	---	-----	----

**Multipart Description/PDF files in .zip description**

Document Description	Start	End
Transmittal of New Application	1	1
Application Data Sheet	2	4
Miscellaneous Incoming Letter	5	6
Information Disclosure Statement (IDS) Filed (SB/08)	7	11
Oath or Declaration filed	12	13
Drawings-only black and white line drawings	14	30

**Warnings:**

**Information:**

3	Fee Worksheet (PTO-875)	fee-info.pdf	38096 16ec64e106f854286993d0a57b3642574f35611	no	2
---	-------------------------	--------------	--	----	---

**Warnings:**

**Information:**

<b>Total Files Size (in bytes):</b>			3558923		
-------------------------------------	--	--	---------	--	--

**This Acknowledgement Receipt evidences receipt on the noted date by the USPTO of the indicated documents, characterized by the applicant, and including page counts, where applicable. It serves as evidence of receipt similar to a Post Card, as described in MPEP 503.**

**New Applications Under 35 U.S.C. 111**

**If a new application is being filed and the application includes the necessary components for a filing date (see 37 CFR 1.53(b)-(d) and MPEP 506), a Filing Receipt (37 CFR 1.54) will be issued in due course and the date shown on this Acknowledgement Receipt will establish the filing date of the application.**

**National Stage of an International Application under 35 U.S.C. 371**

**If a timely submission to enter the national stage of an international application is compliant with the conditions of 35 U.S.C. 371 and other applicable requirements a Form PCT/DO/EO/903 indicating acceptance of the application as a national stage submission under 35 U.S.C. 371 will be issued in addition to the Filing Receipt, in due course.**

**New International Application Filed with the USPTO as a Receiving Office**

**If a new international application is being filed and the international application includes the necessary components for an international filing date (see PCT Article 11 and MPEP 1810), a Notification of the International Application Number and of the International Filing Date (Form PCT/RO/105) will be issued in due course, subject to prescriptions concerning national security, and the date shown on this Acknowledgement Receipt will establish the international filing date of the application.**

Attorney Docket No.: 080379-000130US

Client Reference No.: PN759544USD

## **PATENT APPLICATION**

### **DATA STORAGE AND ACCESS SYSTEMS**

Inventors: Patrick RACZ, a citizen of United Kingdom, residing at  
Petit Alva, Rue de Petit Aleva, St. Peter, Jersey, JE3 7ET

Herman-Ard HULST, a citizen of Netherlands, residing at 23 Tanza Road,  
Hampstead, London, NW3 2UA, United Kingdom

Assignee: Smartflash Technologies Limited  
1070908 Palm Grove House, P.O. Box 438  
Wickhams' Cay, Road Town  
Tortola, British Virgin Islands

Entity: Small

TOWNSEND and TOWNSEND and CREW LLP  
Two Embarcadero Center, Eighth Floor  
San Francisco, California 94111-3834  
Tel: 925-472-5000



## DATA STORAGE AND ACCESS SYSTEMS

### CROSS-REFERENCES TO RELATED APPLICATIONS

[0001] This application is a continuation of U.S. Patent Application No. 12/014,558, filed on  
5 January 15, 2008, which is a continuation of U.S. Patent Application No. 11/336,758, filed on  
January 19, 2006, now issued U.S. Patent Number 7,334,720; which is a continuation of U.S.  
Patent Application No. 10/111,716, filed on September 17, 2002, which application is a national  
stage application under 35 U.S.C. 371, claiming the priority of international PCT Application  
No. GB00104110, filed on October 25, 2000; which claims priority to UK Application No.  
10 9925227.2, filed on October 25, 1999, each of which is incorporated by reference in its entirety  
for all purposes.

### BACKGROUND OF THE INVENTION

[0002] This invention is generally concerned with data storage and access systems. More  
15 particularly, it relates to a portable data carrier for storing and paying for data and to computer  
systems for providing access to data to be stored. The invention also includes corresponding  
methods and computer programs. The invention is particularly useful for managing stored audio  
and video data, but may also be applied to storage and access of text and software, including  
games, as well as other types of data.

[0003] One problem associated with the increasingly wide use of the internet is the growing  
20 prevalence of so-called data pirates. Such pirates obtain data either by unauthorized or  
legitimate means and then make this data available essentially world-wide over the internet  
without authorization. Data can be a very valuable commodity, but once it has been published  
on the internet it is difficult to police access to and use of it by internet users who may not even  
25 realize that it is pirated. This is a particular problem with audio recordings, and, once the  
bandwidth becomes available, is also likely to be evident with video.

[0004] Over the past three or four years compressed audio sources have become increasingly  
widely available on web pages. One widely used audio data compression format is MP3 (MPEG  
- Audio Layer 3 of the MPEG1 compression algorithm), which is an internationally defined

standard including a definition of compressed audio information such as speech or music. It relies on psycho-acoustic properties of human hearing to achieve very large data compression factors. It is thus feasible to download usefully long passages of music in a practically convenient short time. Pirate data suppliers have not been slow to realize the potential of this, and many unauthorized websites have sprung up offering popular music, including recent releases by world-famous bands. This has caused the recording industry considerable concern and there is an urgent need to find a way to address the problem of data piracy.

#### SUMMARY OF THE INVENTION

[0005] According to the present invention there is therefore provided a method of providing portable data comprising providing a portable data storage device comprising downloaded data storage means and payment validation means; providing a terminal for internet access; coupling the portable data storage device to the terminal; reading payment information from the payment validation means using the terminal; validating the payment information; and downloading data into the portable storage device from a data supplier.

[0006] Another aspect of the invention provides a corresponding mobile data retrieval device for retrieving and outputting data such as stored music and/or noise from the data storage device.

[0007] The payment validation means is, for example, means to validate payment with an external authority such as a bank or building society. The combination of the payment validation means with the data storage means allows the access to the downloaded data which is to be stored by the data storage means, to be made conditional upon checked and validated payment being made for the data. Binding the data access and payment together allows the legitimate owners of the data to make the data available themselves over the internet without fear of loss of revenue, thus undermining the position of data pirates.

[0008] A further advantage of the system is that it allows users under the age of 18 to make internet purchases. Currently internet users pay for goods and/or services by credit card. Since credit cards cannot legitimately be used by persons under the age of 18 (at least in the UK), a significant fraction of adventurous internet users are excluded from e-commerce, one of the most significant predicted uses of the internet. In one embodiment of the invention, however, the payment validation means comprises e-cash; that is, the payment validation means stores transaction value information on a cash value of transactions validatable by the data storage means. In simple terms, the data storage means can be a card which is charged up to a desired

cash value (if necessary limited to a maximum value) at a suitable terminal. This might be an internet access terminal but could, more simply, be a device to accept the data storage card and to receive and count money deposited by the user to charge the card, writing update cash value information onto the card. More sophisticated ways of updating the cash value on the card are also possible, such as direct bank transfer. Since, with this type of embodiment, the data storage means is, essentially, precharged with cash rather than acting as a credit card, it can be used by young people without the risk of their incurring large debts.

**[0009]** In one embodiment the data storage means is powered by the retrieval device when it is connected to the device and retains a memory of the downloaded data when it is unpowered.

This can be achieved by the use of Flash RAM or, more generally, any form of programmable read-only memory. Alternatively the data storage means may incorporate a rechargeable cell or capacitor and store information in battery backed-up static RAM.

**[0010]** The downloaded data may be entered into the data storage device by means of an interface such as a magnetically or capacitatively coupled connection or an optical connection, but preferably the interface comprises contacts for direct electrical connection to the storage means. The payment validation means may likewise have one of a variety of interfaces but again preferably comprises a set of electrical contacts. The payment validation means could, however, comprise a magnetic or holographic data-strip such as is known for use with credit cards and phone cards. The interface to receive the downloaded data may be separate from the interface to the payment validation means, to facilitate separate and simultaneous access to both these systems. In other embodiments a single interface may serve for both data storage and payment. Advantageously the payment validation means includes memory storing information to identify the person who is paying for the downloaded data.

**[0011]** For additional security the downloaded data may be encrypted. In this case data decryption may be necessary at some stage, either in the data storage means or in the retrieval device or in an information delivering apparatus such as a data access terminal. Alternatively the data decryption function can be shared amongst one or more of these devices. The skilled person will be aware of a range of suitable encryption/decryption techniques, including Pretty Good Privacy (Registered Trade Mark) and PKI (Public Key Infrastructure). Normally, when the downloaded data is encrypted, a decryption key must be supplied. This can be generated

automatically by the data access terminal or data access service provider or it can be entered by the user into the data access terminal or into the mobile data retrieval device.

5 **[0012]** The data storage means and/or the retrieval device can be provided with access control means to prevent unauthorized access to the downloaded data. Additionally or alternatively, use control means can be provided to stop or provide only limited access of the user to the downloaded data in accordance with the amount paid. These access and use control functions may in some embodiments be combined, permitted use controlling access or permitted access controlling use. Thus, for example, a complete set of data information relating to a particular topic, a particular music track, or a particular software package might be downloaded, although  
10 access to part of the data set might thereafter be controlled by payments made by a user at a later stage. In this way, a user could pay to enable an extra level on a game or to enable further tracks of an album.

**[0013]** In embodiments where the access or use control means is responsive to the payment validation means, access or use control information may be stored with the downloaded data or  
15 in a separate storage area, for example in the payment validation means. The user's access to the downloaded data could advantageously be responsive to the payment validation means, for example, by means of a control line coupling the payment validation means with a memory access or decryption control element.

**[0014]** In one embodiment the data storage means comprises an electronic memory card or  
20 smart card and the mobile data retrieval device is provided with a slot to receive the card. Preferably the card is a push-fit within the retrieval device, and retention of the card may be effected by pressure from electrical interface connections and/or resilience of the housing, or by using a resilient retaining means. In a preferred embodiment the retrieval device includes an audio output and a display, to play a downloaded track and to show information about the track  
25 and/or an accompanying video.

**[0015]** To download data onto the data storage means the user can employ a data access terminal coupled to the internet. The terminal can directly validate payment; for example in the case of a smart card charged with electronic cash it can deduct a cash value from the card. Alternatively it can communicate with a bank or other financial services provider to control  
30 payment. In a preferred embodiment, however, the terminal connects to a data access service provider which provides a portal to other sites and which validates payment and then forwards

data from a data supplier to the user's local access terminal. The data access service provider may alternatively forward payment validation information and/or information from the payment validation authority to the data supplier for control by the supplier of the data supplied. Thus, access to the payment validation system and/or data for downloading may be entirely controlled  
5 by the data supplier.

**[0016]** Data held on the data storage means may advantageously include data relating to the user's or payer's usage of the system. This information may include, for example, information on a user's spending pattern, information on data suppliers used and information on the downloaded data. This information may be accessed by the data supplier and/or data access  
10 service provider and can be used for targeted marketing or loyalty-based incentive schemes such as air miles or the like.

**[0017]** The data access terminal may be a conventional computer or, alternatively, it may be a mobile phone. Wireless Application Protocol (WAP) and i-mode allow mobile phones to efficiently access the internet and this allows a mobile phone to be used to download data to the  
15 data storage means, advantageously, directly. The data storage means can, if desired, incorporate the functionality of a mobile phone SIM (Subscriber Identity Module) card, which cards already include a user identification means, to allow user billing through the phone network operator.

**[0018]** In a preferred embodiment the downloaded data is MP3 or other encoded audio data, but the system finds more general application for other data types. For example, download data  
20 can include software, and particularly games, share price information, current news information, transport timetable information, weather information and catalog shopping information. The downloaded information may also include compressed video data. The storage capacity of the data storage means is adaptable to suit the type of data intended to be downloaded; for example, 32 megabytes is sufficient for CD quality music, but for video it is preferable that the data  
25 storage means has a capacity of 128 megabytes or greater.

**[0019]** In another aspect, the invention provides a portable data carrier comprising an interface for reading and writing data from and to the carrier; non-volatile data memory, coupled to the interface, for storing data on the carrier; non-volatile payment data memory, coupled to the interface, for providing payment data to an external device.

[0020] These features allow the data carrier to store both payment data and content data, thus providing the advantages outlined above. Depending upon the payment system used, the payment data memory may also store code for validating or confirming a payment to an external payment system. The payment data will normally be linked to a card or card holder  
5 identification data for payment by the card holder. The non-volatile memory ensures that stored content and payment data is retained in the data carrier when the data carrier is not receiving power from an external source. Thus "non-volatile" encompasses, for example, low-power memory whose contents are retained by a battery back-up system. In one embodiment the payment data memory comprises EEPROM and the content data memory comprises Flash  
10 memory, but other types of content data memory, such as optical, for example, holographic, data memory can also be used. The data carrier may also be integrated into other apparatus, such as a mobile communications device.

[0021] Preferably, the portable data carrier further comprises a program store for storing code implementable by a processor; and a processor, coupled to the content data memory, the payment  
15 data memory, the interface and to the program store for implementing code in the program store, wherein the code comprises code to output payment data from the payment data memory to the interface and code to provide external access to the data memory.

[0022] Normally, the (content) data memory allows both write and read access for both storing and retrieving data, but in some embodiments the content data memory may be read-only  
20 memory (ROM). In such embodiments, content may be pre-loaded onto the carrier and payment may then be made for permission to access the pre-loaded data.

[0023] Preferably, the data carrier also stores a record of access made to the content data and updates this in response to external access, preferably read access, made to the data memory. The carrier may also store content use rules pertaining to allowed use of stored data items. These  
25 use rules may be linked to payments made from the card to provide payment options such as access to buy content data outright; rental access to content data for a time period or for a specified number of access events; and/or rental/purchase, for example where rental use is provided together with an option to purchase content data at the reduced price after rental access has expired.

[0024] Thus where the data carrier stores, for example, music, the purchase outright option  
30 may be equivalent to the purchase of a compact disc (CD), preferably with some form of content

copy protection such as digital watermarking. In this example, the rental or subscription payment option may be a pay-per-play option, and with this option payment may either be before or after access to the stored data so that the carrier may operate in either a debit or credit payment mode.

5 **[0025]** The portability of the data carrier potentially allows it to be used to access content or, in the example, play music without the need to be linked to a communications system or to be on-line to the internet. By providing a use record memory on the data carrier, use of the stored data can be tracked while off-line and then any necessary payment can be made when the data carrier is next coupled to a communication system. This allows the data carrier to operate in a credit  
10 mode. In a debit mode, the additional storage of use rules facilitates the regulation of access to content data stored on the carrier without the need for further exchange of payment/use data with an external system to validate the use.

**[0026]** By combining digital rights management with content data storage using a single carrier, the stored content data becomes mobile and can be accessed anywhere while retaining  
15 control over the stored data for the data content provider or data copyright owner. Preferably, the data carrier also stores access control data, such as a user ID and a password, as the stored data may be valuable. The access control data may be combined with access control to the payment data, which is typically by means of a PIN (Personal Identification Number) to simplify access to valued content stored on the carrier.

20 **[0027]** In one embodiment the stored content data is encrypted and a unique password or PIN and/or biometric data is required for decryption. The data carrier may be arranged so that the content is erased after a predetermined number of incorrect access attempts. Additionally or alternatively, a permanently stored flag may be set and/or a hardware modification (such as a fusible link) may be made to prevent the data carrier from functioning for further data  
25 storage/retrieval. Preferably, however, access to any stored value/payment data is nevertheless retained.

**[0028]** Supplementary data may also be stored on the carrier in association with stored content data. This supplementary data may comprise customer reward management data and/or advertising data. The supplementary data may comprise a pointer to an external data source  
30 from which data is downloaded either to the data carrier or to a data access device or content

player, so that advertising or other data can be displayed when reviewing or accessing the stored content.

5 [0029] Additional data security and/or a mechanism for rewarding operators at different levels in the data supply chain may be provided using a content synthesis function. The content synthesis function combines partial content information from two or more sources to provide content data items for storage and/or output. Thus, for example, a first percentage of a content data item could be provided by a content retailer, while a remaining percentage could be provided by an on-line data supplier. This would provide an incentive for a user to register with a content retailer or distributor as well as with an on-line system owner and so could encourage the use of existing retailers and could provide a mechanism for paying commission to such retailers. The two portions of data combined to provide a content data item could comprise encryption data and a key but preferably comprise separate parts of a complete data item, for example, least significant bits and most significant bits or high frequencies and low frequencies (for audio). This arrangement also facilitates customer reward and loyalty management.

15 [0030] In one embodiment the data carrier further comprises memory for storing data for accessing a mobile communications network, for example to receive content data over the network. For such an embodiment, the data carrier may replace a SIM (Subscriber Identity Module) card in a mobile communications device, thus providing a single card for both network access and valued content retrieval and storage. Additionally or alternatively the card may also store the web address of a data supplier from whom data may be downloaded onto the carrier.

25 [0031] The data memory for storing content data may be optic, magnetic or semiconductor memory, but preferably comprises Flash memory. Preferably, the data memory has a large capacity for storing large data files such as compressed video data. Preferably, the data memory is partitioned for lock access, that is, for read and/or write access to blocks of, for example, 1K, 4K, 16K or 64K databytes for faster data access, particularly where the stored content data will normally be accessed serially, as is normally the case with audio and video data. Preferably the card is configured as an IC card or smart card and has a credit card-type format, although other formats such as the "memory stick" format may also be used. This provides a small and convenient portable format and facilitates removable interfacing with a variety of devices.

30 [0032] The invention also provides a related method of controlling access to data on a data carrier, the data carrier comprising non-volatile data memory and non-volatile parameter



memory storing use status data and use rules, the method comprising receiving a data access request; reading the use status data and use rules from memory; and evaluating the use status data using the use rules to determine whether access to the stored data is permitted.

5 [0033] According to another aspect of the invention, there is provided a computer system for providing data to a data requester, the system comprising a communication interface; a data access data store for storing records of data items available from the system, each record comprising a data item description and a pointer to a data provider for the data item; a program store storing code implementable by a processor; a processor coupled to the communications interface, to the data access data store, and to the program store for implementing the stored code, the code comprising code to receive a request for a data item from the requester; code to receive from the communications interface payment data comprising data relating to payment for the requested data item; code responsive to the request and to the received payment data, to read data for the requested data item from a content provider; and code to transmit the read data to the requester over the communications interface.

15 [0034] The computer system is operated by a data supplier or data supply "system owner" for providing content data to the data carrier described above. The payment data received may either be data relating to an actual payment made to the data supplier, or it may be a record of a payment made to an e-payment system relating either to a payment to the data supplier, or to a payment to a third party. The data from the content provider, preferably without permanent (local) storage of the forwarded data, improves data security as the content provider retains control over a content data item, and the data supplier, a copy of a data item, is unable to supply data for the item without the content provider's assistance. The computer system may provide temporary storage for a requested data item, for example using a disk cache, but preferably the computer system does not store a complete data item, even temporarily.

25 [0035] Preferably, the computer system includes payment distribution information so that when payment is made for a data item, the payment can be distributed for reimbursing royalties and making other payments. Typically a large fraction of the payment for a data item will be transferred to a copyright owner or "content provider" for the item while smaller payments will go to the artist and/or publisher and/or retailer/distributor. Payment may be made directly by the computer system to the computer systems of other relevant parties using, for example, a signature-transporting type e-payment system. Alternatively, the computer system can issue

30

appropriate instructions to a third party e-payment system for making the transfers. The computer system allows automatic distribution of payments either before, during or after content data download, or after content data access by a user. Instructions for distributing the payments may be issued substantially simultaneously, thereby avoiding long delays in the payment of some parties; for example, it can presently take a year or more for an artist generating content to be paid by conventional methods.

**[0036]** Preferably, the computer system also stores content data item access rule data, for downloading in association with a content data item. The rule data may be stored by a content provider but is preferably held by the computer system, and links a content identifier with an access rule, typically based upon a required payment value, as outlined above in the context of the data carrier. Normally, each content data item will have an associated access rule, but a single rule may apply to a large number of data items. The computer system also, preferably, stores requester reward data for customer reward/loyalty management. This data may again comprise one or more rules linking a payment value and/or content data item type to a specified reward, such as a number of air miles or retailer value points. The computer system preferably also keeps a record of an identified user's or data's carriers content item downloads and payments for market research purposes.

**[0037]** The computer system, in one embodiment, also stores access control data, such as an access request identity and password which can be employed, for example, to create an extranet of system users, which again can be linked to stored access record data for marketing purposes. When further linked to content item type data, such an arrangement can be used to construct a club of users of content data items of a particular type, for example country and western or rock and roll music. As described in connection with the portable data carrier, the computer system may also comprise content synthesis code for additional data security and for more secure management of payment distributions.

**[0038]** The invention also provides a related method of providing data to a data requester comprising receiving a request for a data item from the requester; receiving payment data from the requester relating to payment for the requested data; reading the requested data from a content provider responsive to the received payment data; and transmitting the read data to the requester.

**[0039]** According to a further aspect of the present invention, there is provided a data access terminal for retrieving data from a data supplier and providing the retrieved data to a data carrier, the terminal comprising a first interface for communicating with the data supplier; a data carrier interface for interfacing with the data carrier; a program store storing code implementable by a processor; and a processor, coupled to the first interface, to the data carrier interface and to the program store for implementing the stored code, the code comprising: code to read payment data from the data carrier and to forward the payment data to a payment validation system; code to receive payment validation data from the payment validation system; code responsive to the payment validation data to retrieve data from the data supplier and to write the retrieved data into the data carrier.

**[0040]** This terminal can be used for retrieving data from the above-described computer system and for downloading the retrieved data to the above-described portable data carrier. As with the data supply computer system, it is preferable that there is no (local) storage of content item data forwarded from the data supplier to the data carrier. The data access terminal is not restricted to use with the above-described status supplier and could, for example, retrieve data for downloading to the data carrier from a local data source, such as a CD (Compact Disc) or DVD (Digital Versatile Disc), or from a third party such as a cable TV company.

**[0041]** The terminal reads payment data from the data carrier and transmits this to a payment validation system for validating the data and authorizing the payment. This may be part of the data supplier's computer system or it may be a separate system such as an e-payment system. Thus, the terminal operates with a data carrier storing payment (validation) data and, in some embodiments, additional payment validation code for validating payment to the payment validation system. Again, the terminal is preferably configured to provide a data item use rule to the carrier in conjunction with a data item. As before, the data item use rule will normally be dependent upon payment value information embodied in the payment data read from the data carrier. The terminal is preferably also configured for user input of access control data. This access control data may be forwarded to the data carrier for access permission verification and/or it may be passed to the data supplier computer system for a similar purpose. The terminal may be configured to warn a user of content access or data carrier function inhibition after a predetermined number of access requests have been refused. The terminal may also incorporate content synthesis code as described above.

[0042] The terminal may comprise code to output supplementary data when downloading data to the data carrier. Identity data on the data carrier can be used to retrieve the supplementary data, or a pointer to the supplementary data, from the data supplier computer system, or the supplementary data or a pointer thereto can be retrieved directly from the data carrier.

5 Preferably, however, identification data on the card is used to retrieve characterizing data such as card user preference data from the data supplier computer system, and this characterizing data is then used by the terminal to retrieve and output supplementary data to a terminal user. When the terminal is associated with a contact distributor or retailer, the supplementary data may be  
10 (LAN), wide area network (WAN) or extranet.

[0043] The invention also provides a method of providing data from a data supplier to a data carrier, the method comprising reading payment data from the data carrier; forwarding the payment data to a payment validation system; retrieving data from the data supplier; and writing the retrieved data into the data carrier.

15 [0044] The payment validation system may be part of the data supplier's computer systems or it may be a separate e-payment system. In one embodiment the method further comprises receiving payment validation data from the payment validation system; and transmitting at least a portion of the payment validation data to the data supplier. Alternatively the payment  
20 validation system may comprise a payment processor at the data supplier or at a destination retrieved from the data supplier. The payment processor may also provide payment distribution data for distributing a payment represented by the payment data.

[0045] In a further aspect, the invention provides a data access device for retrieving stored data from a data carrier, the device comprising a user interface; a data carrier interface; a program store storing code implementable by a processor; and a processor coupled to the user interface, to  
25 the data carrier interface and to the program store for implementing the stored code, the code comprising code to retrieve use status data indicating a use status of data stored on the carrier, and use rules data indicating permissible use of data stored on the carrier; code to evaluate the use status data using the use rules data to determine whether access is permitted to the stored data; and code to access the stored data when access is permitted.

30 [0046] The data access device uses the use status data and use rules to determine what access is permitted to data stored on the data carrier. As described above, the use rules will normally be

dependent upon payments made for data stored on the data carrier, but may also comprise access control employing a user identification and password. Since a single data carrier may have more than one user, the use status and use rules may be selected dependent upon a user identity. The data access device may also be configured to present supplementary data when presenting the content data, retrieved as described above, from the card, from a remote computer system or from some other source such as a cable TV network or off-air.

**[0047]** The invention also provides a related method of controlling access to data from a data carrier, comprising retrieving use status data from the data carrier indicating past use of the stored data; retrieving use rules from the data carrier; evaluating the use status data using the use rules to determine whether access to data stored on the carrier is permitted; and permitting access to the data on the data carrier dependent on the result of said evaluating.

**[0048]** According to a further aspect of the invention there is provided a data access system comprising a data supply computer system for forwarding data from a data provider to a data access terminal; an electronic payment system for confirming an electronic payment; a data access terminal for communicating with the data supply system to write data from the data supply system onto a data carrier; and a data carrier for storing data from the data supply system and payment data; wherein data is forwarded from the data provider to the data carrier on validation of payment data provided from the data carrier to the electronic payment system.

**[0049]** In a further aspect of the invention, there is provided a portable data carrier comprising an interface for sending and receiving data from and to the carrier; non-volatile data memory, coupled to the interface, for storing data on the carrier; and a digital rights management processor for controlling access to the stored data.

**[0050]** In a further aspect of the invention, there is provided a portable data carrier comprising an interface for sending and receiving data from and to the carrier; non-volatile data memory, coupled to the interface, for storing data on the carrier; and an access control processor; wherein the data memory is partitioned as data blocks and the access control processor controls external access to the data blocks.

**[0051]** In a further aspect of the invention, there is provided a computer system for providing data to a data requester, the system comprising a communication interface; a data access data store for storing records of data items available from the system, each record comprising a data

item description and a resource locator; a data provider for the data item; a program store storing code implementable by a processor; a processor coupled to the communications interface, to the data access data store, and to the program store for implementing the stored code, the code comprising code to receive a request for a data item from the requester to receive from the communications interface payment data comprising data relating to payment for the requested data item; code, responsive to the request and to the received payment data, to output the item data to the requester over the communication interface; wherein said data access data store further comprises payment distribution information indicating to whom payments should be made for a data item; and further comprising code to output payment data for a data item for making payments for the item when the item is supplied to a requester.

**[0052]** In a further aspect of the invention, there is provided a computer system for providing data to a data requester, the system comprising a communication interface; a data access data store for storing records of data items available from the system, each record comprising a data item description and a printer location data identifying an electronic address for a provider for the data item; a program store storing code implementable by a processor; a processor coupled to the communications interface, to the data access data store, and to the program store for implementing the stored code, the code comprising code to receive a request for a data item from the requester to receive from the communications interface payment data comprising data relating to payment for the requested data item; code responsive to the request and to the received payment data to output the item data to the requester over the communication interface; wherein the data access data store further comprises data item access rule data for output to the requester with a data item; and further comprising code to select access rule data for output with a data item in response to the payment data.

**[0053]** In a yet further aspect of the invention, there is provided a method of providing data to a data requester comprising receiving a request for a data item from the requester; receiving payment data from the requester relating to payment for the requested data; transmitting the requested data to the requester; reading payment distribution information from a data store; and outputting payment data to a payment system for distributing the payment for the requested data.

**[0054]** In a still further aspect of the invention, there is provided a method of providing data to a data requester comprising receiving a request for a data item from the requester; receiving payment data from the requester relating to payment for the requested data; transmitting the

requested data to the requester; and transmitting data access rule data to the requester with the read data.

[0055] These and other aspects of the invention will now be further described, by way of example only, with reference to the accompanying figures.

5

## BRIEF DESCRIPTION OF THE DRAWINGS

[0056] Figure 1 shows a data access device a) from the top; b) from the front; and c) from the side;

[0057] Figure 2 shows, conceptually, a portable data carrier;

[0058] Figures 3a and b show exemplary data access terminals;

10 [0059] Figures 4a and b show, respectively, a logical signal path between elements of a conceptual data access system; and a physical representation of a conceptual data access system;

[0060] Figure 5 shows a content provision system;

[0061] Figure 6 shows a data supply computer system;

[0062] Figure 7 shows a variety of data access terminals;

15 [0063] Figure 8 shows a schematic diagram of components of a data access terminal;

[0064] Figure 9 shows a schematic diagram of components of a data carrier;

[0065] Figure 10 shows a schematic diagram of components of a data access device;

[0066] Figures 11a and 11b are flow diagrams of a data carrier registration process;

20 [0067] Figures 12a-c and 12d-e show, respectively, a flow diagram of data access using a data access terminal; and a flow diagram of data supply using a data supply computer system; and

[0068] Figure 13 shows a flow diagram of data retrieval using a data access device.

## DETAILED DESCRIPTION

[0069] Referring to Figure 1, this shows a data access device for playing MP3 audio (10) with operator controls (12) and LCD display (14). The outline of a smart card data storage device is shown at (16). The operator controls allow a user to select and play tracks, while track information and still or video images are provided on display (14). A slot (18) is provided in the front of the device to receive a smart card-type data storage means. This smart card occupies

space (20) and interfaces with resilient contacts (24); it is held in the data retrieval device against the contacts, by resilient housing element (22).

[0070] Referring now to Figure 2, this shows a portable data carrier (30) suitable for use with the device of Figure 1. The data storage means is based on a standard smart card; it is plastic, about the size of a standard credit card, and has some flexibility. On the card (30) are two sets of contacts, contacts (32) for interfacing with the payment validation means and contacts (34) for interfacing with the memory for storing downloaded data (although in other embodiments, a single set of contacts may be used for both). The surface of the card can be embellished with suitable graphics.

10 [0071] In one embodiment the smart card retains all its useable functionality as specified for standard Electronics Point of Sale Systems (EPOSS) and, if desired, the memory for storing the downloaded data can be electrically separate from this. However, it may be preferable to provide interaction between the standard smart card device and the data memory in order to accomplish the access control/decryption functions described above.

15 [0072] Referring now to Figure 3, an example of a data access terminal is shown at (40). This has a screen (42) and a slot (44) to receive the data carrier (30). Alternatively the data carrier may interface to the terminal via the data access device (10) and an interface (46) to the terminal (40). In Figure 3b a dedicated terminal (50) has a slot (52) to receive the data carrier, a display (54) and controls (56). Coins can be inserted into the terminal at (58) and notes at (60) to charge the data carrier with cash.

20 [0073] Referring now to Figure 4a, this illustrates conceptually the logical connections and data flow between data processing systems involved in payment validation, and data download to the carrier (30). A user connects the data carrier (30) to terminal (40) and logs on to a data web page of data supply service provider (60). Either terminal (40) or service provider (60) then communicates via data paths (62) with a payment validation authority (70) to check and authorize the user's or payer's payment. In the case of electronic cash the terminal (40) may immediately validate the payment information, updating the service provider and/or payment validation authority (70) at a later stage. The logical connection (64) between the terminal and the service provider is preferably made over the internet.



**[0074]** The service provider may provide a direct portal to data providers (80) or may collect information from data suppliers (80) and provide a “front end” to present data from the suppliers to the terminal user. Alternatively, data supply service provider (60) may regulate direct access between terminal (40) and data providers (80), as shown by links (66), by communicating with the terminal and the data providers to provide communication regulation information to, for example, instruct data suppliers about what information the user of terminal (40) should have access to.

**[0075]** In a preferred embodiment, service provider (60) pays royalties at an agreed rate - for example, 10 pence per track or 10 pence per minute - to a computer system owned by a company or entity in the recording industry, such as a content provider or copyright owner, a content publisher or a content creator, and the user of terminal (40) effectively pays the service provider. Billing can also be regulated by bandwidth and/or data download time.

**[0076]** Preferably the service provider (60) monitors the user’s access to the system and either stores or forwards to data providers (80), or downloads to the data carrier (30), usage information. In a preferred embodiment the service provider sends information via terminal (40) to data carrier (30) which can be used to determine incentives to be provided to users of the system.

**[0077]** Figure 4b shows a conceptual physical configuration of the system of Figure 4a in which a plurality of terminals (40), a plurality of service providers (60) and a plurality of data providers (80) all interact via the internet. The physical embodiment of the system is not critical and a skilled person will understand that the terminals, data processing systems and the like can all take a variety of forms.

**[0078]** Referring now to Figure 5, this shows a conceptual illustration of a content provision system 100. Content creators 104a, b generate or receive content data from artist terminals 102a-d and store content data in databases 106a, b. The content data stored in databases 106a, b may comprise audio data, such as music, video data, such as films or TV programs, text, such as literary works, software, such as games software, or other data. Content creators 104a, b are coupled to communications network 101 for communicating created content data over the network. Also coupled to communications network 101 are content publishers 110a and 110b, each of which is coupled to an associated stored content database, 112a and 112b respectively. The content publishers make their stored content available for controlled access using

communications network 101. In some instances, for example where the content data comprises computer games, the functions of content creator and content publisher may be provided by a single entity. Also although conceptually illustrated as blocks in Figure 5, the content creator and content publisher typically each comprise a client server computer network.

5 [0079] The communications network 101 is typically a private communications network, such as an extranet, with security controlled access to entities connected to the network. Physically the network may comprise an internet protocol network or it may comprise, or consist of, dedicated point-to-point links. Thus, for example, a content creator 104 may be directly linked to a content publisher 110 and/or to other entities shown in Figure 5 such as a content provider or  
10 content distributor.

[0080] The content provision system includes a plurality of content providers 108a-e, each coupled to the communications network 101. In the illustrated system, the content providers own copyright in stored content data accessible over communications network 101 and may, in practice, also perform a content publication function. Five content providers own the copyright  
15 in over 80% of all world-wide music sales. The content providers are coupled to stored content databases 106 and 112 via communications network 101, for supplying stored content data.

[0081] A gateway server 114 is also coupled to communications network 101 to link the communications network to other networks such as the internet and/or mobile communications networks. Gateway server 114 provides security and access control functions and firewalls. A  
20 second gateway, content distributor WAN gateway 116, is also shown attached to communications network 101. This provides similar security and firewall functions and coupled communications network 101 to distributor WAN (wide area network) 117. Gateway 116 has logical access to one or more of a content creator, content publisher and content provider for accessing stored content data. Content distributor gateway 116 may be owned by a chain of  
25 record stores and provide content access terminals 118, coupled to WAN 117, in separate retail outlets. Content access terminals 118 have access, via gateway 116, to stored content accessible over communications network 101.

[0082] Referring now to Figure 6, this shows a data supply computer system 120. In this embodiment, three content access terminals 118a-c, e-payment systems 121a, b, and content  
30 access web server 124 are all coupled to internet 142. Data supply system 120 is coupled to the content provision system 100 illustrated in Figure 5. Where communications network 101 of

Figure 5 is an extranet, this extranet physically operates over internet 142; where communications network 101 does not partly operate via internet 142, a connection to internet 142 is established via gateway server 114 as shown in Figure 5. In this way content access terminals 118a-c are provided with controlled access to the stored content data of content provision system 100.

**[0083]** E-payment systems 121a and 121b are coupled to banks 122a, b and c, d respectively. These provide an e-payment system according to, for example, MONDEX, Proton, and/or Visa cash compliant standards. Preferably at least one of e-payment systems 121a, b operates a so-called "open purse" system in which the value is stored as a publicly verifiable digital signature issued by the e-payment system. In such a signature-transporting arrangement, payment data may be validated using public keys and thus payment authentication need not be performed by the e-payment system but may instead be performed by, for example, a data access terminal or data supply system computer, using payment management code. The authenticated signatures, which in effect perform a similar role to checks, are submitted to the relevant e-payment system after authentication for verification and reimbursement or transfer of monetary value. With such a system payments may be made anonymously and thus payer identification is not essential. Data carriers, such as data cards, may be issued with stored value or without value, in which latter case value (that is, a publicly verifiable digital signature) may be written onto the card during an on-line transaction.

**[0084]** In alternative embodiments, a data carrier such as the smart Flash card described below may be used to create value bearing digital signatures as is well-known to those familiar with e-money.

**[0085]** Content access web server 124 is also coupled to internet 142 for providing content access terminals 118a-c with access to content data. Content access web server 124 is typically owned by a content data supply "system owner" who acts as an intermediary between a content access terminal user and a content provider, forwarding content data provided (directly or indirectly) by a content provider to a content access terminal and then to a stored content data carrier. Web server 124 is coupled to web server code storage 126 storing Java code for generating web pages for interpretation by web browsers on content access terminals 111a-c.

The web pages provide the content download, value add, CRM (customer reward management) value check/spend and website link functions described below.

[0086] Web server 124 is coupled to payment processor 128, Digital Rights Management (DRM) processor 130, access control processor 132, and content distribution processor 134. Payment processor 128 includes payment management code storage 128a and is coupled to payment record data store 136. Access control processor 132 includes access control code storage 132a and is coupled to access control data store 138. DRM processor 130 includes DRM code storage 130a and is coupled to content access and DRM data store 140. Content distribution processor 134 includes CRM (customer reward management) and payment distribution management code storage 134a and is also coupled to content access and DRM data store 140. As shown in Figure 6, processors 128-134 are all in communication with one another.

10 [0087] Processors 128, 130, 132 and 134 may comprise separate application programs or a single computer program and may operate on a single physical computer, on which web server 124 may also be provided, or may operate on separate computers. Likewise data stores 136, 138 and 140 may comprise a single physical data store or may be distributed over a plurality of physical devices and may even be at locations physically remote from processors 128-134 and  
15 coupled to these processors via internet 142.

[0088] Web server 124 communicates with processors 128-134 by means of a CGI (common gateway interface) script and the code associated with processors 128-134 may be written in any conventional computer language such as C, C++, or Perl. However, in other embodiments one or more of the processors may be coupled to web server 124 via internet 142 and owned and  
20 operated by a separate entity, such as a financial institution. In this case conventional secure web-based communications may be operated between web server 124 and the relevant processor. In particular, payment processor 128 may be operated by one of the e-payment system providers 128a, b.

[0089] Payment management code 128a issues and authenticates payment data and stores an  
25 audit record in payment record data store 136. Access control code 132a stores identification data (of a user or card) together with registration data provided by a user when registering with the system owner. This data comprises a user password for accessing stored content and/or payment data; user characterizing data, for example characterizing user preferences, for marketing purposes; data indicating an e-payment system to use; and in some embodiments,  
30 further general user related data such as card level data for identifying the provision of "gold" level services to selected users. A copy of the password is stored with the content data on the

portable data carrier, as described further below. Alternatively, one or both of the access control data store and portable data carrier may simply store data for verifying a user-entered password.

5 [0090] Content access and DRM data store 140 stores data related to content access and content use, but does not itself store content data items; these are instead provided via content provision system 100 described above. Data store 140 stores a plurality of records each comprising a data item identifier, a data item description, a data item type or genre, and location data comprising one or more pointers to a location or locations from where the data item can be downloaded. Associated with a data item is also a table of use rule data comprising a list of values (i.e. content data item prices) and corresponding levels of permitted usage. Thus a value of £1 might permit ten plays of a music track, while the value of £10 might permit an unlimited number of plays of the track and copying of the track for personal use.

15 [0091] Also associated with a data item is a table of payment distribution data comprising a list of recipients and corresponding fractions of the data item value each is to receive. Typically, the main recipient will be the copyright owner of the data item and other recipients will be selected from the content creator, the artist or artists, the system owner, the content publisher, and the retailer/distributor. The payment distribution proportions may be dependent upon the payment value, in which case a plurality of sets of payment distribution figures may be associated with each data item, each set of distribution figures corresponding to a payment value range. The payment data and distribution data is here termed DRM (Digital Rights Management) data.

20 [0092] Further associated with a data item is a table of CRM (Customer Reward Management) data, linked to the user rule data, comprising CRM rules to specify, for one or more data item use levels, a quantity of reward points and one or more recipients for the reward points (the recipients may include the card user and the retailer/distributor).

25 [0093] The CRM and payment distribution code 134a operates with content access and DRM data store 140 to inform a system user of the description and value of a data item, to access and download a data item from the content provider system to a content access terminal, to provide content use rules with the data item, and to provide instructions either to payment processor 128 or to e-payment system 121 to distribute payments for the data item to the recipients identified by the data store 140 and to distribute CRM reward points.

**[0094]** The access control data store 138 holds a secure key, such as a secret "public" key in a public key cryptography system, for the system owner to authenticate its identity to a content provider. This data is held securely with other sensitive data in the access control data store 138. As is described in more detail below, when data supply system 120 receives a request for a content data item from a content access terminal 118, it looks up a location from which the data item is available using content access and DRM data store 140 and then determines the identity of the corresponding content provider. This identity is either stored in content access and DRM data store 140 or, as there are relatively few content providers, it may be hard written in DRM code 130a. DRM code 130 then requests access control processor 132 to provide the secure system owner identifier from access control data store 138 to the relevant content provider and sets up a trusted connection between the content provider and content access web server 124 for downloading the data item to a content access terminal 118 and then to a portable data carrier.

**[0095]** Referring now to Figure 7, this shows a variety of content access terminals for accessing data supply computer system 120 over internet 142. The terminals are provided with an interface to a portable data carrier or "smart Flash card" (SFC) as generally described with reference to Figure 2 and as described in more detail below. In most embodiments of the terminal the SFC interface allows the smart Flash card data carrier to be inserted into and removed from the terminal, but in some embodiments the data carrier may be integral with the terminal.

**[0096]** Referring now to the specific embodiments illustrated in Figure 7, a simple content access terminal may comprise a home personal computer 144 with SFC interface 144a. In another embodiment, a mobile communications device 152 is provided with a smart Flash card interface 152a and is coupled to internet 142 via radio tower 150, mobile communications system 148 and mobile communications internet gateway 146.

**[0097]** In another embodiment, a smart Flash card interface is provided to a so-called "set top box" (STB) 154. The set top box is, in effect, a receiver for television programs received on video input 154b, which may comprise a satellite TV signal, a cable TV signal or an off-air TV signal. The video signal is provided from the set top box to television 156 or to some other home entertainment device such as a personal computer (not shown). In another embodiment, content access terminals 166 and 168 each with respective SFC interfaces 166a and 168a are coupled to a retailer local area network (LAN) 160 connected to internet 142 via retailer LAN server 158.

DVD player 164 is also coupled to LAN 160. In a further embodiment a smart Flash card interface 170a is provided for a CD/DVD player 170.

**[0098]** In these latter three embodiments, content data for storage on the smart Flash card may be retrieved from broadcast video and/or a CD or DVD. In this case, the computer data supply system 120 illustrated in Figure 6 may be used to provide use rule data for the content data stored on the smart Flash card, and to pay for data downloaded onto the card; the content data may be captured before or after the data supply system 120 is accessed to enable use of the stored data, but in a preferred embodiment content data written to the card from a supplier other than the content data supply computer system is not accessible to a user until corresponding use rule data has been downloaded from computer system 120, which will normally be after receiving payment for the downloaded data.

**[0099]** Referring now to Figure 8, this shows a schematic diagram of one embodiment of a data access terminal 170. The terminal comprises a general purpose computer including an audio/visual interface 184, a keyboard 186 and a pointing device 188 for providing an interface to the user. The terminal has an internet interface 176, for example a modem, and optionally a LAN/WAN interface 174 for connecting the terminal to a retailer or distributor LAN or WAN. The terminal also has an optional video input 178 for receiving broadcast video data and a media input device 180, such as a CD or DVD drive. Further communications I/O ports 182 may also be provided. A portable data carrier or smart Flash card interface 190 is provided for interfacing to a smart Flash card. Optionally, a cash input and verification system 192, such as is conventionally used in an automatic teller machine (ATM), may also be incorporated within the content access terminal. The terminal has working memory 194 such as RAM and program memory 196 which can comprise any conventional storage device such as RAM, ROM or a disk drive. Program code in program memory 196 may also be stored on removable disk 198. A processor 200 loads and implements program code stored in program memory 196. All the components of the terminal are linked by a data and communications bus 172.

**[0100]** More specifically, processor 200 loads and implements cash payment management code 200a for managing cash input data from cash input and verification system 192, for adding value to a smart Flash card. Processor 200 also implements a web browser 200b for accessing system owner web pages and data exchange interface 200c for exchanging data between a smart Flash card interface to the terminal and data supply system 120.

[0101] Processor 200 also implements off-line contents retrieval code 200d for retrieving data for storage on a smart Flash card from media input device 180 and/or video input 178 and/or LAN/WAN interface 174. The processor implements a content sampler 200e for outputting small extracts of content data items to a user via audio/visual interface 184. Such data item samples may be stored with the content description data in content access data store 140. The processor also implements a smart Flash card interface driver 200f, user interface code 200g and additional communication drivers 200h for driving LAN/WAN interface 174 and/or comms I/O ports 182.

[0102] Referring now to Figure 9, this shows a schematic diagram of components of a portable data carrier 202, in the embodiment shown a so-called "smart Flash card". In this context, "smart Flash card" refers to an IC card similar in size to a plastic payment card incorporating a processor and Flash data memory, preferably of large capacity. For further details on smart cards, reference may be made to the ISO (International Standards Organization) series of standards, including ISO 7810, ISO 7811, ISO 7812, ISO 7813, ISO 7816, ISO 9992 and ISO 10102, which are hereby incorporated by reference.

[0103] Referring in more detail to Figure 9, a data and communications bus 204 links components of the card which include a processor 210, working memory 212, timing and control logic 208 and an external interface which may have contacts (ISO 7816) or be contactless (ISO 10536) for providing external access to a bus 204 for reading data from and writing data to the card 202. Also coupled to bus 204 are permanent program memory 216, non-volatile data memory 218 and non-volatile (Flash) content data memory 214. Non-volatile data memory 218 may comprise EEPROM and permanent program memory 216 may comprise ROM, for example, mask-programmed ROM. All the components of Figure 9 are mounted on a single substrate, in a preferred embodiment bearing contacts for external interface 206.

[0104] Processor 200 loads and implements program code from permanent program memory 216. This code comprises operating system code for providing the card with a basic operating system for at least external communications; payment management code for supplying payment data from non-volatile data memory 218 to pay for downloaded content; DRM (Digital Rights Management) and security code, including code to implement content data use rules and code for password controlled access to data and program functions; CRM code for implementing CRM-



related rules; and content synthesis code for combining stored content data with additional data provided via external interface 206 for synthesizing complete content item data.

5 [0105] Non-volatile data memory 218 stores data including card identity data, access control data, including password data for validating a user password, access record data for storing a record of access attempts and their outcomes, and content supply data such as system owner website addresses and retailer/distributor website addresses.

10 [0106] Data memory 218 further stores card value data comprising e-money such as publicly verifiable digital signatures, and payment data for storing a payment audit trail including payment amounts and data on to whom payments have been made. The memory 218 also stores RFM (Recency Frequency Monetary) data to provide a record of transactions for market research and customer reward purposes, and CRM data storing customer reward points. Data memory 218 also stores an index of content data items stored in Flash memory 214 and associated content use rules, as well as DRM and royalty data for maintaining an audit trail of use history for rights management tracking. Optionally, data memory 218 may also store supply chain data specifying a supply chain route through which data has been obtained from a content provider, which may be used for rewarding supply chain intermediaries, for example on a commission or reward points basis.

20 [0107] Content data memory 214 preferably comprises at least 100 MB of data storage, partitioned as data blocks of a size selected to match the stored content type. For storing video data, Flash memory 214 preferably comprises > 1 GB data storage and the data blocks into which the data memory is partitioned are larger.

25 [0108] Referring now to Figure 10, this shows a schematic diagram of a data access device 220, such as a portable audio/video player. The data access device 220 comprises a conventional dedicated computer system including a processor 238, permanent program memory 236, such as ROM, working memory 234, such as RAM, and timing and control logic 226 all coupled by a data and communications bus 222. Also coupled to the bus are an audio interface 228, a display 230 and user controls 232, for providing a user interface. A smart Flash card interface 224 is coupled to bus 222 for interfacing with a smart Flash card for retrieving and playing stored content data.

**[0109]** Permanent program memory 236 stores program code for implementation by processor 238; this code may also be provided on a data carrier such as a ROM chip or disk 240. Processor 238 implements an SFC interface 238a, a user interface 238b, a content player 238d for retrieving stored content data from a smart Flash card interfaced to the device and for outputting audio and/or video data derived from the retrieved content data (which may comprise compressed audio and/or video data) to a user of the device.

**[0110]** Processor 238 also implements use control 238c for controlling access to and use of contents stored on the smart Flash card by the content access device user. Use control routine 238c and/or DRM and security code in permanent memory 216 on the smart Flash card may also implement digital watermarking and other Secure Digital Music Initiative (SDMI) content protection code as specified in the SDMI portable device specification, part one, version 1.0 (see [www.sdmi.org](http://www.sdmi.org)) which is hereby incorporated by reference.

**[0111]** Figures 11a and 11b show a flow diagram of a process for registering a data carrier or smart Flash card with a data supplier or system owner operating a data supply system as illustrated in Figure 6. A smart Flash card may be issued entirely blank, that is, with no prestored content or value, with prestored value but no prestored content, with prestored content but no prestored value (the content being provided free) or with both prestored value and prestored content. Thus, for example, a user may purchase a card with stored value but no stored content over the counter at a retailer. The process of Figures 11a and 11b illustrates the registration of a card with neither prestored content nor prestored value. As illustrated the registration process records user registration data in the access control data store 138 of Figure 6 and writes value data onto the blank card.

**[0112]** At step S10 a smart Flash card is inserted into a content access terminal smart Flash card interface. The system owner web page is then loaded onto the content access terminal and displayed to the user (step S11). User registration data is then entered into the content access terminal (step S12) and transmitted to the system owner (S13). The user registration data may include a user identity, a preferred e-payment system to use and, optionally, a content access PIN or password, and a service level (for example bronze, silver or gold). The optional password may be a password required by the e-payment system for validation of a payment by the user with the card or it may be a password to protect unauthorized access to content on a smart Flash card to protect stored data in the event, for example, of the card being stolen. A single password

may serve both these functions. The content access terminal web browser is configured so that all sensitive data passing between the terminal and the system owner is securely transmitted, for example by using a conventional encryption system such as PKI (Public Key Infrastructure).

5 [0113] At step S14 a payment request is received from the system owner at the content access terminal and displayed to the user. At step S15 the user enters payment data into the content access terminal and this payment data is transmitted to the system owner, for adding value to the card. This may, for example, be a credit card transaction as is conventionally used for purchase over the internet. Card value data and a card value access code is then received by the content access terminal from the system owner at step S16. The card value corresponds to the payment  
10 made by the user and the value access code may be a password entered by the user at step S12 or may comprise a password or PIN created by payment processor 128 or e-payment system 121 as illustrated in Figure 6. In a preferred embodiment, the user pays the system owner and the system owner then directly provides digital signature data representing value to the content access terminal for writing onto the smart Flash card.

15 [0114] At step S17, card registration data is received from the system owner by the content access terminal and written onto the smart Flash card. This card registration data comprises user identity data, access control data, payment system specifying data, system owner access data, such as a system owner web page address and other dial-up information. At this stage other data may be entered by the user and written onto the card, including, for example, user preference  
20 data, retail outlet and CRM data (alternatively user preference data may be captured at step S12). At step S18 the card value data and card value access code received at step S16 is written onto the card and output to the user visually and, optionally, as a printed record. The card is then available for use, at step S19.

[0115] Figure 11b shows the corresponding registration steps performed by the system owner's data supply system 120. At step S20, a request for a smart card registration web page is received  
25 from a content access device and, at step S21, transmitted to the device. User registration data is then received, at step S22, from the content access terminal and stored in content access control data store 138. The system owner's computer system then transmits, at step S23, a payment request to the content access terminal and receives, at step S24, payment data in reply, this  
30 payment is then authenticated, at step S25, with an e-payment system such as payment system 121 a or b illustrated in Figure 6, and after verification the payment processor 128 of the

computer system transmits, at step S26, value data and a value access code to the content access terminal, for writing onto the smart Flash card. The payment processor then updates the payment record data store 136 with data relating to the transaction (step S27) and, at step S28, retrieves card registration data previously written into the access control data store and transmits this registration data to the content access terminal. At step S29 the transaction is then complete.

**[0116]** Referring now to Figures 12a-c, these illustrate a flow chart for downloading data to a smart Flash card using a data access terminal. At step S30 the smart Flash card is inserted into the content access terminal and the user then enters, at step S31, their password for gaining access to the functionality of the smart Flash card. At step S32, the content access terminal transmits the password to the smart card for verification and the terminal checks, at step S33, whether access is permitted. If access is not permitted, a warning is displayed by the terminal, at step S34, and an access denied count is implemented. A threshold count is then read from the card together with a count of the total number of times access to the card has been denied (step S35). At step S36 the terminal checks whether the total number of denied accesses is within three of the card threshold, and if it is not, returns to step S31, while if it is, it proceeds to step S37 where the terminal displays a warning that a further denied access is likely to result in erasure of content stored on the card. At step S38 the terminal then checks whether its count of denied accesses is greater than its threshold value, returning to step S31 if not, and displaying an access refused message at step S39 if the total number of permitted accesses has been exceeded. The system then waits at step S39 for removal of the smart Flash card from the content access terminal.

**[0117]** If access is permitted at step S33, the terminal loads outline CRM data from the card (step S40) and loads retail data, such as targeted advertising, from the retailer LAN/WAN (step S41). At step S42, the terminal then displays a menu of options, retail data such as advertising or CRM-related data and outline CRM data, such as a total number of reward points earned, on the content access terminal. Many options include download content (from a system owner), add monetary value (to the card), check/spend CRM value stored on the card, follow website links, and exit. At step S43, the user inputs a menu option which, in the illustrated flow chart, is the download option. The system thus passes to step S44 and loads the system owner's content access web page onto the content access terminal and displays this to the user.

[0118] At step S45, the user enters a content search request, which is transmitted to the system owner content distributor processor 134. Content search results are received back from the content distribution processor, including a content identifier, a brief description, and content cost data for at least one payment option, and these results are displayed on the user on the content access terminal. The user then selects one or more content items at step S47 and the selection is transmitted to the content distribution processor 134 where further content cost data and purchase option data is retrieved from data store 140. At step S48, this content cost and purchase data (including use rule data) is received from the system owner and displayed to the terminal user. The user then selects, at step S49, a purchase option and confirms a purchase request or, alternatively, selects "exit" to return to the menu display of step S42. After one or more content items have been selected, together with a purchase option, hard value and CRM data is read from the smart Flash card at step S50, and at step S51 a check is made to determine whether the monetary and/or CRM (reward points) value stored on the smart Flash card is sufficient to purchase the selected purchase data items. If the card value is insufficient, a warning is displayed at step S52 and the system returns to the menu display at step S42. If the card value is sufficient, at step S53 the content access terminal transmits a payment request to the smart Flash card.

[0119] Payment for the data item or items requested may either be made directly to the system owner or may be made to an e-payment system such as e-payment systems 121a and 121b of Figure 6, with these systems then forwarding payment confirmation data to the system owner computer system. Alternatively, the content access terminal may transmit data to the card to set up a transaction directly with a content provider who, being the copyright owner, would normally receive the majority of the payment.

[0120] At step S54, payment data for making a payment to the system owner is received from the smart Flash card by the content access terminal and forwarded to an e-payment system such as e-payment system 121 in Figure 6. Payment record data, validating payment by the card to the system owner, is then received back from the e-payment system at step S55 by the content access terminal and forwarded to the card for updating payment data on the card. In alternative embodiments, payment data from the card may be provided directly to the system owner's data supply computer for authentication and, optionally, further validation with an e-payment system by the system owner's computer.

- 5 [0121] Distribution of the payment received by the system owner from the card is performed by the system owner's computer system, as described elsewhere. Such payment distribution will normally provide a small percentage of the total payment to a "owner" or operator of the content access terminal, such as a retailer, distributor, or in other embodiments, mobile communications network operator or cable TV network operator.
- [0122] In the presently described embodiment, payment record data received in step S55 is transmitted to the system owner to confirm payment by the card and thus it is the content access terminal, in the described embodiment, which authenticates a payment before confirming that the payment has been made to the system owner.
- 10 [0123] In step S56, together with the payment record data, purchase request and card registration data is transmitted to the system owner to identify one or more content data items for purchase and to identify the purchaser. Then, at step S57, the content access terminal sets up a transaction between the system owner data supply computer and the smart Flash card for download of the identified content items requested from the data supplier to the smart Flash card.
- 15 The download is preferably arranged so that there is no permanent storage of downloaded data on the content access terminal (although temporary storage in a disk cache may be permissible), and there is further preferably no temporary storage on the content access terminal of complete data for a content data item. This provides data security and reassurance to the content providers.
- 20 [0124] In the same way as with card registration described with regard to Figure 11, a secure and trusted link is set up between the content access terminal and/or the smart Flash card and the data supply computer in a conventional manner as is well known to those skilled in the art (for example, using public key data encryption). The data transaction may be set up directly between the smart Flash card and the data supply computer, in which case the content access terminal has
- 25 no access to unencrypted content data, or it may be set up between the content access terminal and the data supply computer, in which case unencrypted data is written by the content access terminal to the smart Flash card. Standard transmission protocols are used to ensure complete transmission of a content data item, for example by re-transmitting blocks of data which are not correctly received.
- 30 [0125] Also at step S57, one or more content access rules are received from the system owner data supply computer and written to the smart Flash card so that each content data item has an

associated use rule to specify under what conditions a user of the smart Flash card is allowed access to the content data item.

5 **[0126]** At step S58 the content access terminal receives CRM data from the content distribution processor 134 of the system owner, for example specifying a number of reward points earned by downloading the selected content items. This CRM data will normally be written to the smart Flash card (step S59), but may additionally or alternatively be stored in the content access terminal or in a data store of the content access terminal owner so that the reward points are held by the distributor/retailer/cable TV operator. Finally, also at step S59, a complete record of details of the transactions between the smart Flash card and the content access terminal, 10 the smart Flash card and the system owner, the smart Flash card and the e-payment system, and the content access terminal and the e-payment system and/or data supply computer is recorded on the smart Flash card to provide an audit trail. The system then returns to the menu display at step S42.

15 **[0127]** The add monetary value menu option provided by the menu operates in a similar manner to that described with regard to steps S15 and S16 of Figure 11a and steps S24 to S27 of Figure 11b. In embodiments of the system in which the smart Flash card operates either in a debit (pre-pay) or credit mode, operating mode data may be loaded from the card together with outlying CRM data at step S40. If the card is operating in a credit mode then, at step S41, the content access terminal reads content use data records from the card and proceeds 20 correspondingly to steps S47 and S48 to determine the value of the content accessed and then proceeds according to steps S15 and S16 of Figure 11a and steps S24 to S27 of Figure 11b to retrieve payment for the accessed content from the card owner. Where enhanced access control features are provided, access control data read from the smart Flash card or entered into the content access terminal at step S31 is used, in step S44, to access the system owner content 25 access webpage and, in some embodiments, to set up a secure connection between the content access terminal and system owner data supply computer at step S44.

30 **[0128]** Referring now to Figures 12d and 12e, these show steps in a process implemented on the system owner's data supply computer for providing content data to a content access terminal and thence to a data carrier such as a smart Flash card. At step S60 the system owner's content access web page is requested by a content access terminal and transmitted to the requesting terminal. A search request for searching for a content data item is received, at step S61, from the

content access terminal, and at step S62 content distribution processor 134 of the content supply system searches content access and DRM data store 140 and transmits the search results to the content access terminal. The search results will normally comprise a content item identifier, a content item description, optionally a content item sample, and at least one content item price, for example for a default payment option. The search results may comprise a set of content data items, either selected by type or artist or comprising some predetermined selection in a similar manner to a compilation of tracks on a CD.

**[0129]** At step S63 content item selection data identifying one or more content items is retrieved from the content access terminal, and at step S64 content item purchase data for the selected content items is retrieved from content access and DRM data store 140. This purchase data will normally include, for each selected content item, one or more prices and purchase options. Purchase option data may simply comprise one of a set of standard options, for example "1" to purchase outright, "2" to rent for a period of time, "3" to rent for a number of plays, and "4" to rent with a final purchase option. The purchase option data may also indicate when a content item is available free.

**[0130]** At step S65 the content purchase data is transmitted to the content access terminal, and at step S66 payment record data, indicating a payment made from the smart Flash card to the system owner, purchase request data, card registration data and, optionally, access control data, is received from the content access terminal. The payment record data confirms a payment for the requested data items, the purchase request data specifies the payment option selected for the selected content items, and the card registration data provides data for keeping records of the transaction and providing reward points; the access control data may be required for additional data security. At step S67 the payment record data, in the described embodiment of the system, is validated with an e-payment system such as e-payment system 121 of Figure 6. As illustrated in the flow chart, the data supply system computer checks with the e-payment system that a payment has in fact been made to the system owner. In other embodiments of the system, payment may be made directly to the system owner, and either concurrently with the content access and download process, or, at some later stage, payment data received from the smart Flash card may be verified with the e-payment system for reimbursement of the system owner.

**[0131]** At step S68, payment distribution data is read from the content access data store 140. This data will indicate how payment made by the card for the data is to be distributed among



recipients. In one embodiment, recipient's payment fractions are specified in general terms in the content access data store, for example copyright owner 0.90, system owner 0.01, retailer/distributor 0.02, publisher 0.02, creator 0.05. Identification of who is the relevant copyright owner is stored in the data store together with the content item identifier, but may be selected from more than one possible content provider for the data item, and identification of who is the relevant retailer/distributor may be determined from, for example, content access identity information received from the content access terminal when the system owner content access web page is accessed at step S60. At step S69, payments are then distributed in accordance with the payment distribution data, either by direct distribution of value-bearing digital signatures to the relevant parties, or by issuing a payment distribution instruction to e-payment system 121. Preferably the data supply system stores records of individual card payments and, at intervals, combines the payment distribution data for a plurality of individual records to output payment data for distributing the total payment received by the data supply system from a batch of individual payments.

**[0132]** At step S70, content access rules for the purchased level of service are read from the content access data store. These rules could, for example, specify that only a predetermined number of accesses to the content are permitted, for example 10 plays. Alternatively, the rules could provide access for, say, one month from the download date. Other rules may provide unlimited plays but only on specified players, for example set top boxes owned by a particular cable TV network (as determined by content access device identification data provided to a smart Flash card from a content access device). A content provider identification for the requested content data is also read from the content access data store at step S70 together with CRM data for issuing reward points.

**[0133]** At step S71, content access rules for the requested content data items are retrieved from data store 140 and transmitted to the content access terminal. Then, at step S72, DRM processor 130 of the data supply system transmits a transaction request and authentication data to the content provider identified in step S70. This request identifies the system owner data supply system to the content provider in a secure manner, either by means of physical security, such as a dedicated connection from the system owner data supply system to the content provider, or by means of an electronically secure connection such as an encryption connection. Then, at step S73, the content access web server 124 receives protected content from the content provider, comprising the data items requested by the content access terminal, and transmits this protected

content to the content access terminal. The content is preferably protected by data encryption but may be protected in other ways, for example, by digital watermarking or simply by the large number of other transactions taking place at any one time over the internet. The data supply system computer, at this point, essentially acts as a transparent data forwarder, forwarding data  
5 from the content provider to the content access terminal, which itself is preferably effectively transparent, using data exchange interface 200c to transmit the protected content data directly to the smart Flash card. As described with regard to Figure 12d, the content download protocol includes error protection and transmission retry protocols to ensure substantially error-free data transmission.

10 **[0134]** Once content has been downloaded to the content access terminal (and, hence, to the smart Flash card) at step S74 a record of the purchase data and content accessed is written to payment record data store 136, to provide an audit trail. Then, at step S75, updated CRM data is written to the content access data store 140, using rules stored in the content access data store, in conjunction with a record of the downloaded data items, to calculate the CRM data (i.e. reward  
15 points). The updated CRM data is then also transmitted to the content access terminal, where it can be forwarded to the smart Flash card. Then, at step S76, the process ends.

**[0135]** Referring now to Figure 13, this shows a flow chart for user access of stored data on a smart Flash card using a data access device such as the MP3 player of Figure 1. At step S77 the smart Flash card is inserted into the player and, at step S78, the user enters a password into the  
20 player, which is transmitted to the smart Flash card for validation (this step is optional). If access to stored data on the card is permitted, the process proceeds to step S79 where an index of content data items stored on the card is loaded from the card and displayed together with a menu. The menu provides options including access content, check value (stored on the card), check CRM data (such as reward points) stored on the card, and play options (such as no video, repeat  
25 play, random play, and the like). If the user wishes to access content data items stored on the smart Flash card, a user selection of such items is entered into the player at step S80, for example using cursor keys or a pointer; additionally or alternatively a default play option may be provided to, for example, play the most recently downloaded data.

**[0136]** At step S81 content use status data for the selected content items is loaded from the  
30 smart Flash card together with associated content use rules. Then, at step S82, the use rules and present use status for each selected content item are compared and the result is displayed

together with a content play menu. The content play menu may comprise a simple list of the selected content items with items not available for access highlighted in, for example, red. Alternatively, more detailed content access permission data may be displayed such as the purchased contents use for a content data item, the actual use of the data item made so far, and the available remaining use. Then, at step S83, the player determines whether content use is permitted. If use is not permitted, the process returns to step S79 to re-display the menu; if content use is permitted the system proceeds to step S84.

**[0137]** At step S84 the selected content data items whose use is permitted are retrieved sequentially from the card, decoded as necessary, and the decoded audio and/or video data is made available to the user, for example, by providing audio output at a headphone socket on the player and displaying video output on the player display. Preferably, the player also retrieves supplementary data stored in association with a content data item, such as advertising data, or for a web-enabled player, hot links to web sites for sale of goods or services, particularly those related to the accessed content data item or those identified to appeal to users accessing the data item (such as pop group merchandizing or Harley Davidson (trade mark) motor bikes for rock music/video).

**[0138]** Preferably, the player is provided with "pause" and "continue" functions and corresponding user controls. When "pause" is selected the process passes to step S85 and writes a record to the smart Flash card comprising data specifying how much use has been made of the accessed content data item. In the case of music or video data, this may comprise start and end time markers or simply a play duration time (the start time being predetermined, for example at the start of the data item). In the case of a game the partial use data may comprise an elapsed play time or a number of lives left. In the case of a data item providing a service such as access to stock and share prices, or weather information, or a share dealing service, the partial use information may comprise a status record indicating the status of an interrupted transaction. When the "continue" function is selected on the player the process returns to step S84.

**[0139]** To allow for the smart Flash card being removed from the player between pause and continue events, a check may be made at step S78, by reading a partial use status data from the card, to determine whether a content data item was left in a pause state when the card was last used. If such a pause state is determined to exist for a content data item, the process may then

jump directly to step S85 to allow a user to resume or continue with the content data item and proceed directly to step S84.

5 [0140] Once play is complete the process moves to step S85 where updated content use data is written to the smart Flash card. This updated use data provides a record of the use of a content made in step S84. This record can then be used in steps S81 to S83 to determine, on a subsequent occasion, whether further use of the content data item is permitted. Finally, at step S86, customer reward management reward rules are loaded from the smart Flash card together with CRM data stored on the card. The CRM data is then updated, using the CRM reward rules, to reflect the use of content data items made in step S84 and the updated data is written back to  
10 the smart Flash card.

[0141] In one embodiment the CRM reward rules are determined by the content access terminal owner (retailer/distributor/cable or mobile network operator) and are written onto the card when registering the card. The updated CRM data may then be accessed by a content access terminal for spending or other use when the smart Flash card is next inserted into a  
15 content access terminal. Once the CRM data has been updated, the process returns to step S79 to display the content index and menu.

[0142] The specific embodiments of the invention described above use communication over the internet and web-based technology but this is not essential, and the invention may be implemented using any electronic communications network, such as a wide area network, local  
20 area network, wireless network, or conventional land line network. Likewise, the invention is applicable to the internet, intranets, extranets, and other internet protocol networks.

[0143] The skilled person will understand that many variants to the system are possible and the invention is not limited to the described embodiments but encompasses modifications which lie within the spirit and scope of the present invention.

25

WHAT IS CLAIMED IS:

1           1.       A portable data carrier comprising:  
2           an interface for reading and writing data from and to the carrier;  
3           non-volatile data memory, coupled to the interface, for storing data on the carrier;  
4           non-volatile payment data memory, coupled to the interface, for providing  
5 payment data to an external device.

1           2.       A portable data carrier as claimed in claim 1, further comprising:  
2           a program store storing code implementable by a processor; and  
3           a processor, coupled to the content data memory, the payment data memory, the  
4 interface and to the program store for implementing code in the program store,  
5           wherein the code comprises code to output payment data from the payment data  
6 memory to the interface and code to provide external access to the data memory.

1           3.       A portable data carrier as claimed in claim 2, further comprising a  
2 subscriber identity module (SIM) portion to identify a subscriber to a network operator.

1           4.       A portable data carrier as claimed in claim 3, wherein said payment data  
2 memory is coupled to said SIM portion, and  
3           wherein said providing payment data to an external device comprises providing  
4 said payment data to a network operator to charge said subscriber.

1           5.       A portable data carrier as claimed in claim 2, further comprising non-  
2 volatile use record memory, coupled to the processor, for storing a record of access made to the  
3 data memory and code to update the use record memory in response to external access made to  
4 the data memory.

1           6.       A portable data carrier as claimed in claim 5, further comprising non-  
2 volatile use rule memory, coupled to the processor for storing data use rules, and wherein the  
3 code further comprises code for storing at least one data item in the data memory and at least one  
4 corresponding use rule in the use rule memory and code to provide external access to the data  
5 item in accordance with the use rule.

1           7.       A portable data carrier as claimed in claim 2, further comprising a non-  
2 volatile access control memory coupled to the processor, for storing access control data and  
3 wherein said code to provide external access to the data memory includes code to receive access  
4 request data from the interface, code to determine access permission using the stored access  
5 control data and code to provide external access to the data memory in response to the result of  
6 the determination.

1           8.       A portable data carrier as claimed in claim 14, further comprising non-  
2 volatile access record data memory, coupled to the processor, for storing a record of requests for  
3 external access to the data memory and wherein said code further comprises code to compare  
4 said access record data and said access request data and to erase stored content data in response  
5 to a result of said comparison.

1           9.       A portable data carrier as claimed in claim 2, configured for storing  
2 supplementary data in said data memory, and further comprising code to output the  
3 supplementary data from the interface in addition to the stored data, in response to an external  
4 request to read the data memory.

1           10.      A portable data carrier as claimed in claim 2 further comprising data  
2 synthesis code to receive a first portion of data from the interface and to combine the first portion  
3 with a second portion of data stored in the data memory and to store the result in the data  
4 memory.

1           11.      A portable data carrier as claimed in claim 1, further comprising non-  
2 volatile communications parameter memory for storing data for accessing a communications  
3 network to receive data from the communications network for storage in the data memory.

1           12.      A portable data carrier as claimed in claim 1, wherein the data memory is  
2 partitioned for access on a block-by-block basis, each block comprising a plurality of data bytes  
3 read or written as a set.

1           13.      A portable data carrier as claimed in claim 1 wherein said data memory  
2 has a capacity of greater than 1 MByte, more preferably greater than 100 MBytes, and most  
3 preferably greater than 1 GByte.

1                   14.     A portable data carrier as claimed in claim 1 substantially configured as an  
2 IC card or smart card.

1                   15.     A portable data carrier as claimed in claim 1, wherein the data memory  
2 comprises pre-stored content.

1                   16.     A portable data carrier as claimed in claim 1, wherein the payment data  
2 memory comprises pre-stored payment credit.

1                   17.     A data access device for retrieving stored data from a data carrier, the  
2 device comprising:

3                   a user interface;

4                   a data carrier interface;

5                   a program store storing code implementable by a processor; and

6                   a processor coupled to the user interface, to the data carrier interface and to the  
7 program store for implementing the stored code, the code comprising:

8                   code to retrieve use status data indicating a use status of data stored on the  
9 carrier, and use rules data indicating permissible use of data stored on the carrier;

10                  code to evaluate the use status data using the use rules data to determine  
11 whether access is permitted to the stored data; and

12                  code to access the stored data when access is permitted.

1                   18.     A data access device according to claim 17, further comprising code to  
2 write updated use status data to the carrier after user access to the stored data.

1                   19.     A data access device as claimed in claim 17, further comprising user  
2 access control code to input user access data, to transmit the user access data to the carrier, and to  
3 receive from the carrier user access permission data.

1                   20.     A data access device according to claim 19, further comprising code to  
2 select the use status and use rules data using the user access data.

1                   21.     A data access device as claimed in claim 19, further comprising code to  
2 retrieve and output supplementary data to the user.

1           22.    A data access device according to claim 17 wherein said use rules permit  
2 partial use of a data item stored on the carrier and further comprising code to write partial use  
3 status data to the data carrier when only part of a stored data item has been accessed.

1           23.    A data access device according to claim 17 wherein the device is portable  
2 and the data carrier interface is configured for interfacing with a removable data carrier.

1           24.    A portable data carrier comprising:  
2 an interface for sending and receiving data from and to the carrier;  
3 non-volatile data memory, coupled to the interface, for storing data on the carrier;  
4 and  
5 a digital rights management processor for controlling access to the stored data.

1           25.    A portable data carrier comprising:  
2 an interface for sending and receiving data from and to the carrier;  
3 non-volatile data memory, coupled to the interface, for storing data on the carrier;  
4 and  
5 an access control processor;  
6 wherein the data memory is partitioned as data blocks and the access control  
7 processor controls external access to the data blocks.



ABSTRACT OF THE DISCLOSURE

Data storage and access systems enable downloading and paying for data such as audio and video data, text, software, games and other types of data. A portable data carrier has an interface for sending and receiving data, data memory for storing received content data, and payment validation memory for providing payment validation data to an external device. The carrier may also store a record of access made to the stored content, and content use rules for controlling access to the stored content. Embodiments store further access control data and supplementary data such as hot links to web sites and/or advertising data. A complementary data access terminal, data supply computer system, and data access device are also described. The combination of payment data and stored content data and use rule data helps reduce the risk of unauthorized access to data such as compressed music and video data, especially over the Internet.

I hereby certify that this correspondence is being filed via  
EFS-Web with the United States Patent and Trademark Office  
on November 12, 2010

PATENT  
Attorney Docket No.: 080379-000130US  
Client Reference No.: PN759544USD

TOWNSEND and TOWNSEND and CREW LLP

By: 

**IN THE UNITED STATES PATENT AND TRADEMARK OFFICE**

In re application of:

Patrick RACZ, et al.

Application No.: 12/943,847

Filed: November 10, 2010

For: DATA STORAGE AND ACCESS  
SYSTEMS

Customer No.: 20350

Confirmation No.: 4513

Examiner: Not Yet Assigned

Art Unit: 2876

SUPPLEMENTAL INFORMATION  
DISCLOSURE STATEMENT UNDER  
37 CFR §1.97 and §1.98

Mail Stop Amendment  
Commissioner for Patents  
P.O. Box 1450  
Alexandria, VA 22313-1450

Commissioner:

The reference cited on attached form PTO/SB/08A is being called to the attention of the Examiner. A copy of the reference is not enclosed. It is respectfully requested that the cited references be expressly considered during the prosecution of this application, and the references be made of record therein and appear among the "references cited" on any patent to issue therefrom.

As provided for by 37 CFR §1.97(g) and (h), no inference should be made that the information and references cited are prior art merely because they are in this statement and no representation is being made that a search has been conducted or that this statement encompasses all the possible relevant information.

Applicant believes that no fee is required for submission of this statement. However, if a fee is required, the Commissioner is authorized to deduct such fee from the undersigned's Deposit Account No. 20-1430. Please deduct any additional fees from, or credit any overpayment to, the above-noted Deposit Account.

Respectfully submitted,

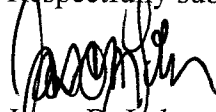

Jason D. Lohr  
Reg. No. 48,163

TOWNSEND and TOWNSEND and CREW LLP  
Two Embarcadero Center, Eighth Floor  
San Francisco, California 94111-3834  
Tel: 925-472-5000  
Fax: 925-472-8895  
JDL:sep  
62996071 v1

Substitute for form 1449/PTO				<b>Complete if Known</b>	
<b>INFORMATION DISCLOSURE STATEMENT BY APPLICANT</b>  (Use as many sheets as necessary)				Application Number	12/943,847
				Filing Date	November 10, 2010
				First Named Inventor	RACZ, Patrick
				Art Unit	2876
				Examiner Name	
Sheet	1	of	1	Attorney Docket Number	080379-000130US

U.S. PATENT DOCUMENTS					
Examiner Initials*	Cite No. <sup>1</sup>	Document Number	Publication Date MM-DD-YYYY	Name of Patentee or Applicant of Cited Document	Pages, Columns, Lines, Where Relevant Passages or Relevant Figures Appear
		Number Kind Code <sup>2</sup> (if known)			
	AA	US 6,658,568 B1	12-02-2003	Ginter et al.	

FOREIGN PATENT DOCUMENTS								
Examiner Initials*	Cite No. <sup>1</sup>	Foreign Patent Document			Publication Date MM-DD-YYYY	Name of Patentee or Applicant of Cited Document	Pages, Columns, Lines, Where Relevant Passages or Relevant Figures Appear	T <sup>6</sup>
		Country Code <sup>3</sup>	Number <sup>4</sup>	Kind Code <sup>5</sup> (if known)				

NON PATENT LITERATURE DOCUMENTS			
Examiner Initials *	Cite No. <sup>1</sup>	Include name of the author (in CAPITAL LETTERS), title of the article (when appropriate), title of the item (book, magazine, journal, serial, symposium, catalog, etc.), date, page(s), volume-issue number(s), publisher, city and/or country where published.	T <sup>6</sup>

Examiner Signature		Date Considered	
-----------------------	--	--------------------	--

EXAMINER: Initial if reference considered, whether or not citation is in conformance with MPEP 609. Draw line through citation if not in conformance and not considered. Include copy of this form with next communication to applicant. <sup>1</sup> Applicant's unique citation designation number (optional). <sup>2</sup> See Kind Codes of U.S. Patent Documents at [www.uspto.gov](http://www.uspto.gov) or MPEP 901.04. <sup>3</sup> Enter Office that issued the document, by the two-letter code (WIPO Standard ST.3). <sup>4</sup> For Japanese patent documents, the indication of the year of the reign of the Emperor must precede the serial number of the patent document. <sup>5</sup> Kind of document by the appropriate symbols as indicated on the document under WIPO Standard ST. 16 if possible. <sup>6</sup> Applicant is to place a check mark here if English language Translation is attached.

## Electronic Acknowledgement Receipt

<b>EFS ID:</b>	8831379
<b>Application Number:</b>	12943847
<b>International Application Number:</b>	
<b>Confirmation Number:</b>	4513
<b>Title of Invention:</b>	DATA STORAGE AND ACCESS SYSTEMS
<b>First Named Inventor/Applicant Name:</b>	Patrick RACZ
<b>Customer Number:</b>	20350
<b>Filer:</b>	Jason Donald Lohr/Scott Pugh
<b>Filer Authorized By:</b>	Jason Donald Lohr
<b>Attorney Docket Number:</b>	080379-000130US
<b>Receipt Date:</b>	12-NOV-2010
<b>Filing Date:</b>	
<b>Time Stamp:</b>	19:59:23
<b>Application Type:</b>	Utility under 35 USC 111(a)

### Payment information:

Submitted with Payment	no
------------------------	----

### File Listing:

Document Number	Document Description	File Name	File Size(Bytes)/ Message Digest	Multi Part /.zip	Pages (if appl.)
1	Information Disclosure Statement (IDS) Filed (SB/08)	SuppIDS_080379_000130US. pdf	97220 <small>dfc41de8b116ab247d7f94795f6c3e3a2f4cf059</small>	no	3

### Warnings:

### Information:

**This Acknowledgement Receipt evidences receipt on the noted date by the USPTO of the indicated documents, characterized by the applicant, and including page counts, where applicable. It serves as evidence of receipt similar to a Post Card, as described in MPEP 503.**

**New Applications Under 35 U.S.C. 111**

**If a new application is being filed and the application includes the necessary components for a filing date (see 37 CFR 1.53(b)-(d) and MPEP 506), a Filing Receipt (37 CFR 1.54) will be issued in due course and the date shown on this Acknowledgement Receipt will establish the filing date of the application.**

**National Stage of an International Application under 35 U.S.C. 371**

**If a timely submission to enter the national stage of an international application is compliant with the conditions of 35 U.S.C. 371 and other applicable requirements a Form PCT/DO/EO/903 indicating acceptance of the application as a national stage submission under 35 U.S.C. 371 will be issued in addition to the Filing Receipt, in due course.**

**New International Application Filed with the USPTO as a Receiving Office**

**If a new international application is being filed and the international application includes the necessary components for an international filing date (see PCT Article 11 and MPEP 1810), a Notification of the International Application Number and of the International Filing Date (Form PCT/RO/105) will be issued in due course, subject to prescriptions concerning national security, and the date shown on this Acknowledgement Receipt will establish the international filing date of the application.**

**PATENT APPLICATION FEE DETERMINATION RECORD**

Substitute for Form PTO-875

Application or Docket Number  
12/943,847

**APPLICATION AS FILED - PART I**

(Column 1) (Column 2)

FOR	NUMBER FILED	NUMBER EXTRA
BASIC FEE (37 CFR 1.16(a), (b), or (c))	N/A	N/A
SEARCH FEE (37 CFR 1.16(k), (l), or (m))	N/A	N/A
EXAMINATION FEE (37 CFR 1.16(o), (p), or (q))	N/A	N/A
TOTAL CLAIMS (37 CFR 1.16(j))	25 minus 20 = *	5
INDEPENDENT CLAIMS (37 CFR 1.16(h))	4 minus 3 = *	1
APPLICATION SIZE FEE (37 CFR 1.16(s))	If the specification and drawings exceed 100 sheets of paper, the application size fee due is \$270 (\$135 for small entity) for each additional 50 sheets or fraction thereof. See 35 U.S.C. 41(a)(1)(G) and 37 CFR 1.16(s).	
MULTIPLE DEPENDENT CLAIM PRESENT (37 CFR 1.16(j))		

\* If the difference in column 1 is less than zero, enter "0" in column 2.

**SMALL ENTITY**

RATE(\$)	FEE(\$)
N/A	82
N/A	270
N/A	110
x 26 =	130
x 110 =	110
	0.00
	0.00
<b>TOTAL</b>	<b>702</b>

**OR OTHER THAN SMALL ENTITY**

RATE(\$)	FEE(\$)
N/A	
N/A	
N/A	
<b>TOTAL</b>	

**APPLICATION AS AMENDED - PART II**

(Column 1) (Column 2) (Column 3)

AMENDMENT A	CLAIMS REMAINING AFTER AMENDMENT	HIGHEST NUMBER PREVIOUSLY PAID FOR	PRESENT EXTRA
	Total (37 CFR 1.16(i))	* Minus **	=
	Independent (37 CFR 1.16(h))	* Minus ***	=
	Application Size Fee (37 CFR 1.16(s))		
FIRST PRESENTATION OF MULTIPLE DEPENDENT CLAIM (37 CFR 1.16(j))			

**SMALL ENTITY**

RATE(\$)	ADDITIONAL FEE(\$)
x =	
x =	
<b>TOTAL ADD'L FEE</b>	

**OR OTHER THAN SMALL ENTITY**

RATE(\$)	ADDITIONAL FEE(\$)
x =	
x =	
<b>TOTAL ADD'L FEE</b>	

(Column 1) (Column 2) (Column 3)

AMENDMENT B	CLAIMS REMAINING AFTER AMENDMENT	HIGHEST NUMBER PREVIOUSLY PAID FOR	PRESENT EXTRA
	Total (37 CFR 1.16(i))	* Minus **	=
	Independent (37 CFR 1.16(h))	* Minus ***	=
	Application Size Fee (37 CFR 1.16(s))		
FIRST PRESENTATION OF MULTIPLE DEPENDENT CLAIM (37 CFR 1.16(j))			

RATE(\$)	ADDITIONAL FEE(\$)
x =	
x =	
<b>TOTAL ADD'L FEE</b>	

**OR OTHER THAN SMALL ENTITY**

RATE(\$)	ADDITIONAL FEE(\$)
x =	
x =	
<b>TOTAL ADD'L FEE</b>	

\* If the entry in column 1 is less than the entry in column 2, write "0" in column 3.

\*\* If the "Highest Number Previously Paid For" IN THIS SPACE is less than 20, enter "20".

\*\*\* If the "Highest Number Previously Paid For" IN THIS SPACE is less than 3, enter "3".

The "Highest Number Previously Paid For" (Total or Independent) is the highest found in the appropriate box in column 1.



UNITED STATES PATENT AND TRADEMARK OFFICE

UNITED STATES DEPARTMENT OF COMMERCE
United States Patent and Trademark Office
Address: COMMISSIONER FOR PATENTS
P.O. Box 1450
Alexandria, Virginia 22313-1450
www.uspto.gov

Table with 7 columns: APPLICATION NUMBER, FILING or 371(c) DATE, GRP ART UNIT, FIL FEE REC'D, ATTY,DOCKET.NO, TOT CLAIMS, IND CLAIMS. Row 1: 12/943,847, 11/10/2010, 2876, 702, 080379-000130US, 25, 4

CONFIRMATION NO. 4513

20350
TOWNSEND AND TOWNSEND AND CREW, LLP
TWO EMBARCADERO CENTER
EIGHTH FLOOR
SAN FRANCISCO, CA 94111-3834

FILING RECEIPT



Date Mailed: 11/24/2010

Receipt is acknowledged of this non-provisional patent application. The application will be taken up for examination in due course. Applicant will be notified as to the results of the examination. Any correspondence concerning the application must include the following identification information: the U.S. APPLICATION NUMBER, FILING DATE, NAME OF APPLICANT, and TITLE OF INVENTION. Fees transmitted by check or draft are subject to collection. Please verify the accuracy of the data presented on this receipt. If an error is noted on this Filing Receipt, please submit a written request for a Filing Receipt Correction. Please provide a copy of this Filing Receipt with the changes noted thereon. If you received a "Notice to File Missing Parts" for this application, please submit any corrections to this Filing Receipt with your reply to the Notice. When the USPTO processes the reply to the Notice, the USPTO will generate another Filing Receipt incorporating the requested corrections

Applicant(s)

Hermen-ard HULST, Amsterdam, NETHERLANDS;
Patrick Sandor RACZ, Saint Heller, JERSEY;

Assignment For Published Patent Application

Smartflash Technologies Limited, Wickhams' Cay, VIRGIN ISLANDS, BRITISH

Power of Attorney: None

Domestic Priority data as claimed by applicant

This application is a CON of 12/014,558 01/15/2008
which is a CON of 11/336,758 01/19/2006 PAT 7,334,720
which is a CON of 10/111,716 09/17/2002 ABN
which is a 371 of PCT/GB00/04110 10/25/2000

Foreign Applications

UNITED KINGDOM 9925227.2 11/25/1999

Request to Retrieve - This application either claims priority to one or more applications filed in an intellectual property Office that participates in the Priority Document Exchange (PDX) program or contains a proper Request to Retrieve Electronic Priority Application(s) (PTO/SB/38 or its equivalent). Consequently, the USPTO will attempt to electronically retrieve these priority documents.

If Required, Foreign Filing License Granted: 11/22/2010

The country code and number of your priority application, to be used for filing abroad under the Paris Convention, is US 12/943,847

Projected Publication Date: 03/03/2011



**Non-Publication Request:** No

**Early Publication Request:** No

**\*\* SMALL ENTITY \*\***

**Title**

DATA STORAGE AND ACCESS SYSTEMS

**Preliminary Class**

235

## **PROTECTING YOUR INVENTION OUTSIDE THE UNITED STATES**

Since the rights granted by a U.S. patent extend only throughout the territory of the United States and have no effect in a foreign country, an inventor who wishes patent protection in another country must apply for a patent in a specific country or in regional patent offices. Applicants may wish to consider the filing of an international application under the Patent Cooperation Treaty (PCT). An international (PCT) application generally has the same effect as a regular national patent application in each PCT-member country. The PCT process **simplifies** the filing of patent applications on the same invention in member countries, but **does not result** in a grant of "an international patent" and does not eliminate the need of applicants to file additional documents and fees in countries where patent protection is desired.

Almost every country has its own patent law, and a person desiring a patent in a particular country must make an application for patent in that country in accordance with its particular laws. Since the laws of many countries differ in various respects from the patent law of the United States, applicants are advised to seek guidance from specific foreign countries to ensure that patent rights are not lost prematurely.

Applicants also are advised that in the case of inventions made in the United States, the Director of the USPTO must issue a license before applicants can apply for a patent in a foreign country. The filing of a U.S. patent application serves as a request for a foreign filing license. The application's filing receipt contains further information and guidance as to the status of applicant's license for foreign filing.

Applicants may wish to consult the USPTO booklet, "General Information Concerning Patents" (specifically, the section entitled "Treaties and Foreign Patents") for more information on timeframes and deadlines for filing foreign patent applications. The guide is available either by contacting the USPTO Contact Center at 800-786-9199, or it can be viewed on the USPTO website at <http://www.uspto.gov/web/offices/pac/doc/general/index.html>.

For information on preventing theft of your intellectual property (patents, trademarks and copyrights), you may wish to consult the U.S. Government website, <http://www.stopfakes.gov>. Part of a Department of Commerce initiative, this website includes self-help "toolkits" giving innovators guidance on how to protect intellectual property in specific countries such as China, Korea and Mexico. For questions regarding patent enforcement issues, applicants may call the U.S. Government hotline at 1-866-999-HALT (1-866-999-4158).

**LICENSE FOR FOREIGN FILING UNDER**  
**Title 35, United States Code, Section 184**  
**Title 37, Code of Federal Regulations, 5.11 & 5.15**

**GRANTED**

The applicant has been granted a license under 35 U.S.C. 184, if the phrase "IF REQUIRED, FOREIGN FILING LICENSE GRANTED" followed by a date appears on this form. Such licenses are issued in all applications where the conditions for issuance of a license have been met, regardless of whether or not a license may be required as set forth in 37 CFR 5.15. The scope and limitations of this license are set forth in 37 CFR 5.15(a) unless an earlier license has been issued under 37 CFR 5.15(b). The license is subject to revocation upon written notification. The date indicated is the effective date of the license, unless an earlier license of similar scope has been granted under 37 CFR 5.13 or 5.14.

This license is to be retained by the licensee and may be used at any time on or after the effective date thereof unless it is revoked. This license is automatically transferred to any related applications(s) filed under 37 CFR 1.53(d). This license is not retroactive.

The grant of a license does not in any way lessen the responsibility of a licensee for the security of the subject matter as imposed by any Government contract or the provisions of existing laws relating to espionage and the national security or the export of technical data. Licensees should apprise themselves of current regulations especially with respect to certain countries, of other agencies, particularly the Office of Defense Trade Controls, Department of State (with respect to Arms, Munitions and Implements of War (22 CFR 121-128)); the Bureau of Industry and Security, Department of Commerce (15 CFR parts 730-774); the Office of Foreign Assets Control, Department of Treasury (31 CFR Parts 500+) and the Department of Energy.

**NOT GRANTED**

No license under 35 U.S.C. 184 has been granted at this time, if the phrase "IF REQUIRED, FOREIGN FILING LICENSE GRANTED" DOES NOT appear on this form. Applicant may still petition for a license under 37 CFR 5.12, if a license is desired before the expiration of 6 months from the filing date of the application. If 6 months has lapsed from the filing date of this application and the licensee has not received any indication of a secrecy order under 35 U.S.C. 181, the licensee may foreign file the application pursuant to 37 CFR 5.15(b).

I hereby certify that this correspondence is being filed via  
EFS-Web with the United States Patent and Trademark Office  
on December 21, 2010

PATENT  
Attorney Docket No.: 080379-000130US  
Client Reference No.: PN759544USD

TOWNSEND and TOWNSEND and CREW LLP

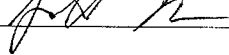
By: 

**IN THE UNITED STATES PATENT AND TRADEMARK OFFICE**

In re application of:

Patrick RACZ, et al.

Application No.: 12/943,847

Filed: November 10, 2010

For: DATA STORAGE AND ACCESS  
SYSTEMS

Customer No.: 20350

Confirmation No.: 4513

Examiner: Not Yet Assigned

Art Unit: 2876

REQUEST FOR CORRECTED FILING  
RECEIPT

Commissioner for Patents  
P.O. Box 1450  
Alexandria, VA 22313-1450

Commissioner:

Attached is a copy of the official Filing Receipt received from the Patent and Trademark Office in the above-noted patent application for which issuance of a corrected filing receipt is respectfully requested.

The filing date of the foreign priority application is listed incorrectly. Please correct as follows:

UNITED KINGDOM 9925227. ~~11/25/1999~~ 10/25/1999

The requested corrections are shown on the enclosed copy of the Official Filing Receipt.

The undersigned believes that no fee is due for correction of the Filing Receipt.  
However, if applicable, please charge any additional fees or credit overpayment to Deposit  
Account No. 20-1430.

Respectfully submitted,

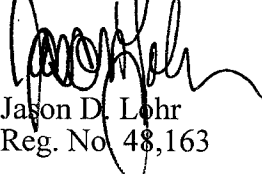

Jason D. Lohr  
Reg. No. 48,163

**Customer No. 20350**

TOWNSEND and TOWNSEND and CREW LLP  
Two Embarcadero Center, Eighth Floor  
San Francisco, California 94111-3834  
Tel: 925-472-5000  
Fax: 415 576-0300  
JDL:sep

63062098 v1



UNITED STATES PATENT AND TRADEMARK OFFICE

UNITED STATES DEPARTMENT OF COMMERCE
United States Patent and Trademark Office
Address: COMMISSIONER FOR PATENTS
P.O. Box 1450
Alexandria, Virginia 22313-1450
www.uspto.gov

Table with 6 columns: APPLICATION NUMBER, FILING or 371(c) DATE, GRP ART UNIT, FIL FEE REC'D, ATTY.DOCKET.NO, TOT CLAIMS, IND CLAIMS. Row 1: 12/943,847, 11/10/2010, 2876, 702, 080379-000130US, 25, 4

CONFIRMATION NO. 4513

FILING RECEIPT



20350
TOWNSEND AND TOWNSEND AND CREW, LLP
TWO EMBARCADERO CENTER
EIGHTH FLOOR
SAN FRANCISCO, CA 94111-3834

Date Mailed: 11/24/2010

Receipt is acknowledged of this non-provisional patent application. The application will be taken up for examination in due course. Applicant will be notified as to the results of the examination. Any correspondence concerning the application must include the following identification information: the U.S. APPLICATION NUMBER, FILING DATE, NAME OF APPLICANT, and TITLE OF INVENTION. Fees transmitted by check or draft are subject to collection. Please verify the accuracy of the data presented on this receipt. If an error is noted on this Filing Receipt, please submit a written request for a Filing Receipt Correction. Please provide a copy of this Filing Receipt with the changes noted thereon. If you received a "Notice to File Missing Parts" for this application, please submit any corrections to this Filing Receipt with your reply to the Notice. When the USPTO processes the reply to the Notice, the USPTO will generate another Filing Receipt incorporating the requested corrections

Applicant(s)

Hermen-ard HULST, Amsterdam, NETHERLANDS;
Patrick Sandor RACZ, Saint Heller, JERSEY;

Assignment For Published Patent Application

Smartflash Technologies Limited, Wickhams' Cay, VIRGIN ISLANDS, BRITISH

Power of Attorney: None

Domestic Priority data as claimed by applicant

This application is a CON of 12/014,558 01/15/2008
which is a CON of 11/336,758 01/19/2006 PAT 7,334,720
which is a CON of 10/111,716 09/17/2002 ABN
which is a 371 of PCT/GB00/04110 10/25/2000

Foreign Applications

UNITED KINGDOM 9925227.2 ~~11/25/1999~~
10/25/1977

Request to Retrieve - This application either claims priority to one or more applications filed in an intellectual property Office that participates in the Priority Document Exchange (PDX) program or contains a proper Request to Retrieve Electronic Priority Application(s) (PTO/SB/38 or its equivalent). Consequently, the USPTO will attempt to electronically retrieve these priority documents.

If Required, Foreign Filing License Granted: 11/22/2010

The country code and number of your priority application, to be used for filing abroad under the Paris Convention, is US 12/943,847

Projected Publication Date: 03/03/2011

**Non-Publication Request:** No

**Early Publication Request:** No

**\*\* SMALL ENTITY \*\***

**Title**

DATA STORAGE AND ACCESS SYSTEMS

**Preliminary Class**

235

## **PROTECTING YOUR INVENTION OUTSIDE THE UNITED STATES**

Since the rights granted by a U.S. patent extend only throughout the territory of the United States and have no effect in a foreign country, an inventor who wishes patent protection in another country must apply for a patent in a specific country or in regional patent offices. Applicants may wish to consider the filing of an international application under the Patent Cooperation Treaty (PCT). An international (PCT) application generally has the same effect as a regular national patent application in each PCT-member country. The PCT process **simplifies** the filing of patent applications on the same invention in member countries, but **does not result** in a grant of "an international patent" and does not eliminate the need of applicants to file additional documents and fees in countries where patent protection is desired.

Almost every country has its own patent law, and a person desiring a patent in a particular country must make an application for patent in that country in accordance with its particular laws. Since the laws of many countries differ in various respects from the patent law of the United States, applicants are advised to seek guidance from specific foreign countries to ensure that patent rights are not lost prematurely.

Applicants also are advised that in the case of inventions made in the United States, the Director of the USPTO **must** issue a license before applicants can apply for a patent in a foreign country. The filing of a U.S. patent application serves as a request for a foreign filing license. The application's filing receipt contains further information and guidance as to the status of applicant's license for foreign filing.

Applicants may wish to consult the USPTO booklet, "General Information Concerning Patents" (specifically, the section entitled "Treaties and Foreign Patents") for more information on timeframes and deadlines for filing foreign patent applications. The guide is available either by contacting the USPTO Contact Center at 800-786-9199, or it can be viewed on the USPTO website at <http://www.uspto.gov/web/offices/pac/doc/general/index.html>.

For information on preventing theft of your intellectual property (patents, trademarks and copyrights), you may wish to consult the U.S. Government website, <http://www.stopfakes.gov>. Part of a Department of Commerce initiative, this website includes self-help "toolkits" giving innovators guidance on how to protect intellectual property in specific countries such as China, Korea and Mexico. For questions regarding patent enforcement issues, applicants may call the U.S. Government hotline at 1-866-999-HALT (1-866-999-4158).

**LICENSE FOR FOREIGN FILING UNDER  
Title 35, United States Code, Section 184  
Title 37, Code of Federal Regulations, 5.11 & 5.15**

**GRANTED**

The applicant has been granted a license under 35 U.S.C. 184, if the phrase "IF REQUIRED, FOREIGN FILING LICENSE GRANTED" followed by a date appears on this form. Such licenses are issued in all applications where the conditions for issuance of a license have been met, regardless of whether or not a license may be required as set forth in 37 CFR 5.15. The scope and limitations of this license are set forth in 37 CFR 5.15(a) unless an earlier license has been issued under 37 CFR 5.15(b). The license is subject to revocation upon written notification. The date indicated is the effective date of the license, unless an earlier license of similar scope has been granted under 37 CFR 5.13 or 5.14.

This license is to be retained by the licensee and may be used at any time on or after the effective date thereof unless it is revoked. This license is automatically transferred to any related applications(s) filed under 37 CFR 1.53(d). This license is not retroactive.

The grant of a license does not in any way lessen the responsibility of a licensee for the security of the subject matter as imposed by any Government contract or the provisions of existing laws relating to espionage and the national security or the export of technical data. Licensees should apprise themselves of current regulations especially with respect to certain countries, of other agencies, particularly the Office of Defense Trade Controls, Department of State (with respect to Arms, Munitions and Implements of War (22 CFR 121-128)); the Bureau of Industry and Security, Department of Commerce (15 CFR parts 730-774); the Office of Foreign Assets Control, Department of Treasury (31 CFR Parts 500+) and the Department of Energy.

**NOT GRANTED**

No license under 35 U.S.C. 184 has been granted at this time, if the phrase "IF REQUIRED, FOREIGN FILING LICENSE GRANTED" DOES NOT appear on this form. Applicant may still petition for a license under 37 CFR 5.12, if a license is desired before the expiration of 6 months from the filing date of the application. If 6 months has lapsed from the filing date of this application and the licensee has not received any indication of a secrecy order under 35 U.S.C. 181, the licensee may foreign file the application pursuant to 37 CFR 5.15(b).

## Electronic Acknowledgement Receipt

<b>EFS ID:</b>	9088352
<b>Application Number:</b>	12943847
<b>International Application Number:</b>	
<b>Confirmation Number:</b>	4513
<b>Title of Invention:</b>	DATA STORAGE AND ACCESS SYSTEMS
<b>First Named Inventor/Applicant Name:</b>	Hermen-ard HULST
<b>Customer Number:</b>	20350
<b>Filer:</b>	Jason Donald Lohr/Scott Pugh
<b>Filer Authorized By:</b>	Jason Donald Lohr
<b>Attorney Docket Number:</b>	080379-000130US
<b>Receipt Date:</b>	21-DEC-2010
<b>Filing Date:</b>	10-NOV-2010
<b>Time Stamp:</b>	16:21:06
<b>Application Type:</b>	Utility under 35 USC 111(a)

### Payment information:

Submitted with Payment	no
------------------------	----

### File Listing:

Document Number	Document Description	File Name	File Size(Bytes)/ Message Digest	Multi Part /.zip	Pages (if appl.)
1	Request for Corrected Filing Receipt	Request_Correct_FR_080379_00130US.pdf	215340 <small>f83f1517c4f52cf66aba4f70e32f454796ebb990</small>	no	5

### Warnings:

### Information:



**This Acknowledgement Receipt evidences receipt on the noted date by the USPTO of the indicated documents, characterized by the applicant, and including page counts, where applicable. It serves as evidence of receipt similar to a Post Card, as described in MPEP 503.**

**New Applications Under 35 U.S.C. 111**

**If a new application is being filed and the application includes the necessary components for a filing date (see 37 CFR 1.53(b)-(d) and MPEP 506), a Filing Receipt (37 CFR 1.54) will be issued in due course and the date shown on this Acknowledgement Receipt will establish the filing date of the application.**

**National Stage of an International Application under 35 U.S.C. 371**

**If a timely submission to enter the national stage of an international application is compliant with the conditions of 35 U.S.C. 371 and other applicable requirements a Form PCT/DO/EO/903 indicating acceptance of the application as a national stage submission under 35 U.S.C. 371 will be issued in addition to the Filing Receipt, in due course.**

**New International Application Filed with the USPTO as a Receiving Office**

**If a new international application is being filed and the international application includes the necessary components for an international filing date (see PCT Article 11 and MPEP 1810), a Notification of the International Application Number and of the International Filing Date (Form PCT/RO/105) will be issued in due course, subject to prescriptions concerning national security, and the date shown on this Acknowledgement Receipt will establish the international filing date of the application.**



UNITED STATES PATENT AND TRADEMARK OFFICE

UNITED STATES DEPARTMENT OF COMMERCE
United States Patent and Trademark Office
Address: COMMISSIONER FOR PATENTS
P.O. Box 1450
Alexandria, Virginia 22313-1450
www.uspto.gov

Table with 7 columns: APPLICATION NUMBER, FILING or 371(c) DATE, GRP ART UNIT, FIL FEE REC'D, ATTY DOCKET NO, TOT CLAIMS, IND CLAIMS. Row 1: 12/943,847, 11/10/2010, 2887, 702, 080379-000130US, 25, 4

CONFIRMATION NO. 4513

CORRECTED FILING RECEIPT



20350
TOWNSEND AND TOWNSEND AND CREW, LLP
TWO EMBARCADERO CENTER
EIGHTH FLOOR
SAN FRANCISCO, CA 94111-3834

Date Mailed: 12/29/2010

Receipt is acknowledged of this non-provisional patent application. The application will be taken up for examination in due course. Applicant will be notified as to the results of the examination. Any correspondence concerning the application must include the following identification information: the U.S. APPLICATION NUMBER, FILING DATE, NAME OF APPLICANT, and TITLE OF INVENTION. Fees transmitted by check or draft are subject to collection. Please verify the accuracy of the data presented on this receipt. If an error is noted on this Filing Receipt, please submit a written request for a Filing Receipt Correction. Please provide a copy of this Filing Receipt with the changes noted thereon. If you received a "Notice to File Missing Parts" for this application, please submit any corrections to this Filing Receipt with your reply to the Notice. When the USPTO processes the reply to the Notice, the USPTO will generate another Filing Receipt incorporating the requested corrections

Applicant(s)

Hermen-ard HULST, Amsterdam, NETHERLANDS;
Patrick Sandor RACZ, Saint Heller, JERSEY;

Assignment For Published Patent Application

Smartflash Technologies Limited, Wickhams' Cay, VIRGIN ISLANDS, BRITISH

Power of Attorney: None

Domestic Priority data as claimed by applicant

This application is a CON of 12/014,558 01/15/2008
which is a CON of 11/336,758 01/19/2006 PAT 7,334,720
which is a CON of 10/111,716 09/17/2002 ABN
which is a 371 of PCT/GB00/04110 10/25/2000

Foreign Applications

UNITED KINGDOM 9925227.2 10/25/1999

Request to Retrieve - This application either claims priority to one or more applications filed in an intellectual property Office that participates in the Priority Document Exchange (PDX) program or contains a proper Request to Retrieve Electronic Priority Application(s) (PTO/SB/38 or its equivalent). Consequently, the USPTO will attempt to electronically retrieve these priority documents.

If Required, Foreign Filing License Granted: 11/22/2010

The country code and number of your priority application, to be used for filing abroad under the Paris Convention, is US 12/943,847

Projected Publication Date: 03/31/2011

**Non-Publication Request:** No

**Early Publication Request:** No

**\*\* SMALL ENTITY \*\***

**Title**

DATA STORAGE AND ACCESS SYSTEMS

**Preliminary Class**

235

## **PROTECTING YOUR INVENTION OUTSIDE THE UNITED STATES**

Since the rights granted by a U.S. patent extend only throughout the territory of the United States and have no effect in a foreign country, an inventor who wishes patent protection in another country must apply for a patent in a specific country or in regional patent offices. Applicants may wish to consider the filing of an international application under the Patent Cooperation Treaty (PCT). An international (PCT) application generally has the same effect as a regular national patent application in each PCT-member country. The PCT process **simplifies** the filing of patent applications on the same invention in member countries, but **does not result** in a grant of "an international patent" and does not eliminate the need of applicants to file additional documents and fees in countries where patent protection is desired.

Almost every country has its own patent law, and a person desiring a patent in a particular country must make an application for patent in that country in accordance with its particular laws. Since the laws of many countries differ in various respects from the patent law of the United States, applicants are advised to seek guidance from specific foreign countries to ensure that patent rights are not lost prematurely.

Applicants also are advised that in the case of inventions made in the United States, the Director of the USPTO must issue a license before applicants can apply for a patent in a foreign country. The filing of a U.S. patent application serves as a request for a foreign filing license. The application's filing receipt contains further information and guidance as to the status of applicant's license for foreign filing.

Applicants may wish to consult the USPTO booklet, "General Information Concerning Patents" (specifically, the section entitled "Treaties and Foreign Patents") for more information on timeframes and deadlines for filing foreign patent applications. The guide is available either by contacting the USPTO Contact Center at 800-786-9199, or it can be viewed on the USPTO website at <http://www.uspto.gov/web/offices/pac/doc/general/index.html>.

For information on preventing theft of your intellectual property (patents, trademarks and copyrights), you may wish to consult the U.S. Government website, <http://www.stopfakes.gov>. Part of a Department of Commerce initiative, this website includes self-help "toolkits" giving innovators guidance on how to protect intellectual property in specific countries such as China, Korea and Mexico. For questions regarding patent enforcement issues, applicants may call the U.S. Government hotline at 1-866-999-HALT (1-866-999-4158).

**LICENSE FOR FOREIGN FILING UNDER**  
**Title 35, United States Code, Section 184**  
**Title 37, Code of Federal Regulations, 5.11 & 5.15**

**GRANTED**

The applicant has been granted a license under 35 U.S.C. 184, if the phrase "IF REQUIRED, FOREIGN FILING LICENSE GRANTED" followed by a date appears on this form. Such licenses are issued in all applications where the conditions for issuance of a license have been met, regardless of whether or not a license may be required as set forth in 37 CFR 5.15. The scope and limitations of this license are set forth in 37 CFR 5.15(a) unless an earlier license has been issued under 37 CFR 5.15(b). The license is subject to revocation upon written notification. The date indicated is the effective date of the license, unless an earlier license of similar scope has been granted under 37 CFR 5.13 or 5.14.

This license is to be retained by the licensee and may be used at any time on or after the effective date thereof unless it is revoked. This license is automatically transferred to any related applications(s) filed under 37 CFR 1.53(d). This license is not retroactive.

The grant of a license does not in any way lessen the responsibility of a licensee for the security of the subject matter as imposed by any Government contract or the provisions of existing laws relating to espionage and the national security or the export of technical data. Licensees should apprise themselves of current regulations especially with respect to certain countries, of other agencies, particularly the Office of Defense Trade Controls, Department of State (with respect to Arms, Munitions and Implements of War (22 CFR 121-128)); the Bureau of Industry and Security, Department of Commerce (15 CFR parts 730-774); the Office of Foreign Assets Control, Department of Treasury (31 CFR Parts 500+) and the Department of Energy.

**NOT GRANTED**

No license under 35 U.S.C. 184 has been granted at this time, if the phrase "IF REQUIRED, FOREIGN FILING LICENSE GRANTED" DOES NOT appear on this form. Applicant may still petition for a license under 37 CFR 5.12, if a license is desired before the expiration of 6 months from the filing date of the application. If 6 months has lapsed from the filing date of this application and the licensee has not received any indication of a secrecy order under 35 U.S.C. 181, the licensee may foreign file the application pursuant to 37 CFR 5.15(b).



UNITED STATES PATENT AND TRADEMARK OFFICE

UNITED STATES DEPARTMENT OF COMMERCE  
United States Patent and Trademark Office  
Address: COMMISSIONER FOR PATENTS  
P.O. Box 1450  
Alexandria, Virginia 22313-1450  
www.uspto.gov

APPLICATION NO.	FILING DATE	FIRST NAMED INVENTOR	ATTORNEY DOCKET NO.	CONFIRMATION NO.
12/943,847	11/10/2010	Hermen-ard HULST	080379-000130US	4513

20350 7590 01/13/2011  
KILPATRICK TOWNSEND & STOCKTON LLP  
TWO EMBARCADERO CENTER  
EIGHTH FLOOR  
SAN FRANCISCO, CA 94111-3834

EXAMINER
----------

LE, THIEN MINH

ART UNIT	PAPER NUMBER
----------	--------------

2887

MAIL DATE	DELIVERY MODE
-----------	---------------

01/13/2011

PAPER

**Please find below and/or attached an Office communication concerning this application or proceeding.**

The time period for reply, if any, is set in the attached communication.

<b>Office Action Summary</b>	<b>Application No.</b> 12/943,847	<b>Applicant(s)</b> HULST ET AL.	
	<b>Examiner</b> THIEN M. LE	<b>Art Unit</b> 2887	

**-- The MAILING DATE of this communication appears on the cover sheet with the correspondence address --**

**Period for Reply**

A SHORTENED STATUTORY PERIOD FOR REPLY IS SET TO EXPIRE 3 MONTH(S) OR THIRTY (30) DAYS, WHICHEVER IS LONGER, FROM THE MAILING DATE OF THIS COMMUNICATION.

- Extensions of time may be available under the provisions of 37 CFR 1.136(a). In no event, however, may a reply be timely filed after SIX (6) MONTHS from the mailing date of this communication.
- If NO period for reply is specified above, the maximum statutory period will apply and will expire SIX (6) MONTHS from the mailing date of this communication.
- Failure to reply within the set or extended period for reply will, by statute, cause the application to become ABANDONED (35 U.S.C. § 133). Any reply received by the Office later than three months after the mailing date of this communication, even if timely filed, may reduce any earned patent term adjustment. See 37 CFR 1.704(b).

**Status**

- 1)  Responsive to communication(s) filed on \_\_\_\_.
- 2a)  This action is **FINAL**.                      2b)  This action is non-final.
- 3)  Since this application is in condition for allowance except for formal matters, prosecution as to the merits is closed in accordance with the practice under *Ex parte Quayle*, 1935 C.D. 11, 453 O.G. 213.

**Disposition of Claims**

- 4)  Claim(s) 1-25 is/are pending in the application.  
4a) Of the above claim(s) \_\_\_\_ is/are withdrawn from consideration.
- 5)  Claim(s) 17-23 is/are allowed.
- 6)  Claim(s) 1,2,5,7,8,14-16,24 and 25 is/are rejected.
- 7)  Claim(s) 3,4,6 and 9-13 is/are objected to.
- 8)  Claim(s) \_\_\_\_ are subject to restriction and/or election requirement.

**Application Papers**

- 9)  The specification is objected to by the Examiner.
- 10)  The drawing(s) filed on 10 November 2010 is/are: a)  accepted or b)  objected to by the Examiner.  
Applicant may not request that any objection to the drawing(s) be held in abeyance. See 37 CFR 1.85(a).  
Replacement drawing sheet(s) including the correction is required if the drawing(s) is objected to. See 37 CFR 1.121(d).
- 11)  The oath or declaration is objected to by the Examiner. Note the attached Office Action or form PTO-152.

**Priority under 35 U.S.C. § 119**

- 12)  Acknowledgment is made of a claim for foreign priority under 35 U.S.C. § 119(a)-(d) or (f).  
a)  All    b)  Some \*    c)  None of:
1.  Certified copies of the priority documents have been received.
2.  Certified copies of the priority documents have been received in Application No. \_\_\_\_.
3.  Copies of the certified copies of the priority documents have been received in this National Stage application from the International Bureau (PCT Rule 17.2(a)).

\* See the attached detailed Office action for a list of the certified copies not received.

**Attachment(s)**

- |   |   |
|---|---|
| 1) <input checked="" type="checkbox"/> Notice of References Cited (PTO-892)   | 4) <input type="checkbox"/> Interview Summary (PTO-413)<br>Paper No(s)/Mail Date. ____. |
| 2) <input type="checkbox"/> Notice of Draftperson's Patent Drawing Review (PTO-948)   | 5) <input type="checkbox"/> Notice of Informal Patent Application                       |
| 3) <input checked="" type="checkbox"/> Information Disclosure Statement(s) (PTO/SB/08)<br>Paper No(s)/Mail Date <u>11/12/2010; 11/10/2010</u> . | 6) <input type="checkbox"/> Other: ____.  |

## DETAILED ACTION

### *Claim Rejections - 35 USC § 102*

The following is a quotation of the appropriate paragraphs of 35 U.S.C. 102 that form the basis for the rejections under this section made in this Office action:

A person shall be entitled to a patent unless –

(b) the invention was patented or described in a printed publication in this or a foreign country or in public use or on sale in this country, more than one year prior to the date of application for patent in the United States.

(e) the invention was described in (1) an application for patent, published under section 122(b), by another filed in the United States before the invention by the applicant for patent or (2) a patent granted on an application for patent by another filed in the United States before the invention by the applicant for patent, except that an international application filed under the treaty defined in section 351(a) shall have the effects for purposes of this subsection of an application filed in the United States only if the international application designated the United States and was published under Article 21(2) of such treaty in the English language.

Claims 1, 2, 5, 7-8, 14-16 and 24-25 are rejected under 35 U.S.C. 102(b) as being anticipated by Hara (Hara – 4,697,073).

**Regarding claims 1, 14-16 and 24-25**, Hara discloses a portable data carrier 1 (figure 1) comprising: (i) an interface for reading and writing data (figure 1, holes 11A for mounting contacts); (ii) a non-volatile memory (5) coupled to the interface (figure 2, figure 4); (iii) a non-volatile payment data memory (figure 3, figure 4, figure 5). The following quotes that are also relied upon are herein presented for further reviews:

(15) EP-ROM 61 has memory areas as shown in FIG. 5. More specifically, EP-ROM 61 has identification data area 70, in which owner's identification data is stored, and application data area 80, in which data of the history of transactions using the IC card is stored. Identification data area 70 includes manufacturer's data section, in which data is written by the manufacturer of the IC card, issuer's data section 72, in which data is written by issuer, and owner's data section 73, in which data is written by the owner of the IC card. Manufacturer's data section 71 has CA (card authenticator) memory area 71 and MPRK (manufacturer's private key code) memory area 71B. In CA memory area 71A is stored an CA code consisting of 64 bits, for instance, which is peculiar

Art Unit: 2887

to each IC card. The CA code is transmitted to a card terminal (not shown) to be used for the computation of SAN (sales approval number).

**Regarding claims 2, 5, 7-8**, see the discussion regarding claim 1. Further, see figures 4- 5 and their descriptions for the CPU and the code for accessing the data carrier.

### ***Allowable Subject Matter***

Claims 17-23 are allowed.

Claims 3-4, 6, 9-13 are objected to as being dependent upon a rejected base claim, but would be allowable if rewritten in independent form including all of the limitations of the base claim and any intervening claims.

The following is a statement of reasons for the indication of allowable subject matter: The prior art fails to disclose a data access device comprising: a user interface, a data carrier interface, a program store, a processor, a code having the functions and characteristics as recited in claim 17. The prior art also fails to disclose a portable data carrier as recited in claim 1 further including the limitations of claims 3-4, 6 and 9-13.

### ***Conclusion***

Any inquiry concerning this communication or earlier communications from the examiner should be directed to THIEN M. LE whose telephone number is (571)272-



Art Unit: 2887

2396. The examiner can normally be reached on Monday - Friday from 7:30am - 4:00pm.

If attempts to reach the examiner by telephone are unsuccessful, the examiner's supervisor, Steve S. Paik can be reached on (571) 272-2404. The fax phone number for the organization where this application or proceeding is assigned is 571-273-8300.

Information regarding the status of an application may be obtained from the Patent Application Information Retrieval (PAIR) system. Status information for published applications may be obtained from either Private PAIR or Public PAIR. Status information for unpublished applications is available through Private PAIR only. For more information about the PAIR system, see <http://pair-direct.uspto.gov>. Should you have questions on access to the Private PAIR system, contact the Electronic Business Center (EBC) at 866-217-9197 (toll-free). If you would like assistance from a USPTO Customer Service Representative or access to the automated information system, call 800-786-9199 (IN USA OR CANADA) or 571-272-1000.

/Thien M. Le/  
Primary Examiner, Art Unit 2887

<b>Notice of References Cited</b>	Application/Control No. 12/943,847	Applicant(s)/Patent Under Reexamination HULST ET AL.	
	Examiner THIEN M. LE	Art Unit 2887	Page 1 of 1

**U.S. PATENT DOCUMENTS**

*	Document Number Country Code-Number-Kind Code	Date MM-YYYY	Name	Classification
*	A US-7,334,720	02-2008	Hulst et al.	235/380
*	B US-2003/0168515	09-2003	Gray, Robert J.	235/492
*	C US-7,000,836	02-2006	Saeki, Kazuto	235/451
*	D US-4,697,073	09-1987	Hara, Kazuya	235/487
	E US-			
	F US-			
	G US-			
	H US-			
	I US-			
	J US-			
	K US-			
	L US-			
	M US-			

**FOREIGN PATENT DOCUMENTS**

*	Document Number Country Code-Number-Kind Code	Date MM-YYYY	Country	Name	Classification
	N				
	O				
	P				
	Q				
	R				
	S				
	T				

**NON-PATENT DOCUMENTS**

*	Document Number Country Code-Number-Kind Code	Date MM-YYYY	Country	Name	Classification
	Include as applicable: Author, Title Date, Publisher, Edition or Volume, Pertinent Pages)				
	U				
	V				
	W				
	X				

\*A copy of this reference is not being furnished with this Office action. (See MPEP § 707.05(a).)  
Dates in MM-YYYY format are publication dates. Classifications may be US or foreign.

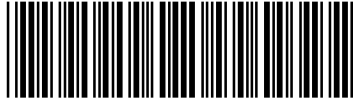
<b>Index of Claims</b>  	<b>Application/Control No.</b> 12943847	<b>Applicant(s)/Patent Under Reexamination</b> HULST ET AL.
	<b>Examiner</b> THIEN M LE	<b>Art Unit</b> 2887

✓	<b>Rejected</b>
=	<b>Allowed</b>

-	<b>Cancelled</b>
÷	<b>Restricted</b>

N	<b>Non-Elected</b>
I	<b>Interference</b>

A	<b>Appeal</b>
O	<b>Objected</b>

Claims renumbered in the same order as presented by applicant
  CPA
  T.D.
  R.1.47

CLAIM		DATE							
Final	Original	01/11/2011							
	1	✓							
	2	✓							
	3	○							
	4	○							
	5	✓							
	6	○							
	7	✓							
	8	✓							
	9	○							
	10	○							
	11	○							
	12	○							
	13	○							
	14	✓							
	15	✓							
	16	✓							
	17	=							
	18	=							
	19	=							
	20	=							
	21	=							
	22	=							
	23	=							
	24	✓							
	25	✓							

<b>Search Notes</b>  	<b>Application/Control No.</b>  12943847	<b>Applicant(s)/Patent Under Reexamination</b>  HULST ET AL.
	<b>Examiner</b>  THIEN M LE	<b>Art Unit</b>  2887

<b>SEARCHED</b>			
<b>Class</b>	<b>Subclass</b>	<b>Date</b>	<b>Examiner</b>
235	380, 382, 382.5, 383, 492, 493	1/11/2011	LTM

<b>SEARCH NOTES</b>		
<b>Search Notes</b>	<b>Date</b>	<b>Examiner</b>
Review Parent Applications; EAST	1/11/2011	LTM

<b>INTERFERENCE SEARCH</b>			
<b>Class</b>	<b>Subclass</b>	<b>Date</b>	<b>Examiner</b>

--	--

## EAST Search History

## EAST Search History (Prior Art)

Ref #	Hits	Search Query	DBs	Default Operator	Plurals	Time Stamp
S1	1	("7334720").PN.	US-PGPUB; USPAT	OR	OFF	2011/01/10 15:21
S2	1	S1 and (portable adj2 data adj2 carrier)	US-PGPUB; USPAT; USOCR; EPO; JPO; DERWENT; IBM_TDB	OR	OFF	2011/01/10 15:23
S3	369	card same (contacts near20 two near20 set)	US-PGPUB; USPAT; USOCR; EPO; JPO; DERWENT; IBM_TDB	OR	OFF	2011/01/10 15:52
S4	3	card same (contacts near20 two near20 set) same payment\$4	US-PGPUB; USPAT; USOCR; EPO; JPO; DERWENT; IBM_TDB	OR	OFF	2011/01/10 15:52
S5	7	card same (contacts near20 two near20 set) same internal same external	US-PGPUB; USPAT; USOCR; EPO; JPO; DERWENT; IBM_TDB	OR	OFF	2011/01/10 16:01
S6	1376	card same (data near10 memory) same (transaction near10 memory)	US-PGPUB; USPAT; USOCR; EPO; JPO; DERWENT; IBM_TDB	OR	OFF	2011/01/10 16:02
S7	397	((IC or smart) adj1 card) same (data near10 memory) same (transaction \$1 near10 memory)	US-PGPUB; USPAT; USOCR; EPO; JPO; DERWENT; IBM_TDB	OR	OFF	2011/01/10 16:02

S8	172	S7 and "235"/\$. ccls.	US-PGPUB; USPAT; USOCR; EPO; JPO; DERWENT; IBM_TDB	OR	OFF	2011/01/10 16:02
S9	15	((IC or smart) adj1 card) same (data near10 memory) same (transaction \$1 near10 memory) same (contacts)	US-PGPUB; USPAT; USOCR; EPO; JPO; DERWENT; IBM_TDB	OR	OFF	2011/01/10 16:05
S10	3041	((IC or smart) adj1 card) same (two near20 (IC or module\$1))	US-PGPUB; USPAT; USOCR; EPO; JPO; DERWENT; IBM_TDB	OR	OFF	2011/01/10 16:07
S11	276	((IC or smart) adj1 card) same ((dual) near5 (IC or module \$1))	US-PGPUB; USPAT; USOCR; EPO; JPO; DERWENT; IBM_TDB	OR	OFF	2011/01/10 16:07
S12	124	((IC or smart) adj1 card) same ((dual) near5 (IC or module \$1)) same contact \$1	US-PGPUB; USPAT; USOCR; EPO; JPO; DERWENT; IBM_TDB	OR	OFF	2011/01/10 16:07
S13	9	((IC or smart) adj1 card) same ((dual) near5 (IC or module \$1)) same contact \$1 same (point\$1)	US-PGPUB; USPAT; USOCR; EPO; JPO; DERWENT; IBM_TDB	OR	OFF	2011/01/10 16:09
S14	0	((IC or smart) adj1 card) same ((dual) near5 (memory)) same contact\$1 same (point\$1)	US-PGPUB; USPAT; USOCR; EPO; JPO; DERWENT; IBM_TDB	OR	OFF	2011/01/10 16:10
S15	24	((IC or smart) adj1 card) same (dual) same contact\$1 same (point\$1)	US-PGPUB; USPAT; USOCR; EPO; JPO; DERWENT; IBM_TDB	OR	OFF	2011/01/10 16:10

S16	4	((IC or smart) adj1 card) same ((dual near5 (ICs or modules)) same contact\$1	US-PGPUB; USPAT; USOCR; EPO; JPO; DERWENT; IBM_TDB	OR	OFF	2011/01/10 16:12
S17	18	((IC or smart) adj1 card) same ((dual or two) near5 (ICs or modules)) same contact\$1	US-PGPUB; USPAT; USOCR; EPO; JPO; DERWENT; IBM_TDB	OR	OFF	2011/01/10 16:13
S18	220	(card) same ((dual or two) near5 (ICs or modules)) same contact\$1	US-PGPUB; USPAT; USOCR; EPO; JPO; DERWENT; IBM_TDB	OR	OFF	2011/01/10 16:19
S19	2	(card) same ((dual or two) near5 (ICs or modules)) same contact\$1 same (payment\$1 or transaction\$1 or bonus\$1)	US-PGPUB; USPAT; USOCR; EPO; JPO; DERWENT; IBM_TDB	OR	OFF	2011/01/10 16:20
S20	52	(card) same ((dual or two) near5 (ICs or modules)) same (payment\$1 or transaction\$1 or bonus\$1)	US-PGPUB; USPAT; USOCR; EPO; JPO; DERWENT; IBM_TDB	OR	OFF	2011/01/10 16:21
S21	5753	two near10 set near10 contacts	US-PGPUB; USPAT; USOCR; EPO; JPO; DERWENT; IBM_TDB	OR	OFF	2011/01/10 16:27
S22	4128	dual near10 contacts	US-PGPUB; USPAT; USOCR; EPO; JPO; DERWENT; IBM_TDB	OR	OFF	2011/01/10 16:27
S23	135	(two near10 set near10 contacts) near30 card	US-PGPUB; USPAT; USOCR; EPO; JPO; DERWENT; IBM_TDB	OR	OFF	2011/01/10 16:28

S24	128	(dual near10 contacts) near30 card	US-PGPUB; USPAT; USOCR; EPO; JPO; DERWENT; IBM_TDB	OR	OFF	2011/01/10 16:28
S25	262	S23 or S24	US-PGPUB; USPAT; USOCR; EPO; JPO; DERWENT; IBM_TDB	OR	OFF	2011/01/10 16:28
S26	77	S25 and "235"/\$. ccls.	US-PGPUB; USPAT; USOCR; EPO; JPO; DERWENT; IBM_TDB	OR	OFF	2011/01/10 16:28
S27	107	(data adj1 memory) same (payment near5 memory)	US-PGPUB; USPAT; USOCR; EPO; JPO; DERWENT; IBM_TDB	OR	OFF	2011/01/10 16:31
S28	42	(data adj1 memory) same (payment near5 memory) same (card)	US-PGPUB; USPAT; USOCR; EPO; JPO; DERWENT; IBM_TDB	OR	OFF	2011/01/10 16:32
S29	6760	(two adj2 IC)	US-PGPUB; USPAT; USOCR; EPO; JPO; DERWENT; IBM_TDB	OR	OFF	2011/01/11 08:54
S30	565	(dual adj2 IC)	US-PGPUB; USPAT; USOCR; EPO; JPO; DERWENT; IBM_TDB	OR	OFF	2011/01/11 08:54
S31	33	(dual adj2 IC\$1) same ((transaction \$1 or credit or smart) adj2 card)	US-PGPUB; USPAT; USOCR; EPO; JPO; DERWENT; IBM_TDB	OR	OFF	2011/01/11 08:54



S32	3	(("6732936") or ("4697073") or ("6290137")).PN.	US-PGPUB; USPAT	OR	OFF	2011/01/11 09:12
-----	---	---	--------------------	----	-----	---------------------

**EAST Search History (I nterference)**

< This search history is empty >

**1 / 11 / 2011 2:44:00 PM**

**C:\ Documents and Settings\ TLe4\ My Documents\ EAST\ Workspaces\ 12943847.wsp**

Substitute for form 1449/PTO				<b>Complete if Known</b>	
<b>INFORMATION DISCLOSURE STATEMENT BY APPLICANT</b>  (Use as many sheets as necessary)				Application Number	12/943,847
				Filing Date	November 10, 2010
				First Named Inventor	RACZ, Patrick
				Art Unit	2876
				Examiner Name	
Sheet	1	of	1	Attorney Docket Number	080379-000130US

U.S. PATENT DOCUMENTS					
Examiner Initials*	Cite No. <sup>1</sup>	Document Number	Publication Date MM-DD-YYYY	Name of Patentee or Applicant of Cited Document	Pages, Columns, Lines, Where Relevant Passages or Relevant Figures Appear
		Number Kind Code <sup>2</sup> (if known)			
	AA	US 6,658,568 B1	12-02-2003	Ginter et al.	

FOREIGN PATENT DOCUMENTS								
Examiner Initials*	Cite No. <sup>1</sup>	Foreign Patent Document			Publication Date MM-DD-YYYY	Name of Patentee or Applicant of Cited Document	Pages, Columns, Lines, Where Relevant Passages or Relevant Figures Appear	T <sup>6</sup>
		Country Code <sup>3</sup>	Number <sup>4</sup>	Kind Code <sup>5</sup> (if known)				

NON PATENT LITERATURE DOCUMENTS			
Examiner Initials *	Cite No. <sup>1</sup>	Include name of the author (in CAPITAL LETTERS), title of the article (when appropriate), title of the item (book, magazine, journal, serial, symposium, catalog, etc.), date, page(s), volume-issue number(s), publisher, city and/or country where published.	T <sup>6</sup>

Examiner Signature	/Thien Le/	Date Considered	01/11/2011
-----------------------	------------	--------------------	------------

\*EXAMINER: Initial if reference considered, whether or not citation is in conformance with MPEP 609. Draw line through citation if not in conformance and not considered. Include copy of this form with next communication to applicant. <sup>1</sup> Applicant's unique citation designation number (optional). <sup>2</sup> See Kind Codes of U.S. Patent Documents at [www.uspto.gov](http://www.uspto.gov) or MPEP 901.04. <sup>3</sup> Enter Office that issued the document, by the two-letter code (WIPO Standard ST.3). <sup>4</sup> For Japanese patent documents, the indication of the year of the reign of the Emperor must precede the serial number of the patent document. <sup>5</sup> Kind of document by the appropriate symbols as indicated on the document under WIPO Standard ST. 16 if possible. <sup>6</sup> Applicant is to place a check mark here if English language Translation is attached.

**UNITED STATES PATENT AND TRADEMARK OFFICE**

UNITED STATES DEPARTMENT OF COMMERCE  
**United States Patent and Trademark Office**  
 Address: COMMISSIONER FOR PATENTS  
 P.O. Box 1450  
 Alexandria, Virginia 22313-1450  
 www.uspto.gov

**BIB DATA SHEET**
**CONFIRMATION NO. 4513**

SERIAL NUMBER	FILING or 371(c) DATE	CLASS	GROUP ART UNIT	ATTORNEY DOCKET NO.		
12/943,847	11/10/2010	235	2887	080379-000130US		
<b>APPLICANTS</b>						
Hermen-ard HULST, Amsterdam, NETHERLANDS; Patrick Sandor RACZ, Saint Heller, JERSEY;						
<b>** CONTINUING DATA *****</b>						
This application is a CON of 12/014,558 01/15/2008 which is a CON of 11/336,758 01/19/2006 PAT 7,334,720 which is a CON of 10/111,716 09/17/2002 ABN which is a 371 of PCT/GB00/04110 10/25/2000						
<b>** FOREIGN APPLICATIONS *****</b>						
UNITED KINGDOM 9925227.2 10/25/1999						
<b>** IF REQUIRED, FOREIGN FILING LICENSE GRANTED ** ** SMALL ENTITY **</b>						
11/22/2010						
Foreign Priority claimed 35 USC 119(a-d) conditions met Verified and Acknowledged	<input type="checkbox"/> Yes <input checked="" type="checkbox"/> No <input type="checkbox"/> Yes <input checked="" type="checkbox"/> No /Thien M. Le / Examiner's Signature	<input type="checkbox"/> Met after Allowance Initials	<b>STATE OR COUNTRY</b> NETHERLANDS	<b>SHEETS DRAWINGS</b> 17	<b>TOTAL CLAIMS</b> 25	<b>INDEPENDENT CLAIMS</b> 4
<b>ADDRESS</b>						
KILPATRICK TOWNSEND & STOCKTON LLP TWO EMBARCADERO CENTER EIGHTH FLOOR SAN FRANCISCO, CA 94111-3834 UNITED STATES						
<b>TITLE</b>						
DATA STORAGE AND ACCESS SYSTEMS						
<b>FILING FEE RECEIVED</b> 702	FEES: Authority has been given in Paper No. _____ to charge/credit DEPOSIT ACCOUNT No. _____ for following:			<input type="checkbox"/> All Fees <input type="checkbox"/> 1.16 Fees (Filing) <input type="checkbox"/> 1.17 Fees (Processing Ext. of time) <input type="checkbox"/> 1.18 Fees (Issue) <input type="checkbox"/> Other _____ <input type="checkbox"/> Credit		

Substitute for form 1449/PTO				<b>Complete if Known</b>	
				Application Number	12/943,847
<b>INFORMATION DISCLOSURE STATEMENT BY APPLICANT</b>  <i>(Use as many sheets as necessary)</i>				Filing Date	11/10/2010
				First Named Inventor	RACZ, Patrick
				Art Unit	2887
				Examiner Name	Le, Thien
				Attorney Docket Number	080379-000130US
Sheet	1	of	3		

U.S. PATENT DOCUMENTS					
Examiner Initials*	Cite No. <sup>1</sup>	Document Number	Publication Date MM-DD-YYYY	Name of Patentee or Applicant of Cited Document	Pages, Columns, Lines, Where Relevant Passages or Relevant Figures Appear
		Number Kind Code <sup>2</sup> (# known)			
	AA	US 4,341,951	07-1982	Benton	
	AB	US 5,226,145	07-06-1993	Moronaga et al.	
	AC	US 5,367,150	11-22-1994	Kitta et al.	
	AD	US 5,406,619	04-11-1995	Akhteruzzaman et al.	
	AE	US 5,457,746	10-10-1995	Dolphin	
	AF	US 5,532,466	07-02-1996	Konno et al.	
	AG	US 5,588,146	12-24-1996	Leroux	
	AH	US 5,677,953	10-14-1997	Dolphin	
	AI	US 5,703,951	12-30-1997	Dolphin	
	AJ	US 5,740,369	04-14-1998	Yokozawa et al.	
	AK	US 5,744,787	04-28-1998	Teicher	
	AL	US 5,754,654	05-19-1998	Hiroya et al.	
	AM	US 5,794,202	08-11-1998	Kim	
	AN	US 5,809,241	09-15-1998	Hanel et al.	
	AO	US 5,845,281 A	12-01-1998	Benson et al.	
	AP	US 5,847,372	12-08-1998	Kreft	
	AQ	US 5,889,860	03-30-1999	Eller et al.	
	AR	US 5,901,330	05-04-1999	Sun et al.	
	AS	US 5,918,213	06-29-1999	Bernard et al.	
	AT	US 5,923,884	07-13-1999	Peyret et al.	
	AU	US 5,933,498 A	08-03-1999	Schneck et al.	
	AV	US 5,936,220	08-10-1999	Hoshino et al.	
	AW	US 6,012,634	01-11-2000	Brogan et al.	
	AX	US 6,018,720 A	01-25-2000	Fujimoto	Corresponds to JP 11-53184
	AY	US 6,078,917	06-20-2000	Paulsen et al.	
	AZ	US 6,119,945	09-19-2000	Muller et al.	
	BA	US 6,142,369	11-2000	Jonstromer	
	BB	US 6,202,056	03-13-2001	Nuttall	
	BC	US 6,385,731	05-07-2002	Ananda	
	BD	US 6,424,975	07-23-2002	Walter et al.	
	BE	US 6,442,570	08-27-2002	Wu	
	BF	US 6,473,829	10-29-2002	Dahman et al.	
	BG	US 6,510,236	01-21-2003	Crane et al.	
	BH	US 6,553,413	04-22-2003	Leighton et al.	
	BI	US 6,554,192	04-29-2003	Tingl	

Examiner Signature	/Thien Le/	Date Considered	01/11/2011
--------------------	------------	-----------------	------------

<sup>1</sup> EXAMINER: Initial if reference considered, whether or not citation is in conformance with MPEP 609. Draw line through citation if not in conformance and not considered. Include copy of this form with next communication to applicant. <sup>2</sup> Applicant's unique citation designation number (optional). <sup>3</sup> See Kind Codes of U.S. Patent Documents at [www.uspto.gov](http://www.uspto.gov) or MPEP 901.04. <sup>4</sup> Enter Office that issued the document, by the two-letter code (WIPO Standard ST.3). <sup>5</sup> For Japanese patent documents, the indication of the year of the reign of the Emperor must precede the serial number of the patent document. <sup>6</sup> Kind of document by the appropriate symbols as indicated on the document under WIPO Standard ST. 16 if possible. <sup>7</sup> Applicant is to place a check mark here if English language Translation is attached.

62992256 v1 ALL REFERENCES CONSIDERED EXCEPT WHERE LINED THROUGH. /T.L./

Substitute for form 1449/PTO			<b>Complete if Known</b>		
<b>INFORMATION DISCLOSURE STATEMENT BY APPLICANT</b>  <i>(Use as many sheets as necessary)</i>			Application Number	12/943,847	
			Filing Date		
			First Named Inventor	RACZ, Patrick	
			Art Unit		
			Examiner Name		
Sheet	2	of	3	Attorney Docket Number	080379-000130US

U.S. PATENT DOCUMENTS						
Examiner Initials*	Cite No. <sup>1</sup>	Document Number		Publication Date MM-DD-YYYY	Name of Patentee or Applicant of Cited Document	Pages, Columns, Lines, Where Relevant Passages or Relevant Figures Appear
		Number	Kind Code <sup>2</sup> (if known)			
	BJ	US 6,574,643		06-03-2003	Walter et al.	
	BK	US 6,993,507		01-31-2006	Meyer et al.	
	BL	US 6,999,936		02-14-2006	Sehr	
	BM	US 7,044,362		05-16-2006	Yu	
	BN	US 7,083,081		08-01-2006	McGee et al.	
	BO	US 7,334,720		02-26-2008	Hulst et al.	
	BP	US 7,677,446		03-16-2010	Wise	
	BQ	US-2006/0249570		11-09-2006	Seifert et al.	
	BR	US-2008/0041938		02-21-2008	Wise	
	BS	US 4,341,951		07-1982	Benton	
	BT	US 5,226,145		07-06-1993	Moronaga et al.	

FOREIGN PATENT DOCUMENTS								
Examiner Initials*	Cite No. <sup>1</sup>	Foreign Patent Document			Publication Date MM-DD-YYYY	Name of Patentee or Applicant of Cited Document	Pages, Columns, Lines, Where Relevant Passages or Relevant Figures Appear	T <sup>6</sup>
		Country Code <sup>3</sup>	Number <sup>4</sup>	Kind Code <sup>5</sup> (if known)				
	BU	EP	0 195 098		10-03-1990	FPDC, Inc.		
	BV	EP	0 542 298		04-22-1998	Hitachi, Ltd.		
	BW	EP	0 713 198	A2	05-22-1996	Nederland PTT		
	BX	EP	0 823 694	A1	02-11-1998	Citibank NA		
	BY	EP	0 843 449	A2	05-07-1998	Sunhawk Corp. Inc.		
	BZ	EP	0 914 001	A1	05-06-1999	Canal Plus SA		
	CA	JP	10-269291	A	10-09-1998	Sony Corp.		
	CB	JP	11-212785	A	08-06-1999	Casio Comput. Co. Ltd.		
	CC	JP	11-213010	A	08-06-1999	Planet Computer:KK		
	CD	JP	11-272762	A	10-08-1999	Hitachi Ltd.		
	CE	JP	11-53184	A	02-26-1999	Seta:KK	Corresponds to US 6,018,720	
	CF	WO	98/19237	A1	05-07-1998	Schulumberger Technologies, Inc.		
	CG	WO	98/33343		07-30-1998	Sonera OY et al.		
	CH	WO	98/37526		08-27-1998	Mondex Int. Ltd.		

Examiner Signature	/Thien Le/	Date Considered	01/11/2011
--------------------	------------	-----------------	------------

\*EXAMINER: Initial if reference considered, whether or not citation is in conformance with MPEP 609. Draw line through citation if not in conformance and not considered. Include copy of this form with next communication to applicant. <sup>1</sup> Applicant's unique citation designation number (optional). <sup>2</sup> See Kind Codes of U.S. Patent Documents at [www.uspto.gov](http://www.uspto.gov) or MPEP 901.04. <sup>3</sup> Enter Office that issued the document, by the two-letter code (WIPO Standard ST.3). <sup>4</sup> For Japanese patent documents, the indication of the year of the reign of the Emperor must precede the serial number of the patent document. <sup>5</sup> Kind of document by the appropriate symbols as indicated on the document under WIPO Standard ST. 16 if possible. <sup>6</sup> Applicant is to place a check mark here if English language Translation is attached.

Substitute for form 1449/PTO  <b>INFORMATION DISCLOSURE STATEMENT BY APPLICANT</b>  (Use as many sheets as necessary)				<i>Complete if Known</i>		
				Application Number	12/943,847	
				Filing Date		
				First Named Inventor	RACZ, Patrick	
				Art Unit		
				Examiner Name		
Sheet	3	of	3	Attorney Docket Number	080379-000120US	

NON PATENT LITERATURE DOCUMENTS			
Examiner Initials *	Cite No. <sup>1</sup>	Include name of the author (in CAPITAL LETTERS), title of the article (when appropriate), title of the item (book, magazine, journal, serial, symposium, catalog, etc.), date, page(s), volume-issue number(s), publisher, city and/or country where published.	T <sup>2</sup>
	CI		<input type="checkbox"/>

Examiner Signature	/Thien Le/	Date Considered	01/11/2011
--------------------	------------	-----------------	------------

\*EXAMINER: Initial if reference considered, whether or not citation is in conformance with MPEP 609. Draw line through citation if not in conformance and not considered. Include copy of this form with next communication to applicant.

<sup>1</sup> Applicant's unique citation designation number (optional). <sup>2</sup> Applicant is to place a check mark here if English language Translation is attached.

I hereby certify that this correspondence is being filed via  
EFS-Web with the United States Patent and Trademark Office  
on February 10, 2011

PATENT  
Attorney Docket No.: 080379-000130US  
Client Ref. No.: PN759544USD

KILPATRICK TOWNSEND & STOCKTON LLP

By:  \_\_\_\_\_

**IN THE UNITED STATES PATENT AND TRADEMARK OFFICE**

In re application of:

Patrick RACZ, et al.

Application No.: 12/943,847

Filed: November 10, 2010

For: DATA STORAGE AND ACCESS  
SYSTEMS

Customer No.: 20350

Confirmation No. 4513

Examiner: Thien Minh Le

Technology Center/Art Unit: 2876

AMENDMENT

Mail Stop Amendment  
Commissioner for Patents  
P.O. Box 1450  
Alexandria, VA 22313-1450

Commissioner:

In response to the Office Action mailed January 13, 2011, please enter the  
following amendments and remarks:

**Amendments to the Claims** are reflected in the listing of claims which begins on page 2 of this  
paper.

**Remarks/Arguments** begin on page 6 of this paper.

**Amendments to the Claims:**

This listing of claims will replace all prior versions, and listings of claims in the application:

**Listing of Claims:**

Claims 1-2. (Canceled)

3. (Currently Amended) A portable data carrier, comprising:  
an interface for reading and writing data from and to the carrier;  
non-volatile data memory, coupled to the interface, for storing data on the carrier;  
non-volatile payment data memory, coupled to the interface, for providing  
payment data to an external device;  
a program store storing code implementable by a processor;  
a processor, coupled to the content data memory, the payment data memory, the  
interface and to the program store for implementing code in the program store; and  
~~as claimed in claim 2, further comprising~~ a subscriber identity module (SIM)  
portion to identify a subscriber to a network operator,  
wherein the code comprises code to output payment data from the payment data  
memory to the interface and code to provide external access to the data memory.

4. (Original) A portable data carrier as claimed in claim 3, wherein said  
payment data memory is coupled to said SIM portion, and  
wherein said providing payment data to an external device comprises providing  
said payment data to a network operator to charge said subscriber.

5. (Canceled)

6. (Currently Amended) A portable data carrier, comprising:  
an interface for reading and writing data from and to the carrier;  
non-volatile data memory, coupled to the interface, for storing data on the carrier;  
non-volatile payment data memory, coupled to the interface, for providing  
payment data to an external device;  
a program store storing code implementable by a processor;



a processor, coupled to the content data memory, the payment data memory, the interface and to the program store for implementing code in the program store;

non-volatile use record memory, coupled to the processor, for storing a record of access made to the data memory and code to update the use record memory in response to external access made to the data memory; and

~~as claimed in claim 5, further comprising~~ non-volatile use rule memory, coupled to the processor, for storing data use rules, and wherein the code ~~further~~ comprises code for storing at least one data item in the data memory and at least one corresponding use rule in the use rule memory and code to provide external access to the data item in accordance with the use rule,

wherein the code further comprises code to output payment data from the payment data memory to the interface and code to provide external access to the data memory.

Claims 7-8. (Canceled)

9. (Currently Amended) A portable data carrier, comprising:  
an interface for reading and writing data from and to the carrier;  
non-volatile data memory, coupled to the interface, for storing data on the carrier;  
non-volatile payment data memory, coupled to the interface, for providing payment data to an external device;

a program store storing code implementable by a processor; and  
a processor, coupled to the content data memory, the payment data memory, the interface and to the program store for implementing code in the program store;

~~as claimed in claim 2, wherein the portable data carrier is configured for storing supplementary data in said data memory, and further comprising code to output the supplementary data from the interface in addition to the stored data, in response to an external request to read the data memory, and~~

wherein the code comprises code to output payment data from the payment data memory to the interface and code to provide external access to the data memory.

10. (Currently Amended) A portable data carrier, comprising:  
an interface for reading and writing data from and to the carrier;

non-volatile data memory, coupled to the interface, for storing data on the carrier;  
non-volatile payment data memory, coupled to the interface, for providing  
payment data to an external device;

a program store storing code implementable by a processor;

a processor, coupled to the content data memory, the payment data memory, the  
interface and to the program store for implementing code in the program store; and

~~as claimed in claim 2, further comprising~~ data synthesis code to receive a first  
portion of data from the interface and to combine the first portion with a second portion of data  
stored in the data memory and to store the result in the data memory,

wherein the code comprises code to output payment data from the payment data  
memory to the interface and code to provide external access to the data memory.

11. (Currently Amended) A portable data carrier, comprising:  
an interface for reading and writing data from and to the carrier;  
non-volatile data memory, coupled to the interface, for storing data on the carrier;  
non-volatile payment data memory, coupled to the interface, for providing  
payment data to an external device; and

~~as claimed in claim 1, further comprising~~ non-volatile communications parameter  
memory for storing data for accessing a communications network to receive data from the  
communications network for storage in the data memory.

12. (Currently Amended) A portable data carrier, comprising:  
an interface for reading and writing data from and to the carrier;  
non-volatile data memory, coupled to the interface, for storing data on the carrier;

and

non-volatile payment data memory, coupled to the interface, for providing  
payment data to an external device,

~~as claimed in claim 1,~~ wherein the data memory is partitioned for access on a  
block-by-block basis, each block comprising a plurality of data bytes read or written as a set.

13. (Currently Amended) A portable data carrier, comprising  
an interface for reading and writing data from and to the carrier;

non-volatile data memory, coupled to the interface, for storing data on the carrier;  
and

non-volatile payment data memory, coupled to the interface, for providing  
payment data to an external device,

~~as claimed in claim 1~~ wherein said data memory has a capacity of greater than 1  
MByte, ~~more preferably greater than 100 MBytes, and most preferably greater than 1 GByte.~~

Claims 14-16. (Canceled)

17. (Original) A data access device for retrieving stored data from a data  
carrier, the device comprising:

a user interface;

a data carrier interface;

a program store storing code implementable by a processor; and

a processor coupled to the user interface, to the data carrier interface and to the  
program store for implementing the stored code, the code comprising:

code to retrieve use status data indicating a use status of data stored on the  
carrier, and use rules data indicating permissible use of data stored on the carrier;

code to evaluate the use status data using the use rules data to determine  
whether access is permitted to the stored data; and

code to access the stored data when access is permitted.

18. (Original) A data access device according to claim 17, further comprising  
code to write updated use status data to the carrier after user access to the stored data.

19. (Original) A data access device as claimed in claim 17, further comprising  
user access control code to input user access data, to transmit the user access data to the carrier,  
and to receive from the carrier user access permission data.

20. (Original) A data access device according to claim 19, further comprising  
code to select the use status and use rules data using the user access data.

21. (Original) A data access device as claimed in claim 19, further comprising  
code to retrieve and output supplementary data to the user.

22. (Original) A data access device according to claim 17 wherein said use rules permit partial use of a data item stored on the carrier and further comprising code to write partial use status data to the data carrier when only part of a stored data item has been accessed.

23. (Original) A data access device according to claim 17 wherein the device is portable and the data carrier interface is configured for interfacing with a removable data carrier.

Claims 24-25. (Canceled)

26. (New) A portable data carrier, comprising  
an interface for reading and writing data from and to the carrier;  
non-volatile data memory, coupled to the interface, for storing data on the carrier;  
and

non-volatile payment data memory, coupled to the interface, for providing  
payment data to an external device,

wherein said data memory has a capacity of greater than 100 MBytes.

27. (New) A portable data carrier, comprising  
an interface for reading and writing data from and to the carrier;  
non-volatile data memory, coupled to the interface, for storing data on the carrier;  
and

non-volatile payment data memory, coupled to the interface, for providing  
payment data to an external device,

wherein said data memory has a capacity of greater than 1 GByte.

**REMARKS/ARGUMENTS**

This Amendment is in response to the Office Action mailed January 13, 2011. Claims 1-25 were pending in the present application. Claims 17-23 are allowed, and claims 3, 4, 6, and 9-13 allowable. This Amendment amends claims 3, 6, and 9-13; cancels claims 1-2, 5, 7-8, 14-16, and 24-25; and adds new claims 26-27; leaving pending in the application claims 3, 4, 6, 9-13, 17-23, and 26-27. Reconsideration of the rejected claims and consideration of the newly presented claims is respectfully requested.

**I. Allowed Claims**

Claims 17-23 are allowed.

**II. Allowable Subject Matter**

Claims 3-4, 6, and 9-13 are objected to as being dependent upon a rejected base claim, but would be allowable if rewritten in independent form including all of the limitations of the base claim and any intervening claims. Applicants have rewritten claims 3, 6, and 9-13 in such form, such that these claims are now in condition for allowance. Claim 4 depends from claim 3 and therefore also is in condition for allowance. Applicants therefore respectfully request that the objections be withdrawn and the claims allowed.

**III. Rejection under 35 U.S.C. §102**

Claims 1, 2, 5, 7-8, 14-16, and 24-25 are rejected under 35 U.S.C. §102(b) as allegedly being anticipated by *Hara* (US Patent No. 4,697,073). Although Applicants do not agree with the rejections, these claims have been canceled in order to expedite issuance of the allowed and allowable claims. Applicants reserve the right to present the same and/or similar claims in one or more continuing applications. As these claims have been canceled, it is respectfully submitted that the rejection is now moot, and that all remaining claims are in condition for allowance.

**IV. Amendment to the Claims**

Unless otherwise specified or addressed in the remarks section, are not intended to alter the scope of the claims or limit any equivalents thereof. The amendments are supported by the specification and do not add new matter.

**V. Newly Presented Claims**

Claims 26 and 27 have been added to enable the three value ranges originally claimed in claim 13 to each be claimed individually via claims 13, 26, and 27. The subject matter was previously indicated to be allowable, and it is respectfully submitted that dividing up the claimed value ranges does not add new matter, is supported by the specification, and retains the allowability of each value range. Applicants therefore respectfully request consideration and allowance of newly presented claims 26-27.

**CONCLUSION**

In view of the foregoing, Applicants believe all claims now pending in this Application are in condition for allowance. The issuance of a formal Notice of Allowance at an early date is respectfully requested.

If the Examiner believes a telephone conference would expedite prosecution of this application, please telephone the undersigned at 925-472-5000.

Respectfully submitted,

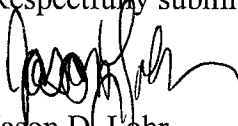

Jason D. Lohr  
Reg. No. 48,163

KILPATRICK TOWNSEND & STOCKTON LLP  
Two Embarcadero Center, Eighth Floor  
San Francisco, California 94111-3834  
Tel: 925-472-5000  
Fax: 415-576-0300  
Attachments  
JDL:jdl  
63146417 v1

## Electronic Patent Application Fee Transmittal

<b>Application Number:</b>	12943847
<b>Filing Date:</b>	10-Nov-2010
<b>Title of Invention:</b>	DATA STORAGE AND ACCESS SYSTEMS
<b>First Named Inventor/Applicant Name:</b>	Hermen-ard HULST
<b>Filer:</b>	Jason Donald Lohr/Scott Pugh
<b>Attorney Docket Number:</b>	080379-000130US

Filed as Large Entity

### Utility under 35 USC 111(a) Filing Fees

Description	Fee Code	Quantity	Amount	Sub-Total in USD(\$)
<b>Basic Filing:</b>				
<b>Pages:</b>				
<b>Claims:</b>				
Independent claims in excess of 3	1201	6	220	1320

**Miscellaneous-Filing:**

**Petition:**

**Patent-Appeals-and-Interference:**

**Post-Allowance-and-Post-Issuance:**

**Extension-of-Time:**

Description	Fee Code	Quantity	Amount	Sub-Total in USD(\$)
<b>Miscellaneous:</b>				
<b>Total in USD (\$)</b>				<b>1320</b>



## Electronic Acknowledgement Receipt

<b>EFS ID:</b>	9422777
<b>Application Number:</b>	12943847
<b>International Application Number:</b>	
<b>Confirmation Number:</b>	4513
<b>Title of Invention:</b>	DATA STORAGE AND ACCESS SYSTEMS
<b>First Named Inventor/Applicant Name:</b>	Hermen-ard HULST
<b>Customer Number:</b>	20350
<b>Filer:</b>	Jason Donald Lohr/Scott Pugh
<b>Filer Authorized By:</b>	Jason Donald Lohr
<b>Attorney Docket Number:</b>	080379-000130US
<b>Receipt Date:</b>	10-FEB-2011
<b>Filing Date:</b>	10-NOV-2010
<b>Time Stamp:</b>	19:16:13
<b>Application Type:</b>	Utility under 35 USC 111(a)

### Payment information:

Submitted with Payment	yes
Payment Type	Deposit Account
Payment was successfully received in RAM	\$1320
RAM confirmation Number	9414
Deposit Account	201430
Authorized User	

The Director of the USPTO is hereby authorized to charge indicated fees and credit any overpayment as follows:

Charge any Additional Fees required under 37 C.F.R. Section 1.16 (National application filing, search, and examination fees)

Charge any Additional Fees required under 37 C.F.R. Section 1.17 (Patent application and reexamination processing fees)

**File Listing:**

Document Number	Document Description	File Name	File Size(Bytes)/ Message Digest	Multi Part /.zip	Pages (if appl.)
1	Amendment/Req. Reconsideration-After Non-Final Reject	Amd_080379_000130US.pdf	336265 fe79682da94e2faf75931c152291c76636e7733c	no	8

**Warnings:****Information:**

2	Fee Worksheet (PTO-875)	fee-info.pdf	30313 ecd9d8eb4f42b2dd1906c7a2723116a70d9621ce	no	2
---	-------------------------	--------------	---	----	---

**Warnings:****Information:**

<b>Total Files Size (in bytes):</b>	366578
-------------------------------------	--------

This Acknowledgement Receipt evidences receipt on the noted date by the USPTO of the indicated documents, characterized by the applicant, and including page counts, where applicable. It serves as evidence of receipt similar to a Post Card, as described in MPEP 503.

**New Applications Under 35 U.S.C. 111**

If a new application is being filed and the application includes the necessary components for a filing date (see 37 CFR 1.53(b)-(d) and MPEP 506), a Filing Receipt (37 CFR 1.54) will be issued in due course and the date shown on this Acknowledgement Receipt will establish the filing date of the application.

**National Stage of an International Application under 35 U.S.C. 371**

If a timely submission to enter the national stage of an international application is compliant with the conditions of 35 U.S.C. 371 and other applicable requirements a Form PCT/DO/EO/903 indicating acceptance of the application as a national stage submission under 35 U.S.C. 371 will be issued in addition to the Filing Receipt, in due course.

**New International Application Filed with the USPTO as a Receiving Office**

If a new international application is being filed and the international application includes the necessary components for an international filing date (see PCT Article 11 and MPEP 1810), a Notification of the International Application Number and of the International Filing Date (Form PCT/RO/105) will be issued in due course, subject to prescriptions concerning national security, and the date shown on this Acknowledgement Receipt will establish the international filing date of the application.

Under the Paperwork Reduction Act of 1995, no persons are required to respond to a collection of information unless it displays a valid OMB control number.

<b>PATENT APPLICATION FEE DETERMINATION RECORD</b> Substitute for Form PTO-875	Application or Docket Number <b>12/943,847</b>	Filing Date <b>11/10/2010</b>	<input type="checkbox"/> To be Mailed
---	---	----------------------------------	---------------------------------------

APPLICATION AS FILED – PART I			OTHER THAN SMALL ENTITY				
	(Column 1)	(Column 2)	SMALL ENTITY <input checked="" type="checkbox"/>	OR			
FOR	NUMBER FILED	NUMBER EXTRA	RATE (\$)	FEE (\$)	OR	RATE (\$)	FEE (\$)
<input type="checkbox"/> BASIC FEE <small>(37 CFR 1.16(a), (b), or (c))</small>	N/A	N/A	N/A			N/A	
<input type="checkbox"/> SEARCH FEE <small>(37 CFR 1.16(k), (j), or (m))</small>	N/A	N/A	N/A			N/A	
<input type="checkbox"/> EXAMINATION FEE <small>(37 CFR 1.16(o), (p), or (q))</small>	N/A	N/A	N/A			N/A	
TOTAL CLAIMS <small>(37 CFR 1.16(j))</small>	minus 20 =	*	X \$ =		OR	X \$ =	
INDEPENDENT CLAIMS <small>(37 CFR 1.16(h))</small>	minus 3 =	*	X \$ =			X \$ =	
<input type="checkbox"/> APPLICATION SIZE FEE <small>(37 CFR 1.16(s))</small>	If the specification and drawings exceed 100 sheets of paper, the application size fee due is \$250 (\$125 for small entity) for each additional 50 sheets or fraction thereof. See 35 U.S.C. 41(a)(1)(G) and 37 CFR 1.16(s).						
<input type="checkbox"/> MULTIPLE DEPENDENT CLAIM PRESENT <small>(37 CFR 1.16(j))</small>							
			TOTAL			TOTAL	

\* If the difference in column 1 is less than zero, enter "0" in column 2.

APPLICATION AS AMENDED – PART II					OTHER THAN SMALL ENTITY				
	(Column 1)	(Column 2)	(Column 3)		SMALL ENTITY	OR			
AMENDMENT	<b>02/10/2011</b>	CLAIMS REMAINING AFTER AMENDMENT	HIGHEST NUMBER PREVIOUSLY PAID FOR	PRESENT EXTRA	RATE (\$)	ADDITIONAL FEE (\$)	OR	RATE (\$)	ADDITIONAL FEE (\$)
	Total <small>(37 CFR 1.16(i))</small>	* 17	Minus ** 25	= 0	X \$26 =	0		X \$ =	
	Independent <small>(37 CFR 1.16(h))</small>	* 10	Minus ***4	= 6	X \$110 =	660		X \$ =	
	<input type="checkbox"/> Application Size Fee <small>(37 CFR 1.16(s))</small>								
	<input type="checkbox"/> FIRST PRESENTATION OF MULTIPLE DEPENDENT CLAIM <small>(37 CFR 1.16(j))</small>						OR		
					TOTAL ADD'L FEE	<b>660</b>	OR	TOTAL ADD'L FEE	

	(Column 1)	(Column 2)	(Column 3)		SMALL ENTITY	OR			
AMENDMENT		CLAIMS REMAINING AFTER AMENDMENT	HIGHEST NUMBER PREVIOUSLY PAID FOR	PRESENT EXTRA	RATE (\$)	ADDITIONAL FEE (\$)	OR	RATE (\$)	ADDITIONAL FEE (\$)
	Total <small>(37 CFR 1.16(i))</small>	*	Minus **	=	X \$ =			X \$ =	
	Independent <small>(37 CFR 1.16(h))</small>	*	Minus ***	=	X \$ =			X \$ =	
	<input type="checkbox"/> Application Size Fee <small>(37 CFR 1.16(s))</small>								
	<input type="checkbox"/> FIRST PRESENTATION OF MULTIPLE DEPENDENT CLAIM <small>(37 CFR 1.16(j))</small>						OR		
					TOTAL ADD'L FEE		OR	TOTAL ADD'L FEE	

\* If the entry in column 1 is less than the entry in column 2, write "0" in column 3.  
 \*\* If the "Highest Number Previously Paid For" IN THIS SPACE is less than 20, enter "20".  
 \*\*\* If the "Highest Number Previously Paid For" IN THIS SPACE is less than 3, enter "3".

The "Highest Number Previously Paid For" (Total or Independent) is the highest number found in the appropriate box in column 1.

Legal Instrument Examiner:  
 /ANTHONY WILLIAMS/

This collection of information is required by 37 CFR 1.16. The information is required to obtain or retain a benefit by the public which is to file (and by the USPTO to process) an application. Confidentiality is governed by 35 U.S.C. 122 and 37 CFR 1.14. This collection is estimated to take 12 minutes to complete, including gathering, preparing, and submitting the completed application form to the USPTO. Time will vary depending upon the individual case. Any comments on the amount of time you require to complete this form and/or suggestions for reducing this burden, should be sent to the Chief Information Officer, U.S. Patent and Trademark Office, U.S. Department of Commerce, P.O. Box 1450, Alexandria, VA 22313-1450. DO NOT SEND FEES OR COMPLETED FORMS TO THIS ADDRESS. **SEND TO: Commissioner for Patents, P.O. Box 1450, Alexandria, VA 22313-1450.**

If you need assistance in completing the form, call 1-800-PTO-9199 and select option 2.



UNITED STATES PATENT AND TRADEMARK OFFICE

UNITED STATES DEPARTMENT OF COMMERCE
United States Patent and Trademark Office
Address: COMMISSIONER FOR PATENTS
P.O. Box 1450
Alexandria, Virginia 22313-1450
www.uspto.gov

Table with 4 columns: APPLICATION NUMBER (12/943,847), FILING OR 371(C) DATE (11/10/2010), FIRST NAMED APPLICANT (Hermen-ard HULST), ATTY. DOCKET NO./TITLE (080379-000130US)

CONFIRMATION NO. 4513

PUBLICATION NOTICE

20350
KILPATRICK TOWNSEND & STOCKTON LLP
TWO EMBARCADERO CENTER
EIGHTH FLOOR
SAN FRANCISCO, CA 94111-3834



Title:DATA STORAGE AND ACCESS SYSTEMS

Publication No.US-2011-0073643-A1
Publication Date:03/31/2011

NOTICE OF PUBLICATION OF APPLICATION

The above-identified application will be electronically published as a patent application publication pursuant to 37 CFR 1.211, et seq. The patent application publication number and publication date are set forth above.

The publication may be accessed through the USPTO's publically available Searchable Databases via the Internet at www.uspto.gov. The direct link to access the publication is currently http://www.uspto.gov/patft/.

The publication process established by the Office does not provide for mailing a copy of the publication to applicant. A copy of the publication may be obtained from the Office upon payment of the appropriate fee set forth in 37 CFR 1.19(a)(1). Orders for copies of patent application publications are handled by the USPTO's Office of Public Records. The Office of Public Records can be reached by telephone at (703) 308-9726 or (800) 972-6382, by facsimile at (703) 305-8759, by mail addressed to the United States Patent and Trademark Office, Office of Public Records, Alexandria, VA 22313-1450 or via the Internet.

In addition, information on the status of the application, including the mailing date of Office actions and the dates of receipt of correspondence filed in the Office, may also be accessed via the Internet through the Patent Electronic Business Center at www.uspto.gov using the public side of the Patent Application Information and Retrieval (PAIR) system. The direct link to access this status information is currently http://pair.uspto.gov/. Prior to publication, such status information is confidential and may only be obtained by applicant using the private side of PAIR.

Further assistance in electronically accessing the publication, or about PAIR, is available by calling the Patent Electronic Business Center at 1-866-217-9197.

Office of Data Management, Application Assistance Unit (571) 272-4000, or (571) 272-4200, or 1-888-786-0101



UNITED STATES PATENT AND TRADEMARK OFFICE

UNITED STATES DEPARTMENT OF COMMERCE
United States Patent and Trademark Office
Address: COMMISSIONER FOR PATENTS
P.O. Box 1450
Alexandria, Virginia 22313-1450
www.uspto.gov

Table with 5 columns: APPLICATION NO., FILING DATE, FIRST NAMED INVENTOR, ATTORNEY DOCKET NO., CONFIRMATION NO.
12/943,847 11/10/2010 Hermen-ard HULST 080379-000130US 4513

20350 7590 04/29/2011
KILPATRICK TOWNSEND & STOCKTON LLP
TWO EMBARCADERO CENTER
EIGHTH FLOOR
SAN FRANCISCO, CA 94111-3834

EXAMINER

LE, THIEN MINH

ART UNIT PAPER NUMBER

2887

NOTIFICATION DATE DELIVERY MODE

04/29/2011

ELECTRONIC

Please find below and/or attached an Office communication concerning this application or proceeding.

The time period for reply, if any, is set in the attached communication.

Notice of the Office communication was sent electronically on above-indicated "Notification Date" to the following e-mail address(es):

Docket@kilpatricktownsend.com
ipefiling@kilpatricktownsend.com
jlhice@kilpatrick.foundationip.com

<b>Office Action Summary</b>	<b>Application No.</b> 12/943,847	<b>Applicant(s)</b> HULST ET AL.	
	<b>Examiner</b> THIEN M. LE	<b>Art Unit</b> 2887	

-- The MAILING DATE of this communication appears on the cover sheet with the correspondence address --

**Period for Reply**

A SHORTENED STATUTORY PERIOD FOR REPLY IS SET TO EXPIRE 3 MONTH(S) OR THIRTY (30) DAYS, WHICHEVER IS LONGER, FROM THE MAILING DATE OF THIS COMMUNICATION.

- Extensions of time may be available under the provisions of 37 CFR 1.136(a). In no event, however, may a reply be timely filed after SIX (6) MONTHS from the mailing date of this communication.
- If NO period for reply is specified above, the maximum statutory period will apply and will expire SIX (6) MONTHS from the mailing date of this communication.
- Failure to reply within the set or extended period for reply will, by statute, cause the application to become ABANDONED (35 U.S.C. § 133). Any reply received by the Office later than three months after the mailing date of this communication, even if timely filed, may reduce any earned patent term adjustment. See 37 CFR 1.704(b).

**Status**

- 1)  Responsive to communication(s) filed on 10 February 2011.
- 2a)  This action is **FINAL**.
- 2b)  This action is non-final.
- 3)  Since this application is in condition for allowance except for formal matters, prosecution as to the merits is closed in accordance with the practice under *Ex parte Quayle*, 1935 C.D. 11, 453 O.G. 213.

**Disposition of Claims**

- 4)  Claim(s) 3,4,6,9-13,17-23,26 and 27 is/are pending in the application.
  - 4a) Of the above claim(s) \_\_\_\_\_ is/are withdrawn from consideration.
- 5)  Claim(s) 3,4,6,9,10 and 17-23 is/are allowed.
- 6)  Claim(s) 11-13,26 and 27 is/are rejected.
- 7)  Claim(s) \_\_\_\_\_ is/are objected to.
- 8)  Claim(s) \_\_\_\_\_ are subject to restriction and/or election requirement.

**Application Papers**

- 9)  The specification is objected to by the Examiner.
- 10)  The drawing(s) filed on 10 November 2010 is/are: a)  accepted or b)  objected to by the Examiner.
  - Applicant may not request that any objection to the drawing(s) be held in abeyance. See 37 CFR 1.85(a).
  - Replacement drawing sheet(s) including the correction is required if the drawing(s) is objected to. See 37 CFR 1.121(d).
- 11)  The oath or declaration is objected to by the Examiner. Note the attached Office Action or form PTO-152.

**Priority under 35 U.S.C. § 119**

- 12)  Acknowledgment is made of a claim for foreign priority under 35 U.S.C. § 119(a)-(d) or (f).
  - a)  All    b)  Some \*    c)  None of:
    - 1.  Certified copies of the priority documents have been received.
    - 2.  Certified copies of the priority documents have been received in Application No. \_\_\_\_\_.
    - 3.  Copies of the certified copies of the priority documents have been received in this National Stage application from the International Bureau (PCT Rule 17.2(a)).

\* See the attached detailed Office action for a list of the certified copies not received.

**Attachment(s)**

- |  |   |
|--|---|
| 1) <input checked="" type="checkbox"/> Notice of References Cited (PTO-892)                                | 4) <input type="checkbox"/> Interview Summary (PTO-413)<br>Paper No(s)/Mail Date. _____ |
| 2) <input type="checkbox"/> Notice of Draftperson's Patent Drawing Review (PTO-948)                        | 5) <input type="checkbox"/> Notice of Informal Patent Application                       |
| 3) <input type="checkbox"/> Information Disclosure Statement(s) (PTO/SB/08)<br>Paper No(s)/Mail Date _____ | 6) <input type="checkbox"/> Other: _____  |

### **DETAILED ACTION**

The amendment filed on 2/10/2011 has been entered. Claims 1-2, 5, 7-8, 14-16, 24-25 have been canceled. Claims 3-4, 6, 9-13, 17-23 and newly added claims 26-27 are presented for examination.

### ***Claim Rejections - 35 USC § 102***

The following is a quotation of the appropriate paragraphs of 35 U.S.C. 102 that form the basis for the rejections under this section made in this Office action:

A person shall be entitled to a patent unless –

(b) the invention was patented or described in a printed publication in this or a foreign country or in public use or on sale in this country, more than one year prior to the date of application for patent in the United States.

(e) the invention was described in (1) an application for patent, published under section 122(b), by another filed in the United States before the invention by the applicant for patent or (2) a patent granted on an application for patent by another filed in the United States before the invention by the applicant for patent, except that an international application filed under the treaty defined in section 351(a) shall have the effects for purposes of this subsection of an application filed in the United States only if the international application designated the United States and was published under Article 21(2) of such treaty in the English language.

(e) the invention was described in a patent granted on an application for patent by another filed in the United States before the invention thereof by the applicant for patent, or on an international application by another who has fulfilled the requirements of paragraphs (1), (2), and (4) of section 371(c) of this title before the invention thereof by the applicant for patent.

The changes made to 35 U.S.C. 102(e) by the American Inventors Protection Act of 1999 (AIPA) and the Intellectual Property and High Technology Technical Amendments Act of 2002 do not apply when the reference is a U.S. patent resulting directly or indirectly from an international application filed before November 29, 2000. Therefore, the prior art date of the reference is determined under 35 U.S.C. 102(e) prior to the amendment by the AIPA (pre-AIPA 35 U.S.C. 102(e)).

Art Unit: 2887

Claims 11-13 and 26 are rejected under 35 U.S.C. 102(e) as being anticipated by Weldon et al. (Weldon et al. – 6,747,930; herein after referred to as Weldon).

**Regarding claims 11-13 and 26**, Weldon discloses a portable data carrier comprising: (i) an interface for reading writing data from and to the carrier (interface for accessing to the recording areas of the card disk); (ii) data areas; (iii) transaction data area; password protections for accessing different data areas and instructions for conducting the transaction over the Internet (see figures 22, 27A-27C, 30A-30C, 31A-31C and their descriptions).

The following quotes that are relied upon are herein presented for further reviews:

(16) Additionally, the need for individuals to easily carry potential large amounts of personal data is becoming increasingly desirable. For example, it is desirable for individuals to carry with themselves their entire medical history, including x-rays and MRIs. Moreover, detailed financial transaction data regarding items purchased and funds available, as well as lines of credit and credit history, may be desirable for a user to easily carry. However, presently known devices for transporting such large amounts of data do not lend themselves to being carried in, for example, a wallet or purse. That is, there have heretofore been no known, readily available devices for reading and/or writing data to/from portable data storage devices, wherein the data storage devices are capable of being carried in a wallet or purse, and wherein large amounts of data (e.g., 50-100 megabytes or more) may be stored.

(22) Another object of the present invention is to provide such an optical medium which is particularly adapted to prevent unrestricted access to encoded information thereon by an optical readout system, wherein the information may be, for example, graphical data, video data, audio data, text data, and/or a software program (summary of the invention).

24) Another object of the present invention is to provide verification or authentication of information provided on or with the novel optical medium of the present invention. For example, the present invention may be used for verifying the authenticity of an optical disk having an audio and/or multimedia presentation thereon. Additionally, when the optical medium of the present invention is incorporated into, for example, a financial transaction card, the card can be verified as authentic.



Art Unit: 2887

31. A method of limiting access to stored data on an optical medium comprising: inserting the optical medium into an optical medium access device for accessing information in at least one of a predetermined first storage portion and a predetermined second storage portion of the optical medium; activating an instance of a desired computer application, wherein said application has program instructions stored in said predetermined second storage portion; purposefully inducing a change in the first storage portion after said step of activating, wherein said change is irreversible; obtaining a response indicative of whether the purposefully induced change exists; and determining whether said instance is allowed to continue access the program instructions in said predetermined second storage portion by accessing said response indicating the existence of said change.

### ***Claim Rejections - 35 USC § 103***

The following is a quotation of 35 U.S.C. 103(a) which forms the basis for all obviousness rejections set forth in this Office action:

(a) A patent may not be obtained though the invention is not identically disclosed or described as set forth in section 102 of this title, if the differences between the subject matter sought to be patented and the prior art are such that the subject matter as a whole would have been obvious at the time the invention was made to a person having ordinary skill in the art to which said subject matter pertains. Patentability shall not be negated by the manner in which the invention was made.

This application currently names joint inventors. In considering patentability of the claims under 35 U.S.C. 103(a), the examiner presumes that the subject matter of the various claims was commonly owned at the time any inventions covered therein were made absent any evidence to the contrary. Applicant is advised of the obligation under 37 CFR 1.56 to point out the inventor and invention dates of each claim that was not commonly owned at the time a later invention was made in order for the examiner to consider the applicability of 35 U.S.C. 103(c) and potential 35 U.S.C. 102(e), (f) or (g) prior art under 35 U.S.C. 103(a).

Claim 27 is rejected under 35 U.S.C. 103(a) as being unpatentable over Weldon et al. (Weldon et al. – 6,747,930; herein after referred to as Weldon).

Art Unit: 2887

**Regarding claim 27**, see the discussions regarding claim 11-13 and 26 above.

The claim differs in calling for a data memory which is greater than 1GBytes. However, this claimed limitation is not new. Optical storage device with capacity more than 1Gbytes such as DVD-RAM have been commercially available. Thus, it would have been obvious to replace the optical storage disk as taught by Weldon with a higher storage capacity disk. The modification is merely an extended application of Weldon's teachings to an environment that requires higher storage capacity.

### ***Allowable Subject Matter***

Claims 3-4, 6, 9-10 and 17-23 are allowed.

The following is a statement of reasons for the indication of allowable subject matter: As previously recited, the prior art fails to disclose a data access device comprising: a user interface, a data carrier interface, a program store, a processor, a code having the functions and characteristics as recited in claim 17. The prior art also fails to disclose a portable data carrier as recited in claims 3-4, 6, 9-10.

### **Remarks**

The examiner has withdrawn the allowability of claims 11-13 due to a newly found reference of record, the Weldon reference (cited in this Office Action). This

Art Unit: 2887

Office Action has been made Non-Final. The examiner appreciates applicant's efforts to amend claims 3-4, 6, 9-10 to place them in condition for allowance.

### ***Conclusion***

Any inquiry concerning this communication or earlier communications from the examiner should be directed to THIEN M. LE whose telephone number is (571)272-2396. The examiner can normally be reached on Monday - Friday from 7:30am - 4:00pm.

If attempts to reach the examiner by telephone are unsuccessful, the examiner's supervisor, Steve S. Paik can be reached on (571) 272-2404. The fax phone number for the organization where this application or proceeding is assigned is 571-273-8300.

Information regarding the status of an application may be obtained from the Patent Application Information Retrieval (PAIR) system. Status information for published applications may be obtained from either Private PAIR or Public PAIR. Status information for unpublished applications is available through Private PAIR only. For more information about the PAIR system, see <http://pair-direct.uspto.gov>. Should you have questions on access to the Private PAIR system, contact the Electronic Business Center (EBC) at 866-217-9197 (toll-free). If you would like assistance from a USPTO Customer Service Representative or access to the automated information system, call 800-786-9199 (IN USA OR CANADA) or 571-272-1000.

/Thien M. Le/  
Primary Examiner, Art Unit 2887

Application/Control Number: 12/943,847  
Art Unit: 2887

Page 7

<b>Notice of References Cited</b>	Application/Control No. 12/943,847	Applicant(s)/Patent Under Reexamination HULST ET AL.	
	Examiner THIEN M. LE	Art Unit 2887	Page 1 of 1

**U.S. PATENT DOCUMENTS**

*	Document Number Country Code-Number-Kind Code	Date MM-YYYY	Name	Classification
*	A	US-2003/0163594	Aasheim et al.	709/310
*	B	US-2006/0179211	Aasheim et al.	711/103
*	C	US-6,721,749	Najm et al.	1/1
*	D	US-5,148,432	Gordon et al.	714/6.32
*	E	US-5,845,201	Funke et al.	455/403
*	F	US-6,747,930	Weldon et al.	369/53.21
*	G	US-5,874,760	Burns et al.	257/315
	H	US-		
	I	US-		
	J	US-		
	K	US-		
	L	US-		
	M	US-		

**FOREIGN PATENT DOCUMENTS**

*	Document Number Country Code-Number-Kind Code	Date MM-YYYY	Country	Name	Classification
	N				
	O				
	P				
	Q				
	R				
	S				
	T				

**NON-PATENT DOCUMENTS**

*	Document Number Country Code-Number-Kind Code	Date MM-YYYY	Country	Name	Classification
	Include as applicable: Author, Title Date, Publisher, Edition or Volume, Pertinent Pages)				
	U				
	V				
	W				
	X				

\*A copy of this reference is not being furnished with this Office action. (See MPEP § 707.05(a).)  
Dates in MM-YYYY format are publication dates. Classifications may be US or foreign.

<b>Index of Claims</b> 	<b>Application/Control No.</b> 12943847	<b>Applicant(s)/Patent Under Reexamination</b> HULST ET AL.
	<b>Examiner</b> THIEN M LE	<b>Art Unit</b> 2887

✓	<b>Rejected</b>
=	<b>Allowed</b>

-	<b>Cancelled</b>
÷	<b>Restricted</b>

N	<b>Non-Elected</b>
I	<b>Interference</b>

A	<b>Appeal</b>
O	<b>Objected</b>

Claims renumbered in the same order as presented by applicant
  CPA
  T.D.
  R.1.47

CLAIM		DATE							
Final	Original	01/11/2011	04/24/2011						
	1	✓	-						
	2	✓	-						
	3	○	=						
	4	○	=						
	5	✓	-						
	6	○	=						
	7	✓	-						
	8	✓	-						
	9	○	=						
	10	○	=						
	11	○	✓						
	12	○	✓						
	13	○	✓						
	14	✓	-						
	15	✓	-						
	16	✓	-						
	17	=	=						
	18	=	=						
	19	=	=						
	20	=	=						
	21	=	=						
	22	=	=						
	23	=	=						
	24	✓	-						
	25	✓	-						
	26		✓						
	27		✓						

<b>Search Notes</b>  	<b>Application/Control No.</b>  12943847	<b>Applicant(s)/Patent Under Reexamination</b>  HULST ET AL.
	<b>Examiner</b>  THIEN M LE	<b>Art Unit</b>  2887

<b>SEARCHED</b>			
<b>Class</b>	<b>Subclass</b>	<b>Date</b>	<b>Examiner</b>
235	380, 382, 382.5, 383, 492, 493	1/11/2011	LTM
updated	same as above	4/24/2011	LTM

<b>SEARCH NOTES</b>		
<b>Search Notes</b>	<b>Date</b>	<b>Examiner</b>
Review Parent Applications; EAST	1/11/2011	LTM
EAST	4/24/2011	LTM

<b>INTERFERENCE SEARCH</b>			
<b>Class</b>	<b>Subclass</b>	<b>Date</b>	<b>Examiner</b>

--	--

## EAST Search History

## EAST Search History (Prior Art)

Ref #	Hits	Search Query	DBs	Default Operator	Plurals	Time Stamp
L1	0	1Gbyte\$4 near20 (optical or magnetic)	US-PGPUB; USPAT; USOCR; EPO; JPO; DERWENT; IBM_TDB	OR	OFF	2011/04/24 20:16
L2	1025	Gbyte\$4 same (optical or magnetic)	US-PGPUB; USPAT; USOCR; EPO; JPO; DERWENT; IBM_TDB	OR	OFF	2011/04/24 20:16
L3	0	Gbyte\$4 near20 (optical or magnetic) near20 card	US-PGPUB; USPAT; USOCR; EPO; JPO; DERWENT; IBM_TDB	OR	OFF	2011/04/24 20:16
L4	43	Gbyte\$4 same (optical or magnetic) same card	US-PGPUB; USPAT; USOCR; EPO; JPO; DERWENT; IBM_TDB	OR	OFF	2011/04/24 20:16
S1	100	(mobile near10 authentikat\$4 near10 card) same user\$1 same transaction\$1	US-PGPUB; USPAT; USOCR; EPO; JPO; DERWENT; IBM_TDB	OR	OFF	2011/04/22 15:37
S2	5385	((payment or transaction) adj2 data) near40 (card)	US-PGPUB; USPAT; USOCR; EPO; JPO; DERWENT; IBM_TDB	OR	OFF	2011/04/22 15:50



S3	0	((payment or transaction) adj2 data) near40 (card) near30 (GB or MB)	US-PGPUB; USPAT; USOCR; EPO; JPO; DERWENT; IBM_TDB	OR	OFF	2011/04/22 15:50
S4	0	((payment or transaction) adj2 data) near40 (card) near40 (GB or MB)	US-PGPUB; USPAT; USOCR; EPO; JPO; DERWENT; IBM_TDB	OR	OFF	2011/04/22 15:50
S5	40	((payment or transaction) adj2 data) near40 (GB or MB)	US-PGPUB; USPAT; USOCR; EPO; JPO; DERWENT; IBM_TDB	OR	OFF	2011/04/22 15:50
S6	0	((payment or transaction) adj2 data) near40 (GB or MB)) same (card or tag or portable)	US-PGPUB; USPAT; USOCR; EPO; JPO; DERWENT; IBM_TDB	OR	OFF	2011/04/22 15:51
S7	41	((payment\$1 or transaction\$1) adj2 data) near40 (GB or MB)	US-PGPUB; USPAT; USOCR; EPO; JPO; DERWENT; IBM_TDB	OR	OFF	2011/04/22 15:54
S8	68	((payment\$1 or transaction\$1) adj2 data) near40 (GB\$4 or MB\$4)	US-PGPUB; USPAT; USOCR; EPO; JPO; DERWENT; IBM_TDB	OR	OFF	2011/04/22 15:54
S9	28	S8 and card\$1	US-PGPUB; USPAT; USOCR; EPO; JPO; DERWENT; IBM_TDB	OR	OFF	2011/04/22 15:54

S10	229	((transaction or payment) adj4 (history or data or information)) same memory same (Megabytes or MB\$4 or Gb\$4 or gigabytes)	US-PGPUB; USPAT; USOCR; EPO; JPO; DERWENT; IBM_TDB	OR	OFF	2011/04/24 06:52
S11	27	((transaction or payment) adj4 (history or data or information)) same (portable or removable) same (Megabytes or MB \$4 or Gb\$4 or gigabytes)	US-PGPUB; USPAT; USOCR; EPO; JPO; DERWENT; IBM_TDB	OR	OFF	2011/04/24 07:09

### EAST Search History (I nterference)

< This search history is empty >

4/ 24/ 2011 8:40:26 PM

C:\ Documents and Settings\ TLe4\ My Documents\ EAST\ Workspaces\ 129438472nd.  
wsp

I hereby certify that this correspondence is being filed via EFS-Web with the United States Patent and Trademark Office on July 7, 2011.

PATENT  
Attorney Docket No.: 87790-794403 (000130US)  
Client Ref. No.: PN759544USD

KILPATRICK TOWNSEND & STOCKTON LLP

By: 

**IN THE UNITED STATES PATENT AND TRADEMARK OFFICE**

In re application of:

Hermen-ard HULST, et al.

Application No.: 12/943,847

Filed: November 10, 2010

For: DATA STORAGE AND ACCESS SYSTEMS

Customer No.: 20350

Confirmation No. 4513

Examiner: Thien Minh Le

Technology Center/Art Unit: 2887

AMENDMENT

Mail Stop Amendment  
Commissioner for Patents  
P.O. Box 1450  
Alexandria, VA 22313-1450

Commissioner:

In response to the Office Action mailed April 29, 2011, please enter the following amendments and remarks:

**Amendments to the Claims** are reflected in the listing of claims which begins on page 2 of this paper.

**Remarks/Arguments** begin on page 6 of this paper.

**Amendments to the Claims:**

This listing of claims will replace all prior versions, and listings of claims in the application:

**Listing of Claims:**

Claims 1-2. (Canceled)

3. (Previously Presented) A portable data carrier, comprising:  
an interface for reading and writing data from and to the carrier;  
non-volatile data memory, coupled to the interface, for storing data on the carrier;  
non-volatile payment data memory, coupled to the interface, for providing  
payment data to an external device;  
a program store storing code implementable by a processor;  
a processor, coupled to the content data memory, the payment data memory, the  
interface and to the program store for implementing code in the program store; and  
a subscriber identity module (SIM) portion to identify a subscriber to a network  
operator  
wherein the code comprises code to output payment data from the payment data  
memory to the interface and code to provide external access to the data memory.

4. (Original) A portable data carrier as claimed in claim 3, wherein said  
payment data memory is coupled to said SIM portion, and  
wherein said providing payment data to an external device comprises providing  
said payment data to a network operator to charge said subscriber.

5. (Canceled)

6. (Previously Amended) A portable data carrier, comprising:  
an interface for reading and writing data from and to the carrier;  
non-volatile data memory, coupled to the interface, for storing data on the carrier;  
non-volatile payment data memory, coupled to the interface, for providing  
payment data to an external device;  
a program store storing code implementable by a processor;

a processor, coupled to the content data memory, the payment data memory, the interface and to the program store for implementing code in the program store;

non-volatile use record memory, coupled to the processor, for storing a record of access made to the data memory and code to update the use record memory in response to external access made to the data memory; and

non-volatile use rule memory, coupled to the processor, for storing data use rules, and wherein the code comprises code for storing at least one data item in the data memory and at least one corresponding use rule in the use rule memory and code to provide external access to the data item in accordance with the use rule,

wherein the code further comprises code to output payment data from the payment data memory to the interface and code to provide external access to the data memory.

Claims 7-8. (Canceled)

9. (Previously Amended) A portable data carrier, comprising:

an interface for reading and writing data from and to the carrier;

non-volatile data memory, coupled to the interface, for storing data on the carrier;

non-volatile payment data memory, coupled to the interface, for providing payment data to an external device;

a program store storing code implementable by a processor; and

a processor, coupled to the content data memory, the payment data memory, the interface and to the program store for implementing code in the program store;

wherein the portable data carrier is configured for storing supplementary data in said data memory, and further comprising code to output the supplementary data from the interface in addition to the stored data, in response to an external request to read the data memory, and

wherein the code comprises code to output payment data from the payment data memory to the interface and code to provide external access to the data memory.

10. (Previously Amended) A portable data carrier, comprising:

an interface for reading and writing data from and to the carrier;

non-volatile data memory, coupled to the interface, for storing data on the carrier;

non-volatile payment data memory, coupled to the interface, for providing payment data to an external device;

a program store storing code implementable by a processor;

a processor, coupled to the content data memory, the payment data memory, the interface and to the program store for implementing code in the program store; and

synthesis code to receive a first portion of data from the interface and to combine the first portion with a second portion of data stored in the data memory and to store the result in the data memory

wherein the code comprises code to output payment data from the payment data memory to the interface and code to provide external access to the data memory.

Claims 11-16. (Canceled)

17. (Original) A data access device for retrieving stored data from a data carrier, the device comprising:

a user interface;

a data carrier interface;

a program store storing code implementable by a processor; and

a processor coupled to the user interface, to the data carrier interface and to the program store for implementing the stored code, the code comprising:

code to retrieve use status data indicating a use status of data stored on the carrier, and use rules data indicating permissible use of data stored on the carrier;

code to evaluate the use status data using the use rules data to determine whether access is permitted to the stored data; and

code to access the stored data when access is permitted.

18. (Original) A data access device according to claim 17, further comprising code to write updated use status data to the carrier after user access to the stored data.

19. (Original) A data access device as claimed in claim 17, further comprising user access control code to input user access data, to transmit the user access data to the carrier, and to receive from the carrier user access permission data.

20. (Original) A data access device according to claim 19, further comprising code to select the use status and use rules data using the user access data.

21. (Original) A data access device as claimed in claim 19, further comprising code to retrieve and output supplementary data to the user.

22. (Original) A data access device according to claim 17 wherein said use rules permit partial use of a data item stored on the carrier and further comprising code to write partial use status data to the data carrier when only part of a stored data item has been accessed.

23. (Original) A data access device according to claim 17 wherein the device is portable and the data carrier interface is configured for interfacing with a removable data carrier.

Claims 24-27. (Canceled)

**REMARKS/ARGUMENTS**

This Amendment is in response to the Office Action mailed April 29, 2011. Claims 3, 4, 6, 9-13, 17-23, 26, and 27 were pending in the present application. Claims 3, 4, 6, 9, 10, and 17-23 are allowed. This Amendment cancels claims 11-13, 26, and 27, without adding or amending any claims, leaving pending in the application allowed claims 3, 4, 6, 9, 10, and 17-23. Issuance of the allowed claims is respectfully requested.

**I. Allowed Claims**

Claims 3, 4, 6, 9, 10, and 17-23 are allowed.

**II. Rejections under 35 U.S.C. §§102 and 103**

Claims 11-13 and 26 are rejected under 35 U.S.C. §102(e) as allegedly being anticipated by *Weldon* (US Patent No. 6,747,930). Claim 27 is rejected under 35 U.S.C. §103(a) as being obvious over *Weldon*. Although Applicants do not agree with the rejections, these claims have been canceled in order to expedite issuance of the allowed claims. Applicants reserve the right to file similar claims in one or more continuing applications. As the claims have been canceled, it is respectfully submitted that the rejections are now moot.

As all claims now pending in the application have been allowed, Applicants respectfully request that the allowed claims be issued.



Appl. No. 12/943,847  
Amdt. dated July 7, 2011  
Reply to Office Action of April 29, 2011

PATENT

**CONCLUSION**

In view of the foregoing, Applicants believe all claims now pending in this Application are in condition for allowance. The issuance of a formal Notice of Allowance at an early date is respectfully requested.

If the Examiner believes a telephone conference would expedite prosecution of this application, please telephone the undersigned at 925-472-5000.

Respectfully submitted,



Jason D. Lohr  
Reg. No. 48,163

KILPATRICK TOWNSEND & STOCKTON LLP  
Two Embarcadero Center, Eighth Floor  
San Francisco, California 94111-3834  
Tel: 925-472-5000  
Fax: 415-576-0300  
Attachments  
JDL:e3g  
63360264 v1

I hereby certify that this correspondence is being filed via  
EFS-Web with the United States Patent and Trademark Office  
on July 7, 2011

PATENT  
Attorney Docket No.: 87790-794403 (000130US)  
Client Reference No.: PN759544USD

KILPATRICK TOWNSEND & STOCKTON LLP

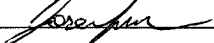
By: 

**IN THE UNITED STATES PATENT AND TRADEMARK OFFICE**

In re application of:

Hermen-ard HULST, et al.

Application No.: 12/943,847

Filed: November 10, 2010

For: DATA STORAGE AND ACCESS  
SYSTEMS

Customer No.: 20350

Confirmation No.: 4513

Examiner: Thien Minh Le

Art Unit: 2887

SUPPLEMENTAL INFORMATION  
DISCLOSURE STATEMENT UNDER  
37 CFR §1.97 and §1.98

Mail Stop Amendment  
Commissioner for Patents  
P.O. Box 1450  
Alexandria, VA 22313-1450

Commissioner:

The reference cited on the attached form PTO/SB/08A is being called to the attention of the Examiner. A copy of the reference is not enclosed.

It is respectfully requested that the cited reference be expressly considered during the prosecution of this application, and the reference be made of record therein and appear among the "references cited" on any patent to issue therefrom.

The reference cited in this IDS was cited in an Office Action mailed on April 14, 2011 in co-pending U.S. Patent Application No. 13/012,541. Copies of the Office Actions in

U.S. Patent Application No. 13/012,541 are available on PAIR and are believed to be readily accessible to the Examiner.

As provided for by 37 CFR §1.97(g) and (h), no inference should be made that the information and reference cited are prior art merely because they are in this statement and no representation is being made that a search has been conducted or that this statement encompasses all the possible relevant information.

This IDS is being filed before the mailing date of the final Office Action or Notice of Allowance.

Please charge the IDS fee of \$180 to Deposit Account No. 20-1430. Please deduct any additional fees from, or credit any overpayment to, the above-noted Deposit Account.

Respectfully submitted,

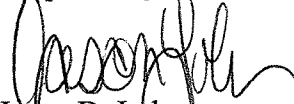

Jason D. Lohr  
Reg. No. 48,163

KILPATRICK TOWNSEND & STOCKTON LLP  
Two Embarcadero Center, Eighth Floor  
San Francisco, California 94111-3834  
Tel: 925-472-5000  
Fax: 925-472-8895  
JDL:j31

63593200 v1

Substitute for form 1449/PTO  <b>INFORMATION DISCLOSURE STATEMENT BY APPLICANT</b>  <i>(Use as many sheets as necessary)</i>				<b>Complete if Known</b>	
				Application Number	12/943,847
				Filing Date	November 10, 2010
				First Named Inventor	HULST, Hermen-ard
				Art Unit	2887
				Examiner Name	Thien Minh Le
Sheet	1	of	1	Attorney Docket Number	87790-794403

U.S. PATENT DOCUMENTS						
Examiner Initials*	Cite No. <sup>1</sup>	Document Number		Publication Date MM-DD-YYYY	Name of Patentee or Applicant of Cited Document	Pages, Columns, Lines, Where Relevant Passages or Relevant Figures Appear
		Number Kind Code <sup>2</sup> (if known)				
	1	6,415,156 B1		Stadelmann		

FOREIGN PATENT DOCUMENTS								
Examiner Initials*	Cite No. <sup>1</sup>	Foreign Patent Document			Publication Date MM-DD-YYYY	Name of Patentee or Applicant of Cited Document	Pages, Columns, Lines, Where Relevant Passages or Relevant Figures Appear	T <sup>6</sup>
		Country Code <sup>3</sup>	Number <sup>4</sup>	Kind Code <sup>5</sup> (if known)				
								<input type="checkbox"/>
								<input type="checkbox"/>

Examiner Signature		Date Considered	
-----------------------	--	--------------------	--

\*EXAMINER: Initial if reference considered, whether or not citation is in conformance with MPEP 609. Draw line through citation if not in conformance and not considered. Include copy of this form with next communication to applicant. <sup>1</sup> Applicant's unique citation designation number (optional). <sup>2</sup> See Kind Codes of U.S. Patent Documents at [www.uspto.gov](http://www.uspto.gov) or MPEP 901.04. <sup>3</sup> Enter Office that issued the document, by the two-letter code (WIPO Standard ST.3). <sup>4</sup> For Japanese patent documents, the indication of the year of the reign of the Emperor must precede the serial number of the patent document. <sup>5</sup> Kind of document by the appropriate symbols as indicated on the document under WIPO Standard ST. 16 if possible. <sup>6</sup> Applicant is to place a check mark here if English language Translation is attached.

## Electronic Patent Application Fee Transmittal

<b>Application Number:</b>	12943847
<b>Filing Date:</b>	10-Nov-2010
<b>Title of Invention:</b>	DATA STORAGE AND ACCESS SYSTEMS
<b>First Named Inventor/Applicant Name:</b>	Hermen-ard HULST
<b>Filer:</b>	Jason Donald Lohr/Jose Luna
<b>Attorney Docket Number:</b>	080379-000130US

Filed as Large Entity

### Utility under 35 USC 111(a) Filing Fees

Description	Fee Code	Quantity	Amount	Sub-Total in USD(\$)
<b>Basic Filing:</b>				
<b>Pages:</b>				
<b>Claims:</b>				
<b>Miscellaneous-Filing:</b>				
<b>Petition:</b>				
<b>Patent-Appeals-and-Interference:</b>				
<b>Post-Allowance-and-Post-Issuance:</b>				
<b>Extension-of-Time:</b>				

Description	Fee Code	Quantity	Amount	Sub-Total in USD(\$)
<b>Miscellaneous:</b>				
Submission- Information Disclosure Stmt	1806	1	180	180
<b>Total in USD (\$)</b>				<b>180</b>

## Electronic Acknowledgement Receipt

<b>EFS ID:</b>	10469895
<b>Application Number:</b>	12943847
<b>International Application Number:</b>	
<b>Confirmation Number:</b>	4513
<b>Title of Invention:</b>	DATA STORAGE AND ACCESS SYSTEMS
<b>First Named Inventor/Applicant Name:</b>	Hermen-ard HULST
<b>Customer Number:</b>	20350
<b>Filer:</b>	Jason Donald Lohr/Jose Luna
<b>Filer Authorized By:</b>	Jason Donald Lohr
<b>Attorney Docket Number:</b>	080379-000130US
<b>Receipt Date:</b>	07-JUL-2011
<b>Filing Date:</b>	10-NOV-2010
<b>Time Stamp:</b>	14:33:05
<b>Application Type:</b>	Utility under 35 USC 111(a)

### Payment information:

Submitted with Payment	yes
Payment Type	Credit Card
Payment was successfully received in RAM	\$180
RAM confirmation Number	775
Deposit Account	
Authorized User	

### File Listing:

Document Number	Document Description	File Name	File Size(Bytes)/ Message Digest	Multi Part /.zip	Pages (if appl.)
-----------------	----------------------	-----------	----------------------------------	------------------	------------------

1	Amendment/Req. Reconsideration-After Non-Final Reject	87790-794403_Amendment_0 7072011.pdf	254134  b6bf83a399cddbbed695b72b08038502313 e69b7c	no	7
<b>Warnings:</b>					
<b>Information:</b>					
2		87790-794403_IDS_07072011. pdf	109529  0479e1f548bbe5c866a6856c6ac8ff402baa 3450	yes	3
	<b>Multipart Description/PDF files in .zip description</b>				
	<b>Document Description</b>		<b>Start</b>	<b>End</b>	
	Transmittal Letter		1	2	
	Information Disclosure Statement (IDS) Form (SB08)		3	3	
<b>Warnings:</b>					
<b>Information:</b>					
3	Fee Worksheet (SB06)	fee-info.pdf	30224  0352014636668e5741fbf4d0e02e4a47d55 e8c34	no	2
<b>Warnings:</b>					
<b>Information:</b>					
<b>Total Files Size (in bytes):</b>			393887		
<p><b>This Acknowledgement Receipt evidences receipt on the noted date by the USPTO of the indicated documents, characterized by the applicant, and including page counts, where applicable. It serves as evidence of receipt similar to a Post Card, as described in MPEP 503.</b></p> <p><b><u>New Applications Under 35 U.S.C. 111</u></b>  <b>If a new application is being filed and the application includes the necessary components for a filing date (see 37 CFR 1.53(b)-(d) and MPEP 506), a Filing Receipt (37 CFR 1.54) will be issued in due course and the date shown on this Acknowledgement Receipt will establish the filing date of the application.</b></p> <p><b><u>National Stage of an International Application under 35 U.S.C. 371</u></b>  <b>If a timely submission to enter the national stage of an international application is compliant with the conditions of 35 U.S.C. 371 and other applicable requirements a Form PCT/DO/EO/903 indicating acceptance of the application as a national stage submission under 35 U.S.C. 371 will be issued in addition to the Filing Receipt, in due course.</b></p> <p><b><u>New International Application Filed with the USPTO as a Receiving Office</u></b>  <b>If a new international application is being filed and the international application includes the necessary components for an international filing date (see PCT Article 11 and MPEP 1810), a Notification of the International Application Number and of the International Filing Date (Form PCT/RO/105) will be issued in due course, subject to prescriptions concerning national security, and the date shown on this Acknowledgement Receipt will establish the international filing date of the application.</b></p>					



Under the Paperwork Reduction Act of 1995, no persons are required to respond to a collection of information unless it displays a valid OMB control number.

<b>PATENT APPLICATION FEE DETERMINATION RECORD</b> Substitute for Form PTO-875	Application or Docket Number <b>12/943,847</b>	Filing Date <b>11/10/2010</b>	<input type="checkbox"/> To be Mailed
---	---	----------------------------------	---------------------------------------

APPLICATION AS FILED – PART I			OTHER THAN SMALL ENTITY			
	(Column 1)	(Column 2)	SMALL ENTITY <input checked="" type="checkbox"/>	OR		
FOR	NUMBER FILED	NUMBER EXTRA	RATE (\$)	FEE (\$)	RATE (\$)	FEE (\$)
<input type="checkbox"/> BASIC FEE <small>(37 CFR 1.16(a), (b), or (c))</small>	N/A	N/A	N/A		N/A	
<input type="checkbox"/> SEARCH FEE <small>(37 CFR 1.16(k), (j), or (m))</small>	N/A	N/A	N/A		N/A	
<input type="checkbox"/> EXAMINATION FEE <small>(37 CFR 1.16(o), (p), or (q))</small>	N/A	N/A	N/A		N/A	
TOTAL CLAIMS <small>(37 CFR 1.16(j))</small>	minus 20 =	*	X \$ =	OR	X \$ =	
INDEPENDENT CLAIMS <small>(37 CFR 1.16(h))</small>	minus 3 =	*	X \$ =		X \$ =	
<input type="checkbox"/> APPLICATION SIZE FEE <small>(37 CFR 1.16(s))</small>	If the specification and drawings exceed 100 sheets of paper, the application size fee due is \$250 (\$125 for small entity) for each additional 50 sheets or fraction thereof. See 35 U.S.C. 41(a)(1)(G) and 37 CFR 1.16(s).					
<input type="checkbox"/> MULTIPLE DEPENDENT CLAIM PRESENT <small>(37 CFR 1.16(j))</small>						
			TOTAL		TOTAL	

\* If the difference in column 1 is less than zero, enter "0" in column 2.

APPLICATION AS AMENDED – PART II					OTHER THAN SMALL ENTITY			
	(Column 1)	(Column 2)	(Column 3)					
AMENDMENT	<b>07/07/2011</b>	CLAIMS REMAINING AFTER AMENDMENT	HIGHEST NUMBER PREVIOUSLY PAID FOR	PRESENT EXTRA	RATE (\$)	ADDITIONAL FEE (\$)	RATE (\$)	ADDITIONAL FEE (\$)
	Total <small>(37 CFR 1.16(i))</small>	* 12	Minus ** 25	= 0	X \$26 =	0	OR	X \$ =
	Independent <small>(37 CFR 1.16(h))</small>	* 5	Minus *** 10	= 0	X \$110 =	0	OR	X \$ =
	<input type="checkbox"/> Application Size Fee <small>(37 CFR 1.16(s))</small>						OR	
	<input type="checkbox"/> FIRST PRESENTATION OF MULTIPLE DEPENDENT CLAIM <small>(37 CFR 1.16(j))</small>						OR	
					TOTAL ADD'L FEE	<b>0</b>	OR	TOTAL ADD'L FEE

	(Column 1)	(Column 2)	(Column 3)					
AMENDMENT		CLAIMS REMAINING AFTER AMENDMENT	HIGHEST NUMBER PREVIOUSLY PAID FOR	PRESENT EXTRA	RATE (\$)	ADDITIONAL FEE (\$)	RATE (\$)	ADDITIONAL FEE (\$)
	Total <small>(37 CFR 1.16(i))</small>	*	Minus **	=	X \$ =		OR	X \$ =
	Independent <small>(37 CFR 1.16(h))</small>	*	Minus ***	=	X \$ =		OR	X \$ =
	<input type="checkbox"/> Application Size Fee <small>(37 CFR 1.16(s))</small>						OR	
	<input type="checkbox"/> FIRST PRESENTATION OF MULTIPLE DEPENDENT CLAIM <small>(37 CFR 1.16(j))</small>						OR	
					TOTAL ADD'L FEE		OR	TOTAL ADD'L FEE

\* If the entry in column 1 is less than the entry in column 2, write "0" in column 3.  
 \*\* If the "Highest Number Previously Paid For" IN THIS SPACE is less than 20, enter "20".  
 \*\*\* If the "Highest Number Previously Paid For" IN THIS SPACE is less than 3, enter "3".  
 The "Highest Number Previously Paid For" (Total or Independent) is the highest number found in the appropriate box in column 1.

Legal Instrument Examiner:  
/ROSA WEST/

This collection of information is required by 37 CFR 1.16. The information is required to obtain or retain a benefit by the public which is to file (and by the USPTO to process) an application. Confidentiality is governed by 35 U.S.C. 122 and 37 CFR 1.14. This collection is estimated to take 12 minutes to complete, including gathering, preparing, and submitting the completed application form to the USPTO. Time will vary depending upon the individual case. Any comments on the amount of time you require to complete this form and/or suggestions for reducing this burden, should be sent to the Chief Information Officer, U.S. Patent and Trademark Office, U.S. Department of Commerce, P.O. Box 1450, Alexandria, VA 22313-1450. DO NOT SEND FEES OR COMPLETED FORMS TO THIS ADDRESS. **SEND TO: Commissioner for Patents, P.O. Box 1450, Alexandria, VA 22313-1450.**

If you need assistance in completing the form, call 1-800-PTO-9199 and select option 2.

I hereby certify that this correspondence is being filed via  
EFS-Web with the United States Patent and Trademark Office  
on July 28, 2011

PATENT  
Attorney Docket No.: 87790-794403 (000130US)  
Client Ref. No.: PN759544USD

TOWNSEND and TOWNSEND and CREW LLP

By: 

**IN THE UNITED STATES PATENT AND TRADEMARK OFFICE**

In re application of:

Hermen-ard HULST, et al.

Application No.: 12/943,847

Filed: November 10, 2010

For: DATA STORAGE AND ACCESS  
SYSTEMS

Customer No.: 20350

Confirmation No.: 4513

Examiner: Le, Thien Minh

Art Unit: 2887

PETITION TO CHANGE ORDER OF  
NAMES OF JOINT INVENTORS IN  
THE HEADING OF THE PATENT  
APPLICATION UNDER 37 CFR 1.182

Mail Stop Petition  
Commissioner for Patents  
P.O. Box 1450  
Alexandria, VA 22313-1450

Commissioner:

Applicants respectfully request that the order of names of joint inventors in the above-captioned patent application be changed to reflect inventor Patrick Racz as the first-named inventor. Both inventors are listed on the most recent filing receipt and, based on the pending claims, should be listed as inventors in the present application. Only the order of the inventors should be changed. The corrected order of inventor names is listed below:

**Patrick S. Racz**, a citizen of the United Kingdom, residing at  
19 Royal Street  
Saint Heller, JE1 4WA Jersey

**Hermen-ard Hulst**, a citizen of Netherlands, residing at  
Van Tuyll van Serooskerweg 75hs  
Amsterdam, 1076 JG Netherlands

It is respectfully requested that this change be reflected on all subsequent correspondence from the United States Patent and Trademark Office directed to this application and that any patent issuing from this application, or a continuation thereof, names the inventors in the order listed above.

A copy of the initial Application Data Sheet, filed November 10, 2010, showing the correct order of inventor names for inventors Patrick Racz and Hermen-ard Hulst is attached.

The Commissioner is hereby authorized to deduct the required fee of \$400 pursuant to 37 CFR 1.17(f) from the undersigned's Deposit Account No. 20-1430. Pleased deduct any additional fees from, or credit any overpayment to, the above-noted deposit account.

If it is believed that a telephone conference would be helpful, please telephone the undersigned at 925-472-5000.

Respectfully submitted,



Jason D. Lehr  
Reg. No. 48,163

KILPATRICK TOWNSEND & STOCKTON LLP  
Two Embarcadero Center, Eighth Floor  
San Francisco, California 94111-3834  
Tel: 925-472-5000  
Fax: 415-576-0300  
Attachment  
JDL:j3l  
63379232 v1

## Application Data Sheet

### Application Information

Application number::	Not Yet Assigned
Filing Date::	11/10/2010
Application Type::	Regular
Subject Matter::	Utility
Title::	DATA STORAGE AND ACCESS SYSTEMS
Attorney Docket Number::	080379-000130US
Request for Early Publication::	No
Request for Non-Publication::	No
Suggested Drawing Figure::	
Total Drawing Sheets::	17
Small Entity?::	Yes
Petition included?::	No
Secrecy Order in Parent Appl.::	No

### Applicant Information

Applicant Authority Type::	Inventor
Primary Citizenship Country::	United Kingdom
Status::	Full Capacity
Given Name::	Patrick
Middle Name::	
Family Name::	RACZ
Name Suffix::	
City of Residence::	Saint Heller
State or Province of Residence::	
Country of Residence::	Jersey
Street of Mailing Address::	19 Royal Street
City of Mailing Address::	Saint Heller

State or Province of mailing address::  
Country of mailing address:: Jersey  
Postal or Zip Code of mailing address:: JE1 4WA

Applicant Authority Type:: Inventor  
Primary Citizenship Country:: Netherlands  
Status:: Full Capacity  
Given Name:: Hermen-ard  
Middle Name::  
Family Name:: Hulst  
Name Suffix::  
City of Residence:: Amsterdam  
State or Province of Residence::  
Country of Residence:: Netherlands  
Street of Mailing Address:: Van Tuyll van Serooskerweg 75hs  
City of Mailing Address:: Amsterdam  
State or Province of mailing address::  
Country of mailing address:: Netherlands  
Postal or Zip Code of mailing address:: 1076 JG

**Correspondence Information**

Correspondence Customer Number:: 20350

**Representative Information**

Representative Customer Number:: 20350

**Domestic Priority Information**

Application::	Continuity Type::	Parent Application::	Parent Filing Date::
This Application	Continuation of	12/014,558	01/15/08
12/014,558	Continuation of	11/336,758	01/19/06
11/336,758	Continuation of	10/111,716	09/17/02

**Foreign Priority Information**

Country::	Application number::	Filing Date::
PCT	GB00104110	10/25/00
United Kingdom	9925227.2	10/25/99

**Assignee Information**

Assignee Name:: Smartflash Technologies Limited  
Street of mailing address:: 1070908 Palm Grove House, P.O. Box 438  
City of mailing address:: Wickhams' Cay, Road Town  
State or Province of mailing address:: Tortola  
Country of mailing address:: British Virgin Islands  
Postal or Zip Code of mailing address::

Submitted by:

Signature

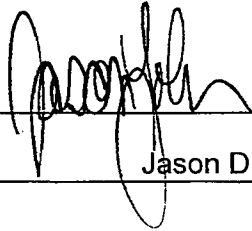

Date

11/10/10

Printed Name

Jason D. Lohr

Registration Number

48,163

## Electronic Patent Application Fee Transmittal

<b>Application Number:</b>	12943847
<b>Filing Date:</b>	10-Nov-2010
<b>Title of Invention:</b>	DATA STORAGE AND ACCESS SYSTEMS
<b>First Named Inventor/Applicant Name:</b>	Hermen-ard HULST
<b>Filer:</b>	Jason Donald Lohr/Heather Armstrong
<b>Attorney Docket Number:</b>	080379-000130US

Filed as Small Entity

### Utility under 35 USC 111(a) Filing Fees

Description	Fee Code	Quantity	Amount	Sub-Total in USD(\$)
<b>Basic Filing:</b>				
<b>Pages:</b>				
<b>Claims:</b>				
<b>Miscellaneous-Filing:</b>				
<b>Petition:</b>				
Petition fee- 37 CFR 1.17(f) (Group I)	1462	1	400	400

**Patent-Appeals-and-Interference:**

**Post-Allowance-and-Post-Issuance:**

**Extension-of-Time:**

Description	Fee Code	Quantity	Amount	Sub-Total in USD(\$)
<b>Miscellaneous:</b>				
<b>Total in USD (\$)</b>				<b>400</b>



## Electronic Acknowledgement Receipt

<b>EFS ID:</b>	10623289
<b>Application Number:</b>	12943847
<b>International Application Number:</b>	
<b>Confirmation Number:</b>	4513
<b>Title of Invention:</b>	DATA STORAGE AND ACCESS SYSTEMS
<b>First Named Inventor/Applicant Name:</b>	Hermen-ard HULST
<b>Customer Number:</b>	20350
<b>Filer:</b>	Jason Donald Lohr/Heather Armstrong
<b>Filer Authorized By:</b>	Jason Donald Lohr
<b>Attorney Docket Number:</b>	080379-000130US
<b>Receipt Date:</b>	28-JUL-2011
<b>Filing Date:</b>	10-NOV-2010
<b>Time Stamp:</b>	18:41:25
<b>Application Type:</b>	Utility under 35 USC 111(a)

### Payment information:

Submitted with Payment	yes
Payment Type	Credit Card
Payment was successfully received in RAM	\$400
RAM confirmation Number	5647
Deposit Account	
Authorized User	

### File Listing:

Document Number	Document Description	File Name	File Size(Bytes)/ Message Digest	Multi Part /.zip	Pages (if appl.)
-----------------	----------------------	-----------	----------------------------------	------------------	------------------

1	Miscellaneous Incoming Letter	2011-07-28- Petition_Change_Order_Invent ors-87790-794403.pdf	133656  2eafcc8ddcfc07c2173055eca4f18bc851471 420	no	5
---	-------------------------------	---	--	----	---

**Warnings:**

**Information:**

2	Fee Worksheet (SB06)	fee-info.pdf	30308  71a687899baa758f157d4bd33d59ae361ec 1c6c7	no	2
---	----------------------	--------------	---	----	---

**Warnings:**

**Information:**

<b>Total Files Size (in bytes):</b>			163964		
-------------------------------------	--	--	--------	--	--

**This Acknowledgement Receipt evidences receipt on the noted date by the USPTO of the indicated documents, characterized by the applicant, and including page counts, where applicable. It serves as evidence of receipt similar to a Post Card, as described in MPEP 503.**

**New Applications Under 35 U.S.C. 111**

**If a new application is being filed and the application includes the necessary components for a filing date (see 37 CFR 1.53(b)-(d) and MPEP 506), a Filing Receipt (37 CFR 1.54) will be issued in due course and the date shown on this Acknowledgement Receipt will establish the filing date of the application.**

**National Stage of an International Application under 35 U.S.C. 371**

**If a timely submission to enter the national stage of an international application is compliant with the conditions of 35 U.S.C. 371 and other applicable requirements a Form PCT/DO/EO/903 indicating acceptance of the application as a national stage submission under 35 U.S.C. 371 will be issued in addition to the Filing Receipt, in due course.**

**New International Application Filed with the USPTO as a Receiving Office**

**If a new international application is being filed and the international application includes the necessary components for an international filing date (see PCT Article 11 and MPEP 1810), a Notification of the International Application Number and of the International Filing Date (Form PCT/RO/105) will be issued in due course, subject to prescriptions concerning national security, and the date shown on this Acknowledgement Receipt will establish the international filing date of the application.**

**POWER OF ATTORNEY TO PROSECUTE APPLICATIONS BEFORE THE USPTO**

I hereby revoke all previous powers of attorney given in the application identified in the attached statement under 37 CFR 3.73(b).

I hereby appoint:

Practitioners associated with the Customer Number: 20350

OR

Practitioner(s) named below (if more than ten patent practitioners are to be named, then a customer number must be used):

Name	Registration Number	Name	Registration Number

as attorney(s) or agent(s) to represent the undersigned before the United States Patent and Trademark Office (USPTO) in connection with any and all patent applications assigned only to the undersigned according to the USPTO assignment records or assignment documents attached to this form in accordance with 37 CFR 3.73(b). I further authorize any of the above-identified practitioners to execute a Statement Under 37 CFR 3.73(b) on the undersigned's behalf to certify the chain of title and establish the undersigned's ownership in any and all patent applications in which rights have been assigned to the undersigned.

Please change the correspondence address for the application identified in the attached statement under 37 CFR 3.73(b) to:

The address associated with Customer Number: 20350

OR

<input type="checkbox"/> Firm or Individual Name			
Address			
City	State	Zip	
Country			
Telephone	Email		

Assignee Name and Address:

Smartflash Technologies Limited  
1070908 Palm Grove House, P.O. Box 438  
Wickhams' Cay, Road Town  
Tortola  
British Virgin Islands

A copy of this form, together with a statement under 37 CFR 3.73(b) (Form PTO/SB/96 or equivalent) is required to be filed in each application in which this form is used. The statement under 37 CFR 3.73(b) may be completed by one of the practitioners appointed in this form if the appointed practitioner is authorized to act on behalf of the assignee, and must identify the application in which this Power of Attorney is to be filed.

**SIGNATURE of Assignee of Record**

The individual whose signature and title is supplied below is authorized to act on behalf of the assignee

Signature		Date	14.01.2011
Name	MAURICE EMERY	Telephone	+41 32 723 2500
Title	a director		

83097047 v1

For and on behalf of Kestrel S.A.,  
acting in its capacity as corporate director  
of Smartflash Technologies Ltd

Under the Paperwork Reduction Act of 1995, no persons are required to respond to a collection of information unless it displays a valid OMB control number.

**STATEMENT UNDER 37 CFR 3.73(b)**

Applicant/Patent Owner: Smartflash Technologies Limited

Application No./Patent No.: 12/943,847

Filed/Issue Date: November 10, 2010

Titled: DATA STORAGE AND ACCESS SYSTEMS

Smartflash Technologies Limited, a corporation

(Name of Assignee)

(Type of Assignee, e.g., corporation, partnership, university, government agency, etc.)

states that it is:

- 1.  the assignee of the entire right, title, and interest in;
- 2.  an assignee of less than the entire right, title, and interest in  
(The extent (by percentage) of its ownership interest is \_\_\_\_\_ %); or
- 3.  the assignee of an undivided interest in the entirety of (a complete assignment from one of the joint inventors was made)

the patent application/patent identified above, by virtue of either:

A.  An assignment from the inventor(s) of the patent application/patent identified above. The assignment was recorded in the United States Patent and Trademark Office at Reel 013583, Frame 0554, or for which a copy therefore is attached.

OR

B.  A chain of title from the inventor(s), of the patent application/patent identified above, to the current assignee as follows:

1. From: \_\_\_\_\_ To: \_\_\_\_\_

The document was recorded in the United States Patent and Trademark Office at  
Reel \_\_\_\_\_, Frame \_\_\_\_\_, or for which a copy thereof is attached.

2. From: \_\_\_\_\_ To: \_\_\_\_\_

The document was recorded in the United States Patent and Trademark Office at  
Reel \_\_\_\_\_, Frame \_\_\_\_\_, or for which a copy thereof is attached.

3. From: \_\_\_\_\_ To: \_\_\_\_\_

The document was recorded in the United States Patent and Trademark Office at  
Reel \_\_\_\_\_, Frame \_\_\_\_\_, or for which a copy thereof is attached.

Additional documents in the chain of title are listed on a supplemental sheet(s).

As required by 37 CFR 3.73(b)(1)(i), the documentary evidence of the chain of title from the original owner to the assignee was, or concurrently is being, submitted for recordation pursuant to 37 CFR 3.11.

[NOTE: A separate copy (i.e., a true copy of the original assignment document(s)) must be submitted to Assignment Division in accordance with 37 CFR Part 3, to record the assignment in the records of the USPTO. See MPEP 302.08]

The undersigned (whose title is supplied below) is authorized to act on behalf of the assignee.

  
\_\_\_\_\_  
Signature

August 5, 2011  
\_\_\_\_\_  
Date

Jason D. Lohr, Reg. No. 48,163  
\_\_\_\_\_  
Printed or Typed Name

Attorney Representing Client  
\_\_\_\_\_  
Title

This collection of information is required by 37 CFR 3.73(b). The information is required to obtain or retain a benefit by the public which is to file (and by the USPTO to process) an application. Confidentiality is governed by 35 U.S.C. 122 and 37 CFR 1.11 and 1.14. This collection is estimated to take 12 minutes to complete, including gathering, preparing, and submitting the completed application form to the USPTO. Time will vary depending upon the individual case. Any comments on the amount of time you require to complete this form and/or suggestions for reducing this burden, should be sent to the Chief Information Officer, U.S. Patent and Trademark Office, U.S. Department of Commerce, P.O. Box 1450, Alexandria, VA 22313-1450. DO NOT SEND FEES OR COMPLETED FORMS TO THIS ADDRESS. SEND TO: Commissioner for Patents, P.O. Box 1450, Alexandria, VA 22313-1450.

## Electronic Acknowledgement Receipt

<b>EFS ID:</b>	10680923
<b>Application Number:</b>	12943847
<b>International Application Number:</b>	
<b>Confirmation Number:</b>	4513
<b>Title of Invention:</b>	DATA STORAGE AND ACCESS SYSTEMS
<b>First Named Inventor/Applicant Name:</b>	Hermen-ard HULST
<b>Customer Number:</b>	20350
<b>Filer:</b>	Jason Donald Lohr/Heather Armstrong
<b>Filer Authorized By:</b>	Jason Donald Lohr
<b>Attorney Docket Number:</b>	080379-000130US
<b>Receipt Date:</b>	05-AUG-2011
<b>Filing Date:</b>	10-NOV-2010
<b>Time Stamp:</b>	19:07:20
<b>Application Type:</b>	Utility under 35 USC 111(a)

### Payment information:

Submitted with Payment	no
------------------------	----

### File Listing:

Document Number	Document Description	File Name	File Size(Bytes)/ Message Digest	Multi Part /.zip	Pages (if appl.)
1		2011-08-05- POA_373B-87790-794403.pdf	172045 <small>ee0eab6e4ff95726831b1e487a5f7a9147754c9c</small>	yes	2

<b>Multipart Description/PDF files in .zip description</b>			
<b>Document Description</b>		<b>Start</b>	<b>End</b>
Power of Attorney		1	1
Assignee showing of ownership per 37 CFR 3.73(b).		2	2

**Warnings:**

**Information:**

<b>Total Files Size (in bytes):</b>	172045
-------------------------------------	--------

**This Acknowledgement Receipt evidences receipt on the noted date by the USPTO of the indicated documents, characterized by the applicant, and including page counts, where applicable. It serves as evidence of receipt similar to a Post Card, as described in MPEP 503.**

**New Applications Under 35 U.S.C. 111**

**If a new application is being filed and the application includes the necessary components for a filing date (see 37 CFR 1.53(b)-(d) and MPEP 506), a Filing Receipt (37 CFR 1.54) will be issued in due course and the date shown on this Acknowledgement Receipt will establish the filing date of the application.**

**National Stage of an International Application under 35 U.S.C. 371**

**If a timely submission to enter the national stage of an international application is compliant with the conditions of 35 U.S.C. 371 and other applicable requirements a Form PCT/DO/EO/903 indicating acceptance of the application as a national stage submission under 35 U.S.C. 371 will be issued in addition to the Filing Receipt, in due course.**

**New International Application Filed with the USPTO as a Receiving Office**

**If a new international application is being filed and the international application includes the necessary components for an international filing date (see PCT Article 11 and MPEP 1810), a Notification of the International Application Number and of the International Filing Date (Form PCT/RO/105) will be issued in due course, subject to prescriptions concerning national security, and the date shown on this Acknowledgement Receipt will establish the international filing date of the application.**



NOTICE OF ALLOWANCE AND FEE(S) DUE

20350 7590 08/09/2011
KILPATRICK TOWNSEND & STOCKTON LLP
TWO EMBARCADERO CENTER
EIGHTH FLOOR
SAN FRANCISCO, CA 94111-3834

EXAMINER
LE, THIEN MINH
ART UNIT PAPER NUMBER

2887
DATE MAILED: 08/09/2011

Table with 5 columns: APPLICATION NO., FILING DATE, FIRST NAMED INVENTOR, ATTORNEY DOCKET NO., CONFIRMATION NO.

12/943,847 11/10/2010 Hermen-ard HULST 080379-000130US 4513
TITLE OF INVENTION: DATA STORAGE AND ACCESS SYSTEMS

Table with 7 columns: APPLN. TYPE, SMALL ENTITY, ISSUE FEE DUE, PUBLICATION FEE DUE, PREV. PAID ISSUE FEE, TOTAL FEE(S) DUE, DATE DUE

THE APPLICATION IDENTIFIED ABOVE HAS BEEN EXAMINED AND IS ALLOWED FOR ISSUANCE AS A PATENT. PROSECUTION ON THE MERITS IS CLOSED. THIS NOTICE OF ALLOWANCE IS NOT A GRANT OF PATENT RIGHTS. THIS APPLICATION IS SUBJECT TO WITHDRAWAL FROM ISSUE AT THE INITIATIVE OF THE OFFICE OR UPON PETITION BY THE APPLICANT. SEE 37 CFR 1.313 AND MPEP 1308.

THE ISSUE FEE AND PUBLICATION FEE (IF REQUIRED) MUST BE PAID WITHIN THREE MONTHS FROM THE MAILING DATE OF THIS NOTICE OR THIS APPLICATION SHALL BE REGARDED AS ABANDONED. THIS STATUTORY PERIOD CANNOT BE EXTENDED. SEE 35 U.S.C. 151. THE ISSUE FEE DUE INDICATED ABOVE DOES NOT REFLECT A CREDIT FOR ANY PREVIOUSLY PAID ISSUE FEE IN THIS APPLICATION. IF AN ISSUE FEE HAS PREVIOUSLY BEEN PAID IN THIS APPLICATION (AS SHOWN ABOVE), THE RETURN OF PART B OF THIS FORM WILL BE CONSIDERED A REQUEST TO REAPPLY THE PREVIOUSLY PAID ISSUE FEE TOWARD THE ISSUE FEE NOW DUE.

HOW TO REPLY TO THIS NOTICE:

I. Review the SMALL ENTITY status shown above.
If the SMALL ENTITY is shown as YES, verify your current SMALL ENTITY status:
A. If the status is the same, pay the TOTAL FEE(S) DUE shown above.
B. If the status above is to be removed, check box 5b on Part B - Fee(s) Transmittal and pay the PUBLICATION FEE (if required) and twice the amount of the ISSUE FEE shown above, or

If the SMALL ENTITY is shown as NO:
A. Pay TOTAL FEE(S) DUE shown above, or
B. If applicant claimed SMALL ENTITY status before, or is now claiming SMALL ENTITY status, check box 5a on Part B - Fee(s) Transmittal and pay the PUBLICATION FEE (if required) and 1/2 the ISSUE FEE shown above.

II. PART B - FEE(S) TRANSMITTAL, or its equivalent, must be completed and returned to the United States Patent and Trademark Office (USPTO) with your ISSUE FEE and PUBLICATION FEE (if required). If you are charging the fee(s) to your deposit account, section "4b" of Part B - Fee(s) Transmittal should be completed and an extra copy of the form should be submitted. If an equivalent of Part B is filed, a request to reapply a previously paid issue fee must be clearly made, and delays in processing may occur due to the difficulty in recognizing the paper as an equivalent of Part B.

III. All communications regarding this application must give the application number. Please direct all communications prior to issuance to Mail Stop ISSUE FEE unless advised to the contrary.

IMPORTANT REMINDER: Utility patents issuing on applications filed on or after Dec. 12, 1980 may require payment of maintenance fees. It is patentee's responsibility to ensure timely payment of maintenance fees when due.

**PART B - FEE(S) TRANSMITTAL**

**Complete and send this form, together with applicable fee(s), to: Mail Mail Stop ISSUE FEE  
 Commissioner for Patents  
 P.O. Box 1450  
 Alexandria, Virginia 22313-1450  
 or Fax (571)-273-2885**

**INSTRUCTIONS:** This form should be used for transmitting the ISSUE FEE and PUBLICATION FEE (if required). Blocks 1 through 5 should be completed where appropriate. All further correspondence including the Patent, advance orders and notification of maintenance fees will be mailed to the current correspondence address as indicated unless corrected below or directed otherwise in Block 1, by (a) specifying a new correspondence address; and/or (b) indicating a separate "FEE ADDRESS" for maintenance fee notifications.

CURRENT CORRESPONDENCE ADDRESS (Note: Use Block 1 for any change of address)

Note: A certificate of mailing can only be used for domestic mailings of the Fee(s) Transmittal. This certificate cannot be used for any other accompanying papers. Each additional paper, such as an assignment or formal drawing, must have its own certificate of mailing or transmission.

20350 7590 08/09/2011  
**KILPATRICK TOWNSEND & STOCKTON LLP**  
 TWO EMBARCADERO CENTER  
 EIGHTH FLOOR  
 SAN FRANCISCO, CA 94111-3834

**Certificate of Mailing or Transmission**

I hereby certify that this Fee(s) Transmittal is being deposited with the United States Postal Service with sufficient postage for first class mail in an envelope addressed to the Mail Stop ISSUE FEE address above, or being facsimile transmitted to the USPTO (571) 273-2885, on the date indicated below.

(Depositor's name)
(Signature)
(Date)

APPLICATION NO.	FILING DATE	FIRST NAMED INVENTOR	ATTORNEY DOCKET NO.	CONFIRMATION NO.
12/943,847	11/10/2010	Hermen-ard HULST	080379-000130US	4513

TITLE OF INVENTION: DATA STORAGE AND ACCESS SYSTEMS

APPLN. TYPE	SMALL ENTITY	ISSUE FEE DUE	PUBLICATION FEE DUE	PREV. PAID ISSUE FEE	TOTAL FEE(S) DUE	DATE DUE
nonprovisional	YES	\$755	\$300	\$0	\$1055	11/09/2011

EXAMINER	ART UNIT	CLASS-SUBCLASS
LE, THIEN MINH	2887	235-380000

<p>1. Change of correspondence address or indication of "Fee Address" (37 CFR 1.363).</p> <p><input type="checkbox"/> Change of correspondence address (or Change of Correspondence Address form PTO/SB/122) attached.</p> <p><input type="checkbox"/> "Fee Address" indication (or "Fee Address" Indication form PTO/SB/47; Rev 03-02 or more recent) attached. <b>Use of a Customer Number is required.</b></p>	<p>2. For printing on the patent front page, list</p> <p>(1) the names of up to 3 registered patent attorneys or agents OR, alternatively, 1 _____</p> <p>(2) the name of a single firm (having as a member a registered attorney or agent) and the names of up to 2 registered patent attorneys or agents. If no name is listed, no name will be printed. 2 _____</p> <p>3 _____</p>
---	---

3. ASSIGNEE NAME AND RESIDENCE DATA TO BE PRINTED ON THE PATENT (print or type)

PLEASE NOTE: Unless an assignee is identified below, no assignee data will appear on the patent. If an assignee is identified below, the document has been filed for recordation as set forth in 37 CFR 3.11. Completion of this form is NOT a substitute for filing an assignment.

(A) NAME OF ASSIGNEE \_\_\_\_\_ (B) RESIDENCE: (CITY and STATE OR COUNTRY) \_\_\_\_\_

Please check the appropriate assignee category or categories (will not be printed on the patent) :  Individual  Corporation or other private group entity  Government

<p>4a. The following fee(s) are submitted:</p> <p><input type="checkbox"/> Issue Fee</p> <p><input type="checkbox"/> Publication Fee (No small entity discount permitted)</p> <p><input type="checkbox"/> Advance Order - # of Copies _____</p>	<p>4b. Payment of Fee(s); (Please first reapply any previously paid issue fee shown above)</p> <p><input type="checkbox"/> A check is enclosed.</p> <p><input type="checkbox"/> Payment by credit card. Form PTO-2038 is attached.</p> <p><input type="checkbox"/> The Director is hereby authorized to charge the required fee(s), any deficiency, or credit any overpayment, to Deposit Account Number _____ (enclose an extra copy of this form).</p>
---	--

5. Change in Entity Status (from status indicated above)

a. Applicant claims SMALL ENTITY status. See 37 CFR 1.27.  b. Applicant is no longer claiming SMALL ENTITY status. See 37 CFR 1.27(g)(2).

NOTE: The Issue Fee and Publication Fee (if required) will not be accepted from anyone other than the applicant; a registered attorney or agent; or the assignee or other party in interest as shown by the records of the United States Patent and Trademark Office.

Authorized Signature \_\_\_\_\_ Date \_\_\_\_\_

Typed or printed name \_\_\_\_\_ Registration No. \_\_\_\_\_

This collection of information is required by 37 CFR 1.311. The information is required to obtain or retain a benefit by the public which is to file (and by the USPTO to process) an application. Confidentiality is governed by 35 U.S.C. 122 and 37 CFR 1.14. This collection is estimated to take 12 minutes to complete, including gathering, preparing, and submitting the completed application form to the USPTO. Time will vary depending upon the individual case. Any comments on the amount of time you require to complete this form and/or suggestions for reducing this burden, should be sent to the Chief Information Officer, U.S. Patent and Trademark Office, U.S. Department of Commerce, P.O. Box 1450, Alexandria, Virginia 22313-1450. DO NOT SEND FEES OR COMPLETED FORMS TO THIS ADDRESS. SEND TO: Commissioner for Patents, P.O. Box 1450, Alexandria, Virginia 22313-1450.

Under the Paperwork Reduction Act of 1995, no persons are required to respond to a collection of information unless it displays a valid OMB control number.





UNITED STATES PATENT AND TRADEMARK OFFICE

UNITED STATES DEPARTMENT OF COMMERCE
United States Patent and Trademark Office
Address: COMMISSIONER FOR PATENTS
P.O. Box 1450
Alexandria, Virginia 22313-1450
www.uspto.gov

Table with 5 columns: APPLICATION NO., FILING DATE, FIRST NAMED INVENTOR, ATTORNEY DOCKET NO., CONFIRMATION NO.
12/943,847 11/10/2010 Hermen-ard HULST 080379-000130US 4513

20350 7590 08/09/2011
KILPATRICK TOWNSEND & STOCKTON LLP
TWO EMBARCADERO CENTER
EIGHTH FLOOR
SAN FRANCISCO, CA 94111-3834

EXAMINER

LE, THIEN MINH

ART UNIT PAPER NUMBER

2887

DATE MAILED: 08/09/2011

Determination of Patent Term Adjustment under 35 U.S.C. 154 (b)
(application filed on or after May 29, 2000)

The Patent Term Adjustment to date is 0 day(s). If the issue fee is paid on the date that is three months after the mailing date of this notice and the patent issues on the Tuesday before the date that is 28 weeks (six and a half months) after the mailing date of this notice, the Patent Term Adjustment will be 0 day(s).

If a Continued Prosecution Application (CPA) was filed in the above-identified application, the filing date that determines Patent Term Adjustment is the filing date of the most recent CPA.

Applicant will be able to obtain more detailed information by accessing the Patent Application Information Retrieval (PAIR) WEB site (http://pair.uspto.gov).

Any questions regarding the Patent Term Extension or Adjustment determination should be directed to the Office of Patent Legal Administration at (571)-272-7702. Questions relating to issue and publication fee payments should be directed to the Customer Service Center of the Office of Patent Publication at 1-(888)-786-0101 or (571)-272-4200.

## Privacy Act Statement

**The Privacy Act of 1974 (P.L. 93-579)** requires that you be given certain information in connection with your submission of the attached form related to a patent application or patent. Accordingly, pursuant to the requirements of the Act, please be advised that: (1) the general authority for the collection of this information is 35 U.S.C. 2(b)(2); (2) furnishing of the information solicited is voluntary; and (3) the principal purpose for which the information is used by the U.S. Patent and Trademark Office is to process and/or examine your submission related to a patent application or patent. If you do not furnish the requested information, the U.S. Patent and Trademark Office may not be able to process and/or examine your submission, which may result in termination of proceedings or abandonment of the application or expiration of the patent.

The information provided by you in this form will be subject to the following routine uses:

1. The information on this form will be treated confidentially to the extent allowed under the Freedom of Information Act (5 U.S.C. 552) and the Privacy Act (5 U.S.C. 552a). Records from this system of records may be disclosed to the Department of Justice to determine whether disclosure of these records is required by the Freedom of Information Act.
2. A record from this system of records may be disclosed, as a routine use, in the course of presenting evidence to a court, magistrate, or administrative tribunal, including disclosures to opposing counsel in the course of settlement negotiations.
3. A record in this system of records may be disclosed, as a routine use, to a Member of Congress submitting a request involving an individual, to whom the record pertains, when the individual has requested assistance from the Member with respect to the subject matter of the record.
4. A record in this system of records may be disclosed, as a routine use, to a contractor of the Agency having need for the information in order to perform a contract. Recipients of information shall be required to comply with the requirements of the Privacy Act of 1974, as amended, pursuant to 5 U.S.C. 552a(m).
5. A record related to an International Application filed under the Patent Cooperation Treaty in this system of records may be disclosed, as a routine use, to the International Bureau of the World Intellectual Property Organization, pursuant to the Patent Cooperation Treaty.
6. A record in this system of records may be disclosed, as a routine use, to another federal agency for purposes of National Security review (35 U.S.C. 181) and for review pursuant to the Atomic Energy Act (42 U.S.C. 218(c)).
7. A record from this system of records may be disclosed, as a routine use, to the Administrator, General Services, or his/her designee, during an inspection of records conducted by GSA as part of that agency's responsibility to recommend improvements in records management practices and programs, under authority of 44 U.S.C. 2904 and 2906. Such disclosure shall be made in accordance with the GSA regulations governing inspection of records for this purpose, and any other relevant (i.e., GSA or Commerce) directive. Such disclosure shall not be used to make determinations about individuals.
8. A record from this system of records may be disclosed, as a routine use, to the public after either publication of the application pursuant to 35 U.S.C. 122(b) or issuance of a patent pursuant to 35 U.S.C. 151. Further, a record may be disclosed, subject to the limitations of 37 CFR 1.14, as a routine use, to the public if the record was filed in an application which became abandoned or in which the proceedings were terminated and which application is referenced by either a published application, an application open to public inspection or an issued patent.
9. A record from this system of records may be disclosed, as a routine use, to a Federal, State, or local law enforcement agency, if the USPTO becomes aware of a violation or potential violation of law or regulation.

**Notice of Allowability**

**Application No.**

12/943,847

**Examiner**

THIEN M. LE

**Applicant(s)**

HULST ET AL.

**Art Unit**

2887

**-- The MAILING DATE of this communication appears on the cover sheet with the correspondence address--**

All claims being allowable, PROSECUTION ON THE MERITS IS (OR REMAINS) CLOSED in this application. If not included herewith (or previously mailed), a Notice of Allowance (PTOL-85) or other appropriate communication will be mailed in due course. **THIS NOTICE OF ALLOWABILITY IS NOT A GRANT OF PATENT RIGHTS.** This application is subject to withdrawal from issue at the initiative of the Office or upon petition by the applicant. See 37 CFR 1.313 and MPEP 1308.

- 1.  This communication is responsive to 7/7/2011.
- 2.  The allowed claim(s) is/are 3,4,6,9,10 and 17-23.
- 3.  Acknowledgment is made of a claim for foreign priority under 35 U.S.C. § 119(a)-(d) or (f).
  - a)  All b)  Some\* c)  None of the:
    - 1.  Certified copies of the priority documents have been received.
    - 2.  Certified copies of the priority documents have been received in Application No. \_\_\_\_\_.
    - 3.  Copies of the certified copies of the priority documents have been received in this national stage application from the International Bureau (PCT Rule 17.2(a)).

\* Certified copies not received: \_\_\_\_\_.

Applicant has THREE MONTHS FROM THE "MAILING DATE" of this communication to file a reply complying with the requirements noted below. Failure to timely comply will result in ABANDONMENT of this application.  
**THIS THREE-MONTH PERIOD IS NOT EXTENDABLE.**

- 4.  A SUBSTITUTE OATH OR DECLARATION must be submitted. Note the attached EXAMINER'S AMENDMENT or NOTICE OF INFORMAL PATENT APPLICATION (PTO-152) which gives reason(s) why the oath or declaration is deficient.
  - 5.  CORRECTED DRAWINGS ( as "replacement sheets") must be submitted.
    - (a)  including changes required by the Notice of Draftsperson's Patent Drawing Review ( PTO-948) attached
      - 1)  hereto or 2)  to Paper No./Mail Date \_\_\_\_\_.
    - (b)  including changes required by the attached Examiner's Amendment / Comment or in the Office action of Paper No./Mail Date \_\_\_\_\_.
- Identifying indicia such as the application number (see 37 CFR 1.84(c)) should be written on the drawings in the front (not the back) of each sheet. Replacement sheet(s) should be labeled as such in the header according to 37 CFR 1.121(d).**
- 6.  DEPOSIT OF and/or INFORMATION about the deposit of BIOLOGICAL MATERIAL must be submitted. Note the attached Examiner's comment regarding REQUIREMENT FOR THE DEPOSIT OF BIOLOGICAL MATERIAL.

**Attachment(s)**

- 1.  Notice of References Cited (PTO-892)
- 2.  Notice of Draftsperson's Patent Drawing Review (PTO-948)
- 3.  Information Disclosure Statements (PTO/SB/08), Paper No./Mail Date 7/7/2011
- 4.  Examiner's Comment Regarding Requirement for Deposit of Biological Material
- 5.  Notice of Informal Patent Application
- 6.  Interview Summary (PTO-413), Paper No./Mail Date \_\_\_\_\_.
- 7.  Examiner's Amendment/Comment
- 8.  Examiner's Statement of Reasons for Allowance
- 9.  Other \_\_\_\_\_.

Art Unit: 2887

### **DETAILED ACTION**

The amendment filed on 7/7/2011 has been entered. Claims 1-2, 5, 7-8, 11-16, 24-27 have been canceled. Claims 3-4, 6, 9-10, 17-23 remain for examination. The information disclosure statement filed on 7/7/2011 has been entered.

### ***Allowable Subject Matter***

Claims 3-4, 6, 9-10 and 17-23 are allowed.

The following is a statement of reasons for the indication of allowable subject matter: As previously recited, the prior art fails to disclose a data access device comprising: a user interface, a data carrier interface, a program store, a processor, a code having the functions and characteristics as recited in claim 17. The prior art also fails to disclose a portable data carrier as recited in claims 3-4, 6, 9-10.

### ***Conclusion***

Any inquiry concerning this communication or earlier communications from the examiner should be directed to THIEN M. LE whose telephone number is (571)272-2396. The examiner can normally be reached on Monday - Friday from 7:30am - 4:00pm.

Art Unit: 2887

If attempts to reach the examiner by telephone are unsuccessful, the examiner's supervisor, Steve S. Paik can be reached on (571) 272-2404. The fax phone number for the organization where this application or proceeding is assigned is 571-273-8300.

Information regarding the status of an application may be obtained from the Patent Application Information Retrieval (PAIR) system. Status information for published applications may be obtained from either Private PAIR or Public PAIR. Status information for unpublished applications is available through Private PAIR only. For more information about the PAIR system, see <http://pair-direct.uspto.gov>. Should you have questions on access to the Private PAIR system, contact the Electronic Business Center (EBC) at 866-217-9197 (toll-free). If you would like assistance from a USPTO Customer Service Representative or access to the automated information system, call 800-786-9199 (IN USA OR CANADA) or 571-272-1000.

/Thien M. Le/  
Primary Examiner, Art Unit 2887

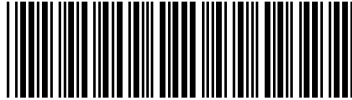
<b>Index of Claims</b>  	<b>Application/Control No.</b> 12943847	<b>Applicant(s)/Patent Under Reexamination</b> HULST ET AL.
	<b>Examiner</b> THIEN M LE	<b>Art Unit</b> 2887

✓	<b>Rejected</b>
=	<b>Allowed</b>

-	<b>Cancelled</b>
÷	<b>Restricted</b>

N	<b>Non-Elected</b>
I	<b>Interference</b>

A	<b>Appeal</b>
O	<b>Objected</b>

Claims renumbered in the same order as presented by applicant
  CPA
  T.D.
  R.1.47

CLAIM		DATE							
Final	Original	01/11/2011	04/24/2011	08/01/2011					
	1	✓	-	-					
	2	✓	-	-					
1	3	○	=	=					
2	4	○	=	=					
	5	✓	-	-					
3	6	○	=	=					
	7	✓	-	-					
	8	✓	-	-					
4	9	○	=	=					
5	10	○	=	=					
	11	○	✓	-					
	12	○	✓	-					
	13	○	✓	-					
	14	✓	-	-					
	15	✓	-	-					
	16	✓	-	-					
6	17	=	=	=					
7	18	=	=	=					
8	19	=	=	=					
9	20	=	=	=					
10	21	=	=	=					
11	22	=	=	=					
12	23	=	=	=					
	24	✓	-	-					
	25	✓	-	-					
	26		✓	-					
	27		✓	-					



<b>Search Notes</b>  	<b>Application/Control No.</b>  12943847	<b>Applicant(s)/Patent Under Reexamination</b>  HULST ET AL.
	<b>Examiner</b>  THIEN M LE	<b>Art Unit</b>  2887

SEARCHED			
Class	Subclass	Date	Examiner
235	380, 382, 382.5, 383, 492, 493	1/11/2011	LTM
updated	same as above	4/24/2011	LTM
updated	same as above	8/1/2011	LTM

SEARCH NOTES		
Search Notes	Date	Examiner
Review Parent Applications; EAST	1/11/2011	LTM
EAST	4/24/2011	LTM
updated	8/1/2011	LTM

INTERFERENCE SEARCH			
Class	Subclass	Date	Examiner
235	380, 382	8/1/2011	LTM

--	--



**UNITED STATES PATENT AND TRADEMARK OFFICE**

UNITED STATES DEPARTMENT OF COMMERCE  
**United States Patent and Trademark Office**  
 Address: COMMISSIONER FOR PATENTS  
 P.O. Box 1450  
 Alexandria, Virginia 22313-1450  
 www.uspto.gov

**BIB DATA SHEET**
**CONFIRMATION NO. 4513**

SERIAL NUMBER	FILING or 371(c) DATE	CLASS	GROUP ART UNIT	ATTORNEY DOCKET NO.	
12/943,847	11/10/2010	235	2887	080379-000130US	
<b>APPLICANTS</b> Hermen-ard HULST, Amsterdam, NETHERLANDS; Patrick Sandor RACZ, Saint Heller, JERSEY;					
<b>** CONTINUING DATA *****</b> This application is a CON of 12/014,558 01/15/2008 PAT 7,942,317 which is a CON of 11/336,758 01/19/2006 PAT 7,334,720 which is a CON of 10/111,716 09/17/2002 ABN which is a 371 of PCT/GB00/04110 10/25/2000					
<b>** FOREIGN APPLICATIONS *****</b> UNITED KINGDOM 9925227.2 10/25/1999					
<b>** IF REQUIRED, FOREIGN FILING LICENSE GRANTED ** ** SMALL ENTITY **</b> 11/22/2010					
Foreign Priority claimed <input checked="" type="checkbox"/> Yes <input type="checkbox"/> No 35 USC 119(a-d) conditions met <input type="checkbox"/> Yes <input checked="" type="checkbox"/> No Verified and / Thien M. Le / Acknowledged Examiner's Signature	<input type="checkbox"/> Met after Allowance Initials	<b>STATE OR COUNTRY</b> NETHERLANDS	<b>SHEETS DRAWINGS</b> 17	<b>TOTAL CLAIMS</b> 25	<b>INDEPENDENT CLAIMS</b> 4
<b>ADDRESS</b> KILPATRICK TOWNSEND & STOCKTON LLP TWO EMBARCADERO CENTER EIGHTH FLOOR SAN FRANCISCO, CA 94111-3834 UNITED STATES					
<b>TITLE</b> DATA STORAGE AND ACCESS SYSTEMS					
<b>FILING FEE RECEIVED</b> 2022	FEES: Authority has been given in Paper No. _____ to charge/credit DEPOSIT ACCOUNT No. _____ for following:		<input type="checkbox"/> All Fees <input type="checkbox"/> 1.16 Fees (Filing) <input type="checkbox"/> 1.17 Fees (Processing Ext. of time) <input type="checkbox"/> 1.18 Fees (Issue) <input type="checkbox"/> Other _____ <input type="checkbox"/> Credit		

## EAST Search History

## EAST Search History (Prior Art)

Ref #	Hits	Search Query	DBs	Default Operator	Plurals	Time Stamp
S1	1	("7334720").PN.	US-PGPUB; USPAT	OR	OFF	2011/01/10 15:21
S2	1	S1 and (portable adj2 data adj2 carrier)	US-PGPUB; USPAT; USOCR; EPO; JPO; DERWENT; IBM_TDB	OR	OFF	2011/01/10 15:23
S3	369	card same (contacts near20 two near20 set)	US-PGPUB; USPAT; USOCR; EPO; JPO; DERWENT; IBM_TDB	OR	OFF	2011/01/10 15:52
S4	3	card same (contacts near20 two near20 set) same payment\$4	US-PGPUB; USPAT; USOCR; EPO; JPO; DERWENT; IBM_TDB	OR	OFF	2011/01/10 15:52
S5	7	card same (contacts near20 two near20 set) same internal same external	US-PGPUB; USPAT; USOCR; EPO; JPO; DERWENT; IBM_TDB	OR	OFF	2011/01/10 16:01
S6	1376	card same (data near10 memory) same (transaction near10 memory)	US-PGPUB; USPAT; USOCR; EPO; JPO; DERWENT; IBM_TDB	OR	OFF	2011/01/10 16:02
S7	397	((IC or smart) adj1 card) same (data near10 memory) same (transaction\$1 near10 memory)	US-PGPUB; USPAT; USOCR; EPO; JPO; DERWENT; IBM_TDB	OR	OFF	2011/01/10 16:02
S8	172	S7 and "235"/\$.cls.	US-PGPUB; USPAT; USOCR; EPO; JPO; DERWENT; IBM_TDB	OR	OFF	2011/01/10 16:02
S9	15	((IC or smart) adj1 card) same (data near10 memory) same (transaction\$1 near10 memory) same (contacts)	US-PGPUB; USPAT; USOCR; EPO; JPO; DERWENT; IBM_TDB	OR	OFF	2011/01/10 16:05
S10	3041	((IC or smart) adj1 card) same (two near20 (IC or module\$1))	US-PGPUB; USPAT; USOCR; EPO; JPO; DERWENT; IBM_TDB	OR	OFF	2011/01/10 16:07
S11	276	((IC or smart) adj1 card) same ((dual) near5 (IC or module\$1))	US-PGPUB; USPAT; USOCR; EPO; JPO; DERWENT; IBM_TDB	OR	OFF	2011/01/10 16:07
S12	124	((IC or smart) adj1 card) same ((dual) near5 (IC or module\$1)) same contact\$1	US-PGPUB; USPAT; USOCR; EPO; JPO; DERWENT; IBM_TDB	OR	OFF	2011/01/10 16:07
S13	9	((IC or smart) adj1 card) same ((dual) near5 (IC or module\$1)) same contact\$1 same (point\$1)	US-PGPUB; USPAT; USOCR; EPO; JPO; DERWENT; IBM_TDB	OR	OFF	2011/01/10 16:09
S14	0	((IC or smart) adj1 card) same ((dual) near5 (memory)) same contact\$1 same (point\$1)	US-PGPUB; USPAT; USOCR; EPO; JPO; DERWENT; IBM_TDB	OR	OFF	2011/01/10 16:10
S15	24	((IC or smart) adj1 card) same (dual) same contact\$1 same (point\$1)	US-PGPUB; USPAT; USOCR; EPO; JPO; DERWENT; IBM_TDB	OR	OFF	2011/01/10 16:10

S16	4	((IC or smart) adj1 card) same ((dual) near5 (ICs or modules)) same contact\$1	US-PGPUB; USPAT; USOCR; EPO; JPO; DERWENT; IBM_TDB	OR	OFF	2011/01/10 16:12
S17	18	((IC or smart) adj1 card) same ((dual or two) near5 (ICs or modules)) same contact\$1	US-PGPUB; USPAT; USOCR; EPO; JPO; DERWENT; IBM_TDB	OR	OFF	2011/01/10 16:13
S18	220	(card) same ((dual or two) near5 (ICs or modules)) same contact\$1	US-PGPUB; USPAT; USOCR; EPO; JPO; DERWENT; IBM_TDB	OR	OFF	2011/01/10 16:19
S19	2	(card) same ((dual or two) near5 (ICs or modules)) same contact\$1 same (payment\$1 or transaction \$1 or bonus\$1)	US-PGPUB; USPAT; USOCR; EPO; JPO; DERWENT; IBM_TDB	OR	OFF	2011/01/10 16:20
S20	52	(card) same ((dual or two) near5 (ICs or modules)) same (payment\$1 or transaction\$1 or bonus\$1)	US-PGPUB; USPAT; USOCR; EPO; JPO; DERWENT; IBM_TDB	OR	OFF	2011/01/10 16:21
S21	5753	two near10 set near10 contacts	US-PGPUB; USPAT; USOCR; EPO; JPO; DERWENT; IBM_TDB	OR	OFF	2011/01/10 16:27
S22	4128	dual near10 contacts	US-PGPUB; USPAT; USOCR; EPO; JPO; DERWENT; IBM_TDB	OR	OFF	2011/01/10 16:27
S23	135	(two near10 set near10 contacts) near30 card	US-PGPUB; USPAT; USOCR; EPO; JPO; DERWENT; IBM_TDB	OR	OFF	2011/01/10 16:28
S24	128	(dual near10 contacts) near30 card	US-PGPUB; USPAT; USOCR; EPO; JPO; DERWENT; IBM_TDB	OR	OFF	2011/01/10 16:28
S25	262	S23 or S24	US-PGPUB; USPAT; USOCR; EPO; JPO; DERWENT; IBM_TDB	OR	OFF	2011/01/10 16:28
S26	77	S25 and "235"/\$.cls.	US-PGPUB; USPAT; USOCR; EPO; JPO; DERWENT; IBM_TDB	OR	OFF	2011/01/10 16:28
S27	107	(data adj1 memory) same (payment near5 memory)	US-PGPUB; USPAT; USOCR; EPO; JPO; DERWENT; IBM_TDB	OR	OFF	2011/01/10 16:31
S28	42	(data adj1 memory) same (payment near5 memory) same (card)	US-PGPUB; USPAT; USOCR; EPO; JPO; DERWENT; IBM_TDB	OR	OFF	2011/01/10 16:32
S29	6760	(two adj2 IC)	US-PGPUB; USPAT; USOCR; EPO; JPO; DERWENT; IBM_TDB	OR	OFF	2011/01/11 08:54
S30	565	(dual adj2 IC)	US-PGPUB; USPAT; USOCR; EPO; JPO; DERWENT; IBM_TDB	OR	OFF	2011/01/11 08:54
S31	33	(dual adj2 IC\$1) same ((transaction\$1 or credit or smart) adj2 card)	US-PGPUB; USPAT; USOCR; EPO; JPO; DERWENT; IBM_TDB	OR	OFF	2011/01/11 08:54
S32	3	(("6732936") or ("4697073") or ("6290137")).PN.	US-PGPUB; USPAT	OR	OFF	2011/01/11 09:12

## EAST Search History (Interference)

Ref #	Hits	Search Query	DBs	Default Operator	Plurals	Time Stamp
L1	185	card same (contacts near20 two near20 set)	US-PGPUB; USPAT; UPAD	OR	OFF	2011/08/01 09:12
L2	7	card same (contacts near20 two near20 set) same payment\$4	US-PGPUB; USPAT; UPAD	OR	OFF	2011/08/01 09:12
L3	6	card same (contacts near20 two near20 set) same internal same external	US-PGPUB; USPAT; UPAD	OR	OFF	2011/08/01 09:13
L4	1126	card same (data near10 memory) same (transaction near10 memory)	US-PGPUB; USPAT; UPAD	OR	OFF	2011/08/01 09:13
L7	302	((IC or smart) adj1 card) same (data near10 memory) same (transaction\$1 near10 memory)	US-PGPUB; USPAT; UPAD	OR	OFF	2011/08/01 09:13
L8	1006	"S7" and "235"/\$.ccls.	US-PGPUB; USPAT; UPAD	OR	OFF	2011/08/01 09:14
L9	203	((IC or smart) adj1 card) same ((dual) near5 (IC or module\$1))	US-PGPUB; USPAT; UPAD	OR	OFF	2011/08/01 09:14
L10	93	((IC or smart) adj1 card) same ((dual) near5 (IC or module\$1)) same contact\$1	US-PGPUB; USPAT; UPAD	OR	OFF	2011/08/01 09:18
L11	8	((IC or smart) adj1 card) same ((dual) near5 (IC or module\$1)) same contact\$1 same (point \$1)	US-PGPUB; USPAT; UPAD	OR	OFF	2011/08/01 09:18
L12	22	((IC or smart) adj1 card) same (dual) same contact\$1 same (point\$1)	US-PGPUB; USPAT; UPAD	OR	OFF	2011/08/01 09:18
L13	16	((IC or smart) adj1 card) same ((dual or two) near5 (ICs or modules)) same contact\$1	US-PGPUB; USPAT; UPAD	OR	OFF	2011/08/01 09:18
L14	53	(card) same ((dual or two) near5 (ICs or modules)) same (payment\$1 or transaction\$1 or bonus\$1)	US-PGPUB; USPAT; UPAD	OR	OFF	2011/08/01 09:18
L16	114	(dual near10 contacts) near30 card	US-PGPUB; USPAT; UPAD	OR	OFF	2011/08/01 09:19

L17	79	(data adj1 memory) same (payment near5 memory)	US-PGPUB; USPAT; UPAD	OR	OFF	2011/08/01 09:19
L18	35	(dual adj2 IC\$1) same ((transaction\$1 or credit or smart) adj2 card)	US-PGPUB; USPAT; UPAD	OR	OFF	2011/08/01 09:19
L19	93	(235/380,382,375,382.5,492,493).CCLS.	UPAD	OR	OFF	2011/08/01 09:20
L20	199	l1 or l2 or l3 or l11 or l12 or l13 or l14 or l17 or l18	USPAT; UPAD	OR	OFF	2011/08/01 09:21
L21	1	l20 and l19	USPAT; UPAD	OR	OFF	2011/08/01 09:21

8/ 1/ 2011 9:22:00 AM

C:\ Documents and Settings\ TLe4\ My Documents\ EAST\ Workspaces\ 12943847.wsp

Substitute for form 1449/PTO  <b>INFORMATION DISCLOSURE STATEMENT BY APPLICANT</b>  (Use as many sheets as necessary)				<b>Complete if Known</b>		
				Application Number	12/943,847	
				Filing Date	November 10, 2010	
				First Named Inventor	HULST, Hermen-ard	
				Art Unit	2887	
				Examiner Name	Thien Minh Le	
Sheet	1	of	1	Attorney Docket Number	87790-794403	

U.S. PATENT DOCUMENTS						
Examiner Initials*	Cite No. <sup>1</sup>	Document Number		Publication Date MM-DD-YYYY	Name of Patentee or Applicant of Cited Document	Pages, Columns, Lines, Where Relevant Passages or Relevant Figures Appear
		Number Kind Code <sup>2</sup> (if known)				
	1	6,415,156	B1	Stadelmann		

FOREIGN PATENT DOCUMENTS								
Examiner Initials*	Cite No. <sup>1</sup>	Foreign Patent Document			Publication Date MM-DD-YYYY	Name of Patentee or Applicant of Cited Document	Pages, Columns, Lines, Where Relevant Passages or Relevant Figures Appear	T <sup>6</sup>
		Country Code <sup>3</sup>	Number <sup>4</sup>	Kind Code <sup>5</sup> (if known)				
								<input type="checkbox"/>
								<input type="checkbox"/>

Examiner Signature	/Thien Le/	Date Considered	08/01/2011
--------------------	------------	-----------------	------------

\*EXAMINER: Initial if reference considered, whether or not citation is in conformance with MPEP 609. Draw line through citation if not in conformance and not considered. Include copy of this form with next communication to applicant. <sup>1</sup> Applicant's unique citation designation number (optional). <sup>2</sup> See Kind Codes of U.S. Patent Documents at [www.uspto.gov](http://www.uspto.gov) or MPEP 901.04. <sup>3</sup> Enter Office that issued the document, by the two-letter code (WIPO Standard ST.3). <sup>4</sup> For Japanese patent documents, the indication of the year of the reign of the Emperor must precede the serial number of the patent document. <sup>5</sup> Kind of document by the appropriate symbols as indicated on the document under WIPO Standard ST. 16 if possible. <sup>6</sup> Applicant is to place a check mark here if English language Translation is attached.



UNITED STATES PATENT AND TRADEMARK OFFICE

UNITED STATES DEPARTMENT OF COMMERCE
United States Patent and Trademark Office
Address: COMMISSIONER FOR PATENTS
P.O. Box 1450
Alexandria, Virginia 22313-1450
www.uspto.gov

Table with 7 columns: APPLICATION NUMBER, FILING or 371(c) DATE, GRP ART UNIT, FIL FEE REC'D, ATTY,DOCKET.NO, TOT CLAIMS, IND CLAIMS. Row 1: 12/943,847, 11/10/2010, 2887, 2022, 87790-794403 (000130US), 25, 4

CONFIRMATION NO. 4513

CORRECTED FILING RECEIPT



20350
KILPATRICK TOWNSEND & STOCKTON LLP
TWO EMBARCADERO CENTER
EIGHTH FLOOR
SAN FRANCISCO, CA 94111-3834

Date Mailed: 08/25/2011

Receipt is acknowledged of this non-provisional patent application. The application will be taken up for examination in due course. Applicant will be notified as to the results of the examination. Any correspondence concerning the application must include the following identification information: the U.S. APPLICATION NUMBER, FILING DATE, NAME OF APPLICANT, and TITLE OF INVENTION. Fees transmitted by check or draft are subject to collection. Please verify the accuracy of the data presented on this receipt. If an error is noted on this Filing Receipt, please submit a written request for a Filing Receipt Correction. Please provide a copy of this Filing Receipt with the changes noted thereon. If you received a "Notice to File Missing Parts" for this application, please submit any corrections to this Filing Receipt with your reply to the Notice. When the USPTO processes the reply to the Notice, the USPTO will generate another Filing Receipt incorporating the requested corrections

Applicant(s)

Patrick Sandor RACZ, Saint Heller, JERSEY;
Hermen-ard HULST, Amsterdam, NETHERLANDS;

Assignment For Published Patent Application

Smartflash Technologies Limited, Wickhams' Cay, VIRGIN ISLANDS, BRITISH

Power of Attorney: None

Domestic Priority data as claimed by applicant

This application is a CON of 12/014,558 01/15/2008 PAT 7,942,317
which is a CON of 11/336,758 01/19/2006 PAT 7,334,720
which is a CON of 10/111,716 09/17/2002 ABN
which is a 371 of PCT/GB00/04110 10/25/2000

Foreign Applications (You may be eligible to benefit from the Patent Prosecution Highway program at the USPTO. Please see http://www.uspto.gov for more information.)

UNITED KINGDOM 9925227.2 10/25/1999

Request to Retrieve - This application either claims priority to one or more applications filed in an intellectual property Office that participates in the Priority Document Exchange (PDX) program or contains a proper Request to Retrieve Electronic Priority Application(s) (PTO/SB/38 or its equivalent). Consequently, the USPTO will attempt to electronically retrieve these priority documents.

If Required, Foreign Filing License Granted: 11/22/2010

The country code and number of your priority application, to be used for filing abroad under the Paris Convention, is US 12/943,847

**Projected Publication Date:** Not Applicable

**Non-Publication Request:** No

**Early Publication Request:** No

**\*\* SMALL ENTITY \*\***

**Title**

DATA STORAGE AND ACCESS SYSTEMS

**Preliminary Class**

235

## **PROTECTING YOUR INVENTION OUTSIDE THE UNITED STATES**

Since the rights granted by a U.S. patent extend only throughout the territory of the United States and have no effect in a foreign country, an inventor who wishes patent protection in another country must apply for a patent in a specific country or in regional patent offices. Applicants may wish to consider the filing of an international application under the Patent Cooperation Treaty (PCT). An international (PCT) application generally has the same effect as a regular national patent application in each PCT-member country. The PCT process **simplifies** the filing of patent applications on the same invention in member countries, but **does not result** in a grant of "an international patent" and does not eliminate the need of applicants to file additional documents and fees in countries where patent protection is desired.

Almost every country has its own patent law, and a person desiring a patent in a particular country must make an application for patent in that country in accordance with its particular laws. Since the laws of many countries differ in various respects from the patent law of the United States, applicants are advised to seek guidance from specific foreign countries to ensure that patent rights are not lost prematurely.

Applicants also are advised that in the case of inventions made in the United States, the Director of the USPTO must issue a license before applicants can apply for a patent in a foreign country. The filing of a U.S. patent application serves as a request for a foreign filing license. The application's filing receipt contains further information and guidance as to the status of applicant's license for foreign filing.

Applicants may wish to consult the USPTO booklet, "General Information Concerning Patents" (specifically, the section entitled "Treaties and Foreign Patents") for more information on timeframes and deadlines for filing foreign patent applications. The guide is available either by contacting the USPTO Contact Center at 800-786-9199, or it can be viewed on the USPTO website at <http://www.uspto.gov/web/offices/pac/doc/general/index.html>.

For information on preventing theft of your intellectual property (patents, trademarks and copyrights), you may wish to consult the U.S. Government website, <http://www.stopfakes.gov>. Part of a Department of Commerce initiative, this website includes self-help "toolkits" giving innovators guidance on how to protect intellectual property in specific countries such as China, Korea and Mexico. For questions regarding patent enforcement issues, applicants may call the U.S. Government hotline at 1-866-999-HALT (1-866-999-4158).



**LICENSE FOR FOREIGN FILING UNDER**  
**Title 35, United States Code, Section 184**  
**Title 37, Code of Federal Regulations, 5.11 & 5.15**

**GRANTED**

The applicant has been granted a license under 35 U.S.C. 184, if the phrase "IF REQUIRED, FOREIGN FILING LICENSE GRANTED" followed by a date appears on this form. Such licenses are issued in all applications where the conditions for issuance of a license have been met, regardless of whether or not a license may be required as set forth in 37 CFR 5.15. The scope and limitations of this license are set forth in 37 CFR 5.15(a) unless an earlier license has been issued under 37 CFR 5.15(b). The license is subject to revocation upon written notification. The date indicated is the effective date of the license, unless an earlier license of similar scope has been granted under 37 CFR 5.13 or 5.14.

This license is to be retained by the licensee and may be used at any time on or after the effective date thereof unless it is revoked. This license is automatically transferred to any related applications(s) filed under 37 CFR 1.53(d). This license is not retroactive.

The grant of a license does not in any way lessen the responsibility of a licensee for the security of the subject matter as imposed by any Government contract or the provisions of existing laws relating to espionage and the national security or the export of technical data. Licensees should apprise themselves of current regulations especially with respect to certain countries, of other agencies, particularly the Office of Defense Trade Controls, Department of State (with respect to Arms, Munitions and Implements of War (22 CFR 121-128)); the Bureau of Industry and Security, Department of Commerce (15 CFR parts 730-774); the Office of Foreign Assets Control, Department of Treasury (31 CFR Parts 500+) and the Department of Energy.

**NOT GRANTED**

No license under 35 U.S.C. 184 has been granted at this time, if the phrase "IF REQUIRED, FOREIGN FILING LICENSE GRANTED" DOES NOT appear on this form. Applicant may still petition for a license under 37 CFR 5.12, if a license is desired before the expiration of 6 months from the filing date of the application. If 6 months has lapsed from the filing date of this application and the licensee has not received any indication of a secrecy order under 35 U.S.C. 181, the licensee may foreign file the application pursuant to 37 CFR 5.15(b).

**PART B - FEE(S) TRANSMITTAL**

Complete and send this form, together with applicable fee(s), to: **Mail** Mail Stop ISSUE FEE  
**Commissioner for Patents**  
**P.O. Box 1450**  
**Alexandria, Virginia 22313-1450**  
**or Fax (571)-273-2885**

**INSTRUCTIONS:** This form should be used for transmitting the ISSUE FEE and PUBLICATION FEE (if required). Blocks 1 through 5 should be completed where appropriate. All further correspondence including the Patent, advance orders and notification of maintenance fees will be mailed to the current correspondence address as indicated unless corrected below or directed otherwise in Block 1, by (a) specifying a new correspondence address; and/or (b) indicating a separate "FEE ADDRESS" for maintenance fee notifications.

CURRENT CORRESPONDENCE ADDRESS (Note: Use Block 1 for any change of address)

Note: A certificate of mailing can only be used for domestic mailings of the Fee(s) Transmittal. This certificate cannot be used for any other accompanying papers. Each additional paper, such as an assignment or formal drawing, must have its own certificate of mailing or transmission.

**Certificate of Mailing or Transmission**  
 I hereby certify that this Fee(s) Transmittal is being deposited with the United States Postal Service with sufficient postage for first class mail in an envelope addressed to the Mail Stop ISSUE FEE address above, or being facsimile transmitted to the USPTO (571) 273-2885, on the date indicated below.

Heather Armstrong	(Depositor's name)
/Heather Armstrong/	(Signature)
Via EFS-Web - August 25, 2011	
	(Date)

APPLICATION NO.	FILING DATE	FIRST NAMED INVENTOR	ATTORNEY DOCKET NO.	CONFIRMATION NO.
12/943,847	11/10/2010	<del>Herman and HULST</del> Patrick Sandor RACZ	<del>000379-000130US</del> 87790-794403 (000130US)	4513

TITLE OF INVENTION: DATA STORAGE AND ACCESS SYSTEMS

APPLN. TYPE	SMALL ENTITY	ISSUE FEE DUE	PUBLICATION FEE DUE	PREV. PAID ISSUE FEE	TOTAL FEE(S) DUE	DATE DUE
nonprovisional	YES	\$755	\$300	\$0	\$1055	11/09/2011

EXAMINER	ART UNIT	CLASS-SUBCLASS
I.E, THIEN MINH	2887	235-380000

1. Change of correspondence address or indication of "Fee Address" (37 CFR 1.363).

- Change of correspondence address (or Change of Correspondence Address form PTO/SB/122) attached.
- "Fee Address" indication (or "Fee Address" Indication form PTO/SB/47; Rev 03-02 or more recent) attached. **Use of a Customer Number is required.**

2. For printing on the patent front page, list

- (1) the names of up to 3 registered patent attorneys or agents OR, alternatively,
- (2) the name of a single firm (having as a member a registered attorney or agent) and the names of up to 2 registered patent attorneys or agents. If no name is listed, no name will be printed.

- 1 \_\_\_\_\_
- 2 Kilpatrick Townsend &
- 3 Stockton LLP

3. ASSIGNEE NAME AND RESIDENCE DATA TO BE PRINTED ON THE PATENT (print or type)

PLEASE NOTE: Unless an assignee is identified below, no assignee data will appear on the patent. If an assignee is identified below, the document has been filed for recordation as set forth in 37 CFR 3.11. Completion of this form is NOT a substitute for filing an assignment.

(A) NAME OF ASSIGNEE: Smartflash Technologies Limited  
 (B) RESIDENCE: (CITY and STATE OR COUNTRY) Tortola, British Virgin Islands

Please check the appropriate assignee category or categories (will not be printed on the patent):  Individual  Corporation or other private group entity  Government

4a. The following fee(s) are submitted:

- Issue Fee
- Publication Fee (No small entity discount permitted)
- Advance Order - # of Copies \_\_\_\_\_

4b. Payment of Fee(s): (Please first reapply any previously paid issue fee shown above)

- A check is enclosed.
- Payment by credit card. Form PTO-2038 is attached.
- The Director is hereby authorized to charge the required fee(s), any deficiency, or credit any overpayment, to Deposit Account Number 201430 (enclose an extra copy of this form).

5. Change in Entity Status (from status indicated above)

- a. Applicant claims SMALL ENTITY status. See 37 CFR 1.27.
- b. Applicant is no longer claiming SMALL ENTITY status. See 37 CFR 1.27(g)(2).

NOTE: The Issue Fee and Publication Fee (if required) will not be accepted from anyone other than the applicant; a registered attorney or agent; or the assignee or other party in interest as shown by the records of the United States Patent and Trademark Office.

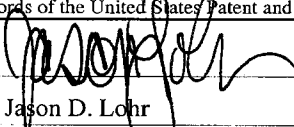
Authorized Signature   
 Typed or printed name Jason D. Lohr

Date August 25, 2011  
 Registration No. 48,163

This collection of information is required by 37 CFR 1.311. The information is required to obtain or retain a benefit by the public which is to file (and by the USPTO to process) an application. Confidentiality is governed by 35 U.S.C. 122 and 37 CFR 1.14. This collection is estimated to take 12 minutes to complete, including gathering, preparing, and submitting the completed application form to the USPTO. Time will vary depending upon the individual case. Any comments on the amount of time you require to complete this form and/or suggestions for reducing this burden, should be sent to the Chief Information Officer, U.S. Patent and Trademark Office, U.S. Department of Commerce, P.O. Box 1450, Alexandria, Virginia 22313-1450. DO NOT SEND FEES OR COMPLETED FORMS TO THIS ADDRESS. SEND TO: Commissioner for Patents, P.O. Box 1450, Alexandria, Virginia 22313-1450.

Under the Paperwork Reduction Act of 1995, no persons are required to respond to a collection of information unless it displays a valid OMB control number.

## Electronic Patent Application Fee Transmittal

<b>Application Number:</b>	12943847
<b>Filing Date:</b>	10-Nov-2010
<b>Title of Invention:</b>	DATA STORAGE AND ACCESS SYSTEMS
<b>First Named Inventor/Applicant Name:</b>	Patrick Sandor RACZ
<b>Filer:</b>	Jason Donald Lohr/Heather Armstrong
<b>Attorney Docket Number:</b>	87790-794403 (000130US)

Filed as Small Entity

### Utility under 35 USC 111(a) Filing Fees

Description	Fee Code	Quantity	Amount	Sub-Total in USD(\$)
<b>Basic Filing:</b>				
<b>Pages:</b>				
<b>Claims:</b>				
<b>Miscellaneous-Filing:</b>				
<b>Petition:</b>				
<b>Patent-Appeals-and-Interference:</b>				
<b>Post-Allowance-and-Post-Issuance:</b>				
Utility Appl issue fee	2501	1	755	755
Publ. Fee- early, voluntary, or normal	1504	1	300	300

Description	Fee Code	Quantity	Amount	Sub-Total in USD(\$)
<b>Extension-of-Time:</b>				
<b>Miscellaneous:</b>				
<b>Total in USD (\$)</b>				<b>1055</b>

## Electronic Acknowledgement Receipt

<b>EFS ID:</b>	10818664
<b>Application Number:</b>	12943847
<b>International Application Number:</b>	
<b>Confirmation Number:</b>	4513
<b>Title of Invention:</b>	DATA STORAGE AND ACCESS SYSTEMS
<b>First Named Inventor/Applicant Name:</b>	Patrick Sandor RACZ
<b>Customer Number:</b>	20350
<b>Filer:</b>	Jason Donald Lohr/Heather Armstrong
<b>Filer Authorized By:</b>	Jason Donald Lohr
<b>Attorney Docket Number:</b>	87790-794403 (000130US)
<b>Receipt Date:</b>	25-AUG-2011
<b>Filing Date:</b>	10-NOV-2010
<b>Time Stamp:</b>	19:20:51
<b>Application Type:</b>	Utility under 35 USC 111(a)

### Payment information:

Submitted with Payment	yes
Payment Type	Credit Card
Payment was successfully received in RAM	\$1055
RAM confirmation Number	8389
Deposit Account	
Authorized User	

### File Listing:

Document Number	Document Description	File Name	File Size(Bytes)/ Message Digest	Multi Part /.zip	Pages (if appl.)
-----------------	----------------------	-----------	----------------------------------	------------------	------------------

1	Issue Fee Payment (PTO-85B)	2011-08-25- Issue_Fee_Trans-87790-794403 .pdf	102114  6e76918992c3957cb444dda61257893966e 38845	no	1
---	-----------------------------	---	--	----	---

**Warnings:**

**Information:**

2	Fee Worksheet (SB06)	fee-info.pdf	31938  c473ba10765add5774659e8d885184e53f8 d534e	no	2
---	----------------------	--------------	---	----	---

**Warnings:**

**Information:**

<b>Total Files Size (in bytes):</b>			134052		
-------------------------------------	--	--	--------	--	--

**This Acknowledgement Receipt evidences receipt on the noted date by the USPTO of the indicated documents, characterized by the applicant, and including page counts, where applicable. It serves as evidence of receipt similar to a Post Card, as described in MPEP 503.**

**New Applications Under 35 U.S.C. 111**

**If a new application is being filed and the application includes the necessary components for a filing date (see 37 CFR 1.53(b)-(d) and MPEP 506), a Filing Receipt (37 CFR 1.54) will be issued in due course and the date shown on this Acknowledgement Receipt will establish the filing date of the application.**

**National Stage of an International Application under 35 U.S.C. 371**

**If a timely submission to enter the national stage of an international application is compliant with the conditions of 35 U.S.C. 371 and other applicable requirements a Form PCT/DO/EO/903 indicating acceptance of the application as a national stage submission under 35 U.S.C. 371 will be issued in addition to the Filing Receipt, in due course.**

**New International Application Filed with the USPTO as a Receiving Office**

**If a new international application is being filed and the international application includes the necessary components for an international filing date (see PCT Article 11 and MPEP 1810), a Notification of the International Application Number and of the International Filing Date (Form PCT/RO/105) will be issued in due course, subject to prescriptions concerning national security, and the date shown on this Acknowledgement Receipt will establish the international filing date of the application.**



UNITED STATES PATENT AND TRADEMARK OFFICE

UNITED STATES DEPARTMENT OF COMMERCE
United States Patent and Trademark Office
Address: COMMISSIONER FOR PATENTS
P.O. Box 1450
Alexandria, Virginia 22313-1450
www.uspto.gov

Table with 5 columns: APPLICATION NO., FILING DATE, FIRST NAMED INVENTOR, ATTORNEY DOCKET NO., CONFIRMATION NO.
12/943,847 11/10/2010 Patrick Sandor RACZ 87790-794403 (000130US) 4513

20350 7590 09/09/2011
KILPATRICK TOWNSEND & STOCKTON LLP
TWO EMBARCADERO CENTER
EIGHTH FLOOR
SAN FRANCISCO, CA 94111-3834

EXAMINER

LE, THIEN MINH

ART UNIT PAPER NUMBER

2887

NOTIFICATION DATE DELIVERY MODE

09/09/2011

ELECTRONIC

Please find below and/or attached an Office communication concerning this application or proceeding.

The time period for reply, if any, is set in the attached communication.

Notice of the Office communication was sent electronically on above-indicated "Notification Date" to the following e-mail address(es):

- Docket@kilpatricktownsend.com
ipefiling@kilpatricktownsend.com
jlhice@kilpatrick.foundationip.com



**UNITED STATES DEPARTMENT OF COMMERCE**

**U.S. Patent and Trademark Office**

Address : COMMISSIONER FOR PATENTS  
P.O. Box 1450  
Alexandria, Virginia 22313-1450

<b>APPLICATION NO./ CONTROL NO.</b>	<b>FILING DATE</b>	<b>FIRST NAMED INVENTOR / PATENT IN REEXAMINATION</b>	<b>ATTORNEY DOCKET NO.</b>
---	--------------------	---	----------------------------

12/943,847  
(000130US)

10 November 2010

RACZ ET AL.

87790-794403

KILPATRICK TOWNSEND & STOCKTON LLP  
TWO EMBARCADERO CENTER  
EIGHTH FLOOR  
SAN FRANCISCO, CA 94111-3834

**EXAMINER**

THIEN M. LE

<b>ART UNIT</b>	<b>PAPER</b>
-----------------	--------------

2887

20110901

DATE MAILED:

**Please find below and/or attached an Office communication concerning this application or proceeding.**

**Commissioner for Patents**

The information disclosure statement filed on 11/12/2010 has been re-considered to include the initial of the examiner.

/THIEN M LE/  
Primary Examiner, Art Unit 2887



Substitute for form 1449/PTO  <b>INFORMATION DISCLOSURE STATEMENT BY APPLICANT</b>  (Use as many sheets as necessary)				<b>Complete if Known</b>		
				Application Number	12/943,847	
				Filing Date	November 10, 2010	
				First Named Inventor	RACZ, Patrick	
				Art Unit	2876	
				Examiner Name		
Sheet	1	of	1	Attorney Docket Number	080379-000130US	

U.S. PATENT DOCUMENTS					
Examiner Initials*	Cite No. <sup>1</sup>	Document Number	Publication Date MM-DD-YYYY	Name of Patentee or Applicant of Cited Document	Pages, Columns, Lines, Where Relevant Passages or Relevant Figures Appear
		Number Kind Code <sup>2</sup> (if known)			
	AA	US 6,658,568 B1	12-02-2003	Ginter et al.	

FOREIGN PATENT DOCUMENTS								
Examiner Initials*	Cite No. <sup>1</sup>	Foreign Patent Document			Publication Date MM-DD-YYYY	Name of Patentee or Applicant of Cited Document	Pages, Columns, Lines, Where Relevant Passages or Relevant Figures Appear	T <sup>6</sup>
		Country Code <sup>3</sup>	Number <sup>4</sup>	Kind Code <sup>5</sup> (if known)				

NON PATENT LITERATURE DOCUMENTS			
Examiner Initials *	Cite No. <sup>1</sup>	Include name of the author (in CAPITAL LETTERS), title of the article (when appropriate), title of the item (book, magazine, journal, serial, symposium, catalog, etc.), date, page(s), volume-issue number(s), publisher, city and/or country where published.	T <sup>6</sup>

Examiner Signature	/Thien Le/	Date Considered	09/01/2011
--------------------	------------	-----------------	------------

<sup>1</sup> EXAMINER: Initial if reference considered, whether or not citation is in conformance with MPEP 609. Draw line through citation if not in conformance and not considered. Include copy of this form with next communication to applicant. <sup>2</sup> Applicant's unique citation designation number (optional). <sup>3</sup> See Kind Codes of U.S. Patent Documents at [www.uspto.gov](http://www.uspto.gov) or MPEP 901.04. <sup>4</sup> Enter Office that issued the document, by the two-letter code (WIPO Standard ST.3). <sup>5</sup> For Japanese patent documents, the indication of the year of the reign of the Emperor must precede the serial number of the patent document. <sup>6</sup> Kind of document by the appropriate symbols as indicated on the document under WIPO Standard ST. 16 if possible. <sup>6</sup> Applicant is to place a check mark here if English language Translation is attached.

Substitute for form 1449/PTO				<b>Complete if Known</b>	
				<b>Application Number</b>	12/943,847
<b>INFORMATION DISCLOSURE STATEMENT BY APPLICANT</b>				<b>Filing Date</b>	November 10, 2010
				<b>First Named Inventor</b>	HULST, Hermen-ard
				<b>Art Unit</b>	2887
				<b>Examiner Name</b>	Thien Minh Le
				<b>Attorney Docket Number</b>	87790-794403
Sheet	1	of	1		

(Use as many sheets as necessary)

Change(s) applied to document, N.C.C. 8/26/2011

U.S. PATENT DOCUMENTS						
Examiner Initials*	Cite No. <sup>1</sup>	Document Number		Publication Date MM-DD-YYYY	Name of Patentee or Applicant of Cited Document	Pages, Columns, Lines, Where Relevant Passages or Relevant Figures Appear
		Number Kind Code <sup>2</sup> (if known)				
	1	6,415,156	B1	Stadelmann	7/2002	

FOREIGN PATENT DOCUMENTS								
Examiner Initials*	Cite No. <sup>1</sup>	Foreign Patent Document			Publication Date MM-DD-YYYY	Name of Patentee or Applicant of Cited Document	Pages, Columns, Lines, Where Relevant Passages or Relevant Figures Appear	T <sup>6</sup>
		Country Code <sup>3</sup>	Number <sup>4</sup>	Kind Code <sup>5</sup> (if known)				
								<input type="checkbox"/>
								<input type="checkbox"/>

Examiner Signature	/Thien Le/	Date Considered	08/01/2011
--------------------	------------	-----------------	------------

\*EXAMINER: Initial if reference considered, whether or not citation is in conformance with MPEP 609. Draw line through citation if not in conformance and not considered. Include copy of this form with next communication to applicant. <sup>1</sup> Applicant's unique citation designation number (optional). <sup>2</sup> See Kind Codes of U.S. Patent Documents at [www.uspto.gov](http://www.uspto.gov) or MPEP 901.04. <sup>3</sup> Enter Office that issued the document, by the two-letter code (WIPO Standard ST.3). <sup>4</sup> For Japanese patent documents, the indication of the year of the reign of the Emperor must precede the serial number of the patent document. <sup>5</sup> Kind of document by the appropriate symbols as indicated on the document under WIPO Standard ST. 16 if possible. <sup>6</sup> Applicant is to place a check mark here if English language Translation is attached.



APPLICATION NO.	ISSUE DATE	PATENT NO.	ATTORNEY DOCKET NO.	CONFIRMATION NO.
12/943,847	10/11/2011	8033458	87790-794403 (000130US)	4513

20350 7590 09/21/2011  
KILPATRICK TOWNSEND & STOCKTON LLP  
TWO EMBARCADERO CENTER  
EIGHTH FLOOR  
SAN FRANCISCO, CA 94111-3834

### ISSUE NOTIFICATION

The projected patent number and issue date are specified above.

#### **Determination of Patent Term Adjustment under 35 U.S.C. 154 (b)** (application filed on or after May 29, 2000)

The Patent Term Adjustment is 0 day(s). Any patent to issue from the above-identified application will include an indication of the adjustment on the front page.

If a Continued Prosecution Application (CPA) was filed in the above-identified application, the filing date that determines Patent Term Adjustment is the filing date of the most recent CPA.

Applicant will be able to obtain more detailed information by accessing the Patent Application Information Retrieval (PAIR) WEB site (<http://pair.uspto.gov>).

Any questions regarding the Patent Term Extension or Adjustment determination should be directed to the Office of Patent Legal Administration at (571)-272-7702. Questions relating to issue and publication fee payments should be directed to the Application Assistance Unit (AAU) of the Office of Data Management (ODM) at (571)-272-4200.

APPLICANT(s) (Please see PAIR WEB site <http://pair.uspto.gov> for additional applicants):

Patrick Sandor RACZ, Saint Heller, JERSEY;  
Hermen-ard HULST, Amsterdam, NETHERLANDS;

AO 120 (Rev. 08/10)

TO: <b>Mail Stop 8</b> <b>Director of the U.S. Patent and Trademark Office</b> <b>P.O. Box 1450</b> <b>Alexandria, VA 22313-1450</b>	<b>REPORT ON THE</b> <b>FILING OR DETERMINATION OF AN</b> <b>ACTION REGARDING A PATENT OR</b> <b>TRADEMARK</b>
---	---

In Compliance with 35 U.S.C. § 290 and/or 15 U.S.C. § 1116 you are hereby advised that a court action has been filed in the U.S. District Court Eastern District of Texas Tyler Division on the following  
 Trademarks or  Patents. (  the patent action involves 35 U.S.C. § 292.):

DOCKET NO. 6:13-cv-448	DATE FILED 5/29/2013	U.S. DISTRICT COURT Eastern District of Texas Tyler Division
PLAINTIFF Smartflash LLC and Smartflash Technologies Limited		DEFENDANT Samsung Electronics Co., Ltd., Samsung Electronics America, Inc., Samsung Telecommunications America, LLC, HTC Corporation, HTC America, Inc., Exedea, Inc. and Game Circus LLC
PATENT OR TRADEMARK NO.	DATE OF PATENT OR TRADEMARK	HOLDER OF PATENT OR TRADEMARK
1 7,334,720	2/26/2008	Smartflash LLC
2 7,942,317	5/17/2011	Smartflash LLC
3 8,033,458	10/11/2011	Smartflash LLC
4 8,061,598	11/22/2011	Smartflash LLC
5 8,118,221	2/21/2012	Smartflash LLC

In the above—entitled case, the following patent(s)/ trademark(s) have been included:

DATE INCLUDED	INCLUDED BY <input type="checkbox"/> Amendment <input type="checkbox"/> Answer <input type="checkbox"/> Cross Bill <input type="checkbox"/> Other Pleading	
PATENT OR TRADEMARK NO.	DATE OF PATENT OR TRADEMARK	HOLDER OF PATENT OR TRADEMARK
1 8,336,772		
2		
3		
4		
5		

In the above—entitled case, the following decision has been rendered or judgement issued:

DECISION/JUDGEMENT
--------------------

CLERK	(BY) DEPUTY CLERK	DATE
-------	-------------------	------

Copy 1—Upon initiation of action, mail this copy to Director    Copy 3—Upon termination of action, mail this copy to Director  
 Copy 2—Upon filing document adding patent(s), mail this copy to Director    Copy 4—Case file copy

AO 120 (Rev. 08/10)

TO: <b>Mail Stop 8</b> <b>Director of the U.S. Patent and Trademark Office</b> <b>P.O. Box 1450</b> <b>Alexandria, VA 22313-1450</b>	<b>REPORT ON THE</b> <b>FILING OR DETERMINATION OF AN</b> <b>ACTION REGARDING A PATENT OR</b> <b>TRADEMARK</b>
---	---

In Compliance with 35 U.S.C. § 290 and/or 15 U.S.C. § 1116 you are hereby advised that a court action has been filed in the U.S. District Court Eastern District of Texas Tyler Division on the following

Trademarks or  Patents. (  the patent action involves 35 U.S.C. § 292.):

DOCKET NO. 6:13-cv-447	DATE FILED 5/29/2013	U.S. DISTRICT COURT Eastern District of Texas Tyler Division
PLAINTIFF Smartflash LLC and Smartflash Technologies Limited		DEFENDANT Apple Inc., Robot Entertainment, Inc., Kingsisle Entertainment, Inc. and Game Circus LLC
PATENT OR TRADEMARK NO.	DATE OF PATENT OR TRADEMARK	HOLDER OF PATENT OR TRADEMARK
1 7,334,720	2/26/2008	Smartflash LLC
2 7,942,317	5/17/2011	Smartflash LLC
3 8,033,458	10/11/2011	Smartflash LLC
4 8,061,598	11/22/2011	Smartflash LLC
5 8,118,221	2/21/2012	Smartflash LLC

In the above—entitled case, the following patent(s)/ trademark(s) have been included:

DATE INCLUDED	INCLUDED BY <input type="checkbox"/> Amendment <input type="checkbox"/> Answer <input type="checkbox"/> Cross Bill <input type="checkbox"/> Other Pleading		
PATENT OR TRADEMARK NO.	DATE OF PATENT OR TRADEMARK	HOLDER OF PATENT OR TRADEMARK	
1 8,336,772			
2			
3			
4			
5			

In the above—entitled case, the following decision has been rendered or judgement issued:

DECISION/JUDGEMENT
--------------------

CLERK	(BY) DEPUTY CLERK	DATE
-------	-------------------	------

Copy 1—Upon initiation of action, mail this copy to Director Copy 3—Upon termination of action, mail this copy to Director  
 Copy 2—Upon filing document adding patent(s), mail this copy to Director Copy 4—Case file copy