



US008061598B2

(12) **United States Patent**  
**Racz et al.**

(10) **Patent No.:** **US 8,061,598 B2**

(45) **Date of Patent:** **\*Nov. 22, 2011**

(54) **DATA STORAGE AND ACCESS SYSTEMS**

(75) Inventors: **Patrick Racz**, Saint Heller (JE);  
**Hermen-ard Hulst**, Amsterdam (NL)

(73) Assignee: **Smartflash Technologies Limited**,  
Tortola (VG)

(\*) Notice: Subject to any disclaimer, the term of this  
patent is extended or adjusted under 35  
U.S.C. 154(b) by 0 days.

This patent is subject to a terminal dis-  
claimer.

5,148,432 A	9/1992	Gordon et al.
5,226,145 A	7/1993	Moronaga et al.
5,367,150 A	11/1994	Kitta et al.
5,406,619 A	4/1995	Akhteruzzaman et al.
5,457,746 A	10/1995	Dolphin
5,532,466 A	7/1996	Konno et al.
5,588,146 A	12/1996	Leroux
5,677,953 A	10/1997	Dolphin
5,703,951 A	12/1997	Dolphin
5,740,369 A	4/1998	Yokozawa et al.
5,744,787 A	4/1998	Teicher
5,754,654 A	5/1998	Hiroya et al.
5,794,202 A	8/1998	Kim

(Continued)

FOREIGN PATENT DOCUMENTS

(21) Appl. No.: **13/012,541**

EP 0 195 098 10/1990

(22) Filed: **Jan. 24, 2011**

(Continued)

(65) **Prior Publication Data**

US 2011/0114723 A1 May 19, 2011

*Primary Examiner* — Thien M Le

(74) *Attorney, Agent, or Firm* — Kilpatrick Townsend &  
Stockton LLP

**Related U.S. Application Data**

(63) Continuation of application No. 12/014,558, filed on  
Jan. 15, 2008, now Pat. No. 7,942,317, which is a  
continuation of application No. 11/336,758, filed on  
Jan. 19, 2006, now Pat. No. 7,334,720, which is a  
continuation of application No. 10/111,716, filed on  
Sep. 17, 2002, now abandoned.

(57) **ABSTRACT**

Data storage and access systems enable downloading and  
paying for data such as audio and video data, text, software,  
games and other types of data. A portable data carrier has an  
interface for sending and receiving data, data memory for  
storing received content data, and payment validation  
memory for providing payment validation data to an external  
device. The carrier may also store a record of access made to  
the stored content, and content use rules for controlling access  
to the stored content. Embodiments store further access con-  
trol data and supplementary data such as hot links to web sites  
and/or advertising data. A complementary data access termi-  
nal, data supply computer system, and data access device are  
also described. The combination of payment data and stored  
content data and use rule data helps reduce the risk of unau-  
thorized access to data such as compressed music and video  
data, especially over the Internet.

(51) **Int. Cl.**

**G06K 5/00** (2006.01)

(52) **U.S. Cl.** ..... **235/380**; 235/382

(58) **Field of Classification Search** ..... 235/380,  
235/382, 492, 451

See application file for complete search history.

(56) **References Cited**

U.S. PATENT DOCUMENTS

4,341,951 A	7/1982	Benton
4,697,073 A	9/1987	Hara

**41 Claims, 17 Drawing Sheets**

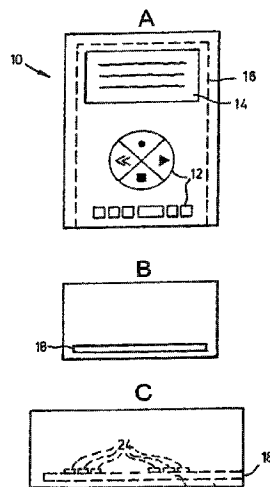

U.S. PATENT DOCUMENTS

5,809,241 A 9/1998 Hanel et al.  
 5,845,201 A 12/1998 Funke et al.  
 5,845,281 A 12/1998 Benson et al.  
 5,847,372 A 12/1998 Kreft  
 5,874,760 A 2/1999 Burns et al.  
 5,889,860 A 3/1999 Eller et al.  
 5,901,330 A 5/1999 Sun et al.  
 5,918,213 A 6/1999 Bernard et al.  
 5,923,884 A 7/1999 Peyret et al.  
 5,933,498 A 8/1999 Schneck et al.  
 5,936,220 A 8/1999 Hoshino et al.  
 6,012,634 A 1/2000 Brogan et al.  
 6,018,720 A 1/2000 Fujimoto  
 6,078,917 A 6/2000 Paulsen et al.  
 6,119,945 A 9/2000 Muller et al.  
 6,142,369 A 11/2000 Jonstromer  
 6,202,056 B1 3/2001 Nuttall  
 6,385,731 B2 5/2002 Ananda  
 6,415,156 B1\* 7/2002 Stadelmann ..... 455/466  
 6,424,975 B1 7/2002 Walter et al.  
 6,442,570 B1 8/2002 Wu  
 6,473,829 B1 10/2002 Dahman et al.  
 6,510,236 B1 1/2003 Crane et al.  
 6,553,413 B1 4/2003 Leighton et al.  
 6,554,192 B2 4/2003 Tingl  
 6,574,643 B2 6/2003 Walter et al.  
 6,658,568 B1 12/2003 Ginter et al.  
 6,721,749 B1 4/2004 Najm et al.  
 6,747,930 B1 6/2004 Weldon et al.

6,993,507 B2 1/2006 Meyer et al.  
 6,999,936 B2 2/2006 Sehr  
 7,000,836 B2 2/2006 Saeki  
 7,044,362 B2 5/2006 Yu  
 7,083,081 B2 8/2006 McGee et al.  
 7,334,720 B2 2/2008 Hulst et al.  
 7,677,446 B2 3/2010 Wise  
 2003/0163594 A1 8/2003 Aasheim et al.  
 2003/0168515 A1 9/2003 Gray  
 2006/0179211 A1 8/2006 Aasheim et al.  
 2006/0249570 A1 11/2006 Seifert et al.  
 2007/0162300 A1\* 7/2007 Roever et al. .... 705/1  
 2008/0041938 A1 2/2008 Wise  
 2008/0314974 A1\* 12/2008 Hulst et al. .... 235/380

FOREIGN PATENT DOCUMENTS

EP 0 713 198 A2 5/1996  
 EP 0 823 694 A1 2/1998  
 EP 0 542 298 4/1998  
 EP 0 843 449 A2 5/1998  
 EP 0 914 001 A1 5/1999  
 JP 10-269291 A 10/1998  
 JP 11-53184 A 2/1999  
 JP 11-212785 A 8/1999  
 JP 11-213010 A 8/1999  
 JP 11-272762 A 10/1999  
 WO WO 98/19237 A1 5/1998  
 WO WO 98/33343 7/1998  
 WO WO 98/37526 8/1998

\* cited by examiner

Fig. 1

A

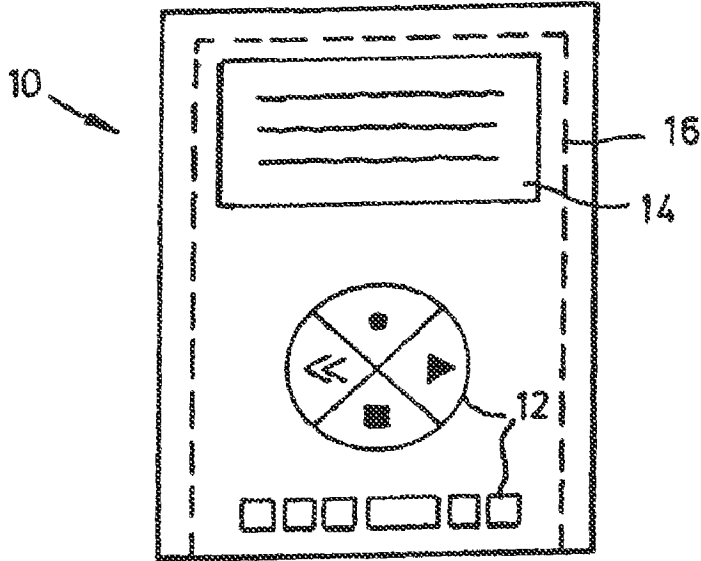

B

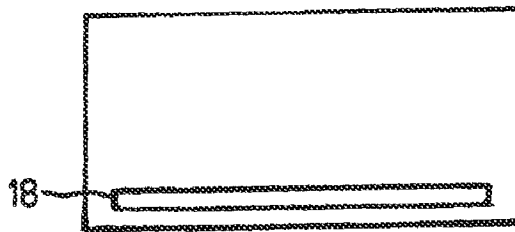

C

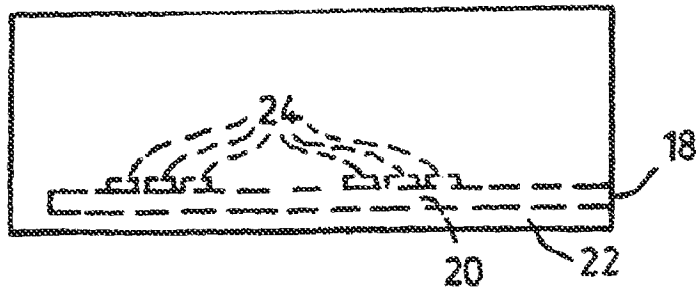

Fig. 2

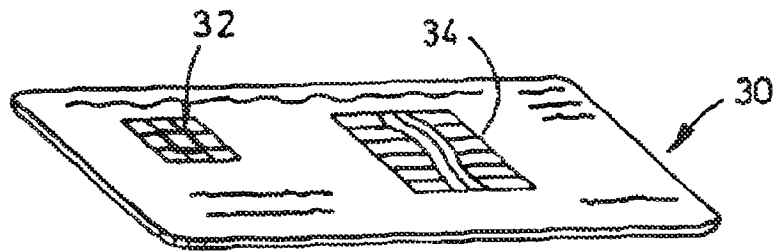

Fig. 3

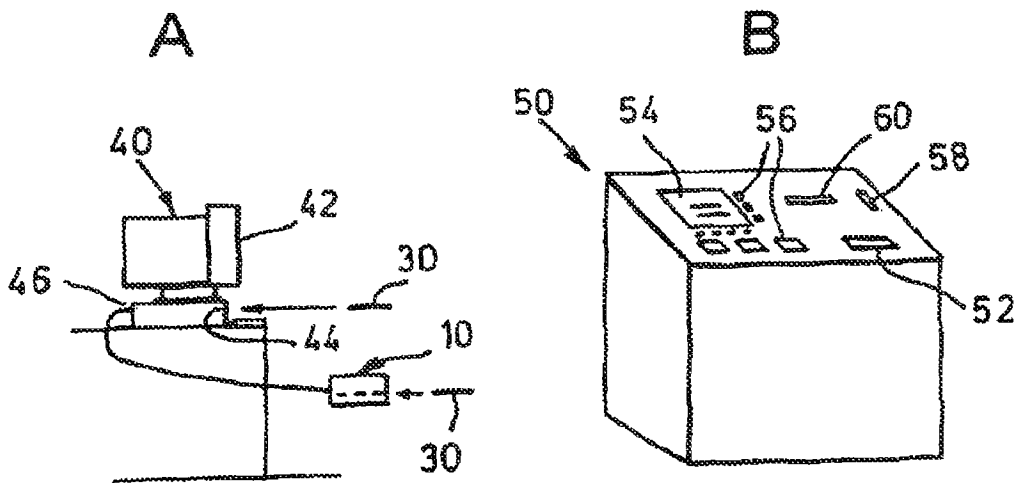
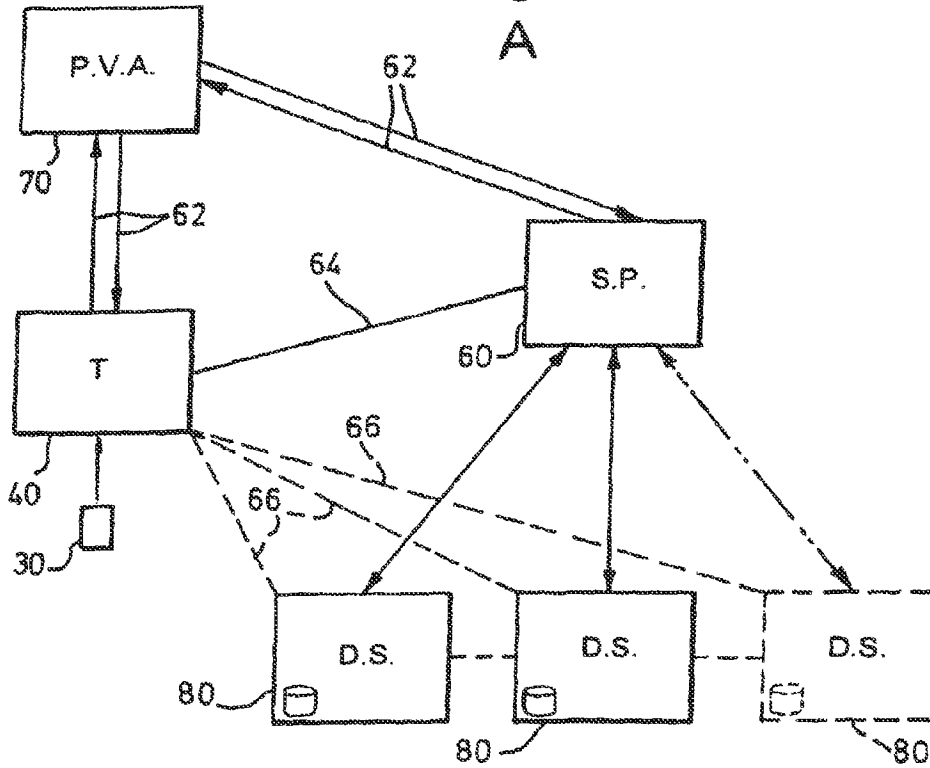
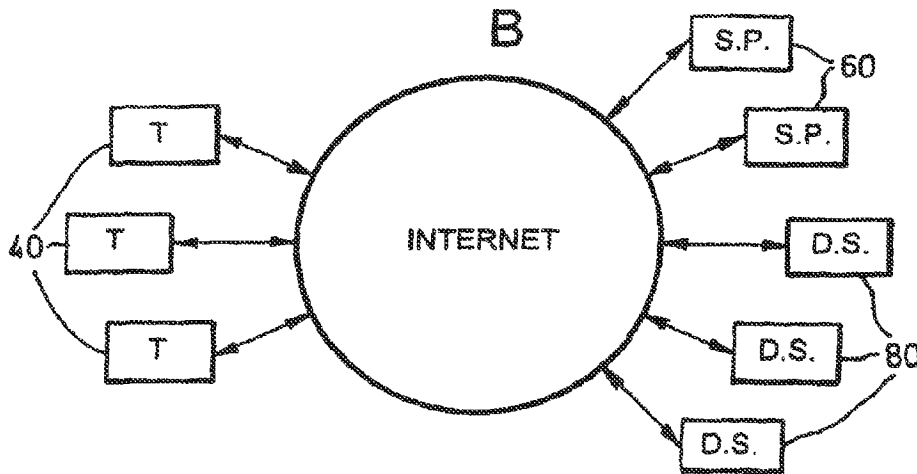

Fig. 4  
A



B



# Explore Litigation Insights

Docket Alarm provides insights to develop a more informed litigation strategy and the peace of mind of knowing you're on top of things.

## Real-Time Litigation Alerts



Keep your litigation team up-to-date with **real-time alerts** and advanced team management tools built for the enterprise, all while greatly reducing PACER spend.

Our comprehensive service means we can handle Federal, State, and Administrative courts across the country.

## Advanced Docket Research



With over 230 million records, Docket Alarm's cloud-native docket research platform finds what other services can't. Coverage includes Federal, State, plus PTAB, TTAB, ITC and NLRB decisions, all in one place.

Identify arguments that have been successful in the past with full text, pinpoint searching. Link to case law cited within any court document via Fastcase.

## Analytics At Your Fingertips



Learn what happened the last time a particular judge, opposing counsel or company faced cases similar to yours.

Advanced out-of-the-box PTAB and TTAB analytics are always at your fingertips.

## API

Docket Alarm offers a powerful API (application programming interface) to developers that want to integrate case filings into their apps.

## LAW FIRMS

Build custom dashboards for your attorneys and clients with live data direct from the court.

Automate many repetitive legal tasks like conflict checks, document management, and marketing.

## FINANCIAL INSTITUTIONS

Litigation and bankruptcy checks for companies and debtors.

## E-DISCOVERY AND LEGAL VENDORS

Sync your system to PACER to automate legal marketing.