



(12) **United States Patent**  
**Racz et al.**

(10) **Patent No.:** **US 7,942,317 B2**  
(45) **Date of Patent:** **\*May 17, 2011**

(54) **DATA STORAGE AND ACCESS SYSTEMS**

(75) Inventors: **Patrick Racz**, Saint Heller (JE);  
**Hermen-ard Hulst**, Amsterdam (NL)  
(73) Assignee: **Smartflash Technologies Limited**, Road  
Town, Tortola  
(\* ) Notice: Subject to any disclaimer, the term of this  
patent is extended or adjusted under 35  
U.S.C. 154(b) by 245 days.  
This patent is subject to a terminal dis-  
claimer.

(56) **References Cited**

U.S. PATENT DOCUMENTS			
4,697,073	A	9/1987	Hara
5,226,145	A	7/1993	Moronaga et al.
5,367,150	A	11/1994	Kitta et al.
5,406,619	A	4/1995	Akhteruzzaman et al.
5,457,746	A	10/1995	Dolphin
5,532,466	A	7/1996	Konno et al.
5,588,146	A	12/1996	Leroux
5,677,953	A	10/1997	Dolphin
5,703,951	A	12/1997	Dolphin
5,740,369	A *	4/1998	Yokozawa et al. .... 709/217
5,744,787	A	4/1998	Teicher
5,754,654	A	5/1998	Hiroya et al.

(Continued)

(21) Appl. No.: **12/014,558**

(22) Filed: **Jan. 15, 2008**

(65) **Prior Publication Data**

US 2008/0314974 A1 Dec. 25, 2008

**Related U.S. Application Data**

(63) Continuation of application No. 11/336,758, filed on  
Jan. 19, 2006, now Pat. No. 7,334,720, which is a  
continuation of application No. 10/111,716, filed as  
application No. PCT/GB00/04110 on Oct. 25, 2000,  
now abandoned.

(30) **Foreign Application Priority Data**

Nov. 25, 1999 (GB) ..... 9925227.2

(51) **Int. Cl.**  
**G06K 5/00** (2006.01)

(52) **U.S. Cl.** ..... **235/380; 235/382**

(58) **Field of Classification Search** ..... 235/451,  
235/380, 382, 492; 711/100, 101, 103  
See application file for complete search history.

FOREIGN PATENT DOCUMENTS

EP 0 195 098 10/1990

(Continued)

*Primary Examiner* — Thien M Le

(74) *Attorney, Agent, or Firm* — Kilpatrick Townsend  
Stockton LLP

(57) **ABSTRACT**

Data storage and access systems are described for download-  
ing and paying for data such as audio and video data, text,  
software, games and other types of data. A portable data  
carrier has an interface for sending and receiving data, non-  
volatile data memory for storing received content data and  
non-volatile payment validation memory for providing pay-  
ment validation data to an external device. The carrier may  
also store a record of access made to the stored content, and  
content use rules for controlling access to the stored content.  
Preferred embodiments store further access control data and  
supplementary data such as hot links to web sites and/or  
advertising data. A complementary data access terminal, data  
supply computer system and data access device are also  
described. The combination of payment data and stored con-  
tent data and, in preferred embodiments, use rule data, helps  
reduce the risk of unauthorized access to data such as com-  
pressed music and video data, especially over the Internet.

**19 Claims, 17 Drawing Sheets**

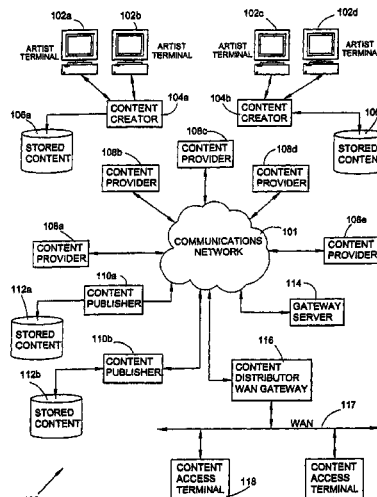

# US 7,942,317 B2

Page 2

## U.S. PATENT DOCUMENTS

5,794,202	A	8/1998	Kim	
5,809,241	A	9/1998	Hanel et al.	
5,845,281	A	12/1998	Benson et al.	
5,847,372	A	12/1998	Kreft	
5,889,860	A	3/1999	Eller et al.	
5,901,330	A	5/1999	Sun et al.	
5,918,213	A	6/1999	Bernard et al.	
5,923,884	A	7/1999	Peyret et al.	
5,933,498	A	8/1999	Schneck et al.	
5,936,220	A	8/1999	Hoshino et al.	
6,012,634	A	1/2000	Brogan et al.	
6,018,720	A	1/2000	Fujimoto	
6,078,917	A	6/2000	Paulsen et al.	
6,119,945	A	9/2000	Muller et al.	
6,142,369	A	11/2000	Jonstromer	
6,202,056	B1	3/2001	Nuttall	
6,385,731	B2	5/2002	Ananda	
6,424,975	B1	7/2002	Walter et al.	
6,442,570	B1	8/2002	Wu	
6,473,829	B1	10/2002	Dahman et al.	
6,510,236	B1	1/2003	Crane et al.	
6,553,413	B1	4/2003	Leighton et al.	
6,554,192	B2*	4/2003	Tingl .....	235/487
6,574,643	B2	6/2003	Walter et al.	
6,658,568	B1	12/2003	Ginter et al.	

6,993,507	B2*	1/2006	Meyer et al. ....	705/40
6,999,936	B2	2/2006	Sehr	
7,000,836	B2	2/2006	Saeki	
7,044,362	B2	5/2006	Yu	
7,083,081	B2	8/2006	McGee et al.	
7,334,720	B2*	2/2008	Hulst et al. ....	235/380
7,677,446	B2*	3/2010	Wise .....	235/380
2003/0168515	A1	9/2003	Gray	
2006/0249570	A1*	11/2006	Seifert et al. ....	235/380
2008/0041938	A1*	2/2008	Wise .....	235/380

## FOREIGN PATENT DOCUMENTS

EP	0 713 198	A2	5/1996
EP	0 823 694	A1	2/1998
EP	0 542 298		4/1998
EP	0 843 449	A2	5/1998
EP	0 914 001	A1	5/1999
JP	10-269291	A	10/1998
JP	11-53184	A	2/1999
JP	11-212785	A	8/1999
JP	11-213010	A	8/1999
JP	11-272762	A	10/1999
WO	WO 98/19237	A1	5/1998
WO	WO 98/33343		7/1998
WO	WO 98/37526		8/1998

\* cited by examiner

Fig. 1

A

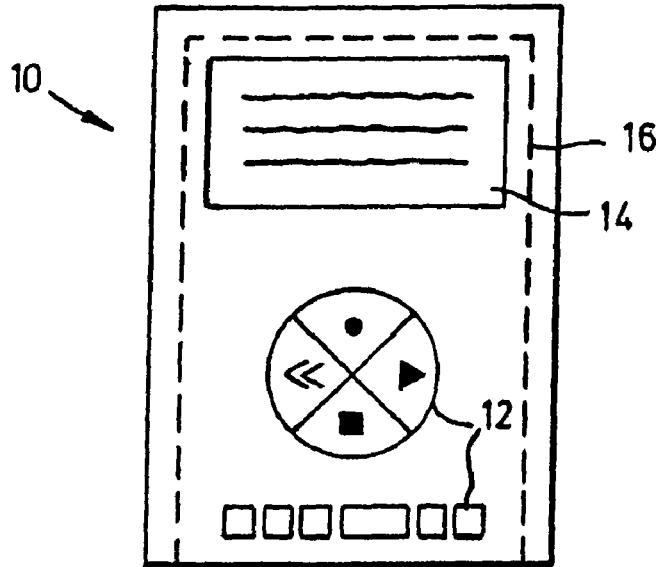

B

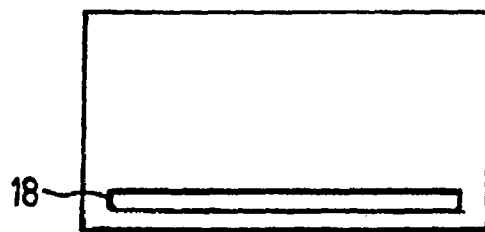

C

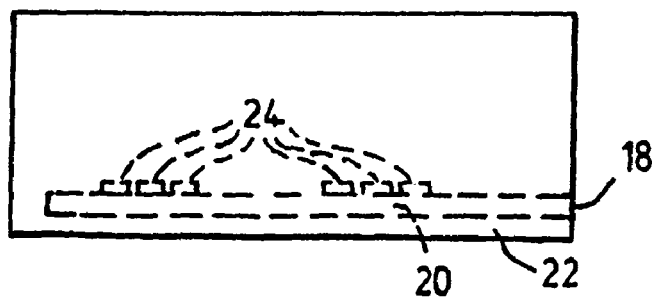

Fig. 2

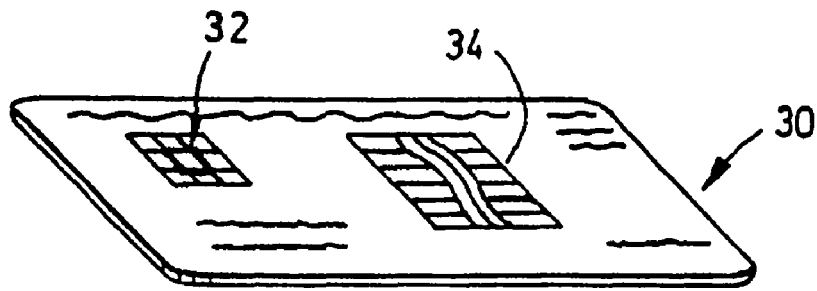

Fig. 3

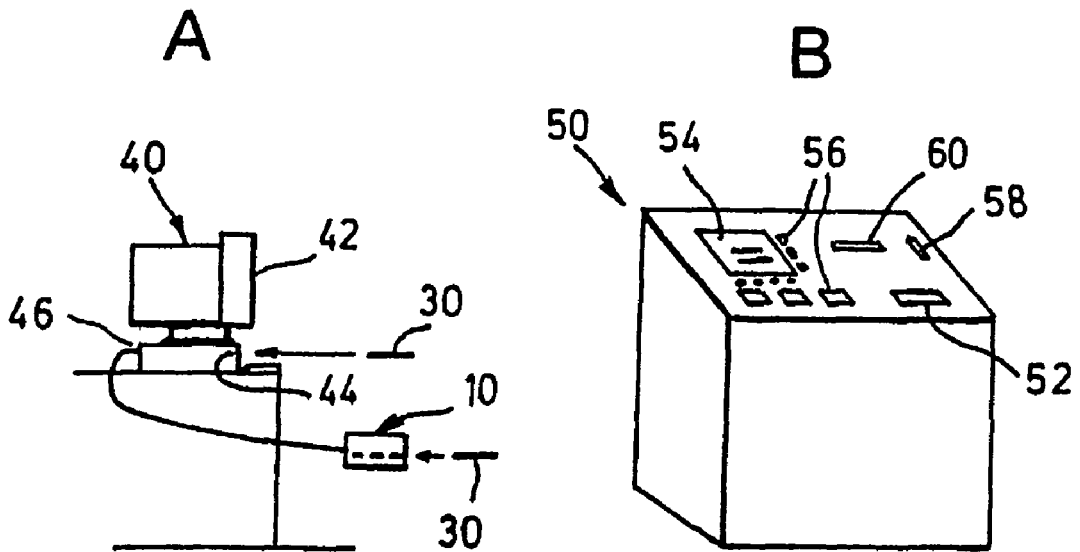
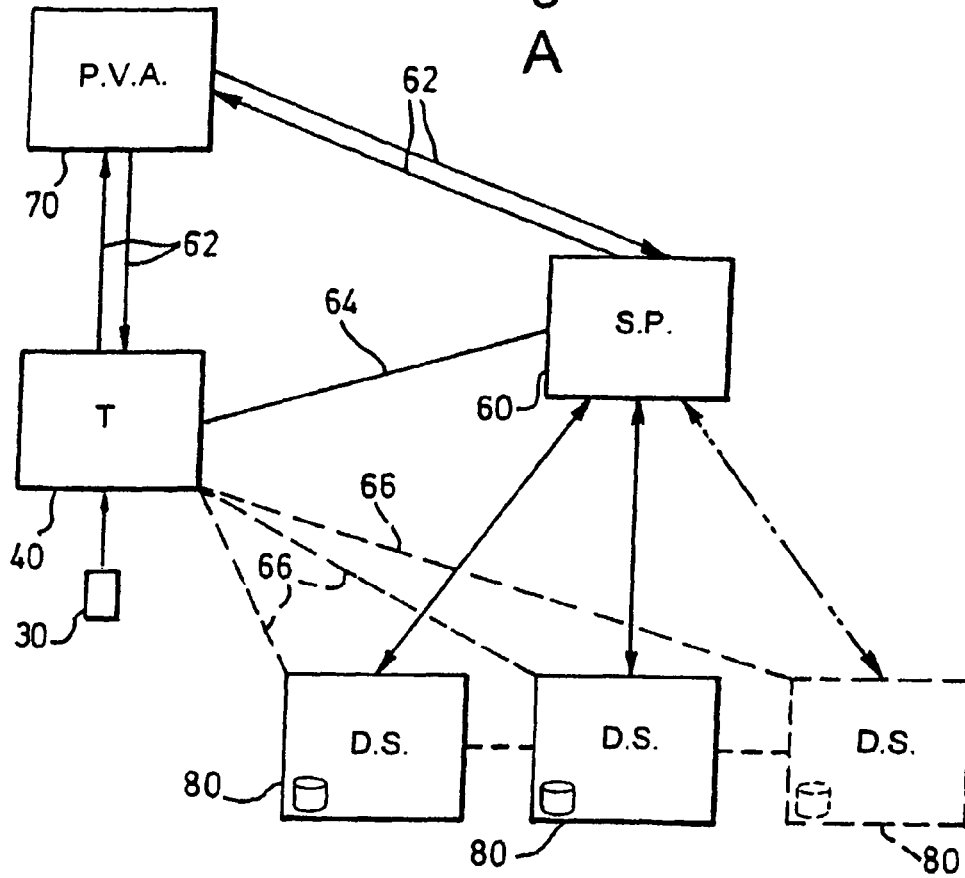
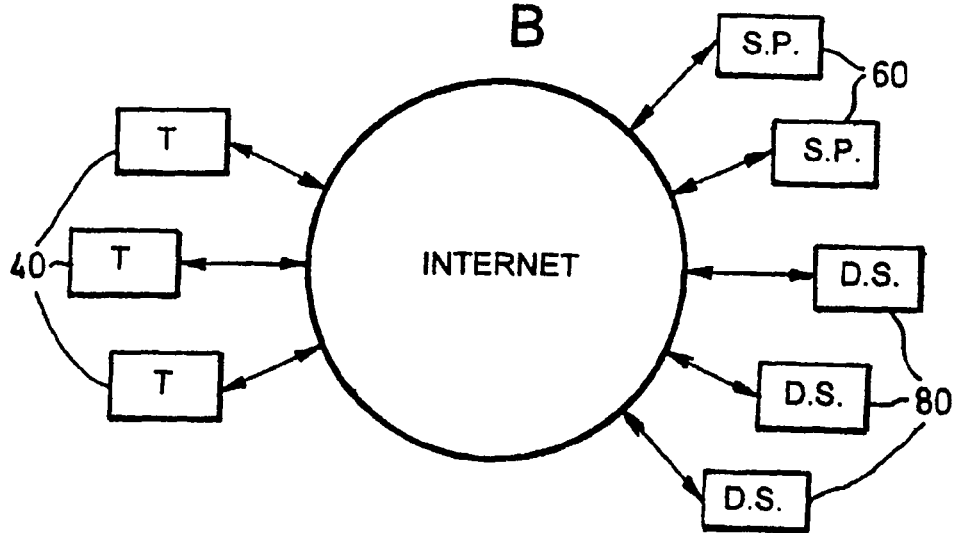

Fig. 4  
A



B



# Explore Litigation Insights

Docket Alarm provides insights to develop a more informed litigation strategy and the peace of mind of knowing you're on top of things.

## Real-Time Litigation Alerts



Keep your litigation team up-to-date with **real-time alerts** and advanced team management tools built for the enterprise, all while greatly reducing PACER spend.

Our comprehensive service means we can handle Federal, State, and Administrative courts across the country.

## Advanced Docket Research



With over 230 million records, Docket Alarm's cloud-native docket research platform finds what other services can't. Coverage includes Federal, State, plus PTAB, TTAB, ITC and NLRB decisions, all in one place.

Identify arguments that have been successful in the past with full text, pinpoint searching. Link to case law cited within any court document via Fastcase.

## Analytics At Your Fingertips



Learn what happened the last time a particular judge, opposing counsel or company faced cases similar to yours.

Advanced out-of-the-box PTAB and TTAB analytics are always at your fingertips.

## API

Docket Alarm offers a powerful API (application programming interface) to developers that want to integrate case filings into their apps.

## LAW FIRMS

Build custom dashboards for your attorneys and clients with live data direct from the court.

Automate many repetitive legal tasks like conflict checks, document management, and marketing.

## FINANCIAL INSTITUTIONS

Litigation and bankruptcy checks for companies and debtors.

## E-DISCOVERY AND LEGAL VENDORS

Sync your system to PACER to automate legal marketing.