

Start Time	Description	Length	Units	Format Type	Reference ID	Priority
00:00:00	Legal ID	00:00	0	Log Note	2	
00:04:00	Commercials	02:00	4	Break	1	1
00:20:00	Commercials	02:00	4	Break	1	1
00:45:00	Commercials	02:00	4	Break	1	1
01:00:00	Legal ID	00:00	0	Log Note	2	
01:04:00	Commercials	02:00	4	Break	1	1
01:20:00	Commercials	02:00	4	Break	1	1
01:45:00	Commercials	02:00	4	Break	1	1
02:00:00	Legal ID	00:00	0	Log Note	2	
02:00:00	The bill circilly s...	23:32	0	Programs	2	
02:04:00	Commercials	02:00	4	Break	1	1
02:20:00	Commercials	02:00	4	Break	1	1
02:45:00	Commercials	02:00	4	Break	1	1
03:00:00	Legal ID	00:00	0	Log Note	2	
03:04:00	Commercials	02:00	4	Break	1	1
03:20:00	Commercials	02:00	4	Break	1	1
03:45:00	Commercials	02:00	4	Break	1	1
04:00:00	Legal ID	00:00	0	Log Note	2	
04:04:00	Commercials	02:00	4	Break	1	1
04:20:00	Commercials	02:00	4	Break	1	1
04:45:00	Commercials	02:00	4	Break	1	1
05:00:00	Legal ID	00:00	0	Log Note	2	

**Log Templates**

Log templates are easy to set up in RadioTraffic.com. Commercial avails and limits go in here. Certain stop sets can be set to always get filled, then others are filled based on priorities. Automation codes are normally kept off edit screens and printed logs but can be viewed if desired.

**FIGURE 8.11**  
Accounts are entered to a log at the time they have purchased. Courtesy RadioTraffic.com.



**FIGURE 8.12**  
Traffic department in cluster operation. Courtesy Clear Channel.





- [Home](#)
- [Products](#)
- [Support](#)
- [Training](#)
- [Client Login](#)
- [Contact](#)

- [Marketron Traffic](#)
- [View All Traffic](#)
- [Database](#)
- [Contract Review](#)
- [Commission Manager](#)
- [Exchange](#)
- [Demos](#)

The Marketron Radio Traffic solution manages all station spot scheduling and billing via a single, intuitive interface. It automates workflow, electronically tracks contract data and revisions and provides detailed spot information to improve productivity.

Marketron offers a hosted solution that provides all of the features and functionality of our client-server applications via the Internet. Marketron clients benefit from unmatched performance, time-to-market and reach.

<p>Marketron Radio Traffic offers the following features and benefits:</p> <p><b>Streamlined Order Processing</b> - Reduces data entry errors and eliminates communication lapses. With a single database, all traffic processes such as assigning approvals, conversion to contract, spot scheduling and generation of invoices, are completed electronically.</p> <p><b>Advanced Inventory Controls</b> - Enable traffic managers to easily review inventory and manipulate spot placement so as to maximize revenue and reduce makegoods. Through powerful inventory query features, traffic managers can quickly identify and reschedule lower rate spots to accommodate higher paying advertisers.</p> <p><b>Multi-Market and Multi-Station Capabilities</b> - Enable large station groups to easily manage the scheduling and billing of advertising orders across multiple stations via one central location. Multiple station contracts are handled seamlessly from order entry through to single invoice billing.</p> <p><b>Automated Reporting for Station Management</b> - Provides up-to-the-minute, custom reports, enabling station management to monitor progress and make immediate corrections to maximize revenue. Review of station revenue streams and inventory sales allows corporate management to accurately design group-wide or regional goals.</p>	<p style="text-align: center;"><b>Marketron Hosting</b></p> <p>Marketron Hosting provides the following features and benefits:</p> <p><b>Competitive Advantage</b> - Because we maintain the application suites centrally, all enhancements, upgrades and new releases are deployed immediately and automatically. As a result, sales, traffic and management personnel using our hosted solutions always utilize the most advanced applications and technology, giving them the capability to out-strategize, out-sell and out-execute the competition.</p> <p><b>Mission Critical Focus</b> - Marketron Hosting frees corporate and IT resources from ongoing application implementation and support demands, freeing them for other mission critical functions. Moreover, Marketron Hosting eliminates IT budgeting for application deployment.</p> <p><b>Unsurpassed Reach</b> - If you can get to the Internet, you can use Marketron's hosted applications.</p> <p><b>Outstanding Performance</b> - Marketron's state-of-the-art back-end server equipment scales quickly and on demand.</p> <p><b>Advanced Technology</b> - Marketron Hosting provides the latest technology at a fraction of the cost to develop in-house. Economies of scale allow us to give Marketron Hosting customers the ultimate in infrastructure, failover and security.</p>	<p><b>More Information</b></p> <ul style="list-style-type: none"> <li>▶ <a href="#">Schedule a Live Demo</a></li> <li>▶ <a href="#">Brochure</a></li> <li>▶ <a href="#">Why Switch to Marketron Traffic?</a></li> <li>▶ <a href="#">Hosting Benefits</a></li> <li>▶ <a href="#">Traffic Requirements</a></li> <li>▶ <a href="#">Hosting Requirements</a></li> <li>▶ <a href="#">Contact Sales</a></li> </ul>
---	---	--

Copyright Marketron © 2008

[Privacy](#) [Legal](#)

**FIGURE 8.15**  
Traffic management services are of great assistance to stations. Courtesy Marketron.

## CHAPTER HIGHLIGHTS

1. Each commercial slot on a station is called an *availability*. Availabilities constitute a station's salable inventory.
2. The traffic manager (or traffic director) controls and is accountable for the broadcast time inventory.
3. The traffic manager prepares a log to inform the deejays of what to broadcast and at what time.
4. The traffic manager is also responsible for ensuring that an ad order is logged as specified, that a record of when each client's spots are aired is maintained, and that copy and production tapes are in on time.
5. Programming relies on the traffic manager for the logs that function as scheduling guides for on-air personnel; the sales department depends on the traffic manager to inform them of existing availabilities and to process orders onto the air.
6. Although most traffic people are trained in-house and are drawn from the administrative or clerical ranks, they must possess patience, an eye for detail, the ability to work under pressure, and keyboarding skills.
7. Most traffic departments have been computerized to enhance speed and efficiency. Therefore, traffic managers must be computer knowledgeable.
8. In many instances, consolidation (clustering) has eliminated individual station traffic and billing departments and a single traffic hub within the cluster prepares logs and sponsor invoices for all the stations. In some cases, outside companies have assumed the task.
9. Based on the spots aired, as recorded and verified by the traffic department, the billing department sends invoices weekly or biweekly to each client. Invoices are notarized for clients with co-op contracts.
10. Since the FCC eliminated program log requirements in the early 1980s, stations have been able to design logs that inform programming personnel of what is scheduled for broadcast and that provide necessary information for the traffic and billing departments.

**SUGGESTED FURTHER READING**

- Diamond, S.Z., *Records Management: A Practical Guide*, AMACOM, New York, 1983.
- Doyle, D.M., *Efficient Accounting and Record Keeping*, David McKay and Company, New York, 1977.
- Heighton, E.J., and Cunningham, D.R., *Advertising in the Broadcast and Cable Media*, 2nd edition, Wadsworth Publishing, Belmont, CA, 1984.
- Hunter, J., and Thiebaud, M., *Telecommunications Billing Systems*, McGraw-Hill, New York, 2002.
- Keith, M.C., *Selling Radio Direct*, Focal Press, Boston, MA, 1992.
- Muller, M., *Essentials of Inventory Management*, American Management Association, New York, 2002.
- Murphy, J., *Handbook of Radio Advertising*, Chilton, Radnor, PA, 1980.
- Schreibfeder, J., *Achieving Effective Inventory Management*, Effective Inventory Management, Dallas, TX, 2005.
- Shane, E., *Selling Electronic Media*, Focal Press, Boston, MA, 1999.
- Slater, J., *Simplifying Accounting Language*, Kendall-Hall Publishing, Dubuque, IA, 1975.
- Warner, C., and Buchman, J., *Broadcast, Cable, Print, and Interactive*, Iowa State University Press, Ames, IA, 2003.
- Wild, T., *Best Practice in Inventory Management*, John Wiley & Sons, New York, 1998.
- Zeigler, S.K., and Howard, H.H., *Broadcast Advertising: A Comprehensive Working Textbook*, 2nd edition, Grid Publishing, Columbus, OH, 1984.

## APPENDIX: A Traffic Manager's Account

Every radio station has a person who manages "traffic." Traffic management is the scheduling of commercials. Client orders are entered into the traffic software specifying the dates, times, length, and rate of the requested commercials.

Once the order is entered, the questions "Who wants to advertise?" and "When do they want to be on the air?" are answered. Clients can choose to run a certain number of commercials over a period of days, or they can opt for a specific number of commercials on specific days. In general, the more detailed the client specifications for placement, the greater the cost of the commercial.

After deciding when they want to run and how much flexibility they have in day placement, the client must choose the scheduling plan. Every radio station has a "run of station" plan that means the client's commercials will be placed randomly by the computer in whatever openings are available. This is generally called ROS or BTA (best times available) and is the least expensive placement option. A client may want to ensure that his commercials will run throughout the day. A plan that guarantees an even distribution throughout the dayparts is the next step up from an ROS schedule. Clients who specifically want a certain number of commercials in a particular daypart on a chosen day will pay the highest rate for the individual commercial unit. The customary dayparts are 6 A.M.-10 A.M., 10 A.M.-3 P.M., 3 P.M.-7 P.M., 7 P.M.-Mid.

The next question after "Who" wants to advertise and "When" is "What do they want to advertise?" The two most common reasons for advertising are "image" and "event."

Clients may want to advertise on a consistent basis to have their name and message in the public awareness, or they may want to hype a particular event or sale.

Commercials may be produced by the radio station production department from a script or copy points provided by the client. Finished commercials can be sent in the form of reel, over the Internet (MP3), or through commercial delivery systems. However the commercial arrives, the information about how to run that commercial must go to the traffic manager. The acceptable dates and times for each commercial are entered into the computer as well as rotation instructions if there are multiple commercials running for a client. Code numbers or information about the commercials that must be provided on the invoice are also entered.

Once all the contracts and traffic instructions are input, the traffic manager assembles and arranges a daily log. A multilevel priority system is used to ensure that the clients specifying the most detailed placement are scheduled first. If the traffic and in-studio computers are linked, the commercial log is immediately in place and ready to be merged with the music log. Any additions, deletions, or adjustments are registered as they occur. If the traffic and in-studio computer systems are not linked, the completed commercial log is transferred by disk and changes are entered manually into the traffic software.

Invoices specifying the date and time that each commercial aired are generated from the finalized log information.

Courtesy WIZN/WBTZ

# 9

## Production

### A Spot Retrospective

Radio has entered a new era in mixing and sound imaging. Still, a typical broadcast radio station produces thousands of commercials, public service announcements (PSAs), and promos annually. Meanwhile, satellite radio stations will mix a vast array of liners, voicers, promos, and features, and Web radio operations frequently do likewise.

Initially, commercials were aired live, due to a lack of recording technology. In the 1920s, most paid announcements consisted of lengthy speeches on the virtues of a particular product or service. Perhaps the most representative of the commercials of the period was one of the first ever to be broadcast, which lasted over 10 minutes and was announced by a representative of a Queens, New York, real estate firm. Aired live over WEAJ in 1922, by today's standards the message would sound more like a classroom lecture than a broadcast advertisement. Certainly, no snappy jingle or ear-catching sound effects accompanied the episodic announcement.

Most commercial messages resembled the first until 1926. On Christmas Eve of that year the radio jingle was introduced, when four singers gathered for a musical tribute to Wheaties cereal. It was not for several years, however, that singing commercials were commonplace. For the most part, commercial production during the medium's first decade was relatively mundane. The reason was twofold: the government had resisted the idea of blatant or direct commercialism from the start, which fostered a low-key approach to advertising, and the medium was

just in the process of evolving and therefore lacked the technical and creative wherewithal to present a more sophisticated spot.

Things changed by 1930, however. The austere, no-frills pitch, occasionally accompanied by a piano but more often done a cappella, was gradually replaced by the dialogue spot that used drama or comedy to sell its product. A great deal of imagination and creativity went into the writing and production of commercials, which were presented live throughout the 1930s. The production demands of some commercials equaled and even exceeded those of the programs they interrupted. Orchestras, actors, and lavishly constructed sound effects commonly were required to sell a chocolate-flavored syrup or a muscle liniment. By the late 1930s, certain commercials had become as famous as the favorite programs of the day. Commercials had achieved the status of pop art.

Still, the early radio station production room was primitive by today's standards. Sound effects were mostly improvised show by show, commercial by commercial, in some cases using the actual objects with which sounds were identified. Glass was shattered, guns fired, and furniture overturned as the studio's on-air light flashed. Before World War II, few sound effects were available on records. It was just as rare for a station to broadcast prerecorded commercials, although 78rpm and wire recordings were used by certain major advertisers. The creation of vinyl discs in the 1940s inspired more widespread use of electrical transcriptions for radio advertising purposes. Today, sound effects are taken from CDs and downloaded from the Internet.

**FIGURE 9.1**  
Sirius Satellite  
Radio's "live" studio.  
Courtesy Sirius.



The live spot was the mainstay at most stations into the 1950s, when two innovations brought about a greater reliance on the prerecorded message. Magnetic recording tape and 33 LPs revolutionized radio production methods. Recording tape brought about the greatest transformation and, ironically, was the product of Nazi scientists who developed acetate recorders and tape for espionage purposes. The adoption of magnetic tape by radio stations was costlier and thus occurred at a slower pace than 33 rpm, which essentially required a turntable modification.

Throughout the 1950s, advertising agencies grew to rely on LPs. By 1960, magnetic tape recorders were a familiar piece of studio equipment. More and more commercials were prerecorded. Some stations, especially those automated, did away with live announcements entirely, preferring to tape everything to avoid on-air mistakes.

Commercials themselves became more sophisticated sounding since practically anything could be accomplished on tape. Perhaps, no individual in the 1960s more effectively demonstrated the unique nature

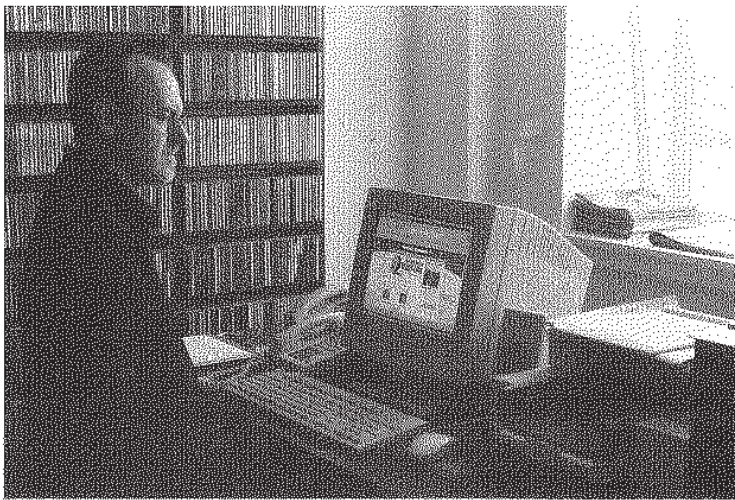
of radio as an advertising medium than did Stan Freberg. Through skillful writing and the clever use of sound effects, Freberg transformed Lake Michigan into a basin of hot chocolate crowned by a 700-foot-high mountain of whipped cream, and no one doubted the feat.

Today, the sounds of millions of skillfully prepared commercials trek through the ether and into the minds of practically every man, woman, and child in America. Good writing and production are what make the medium so successful.

### Formatted Spots

In the 1950s the medium took to *formatting* to survive and prosper. Today listeners are offered myriad sounds from which to choose; there is something for practically every taste. Stations concentrate their efforts on delivering a specific format, which may be defined as Adult Contemporary, Country, Easy Listening, or any one of a dozen others. As you will recall from the discussion in



**FIGURE 9.2**

Today mixing is done in the digital box.  
Courtesy Sirius.

Chapter 3, each format has its own distinctive sound, which is accomplished through a careful selection and arrangement of compatible program elements. To this end, commercials attempt to reflect a station's format. In the age of consolidation, says Larry Miller, "There is a tendency to do one size fits all at the agency level. In-house local retail may be more customized to fit the format. We used to make a point of avoiding loud rock 'n' roll spots at the classical station I worked for, but I'm not sure if that's still a consideration."

## The Production Room

In general, metro market stations and clusters employ a full-time production person (known variously as production director, production manager, production chief, and more recently as chief imager or head audio animator). This individual's primary duties are to record voice-tracks and mix commercials and PSAs. Other duties involve the maintenance of the bed and sound effects library and the mixdown of promotional material and special programs, such as public affairs features, interviews, and documentaries.

Stations that do not have a slot for a full-time production person divide work among the on-air staff. In this case, the program director (PD) often oversees production responsibilities, or a deejay may be assigned

several hours of production duties each day and be called the production director.

At most medium and small outlets, on-air personnel take part in the production process. Production may include the simple transfer of an agency spot into the computer system, a mixdown that requires a single bed (background music) under a 30-second voicer, or a multielement mixdown of a 60-second two-voicer with sound effects and several bed transitions. Station production can run from the mundane to the exciting and challenging (mixing a commercial without words conveyed through a confluence of sounds).

Most production directors, in this digital age often called imaging directors, are recruited from the on-air ranks, having acquired the necessary studio dexterity and know how to meet the demands of the position. In addition to the broad range of mixdown skills required by the job, a solid knowledge of editing is essential. The production director routinely is called on to make rudimentary edits or perform more complex editing chores, such as the rearrangement of elements in a 60-second concert promo. (Editing is covered in more detail later in this chapter.)

The production/imaging director works closely with many people but perhaps most closely with the program director. The person responsible for production is expected to have a complete understanding of the station's programming philosophy and objective. This is necessary because commercials

constitute an element of programming and therefore must fit in. A production person must be able to determine when an incoming commercial clashes with the station's image. When a question exists as to the spot's appropriateness, the program director will be called on to make the final judgment, because it is he or she who is ultimately responsible for what gets on the air. In the final analysis, station production is a product of programming. In most broadcast organizations, the production director answers to the program director. It is a logical arrangement given the relationship of the two areas.

The production/imaging director also works closely with the station copywriter. Their combined efforts make or break a commercial. The copywriter conceives of the concept, and the producer brings it to fruition. The traffic department also is in close and constant contact with production, because one of its primary responsibilities is to see that copy gets processed and placed in the on-air studio where it is scheduled for broadcast.

Once again the extensive clustering of station facilities in the age of consolidation finds many production responsibilities centralized. By now many radio groups have established one production hub to mix

the spots of their other outlets, especially when in the same market. Typically, this has resulted in the downsizing of individual station production staffs and the elimination of comprehensive mixdown studios at these sites.

## The Studios

A radio station has two kinds of studios: on-air and production. Both share basic design features and have comparable equipment. In cluster operations where stations are colocated, there is often a single primary production facility. For ease of movement and accessibility, audio equipment commonly is set up in a U-shape within which the operator or producer is seated.

The standard equipment found in radio studios includes microphones, an audio console (commonly referred to as the "board"), computer workstations (on-air studio usually networked to production studio – this computer would also contain automation software, such as Audio Vault), video display monitors, compact disc machines, mini-disc machines, digital effects boxes, patch panel (digital consoles typically have these built in), and a distribution amplifier (see Figure 9.4).

**FIGURE 9.3**

This cutting-edge digital studio is state of the art. Courtesy RTBF.



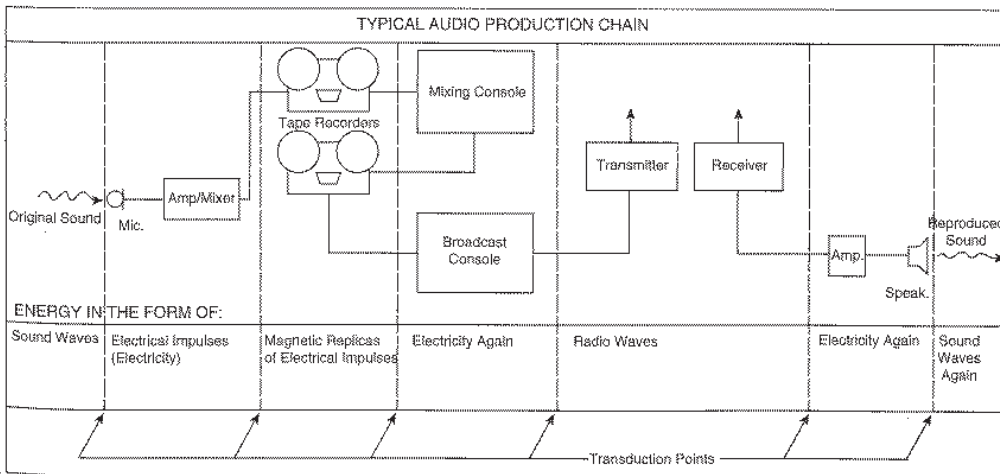


**FIGURE 9.4**  
Although each production studio is unique, the basics of layout are fairly consistent from station to station. For the sake of ease and accessibility, most studios are developed in a U-shape or a variation thereof. However, computer workstations have had an effect on equipment layout, since most work is done on the mouse and keyboard. Courtesy Clear Channel.

### Audio Console

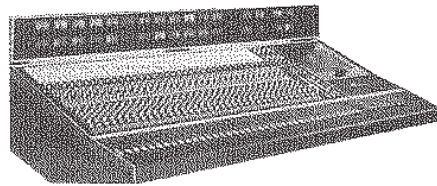
The audio console is the centerpiece, the very heart of the radio station. Dozens of manufacturers produce audio consoles, and although design characteristics vary, the basic

components remain relatively constant. Consoles come in all different sizes and shapes and all contain inputs that permit audio energy to enter the console, outputs through which audio energy is fed to other locations, VU meters that measure the amount or level

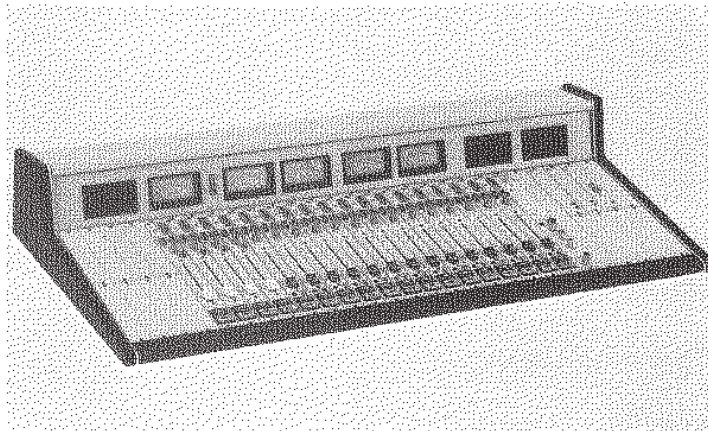


**FIGURE 9.5**  
Transduction points in a typical audio chain.

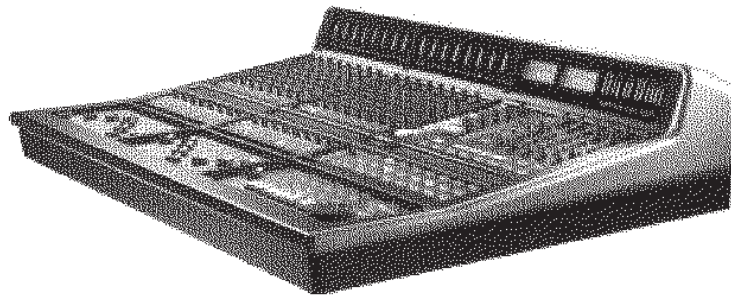
**FIGURE 9.6**  
Multichannel board.  
Courtesy Auditronics.



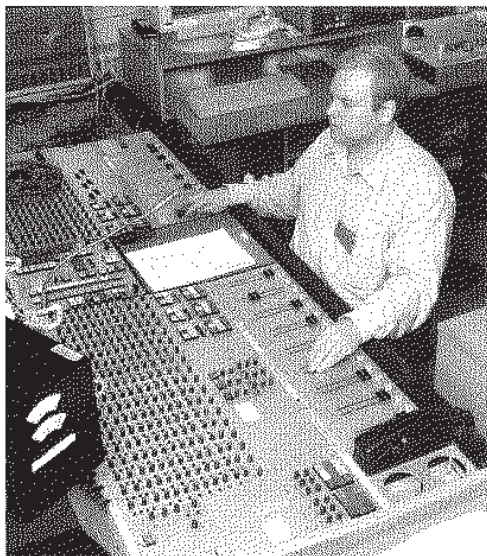
**FIGURE 9.7**  
Audio console  
with linear faders,  
popularly referred  
to as a "slide"  
board.  
Courtesy Auditronics.



**FIGURE 9.8**  
A digital console.  
Courtesy Solid State  
Logic.



**FIGURE 9.9**  
Audio mixing  
requires special  
skills and dexterity.  
Courtesy Danmarks  
Radio.

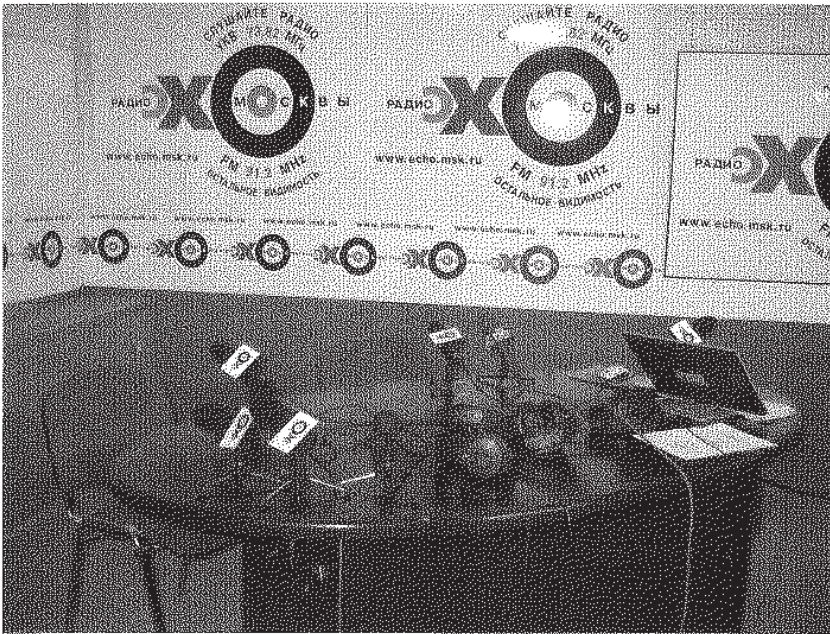


of sound, pots (faders) that control gain or the quantity of sound, monitor gains that control in-studio volume, and master gains for the purpose of controlling general output levels (see Figures 9.6–9.8).

Since the late 1960s, the manufacture of consoles equipped with linear faders has surpassed those with rotary faders. *Slide* (another term used) faders perform the same function as the more traditional pots, and they are easier to read and handle.

### Cue Mode

A low-power amplifier is built into the console so that the operator may hear audio from various sources without it actually being distributed to other points. The



**FIGURE 9.10**  
Mic setup in a  
Moscow radio studio.  
Courtesy Echo  
Musika.

purpose of this is to facilitate the setup of certain sound elements, such as records and tapes, for eventual introduction into the mixdown sequence (see Figure 9.9).

## Computers

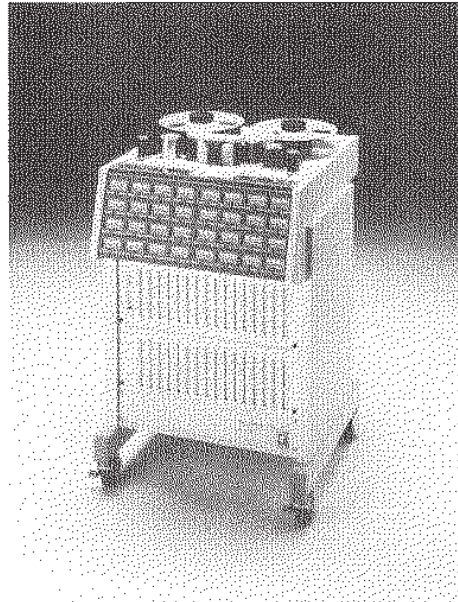
Computers have become the soul of the audio studio – both on-air and production. Observes Vic Michaels, “Studio computers would contain editing software, like Pro Tools or Adobe Audition. The on-air

computer would also contain automation software, such as Audio Vault. It would also possess Selector, which is needed to tell the Audio Vault system what to play. At my station, we have three computers in production: one is for Audio Vault automation, the second is for Selector music software, and the third is for editing on Pro Tools. All three are networked to the on-air computer. Everything now is “audio files.” When one makes a commercial or records a song off a CD, it becomes an audio file that can be moved from computer to computer.”

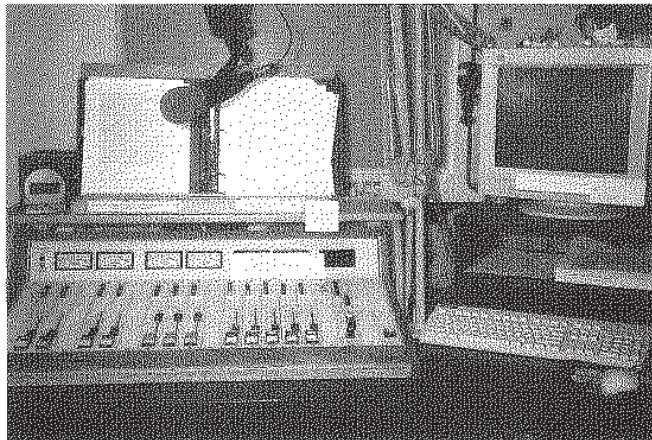


**FIGURE 9.11**  
An integrated  
console environment.  
Courtesy Digidesign  
Icon.

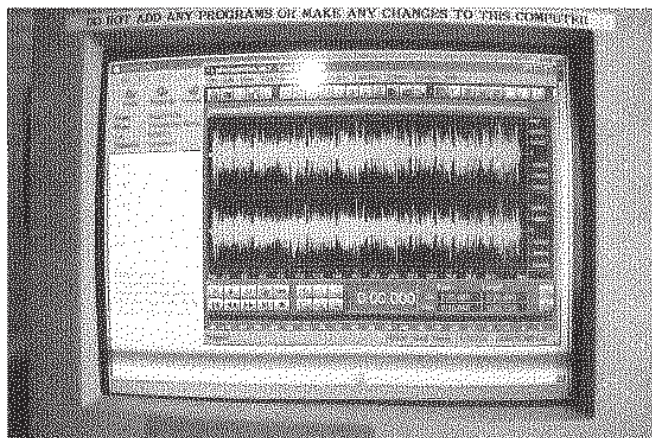
**FIGURE 9.12**  
Multitrack reel-to-reel recording is used but the computer has mainly taken over this task. This is a 32-track recorder, using 2-inch audio tape. Courtesy Otari.



**FIGURE 9.13**  
A typical on-air and production combination. Courtesy WIZN.



**FIGURE 9.14**  
Monitoring the sound wave on the screen. Courtesy WIZN.



## Digital (Mini) Disc Machines

Analog cart machines were replaced by random-access mini-disc (record/playback) technology. These machines have not become as popular as the cart machines they replaced, because of other studio innovations. The so-called new-age cart machine allows producers to digitally archive vast amounts of audio on mini reusable discs. Says station manager Vic Michaels, "They replaced the old-line carts, because they were faster, programmable, visual, digital, and competitively priced." Companies like Sony, 360 Systems, Harris, Denon, and Otari manufactured the mini-disc machine, which replaced the traditional analog cart machine at most stations – another victim of the computer age.

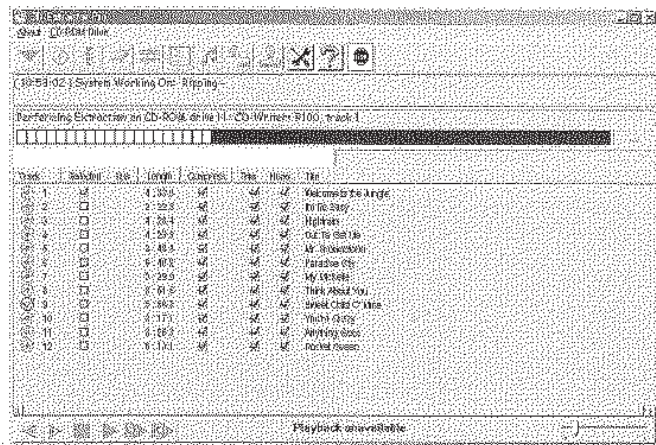
Among other things, digi-disc machines offer instant start (there is none of the hesitation or drag common in its analog



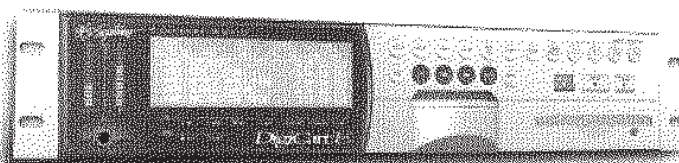
**FIGURE 9.15**  
Production elements and their mixing are centered in the workstation. Courtesy WIZN.

### Specifications & Details:

- A minimum of 2 gigabytes of hard drive space.
- Extract audio from more than 7 approved CD-ROMs with the appropriate workstation configuration simultaneously, with the power to support multiple SCSI drives.
- CD-ROM drives may be either EIDE or SCSI devices and must be connected to the workstation.
- Minimum of 256 megabytes of RAM, more if you will be importing from multiple CD devices or importing audio over 20 minutes long.
- Designed to run as an integrated component of the NexGen Digital system. Windows 98, Windows 2000 or Windows NT required.



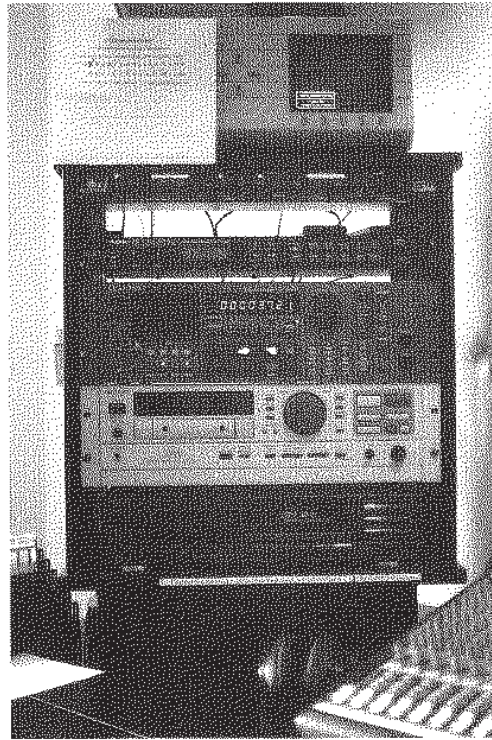
**FIGURE 9.16**  
Computer-driven production tools have greatly enhanced mixdown. Courtesy Prophet Systems.



DigiCart/E Ethernet Audio™ Recorder

**FIGURE 9.17**  
The old-line analog cart machine is now an all-function, digital recording source. Courtesy 360 Systems.

**FIGURE 9.18**  
Production studio  
equipment rack.  
Courtesy WIZN.



predecessor), back cueing, track selection, end marking, automatic fade-in, visual ID and cueing, digital editing, and so forth.

### Compact Discs

Compact disc players entered the radio production studio in the 1980s. Although CD players have become less and less evident in studios, their value as a piece

of production equipment has not entirely vanished. Observes Skip Pizzi: "Digital audio had its greatest initial acceptance as CD hardware, to the point where it was estimated that over half of the radio stations in the USA used CD to some extent. In major markets, this figure rose steeply. Many of these stations programmed music exclusively from CD, or nearly so. The practice of providing promotional copies of new releases on CD by record companies (following an earlier period of general reluctance to do so) became common practice. Second- and third-generation professional CD players aided in the process of acceptance" (see Figure 9.20).

CD players employ a laser beam to read encoded data at a rate of 4.3218 million bits per second. A compact disc is 4.7 inches wide and 1.2 mm thick, and players are quite light and compact as well. This feature alone makes them attractive to broadcasters. But what makes a CD player most appealing to broadcasters is its superior sound. Compact disc players offer, among other features, far greater dynamic range than standard turntables and a lower signal-to-noise ratio. They also eliminate the need for physical contact during cueing, and wow and distortion are virtually gone.

Because digital discs are specially coated, they are much more resistant to damage than are analog discs. This is not to suggest that CDs are impervious; they are not. In fact, the majority of CD-related problems stem from the discs themselves and not the players.

**FIGURE 9.19**  
To clean a CD, use  
a piece of lint free  
cloth. Never touch  
the encoded surface  
and handle the disc  
at its edges.







**FIGURE 9.20**  
CD players cart  
players continue  
to be used in some  
studios. Courtesy  
Denon.

Despite initial claims of the invincibility of the digital disc, experience has shown that mishandling of discs is courting disaster. CDs cannot be mistreated – that is, used as Frisbees or placemats for peanut butter sandwiches – and still be expected to work like new. The simple fact is that although compact discs are more resistant to damage, they can be harmed.

A CD reads a disc from its core outward, moving from 500rpm on the inside to 200rpm on the outer edge of the disc. Most CD players feature a variety of effect options, which can be of particular use to a production mix. Accessing cuts on a CD player is quick and simple, though excerpting segments from a track for inclusion in a mixdown can be somewhat less expedient. Nonetheless, CD players are still useful in the production studio. Compact discs are a wonderful source for bed music (music that serves as background under voiced copy) and sound effects.

Working with a CD unit is anything but complicated. Press a button and a tray ejects (on top-loaded models a door pops open). A disc is placed into the tray, and the press of the same button returns the tray and disc into the player. The operator then selects the track to be played and presses the appropriately numbered button. The audio rolls.

Burnable CD units (CD-R and CD-RW) are prominent in the production room.

CD-Rs allow one time burning, whereas CD-RWs allow multiple burnings.

## Compressors, Equalizers, and Audio Processing

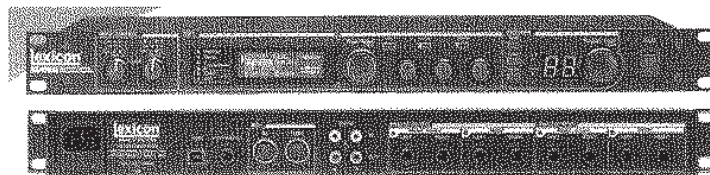
“There are three domains of audio,” says producer Ty Ford. “They are amplitude, frequency, and time.” Some stations alter amplitude to create the illusion of being louder without actually changing level. This is called compressing the signal. Production people use compressors to enhance loudness as well as to eliminate or cut out ambient noise, thus focusing on specifics of mix. Compression often is used as a method of getting listeners to take greater notice of a piece of production and as a remedy to certain problems (see Figure 9.22).

Equalizers (EQs) work the frequency domain of audio by boosting and/or cutting lows (hertz\obHz\cb range) and highs (kilo-hertz\obkHz\cb range). EQs allow producers to correct problems as well as to create parity between different elements of production. They are also useful in creating special effects. EQs are available in-board (part of the audio console) and out-of-board (stand-alone unit) and as part of certain integrated audio effects processors.

**FIGURE 9.21**  
Screens, screens everywhere. The modern studio. Courtesy Afan FM.



**FIGURE 9.22**  
Digital effects processor. Courtesy Lexicon.



Most audio processors (also called effects processors or simply boxes) are time-domain devices. Stations use these digital boxes to create a wide range of effects such as reverb, echo, and flange.

In the last few years, radio stations have become increasingly interested in what audio processors have to offer their mixes. Today these boxes are a familiar, often integral, item in production rooms at the majority of stations. Their value in the creation of commercials, PSAs, promos, and features is inestimable. The use of samplers and synthesizers is common in radio production rooms too. Samplers let a production person load a studio audio source (recorder, live mike) into its built-in microprocessor and then manipulate the digitized data with the aid of a musical keyboard to create a multitude of effects. Samplers employ magnetic microfloppies

and are wired to an audio console so that the sounds they produce may be integrated into mixdown. Samplers are also found in certain audio effects processors with musical instrument digital interface (MIDI). A sample is a digital recording of a small bit of sound.

"A lot of musical instrument (MI) gear has been introduced into the radio production studio. Synths, samplers, and sequencers are pretty commonplace today," notes Ty Ford.

Many software applications, such as Cool Edit Pro and Pro Tools, have these and other signal processing built in.

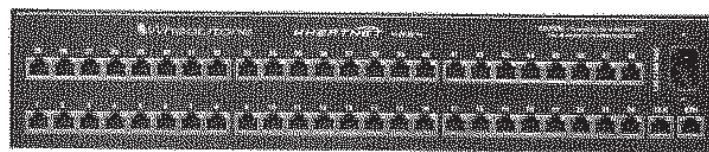
### Patch Panels and ISDNs

A patch panel consists of rows of inputs and outputs connected to various external sources – studios, equipment,

remote locations, network lines, and so forth. Patch panels essentially are routing devices that allow for items not directly wired into an audio console to become a part of a broadcast or production mixdown. Today, says Vic Michaels, "Patch panels are still utilized but not as frequently as before. Use is based on a station's needs. Digital consoles now have internal patch capabilities built right into the console so one can patch in certain effects or sources to any channel" (see Figure 9.23).

ISDNs are digital phone lines that bring voices and other audio to studios with near perfect sound quality. Because voice tracking has become the means by which so many stations fill their airwaves, ISDN connections have become invaluable.

As production director Matt Grasso observes, "The day of the scratchy cell phone or muddy dedicated line is over. Your talent sounds like they are right in the studio. If they are at a club, not only can they talk, but they can broadcast the music they are playing there right over the air with the same quality you would get from a CD player in the main studio. ISDN means no reel to reels or DATS coming to a station via snailmail either."



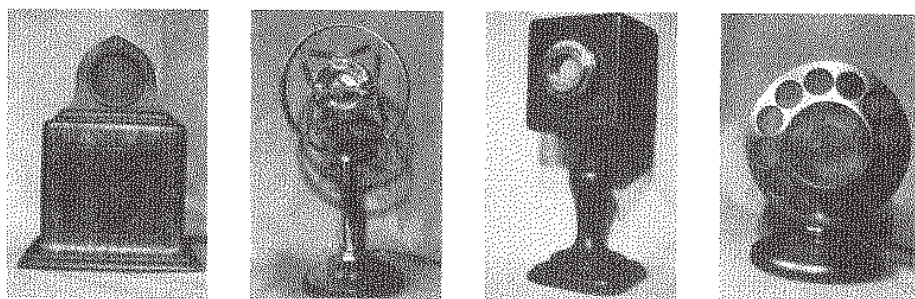
## Microphones

Microphones are designed with different pickup patterns. Omnidirectional microphones are sensitive to sound from all directions (360°), whereas bidirectional microphones pick up sound from two directions (180°). The unidirectional microphone draws sound from only one path (90°), and because of its highly directed field of receptivity, extraneous sounds are not amplified. This feature has made the unidirectional microphone popular in both the control and production studios, where generally one person is at work at a time. Most studio consoles possess two or more microphone inputs so that additional voices can be accommodated when the need arises (see Figure 9.25).

Omnidirectional and bidirectional microphones often are used when more than one voice is involved. For instance, an omnidirectional may be used for the broadcast or recording of a round-table discussion, and the bidirectional during a one-on-one interview.

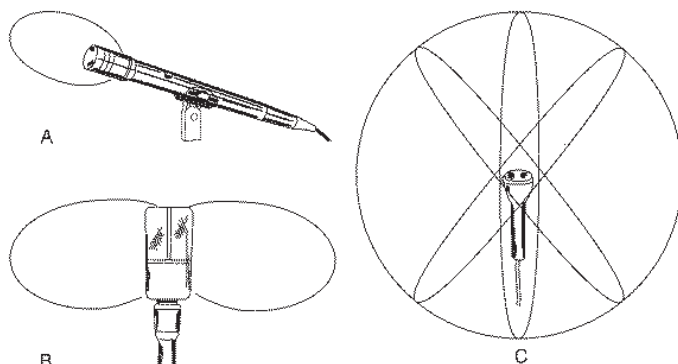
**FIGURE 9.23**

Digital switching systems for connection from one source (studio/equipment) to another. Courtesy Wheatstone.



**FIGURE 9.24**

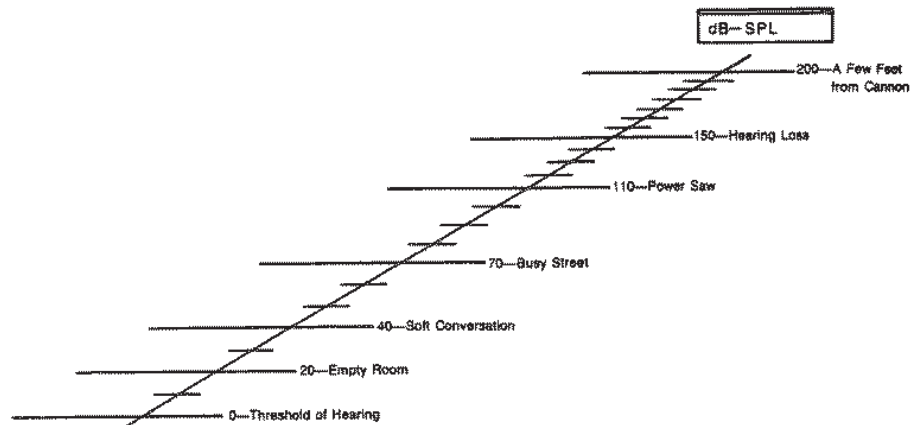
The look of microphones in the 1920s. Courtesy Jim Steele.



**FIGURE 9.25**

Microphone pickup patterns: (A) unidirectional, (B) bidirectional, and (C) omnidirectional.

**FIGURE 9.26**  
Sound pressure level (SPL) chart depicting volume of different sounds in relation to human aural perception.



Announcers must be aware of a microphone's directional features. Proper positioning in relation to a microphone is important. Being outside the path of a microphone's pickup (off-mike) affects sound quality. At the same time, being too close to a microphone can result in distortion, known as popping and blasting. Keeping a hand's length away from a microphone will usually prevent this from occurring. Windscreens and blast filters may be attached to a microphone to help reduce distortion.

## Digital Editing

Old time tape editing is a lost art that ranged from a simple repair to a complicated rearrangement of sound elements. Today the

old razor approach to editing and splicing tape is all but ancient history, having lost ground to "nondestructive" tapeless digital methods.

Computers handle the bulk of editing in the production room. This tapeless approach involves loading audio into a RAM or hard disc and making edits via a monitor (with the aid of a mouse, a keyboard, or a console). Although this technology has been costly in the past, today prices are quite affordable, motivating more and more stations to convert to the tapeless studio. Computerized audio workstations were once perceived as the studio of the future, but they are the studio of today (see radio production expert David Reeses' discussion and advice on digital editing in this chapter).

## David Reese



**FIGURE 9.27**  
David Reese.

## Basic Digital Audio Editing (and a few tips)

Today, nearly all audio-production employs a computer (or computer-based audio equipment) with audio editing software and involves four basic processes: recording, editing, mixing, and mastering.

**Step 1: Recording Audio.** This can be accomplished by recording with a microphone, by opening an existing audio file, or by extracting audio from a CD. If you're live recording, watch volume levels and err on the low side.  
*TIP: Record around -10 db on the VU*

*meter.* Low audio levels can generally be raised with the editing software; over-modulated, high-volume audio can't be fixed and will leave you with distorted audio.

**Step 2: Editing Audio.** Audio editing is similar to word processing — you are using a lot of cut, paste, and copy functions. Not only can you hear the audio, but you can "read" the audio waveform. You see a visual representation of the audio with a vertical axis showing volume level and a horizontal

axis showing time. It's usually easy to see groups of words and the spaces between words. Editing often involves making an "edit in" point and an "edit out" point and then cutting out a word, several words, or a chunk of music. *TIP: Always make your edit in point just before the first word you want to cut out and your edit out point just before the first word you want to leave in.* This will maintain proper phrasing and the natural flow of words; however, if you make a mistake, remember, most editing functions include an "Undo" command.

**Step 3: Mixing Audio.** Most audio production uses two "tracks" (stereo) or several tracks (multitrack). Once you've edited the various tracks, mixing is the blending of those tracks together. One aspect of the mix is balancing

levels. For example, a simple radio spot might include an announcer vocal track and a music bed. In mixing them together, you would want to lower the volume of the music when the vocal is playing. Mixing also involves panning tracks to the left or right channel or somewhere in between. *TIP: Use audio processing, like echo or reverb, to add "depth" to the sound track.* You can also use equalization to enhance specific tracks or segments giving them brighter highs or a boss boost. Don't forget to save your mix so you can go back and make changes, if necessary.

**Step 4: Mastering Audio.** The final step is to listen critically to your work several times and make any fine-tuning adjustments. *TIP: If you hear any "plosives" (those "pops" on p, t,*

*b sounds), you usually can't eliminate them, but you can diminish them. With your editor, select just the plosive part and slightly decrease the volume to reduce the impact of the plosive sound.* In most cases, a multitrack production will be mastered down to stereo and saved as the finished product. You may need to transfer your audio file from the production computer to another server for eventual playback or you may need to burn a copy onto CD for playback, to give a client, or just to archive.

Digital editing gives you almost unlimited ways to manipulate audio and to build a creative, finished product. Don't be afraid to experiment; you never know what unique effect you might come up with.

## Copywriting

As stated earlier, poet Stephen Vincent Benet, who wrote for radio during its heyday, called the medium *the theater of the mind*. Indeed, the person who tunes into radio gets no visual aids but must manufacture images on his or her own to

accompany the words and sounds broadcast. The station employee who prepares written material is called a copywriter. A copywriter job consists primarily of writing commercials, promos, and PSAs, with the emphasis on the first of the three.

Not all stations employ a full-time copywriter. This is especially true in small

**Move Up from Carts to Touchscreen Digital Audio**

**Play Any Audio at a Touch**  
Nothing else makes radio as fast or easy as having all your spots, promos and commercials with your fingertips—change on-line and ready to play from hard disk. And nothing else makes your station sound as good or as exciting as touchscreen digital and remote access with the new Scott Studio System.

Here's how it works: Six buttons on the left of the 17" computer touchscreen play what's on your program log. Scheduled spots, promos, PSAs and live copy come in automatically from your Scott System Production Desk and your radio and copy computers. You see audible labels for everything, showing full names, intro times, lengths, endings, announcer initials, outlines, spots, news, promos and live. Your radio can interrupt anything easily by touching arrows (on touchscreen), or opening windows with the entire day's log and list of all your recordings.

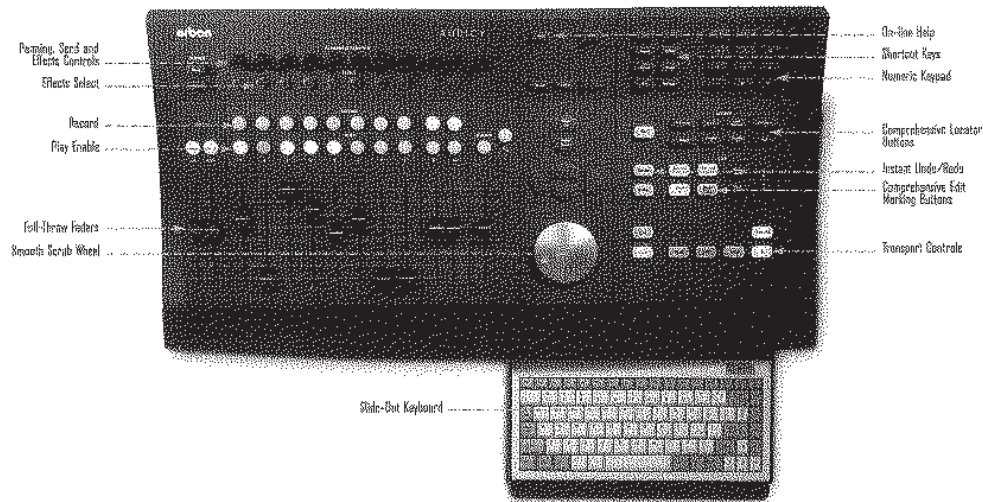
On the right, 16 "hot keys" start unscheduled spots, requests, alerts, contests or promote the spot of the moment. You get 25 sets of 16 user-defined instant audio "hot keys" for your radio's different needs.

Large digital timers automatically count down intro times, and flash 10-, 45- and 30-second before and overruns. You also get clear count-downs the last 15 seconds of each event.

The Scott Studio System is your best way to make the move to digital audio and eliminate touchsome carts. Each button on the touchscreen plays whatever you want instantly. All scheduled spots, promos and scripts come in from your traffic and copy computers.

**FIGURE 9.28** Digital audio puts the next-generation studio in a box. A world of production sound at your fingertips. Courtesy Scott.

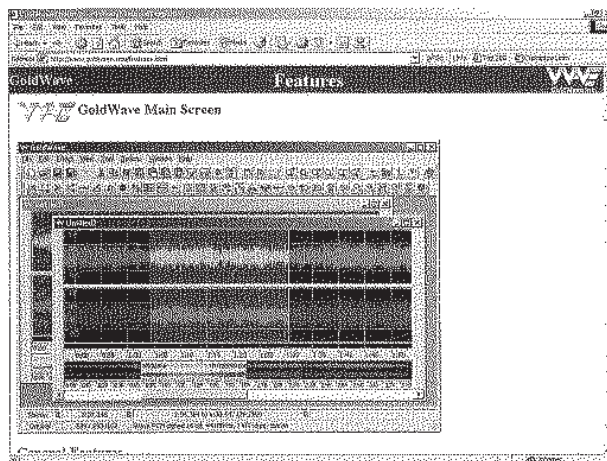
**FIGURE 9.29**  
A digital mixing board. Courtesy Orban.



markets where economics dictate that the salesperson write for his or her own account. Deejays also are called on to pen commercials. At stations with bigger operating budgets, a full-time copywriter often will handle the bulk of the writing chores.

Copywriters must possess a complete understanding of the unique nature of the medium, a familiarity with the audience for which the commercial message is intended, and knowledge of the product being promoted. A station's format will influence the style of writing in a commercial; thus, the copywriter also must be thoroughly acquainted with the station's particular programming approach. Commercials must be compatible with the station's sound. For instance, copy written for Lite AC usually is more conservative in tone than that written for Modern Rock stations, and so on.

**FIGURE 9.30**  
Today most audio editing is done on the screen. Waveforms are altered and manipulated to create the sound sought. Reprinted with permission from GoldWave.



WXXX

"Home of the Hits" (SFX: Bed in)  
TJ'S ROCKHOUSE, MARK STREET,  
DOWNTOWN BOISE, PRESENTS CLEO  
AND THE GANG ROCKING OUT  
EVERY FRIDAY AND SATURDAY NIGHT.  
AT TJ'S THERE'S NEVER A COVER  
OR MINIMUM, JUST A GOOD TIME.  
SUNDAY IDAHO'S MONARCHS OF  
ROCKABILLY, JOBBE LANE, RAISE THE  
ROOF AT TJ'S. YOU BETTER BE READY  
TO SHAKE IT, BECAUSE NOBODY  
STANDS STILL WHEN JOBBE LANE  
ROCKS. THURSDAY IS HALPRICE  
NIGHT, AND LADIES ALWAYS GET  
THEIR FIRST DRINK FREE AT BOISE'S  
NUMBER ONE CLUB FOR FUN AND  
MUSIC. TAKE MAIN TO MARK STREET,  
AND LOOK FOR THE HOUSE THAT  
ROCKS, TJ'S ROCK-HOUSE.  
(SFX: Stinger out)

WYYY

"Soothing Sounds"  
ELEGANT DINING IS JUST A SCENIC  
RIDE AWAY. (SFX: Bed in and under)  
THE CRITICALLY ACCLAIMED VIS-  
COUNT (VYCOUNT) INN IN CEDAR  
GLENN OFFERS PATRONS AN EXQUI-  
SITE MENU IN A SETTING WITHOUT  
EQUAL. THE VISCOUNT'S 18TH  
CENTURY CHARM WILL MAKE YOUR  
EVENING OUT ONE TO REMEMBER.  
JAMISON LONGLEY OF THE WISCON-  
SIN REGISTER GIVES THE VISCOUNT  
A FOURSTAR RATING FOR SERVICE,  
CUISINE, AND ATMOSPHERE. THE  
VISCOUNT (SFX: Royal fanfare) WILL  
SATISFY YOUR ROYAL TASTES. CALL

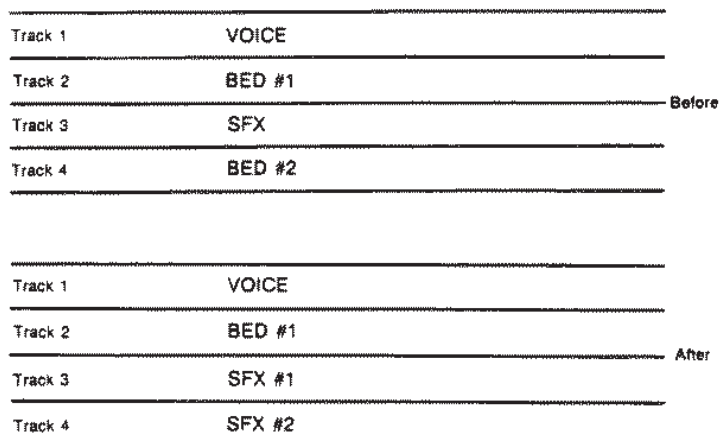
675-2180 FOR RESERVATIONS. TAKE ROUTE 17 NORTH TO THE VISCOUNT INN, 31 STONY LANE, CEDAR GLENN.

Some basic rules pertain to the mechanics of copy preparation. First, copy is typed in uppercase and is double-spaced for ease of reading. Next, left and right margins are set at 1 inch. Sound effects are noted in parentheses at that point in the copy where they are to occur. Proper punctuation and grammar are vital, too. A comma in the wrong place can throw off the meaning of an entire sentence. Be mindful, also, that commercials are designed to be heard and not read. Keep sentence structure as uncomplicated as possible. Maintaining a conversational style will make the client's message more accessible.

Timing a piece of copy is relatively simple. There are a couple of methods: one involves counting words, and the other counting lines. In the first approach, 25 words would constitute 10 seconds; 65 words, 30 seconds; and 125 words, 1 minute. Counting lines is an easier and quicker way of timing copy. This method is based on the assumption that it takes, on average, 3 seconds to read one line of copy from margin to margin. Therefore, 9 to 10 lines of copy would time out to 30 seconds, and 18–20 lines to 1 minute. Of course, production elements such as sound effects and beds must be included as part of the count and deducted accordingly. For example, 6 seconds worth of sound effects in a 30-second commercial would shorten the amount of actual copy by 2 lines.

Because everything written in radio is intended to be read aloud, it is important that words with unusual or uncommon pronunciations be given special attention. Phonetic spelling is used to convey the way a word is pronounced. For instance: "DINNER AT THE FO'C'SLE (FOKE-SIL) RESTAURANT IN LAITONE (LAY-TON) SHORES IS A SEA ADVENTURE." Incorrect pronunciation has resulted in more than one canceled account. The copywriter must make certain that the announcer assigned to voice-track a commercial is fully aware of any particulars in the copy. In other words, when in doubt spell it out.

Excessive numbers and complex directions are to be avoided in radio copy. Numbers, such as an address or telephone



**FIGURE 9.31**  
Editing a multitrack involves adding or deleting tracks. Here BED 2 is replaced by SFX 2 on track 4.

number, should be repeated and directions should be as simple as possible. The use of landmarks ("ACROSS FROM CITY HALL . . .") can reduce confusion. Listeners are seldom in a position to write down something at the exact moment they hear it. Copy should communicate, not confuse or frustrate.

Of course, the purpose of any piece of copy is to sell the client's product. Creativity plays an important role. The radio writer has the world of the imagination to work with and is limited only by the boundaries of his own.

## Announcing Tips

Although the radio announcer ranks have dwindled as radio companies consolidate and downsize their staffs and employ voice-tracking to serve multiple stations, thousands of men and women in this country still make their living before the microphone. In few other professions is the salary range so broad. A beginning announcer may make little more than minimum wage, whereas a seasoned professional in a major market may earn a salary in the six-figure range.

Although announcer salaries can be very modest in smaller markets, the financial rewards tend to be substantial at metro market stations, which can afford to pay more. Of course, competition for the metro market station positions is keener, and expectations are higher. "You have to pay your dues in this profession. No one

walks out of a classroom and into WNBC. It's usually a long and winding road. It takes time to develop the on-air skills that the big stations want. It's hard work to become really good, but you can make an enormous amount of money, or at least a very comfortable income, when you do," says radio personality Mike Morin.

The duties of an announcer vary depending on the size or ranking of a station. In the small station, announcers generally fill news and/or production shifts as well. For example, a midday announcer at WXXX, who is on the air from 10 A.M. until 3 P.M., may be held responsible for the 4 and 5 P.M. newscasts, plus any production that arises during that same period. Meanwhile, the larger station may require nothing more of its announcers than the taping of voiceovers. Of course, the preparation for an airshift at a major-market station can be very time consuming.

An announcer must, above all else, possess the ability to effectively read copy aloud. Among other things, this involves proper enunciation and inflection, which are improved through practice. Programmer Bill Towery contends that the more a person reads for personal enjoyment or enrichment, the easier it is to communicate orally. "I'd advise anyone who aspires to the microphone to read, read, read. The more the better. Announcing is oral interpretation of the printed page. You must first understand what is on the page before you can communicate it aloud. Bottom line here is that if you want to become an announcer, first become a reader."

Having a naturally resonant and pleasant-sounding voice certainly is an advantage.

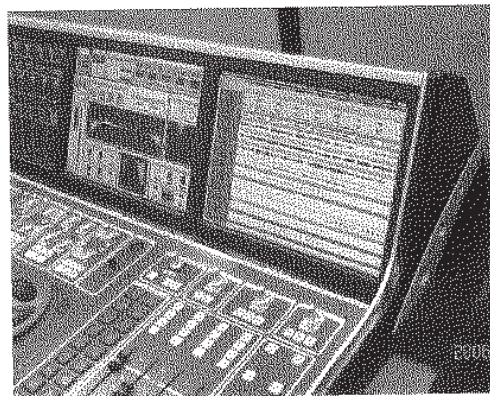
Voice quality still is very important in radio. There is an inclination toward the voice with a deeper register. This is true for female announcers as well as male. However, most voices possess considerable range and with training, practice, and experience even a person with a high-pitched voice can develop an appealing on-air sound. Forcing the voice into a lower register to achieve a deeper sound can result in injury to the vocal chords. "Making the most of what you already have is a lot better than trying to be something you're not. Perfect yourself and be natural," advises Morin.

Relaxation is important. The voice simply is at its best when it is not strained. Moreover, announcing is enhanced by proper breathing, which is only possible when one is free of stress. Initially, being "on-mike" can be an intimidating experience, resulting in nervousness that can be debilitating. Here are some things announcers do to achieve a state of relaxation:

1. Read copy aloud before going on the air. Get the feel of it. This will automatically increase confidence, thus aiding in relaxation.
2. Take several deep breaths and slowly exhale while keeping your eyes closed.
3. Sit still for a couple of moments with your arms limp at your sides. Tune out. Let the dust settle. Conjure pleasant images. Allow yourself to drift a bit, and then slowly return to the job at hand.
4. Stand and slowly move your upper torso in a circular motion for a minute or so. Flex your shoulders and arms. Stretch luxuriously.
5. When seated, check your posture. Do not slump over as you announce. A curved diaphragm impedes breathing. Sit erect, but not stiffly.
6. Hum a few bars of your favorite song. The vibration helps relax the throat muscles and vocal chords.
7. Give yourself ample time to settle in before going on. Dashing into the studio at the last second will jar your focus and shake your composure.

In most situations, an accent – regional or otherwise – is a handicap and should be eliminated. Most radio announcers in the

**FIGURE 9.32**  
Digital audio workstations mark a new era in radio production mixing, editing, and storage. Courtesy Ardour.





South do not have a drawl, and the majority of announcers in Boston put the "r" in the word *car*. A noticeable or pronounced accent will almost always put the candidate for an announcer's job out of the running. Accents are not easy to eliminate, but with practice they can be overcome.

### Voice-Tracking

In the age of station consolidation and clusters (station malls), radio corporations are finding it cost efficient to feed their stations prerecorded voices. In other words, these days as much station announcing takes place away from the station as it does at the station. Radio companies hire announcers to provide their stations with their voicing needs, so there is less and less on-sight voice origination. One announcer may be the voice of a hundred stations. Through satellite feeds and ISDN lines, local station airwaves are filled with out-of-town voices. When voice-tracking is done at the station level, it is to allow more multitasking opportunities for the announcer. Says Ed Shane, "Voice-tracking is an ideal productivity tool, allowing air talent to prerecord their air shifts in order to use their work time producing commercials, appearing live at sponsor locations, or doing a variety of jobs other than waiting for songs to end in order to deliver a 10-second talkover."

Voice-tracking has generated concern because the ranks of announcers are being thinned down. Jackie O'Brien, Metro Networks director of operations, observes, "The field of radio broadcasting has changed tremendously over the past few years. Many positions have been lost due to the innovation of voice-tracking. While this may be a cost-efficient way to run a radio group, it has taken away the personality of the service. When I started in broadcasting, I felt the position was more than the sound of my own voice. There was a commitment made to service the public with news, information, and a little entertainment. This meant staying on through a snowstorm or covering local elections. It also meant talking the occasional lonely heart out of suicide. I've been at Metro Networks for four years. In


that time, I've watched old positions I held in radio disappear to voice-tracking."

Despite concern for the impact voice-tracking has on the announcing profession and radio localism, more and more stations are using it, and the future would suggest that this practice – for better or worse – will grow.

### The Sound Library

Music is used to enhance an advertiser's message – to make it more appealing, more listenable. The music used in a radio commercial is called a *bed* simply because it backs the voice. It is the platform on which the voice is set. A station may bed thousands of commercials over the course of a year. Music is an integral component of the production mixdown.

**FIGURE 9.33**  
Production order.  
Courtesy WBTZ.

106.7 WIZN		<b>PRODUCTION ORDER</b>			
Client <u>SMITH HDWARE AE KEITH</u>					
STATION: WIZN <u>WBTZ</u> :30 :60					
START DATE <u>9-14</u> END DATE <u>11-21</u>					
ROTATION INSTRUCTIONS <u>Equa</u>					
(How many versions? <u>2</u> )					
<input checked="" type="checkbox"/> PRODUCE USING ATTACHED COPY <input type="checkbox"/> ADD TAG TO EXISTING SPOT <input type="checkbox"/> SPEC SPOT <input type="checkbox"/> NEED A CASSETTE					
DUB FROM:			SEND DUB TO: <u>KALO</u>		
MP3 <input checked="" type="checkbox"/>			<u>via MP3</u> via reel		
DGS _____			Address: _____		
Spot Taxi _____			_____		
Other _____			_____		
<b>APPROVALS:</b>					
<input type="checkbox"/> NO APPROVAL NEEDED					
<input checked="" type="checkbox"/> NEEDS APPROVAL					
CONTACT: _____					
PHONE NUMBER: _____					
<input type="checkbox"/> OK TO LEAVE ON VOICE MAIL AND PUT ON THE AIR					
OTHER INSTRUCTIONS <u>Use Bill on VT</u>					
_____					
_____					
<b>FOR PRODUCTION USE ONLY</b>			<b>CART NUMBERS</b>		
Music/SEFX _____			WIZN _____		
Date/Time Produced _____			Buzz _____		
Date/Time Approved _____			_____		

Today, sound libraries are almost always delivered via downloads. However, many stations still derive bed music from other sources. Demonstration CDs (demos) sent by recording companies to radio stations are a familiar source, since few actually make it onto playlists and into on-air rotations. These CDs are particularly useful because the music is unfamiliar to the listening audience. Known tunes generally are avoided in the mixdown of spots because they tend to distract the listener from the copy. However, there are times when familiar tunes are used to back spots. Nightclubs often request that popular music be used in their commercials to convey a certain mood and ambiance.

Movie soundtrack CDs are another good place to find beds because they often contain a variety of music, ranging from the bizarre to the conventional. They also are an excellent source for special audio effects, which can be used to great advantage in the right commercial.

On-air CDs are screened for potential production use as well. Although several tracks may be placed in on-air rotation and thereby eliminated for use in the mixdown of commercials, some cuts will not be programmed and therefore will not be available for production purposes.

Syndicated bed music libraries are available at a price and are widely used at larger

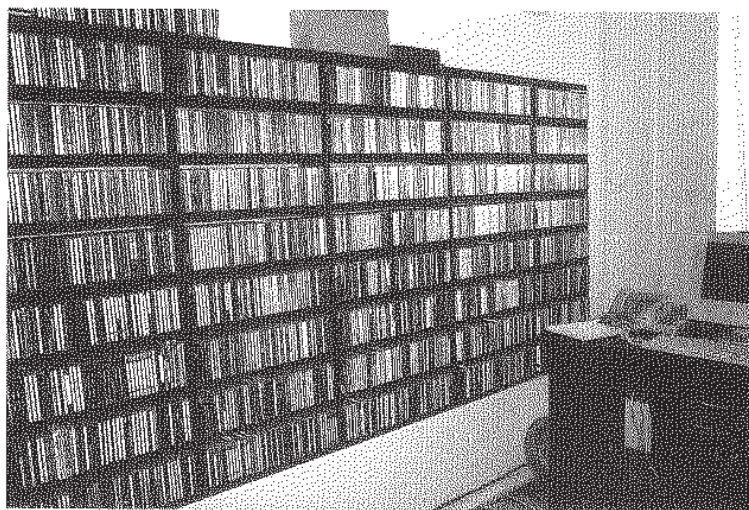
stations. *Broadcasting Yearbook* contains a complete listing of production companies offering bed music libraries. Similarly, a search of the Internet will yield lists of audio production sources. The majority of stations continue to lift beds from in-house CDs (see Figure 9.34).

Music used for production purposes is catalogued so that it can be located and reused. Syndicated libraries come fully catalogued. An old system employed index cards, which could be stored for easy access in a container or on a rotating drum. At most stations today, computers are used to store production library information and files.

If a file exists for a bed that is not in current use and the bed is appropriate for a new account, then either a fresh file will be prepared or the new information will be added into the existing file.

No production studio is complete without a commercial sound effects library, but in the digital age, many effects are made in-house. Sound effects libraries can be purchased for as little as \$100, or they can cost thousands. The quality and selection of effects vary accordingly. Specially tailored audio effects also can run into the thousands but can add a unique touch to a station's sound.

**FIGURE 9.34**  
CD library in studio.  
Courtesy WIZN.





## WRITE GREAT COPY

Good copy is essential for successful advertising. To make certain the ad will attract customers for your client, remember these points:

- 1) Make your first sentence count. Does it provoke interest? Does it demand attention? Does it create a mood? If your first sentence doesn't have it, you've lost your best chance at getting the listeners' attention.
- 2) Keep your copy simple. The most eloquent thoughts are expressed in few words. If good writers can express complex emotions such as "love" simply, why are convoluted sentences needed to sell a leather coat? Cogent copy takes time and effort. The results are worth it.
- 3) Write for one person. Don't use words like "many of you" that refer to a lot of people listening. Radio isn't TV; people listen and respond to radio as individuals. Make your copy personal.
- 4) Eliminate the details. Store hours, telephone numbers, the credit cards they accept are useful in newspaper ads, not on radio. People don't listen to radio with a scratch pad handy. These details take up space and won't motivate anyone to buy anything.
- 5) Use a "locator." Store addresses are hard to remember, harder to visualize where they might be. Listeners relate better to "locators"—places they know or can easily find. "Across from the fairgrounds" will be remembered, "1365 N. King Street" likely won't be.
- 6) Focus on one thought or idea. What is the single most important thing you want the listener to know? Make it personal, make it entertaining, make it exciting—but concentrate on one theme idea. Never resort to a laundry list of services or use clichés.
- 7) Create and consistently use a phrase that "positions" the business or product. This will help the listener recall the business and why he/she should go there. Examples: Chevy Trucks: "Like a Rock"; Fox News Channel, "Fair and Balanced"; "Dude, you're gettin' a Dell."
- 8) After you've written the copy, read it aloud to someone else. Find out what they remembered. You may need to revise it.

BROADCAST MARKETING CONSULTANTS • 25 Main Street, Weyland, Massachusetts 01778 • 508/693-7200 • Fax 508/693-4068

**FIGURE 9.35**  
Tips on writing effective copy.  
Courtesy  
Broadcasting  
Unlimited.

## CHAPTER HIGHLIGHTS

1. The first radio commercials aired in 1922.
2. Early commercials were live readings: no music, sound effects, or singing.
3. Dialogue spots, using drama and comedy to sell the product, became prominent in the 1930s. Elaborate sound effects, actors, and orchestras were employed.
4. With the introduction of magnetic recording tape and 33 LPs in the 1950s, live commercial announcements were replaced by prerecorded messages.
5. The copy, delivery, and mixdown of commercials must be adapted to match the station's format to avoid audience tune-out.
6. The production director (imaging director) records voice tracks, mixes commercials and PSAs, maintains the bed music and special effects libraries, mixes promotional material and special programs, and performs basic editing chores.
7. At smaller stations the production responsibilities are assigned part-time to on-air personnel or the program director.
8. The production director (increasingly referred to as the imaging director at stations mixing with computers), who usually answers to the program director, also works closely with the copywriter and the traffic manager.

9. For ease of movement and accessibility, both on-air and production studio equipment are arranged in a U-shape.
10. The audio console (board) is the central piece of equipment. It consists of inputs, which permit audio energy to enter the console; outputs through which audio energy is fed to other locations; VU meters, which measure the level of sound; pots (faders), which control the quantity (gain) of sound; monitor gains, which control in-studio volume; and master gains, which control general output levels.
11. When operating the console in cue mode, the operator can listen to various audio sources without channeling them through an output.
12. Digital cart audio devices (360 Systems) have replaced the standard analog cart deck. They let producers digitally mix and archive extensive amounts of audio.
13. Compact disc players use a laser beam to decode the disc's surface, which eliminates stylus and turntable noises, distortion, and record damage. Recordable CDs are now in use.
14. Audio processors, samplers, digital carts, and MIDI enhance a radio production studio's product. Software such as Cool Edit Pro and Pro Tools have these features built in.
15. A patch panel is a routing device, consisting of inputs and outputs, connecting the audio console with various external sources.
16. Microphones are designed with different pickup patterns to accommodate different functions: omnidirectional (all directions), bidirectional (two directions), and unidirectional (one direction).
17. Audio editing ranges from simple repairs to complicated rearrangements of sound elements. Today the once conventional razor-cut approach to tape editing has been replaced by nondestructive computer and multitrack methods.
18. Digital audio workstations, which rely on computer technology and software (Pro Tools is very popular), are currently used in a vast number of radio production studios.
19. The station copywriter, who writes the commercials, promos, and PSAs, must be familiar with the intended audience and the product being sold. The station's format and programming approach influence the style of writing. Copy should be typed in uppercase, be double-spaced, and have 1-inch margins. Sound effects are noted in parentheses, and phonetic spellings are provided for difficult words.
20. Aspiring announcers must be able to read copy aloud with proper inflection and enunciation. A naturally resonant and pleasant-sounding voice without a regional accent is an advantage.
21. The practice of voice-tracking is reducing the number of announcing jobs. More and more, local station announcing

**FIGURE 9.36**

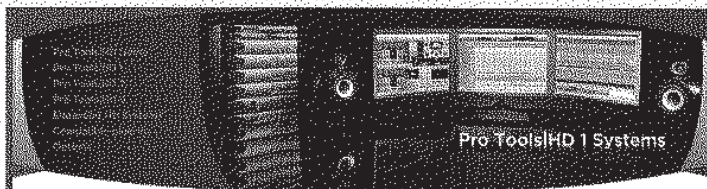
The production person remains the station's true artist whether the studio be cutting-edge digital or old-world analog. Courtesy WIZN.



originates elsewhere, especially in cluster operations and when stations are a part of major station groups.

22. Every station maintains a sound library for use in spot mixdowns. Commercially produced sound effects, bed music collections,

and unfamiliar cuts from CDs and the Internet (and even LPs) are common source materials. Digital equipment and computer workstations allow producers to create their own in-house effects.



**FIGURE 9.37**

At many stations, Pro Tools is the new sound and effects library. Courtesy Digidesign.



**FIGURE 9.38**

The book's author sits in what was regarded as a state of the art studio in 1960. Courtesy Boston College.

## SUGGESTED FURTHER READING

- Adams, M.H., and Massey, K., *Introduction to Radio: Production and Programming*, Brown and Benchmark, Madison, WI, 1995.
- Alburger, J.R., and Hall, M., *The Art of Voice Acting*, Focal Press, Boston, MA, 2002.
- Alten, S.R., *Audio in Media*, 8th edition, Wadsworth Publishing, Belmont, CA, 2007.
- Bartlett, B., *Stereo Microphone Techniques*, Focal Press, Boston, MA, 1991.
- Campbell, T., *Wireless Writing in the Age of Marconi*, University of Minnesota, Minneapolis, MN, 2006.
- Ford, T., *Advanced Audio Production Techniques*, Focal Press, Boston, MA, 1993.
- Gross, L., Reese, D.E., and Gross, B., *Radio Production Worktext: Concepts, Techniques, and Equipment*, 6th edition, Focal Press, Boston, MA, 2009.
- Hausman, C., et al., *Modern Radio Production*, Wadsworth Publishing, Belmont, CA, 2006.
- Hilliard, R.L., *Writing for Television, Radio, and New Media*, 9th edition, Wadsworth Publishing, Belmont, CA, 2007.

- Hoffer, J., *Radio Production Techniques*, Tab Books, Blue Ridge Summit, PA, 1974.
- Hyde, S.W., *Television and Radio Announcing*, 7th edition, Houghton Mifflin, Boston, MA, 1995.
- Kaempfer, R., and Swanson, J., *The Radio Producer's Handbook*, Allworth Press, New York, 2004.
- Keith, M.C., *Broadcast Voice Performance*, Focal Press, Boston, MA, 1989.
- Keith, M.C., *Radio Production: Art and Science*, Focal Press, Boston, MA, 1990.
- Labelle, B., *Background Noise: Perspectives on Sound Art*, Continuum International Publishing, London, UK, 2006.
- McLeish, R., *Radio Production*, 5th edition, Focal Press, Boston, MA, 2005.
- Mott, R.L., *Radio Sounds Effects*, McFarland Publishing, Jefferson, NC, 2005.
- National Association of Broadcasters, *Guidelines for Radio Continuity*, NAB Publishing, Washington, DC, 1982.
- National Association of Broadcasters, *Guidelines for Radio Copywriting*, NAB Publications, Washington, DC, 1993.
- Nisbet, A., *The Technique of the Sound Studio*, 4th edition, Focal Press, Boston, MA, 1979.
- Nisbet, A., *The Use of Microphones*, 3rd edition, Focal Press, Boston, MA, 1989.
- O'Donnell, L.B., Hauseman, C., and Benoit, P., *Announcing: Broadcast Communication Today*, 5th edition, Wadsworth Publishing, Belmont, CA, 2000.
- O'Donnell, L.B., Hauseman, C., and Benoit, P., *Modern Radio Production*, 5th edition, Wadsworth Publishing, Belmont, CA, 2003.
- Oringel, R.S., *Audio Control Handbook*, 6th edition, Focal Press, Boston, MA, 1989.
- Orlik, P.B., *Broadcast/Cable Copywriting*, 7th edition, Allyn & Bacon, Boston, MA, 2003.
- Pohlmann, K.C., *Advanced Digital Audio*, SAMS, Indianapolis, IN, 1991.
- Priestman, C., *Web Radio: Radio Production for Internet Streaming*, Focal Press, Boston, MA, 2002.
- Reese, D.E., et al., *Broadcast Announcing Worktext*, Focal Press, Boston, MA, 2005.
- Rumsey, F., *Digital Audio Operation*, Focal Press, Boston, MA, 1991.
- Rumsey, F., *Tapeless Sound Recording*, Focal Press, Boston, MA, 1990.
- Watkinson, J., *Digital Audio and Compact Disc Technology*, 3rd edition, Focal Press, Boston, MA, 1995.

# Engineering

# 10

## Pioneer Engineers

Radio at its core is a technology. Therefore, anyone who has ever spoken into a microphone or sat before a radio receiver owes an immense debt of gratitude to the many technical innovators who made it possible. Guglielmo Marconi, a diminutive Italian with enormous genius, first used electromagnetic (radio) waves to send a message. Marconi made his historical transmission, and several others, in the last decade of the nineteenth century. Relying, at least in part, on the findings of two earlier scientists, James Clerk Maxwell and Heinrich Hertz, Marconi developed his wireless telegraph, thus revolutionizing the field of electronic communications.

Other wireless innovators made significant contributions to the refinement of Marconi's device. J. Ambrose Fleming developed the diode tube in 1904, and 2 years later Lee de Forest created the three-element triode tube called the Audion. Both innovations, along with many others, expanded the capability of the wireless.

In 1906, Reginald Fessenden demonstrated the transmission of voice over the wireless from his experimental station at Brant Rock, Massachusetts. Until that time, Marconi's invention had been used to send Morse code or coded messages. An earlier experiment in the transmission of voice via the electromagnetic spectrum also had been conducted. In 1892, on a small farm in Murray, Kentucky, Nathan B. Stubblefield managed to send voice across a field using the induction method of transmission, yet Fessenden's method of mounting sound impulses atop

electrical oscillations and transmitting them from an antenna proved far more effective. Fessenden's wireless voice message was received hundreds of miles away.

Few pioneer broadcast technologists contributed as much as Edwin Armstrong. His development of the regenerative and super-heterodyne circuits vastly improved receiver efficiency. In the 1920s Armstrong worked at developing a static-free mode of broadcasting, and in 1933 he demonstrated the results of his labor – FM. Armstrong was a man ahead of his time. It would be decades before his innovation would fully be appreciated, and he would not live to witness the tremendous strides it would take.

Had it not been for these men, and many others like them, there would be no radio medium. Today's broadcast engineers and technologists continue in the tradition of

**FIGURE 10.1**  
Assembling the technology. Courtesy Library of Congress.



their forebears. Without their knowledge and expertise, there would be no broadcast industry because there would be no medium. Radio is first and foremost an engineer's medium. It is engineers who put the stations on the air and keep them there.

## Radio Technology

Radio broadcasters utilize part of the electromagnetic spectrum to transmit their signals, and they are obliged to pay spectrum fees of up to \$1500 annually (depending on their size) for this privilege. A natural resource, the electromagnetic spectrum is composed of radio waves at the low-frequency end and cosmic rays at the high-frequency end. In the spectrum between are infrared rays, light rays, X rays, and gamma rays. Broadcasters, of course, use the radio wave portion of the spectrum for their purposes.

Electromagnetic waves carry broadcast transmissions (radio frequency) from station to receiver. It is the function of the transmitter to generate and shape the radio wave to conform to the frequency the station has been assigned by the FCC. Audio current is sent by a line from the control room to the transmitter. The current then modulates the carrier wave so that it may achieve its authorized frequency. A carrier wave that is undisturbed by audio current is called an unmodulated carrier.

The antenna radiates the radio frequency. Receivers are designed to pick up transmissions,

convert the carrier into sound waves, and distribute them to the frequency tuned. Thus, in order for a station assigned a frequency of 950kHz (a kilohertz equals 1000 hertz [Hz]) to reach a radio tuned to that position on the dial, it must alter its carrier wave 950,000 cycles (Hz) per second. The tuner counts the incoming radio frequency.

## AM/FM

AM and FM stations are located at different points in the spectrum: AM stations are assigned frequencies between 540 and 1700kHz on the Standard Broadcast band, and FM stations are located between 88.1 and 107.9 MHz (megahertz equals 1 million hertz) on the FM band.

Ten kilocycles (kc) separate frequencies in AM, and there are 200kc between FM frequencies. FM broadcasters utilize 30kc for over-the-air transmissions and are permitted to provide subcarrier transmission (SCA) to subscribers on the remaining frequency. The larger channel width provides FM listeners a better opportunity to fine-tune their favorite stations as well as to receive broadcasts in stereo. To achieve parity, AM broadcasters developed a way to transmit in stereo, and by 1990 hundreds were doing so. The fine-tuning edge still belongs to FM, because its sidebands (15kc) are three times wider than AM's (5kc).

FM broadcasts at a much higher frequency (millions of cycles per second) compared to AM (thousands of cycles per second). At such a high frequency, FM is immune to low-frequency emissions, which plague AM. Although a car motor or an electric storm generally will interfere with AM reception, FM is static free. Broadcast engineers have attempted to improve the quality of the AM band, but the basic nature of the lower frequency makes AM simply more prone to interference than FM. FM broadcasters see this as a key competitive advantage and refer to AM's move to stereo as "stereo with static."

## Signal Propagation

The paths of AM and FM signals differ from one another. Ground waves create AM's primary service area as they travel across

**FIGURE 10.2**  
Station engineering operations in the digital age. Courtesy Clear Channel.





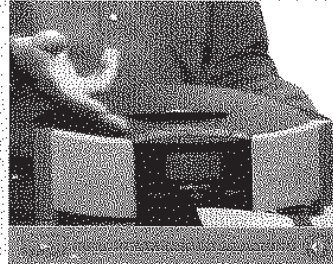
## iTunes® Tagging

**Hear it. Tag it. Download it. Never forget it.**

How many times have you heard a song on the radio you'd really like to hear again? Wouldn't it be great if you could tag that song and buy it?

With an iTunes Tagging enabled HD Radio™ receiver you can. When you hear a song you like on your local FM HD Radio station, you simply hit the "tag" button. The song's info will be saved from your HD Radio receiver to your iPod®. The songs will show up in a playlist called "Tagged" in iTunes the next time you sync your iPod to your computer. So you can click, download and buy the songs you want directly from the Apple® iTunes Music Store.

With a brand new HD Radio receiver, you will be able to tag songs while you listen to your favorite music in pure crystal-clear digital sound. And if that isn't enough, many HD Radio stations now are broadcasting additional digital channels called HD2 and HD3, all subscription-free.



Video Demo



the earth's surface. High-power AM stations are able to reach listeners hundreds of miles away during the day. At night AM's signal is reflected by the atmosphere (ionosphere), thus creating a skywave that carries considerably farther, sometimes thousands of miles. Skywaves constitute AM's secondary service area.

In contrast to AM signal radiation, FM propagates its radio waves in a direct or line-of-sight pattern. FM stations are not affected by evening changes in the atmosphere and generally do not carry as far as AM stations. A high-power FM station may reach listeners within an 80- to 100-mile radius because its signal weakens as it approaches the horizon. Because FM outlets radiate direct waves, antenna height becomes nearly as important as power. In general, the higher an FM antenna, the farther the signal travels.

### Skywave Interference

The fact that AM station signals travel greater distances at night is a mixed blessing. Although some stations benefit from the expanded coverage area created by the skywave phenomenon, many do not. In fact, over 2000 radio stations around the

country must cease operation near sunset, and thousands more must make substantial transmission adjustments to prevent interference. For example, many stations must decrease power after sunset to ensure noninterference with others on the same frequency: WXXX-AM is 5000W (5kW) during the day, but at night it must drop to 1000 W (1 kW). Another measure designed to prevent interference requires that certain stations direct their signals away from stations on the same frequency. Directional stations require two or more antennas to shape the pattern of their radiation, whereas a nondirectional station that distributes its signal evenly in all directions needs only a single antenna. Because of its limited direct wave signal, FM is not subject to the post-sunset operating constraints that affect most AM outlets.

### Station Classifications

To guarantee the efficient use of the broadcast spectrum, the FCC established a classification system for both AM and FM stations. Under this system, the nation's 10,000 radio outlets operate free of the debilitating interference that plagued broadcasters prior to the Radio Act of 1927.

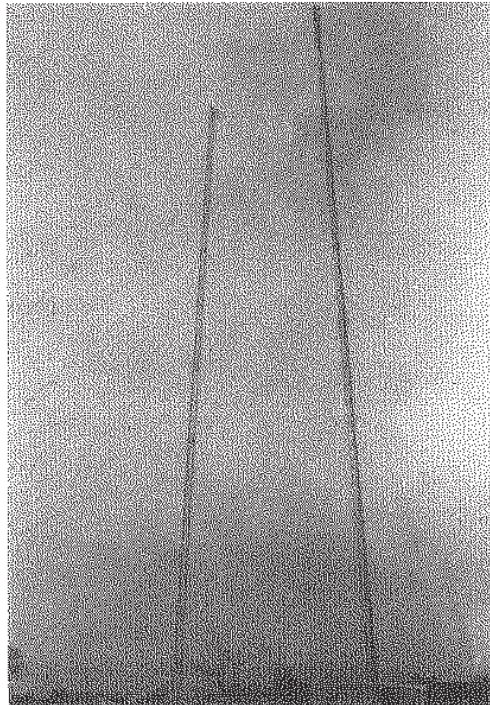
**FIGURE 10.3**

Technology provides the latest in audio features. Courtesy iTunes.

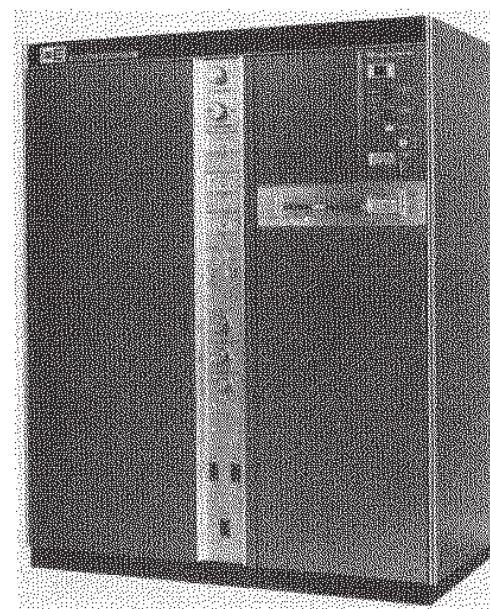
AM classifications are as follows:

- **Class A:** Clear channel stations with power not exceeding 50kW. Their frequencies are protected from interference up to 750 miles. Among the pioneer, or oldest, stations in the country are KDKA, WBZ, WSM, and WJR.
- **Class B:** Stations with power ranging from a minimum of 250W to a maximum of 50kW. They must protect Class I outlets by altering their signals around sunset. As a Class B station, WINZ-AM in Miami is required to reduce power from 50kW to 250W so as not to intrude on other stations at 940kHz. These stations also operate on regional channels. If a station is authorized to operate in the expanded band (1610–1700), the maximum power is 10kW.
- **Class C:** Stations that operate on local and regional channels with power between 250 and 1000W. They may operate without time restrictions.
- **Class D:** Stations that operate either daytime, limited time, or unlimited time with a nighttime power less than 250W. Daytime-only stations are Class D.

**FIGURE 10.4**  
Antennas (towers)  
propagate station  
signals.



**FIGURE 10.5**  
A 3-kW FM  
transmitter. Courtesy  
Broadcast Electronics.



Section 73.21 of the *Code of Federal Regulations*, Part 73, provides more details on AM station classifications.

New AM band space (1605–1705 kHz) is currently being allocated, and the FCC is encouraging existing AM license holders to shift to the new space as a means of reducing interference on the clogged band.

FM classifications include the following:

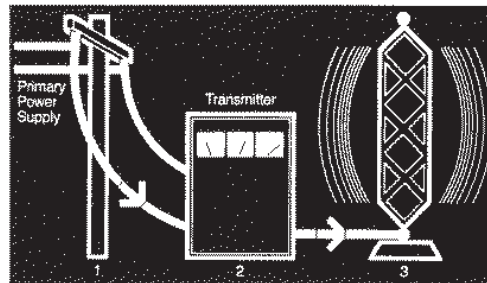
- **Class C:** The most powerful FM outlets with the greatest service parameters, these stations may be assigned a maximum ERP of 100kW and a tower height of up to 2000 feet. Class C radio waves carry, on average, 70 miles from their point of transmission.
- **Class B:** These stations operate with less power – up to 50kW – than Class Cs and are intended to serve smaller areas. The maximum antenna height for stations in this class is 500 feet, and signals generally do not reach beyond 40–50 miles.
- **Class A:** The least powerful of commercial FM stations; they seldom exceed 3 kW ERP (except in select cases where a ceiling of 6 kW is imposed) and 328 feet in antenna height. The average service contour for stations in this category is 10–20 miles.
- **Class D:** Set aside for noncommercial stations with 10W ERP, this type of station is most apt to be licensed to a school or college.

FM Station Class	Reference (Maximum) Facilities for Station Class (see 47 CFR Section 73.211)  ERP (in kW) / HAAT (in meters)	FM Protected or Primary Service Contour		Distance to Protected or Primary Service Contour (km)	Distance to 70 dBu (or 3.16 mV/m) City Grade or Principal Community Coverage Contour (see 47 CFR Section 73.315) (km)
		dBu	mV/m		
Class A	6.0 kW / 100 meters	60 dBu	1.0 mV/m	28.3 km	16.2 km
Class B1	25.0 kW / 100 meters	57 dBu	0.71 mV/m	44.7 km	23.2 km
Class B	50.0 kW / 150 meters	54 dBu	0.50 mV/m	65.1 km	32.6 km
Class C3	25.0 kW / 100 meters	60 dBu	1.0 mV/m	39.1 km	23.2 km
Class C2	50.0 kW / 150 meters	60 dBu	1.0 mV/m	52.2 km	32.6 km
Class C1	100.0 kW / 299 meters	60 dBu	1.0 mV/m	72.3 km	50.0 km
Class C0 (C-zero)	100.0 kW / 450 meters	60 dBu	1.0 mV/m	83.4 km	59.0 km
Class C	100.0 kW / 600 meters	60 dBu	1.0 mV/m	91.8 km	67.7 km

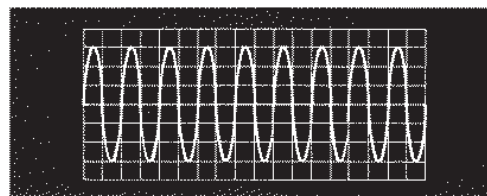
**FIGURE 10.6**  
FM station classes.  
Courtesy Federal Communications Commission.

In the 1980s, the FCC introduced three new classes of FM stations under Docket 80-90 in an attempt to provide several hundred additional frequencies, and more subclasses were added later. They are as follows:

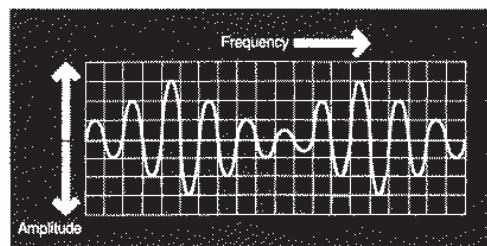
- **Class C1:** Stations granted licenses to operate within this classification may be authorized to transmit up to 100 kW ERP with antennas not exceeding 984 feet. The maximum reach of stations in this class is about 50 miles.
- **Class C2:** The operating parameters of stations in Class C2 are close to Class Bs. The maximum power granted Class C2 outlets is 50kW, and antennas may not exceed 492 feet. Class C2 stations reach approximately 35 miles.
- **Class C3:** These stations operate with shorter antennas and with power that typically exceeds 6kW ERP.
- **Class B1:** The maximum antenna height permitted for Class B1 stations (328 feet) is identical to Class As; however, Class B1s are assigned at least 25 kW ERP. Class B1 signals carry 25-30 miles.



**FIGURE 10.7**  
Stations receive their power from conventional utility companies. From *FCC Broadcast Operator's Handbook*, Figure 3-1.



**FIGURE 10.8**  
Unmodulated (undisturbed) carrier. From *FCC Broadcast Operator's Handbook*, Figure 5-1.



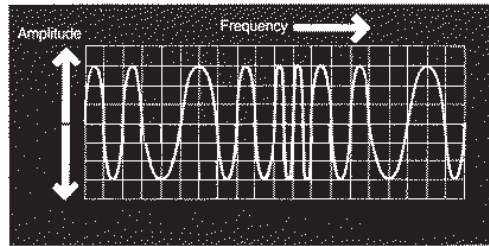
**FIGURE 10.9**  
Amplitude modulated (AM) carrier. From *FCC Broadcast Operator's Handbook*, Figure 5-2.

LPM classifications include the following:

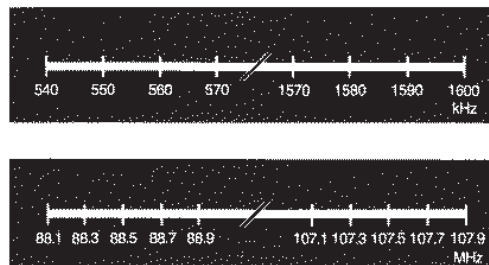
- Class L1: 50–100 W ERP
- Class L2: 1–10 W ERP

In view of the ongoing revisions made to FM classifications, we suggest you consult Section 73.210 of the current *Code of Federal Regulations*, Part 73.

**FIGURE 10.10**  
Frequency modulated (FM) carrier. From *FCC Broadcast Operator's Handbook*, Figure 5-4.



**FIGURE 10.11**  
Standard AM and FM band. From *FCC Broadcast Operator's Handbook*, Figures 4-7 and 4-8.



Boeing HS 702 satellites) were set aloft in a geostationary orbit, Sirius Satellite Radio's birds (three SS/L-1300 satellites) rotate in an elliptical pattern ensuring that each satellite spends around 16 hours over the United States. Offering CD-quality digital radio, these satellite radio signals are beamed to nearly 10 million receiving dishes located in cars and homes. Satellite radio uses the S-band (2.3 GHz) for its digital audio radio service (DARS). Both services keep a satellite ready for launch in the event one of their satellites malfunctions. Program origination from ground stations are uplinked to the satellites and then relayed to terrestrial end users (subscribers). Receivers unscramble the incoming signals, which offer over 100 channels each. In addition, the signals contain encoded data for display on receivers allowing listeners to see what is being broadcast (artist, song, etc.). Ground repeaters are employed when needed to strengthen incoming satellite signals. An international satellite radio service called WorldSpace utilizes the L-band to provide digital audio to Africa and Asia. According to former XM Satellite's chief programmer, Lee Abrams, the operation's technical department consists of four key areas: studios, hardware development, satellites and repeaters, and IT.

## Satellite and Internet Radio

### Satellite Radio

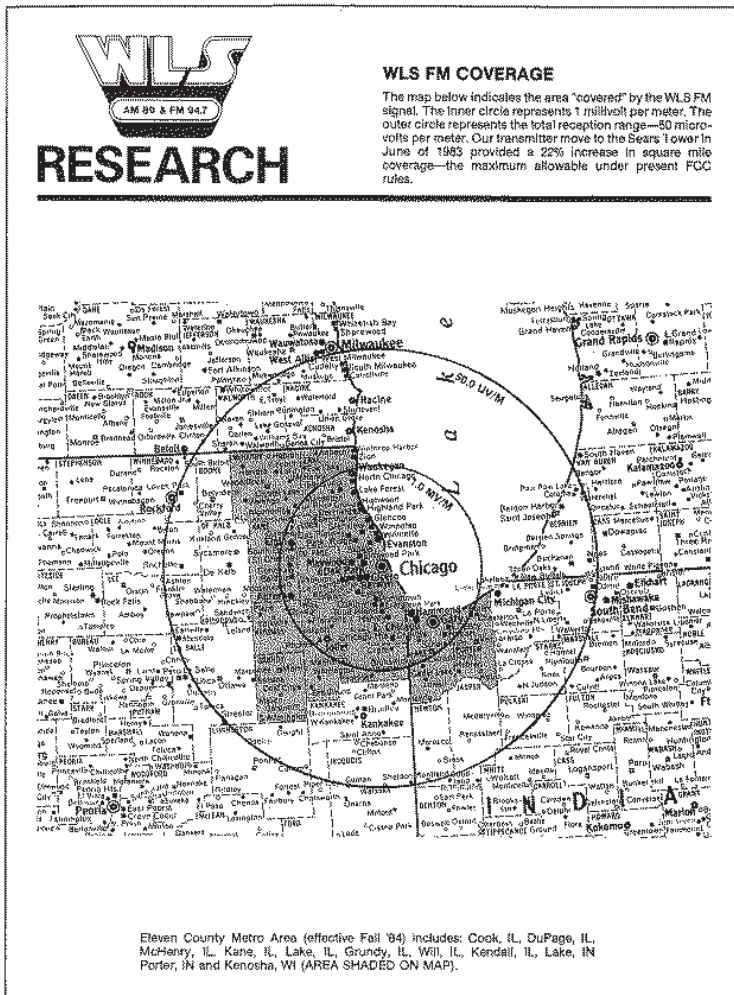
Satellite radio signals come from over 22,000 miles out in space. Although former XM Satellite Radio's transponders (two

### Internet Radio

Since the 1990s, radio has been available over the Internet. There are two types of Internet radio stations: those generated by broadcast stations and those that are Web-only in origin. In the case of the first

**FIGURE 10.12**  
Radio spectrum table.

VLF (Very Low Frequency) 30 kHz and below	—Maritime use
LF (Low Frequency) 30 kHz to 300 kHz	—Aeronautical/maritime
MF (Medium Frequency) 300 kHz to 3000 kHz	—AM, amateur, distress, etc.
HF (High Frequency) 3 MHz to 30 MHz	—CB, fax, international, etc.
VHF (Very High Frequency) 30 MHz to 300 MHz	—FM, TV, satellite, etc.
UHF (Ultra High Frequency) 300 MHz to 3000 MHz	—TV, satellite, CB, DAB (proposed), etc.
SHF (Super High Frequency) 3 GHz to 30 GHz	—Satellite, radar, space, etc.
EHF (Extreme High Frequency) 30 GHz to 300 GHz	—Space, amateur, experimental, etc.



**FIGURE 10.13**  
Coverage maps show where a station's signal reaches.  
Courtesy WLS.

category, stations typically simulcast their broadcast signals over the Web. The second category of Internet station is typically more eclectic in its programming offerings, because the formatting constraints prevalent in broadcast radio do not exist in the independent, cyber-only outlets. Unlike traditional terrestrial stations, whose reach and operating parameters are limited, there are no geographical limitations in Internet radio. With Web access, anyone anywhere can enjoy the medium. A Web station emanating from Dayton, Ohio, may be heard in Bangkok, Thailand, and tens of thousands of broadcasts are available. Unlike terrestrial and satellite radio, Internet radio has the capability of providing a full range of visual data, such as photos, text, and links. Interactivity also adds further cache to the

medium's appeal, which has been battling copyright issues concerning the use of music through the decade.

The process of distributing an Internet radio signal is not complex. Internet radio operations possess an encoding computer, which converts the audio in a stream. The audio is then sent to a server and it routes the audio data over the Internet to the computer plug-in of the end-user/listener.

### Digital Audio Broadcasting (HD Radio)

Radio has been undergoing a metamorphosis as analog signal processing is being supplanted by digital processing. The reason for

**FIGURE 10.14**  
The difference between the two bands. Courtesy Brian Belanger, Radio and Television Museum.

## FM vs. AM: Technical Considerations

If electrical signals could be seen, they would look like the figures shown here. (Actually, they *can* be seen, on an instrument called an oscilloscope, which resembles a small television set.) If one were to whistle into a microphone with a pure low-frequency audio tone, the microphone would convert the voice into an electrical signal like Fig. 1.

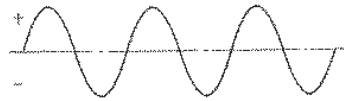


Figure 1. A pure audio tone converted into an electrical signal.

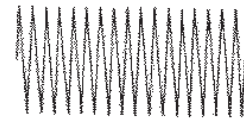


Figure 2. A carrier wave produced by a radio transmitter.

An essential portion of a radio transmitter produces a much higher frequency electrical signal called the carrier wave like Fig. 2. To transmit intelligence, the radio transmitter must somehow superimpose the voice signal on the carrier wave, a process called modulation. (The radio receiver *demodulates*, or separates the desired audio signal from the carrier wave.)

Amplitude modulation or AM was the first type of modulation developed, early in the 20<sup>th</sup> century. When the amplitude or height of the carrier is changed in time with the audio signal, the result would look like Fig. 3.

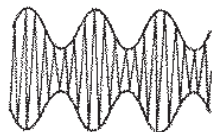


Figure 3. An amplitude modulated radio signal.



Figure 4. A frequency modulated radio signal, modulated by the same audio signal as in Fig. 3.

Instead of modulating the amplitude of the carrier, one can use the audio signal to change the *frequency* of the carrier, and that is frequency modulation. If the carrier were frequency modulated by the same audio signal as in Fig. 3, the result would look like Fig. 4. The frequency increases and decreases, but the amplitude of the modulated signal stays constant. The same intelligence has been transmitted. Of course a symphony concert with its multitude of sounds would produce a much more complicated looking waveform.

### Questions About AM vs. FM:

*Why is FM more static-free than AM?*

Static is caused by things like lightning discharges or electrical discharges from nearby motors or other electrical devices, and those discharges produce small bursts of radiated energy. The

the transformation is simple: the demand for better and more evolved sound is at an all-time high. Broadcast stations must convert to digital, or they will not be competitive with audio alternatives, such as MP3 players, satellite radio, and mobile music services.

The full conversion to digital broadcasting is being planned and is likely to be completely realized within a few years. At the 1992 World Administrative Radio Conference (WARC), conducted by the International Telecommunications Union (ITU) in Spain, the FCC proposed use of the S-band

FIGURE 10.14  
Continued

AM receiver picks up the bursts of static along with the desired signal and adds them together. Static shows up as sharp vertical peaks (spikes) on the modulated waveform, and AM radios respond to them. However, in an FM receiver, the amplitude of the signal does not matter—only changes in frequency matter—so there is no static with FM.

*If it is better, why didn't people use FM in the early days of radio?*

AM was discovered first, and tends to be simpler. In the early days of radio, mathematicians thought they had "proved" that FM would not work as well as AM, but their analyses were oversimplified. E. H. Armstrong showed that if one used a sufficiently wide bandwidth, FM works just fine. For FM to work well, a much wider channel (bandwidth) is required than with an AM station. At the frequencies used in the AM broadcast band (roughly 550 to 1700 kilohertz) there is insufficient spectrum "space" to permit the wide channels needed for FM, but there is sufficient channel space available at the higher frequencies now used for FM (88 to 108 Megahertz). Another problem was that in the early days of radio, the vacuum tubes then available did not work well at the high frequencies where FM needed to operate. Another benefit of FM: the wider channels occupied by FM stations can accommodate modulation with wider frequency excursions than those from AM stations, so FM stations broadcast with much higher fidelity.

*Why can you sometimes hear far away stations on AM but not on FM?*

That has to do not with the difference between AM and FM, but rather *the different radio propagation conditions* in the AM band vs. the FM band. At the frequencies used in the AM broadcast band, signals can bounce off the ionosphere, especially at night, and be reflected back to earth at considerable distances from the transmitter, as shown in the figure below. But signals at the much higher frequencies used for FM generally do *not* bounce off the ionosphere, and so FM reception is limited to more or less a line-of-sight path.

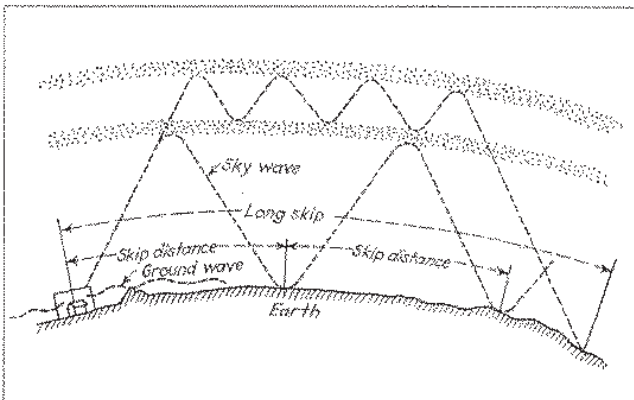


Figure 5. Charged particles in the ionosphere can reflect radio signals, which can then come back to earth quite some distance away from the transmitter. These reflected signals often shows up at the frequencies used in the AM broadcast band, especially at night, but NOT at the much higher frequencies used for FM.

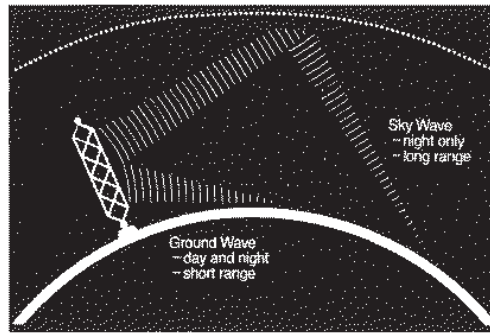
(2310–2360 MHz) for the propagation of DAB signals.

Although some things remain to be resolved, in-band on-channel (IBOC) digital radio, as created by iBiquity, has been given the go-ahead. This is something the NAB has long supported as a way of maintaining

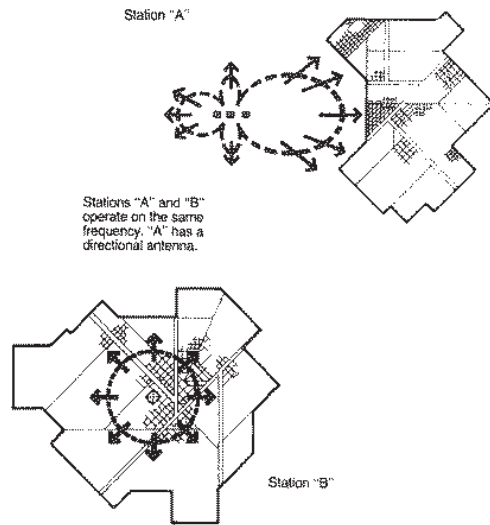
a station's brand identity as established by its frequency numbers.

Although the present system of analog broadcasting essentially replicates sound waves (with inherent shortcomings), digital converts sound waves into a bit-stream of 1's and 0's for processing into a low bandwidth.

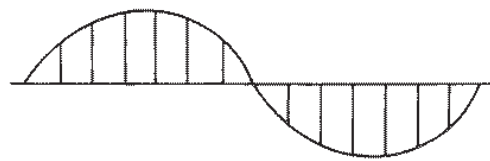
**FIGURE 10.15**  
AM signal radiation.  
From *FCC Broadcast Operator's Handbook*,  
Figure 3-2.



**FIGURE 10.16**  
Nondirectional and directional antenna radiation.  
From *FCC Broadcast Operator's Handbook*, Figure 7-2.



**FIGURE 10.17**  
In digital processing of sound, an analog waveform is quantified, that is, given a numeric binary value.



In digital, sound waves are assigned numeric values and become coded pulses.

Simply put, in digital, sounds are quantified. This allows a more accurate representation of audio signals. Unlike analog, which is limited in what it can reproduce, digital provides greater frequency response and dynamic range. Thus, more audio information is conveyed to the listener, who hears more. Another positive feature from the broadcast operator's perspective is the fact that digital signals do not require as much power as do analog signals.

Obviously, the transition to digital requires the manufacture of new receivers, and several companies now offer such

products. Part of their appeal, according to telecommunications professor Ernest Hakanen, is the fact that they "will allow for much more faithfulness of signal reproduction. High-definition (HD) receivers are designed to use reflected signals as alternative sources of information when the primary signal deteriorates. Using receivers that correct the fading and interference problems associated with AM and FM broadcasts, DAB signals that include specific information that can 'tell' the receiver how to compensate for information lost between transmitter and receiver can be received."

Eventually, the existing analog system of AM and FM broadcasting will be passé. It is not likely, however, that the conversion to digital will occur overnight. Some predict that analog broadcasting will be around for a few more years and that, even when digital is the preeminent broadcasting system, analog AM and FM stations will still be out there – that is, until the FCC no longer perceives them as providing a viable service. In any event, the switch to digital is mandated, and so digital is inevitable. Analog broadcasting will go the way of the turntable.

Radio engineer Aaron Reed expresses his views on the issues that will confront the full implementation of digital radio. "Dealing with the political boondoggle and the necessary paradigm shift in how 'radio' will be done after its implementation (from the technical changes necessary to augment the programming delivery to the altering of the way people think of radio as a mostly one-way medium) will prove a major challenge to any engineer. Couple that with station managers demanding they be digital because 'the other guy is' but then balking at the hefty price and you can see the problems. It won't be easy, and inevitably many stations will try to do it on the cheap and fail because DAB is not something that can be done incrementally. Just saying your station is digital is not going to get the listeners. Something far more radical in the programming services that stations offer will be required. The potential is there. Whether engineers and their moneymen are willing to do it is the big question."



## Smart Receivers

It is now possible to get more than just audio from a radio receiver. The new HD sets and satellite radio receivers are programmable and provide visual screens offering copious data. In fact, consumers are able to format scan without actually having to listen to stations. These so-called smart receivers feature emergency alerting capabilities, traffic announcements, advertisements and promos, music tagging options, and other informational services via a built-in LCD display panel. This was proposed in the early 1990s by Radio Broadcast Data Systems but never realized. Now with the existence of digital and satellite radio it has come to fruition.

Some programmers opposed the idea of "sightradio" (a throwback term used to describe television at its onset) because they felt that it was difficult to categorize a format given the existing options, especially with a limited number of letters. The thought of a quasi-teletext component to radio inspires mixed emotions in many broadcasters. Will people be *watching* radio, and what exactly will that mean? In the main, however, "screen" radio is perceived as an important value-added feature for the medium, and something it must offer in the computer age.

Although it is difficult at this time to predict the future impact and role of these innovations, it is certain, with the conversion to digital, that eventually receivers will do more than simply tune frequencies.

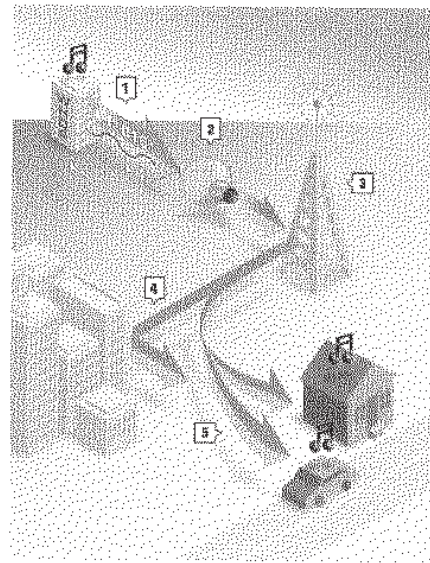
One other plus offered by smart-receiver technology is that it will allow car radios to automatically retune a different station offering the same format when a vehicle leaves the coverage area of the first station.

## Becoming an Engineer

Most station managers or chief engineers look for experience when hiring technical people. Formal training such as college ranks high but not as high as actual hands-on technical experience. "A good electronics background is preferred, of course. This doesn't necessarily mean 10 years of experience or an advanced degree in electronic engineering,

### HD Radio: How HD Radio Works

- 1 Stations bundle analog and digital audio signals (with textual data, such as artist and song information, weather and traffic, and more).
- 2 The digital signal layer is compressed using iBiquity's HDC compression technology.
- 3 The combined analog and digital signals are transmitted.
- 4 The most common form of interference, multipath distortion, occurs when part of a signal bounces off an object and arrives at the receiver at a different time than the main signal. HD Radio receivers are designed to sort through the reflected signals and reduce static, hiss, pops and fades.
- 5 The signal will be compatible with HD Radio receivers and analog radios.



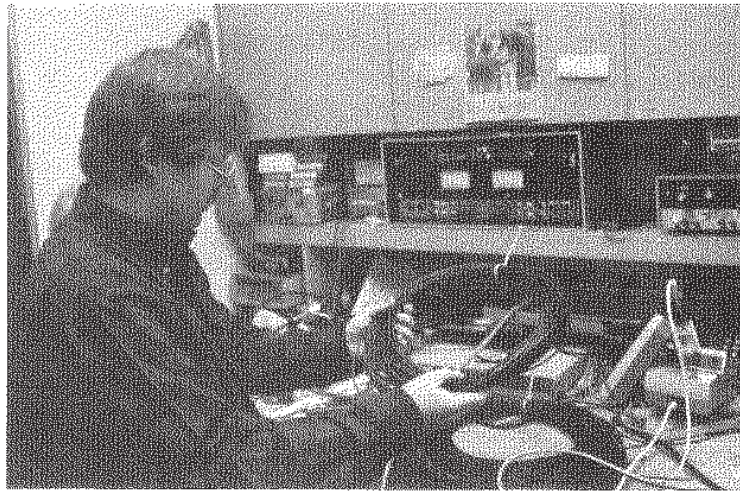
**FIGURE 10.18**  
How HD Radio works.  
Courtesy iBiquity.

but rather a person with a solid foundation in the fundamentals of radio electronics, perhaps derived from an interest in amateur radio, computers, or another hobby of a technical nature. This is a good starting point. Actually, it has been my experience that people with this kind of a background are more attuned to the nature of this business. You don't need a person with a physics degree from MIT, but what you do want is someone with a natural inclination for the technical side. Ideally speaking, you want to hire a person with a tech history as well as some formal in-class training," contends Kevin McNamara, Director of Engineering, Beasley Broadcasting Group.

Chief engineer Jim Puriez concurs. "A formal education in electronics is good, but not essential. In this business if you have the desire and natural interest, you can learn from the inside out. You don't find that many broadcast engineers with actual electronics degrees. Of course, most have taken basic electronics courses. The majority are long on experience and have acquired their skills on the job. While a college degree is a nice credential, I think most managers hire tech people on the basis of experience more than anything else."

Station engineer Sid Schweiger also cites experience as the key criterion for gaining

**FIGURE 10.19**  
Station engineer  
at the workbench.  
Courtesy WMJX-FM.



a broadcast engineer's position. "When I'm in the market for a tech person, I'll check smaller market stations for someone interested in making the move to a larger station. This way, I've got someone with experience right from the start. The little station is a good place for the newcomer to gain experience."

In his column in *Radio World* (June 9, 1999), editor Paul J. McLane lamented the dearth of young people entering the field and the need for specialists with various technical and computer skills. Wrote McLane, "Fluency never stops. People I respect say radio engineers should learn to think large, and that goes for digital audio and data training."

Numerous schools and colleges offer formal training in electronics. The number shrinks somewhat when it comes to those institutions actually providing curricula in broadcast engineering. However, a number of technical schools do offer basic electronics courses applicable to broadcast operations.

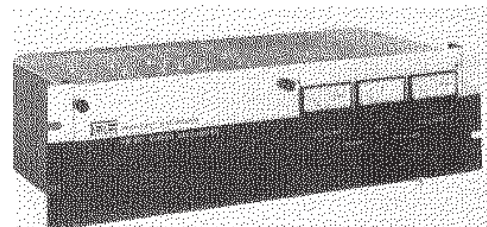
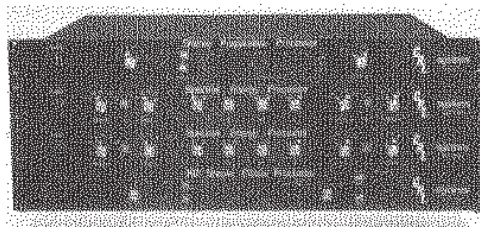
Before August 1981, the FCC required that broadcast engineers hold a First Class Radiotelephone license. To receive the license, applicants were expected to pass

an examination. An understanding of basic broadcast electronics and knowledge of the FCC rules and regulations pertaining to station technical operations were necessary to pass the lengthy examination. Today a station's chief engineer (also called chief operator) need possess only a Restricted Operator Permit. Those who held First Class licenses prior to their elimination now receive either a Restricted Operator Permit or a General Radiotelephone license at renewal time.

It is left to the discretion of the individual radio station to establish criteria regarding engineer credentials. Many do require a General Radiotelephone license or certification from associations, such as the Society of Broadcast Engineers (SBE) or the National Association of Radio and Telecommunications Engineers (NARTE), as a preliminary means of establishing a prospective engineer's qualifications. The appendix at the end of this chapter contains a reproduction of SBE's membership application form.

Communication skills rank highest on the list of personal qualities for station engineers, according to McNamara. "The old

**FIGURE 10.20**  
A station engineer must be knowledgeable about the sophisticated state-of-the-art audio processing equipment (such as the limiter and processor shown here) used by many stations, especially in metro markets where great sound gives a station an important competitive edge.  
Courtesy CRL Audio and Broadcast Electronics.



stereotype of the station 'tech-head' in white socks, chinos, and shirt-pocket pen holder weighed down by its inky contents is losing its validity. Today, more than ever, I think, the radio engineer must be able to communicate with members of the staff from the manager to the deejay. Good interpersonal skills are necessary. Things have become very sophisticated, and engineers play an integral role in the operation of a facility, perhaps more now than in the past. The field of broadcast engineering has become more competitive, too, with the elimination of many operating requirements."

Because of a number of regulation changes in the 1980s, most notably the elimination of upper-grade license requirements, the prospective engineer now comes under even closer scrutiny by station management. The day when a "1st phone" was enough to get an engineering job is gone. There is no direct "ticket" anymore. As in most other areas of radio, skill, experience, and training open the doors the widest.

Because the very landscape of radio has changed as the result of the Telecommunications Act of 1996, station clusters abound. This means a chief engineer or director of a cluster's technical operation has formidable responsibilities. Instead of keeping one station on the air, this person may have as many as eight signals to watch over. In cluster operations, there may be several experienced engineers on site or one senior engineer who directs the duties of several techs and producers.

also is available should a technical problem arise. Larger stations and cluster operations with more studios and operating equipment often employ an engineer on a full-time basis. It is a question of economics. The small station can little afford a day-to-day engineer, whereas the larger station or cluster usually finds that it can ill afford to do without one.

Beasley Broadcast Group's McNamara considers protecting the station's license his number one priority. "A station is only as good as its license to operate. If it loses it, the show is over. No other area of a station is under such scrutiny by the FCC as is the technical. The dereg movement in recent years has affected programming much more than engineering. My job is to first keep the station honest, that is, in compliance with the commission's rules. This means, keep the station operating within the assigned operating parameters, i.e., power, antenna phase, modulation, and so on, and to take corrective action if needed."

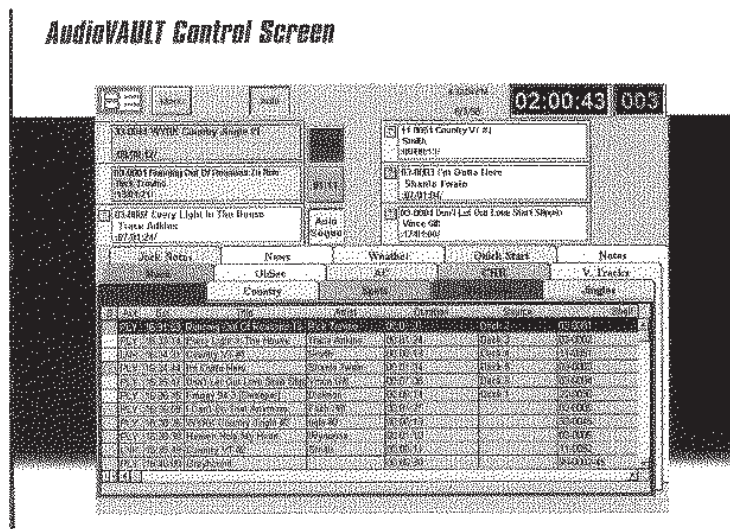
Chief engineer Steve Church says that maintenance and equipment repairs consume a large portion of an engineer's time. "General repairs keep you busy. One moment you may be adjusting a pot on a studio console and the next replacing a part on some remote equipment. A broadcast facility is an amalgam of equipment that requires care and attention. Problems must be detected early or they can snowball. The proper installation of new equipment eliminates the chance of certain

**FIGURE 10.21** Station engineers must possess a high level of proficiency with computer technology. Courtesy BE.

## The Engineer's Duties

The FCC requires that all stations designate someone as chief operator. This individual is responsible for a station's technical operations. Equipment repairs and adjustments, as well as weekly inspections and calibrations of the station transmitter, remote control equipment, and monitoring and metering systems, fall within the chief operator's area of responsibility.

Depending on the makeup and size of a station or cluster, either a full-time or part-time engineer will be contracted. Many small outlets find they can get by with a weekly visit by a qualified engineer who



problems later on. The station's chief must be adept at a whole lot."

Other duties of the chief engineer include training techs, monitoring radiation levels, planning maintenance schedules, and handling a budget. Many stations hire outside engineering firms to conduct performance proofs, but it is ultimately the responsibility of the chief operator to ensure that the outlet meets its technical performance level. Proofs ascertain whether a station's audio equipment performance measurements fall within the prescribed parameters. A station's frequency response, harmonic distortion, FM noise level, AM noise level, stereo separation, crosstalk, and subcarrier suppression are gauged. If found adequate, the proof is passed. If not, the chief sees to it that necessary adjustments are made. Although the FCC no longer requires Proof of Performance checks, many stations continue to observe the practice as a fail-safe measure.

The duties of a station engineer are wide ranging and demanding. It is a position that requires a thorough grasp of electronics relative to the broadcast environment, knowledge of FCC rules and regulations pertaining to station technical operations, and, especially in the case of the chief engineer, the ability to manage finances and people.

### Station Log

In 1983, the FCC dispensed with its requirement that radio stations keep maintenance and operating logs. In their place the commission created a new and considerably modified document called the Station Log, which stations must maintain. The new log requires that information pertaining to tower light malfunctions, Emergency Alert System (EAS) tests, and AM directional antenna systems be entered. Station Logs are kept on file for a period of 2 years.

Despite the fact that the FCC has eliminated the more involved logging procedures, some stations continue to employ the old system. "I like the accountability that maintenance and operating logs provide. We still use them here, and they are inspected daily. Despite the elimination

of certain requirements, namely, the tech logs, a station is still required to meet the operating stipulations of their license. Actually, enforcement action has been on the rise at the FCC, perhaps in reaction to the dereg. The commission is really interested in station technical operations. Keeping daily logs ensures compliance," says McNamara.

### § 73.1820 Station Log

(a) Entries must be made in the station log either manually by a properly licensed operator in actual charge of the transmitting apparatus, or by automatic devices meeting the requirements of paragraph (b) of this section. Indications of operating parameters that are required to be logged must be logged prior to any adjustment of the equipment. Where adjustments are made to restore parameters to their proper operating values, the corrected indications must be logged and accompanied, if any parameter deviation was beyond a prescribed tolerance, by a notation describing the nature of the corrective action. Indications of all parameters whose values are affected by the modulation of the carrier must be read without modulation. The actual time of observation must be included in each log entry. The following information must be entered:

(I) *All stations:* (i) Entries required by § 17.49 of this chapter concerning any observed or otherwise known extinguishment or improper functioning of a tower light:

(A) The nature of such extinguishment or improper functioning.

(B) The date and time the extinguishment or improper operation was observed or otherwise noted.

(C) The date, time and nature of adjustments, repairs or replacements made.

(ii) Any entries not specifically required in this section, but required by the instrument of authorization or elsewhere in this part.

(iii) An entry of each test of the EAS procedures pursuant to the requirement of Subpart G of this part and the appropriate EAS checklist. All stations may keep EAS test data in a special EAS log, which shall be maintained at any convenient location; however, such log should be considered a part of the station log.

(2) Directional AM stations without an FCC-approved antenna sampling system (see § 73.68): (i) An entry at the beginning of operations in each mode of operation, and thereafter at intervals not exceeding 3 hours, of the following (actual readings observed prior to making any adjustments to the equipment and an indication of any corrections to restore parameters to normal operating values):

(A) Common point current.

(B) When the operating power is determined by the indirect method, the efficiency factor  $F$  and either the product of the final amplifier input voltage and current or the calculated antenna input power. See § 73.51(e).

(C) Antenna monitor phase or phase deviation indications.

(D) Antenna monitor sample currents, current ratios, or ratio deviation indications.

(ii) Entries required by § 73.61 performed in accordance with the schedule specified therein.

(iii) Entries of the results of calibration of automatic logging devices (see paragraph (b) of this section), extension meters (see § 73.1550) or indicating instruments (see § 73.67) whenever performed.

(b) Automatic devices accurately calibrated and with appropriate time, date and circuit functions may be utilized to record entries in the station log provided:

(1) The recording devices do not affect the operation of circuits or accuracy of indicating instruments of the equipment being recorded;

(2) The recording devices have an accuracy equivalent to the accuracy of the indicating instruments;

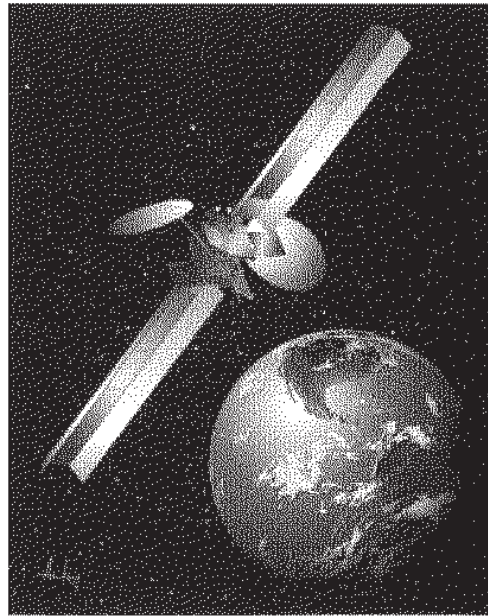
(3) The calibration is checked against the original indicators as often as necessary to ensure recording accuracy;

(4) Provision is made to actuate automatically an aural alarm circuit located near the operator on duty if any of the automatic log readings are not within the tolerances or other requirements specified in the rules or station license;

(5) The alarm circuit operates continuously or the devices that record each parameter in sequence must read each parameter at least once during each 30-minute period;

(6) The automatic logging equipment is located at the remote control point if the transmitter is remotely controlled or at the transmitter location if the transmitter is manually controlled;

(7) The automatic logging equipment is located in the near vicinity of the operator on duty and is inspected periodically during the broadcast day. In the event of failure or malfunctioning of the automatic equipment, the employee responsible for the log shall make the required entries in the log manually at that time;



**FIGURE 10.22**

A satellite beams down program channels to subscribers. Courtesy XM Satellite Radio.



**FIGURE 10.23**

Maintaining prescribed technical parameters is one of many engineering responsibilities.

(8) The indicating equipment conforms to the requirements of § 73.1215 (indicating instruments – specifications) except that the scales need not exceed 2 inches in length. Arbitrary scales may not be used.

(c) In preparing the station log, original data may be recorded in rough form and later transcribed into the log. (43 FR 45854, Oct. 4, 1978, as amended at 44 FR 5873, Oct. 11, 1979; 47 FR 24580, June 7, 1982; 48 FR 38481, Aug. 24, 1983; 48 FR 4480, Sept. 30, 1983; 49 FR 33603, Aug. 23, 1984)

### § 73.1835 Special Technical Records

The FCC may require a broadcast station licensee to keep operating and maintenance records as necessary to resolve conditions of actual or potential interference, rule violations, or deficient technical operation. (48 FR 38482, Aug. 24, 1983)

### § 73.1840 Retention of Logs

(a) Any log required to be kept by station licensees shall be retained by them for a period of 2 years. However, logs involving communications incident to a disaster or which include communications incident to or involved in an investigation by the FCC and about which the licensee has been notified, shall be retained by the licensee until specifically authorized in writing by the FCC to destroy them. Logs incident to or involved in any claim or complaint of which the licensee has notice shall be retained by the licensee until such claim or complaint has been fully satisfied or until the same has been barred by statute limiting the time for filing of suits upon such claims.

(b) Logs may be retained on microfilm, microfiche, or other data-storage systems subject to the following conditions:

1. Suitable viewing-reading devices shall be available to permit FCC inspection of logs pursuant to § 73.1226, availability to FCC of station logs and records.

2. Reproduction of logs, stored on data-storage systems, to full-size copies, is required of licensees if requested by the FCC or the public as authorized by FCC rules. Such reproductions must be completed within two full work days of the time of the request.

3. Corrections to logs shall be made:

- (i) Prior to converting to a data storage system pursuant to the requirements of § 73.1800(c) and (d) (§ 73.1800, General requirements relating to logs).

- (ii) After converting to a data-storage system by separately making such corrections and then associating with the related data-stored logs. Such corrections shall contain sufficient information to allow those reviewing the logs to identify where corrections have been made, and when and by whom the corrections were made.

4. Copies of any log required to be filed with any application; or placed in the station's local public inspection file as part of an application; or filed with reports to the FCC must be reproduced in full-size form when complying with these requirements. (45 FR 41151, June 18, 1980, as amended at 46 FR 13907, Feb. 24, 1981; 46 FR 18557, Mar. 25, 1981; 49 FR 33663, Aug. 24, 1984)

## The Emergency Alert System

In 1994, the FCC established the EAS, which replaced the old Emergency Broadcast System (EBS). The EBS came into existence following World War II as the nation and the world entered the nuclear age. The system was designed to provide the president and heads of state and local government with a way to communicate with the public in the event of a major emergency.

In the 1990s, EBS was viewed as outmoded due to the revolution in technology, and it was significantly revamped. EAS is intended to upgrade the effectiveness of broadcast warnings by employing digital equipment and sophisticated automation. Its speed and timeliness are greatly enhanced under the new protocol. Stations were expected to have the new EAS system fully installed by mid-1997. At present, stations take the following steps should the president and/or heads of state and local government agencies deem it necessary to alert the public of a potential or imminent disaster:

1. Receive Emergency Action Notification (EAN) via AP/UPI feeds, network feed,

- or EAS decoder display. Continue to monitor for further instructions.
2. Discontinue normal programming.
3. Transmit EAN announcement.
4. Transmit EAN header codes followed by the attention signal.
5. Monitor Local Primary Source (LP), State Relay Source (SR), any other broadcast station for further instructions.
6. Transmit emergency messages as soon as they are available.
7. Announce termination of EAN.

## Allen Myers



**FIGURE 10.24**  
Allen Myers.

In evaluating the service to the radio medium provided by the Federal Communications Commission, it is necessary to understand that the Commission was created by Congress in the Communications Act of 1934 and that the agency, therefore, carries out the wishes of that body. If the Commission wants to implement regulations for which it lacks the statutory authority, it must first obtain the approval of Congress.

The Commission's service to the radio medium is twofold. First, it sets the technical standards under which the medium operates. Second, it ensures an adequate and equitable distribution of radio services throughout the United States. The Commission was created by Congress to specifically carry out these objectives. Prior to the existence

## The FCC and Radio

of the Commission and its predecessor, the Federal Radio Commission, radio broadcasting in this country was in a state of chaos. There was no spectrum planning. Operators put the stations on the air wherever they wanted. If a new station caused interference to a station already on the air, the operator of the older station often would just increase power – sort of an electronic shouting match. There were also no standards for radio receivers to prevent them from causing radiofrequency interference. So when Congress created the FCC, it charged it with making the radio medium “serve the public interest need and necessity.”

The Commission's principal missions are accomplished with this objective in mind. Some of the agency's rules set minimum and maximum power requirements for radio stations; others set interference and distance standards – all with the objective of making sure that when a listener tunes to a radio station, he or she will be able to hear it clearly. The Commission's role in setting technical standards also extends to the equipment used in the transmission of radio signals. Manufacturers of transmitters and receivers are required to receive FCC “type acceptance” approval before putting their products on the market. This insures that a clean signal is transmitted and received and that the equipment does not cause interference to other stations or electronic services. Other Commission rules deal with spectrum planning and are intended to ensure an equitable distribution of radio stations throughout the country so that as many communities as possible


will have a local radio station and possibly access to several different stations to provide a multitude of voices.

The Commission recognizes the different types of services that radio stations provide to listeners. To this end, it will often establish rules to foster the growth of a group of stations providing a unique service. For example, in 1945 the Commission reserved the first 20 channels in the FM band (88.1–91.9 MHz) for radio stations licensed to nonprofit, educational institutions and organizations to be operated as noncommercial, educational radio stations. The Commission then established a set of rules for this type of station, including both technical standards and spectrum planning. Similarly, in 2000 the Commission accepted applications for the first Low Power FM (“LPFM”) stations to further enhance the public's access to local, noncommercial FM radio stations.

Finally, in looking at the Commission's service to the radio medium, one must realize that the Communications Act is a living document. It has been amended many times to allow for new technologies in the radio medium, and the Commission has implemented regulations to carry out these changes. There is no doubt that the Communications Act will continue to be amended to take into consideration future changes in radio service and the Commission will proscribe regulations implementing these changes.

*The views expressed by the author are not necessarily those of the Federal Communications Commission.*

**FIGURE 10.25**  
Operating log  
currently in use at  
WFBQ-FM. Courtesy  
WFBQ-FM.



# WFBQ-FM

## operating log

DAY \_\_\_\_\_  
DATE \_\_\_\_\_

Time	Plate Volts	Plate Amps	Power Out

1. All times are EST.
2. Unless otherwise noted, all operations are continued from previous day.
3. WFBQ leases its subcarrier to Comcast, Inc. for the operation of a background music service. Unless otherwise noted, subcarrier program material is background music provided by the Muzak Corp., subcarrier is on continuously when modulation present, and, with the exception of short breaks between music segments, modulation is continuous.
4. Responsibility for tower maintenance and light checks delegated to WRTV
5.  $P_o = E_p \times I_p \times \text{Eff}$   
 $\text{Eff} = 74.12\%$  as ind. in mfrs instr.

Comments:

**POWER TOLERANCE:** Low Limit = 18,000 w / High Limit = 21,000 w

**EBS TEST SENT**

\_\_\_\_\_

time          initial

**EBS TEST RECEIVED**

VIA \_\_\_\_\_

\_\_\_\_\_

time          initial

**EBS RECEIVER CHECK**

\_\_\_\_\_

time          initial

Operator on	Time	Operator off	Time

Ch.Op. Review: \_\_\_\_\_  
 Date \_\_\_\_\_

Stations not designated to remain in operation in the event of an EAN then remove their carriers from the air after advising listeners where to tune for further information. Those participating stations continue to broadcast information as it is received from the nation's base of operations. Every radio station is required to install and operate an

EAS monitor. Failure to do so can result in a substantial penalty imposed by the FCC. Stations are also required to test the EAS by airing both an announcement and an attention signal. EAS tests are documented in the Station Log when they are broadcast. The entry must include the time and the date of the test.



The Federal Emergency Management Agency (FEMA) makes funds available to stations designated to remain on the air during an authentic emergency through the Broadcast Station Protection Plan. Under this provision the government provides financial assistance to EAS stations for the purpose of constructing and equipping a shelter designed to operate for at least 14 days under emergency conditions.

In the 1990s, the FCC began an inquiry into whether the system needed updating or replacement. Critics of the old EBS claimed that the system had become obsolete. In late 1992, proposed EBS revisions included the following:

- Replacement of the existing emergency alerting system.
- Updating of EBS equipment.
- Cable media involvement in emergency alerting.
- Self-testing of the system.
- Mandated equipment standards.
- Rules to prohibit false and deceptive use of the system.
- Revised EBS test script.

Today EAS embraces many of these revisions, as well as additional innovations and procedures. It is always a system under evaluation as world events, such as 9/11 and Hurricane Katrina, increase the need for an effective emergency alert system.

## Automation

The FCC's decision in the mid-1960s requiring that AM/FM operations in markets with populations of more than 100,000 originate separate programming 50% of the time provided significant impetus to radio automation. Before then combo stations, as they were called, simulcast their AM programming on FM primarily as a way of curtailing expenses. FM was still the poor second cousin of AM. (In the late 1980s, the FCC dropped most of its simulcast requirements. Since then many stations have resorted to simulcasting as a means of dealing with the realities of fierce competition and a declining AM market.)

The screenshot shows a web browser window displaying the FCC's FM station classification table. The table is titled "FM Station Class" and lists various classes (A, B1, B, C3, C2, C1, C0, C) with their respective ERP/HAAT, reference facilities, FM protected contours, and distances to protected areas and city/coverage contours.

FM Station Class	Reference (Maximum) Facilities for Station Class (see 47 CFR Section 73.211)	FM Protected or Primary Service Contour		Distance to Protected or Primary Service Contour (km)	Distance to 70 dBu (or 3.16 mV/m) City Grade or Principal Community Coverage Contour (see 47 CFR Section 73.315) (km)
		ERP (in kW) / HAAT (in meters)	dBu / mV/m		
Class A	6.0 kW / 100 meters	60 dBu	1.0 mV/m	28.3 km	16.2 km
Class B1	25.0 kW / 100 meters	57 dBu	0.71 mV/m	44.7 km	23.2 km
Class B	50.0 kW / 150 meters	54 dBu	0.50 mV/m	65.1 km	32.6 km
Class C3	25.0 kW / 100 meters	60 dBu	1.0 mV/m	39.1 km	22.2 km
Class C2	50.0 kW / 150 meters	60 dBu	1.0 mV/m	52.2 km	32.6 km
Class C1	100.0 kW / 299 meters	60 dBu	1.0 mV/m	72.3 km	50.0 km
Class C0 (C-zero)	100.0 kW / 450 meters	60 dBu	1.0 mV/m	83.4 km	59.2 km
Class C	100.0 kW / 600 meters	60 dBu	1.0 mV/m	91.8 km	67.7 km

Notes: Class B and B1 stations are authorized only in Zones 1 and 1-A, which include the following states and areas: CA (south of 40° latitude), CT, DC, DE, IL, IN, MA, MD, coastal ME, RI (south of 43.5° latitude), NJ, NH (south of 43.5° latitude), NY (south of 43.5° latitude), OH, PA, PR, RI, northwestern VA, VT (south of 43.5° latitude), southeastern WI, WV. Class C, C2, C1, C2, and C3 stations are not authorized in zones 1 or 1-A, but may be authorized elsewhere. See Section 73.205 for the exact zone boundaries. You may also use [FISUSER](#) to determine whether a particular class is valid in a given state.

FIGURE 10.26  
FM station  
classification table.  
Courtesy FCC.

Responding to the rule changes, many stations resorted to automation systems as a way to keep expenses down. Interestingly enough, however, automation for programming, with its emphasis on music and deemphasis on chatter, actually helped FM secure a larger following, resulting in increased revenue and stature.

Today, over a third of all commercial stations are automated. Some are fully automated (computer driven); others rely on automation for part of their broadcast day. Automation is far more prevalent on FM, but in the late 1970s and 1980s many AM outlets were employing automation systems to present Nostalgia and Easy Listening programming. The advent of AM stereo also generated some use of automation on the Standard Broadcast band, but since AM stereo all but fizzled, this specific application of automation remained minuscule.

**FIGURE 10.27**  
Satellite networks may interface with station automation systems. Courtesy SMN.

**SET UP SUGGESTIONS FOR BROADCAST OF SMN FORMATS**  
Examples of how some SMN affiliates have set up simple broadcast systems that are effective in delivering a high quality sound.

**1 AUTOMATION SYSTEMS**  
In the 80's and 90's many stations purchased automation systems that gave the station operator hours of walk-away time. The good news is that with Satellite Music Network (SMN) you can put that system back to work for you. Times that SMN format is another source. If you have a network source, you can use up to 80% of the way you would any tape machine or cartridge machine. You can use the direct outputs for the spot, direct as an end of message (EOM) cue for that particular source. Your control console for the lines, buttons and 12's should be hooked up to separate cartridge machines to fire them individually. We can discuss individual carts.  
All dedicated carts should be connected with their auto outputs parallel to the auto output but over the 48 all times. A good place to insert the dedicated cart audio is the auto processor input by using a switching card or some other auto switching device. The dedicated cart audio can also be combined at the output of the automation system.

**2 REEL AND AUDIO SWITCHER**  
Another set up utilizes a reel to reel machine and a switcher. Basically an audio switcher needs to do is turn off or route the network audio when you take a local cart break. You can build a latching relay using the contact closure from the auto break to latch the walk off line on signal line. When the break is done they use the contact closure for the line cart machine, but release the latch and return the network audio to the on-air bus (normalization). The reel to reel machine can be loaded with commercial spots that are timed for each break. Serial spots can have as much as 1 1/2 hour's worth, any time with the system depending on their spot length. It is necessary to provide a function to start your reel after each spot break so you do not get out of sequence. The lines 1 1's and swappers need to be an dedicated carts with the cart audio parallel with the reel audio bus. This is called the old sound on sound concept.

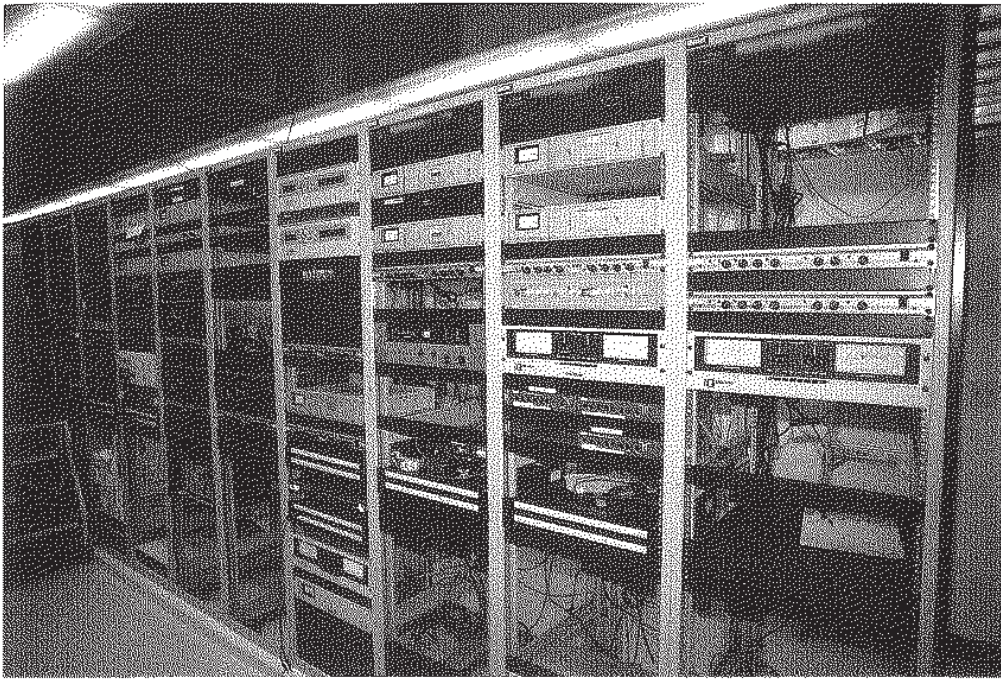
**3 CART MACHINES AND AUDIO SWITCHER**  
Basically the same as example #2 except the reel to reel is replaced with several cart machines that can handle the spot breaks. The only difference in this system is that the carts need to be changed out after each spot break. All other functions remain the same.

Although a substantial initial investment usually is necessary, the basic purpose of automation is to save a station money, and this it does by cutting staffing costs. Automation may also reduce the number of personnel problems. However, despite early predictions that automation eventually would replace the bulk of the radio workforce, very few jobs have actually been lost. In fact, new positions have been created.

Automated stations employ operators as well as announcers and production people (unless satellite-fed by syndicators). The extent to which a station uses automation often bears directly on staffing needs. Obviously, a fully automated station will employ

**FIGURE 10.28**  
Rack rooms in cluster operation. Courtesy Clear Channel.





**FIGURE 10.28**  
*Continued*

fewer programming people than a partially automated outlet.

An automation system consists of a computer that also produces logs, music sheets, invoices, affidavits, and so on. Automated operations typically consist of a fully loaded computer system containing all of a station's music and announcement inventory. Indeed, the day of in-house loading of format elements is all but gone. Satellite syndicators using computers control local station ingredients (news, weather, promos, spots) remotely from the uplinks.

Today, thanks to the prevalence of computers, larger stations may employ a manager of information systems (MIS), who serves the computer tech needs of an outlet or entire cluster operation. This is another example of the so-called station in a box trend.

## Posting Licenses and Permits

The FCC requires that a station's license and the permits of its operators be posted. What follows are the rules pertaining to this requirement as outlined in Subpart H, § 73.1230, of the FCC's regulations.

### § 73.1230 Posting of Station and Operator Licenses

(a) The station license and any other instrument of station authorization shall be posted in a conspicuous place and in such a manner that all terms are visible at the place the licensee considers to be the principal control point of the transmitter. At all other control or ATS monitoring and alarm points a photocopy of the station license and other authorizations shall be posted.

(b) The operator license of each station operator employed full-time or part-time or via contract shall be permanently posted and shall remain posted so long as the operator is employed by the licensee. Operators employed at two or more stations, which are not colocated, shall post their operator license or permit at one of the stations, and a photocopy of the license or permit at each other station. The operator license shall be posted where the operator is on duty, either:

- (1) At the transmitter; or
- (2) At the extension meter location; or
- (3) At the remote control point, if the station is operated by remote control; or
- (4) At the monitoring and alarm point, if the station is using an automatic transmission system.

(c) Posting of the operator licenses and the station license and any other instruments of authorization shall be done by affixing the licenses to the wall at the posting location, or by enclosing them in a binder or folder

which is retained at the posting location so that the documents will be readily available and easily accessible. (43 FR 45847, Oct. 4, 1978, as amended at 49 FR 29069, July 18, 1984)

## CHAPTER HIGHLIGHTS

1. Guglielmo Marconi first used electromagnetic (radio) waves to send a message at the end of the nineteenth century. Marconi used earlier findings by James C. Maxwell and Heinrich Hertz.

2. J. Ambrose Fleming developed the diode tube (1904), and Reginald Fessenden transmitted voice over the wireless (1906).

3. Edwin Armstrong developed the regenerative and superheterodyne circuits, and first demonstrated the static-free FM broadcast signal (1933).

4. Broadcast transmissions are carried on electromagnetic waves. The transmitter creates and shapes the wave to correspond to the "frequency" assigned by the FCC.

5. Receivers pick up the transmissions, converting the incoming radio frequency (RF) into sound waves.

6. AM stations are assigned frequencies between 535 and 1705 kHz, with 10 kc separations between frequencies. AM is disrupted by low-frequency emissions, can be blocked by irregular topography, and can travel hundreds (along surface level ground waves) or thousands (along nighttime sky waves) of miles.

7. Because AM station signals travel greater distances at night, to avoid skywave interference, over 2000 stations around the country must cease operation near sunset. Thousands more must make substantial nighttime transmission adjustments (decrease power), and others (directional stations) must use two or more antennas to shape the pattern of their radiation.

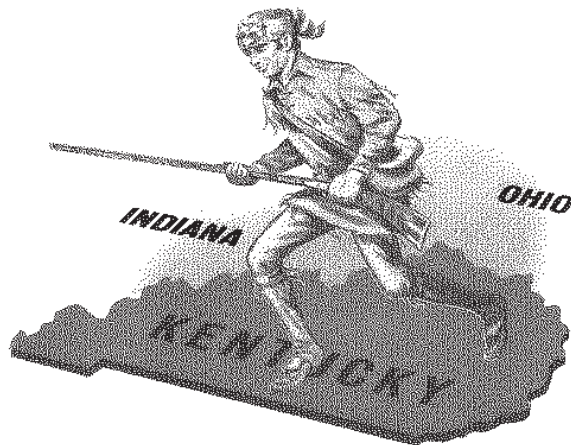
8. FM stations are assigned frequencies between 88.1 and 107.9 MHz, with 200 kc separations between frequencies. FM is static free, with direct waves (line-of-sight) carrying up to 80–100 miles. Both AM and FM stations are licensed for 8 years as of this writing.

9. To guarantee efficient use of the broadcast spectrum and to minimize station-to-station interferences, the FCC established four classifications for AM stations and eight classifications for FM. Lower classification stations are obligated to avoid interference with higher classification stations. Recent FCC actions have created more subclassifications.

10. Satellite radio employs both geosynchronous (former XM) and elliptical (Sirius) orbits from over 22,000 miles in space. When necessary, ground repeaters are used to strengthen signals.

11. Analog is being replaced by digital audio (DAB/HD) because digital audio provides superior frequency response and greater dynamic range. New spectrum space may be allocated to accommodate the digital service.

12. A station's chief engineer (chief operator) needs experience with basic broadcast electronics, as well as a knowledge of the FCC regulations affecting the station's technical operation. The chief must repair and adjust equipment, and perform weekly inspections and calibrations. Other duties may include installing new equipment, training techs, planning maintenance schedules, and handling a budget.



**FIGURE 10.29**  
Stations that generated 50 kw promoted their greater coverage areas. Courtesy WHAS.

## 1,000 COUNTIES — 40 STATES

It was July 18, 1922. On this day, John Glenn celebrated his first birthday in neighboring Ohio and WHAS pioneered Kentucky broadcasting as a 500-watter in Louisville.

The years flew by and WHAS helped transform a sprawling, backwoods Kentuckiana area into a rich, diversified market. WHAS has continued to pioneer with specialized departments for News, Sports, Farm, Home and Public Affairs programming.

Today, WHAS programs are airborne by a 50,000 watt, clear channel thrust and have boosters who respond from nearly 1,000 American counties in more than 40 states.

Pioneering is a good life. And in Kentuckiana, the good life for listeners and advertisers begins at eighty . . . WHAS 840 Radio.

# WHAS

**840 RADIO** LOUISVILLE, KY. 50,000 WATTS, 1-A CLEAR CHANNEL

**Measure of a Great Radio Station**

*Represented Nationally by Henry I. Christal Co., Inc.*



**13.** A Proof of Performance involves checking the station's frequency response, harmonic distortion, FM noise level, AM noise level, stereo separation, crosstalk, and sub-carrier suppression.

**14.** Although the FCC dispensed with the maintenance and operating log requirements (1983), a Station Log must be maintained. The log lists information about tower light malfunctions, EAS tests, and AM directional antenna systems.

**15.** The EAS (formerly the EBS), implemented after World War II, provides the government with a means of communicating

with the public in an emergency. Stations must follow rigid instructions both during periodic tests of the system and during an actual emergency.

**16.** Over one-quarter of today's commercial stations are fully or partially automated. More prevalent in FM stations, automation reduces staffing costs but requires a significant equipment investment. Automated programming elements are aired when a trip mechanism is activated by a cue tone, which is impressed on all program material. Either an operator or a computer can maintain the programming chain.

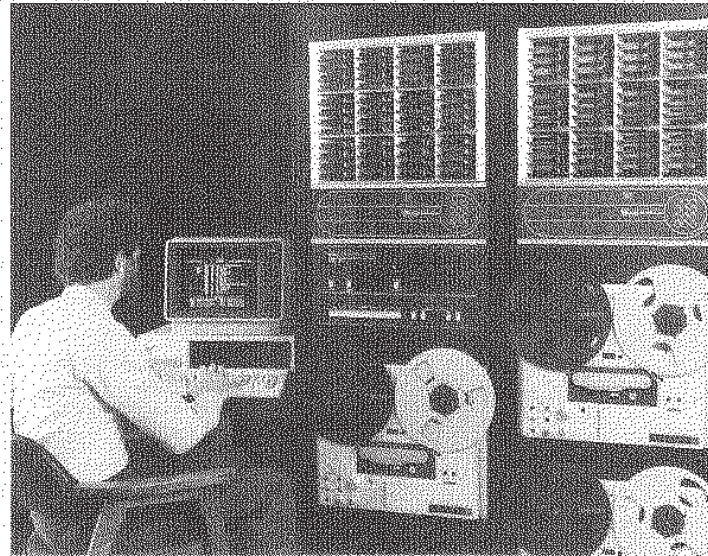
At many stations, satellite programming services use computers (at both uplink and downlink sites) to control station automation systems.

17. A MIS maintains a station's computer systems.

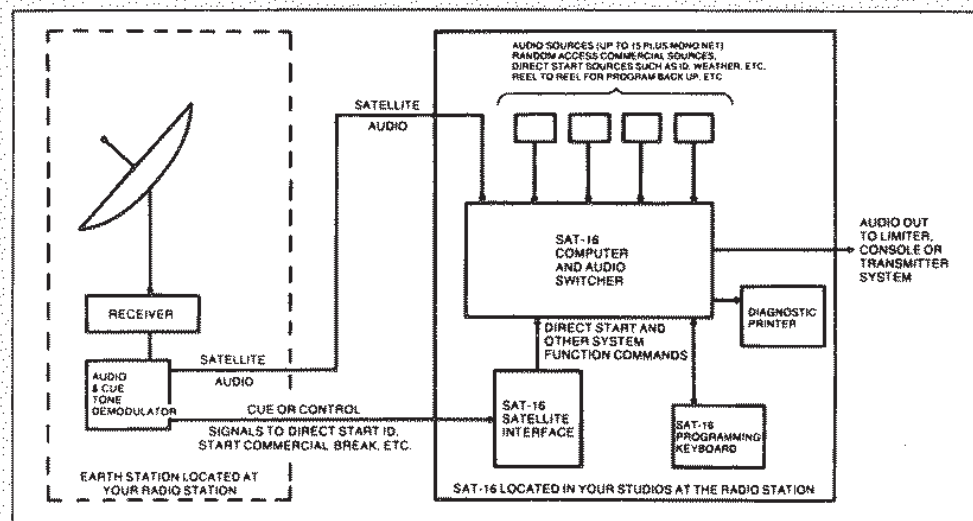
18. Direct satellite-fed stations need little equipment because programming originates at the syndicator's studios.

19. The FCC requires that a station's license and the permits of its operators be accessible in the station area.

**FIGURE 10.30**  
A 1970s PC-based program controller running an automation system. Courtesy IGM Communications.



**FIGURE 10.31**  
Satellite-linked automation systems are available in certain formats. Diagram shows how the system works. Courtesy Broadcast Electronics.



**SUGGESTED FURTHER READING**

- Abel, J.D., and Ducey, R.V., *Gazing into the Crystal Ball: A Radio Station Manager's Technological Guide to the Future*, NAB, Washington, DC, 1987.
- Antebi, E., *The Electronic Epoch*, Van Nostrand Reinhold, New York, 1982.
- Butler, A., *Practical Tips for Choosing and Using Consulting and Contract Engineers*, NAB Publications, Washington, DC, 1994.
- Cheney, M., *Tesla: Man out of Time*, Prentice Hall, Englewood Cliffs, NJ, 1983.
- Considine, D.M., editor, *Van Nostrand's Scientific Encyclopedia*, Van Nostrand Reinhold, New York, 1983.
- Davidson, F.P., *Macro: A Clear Vision of How Science and Technology Will Shape Our Future*, William Morrow, New York, 1983.
- Ebersole, S., *Broadcast Technology Worktext*, Focal Press, Boston, MA, 1992.
- Grant, A.E., *Communication Technology Update*, Focal Press, Boston, MA, 1995.
- Hilliard, R.L., *FCC Primer*, Focal Press, Boston, MA, 1991.
- Hoeg, W., and Lauterbach, T., editors, *Digital Broadcast Audio: Principles and Application of Digital Radio*, 2nd edition, Wiley, Hoboken, NJ, 2003.
- Hong, S., *From Marconi's Black-Box to the Audion*, The MIT Press, Cambridge, MA, 2001.
- Mirabito, M., and Morgenstern, B., *The New Communication Technologies*, 2nd edition, Focal Press, Boston, MA, 1994.
- Morton, D.L., Jr., *Sound Recording: The Life Story of a Technology*, Johns Hopkins University Press, Baltimore, MD, 2006.
- National Association of Broadcasters. *Broadcast Engineering*, NAB Publications, Washington, DC, 2008.
- Noll, E.M., *Broadcast Radio and Television Handbook*, 6th edition, Howard Sams, Indianapolis, IN, 1983.
- Priestman, C., *Web Radio: Radio Production for Internet Streaming*, Focal Press, Boston, MA, 2005.
- Reed, J.H., *Software Radio: A Modern Approach to Radio Engineering*, Prentice-Hall, Englewood Cliffs, NJ, 2002.
- Regal, B., *Radio: The Life Story of a Technology*, Greenwood, Westport, CT, 2005.
- Reitz, J.R., *Foundations of Electromagnetic Theory*, Addison-Wesley, Reading, MA, 1960.
- Roberts, R.S., *Dictionary of Audio, Radio, and Video*, Butterworths, Boston, MA, 1981.
- Sarkar, T.K., et al., editors. *History of the Wireless*, Wiley-Interscience, New York, 2006.
- Starr, W., *Electrical Wiring and Design: A Practical Approach*, John Wiley & Sons, New York, 1983.
- Watkinson, J., *The Art of Digital Audio*, Focal Press, Boston, MA, 1992.
- Wilson, D., *A Broadcast Engineering Tutorial for Non-Engineers*, NAB, Washington, DC, 1999.
- Wurtzler, S.J., *Electronic Sounds: Technological Changer and the Rise of Corporate Mass Media*, Columbia University Press, New York, 2007.

## APPENDIX: Federal Communications Commission

### Fact Sheet: Hints on Filing Comments with the FCC

The FCC is interested in any experiences, knowledge, or insights that outside parties may have to shed light on issues and questions raised in the rule-making process. The public and industry have the opportunity to comment upon Petitions for Rule Makings, NOIs, NPRMs, Further NPRMs, Reports and Orders, and others' comments on the aforementioned documents. It is a common misconception that only a lawyer can file comments with the FCC, but all that is necessary is an interest in an issue and the ability to read and follow directions.

Prior to drafting comments it is crucial to read and understand fully the item on which you wish to comment. Usually, the NPRM, NOI, or other item will specify and invite comment upon the issue(s) that the Commission is interested in studying further. Examination of the issue(s) and relevant documents is the most important part of the comment process. Comments may take any form, but the following hints may assist you in writing them.

**Format.** There is no required format for informal comments, although if you plan to file formally, it is required that they be typed, double-spaced, and on 8.5" x 11" paper. Additional requirements for formal filings are set forth in Sections 1.49 and 1.419 of the FCC Rules. The Docket Number or Rule Making Number of the item at hand should be included on your comments and can be found on the front page of the Commission document or public notice. You should also include your name and complete mailing address.

**Content.** Your comments should state who you are and what your specific interest is. (You do not need to represent yourself in an official capacity. You may, for example, express your opinion as a concerned consumer, concerned parent, etc., and sign your name.) State your position and the facts directly, as thoroughly but as briefly as possible. Explain your position as it relates to your experience and be explicit. Make clear if the details of a proposed rule or only one of several provisions of the rule are objectionable. If the rule would be acceptable with certain safeguards, explain them and why they are necessary.

**Support.** Statements of agreement or dissent in comments should be supported to the best extent possible by factual (studies, statistics, etc.),

logical, and/or legal information. Support should illustrate why your position is in the public interest. The more support made, the more persuasive the comments will be.

**Length.** Comments may be any length, although it is preferred that they be succinct and direct. If formal comments are longer than 10 pages, a summary sheet is required.

**Time frame.** Your comments should be submitted well within the time frame designated on the original document or public notice. It is almost always included on the first page of an NPRM or NOI. However, if the deadline has passed, you can still submit your views informally in a permissible ex parte presentation.

**Filing.** Send your written comments to Secretary, Federal Communications Commission, 445 Twelfth Street, S.W., Washington, D.C. 20554. If you wish your comments to be received as an informal filing, submit the original and one copy. If you want your comments to be received as a formal filing, you should submit an original and four copies. For more specific filing information, please refer to the FCC Public Notice "Guidelines for Uniform Filings" available from the same address.

**Reply comments.** As the name implies, reply comments are used to respond to comments filed by other parties. You may file reply comments even if you did not submit comments initially. When drafting reply comments use the same guidelines expressed earlier regarding content and be careful not to raise additional or irrelevant issues.

**Tracking your comments.** After you have properly filed your comments with the FCC, they will be part of the official Commission record. To track the progress of proceedings in which you have filed comments, you may check the *Daily Digest* or *Federal Register* for releases and notices. The *Daily Digest* can be obtained from the Office of Public Affairs, 445 Twelfth Street, S.W., Washington, D.C. 20554 or from a daily recorded listing of texts and releases at 202-418-2222.

**For further information.** For further information, you may contact the Secretary's office at the FCC directly, at 202-418-0300. Explicit information about filings in rulemaking proceedings can be found in Sections 1.49 and 1.419 of the



FCC Rules. Copies of any FCC documents can be obtained through the FCC's duplicating contractor, Best Copy and Printing, Inc. www.bcpjweb.com 1-800-378-3160 or from one

of the private distributors of FCC releases. A list of distributors is available from the Public Service Division, 445 Twelfth Street, S.W., Washington, D.C. 20554, 202-418-0190.

FIGURE 10.32  
SBE application.

## An invitation to join SBE



### Who are we?

The Society of Broadcast Engineers, formed in 1963 as the Institute of Broadcast Engineers, is a non-profit organization serving the interests of broadcast engineers. We are the only society devoted to all levels of broadcast engineering.

Our membership, which is international in scope, is made up of studio and transmitter operators and technicians, supervisors, announcer-technicians, chief engineers of large and small stations and of commercial and educational stations, engineering vice presidents, consultants, field service and sales engineers, broadcast engineers from recording studios, schools, CCTV and CATV systems, production houses, advertising agencies, corporations, audio-visual departments, and all other facilities that utilize broadcast engineers.

### What can we do for you?

- Help you keep pace with our rapidly changing industry through educational seminars, and a look at new technology through industry tours and exhibits at monthly chapter meetings, regional conventions, and our national meeting held in conjunction with the National Association of Broadcasters (NAB).
- Give you national representation. To serve as a voice for you in the industry; a liaison for you with governmental agencies as well as other industry groups.
- To provide a forum for the exchange of ideas and sharing of information with other broadcast engineers and industry people.
- To promote the profession of broadcast engineering.
- To establish standards of professional education and training for broadcast engineering, and to recognize achievement of these standards.
- In addition to the intangible benefits of membership in the SBE, the tangible benefits of an insurance program, com-

munications through **The SBE Signal**, certification and re-certification opportunities, and a readily available network of specialized professionals.

All this adds up to an increase in your worth as a broadcast engineer to your employer.

### Where does your money go?

- A small office staff handling membership, certification, and the day-to-day business of the Society. Many duties of the SBE are handled by officers and board members who volunteer their time with no remuneration.
- A library of videotape training material for loan from the national headquarters.
- The production of our bi-monthly newsletter, **The SBE Signal**.
- Allows SBE representation—through a professionally designed informational booth at state and regional meetings as well as NAB and NRBA.
- A portion of your annual dues returns to subsidize the local chapter.
- Supplements expenses for special events such as NAB Chapter Chairman and Certification Chairman Meetings, and invitational opportunities to represent the SBE.

### How to be one of us

Membership categories include Student, Associate Member, Member, Senior Member, Honorary Member, and Fellow.

Qualification for Member grade requires that the individual be actively engaged in broadcast engineering or have an academic degree in electrical engineering or its equivalent in scientific or professional experience in broadcast engineering or a closely related field or art.

The cost of membership is \$20 annually for member and associate member grades, and \$10 for student memberships.

### Group Insurance Program

When you join the SBE, you have the opportunity to participate in the Group Insurance Program for SBE members and their dependents, which offers a wide range of coverage to suit your individual needs. The low rates are made possible through the economics of group administration and by the fact that SBE does not profit from the insurance program. Please note that requests for coverage under some of the plans are subject to insurance company approval.

- Term Life Insurance Plan offers options of up to \$195,000 for eligible members, with lesser amounts for dependents.
- High-Limit Accident Insurance provides protection wherever you go, 24 hours a day, and eliminates the need for special accident insurance every time you travel.
- Disability Income Plan protects your income by providing monthly benefit payments when you are unable to work due to a disabling illness or accident.
- Excess Major Medical Plan supplements your regular hospital/medical coverage in the event of a catastrophic illness or accident, paying up to \$1,000,000 after you satisfy your deductible.
- In-Hospital Plan pays up to \$100 per day for every day you spend in the hospital—up to 365 days—directly to you, to spend as you wish.
- Major Medical Expense Insurance is designed for members who have little or no basic medical coverage.

For further information concerning membership, certification, application, regional meetings and conventions, contact the Society of Broadcast Engineers, Inc., P.O. Box 50844, Indianapolis, IN 46250, (317) 842-0836.

### What do we want from you?

First, we'd like to have your name on the SBE roster.

Strength in numbers gives us additional clout. And we want and need your participation and input at the regional and national levels as well as at the local level.

### Certification Program

The program issued its first certificates on January 1, 1977, and now conducts tests at various times and places for those people, either members or non-members, who wish to have a certificate attesting to their competence as broadcast engineers. The certificates are issued for two different levels of achievement in either radio or TV and are valid for five years from date of issue. Recertification may be accomplished by earning professional credits for activities which maintain competence in the state-of-the-art or by re-examination.

Emphasis in the tests is on practical working knowledge rather than general theory. The tests are as valid for people in related industries as they are for broadcasters.

An entry-level certificate was added to the certification program in January 1982 to attract new technical talent to the broadcast industry and provide incentive for them to grow with technology.

The certification program is conducted by the SBE to benefit everyone in the industry. The program recognizes professional competence as judged by one's peers, and encourages participation in seminars, conventions, and meetings to help keep abreast of the constantly changing technology in broadcast engineering.

### If you ever wanted to meet the people who design the equipment you use,

- to talk with your fellow engineers and technicians,
- to tour the many facilities that employ engineers and technicians,
- to keep abreast of the state-of-the-art equipment,
- to upgrade your skills for certification,
- here is the opportunity to become a member of the most prestigious society in its field.



SOCIETY OF BROADCAST ENGINEERS, INC.  
P.O. Box 50844, Indianapolis, Indiana 46250

FIGURE 10.32  
Continued

### MEMBERSHIP APPLICATION

**NEW MEMBER**  
 **RENEWAL**  
 **REINSTATEMENT**

**SOCIETY OF BROADCAST ENGINEERS**  
P.O. Box 36144 • Indianapolis, Indiana 47236 • 317/542-2424

(Please type or print)

Name: \_\_\_\_\_  
 Full home Address: (don't abbreviate) \_\_\_\_\_ Receive SBE Mail here?   
 \_\_\_\_\_  
 Home Phone ( ) \_\_\_\_\_  
 Full Company Name and Address: \_\_\_\_\_ or here?  
 \_\_\_\_\_  
 Business Phone ( ) \_\_\_\_\_

If successful, please consider me a member of \_\_\_\_\_ Chapter  
 SBE Certification # \_\_\_\_\_ (if applicable) Date of Birth \_\_\_\_\_  
 Current Job Title: \_\_\_\_\_ Date Employed: \_\_\_\_\_  
 Type of Facility: \_\_\_\_\_  
 Description of Duties: \_\_\_\_\_  
 Total years of responsible Engineering Experience: \_\_\_\_\_  
 Field of Activity:  Radio  Television  Other \_\_\_\_\_

PROFESSIONAL LICENSES OR CERTIFICATES

\_\_\_\_\_

ADDITIONAL INFORMATION REQUESTED ON REVERSE SIDE

ADMISSIONS COMMITTEE ACTION

Date: \_\_\_\_\_

Action deferred for more information \_\_\_\_\_

Admissions Committee Chairman's Signature: \_\_\_\_\_ Approved for Grade \_\_\_\_\_

Candidate Notified \_\_\_\_\_ Entered in Records \_\_\_\_\_

### EXPERIENCE RECORD

List in chronological order, beginning with the most recent, all formal experience in Broadcast Engineering or related employment. Indicate field or fields of specialization under "Position." Please do not limit yourself to the four spaces below. ATTACH A BRIEF DESCRIPTION OF DUTIES.

From Mo. Yr.	To Mo. Yr.	Company Name and Location	Position or Title	Type of Facility

### EDUCATION

College, University, or Technical Institute	From Mo. Yr.	To Mo. Yr.	Credits or Yrs. Compl.	Degree or Major	Degree

List Short Courses, Seminars Related to Broadcast Communications Technology

\_\_\_\_\_

### SPECIAL ACHIEVEMENTS

List awards, patents, books, articles, etc.

\_\_\_\_\_

### REFERENCES

List two references - familiar with your work

Name	Company	Address	Phone

Have you ever been convicted of a violation of the Communications Act of 1934, as amended. Yes  No . If so, describe in full: (Use additional space if necessary) \_\_\_\_\_

Signed \_\_\_\_\_ I agree to abide by the By-Laws of the Society if admitted. Date \_\_\_\_\_ 19\_\_

## Consultants and Syndicators

### Radio Aid

Two things directly contributed to the rise of radio consultants: more stations – from 2000 in the 1950s to 12,000 in 2000 – and more formats – from a half dozen to several dozen during the same period. Broadcast consultants have been around almost from the start, but it was not until the medium set a new course following the advent of television that the field grew to real prominence. By the 1960s, consultants were directing the programming efforts of hundreds of stations. In the 1970s, over a third of the nation's stations enlisted the services of consultants. Today, the field of radio consultancy has shrunk substantially due to the corporatization of the radio industry. The ranks have dwindled to half of its former number. Says former top radio consultant Kent Burkhardt, "Since consolidation many of the small consulting companies have shut their doors. Most of the large consulting companies with lots of assets (meaning an exclusive format, research partners, marketing connections, etc.) have done well financially...but not as well as before. Prior to consolidation our company (Burkhardt/Abrams) was charging a certain fee for each station in a group. However, since consolidation many groups have hired one chief programming executive for a lot less money than the aforementioned fee per station. I thought consolidation would change the face, operations, and efficiency our consulting company and others. It didn't sound like fun to me, so prior to the consolidation rollout I sold our consulting company in 1995."

Consultant Donna Halper shares a similar view of the impact of consolidation on her profession, "It's certainly affected radio consulting. With fewer independent stations that means radio conglomerates are relying more on voice-tracking and syndication. It used to be that consultants trained and developed talent in small and medium markets, but these days a company might simulcast the same programs on two or more of their stations or use voice-tracking from another city to give the impression that a live and local personality is on the air. They may also have an in-house person who oversees the stations. Yet, this saves the companies money on hiring talent (and also saves them from hiring a consultant), but it also presents a problem. Many of these companies are not planning for the future. Rush Limbaugh and Howard Stern will not live forever, and without developing new talent, who will take their place? As we witnessed during the 9/11 and Hurricane Katrina crises, people DO want live and local radio, yet in many markets, there are no local personalities at all. Sooner or later somebody will have to start developing talent again and creating radio stations that are unique. We are already raising a generation of young adults who don't rely on radio the way their parents did. To get these people back (and I do believe it can be done) radio needs to return to its roots and get involved with the community again. As a consultant and someone who loves radio, I hope we will see more local personalities and more local programming. Radio needs to get back to being a friend again."

Echoing Halper's sentiments, consultant Doug Erickson says, "The biggest challenge for radio consultants today is the corporate resistance to new ideas. As radio has become a consolidated industry, it has become more conservative in many ways. General managers (GM) and program directors (PDs) feel more pressure to make the 'right' choice and this often leads to making the 'safest' choice – which is not always in the best interest of the station. As a consultant I try to make station management aware of the risks of doing nothing innovative. If terrestrial radio is to continue to be a part of the daily lives of most people, it must find a new way to remain personal and relevant, and it must do as much to touch the hearts of listeners as it does their ears." Meanwhile, consultant Gary Berkowicz says that consolidation has not impacted his business greatly but admits it has taken its toll on the field, "I still fly over 100,000 miles a year, so I'd say things are pretty good. In all seriousness, there is no doubt that it has changed. There are fewer consultants today, and somewhat fewer opportunities and stations to work for." Also, from the perspective of Juan Carlos Hidalgo, who

consults Spanish radio, the market for his services is strong. "It's been a fascinating experience working for stations in major markets, such as Los Angeles, Chicago, and San Francisco, where you have all the tools, like research and marketing budgets to compliment programming efforts. At the same time in the smaller markets that I consult, I have to rely more on creativity due to the limited budgets and tools. The dynamic of these two different situations keeps me on the cutting edge of doing new and exciting things to improve the performance of my client radio stations. Consolidation hasn't impacted my business. Maybe in the future."

Whether the radio consultancy function will be completely absorbed by corporations remains to be seen. However, consultants continue to play an important role in the shaping and management of the medium today. Observes prominent radio consultant George Burns, "The principal role of radio consultants has evolved considerably since Mike Joseph started the whole thing in the 1950s. We began by being very specifically task oriented. A consultant was assumed to have greater expertise at the job

**FIGURE 11.1**  
There are an abundance of radio consulting services from which stations can choose. Courtesy Lund Consultants.

**the Lund Consultants**  
lundradio.com

Lund Media Research

Client Login

who we are & what we do

programming war room

radio internet strategies

marketing department

general manager's office

winning track record in your formats

Radio Shopping Cart:  
promotions  
show prep  
liners  
marketing guides  
more terrific  
programming  
and management tools

**Newsroom**

Decades of experience with fresh ideas for Radio today...

The Lund Know Your Market Checklist is online...

Click on Lund Client

**Format Info**

adult contemporary  
news, talk, sports  
rock, alternative  
classic rock  
chr, top 40  
country  
oldies & classic hits  
special services

contact us

research for results

## Specialized services for your Station(s) and individual Cluster(s)

FIGURE 11.1  
Continued

- 24/7 phone and email access at no additional charge.
- Bi-weekly scheduled phone conferences.
- Music scheduling.
- Weekly Personality critique with confidential written reports to you, the station management.
- Talent recruitment and coaching.
- Music testing preparation, with interpretation for burn and making sure that each title is familiar to your P1's. Increasing CUME and TSL listenership and driving AQH!
- Branding/Imaging preparation, writing and creation of Imaging that stands above the crowd. Making you unique.
- Voiceover talent located, retainer price negotiated and management made easy.
- Arbitron interpretation, with straightforward, easy to interpret reports, showing your strengths as well as your station's weaknesses in the market. This is a different approach from what your PD "spins" and thinks you want to hear.

than anyone that the station could afford fulltime. Currently consultants serve primarily as outside (and, it is hoped, impartial) monitors of station progress. The job is to assure management that everything possible is being done to maximize the station's potential. If something is not functioning properly or needs to be changed, consultants are expected to give voice to these concerns. Over the years, the job has become infinitely more complex. Musical and nonmusical aspects of programming have spread widely apart. Research has become a separate discipline. And lately, the marketing side of radio has achieved a 'life of its own.' Different consultants approach each station's progress from varying points of view. Specialization was inevitable."

Stations use consultants for various reasons, says Fred Jacobs, president of Jacob's Media: "Stations realize that they need an experienced, objective ear to make intelligent evaluations. Consultants are also exposed to ideas and innovations from around the country that they can bring to their client stations. As radio has become more competitive, stations understand that their need for up-to-date information about

current trends in programming and marketing has increased."

Dave Scott, former president of Century 21 Programming (now TM Century), Dallas, Texas, adds that a lack of research expertise on the local station level prompts many stations to use consultants. "We're well into the information age, the age of highly sophisticated research techniques and computerized data. It takes a lot of resources to assess a market and prescribe a course of action. Most stations do not have the wherewithal. At the former Century 21 Programming, each of our consultants went through more ratings surveys and research data than most station owners, managers, or program directors did in a lifetime. The way the marketplace is today, using a consultant generally is a wise move. Radio stations that attempt to find their niche by trial and error make costly mistakes. A veteran consultant can accelerate a station's move on the road to success."

Donna Halper agrees with Scott and adds, "Consultants give their client stations an objective viewpoint and another experienced person's input. Consultants are support people, resource people, who bring to a situation a broader vision rather

than the purely local perspective. Consultants, and not just out-of-work PDs who call themselves consultants but in reality aren't, have a lot of research, information, and expertise they can make available to a client with an ailing station."

Mikel Hunter of Mikel Hunter Broadcast Services, Las Vegas, says consultants' help stations develop a distinctiveness that they need to succeed. "Unfortunately most station PDs are bandwagon riders. Many watch what other stations do around the country and clone them in their markets. Sometimes this works. Often it doesn't. It likely was a consultant who helped design the programming of that successful station being copied, and the consultant did so based on what was germane to that particular market, not one a thousand miles away. Therein lies the problem. Simply because a station in Denver is doing great book by programming a certain way does not guarantee that a station in Maryland can duplicate that success. A good consultant brings originality and creativity to each new situation, in addition to the knowledge and experience he possesses. The follow-the-leader method so prevalent among programmers actually creates a lot of the problems that consultants are called on to remedy."

Fewer than 100 broadcast consultants are listed in the various media directories around the country. More than half of this number specializes in radio. Says Ed Shane, "I remember a time when there were 250 programming consultants listed in the *R&R* directory. The number has tumbled since consolidation. One-man shops that couldn't make it as clients were swallowed by competing companies. Some consulting firms merged (Holland Cooke and McVay Media, for example). Others folded to go in-house at major companies (Jack Taddeo to Capstar, for instance)."

In general, consultancy companies average around 20-30 employees but may be composed of as few as two or three and in some cases are a one-person operation. Many successful program directors also provide consultancy to stations in other markets in addition to their regular programming duties. A growing number of station rep companies provide their client stations consultancy services for an additional fee.

Again, in the age of station consolidation and massive radio groups, consultancy often originates in-house.

## Consultant Services

Successful consultant Valerie Geller believes that station concentration actually creates a need for her services and expertise. "Programmers and managers tend to be stretched very thin these days because of consolidation; thus experienced consultants are more needed than ever." Stations hire program consultants to improve or strengthen their standings in the ratings surveys. An outside consultant may share general program decisions with the station's PD or may be endowed with full control over all decisions affecting the station's sound, contends Halper. "I have as little or as much involvement as the client desires. Depending on the case, I can hire and train staff (or fire staff), design or fine-tune a format, or simply motivate and direct deejays, which is actually anything but simple. Whatever a station wants, as a professional consultant I can provide. Usually, I make recommendations and then the owner or GM decides whether or not I will carry them out. At some of my stations, I've functioned as the acting PD, for all intents and purposes. At other client stations, I've been sort of the unofficial mother figure, providing support, encouragement, and sometimes a much-needed kick in the behind."

Among other services, Fred Jacobs says his company offers "in-market visits for monitoring and strategizing; ongoing monitors of client competition from airchecks or station 'listen lines'; critiques of on-air talent, assistance/design of music scheduling and selection; computer programs that assist with promo scheduling, database marketing, and morning show preparation; design of off-air advertising and coordination with production; and design/implementation of market research for programming, image, and music."

Most consultant firms are equipped to provide either comprehensive or limited support to stations. "In some cases, consultants offer a packaged 'system for success'

**FIGURE 11.2**  
Consultants make a dramatic difference at many stations. Courtesy Berkowitz Broadcast Consultants.

in the same way a McDonald's hamburger franchise delivers a 'system for success' to an investor. The consultant gets control. In other instances, consultants deliver objective advice or research input to a station more on a one-to-one basis. This parallels the role of most accountants or attorneys in that the decisions are still made by the station management, not the consultant," notes Dave Scott.

In the mid-1990s, niche consultants came into vogue. For example, a consulting service called Air Support focuses on improving the ratings of station morning shows by working on "talent development, preparation, creativity, and performance," reports *Radio Ink*.

Program consultants diagnose the problems that impair a station's growth and then prescribe a plan of action designed to remedy the ills. For example, station WXXX, located in a 20-station market, is one of three that programs current hits, yet it lags behind both of its competitors in the ratings. A consultant is hired to assess the situation and suggest a solution. The consultant's preliminary report cites several weaknesses in WXXX's overall programming. The consultant's critique submitted to the station's general manager may be written like this:

Dear GM:

Following a month-long analysis of WXXX's on-air product, here are some initial impressions. A more extensive report on each of the areas cited herein will follow our scheduled conference next week.

1. Personnel: Morning man Jay Allen lacks the energy and appeal necessary to attract and sustain an audience in this daypart. Although Allen possesses a smoothness and warmth that would work well in other time slots, namely midday or evenings, he does not have the "wake-up and roll" sound, nor the type of humor listeners have come to expect at this time of day. The other "hot hit" stations in the market offer bright and lively morning teams. Allen does not stand up against the competition. His contrasting style is ill-suited for AM drive, whereas midday man Mike Curtis would be more at home during this period. His upbeat, witty, and casual style when teamed with news people Chuck Tuttle and Mark Fournier would strengthen the morning slot.

Tracy Jessick and Michelle Jones perform well in their respective time periods. Overnight man Johnny Christensen is very adequate - potential as midday man should Curtis be moved into morning slot. Weekend personnel uneven. Better balance needed. Carol Miranda, 2:00-7:00 P.M. Sunday, is the strongest of the part-timers. Serious pacing problems with Larry Coty in 7:00 P.M. to midnight slot on Saturday. Can't read copy.

2. Music: Rotation problems in all dayparts. Playlist narrowing and updating necessary. Better definition needed. As stands, station verges on Adult Contemporary at certain times of the day, especially during A.M. drive. On Monday the fourteenth, during evening daypart, station abandoned currents and assumed Oldies sound. More stability and consistency within format essential. Computerized music scheduling possible solution. Separate report to follow.

3. News programming: General revamp- ing necessary. Too heavy an emphasis during


both drive periods. Cut back by 20–30% in these two dayparts. Fifteen-minute "Noon News" needs to be eliminated. Tune-out factor in targeted demos. Same holds true for half-hour, 5:00–5:30 P.M., "News Roundup." Hourly 5-minute casts reduced to minute headlines after 7:00 P.M. Both content and style of newscasts presently inappropriate for demos sought. Air presentations need adjusting to better, more compatibly suit format. Tuttle and Fournier of morning show are strong, whereas P.M. drive news would benefit from a comparable team. Ovitt, Hart, and Lexis do not complement each other. Van Sanders is effective in evening slot. More sounders and actualities in hourly newscasts. Greater local slant needed, especially on sports events.

**FIGURE 11.3**  
Consultants offer various services to stations. Courtesy Shane Media.

They're the consultants for companies that "don't use consultants."

They're our station's secret weapon.

- Today's # 1 stations choose Shane Media for programming.
- Now, a full menu of research services, too.
- Our 20th Year of thinking ahead!



**SHANE MEDIA**  
(713) 952-9221  
Radio Programming and Research  
[www.shanemedia.com](http://www.shanemedia.com)

4. General programming: Too much clutter! A log-jam in drive dayparts. Spots clustered four deep in spot sets, sometimes at quarter hour. So much for maintenance. Rescheduling needed for flow purposes as well. "Consumer Call" at 8:00 A.M., noon, and 5:00 P.M. not suitable for demos. "Band News" good, but too long. One-minute capsule versions scheduled through day would be more effective. Friday evening "Oldies Party" too geriatric – breaks format objective. Sends target demos off to competition by appealing to older listeners with songs dating back to 1960s. Public affairs programs scheduled between 9:00 A.M. and noon on Sundays delivers teens to competition that airs music during same time period. Jingles and promos dated. Smacks of decade ago. New package would add contemporary luster needed to sell format to target demo.

5. Promotions: "Bermuda Triangle" contest aimed at older demos. Contest prizes geared for 25–39-year-old listener. Ages station. Concert tie-in good. Album giveaway could be embellished with other prizes. Too thin as is. Response would indicate lack of motivation. True also of "Cash Call." Larger sums need to be awarded. Curtis's "Rock Trivia" on target. Hits demos on the money. Expand into other dayparts. Bumper stickers and "X-100" calendar do not project appropriate image. New billboards and bus-boards also need adjusting. Paper ads focus on weak logo. Waiting to view TV promo. Competition promos are very weak. A good "X-100" TV promo would create advantage in this area. Opportunity.

6. Technical: Signal strong. Reaches areas that competition does not. Significant null in Centerville area. Competition's signals unaffected. Occasional disparity in levels. Spots sometimes very hot. Promos and public service announcements (PSAs), especially UNICEF and American Cancer Society, slightly muddy. In general, fidelity acceptable on music. Extraneous noise, possibly caused by scratches or dirt, on some power rotation cuts. Stereo separation good. Recommend compressor and new limiter. Further plant evaluation in progress. A more detailed report to follow.

Following an extensive assessment of a station's programming, a consultant may suggest a major change. "After an in-depth evaluation and analysis, we may conclude that a station is improperly positioned in its particular market and recommend a format switch. Sometimes station management disagrees. Changing formats can be pretty traumatic, so there often is resistance to the idea. A critique more often



## Gary Berkowitz

## Station Consulting



FIGURE 11.4  
Gary Berkowitz.

The principal reason stations hire consultants is the experience, knowledge, and wisdom that are not necessarily available to them on a local basis or in a market that is smaller. Today's program directors can be responsible for multiple stations, pull airshifts, and also do the job of a few other people. I can focus in on one station, develop a strategy, and make sure that strategy is being followed. In terms of the effect of consolidation on the field of radio consultancy, if one of the large companies likes you, it's good. If not, it can be tough to get new

clients. Many of the larger companies don't use outside consultants, so that has also added some interesting twists. There are still many broadcasters who need the savvy of solid consultants. As far as the effects of all the new audio technologies on the consultancy profession, it has not been as significant as one might think. Radio stations are still judged by the ratings and ratings are still determined by having the best sounding and best-marketed product. Terrestrial radio still fights for every ad dollar available, so the ratings are now more important than ever.

recommends that adjustments be made in an existing format than a changeover to a different one. There are times when a consultant is simply called upon to assist in the hiring of a new jock or newsperson. Major surgery is not always necessary or desired," says Halper.

Today, the majority of stations in major and medium markets switching formats do so with the aid of a consultant (or an in-house programming executive in cluster situations). According to the National Association of Broadcasters (NAB), 3–5% of the nation's stations change formats each year. Consultant fees range from \$500 to more than \$1200 a day, depending on the complexity of the services rendered and the size of the station.

### Consultant Qualifications

Most consultants begin as broadcasters. Some successfully programmed stations before embarking on their own or joining

consultancy firms. According to fabled programmer Rick Sklar, deceased president of Sklar Communications, consultants who have a background in the medium have a considerable edge over those who do not. "The best way to fully understand and appreciate radio is to work in it. As you might imagine, radio experience is very helpful in this business." Jacobs agrees with Sklar. "Ideally a consultant should have a successful background in programming, with expertise in a number of areas, including research, sales, marketing, and promotion. The key word is *success* – a solid track record in a number of different market situations is invaluable. Consultants also need to have strong communication and tracking skills to best work with a variety of clients in markets around the country." Not all consultants have extensive backgrounds in the medium. Most do possess a thorough knowledge of how radio operates on all its different levels, from having worked closely with stations and having acquired formal training in

colleges offering research methodology, audience measurement, and broadcast management courses. "A solid education is particularly important for those planning to become broadcast consultants. It is a very complex and demanding field today, and it is becoming more so with each passing day. My advice is to load up. Get the training and experience up front. It is very competitive out there. You make your own opportunities in this profession," says Dave Scott.

Both Halper and Scott rate people skills and objectivity highly. "Consulting requires an ability to deal with people. Decisions – for example, changing formats – sometimes result in drastic personnel changes. A consultant must be adept at diplomacy but must act with conviction when the diagnosis has been made. Major surgery invariably is traumatic, but the idea is to make the patient, the station, healthy again. You can't let your own personal biases or tastes get in the way of what will work in a given market," observes Halper. Dave Scott shares Halper's sentiments. "A consultant, like a doctor, must be compassionate and at the same time maintain his objectivity. It is our intention and goal as a program consultant service to make our client stations thrive. As consultants, we're successful because we do what we have to do. It's not a question of being mercenary. It's a question of doing what you have to do to make a station prosper and realize its potential."

Consultant company executives also consider wit, patience, curiosity, sincerity, eagerness, competitiveness, and drive – not necessarily in that order – among the other virtues that the aspiring consultant should possess. Adds Gary Berkowitz, "All of those things are important. Indeed experience, integrity, and honesty top the list, as does the ability to tell clients what you really think versus what they might want to hear."

### **Consultants: Pros and Cons**

There are as many opponents of program consultants within the radio industry as there are advocates. Broadcasters who do

not use consultants argue that local flavor is lost when an outsider comes into a market to direct a station's programming. Donna Halper contends that this may be true to some degree but believes that most professional consultants are sensitive to a station's local identity. "Some consultants do clone their stations. Others of us do not. In fact, I'd say most do not. For those of us who recognize local differences, there need not be any loss whatsoever as a consequence of consultant-recommended changes. But the hits are pretty much the hits, and good radio is something that Tulsa deserves as well as Rochester. So I do try to localize my music research and acquire a good feel for the market I'm working in. But as far as basic rules of good radio are concerned, those don't vary much no matter what the market is. It's important for a station to reflect the market it serves, and I support my clients in that. Because I work out of Boston doesn't mean that my AOR client in Duluth should sound like a Boston album rocker. It should sound like a solid AOR station that could be respected in any city but fits the needs of Duluth."

Consultant Dwight Douglas says that localization is essential for any radio station and that consultants are amply aware of this fact. "It is an industry axiom that a station must be a part of its environment. An excellent station will be uniquely local in relating to its audience. That tends to take the form of news, weather, sports, public service, general information, and jock talk. A good consultant will free a station from music worries and allow it to concentrate on developing local identity. We work hard at customizing formats to suit the demographics or lifestyles of the audiences of our client stations."

A station has an obligation to retain its sense of locality regardless of what a consultant may suggest, contends Mikel Hunter. "No station should simply turn itself over body and soul to a consultant. Local flavor does not have to be sacrificed if a station has a strong PD and a general manager who doesn't insist that the PD merely follow the consultant's suggestions. A station should not let itself become a local franchise. Consultants are a valuable resource, but both the station and

the consultant must pool their wisdom to make the plan work."

Jacobs strikes a similar note of caution regarding the importance of local connection. "With a consultant, a station can conceivably lose some of its localness if there isn't adequate effort to give it a hometown flavor. But the loss of local presence is far more likely with satellite-delivered formats. Consultants need to work closely with station management (and vice versa) to find local ties and signposts, because listeners care most about what's happening in their town. It's always important to understand that there are regional differences in taste, personalities, and music. Many high-powered on-air personalities would be hard-pressed to duplicate their success in another market."

The cost factor is another reason why some stations do not use consultants. "Consultants can be expensive, although most consultants scale their fees to suit the occasion, that is, the size of the market. A few hundred dollars a day can be exorbitant for many smaller stations. But the cost of the research, analysis, and strategy usually is worth the money. I believe that a station, in most cases, gets everything it pays for when it uses a consultant. It's worth investing a few thousand to make back a million," contends Dwight Douglas.

Dave Scott believes that certain stations can become too dependent on consultants. "A consultant is there to provide support and direction when needed. If a station is infirm, it needs attention, perhaps extensive care. However, when a station regains its health, an annual or semi-annual checkup is usually sufficient. A checkup generally can prevent problems from recurring."

Mikel Hunter agrees with Scott, adding, "A radio doctor needs the cooperation of his client. On the other hand, a station must insist that a consultant do more than diagnose or critique. Positive input, that is, a remedying prescription, is what a consultant should provide. Conversely, a station should be willing to use the aid that the consultant provides."

Statistically, those stations that use programming consultants more often than not

experience improved ratings. In case, after case consultants have taken their client stations from bottom to top in many of the country's largest markets. Of course, not all succeed quite so dramatically. However, a move from eleventh place to sixth in a metro market is considered a noteworthy achievement and has a very invigorating effect on station revenue. "The vast majority of consultants benefit their clients by increasing their position in the book. This means better profits," notes Halper, who has improved the ratings of 90% of her client stations.

**FIGURE 11.5**  
Consultant's response to commonly asked questions. Courtesy Donna Halper and Associates.

**Donna Halper & Associates**  
Radio Programming Consultants  
304 Newbury St., #508  
Boston, MA 02115  
(617) 786-0666

**QUESTIONS I AM OFTEN ASKED ABOUT HIRING A CONSULTANT**

**1. What kind of station would hire a consultant?**

All kinds! From major market #1 stations that want to stay that way to new stations that need help choosing a format or hiring staff.

**2. Aren't most consultants just out-of-work Program Directors?**

Not today. Competition is too intense. Most of us who have stayed in the consulting field have years of experience in one thing: CONSULTING.

**3. Should I hire a 'big name' consultant?**

Since the majority of consultants today are experienced, you should choose one based on what his/her areas of expertise are. Interview a few consultants and you will see that each has some specialty-- whether it's a certain format (some consultants prefer to do only one format) or a certain market size. Choosing the right consultant for your station is an important decision, and you shouldn't do it on name alone.

**4. What can a consultant offer my station that my own people can't provide?**

First, consultants aren't there to replace your people, nor do they want them to look bad. While staff changes may result from the recommendations of a consultant, our first purpose is to offer you an UNBIASED, outside overview of how your station sounds, both its strengths and its weaknesses. We work WITH your people, providing research, guidance, training, market studies, etc. Often, because we are not caught up in the day-to-day circumstances, we can offer a fresh, objective point of view.

**5. What are the benefits of HALPER & ASSOCIATES?**

I'm glad you asked. We've been in business since 1980. (Before that, Donna Halper spent 13 years in major markets as an announcer, Music Director, PD, news reporter, and writer/producer of special programming.) Our specialties include critiques/positioning studies, staff training and motivation, and talent development. We work in markets of all sizes, but we are best-known for our ability to turn around failing small and medium market stations. We also do motivational seminars, and are expert at handling morale problems. Unlike some consultants who only do one format, Halper & Associates can show success stories in AC, Gold, CHR, Urban, Classic Rock, Full-Service/M-O-R, and Country. SINCE 1980, OVER 90% OF OUR CLIENTS HAVE SHOWN RATINGS GROWTH. And, our critiques and market studies have been used by some of the biggest and best companies. Also, Halper and Associates has experience with Canadian radio, and we have consulted in Puerto Rico.

**6. Can you promise results for every client?**

No consultant wins 'em all, although we'd like to. But, our slogan has always been "NO PROMISES...JUST RESULTS." We are proud of our many satisfied clients and our renewal rate is quite high. Many of our clients say they would never use another consultant. So, when it's time to think about a consultant, choose DONNA HALPER & ASSOCIATES. We can get results for you. To find out more, call us at 617-786-0666. We'll give you the attention you might not get from the "big names," affordable rates, and, most important, you can count on us to make a positive impact on your station and its staff! DONNA HALPER GETS RESULTS!!!

## A Good Consultant Can Make A Difference...

With so many good consultants out there, it can be a difficult task to choose the one who is right for your station. To help you make such an important decision, HALPER & ASSOCIATES offers a few facts about what we can do for you:

1. HALPER & ASSOCIATES has gotten results for our clients since 1980. Our staff and our reputation are solid.
2. HALPER & ASSOCIATES has success stories in nearly every format, from CHR to Urban, Gold to Classic Rock, Country to AC, News and MOR. We've helped turn around many stations — both AM's and FM's. Recently, for example, we took a declining Urban/CHR from a 5.3 to an 8.4 in one year. An AC client of ours has grown from a 13.0 to a 17.1 in two years. Since 1980, over 90% of our clients have shown ratings increases. Many are now #1 or #2.
3. HALPER & ASSOCIATES gets results in markets of all sizes, from the East Coast to the West Coast, Canada and Puerto Rico. We have clients in major and large markets, but we have become known for our work in small and medium markets. We understand the special challenges of these markets and can make an impact even if you don't have a huge promotion budget or a legendary air staff.
4. HALPER & ASSOCIATES offers more than just better ratings. Our specialty is motivation and talent development. We can help to bring out the best in your staff, handle morale problems, or give your department heads the training and input they need to do their jobs more effectively. We are also known for our thorough market analyses, critiques and positioning studies. We can help you find the right format, or fine tune the one you now have.
5. HALPER & ASSOCIATES never clones stations or deals in fad formats. Each of our clients is unique. We are there whenever you need us.

## No promises. Just results.

**Donna Halper and Associates**  
Radio Programming Consultants  
304 Newbury Street #506  
Boston, Mass. 02115  
(617) 786-0666

**FIGURE 11.6**  
Consultant promotional piece. Courtesy Donna Halper and Associates.

About the future of radio consultancy, George Burns says, "I see the role of consultants undergoing considerable change in the next few years. The rules of ownership and the very principles under which our industry is organized are altering radically. Consultants will probably take even more of an advisory role and have less involvement in the day-to-day operations of a station. The new and larger broadcasting companies, in all size markets, will keep expertise in-house and rely less on outside input in these areas. I see consultants operating at 'higher levels' in the future. They will be working on organization, continuing education, motivation, compensation, human resources, and other 'top management' concerns. Consultants, I believe, will become more policy

oriented and less concerned with ground level activities."

## Program Suppliers

The widespread use of automation equipment commencing in the 1960s sparked significant growth in the field of programming syndication. Initially, the installation of automation systems motivated station management to seek out syndicator services. Today, the highly successful and sophisticated program formats offered by myriad syndicators often inspires stations to invest in automation equipment. Of course, many of the large radio corporations create programming for distribution to their own stations, and this has had an effect on the number of program suppliers still in operation. Observes Jay Williams, "The syndication business has changed because of consolidation, which reduced the opportunities for selling programs by syndication companies on the one hand and on the other made the larger companies aware that they should be syndicating programs on their own. I think some of the most innovative syndication is being done now by News Corp, which has taken their TV personalities, most recently 'Brian and the Judge,' who have individually made a name for themselves on the Fox News Channel, and developed new radio programs for them (even though they don't actually appear together on television). Formats like Adult Contemporary (where product is becoming more generic and less innovative) are declining in numbers across the country, whereas the numbers of News/Talk and Sports stations are increasing, so there are opportunities for syndicating talk programming. Short form programming syndication appears to have very limited appeal. On the other hand, long form program syndication, which can garner ratings over time, appears to be increasing. Finally, advertisers believe ads work better in talk programming since they blend with the format and the spot clusters don't have to be as long."

It is estimated that over half of the country's radio outlets purchase

syndicated programming of some type, which may consist of as little as a series of one- or two-minute features or as much as a 24-hour, year-round station format. Longtime program specialist Dick Ellis cites economics as the primary reason why stations resort to syndicators. "When I programmed for Peters Productions they supplied high-quality programming and engineering at a relatively low cost. For instance, for a few hundred dollars a month a small market operator gets a successful program director, a highly skilled mastering engineer, all the music he'll ever need (no service problems with record companies) recorded on the highest quality tapes available. It takes a programmer eight hours to program one twenty-four-hour cut reel. It takes a mastering engineer eight hours to remove all the pops and clicks found on even brand new records, plus place the automation tones. All of this frees the local operator to concentrate his efforts on promotion and, of course, sales."

William Stockman, who led Schulke Radio Productions (SRP was purchased by Bonneville Broadcasting System in the mid-1980s), says that stations are attracted to syndicators because of the highly professional, major market sound they are able to provide. "By using SRP's unique programming service, a smaller station with limited resources can sound as polished and sophisticated as any metro station."

Both economics and service motivate radio stations to contract syndicators, contends former Satellite Music Network (now part of ABC Radio) programmer Lee Abrams (now heading the programming effort of XM Satellite). "Stations are attracted to our affordable, high-quality programming. It's just that simple. Syndies provided an excellent product within a cost-effective context. Their expertise in delivering niche concepts was very appealing to radio operators."

The late and great Rick Sklar observed, "In today's cost-conscious economic climate, more and more radio station operators are turning to suppliers of twenty-four-hour formats for their programming. Whether delivered via satellite, conventional tape, CD or DAT, these increasingly sophisticated

Pro's and con's of using a consultant:	
+ 's	- 's
* Objective, experienced view	* Overreliance on consultant and not enough local input
* Exposure to new ideas	* Program director gets too much advice from too many sources
* Ongoing evaluation of the station	
* Input about stations from around the country	
* National research and information	
* Experience/assistance in a wide range of areas including music, promotion, marketing, talent management, etc.	

products are not only penetrating new markets but larger markets as well, where until now, traditional thinking has held that locally originated programming was the only way to go."

The demand for syndicator product has paralleled, if not exceeded, the increase in the number of radio outlets since the 1960s. Again, the new millennium has brought a change in the field of program syndication with the large radio corporations often assuming the chore of program generation in-house.

Every part of the broadcast day is served by syndicators, and morning drive in particular, observes Ed Shane. "Syndicated morning shows are widespread and proliferating. There are almost too many to keep track of. At a quick glance, you've got Bob and Sheri, John Boy and Billy, Bob and Tom, Mark and Brian, Steve and DC, Big D and Bubba, Mancow, Opie & Anthony, and on and on."

## Syndicator Services

The major program syndicators usually market several distinctive, fully packaged radio formats. "In its heyday, Peters Productions made available a complete format service with each of their format blends. They were not merely a music service. Their programming goal was the emotional gratification of the type of person attracted to a particular format," says Dick Ellis, whose former company offered a dozen different formats, including Beautiful Music, Easy Listening, Standard Country, Modern

**FIGURE 11.7**  
Courtesy Jacobs Media.

Country, Adult Contemporary, Standard MOR, Super Hits, Easy Contemporary, and a country and contemporary hybrid called Natural Sound.

Century 21 Programming also was a leader in format diversity, explains Dave Scott. "Our inventory included everything from the most contemporary super hits sound to several Christian formats. We even offered a full-time Jazz format. We had programming to fit any need in any market."

Drake-Chenault Enterprises (now owned by Jones Satellite Networks) was among the oldest and largest of syndicators and specialized in Beautiful Music. Today, Classical Music Network, TM Century, Jones Satellite Network, Westwood One, United Station Radio Network, and NBG Radio Networks also are among the most successful of those syndicators marketing several program formats. Some syndicators prefer to specialize in one or two programming areas. For example, Bonneville Broadcasting and Churchill Productions primarily specialize in the adult Easy Listening format.

Syndicator formats are fully tested before they are marketed, explains Stockman. "At Schulke our strategy was to reorient the music from essentially a producer-oriented to a consumer-oriented product. Music was tested on a cut-by-cut basis in several markets coast-to-coast. Using patented and proven methodology, music was carefully added or selectively deleted. By determining what songs the listeners like to hear and which songs they dislike, SRP assembled a totally researched library that has been on the air via our subscriber stations since March 1983. Every song played on our stations has been rated by the listeners as a 'winner' and all the 'stiffs' that have a high dislike factor have been eliminated altogether."

Customized sound hours are designed for each format to ensure consistency and compatibility on the local station level. "An exact clock is tailored for our client station after our market study. The format we provide will perfectly match the station in tempo, style, music mix, announcing, promos, news, weather, and commercial load," says program syndicator

Dave Scott. Observes Ed Shane, "The key to using syndicator or network programming is to make it sound like it belongs to the station. Even big personality shows like Rush and Dr. Laura can make use of local avails and bumpers for personalized call letters and promos."

Audience and market research and analysis are conducted by syndicators before implementing a particular format. "Our clients receive comprehensive consulting services from our seasoned staff. We begin with a detailed study of our client station's market. We probe demographics, psychographics, and population growth trends of a station's available audience. We analyze a client's competition quantitatively through available ratings and qualitatively from airchecks. Then the programming our service provides is professionally positioned to maximize our client's sales, ratings, and profits. All of our programming is solidly backed by systematic studies of the listening tastes of each format's target audience. Our research includes call-out and focus group studies, in-depth market analysis, attitudinal audience feedback, psychographic patterns and tests, and several in-house computers with ratings data online," says Dave Scott.

Format programming packages include hundreds of hours of music, as well as breaks, promos, and IDs, by seasoned metro market announcers. Customized identity elements, such as jingles and other special formatic features (taped time checks), are made available by the majority of syndicators. "We try to cover all bases to ensure the success of our clients. We back each of our formats a dozen different ways. For example, image builders in the form of promotions, contests, and graphics also are an element of our programming service at Radio Arts," says programmer Larry Vanderveen.

To stay in step with the ever-changing marketplace, syndicators routinely update the programming they provide their subscribers. "When you want people to listen to a station a lot, you've got to keep them interested in it. To do so you have to air a sound that's always fresh and current. Tape updates are plentiful. We give stations the most extensive initial collection

of  
the  
the  
anc  
up  
qu  
fre  
tha  
op  
lon  
"Si  
im  
anc  
alw  
Au  
are  
clo  
wo  
as  
S  
ins  
for  
anc  
siv  
scr  
S  
bas

# Programming Power

## Jones Music Programming

### More Options for Better Radio

Jones Music Programming is the single source for all of your music programming needs. Whether you need an hour of music or 24, a word of advice or an entire makeover, we have the solution.

### The Total Solution: Satellite-Delivered Formats

Choose from 11 targeted, localized, and talent driven formats to give your station a competitive edge. With our satellite-delivered formats you can put your mind at ease and your resources to work on other issues important to your business.

1-800-822-8228

### Music 101: Understanding Song-by-Song Music Logs

Select Song-by-Song Music Logs and the music scheduling is done for you. Receive fully researched music logs in a format designed to fit your market and your hard drive. We provide you with the complete music library, 24/7 music logs, Chartbreakers Weekly Hits music disc along with the expertise of our programming and consulting team.

1-800-822-8228

### Schedule Plus

We make it easy to build your own music logs. Schedule Plus provides you with the software, researched music, song database, clocks, music policies and rules.

### Chartbreakers Weekly Hits

Stay up-to-date with our Chartbreakers Weekly Hits CDs. Available for Country, AC, CHR, Rock, Urban, Hip Hop, Christian, Latin Pop, Smooth Jazz, and more!

1-800-822-8228

**FIGURE 11.8**  
"Full-service syndicators for every programming need. Courtesy Jones Radio Networks."

of music tapes available. Then we follow them up with hundreds more throughout the year. For instance, our CHR, AOR, and Country subscribers receive over 100 updates annually. All categories have frequent updates, so our client's sound stays fresh and vital," says Dave Scott, who adds that the lines of communication are kept open between the client and syndicator long after the agreement has been signed. "Since the success of our clients is very important to us, continuing consultation and assistance via a toll-free hotline is always available twenty-four hours a day. Automation-experienced broadcasters are in our production studios around the clock, and consultants can be reached at work or home any time. Help is as close as the phone."

Syndicators assist stations during the installation and implementation stage of a format and provide training for operators and other station personnel. Comprehensive operations manuals are left with subscribers as a source of further assistance.

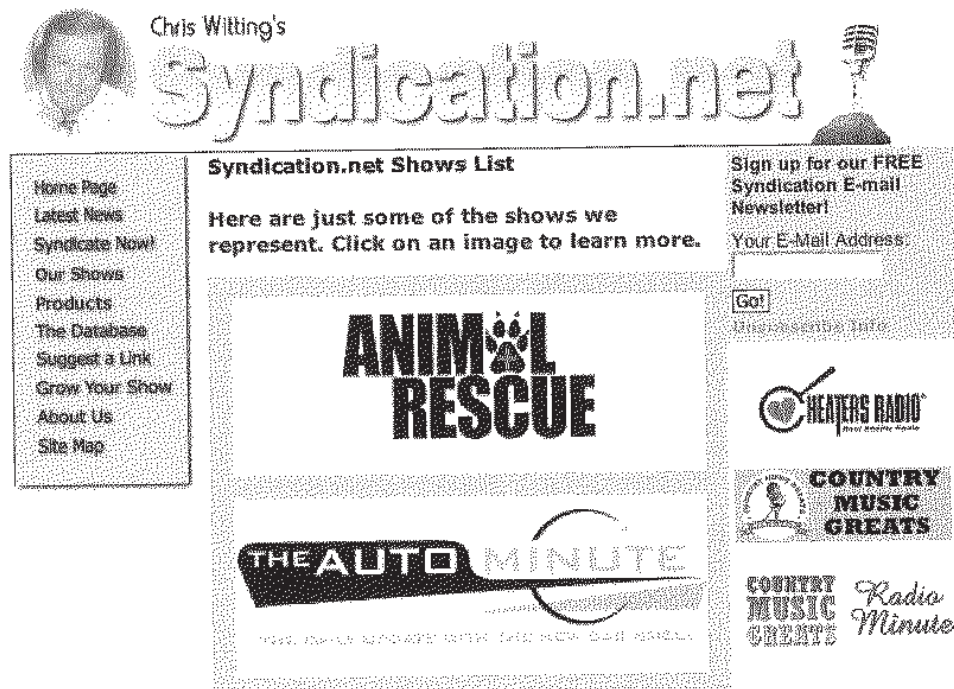
Syndicators offer programs on a barter basis, for a fee without presold spots or for

a fee containing spots. Leasing agreements generally stipulate a minimum 2-year term and assure the subscriber that the syndicator will not lease a similar format to another station in the same market. Should a station choose not to renew its agreement with the syndicator, all material must be returned unless otherwise stipulated.

The majority of format syndicators also market production libraries, jingles, and special features for general market consumption.

What is the difference between a network and a syndicator? Ed Shane explains, "Networks and syndicators are essentially or almost the same. Premiere calls Rush Limbaugh a 'network' and Dr. Laura a 'syndicated show.' United Stations Radio Network works the same way. (It has more to do with the way spots are sold than the realities of programming.) Westwood One is more of a network, combining CBS News, CNN Radio, long form music programs, Metro Traffic and News with syndicated programming like country music specials. ESPN is networked for all talk shows and live sports (NFL football play-by-play, for example) by ABC."

**FIGURE 11.9**  
Century 21's catalog  
of syndicated  
formats in the 1990s.  
Courtesy Century 21.



Chris Witting's  
**Syndication.net**

**Syndication.net Shows List**

Here are just some of the shows we represent. Click on an image to learn more.

Sign up for our FREE Syndication E-mail Newsletter!

Your E-Mail Address:

Go!

Home Page  
Latest News  
Syndicate Now!  
Our Shows  
Products  
The Database  
Suggest a Link  
Grow Your Show  
About Us  
Site Map

**ANIMAL RESCUE**

**THE AUTO MINUTE**

**HEATERS RADIO**

**COUNTRY MUSIC GREATS**

**COUNTRY MUSIC GREATS** Radio Minute

## Billy Bush

Interviewed by Jay Williams Syndication



**FIGURE 11.10**  
Billy Bush.

**Jay Williams** – Billy, although you're best known as a TV star, you began your career in radio. What attracted you to radio?

**Billy Bush** – The intimacy of radio. I got to talk with people in a one-on-one conversation and that was extremely cool and it still is.

**JW** – What kinds of jobs did you have in radio, and which were the most rewarding for you?

**BB** – I had the luxury of starting in a small market where I had every job. I was a sales guy during the day, and boy is that a humbling experience, and I was on the air one night a week, and on the weekends I did promotions. I pumped up the station balloon and I handed out hundreds of fliers. There is not a job in radio I have not done outside of management, and I never want to do that.

**JW** – With "Access Hollywood" and your syndicated "Billy Bush Show," you shift from one medium to the other every day. Is that difficult? Also, what are the major differences as a performer between the two mediums?

**BB** – In radio, the greatest preparation is just knowledge. It's just

knowing what you're talking about. It's about drawing on life experiences. In TV, you have a lot of people helping you. You've got a lot of people preparing and editing and all that. In radio, you need to be your own research department. So radio's a lot more difficult.

**JW** – Tell us about radio. What makes radio unique in your view?

**BB** – The car, because the car is a unique environment, and radio will always be the easiest and best choice for people. People who are texting and using the Internet in their car are very few and far between. The automobile is ideal for radio and that single invention years ago is what makes radio unique, and it's what will insure that radio will be there forever.

**JW** – As we are talking, radio is going through technological changes,



facing new competition and economic distress. Yet, your well-received syndicated show is rapidly expanding across the country. How do you see radio's future?

**BB** – Radio's future is secure because of the car. I said that. But my syndicated show is a great answer for people who are facing economic problems because it's cost effective. I don't cost them anything. They just have to give me some inventory. They give me 4 minutes an hour, and that's it. So it's an opportunity cost and not an actual outlay of cash.

**JW** – Syndication seems to be growing, too. From the old network programs such as Paul Harvey news to later off-network radio syndication, such as Howard Stern, Bob and Tom, Rush Limbaugh, more stations seem to be embracing syndication. Do you see that as a growing trend and why?

**BB** – Yes, because syndication makes sense. If you have great talent and content, then you're just giving up time. If the ratings are big, then you'll be able to charge more for the commercials that you do get revenue for. So it's all about choosing the right talent, the biggest will survive and I believe we are in that direction.

**JW** – Your show is marketed by Westwood One, one of the largest syndication companies. Tell us about your role versus theirs; how much are you personally involved, and how much control do you have over your own show?

**BB** – I have entire control over editorial; what I put out there is what goes on the air. In that regard it's great. I'm very personally involved and I control all the content. As for the sales and marketing of the show, I weigh in whenever I want to, but we agree between Westwood and me. If I feel strongly about anything, I'm confident my voice is heard and I'll usually prevail because at the end of the day the talent has to be happy to provide. However, having done every job in radio, I have total respect for the people who do things outside of what I do, and I'm totally open to whatever they have to say.

**JW** – It must be demanding preparing and voicing a new show every

day. Who and what does it take to produce your show?

**BB** – I have a broadcast producer, Michelle Salvatore, who takes in all my content and who arranges and organizes our schedule and lays out what the show is going to be each day. I have five bookers who book guests for me on the radio show. I book a lot myself because my BlackBerry has gotten pretty deep over the years. We have three editors on the other side of things who package the show at the end of the day. We are spread out perfectly.

**JW** – You are heavily involved with getting new station clients. Tell us a bit about how that process works.

**BB** – Everything is sales in life, and each client, each station I'm on needs to feel that if they need to get in touch with me they can. The truth is, they can. Anyone can call and set up a time to talk on the phone through Michelle or anybody else or my assistant, Marla, and I will talk to any station clients. There are walls because it makes it easier for everyone, but if someone needs to weigh in with me, they can.

**JW** – "The Billy Bush Show" competes with locally produced shows in many markets. How do you react to objections from potential clients that your show "won't work in this market because it isn't local"?

**BB** – Entertainment is everywhere. There is an insatiability for celebrity content. What I do is provide an everyman's perspective to it. I tell people about what it's like behind the scenes. I make it personally relatable for them because they hear someone they trust and listen to and connect with deal with celebrities in these situations and they love it. Also I'm honest; I tell it like it is. If someone is difficult, I share that.

**JW** – How do you position your show against other syndicated shows? What makes "The Billy Bush Show" unique or better?

**BB** – My main competition, I think, is probably Ryan Seacrest, although there are others. I'm not positive how Ryan does his show, but I do believe there's a lot of people taking his existing content and putting it out there. What I do is a totally new and original show for my stations every single day. A lot

of syndicated shows are packaged. They do three, four, or five shows at a time. I do a new show every day with new analysis, new insights, and new guests.

**JW** – Do you think more radio stations will embrace syndicated shows because it gives them access to better on-air talent than they can find locally or because, in some cases, syndicated shows may save them money?

**BB** – The answer is a little bit of both, absolutely. The best on-air talent will survive and grow, and those particular people will continue to survive. The better known you are, the better chance you have out of the gate. Although that doesn't mean local people can't rise to that level. And yes, my show saves a lot of money for stations because they're not paying me. They're giving me commercial time and if my ratings are good, they're going to get more money for the commercial time that they do have left.

**JW** – Does syndication help or hurt radio?

**BB** – I think syndication helps radio because you want to have big names in your field. You want to be as relevant and taken as seriously as everyone else. The bigger stars you have on radio, I think, the higher the profile of radio but the trap is – and I hope radio stations don't fall into it – to go for the biggest name you can get just because of the name. At the end of the day, they have to deliver, they have to work, they have to have that strong ethic. And the biggest radio names are really hardworking people.

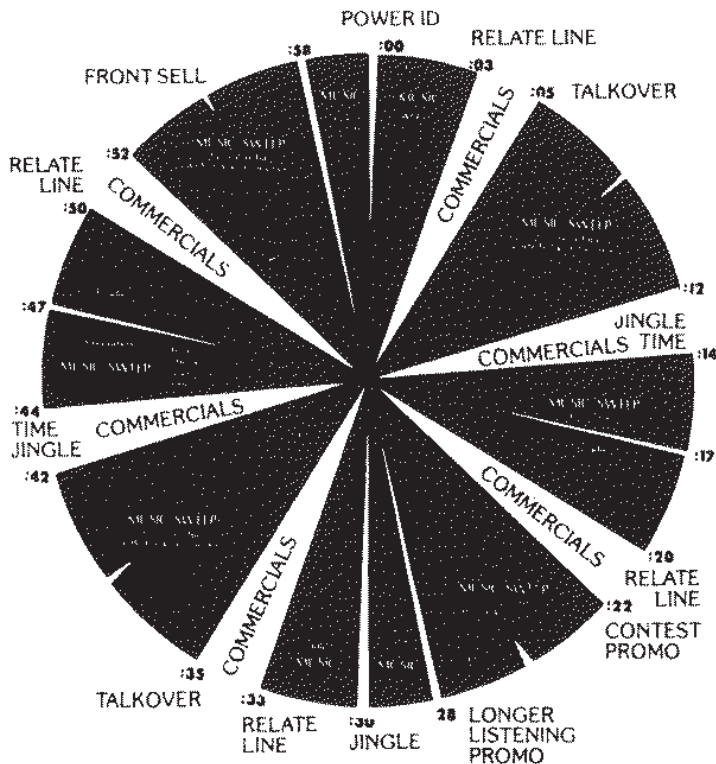
**JW** – You're a big TV star, you travel the world to do pageants, events, even the Olympics, and you certainly don't need extra work. So why did you launch "The Billy Bush Show" and get back into radio?

**BB** – Because I love radio, and because radio gives me the opportunity to expand upon my thoughts. It gives me a chance to walk a tightrope without a net. I love being able to express my opinions. I know Hollywood and understand it very well and I have an insider's perspective, and I love being able to share that with people.

## Hardware Requirements and Quality

**FIGURE 11.11**  
Sample customized  
sound hour. Courtesy  
Century 21.

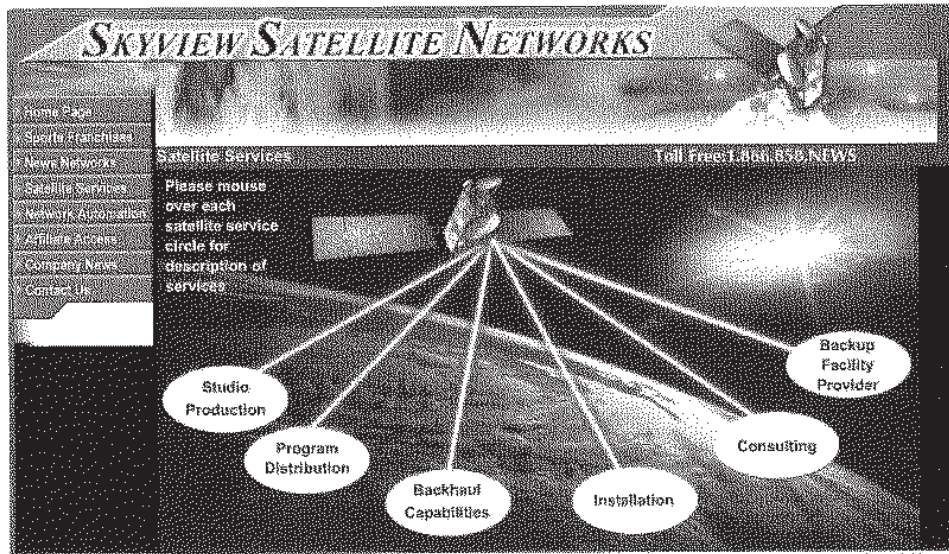
Everything is computer-based now, and the use of satellites by syndicators has grown enormously since 1980. An NAB survey



concluded that over three-quarters of the nation's stations receive some form of satellite programming. The majority of stations with satellite dishes use them to draw network feeds. However, the percentage of stations receiving product from syndicators and other programming services has more than doubled during the past couple of decades, and the use of station hardware (other than computers) for syndicator programming is nearly extinct. It is more cost effective and efficient to catch the digital satellite signals than it is to handle actual product on the local station level. In fact, the majority of program syndicators have ceased to mail material to stations, opting to beam it to them instead.

Satellite-fed syndicator programs are often archived for later replay. Drew Carey of Clear Channel Communications discusses the procedure for doing so for one of his company's shows: "The Bob & Tom Show is designed to air in its entirety for the full four hours as sent with no editing. Stations in the Central, Mountain, and Pacific time zones run the show either at 5 to 9 A.M. or 6 to 10 P.M. depending upon their competitive situation. Stations use one of three methods to delay broadcast of the show: 1. Station automation systems (record to system, such as Audio Vault, then replay automatically), 2. Record to DAT then replay (requires the station be staffed overnight and during playback), and

**FIGURE 11.12**  
Satellite program  
services. Courtesy  
WFMT.



**Jones Radio Networks**  
SEATTLE COLORADO DENVER WASHINGTON, DC

**THE BILL PRESS SHOW**

**Country**

**CLARK**

**Classic Hits**

**Jones Radio Networks, Inc.**  
Jones Radio Networks, Inc. (JRN) is America's leading independent radio programming company, with offices and studios in New York, Seattle, Denver and Nashville. From Daypart Personalities, Innovative News & Talk programming, Satellite-Delivered Formats and more than 40 Music on Hard Drive Formats, Music Scheduling, One-to-One Consulting, Research, Prep, Short Features, and more, the Jones Radio Networks lineup reaches 48 million listeners every week.

**What's New Variety Hits**

Daypart Personalities  
News and Talk  
Satellite-Delivered Formats  
Jones Music Programming  
Jones Research Network  
Prep & Short Features

affiliate access Contact Us About JRN JRN News Help

**FIGURE 11.13**  
Major syndicators offer a host of formats. Courtesy Jones Radio.

3. Record to mini-disc the replay (requires the station be staffed overnight and during playback)."

Concerning audio quality, syndicators are very particular about sound quality and make every effort to ensure that their programming meets or exceeds fidelity standards. "TM Century uses the finest quality recording studio equipment. Actually, it's far superior to most broadcast-grade gear. Therefore, it is quite important that subscribers have

adequate hardware, too. We utilize a number of highly regarded audio experts to make the sound and the client's are the very best possible. In fact, we use special audiophile 'super disks,' master tapes from record companies, noise reduction, click editing, and precise level control or slight equalization, if needed," says Scott.

Periodic airchecks of subscriber stations are analyzed from a technical perspective to detect any deficiencies in sound quality.

## CHAPTER HIGHLIGHTS

1. The significant increase in stations and formats created a market for consultants. Today, the ranks of radio consultants has been reduced due to consolidation and major radio companies typically have their own in-house consultant in the form of an experienced programming executive.

2. Consultants provide various services, including market research, programming and format design, hiring and training of staff, staff motivation, advertising and public relations campaigns, news and public affairs restructuring, and technical evaluation (periodic airchecks of sound quality).

3. Aspiring consultants should acquire background experience in the medium, solid educational preparation, and strong interpersonal skills.

4. Station executives opposed to using consultants fear losing the station's local flavor, becoming a clone of other stations, and the substantial cost.

5. Statistically, stations using programming consultants more often than not experience improved ratings.

6. Increased use of programming syndication is related to the increased use of computers and satellites. Most of the nation's

- stations purchase some form of syndicated programming.
7. Syndicated programs are generally cost effective, of high quality, and reliable, thus allowing smaller stations to achieve a metro station sound.
  8. Program syndicators provide a variety of test-marketed, packaged radio formats—from Country to Top 40 to Religious. Packages may include music, breaks, promos, customized IDs, and even promotions. Package updates are frequent.
  9. Networks and syndicators are essentially one and the same.
  10. The number of syndicators using satellites to deliver programming is at an all-time high. Many deliver programming only via satellite.

### SUGGESTED FURTHER READING

- Broadcasting Yearbook*, Broadcast Publishing, Washington, DC, 1935 to date, annually.
- Crouch, S., *No Static: A Guide to Creative Radio Programming*. Backbeat Books, San Francisco, CA, 2002.
- Deweese, S.B., *Radio Syndication: How to Create, Produce, and Distribute Your Own Show*, Elfin Cove Press, Bellevue, WA, 2001.
- Fornatale, P., and Mills, J., *Radio in the Television Age*, Overlook Press, Woodstock, NY, 1980.
- Geller, V., *Creating Powerful Radio*, Focal Press, Boston, MA, 2007.
- Hall, C., and Hall, B., *This Business of Radio Programming*, Billboard Publishing, New York, 1977.
- Howard, H.H., and Kievman, M.S., *Radio and Television Programming*, Grid Publishing, Columbus, OH, 1983.
- Inglis, A.F., *Satellite Technology*, Focal Press, Boston, MA, 1991.
- Keith, M.C., *Radio Programming: Consultancy and Formatics*, Focal Press, Boston, MA, 1987.
- Kempner, M.A., *Can't Wait Til Monday Morning: Syndication in Broadcasting*, Rivercross Publishing, Orlando, FL, 1998.
- Mirabito, M.M., and Morgenstern, B.L., *New Communication Technologies: Applications, Policy, and Impact*, 4th edition, Focal Press, Boston, MA, 2000.
- The Radio Programs Sourcebook*, 2nd edition, Broadcast Information Bureau, Syosset, NY, 1983.
- Series, Serials, and Packages*, Broadcast Information Bureau, Syosset, NY, annually.
- Shane, E., *Selling Electronic Media*, Focal Press, Boston, MA, 1999.
- Vane, E.T., and Gross, L.S., *Programming for TV, Radio, and Cable*, Focal Press, Boston, MA, 1994.
- Wasserman, P., *Consultants and Consulting Organization Directory*, 3rd edition, Gale Research, Detroit, MI, 1976.

## APPENDIX 11A: Station Critique

To: GM/BRadio  
 Fr: Donna L. Halper, Halper & Associates  
 Re: Critique of tapes of B

Thanks for sending along the latest batch of tapes for me to critique. I do hear some improvements since I last visited the station. On the other hand, I am still hearing some areas that we need to work on. Most of what I noticed are problems with formatics, although a few little things stood out. In no particular order,

1. Bet is back to being too close to the mic, causing her to pop her Ps again. The good news is that on this tape, her voice is now VERY midrange – and not high-end or “cutesy,” and she sounds more natural. The bad news is that she seems determined to use verbal clichés (however, she is not the only one with this habit). For example, when she reads the liner about “playing the music that made FM great,” she repeatedly says “and here’s another great example” when she introduces the next song. She is also trying too hard to make simple format elements sound enthusiastic: the school lunch menu basically just needs to be read, rather than embellished upon for two minutes. I know she is *trying*, but it just sounds artificial to get *that* excited about school lunches. The entire staff seems stuck on the phrases *keep it locked* and *music from . . .* (“that was music from the Beatles; now here’s music from Steely Dan”). In real life, do we really talk



**FIGURE 11.14**  
 Many syndicators use satellites to feed programming to client stations. This greatly simplifies the distribution process. Handling of tapes and mailing is eliminated. Satellite syndication also keeps station equipment costs down. Courtesy IDB.

that way, or do we talk about great SONGS, or use phrases like “a classic from. . . .” We need to VARY what we say, or else we sound like robots. Thus, if I just said “Now, here’s a classic from Bob Dylan,” I don’t want to use that phrase for every front-sell. Ditto for “keep it locked” – it’s a rather overused AOR phrase as it is, but boy, do our jocks say it a lot . . . can’t we find some other ways to invite people to listen?

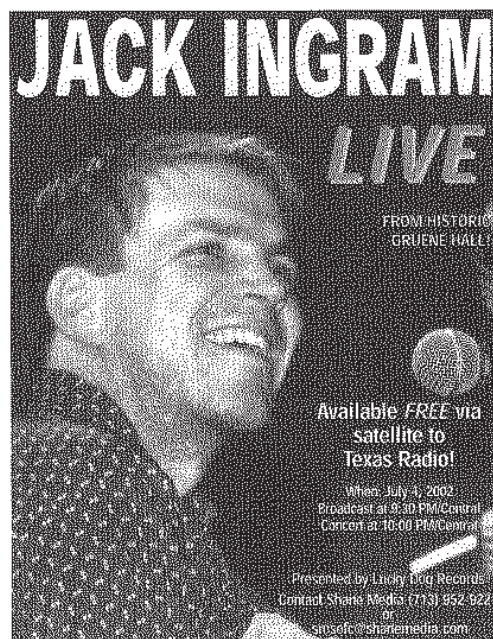
2. Virtually everyone seems to have acute lineritis. It’s a disease where you want to read a lot of liners all at once. I heard “the all-new

**FIGURE 11.15**  
 Satellite Music Network program clock. Courtesy SMN.

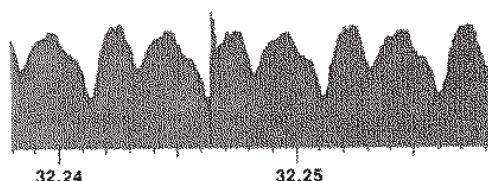
B-, the station that plays the classic hits and the music that made FM great!!!" ONE LINER PER BREAK IS JUST FINE, THANKS. If we just used "the all-new B-" or "your station for Classic Hits," we don't need to add in two more liners. A good front-sell might be as simple as "on the home of classic hits, B-, here's Cat Stevens." Or "playing the music that made FM great, we're B-, with Fleetwood Mac." Simple is better, in other words.

3. How much weather do we need in middays? During morning drive, the announcer should give time, temp, and say good morning to the audience each break; that isn't necessary the rest of the day. Unless there are major storms coming, I wouldn't have so many

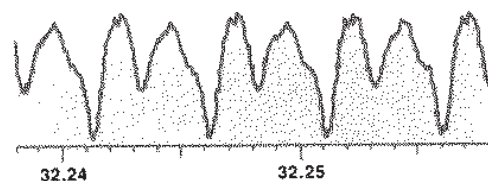
**FIGURE 11.16**  
Syndicator features provide stations with the seasoning to keep programming interesting. Courtesy Shane Media.



**FIGURE 11.17**  
Syndicators are especially sensitive to quality control. Here, a commercial CD is enhanced by a syndicator's computer prior to shipment to a client. Courtesy Century 21.



Waveform of commercial CD with clicks and tape hiss.



weather forecasts during the workday – folks already got there, the kids are in school, etc. But we should still be friendly: I seldom heard Dave say his name (I assume it was Dave?), and I like a liner that thanks people for listening or invites them to tell a friend about the All-New B-.

4. Although I agree that call letters are crucial, I heard them used way too much at some times: It is not conversational to say "on the all-new B-, here's Bob Seger on the all-new B-." That just sounds repetitious. My training has been to use call letters going into a song and use them when coming out of a long music set ("That was Traffic on the All-New B-, and we also heard Joan Baez and Dan Fogelberg.") But to use them two or three times within the same front-sell strikes me as too much of a good thing. Also, I'm hearing B- a lot more than I'm hearing Classic Hits. And a final grammatical note – you CAN'T say "the classic hits of all time" – you can play the greatest hits, but *classic hits* are a format description and a positioning statement. I'd suggest "playing ALL the classic hits" or "playing nothing but classic hits" or "playing the classic hits of the past and the classic hits of today" – you get the idea.

5. More clichés – why is Wednesday called *hump day*? Again, do we really talk that way? And in several of the forecasts I heard various people do, I heard about *scattered rain* – I knew that showers could be scattered, but rain? I remind everyone to keep being CONVERSATIONAL – how would you talk to a FRIEND? Would you really say "It's 52 minutes past the hour of 6 o'clock"? I also like consistency – some jocks, as mentioned earlier, said their name often, some said it repeatedly, some seldom said it at all. Some used one liner over and over, some used a variety. These elements must be formatted in so that all the liners are rotated evenly. Also, I'm not sure if it was the skimmer, but I heard some problems with levels when a song ended. The jock's voice sounded much louder or much softer than the song at certain times. A request – could you tape an hour of each jock and NOT scope it down – in other words, just put a tape in a boom-box and let it run, so that I can hear an uninterrupted hour, commercials and all? I'd like to hear what the audience heard.

More critique later – I'll go over the music in more detail in my next memo. What I heard sounded basically hit-oriented, which is good, but let's stress CLASSIC HITS too, because we are getting to a point where the variety of the music is right on target! I'll be in touch.

P.S. I meant to mention that the PSA or Street-Sheet outro may be too long, although it may also be the jock ad-libbing. The ending of a PSA should be brief and to the point. What I heard

was over a MINUTE of numbers and advice – “If your church, social club, or nonprofit organization has a message you want to be publicized, just send the who-what-when-where-how-and-why, etc.” – boy, that’s wordy!!! It’s better to be simple, without tons of addresses and phone numbers. You are wiser to advise those with something to send to call B- for our fax number, rather than taking up so much time telling them they can phone it or fax it or mail it, then giving the address on top of everything. This slows the station down too much. It also goes without saying that the way something is sent to us on a

press release may not sound good read verbatim on the air. What I heard B- reading sounded as if we had just put the press release right into the studio with no rewrite. Local news and local PSAs should be rewritten for clarity, and it helps that they be conversational. (I would also like to hear our local news, by the way, plus how Chris sounds.) Perhaps the announcers were nervous because they were doing an aircheck, but they do need to become accustomed to taping themselves regularly so that they can eliminate the verbal crutches they use and make their show sound smoother.

## APPENDIX 11B: Network Radio/Syndication

### FIGURE 11.18

This interview with Ron Hartenbaum was conducted by Jay Williams, Jr. Courtesy same.

Interview with: Ron Hartenbaum, CEO, Jones Radio Networks (New York)

Difference between network and syndication? "You can't separate them, there is no difference. It's a fallacy to think there is; the same thing is happening" with network and syndication. In the old model, the Federal Communications Commission (FCC) used to separate networks as they distributed programming regularly using dedicated telephone lines (and that distribution method was how a network was described). That was done throughout the 30s, 40s, and 50s. "That's an ancient way of distribution, with bad fidelity, and no longer applies. Now network-syndication programming is distributed in a variety of ways . . . CD, the Internet, wired and wireless, satellite . . . it's based on which method is the most 'cost effective' for them."

"There is no difference between syndication and network – it's all national programming. A Matchbox 20 Concert or a Tony Bennett special for the Thanksgiving Weekend might be distributed by CD, as there is not an urgent time constraint. Breaking news, though, wouldn't go out on CD. You would use the distribution method that is best and most cost efficient for the product you're sending out. If it's live, immediate, and interactive (with phone calls) such as Rush Limbaugh, it's delivered via satellite; if it's not time sensitive, it may be mailed out on CD. But it's all national radio."

"It's all audio. It's how do we deliver a signal to as many ears as we can. How do we deliver an audience to an advertiser." And the trend is to deliver increasingly specific audiences that can appeal to specific types of advertisers. "National radio and network radio are the same."

Even the old radio networks have changed, although they retain part of their names. CBS/Viacom Radio is now handled by Westwood One, itself a division of Viacom. The GE/NBC Network is also distributed by Viacom. ABC/Disney is still the ABC Radio Network.

Current Example. Jones Radio works with the CNN Radio Network "en Espanol." CNN creates the news, but Jones Radio Network handles all the advertising and all the affiliate sales. Programming is delivered on the Internet. And using the special client feature, in a special password protected part of the Web site – called Ala Carta – stations can pick the items and information that best suits their specific mix of Hispanics in their individual communities. For example, New York might want programming for Puerto Rican and Cuban Hispanics that would not be needed in Los Angeles where most of the population consists of Mexican and Central American Hispanics. This distribution flexibility and choice are both the present and future of syndication.

National radio revenues are over \$1 billion annually. There are only four major companies: Westwood One (the largest with almost half that revenue), ABC, Premier, and Jones; there once were over a dozen.

"But how do you look at Sirius and XM? These are national radio stations just using a different model." In other words, people looking to buy national radio would include these two satellite radio systems in their plans.

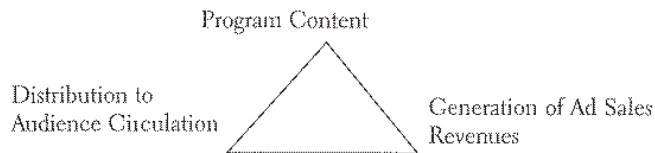
Ron also believes that "streaming media" could have been part of national radio but was killed by the "greed of music publishing and actor's union's rights fees. Internet radio was economically squashed before it could get started – everybody ended up losing."

The future: There probably won't be much more consolidation and there could even be more producers and distributors of content in the future.



The distribution model is always changing. Ron used the example of mail . . . moving from horseback to rail, truck, airplanes, and the Internet. But it's still mail.

He suggests that a triangle is the best way to show the business model. At the top is product/program/content. At the lower left corner is the audience/circulation/distribution. At the lower right side is generation of ad sales revenue. If you make a good product (program) then "people will want it," they'll want to listen to it or watch it. If they watch, you can generate ad sales revenue (and then, "if you're smart, you'll put some of that revenue back into the product"). Jones is in all three parts of this model – programming, distribution and sales. Ron adds: "You learn in business school that if you're standing still, you're losing. You have to constantly evolve your product and your product lines" and that means you have to invest in them.



Ron also believes that there are only three ways that programming/content is being distributed: Pay/subscription, Ad supported, or a blend of the two. "Someone has to make money. There are costs to generate news and to develop music programming."

[He has this analogy for college students who think music is free and should remain that way – "What if you went to college, went to all the classes, took all the tests, wrote all the papers, and handed in the work and didn't get a grade? "Where's my grade?" you'd say; we'd say that we've downloaded all your information on the Internet and we don't need to give you a grade."]

[We also discussed news programming and Ron gave some thoughts you may want to use in a separate section. There is increasing pressure on these big companies to eliminate money-losing divisions. Either you amortize your costs over a variety of channels and outlets (as NBC) or you look to mergers to be able to reduce those costs (ABC's talks with CNN). Rupert Murdoch was one of the first to work with a "global platform" and "by having papers and networks all over the world, he doesn't have to open a foreign bureau, he's already there. A Fox News anchor can get information from a New York Post reporter in New York or a co-owned newspaper in Sydney in seconds. You must either get more customers for your programming or reduce your costs."]

**FIGURE 11.18**  
*Continued*

## APPENDIX 11C: Syndication

**FIGURE 11.19**  
This interview with Tom Griswold was conducted by Jay Williams, Jr. Courtesy same.

Interview with Tom Griswold, of the Bob & Tom Show, Indianapolis "Quotations" are from Tom Griswold

Show is delivered to 125 stations nationwide via satellite.

It's distributed by Premier Radio Network (owned by Clear Channel).

Interesting note . . . Premier used to have separate salespeople for certain shows and they are now moving to a model where all the sales people will sell all the shows.

Shows are fed live from 6:00 to 10:00 A.M. Eastern time . . . with three 6 minute breaks per hour for local programming (commercials, news updates, etc). Some stations, mostly in the Mountain States or on the West Coast, will tape delay the broadcast to fit their morning time slots.

Bob and Tom try to entertain . . . and don't focus on their local area at all. "If you listen to the show, you wouldn't know where we were here" (Indianapolis). Tom doesn't think syndicated shows like Bob and Tom will replace local shows but believes "there will be a mix of local and syndicated shows. There is still a big demand for a lot of local content."

"We tip-toed into it (syndication) starting out with three affiliates. But the show took off quickly. One magazine had voted us as one of the 'most stolen-from radio shows in America,' and it was great to be able to get our show out there."

Preparing for a show. "There's at least one aspect that's easier. If you make a comment about a local institution, it could cost your station billings from some advertiser who gets upset. But when you're getting material from all over the nation, rarely do you get negative feedback. And there's a lot more ammo to choose from nationally – you don't have to rely on what happened at the local school board."

Live is very important. "I could listen to tapes or CD's, but I listen to radio just to keep in touch."

XM and Sirius – "both of them will make it" . . . maybe not with the same stockholders, but they will be able to produce great shows and have great talent. These national satellite radio networks "are delivering variety with low commercial loads; local radio stations have lots of commercials and all sound the same. XM even went after Howard Stern – they know the next step is to get great talent on the air." John considers satellite radio, national radio, or syndicated radio, just in a slightly different form.

## APPENDIX 11D: Syndication

Interview with John H. Garabedian

Radio and TV entrepreneur, former president of Superadio Networks, and current host of "Open House Party." John also started V66 in Boston, probably the first music video television station.

"Quotation marks" are from John Garabedian

Much of the live programming is done using C-Band satellite distribution (vs. the less reliable KU satellite systems). The costs of satellite distribution keeps coming down and a satellite uplink only costs about \$150,000, so programming can come from almost anywhere.

Hundreds of successful programs are distributed nationally . . . including Delilah, Paul Harvey news, Rush Limbaugh, and Howard Stern. It's over a \$1 billion business.

John says there's not much difference between network radio and syndication but suggests the difference is that Network programs are rated by RADAR, a national service (now owned by Arbitron) that produces ratings for radio network programming. He says that other than that, there is really no difference.

He says that Superadio, now owned by Access One Communications (also owners of American Urban Radio Network and individual radio stations), sends out over 5000 CDs a week!

John believes that "live and local shows" are overrated in radio.

"Everyone in radio thinks you have to have a local morning show to win. That radio is local. That's wrong. Don't waste your time with the 'Bob and Debbie' show. The people who control radio in the future will be the people who have the talent . . ." "Howard Stern died for our (syndicators') sins. He said, 'Don't put on local shows – just put on the Howard Stern Show and you'll be #1,' and he was right."

The goal of the big radio groups is "to control all their own programming. There will be more centrally programmed live shows." If they don't do it nationally, they'll probably start doing it regionally. "They can take the best talent from all of their classic rock stations and make one really great radio station" that people will really want to listen to and save a fortune in costs in the process. "And local PD's won't screw up making bad music decisions." All programming, he believes, will become more national.

**FIGURE 11.20**

This interview with John H. Garabedian was conducted by Jay Williams, Jr. Courtesy same.

## Afterword

### Jay Williams, Jr.



The cliché, "The future's just not what it used to be," applied to radio, is also true. The radio industry is experiencing wrenching structural upheaval, sea changes in operating philosophies, painful personnel layoffs, plunging revenues and business valuations, and uncertainty about its future. But this 85-year-old medium has been counted out before, and it came back stronger than ever.

#### Two Breathtaking Inventions

Radio, Marconi's invention that magically reproduced sound from thin air, was an instant success. From the early

### The Future of Radio

1920s, families gathered around the large consoles to hear drama, news, orchestras, and FDR's "Fireside Chats." Late into the night, kids listened to stations from far-away cities, mesmerized by the mysterious glowing tubes that created the staticky sound. Television arrived to a war-weary country in the 1950s, and TV's explosive impact cannot be overstated! TV was radio with pictures. Universally loved radio stars like Jack Benny jumped to this new medium, and experts predicted radio's demise. But radio adapted and innovated, dropping network dramas for live news, personalities, and music. Programming innovations, coinciding with the rise of rock 'n' roll music and the invention of inexpensive, portable battery-powered transistor radios, gave radio a new life and future.

#### Technology Changed Consumer Expectations

In the early 70s, another invention upended the very concept of broadcasting. Before the VCR, families had to watch the "Carol Burnett Show" at 8 P.M. on Wednesday, or miss it entirely. The VCR changed how media was used by transforming "real time" into "my time." The VCR marked the beginning of a new era of consumer

control of media. Another 20 years later, computer and digital technology spawned a tsunami of innovations that have changed the media landscape completely.

Digital technology has transformed the way we live and work, propelled by systems and devices only dreamed of a few years ago. Once meaningless letter and alphanumeric combinations such as MP3, DVD, iPod, PDA, Ti-Vo, SMS, and GPS are now digital necessities. The fierce battle to supply consumers with entertainment, information, and communication options is having its impact on all media, including radio. One battle for the keys into the consumers' homes is evidenced by competing ads for cable, satellite TV, and "bundled" fiber optics telephone services. But the critical battle is for control of enhanced digital handheld devices that have become more versatile and powerful even as they shrink. Portability, the once unique edge radio owned, is making handhelds indispensable for consumers.

Technology itself has become its own force driving listening and media decisions. Technology precipitated the growth of the Internet, huge numbers of distribution channels, wireless communications, and social networking that, along with increasingly flexible and glamorous devices, lure consumers

with boundless content choices, and on-demand capabilities.

## Technology, Regulation, and New Competition

Digital technology, coupled with the Telecom Act of 1996 that legalized publicly traded radio companies and the consolidation of the industry, revolutionized radio operations. Unattended operations, digital workstations, ISDN lines, and centralized billing and traffic systems streamlined radio operations. Voice-tracking hour-long music programs in minutes enhanced personnel productivity and flexibility. Group operators utilized digital technology to reduce costs by putting their best on-air people and syndicated products on multiple stations. But while technology delivered new efficiencies, it also gave rise to new competition and challenges.

Until the 1990s, "radio" described the AM and FM stations licensed to a limited number of frequencies in a given city or market because of the limitations of the radio spectrum. Technology demolished those limitations. The term "radio" now encompasses new distribution channels that encompass thousands of Internet stations, Sirius-XM and other satellite radio services, web-based "personalization technology-powered" stations such as Pandora, low-power FM stations (soon to become more prolific), and HD (high definition) channels. Not only are all these "stations" vying for their share of the listeners and ultimately revenues, they compete for consumers' time and minds with an immense number of global providers shoving content through an endless stream of devices: TV, computers, iPods, BlackBerrys, Xbox, Kindle, and many more.

## The Impact on Radio

Traditional or "old media" is under siege. Newspapers, some published for 200 years, are in rapid economic decline, battered by free, up-to-the-second online versions and an economic crisis that demolished advertising budgets. Yellow pages, television,

magazines, and radio have all felt the impact; even "new media" including satellite and Internet radio are suffering. This new choice-filled environment arrives at an inopportune time for terrestrial radio. Too much talk, too many commercials, lack of compelling content, flagging community involvement, homogenized music, absence of exciting head-to-head competition, and staff reductions have contributed to radio's vulnerability. Radio has been too content to simply "broadcast," spending few resources on listener feedback or relationships. Revenue and valuation declines, accelerated by a weakened economy, forced many debt-stressed operators to slash overhead well beyond "streamlining." Hundreds of personalities, news and sportscasters, salespeople, and managers nationwide have been axed from payrolls. Although locally programmed stations operated by dedicated broadcasters still exist, those numbers are declining. The golden age of local radio has passed.

## Radio Reacts

Terrestrial radio broadcasters view the future with trepidation, but they are making changes to meet it. High definition, HD radio, rapidly launched in 2006, uses digital technology to create new "side channels" from existing terrestrial signals. Although listeners must buy a new HD radio to receive these new stations, listeners can receive them free. Promising more unique programming, broadcasters see HD radio as a new way forward.

Many broadcasters are pressing for the expansion of more precise electronic audience measurement technologies such as the PPM, the Personal People Meter, to replace the diary system of listening "estimates" to establish more credibility with advertisers and agencies determined to get better value for their advertising dollars. Other broadcasters are striving to develop new sources of revenue by updating and monetizing station websites, developing promotional and event marketing tie-ins, and targeting new

sources of advertising such as government programs and recruitment.

In this choice-filled environment, it is not surprising that people have become more "atomized" than ever before. Traditional social institutions such as the church, town meetings, fraternal and service organizations are disappearing; humans, who require social interaction for enjoyment and health, are progressively drawn toward "causes" and social networking to supply the "communities" that they need. This presents an opportunity for radio to nurture social involvement on a local level.

## Radio Requires Renewal and Reinvestment

Radio's core strengths remain; expanding on them is the best course to ensure terrestrial radio's future. Radio has well-known personalities, personalities so influential that President Obama chided political opponents by saying, "You can't just listen to Rush Limbaugh and get things done." Like Limbaugh or not, the president's comment is testimony to radio's power and influence. From Don McNeill, to Larry Lujack, Howard Stern, and Mark Levin, personalities have made radio compelling through generations. These familiar voices serve as companions and friends, commanding enduring loyalties unlike any other media. That's because listening to radio, even in a carpool, is a personal, one-on-one experience. Radio is the perfect multitasking medium that is often used surfing the web, studying, or in the workplace. Radio has the best opportunity to be local, be integrated in the community and provide a social network. With the decline of newspapers, magazines, yellow pages, and other media, radio also has a renewed opportunity to capture new local advertising revenue. Radio serves as an editor. In this world of expanding choice and complexity, radio serves as a personal filter, eliminating the necessity of wading through limitless material by selecting the most interesting, entertaining, and popular sources of music and information. Unlike an iPod, radio

continuously refreshes and edits content for the listener, adding the benefit of "surprise." Radio is free, easy to use, portable, and universally accessible. Almost 95% of all Americans listen to radio once a week, amazingly loyal to radio's relatability, reliability, personalities, and content. The industry must now press to ensure that radio is included in as many handheld devices as possible.

### Focus on the Future

Radio's future requires reinvestment. This will mean finding, training, and promoting on-air talent to rebuild radio's product and appeal. Radio must reframe itself for the advertiser and abandon its antiquated "mass appeal" approach. Radio should focus on its exceptional efficiency as a targeted, personal medium that reaches age 25+ working consumers in a local market. Gone are the days of competing with TV or newspapers on a mass scale; that's no longer relevant. The radio industry knows too little about its own customers; fixing this will require a commitment to identify, target, and develop a relationship with radio's core listeners to enable it to be more responsive, useable, and relatable.

Radio must quickly look outside itself to expand its reach and brand by integrating into far reaching social networking communities. Radio's leaders must oppose the so-called Fairness Doctrine, issue-strangling legislation that failed in the 60s. Under the principle that every station must broadcast "opposing views," virtually impossible to administer in a political environment with multiple positions, this proposal ignores the existence of the "unregulated" media marketplace that includes satellite, Internet, cable TV, and other distribution channels. If the "Fairness Doctrine" is revived, the loser will be local terrestrial radio that, financially unable to hire enough lawyers or pay government fines, will forfeit politically oriented personalities to other outlets. Given the decline of newspapers with their free press guarantees, any government regulation of broadcast content will cast a chilling pall on Free Speech. Importantly, it will take reinvigorated confidence and belief in the medium by a breed of radio leaders who see possibilities, not obstacles. With a new infusion of leadership, radio, even in its most traditional form, will still be there to inform, stimulate, and entertain in more ways than ever before.

### A Personal Note

If you're a student, inquisitive, observant, and willing to work, you can be an important part of radio's future. Radio, as with all media, needs intelligent young people at all levels who can communicate clearly and knowledgeably. Editing and filtering information to listeners are important, thoughtful processes requiring a familiarity with history to give events proper context and the ability to write interestingly and concisely. Understanding business and observing consumer trends is important for sales and sales managers who are ultimately successful by helping their advertising clients become successful. A desire to become involved in shaping and serving the needs of a community and its organizations, charities, and infrastructure is essential to radio's mission and continued importance. An understanding of technology, what it can do, and an ability to imagine what it might do in the future will also serve you well. Sherlock Holmes once said to Dr. Watson, "You see, but you do not observe. There is a distinction." Successful radio reflects its community; this cannot be done by those who do not observe what they see around them.

## Glossary

- ABC** American Broadcasting Company; network.
- AC** Adult Contemporary format.
- Account executive** Station or agency salesperson.
- Actives** Listeners who call radio stations to make requests and comments or in response to contests and promotions.
- Actuality** Actual recording of news event or person(s) involved.
- ADI** Area of Dominant Influence; Arbitron measurement area.
- Adjacencies** Commercials strategically placed next to a feature.
- Ad lib** Improvisation; unrehearsed and spontaneous comments.
- Affidavit** Statement attesting to the airing of a spot schedule.
- AFTRA** American Federation of Television and Radio Artists; union composed of broadcast performers: announcers, deejays, and newscasters.
- Aircheck** Tape of live broadcast.
- AM** Amplitude modulation; method of signal transmission using Standard Broadcast band with frequencies between 535 and 1605 (1705) kHz.
- AMAX** Enhanced AM receiver developed by the NAB.
- Analog** Continuous variation in quantity of soundwaves and current.
- Announcement** Commercial (spot) or public service message of varying length.
- AOR** Album-Oriented Rock radio format.
- AP** Associated Press; wire and audio news service.
- Arbitron** Audience measurement service employing a 7-day diary to determine the number of listeners tuned to area stations.
- ASCAP** American Society of Composers, Authors, and Publishers; music licensing service.
- Attenuate** Reduce signal; decrease levels or output.
- Audio** Sound; modulation.
- Audio animator** Term used by satellite radio for production person.
- Audition tape** Telescoped recording showcasing talents of air person.
- Automation** Equipment system designed to play prepackaged programming.
- Average quarter-hour (AQH) persons** See the research glossaries in the Appendices of Chapter 6.
- AWRT** American Women in Radio and Television.
- Back announce** Recap of preceding music selections.
- Barter** Exchange of airtime for programming or goods.
- BEA** Broadcast Education Association.
- Bed** Music behind voice in commercial.
- Blasting** Excessive volume resulting in distortion.
- Blend** Merging of complementary sound elements.
- Blog** Internet journal or diary page of personality or talk host.
- Book** Term used to describe rating survey document; "bible."
- BM** Beautiful Music radio format.
- BMI** Broadcast Music Incorporated; music licensing service.
- Branding** Establishing station identity and value.
- Bridge** Sound used between program elements.

- BTA** Best-time-available, also run-of-station (ROS); commercials logged at available times.
- Bulk eraser** Tool for removing magnetic impressions from recording tape.
- Bumper** Music played to intro segments on talk programs and features.
- Call letters** Assigned station identification beginning with "W" east of the Mississippi and "K" west.
- Capstan** Shaft in recorder that drives tape.
- Cart** Plastic cartridge containing a continuous loop of recording tape.
- CCC** Clear Channel Communications
- CFR** *Code of Federal Regulations*.
- Chain broadcasting** Forerunner of network broadcasting.
- CHR** Contemporary Hit Radio format.
- Clock** Wheel indicating sequence or order of programming ingredients aired during one hour.
- Clustering** Combining the operations of several stations.
- Cold** Background fade on last line of copy.
- Combo** Announcer with engineering duties; AM/FM operation.
- Commercial Paid** advertising announcement; spot.
- Compact disc (CD)** Digital recording using laser beam to decode surface.
- Compression** Manipulation of audio dynamic range; control frequency range.
- Console** Audio mixer consisting of inputs, outputs, toggles, meters, and pots; board.
- Consolidation.** See *Clustering*.
- Consultant** Station advisor or counselor; "radio doctor."
- Control room** Center of broadcast operations from which programming originates; air studio.
- Cool out** Gradual fade of bed music at conclusion of spot.
- Co-op** Arrangement between retailer and manufacturer for the purpose of sharing radio advertising expenses.
- Copy** Advertising message; continuity; commercial script.
- Cost per point (CPP)** See the research glossaries in the Appendices of Chapter 6.
- Cost per thousand (CPM)** See the research glossaries in the Appendices of Chapter 6.
- CPB** Corporation for Public Broadcasting.
- CRB** Copyright Review Board.
- CRMC** Certified Radio Marketing Consultant.
- Crossfade** Fade-out of one element while introducing another.
- Cue** Signal for the start of action; prepare element for airing; queue.
- Cue burn** Distortion at the beginning of a record cut resulting from heavy cueing.
- Cume** See the research glossaries in the Appendices of Chapter 6.
- DAB** Digital audio broadcasting.
- DARS** Digital Audio Radio Service.
- DAT** Digital audio tape.
- Dayparts** Periods or segments of broadcast day: for example, 6 to 10 A.M., 10 A.M. to 3 P.M., 3 to 7 P.M.
- Daytimer** AM station required to leave the air at or near sunset.
- Dead air** Silence where sound usually should be; absence of programming.
- Deejay** Host of radio music program; announcer; disk jockey.
- Demagnetize** See *Erase*.
- Demographics** Audience statistical data pertaining to age, sex, race, income, and so forth.
- Digital** Convergence of analog waveform to numerical code.
- Direct Broadcast Satellite (DBS)** Powerful communications satellite that beams programming to receiving dishes at earth stations.
- Directional** Station transmitting signal in a preordained pattern so as to protect other stations on similar frequency.
- Distortion** Audio garble.
- DMX** Digital music satellite service.
- Dolby** Noise reduction system.
- Donut spot** Commercial in which copy is inserted between segments of music.
- DOS** Director of Sales.
- Double billing** Illegal station billing practice in which client is charged twice.
- Downloading** Gathering audio or video from the Internet for storing on a portable device.
- Downsizing** Reducing staff by combining functions and departments.
- Drivetime** Radio's prime time: 6 to 10 A.M. and 3 to 7 P.M.
- Dub** Copy of recording; duplicate (dupe).
- EBS/EAS** Emergency Broadcast System/Emergency Alert System.
- Edit** To alter composition of recorded material; splice.



- ENG** Electronic news gathering.
- Equalization** Manipulation of frequency spectrum.
- Erase** Wipe clean magnetic impressions; degauss, bulk, deflux, demagnetize.
- ERP** Effective radiated power; tape head configuration: erase, record, playback.
- ET** Electrical transcription.
- Ethnic** Programming for minority group audiences.
- Fact sheet** List of pertinent information on a sponsor.
- Fade** To slowly lower or raise volume level.
- FCC** Federal Communications Commission; government regulatory body with authority over radio operations.
- Feedback** Recycling of audio signal; reamplification.
- Fidelity** Trueness of sound dissemination or reproduction.
- Fixed position** Spot routinely logged at a specified time.
- Flight** Advertising air schedule.
- FM** Frequency modulation; method of signal transmission using 88 to 108 MHz band.
- FMX** System used to improve FM reception.
- Format** Type of programming a station offers; arrangement of material, formula.
- Frequency** Number of cycles-per-second of a sine wave.
- Fulltrack** Recording utilizing entire width of tape.
- Gain** Volume; amplification.
- Generation** Dub; dupe.
- Grease pencil** Soft-tip marker used to inscribe recording tape for editing purposes.
- Grid** Rate card structure based on supply and demand.
- Gross rating points (GRP)** See the research glossaries in the Appendices of Chapter 6.
- Ground wave** AM signal traveling the earth's surface; primary signal.
- HD** High-definition radio.
- HID2** An HD radio frequency side-channel.
- Headphones** Speakers mounted on ears; headsets, cans.
- Hertz (Hz)** Cycles per second; unit of electromagnetic frequency.
- HLT** Highly leveraged transaction.
- Hot** Overmodulated.
- Hot clock** Wheel indicating when particular music selections are to be aired.
- Hype** Exaggerated presentation; high intensity, punched.
- IBEW** International Brotherhood of Electrical Workers; union.
- IBOC** In Band On Channel.
- ID** Station identification required by law to be broadcast as close to the top of the hour as possible; station break.
- Imager** Audio production person.
- Input** Terminal receiving incoming current.
- Institutional** Message promoting general image.
- iPod** Portable media player.
- IPS** Inches per second; tape speed: 1, 3, 15, 30 IPS.
- IRT** Internet radio tuner.
- ISDN** Integrated Services Digital Network.
- ITU** International Telecommunications Union; world broadcasting regulatory agency.
- Jack** Plug for patching sound sources; patch-cord, socket, input.
- Jack format** Programming emulating iPod sound mix.
- Jingle** Musical commercial or promo; signature, logo.
- Jock** See *Deejay*.
- JRAM** *Journal of Radio and Audio Media*.
- KDKA** Radio station first to offer regularly scheduled broadcasts (1920).
- Kilohertz (kHz)** One thousand cycles per second; AM frequency measurement, kilocycles.
- Leader tape** Plastic, metallic, or paper tape used in conjunction with magnetic tape for marking and spacing purposes.
- Level** Amount of volume units; audio measurement.
- Licensee** Individual or company holding license issued by the FCC for broadcast purposes.
- Line** Connection used for transmission of audio; phone line.
- Line-of-sight** Path of FM signal; FM propagation.
- Liner cards** Written on-air promos used to ensure adherence to station image; prepared ad-libs.
- Live copy** Material read over air; not prerecorded.

- Live tag** Postscript to taped message.
- LMA** Local marketing (or management) agreement.
- Local channels** Class D AM stations found at high end of band: 1200 to 1600kHz.
- LPFM** Low power FM.
- Make-good** Replacement spot for one missed.
- Market Area** served by a broadcast facility; ADI.
- Master** Original recording.
- Master control** See *Control room*.
- MBS** Mutual Broadcasting System; radio network.
- Megahertz (MHz)** Million cycles per second; FM frequency measurement, megacycles.
- Mergers** Consolidation or combining of assets and resources.
- Mini-disc machines** Digital cart decks employing floppy disc technology for audio reproduction and archiving.
- MIS** Manager of Information Systems.
- Mixdown** Integration of sound elements to create desired effect; production.
- MMD** Mobile multimedia device.
- MMS** Mobile music services.
- Monitor** Studio speaker; aircheck.
- Mono** Single or full-track sound; monaural, monophonic.
- MOR** Middle-of-the-Road radio format.
- Morning Drive** radio's primetime daypart: 6 to 10 A.M.
- MP3** Digital audio player.
- MSA** Metro Survey Area; geographic area in radio survey.
- Multitasking** Performing several duties.
- Multitracking** Recording sound-on-sound; overdubbing, stacking tracks.
- Music sweep** Several selections played back-to-back without interruption; music segue.
- NAB** National Association of Broadcasters.
- NAEB** National Association of Educational Broadcasters.
- Narrowcasting** Directed programming; targeting specific audience demographic.
- NBC** National Broadcasting Company; network.
- Network** Broadcast combine providing programming to affiliates: NBC, CBS, ABC, MBS.
- Network feed** Programs sent via telephone lines or satellites to affiliate stations.
- News block** Extended news broadcast.
- NPR** National Public Radio.
- NRSC** National Radio Systems Committee.
- NTR** Nontraditional revenue.
- O & Os** Network or group owned and operated stations.
- OES** Optimum effective scheduling.
- Off-mike** Speech outside normal range of microphone.
- Out-cue** Last words in a line of recorded copy.
- Output** Transmission of audio or power from one location to another; transfer terminal.
- Overdubbing.** See *Multitracking*.
- Overmodulate** Exceed standard or prescribed audio levels: pinning VU needle.
- Packaged** Canned programming; syndicated, prerecorded, taped.
- Pandora** Internet music source.
- Passives** Listeners who do not call stations in response to contests or promotions or to make requests or comments.
- Patch** Circuit connector; cord, cable.
- Patch panel** Jack board for connecting audio sources: remotes, studios, equipment; patch bay.
- PBS** Public Broadcasting System.
- PDA** Personal digital assistant.
- Pinch roller** Rubber wheel that presses recording tape against capstan.
- Playback** Reproduction of recorded sound.
- Playlist** Roster of music for airing.
- Plug** Promo; connector
- P1, P2, P3** Arbitron scale of a station's time spent listening (TSL).
- Podcast** Online archived/posted audio available for downloading.
- Popping** Break-up of audio due to gusting or blowing into mic; blasting.
- Positioner** Brief statement used on-air to define a station's position in a market.
- Pot** Potentiometer; volume control knob, gain control, fader, attenuator, rheostat.
- PPM** Portable People Meter.
- Production.** See *Mixdown*.
- Promax** Broadcast promotion and marketing executives association.
- PSA** Public Service Announcement; noncommercial message.
- Psychographics** Research term dealing with listener personality, such as attitude, behavior, values, opinions, and beliefs.
- Punch** Emphasis; stress.
- Quadraphonic** Four-speaker/channel sound reproduction.

- RAB** Radio Advertising Bureau.
- Rack** Prepare or set up for play or record: "rack it up"; equipment container.
- RADAR** Nationwide measurement service by Statistical Research, Inc.
- RAIN** *Radio and Internet Newsletter*.
- Rate card** Statement of advertising fees and terms.
- Rating** Estimated audience tuned to a station; size of listenership, ranking.
- RCA** Radio Corporation of America; NBC parent company.
- RDS/RBDS** Technology that enables AM and FM stations to send data to "smart" receivers, allowing them to perform several automatic functions.
- Recut** Retake; rerecord, remix.
- Reel-to-reel** Recording machine with feed and take-up reels.
- Remote** Broadcast originating away from station control room.
- Reverb** Echo; redundancy of sound.
- Rewind** Speeded return of recording tape from take-up reel.
- Ride gain** Monitor level; watch VU needle.
- Rip'n read** Airing copy unaltered from wire.
- rpm** Revolutions per minute:  $33\frac{1}{3}$ , 45, and 78 rpm.
- R&R** *Radio & Records* magazine
- RTNDA** Radio and Television News Directors Association.
- Run-of-station (ROS)** See *BTA*.
- Satellite** Orbiting device for relaying audio from one earth station to another; DBS, Comsat, Satcom.
- SBE** Society of Broadcast Engineers.
- SCA** Subsidiary Communication Authority; subcarrier FM.
- Secondary service area** AM skywave listening area.
- Segue** Uninterrupted flow of recorded material; continuous.
- SESAC** Society of European Stage Authors and Composers; music licensing service.
- SFX** Abbreviation for sound effect.
- Share** Percentage of station's listenership compared to competition; piece of audience pie.
- Side-channel** An additional HD channel or frequency.
- Signal** Sound transmission; RF. Signature Theme; logo, jingle, ID.
- Simulcast** Simultaneous broadcast over two or more frequencies.
- SiriusXM** Satellite radio service; subscriber-based audio source.
- Sound Imager** Audio producer, animator.
- Spec spot** Specially tailored commercial used as a sales tool to help sell an account.
- Splice** To join ends of recording tape with adhesive; edit.
- Splicing bar** Grooved platform for cutting and joining recording tape; edit bar.
- Sponsor** Advertiser; client, account, underwriter.
- Spot set** Group or cluster of announcements; stop set.
- Spots** Commercials; paid announcements.
- Station** Broadcast facility given specific frequency by FCC.
- Station identification** See *ID*.
- Station log** Document containing specific operating information as outlined in Section 73.1820 of the *FCC Rules and Regulations*.
- Station rep** Company acting in behalf of local stations to national agencies.
- Stereo** Multichannel sound; two program channels.
- Stinger** Music or sound effect finale preceded by last line of copy; button, punctuation.
- Straight copy** Announcement employing unaffected, nongimmicky approach; institutional.
- Stringer** Field or on-scene reporter.
- Subliminal** Advertising or programming not consciously perceived; below-normal range of awareness, background.
- Sweep link** Transitional jingle between sound elements.
- Syndicator** Producer of purchasable program material.
- Tag** See *Live tag*.
- Tagging device** Allows listener to buy songs they hear on radio.
- Talent** Radio performer; announcer, deejay, newscaster.
- Talk** Conversation and interview radio format.
- TAP** Total audience plan; spot package divided between specific dayparts: AAA, AA, A.
- Tape speed** Movement measured in inches per second: 3, 7, 15 IPS.
- Telescoping** Compressing of sound to fit a desired length; technique used in audition tapes and concert promos, editing.
- TFN** Till further notice; without specific kill date.

- Trade-out** Exchange of station airtime for goods or services.
- Traffic** Station department responsible for scheduling sponsor announcements. Transmit to broadcast; propagate signal; air.
- TSA** Total survey area; geographic area in radio survey.
- Underwriter** See *Sponsor*.
- Unidirectional mic** Microphone designed to pick up sound in one direction; car-dioid, studio mic.
- UPI** United Press International; wire and audio news service.
- VOA** Voice of America.
- Voicer** Voice of another news reporter.
- Voiceover** Talk over sound.
- Voice-tracking** Prerecorded announcer.
- Volume** Quantity of sound; audio level.
- Volume control** See *Pot*.
- VU** Meter gauge measuring units of sound.
- WARC** World Administrative Radio Conference; international meeting charged with assigning spectrum space.
- Web radio** Online radio station.
- Web site** Station Internet site.
- Wheel** See *Clock*.
- Wifi** Wireless Internet access.
- Windscreen** Microphone filter used to prevent popping and distortion.
- Wireless telegraphy** Early radio used to transmit Morse code.
- Wow** Distortion of sound created by inappropriate speed; miscue.
- Wrap** Open and close voicers in actuality.
- XM Satellite** Former independent satellite radio service; subscriber audio source.

8  
a  
/

## Index

Note: Page numbers in italics indicate boxes and figures.

- A**  
Aaron, Paul, 49–50  
ABC (American Broadcasting Company), 6, 35, 162–163, 173  
Abel, John, 23  
Abrams, Lee, 26, 58, 97, 280, 313  
Account executives, becoming, 128–130  
Active Rock format, 81  
Actualities, 166, 171  
ADI (Areas of Dominant Influence), 184  
Adult Contemporary (AC) format, 76–77, 312  
Advertising, *see also* Commercials  
  BTA plans, 135  
  budget, 135  
  co-op, 151–153, 246  
  cost of, 15, 133–137  
  direct, 125  
  indirect, 125  
  mixed media, 143  
  optimum effective scheduling, 135  
  reasons to, 140  
  run-of-station plans, 135  
  sales pitch, 137–139, 147  
  station trade agreement form, 151  
  terms and conditions, 243  
  total audience plan, 135  
  trade-outs, 153  
Advertising agencies, 147–148  
  budget, 147  
  full-service, 148  
  how agencies buy radio, 198  
  in-house agencies, 148  
  modular, 148  
  software for, 138  
ADWEEK, 133  
African American (Ethnic) format, 87  
AFTRA (American Federation of Television and Radio Artists), 67  
Age, listeners by, 3, 20  
*Airplay Monitor*, 109  
Album Oriented Rock (AOR) format, 80–81  
All Sports format, 82  
*All Things Considered* program, 12, 13  
All-News format, 14, 81, 163–164  
*Alternative Radio Confidential*, 56  
Alternative Rock format, 80–81  
AM, 52, 276  
broadcast frequencies, 16, 276  
carrier, 279  
daytimer, 15  
listeners by age/gender, 20  
signal propagation, 276–277  
skywave interference, 277  
station classifications, 277–280  
stereo, 11  
talk radio format, 11  
*vs.* FM, 282–283  
during World War II, 7–8  
American Broadcasting Company (ABC), 6, 35, 162–163, 173  
American Indian Radio on Satellite (AIROS), 88  
American Marketing Association, 195  
American Research Corporation, 87  
American Research Foundation, 195  
American Society of Composers, Authors and Publishers (ASCAP), 84, 106, 118  
*Amos'n Andy* radio show, 6–7, 35  
Analog broadcasting, 23, 281–284  
Announcers, tips for, 267–269  
ANOVA (analysis of variance), 200  
Antennas, 276, 278  
AOR (Album Oriented Rock) format, 80–81  
AP (Associated Press), 159, 171–172, 174  
AQH (average quarter-hour) audience, 191, 198  
Arbitron, 79, 82–83, 87, 95, 98, 161  
  average share trends, 185  
  comScore service, 187–188  
  Radio Market Report, 185  
  Radio Report, 193  
  rating system, 146, 150, 183–189  
  software, 138  
Arcara, Jim, 47  
Armstrong, Edwin H., 9, 36, 275, 296  
ASCAP (American Society of Composers, Authors and Publishers), 84, 106, 118  
Associations, managers and industry, 68–70  
AT&T, 4–5  
Audiences  
  demographics, 104, 160, 206  
  and program directors, 104–105  
Audio  
  consoles, 254–256, 272  
  processing, 255, 261–262, 264, 286  
Automation system, 293–295  
syndicated programming, 312–313
- B**  
Baldassano, Corinne, 93, 228  
Balon, Rob, 198  
Bartlett, Dave, 177  
Bates, Carol, 238  
BDS (Broadcast Data Systems), 109  
Beautiful Music format, 10, 14, 36, 79, 163  
Bed music, 261, 270  
Begin, Gary, 96, 197, 202  
Bell, Frank, 109  
Benet, Stephen Vincent, 90, 265  
Benny, Jack, 328  
Berkowicz, Gary, 304, 309, 310  
Best-time-available (BTA) plans, 135  
Beswick, Phil, 188  
Big Band format, 83  
*Billboard*, 91, 107–109  
Billing, 241  
  software for, 240–241  
  tracking of accounts, 243  
Birch/Scarborough, 183, 188–189, 195, 197  
Black formats, 87  
Blogs, 102–104  
Bloom, Andy, 91, 98, 112  
Blone, Chuck, 83  
BMI (Broadcast Music Incorporated), 106, 118  
Board (audio console), 254–256, 272  
Bolton, Ted, 199–201  
Bongarten, Randy, 47  
Bouvard, Pierre, 135  
Boxes (effects processors), 262  
BPA (Broadcasters Promotion Association), 234  
BPME (Broadcast Promotion and Marketing Executives), 234  
Bremkamp, Richard, Jr., 50, 56, 65, 128, 197, 222  
Bridge format, 88  
Broadcast Data Systems (BDS), 109  
*Broadcast Engineering* magazine, 17  
Broadcast frequencies, 17  
Broadcast Music Incorporated (BMI), 106, 118  
Broadcast Promotion and Marketing Executives (BPME), 234  
Broadcast Rating Council, 183  
Broadcasters Promotion Association (BPA), 234  
*Broadcasting and Cable* magazine, 55–56  
*Broadcasting and Cable Market Place* magazine, 70  
*Broadcasting* magazine, 17, 169

- Broadcasting Yearbook*, 69, 240, 270  
 Brokerage firms, 21  
 Budgets  
   advertising, 135, 147  
   programming, 94  
   promotions, 230-233  
   station, 54, 60, 63  
 Building radio station, 70-72  
 Bumper stickers, 225, 226  
 Burkhardt, Kent, 14, 17, 83, 303  
 Burns, George, 55, 304, 312  
 Bush, Billy, 316-317  
 Buying radio stations, 21-22, 70-72
- C**  
 CAB (Cooperative Analysis of Broadcasting), 182  
 Cable radio, 24-26  
 Call letters, 71, 222-223  
 Call sheet, salesperson's, 146  
 Campbell, Bill, 18, 21, 52, 239  
 Cantril, Hadley, 182  
 Car radio, 2  
 Carey, Drew, 318  
 Carriers, 279, 280  
 Cart machines, 259  
 Cassidy, Gregg, 97  
 CBS (Columbia Broadcasting System), 5-6, 35, 159, 162-163, 173, 190  
 CDs (compact disc), 23, 260-261  
 Cell phones and research, 190, 192  
 CFM (Cash flow management), 48  
 CFR, *see Code of Federal Regulations*  
 Chain broadcasting, 5, 35  
 Chapman, Ron, 229  
 Charts, music, 108-109  
 Chief engineers, 60, 66, 285-286, 288  
 CHR (Contemporary Hit Radio) format, 77-78  
 Christian, Lynn, 20, 24, 27, 38, 47, 49, 56, 61, 89, 101, 221  
 Christian format, 86-87  
 Church, Steve, 287  
 Classic format, 83-84  
 Classical format, 85-86  
 Classifications, station, 277-280  
 Clear Channel, 20, 25, 32  
 Cliff, Vicki, 239  
 Clocks  
   morning drive time, 99  
   newscast format, 171-172  
   program, 98, 99, 171-172  
 Cluster, 18-21  
   managing, 56-57  
   programming, 96-97  
   sales organization, 139  
   traffic in, 240-241, 245  
*Code of Federal Regulations*, 66, 111, 233, 278, 280  
 Cohen, Ed, 183  
 Collaborator, manager as chief, 47-49  
 Colleges and noncommercial/public radio, 11-14  
 Colletto, John, 174-175  
 Collier, Dan, 15  
 Commercials, *see also Advertising*  
   first aired, 5  
   formatted spots, 252-253  
   rotated or orbited, 153  
   spec spots, 141-142  
   spot retrospective, 251-252  
 Communications Act of 1934, 7, 30, 36, 291  
*Communicator* newsletter, 169, 177  
 Community and managers, 64-65  
 Community noncommercial radio, 12, 13  
 Compressing signals, 261  
 Computer software  
   for ad agencies, 138  
   for monitoring sales, 144  
   music rotation, 106  
   for newsroom, 165  
   production, 254, 257, 262  
   traffic and billing, 240-241  
 Computers, using in  
   automation system, 293-295  
   electronic newsroom, 164-165  
   logging, 108, 239, 242  
   music programming, 106-107  
   production, 257  
   traffic process, 239-240  
   wire services, 172  
 comScore service, 187-188  
 Concert Music Broadcasters Association, 85  
 Consolidations, 18-21  
 Construction permit (CP), 66, 70  
 Consultants, *see also Syndicator*  
   fees, 309  
   pros and cons, 310-312, 313  
   qualifications, 309-310  
   questions about hiring, 311  
   radio aid and, 303-306  
   services, 304-305, 306-309  
   station critiques, 307-308  
 Contemporary Hit Radio (CHR) format, 77-78  
 Contests, 223  
   and FCC, 233  
   on-air, 223, 232  
   promoting, 219, 231, 232  
   rules, 228, 233, 234  
 Convergence and copyright, 119  
 Cooke, Holland, 161  
 Cool Edit Pro, 262  
 Coolidge, Calvin (President), 4, 5-6  
 Co-op advertising, 151-153, 246  
 Copyright and broadcast industry, 26, 118-119  
 Copywriting, 265-267  
 Cortese, Joe, 93  
 Corwin, Norman, 90, 105  
 Cost per thousand (CPM), 198  
 Costa, Kenneth J., 1, 69  
 Country format, 78-79  
 Country Music Association, 78  
 Country Radio Broadcasters, Organization of, 79  
 Coverage map, 132  
 CPB (Corporation for Public Broadcasting), 12, 13  
 CPP (cost per point), 198, 207  
 Crosley, Roger, 175  
 Crossley, Archibald M., 182  
 Cue mode, 256-257  
 Curran, Andrew, 224, 230
- D**  
 DAB (Digital Audio Broadcasting), 18, 23-24, 36, 281-284  
 DARS (Digital Audio Radio Service), 280  
 Data, qualitative and quantitative, 189-190  
 David, John, 53  
 Davis, Chuck, 218-219, 222, 230  
 Day-parting, 81, 105  
 Declared accounts, 143  
 Deejays, 62, 77, 94, 101-102  
 Demographics, 104, 160, 206  
 Depression, radio during, 6-7  
*Deregulation: A Lawyer's Lament* (Krasnow), 34  
 Diary for audience surveys  
   instructions for filling out, 187  
   log sheet, 188  
 Digital Audio Broadcasting (DAB), 18, 23-24, 36, 281-284  
 Digital audio editing, 264-265  
 Digital Millennium Copyright Act of 1998, 26  
 Digital (mini) disc machines, 259-260  
 Digital Performance Rights in Sound Recording Act (DPRA), 119  
 Digital radio  
   digital and HD radio revolution, 23-24  
   engineering, 281-284  
   in-band on-channel, 23, 29, 283  
   Williams on future of, 328-329  
 Digital sampling and copyright, 119  
 Direct advertising, 125  
 Direct marketing, 226-227, 228  
 Direct sales, 155  
 Director of sales (DOS), 60, 131  
 Directors  
   news, 166  
   program, *see Program directors (PDs)*  
   promotion, *see Promotion director*  
 Disc machines, mini, 259-260  
 Disco format, 84, 87  
 Dix Communications, 57  
 Dolan, Jim, 240  
 Donahue, Tom ("Big Daddy"), 10  
 DOS (Director of Sales), 58  
 Douglas, Dwight, 199, 201, 310-311  
 Douglas, Susan, 189  
 Downsizings, 18-21  
 DPRA (Digital Performance Rights in Sound Recording Act), 119  
 Drake, Bill, 77, 83, 101  
 Drew, Peter, 151  
 DST (Differential Survey Treatment), 195  
 Ducoty, Chuck, 93, 111  
 Dunklee, Jane, 48, 50, 52  
 Dylan, Bob, 25, 118
- E**  
 EAN (Emergency Action Notification), 290, 292  
 EAS (Emergency Alert System), 111, 288, 290-293  
 Easy Listening format, 79-80  
 EBS (Emergency Broadcast System), 290, 293  
 Editing  
   digital and multitrack, 264, 267  
   production room, 253-254  
   software tools for, 257, 262  
 EEO (Equal employment opportunity), 65, 111  
 Effects processors, 262  
 Eldredge, Tripp, 190-191  
 Electronic Media Planning Council, 183, 202  
 Electronic newsroom, 164-165  
 Ellis, Dick, 11, 88, 313  
 Ellis, Dwight, 33  
 E-mail surveys, 194  
 Emergency Alert System (EAS), 111, 288, 290-293  
 Employment  
   careers in research, 198-199  
   EEO, 65, 111  
   jobs and equality in radio, 32-35

- Engineering  
 AM/FM broadcast frequencies, 276  
 automation, 293-295  
 digital audio broadcasting, 281-284  
 emergency alert system, 290-293  
 Internet radio, 280-281  
 posting licenses and permits, 295-296  
 radio technology, 276  
 satellite radio, 280  
 signal propagation, 276-277  
 skywave interference, 277  
 smart receivers, 285  
 station classifications, 277-280  
 station logs, 288-290
- Engineers  
 becoming an, 285-287  
 chief, 60, 66, 285-286, 288  
 duties, 287-288  
 pioneer, 3-4, 275-276  
 station, 286-287, 288
- Equal employment opportunity (EEO), 65, 111
- Equalizers (EQs), 261-262
- Erickson, Doug, 304
- Etheridge, Gene, 129, 145
- Ethics, news, 176
- Ethnic formats, 87-88
- Evans, Carl, 50, 54, 62
- Event marketing, 153
- F**  
 F.A.C.T. (Fit Acceptance and Compatibility Test), 189
- Faders, 256
- Fairness Doctrine, 30-32, 37, 330
- Falconi, Peter, 91, 105, 111
- Fatherly, Dick, 91, 95, 111
- FCC (Federal Communications Commission), 5, 16, 46, *see also* Government regulations/legislation  
 contests and, 233  
 establishment of, 7  
 Fairness Doctrine, 30-32, 37  
 FCC Docket, 16  
 fines and violations, 33, 65, 110  
 FM regulations, 9-10  
 inspection checklist, 66  
 log requirements, 288-290  
 network restrictions (1940s), 5-6  
 ownership and license application form, 68  
 posting requirements, 295-296  
 and program directors, 110-111  
 promotions and, 220, 233-234  
 radio and government regulations, 29-32, 291  
 and radio news, 175-176, 177  
 regulatory fees, 69  
 retention requirements, 290  
 rule-making process, 34  
 special records requirements, 290  
 station classification, 277-280  
 station logs, 288-290  
 and traffic, 242-244  
 Web site, 19
- Federal Radio Commission (FRC), 6, 35
- Federal Register, 66
- Fees  
 consultants, 309  
 FCC regulatory, 69  
 licensing, 106
- FEMA (Federal Emergency Management Agency), 293
- Ferber, Doug, 22
- Ferris, Charles, 31
- Fessenden, Reginald, 3, 275
- Feuer, Norm, 50, 52, 56, 61
- Fiddick, Paul, 64
- Fifth estate, state of  
 in air-everywhere, 1-3  
 AM stereo, 11  
 birth of networks, 5-6  
 buying/selling radio stations, 21-22  
 conflict in air, 6  
 consolidations, downsizings, and clusters, 18-21  
 digital and HD radio revolution, 23-24  
 economics and survival, 16-18  
 FM's ascent, 9-11  
 as household utility, 3-4  
 Internet radio, 26-27  
 jobs and equality in radio, 32-35  
 L.PFM, 29  
 new direction, 8-9  
 noncommercial/public radio, 11-14  
 profits in air, 15-16  
 proliferation and frag-out, 14-15  
 radio and government regulations, 29-32  
 radio during World War II, 7-8  
 radio prospers during Depression, 6-7  
 radio rocks and roars, 9  
 satellite and cable radio, 24-26  
 surviving economic downturns, 16-18  
 television appears, 8  
 toll on radio, 4-5
- Finances, profit trends in AM/FM, 15-16
- Fishman, Donald, 118-119
- Fleming, J. Ambrose, 3, 275, 296
- Flintoff, Corey, 162, 165, 170
- FM, 52, 276  
 ascent of, 9-11  
 broadcast frequencies, 276  
 carriers, 280  
 listeners by age/gender, 20  
 signal propagation, 276-277  
 skywave interference, 277  
 station classifications, 277-280  
 stereo, 10  
 talk radio format, 10, 82-83  
*vs.* AM, 282-283
- Ford, Ty, 17, 139, 261
- Forest, Lee de, 3, 275
- Formats, program, 75, 313-314  
 Adult Contemporary, 76-77, 312  
 All Sports, 82  
 All-News, 14, 81, 163-164  
 AM talk, 11  
 Beautiful Music, 10, 36, 79, 163  
 Black/African American, 87  
 Classical, 85-86  
 Classic/Oldies/Nostalgia, 83-84  
 Contemporary Hit Radio, 77-78  
 Country, 78-79  
 debuts, by decade, 85  
 Disco, 84, 87  
 ethnic, 87-88  
 FM talk, 82-83  
 Full Service, 88  
 HD<sup>2</sup>, 88-89  
 Hispanic, 87-88, 111  
 Jack, 89  
 market format breakdown, 78  
 new direction (1950s), 8-9  
 News and Talk, 81-82, 163, 168  
 Niche, 88-89  
 nichecasting, 14  
 program clocks, 171-172  
 program suppliers, 312-313  
 proliferation and frag-out, 14-15
- Public radio, 89-90  
 Radio Theater, 90-91  
 Religious/Christian, 86-87  
 Rock and Alternative, 14, 80-81  
 Soft Adult/Easy Listening/Smooth Jazz, 79-80  
 syndicator, 314-315, 316, 319  
 Top 40, 9, 36  
 Urban Contemporary, 84-85
- Forms  
 co-op agreements, 246  
 FCC ownership and license application, 68  
 missed commercials, 240  
 operating log, 292  
 production order, 269  
 spot schedule order, 242  
 station trade agreement, 151
- Fowler, Mark, 31
- Frag-out and proliferation, 14-15
- FRC (Federal Radio Commission), 6, 35, 291
- Freberg, Stan, 252
- Freed, Alan, 9
- Frequencies, broadcast, 276  
 digital audio broadcasting, 281-284  
 radio spectrum table, 280  
 signal propagation, 276-277  
 skywave interference, 277  
 Standard Broadcast band, 6, 35  
 station classifications, 277-280
- Fresh Air*, 13
- Friedman, Charles W., 127-129, 145
- Full Service (FS) format, 88
- Full-service agencies, 148
- G**  
*Gavin Report, The*, 108-109
- Gehron, John, 50
- Geller, Valerie, 47, 306
- Girard, Martha L., 66
- Glickenhau, Mike, 52-53
- GM (general manager), 51, 54, 59
- Government regulations/legislation  
*Code of Federal Regulations*, 66, 111, 233, 278, 280  
 Communications Act of 1934, 7, 30  
 Digital Millennium Copyright Act of 1998, 26  
 FM, 10  
 future of radio, 328-330  
 overview, 29-34  
 Radio Act of 1912, 30  
 Radio Act of 1927, 6, 35  
 Small Webcaster Settlement Act, 26  
 Telecommunications Act of 1996, 18, 19, 31, 37
- Grasso, Matt, 97, 102-103, 263
- Gregory, John, 142, 145, 147
- Grid structure, 134
- GRP (Gross rating point), 198, 207
- Grube, John, 216, 219, 222, 224, 228
- GSM (General sales manager), 58, 131
- H**  
 Hagen, Don, 186, 198-199
- Hakanen, Ernest, 24, 284
- Halper, Donna, 5, 165, 303, 305-306, 309-311
- Ham, Al, 83
- Harney, Peg, 216
- Harvey, Paul, 170
- HD (high-definition) radio, 36, 55, 281-284  
 digital and HD radio revolution, 23-24  
 engineering, 281-284

- HD<sup>2</sup> format, 23–24, 88–89  
 HD<sup>2</sup> selling, 150–151  
 Hertz, Heinrich, 3, 275  
 Heyday, 15  
 Hidalgo, Juan Carlos, 304  
 Hildreth, Jan, 238  
 Hilliard, Robert, 31  
 Hindley, Stephanie, 81  
 Hiring considerations, 61–62  
 Hispanic formats, 87–88, 111  
 HLT (highly leveraged transaction), 17, 36  
 Hooper, C.E., 182  
 Hour-by-hour listening, 4  
 Household utility, 3–4  
 Human resources, 60–61  
 Hunter, Mikel, 306, 310–311
- I**
- IBEW (International Brotherhood of Electrical Workers), 67  
*In Search of Excellence* (Peters), 52  
 In-band on-channel (IBOC) digital signaling, 23, 29, 37, 283  
 Indirect advertising, 125  
 Industry associations and station management, 68–70  
 Ingram, Roger, 50, 54  
 In-house agencies, 148  
 In-house research techniques, 194–195  
 INS (International News Service), 159, 172  
 Insalaco, Jason, 26–27, 82, 103, 150, 165  
*Inside Radio*, 22, 56  
 Intercollegiate Broadcasting System (IBS), 13, 24  
 Internet radio, 26–27, 103, 116  
   engineering, 280–281  
 Internet services, 172  
 Internet surveys, 184, 187  
 Inventory control, 239  
 iPod, 23, 28, 78, 103  
 ISDN (Integrated Services Digital Network), 165, 262–263  
 ITU (International Telecommunications Union), 282  
 iTunes, 102, 277
- J**
- Jack format, 89  
 Jacobs, Fred, 18, 305–306, 311  
 Jansen, Mike, 90  
 Jewett, Larry, 166–167, 178  
 Jordan, Ted, 33, 126, 161  
*Journal of Radio Studies*, 77  
 Journalists, Society of Professional, 176  
 Joyner, Tom, 102
- K**
- KABL (San Francisco), 14  
 Kalulas, Barbara, 238  
 Katz Radio Group study, 2  
 Kennard, William, 29  
 Kennedy, Robert, 160  
 King, Martin Luther, Jr., 160  
 Krasness, Michael A., 28  
 Krasnow, Erwin G., 32, 70
- L**
- Lane, Randy, 46, 51, 53  
 Large-market radio stations, 58  
 Lazarsfeld, Paul F., 182  
 L-band, 23, 280  
 Libraries, sound, 269–270  
 Licenses  
   application form, 68  
   music, 106  
   protecting, 65  
   station, posting, 295–296
- Lifestyles**  
 of listeners, 3, 104–105  
 rating systems organized by, 189
- Lima, Bob, 216, 219, 222–223, 229  
 Limbaugh, Rush, 329  
 Linear faders, 256  
 List building and prospecting, 143–144  
 Listener's perception, of radio  
   business, 46
- Listenership**  
 by age and gender, 3  
 AM, 20  
 estimates of, 1–2  
 FM, 10, 20, 36  
 history of researching, 182–183  
 hour-by-hour listening, 4, 105  
 listening locations, 86  
 public radio, 12  
 during World War II, 7
- Local marketing agreements (LMAs), 17–19, 36  
 Locations, listening, 86
- Log**  
 accounts entered into, 245  
 computerized, 108, 239, 242  
 maintenance, 288, 290  
 operating, 288, 292  
 preparation of, 237–238  
 station, 288–290  
 templates, 245
- Loomis, Mary, 9  
 LPFM (Low-Power FM), 29, 291  
 Lutes, Jon, 106–107
- M**
- M Street Journal*, 86, 88  
 Mail surveys, 194  
 Maintenance logs, 288, 290  
 Management philosophy, 59  
 Manager of information services (MIS), 103, 295
- Managers**  
 and cash flow, 48  
 as chief collaborator, 47–49  
 and community, 64–65  
 duties and responsibilities, 52–56  
 and government, 65–66  
 hiring considerations, 61–62  
 and industry associations, 68–70  
 managing cluster, 56–57  
 objective of, 52  
 organizational chart, 37  
 and profit motive, 62–63  
 publications for, 55  
 qualities of, 49–51  
 small-market stations, 54  
 and unions, 67–68  
 what makes successful, 64
- MapMAKER, 189  
 Marconi, Guglielmo, 3, 30, 35, 275, 296  
 Market rate card, 134  
 Marketing, 148, 221  
   direct, 226–227, 228  
   event, 153  
   local marketing agreements, 17–19  
 Martin, Joe, 129–130, 145  
 Martin, Robin, 22, 32, 71  
 Marx, Steve, 135  
 Mason, Cecilia, 166–167, 172, 178  
 Mason, Dan, 51  
 Maxwell, James Clerk, 3, 275, 296
- Maynard, Dave, 225  
 MBS (Mutual Broadcasting System), 5, 35, 173  
 McCann, Jennifer, 136  
 McLane, Paul J., 286  
 McLendon, Gordon, 10, 14, 81, 163, 215  
 McMullen, Janet, 86  
 McNally, Pat, 17, 48  
 McNamara, Kevin, 285–286, 288  
 Media Rating Council (MRC), 183, 190, 202  
 Medium-market stations, 57–58  
 Melting pot format, 84  
 Men, listeners by age, 3, 20  
 Metro market station manager, 45  
 Michaels, Randy, 1, 18, 227  
 Michaels, Vic, 202, 257, 259, 263  
 Microphones, 263–264  
 Middle-of-the road (MOR) format, 88  
 MIDI (Musical Instrument Digital Interface), 262, 272  
 Miller, Larry, 10, 165, 172, 216, 222, 227, 230, 232, 253  
 Mills, Ken, 12  
 Mini-disc machines, 259–260  
 Minorities and survey results, 195  
 Mirroring effect, 95  
 Mitchell, Brian, 91, 94, 101, 105  
 Mixed media advertising, 143  
 Mobile music services, 28–29, 43  
 Modern Rock format, 81  
 Modular agencies, 148  
*Monday Morning Replay*, 107  
 Morin, Mike, 268  
*Morning Edition* program, 12, 13  
 Morriss, Charlie, 215–216, 219–220, 222–223, 229  
 Morse code, 275  
 MP3 files, 119  
 MP3 players, 282  
 MSA (Metro Survey Area), 184, 202  
 Murphy, Jim, 91  
 Murrow, Edward R., 7
- Music**  
 charts, 108–109  
 file sharing and copyright, 119  
 library, 106, 110  
 licensing fees, 106  
 mobile services, 27–29, 43  
 and program director, 105–110  
 testing, 97, 189, 206  
 Music director, duties of, 105–106, 109  
 Music radio  
   news in, 177–179  
   newscast in, 171–172  
 Myers, Allen, 291
- N**
- NAB (National Association of Broadcasters), 23–24, 29, 33, 51, 55, 119, 240, 309, 318  
 NABET (National Association of Broadcast Employees and Technicians), 67  
 Nadel, Roger, 179  
 Narrowcasting, 14  
 NARTE (National Association of Radio and Telecommunications Engineers), 286  
 National Radio Conferences, 6  
 National Radio Format Share and Station Counts, 76  
 NBC (National Broadcasting Company), 5–6, 35, 159, 173  
   birth of, 5–6  
   chain broadcasting, 5



- Networks  
   birth of, 5-6  
   chain broadcasting, 5, 35  
   radio network news, 172-173  
   vs. syndicator, 315  
*New York Times*, 2  
 Jews  
   All-News format, 14, 81, 163-164  
   and/or Talk format, 81, 163, 168  
   audience demographics, 160  
   directors, 166  
   ethics, 176  
   and FCC, 175-176  
   format, 81-82  
   global, 115  
   history of broadcasting, 159-160  
   Internet services, 172  
   in music radio, 177-179  
   newsperson, 167-169  
   newsroom, 162-165  
   preparing news stories, 169-170  
   on public radio, 12  
   radio during World War II, 7-8  
   radio network news, 172-173  
   in satellite radio, 163  
   for Spanish language station, 178  
   sportscasts, 173-175  
   and talk stations, 164  
   and today's radio, 160-162  
   traffic reports, 176-177  
   wire services, 159, 172  
   lewscasts, organizing, 171-172  
   newspapers, off-air promotion, 225  
   newsperson, 167-169  
   newsroom, 162-163  
     electronic, 164-165  
     software for, 165  
   niche format, 88-89  
   nichercasting, 14  
   NIS (News and Information Service), 173  
   noble, Edward J., 6  
   non-commercial radio, 11-14  
   noonan, Edward J., 183, 198, 201  
   nostalgia format, 83-84  
   NPR (National Public Radio), 11, 12-13, 38, 163  
   NTR (nontraditional revenue), 127  
 )  
 YBrien, Jackie, 269  
 YES (optimum effective scheduling), 135  
 Off-air promotions, 222, 224-226  
 Oldies format, 83-84  
 On-air promotions, 222, 224-225  
 Operating logs, 288, 292  
 Operations manager, 59-60  
 Operator licenses, 295-296  
 Oppenheimer, Dick, 60  
 Optimum effective scheduling (OES), 135  
 Orbited announcements, 135  
 Organizational structure, 57-59  
   of small-market station, 58  
   of station management, 57-59  
   of XM Satellite Radio, 58  
 ORR (Office of Radio Research), 182  
 Ozman, Lorna, 99, 197  
 Personalities, on-air, 25, 88, 216, 217, 218, 311  
 Peters, Rick, 218, 222, 232  
 Pioneers in development of radio, 3-4, 275-276  
 Piro, Ron, 138, 142, 144-145, 147  
 Pitch, sales, 147  
 Planning, for sales day, 144-146  
 Playlist, constructing, 109  
 Plugola, 110, 115  
 PMT (Personalized Music Tests), 199  
 Podcasts, 100, 102-104, 150-151  
 Pollack, Jeff, 77, 89  
 Portable People Meter (PPM), 183, 184, 190-194  
 Porter, Christopher, 189-190, 196, 201  
 Posting licenses and permits, 295-296  
 Power-Gold and Music Master, 106, 107  
 PPM (Portable People Meter), 183, 184, 190-194  
*Prairie Home Companion*, A, program, 13  
 PRI (Public Radio International), 12  
 Price, Lynne, 198  
 Priddy, Bob, 177  
 Prizes  
   budgeting promotions, 231-232  
   FCC considerations, 233-234  
 Pro Tool, 257, 262  
 Processing audio, 261-262  
 Processors, effect, 262  
 Production  
   announcers, tips for, 267-269  
   audio console, 255-256  
   cart machines, 259  
   CDs, 260-261  
   compressors, 261-262  
   computer use, 257  
   copywriting, 265-267  
   cue mode, 256-257  
   digital editing, 264  
   digital (mini) disc machines, 259-260  
   faders, 256  
   formatted spots, 252-253  
   microphones, 263-264  
   order, example, 269  
   patch panels and ISDNs, 262-263  
   production room, 253-254  
   samplers and synthesizers, 262  
   software for, 254, 257, 262  
   sound libraries, 269-270  
   spot retrospective, 251-252  
   studio, overview, 254  
   voice-tracking, 269  
 Profits  
   managers and profit motive, 62-63  
   trends in AM/FM, 15-16  
 Program directors (PDs), 51, 60, 77, 91-93, 102  
   and audience, 104-105  
   checklist, 229  
   duties and responsibilities, 60, 93-96  
   and FCC, 110-111  
   and music, 105-110  
   news director and, 166  
   programming experience, 91-93  
   rules for success, 114  
   and upper management, 111-112  
 Program suppliers, 312-313  
 Programmers, 91-93  
   advice to, 95, 109  
 Programming, 75-121  
   Adult Contemporary, 76-77  
   advice to programmers, 95, 109  
   All Sports, 82  
   All-News, 81  
   AM talk, 11  
   Black/African American, 87  
   budgets, 94  
   Classical, 85-86  
   Classic/Oldies/Nostalgia, 83-84  
   clocks, 98, 99  
   cluster operation, 96-97  
   computerized logging, 108  
   computers in, 106-107  
   Contemporary Hit Radio, 77-78  
   Country, 78-79  
   Disco, 84, 87  
   elements of, 98-102  
   ethnic, 87-88  
   FM talk, 82-83  
   format debuts, by decade, 85  
   formatted spots, 252-253  
   Full Service, 88  
   HD<sup>2</sup>, 88-89  
   Hispanic, 87-88, 111  
   Jack, 89  
   market format breakdown, 78  
   new direction (1950s), 8-9  
   News and Talk, 81-82  
   Niche, 88-89  
   program clocks, 99  
   program wheels, 98-99, 102  
   Public radio, 89-90  
   Radio Theater, 90-91  
   Religious/Christian, 86-87  
   Rock and Alternative, 80-81  
   satellite radio, 97-98, 318  
   Soft Adult/Easy Listening/Smooth Jazz, 79-80  
   syndication, 312-317  
   tracking song's performance, 104  
   Urban Contemporary, 84-85  
   Proliferation and frag-out, 14-15  
   Promax International, 234  
 Promotion director, 95, 215, 228  
   hiring of, 221-222  
   job of, 219-221, 232  
 Promotions, 215-234  
   budgeting, 230-233  
   contests rules, 228, 233, 234  
   director's/manager's job, 219-221  
   and FCC, 220, 233-234  
   involving prizes, 218  
   mistakes, 220  
   off-air, 222, 224-226  
   on-air, 222, 224-225  
   past and purpose, 215-216  
   practical and bizarre, 216-219  
   and ratings, relationship between, 215  
   research and planning of, 228-230  
   sales, 227  
   selling, 227  
   stealth, 224  
   types of, 222-227  
 Propagation, signal, 276-277  
 Prospecting and list building, 143-144  
 Provizer, Stephen, 29  
 PSAs (Public Service Announcements), 251, 253, 262, 265  
 Public File, 66-67, 111  
 Public radio, 11-14  
   format, 89-90  
   Siemering on, 13  
 Public Radio International (PRI), 12  
 Publications for managers, 55  
 Puriez, Jim, 285  
 Put-offs, sales, 138

- Q**  
 Quaal, Ward, 59, 65  
 Qualitative and quantitative data, 189–190  
 Quarter-hour maintenance, 98, 99
- R**  
 RAB (Radio Advertising Bureau), 1–2, 26, 55, 69, 128, 133, 196  
 Rabbitt, Johnny, 216  
 RADAR (Radio's All Dimensional Audience Research), 2, 183  
 Radio  
   cable, 24–26  
   future of research in, 201–202  
   history of, 1–15  
   Internet, 26–27, 103, 116, 280–281  
   public, 11–14  
   satellite, 24–26  
   Williams, on future of, 1, 328–330  
 Radio Act of 1912, 30  
 Radio Act of 1927, 6, 31, 35, 277  
 Radio and Internet Newsletter (RAIN), 27  
 Radio Broadcast Data Systems, 285  
*Radio Business Report*, 21, 55–56, 133  
 Radio Industry Association of America (RIAA), 26, 119  
*Radio Ink* magazine, 18, 27, 55, 65, 77, 240, 307  
 Radio stations  
   availabilities, 239  
   bumper stickers, 225, 226  
   buying or building, 70–72  
   call letters, 222–223  
   competitive environment, model of, 96  
   critiques by consultants, 307–308  
   ID (station identification), 110  
   reach of, 1–2  
   station classification, 277–280  
   Web sites, 27, 102–104, 150–151  
 Radio technology, 276  
 Radio Theater format, 90–91  
*Radio Today* annual report, 2  
*Radio World* magazine, 17–18, 179, 286  
 RadioTraffic.com, 241  
 Ramsey, Mark, 28  
 Rate cards, 132, 133–137  
   audience size and, 133  
   major market, 134  
   sales tools, 133–137  
 Ratings and survey services, 183–189  
 RCA (Radio Corporation of America), 5, 9, 35  
 Reagan, Ronald (President), 31  
 Receivers, radio, 2, 15  
   smart receivers, 285  
 Reed, Aaron, 284  
 Reese, David, 165, 264–265  
 Rehr, David, 69  
 Reising, Rebecca, 189  
 Religious format, 86–87  
 Rep companies, 56, 148–150  
 Research  
   careers in, 198–199  
   cell phones and, 190, 192  
   companies, 189  
   deficits, 195–197  
   future of, 201–202  
   how agencies buy radio, 198  
   minorities and survey results, 195  
   Portable People Meter, 183, 184, 190–194  
   qualitative and quantitative data, 189–190  
   ratings and survey services, 183–189  
   techniques, 194–195  
   who is listening, 182–183  
   Revenues, 9, 15, 17–18, *see also* Sales nontraditional, 67, 151–153  
   Rhoads, B. Eric, 18, 26, 91  
   Richards, Bill, 77  
   Ridgeway, Rip, 197  
   Robertson, Jim, 33, 49, 54–55, 57  
   Rock format, 14, 80–81  
   Rock'n roll, 9  
*Rocking America* (Sklar), 228  
 Roosevelt, Franklin D. (President), 7, 35, 159  
 Rotary faders, 256  
 Rotated announcements, 135  
 Rouge, Baton, 52  
 Royalty Tribune, 119  
 Rozanski, Al, 241  
*R&R (Radio and Records)* magazine, 55–56, 107–109, 169  
 RTNDA (Radio-Television News Directors Association's), 169, 173, 176–177  
 Run-of-station (ROS) plans, 135
- S**  
 Sales, 125–155  
   advertising agencies, 147–148  
   becoming an account executive, 128–130  
   commercialization, retrospective, 125–126  
   contract, radio, 146  
   declared accounts, 143  
   do/don't checklists, 138  
   levels of, 139–141  
   nontraditional revenue, 151–153  
   objectives of advertising, 142–143  
   pitch, 137–139, 147  
   planning sales day, 144–146  
   promotions, 227  
   prospecting and list building, 143–144  
   of radio receivers, 2  
   radio sales tools, 133–137  
   rep companies, 148–150  
   sales manager, 131–133  
   selling airtime, 127  
   selling with and without numbers, 146–147  
   software for monitoring, 144  
   spec spots, 141–142  
   trade-outs, 153  
   typical put-offs, 138  
   Web site, podcast and HD<sup>2</sup> selling, 150–151  
 Sales managers, 60, 131–133  
 Sales pitch, 137–139  
   online pitch, 147  
 Salespeople, characteristics of, 129  
 Salter, J.G., 46, 53, 62  
 Samplers, in production studio, 262  
 Saperstein, David, 54, 94, 173, 176  
 Sarnoff, David, 3–5, 8, 30, 35  
 Satellite radio, 24–26, 92, 280, 296, 298  
   news in, 163  
   programming department, 97–98, 318  
   Williams, on future of, 329  
 S-band, 23, 280, 282  
 SBE (Society of Broadcast Engineers), 286  
 Schweiger, Sid, 285  
 Scott, Dave, 17, 240–241, 305, 307, 310–311, 314–315, 319  
 Sedaka, Neil, 118  
 Selling, *see also* Sales  
   airtime, 127  
   radio stations, 21–22  
   with and without numbers, 146–147  
 SESAC (Society of European Stage Authors and Composers), 106, 118  
 Severeid, Eric, 7  
 Severino, Tom, 57–58  
 Shane, Ed  
   on consultants and syndicators, 306, 313–315  
   on news, 159, 161  
   on programming, 75–78, 82, 87, 92, 98, 103, 106  
   on promotion, 219, 225, 227  
   on research, 190, 197  
   on state of Fifth Estate, 20–21, 29, 33  
   on station management, 52, 55, 62, 72  
 Shank, Cliff, 52, 62  
 Siemering, William, 13  
 Sightradio, 14  
 Signal compression, 261  
 Signal propagation, 276–277  
 Silva, Indra de, 166, 176  
 Simulcasting, 10, 27, 36, 293, 303  
 Sirius Satellite Radio, 2, 25, 252, 280  
 Sklar, Rick, 17–18, 228–229, 309, 313  
 Slide faders, 256  
 Slogans, 222  
 Small Webcaster Settlement Act, 26  
 Small-market radio outlets, 57  
 Smart receivers, 285  
 Smith, Elroy, 87  
 Smith, Judy, 166–168, 170  
 Smooth Jazz format, 79–80  
 Smulyan, Jeff, 49  
 Soft Adult format, 79–80  
 Software, *see* Computer software  
 Sound libraries, 269–270  
 Spanish language station, 87, 178  
 Spec spots, 141–142  
 Specialization, 14  
 Sponsorships, 125  
   cost of, 133–137  
 Sports  
   first network broadcasts, 5  
   radio sportscasts, 82, 91, 173–175  
 Spot schedule, 237–238  
   order form, 237, 242  
 Spruce, Christopher, 61  
 Standard Broadcast band, 6, 35, 276  
 Stanton, Frank, 182  
 Station classifications, 277–280  
 Station engineers, 286–287, 288  
 Station logs, 288–290  
   FCC log requirements, 288–290  
   FCC retention requirements, 290  
   FCC special records requirements, 290  
 Station management, 45  
   buying or building radio station, 70–72  
   chief engineers, 60  
   hiring considerations and, 61–62  
   human resources, 60–61  
   management philosophy, 59  
   manager and industry associations, 68–70  
   manager and profit motive, 62–63  
   manager and unions, 67–68  
   manager as chief collaborator, 47–49  
   managers and community, 64–65  
   managers and government, 65–66  
   managers and industry associations, 68–70  
   manager's duties and responsibilities, 52–56  
   managing cluster, 56–57  
   nature of business, 45–47  
   operations manager, 59–60  
   organizational structure of, 57–59  
   promotion director's/manager's, 219–221  
   Public File, 66–67  
   qualities of managers, 49–51

- sales managers, 60  
 summary, 72-73  
 what makes successful, 64
- Steal, Jimmy, 96, 102
- Stealth promotion, 224
- Stereo  
 AM, 11  
 FM, 10
- Sterling, Christopher, 25
- Stern, Howard, 25, 110, 119, 216, 329
- Steward, Bill, 14
- Stockman, William, 313-314
- Stories, preparing news, 169-170
- Storz, Todd, 9, 14, 215
- Streaming, 26
- Studios  
 on-air, 254  
 production, *see* Production
- Survey services and ratings, 183-189
- Syndicator  
 formats, 314-315, 316, 319  
 hardware requirements and quality, 318-319  
 interview of, 316-317  
 programming, 312-317  
 satellites programs, 318  
 services, 313-315  
 short form programs by, 315  
 vs. network, 315
- Synthesizers, 262
- T**
- Talk format, 81-82
- Talk radio  
 AM, 11  
 FM, 10  
 personalities, 25
- TAPSCAN, 138
- Taylor, Marlin R., 48, 54, 63, 232
- Telecommunications Act of 1996, 31, 37, 52, 57, 287  
 text of, 18, 19
- Telephone surveys, 182-183, 194
- Television, 8
- Tellis, Jeff, 24
- Tesla, Nikola, 3
- Theater of mind, 90
- Time periods  
 classifications and rate cards, 133-137  
 hour-by-hour listening, 4
- Time spent listening (TSL), 102
- Timing copy, 267
- Titanic* (ship), 30, 159
- Titus, Frank, 167-168, 179
- Tolls on radio, history of, 4-5
- Top 40 format, 9, 14, 36, 77, 98, 101
- Total audience plan (TAP), 135
- Towery, Bill, 268
- Trade agreement forms, 151
- Trade-outs, 153
- Traffic  
 airtime, 237  
 in clusters, 240-241, 245  
 computerizing, 239-240  
 directing traffic, 239-240  
 FCC and, 242-244  
 management services, 247  
 reports, 176-177  
 software for, 240
- Traffic manager  
 credentials, 238-239  
 job of, 237-238  
 log preparation, 237-238
- Transistor, creation of, 8
- TSA (Total Survey Area), 184
- TSL (time spent listening), 1, 2, 102
- Turley, Bob, 128
- U**
- Unions, managers and, 67-68
- UP (United Press), 159, 172
- UPI (United Press International), 171-172, 178
- Urban Contemporary format, 84-85
- V**
- Van Deerlin, Lionel, 31
- Vanderveen, Larry, 314
- VDTs (video display terminals), 164
- Violations and fines, FCC, 33, 65, 110
- Voice-tracking, 269
- Vonnegut, Kurt, 197
- W**
- Walden, Glynn, 23
- War of the Worlds* (Wells), 90
- WARC (World Administrative Radio Conference), 23-24, 282
- Warner, Dick, 189, 198
- Web sites, 54  
 FCC, 19  
 Internet radio, 26-27  
 station, 27, 102-104, 150-151
- Webcasting and copyrights, 26, 119
- Wegmann, Chris, 52
- Wells, H.G., 90
- Whitman, Sherman, 168, 172
- Williams, Jay, Jr., 1, 20, 26, 52, 136, 150, 153, 162, 223, 226, 240, 312, 316-317, 328  
 on future of radio, 328-330
- Winchell, Walter, 8
- Wire services, 159, 172
- Wireless Ship Act of 1910, 30
- Wireless telegraph, 3, 159, 275
- Wisdom* (magazine), 8
- Women  
 jobs and equality in radio, 32-35  
 listeners by age, 3, 20
- Woodbury, Steven, 48, 52
- X**
- XM Satellite Radio, 25, 97  
 engineering, 280, 289, 296  
 organizational structure of, 58

THE

# RADIO



EIGHTH  
EDITION

# STATION

BROADCAST  
SATELLITE  
AND  
INTERNET



MICHAEL C. KEITH



Focal  
Press

# THE RADIO STATION

EIGHTH EDITION



**MICHAEL C. KEITH** FOREWORD BY LEE ABRAMS

## THIS EIGHTH EDITION FEATURES NEW AND EXPANDED SECTIONS INCLUDING:

- Satellite, web, and digital radio
- Programming for Podcasting and Blogs
- Rules and regulations
- Portable People Meter and electronic research
- Integration of new digital technology
- Clustering of radio stations and management
- New companion website - <http://booksite.focalpress.com/Keith>  
Please register for the website using the unique access code found on the inside back cover of this book.

**The Radio Station** is considered the standard work on radio media. It remains a concise and candid guide to the internal workings of radio stations and the radio industry in all of its various forms. A comprehensive blueprint, this book details the functions performed successfully within every well-known station. Not only will readers understand how each job is best performed, they will know how it meshes with those of the rest of the radio station staff. For readers uncertain of career goals, this book provides a solid foundation in who does what, when, and why. In a fresh and engaging style, **The Radio Station, Eighth Edition**, details all departments within a radio station—from the inside-out, covering technology to operations, and sales to syndication. It also offers an overview of how government regulations affect radio stations today and how radio stations have adapted to new communications technologies. Drawing on the insights and observations of those who make their daily living by working in the industry, this edition continues its tradition of presenting the real-world perspective of where radio comes from, and where it is heading.

The Eighth Edition of this classic text includes expanded sections on digital, satellite, and Internet radio; integration of new technologies; new and evolving formats; the uses and applications of podcasts and blogs; mobile multimedia devices; programming for the new radio formats; new contributions by key industry executives; digital studios; station clustering and consolidation; industry economics and statistics; and updated rules and regulations. The new companion website features the interviews and essays with industry professionals, an image bank, additional suggested reading, and a listing of helpful links to industry websites.

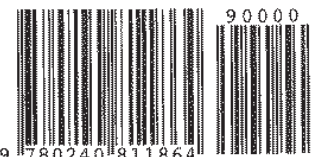
**Michael C. Keith**, Ph.D., ranks among the most prolific authors on the subject of broadcast media, in particular radio. He is a member of the Communication Department at Boston College and is author of over twenty books, including *Voices in the Purple Haze*, *Signals in the Air*, *Talking Radio*, *Radio Cultures*, and *Sounds in the Dark*. With Robert Hilliard he has co-authored *The Broadcast Century and Beyond*, *Waves of Rancor*, *Dirty Discourse*, *Global Broadcasting Systems*, and *The Hidden Screen*. With Christopher Sterling he co-authored *Sounds of Change: FM Broadcasting in America*. In addition, he is the author of numerous journal articles and has served in a number of editorial positions. He is the past Chair of Education for the Museum of Broadcast Communications, the inaugural chair of the Broadcast Education Association's Radio Division, and a former broadcaster. He is the recipient of several honors, including the Distinguished Scholar Award given by the Broadcast Education Association in 2008, and the Stanton Fellow Award given by the international Radio Television Society. He is the author of a critically acclaimed memoir, *The Next Better Place: A Father and Son on the Road* (Algonquin Press), in 2003. Visit the author's website: [www.michaelcketh.com](http://www.michaelcketh.com).



Focal Press  
An imprint of Elsevier  
[www.focalpress.com](http://www.focalpress.com)

If you  
enjoyed this  
book please post  
a review to your  
favorite online  
bookstore  
today.

ISBN: 978-0-240-81186-4



9 780240 811864

Cover images © iStockphoto

PUBLIC LAW 105-304—OCT. 28, 1998

DIGITAL MILLENNIUM COPYRIGHT ACT

Public Law 105–304  
105th Congress

An Act

Oct. 28, 1998  
[H.R. 2281]

To amend title 17, United States Code, to implement the World Intellectual Property Organization Copyright Treaty and Performances and Phonograms Treaty, and for other purposes.

Digital  
Millennium  
Copyright Act.  
17 USC 101 note.

*Be it enacted by the Senate and House of Representatives of the United States of America in Congress assembled,*

**SECTION 1. SHORT TITLE.**

This Act may be cited as the “Digital Millennium Copyright Act”.

**SEC. 2. TABLE OF CONTENTS.**

- Sec. 1. Short title.  
Sec. 2. Table of contents.

TITLE I—WIPO TREATIES IMPLEMENTATION

- Sec. 101. Short title.  
Sec. 102. Technical amendments.  
Sec. 103. Copyright protection systems and copyright management information.  
Sec. 104. Evaluation of impact of copyright law and amendments on electronic commerce and technological development.  
Sec. 105. Effective date.

TITLE II—ONLINE COPYRIGHT INFRINGEMENT LIABILITY LIMITATION

- Sec. 201. Short title.  
Sec. 202. Limitations on liability for copyright infringement.  
Sec. 203. Effective date.

TITLE III—COMPUTER MAINTENANCE OR REPAIR COPYRIGHT EXEMPTION

- Sec. 301. Short title.  
Sec. 302. Limitations on exclusive rights; computer programs.

TITLE IV—MISCELLANEOUS PROVISIONS

- Sec. 401. Provisions Relating to the Commissioner of Patents and Trademarks and the Register of Copyrights.  
Sec. 402. Ephemeral recordings.  
Sec. 403. Limitations on exclusive rights; distance education.  
Sec. 404. Exemption for libraries and archives.  
Sec. 405. Scope of exclusive rights in sound recordings; ephemeral recordings.  
Sec. 406. Assumption of contractual obligations related to transfers of rights in motion pictures.  
Sec. 407. Effective date.

TITLE V—PROTECTION OF CERTAIN ORIGINAL DESIGNS

- Sec. 501. Short title.  
Sec. 502. Protection of certain original designs.  
Sec. 503. Conforming amendments.  
Sec. 504. Joint study of the effect of this title.  
Sec. 505. Effective date.

## TITLE I—WIPO TREATIES IMPLEMENTATION

WIPO Copyright  
and  
Performances  
and Phonograms  
Treaties  
Implementation  
Act of 1998.  
17 USC 101 note.

### SEC. 101. SHORT TITLE.

This title may be cited as the “WIPO Copyright and Performances and Phonograms Treaties Implementation Act of 1998”.

### SEC. 102. TECHNICAL AMENDMENTS.

(a) DEFINITIONS.—Section 101 of title 17, United States Code, is amended—

- (1) by striking the definition of “Berne Convention work”;
- (2) in the definition of “The ‘country of origin’ of a Berne Convention work”—

- (A) by striking “The ‘country of origin’ of a Berne Convention work, for purposes of section 411, is the United States if” and inserting “For purposes of section 411, a work is a ‘United States work’ only if”;

- (B) in paragraph (1)—

- (i) in subparagraph (B) by striking “nation or nations adhering to the Berne Convention” and inserting “treaty party or parties”;

- (ii) in subparagraph (C) by striking “does not adhere to the Berne Convention” and inserting “is not a treaty party”; and

- (iii) in subparagraph (D) by striking “does not adhere to the Berne Convention” and inserting “is not a treaty party”; and

- (C) in the matter following paragraph (3) by striking “For the purposes of section 411, the ‘country of origin’ of any other Berne Convention work is not the United States.”;

- (3) by inserting after the definition of “fixed” the following:

“The ‘Geneva Phonograms Convention’ is the Convention for the Protection of Producers of Phonograms Against Unauthorized Duplication of Their Phonograms, concluded at Geneva, Switzerland, on October 29, 1971.”;

- (4) by inserting after the definition of “including” the following:

“An ‘international agreement’ is—

- “(1) the Universal Copyright Convention;

- “(2) the Geneva Phonograms Convention;

- “(3) the Berne Convention;

- “(4) the WTO Agreement;

- “(5) the WIPO Copyright Treaty;

- “(6) the WIPO Performances and Phonograms Treaty;

and

- “(7) any other copyright treaty to which the United States is a party.”;

- (5) by inserting after the definition of “transmit” the following:

“A ‘treaty party’ is a country or intergovernmental organization other than the United States that is a party to an international agreement.”;

- (6) by inserting after the definition of “widow” the following:



“The ‘WIPO Copyright Treaty’ is the WIPO Copyright Treaty concluded at Geneva, Switzerland, on December 20, 1996.”;

(7) by inserting after the definition of “The ‘WIPO Copyright Treaty’” the following:

“The ‘WIPO Performances and Phonograms Treaty’ is the WIPO Performances and Phonograms Treaty concluded at Geneva, Switzerland, on December 20, 1996.”; and

(8) by inserting after the definition of “work made for hire” the following:

“The terms ‘WTO Agreement’ and ‘WTO member country’ have the meanings given those terms in paragraphs (9) and (10), respectively, of section 2 of the Uruguay Round Agreements Act.”.

(b) SUBJECT MATTER OF COPYRIGHT; NATIONAL ORIGIN.—Section 104 of title 17, United States Code, is amended—

(1) in subsection (b)—

(A) in paragraph (1) by striking “foreign nation that is a party to a copyright treaty to which the United States is also a party” and inserting “treaty party”;

(B) in paragraph (2) by striking “party to the Universal Copyright Convention” and inserting “treaty party”;

(C) by redesignating paragraph (5) as paragraph (6);

(D) by redesignating paragraph (3) as paragraph (5) and inserting it after paragraph (4);

(E) by inserting after paragraph (2) the following:

“(3) the work is a sound recording that was first fixed in a treaty party; or”;

(F) in paragraph (4) by striking “Berne Convention work” and inserting “pictorial, graphic, or sculptural work that is incorporated in a building or other structure, or an architectural work that is embodied in a building and the building or structure is located in the United States or a treaty party”; and

(G) by inserting after paragraph (6), as so redesignated, the following:

“For purposes of paragraph (2), a work that is published in the United States or a treaty party within 30 days after publication in a foreign nation that is not a treaty party shall be considered to be first published in the United States or such treaty party, as the case may be.”; and

(2) by adding at the end the following new subsection:

“(d) EFFECT OF PHONOGRAMS TREATIES.—Notwithstanding the provisions of subsection (b), no works other than sound recordings shall be eligible for protection under this title solely by virtue of the adherence of the United States to the Geneva Phonograms Convention or the WIPO Performances and Phonograms Treaty.”.

(c) COPYRIGHT IN RESTORED WORKS.—Section 104A(h) of title 17, United States Code, is amended—

(1) in paragraph (1), by striking subparagraphs (A) and (B) and inserting the following:

“(A) a nation adhering to the Berne Convention;

“(B) a WTO member country;

“(C) a nation adhering to the WIPO Copyright Treaty;

“(D) a nation adhering to the WIPO Performances and Phonograms Treaty; or

“(E) subject to a Presidential proclamation under subsection (g).”;

(2) by amending paragraph (3) to read as follows:

“(3) The term ‘eligible country’ means a nation, other than the United States, that—

“(A) becomes a WTO member country after the date of the enactment of the Uruguay Round Agreements Act;

“(B) on such date of enactment is, or after such date of enactment becomes, a nation adhering to the Berne Convention;

“(C) adheres to the WIPO Copyright Treaty;

“(D) adheres to the WIPO Performances and Phonograms Treaty; or

“(E) after such date of enactment becomes subject to a proclamation under subsection (g).”;

(3) in paragraph (6)—

(A) in subparagraph (C)(iii) by striking “and” after the semicolon;

(B) at the end of subparagraph (D) by striking the period and inserting “; and”; and

(C) by adding after subparagraph (D) the following:

“(E) if the source country for the work is an eligible country solely by virtue of its adherence to the WIPO Performances and Phonograms Treaty, is a sound recording.”;

(4) in paragraph (8)(B)(i)—

(A) by inserting “of which” before “the majority”; and

(B) by striking “of eligible countries”; and

(5) by striking paragraph (9).

(d) REGISTRATION AND INFRINGEMENT ACTIONS.—Section 411(a) of title 17, United States Code, is amended in the first sentence—

(1) by striking “actions for infringement of copyright in Berne Convention works whose country of origin is not the United States and”; and

(2) by inserting “United States” after “no action for infringement of the copyright in any”.

(e) STATUTE OF LIMITATIONS.—Section 507(a) of title 17, United States Code, is amended by striking “No” and inserting “Except as expressly provided otherwise in this title, no”.

#### **SEC. 103. COPYRIGHT PROTECTION SYSTEMS AND COPYRIGHT MANAGEMENT INFORMATION.**

(a) IN GENERAL.—Title 17, United States Code, is amended by adding at the end the following new chapter:

### **“CHAPTER 12—COPYRIGHT PROTECTION AND MANAGEMENT SYSTEMS**

“Sec.

“1201. Circumvention of copyright protection systems.

“1202. Integrity of copyright management information.

“1203. Civil remedies.

“1204. Criminal offenses and penalties.

“1205. Savings clause.

#### **“§ 1201. Circumvention of copyright protection systems**

“(a) VIOLATIONS REGARDING CIRCUMVENTION OF TECHNOLOGICAL MEASURES.—(1)(A) No person shall circumvent a technological measure that effectively controls access to a work protected

Effective date.	<p>under this title. The prohibition contained in the preceding sentence shall take effect at the end of the 2-year period beginning on the date of the enactment of this chapter.</p> <p>“(B) The prohibition contained in subparagraph (A) shall not apply to persons who are users of a copyrighted work which is in a particular class of works, if such persons are, or are likely to be in the succeeding 3-year period, adversely affected by virtue of such prohibition in their ability to make noninfringing uses of that particular class of works under this title, as determined under subparagraph (C).</p>
Reports. Regulations.	<p>“(C) During the 2-year period described in subparagraph (A), and during each succeeding 3-year period, the Librarian of Congress, upon the recommendation of the Register of Copyrights, who shall consult with the Assistant Secretary for Communications and Information of the Department of Commerce and report and comment on his or her views in making such recommendation, shall make the determination in a rulemaking proceeding on the record for purposes of subparagraph (B) of whether persons who are users of a copyrighted work are, or are likely to be in the succeeding 3-year period, adversely affected by the prohibition under subparagraph (A) in their ability to make noninfringing uses under this title of a particular class of copyrighted works. In conducting such rulemaking, the Librarian shall examine—</p> <p style="padding-left: 20px;">“(i) the availability for use of copyrighted works;</p> <p style="padding-left: 20px;">“(ii) the availability for use of works for nonprofit archival, preservation, and educational purposes;</p> <p style="padding-left: 20px;">“(iii) the impact that the prohibition on the circumvention of technological measures applied to copyrighted works has on criticism, comment, news reporting, teaching, scholarship, or research;</p> <p style="padding-left: 20px;">“(iv) the effect of circumvention of technological measures on the market for or value of copyrighted works; and</p> <p style="padding-left: 20px;">“(v) such other factors as the Librarian considers appropriate.</p>
Publication.	<p>“(D) The Librarian shall publish any class of copyrighted works for which the Librarian has determined, pursuant to the rulemaking conducted under subparagraph (C), that noninfringing uses by persons who are users of a copyrighted work are, or are likely to be, adversely affected, and the prohibition contained in subparagraph (A) shall not apply to such users with respect to such class of works for the ensuing 3-year period.</p> <p>“(E) Neither the exception under subparagraph (B) from the applicability of the prohibition contained in subparagraph (A), nor any determination made in a rulemaking conducted under subparagraph (C), may be used as a defense in any action to enforce any provision of this title other than this paragraph.</p> <p>“(2) No person shall manufacture, import, offer to the public, provide, or otherwise traffic in any technology, product, service, device, component, or part thereof, that—</p> <p style="padding-left: 20px;">“(A) is primarily designed or produced for the purpose of circumventing a technological measure that effectively controls access to a work protected under this title;</p> <p style="padding-left: 20px;">“(B) has only limited commercially significant purpose or use other than to circumvent a technological measure that effectively controls access to a work protected under this title;</p> <p style="padding-left: 20px;">or</p>

“(C) is marketed by that person or another acting in concert with that person with that person’s knowledge for use in circumventing a technological measure that effectively controls access to a work protected under this title.

“(3) As used in this subsection—

“(A) to ‘circumvent a technological measure’ means to descramble a scrambled work, to decrypt an encrypted work, or otherwise to avoid, bypass, remove, deactivate, or impair a technological measure, without the authority of the copyright owner; and

“(B) a technological measure ‘effectively controls access to a work’ if the measure, in the ordinary course of its operation, requires the application of information, or a process or a treatment, with the authority of the copyright owner, to gain access to the work.

“(b) ADDITIONAL VIOLATIONS.—(1) No person shall manufacture, import, offer to the public, provide, or otherwise traffic in any technology, product, service, device, component, or part thereof, that—

“(A) is primarily designed or produced for the purpose of circumventing protection afforded by a technological measure that effectively protects a right of a copyright owner under this title in a work or a portion thereof;

“(B) has only limited commercially significant purpose or use other than to circumvent protection afforded by a technological measure that effectively protects a right of a copyright owner under this title in a work or a portion thereof; or

“(C) is marketed by that person or another acting in concert with that person with that person’s knowledge for use in circumventing protection afforded by a technological measure that effectively protects a right of a copyright owner under this title in a work or a portion thereof.

“(2) As used in this subsection—

“(A) to ‘circumvent protection afforded by a technological measure’ means avoiding, bypassing, removing, deactivating, or otherwise impairing a technological measure; and

“(B) a technological measure ‘effectively protects a right of a copyright owner under this title’ if the measure, in the ordinary course of its operation, prevents, restricts, or otherwise limits the exercise of a right of a copyright owner under this title.

“(c) OTHER RIGHTS, ETC., NOT AFFECTED.—(1) Nothing in this section shall affect rights, remedies, limitations, or defenses to copyright infringement, including fair use, under this title.

“(2) Nothing in this section shall enlarge or diminish vicarious or contributory liability for copyright infringement in connection with any technology, product, service, device, component, or part thereof.

“(3) Nothing in this section shall require that the design of, or design and selection of parts and components for, a consumer electronics, telecommunications, or computing product provide for a response to any particular technological measure, so long as such part or component, or the product in which such part or component is integrated, does not otherwise fall within the prohibitions of subsection (a)(2) or (b)(1).

“(4) Nothing in this section shall enlarge or diminish any rights of free speech or the press for activities using consumer electronics, telecommunications, or computing products.

“(d) EXEMPTION FOR NONPROFIT LIBRARIES, ARCHIVES, AND EDUCATIONAL INSTITUTIONS.—(1) A nonprofit library, archives, or educational institution which gains access to a commercially exploited copyrighted work solely in order to make a good faith determination of whether to acquire a copy of that work for the sole purpose of engaging in conduct permitted under this title shall not be in violation of subsection (a)(1)(A). A copy of a work to which access has been gained under this paragraph—

“(A) may not be retained longer than necessary to make such good faith determination; and

“(B) may not be used for any other purpose.

“(2) The exemption made available under paragraph (1) shall only apply with respect to a work when an identical copy of that work is not reasonably available in another form.

“(3) A nonprofit library, archives, or educational institution that willfully for the purpose of commercial advantage or financial gain violates paragraph (1)—

“(A) shall, for the first offense, be subject to the civil remedies under section 1203; and

“(B) shall, for repeated or subsequent offenses, in addition to the civil remedies under section 1203, forfeit the exemption provided under paragraph (1).

“(4) This subsection may not be used as a defense to a claim under subsection (a)(2) or (b), nor may this subsection permit a nonprofit library, archives, or educational institution to manufacture, import, offer to the public, provide, or otherwise traffic in any technology, product, service, component, or part thereof, which circumvents a technological measure.

“(5) In order for a library or archives to qualify for the exemption under this subsection, the collections of that library or archives shall be—

“(A) open to the public; or

“(B) available not only to researchers affiliated with the library or archives or with the institution of which it is a part, but also to other persons doing research in a specialized field.

“(e) LAW ENFORCEMENT, INTELLIGENCE, AND OTHER GOVERNMENT ACTIVITIES.—This section does not prohibit any lawfully authorized investigative, protective, information security, or intelligence activity of an officer, agent, or employee of the United States, a State, or a political subdivision of a State, or a person acting pursuant to a contract with the United States, a State, or a political subdivision of a State. For purposes of this subsection, the term ‘information security’ means activities carried out in order to identify and address the vulnerabilities of a government computer, computer system, or computer network.

“(f) REVERSE ENGINEERING.—(1) Notwithstanding the provisions of subsection (a)(1)(A), a person who has lawfully obtained the right to use a copy of a computer program may circumvent a technological measure that effectively controls access to a particular portion of that program for the sole purpose of identifying and analyzing those elements of the program that are necessary to achieve interoperability of an independently created computer program with other programs, and that have not previously been

readily available to the person engaging in the circumvention, to the extent any such acts of identification and analysis do not constitute infringement under this title.

“(2) Notwithstanding the provisions of subsections (a)(2) and (b), a person may develop and employ technological means to circumvent a technological measure, or to circumvent protection afforded by a technological measure, in order to enable the identification and analysis under paragraph (1), or for the purpose of enabling interoperability of an independently created computer program with other programs, if such means are necessary to achieve such interoperability, to the extent that doing so does not constitute infringement under this title.

“(3) The information acquired through the acts permitted under paragraph (1), and the means permitted under paragraph (2), may be made available to others if the person referred to in paragraph (1) or (2), as the case may be, provides such information or means solely for the purpose of enabling interoperability of an independently created computer program with other programs, and to the extent that doing so does not constitute infringement under this title or violate applicable law other than this section.

“(4) For purposes of this subsection, the term ‘interoperability’ means the ability of computer programs to exchange information, and of such programs mutually to use the information which has been exchanged.

“(g) ENCRYPTION RESEARCH.—

“(1) DEFINITIONS.—For purposes of this subsection—

“(A) the term ‘encryption research’ means activities necessary to identify and analyze flaws and vulnerabilities of encryption technologies applied to copyrighted works, if these activities are conducted to advance the state of knowledge in the field of encryption technology or to assist in the development of encryption products; and

“(B) the term ‘encryption technology’ means the scrambling and descrambling of information using mathematical formulas or algorithms.

“(2) PERMISSIBLE ACTS OF ENCRYPTION RESEARCH.—Notwithstanding the provisions of subsection (a)(1)(A), it is not a violation of that subsection for a person to circumvent a technological measure as applied to a copy, phonorecord, performance, or display of a published work in the course of an act of good faith encryption research if—

“(A) the person lawfully obtained the encrypted copy, phonorecord, performance, or display of the published work;

“(B) such act is necessary to conduct such encryption research;

“(C) the person made a good faith effort to obtain authorization before the circumvention; and

“(D) such act does not constitute infringement under this title or a violation of applicable law other than this section, including section 1030 of title 18 and those provisions of title 18 amended by the Computer Fraud and Abuse Act of 1986.

“(3) FACTORS IN DETERMINING EXEMPTION.—In determining whether a person qualifies for the exemption under paragraph (2), the factors to be considered shall include—

“(A) whether the information derived from the encryption research was disseminated, and if so, whether

it was disseminated in a manner reasonably calculated to advance the state of knowledge or development of encryption technology, versus whether it was disseminated in a manner that facilitates infringement under this title or a violation of applicable law other than this section, including a violation of privacy or breach of security;

“(B) whether the person is engaged in a legitimate course of study, is employed, or is appropriately trained or experienced, in the field of encryption technology; and

“(C) whether the person provides the copyright owner of the work to which the technological measure is applied with notice of the findings and documentation of the research, and the time when such notice is provided.

“(4) USE OF TECHNOLOGICAL MEANS FOR RESEARCH ACTIVITIES.—Notwithstanding the provisions of subsection (a)(2), it is not a violation of that subsection for a person to—

“(A) develop and employ technological means to circumvent a technological measure for the sole purpose of that person performing the acts of good faith encryption research described in paragraph (2); and

“(B) provide the technological means to another person with whom he or she is working collaboratively for the purpose of conducting the acts of good faith encryption research described in paragraph (2) or for the purpose of having that other person verify his or her acts of good faith encryption research described in paragraph (2).

Deadline.

“(5) REPORT TO CONGRESS.—Not later than 1 year after the date of the enactment of this chapter, the Register of Copyrights and the Assistant Secretary for Communications and Information of the Department of Commerce shall jointly report to the Congress on the effect this subsection has had on—

“(A) encryption research and the development of encryption technology;

“(B) the adequacy and effectiveness of technological measures designed to protect copyrighted works; and

“(C) protection of copyright owners against the unauthorized access to their encrypted copyrighted works.

The report shall include legislative recommendations, if any.

“(h) EXCEPTIONS REGARDING MINORS.—In applying subsection (a) to a component or part, the court may consider the necessity for its intended and actual incorporation in a technology, product, service, or device, which—

“(1) does not itself violate the provisions of this title; and

“(2) has the sole purpose to prevent the access of minors to material on the Internet.

“(i) PROTECTION OF PERSONALLY IDENTIFYING INFORMATION.—

(1) CIRCUMVENTION PERMITTED.—Notwithstanding the provisions of subsection (a)(1)(A), it is not a violation of that subsection for a person to circumvent a technological measure that effectively controls access to a work protected under this title, if—

“(A) the technological measure, or the work it protects, contains the capability of collecting or disseminating personally identifying information reflecting the online activities of a natural person who seeks to gain access to the work protected;

“(B) in the normal course of its operation, the technological measure, or the work it protects, collects or disseminates personally identifying information about the person who seeks to gain access to the work protected, without providing conspicuous notice of such collection or dissemination to such person, and without providing such person with the capability to prevent or restrict such collection or dissemination;

“(C) the act of circumvention has the sole effect of identifying and disabling the capability described in subparagraph (A), and has no other effect on the ability of any person to gain access to any work; and

“(D) the act of circumvention is carried out solely for the purpose of preventing the collection or dissemination of personally identifying information about a natural person who seeks to gain access to the work protected, and is not in violation of any other law.

“(2) INAPPLICABILITY TO CERTAIN TECHNOLOGICAL MEASURES.—This subsection does not apply to a technological measure, or a work it protects, that does not collect or disseminate personally identifying information and that is disclosed to a user as not having or using such capability.

“(j) SECURITY TESTING.—

“(1) DEFINITION.—For purposes of this subsection, the term ‘security testing’ means accessing a computer, computer system, or computer network, solely for the purpose of good faith testing, investigating, or correcting, a security flaw or vulnerability, with the authorization of the owner or operator of such computer, computer system, or computer network.

“(2) PERMISSIBLE ACTS OF SECURITY TESTING.—Notwithstanding the provisions of subsection (a)(1)(A), it is not a violation of that subsection for a person to engage in an act of security testing, if such act does not constitute infringement under this title or a violation of applicable law other than this section, including section 1030 of title 18 and those provisions of title 18 amended by the Computer Fraud and Abuse Act of 1986.

“(3) FACTORS IN DETERMINING EXEMPTION.—In determining whether a person qualifies for the exemption under paragraph (2), the factors to be considered shall include—

“(A) whether the information derived from the security testing was used solely to promote the security of the owner or operator of such computer, computer system or computer network, or shared directly with the developer of such computer, computer system, or computer network; and

“(B) whether the information derived from the security testing was used or maintained in a manner that does not facilitate infringement under this title or a violation of applicable law other than this section, including a violation of privacy or breach of security.

“(4) USE OF TECHNOLOGICAL MEANS FOR SECURITY TESTING.—Notwithstanding the provisions of subsection (a)(2), it is not a violation of that subsection for a person to develop, produce, distribute or employ technological means for the sole purpose of performing the acts of security testing described



in subsection (2), provided such technological means does not otherwise violate section (a)(2).

“(k) CERTAIN ANALOG DEVICES AND CERTAIN TECHNOLOGICAL MEASURES.—

“(1) CERTAIN ANALOG DEVICES.—

Effective date.

“(A) Effective 18 months after the date of the enactment of this chapter, no person shall manufacture, import, offer to the public, provide or otherwise traffic in any—

“(i) VHS format analog video cassette recorder unless such recorder conforms to the automatic gain control copy control technology;

“(ii) 8mm format analog video cassette camcorder unless such camcorder conforms to the automatic gain control technology;

“(iii) Beta format analog video cassette recorder, unless such recorder conforms to the automatic gain control copy control technology, except that this requirement shall not apply until there are 1,000 Beta format analog video cassette recorders sold in the United States in any one calendar year after the date of the enactment of this chapter;

“(iv) 8mm format analog video cassette recorder that is not an analog video cassette camcorder, unless such recorder conforms to the automatic gain control copy control technology, except that this requirement shall not apply until there are 20,000 such recorders sold in the United States in any one calendar year after the date of the enactment of this chapter; or

“(v) analog video cassette recorder that records using an NTSC format video input and that is not otherwise covered under clauses (i) through (iv), unless such device conforms to the automatic gain control copy control technology.

Effective date.

“(B) Effective on the date of the enactment of this chapter, no person shall manufacture, import, offer to the public, provide or otherwise traffic in—

“(i) any VHS format analog video cassette recorder or any 8mm format analog video cassette recorder if the design of the model of such recorder has been modified after such date of enactment so that a model of recorder that previously conformed to the automatic gain control copy control technology no longer conforms to such technology; or

“(ii) any VHS format analog video cassette recorder, or any 8mm format analog video cassette recorder that is not an 8mm analog video cassette camcorder, if the design of the model of such recorder has been modified after such date of enactment so that a model of recorder that previously conformed to the four-line colorstripe copy control technology no longer conforms to such technology.

Manufacturers that have not previously manufactured or sold a VHS format analog video cassette recorder, or an 8mm format analog cassette recorder, shall be required to conform to the four-line colorstripe copy control technology in the initial model of any such recorder manufactured after the date of the enactment of this chapter,

and thereafter to continue conforming to the four-line colorstripe copy control technology. For purposes of this subparagraph, an analog video cassette recorder ‘conforms to’ the four-line colorstripe copy control technology if it records a signal that, when played back by the playback function of that recorder in the normal viewing mode, exhibits, on a reference display device, a display containing distracting visible lines through portions of the viewable picture.

“(2) CERTAIN ENCODING RESTRICTIONS.—No person shall apply the automatic gain control copy control technology or colorstripe copy control technology to prevent or limit consumer copying except such copying—

“(A) of a single transmission, or specified group of transmissions, of live events or of audiovisual works for which a member of the public has exercised choice in selecting the transmissions, including the content of the transmissions or the time of receipt of such transmissions, or both, and as to which such member is charged a separate fee for each such transmission or specified group of transmissions;

“(B) from a copy of a transmission of a live event or an audiovisual work if such transmission is provided by a channel or service where payment is made by a member of the public for such channel or service in the form of a subscription fee that entitles the member of the public to receive all of the programming contained in such channel or service;

“(C) from a physical medium containing one or more prerecorded audiovisual works; or

“(D) from a copy of a transmission described in subparagraph (A) or from a copy made from a physical medium described in subparagraph (C).

In the event that a transmission meets both the conditions set forth in subparagraph (A) and those set forth in subparagraph (B), the transmission shall be treated as a transmission described in subparagraph (A).

“(3) INAPPLICABILITY.—This subsection shall not—

“(A) require any analog video cassette camcorder to conform to the automatic gain control copy control technology with respect to any video signal received through a camera lens;

“(B) apply to the manufacture, importation, offer for sale, provision of, or other trafficking in, any professional analog video cassette recorder; or

“(C) apply to the offer for sale or provision of, or other trafficking in, any previously owned analog video cassette recorder, if such recorder was legally manufactured and sold when new and not subsequently modified in violation of paragraph (1)(B).

“(4) DEFINITIONS.—For purposes of this subsection:

“(A) An ‘analog video cassette recorder’ means a device that records, or a device that includes a function that records, on electromagnetic tape in an analog format the electronic impulses produced by the video and audio portions of a television program, motion picture, or other form of audiovisual work.

“(B) An ‘analog video cassette camcorder’ means an analog video cassette recorder that contains a recording function that operates through a camera lens and through a video input that may be connected with a television or other video playback device.

“(C) An analog video cassette recorder ‘conforms’ to the automatic gain control copy control technology if it—

“(i) detects one or more of the elements of such technology and does not record the motion picture or transmission protected by such technology; or

“(ii) records a signal that, when played back, exhibits a meaningfully distorted or degraded display.

“(D) The term ‘professional analog video cassette recorder’ means an analog video cassette recorder that is designed, manufactured, marketed, and intended for use by a person who regularly employs such a device for a lawful business or industrial use, including making, performing, displaying, distributing, or transmitting copies of motion pictures on a commercial scale.

“(E) The terms ‘VHS format’, ‘8mm format’, ‘Beta format’, ‘automatic gain control copy control technology’, ‘colorstripe copy control technology’, ‘four-line version of the colorstripe copy control technology’, and ‘NTSC’ have the meanings that are commonly understood in the consumer electronics and motion picture industries as of the date of the enactment of this chapter.

“(5) VIOLATIONS.—Any violation of paragraph (1) of this subsection shall be treated as a violation of subsection (b)(1) of this section. Any violation of paragraph (2) of this subsection shall be deemed an ‘act of circumvention’ for the purposes of section 1203(c)(3)(A) of this chapter.

#### “§ 1202. Integrity of copyright management information

“(a) FALSE COPYRIGHT MANAGEMENT INFORMATION.—No person shall knowingly and with the intent to induce, enable, facilitate, or conceal infringement—

“(1) provide copyright management information that is false, or

“(2) distribute or import for distribution copyright management information that is false.

“(b) REMOVAL OR ALTERATION OF COPYRIGHT MANAGEMENT INFORMATION.—No person shall, without the authority of the copyright owner or the law—

“(1) intentionally remove or alter any copyright management information,

“(2) distribute or import for distribution copyright management information knowing that the copyright management information has been removed or altered without authority of the copyright owner or the law, or

“(3) distribute, import for distribution, or publicly perform works, copies of works, or phonorecords, knowing that copyright management information has been removed or altered without authority of the copyright owner or the law,

knowing, or, with respect to civil remedies under section 1203, having reasonable grounds to know, that it will induce, enable, facilitate, or conceal an infringement of any right under this title.

“(c) DEFINITION.—As used in this section, the term ‘copyright management information’ means any of the following information conveyed in connection with copies or phonorecords of a work or performances or displays of a work, including in digital form, except that such term does not include any personally identifying information about a user of a work or of a copy, phonorecord, performance, or display of a work:

“(1) The title and other information identifying the work, including the information set forth on a notice of copyright.

“(2) The name of, and other identifying information about, the author of a work.

“(3) The name of, and other identifying information about, the copyright owner of the work, including the information set forth in a notice of copyright.

“(4) With the exception of public performances of works by radio and television broadcast stations, the name of, and other identifying information about, a performer whose performance is fixed in a work other than an audiovisual work.

“(5) With the exception of public performances of works by radio and television broadcast stations, in the case of an audiovisual work, the name of, and other identifying information about, a writer, performer, or director who is credited in the audiovisual work.

“(6) Terms and conditions for use of the work.

“(7) Identifying numbers or symbols referring to such information or links to such information.

“(8) Such other information as the Register of Copyrights may prescribe by regulation, except that the Register of Copyrights may not require the provision of any information concerning the user of a copyrighted work.

“(d) LAW ENFORCEMENT, INTELLIGENCE, AND OTHER GOVERNMENT ACTIVITIES.—This section does not prohibit any lawfully authorized investigative, protective, information security, or intelligence activity of an officer, agent, or employee of the United States, a State, or a political subdivision of a State, or a person acting pursuant to a contract with the United States, a State, or a political subdivision of a State. For purposes of this subsection, the term ‘information security’ means activities carried out in order to identify and address the vulnerabilities of a government computer, computer system, or computer network.

“(e) LIMITATIONS ON LIABILITY.—

“(1) ANALOG TRANSMISSIONS.—In the case of an analog transmission, a person who is making transmissions in its capacity as a broadcast station, or as a cable system, or someone who provides programming to such station or system, shall not be liable for a violation of subsection (b) if—

“(A) avoiding the activity that constitutes such violation is not technically feasible or would create an undue financial hardship on such person; and

“(B) such person did not intend, by engaging in such activity, to induce, enable, facilitate, or conceal infringement of a right under this title.

“(2) DIGITAL TRANSMISSIONS.—

“(A) If a digital transmission standard for the placement of copyright management information for a category of works is set in a voluntary, consensus standard-setting process involving a representative cross-section of broadcast

stations or cable systems and copyright owners of a category of works that are intended for public performance by such stations or systems, a person identified in paragraph (1) shall not be liable for a violation of subsection (b) with respect to the particular copyright management information addressed by such standard if—

“(i) the placement of such information by someone other than such person is not in accordance with such standard; and

“(ii) the activity that constitutes such violation is not intended to induce, enable, facilitate, or conceal infringement of a right under this title.

“(B) Until a digital transmission standard has been set pursuant to subparagraph (A) with respect to the placement of copyright management information for a category or works, a person identified in paragraph (1) shall not be liable for a violation of subsection (b) with respect to such copyright management information, if the activity that constitutes such violation is not intended to induce, enable, facilitate, or conceal infringement of a right under this title, and if—

“(i) the transmission of such information by such person would result in a perceptible visual or aural degradation of the digital signal; or

“(ii) the transmission of such information by such person would conflict with—

“(I) an applicable government regulation relating to transmission of information in a digital signal;

“(II) an applicable industry-wide standard relating to the transmission of information in a digital signal that was adopted by a voluntary consensus standards body prior to the effective date of this chapter; or

“(III) an applicable industry-wide standard relating to the transmission of information in a digital signal that was adopted in a voluntary, consensus standards-setting process open to participation by a representative cross-section of broadcast stations or cable systems and copyright owners of a category of works that are intended for public performance by such stations or systems.

“(3) DEFINITIONS.—As used in this subsection—

“(A) the term ‘broadcast station’ has the meaning given that term in section 3 of the Communications Act of 1934 (47 U.S.C. 153); and

“(B) the term ‘cable system’ has the meaning given that term in section 602 of the Communications Act of 1934 (47 U.S.C. 522).

### “§ 1203. Civil remedies

“(a) CIVIL ACTIONS.—Any person injured by a violation of section 1201 or 1202 may bring a civil action in an appropriate United States district court for such violation.

“(b) POWERS OF THE COURT.—In an action brought under subsection (a), the court—

“(1) may grant temporary and permanent injunctions on such terms as it deems reasonable to prevent or restrain a violation, but in no event shall impose a prior restraint on free speech or the press protected under the 1st amendment to the Constitution;

“(2) at any time while an action is pending, may order the impounding, on such terms as it deems reasonable, of any device or product that is in the custody or control of the alleged violator and that the court has reasonable cause to believe was involved in a violation;

“(3) may award damages under subsection (c);

“(4) in its discretion may allow the recovery of costs by or against any party other than the United States or an officer thereof;

“(5) in its discretion may award reasonable attorney’s fees to the prevailing party; and

“(6) may, as part of a final judgment or decree finding a violation, order the remedial modification or the destruction of any device or product involved in the violation that is in the custody or control of the violator or has been impounded under paragraph (2).

“(c) AWARD OF DAMAGES.—

“(1) IN GENERAL.—Except as otherwise provided in this title, a person committing a violation of section 1201 or 1202 is liable for either—

“(A) the actual damages and any additional profits of the violator, as provided in paragraph (2), or

“(B) statutory damages, as provided in paragraph (3).

“(2) ACTUAL DAMAGES.—The court shall award to the complaining party the actual damages suffered by the party as a result of the violation, and any profits of the violator that are attributable to the violation and are not taken into account in computing the actual damages, if the complaining party elects such damages at any time before final judgment is entered.

“(3) STATUTORY DAMAGES.—(A) At any time before final judgment is entered, a complaining party may elect to recover an award of statutory damages for each violation of section 1201 in the sum of not less than \$200 or more than \$2,500 per act of circumvention, device, product, component, offer, or performance of service, as the court considers just.

“(B) At any time before final judgment is entered, a complaining party may elect to recover an award of statutory damages for each violation of section 1202 in the sum of not less than \$2,500 or more than \$25,000.

“(4) REPEATED VIOLATIONS.—In any case in which the injured party sustains the burden of proving, and the court finds, that a person has violated section 1201 or 1202 within 3 years after a final judgment was entered against the person for another such violation, the court may increase the award of damages up to triple the amount that would otherwise be awarded, as the court considers just.

“(5) INNOCENT VIOLATIONS.—

“(A) IN GENERAL.—The court in its discretion may reduce or remit the total award of damages in any case in which the violator sustains the burden of proving, and

the court finds, that the violator was not aware and had no reason to believe that its acts constituted a violation.

“(B) NONPROFIT LIBRARY, ARCHIVES, OR EDUCATIONAL INSTITUTIONS.—In the case of a nonprofit library, archives, or educational institution, the court shall remit damages in any case in which the library, archives, or educational institution sustains the burden of proving, and the court finds, that the library, archives, or educational institution was not aware and had no reason to believe that its acts constituted a violation.

“§ 1204. Criminal offenses and penalties

“(a) IN GENERAL.—Any person who violates section 1201 or 1202 willfully and for purposes of commercial advantage or private financial gain—

“(1) shall be fined not more than \$500,000 or imprisoned for not more than 5 years, or both, for the first offense; and

“(2) shall be fined not more than \$1,000,000 or imprisoned for not more than 10 years, or both, for any subsequent offense.

“(b) LIMITATION FOR NONPROFIT LIBRARY, ARCHIVES, OR EDUCATIONAL INSTITUTION.—Subsection (a) shall not apply to a nonprofit library, archives, or educational institution.

“(c) STATUTE OF LIMITATIONS.—No criminal proceeding shall be brought under this section unless such proceeding is commenced within 5 years after the cause of action arose.

“§ 1205. Savings clause

“Nothing in this chapter abrogates, diminishes, or weakens the provisions of, nor provides any defense or element of mitigation in a criminal prosecution or civil action under, any Federal or State law that prevents the violation of the privacy of an individual in connection with the individual’s use of the Internet.”

(b) CONFORMING AMENDMENT.—The table of chapters for title 17, United States Code, is amended by adding after the item relating to chapter 11 the following:

“12. Copyright Protection and Management Systems ..... 1201”.

17 USC 109 note.

SEC. 104. EVALUATION OF IMPACT OF COPYRIGHT LAW AND AMENDMENTS ON ELECTRONIC COMMERCE AND TECHNOLOGICAL DEVELOPMENT.

(a) EVALUATION BY THE REGISTER OF COPYRIGHTS AND THE ASSISTANT SECRETARY FOR COMMUNICATIONS AND INFORMATION.—The Register of Copyrights and the Assistant Secretary for Communications and Information of the Department of Commerce shall jointly evaluate—

(1) the effects of the amendments made by this title and the development of electronic commerce and associated technology on the operation of sections 109 and 117 of title 17, United States Code; and

(2) the relationship between existing and emergent technology and the operation of sections 109 and 117 of title 17, United States Code.

Deadline.

(b) REPORT TO CONGRESS.—The Register of Copyrights and the Assistant Secretary for Communications and Information of the Department of Commerce shall, not later than 24 months after the date of the enactment of this Act, submit to the Congress a joint report on the evaluation conducted under subsection (a),

including any legislative recommendations the Register and the Assistant Secretary may have.

**SEC. 105. EFFECTIVE DATE.**

17 USC 101 note.

(a) IN GENERAL.—Except as otherwise provided in this title, this title and the amendments made by this title shall take effect on the date of the enactment of this Act.

(b) AMENDMENTS RELATING TO CERTAIN INTERNATIONAL AGREEMENTS.—(1) The following shall take effect upon the entry into force of the WIPO Copyright Treaty with respect to the United States:

(A) Paragraph (5) of the definition of “international agreement” contained in section 101 of title 17, United States Code, as amended by section 102(a)(4) of this Act.

(B) The amendment made by section 102(a)(6) of this Act.

(C) Subparagraph (C) of section 104A(h)(1) of title 17, United States Code, as amended by section 102(c)(1) of this Act.

(D) Subparagraph (C) of section 104A(h)(3) of title 17, United States Code, as amended by section 102(c)(2) of this Act.

(2) The following shall take effect upon the entry into force of the WIPO Performances and Phonograms Treaty with respect to the United States:

(A) Paragraph (6) of the definition of “international agreement” contained in section 101 of title 17, United States Code, as amended by section 102(a)(4) of this Act.

(B) The amendment made by section 102(a)(7) of this Act.

(C) The amendment made by section 102(b)(2) of this Act.

(D) Subparagraph (D) of section 104A(h)(1) of title 17, United States Code, as amended by section 102(c)(1) of this Act.

(E) Subparagraph (D) of section 104A(h)(3) of title 17, United States Code, as amended by section 102(c)(2) of this Act.

(F) The amendments made by section 102(c)(3) of this Act.

## TITLE II—ONLINE COPYRIGHT INFRINGEMENT LIABILITY LIMITATION

Online Copyright  
Infringement  
Liability  
Limitation Act.

**SEC. 201. SHORT TITLE.**

17 USC 101 note.

This title may be cited as the “Online Copyright Infringement Liability Limitation Act”.

**SEC. 202. LIMITATIONS ON LIABILITY FOR COPYRIGHT INFRINGEMENT.**

(a) IN GENERAL.—Chapter 5 of title 17, United States Code, is amended by adding after section 511 the following new section:

**“§ 512. Limitations on liability relating to material online**

“(a) TRANSITORY DIGITAL NETWORK COMMUNICATIONS.—A service provider shall not be liable for monetary relief, or, except as provided in subsection (j), for injunctive or other equitable relief,



for infringement of copyright by reason of the provider's transmitting, routing, or providing connections for, material through a system or network controlled or operated by or for the service provider, or by reason of the intermediate and transient storage of that material in the course of such transmitting, routing, or providing connections, if—

“(1) the transmission of the material was initiated by or at the direction of a person other than the service provider;

“(2) the transmission, routing, provision of connections, or storage is carried out through an automatic technical process without selection of the material by the service provider;

“(3) the service provider does not select the recipients of the material except as an automatic response to the request of another person;

“(4) no copy of the material made by the service provider in the course of such intermediate or transient storage is maintained on the system or network in a manner ordinarily accessible to anyone other than anticipated recipients, and no such copy is maintained on the system or network in a manner ordinarily accessible to such anticipated recipients for a longer period than is reasonably necessary for the transmission, routing, or provision of connections; and

“(5) the material is transmitted through the system or network without modification of its content.

“(b) SYSTEM CACHING.—

“(1) LIMITATION ON LIABILITY.—A service provider shall not be liable for monetary relief, or, except as provided in subsection (j), for injunctive or other equitable relief, for infringement of copyright by reason of the intermediate and temporary storage of material on a system or network controlled or operated by or for the service provider in a case in which—

“(A) the material is made available online by a person other than the service provider;

“(B) the material is transmitted from the person described in subparagraph (A) through the system or network to a person other than the person described in subparagraph (A) at the direction of that other person; and

“(C) the storage is carried out through an automatic technical process for the purpose of making the material available to users of the system or network who, after the material is transmitted as described in subparagraph (B), request access to the material from the person described in subparagraph (A),

if the conditions set forth in paragraph (2) are met.

(2) CONDITIONS.—The conditions referred to in paragraph (1) are that—

“(A) the material described in paragraph (1) is transmitted to the subsequent users described in paragraph (1)(C) without modification to its content from the manner in which the material was transmitted from the person described in paragraph (1)(A);

“(B) the service provider described in paragraph (1) complies with rules concerning the refreshing, reloading, or other updating of the material when specified by the person making the material available online in accordance

with a generally accepted industry standard data communications protocol for the system or network through which that person makes the material available, except that this subparagraph applies only if those rules are not used by the person described in paragraph (1)(A) to prevent or unreasonably impair the intermediate storage to which this subsection applies;

“(C) the service provider does not interfere with the ability of technology associated with the material to return to the person described in paragraph (1)(A) the information that would have been available to that person if the material had been obtained by the subsequent users described in paragraph (1)(C) directly from that person, except that this subparagraph applies only if that technology—

“(i) does not significantly interfere with the performance of the provider’s system or network or with the intermediate storage of the material;

“(ii) is consistent with generally accepted industry standard communications protocols; and

“(iii) does not extract information from the provider’s system or network other than the information that would have been available to the person described in paragraph (1)(A) if the subsequent users had gained access to the material directly from that person;

“(D) if the person described in paragraph (1)(A) has in effect a condition that a person must meet prior to having access to the material, such as a condition based on payment of a fee or provision of a password or other information, the service provider permits access to the stored material in significant part only to users of its system or network that have met those conditions and only in accordance with those conditions; and

“(E) if the person described in paragraph (1)(A) makes that material available online without the authorization of the copyright owner of the material, the service provider responds expeditiously to remove, or disable access to, the material that is claimed to be infringing upon notification of claimed infringement as described in subsection (c)(3), except that this subparagraph applies only if—

“(i) the material has previously been removed from the originating site or access to it has been disabled, or a court has ordered that the material be removed from the originating site or that access to the material on the originating site be disabled; and

“(ii) the party giving the notification includes in the notification a statement confirming that the material has been removed from the originating site or access to it has been disabled or that a court has ordered that the material be removed from the originating site or that access to the material on the originating site be disabled.

“(c) INFORMATION RESIDING ON SYSTEMS OR NETWORKS AT DIRECTION OF USERS.—

“(1) IN GENERAL.—A service provider shall not be liable for monetary relief, or, except as provided in subsection (j), for injunctive or other equitable relief, for infringement of copyright by reason of the storage at the direction of a user of

material that resides on a system or network controlled or operated by or for the service provider, if the service provider—

“(A)(i) does not have actual knowledge that the material or an activity using the material on the system or network is infringing;

“(ii) in the absence of such actual knowledge, is not aware of facts or circumstances from which infringing activity is apparent; or

“(iii) upon obtaining such knowledge or awareness, acts expeditiously to remove, or disable access to, the material;

“(B) does not receive a financial benefit directly attributable to the infringing activity, in a case in which the service provider has the right and ability to control such activity; and

“(C) upon notification of claimed infringement as described in paragraph (3), responds expeditiously to remove, or disable access to, the material that is claimed to be infringing or to be the subject of infringing activity.

“(2) DESIGNATED AGENT.—The limitations on liability established in this subsection apply to a service provider only if the service provider has designated an agent to receive notifications of claimed infringement described in paragraph (3), by making available through its service, including on its website in a location accessible to the public, and by providing to the Copyright Office, substantially the following information:

“(A) the name, address, phone number, and electronic mail address of the agent.

“(B) other contact information which the Register of Copyrights may deem appropriate.

The Register of Copyrights shall maintain a current directory of agents available to the public for inspection, including through the Internet, in both electronic and hard copy formats, and may require payment of a fee by service providers to cover the costs of maintaining the directory.

“(3) ELEMENTS OF NOTIFICATION.—

“(A) To be effective under this subsection, a notification of claimed infringement must be a written communication provided to the designated agent of a service provider that includes substantially the following:

“(i) A physical or electronic signature of a person authorized to act on behalf of the owner of an exclusive right that is allegedly infringed.

“(ii) Identification of the copyrighted work claimed to have been infringed, or, if multiple copyrighted works at a single online site are covered by a single notification, a representative list of such works at that site.

“(iii) Identification of the material that is claimed to be infringing or to be the subject of infringing activity and that is to be removed or access to which is to be disabled, and information reasonably sufficient to permit the service provider to locate the material.

“(iv) Information reasonably sufficient to permit the service provider to contact the complaining party, such as an address, telephone number, and, if available, an electronic mail address at which the complaining party may be contacted.

Records.  
Public  
information.

“(v) A statement that the complaining party has a good faith belief that use of the material in the manner complained of is not authorized by the copyright owner, its agent, or the law.

“(vi) A statement that the information in the notification is accurate, and under penalty of perjury, that the complaining party is authorized to act on behalf of the owner of an exclusive right that is allegedly infringed.

“(B)(i) Subject to clause (ii), a notification from a copyright owner or from a person authorized to act on behalf of the copyright owner that fails to comply substantially with the provisions of subparagraph (A) shall not be considered under paragraph (1)(A) in determining whether a service provider has actual knowledge or is aware of facts or circumstances from which infringing activity is apparent.

“(ii) In a case in which the notification that is provided to the service provider’s designated agent fails to comply substantially with all the provisions of subparagraph (A) but substantially complies with clauses (ii), (iii), and (iv) of subparagraph (A), clause (i) of this subparagraph applies only if the service provider promptly attempts to contact the person making the notification or takes other reasonable steps to assist in the receipt of notification that substantially complies with all the provisions of subparagraph (A).

“(d) INFORMATION LOCATION TOOLS.—A service provider shall not be liable for monetary relief, or, except as provided in subsection (j), for injunctive or other equitable relief, for infringement of copyright by reason of the provider referring or linking users to an online location containing infringing material or infringing activity, by using information location tools, including a directory, index, reference, pointer, or hypertext link, if the service provider—

“(1)(A) does not have actual knowledge that the material or activity is infringing;

“(B) in the absence of such actual knowledge, is not aware of facts or circumstances from which infringing activity is apparent; or

“(C) upon obtaining such knowledge or awareness, acts expeditiously to remove, or disable access to, the material;

“(2) does not receive a financial benefit directly attributable to the infringing activity, in a case in which the service provider has the right and ability to control such activity; and

“(3) upon notification of claimed infringement as described in subsection (c)(3), responds expeditiously to remove, or disable access to, the material that is claimed to be infringing or to be the subject of infringing activity, except that, for purposes of this paragraph, the information described in subsection (c)(3)(A)(iii) shall be identification of the reference or link, to material or activity claimed to be infringing, that is to be removed or access to which is to be disabled, and information reasonably sufficient to permit the service provider to locate that reference or link.

“(e) LIMITATION ON LIABILITY OF NONPROFIT EDUCATIONAL INSTITUTIONS.—(1) When a public or other nonprofit institution of higher education is a service provider, and when a faculty member or graduate student who is an employee of such institution

is performing a teaching or research function, for the purposes of subsections (a) and (b) such faculty member or graduate student shall be considered to be a person other than the institution, and for the purposes of subsections (c) and (d) such faculty member's or graduate student's knowledge or awareness of his or her infringing activities shall not be attributed to the institution, if—

“(A) such faculty member's or graduate student's infringing activities do not involve the provision of online access to instructional materials that are or were required or recommended, within the preceding 3-year period, for a course taught at the institution by such faculty member or graduate student;

“(B) the institution has not, within the preceding 3-year period, received more than two notifications described in subsection (c)(3) of claimed infringement by such faculty member or graduate student, and such notifications of claimed infringement were not actionable under subsection (f); and

“(C) the institution provides to all users of its system or network informational materials that accurately describe, and promote compliance with, the laws of the United States relating to copyright.

Applicability.

“(2) INJUNCTIONS.—For the purposes of this subsection, the limitations on injunctive relief contained in subsections (j)(2) and (j)(3), but not those in (j)(1), shall apply.

“(f) MISREPRESENTATIONS.—Any person who knowingly materially misrepresents under this section—

“(1) that material or activity is infringing, or

“(2) that material or activity was removed or disabled by mistake or misidentification,

shall be liable for any damages, including costs and attorneys' fees, incurred by the alleged infringer, by any copyright owner or copyright owner's authorized licensee, or by a service provider, who is injured by such misrepresentation, as the result of the service provider relying upon such misrepresentation in removing or disabling access to the material or activity claimed to be infringing, or in replacing the removed material or ceasing to disable access to it.

“(g) REPLACEMENT OF REMOVED OR DISABLED MATERIAL AND LIMITATION ON OTHER LIABILITY.—

“(1) NO LIABILITY FOR TAKING DOWN GENERALLY.—Subject to paragraph (2), a service provider shall not be liable to any person for any claim based on the service provider's good faith disabling of access to, or removal of, material or activity claimed to be infringing or based on facts or circumstances from which infringing activity is apparent, regardless of whether the material or activity is ultimately determined to be infringing.

“(2) EXCEPTION.—Paragraph (1) shall not apply with respect to material residing at the direction of a subscriber of the service provider on a system or network controlled or operated by or for the service provider that is removed, or to which access is disabled by the service provider, pursuant to a notice provided under subsection (c)(1)(C), unless the service provider—

“(A) takes reasonable steps promptly to notify the subscriber that it has removed or disabled access to the material;

“(B) upon receipt of a counter notification described in paragraph (3), promptly provides the person who provided the notification under subsection (c)(1)(C) with a copy of the counter notification, and informs that person that it will replace the removed material or cease disabling access to it in 10 business days; and

“(C) replaces the removed material and ceases disabling access to it not less than 10, nor more than 14, business days following receipt of the counter notice, unless its designated agent first receives notice from the person who submitted the notification under subsection (c)(1)(C) that such person has filed an action seeking a court order to restrain the subscriber from engaging in infringing activity relating to the material on the service provider’s system or network.

“(3) CONTENTS OF COUNTER NOTIFICATION.—To be effective under this subsection, a counter notification must be a written communication provided to the service provider’s designated agent that includes substantially the following:

“(A) A physical or electronic signature of the subscriber.

“(B) Identification of the material that has been removed or to which access has been disabled and the location at which the material appeared before it was removed or access to it was disabled.

“(C) A statement under penalty of perjury that the subscriber has a good faith belief that the material was removed or disabled as a result of mistake or misidentification of the material to be removed or disabled.

“(D) The subscriber’s name, address, and telephone number, and a statement that the subscriber consents to the jurisdiction of Federal District Court for the judicial district in which the address is located, or if the subscriber’s address is outside of the United States, for any judicial district in which the service provider may be found, and that the subscriber will accept service of process from the person who provided notification under subsection (c)(1)(C) or an agent of such person.

“(4) LIMITATION ON OTHER LIABILITY.—A service provider’s compliance with paragraph (2) shall not subject the service provider to liability for copyright infringement with respect to the material identified in the notice provided under subsection (c)(1)(C).

“(h) SUBPOENA TO IDENTIFY INFRINGER.—

“(1) REQUEST.—A copyright owner or a person authorized to act on the owner’s behalf may request the clerk of any United States district court to issue a subpoena to a service provider for identification of an alleged infringer in accordance with this subsection.

“(2) CONTENTS OF REQUEST.—The request may be made by filing with the clerk—

“(A) a copy of a notification described in subsection (c)(3)(A);

“(B) a proposed subpoena; and

“(C) a sworn declaration to the effect that the purpose for which the subpoena is sought is to obtain the identity of an alleged infringer and that such information will only

be used for the purpose of protecting rights under this title.

“(3) CONTENTS OF SUBPOENA.—The subpoena shall authorize and order the service provider receiving the notification and the subpoena to expeditiously disclose to the copyright owner or person authorized by the copyright owner information sufficient to identify the alleged infringer of the material described in the notification to the extent such information is available to the service provider.

“(4) BASIS FOR GRANTING SUBPOENA.—If the notification filed satisfies the provisions of subsection (c)(3)(A), the proposed subpoena is in proper form, and the accompanying declaration is properly executed, the clerk shall expeditiously issue and sign the proposed subpoena and return it to the requester for delivery to the service provider.

“(5) ACTIONS OF SERVICE PROVIDER RECEIVING SUBPOENA.—Upon receipt of the issued subpoena, either accompanying or subsequent to the receipt of a notification described in subsection (c)(3)(A), the service provider shall expeditiously disclose to the copyright owner or person authorized by the copyright owner the information required by the subpoena, notwithstanding any other provision of law and regardless of whether the service provider responds to the notification.

“(6) RULES APPLICABLE TO SUBPOENA.—Unless otherwise provided by this section or by applicable rules of the court, the procedure for issuance and delivery of the subpoena, and the remedies for noncompliance with the subpoena, shall be governed to the greatest extent practicable by those provisions of the Federal Rules of Civil Procedure governing the issuance, service, and enforcement of a subpoena duces tecum.

“(i) CONDITIONS FOR ELIGIBILITY.—

“(1) ACCOMMODATION OF TECHNOLOGY.—The limitations on liability established by this section shall apply to a service provider only if the service provider—

“(A) has adopted and reasonably implemented, and informs subscribers and account holders of the service provider’s system or network of, a policy that provides for the termination in appropriate circumstances of subscribers and account holders of the service provider’s system or network who are repeat infringers; and

“(B) accommodates and does not interfere with standard technical measures.

“(2) DEFINITION.—As used in this subsection, the term ‘standard technical measures’ means technical measures that are used by copyright owners to identify or protect copyrighted works and—

“(A) have been developed pursuant to a broad consensus of copyright owners and service providers in an open, fair, voluntary, multi-industry standards process;

“(B) are available to any person on reasonable and nondiscriminatory terms; and

“(C) do not impose substantial costs on service providers or substantial burdens on their systems or networks.

Applicability.

“(j) INJUNCTIONS.—The following rules shall apply in the case of any application for an injunction under section 502 against a service provider that is not subject to monetary remedies under this section:

“(1) SCOPE OF RELIEF.—(A) With respect to conduct other than that which qualifies for the limitation on remedies set forth in subsection (a), the court may grant injunctive relief with respect to a service provider only in one or more of the following forms:

“(i) An order restraining the service provider from providing access to infringing material or activity residing at a particular online site on the provider’s system or network.

“(ii) An order restraining the service provider from providing access to a subscriber or account holder of the service provider’s system or network who is engaging in infringing activity and is identified in the order, by terminating the accounts of the subscriber or account holder that are specified in the order.

“(iii) Such other injunctive relief as the court may consider necessary to prevent or restrain infringement of copyrighted material specified in the order of the court at a particular online location, if such relief is the least burdensome to the service provider among the forms of relief comparably effective for that purpose.

“(B) If the service provider qualifies for the limitation on remedies described in subsection (a), the court may only grant injunctive relief in one or both of the following forms:

“(i) An order restraining the service provider from providing access to a subscriber or account holder of the service provider’s system or network who is using the provider’s service to engage in infringing activity and is identified in the order, by terminating the accounts of the subscriber or account holder that are specified in the order.

“(ii) An order restraining the service provider from providing access, by taking reasonable steps specified in the order to block access, to a specific, identified, online location outside the United States.

“(2) CONSIDERATIONS.—The court, in considering the relevant criteria for injunctive relief under applicable law, shall consider— Courts.

“(A) whether such an injunction, either alone or in combination with other such injunctions issued against the same service provider under this subsection, would significantly burden either the provider or the operation of the provider’s system or network;

“(B) the magnitude of the harm likely to be suffered by the copyright owner in the digital network environment if steps are not taken to prevent or restrain the infringement;

“(C) whether implementation of such an injunction would be technically feasible and effective, and would not interfere with access to noninfringing material at other online locations; and

“(D) whether other less burdensome and comparably effective means of preventing or restraining access to the infringing material are available.

“(3) NOTICE AND EX PARTE ORDERS.—Injunctive relief under this subsection shall be available only after notice to the service provider and an opportunity for the service provider



to appear are provided, except for orders ensuring the preservation of evidence or other orders having no material adverse effect on the operation of the service provider's communications network.

“(k) DEFINITIONS.—

“(1) SERVICE PROVIDER.—(A) As used in subsection (a), the term ‘service provider’ means an entity offering the transmission, routing, or providing of connections for digital online communications, between or among points specified by a user, of material of the user's choosing, without modification to the content of the material as sent or received.

“(B) As used in this section, other than subsection (a), the term ‘service provider’ means a provider of online services or network access, or the operator of facilities therefor, and includes an entity described in subparagraph (A).

“(2) MONETARY RELIEF.—As used in this section, the term ‘monetary relief’ means damages, costs, attorneys’ fees, and any other form of monetary payment.

“(l) OTHER DEFENSES NOT AFFECTED.—The failure of a service provider's conduct to qualify for limitation of liability under this section shall not bear adversely upon the consideration of a defense by the service provider that the service provider's conduct is not infringing under this title or any other defense.

“(m) PROTECTION OF PRIVACY.—Nothing in this section shall be construed to condition the applicability of subsections (a) through (d) on—

“(1) a service provider monitoring its service or affirmatively seeking facts indicating infringing activity, except to the extent consistent with a standard technical measure complying with the provisions of subsection (i); or

“(2) a service provider gaining access to, removing, or disabling access to material in cases in which such conduct is prohibited by law.

“(n) CONSTRUCTION.—Subsections (a), (b), (c), and (d) describe separate and distinct functions for purposes of applying this section. Whether a service provider qualifies for the limitation on liability in any one of those subsections shall be based solely on the criteria in that subsection, and shall not affect a determination of whether that service provider qualifies for the limitations on liability under any other such subsection.”.

(b) CONFORMING AMENDMENT.—The table of sections for chapter 5 of title 17, United States Code, is amended by adding at the end the following:

“512. Limitations on liability relating to material online.”.

17 USC 512 note. **SEC. 203. EFFECTIVE DATE.**

This title and the amendments made by this title shall take effect on the date of the enactment of this Act.

Computer  
Maintenance  
Competition  
Assurance Act.

### **TITLE III—COMPUTER MAINTENANCE OR REPAIR COPYRIGHT EXEMPTION**

17 USC 101 note. **SEC. 301. SHORT TITLE.**

This title may be cited as the “Computer Maintenance Competition Assurance Act”.

**SEC. 302. LIMITATIONS ON EXCLUSIVE RIGHTS; COMPUTER PROGRAMS.**

Section 117 of title 17, United States Code, is amended—

(1) by striking “Notwithstanding” and inserting the following:  
 “(a) MAKING OF ADDITIONAL COPY OR ADAPTATION BY OWNER OF COPY.—Notwithstanding”;

(2) by striking “Any exact” and inserting the following:

“(b) LEASE, SALE, OR OTHER TRANSFER OF ADDITIONAL COPY OR ADAPTATION.—Any exact”; and

(3) by adding at the end the following:

“(c) MACHINE MAINTENANCE OR REPAIR.—Notwithstanding the provisions of section 106, it is not an infringement for the owner or lessee of a machine to make or authorize the making of a copy of a computer program if such copy is made solely by virtue of the activation of a machine that lawfully contains an authorized copy of the computer program, for purposes only of maintenance or repair of that machine, if—

“(1) such new copy is used in no other manner and is destroyed immediately after the maintenance or repair is completed; and

“(2) with respect to any computer program or part thereof that is not necessary for that machine to be activated, such program or part thereof is not accessed or used other than to make such new copy by virtue of the activation of the machine.

“(d) DEFINITIONS.—For purposes of this section—

“(1) the ‘maintenance’ of a machine is the servicing of the machine in order to make it work in accordance with its original specifications and any changes to those specifications authorized for that machine; and

“(2) the ‘repair’ of a machine is the restoring of the machine to the state of working in accordance with its original specifications and any changes to those specifications authorized for that machine.”.

## **TITLE IV—MISCELLANEOUS PROVISIONS**

**SEC. 401. PROVISIONS RELATING TO THE COMMISSIONER OF PATENTS AND TRADEMARKS AND THE REGISTER OF COPYRIGHTS**

(a) COMPENSATION.—(1) Section 3(d) of title 35, United States Code, is amended by striking “prescribed by law for Assistant Secretaries of Commerce” and inserting “in effect for level III of the Executive Schedule under section 5314 of title 5, United States Code”.

(2) Section 701(e) of title 17, United States Code, is amended—

(A) by striking “IV” and inserting “III”; and

(B) by striking “5315” and inserting “5314”.

(3) Section 5314 of title 5, United States Code, is amended by adding at the end the following:

“Assistant Secretary of Commerce and Commissioner of Patents and Trademarks.

“Register of Copyrights.”.

(b) CLARIFICATION OF AUTHORITY OF THE COPYRIGHT OFFICE.—Section 701 of title 17, United States Code, is amended—

(1) by redesignating subsections (b) through (e) as subsections (c) through (f), respectively; and

(2) by inserting after subsection (a) the following:

“(b) In addition to the functions and duties set out elsewhere in this chapter, the Register of Copyrights shall perform the following functions:

“(1) Advise Congress on national and international issues relating to copyright, other matters arising under this title, and related matters.

“(2) Provide information and assistance to Federal departments and agencies and the Judiciary on national and international issues relating to copyright, other matters arising under this title, and related matters.

“(3) Participate in meetings of international intergovernmental organizations and meetings with foreign government officials relating to copyright, other matters arising under this title, and related matters, including as a member of United States delegations as authorized by the appropriate Executive branch authority.

“(4) Conduct studies and programs regarding copyright, other matters arising under this title, and related matters, the administration of the Copyright Office, or any function vested in the Copyright Office by law, including educational programs conducted cooperatively with foreign intellectual property offices and international intergovernmental organizations.

“(5) Perform such other functions as Congress may direct, or as may be appropriate in furtherance of the functions and duties specifically set forth in this title.”.

#### SEC. 402. EPHEMERAL RECORDINGS.

Section 112(a) of title 17, United States Code, is amended—

(1) by redesignating paragraphs (1), (2), and (3) as subparagraphs (A), (B), and (C), respectively;

(2) by inserting “(1)” after “(a)”;

(3) by inserting after “under a license” the following: “, including a statutory license under section 114(f);”;

(4) by inserting after “114(a),” the following: “or for a transmitting organization that is a broadcast radio or television station licensed as such by the Federal Communications Commission and that makes a broadcast transmission of a performance of a sound recording in a digital format on a nonsubscription basis;” and

(5) by adding at the end the following:

“(2) In a case in which a transmitting organization entitled to make a copy or phonorecord under paragraph (1) in connection with the transmission to the public of a performance or display of a work is prevented from making such copy or phonorecord by reason of the application by the copyright owner of technical measures that prevent the reproduction of the work, the copyright owner shall make available to the transmitting organization the necessary means for permitting the making of such copy or phonorecord as permitted under that paragraph, if it is technologically feasible and economically reasonable for the copyright owner to do so. If the copyright owner fails to do so in a timely manner in light of the transmitting organization’s reasonable business requirements, the transmitting organization shall not be liable for

a violation of section 1201(a)(1) of this title for engaging in such activities as are necessary to make such copies or phonorecords as permitted under paragraph (1) of this subsection.”.

**SEC. 403. LIMITATIONS ON EXCLUSIVE RIGHTS; DISTANCE EDUCATION.**

(a) **RECOMMENDATIONS BY REGISTER OF COPYRIGHTS.**—Not later than 6 months after the date of the enactment of this Act, the Register of Copyrights, after consultation with representatives of copyright owners, nonprofit educational institutions, and nonprofit libraries and archives, shall submit to the Congress recommendations on how to promote distance education through digital technologies, including interactive digital networks, while maintaining an appropriate balance between the rights of copyright owners and the needs of users of copyrighted works. Such recommendations shall include any legislation the Register of Copyrights considers appropriate to achieve the objective described in the preceding sentence.

Deadline.

(b) **FACTORS.**—In formulating recommendations under subsection (a), the Register of Copyrights shall consider—

(1) the need for an exemption from exclusive rights of copyright owners for distance education through digital networks;

(2) the categories of works to be included under any distance education exemption;

(3) the extent of appropriate quantitative limitations on the portions of works that may be used under any distance education exemption;

(4) the parties who should be entitled to the benefits of any distance education exemption;

(5) the parties who should be designated as eligible recipients of distance education materials under any distance education exemption;

(6) whether and what types of technological measures can or should be employed to safeguard against unauthorized access to, and use or retention of, copyrighted materials as a condition of eligibility for any distance education exemption, including, in light of developing technological capabilities, the exemption set out in section 110(2) of title 17, United States Code;

(7) the extent to which the availability of licenses for the use of copyrighted works in distance education through interactive digital networks should be considered in assessing eligibility for any distance education exemption; and

(8) such other issues relating to distance education through interactive digital networks that the Register considers appropriate.

**SEC. 404. EXEMPTION FOR LIBRARIES AND ARCHIVES.**

Section 108 of title 17, United States Code, is amended—

(1) in subsection (a)—

(A) by striking “Notwithstanding” and inserting “Except as otherwise provided in this title and notwithstanding”;

(B) by inserting after “no more than one copy or phonorecord of a work” the following: “, except as provided in subsections (b) and (c)”;

(C) in paragraph (3) by inserting after “copyright” the following: “that appears on the copy or phonorecord that is reproduced under the provisions of this section, or

includes a legend stating that the work may be protected by copyright if no such notice can be found on the copy or phonorecord that is reproduced under the provisions of this section”;

(2) in subsection (b)—

(A) by striking “a copy or phonorecord” and inserting “three copies or phonorecords”;

(B) by striking “in facsimile form”; and

(C) by striking “if the copy or phonorecord reproduced is currently in the collections of the library or archives.” and inserting “if—

“(1) the copy or phonorecord reproduced is currently in the collections of the library or archives; and

“(2) any such copy or phonorecord that is reproduced in digital format is not otherwise distributed in that format and is not made available to the public in that format outside the premises of the library or archives.”; and

(3) in subsection (c)—

(A) by striking “a copy or phonorecord” and inserting “three copies or phonorecords”;

(B) by striking “in facsimile form”;

(C) by inserting “or if the existing format in which the work is stored has become obsolete,” after “stolen,”;

(D) by striking “if the library or archives has, after a reasonable effort, determined that an unused replacement cannot be obtained at a fair price.” and inserting “if—

“(1) the library or archives has, after a reasonable effort, determined that an unused replacement cannot be obtained at a fair price; and

“(2) any such copy or phonorecord that is reproduced in digital format is not made available to the public in that format outside the premises of the library or archives in lawful possession of such copy.”; and

(E) by adding at the end the following:

“For purposes of this subsection, a format shall be considered obsolete if the machine or device necessary to render perceptible a work stored in that format is no longer manufactured or is no longer reasonably available in the commercial marketplace.”.

**SEC. 405. SCOPE OF EXCLUSIVE RIGHTS IN SOUND RECORDINGS; EPHEMERAL RECORDINGS.**

(a) SCOPE OF EXCLUSIVE RIGHTS IN SOUND RECORDINGS.—Section 114 of title 17, United States Code, is amended as follows:

(1) Subsection (d) is amended—

(A) in paragraph (1) by striking subparagraph (A) and inserting the following:

“(A) a nonsubscription broadcast transmission;”;

(B) by amending paragraph (2) to read as follows:

“(2) STATUTORY LICENSING OF CERTAIN TRANSMISSIONS.—The performance of a sound recording publicly by means of a subscription digital audio transmission not exempt under paragraph (1), an eligible nonsubscription transmission, or a transmission not exempt under paragraph (1) that is made by a preexisting satellite digital audio radio service shall be subject to statutory licensing, in accordance with subsection (f) if—

“(A)(i) the transmission is not part of an interactive service;

“(ii) except in the case of a transmission to a business establishment, the transmitting entity does not automatically and intentionally cause any device receiving the transmission to switch from one program channel to another; and

“(iii) except as provided in section 1002(e), the transmission of the sound recording is accompanied, if technically feasible, by the information encoded in that sound recording, if any, by or under the authority of the copyright owner of that sound recording, that identifies the title of the sound recording, the featured recording artist who performs on the sound recording, and related information, including information concerning the underlying musical work and its writer;

“(B) in the case of a subscription transmission not exempt under paragraph (1) that is made by a preexisting subscription service in the same transmission medium used by such service on July 31, 1998, or in the case of a transmission not exempt under paragraph (1) that is made by a preexisting satellite digital audio radio service—

“(i) the transmission does not exceed the sound recording performance complement; and

“(ii) the transmitting entity does not cause to be published by means of an advance program schedule or prior announcement the titles of the specific sound recordings or phonorecords embodying such sound recordings to be transmitted; and

“(C) in the case of an eligible nonsubscription transmission or a subscription transmission not exempt under paragraph (1) that is made by a new subscription service or by a preexisting subscription service other than in the same transmission medium used by such service on July 31, 1998—

“(i) the transmission does not exceed the sound recording performance complement, except that this requirement shall not apply in the case of a retransmission of a broadcast transmission if the retransmission is made by a transmitting entity that does not have the right or ability to control the programming of the broadcast station making the broadcast transmission, unless—

“(I) the broadcast station makes broadcast transmissions—

“(aa) in digital format that regularly exceed the sound recording performance complement; or

“(bb) in analog format, a substantial portion of which, on a weekly basis, exceed the sound recording performance complement; and

“(II) the sound recording copyright owner or its representative has notified the transmitting entity in writing that broadcast transmissions of the copyright owner’s sound recordings exceed the sound recording performance complement as provided in this clause;

“(ii) the transmitting entity does not cause to be published, or induce or facilitate the publication, by means of an advance program schedule or prior announcement, the titles of the specific sound recordings to be transmitted, the phonorecords embodying such sound recordings, or, other than for illustrative purposes, the names of the featured recording artists, except that this clause does not disqualify a transmitting entity that makes a prior announcement that a particular artist will be featured within an unspecified future time period, and in the case of a retransmission of a broadcast transmission by a transmitting entity that does not have the right or ability to control the programming of the broadcast transmission, the requirement of this clause shall not apply to a prior oral announcement by the broadcast station, or to an advance program schedule published, induced, or facilitated by the broadcast station, if the transmitting entity does not have actual knowledge and has not received written notice from the copyright owner or its representative that the broadcast station publishes or induces or facilitates the publication of such advance program schedule, or if such advance program schedule is a schedule of classical music programming published by the broadcast station in the same manner as published by that broadcast station on or before September 30, 1998;

“(iii) the transmission—

“(I) is not part of an archived program of less than 5 hours duration;

“(II) is not part of an archived program of 5 hours or greater in duration that is made available for a period exceeding 2 weeks;

“(III) is not part of a continuous program which is of less than 3 hours duration; or

“(IV) is not part of an identifiable program in which performances of sound recordings are rendered in a predetermined order, other than an archived or continuous program, that is transmitted at—

“(aa) more than 3 times in any 2-week period that have been publicly announced in advance, in the case of a program of less than 1 hour in duration, or

“(bb) more than 4 times in any 2-week period that have been publicly announced in advance, in the case of a program of 1 hour or more in duration,

except that the requirement of this subclause shall not apply in the case of a retransmission of a broadcast transmission by a transmitting entity that does not have the right or ability to control the programming of the broadcast transmission, unless the transmitting entity is given notice in writing by the copyright owner of the sound recording that the broadcast station makes broadcast

transmissions that regularly violate such requirement;

“(iv) the transmitting entity does not knowingly perform the sound recording, as part of a service that offers transmissions of visual images contemporaneously with transmissions of sound recordings, in a manner that is likely to cause confusion, to cause mistake, or to deceive, as to the affiliation, connection, or association of the copyright owner or featured recording artist with the transmitting entity or a particular product or service advertised by the transmitting entity, or as to the origin, sponsorship, or approval by the copyright owner or featured recording artist of the activities of the transmitting entity other than the performance of the sound recording itself;

“(v) the transmitting entity cooperates to prevent, to the extent feasible without imposing substantial costs or burdens, a transmission recipient or any other person or entity from automatically scanning the transmitting entity’s transmissions alone or together with transmissions by other transmitting entities in order to select a particular sound recording to be transmitted to the transmission recipient, except that the requirement of this clause shall not apply to a satellite digital audio service that is in operation, or that is licensed by the Federal Communications Commission, on or before July 31, 1998;

“(vi) the transmitting entity takes no affirmative steps to cause or induce the making of a phonorecord by the transmission recipient, and if the technology used by the transmitting entity enables the transmitting entity to limit the making by the transmission recipient of phonorecords of the transmission directly in a digital format, the transmitting entity sets such technology to limit such making of phonorecords to the extent permitted by such technology;

“(vii) phonorecords of the sound recording have been distributed to the public under the authority of the copyright owner or the copyright owner authorizes the transmitting entity to transmit the sound recording, and the transmitting entity makes the transmission from a phonorecord lawfully made under the authority of the copyright owner, except that the requirement of this clause shall not apply to a retransmission of a broadcast transmission by a transmitting entity that does not have the right or ability to control the programming of the broadcast transmission, unless the transmitting entity is given notice in writing by the copyright owner of the sound recording that the broadcast station makes broadcast transmissions that regularly violate such requirement;

“(viii) the transmitting entity accommodates and does not interfere with the transmission of technical measures that are widely used by sound recording copyright owners to identify or protect copyrighted works, and that are technically feasible of being



transmitted by the transmitting entity without imposing substantial costs on the transmitting entity or resulting in perceptible aural or visual degradation of the digital signal, except that the requirement of this clause shall not apply to a satellite digital audio service that is in operation, or that is licensed under the authority of the Federal Communications Commission, on or before July 31, 1998, to the extent that such service has designed, developed, or made commitments to procure equipment or technology that is not compatible with such technical measures before such technical measures are widely adopted by sound recording copyright owners; and

“(ix) the transmitting entity identifies in textual data the sound recording during, but not before, the time it is performed, including the title of the sound recording, the title of the phonorecord embodying such sound recording, if any, and the featured recording artist, in a manner to permit it to be displayed to the transmission recipient by the device or technology intended for receiving the service provided by the transmitting entity, except that the obligation in this clause shall not take effect until 1 year after the date of the enactment of the Digital Millennium Copyright Act and shall not apply in the case of a retransmission of a broadcast transmission by a transmitting entity that does not have the right or ability to control the programming of the broadcast transmission, or in the case in which devices or technology intended for receiving the service provided by the transmitting entity that have the capability to display such textual data are not common in the marketplace.”.

(2) Subsection (f) is amended—

(A) in the subsection heading by striking “NONEXEMPT SUBSCRIPTION” and inserting “CERTAIN NONEXEMPT”;

(B) in paragraph (1)—

(i) in the first sentence—

(I) by striking “(1) No” and inserting “(1)(A) No”;

(II) by striking “the activities” and inserting “subscription transmissions by preexisting subscription services and transmissions by preexisting satellite digital audio radio services”; and

(III) by striking “2000” and inserting “2001”; and

(ii) by amending the third sentence to read as follows: “Any copyright owners of sound recordings, preexisting subscription services, or preexisting satellite digital audio radio services may submit to the Librarian of Congress licenses covering such subscription transmissions with respect to such sound recordings.”; and

(C) by striking paragraphs (2), (3), (4), and (5) and inserting the following:

“(B) In the absence of license agreements negotiated under subparagraph (A), during the 60-day period commencing 6

months after publication of the notice specified in subparagraph (A), and upon the filing of a petition in accordance with section 803(a)(1), the Librarian of Congress shall, pursuant to chapter 8, convene a copyright arbitration royalty panel to determine and publish in the Federal Register a schedule of rates and terms which, subject to paragraph (3), shall be binding on all copyright owners of sound recordings and entities performing sound recordings affected by this paragraph. In establishing rates and terms for preexisting subscription services and preexisting satellite digital audio radio services, in addition to the objectives set forth in section 801(b)(1), the copyright arbitration royalty panel may consider the rates and terms for comparable types of subscription digital audio transmission services and comparable circumstances under voluntary license agreements negotiated as provided in subparagraph (A).

“(C)(i) Publication of a notice of the initiation of voluntary negotiation proceedings as specified in subparagraph (A) shall be repeated, in accordance with regulations that the Librarian of Congress shall prescribe—

Regulations.

“(I) no later than 30 days after a petition is filed by any copyright owners of sound recordings, any preexisting subscription services, or any preexisting satellite digital audio radio services indicating that a new type of subscription digital audio transmission service on which sound recordings are performed is or is about to become operational; and

“(II) in the first week of January 2001, and at 5-year intervals thereafter.

“(ii) The procedures specified in subparagraph (B) shall be repeated, in accordance with regulations that the Librarian of Congress shall prescribe, upon filing of a petition in accordance with section 803(a)(1) during a 60-day period commencing—

“(I) 6 months after publication of a notice of the initiation of voluntary negotiation proceedings under subparagraph (A) pursuant to a petition under clause (i)(I) of this subparagraph; or

“(II) on July 1, 2001, and at 5-year intervals thereafter.

“(iii) The procedures specified in subparagraph (B) shall be concluded in accordance with section 802.

“(2)(A) No later than 30 days after the date of the enactment of the Digital Millennium Copyright Act, the Librarian of Congress shall cause notice to be published in the Federal Register of the initiation of voluntary negotiation proceedings for the purpose of determining reasonable terms and rates of royalty payments for public performances of sound recordings by means of eligible nonsubscription transmissions and transmissions by new subscription services specified by subsection (d)(2) during the period beginning on the date of the enactment of such Act and ending on December 31, 2000, or such other date as the parties may agree. Such rates and terms shall distinguish among the different types of eligible nonsubscription transmission services and new subscription services then in operation and shall include a minimum fee for each such type of service. Any copyright owners of sound recordings or any entities performing sound recordings affected by this paragraph may submit to the Librarian of Congress licenses covering

Deadline.  
Federal Register,  
publication.  
Notice.

Federal Register,  
publication.

such eligible nonsubscription transmissions and new subscription services with respect to such sound recordings. The parties to each negotiation proceeding shall bear their own costs.

“(B) In the absence of license agreements negotiated under subparagraph (A), during the 60-day period commencing 6 months after publication of the notice specified in subparagraph (A), and upon the filing of a petition in accordance with section 803(a)(1), the Librarian of Congress shall, pursuant to chapter 8, convene a copyright arbitration royalty panel to determine and publish in the Federal Register a schedule of rates and terms which, subject to paragraph (3), shall be binding on all copyright owners of sound recordings and entities performing sound recordings affected by this paragraph during the period beginning on the date of the enactment of the Digital Millennium Copyright Act and ending on December 31, 2000, or such other date as the parties may agree. Such rates and terms shall distinguish among the different types of eligible nonsubscription transmission services then in operation and shall include a minimum fee for each such type of service, such differences to be based on criteria including, but not limited to, the quantity and nature of the use of sound recordings and the degree to which use of the service may substitute for or may promote the purchase of phonorecords by consumers. In establishing rates and terms for transmissions by eligible nonsubscription services and new subscription services, the copyright arbitration royalty panel shall establish rates and terms that most clearly represent the rates and terms that would have been negotiated in the marketplace between a willing buyer and a willing seller. In determining such rates and terms, the copyright arbitration royalty panel shall base its decision on economic, competitive and programming information presented by the parties, including—

“(i) whether use of the service may substitute for or may promote the sales of phonorecords or otherwise may interfere with or may enhance the sound recording copyright owner’s other streams of revenue from its sound recordings; and

“(ii) the relative roles of the copyright owner and the transmitting entity in the copyrighted work and the service made available to the public with respect to relative creative contribution, technological contribution, capital investment, cost, and risk.

In establishing such rates and terms, the copyright arbitration royalty panel may consider the rates and terms for comparable types of digital audio transmission services and comparable circumstances under voluntary license agreements negotiated under subparagraph (A).

Regulations.

“(C)(i) Publication of a notice of the initiation of voluntary negotiation proceedings as specified in subparagraph (A) shall be repeated in accordance with regulations that the Librarian of Congress shall prescribe—

“(I) no later than 30 days after a petition is filed by any copyright owners of sound recordings or any eligible nonsubscription service or new subscription service indicating that a new type of eligible nonsubscription service or new subscription service on which sound recordings are performed is or is about to become operational; and

“(II) in the first week of January 2000, and at 2-year intervals thereafter, except to the extent that different years for the repeating of such proceedings may be determined in accordance with subparagraph (A).

“(ii) The procedures specified in subparagraph (B) shall be repeated, in accordance with regulations that the Librarian of Congress shall prescribe, upon filing of a petition in accordance with section 803(a)(1) during a 60-day period commencing—

“(I) 6 months after publication of a notice of the initiation of voluntary negotiation proceedings under subparagraph (A) pursuant to a petition under clause (i)(I); or

“(II) on July 1, 2000, and at 2-year intervals thereafter, except to the extent that different years for the repeating of such proceedings may be determined in accordance with subparagraph (A).

“(iii) The procedures specified in subparagraph (B) shall be concluded in accordance with section 802.

“(3) License agreements voluntarily negotiated at any time between 1 or more copyright owners of sound recordings and 1 or more entities performing sound recordings shall be given effect in lieu of any determination by a copyright arbitration royalty panel or decision by the Librarian of Congress.

“(4)(A) The Librarian of Congress shall also establish requirements by which copyright owners may receive reasonable notice of the use of their sound recordings under this section, and under which records of such use shall be kept and made available by entities performing sound recordings.

“(B) Any person who wishes to perform a sound recording publicly by means of a transmission eligible for statutory licensing under this subsection may do so without infringing the exclusive right of the copyright owner of the sound recording—

“(i) by complying with such notice requirements as the Librarian of Congress shall prescribe by regulation and by paying royalty fees in accordance with this subsection; or

“(ii) if such royalty fees have not been set, by agreeing to pay such royalty fees as shall be determined in accordance with this subsection.

“(C) Any royalty payments in arrears shall be made on or before the twentieth day of the month next succeeding the month in which the royalty fees are set.”.

(3) Subsection (g) is amended—

(A) in the subsection heading by striking “SUBSCRIPTION”;

(B) in paragraph (1) in the matter preceding subparagraph (A), by striking “subscription transmission licensed” and inserting “transmission licensed under a statutory license”;

(C) in subparagraphs (A) and (B) by striking “subscription”; and

(D) in paragraph (2) by striking “subscription”.

(4) Subsection (j) is amended—

(A) by striking paragraphs (4) and (9) and redesignating paragraphs (2), (3), (5), (6), (7), and (8) as paragraphs (3), (5), (9), (12), (13), and (14), respectively;

Regulations.

(B) by inserting after paragraph (1) the following:

“(2) An ‘archived program’ is a predetermined program that is available repeatedly on the demand of the transmission recipient and that is performed in the same order from the beginning, except that an archived program shall not include a recorded event or broadcast transmission that makes no more than an incidental use of sound recordings, as long as such recorded event or broadcast transmission does not contain an entire sound recording or feature a particular sound recording.”;

(C) by inserting after paragraph (3), as so redesignated, the following:

“(4) A ‘continuous program’ is a predetermined program that is continuously performed in the same order and that is accessed at a point in the program that is beyond the control of the transmission recipient.”;

(D) by inserting after paragraph (5), as so redesignated, the following:

“(6) An ‘eligible nonsubscription transmission’ is a noninteractive nonsubscription digital audio transmission not exempt under subsection (d)(1) that is made as part of a service that provides audio programming consisting, in whole or in part, of performances of sound recordings, including retransmissions of broadcast transmissions, if the primary purpose of the service is to provide to the public such audio or other entertainment programming, and the primary purpose of the service is not to sell, advertise, or promote particular products or services other than sound recordings, live concerts, or other music-related events.

“(7) An ‘interactive service’ is one that enables a member of the public to receive a transmission of a program specially created for the recipient, or on request, a transmission of a particular sound recording, whether or not as part of a program, which is selected by or on behalf of the recipient. The ability of individuals to request that particular sound recordings be performed for reception by the public at large, or in the case of a subscription service, by all subscribers of the service, does not make a service interactive, if the programming on each channel of the service does not substantially consist of sound recordings that are performed within 1 hour of the request or at a time designated by either the transmitting entity or the individual making such request. If an entity offers both interactive and noninteractive services (either concurrently or at different times), the noninteractive component shall not be treated as part of an interactive service.

“(8) A ‘new subscription service’ is a service that performs sound recordings by means of noninteractive subscription digital audio transmissions and that is not a preexisting subscription service or a preexisting satellite digital audio radio service.”;

(E) by inserting after paragraph (9), as so redesignated, the following:

“(10) A ‘preexisting satellite digital audio radio service’ is a subscription satellite digital audio radio service provided pursuant to a satellite digital audio radio service license issued by the Federal Communications Commission on or before July 31, 1998, and any renewal of such license to the extent of

the scope of the original license, and may include a limited number of sample channels representative of the subscription service that are made available on a nonsubscription basis in order to promote the subscription service.

“(11) A ‘preexisting subscription service’ is a service that performs sound recordings by means of noninteractive audio-only subscription digital audio transmissions, which was in existence and was making such transmissions to the public for a fee on or before July 31, 1998, and may include a limited number of sample channels representative of the subscription service that are made available on a nonsubscription basis in order to promote the subscription service.”; and

(F) by adding at the end the following:

“(15) A ‘transmission’ is either an initial transmission or a retransmission.”.

(5) The amendment made by paragraph (2)(B)(i)(III) of this subsection shall be deemed to have been enacted as part of the Digital Performance Right in Sound Recordings Act of 1995, and the publication of notice of proceedings under section 114(f)(1) of title 17, United States Code, as in effect upon the effective date of that Act, for the determination of royalty payments shall be deemed to have been made for the period beginning on the effective date of that Act and ending on December 1, 2001. 17 USC 114 note.

(6) The amendments made by this subsection do not annul, limit, or otherwise impair the rights that are preserved by section 114 of title 17, United States Code, including the rights preserved by subsections (c), (d)(4), and (i) of such section. 17 USC 114 note.

(b) EPHEMERAL RECORDINGS.—Section 112 of title 17, United States Code, is amended—

(1) by redesignating subsection (e) as subsection (f); and

(2) by inserting after subsection (d) the following:

“(e) STATUTORY LICENSE.—(1) A transmitting organization entitled to transmit to the public a performance of a sound recording under the limitation on exclusive rights specified by section 114(d)(1)(C)(iv) or under a statutory license in accordance with section 114(f) is entitled to a statutory license, under the conditions specified by this subsection, to make no more than 1 phonorecord of the sound recording (unless the terms and conditions of the statutory license allow for more), if the following conditions are satisfied:

“(A) The phonorecord is retained and used solely by the transmitting organization that made it, and no further phonorecords are reproduced from it.

“(B) The phonorecord is used solely for the transmitting organization’s own transmissions originating in the United States under a statutory license in accordance with section 114(f) or the limitation on exclusive rights specified by section 114(d)(1)(C)(iv).

“(C) Unless preserved exclusively for purposes of archival preservation, the phonorecord is destroyed within 6 months from the date the sound recording was first transmitted to the public using the phonorecord.

“(D) Phonorecords of the sound recording have been distributed to the public under the authority of the copyright owner or the copyright owner authorizes the transmitting entity to transmit the sound recording, and the transmitting entity

makes the phonorecord under this subsection from a phonorecord lawfully made and acquired under the authority of the copyright owner.

“(3) Notwithstanding any provision of the antitrust laws, any copyright owners of sound recordings and any transmitting organizations entitled to a statutory license under this subsection may negotiate and agree upon royalty rates and license terms and conditions for making phonorecords of such sound recordings under this section and the proportionate division of fees paid among copyright owners, and may designate common agents to negotiate, agree to, pay, or receive such royalty payments.

Deadline.  
Federal Register,  
publication.  
Notice.

“(4) No later than 30 days after the date of the enactment of the Digital Millennium Copyright Act, the Librarian of Congress shall cause notice to be published in the Federal Register of the initiation of voluntary negotiation proceedings for the purpose of determining reasonable terms and rates of royalty payments for the activities specified by paragraph (2) of this subsection during the period beginning on the date of the enactment of such Act and ending on December 31, 2000, or such other date as the parties may agree. Such rates shall include a minimum fee for each type of service offered by transmitting organizations. Any copyright owners of sound recordings or any transmitting organizations entitled to a statutory license under this subsection may submit to the Librarian of Congress licenses covering such activities with respect to such sound recordings. The parties to each negotiation proceeding shall bear their own costs.

Federal Register,  
publication.

“(5) In the absence of license agreements negotiated under paragraph (3), during the 60-day period commencing 6 months after publication of the notice specified in paragraph (4), and upon the filing of a petition in accordance with section 803(a)(1), the Librarian of Congress shall, pursuant to chapter 8, convene a copyright arbitration royalty panel to determine and publish in the Federal Register a schedule of reasonable rates and terms which, subject to paragraph (6), shall be binding on all copyright owners of sound recordings and transmitting organizations entitled to a statutory license under this subsection during the period beginning on the date of the enactment of the Digital Millennium Copyright Act and ending on December 31, 2000, or such other date as the parties may agree. Such rates shall include a minimum fee for each type of service offered by transmitting organizations. The copyright arbitration royalty panel shall establish rates that most clearly represent the fees that would have been negotiated in the marketplace between a willing buyer and a willing seller. In determining such rates and terms, the copyright arbitration royalty panel shall base its decision on economic, competitive, and programming information presented by the parties, including—

“(A) whether use of the service may substitute for or may promote the sales of phonorecords or otherwise interferes with or enhances the copyright owner’s traditional streams of revenue; and

“(B) the relative roles of the copyright owner and the transmitting organization in the copyrighted work and the service made available to the public with respect to relative creative contribution, technological contribution, capital investment, cost, and risk.

In establishing such rates and terms, the copyright arbitration royalty panel may consider the rates and terms under voluntary

license agreements negotiated as provided in paragraphs (3) and (4). The Librarian of Congress shall also establish requirements by which copyright owners may receive reasonable notice of the use of their sound recordings under this section, and under which records of such use shall be kept and made available by transmitting organizations entitled to obtain a statutory license under this subsection.

“(6) License agreements voluntarily negotiated at any time between 1 or more copyright owners of sound recordings and 1 or more transmitting organizations entitled to obtain a statutory license under this subsection shall be given effect in lieu of any determination by a copyright arbitration royalty panel or decision by the Librarian of Congress.

“(7) Publication of a notice of the initiation of voluntary negotiation proceedings as specified in paragraph (4) shall be repeated, in accordance with regulations that the Librarian of Congress shall prescribe, in the first week of January 2000, and at 2-year intervals thereafter, except to the extent that different years for the repeating of such proceedings may be determined in accordance with paragraph (4). The procedures specified in paragraph (5) shall be repeated, in accordance with regulations that the Librarian of Congress shall prescribe, upon filing of a petition in accordance with section 803(a)(1), during a 60-day period commencing on July 1, 2000, and at 2-year intervals thereafter, except to the extent that different years for the repeating of such proceedings may be determined in accordance with paragraph (4). The procedures specified in paragraph (5) shall be concluded in accordance with section 802.

Regulations.

“(8)(A) Any person who wishes to make a phonorecord of a sound recording under a statutory license in accordance with this subsection may do so without infringing the exclusive right of the copyright owner of the sound recording under section 106(1)—

“(i) by complying with such notice requirements as the Librarian of Congress shall prescribe by regulation and by paying royalty fees in accordance with this subsection; or

“(ii) if such royalty fees have not been set, by agreeing to pay such royalty fees as shall be determined in accordance with this subsection.

“(B) Any royalty payments in arrears shall be made on or before the 20th day of the month next succeeding the month in which the royalty fees are set.

“(9) If a transmitting organization entitled to make a phonorecord under this subsection is prevented from making such phonorecord by reason of the application by the copyright owner of technical measures that prevent the reproduction of the sound recording, the copyright owner shall make available to the transmitting organization the necessary means for permitting the making of such phonorecord as permitted under this subsection, if it is technologically feasible and economically reasonable for the copyright owner to do so. If the copyright owner fails to do so in a timely manner in light of the transmitting organization’s reasonable business requirements, the transmitting organization shall not be liable for a violation of section 1201(a)(1) of this title for engaging in such activities as are necessary to make such phonorecords as permitted under this subsection.

“(10) Nothing in this subsection annuls, limits, impairs, or otherwise affects in any way the existence or value of any of



the exclusive rights of the copyright owners in a sound recording, except as otherwise provided in this subsection, or in a musical work, including the exclusive rights to reproduce and distribute a sound recording or musical work, including by means of a digital phonorecord delivery, under sections 106(1), 106(3), and 115, and the right to perform publicly a sound recording or musical work, including by means of a digital audio transmission, under sections 106(4) and 106(6).”

17 USC 112 note.

(c) SCOPE OF SECTION 112(a) OF TITLE 17 NOT AFFECTED.—Nothing in this section or the amendments made by this section shall affect the scope of section 112(a) of title 17, United States Code, or the entitlement of any person to an exemption thereunder.

(d) PROCEDURAL AMENDMENTS TO CHAPTER 8.—Section 802 of title 17, United States Code, is amended—

(1) in subsection (f)—

(A) in the first sentence by striking “60” and inserting “90”; and

(B) in the third sentence by striking “that 60-day period” and inserting “an additional 30-day period”; and

(2) in subsection (g) by inserting after the second sentence the following: “When this title provides that the royalty rates or terms that were previously in effect are to expire on a specified date, any adjustment by the Librarian of those rates or terms shall be effective as of the day following the date of expiration of the rates or terms that were previously in effect, even if the Librarian’s decision is rendered on a later date.”.

(e) CONFORMING AMENDMENTS.—(1) Section 801(b)(1) of title 17, United States Code, is amended in the second sentence by striking “sections 114, 115, and 116” and inserting “sections 114(f)(1)(B), 115, and 116”.

(2) Section 802(c) of title 17, United States Code, is amended by striking “section 111, 114, 116, or 119, any person entitled to a compulsory license” and inserting “section 111, 112, 114, 116, or 119, any transmitting organization entitled to a statutory license under section 112(f), any person entitled to a statutory license”.

(3) Section 802(g) of title 17, United States Code, is amended by striking “sections 111, 114” and inserting “sections 111, 112, 114”.

(4) Section 802(h)(2) of title 17, United States Code, is amended by striking “section 111, 114” and inserting “section 111, 112, 114”.

(5) Section 803(a)(1) of title 17, United States Code, is amended by striking “sections 114, 115” and inserting “sections 112, 114, 115”.

(6) Section 803(a)(5) of title 17, United States Code, is amended—

(A) by striking “section 114” and inserting “section 112 or 114”; and

(B) by striking “that section” and inserting “those sections”.

**SEC. 406. ASSUMPTION OF CONTRACTUAL OBLIGATIONS RELATED TO TRANSFERS OF RIGHTS IN MOTION PICTURES.**

(a) IN GENERAL.—Part VI of title 28, United States Code, is amended by adding at the end the following new chapter:

**“CHAPTER 180—ASSUMPTION OF CERTAIN  
CONTRACTUAL OBLIGATIONS**

“Sec. 4001. Assumption of contractual obligations related to transfers of rights in motion pictures.

**“§ 4001. Assumption of contractual obligations related to transfers of rights in motion pictures**

“(a) ASSUMPTION OF OBLIGATIONS.—(1) In the case of a transfer of copyright ownership under United States law in a motion picture (as the terms ‘transfer of copyright ownership’ and ‘motion picture’ are defined in section 101 of title 17) that is produced subject to 1 or more collective bargaining agreements negotiated under the laws of the United States, if the transfer is executed on or after the effective date of this chapter and is not limited to public performance rights, the transfer instrument shall be deemed to incorporate the assumption agreements applicable to the copyright ownership being transferred that are required by the applicable collective bargaining agreement, and the transferee shall be subject to the obligations under each such assumption agreement to make residual payments and provide related notices, accruing after the effective date of the transfer and applicable to the exploitation of the rights transferred, and any remedies under each such assumption agreement for breach of those obligations, as those obligations and remedies are set forth in the applicable collective bargaining agreement, if—

“(A) the transferee knows or has reason to know at the time of the transfer that such collective bargaining agreement was or will be applicable to the motion picture; or

“(B) in the event of a court order confirming an arbitration award against the transferor under the collective bargaining agreement, the transferor does not have the financial ability to satisfy the award within 90 days after the order is issued.

“(2) For purposes of paragraph (1)(A), ‘knows or has reason to know’ means any of the following:

“(A) Actual knowledge that the collective bargaining agreement was or will be applicable to the motion picture.

“(B)(i) Constructive knowledge that the collective bargaining agreement was or will be applicable to the motion picture, arising from recordation of a document pertaining to copyright in the motion picture under section 205 of title 17 or from publication, at a site available to the public on-line that is operated by the relevant union, of information that identifies the motion picture as subject to a collective bargaining agreement with that union, if the site permits commercially reasonable verification of the date on which the information was available for access.

“(ii) Clause (i) applies only if the transfer referred to in subsection (a)(1) occurs—

“(I) after the motion picture is completed, or

“(II) before the motion picture is completed and—

“(aa) within 18 months before the filing of an application for copyright registration for the motion picture under section 408 of title 17, or

“(bb) if no such application is filed, within 18 months before the first publication of the motion picture in the United States.

“(C) Awareness of other facts and circumstances pertaining to a particular transfer from which it is apparent that the collective bargaining agreement was or will be applicable to the motion picture.

“(b) SCOPE OF EXCLUSION OF TRANSFERS OF PUBLIC PERFORMANCE RIGHTS.—For purposes of this section, the exclusion under subsection (a) of transfers of copyright ownership in a motion picture that are limited to public performance rights includes transfers to a terrestrial broadcast station, cable system, or programmer to the extent that the station, system, or programmer is functioning as an exhibitor of the motion picture, either by exhibiting the motion picture on its own network, system, service, or station, or by initiating the transmission of an exhibition that is carried on another network, system, service, or station. When a terrestrial broadcast station, cable system, or programmer, or other transferee, is also functioning otherwise as a distributor or as a producer of the motion picture, the public performance exclusion does not affect any obligations imposed on the transferee to the extent that it is engaging in such functions.

“(c) EXCLUSION FOR GRANTS OF SECURITY INTERESTS.—Subsection (a) shall not apply to—

“(1) a transfer of copyright ownership consisting solely of a mortgage, hypothecation, or other security interest; or

“(2) a subsequent transfer of the copyright ownership secured by the security interest described in paragraph (1) by or under the authority of the secured party, including a transfer through the exercise of the secured party’s rights or remedies as a secured party, or by a subsequent transferee. The exclusion under this subsection shall not affect any rights or remedies under law or contract.

“(d) DEFERRAL PENDING RESOLUTION OF BONA FIDE DISPUTE.—A transferee on which obligations are imposed under subsection (a) by virtue of paragraph (1) of that subsection may elect to defer performance of such obligations that are subject to a bona fide dispute between a union and a prior transferor until that dispute is resolved, except that such deferral shall not stay accrual of any union claims due under an applicable collective bargaining agreement.

“(e) SCOPE OF OBLIGATIONS DETERMINED BY PRIVATE AGREEMENT.—Nothing in this section shall expand or diminish the rights, obligations, or remedies of any person under the collective bargaining agreements or assumption agreements referred to in this section.

“(f) FAILURE TO NOTIFY.—If the transferor under subsection (a) fails to notify the transferee under subsection (a) of applicable collective bargaining obligations before the execution of the transfer instrument, and subsection (a) is made applicable to the transferee solely by virtue of subsection (a)(1)(B), the transferor shall be liable to the transferee for any damages suffered by the transferee as a result of the failure to notify.

“(g) DETERMINATION OF DISPUTES AND CLAIMS.—Any dispute concerning the application of subsections (a) through (f) shall be determined by an action in United States district court, and the court in its discretion may allow the recovery of full costs by or against any party and may also award a reasonable attorney’s fee to the prevailing party as part of the costs.

“(h) **STUDY.**—The Comptroller General, in consultation with the Register of Copyrights, shall conduct a study of the conditions in the motion picture industry that gave rise to this section, and the impact of this section on the motion picture industry. The Comptroller General shall report the findings of the study to the Congress within 2 years after the effective date of this chapter.”.

Reports.

(b) **CONFORMING AMENDMENT.**—The table of chapters for part VI of title 28, United States Code, is amended by adding at the end the following:

“**180. Assumption of Certain Contractual Obligations** ..... **4001**”.

**SEC. 407. EFFECTIVE DATE.**

17 USC 108 note.

Except as otherwise provided in this title, this title and the amendments made by this title shall take effect on the date of the enactment of this Act.

**TITLE V—PROTECTION OF CERTAIN ORIGINAL DESIGNS**

Vessel Hull Design Protection Act.

**SEC. 501. SHORT TITLE.**

17 USC 101 note.

This Act may be referred to as the “Vessel Hull Design Protection Act”.

**SEC. 502. PROTECTION OF CERTAIN ORIGINAL DESIGNS.**

Title 17, United States Code, is amended by adding at the end the following new chapter:

**“CHAPTER 13—PROTECTION OF ORIGINAL DESIGNS**

- “Sec.
- “1301. Designs protected.
- “1302. Designs not subject to protection.
- “1303. Revisions, adaptations, and rearrangements.
- “1304. Commencement of protection.
- “1305. Term of protection.
- “1306. Design notice.
- “1307. Effect of omission of notice.
- “1308. Exclusive rights.
- “1309. Infringement.
- “1310. Application for registration.
- “1311. Benefit of earlier filing date in foreign country.
- “1312. Oaths and acknowledgments.
- “1313. Examination of application and issue or refusal of registration.
- “1314. Certification of registration.
- “1315. Publication of announcements and indexes.
- “1316. Fees.
- “1317. Regulations.
- “1318. Copies of records.
- “1319. Correction of errors in certificates.
- “1320. Ownership and transfer.
- “1321. Remedy for infringement.
- “1322. Injunctions.
- “1323. Recovery for infringement.
- “1324. Power of court over registration.
- “1325. Liability for action on registration fraudulently obtained.
- “1326. Penalty for false marking.
- “1327. Penalty for false representation.
- “1328. Enforcement by Treasury and Postal Service.
- “1329. Relation to design patent law.
- “1330. Common law and other rights unaffected.
- “1331. Administrator; Office of the Administrator.
- “1332. No retroactive effect.

**“§ 1301. Designs protected**

“(a) **DESIGNS PROTECTED.**—

“(1) IN GENERAL.—The designer or other owner of an original design of a useful article which makes the article attractive or distinctive in appearance to the purchasing or using public may secure the protection provided by this chapter upon complying with and subject to this chapter.

“(2) VESSEL HULLS.—The design of a vessel hull, including a plug or mold, is subject to protection under this chapter, notwithstanding section 1302(4).

“(b) DEFINITIONS.—For the purpose of this chapter, the following terms have the following meanings:

“(1) A design is ‘original’ if it is the result of the designer’s creative endeavor that provides a distinguishable variation over prior work pertaining to similar articles which is more than merely trivial and has not been copied from another source.

“(2) A ‘useful article’ is a vessel hull, including a plug or mold, which in normal use has an intrinsic utilitarian function that is not merely to portray the appearance of the article or to convey information. An article which normally is part of a useful article shall be deemed to be a useful article.

“(3) A ‘vessel’ is a craft, especially one larger than a row-boat, designed to navigate on water, but does not include any such craft that exceeds 200 feet in length.

“(4) A ‘hull’ is the frame or body of a vessel, including the deck of a vessel, exclusive of masts, sails, yards, and rigging.

“(5) A ‘plug’ means a device or model used to make a mold for the purpose of exact duplication, regardless of whether the device or model has an intrinsic utilitarian function that is not only to portray the appearance of the product or to convey information.

“(6) A ‘mold’ means a matrix or form in which a substance for material is used, regardless of whether the matrix or form has an intrinsic utilitarian function that is not only to portray the appearance of the product or to convey information.

#### “§ 1302. Designs not subject to protection

“Protection under this chapter shall not be available for a design that is—

“(1) not original;

“(2) staple or commonplace, such as a standard geometric figure, a familiar symbol, an emblem, or a motif, or another shape, pattern, or configuration which has become standard, common, prevalent, or ordinary;

“(3) different from a design excluded by paragraph (2) only in insignificant details or in elements which are variants commonly used in the relevant trades;

“(4) dictated solely by a utilitarian function of the article that embodies it; or

“(5) embodied in a useful article that was made public by the designer or owner in the United States or a foreign country more than 1 year before the date of the application for registration under this chapter.

#### “§ 1303. Revisions, adaptations, and rearrangements

“Protection for a design under this chapter shall be available notwithstanding the employment in the design of subject matter excluded from protection under section 1302 if the design is a substantial revision, adaptation, or rearrangement of such subject

matter. Such protection shall be independent of any subsisting protection in subject matter employed in the design, and shall not be construed as securing any right to subject matter excluded from protection under this chapter or as extending any subsisting protection under this chapter.

**“§ 1304. Commencement of protection**

“The protection provided for a design under this chapter shall commence upon the earlier of the date of publication of the registration under section 1313(a) or the date the design is first made public as defined by section 1310(b).

**“§ 1305. Term of protection**

“(a) IN GENERAL.—Subject to subsection (b), the protection provided under this chapter for a design shall continue for a term of 10 years beginning on the date of the commencement of protection under section 1304.

“(b) EXPIRATION.—All terms of protection provided in this section shall run to the end of the calendar year in which they would otherwise expire.

“(c) TERMINATION OF RIGHTS.—Upon expiration or termination of protection in a particular design under this chapter, all rights under this chapter in the design shall terminate, regardless of the number of different articles in which the design may have been used during the term of its protection.

**“§ 1306. Design notice**

“(a) CONTENTS OF DESIGN NOTICE.—(1) Whenever any design for which protection is sought under this chapter is made public under section 1310(b), the owner of the design shall, subject to the provisions of section 1307, mark it or have it marked legibly with a design notice consisting of—

“(A) the words ‘Protected Design’, the abbreviation ‘Prot’d Des.’, or the letter ‘D’ with a circle, or the symbol “\*D\*”;

“(B) the year of the date on which protection for the design commenced; and

“(C) the name of the owner, an abbreviation by which the name can be recognized, or a generally accepted alternative designation of the owner.

Any distinctive identification of the owner may be used for purposes of subparagraph (C) if it has been recorded by the Administrator before the design marked with such identification is registered.

“(2) After registration, the registration number may be used instead of the elements specified in subparagraphs (B) and (C) of paragraph (1).

“(b) LOCATION OF NOTICE.—The design notice shall be so located and applied as to give reasonable notice of design protection while the useful article embodying the design is passing through its normal channels of commerce.

“(c) SUBSEQUENT REMOVAL OF NOTICE.—When the owner of a design has complied with the provisions of this section, protection under this chapter shall not be affected by the removal, destruction, or obliteration by others of the design notice on an article.

**“§ 1307. Effect of omission of notice**

“(a) ACTIONS WITH NOTICE.—Except as provided in subsection (b), the omission of the notice prescribed in section 1306 shall

not cause loss of the protection under this chapter or prevent recovery for infringement under this chapter against any person who, after receiving written notice of the design protection, begins an undertaking leading to infringement under this chapter.

“(b) ACTIONS WITHOUT NOTICE.—The omission of the notice prescribed in section 1306 shall prevent any recovery under section 1323 against a person who began an undertaking leading to infringement under this chapter before receiving written notice of the design protection. No injunction shall be issued under this chapter with respect to such undertaking unless the owner of the design reimburses that person for any reasonable expenditure or contractual obligation in connection with such undertaking that was incurred before receiving written notice of the design protection, as the court in its discretion directs. The burden of providing written notice of design protection shall be on the owner of the design.

**“§ 1308. Exclusive rights**

“The owner of a design protected under this chapter has the exclusive right to—

“(1) make, have made, or import, for sale or for use in trade, any useful article embodying that design; and

“(2) sell or distribute for sale or for use in trade any useful article embodying that design.

**“§ 1309. Infringement**

“(a) ACTS OF INFRINGEMENT.—Except as provided in subsection (b), it shall be infringement of the exclusive rights in a design protected under this chapter for any person, without the consent of the owner of the design, within the United States and during the term of such protection, to—

“(1) make, have made, or import, for sale or for use in trade, any infringing article as defined in subsection (e); or

“(2) sell or distribute for sale or for use in trade any such infringing article.

“(b) ACTS OF SELLERS AND DISTRIBUTORS.—A seller or distributor of an infringing article who did not make or import the article shall be deemed to have infringed on a design protected under this chapter only if that person—

“(1) induced or acted in collusion with a manufacturer to make, or an importer to import such article, except that merely purchasing or giving an order to purchase such article in the ordinary course of business shall not of itself constitute such inducement or collusion; or

“(2) refused or failed, upon the request of the owner of the design, to make a prompt and full disclosure of that person’s source of such article, and that person orders or reorders such article after receiving notice by registered or certified mail of the protection subsisting in the design.

“(c) ACTS WITHOUT KNOWLEDGE.—It shall not be infringement under this section to make, have made, import, sell, or distribute, any article embodying a design which was created without knowledge that a design was protected under this chapter and was copied from such protected design.

“(d) ACTS IN ORDINARY COURSE OF BUSINESS.—A person who incorporates into that person’s product of manufacture an infringing article acquired from others in the ordinary course of business,

or who, without knowledge of the protected design embodied in an infringing article, makes or processes the infringing article for the account of another person in the ordinary course of business, shall not be deemed to have infringed the rights in that design under this chapter except under a condition contained in paragraph (1) or (2) of subsection (b). Accepting an order or reorder from the source of the infringing article shall be deemed ordering or reordering within the meaning of subsection (b)(2).

“(e) INFRINGING ARTICLE DEFINED.—As used in this section, an ‘infringing article’ is any article the design of which has been copied from a design protected under this chapter, without the consent of the owner of the protected design. An infringing article is not an illustration or picture of a protected design in an advertisement, book, periodical, newspaper, photograph, broadcast, motion picture, or similar medium. A design shall not be deemed to have been copied from a protected design if it is original and not substantially similar in appearance to a protected design.

“(f) ESTABLISHING ORIGINALITY.—The party to any action or proceeding under this chapter who alleges rights under this chapter in a design shall have the burden of establishing the design’s originality whenever the opposing party introduces an earlier work which is identical to such design, or so similar as to make prima facie showing that such design was copied from such work.

“(g) REPRODUCTION FOR TEACHING OR ANALYSIS.—It is not an infringement of the exclusive rights of a design owner for a person to reproduce the design in a useful article or in any other form solely for the purpose of teaching, analyzing, or evaluating the appearance, concepts, or techniques embodied in the design, or the function of the useful article embodying the design.

### “§ 1310. Application for registration

“(a) TIME LIMIT FOR APPLICATION FOR REGISTRATION.—Protection under this chapter shall be lost if application for registration of the design is not made within 2 years after the date on which the design is first made public.

“(b) WHEN DESIGN IS MADE PUBLIC.—A design is made public when an existing useful article embodying the design is anywhere publicly exhibited, publicly distributed, or offered for sale or sold to the public by the owner of the design or with the owner’s consent.

“(c) APPLICATION BY OWNER OF DESIGN.—Application for registration may be made by the owner of the design.

“(d) CONTENTS OF APPLICATION.—The application for registration shall be made to the Administrator and shall state—

“(1) the name and address of the designer or designers of the design;

“(2) the name and address of the owner if different from the designer;

“(3) the specific name of the useful article embodying the design;

“(4) the date, if any, that the design was first made public, if such date was earlier than the date of the application;

“(5) affirmation that the design has been fixed in a useful article; and

“(6) such other information as may be required by the Administrator.



The application for registration may include a description setting forth the salient features of the design, but the absence of such a description shall not prevent registration under this chapter.

“(e) SWORN STATEMENT.—The application for registration shall be accompanied by a statement under oath by the applicant or the applicant’s duly authorized agent or representative, setting forth, to the best of the applicant’s knowledge and belief—

“(1) that the design is original and was created by the designer or designers named in the application;

“(2) that the design has not previously been registered on behalf of the applicant or the applicant’s predecessor in title; and

“(3) that the applicant is the person entitled to protection and to registration under this chapter.

If the design has been made public with the design notice prescribed in section 1306, the statement shall also describe the exact form and position of the design notice.

“(f) EFFECT OF ERRORS.—(1) Error in any statement or assertion as to the utility of the useful article named in the application under this section, the design of which is sought to be registered, shall not affect the protection secured under this chapter.

“(2) Errors in omitting a joint designer or in naming an alleged joint designer shall not affect the validity of the registration, or the actual ownership or the protection of the design, unless it is shown that the error occurred with deceptive intent.

“(g) DESIGN MADE IN SCOPE OF EMPLOYMENT.—In a case in which the design was made within the regular scope of the designer’s employment and individual authorship of the design is difficult or impossible to ascribe and the application so states, the name and address of the employer for whom the design was made may be stated instead of that of the individual designer.

“(h) PICTORIAL REPRESENTATION OF DESIGN.—The application for registration shall be accompanied by two copies of a drawing or other pictorial representation of the useful article embodying the design, having one or more views, adequate to show the design, in a form and style suitable for reproduction, which shall be deemed a part of the application.

“(i) DESIGN IN MORE THAN ONE USEFUL ARTICLE.—If the distinguishing elements of a design are in substantially the same form in different useful articles, the design shall be protected as to all such useful articles when protected as to one of them, but not more than one registration shall be required for the design.

“(j) APPLICATION FOR MORE THAN ONE DESIGN.—More than one design may be included in the same application under such conditions as may be prescribed by the Administrator. For each design included in an application the fee prescribed for a single design shall be paid.

**“§ 1311. Benefit of earlier filing date in foreign country**

“An application for registration of a design filed in the United States by any person who has, or whose legal representative or predecessor or successor in title has, previously filed an application for registration of the same design in a foreign country which extends to designs of owners who are citizens of the United States, or to applications filed under this chapter, similar protection to that provided under this chapter shall have that same effect as if filed in the United States on the date on which the application

was first filed in such foreign country, if the application in the United States is filed within 6 months after the earliest date on which any such foreign application was filed.

**“§ 1312. Oaths and acknowledgments**

“(a) IN GENERAL.—Oaths and acknowledgments required by this chapter—

“(1) may be made—

“(A) before any person in the United States authorized by law to administer oaths; or

“(B) when made in a foreign country, before any diplomatic or consular officer of the United States authorized to administer oaths, or before any official authorized to administer oaths in the foreign country concerned, whose authority shall be proved by a certificate of a diplomatic or consular officer of the United States; and

“(2) shall be valid if they comply with the laws of the State or country where made.

“(b) WRITTEN DECLARATION IN LIEU OF OATH.—(1) The Administrator may by rule prescribe that any document which is to be filed under this chapter in the Office of the Administrator and which is required by any law, rule, or other regulation to be under oath, may be subscribed to by a written declaration in such form as the Administrator may prescribe, and such declaration shall be in lieu of the oath otherwise required.

“(2) Whenever a written declaration under paragraph (1) is used, the document containing the declaration shall state that willful false statements are punishable by fine or imprisonment, or both, pursuant to section 1001 of title 18, and may jeopardize the validity of the application or document or a registration resulting therefrom.

**“§ 1313. Examination of application and issue or refusal of registration**

“(a) DETERMINATION OF REGISTRABILITY OF DESIGN; REGISTRATION.—Upon the filing of an application for registration in proper form under section 1310, and upon payment of the fee prescribed under section 1316, the Administrator shall determine whether or not the application relates to a design which on its face appears to be subject to protection under this chapter, and, if so, the Register shall register the design. Registration under this subsection shall be announced by publication. The date of registration shall be the date of publication.

Publication.

“(b) REFUSAL TO REGISTER; RECONSIDERATION.—If, in the judgment of the Administrator, the application for registration relates to a design which on its face is not subject to protection under this chapter, the Administrator shall send to the applicant a notice of refusal to register and the grounds for the refusal. Within 3 months after the date on which the notice of refusal is sent, the applicant may, by written request, seek reconsideration of the application. After consideration of such a request, the Administrator shall either register the design or send to the applicant a notice of final refusal to register.

“(c) APPLICATION TO CANCEL REGISTRATION.—Any person who believes he or she is or will be damaged by a registration under this chapter may, upon payment of the prescribed fee, apply to the Administrator at any time to cancel the registration on the

ground that the design is not subject to protection under this chapter, stating the reasons for the request. Upon receipt of an application for cancellation, the Administrator shall send to the owner of the design, as shown in the records of the Office of the Administrator, a notice of the application, and the owner shall have a period of 3 months after the date on which such notice is mailed in which to present arguments to the Administrator for support of the validity of the registration. The Administrator shall also have the authority to establish, by regulation, conditions under which the opposing parties may appear and be heard in support of their arguments. If, after the periods provided for the presentation of arguments have expired, the Administrator determines that the applicant for cancellation has established that the design is not subject to protection under this chapter, the Administrator shall order the registration stricken from the record. Cancellation under this subsection shall be announced by publication, and notice of the Administrator's final determination with respect to any application for cancellation shall be sent to the applicant and to the owner of record.

Regulations.

Publication.

#### **“§ 1314. Certification of registration**

“Certificates of registration shall be issued in the name of the United States under the seal of the Office of the Administrator and shall be recorded in the official records of the Office. The certificate shall state the name of the useful article, the date of filing of the application, the date of registration, and the date the design was made public, if earlier than the date of filing of the application, and shall contain a reproduction of the drawing or other pictorial representation of the design. If a description of the salient features of the design appears in the application, the description shall also appear in the certificate. A certificate of registration shall be admitted in any court as prima facie evidence of the facts stated in the certificate.

#### **“§ 1315. Publication of announcements and indexes**

“(a) PUBLICATIONS OF THE ADMINISTRATOR.—The Administrator shall publish lists and indexes of registered designs and cancellations of designs and may also publish the drawings or other pictorial representations of registered designs for sale or other distribution.

“(b) FILE OF REPRESENTATIVES OF REGISTERED DESIGNS.—The Administrator shall establish and maintain a file of the drawings or other pictorial representations of registered designs. The file shall be available for use by the public under such conditions as the Administrator may prescribe.

#### **“§ 1316. Fees**

“The Administrator shall by regulation set reasonable fees for the filing of applications to register designs under this chapter and for other services relating to the administration of this chapter, taking into consideration the cost of providing these services and the benefit of a public record.

#### **“§ 1317. Regulations**

“The Administrator may establish regulations for the administration of this chapter.

**“§ 1318. Copies of records**

“Upon payment of the prescribed fee, any person may obtain a certified copy of any official record of the Office of the Administrator that relates to this chapter. That copy shall be admissible in evidence with the same effect as the original.

**“§ 1319. Correction of errors in certificates**

“The Administrator may, by a certificate of correction under seal, correct any error in a registration incurred through the fault of the Office, or, upon payment of the required fee, any error of a clerical or typographical nature occurring in good faith but not through the fault of the Office. Such registration, together with the certificate, shall thereafter have the same effect as if it had been originally issued in such corrected form.

**“§ 1320. Ownership and transfer**

“(a) PROPERTY RIGHT IN DESIGN.—The property right in a design subject to protection under this chapter shall vest in the designer, the legal representatives of a deceased designer or of one under legal incapacity, the employer for whom the designer created the design in the case of a design made within the regular scope of the designer’s employment, or a person to whom the rights of the designer or of such employer have been transferred. The person in whom the property right is vested shall be considered the owner of the design.

“(b) TRANSFER OF PROPERTY RIGHT.—The property right in a registered design, or a design for which an application for registration has been or may be filed, may be assigned, granted, conveyed, or mortgaged by an instrument in writing, signed by the owner, or may be bequeathed by will.

“(c) OATH OR ACKNOWLEDGEMENT OF TRANSFER.—An oath or acknowledgment under section 1312 shall be prima facie evidence of the execution of an assignment, grant, conveyance, or mortgage under subsection (b).

“(d) RECORDATION OF TRANSFER.—An assignment, grant, conveyance, or mortgage under subsection (b) shall be void as against any subsequent purchaser or mortgagee for a valuable consideration, unless it is recorded in the Office of the Administrator within 3 months after its date of execution or before the date of such subsequent purchase or mortgage.

**“§ 1321. Remedy for infringement**

“(a) IN GENERAL.—The owner of a design is entitled, after issuance of a certificate of registration of the design under this chapter, to institute an action for any infringement of the design.

“(b) REVIEW OF REFUSAL TO REGISTER.—(1) Subject to paragraph (2), the owner of a design may seek judicial review of a final refusal of the Administrator to register the design under this chapter by bringing a civil action, and may in the same action, if the court adjudges the design subject to protection under this chapter, enforce the rights in that design under this chapter.

“(2) The owner of a design may seek judicial review under this section if—

“(A) the owner has previously duly filed and prosecuted to final refusal an application in proper form for registration of the design;

“(B) the owner causes a copy of the complaint in the action to be delivered to the Administrator within 10 days after the commencement of the action; and

“(C) the defendant has committed acts in respect to the design which would constitute infringement with respect to a design protected under this chapter.

“(c) ADMINISTRATOR AS PARTY TO ACTION.—The Administrator may, at the Administrator’s option, become a party to the action with respect to the issue of registrability of the design claim by entering an appearance within 60 days after being served with the complaint, but the failure of the Administrator to become a party shall not deprive the court of jurisdiction to determine that issue.

“(d) USE OF ARBITRATION TO RESOLVE DISPUTE.—The parties to an infringement dispute under this chapter, within such time as may be specified by the Administrator by regulation, may determine the dispute, or any aspect of the dispute, by arbitration. Arbitration shall be governed by title 9. The parties shall give notice of any arbitration award to the Administrator, and such award shall, as between the parties to the arbitration, be dispositive of the issues to which it relates. The arbitration award shall be unenforceable until such notice is given. Nothing in this subsection shall preclude the Administrator from determining whether a design is subject to registration in a cancellation proceeding under section 1313(c).

### § 1322. Injunctions

“(a) IN GENERAL.—A court having jurisdiction over actions under this chapter may grant injunctions in accordance with the principles of equity to prevent infringement of a design under this chapter, including, in its discretion, prompt relief by temporary restraining orders and preliminary injunctions.

“(b) DAMAGES FOR INJUNCTIVE RELIEF WRONGFULLY OBTAINED.—A seller or distributor who suffers damage by reason of injunctive relief wrongfully obtained under this section has a cause of action against the applicant for such injunctive relief and may recover such relief as may be appropriate, including damages for lost profits, cost of materials, loss of good will, and punitive damages in instances where the injunctive relief was sought in bad faith, and, unless the court finds extenuating circumstances, reasonable attorney’s fees.

### “§ 1323. Recovery for infringement

“(a) DAMAGES.—Upon a finding for the claimant in an action for infringement under this chapter, the court shall award the claimant damages adequate to compensate for the infringement. In addition, the court may increase the damages to such amount, not exceeding \$50,000 or \$1 per copy, whichever is greater, as the court determines to be just. The damages awarded shall constitute compensation and not a penalty. The court may receive expert testimony as an aid to the determination of damages.

“(b) INFRINGER’S PROFITS.—As an alternative to the remedies provided in subsection (a), the court may award the claimant the infringer’s profits resulting from the sale of the copies if the court finds that the infringer’s sales are reasonably related to the use of the claimant’s design. In such a case, the claimant shall be required to prove only the amount of the infringer’s sales and

the infringer shall be required to prove its expenses against such sales.

“(c) STATUTE OF LIMITATIONS.—No recovery under subsection (a) or (b) shall be had for any infringement committed more than 3 years before the date on which the complaint is filed.

“(d) ATTORNEY’S FEES.—In an action for infringement under this chapter, the court may award reasonable attorney’s fees to the prevailing party.

“(e) DISPOSITION OF INFRINGING AND OTHER ARTICLES.—The court may order that all infringing articles, and any plates, molds, patterns, models, or other means specifically adapted for making the articles, be delivered up for destruction or other disposition as the court may direct.

#### “§ 1324. Power of court over registration

“In any action involving the protection of a design under this chapter, the court, when appropriate, may order registration of a design under this chapter or the cancellation of such a registration. Any such order shall be certified by the court to the Administrator, who shall make an appropriate entry upon the record.

#### “§ 1325. Liability for action on registration fraudulently obtained

“Any person who brings an action for infringement knowing that registration of the design was obtained by a false or fraudulent representation materially affecting the rights under this chapter, shall be liable in the sum of \$10,000, or such part of that amount as the court may determine. That amount shall be to compensate the defendant and shall be charged against the plaintiff and paid to the defendant, in addition to such costs and attorney’s fees of the defendant as may be assessed by the court.

#### “§ 1326. Penalty for false marking

“(a) IN GENERAL.—Whoever, for the purpose of deceiving the public, marks upon, applies to, or uses in advertising in connection with an article made, used, distributed, or sold, a design which is not protected under this chapter, a design notice specified in section 1306, or any other words or symbols importing that the design is protected under this chapter, knowing that the design is not so protected, shall pay a civil fine of not more than \$500 for each such offense.

“(b) SUIT BY PRIVATE PERSONS.—Any person may sue for the penalty established by subsection (a), in which event one-half of the penalty shall be awarded to the person suing and the remainder shall be awarded to the United States.

#### “§ 1327. Penalty for false representation

“Whoever knowingly makes a false representation materially affecting the rights obtainable under this chapter for the purpose of obtaining registration of a design under this chapter shall pay a penalty of not less than \$500 and not more than \$1,000, and any rights or privileges that individual may have in the design under this chapter shall be forfeited.

**“§ 1328. Enforcement by Treasury and Postal Service**

“(a) REGULATIONS.—The Secretary of the Treasury and the United States Postal Service shall separately or jointly issue regulations for the enforcement of the rights set forth in section 1308 with respect to importation. Such regulations may require, as a condition for the exclusion of articles from the United States, that the person seeking exclusion take any one or more of the following actions:

“(1) Obtain a court order enjoining, or an order of the International Trade Commission under section 337 of the Tariff Act of 1930 excluding, importation of the articles.

“(2) Furnish proof that the design involved is protected under this chapter and that the importation of the articles would infringe the rights in the design under this chapter.

“(3) Post a surety bond for any injury that may result if the detention or exclusion of the articles proves to be unjustified.

“(b) SEIZURE AND FORFEITURE.—Articles imported in violation of the rights set forth in section 1308 are subject to seizure and forfeiture in the same manner as property imported in violation of the customs laws. Any such forfeited articles shall be destroyed as directed by the Secretary of the Treasury or the court, as the case may be, except that the articles may be returned to the country of export whenever it is shown to the satisfaction of the Secretary of the Treasury that the importer had no reasonable grounds for believing that his or her acts constituted a violation of the law.

**“§ 1329. Relation to design patent law**

“The issuance of a design patent under title 35, United States Code, for an original design for an article of manufacture shall terminate any protection of the original design under this chapter.

**“§ 1330. Common law and other rights unaffected**

“Nothing in this chapter shall annul or limit—

“(1) common law or other rights or remedies, if any, available to or held by any person with respect to a design which has not been registered under this chapter; or

“(2) any right under the trademark laws or any right protected against unfair competition.

**“§ 1331. Administrator; Office of the Administrator**

“In this chapter, the ‘Administrator’ is the Register of Copyrights, and the ‘Office of the Administrator’ and the ‘Office’ refer to the Copyright Office of the Library of Congress.

**“§ 1332. No retroactive effect**

“Protection under this chapter shall not be available for any design that has been made public under section 1310(b) before the effective date of this chapter.”

**SEC. 503. CONFORMING AMENDMENTS.**

(a) TABLE OF CHAPTERS.—The table of chapters for title 17, United States Code, is amended by adding at the end the following:

“13. Protection of Original Designs ..... 1301”.

(b) JURISDICTION OF DISTRICT COURTS OVER DESIGN ACTIONS.—(1) Section 1338(c) of title 28, United States Code, is amended by inserting “, and to exclusive rights in designs under chapter 13 of title 17,” after “title 17”.

(2)(A) The section heading for section 1338 of title 28, United States Code, is amended by inserting “**designs,**” after “**mask works,**”.

(B) The item relating to section 1338 in the table of sections at the beginning of chapter 85 of title 28, United States Code, is amended by inserting “designs,” after “mask works,”.

(c) PLACE FOR BRINGING DESIGN ACTIONS.—(1) Section 1400(a) of title 28, United States Code, is amended by inserting “or designs” after “mask works”.

(2) The section heading for section 1400 of title 28, United States Code, is amended to read as follows:

**“Patents and copyrights, mask works, and designs”.**

(3) The item relating to section 1400 in the table of sections at the beginning of chapter 87 of title 28, United States Code, is amended to read as follows:

“1400. Patents and copyrights, mask works, and designs.”.

(d) ACTIONS AGAINST THE UNITED STATES.—Section 1498(e) of title 28, United States Code, is amended by inserting “, and to exclusive rights in designs under chapter 13 of title 17,” after “title 17”.

**SEC. 504. JOINT STUDY OF THE EFFECT OF THIS TITLE.**

(a) IN GENERAL.—Not later than 1 year after the date of the enactment of this Act, and not later than 2 years after such date of enactment, the Register of Copyrights and the Commissioner of Patents and Trademarks shall submit to the Committees on the Judiciary of the Senate and the House of Representatives a joint report evaluating the effect of the amendments made by this title.

(b) ELEMENTS FOR CONSIDERATION.—In carrying out subsection (a), the Register of Copyrights and the Commissioner of Patents and Trademarks shall consider—

(1) the extent to which the amendments made by this title has been effective in suppressing infringement of the design of vessel hulls;

(2) the extent to which the registration provided for in chapter 13 of title 17, United States Code, as added by this title, has been utilized;

(3) the extent to which the creation of new designs of vessel hulls have been encouraged by the amendments made by this title;

(4) the effect, if any, of the amendments made by this title on the price of vessels with hulls protected under such amendments; and

(5) such other considerations as the Register and the Commissioner may deem relevant to accomplish the purposes of the evaluation conducted under subsection (a).

17 USC 1301  
note.  
Deadlines.  
Reports.



17 USC 1301  
note.

**SEC. 505. EFFECTIVE DATE.**

The amendments made by sections 502 and 503 shall take effect on the date of the enactment of this Act and shall remain in effect until the end of the 2-year period beginning on such date of enactment. No cause of action based on chapter 13 of title 17, United States Code, as added by this title, may be filed after the end of that 2-year period.

Approved October 28, 1998.

---

**LEGISLATIVE HISTORY—H.R. 2281 (S. 2037):**

**HOUSE REPORTS:** Nos. 105-551, Pt. 1 (Comm. on the Judiciary) and Pt. 2 (Comm. on Commerce) and 105-796 (Comm. of Commerce).

**SENATE REPORTS:** No. 105-190 accompanying S. 2037 (Comm. on the Judiciary).

**CONGRESSIONAL RECORD, Vol. 144 (1998):**

Aug. 4, considered and passed House.

Sept. 17, considered and passed Senate, amended, in lieu of S. 2037.

Oct. 8, Senate agreed to conference report.

Oct. 12, House agreed to conference report.

**WEEKLY COMPILATION OF PRESIDENTIAL DOCUMENTS, Vol. 34 (1998):**

Oct. 28, Presidential statement.

