



(12) **United States Patent**  
**Racz et al.**

(10) **Patent No.:** **US 7,942,317 B2**  
(45) **Date of Patent:** **\*May 17, 2011**

(54) **DATA STORAGE AND ACCESS SYSTEMS**

(75) Inventors: **Patrick Racz**, Saint Heller (JE);  
**Hermen-ard Hulst**, Amsterdam (NL)  
(73) Assignee: **Smartflash Technologies Limited**, Road  
Town, Tortola  
(\* ) Notice: Subject to any disclaimer, the term of this  
patent is extended or adjusted under 35  
U.S.C. 154(b) by 245 days.  
This patent is subject to a terminal dis-  
claimer.

(56) **References Cited**

U.S. PATENT DOCUMENTS			
4,697,073	A	9/1987	Hara
5,226,145	A	7/1993	Moronaga et al.
5,367,150	A	11/1994	Kitta et al.
5,406,619	A	4/1995	Akhteruzzaman et al.
5,457,746	A	10/1995	Dolphin
5,532,466	A	7/1996	Konno et al.
5,588,146	A	12/1996	Leroux
5,677,953	A	10/1997	Dolphin
5,703,951	A	12/1997	Dolphin
5,740,369	A *	4/1998	Yokozawa et al. .... 709/217
5,744,787	A	4/1998	Teicher
5,754,654	A	5/1998	Hiroya et al.

(Continued)

(21) Appl. No.: **12/014,558**

(22) Filed: **Jan. 15, 2008**

(65) **Prior Publication Data**

US 2008/0314974 A1 Dec. 25, 2008

**Related U.S. Application Data**

(63) Continuation of application No. 11/336,758, filed on  
Jan. 19, 2006, now Pat. No. 7,334,720, which is a  
continuation of application No. 10/111,716, filed as  
application No. PCT/GB00/04110 on Oct. 25, 2000,  
now abandoned.

(30) **Foreign Application Priority Data**

Nov. 25, 1999 (GB) ..... 9925227.2

(51) **Int. Cl.**  
**G06K 5/00** (2006.01)

(52) **U.S. Cl.** ..... **235/380; 235/382**

(58) **Field of Classification Search** ..... 235/451,  
235/380, 382, 492; 711/100, 101, 103  
See application file for complete search history.

**FOREIGN PATENT DOCUMENTS**

EP 0 195 098 10/1990

(Continued)

*Primary Examiner* — Thien M Le

(74) *Attorney, Agent, or Firm* — Kilpatrick Townsend  
Stockton LLP

(57) **ABSTRACT**

Data storage and access systems are described for download-  
ing and paying for data such as audio and video data, text,  
software, games and other types of data. A portable data  
carrier has an interface for sending and receiving data, non-  
volatile data memory for storing received content data and  
non-volatile payment validation memory for providing pay-  
ment validation data to an external device. The carrier may  
also store a record of access made to the stored content, and  
content use rules for controlling access to the stored content.  
Preferred embodiments store further access control data and  
supplementary data such as hot links to web sites and/or  
advertising data. A complementary data access terminal, data  
supply computer system and data access device are also  
described. The combination of payment data and stored con-  
tent data and, in preferred embodiments, use rule data, helps  
reduce the risk of unauthorized access to data such as com-  
pressed music and video data, especially over the Internet.

**19 Claims, 17 Drawing Sheets**

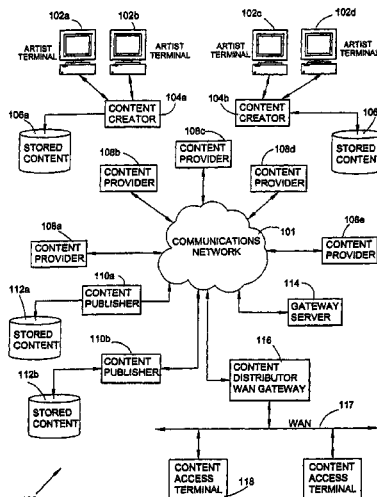

# US 7,942,317 B2

Page 2

## U.S. PATENT DOCUMENTS

5,794,202 A 8/1998 Kim  
5,809,241 A 9/1998 Hanel et al.  
5,845,281 A 12/1998 Benson et al.  
5,847,372 A 12/1998 Kreft  
5,889,860 A 3/1999 Eller et al.  
5,901,330 A 5/1999 Sun et al.  
5,918,213 A 6/1999 Bernard et al.  
5,923,884 A 7/1999 Peyret et al.  
5,933,498 A 8/1999 Schneck et al.  
5,936,220 A 8/1999 Hoshino et al.  
6,012,634 A 1/2000 Brogan et al.  
6,018,720 A 1/2000 Fujimoto  
6,078,917 A 6/2000 Paulsen et al.  
6,119,945 A 9/2000 Muller et al.  
6,142,369 A 11/2000 Jonstromer  
6,202,056 B1 3/2001 Nuttall  
6,385,731 B2 5/2002 Ananda  
6,424,975 B1 7/2002 Walter et al.  
6,442,570 B1 8/2002 Wu  
6,473,829 B1 10/2002 Dahman et al.  
6,510,236 B1 1/2003 Crane et al.  
6,553,413 B1 4/2003 Leighton et al.  
6,554,192 B2\* 4/2003 Tingl ..... 235/487  
6,574,643 B2 6/2003 Walter et al.  
6,658,568 B1 12/2003 Ginter et al.

6,993,507 B2\* 1/2006 Meyer et al. .... 705/40  
6,999,936 B2 2/2006 Sehr  
7,000,836 B2 2/2006 Saeki  
7,044,362 B2 5/2006 Yu  
7,083,081 B2 8/2006 McGee et al.  
7,334,720 B2\* 2/2008 Hulst et al. .... 235/380  
7,677,446 B2\* 3/2010 Wise ..... 235/380  
2003/0168515 A1 9/2003 Gray  
2006/0249570 A1\* 11/2006 Seifert et al. .... 235/380  
2008/0041938 A1\* 2/2008 Wise ..... 235/380

## FOREIGN PATENT DOCUMENTS

EP 0 713 198 A2 5/1996  
EP 0 823 694 A1 2/1998  
EP 0 542 298 4/1998  
EP 0 843 449 A2 5/1998  
EP 0 914 001 A1 5/1999  
JP 10-269291 A 10/1998  
JP 11-53184 A 2/1999  
JP 11-212785 A 8/1999  
JP 11-213010 A 8/1999  
JP 11-272762 A 10/1999  
WO WO 98/19237 A1 5/1998  
WO WO 98/33343 7/1998  
WO WO 98/37526 8/1998

\* cited by examiner

Fig. 1

A

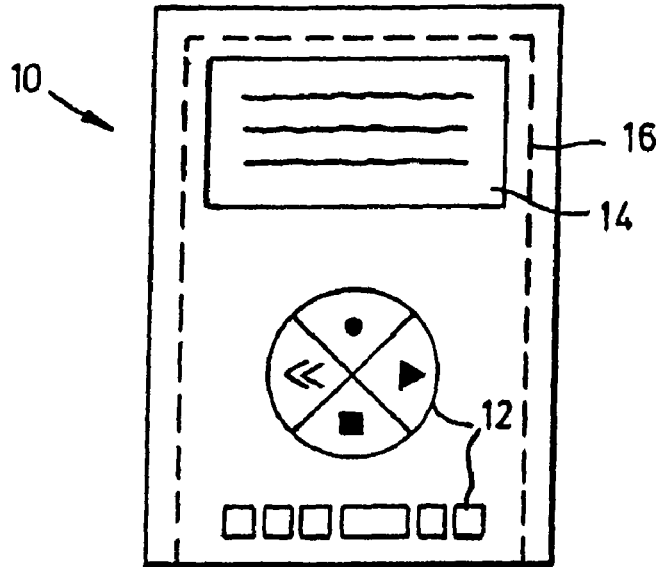

B

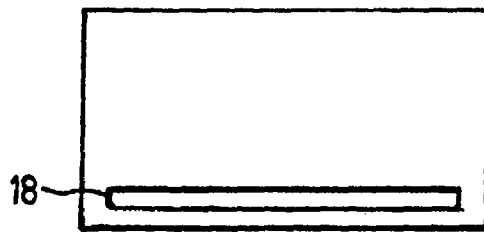

C

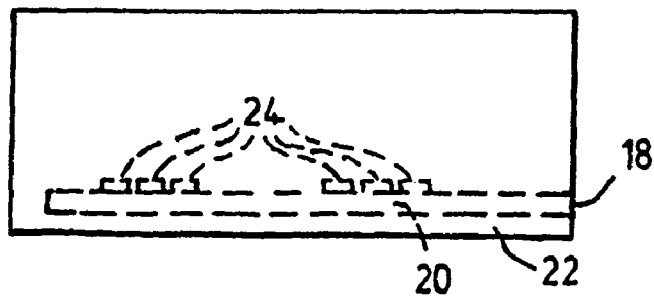

Fig. 2

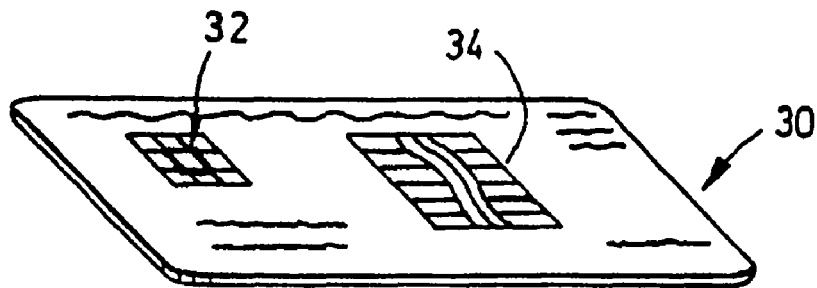

Fig. 3

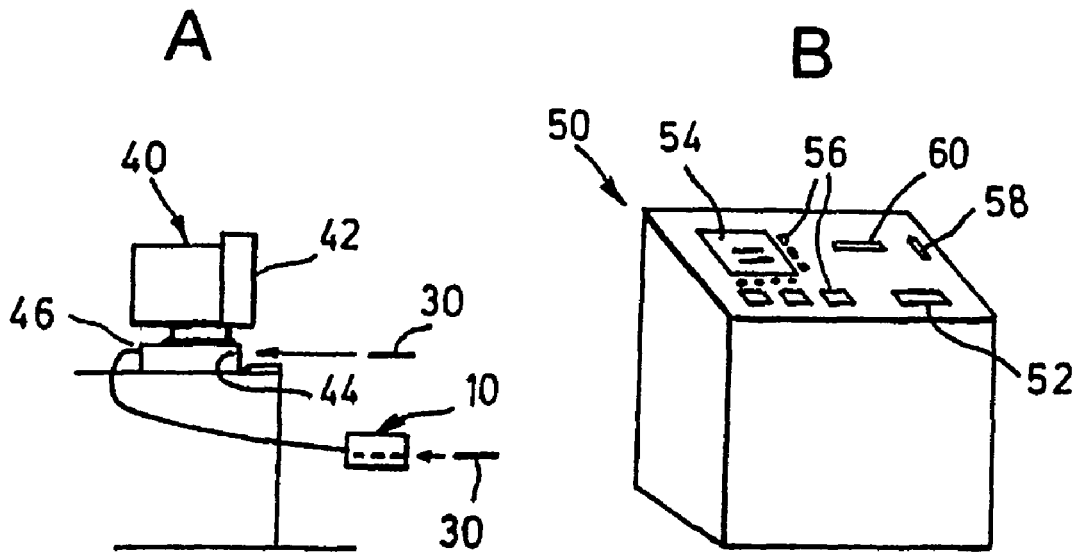
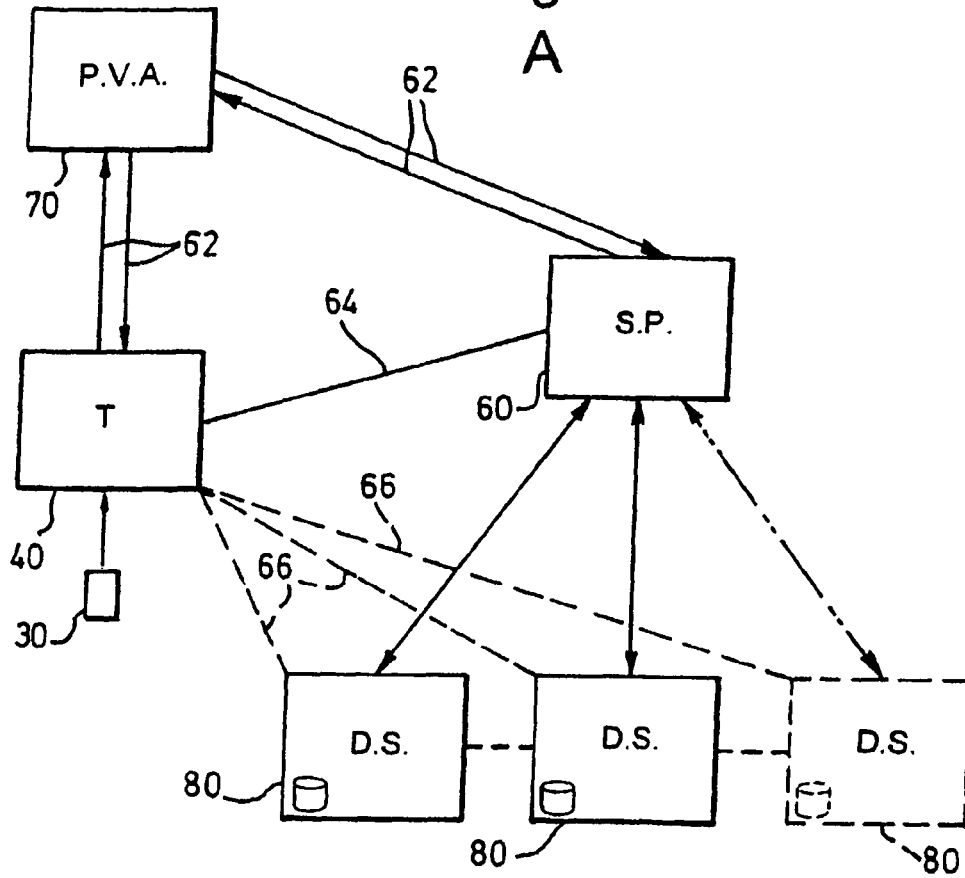
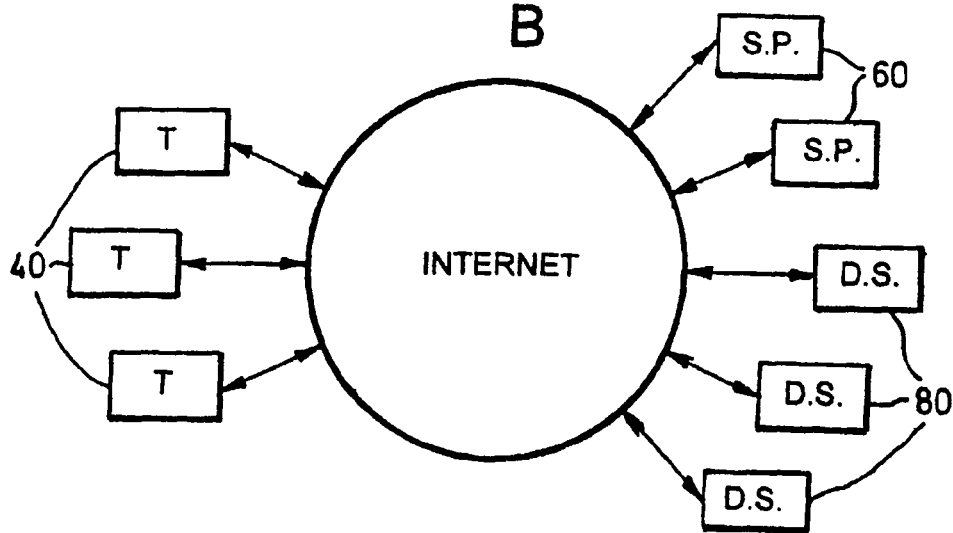

Fig. 4  
A



B



# Explore Litigation Insights

Docket Alarm provides insights to develop a more informed litigation strategy and the peace of mind of knowing you're on top of things.

## Real-Time Litigation Alerts



Keep your litigation team up-to-date with **real-time alerts** and advanced team management tools built for the enterprise, all while greatly reducing PACER spend.

Our comprehensive service means we can handle Federal, State, and Administrative courts across the country.

## Advanced Docket Research



With over 230 million records, Docket Alarm's cloud-native docket research platform finds what other services can't. Coverage includes Federal, State, plus PTAB, TTAB, ITC and NLRB decisions, all in one place.

Identify arguments that have been successful in the past with full text, pinpoint searching. Link to case law cited within any court document via Fastcase.

## Analytics At Your Fingertips



Learn what happened the last time a particular judge, opposing counsel or company faced cases similar to yours.

Advanced out-of-the-box PTAB and TTAB analytics are always at your fingertips.

## API

Docket Alarm offers a powerful API (application programming interface) to developers that want to integrate case filings into their apps.

## LAW FIRMS

Build custom dashboards for your attorneys and clients with live data direct from the court.

Automate many repetitive legal tasks like conflict checks, document management, and marketing.

## FINANCIAL INSTITUTIONS

Litigation and bankruptcy checks for companies and debtors.

## E-DISCOVERY AND LEGAL VENDORS

Sync your system to PACER to automate legal marketing.