

UTILITY PATENT APPLICATION TRANSMITTAL <i>(Only for new nonprovisional applications under 37 CFR 1.53(b))</i>	Attorney Docket No.	87790-818158 (000150US)
	First Inventor	Patrick RACZ
	Title	DATA STORAGE AND ACCESS SYSTEMS

APPLICATION ELEMENTS <i>See MPEP chapter 600 concerning utility patent application contents.</i>	ADDRESS TO: Commissioner for Patents P.O. Box 1450 Alexandria, VA 22313-1450
--	--

<p>1. <input checked="" type="checkbox"/> Fee Transmittal Form (e.g., PTO/SB/17)</p> <p>2. <input checked="" type="checkbox"/> Applicant claims small entity status. See 37 CFR 1.27.</p> <p>3. <input checked="" type="checkbox"/> Specification [Total Pages <u>51</u>] Both the claims and abstract must start on a new page <i>(For information on the preferred arrangement, see MPEP 608.01(a))</i></p> <p>4. <input checked="" type="checkbox"/> Drawing(s) (35 U.S.C. 113) [Total Sheets <u>17</u>]</p> <p>5. Oath or Declaration [Total Sheets <u>2</u>] a. <input type="checkbox"/> Newly executed (original or copy) b. <input checked="" type="checkbox"/> A copy from a prior application (37 CFR 1.63 (d)) <i>(for a continuation/divisional with Box 18 completed)</i> i. <input type="checkbox"/> DELETION OF INVENTOR(S) Signed statement attached deleting inventor(s) named in the prior application, see 37 CFR 1.63(d)(2) and 1.33(b).</p> <p>6. <input checked="" type="checkbox"/> Application Data Sheet. See 37 CFR 1.76</p> <p>7. <input type="checkbox"/> CD-ROM or CD-R in duplicate, large table or Computer Program (<i>Appendix</i>) <input type="checkbox"/> Landscape Table on CD</p> <p>8. Nucleotide and/or Amino Acid Sequence Submission <i>(if applicable, items a. - c. are required)</i> a. <input type="checkbox"/> Computer Readable Form (CRF) b. <input type="checkbox"/> Specification Sequence Listing on: i. <input type="checkbox"/> CD-ROM or CD-R (2 copies); or ii. <input type="checkbox"/> Paper c. <input type="checkbox"/> Statements verifying identity of above copies</p>	<p style="text-align: center;">ACCOMPANYING APPLICATION PARTS</p> <p>9. <input type="checkbox"/> Assignment Papers (cover sheet & document(s)) Name of Assignee _____</p> <p>10. <input checked="" type="checkbox"/> 37 CFR 3.73(b) Statement <input checked="" type="checkbox"/> Power of Attorney <i>(when there is an assignee)</i></p> <p>11. <input type="checkbox"/> English Translation Document <i>(if applicable)</i></p> <p>12. <input checked="" type="checkbox"/> Information Disclosure Statement (PTO/SB/08 or PTO-1449) <input type="checkbox"/> Copies of citations attached</p> <p>13. <input type="checkbox"/> Preliminary Amendment</p> <p>14. <input type="checkbox"/> Return Receipt Postcard (MPEP 503) <i>(Should be specifically itemized)</i></p> <p>15. <input type="checkbox"/> Certified Copy of Priority Document(s) <i>(if foreign priority is claimed)</i></p> <p>16. <input type="checkbox"/> Nonpublication Request under 35 U.S.C. 122 (b)(2)(B)(i). Applicant must attach form PTO/SB/35 or equivalent.</p> <p>17. <input checked="" type="checkbox"/> Other: <u>Communication</u></p>
---	--

18. If a CONTINUING APPLICATION, check appropriate box, and supply the requisite information below and in the first sentence of the specification following the title, or in an Application Data Sheet under 37 CFR 1.76:

Continuation Divisional Continuation-in-part (CIP) of prior application No: 13/012,541

Prior application information: Examiner Thien Minh Le Art Unit: 2887

19. CORRESPONDENCE ADDRESS

The address associated with Customer Number: **20350** OR Correspondence address below

Name				
Address				
City	State	Zip Code		
Country	Telephone	Email		

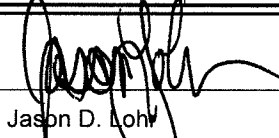
Signature		Date	August 17, 2011	
Name (Print/Type)	Jason D. Loh	Registration No. (Attorney/Agent)	48,163	

Effective on 12/08/2004. Fees pursuant to the Consolidated Appropriations Act, 2005 (H.R. 4818).		Complete if Known	
FEE TRANSMITTAL For FY 2009		Application Number	Unassigned
		Filing Date	Herewith
		First Named Inventor	Patrick RACZ
		Examiner Name	Unassigned
		Art Unit	Unassigned
		Attorney Docket No.	87790-818158 (000150US)
<input checked="" type="checkbox"/> Applicant claims small entity status. See 37 CFR 1.27			
TOTAL AMOUNT OF PAYMENT (\$) 1836			

METHOD OF PAYMENT (check all that apply)

Check Credit Card Money Order None Other (please identify): _____

Deposit Account Deposit Account Number: 20-1430 Deposit Account Name: Kilpatrick Townsend & Stockton LLP

For the above-identified deposit account, the Director is hereby authorized to: (check all that apply)

Charge fee(s) indicated below Charge fee(s) indicated below, except for the filing fee

Charge any additional fee(s) or underpayments of fee(s) under 37 CFR 1.16 and 1.17 Credit any overpayments

WARNING: Information on this form may become public. Credit card information should not be included on this form. Provide credit card information and authorization on PTO-2038.

FEE CALCULATION

1. BASIC FILING, SEARCH, AND EXAMINATION FEES

Application Type	FILING FEES		SEARCH FEES		EXAMINATION FEES		Fees Paid (\$)
	Small Entity Fee (\$)	Fee (\$)	Small Entity Fee (\$)	Fee (\$)	Small Entity Fee (\$)	Fee (\$)	
Utility	330	82	540	270	220	110	462
Design	220	110	100	50	140	70	
Plant	220	110	330	165	170	85	
Reissue	330	165	540	270	650	325	
Provisional	220	110	0	0	0	0	

2. EXCESS CLAIM FEES

Fee Description	Small Entity Fee (\$)	Fee (\$)
Each claim over 20 (including Reissues)	52	26
Each independent claim over 3 (including Reissues)	220	110
Multiple dependent claims	390	195
Total Claims		
39 -20 or HP = 19 x 26 = 494		
HP = highest number of total claims paid for, if greater than 20		
Indep. Claims		
11 -3 or HP = 8 x 110 = 880		
HP = highest number of independent claims paid for, if greater than 3		

3. APPLICATION SIZE FEE

If the specification and drawings exceed 100 sheets of paper (excluding electronically filed sequence or computer listings under 37 CFR 1.52(e)), the application size fee due is \$270 (\$135 for small entity) for each additional 50 sheets or fraction thereof. See 35 U.S.C. 41(a)(1)(G) and 37 CFR 1.16(s).

Total Sheets	Extra Sheets	Number of each additional 50 or fraction thereof	Fee (\$)	Fee Paid (\$)
_____ - 100 = _____	_____ / 50 = _____	_____ (round up to a whole number)	_____ x _____ = _____	

4. OTHER FEE(S)

Description	Fee (\$)	Fees Paid (\$)
Non-English Specification, \$130 fee (no small entity discount)		
Other (e.g., late filing surcharge): _____		

SUBMITTED BY

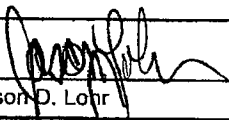
Signature		Registration No. (Attorney/Agent) 48,163	Telephone 925-472-5000
Name (Print/Type)	Jason D. Lohr		Date August 17, 2011

UTILITY PATENT APPLICATION TRANSMITTAL <i>(Only for new nonprovisional applications under 37 CFR 1.53(b))</i>	Attorney Docket No.	87790-818158 (000150US)
	First Inventor	Patrick RACZ
	Title	DATA STORAGE AND ACCESS SYSTEMS

APPLICATION ELEMENTS <i>See MPEP chapter 600 concerning utility patent application contents.</i>	ADDRESS TO: Commissioner for Patents P.O. Box 1450 Alexandria, VA 22313-1450
--	--

<p>1. <input checked="" type="checkbox"/> Fee Transmittal Form (e.g., PTO/SB/17)</p> <p>2. <input checked="" type="checkbox"/> Applicant claims small entity status. See 37 CFR 1.27.</p> <p>3. <input checked="" type="checkbox"/> Specification [Total Pages <u>51</u>] Both the claims and abstract must start on a new page <i>(For information on the preferred arrangement, see MPEP 608.01(a))</i></p> <p>4. <input checked="" type="checkbox"/> Drawing(s) (35 U.S.C. 113) [Total Sheets <u>17</u>]</p> <p>5. Oath or Declaration [Total Sheets <u>2</u>] a. <input type="checkbox"/> Newly executed (original or copy) b. <input checked="" type="checkbox"/> A copy from a prior application (37 CFR 1.63 (d)) <i>(for a continuation/divisional with Box 18 completed)</i> i. <input type="checkbox"/> DELETION OF INVENTOR(S) Signed statement attached deleting inventor(s) named in the prior application, see 37 CFR 1.63(d)(2) and 1.33(b).</p> <p>6. <input checked="" type="checkbox"/> Application Data Sheet. See 37 CFR 1.76</p> <p>7. <input type="checkbox"/> CD-ROM or CD-R in duplicate, large table or Computer Program (<i>Appendix</i>) <input type="checkbox"/> Landscape Table on CD</p> <p>8. Nucleotide and/or Amino Acid Sequence Submission <i>(if applicable, items a. - c. are required)</i> a. <input type="checkbox"/> Computer Readable Form (CRF) b. <input type="checkbox"/> Specification Sequence Listing on: i. <input type="checkbox"/> CD-ROM or CD-R (2 copies); or ii. <input type="checkbox"/> Paper c. <input type="checkbox"/> Statements verifying identity of above copies</p>	<p style="text-align: center;">ACCOMPANYING APPLICATION PARTS</p> <p>9. <input type="checkbox"/> Assignment Papers (cover sheet & document(s)) Name of Assignee _____</p> <p>10. <input checked="" type="checkbox"/> 37 CFR 3.73(b) Statement <input checked="" type="checkbox"/> Power of Attorney <i>(when there is an assignee)</i></p> <p>11. <input type="checkbox"/> English Translation Document <i>(if applicable)</i></p> <p>12. <input checked="" type="checkbox"/> Information Disclosure Statement (PTO/SB/08 or PTO-1449) <input type="checkbox"/> Copies of citations attached</p> <p>13. <input type="checkbox"/> Preliminary Amendment</p> <p>14. <input type="checkbox"/> Return Receipt Postcard (MPEP 503) <i>(Should be specifically itemized)</i></p> <p>15. <input type="checkbox"/> Certified Copy of Priority Document(s) <i>(if foreign priority is claimed)</i></p> <p>16. <input type="checkbox"/> Nonpublication Request under 35 U.S.C. 122 (b)(2)(B)(i). Applicant must attach form PTO/SB/35 or equivalent.</p> <p>17. <input checked="" type="checkbox"/> Other: <u>Communication</u></p>
---	---

18. If a CONTINUING APPLICATION, check appropriate box, and supply the requisite information below and in the first sentence of the specification following the title, or in an Application Data Sheet under 37 CFR 1.76:

Continuation Divisional Continuation-in-part (CIP) of prior application No: 13/012,541

Prior application information: Examiner Thien Minh Le Art Unit: 2887

19. CORRESPONDENCE ADDRESS

The address associated with Customer Number: 20350 OR Correspondence address below

Name				
Address				
City	State	Zip Code		
Country	Telephone	Email		

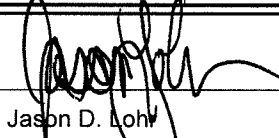
Signature		Date	August 17, 2011	
Name (Print/Type)	Jason D. Loh	Registration No. (Attorney/Agent)	48,163	

Effective on 12/08/2004. Fees pursuant to the Consolidated Appropriations Act, 2005 (H.R. 4818).		Complete if Known	
FEE TRANSMITTAL For FY 2009		Application Number	Unassigned
		Filing Date	Herewith
<input checked="" type="checkbox"/> Applicant claims small entity status. See 37 CFR 1.27		First Named Inventor	Patrick RACZ
		Examiner Name	Unassigned
TOTAL AMOUNT OF PAYMENT (\$)		Art Unit	Unassigned
		Attorney Docket No.	87790-818158 (000150US)
TOTAL AMOUNT OF PAYMENT (\$)		1836	

METHOD OF PAYMENT (check all that apply)

Check Credit Card Money Order None Other (please identify): _____

Deposit Account Deposit Account Number: 20-1430 Deposit Account Name: Kilpatrick Townsend & Stockton LLP

For the above-identified deposit account, the Director is hereby authorized to: (check all that apply)

Charge fee(s) indicated below Charge fee(s) indicated below, except for the filing fee

Charge any additional fee(s) or underpayments of fee(s) under 37 CFR 1.16 and 1.17 Credit any overpayments

WARNING: Information on this form may become public. Credit card information should not be included on this form. Provide credit card information and authorization on PTO-2038.

FEE CALCULATION

1. BASIC FILING, SEARCH, AND EXAMINATION FEES

Application Type	FILING FEES		SEARCH FEES		EXAMINATION FEES		Fees Paid (\$)
	Small Entity Fee (\$)	Fee (\$)	Small Entity Fee (\$)	Fee (\$)	Small Entity Fee (\$)	Fee (\$)	
Utility	330	82	540	270	220	110	462
Design	220	110	100	50	140	70	
Plant	220	110	330	165	170	85	
Reissue	330	165	540	270	650	325	
Provisional	220	110	0	0	0	0	

2. EXCESS CLAIM FEES

Fee Description	Small Entity Fee (\$)	Fee (\$)
Each claim over 20 (including Reissues)	52	26
Each independent claim over 3 (including Reissues)	220	110
Multiple dependent claims	390	195
Total Claims		
39 -20 or HP = 19 x 26 =		494
HP = highest number of total claims paid for, if greater than 20		
Indep. Claims		
11 -3 or HP = 8 x 110 =		880
HP = highest number of independent claims paid for, if greater than 3		

3. APPLICATION SIZE FEE

If the specification and drawings exceed 100 sheets of paper (excluding electronically filed sequence or computer listings under 37 CFR 1.52(e)), the application size fee due is \$270 (\$135 for small entity) for each additional 50 sheets or fraction thereof. See 35 U.S.C. 41(a)(1)(G) and 37 CFR 1.16(s).

Total Sheets	Extra Sheets	Number of each additional 50 or fraction thereof	Fee (\$)	Fee Paid (\$)
_____ - 100 = _____	/ 50 = _____	(round up to a whole number) x _____	= _____	

4. OTHER FEE(S)

Description	Fee (\$)	Fees Paid (\$)
Non-English Specification,	\$130 fee (no small entity discount)	
Other (e.g., late filing surcharge):		

SUBMITTED BY

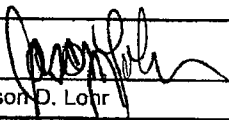
Signature		Registration No. (Attorney/Agent)	48,163	Telephone	925-472-5000
Name (Print/Type)	Jason D. Lohr	Date	August 17, 2011		

PATENT APPLICATION

DATA STORAGE AND ACCESS SYSTEMS

Inventor(s): Patrick Racz, a citizen of United Kingdom, residing at
19 Royal Street
Saint Heller, JE1 4WA Jersey

Hermen-ard Hulst, a citizen of Netherlands, residing at
Van Tuyll van Serooskerweg 75hs
Amsterdam, 1076 JG
Netherlands

Assignee: Smartflash Technologies Limited
1070908 Palm Grove House, PO Box 438
Wickhams' Cay, Road Town
British Virgin Islands

Entity: Small

DATA STORAGE AND ACCESS SYSTEMS

CROSS-REFERENCES TO RELATED APPLICATIONS

5 [0001] This application is a continuation of U.S. Patent Application Number 12/943,872, filed on November 10, 2010; which is a continuation of U.S. Patent Application Number 12/014,558, filed on January 15, 2008, now issued U.S. Patent Number 7,942,317; which is a continuation of U.S. Patent Application No. 11/336,758, filed on January 19, 2006, now issued U.S. Patent Number 7,334,720; which is a continuation of U.S. Patent Application No. 10/111,716, filed on September 17, 2002, which application is a national stage application under 35 U.S.C. 371,
10 claiming the priority of international PCT Application No. GB00104110, filed on October 25, 2000; which claims priority to UK Application No. 9925227.2, filed on October 25, 1999, each of which is incorporated by reference in its entirety for all purposes.

BACKGROUND OF THE INVENTION

15 [0002] This invention is generally concerned with data storage and access systems. More particularly, it relates to a portable data carrier for storing and paying for data and to computer systems for providing access to data to be stored. The invention also includes corresponding methods and computer programs. The invention is particularly useful for managing stored audio and video data, but may also be applied to storage and access of text and software, including
20 games, as well as other types of data.

[0003] One problem associated with the increasingly wide use of the internet is the growing prevalence of so-called data pirates. Such pirates obtain data either by unauthorized or legitimate means and then make this data available essentially world-wide over the internet without authorization. Data can be a very valuable commodity, but once it has been published
25 on the internet it is difficult to police access to and use of it by internet users who may not even realize that it is pirated. This is a particular problem with audio recordings, and, once the bandwidth becomes available, is also likely to be evident with video.

[0004] Over the past three or four years compressed audio sources have become increasingly widely available on web pages. One widely used audio data compression format is MP3 (MPEG

- Audio Layer 3 of the MPEG1 compression algorithm), which is an internationally defined standard including a definition of compressed audio information such as speech or music. It relies on psycho-acoustic properties of human hearing to achieve very large data compression factors. It is thus feasible to download usefully long passages of music in a practically
5 convenient short time. Pirate data suppliers have not been slow to realize the potential of this, and many unauthorized websites have sprung up offering popular music, including recent releases by world-famous bands. This has caused the recording industry considerable concern and there is an urgent need to find a way to address the problem of data piracy.

SUMMARY OF THE INVENTION

10 **[0005]** According to the present invention there is therefore provided a method of providing portable data comprising providing a portable data storage device comprising downloaded data storage means and payment validation means; providing a terminal for internet access; coupling the portable data storage device to the terminal; reading payment information from the payment
15 validation means using the terminal; validating the payment information; and downloading data into the portable storage device from a data supplier.

[0006] Another aspect of the invention provides a corresponding mobile data retrieval device for retrieving and outputting data such as stored music and/or noise from the data storage device.

[0007] The payment validation means is, for example, means to validate payment with an external authority such as a bank or building society. The combination of the payment validation
20 means with the data storage means allows the access to the downloaded data which is to be stored by the data storage means, to be made conditional upon checked and validated payment being made for the data. Binding the data access and payment together allows the legitimate owners of the data to make the data available themselves over the internet without fear of loss of revenue, thus undermining the position of data pirates.

25 **[0008]** A further advantage of the system is that it allows users under the age of 18 to make internet purchases. Currently internet users pay for goods and/or services by credit card. Since credit cards cannot legitimately be used by persons under the age of 18 (at least in the UK), a significant fraction of adventurous internet users are excluded from e-commerce, one of the most significant predicted uses of the internet. In one embodiment of the invention, however, the
30 payment validation means comprises e-cash; that is, the payment validation means stores transaction value information on a cash value of transactions validatable by the data storage

means. In simple terms, the data storage means can be a card which is charged up to a desired cash value (if necessary limited to a maximum value) at a suitable terminal. This might be an internet access terminal but could, more simply, be a device to accept the data storage card and to receive and count money deposited by the user to charge the card, writing update cash value information onto the card. More sophisticated ways of updating the cash value on the card are also possible, such as direct bank transfer. Since, with this type of embodiment, the data storage means is, essentially, precharged with cash rather than acting as a credit card, it can be used by young people without the risk of their incurring large debts.

[0009] In one embodiment the data storage means is powered by the retrieval device when it is connected to the device and retains a memory of the downloaded data when it is unpowered. This can be achieved by the use of Flash RAM or, more generally, any form of programmable read-only memory. Alternatively the data storage means may incorporate a rechargeable cell or capacitor and store information in battery backed-up static RAM.

[0010] The downloaded data may be entered into the data storage device by means of an interface such as a magnetically or capacitatively coupled connection or an optical connection, but preferably the interface comprises contacts for direct electrical connection to the storage means. The payment validation means may likewise have one of a variety of interfaces but again preferably comprises a set of electrical contacts. The payment validation means could, however, comprise a magnetic or holographic data-strip such as is known for use with credit cards and phone cards. The interface to receive the downloaded data may be separate from the interface to the payment validation means, to facilitate separate and simultaneous access to both these systems. In other embodiments a single interface may serve for both data storage and payment. Advantageously the payment validation means includes memory storing information to identify the person who is paying for the downloaded data.

[0011] For additional security the downloaded data may be encrypted. In this case data decryption may be necessary at some stage, either in the data storage means or in the retrieval device or in an information delivering apparatus such as a data access terminal. Alternatively the data decryption function can be shared amongst one or more of these devices. The skilled person will be aware of a range of suitable encryption/decryption techniques, including Pretty Good Privacy (Registered Trade Mark) and PKI (Public Key Infrastructure). Normally, when the downloaded data is encrypted, a decryption key must be supplied. This can be generated

automatically by the data access terminal or data access service provider or it can be entered by the user into the data access terminal or into the mobile data retrieval device.

5 [0012] The data storage means and/or the retrieval device can be provided with access control means to prevent unauthorized access to the downloaded data. Additionally or alternatively, use control means can be provided to stop or provide only limited access of the user to the downloaded data in accordance with the amount paid. These access and use control functions may in some embodiments be combined, permitted use controlling access or permitted access controlling use. Thus, for example, a complete set of data information relating to a particular topic, a particular music track, or a particular software package might be downloaded, although 10 access to part of the data set might thereafter be controlled by payments made by a user at a later stage. In this way, a user could pay to enable an extra level on a game or to enable further tracks of an album.

15 [0013] In embodiments where the access or use control means is responsive to the payment validation means, access or use control information may be stored with the downloaded data or in a separate storage area, for example in the payment validation means. The user's access to the downloaded data could advantageously be responsive to the payment validation means, for example, by means of a control line coupling the payment validation means with a memory access or decryption control element.

20 [0014] In one embodiment the data storage means comprises an electronic memory card or smart card and the mobile data retrieval device is provided with a slot to receive the card. Preferably the card is a push-fit within the retrieval device, and retention of the card may be effected by pressure from electrical interface connections and/or resilience of the housing, or by using a resilient retaining means. In a preferred embodiment the retrieval device includes an audio output and a display, to play a downloaded track and to show information about the track 25 and/or an accompanying video.

[0015] To download data onto the data storage means the user can employ a data access terminal coupled to the internet. The terminal can directly validate payment; for example in the case of a smart card charged with electronic cash it can deduct a cash value from the card. Alternatively it can communicate with a bank or other financial services provider to control 30 payment. In a preferred embodiment, however, the terminal connects to a data access service provider which provides a portal to other sites and which validates payment and then forwards

data from a data supplier to the user's local access terminal. The data access service provider may alternatively forward payment validation information and/or information from the payment validation authority to the data supplier for control by the supplier of the data supplied. Thus, access to the payment validation system and/or data for downloading may be entirely controlled
5 by the data supplier.

[0016] Data held on the data storage means may advantageously include data relating to the user's or payer's usage of the system. This information may include, for example, information on a user's spending pattern, information on data suppliers used and information on the downloaded data. This information may be accessed by the data supplier and/or data access
10 service provider and can be used for targeted marketing or loyalty-based incentive schemes such as air miles or the like.

[0017] The data access terminal may be a conventional computer or, alternatively, it may be a mobile phone. Wireless Application Protocol (WAP) and i-mode allow mobile phones to efficiently access the internet and this allows a mobile phone to be used to download data to the
15 data storage means, advantageously, directly. The data storage means can, if desired, incorporate the functionality of a mobile phone SIM (Subscriber Identity Module) card, which cards already include a user identification means, to allow user billing through the phone network operator.

[0018] In a preferred embodiment the downloaded data is MP3 or other encoded audio data, but the system finds more general application for other data types. For example, download data
20 can include software, and particularly games, share price information, current news information, transport timetable information, weather information and catalog shopping information. The downloaded information may also include compressed video data. The storage capacity of the data storage means is adaptable to suit the type of data intended to be downloaded; for example, 32 megabytes is sufficient for CD quality music, but for video it is preferable that the data
25 storage means has a capacity of 128 megabytes or greater.

[0019] In another aspect, the invention provides a portable data carrier comprising an interface for reading and writing data from and to the carrier; non-volatile data memory, coupled to the interface, for storing data on the carrier; non-volatile payment data memory, coupled to the interface, for providing payment data to an external device.

[0020] These features allow the data carrier to store both payment data and content data, thus providing the advantages outlined above. Depending upon the payment system used, the payment data memory may also store code for validating or confirming a payment to an external payment system. The payment data will normally be linked to a card or card holder
5 identification data for payment by the card holder. The non-volatile memory ensures that stored content and payment data is retained in the data carrier when the data carrier is not receiving power from an external source. Thus "non-volatile" encompasses, for example, low-power memory whose contents are retained by a battery back-up system. In one embodiment the payment data memory comprises EEPROM and the content data memory comprises Flash
10 memory, but other types of content data memory, such as optical, for example, holographic, data memory can also be used. The data carrier may also be integrated into other apparatus, such as a mobile communications device.

[0021] Preferably, the portable data carrier further comprises a program store for storing code implementable by a processor; and a processor, coupled to the content data memory, the payment
15 data memory, the interface and to the program store for implementing code in the program store, wherein the code comprises code to output payment data from the payment data memory to the interface and code to provide external access to the data memory.

[0022] Normally, the (content) data memory allows both write and read access for both storing and retrieving data, but in some embodiments the content data memory may be read-only
20 memory (ROM). In such embodiments, content may be pre-loaded onto the carrier and payment may then be made for permission to access the pre-loaded data.

[0023] Preferably, the data carrier also stores a record of access made to the content data and updates this in response to external access, preferably read access, made to the data memory. The carrier may also store content use rules pertaining to allowed use of stored data items. These
25 use rules may be linked to payments made from the card to provide payment options such as access to buy content data outright; rental access to content data for a time period or for a specified number of access events; and/or rental/purchase, for example where rental use is provided together with an option to purchase content data at the reduced price after rental access has expired.

[0024] Thus where the data carrier stores, for example, music, the purchase outright option
30 may be equivalent to the purchase of a compact disc (CD), preferably with some form of content

copy protection such as digital watermarking. In this example, the rental or subscription payment option may be a pay-per-play option, and with this option payment may either be before or after access to the stored data so that the carrier may operate in either a debit or credit payment mode.

5 [0025] The portability of the data carrier potentially allows it to be used to access content or, in the example, play music without the need to be linked to a communications system or to be on-line to the internet. By providing a use record memory on the data carrier, use of the stored data can be tracked while off-line and then any necessary payment can be made when the data carrier is next coupled to a communication system. This allows the data carrier to operate in a credit
10 mode. In a debit mode, the additional storage of use rules facilitates the regulation of access to content data stored on the carrier without the need for further exchange of payment/use data with an external system to validate the use.

[0026] By combining digital rights management with content data storage using a single carrier, the stored content data becomes mobile and can be accessed anywhere while retaining
15 control over the stored data for the data content provider or data copyright owner. Preferably, the data carrier also stores access control data, such as a user ID and a password, as the stored data may be valuable. The access control data may be combined with access control to the payment data, which is typically by means of a PIN (Personal Identification Number) to simplify access to valued content stored on the carrier.

20 [0027] In one embodiment the stored content data is encrypted and a unique password or PIN and/or biometric data is required for decryption. The data carrier may be arranged so that the content is erased after a predetermined number of incorrect access attempts. Additionally or alternatively, a permanently stored flag may be set and/or a hardware modification (such as a fusible link) may be made to prevent the data carrier from functioning for further data
25 storage/retrieval. Preferably, however, access to any stored value/payment data is nevertheless retained.

[0028] Supplementary data may also be stored on the carrier in association with stored content data. This supplementary data may comprise customer reward management data and/or advertising data. The supplementary data may comprise a pointer to an external data source
30 from which data is downloaded either to the data carrier or to a data access device or content

player, so that advertising or other data can be displayed when reviewing or accessing the stored content.

[0029] Additional data security and/or a mechanism for rewarding operators at different levels in the data supply chain may be provided using a content synthesis function. The content synthesis function combines partial content information from two or more sources to provide content data items for storage and/or output. Thus, for example, a first percentage of a content data item could be provided by a content retailer, while a remaining percentage could be provided by an on-line data supplier. This would provide an incentive for a user to register with a content retailer or distributor as well as with an on-line system owner and so could encourage the use of existing retailers and could provide a mechanism for paying commission to such retailers. The two portions of data combined to provide a content data item could comprise encryption data and a key but preferably comprise separate parts of a complete data item, for example, least significant bits and most significant bits or high frequencies and low frequencies (for audio). This arrangement also facilitates customer reward and loyalty management.

[0030] In one embodiment the data carrier further comprises memory for storing data for accessing a mobile communications network, for example to receive content data over the network. For such an embodiment, the data carrier may replace a SIM (Subscriber Identity Module) card in a mobile communications device, thus providing a single card for both network access and valued content retrieval and storage. Additionally or alternatively the card may also store the web address of a data supplier from whom data may be downloaded onto the carrier.

[0031] The data memory for storing content data may be optic, magnetic or semiconductor memory, but preferably comprises Flash memory. Preferably, the data memory has a large capacity for storing large data files such as compressed video data. Preferably, the data memory is partitioned for lock access, that is, for read and/or write access to blocks of, for example, 1K, 4K, 16K or 64K databytes for faster data access, particularly where the stored content data will normally be accessed serially, as is normally the case with audio and video data. Preferably the card is configured as an IC card or smart card and has a credit card-type format, although other formats such as the "memory stick" format may also be used. This provides a small and convenient portable format and facilitates removable interfacing with a variety of devices.

[0032] The invention also provides a related method of controlling access to data on a data carrier, the data carrier comprising non-volatile data memory and non-volatile parameter

memory storing use status data and use rules, the method comprising receiving a data access request; reading the use status data and use rules from memory; and evaluating the use status data using the use rules to determine whether access to the stored data is permitted.

5 [0033] According to another aspect of the invention, there is provided a computer system for providing data to a data requester, the system comprising a communication interface; a data access data store for storing records of data items available from the system, each record comprising a data item description and a pointer to a data provider for the data item; a program store storing code implementable by a processor; a processor coupled to the communications interface, to the data access data store, and to the program store for implementing the stored
10 code, the code comprising code to receive a request for a data item from the requester; code to receive from the communications interface payment data comprising data relating to payment for the requested data item; code responsive to the request and to the received payment data, to read data for the requested data item from a content provider; and code to transmit the read data to the requester over the communications interface.

15 [0034] The computer system is operated by a data supplier or data supply "system owner" for providing content data to the data carrier described above. The payment data received may either be data relating to an actual payment made to the data supplier, or it may be a record of a payment made to an e-payment system relating either to a payment to the data supplier, or to a payment to a third party. The data from the content provider, preferably without permanent
20 (local) storage of the forwarded data, improves data security as the content provider retains control over a content data item, and the data supplier, a copy of a data item, is unable to supply data for the item without the content provider's assistance. The computer system may provide temporary storage for a requested data item, for example using a disk cache, but preferably the computer system does not store a complete data item, even temporarily.

25 [0035] Preferably, the computer system includes payment distribution information so that when payment is made for a data item, the payment can be distributed for reimbursing royalties and making other payments. Typically a large fraction of the payment for a data item will be transferred to a copyright owner or "content provider" for the item while smaller payments will go to the artist and/or publisher and/or retailer/distributor. Payment may be made directly by the
30 computer system to the computer systems of other relevant parties using, for example, a signature-transporting type e-payment system. Alternatively, the computer system can issue

appropriate instructions to a third party e-payment system for making the transfers. The computer system allows automatic distribution of payments either before, during or after content data download, or after content data access by a user. Instructions for distributing the payments may be issued substantially simultaneously, thereby avoiding long delays in the payment of some parties; for example, it can presently take a year or more for an artist generating content to be paid by conventional methods.

[0036] Preferably, the computer system also stores content data item access rule data, for downloading in association with a content data item. The rule data may be stored by a content provider but is preferably held by the computer system, and links a content identifier with an access rule, typically based upon a required payment value, as outlined above in the context of the data carrier. Normally, each content data item will have an associated access rule, but a single rule may apply to a large number of data items. The computer system also, preferably, stores requester reward data for customer reward/loyalty management. This data may again comprise one or more rules linking a payment value and/or content data item type to a specified reward, such as a number of air miles or retailer value points. The computer system preferably also keeps a record of an identified user's or data's carriers content item downloads and payments for market research purposes.

[0037] The computer system, in one embodiment, also stores access control data, such as an access request identity and password which can be employed, for example, to create an extranet of system users, which again can be linked to stored access record data for marketing purposes. When further linked to content item type data, such an arrangement can be used to construct a club of users of content data items of a particular type, for example country and western or rock and roll music. As described in connection with the portable data carrier, the computer system may also comprise content synthesis code for additional data security and for more secure management of payment distributions.

[0038] The invention also provides a related method of providing data to a data requester comprising receiving a request for a data item from the requester; receiving payment data from the requester relating to payment for the requested data; reading the requested data from a content provider responsive to the received payment data; and transmitting the read data to the requester.

[0039] According to a further aspect of the present invention, there is provided a data access terminal for retrieving data from a data supplier and providing the retrieved data to a data carrier, the terminal comprising a first interface for communicating with the data supplier; a data carrier interface for interfacing with the data carrier; a program store storing code implementable by a processor; and a processor, coupled to the first interface, to the data carrier interface and to the program store for implementing the stored code, the code comprising: code to read payment data from the data carrier and to forward the payment data to a payment validation system; code to receive payment validation data from the payment validation system; code responsive to the payment validation data to retrieve data from the data supplier and to write the retrieved data into the data carrier.

[0040] This terminal can be used for retrieving data from the above-described computer system and for downloading the retrieved data to the above-described portable data carrier. As with the data supply computer system, it is preferable that there is no (local) storage of content item data forwarded from the data supplier to the data carrier. The data access terminal is not restricted to use with the above-described status supplier and could, for example, retrieve data for downloading to the data carrier from a local data source, such as a CD (Compact Disc) or DVD (Digital Versatile Disc), or from a third party such as a cable TV company.

[0041] The terminal reads payment data from the data carrier and transmits this to a payment validation system for validating the data and authorizing the payment. This may be part of the data supplier's computer system or it may be a separate system such as an e-payment system. Thus, the terminal operates with a data carrier storing payment (validation) data and, in some embodiments, additional payment validation code for validating payment to the payment validation system. Again, the terminal is preferably configured to provide a data item use rule to the carrier in conjunction with a data item. As before, the data item use rule will normally be dependent upon payment value information embodied in the payment data read from the data carrier. The terminal is preferably also configured for user input of access control data. This access control data may be forwarded to the data carrier for access permission verification and/or it may be passed to the data supplier computer system for a similar purpose. The terminal may be configured to warn a user of content access or data carrier function inhibition after a predetermined number of access requests have been refused. The terminal may also incorporate content synthesis code as described above.

[0042] The terminal may comprise code to output supplementary data when downloading data to the data carrier. Identity data on the data carrier can be used to retrieve the supplementary data, or a pointer to the supplementary data, from the data supplier computer system, or the supplementary data or a pointer thereto can be retrieved directly from the data carrier.

5 Preferably, however, identification data on the card is used to retrieve characterizing data such as card user preference data from the data supplier computer system, and this characterizing data is then used by the terminal to retrieve and output supplementary data to a terminal user. When the terminal is associated with a contact distributor or retailer, the supplementary data may be retrieved over a network associated with the retailer/distributor such as a local area network
10 (LAN), wide area network (WAN) or extranet.

[0043] The invention also provides a method of providing data from a data supplier to a data carrier, the method comprising reading payment data from the data carrier; forwarding the payment data to a payment validation system; retrieving data from the data supplier; and writing the retrieved data into the data carrier.

15 [0044] The payment validation system may be part of the data supplier's computer systems or it may be a separate e-payment system. In one embodiment the method further comprises receiving payment validation data from the payment validation system; and transmitting at least a portion of the payment validation data to the data supplier. Alternatively the payment validation system may comprise a payment processor at the data supplier or at a destination
20 retrieved from the data supplier. The payment processor may also provide payment distribution data for distributing a payment represented by the payment data.

[0045] In a further aspect, the invention provides a data access device for retrieving stored data from a data carrier, the device comprising a user interface; a data carrier interface; a program store storing code implementable by a processor; and a processor coupled to the user interface, to
25 the data carrier interface and to the program store for implementing the stored code, the code comprising code to retrieve use status data indicating a use status of data stored on the carrier, and use rules data indicating permissible use of data stored on the carrier; code to evaluate the use status data using the use rules data to determine whether access is permitted to the stored data; and code to access the stored data when access is permitted.

30 [0046] The data access device uses the use status data and use rules to determine what access is permitted to data stored on the data carrier. As described above, the use rules will normally be

dependent upon payments made for data stored on the data carrier, but may also comprise access control employing a user identification and password. Since a single data carrier may have more than one user, the use status and use rules may be selected dependent upon a user identity. The data access device may also be configured to present supplementary data when presenting the content data, retrieved as described above, from the card, from a remote computer system or from some other source such as a cable TV network or off-air.

[0047] The invention also provides a related method of controlling access to data from a data carrier, comprising retrieving use status data from the data carrier indicating past use of the stored data; retrieving use rules from the data carrier; evaluating the use status data using the use rules to determine whether access to data stored on the carrier is permitted; and permitting access to the data on the data carrier dependent on the result of said evaluating.

[0048] According to a further aspect of the invention there is provided a data access system comprising a data supply computer system for forwarding data from a data provider to a data access terminal; an electronic payment system for confirming an electronic payment; a data access terminal for communicating with the data supply system to write data from the data supply system onto a data carrier; and a data carrier for storing data from the data supply system and payment data; wherein data is forwarded from the data provider to the data carrier on validation of payment data provided from the data carrier to the electronic payment system.

[0049] In a further aspect of the invention, there is provided a portable data carrier comprising an interface for sending and receiving data from and to the carrier; non-volatile data memory, coupled to the interface, for storing data on the carrier; and a digital rights management processor for controlling access to the stored data.

[0050] In a further aspect of the invention, there is provided a portable data carrier comprising an interface for sending and receiving data from and to the carrier; non-volatile data memory, coupled to the interface, for storing data on the carrier; and an access control processor; wherein the data memory is partitioned as data blocks and the access control processor controls external access to the data blocks.

[0051] In a further aspect of the invention, there is provided a computer system for providing data to a data requester, the system comprising a communication interface; a data access data store for storing records of data items available from the system, each record comprising a data

item description and a resource locator; a data provider for the data item; a program store storing code implementable by a processor; a processor coupled to the communications interface, to the data access data store, and to the program store for implementing the stored code, the code comprising code to receive a request for a data item from the requester to receive from the communications interface payment data comprising data relating to payment for the requested data item; code, responsive to the request and to the received payment data, to output the item data to the requester over the communication interface; wherein said data access data store further comprises payment distribution information indicating to whom payments should be made for a data item; and further comprising code to output payment data for a data item for making payments for the item when the item is supplied to a requester.

[0052] In a further aspect of the invention, there is provided a computer system for providing data to a data requester, the system comprising a communication interface; a data access data store for storing records of data items available from the system, each record comprising a data item description and a printer location data identifying an electronic address for a provider for the data item; a program store storing code implementable by a processor; a processor coupled to the communications interface, to the data access data store, and to the program store for implementing the stored code, the code comprising code to receive a request for a data item from the requester to receive from the communications interface payment data comprising data relating to payment for the requested data item; code responsive to the request and to the received payment data to output the item data to the requester over the communication interface; wherein the data access data store further comprises data item access rule data for output to the requester with a data item; and further comprising code to select access rule data for output with a data item in response to the payment data.

[0053] In a yet further aspect of the invention, there is provided a method of providing data to a data requester comprising receiving a request for a data item from the requester; receiving payment data from the requester relating to payment for the requested data; transmitting the requested data to the requester; reading payment distribution information from a data store; and outputting payment data to a payment system for distributing the payment for the requested data.

[0054] In a still further aspect of the invention, there is provided a method of providing data to a data requester comprising receiving a request for a data item from the requester; receiving payment data from the requester relating to payment for the requested data; transmitting the

requested data to the requester; and transmitting data access rule data to the requester with the read data.

[0055] These and other aspects of the invention will now be further described, by way of example only, with reference to the accompanying figures.

5 BRIEF DESCRIPTION OF THE DRAWINGS

[0056] Figure 1 shows a data access device a) from the top; b) from the front; and c) from the side;

[0057] Figure 2 shows, conceptually, a portable data carrier;

[0058] Figures 3a and b show exemplary data access terminals;

10 [0059] Figures 4a and b show, respectively, a logical signal path between elements of a conceptual data access system; and a physical representation of a conceptual data access system;

[0060] Figure 5 shows a content provision system;

[0061] Figure 6 shows a data supply computer system;

[0062] Figure 7 shows a variety of data access terminals;

15 [0063] Figure 8 shows a schematic diagram of components of a data access terminal;

[0064] Figure 9 shows a schematic diagram of components of a data carrier;

[0065] Figure 10 shows a schematic diagram of components of a data access device;

[0066] Figures 11a and 11b are flow diagrams of a data carrier registration process;

[0067] Figures 12a-c and 12d-e show, respectively, a flow diagram of data access using a data
20 access terminal; and a flow diagram of data supply using a data supply computer system; and

[0068] Figure 13 shows a flow diagram of data retrieval using a data access device.

DETAILED DESCRIPTION

[0069] Referring to Figure 1, this shows a data access device for playing MP3 audio (10) with operator controls (12) and LCD display (14). The outline of a smart card data storage device is
25 shown at (16). The operator controls allow a user to select and play tracks, while track information and still or video images are provided on display (14). A slot (18) is provided in the front of the device to receive a smart card-type data storage means. This smart card occupies

space (20) and interfaces with resilient contacts (24); it is held in the data retrieval device against the contacts, by resilient housing element (22).

[0070] Referring now to Figure 2, this shows a portable data carrier (30) suitable for use with the device of Figure 1. The data storage means is based on a standard smart card; it is plastic, about the size of a standard credit card, and has some flexibility. On the card (30) are two sets of contacts, contacts (32) for interfacing with the payment validation means and contacts (34) for interfacing with the memory for storing downloaded data (although in other embodiments, a single set of contacts may be used for both). The surface of the card can be embellished with suitable graphics.

[0071] In one embodiment the smart card retains all its useable functionality as specified for standard Electronics Point of Sale Systems (EPOSS) and, if desired, the memory for storing the downloaded data can be electrically separate from this. However, it may be preferable to provide interaction between the standard smart card device and the data memory in order to accomplish the access control/decryption functions described above.

[0072] Referring now to Figure 3, an example of a data access terminal is shown at (40). This has a screen (42) and a slot (44) to receive the data carrier (30). Alternatively the data carrier may interface to the terminal via the data access device (10) and an interface (46) to the terminal (40). In Figure 3b a dedicated terminal (50) has a slot (52) to receive the data carrier, a display (54) and controls (56). Coins can be inserted into the terminal at (58) and notes at (60) to charge the data carrier with cash.

[0073] Referring now to Figure 4a, this illustrates conceptually the logical connections and data flow between data processing systems involved in payment validation, and data download to the carrier (30). A user connects the data carrier (30) to terminal (40) and logs on to a data web page of data supply service provider (60). Either terminal (40) or service provider (60) then communicates via data paths (62) with a payment validation authority (70) to check and authorize the user's or payer's payment. In the case of electronic cash the terminal (40) may immediately validate the payment information, updating the service provider and/or payment validation authority (70) at a later stage. The logical connection (64) between the terminal and the service provider is preferably made over the internet.

[0074] The service provider may provide a direct portal to data providers (80) or may collect information from data suppliers (80) and provide a “front end” to present data from the suppliers to the terminal user. Alternatively, data supply service provider (60) may regulate direct access between terminal (40) and data providers (80), as shown by links (66), by communicating with the terminal and the data providers to provide communication regulation information to, for example, instruct data suppliers about what information the user of terminal (40) should have access to.

[0075] In a preferred embodiment, service provider (60) pays royalties at an agreed rate - for example, 10 pence per track or 10 pence per minute - to a computer system owned by a company or entity in the recording industry, such as a content provider or copyright owner, a content publisher or a content creator, and the user of terminal (40) effectively pays the service provider. Billing can also be regulated by bandwidth and/or data download time.

[0076] Preferably the service provider (60) monitors the user’s access to the system and either stores or forwards to data providers (80), or downloads to the data carrier (30), usage information. In a preferred embodiment the service provider sends information via terminal (40) to data carrier (30) which can be used to determine incentives to be provided to users of the system.

[0077] Figure 4b shows a conceptual physical configuration of the system of Figure 4a in which a plurality of terminals (40), a plurality of service providers (60) and a plurality of data providers (80) all interact via the internet. The physical embodiment of the system is not critical and a skilled person will understand that the terminals, data processing systems and the like can all take a variety of forms.

[0078] Referring now to Figure 5, this shows a conceptual illustration of a content provision system 100. Content creators 104a, b generate or receive content data from artist terminals 102a-d and store content data in databases 106a, b. The content data stored in databases 106a, b may comprise audio data, such as music, video data, such as films or TV programs, text, such as literary works, software, such as games software, or other data. Content creators 104a, b are coupled to communications network 101 for communicating created content data over the network. Also coupled to communications network 101 are content publishers 110a and 110b, each of which is coupled to an associated stored content database, 112a and 112b respectively. The content publishers make their stored content available for controlled access using

communications network 101. In some instances, for example where the content data comprises computer games, the functions of content creator and content publisher may be provided by a single entity. Also although conceptually illustrated as blocks in Figure 5, the content creator and content publisher typically each comprise a client server computer network.

5 [0079] The communications network 101 is typically a private communications network, such as an extranet, with security controlled access to entities connected to the network. Physically the network may comprise an internet protocol network or it may comprise, or consist of, dedicated point-to-point links. Thus, for example, a content creator 104 may be directly linked to a content publisher 110 and/or to other entities shown in Figure 5 such as a content provider or
10 content distributor.

[0080] The content provision system includes a plurality of content providers 108a-e, each coupled to the communications network 101. In the illustrated system, the content providers own copyright in stored content data accessible over communications network 101 and may, in practice, also perform a content publication function. Five content providers own the copyright
15 in over 80% of all world-wide music sales. The content providers are coupled to stored content databases 106 and 112 via communications network 101, for supplying stored content data.

[0081] A gateway server 114 is also coupled to communications network 101 to link the communications network to other networks such as the internet and/or mobile communications networks. Gateway server 114 provides security and access control functions and firewalls. A
20 second gateway, content distributor WAN gateway 116, is also shown attached to communications network 101. This provides similar security and firewall functions and coupled communications network 101 to distributor WAN (wide area network) 117. Gateway 116 has logical access to one or more of a content creator, content publisher and content provider for accessing stored content data. Content distributor gateway 116 may be owned by a chain of
25 record stores and provide content access terminals 118, coupled to WAN 117, in separate retail outlets. Content access terminals 118 have access, via gateway 116, to stored content accessible over communications network 101.

[0082] Referring now to Figure 6, this shows a data supply computer system 120. In this embodiment, three content access terminals 118a-c, e-payment systems 121a, b, and content
30 access web server 124 are all coupled to internet 142. Data supply system 120 is coupled to the content provision system 100 illustrated in Figure 5. Where communications network 101 of

Figure 5 is an extranet, this extranet physically operates over internet 142; where communications network 101 does not partly operate via internet 142, a connection to internet 142 is established via gateway server 114 as shown in Figure 5. In this way content access terminals 118a-c are provided with controlled access to the stored content data of content provision system 100.

[0083] E-payment systems 121a and 121b are coupled to banks 122a, b and c, d respectively.

These provide an e-payment system according to, for example, MONDEX, Proton, and/or Visa cash compliant standards. Preferably at least one of e-payment systems 121a, b operates a so-called "open purse" system in which the value is stored as a publicly verifiable digital signature

issued by the e-payment system. In such a signature-transporting arrangement, payment data

may be validated using public keys and thus payment authentication need not be performed by the e-payment system but may instead be performed by, for example, a data access terminal or

data supply system computer, using payment management code. The authenticated signatures, which in effect perform a similar role to checks, are submitted to the relevant e-payment system

after authentication for verification and reimbursement or transfer of monetary value. With such a system payments may be made anonymously and thus payer identification is not essential.

Data carriers, such as data cards, may be issued with stored value or without value, in which latter case value (that is, a publicly verifiable digital signature) may be written onto the card during an on-line transaction.

[0084] In alternative embodiments, a data carrier such as the smart Flash card described below may be used to create value bearing digital signatures as is well-known to those familiar with e-money.

[0085] Content access web server 124 is also coupled to internet 142 for providing content access terminals 118a-c with access to content data. Content access web server 124 is typically

owned by a content data supply "system owner" who acts as an intermediary between a content access terminal user and a content provider, forwarding content data provided (directly or indirectly) by a content provider to a content access terminal and then to a stored content data carrier. Web server 124 is coupled to web server code storage 126 storing Java code for generating web pages for interpretation by web browsers on content access terminals 111a-c.

The web pages provide the content download, value add, CRM (customer reward management) value check/spend and website link functions described below.

[0086] Web server 124 is coupled to payment processor 128, Digital Rights Management (DRM) processor 130, access control processor 132, and content distribution processor 134. Payment processor 128 includes payment management code storage 128a and is coupled to payment record data store 136. Access control processor 132 includes access control code storage 132a and is coupled to access control data store 138. DRM processor 130 includes DRM code storage 130a and is coupled to content access and DRM data store 140. Content distribution processor 134 includes CRM (customer reward management) and payment distribution management code storage 134a and is also coupled to content access and DRM data store 140. As shown in Figure 6, processors 128-134 are all in communication with one another.

[0087] Processors 128, 130, 132 and 134 may comprise separate application programs or a single computer program and may operate on a single physical computer, on which web server 124 may also be provided, or may operate on separate computers. Likewise data stores 136, 138 and 140 may comprise a single physical data store or may be distributed over a plurality of physical devices and may even be at locations physically remote from processors 128-134 and coupled to these processors via internet 142.

[0088] Web server 124 communicates with processors 128-134 by means of a CGI (common gateway interface) script and the code associated with processors 128-134 may be written in any conventional computer language such as C, C++, or Perl. However, in other embodiments one or more of the processors may be coupled to web server 124 via internet 142 and owned and operated by a separate entity, such as a financial institution. In this case conventional secure web-based communications may be operated between web server 124 and the relevant processor. In particular, payment processor 128 may be operated by one of the e-payment system providers 128a, b.

[0089] Payment management code 128a issues and authenticates payment data and stores an audit record in payment record data store 136. Access control code 132a stores identification data (of a user or card) together with registration data provided by a user when registering with the system owner. This data comprises a user password for accessing stored content and/or payment data; user characterizing data, for example characterizing user preferences, for marketing purposes; data indicating an e-payment system to use; and in some embodiments, further general user related data such as card level data for identifying the provision of "gold" level services to selected users. A copy of the password is stored with the content data on the

portable data carrier, as described further below. Alternatively, one or both of the access control data store and portable data carrier may simply store data for verifying a user-entered password.

5 [0090] Content access and DRM data store 140 stores data related to content access and content use, but does not itself store content data items; these are instead provided via content provision system 100 described above. Data store 140 stores a plurality of records each comprising a data item identifier, a data item description, a data item type or genre, and location data comprising one or more pointers to a location or locations from where the data item can be downloaded. Associated with a data item is also a table of use rule data comprising a list of values (i.e. content data item prices) and corresponding levels of permitted usage. Thus a value of £1 might permit ten plays of a music track, while the value of £10 might permit an unlimited number of plays of the track and copying of the track for personal use.

15 [0091] Also associated with a data item is a table of payment distribution data comprising a list of recipients and corresponding fractions of the data item value each is to receive. Typically, the main recipient will be the copyright owner of the data item and other recipients will be selected from the content creator, the artist or artists, the system owner, the content publisher, and the retailer/distributor. The payment distribution proportions may be dependent upon the payment value, in which case a plurality of sets of payment distribution figures may be associated with each data item, each set of distribution figures corresponding to a payment value range. The payment data and distribution data is here termed DRM (Digital Rights Management) data.

20 [0092] Further associated with a data item is a table of CRM (Customer Reward Management) data, linked to the user rule data, comprising CRM rules to specify, for one or more data item use levels, a quantity of reward points and one or more recipients for the reward points (the recipients may include the card user and the retailer/distributor).

25 [0093] The CRM and payment distribution code 134a operates with content access and DRM data store 140 to inform a system user of the description and value of a data item, to access and download a data item from the content provider system to a content access terminal, to provide content use rules with the data item, and to provide instructions either to payment processor 128 or to e-payment system 121 to distribute payments for the data item to the recipients identified by the data store 140 and to distribute CRM reward points.

[0094] The access control data store 138 holds a secure key, such as a secret "public" key in a public key cryptography system, for the system owner to authenticate its identity to a content provider. This data is held securely with other sensitive data in the access control data store 138. As is described in more detail below, when data supply system 120 receives a request for a
5 content data item from a content access terminal 118, it looks up a location from which the data item is available using content access and DRM data store 140 and then determines the identity of the corresponding content provider. This identity is either stored in content access and DRM data store 140 or, as there are relatively few content providers, it may be hard written in DRM code 130a. DRM code 130 then requests access control processor 132 to provide the secure
10 system owner identifier from access control data store 138 to the relevant content provider and sets up a trusted connection between the content provider and content access web server 124 for downloading the data item to a content access terminal 118 and then to a portable data carrier.

[0095] Referring now to Figure 7, this shows a variety of content access terminals for accessing data supply computer system 120 over internet 142. The terminals are provided with
15 an interface to a portable data carrier or "smart Flash card" (SFC) as generally described with reference to Figure 2 and as described in more detail below. In most embodiments of the terminal the SFC interface allows the smart Flash card data carrier to be inserted into and removed from the terminal, but in some embodiments the data carrier may be integral with the terminal.

[0096] Referring now to the specific embodiments illustrated in Figure 7, a simple content access terminal may comprise a home personal computer 144 with SFC interface 144a. In another embodiment, a mobile communications device 152 is provided with a smart Flash card interface 152a and is coupled to internet 142 via radio tower 150, mobile communications
20 system 148 and mobile communications internet gateway 146.

[0097] In another embodiment, a smart Flash card interface is provided to a so-called "set top box" (STB) 154. The set top box is, in effect, a receiver for television programs received on video input 154b, which may comprise a satellite TV signal, a cable TV signal or an off-air TV signal. The video signal is provided from the set top box to television 156 or to some other home entertainment device such as a personal computer (not shown). In another embodiment, content
25 access terminals 166 and 168 each with respective SFC interfaces 166a and 168a are coupled to a retailer local area network (LAN) 160 connected to internet 142 via retailer LAN server 158.

DVD player 164 is also coupled to LAN 160. In a further embodiment a smart Flash card interface 170a is provided for a CD/DVD player 170.

[0098] In these latter three embodiments, content data for storage on the smart Flash card may be retrieved from broadcast video and/or a CD or DVD. In this case, the computer data supply system 120 illustrated in Figure 6 may be used to provide use rule data for the content data stored on the smart Flash card, and to pay for data downloaded onto the card; the content data may be captured before or after the data supply system 120 is accessed to enable use of the stored data, but in a preferred embodiment content data written to the card from a supplier other than the content data supply computer system is not accessible to a user until corresponding use rule data has been downloaded from computer system 120, which will normally be after receiving payment for the downloaded data.

[0099] Referring now to Figure 8, this shows a schematic diagram of one embodiment of a data access terminal 170. The terminal comprises a general purpose computer including an audio/visual interface 184, a keyboard 186 and a pointing device 188 for providing an interface to the user. The terminal has an internet interface 176, for example a modem, and optionally a LAN/WAN interface 174 for connecting the terminal to a retailer or distributor LAN or WAN. The terminal also has an optional video input 178 for receiving broadcast video data and a media input device 180, such as a CD or DVD drive. Further communications I/O ports 182 may also be provided. A portable data carrier or smart Flash card interface 190 is provided for interfacing to a smart Flash card. Optionally, a cash input and verification system 192, such as is conventionally used in an automatic teller machine (ATM), may also be incorporated within the content access terminal. The terminal has working memory 194 such as RAM and program memory 196 which can comprise any conventional storage device such as RAM, ROM or a disk drive. Program code in program memory 196 may also be stored on removable disk 198. A processor 200 loads and implements program code stored in program memory 196. All the components of the terminal are linked by a data and communications bus 172.

[0100] More specifically, processor 200 loads and implements cash payment management code 200a for managing cash input data from cash input and verification system 192, for adding value to a smart Flash card. Processor 200 also implements a web browser 200b for accessing system owner web pages and data exchange interface 200c for exchanging data between a smart Flash card interface to the terminal and data supply system 120.

[0101] Processor 200 also implements off-line contents retrieval code 200d for retrieving data for storage on a smart Flash card from media input device 180 and/or video input 178 and/or LAN/WAN interface 174. The processor implements a content sampler 200e for outputting small extracts of content data items to a user via audio/visual interface 184. Such data item samples may be stored with the content description data in content access data store 140. The processor also implements a smart Flash card interface driver 200f, user interface code 200g and additional communication drivers 200h for driving LAN/WAN interface 174 and/or comms I/O ports 182.

[0102] Referring now to Figure 9, this shows a schematic diagram of components of a portable data carrier 202, in the embodiment shown a so-called "smart Flash card". In this context, "smart Flash card" refers to an IC card similar in size to a plastic payment card incorporating a processor and Flash data memory, preferably of large capacity. For further details on smart cards, reference may be made to the ISO (International Standards Organization) series of standards, including ISO 7810, ISO 7811, ISO 7812, ISO 7813, ISO 7816, ISO 9992 and ISO 10102, which are hereby incorporated by reference.

[0103] Referring in more detail to Figure 9, a data and communications bus 204 links components of the card which include a processor 210, working memory 212, timing and control logic 208 and an external interface which may have contacts (ISO 7816) or be contactless (ISO 10536) for providing external access to a bus 204 for reading data from and writing data to the card 202. Also coupled to bus 204 are permanent program memory 216, non-volatile data memory 218 and non-volatile (Flash) content data memory 214. Non-volatile data memory 218 may comprise EEPROM and permanent program memory 216 may comprise ROM, for example, mask-programmed ROM. All the components of Figure 9 are mounted on a single substrate, in a preferred embodiment bearing contacts for external interface 206.

[0104] Processor 200 loads and implements program code from permanent program memory 216. This code comprises operating system code for providing the card with a basic operating system for at least external communications; payment management code for supplying payment data from non-volatile data memory 218 to pay for downloaded content; DRM (Digital Rights Management) and security code, including code to implement content data use rules and code for password controlled access to data and program functions; CRM code for implementing CRM-

related rules; and content synthesis code for combining stored content data with additional data provided via external interface 206 for synthesizing complete content item data.

5 [0105] Non-volatile data memory 218 stores data including card identity data, access control data, including password data for validating a user password, access record data for storing a record of access attempts and their outcomes, and content supply data such as system owner website addresses and retailer/distributor website addresses.

10 [0106] Data memory 218 further stores card value data comprising e-money such as publicly verifiable digital signatures, and payment data for storing a payment audit trail including payment amounts and data on to whom payments have been made. The memory 218 also stores RFM (Recency Frequency Monetary) data to provide a record of transactions for market research and customer reward purposes, and CRM data storing customer reward points. Data memory 218 also stores an index of content data items stored in Flash memory 214 and associated content use rules, as well as DRM and royalty data for maintaining an audit trail of use history for rights management tracking. Optionally, data memory 218 may also store supply chain data specifying
15 a supply chain route through which data has been obtained from a content provider, which may be used for rewarding supply chain intermediaries, for example on a commission or reward points basis.

20 [0107] Content data memory 214 preferably comprises at least 100 MB of data storage, partitioned as data blocks of a size selected to match the stored content type. For storing video data, Flash memory 214 preferably comprises > 1 GB data storage and the data blocks into which the data memory is partitioned are larger.

25 [0108] Referring now to Figure 10, this shows a schematic diagram of a data access device 220, such as a portable audio/video player. The data access device 220 comprises a conventional dedicated computer system including a processor 238, permanent program memory 236, such as ROM, working memory 234, such as RAM, and timing and control logic 226 all coupled by a data and communications bus 222. Also coupled to the bus are an audio interface 228, a display 230 and user controls 232, for providing a user interface. A smart Flash card interface 224 is coupled to bus 222 for interfacing with a smart Flash card for retrieving and playing stored content data.

[0109] Permanent program memory 236 stores program code for implementation by processor 238; this code may also be provided on a data carrier such as a ROM chip or disk 240. Processor 238 implements an SFC interface 238a, a user interface 238b, a content player 238d for retrieving stored content data from a smart Flash card interfaced to the device and for outputting audio and/or video data derived from the retrieved content data (which may comprise compressed audio and/or video data) to a user of the device.

[0110] Processor 238 also implements use control 238c for controlling access to and use of contents stored on the smart Flash card by the content access device user. Use control routine 238c and/or DRM and security code in permanent memory 216 on the smart Flash card may also implement digital watermarking and other Secure Digital Music Initiative (SDMI) content protection code as specified in the SDMI portable device specification, part one, version 1.0 (see www.sdmi.org) which is hereby incorporated by reference.

[0111] Figures 11a and 11b show a flow diagram of a process for registering a data carrier or smart Flash card with a data supplier or system owner operating a data supply system as illustrated in Figure 6. A smart Flash card may be issued entirely blank, that is, with no prestored content or value, with prestored value but no prestored content, with prestored content but no prestored value (the content being provided free) or with both prestored value and prestored content. Thus, for example, a user may purchase a card with stored value but no stored content over the counter at a retailer. The process of Figures 11a and 11b illustrates the registration of a card with neither prestored content nor prestored value. As illustrated the registration process records user registration data in the access control data store 138 of Figure 6 and writes value data onto the blank card.

[0112] At step S10 a smart Flash card is inserted into a content access terminal smart Flash card interface. The system owner web page is then loaded onto the content access terminal and displayed to the user (step S11). User registration data is then entered into the content access terminal (step S12) and transmitted to the system owner (S13). The user registration data may include a user identity, a preferred e-payment system to use and, optionally, a content access PIN or password, and a service level (for example bronze, silver or gold). The optional password may be a password required by the e-payment system for validation of a payment by the user with the card or it may be a password to protect unauthorized access to content on a smart Flash card to protect stored data in the event, for example, of the card being stolen. A single password

may serve both these functions. The content access terminal web browser is configured so that all sensitive data passing between the terminal and the system owner is securely transmitted, for example by using a conventional encryption system such as PKI (Public Key Infrastructure).

5 **[0113]** At step S14 a payment request is received from the system owner at the content access terminal and displayed to the user. At step S15 the user enters payment data into the content access terminal and this payment data is transmitted to the system owner, for adding value to the card. This may, for example, be a credit card transaction as is conventionally used for purchase over the internet. Card value data and a card value access code is then received by the content access terminal from the system owner at step S16. The card value corresponds to the payment
10 made by the user and the value access code may be a password entered by the user at step S12 or may comprise a password or PIN created by payment processor 128 or e-payment system 121 as illustrated in Figure 6. In a preferred embodiment, the user pays the system owner and the system owner then directly provides digital signature data representing value to the content access terminal for writing onto the smart Flash card.

15 **[0114]** At step S17, card registration data is received from the system owner by the content access terminal and written onto the smart Flash card. This card registration data comprises user identity data, access control data, payment system specifying data, system owner access data, such as a system owner web page address and other dial-up information. At this stage other data may be entered by the user and written onto the card, including, for example, user preference
20 data, retail outlet and CRM data (alternatively user preference data may be captured at step S12). At step S18 the card value data and card value access code received at step S16 is written onto the card and output to the user visually and, optionally, as a printed record. The card is then available for use, at step S19.

[0115] Figure 11b shows the corresponding registration steps performed by the system owner's data supply system 120. At step S20, a request for a smart card registration web page is received
25 from a content access device and, at step S21, transmitted to the device. User registration data is then received, at step S22, from the content access terminal and stored in content access control data store 138. The system owner's computer system then transmits, at step S23, a payment request to the content access terminal and receives, at step S24, payment data in reply, this
30 payment is then authenticated, at step S25, with an e-payment system such as payment system 121 a or b illustrated in Figure 6, and after verification the payment processor 128 of the

computer system transmits, at step S26, value data and a value access code to the content access terminal, for writing onto the smart Flash card. The payment processor then updates the payment record data store 136 with data relating to the transaction (step S27) and, at step S28, retrieves card registration data previously written into the access control data store and transmits this registration data to the content access terminal. At step S29 the transaction is then complete.

[0116] Referring now to Figures 12a-c, these illustrate a flow chart for downloading data to a smart Flash card using a data access terminal. At step S30 the smart Flash card is inserted into the content access terminal and the user then enters, at step S31, their password for gaining access to the functionality of the smart Flash card. At step S32, the content access terminal transmits the password to the smart card for verification and the terminal checks, at step S33, whether access is permitted. If access is not permitted, a warning is displayed by the terminal, at step S34, and an access denied count is implemented. A threshold count is then read from the card together with a count of the total number of times access to the card has been denied (step S35). At step S36 the terminal checks whether the total number of denied accesses is within three of the card threshold, and if it is not, returns to step S31, while if it is, it proceeds to step S37 where the terminal displays a warning that a further denied access is likely to result in erasure of content stored on the card. At step S38 the terminal then checks whether its count of denied accesses is greater than its threshold value, returning to step S31 if not, and displaying an access refused message at step S39 if the total number of permitted accesses has been exceeded. The system then waits at step S39 for removal of the smart Flash card from the content access terminal.

[0117] If access is permitted at step S33, the terminal loads outline CRM data from the card (step S40) and loads retail data, such as targeted advertising, from the retailer LAN/WAN (step S41). At step S42, the terminal then displays a menu of options, retail data such as advertising or CRM-related data and outline CRM data, such as a total number of reward points earned, on the content access terminal. Many options include download content (from a system owner), add monetary value (to the card), check/spend CRM value stored on the card, follow website links, and exit. At step S43, the user inputs a menu option which, in the illustrated flow chart, is the download option. The system thus passes to step S44 and loads the system owner's content access web page onto the content access terminal and displays this to the user.

[0118] At step S45, the user enters a content search request, which is transmitted to the system owner content distributor processor 134. Content search results are received back from the content distribution processor, including a content identifier, a brief description, and content cost data for at least one payment option, and these results are displayed on the user on the content access terminal. The user then selects one or more content items at step S47 and the selection is transmitted to the content distribution processor 134 where further content cost data and purchase option data is retrieved from data store 140. At step S48, this content cost and purchase data (including use rule data) is received from the system owner and displayed to the terminal user. The user then selects, at step S49, a purchase option and confirms a purchase request or, alternatively, selects "exit" to return to the menu display of step S42. After one or more content items have been selected, together with a purchase option, hard value and CRM data is read from the smart Flash card at step S50, and at step S51 a check is made to determine whether the monetary and/or CRM (reward points) value stored on the smart Flash card is sufficient to purchase the selected purchase data items. If the card value is insufficient, a warning is displayed at step S52 and the system returns to the menu display at step S42. If the card value is sufficient, at step S53 the content access terminal transmits a payment request to the smart Flash card.

[0119] Payment for the data item or items requested may either be made directly to the system owner or may be made to an e-payment system such as e-payment systems 121a and 121b of Figure 6, with these systems then forwarding payment confirmation data to the system owner computer system. Alternatively, the content access terminal may transmit data to the card to set up a transaction directly with a content provider who, being the copyright owner, would normally receive the majority of the payment.

[0120] At step S54, payment data for making a payment to the system owner is received from the smart Flash card by the content access terminal and forwarded to an e-payment system such as e-payment system 121 in Figure 6. Payment record data, validating payment by the card to the system owner, is then received back from the e-payment system at step S55 by the content access terminal and forwarded to the card for updating payment data on the card. In alternative embodiments, payment data from the card may be provided directly to the system owner's data supply computer for authentication and, optionally, further validation with an e-payment system by the system owner's computer.

[0121] Distribution of the payment received by the system owner from the card is performed by the system owner's computer system, as described elsewhere. Such payment distribution will normally provide a small percentage of the total payment to a "owner" or operator of the content access terminal, such as a retailer, distributor, or in other embodiments, mobile communications network operator or cable TV network operator.

[0122] In the presently described embodiment, payment record data received in step S55 is transmitted to the system owner to confirm payment by the card and thus it is the content access terminal, in the described embodiment, which authenticates a payment before confirming that the payment has been made to the system owner.

[0123] In step S56, together with the payment record data, purchase request and card registration data is transmitted to the system owner to identify one or more content data items for purchase and to identify the purchaser. Then, at step S57, the content access terminal sets up a transaction between the system owner data supply computer and the smart Flash card for download of the identified content items requested from the data supplier to the smart Flash card. The download is preferably arranged so that there is no permanent storage of downloaded data on the content access terminal (although temporary storage in a disk cache may be permissible), and there is further preferably no temporary storage on the content access terminal of complete data for a content data item. This provides data security and reassurance to the content providers.

[0124] In the same way as with card registration described with regard to Figure 11, a secure and trusted link is set up between the content access terminal and/or the smart Flash card and the data supply computer in a conventional manner as is well known to those skilled in the art (for example, using public key data encryption). The data transaction may be set up directly between the smart Flash card and the data supply computer, in which case the content access terminal has no access to unencrypted content data, or it may be set up between the content access terminal and the data supply computer, in which case unencrypted data is written by the content access terminal to the smart Flash card. Standard transmission protocols are used to ensure complete transmission of a content data item, for example by re-transmitting blocks of data which are not correctly received.

[0125] Also at step S57, one or more content access rules are received from the system owner data supply computer and written to the smart Flash card so that each content data item has an

associated use rule to specify under what conditions a user of the smart Flash card is allowed access to the content data item.

5 [0126] At step S58 the content access terminal receives CRM data from the content distribution processor 134 of the system owner, for example specifying a number of reward points earned by downloading the selected content items. This CRM data will normally be written to the smart Flash card (step S59), but may additionally or alternatively be stored in the content access terminal or in a data store of the content access terminal owner so that the reward points are held by the distributor/retailer/cable TV operator. Finally, also at step S59, a complete record of details of the transactions between the smart Flash card and the content access terminal, 10 the smart Flash card and the system owner, the smart Flash card and the e-payment system, and the content access terminal and the e-payment system and/or data supply computer is recorded on the smart Flash card to provide an audit trail. The system then returns to the menu display at step S42.

15 [0127] The add monetary value menu option provided by the menu operates in a similar manner to that described with regard to steps S15 and S16 of Figure 11a and steps S24 to S27 of Figure 11b. In embodiments of the system in which the smart Flash card operates either in a debit (pre-pay) or credit mode, operating mode data may be loaded from the card together with outlying CRM data at step S40. If the card is operating in a credit mode then, at step S41, the content access terminal reads content use data records from the card and proceeds 20 correspondingly to steps S47 and S48 to determine the value of the content accessed and then proceeds according to steps S15 and S16 of Figure 11a and steps S24 to S27 of Figure 11b to retrieve payment for the accessed content from the card owner. Where enhanced access control features are provided, access control data read from the smart Flash card or entered into the content access terminal at step S31 is used, in step S44, to access the system owner content 25 access webpage and, in some embodiments, to set up a secure connection between the content access terminal and system owner data supply computer at step S44.

30 [0128] Referring now to Figures 12d and 12e, these show steps in a process implemented on the system owner's data supply computer for providing content data to a content access terminal and thence to a data carrier such as a smart Flash card. At step S60 the system owner's content access web page is requested by a content access terminal and transmitted to the requesting terminal. A search request for searching for a content data item is received, at step S61, from the

content access terminal, and at step S62 content distribution processor 134 of the content supply system searches content access and DRM data store 140 and transmits the search results to the content access terminal. The search results will normally comprise a content item identifier, a content item description, optionally a content item sample, and at least one content item price, for example for a default payment option. The search results may comprise a set of content data items, either selected by type or artist or comprising some predetermined selection in a similar manner to a compilation of tracks on a CD.

[0129] At step S63 content item selection data identifying one or more content items is retrieved from the content access terminal, and at step S64 content item purchase data for the selected content items is retrieved from content access and DRM data store 140. This purchase data will normally include, for each selected content item, one or more prices and purchase options. Purchase option data may simply comprise one of a set of standard options, for example "1" to purchase outright, "2" to rent for a period of time, "3" to rent for a number of plays, and "4" to rent with a final purchase option. The purchase option data may also indicate when a content item is available free.

[0130] At step S65 the content purchase data is transmitted to the content access terminal, and at step S66 payment record data, indicating a payment made from the smart Flash card to the system owner, purchase request data, card registration data and, optionally, access control data, is received from the content access terminal. The payment record data confirms a payment for the requested data items, the purchase request data specifies the payment option selected for the selected content items, and the card registration data provides data for keeping records of the transaction and providing reward points; the access control data may be required for additional data security. At step S67 the payment record data, in the described embodiment of the system, is validated with an e-payment system such as e-payment system 121 of Figure 6. As illustrated in the flow chart, the data supply system computer checks with the e-payment system that a payment has in fact been made to the system owner. In other embodiments of the system, payment may be made directly to the system owner, and either concurrently with the content access and download process, or, at some later stage, payment data received from the smart Flash card may be verified with the e-payment system for reimbursement of the system owner.

[0131] At step S68, payment distribution data is read from the content access data store 140. This data will indicate how payment made by the card for the data is to be distributed among

recipients. In one embodiment, recipient's payment fractions are specified in general terms in the content access data store, for example copyright owner 0.90, system owner 0.01, retailer/distributor 0.02, publisher 0.02, creator 0.05. Identification of who is the relevant copyright owner is stored in the data store together with the content item identifier, but may be selected from more than one possible content provider for the data item, and identification of who is the relevant retailer/distributor may be determined from, for example, content access identity information received from the content access terminal when the system owner content access web page is accessed at step S60. At step S69, payments are then distributed in accordance with the payment distribution data, either by direct distribution of value-bearing digital signatures to the relevant parties, or by issuing a payment distribution instruction to e-payment system 121. Preferably the data supply system stores records of individual card payments and, at intervals, combines the payment distribution data for a plurality of individual records to output payment data for distributing the total payment received by the data supply system from a batch of individual payments.

[0132] At step S70, content access rules for the purchased level of service are read from the content access data store. These rules could, for example, specify that only a predetermined number of accesses to the content are permitted, for example 10 plays. Alternatively, the rules could provide access for, say, one month from the download date. Other rules may provide unlimited plays but only on specified players, for example set top boxes owned by a particular cable TV network (as determined by content access device identification data provided to a smart Flash card from a content access device). A content provider identification for the requested content data is also read from the content access data store at step S70 together with CRM data for issuing reward points.

[0133] At step S71, content access rules for the requested content data items are retrieved from data store 140 and transmitted to the content access terminal. Then, at step S72, DRM processor 130 of the data supply system transmits a transaction request and authentication data to the content provider identified in step S70. This request identifies the system owner data supply system to the content provider in a secure manner, either by means of physical security, such as a dedicated connection from the system owner data supply system to the content provider, or by means of an electronically secure connection such as an encryption connection. Then, at step S73, the content access web server 124 receives protected content from the content provider, comprising the data items requested by the content access terminal, and transmits this protected

content to the content access terminal. The content is preferably protected by data encryption but may be protected in other ways, for example, by digital watermarking or simply by the large number of other transactions taking place at any one time over the internet. The data supply system computer, at this point, essentially acts as a transparent data forwarder, forwarding data
5 from the content provider to the content access terminal, which itself is preferably effectively transparent, using data exchange interface 200c to transmit the protected content data directly to the smart Flash card. As described with regard to Figure 12d, the content download protocol includes error protection and transmission retry protocols to ensure substantially error-free data transmission.

10 **[0134]** Once content has been downloaded to the content access terminal (and, hence, to the smart Flash card) at step S74 a record of the purchase data and content accessed is written to payment record data store 136, to provide an audit trail. Then, at step S75, updated CRM data is written to the content access data store 140, using rules stored in the content access data store, in conjunction with a record of the downloaded data items, to calculate the CRM data (i.e. reward
15 points). The updated CRM data is then also transmitted to the content access terminal, where it can be forwarded to the smart Flash card. Then, at step S76, the process ends.

[0135] Referring now to Figure 13, this shows a flow chart for user access of stored data on a smart Flash card using a data access device such as the MP3 player of Figure 1. At step S77 the smart Flash card is inserted into the player and, at step S78, the user enters a password into the
20 player, which is transmitted to the smart Flash card for validation (this step is optional). If access to stored data on the card is permitted, the process proceeds to step S79 where an index of content data items stored on the card is loaded from the card and displayed together with a menu. The menu provides options including access content, check value (stored on the card), check CRM data (such as reward points) stored on the card, and play options (such as no video, repeat
25 play, random play, and the like). If the user wishes to access content data items stored on the smart Flash card, a user selection of such items is entered into the player at step S80, for example using cursor keys or a pointer; additionally or alternatively a default play option may be provided to, for example, play the most recently downloaded data.

[0136] At step S81 content use status data for the selected content items is loaded from the
30 smart Flash card together with associated content use rules. Then, at step S82, the use rules and present use status for each selected content item are compared and the result is displayed

together with a content play menu. The content play menu may comprise a simple list of the selected content items with items not available for access highlighted in, for example, red. Alternatively, more detailed content access permission data may be displayed such as the purchased contents use for a content data item, the actual use of the data item made so far, and the available remaining use. Then, at step S83, the player determines whether content use is permitted. If use is not permitted, the process returns to step S79 to re-display the menu; if content use is permitted the system proceeds to step S84.

[0137] At step S84 the selected content data items whose use is permitted are retrieved sequentially from the card, decoded as necessary, and the decoded audio and/or video data is made available to the user, for example, by providing audio output at a headphone socket on the player and displaying video output on the player display. Preferably, the player also retrieves supplementary data stored in association with a content data item, such as advertising data, or for a web-enabled player, hot links to web sites for sale of goods or services, particularly those related to the accessed content data item or those identified to appeal to users accessing the data item (such as pop group merchandizing or Harley Davidson (trade mark) motor bikes for rock music/video).

[0138] Preferably, the player is provided with "pause" and "continue" functions and corresponding user controls. When "pause" is selected the process passes to step S85 and writes a record to the smart Flash card comprising data specifying how much use has been made of the accessed content data item. In the case of music or video data, this may comprise start and end time markers or simply a play duration time (the start time being predetermined, for example at the start of the data item). In the case of a game the partial use data may comprise an elapsed play time or a number of lives left. In the case of a data item providing a service such as access to stock and share prices, or weather information, or a share dealing service, the partial use information may comprise a status record indicating the status of an interrupted transaction. When the "continue" function is selected on the player the process returns to step S84.

[0139] To allow for the smart Flash card being removed from the player between pause and continue events, a check may be made at step S78, by reading a partial use status data from the card, to determine whether a content data item was left in a pause state when the card was last used. If such a pause state is determined to exist for a content data item, the process may then

jump directly to step S85 to allow a user to resume or continue with the content data item and proceed directly to step S84.

5 [0140] Once play is complete the process moves to step S85 where updated content use data is written to the smart Flash card. This updated use data provides a record of the use of a content made in step S84. This record can then be used in steps S81 to S83 to determine, on a subsequent occasion, whether further use of the content data item is permitted. Finally, at step S86, customer reward management reward rules are loaded from the smart Flash card together with CRM data stored on the card. The CRM data is then updated, using the CRM reward rules, to reflect the use of content data items made in step S84 and the updated data is written back to
10 the smart Flash card.

[0141] In one embodiment the CRM reward rules are determined by the content access terminal owner (retailer/distributor/cable or mobile network operator) and are written onto the card when registering the card. The updated CRM data may then be accessed by a content access terminal for spending or other use when the smart Flash card is next inserted into a
15 content access terminal. Once the CRM data has been updated, the process returns to step S79 to display the content index and menu.

[0142] The specific embodiments of the invention described above use communication over the internet and web-based technology but this is not essential, and the invention may be implemented using any electronic communications network, such as a wide area network, local
20 area network, wireless network, or conventional land line network. Likewise, the invention is applicable to the internet, intranets, extranets, and other internet protocol networks.

[0143] The skilled person will understand that many variants to the system are possible and the invention is not limited to the described embodiments but encompasses modifications which lie within the spirit and scope of the present invention.

WHAT IS CLAIMED IS:

1 1. A handheld multimedia terminal, comprising:
2 a wireless interface configured to interface with a wireless network for accessing
3 a remote computer system;
4 non-volatile memory configured to store multimedia content, wherein said
5 multimedia content comprises one or more of music data, video data and computer game data;
6 a program store storing processor control code;
7 a processor coupled to said non-volatile memory, said program store, said
8 wireless interface and
9 a user interface to allow a user to select and play said multimedia content;
10 a display for displaying one or both of said played multimedia content and data
11 relating to said played multimedia content;
12 wherein the processor control code comprises:
13 code to request identifier data identifying one or more items of multimedia
14 content stored in the non-volatile memory;
15 code to receive said identifier data;
16 code to present to a user on said display said identified one or more items
17 of multimedia content available from the non-volatile memory;
18 code to receive a user selection to select at least one of said one or more of
19 said stored items of multimedia content;
20 code responsive to said user selection of said at least one selected item of
21 multimedia content to transmit payment data relating to payment for said at least one
22 selected item of multimedia content via said wireless interface for validation by a
23 payment validation system;
24 code to receive payment validation data via said wireless interface
25 defining if said payment validation system has validated payment for said at least one
26 selected item of multimedia content; and
27 code to control access to said at least one selected item of multimedia
28 content on said terminal responsive to said payment validation data,
29 wherein said user interface is operable to enable a user to select said at least one
30 item of multimedia content available from said non-volatile memory; and

31 wherein said user interface is operable to enable a user to access said at least one
32 selected item of multimedia content responsive to said code to control access permitting access
33 to said at least one selected item of multimedia content.

1 2. A handheld multimedia terminal as claimed in claim 1, wherein the code
2 to control access to said at least one selected item of multimedia content on said terminal
3 responsive to said payment validation data comprises code to modify use control data stored in
4 said non-volatile memory to enable access to said at least one selected item of multimedia
5 content.

1 3. A handheld multimedia terminal as claimed in claim 1, further comprising
2 code to request content cost data via said wireless interface for said identified one or more items
3 of multimedia content, and further comprising code to receive said requested content cost data
4 via said wireless interface for said identified one or more items of multimedia content.

1 4. A handheld multimedia terminal as claimed in claim 1, wherein said code
2 responsive to said user selection of said at least one selected item of multimedia content to
3 transmit payment data relating to payment for said at least one selected item of multimedia
4 content via said wireless interface for validation by a payment validation system comprises
5 transmitting said payment data to a data access service provider.

1 5. A handheld multimedia terminal as claimed in claim 1, further comprising
2 code to retrieve supplementary data via said wireless interface and output said supplementary
3 data to said user using said display.

1 6. A handheld multimedia terminal as claimed in claim 1, further
2 comprising:
3 code to read use status data and use rules from said non-volatile memory
4 pertaining to said at least one selected item of multimedia content; and
5 wherein said code to control access to said selected item of multimedia content
6 further comprises code to evaluate said use status data and said use rules to determine whether
7 access is permitted to said at least one selected item of multimedia content.

1 7. A handheld multimedia terminal as claimed in claim 1, wherein said at
2 least one selected items of multimedia content comprises additional multimedia content for
3 another stored item of multimedia content.

1 8. A data access terminal for controlling access to one or more content data
2 items stored on a data carrier, the data access terminal comprising:

3 a user interface;

4 a data carrier interface;

5 a program store storing code implementable by a processor; and

6 a processor coupled to the user interface, to the data carrier interface and to the

7 program store for implementing the stored code, the code comprising:

8 code to request identifier data identifying one or more content data items stored
9 on the data carrier;

10 code to receive said identifier data;

11 code to present to a user via said user interface said identified one or more content
12 data items available from the data carrier;

13 code to receive a user selection selecting at least one of said one or more of said
14 stored content data items;

15 code responsive to said user selection of said selected content data item to
16 transmit payment data relating to payment for said selected content item for validation by a
17 payment validation system;

18 code to receive payment validation data defining if said payment validation
19 system has validated payment for said content data item; and

20 code to control access to said selected content data item responsive to the
21 payment validation data.

1 9. A data access terminal as claimed in claim 8, wherein said data carrier is
2 integrated into the data access terminal, and wherein said data carrier comprises flash memory.

1 10. A data access terminal as claimed in claim 8, wherein said data access
2 terminal is integrated with a mobile communications device and audio/video player.

1 11. A data access terminal as claimed in claim 8, wherein said data access
2 terminal is integrated with a set top box.

1 12. A data access terminal as claimed in claim 8, wherein the content data
2 item comprises additional content data for another stored content data item.

1 13. A data access terminal as claimed in claim 12, wherein the additional
2 content data comprises a level on a game.

1 14. A handheld multimedia terminal, comprising:
2 a wireless interface configured to interface with a wireless network for
3 communicating with a data supplier;
4 non-volatile memory configured to store multimedia content, wherein said
5 multimedia content comprises one or more of music data, video data and computer game data;
6 a program store storing processor control code;
7 a processor coupled to said non-volatile memory, said program store, said
8 wireless interface and a user interface to allow a user to select and play said multimedia content;
9 a display for displaying one or both of said played multimedia content and data
10 relating to said played multimedia content;

11 wherein the processor control code comprises:
12 code to request identifier data identifying one or more items of multimedia
13 content available for retrieving via said wireless interface;
14 code to receive said identifier data via said wireless interface, said
15 identifier data identifying said one or more items of multimedia content available for
16 retrieving via said wireless interface;
17 code to request content information via said wireless interface, wherein
18 said content information comprises one or more of description data and cost data
19 pertaining to at least one of said one or more items of multimedia content identified by
20 said identifier data;
21 code to receive said content information via said wireless interface;
22 code to present said content information pertaining to said identified one
23 or more items of multimedia content available for retrieving to a user on said display;

24 code to receive a user selection selecting at least one of said one or more
25 items of multimedia content available for retrieving;
26 code responsive to said user selection of said selected at least one item of
27 multimedia content to transmit payment data relating to payment for said selected at least
28 one item of multimedia content via said wireless interface for validation by a payment
29 validation system;
30 code to receive payment validation data via said wireless interface
31 defining if said payment validation system has validated payment for said selected at
32 least one item of multimedia content; and
33 code responsive to said payment validation data to retrieve said selected at
34 least one item of multimedia content via said wireless interface from a data supplier and
35 to write said retrieved at least one item of multimedia content into said non-volatile
36 memory,
37 wherein said user interface is operable to enable a user to select said selected at
38 least one item of multimedia content available for retrieving.

1 15. A handheld multimedia terminal as claimed in claim 14, wherein said code
2 to request content information comprises code to request said content information from a content
3 access web server.

1 16. A handheld multimedia terminal as claimed in claim 14, wherein said code
2 to receive said content data item comprises code to retrieve said content data item from a content
3 provider.

1 17. A handheld multimedia terminal as claimed in claim 14, wherein said
2 identifier data is retrieved from a data supplier.

1 18. A handheld multimedia terminal as claimed in claim 14, further
2 comprising code to transmit at least a portion of said payment validation data to a data supplier
3 or to a destination received from said data supplier.

1 19. A data access terminal for retrieving a content data item from a data
2 supplier and providing the retrieved data item to a data carrier, the data access terminal
3 comprising:

4 a first interface for communicating with the data supplier;
5 a user interface;
6 a data carrier interface;
7 a program store storing code implementable by a processor; and
8 a processor coupled to the user interface, to the data carrier interface and to the
9 program store for implementing the stored code, the code comprising:
10 code to request identifier data identifying one or more content data items
11 available for retrieving;
12 code to receive said identifier data identifying said one or more content
13 data items available for retrieving;
14 code to request content information pertaining to at least one of said one
15 or more content data items identified by said identified data;
16 code to receive said content information;
17 code to present said content information to a user via said user interface
18 pertaining to said identified one or more content data items available for retrieving;
19 code to receive a user selection selecting at least one of said one or more
20 of said content data items available for retrieving;
21 code responsive to said user selection of said selected at least one content
22 data item to transmit payment data relating to payment for said selected at least one
23 content item for validation by a payment validation system;
24 code to receive payment validation data defining if said payment
25 validation system has validated payment for said selected at least one content data item;
26 and
27 code responsive to the payment validation data to retrieve said selected at
28 least one content data item from a data supplier and to write said retrieved at least one
29 content data item into said data carrier.

1 20. A data access terminal as claimed in claim 19, wherein said content
2 information comprises at least one of a content data item description and content cost data.

1 21. A data access terminal as claimed in claim 19, wherein said data carrier is
2 integrated into said data access terminal, and wherein said data carrier comprises flash memory.

1 22. A data access terminal as claimed in claim 19, wherein said data access
2 terminal is integrated with a mobile communications device and audio/video player.

1 23. A data access terminal as claimed in claim 19, wherein said data access
2 terminal is integrated with a set top box.

1 24. A data access terminal as claimed in claim 19, wherein the content data
2 item comprises one or more of music, films, TV programs, text, software, or games software.

1 25. A handheld multimedia terminal for retrieving and accessing protected
2 multimedia content, comprising:

3 a wireless interface configured to interface with a wireless network for
4 communicating with a data supplier;

5 non-volatile memory configured to store multimedia content, wherein said
6 multimedia content comprises one or more of music data, video data and computer game data;

7 a program store storing processor control code;

8 a processor coupled to said non-volatile memory, said program store, said
9 wireless interface and

10 a user interface to allow a user to select and play said multimedia content;

11 a display for displaying one or both of said played multimedia content and data
12 relating to said played multimedia content;

13 wherein the processor control code comprises:

14 code to request identifier data identifying one or more items of multimedia
15 content available for retrieving via said wireless interface;

16 code to receive said identifier data via said wireless interface, said
17 identifier data identifying said one or more items of multimedia content available for
18 retrieving via said wireless interface;

19 code to request content information via said wireless interface, wherein
20 said content information comprises one or more of description data and cost data
21 pertaining to at least one of said one or more items of multimedia content identified by
22 said identifier data;

23 code to receive said content information via said wireless interface;

24 code to present said content information pertaining to said identified one
25 or more items of multimedia content available for retrieving to a user on said display;
26 code to receive a first user selection selecting at least one of said one or
27 more items of multimedia content available for retrieving;
28 code responsive to said first user selection of said selected at least one
29 item of multimedia content to transmit payment data relating to payment for said selected
30 at least one item of multimedia content via said wireless interface for validation by a
31 payment validation system;
32 code to receive payment validation data via said wireless interface
33 defining if said payment validation system has validated payment for said selected at
34 least one item of multimedia content; and
35 code responsive to said payment validation data to retrieve said selected at
36 least one item of multimedia content via said wireless interface from a data supplier and
37 to write said retrieved at least one item of multimedia content into said non-volatile
38 memory,
39 code to receive a second user selection selecting one or more of said items
40 of retrieved multimedia content to access;
41 code to read use status data and use rules from said non-volatile memory
42 pertaining to said second selected one or more items of retrieved multimedia content; and
43 code to evaluate said use status data and use rules to determine whether
44 access is permitted to said second selected one or more items of retrieved multimedia
45 content,
46 wherein said user interface is operable to enable a user to make said first user
47 selection of said selected at least one item of multimedia content available for retrieving,
48 wherein said user interface is operable to enable a user to make said second user
49 selection of said one or more items of retrieved multimedia content available for accessing, and
50 wherein said user interface is operable to enable a user to access said second user
51 selection of said one or more item of retrieved multimedia content responsive to said code to
52 control access permitting access to said second selected one or more items of retrieved
53 multimedia content.

1 26. A handheld multimedia terminal as claimed in claim 25, further
2 comprising code to present said second selected one or more items of retrieved multimedia
3 content to a user via said display if access is permitted.

1 27. A handheld multimedia terminal as claimed in claim 25, wherein the rules
2 comprise one or more of purchase rules, rental rules and subscription rules for said second
3 selected one or more items of retrieved multimedia content.

1 28. A handheld multimedia terminal as claimed in claim 25, further
2 comprising code to write updated use status data to said non volatile memory after user access to
3 the second selected one or more items of retrieved multimedia content.

1 29. A handheld multimedia as claimed in claim 28, further comprising code to
2 write partial use status data to said non volatile memory when only part of one of said second
3 selected one or more items of retrieved multimedia content has been accessed.

1 30. A data access terminal for controlling access to one or more content data
2 items stored on a data carrier, the data access terminal comprising:

- 3 a user interface;
- 4 a data carrier interface;
- 5 a program store storing code implementable by a processor; and
- 6 a processor coupled to the user interface, to the data carrier interface and to the
- 7 program store for implementing the stored code, the code comprising:
 - 8 code to request identifier data identifying one or more content data
 - 9 items available for retrieving;
 - 10 code to receive said identifier data identifying said one or more
 - 11 content data items available for retrieving;
 - 12 code to request content information pertaining to at least one of
 - 13 said one or more content data items identified by said identified data;
 - 14 code to receive said content information;
 - 15 code to present said content information to a user via said user
 - 16 interface pertaining to said identified one or more content data items available for
 - 17 retrieving;

18 code to receive a first user selection selecting at least one of said
19 one or more of said content data items available for retrieving;
20 code responsive to said first user selection of said selected at least
21 one content data item to transmit payment data relating to payment for said
22 selected at least one content item for validation by a payment validation system;
23 code to receive payment validation data defining if said payment
24 validation system has validated payment for said selected at least one content data
25 item;
26 code responsive to the payment validation data to retrieve said
27 selected at least one content data item from a data supplier and to write said
28 retrieved at least one content data item into said data carrier;
29 code to receive a second user selection selecting one of said one or
30 more of said retrieved content data items to access;
31 code to read use status data and use rules from said data carrier
32 pertaining to said second selected one or more retrieved content data items; and
33 code to evaluate said use status data and use rules to determine
34 whether access is permitted to said second selected one or more retrieved content
35 data items.

1 31. A data access terminal as claimed in claim 30, wherein said data carrier is
2 integrated into said data access terminal, and wherein said data carrier comprises flash memory.

1 32. A data access terminal as claimed in claim 30, wherein said data access
2 terminal is integrated with a mobile communications device and audio/video player.

1 33. A data access terminal as claimed in claim 30, wherein said data access
2 terminal is integrated with a set top box.

1 34. A data access terminal as claimed in claim 30, wherein the content data
2 item comprises one or more of music, films, TV programs, text, software, or games software.

1 35. A data access terminal for retrieving data from a data supplier and
2 providing the retrieved data to a data carrier, the terminal comprising:

3 a first interface for communicating with the data supplier;

4 a data carrier interface for interfacing with the data carrier;
5 a program store storing code; and
6 a processor coupled to the first interface, the data carrier interface, and the
7 program store for implementing the stored code,
8 the code comprising:
9 code to read payment data from the data carrier and to forward the
10 payment data to a payment validation system;
11 code to receive payment validation data from the payment validation
12 system;
13 code responsive to the payment validation data to retrieve data from the
14 data supplier and to write the retrieved data into the data carrier;
15 code responsive to the payment validation data to receive at least one
16 access rule from the data supplier and to write the at least one access rule into the data
17 carrier, the at least one access rule specifying at least one condition for accessing the
18 retrieved data written into the data carrier, the at least one condition being dependent
19 upon the amount of payment associated with the payment data forwarded to the payment
20 validation system;
21 code to retrieve from the data supplier and output to a user stored data
22 identifier data and associated value data and use rule data for a data item available from
23 the data supplier; and
24 code to write use rule data for a data item into the data carrier with the
25 associated data item,
26 wherein the data access terminal is integrated with a mobile
27 communication device, a personal computer, an audio/video player, and/or a set top box.

1 36. A data access device for retrieving stored data from a data carrier, the
2 device comprising:
3 a user interface;
4 a data carrier interface;
5 a program store storing code implementable by a processor; and
6 a processor coupled to the user interface, to the data carrier interface and to the
7 program store for implementing the stored code,
8 the code comprising:

9 code to retrieve use status data indicating a use status of data stored on the
10 carrier, and use rules data indicating permissible use of data stored on the carrier;
11 code to evaluate the use status data using the use rules data to determine
12 whether access is permitted to the stored data;
13 code to access the stored data when access is permitted; and
14 code to write partial use status data to the data carrier when only part of a
15 stored data item has been accessed,
16 wherein the data access terminal is integrated with a mobile communication
17 device, a personal computer, an audio/video player, and/or a set top box.

1 37. A portable data carrier, comprising:
2 an interface for reading and writing data from and to the carrier;
3 non-volatile data memory, coupled to the interface, for storing data on the carrier;
4 non-volatile payment data memory, coupled to the interface, for providing
5 payment
6 data to an external device; and
7 non-volatile communications parameter memory for storing data for accessing a
8 communications network to receive data from the communications network for storage in the
9 data memory.

1 38. A portable data carrier, comprising:
2 an interface for reading and writing data from and to the carrier;
3 non-volatile data memory, coupled to the interface, for storing data on the carrier;
4 and
5 non-volatile payment data memory, coupled to the interface, for providing
6 payment data to an external device,
7 wherein the data memory is partitioned for access on a block-by-block basis, each
8 block comprising a plurality of data bytes read or written as a set.

1 39. A portable data carrier, comprising:
2 an interface for reading and writing data from and to the carrier;
3 non-volatile data memory, coupled to the interface, for storing data on the carrier;
4 and

5 non-volatile payment data memory, coupled to the interface, for providing
6 payment data to an external device,
7 wherein said data memory has a capacity of greater than 1 MByte, more
8 preferably greater than 100 Mbytes, and most preferably greater than 1GByte.

ABSTRACT OF THE DISCLOSURE

Data storage and access systems enable downloading and paying for data such as audio and video data, text, software, games and other types of data. A portable data carrier has an interface for sending and receiving data, data memory for storing received content data, and payment validation memory for providing payment validation data to an external device. The carrier may also store a record of access made to the stored content, and content use rules for controlling access to the stored content. Embodiments store further access control data and supplementary data such as hot links to web sites and/or advertising data. A complementary data access terminal, data supply computer system, and data access device are also described. The combination of payment data and stored content data and use rule data helps reduce the risk of unauthorized access to data such as compressed music and video data, especially over the Internet.

63664751 v1

Fig. 1

A

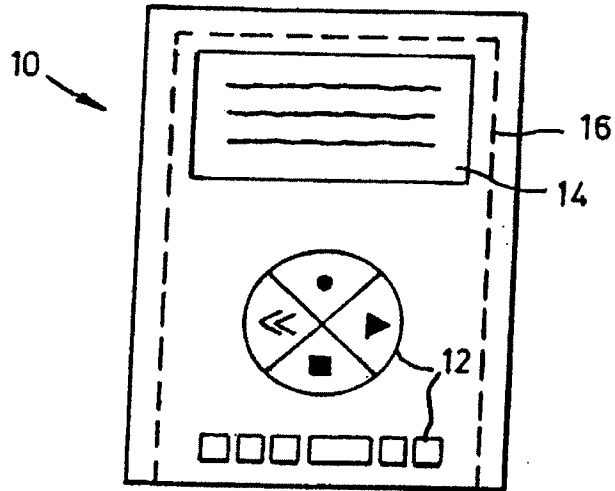

B

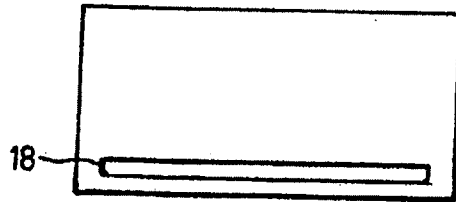

C

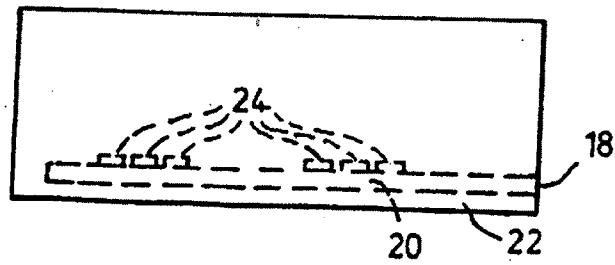

Fig. 2

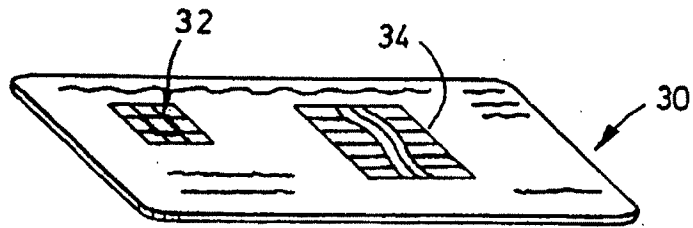

Fig. 3

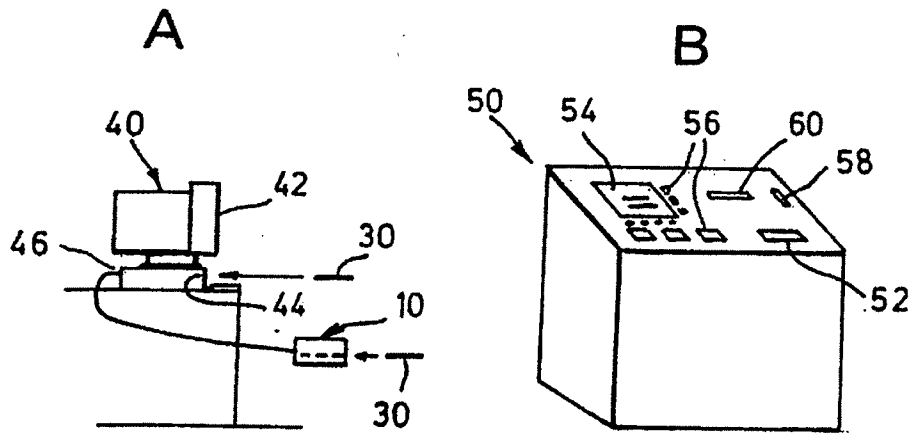
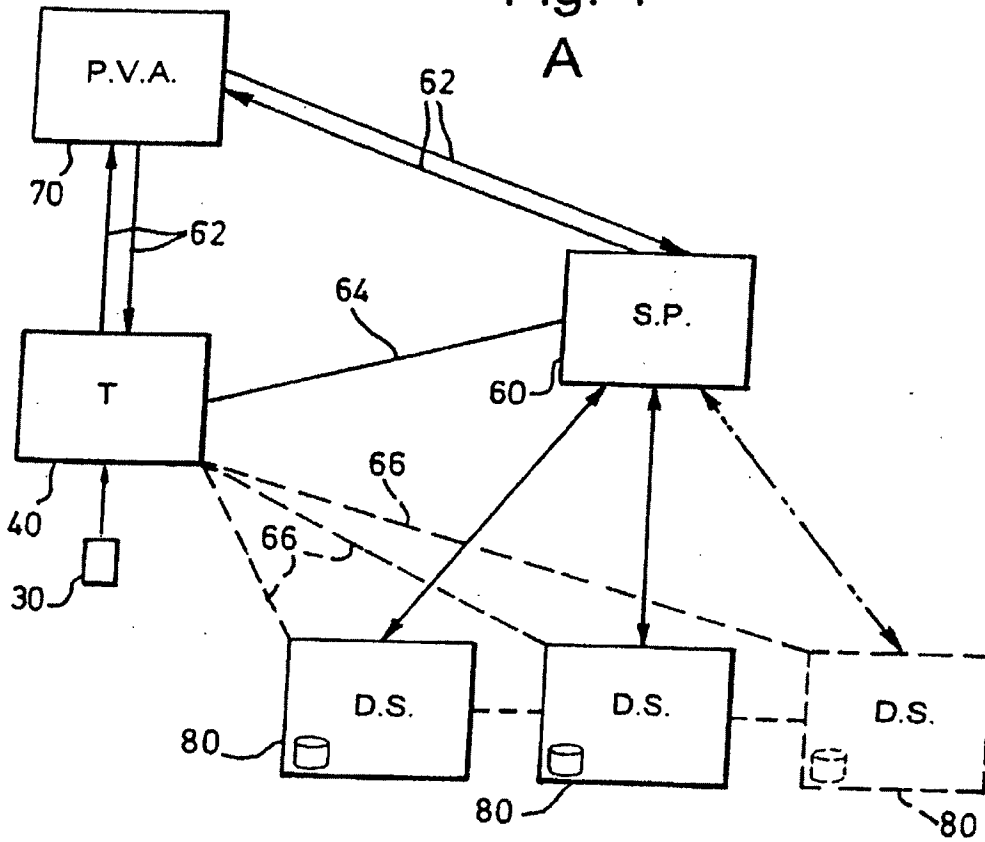
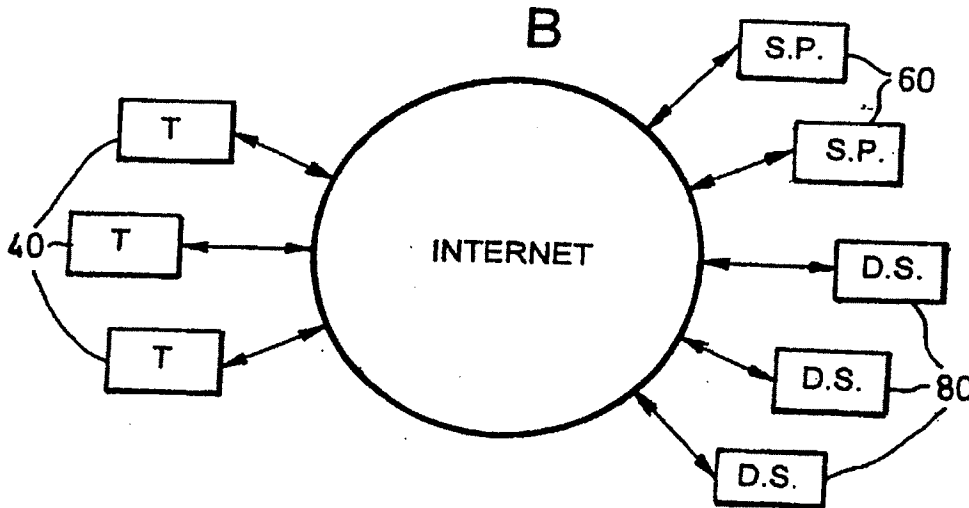

Fig. 4
A



B



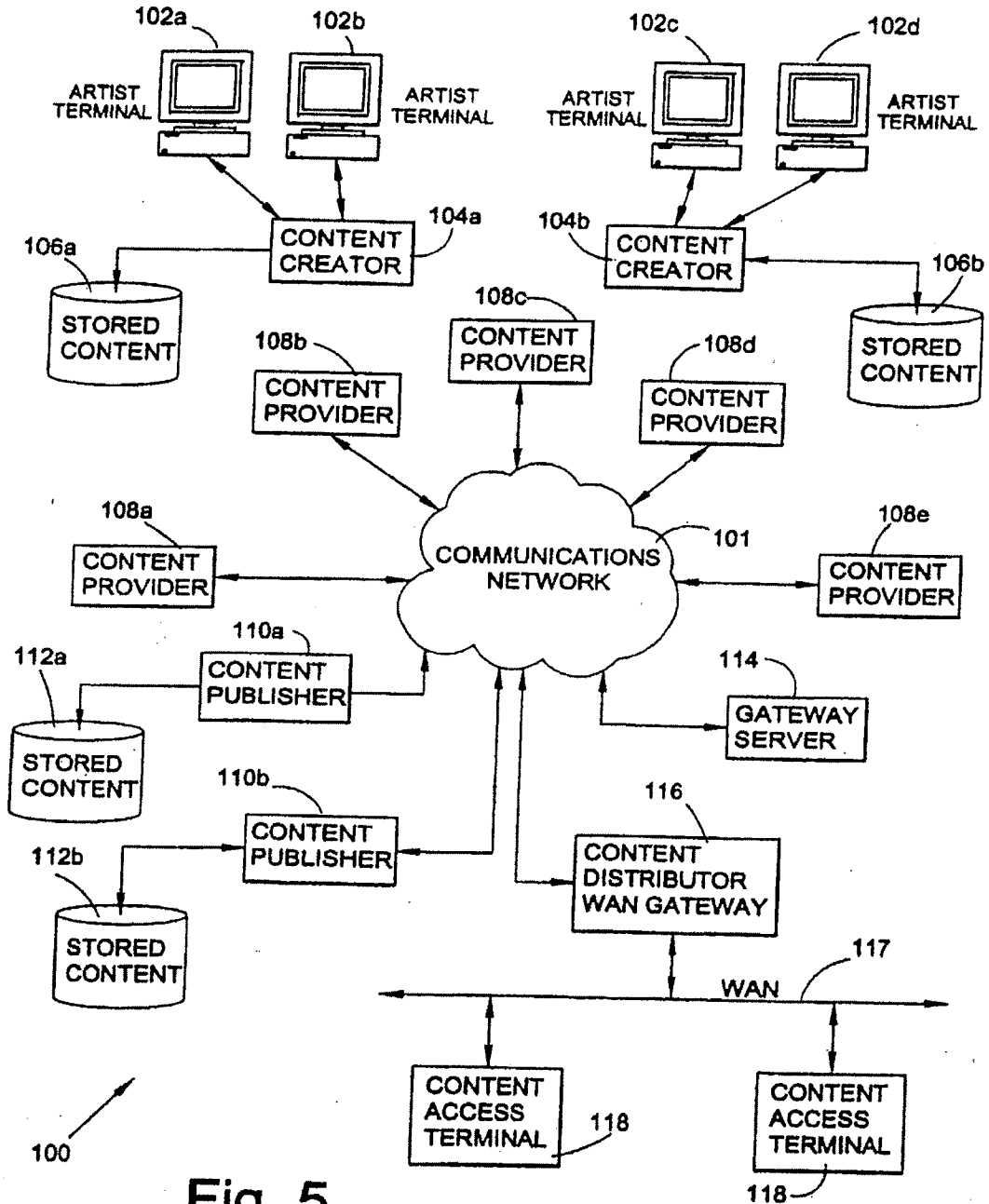

Fig. 5

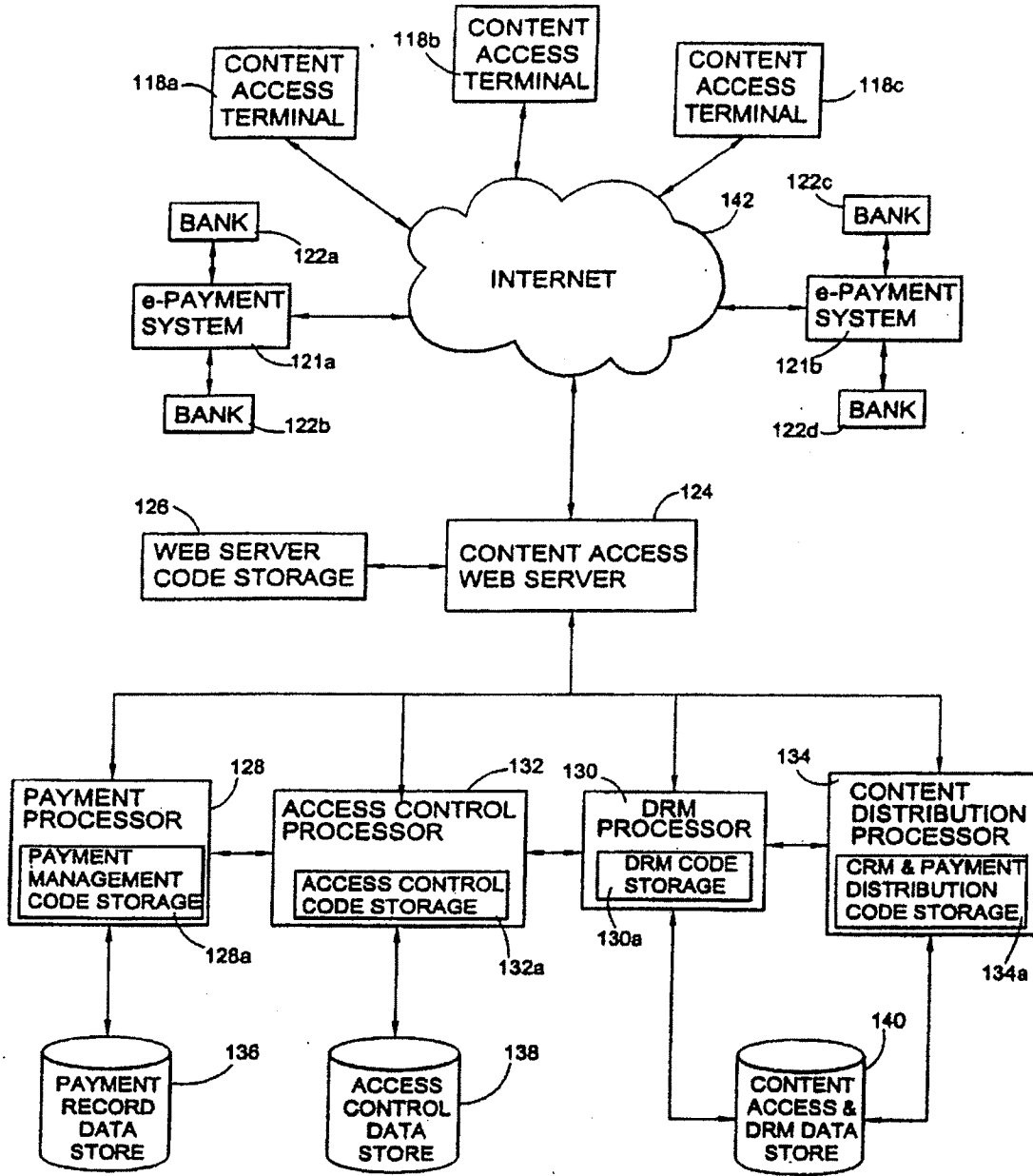

Fig.6

120

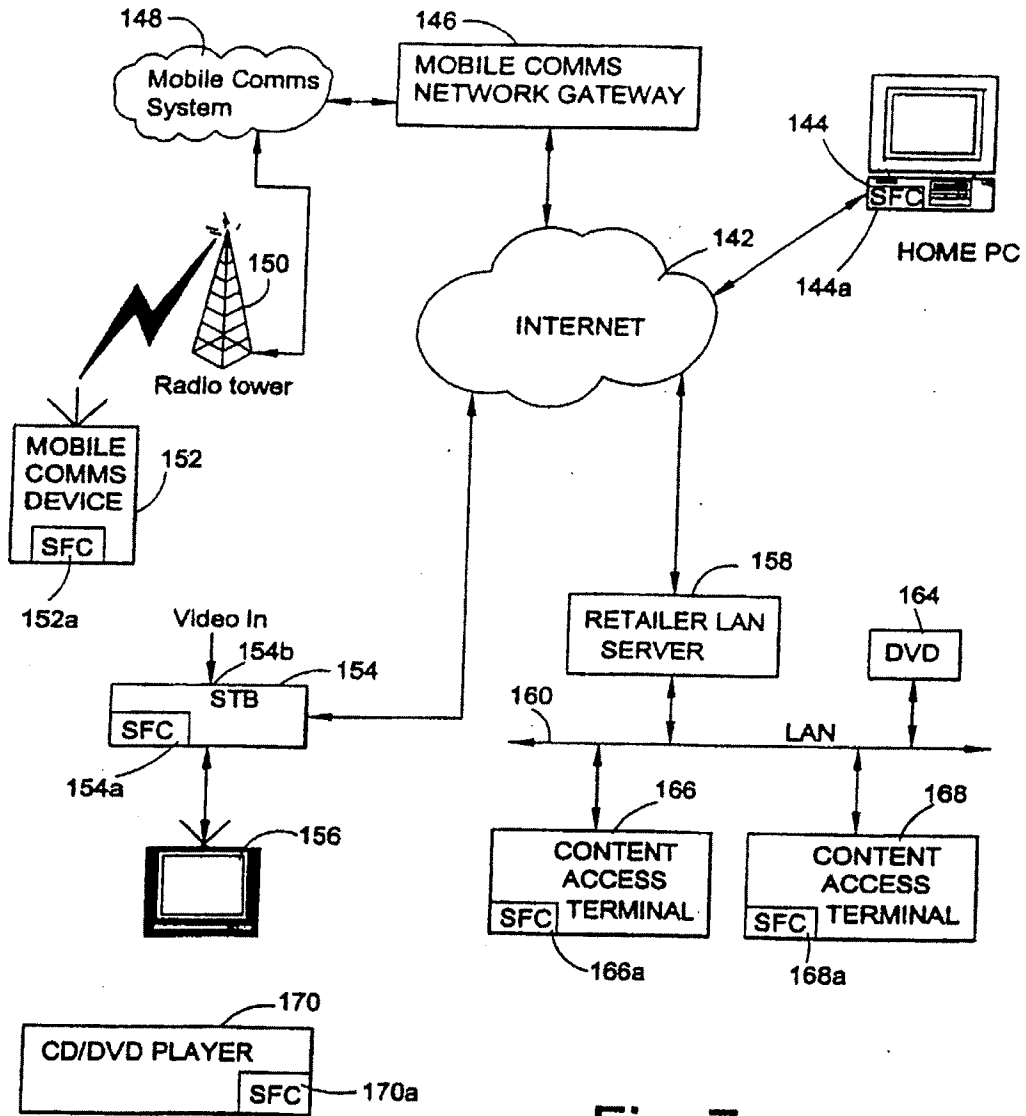

Fig. 7

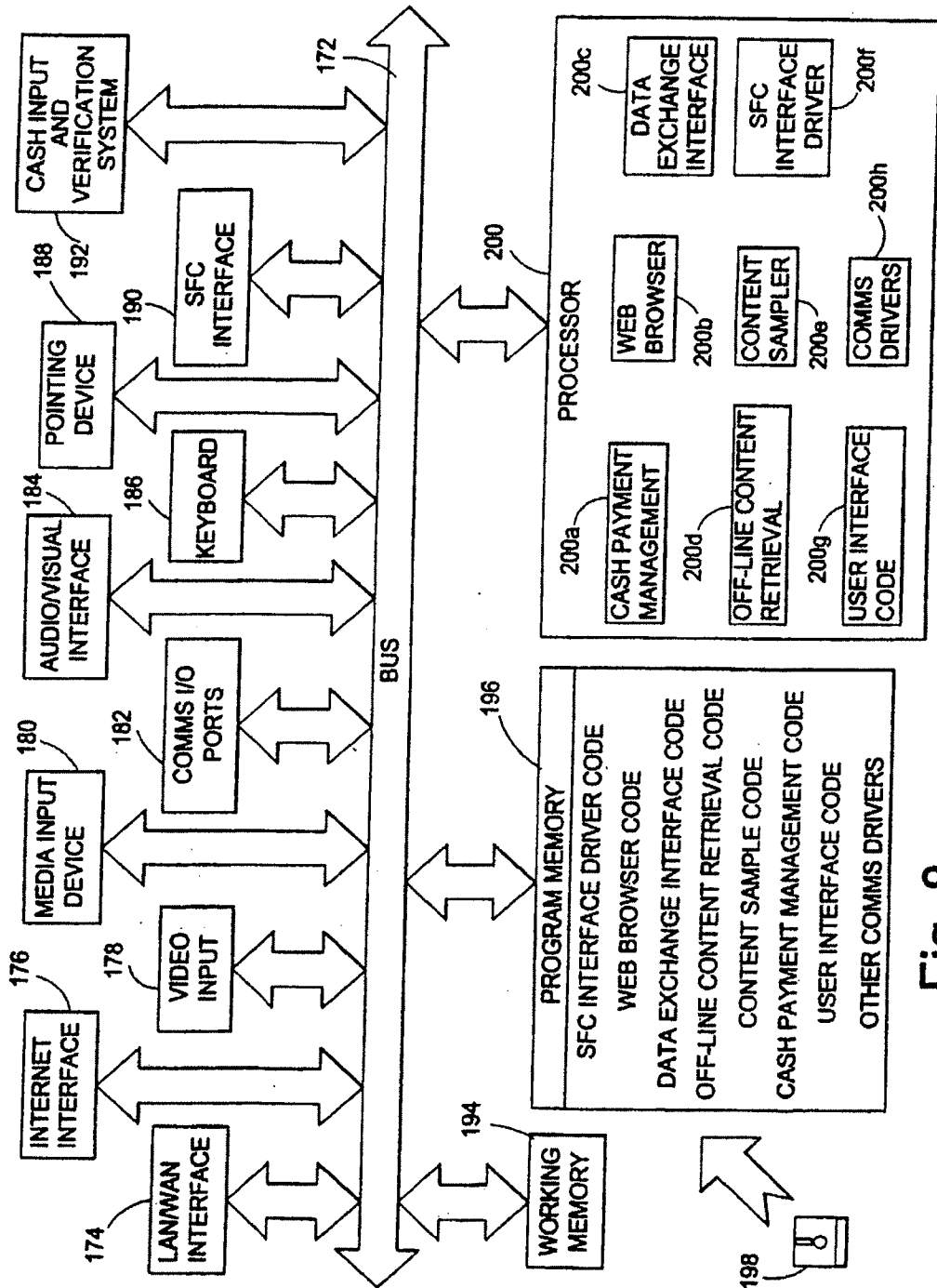

Fig. 8

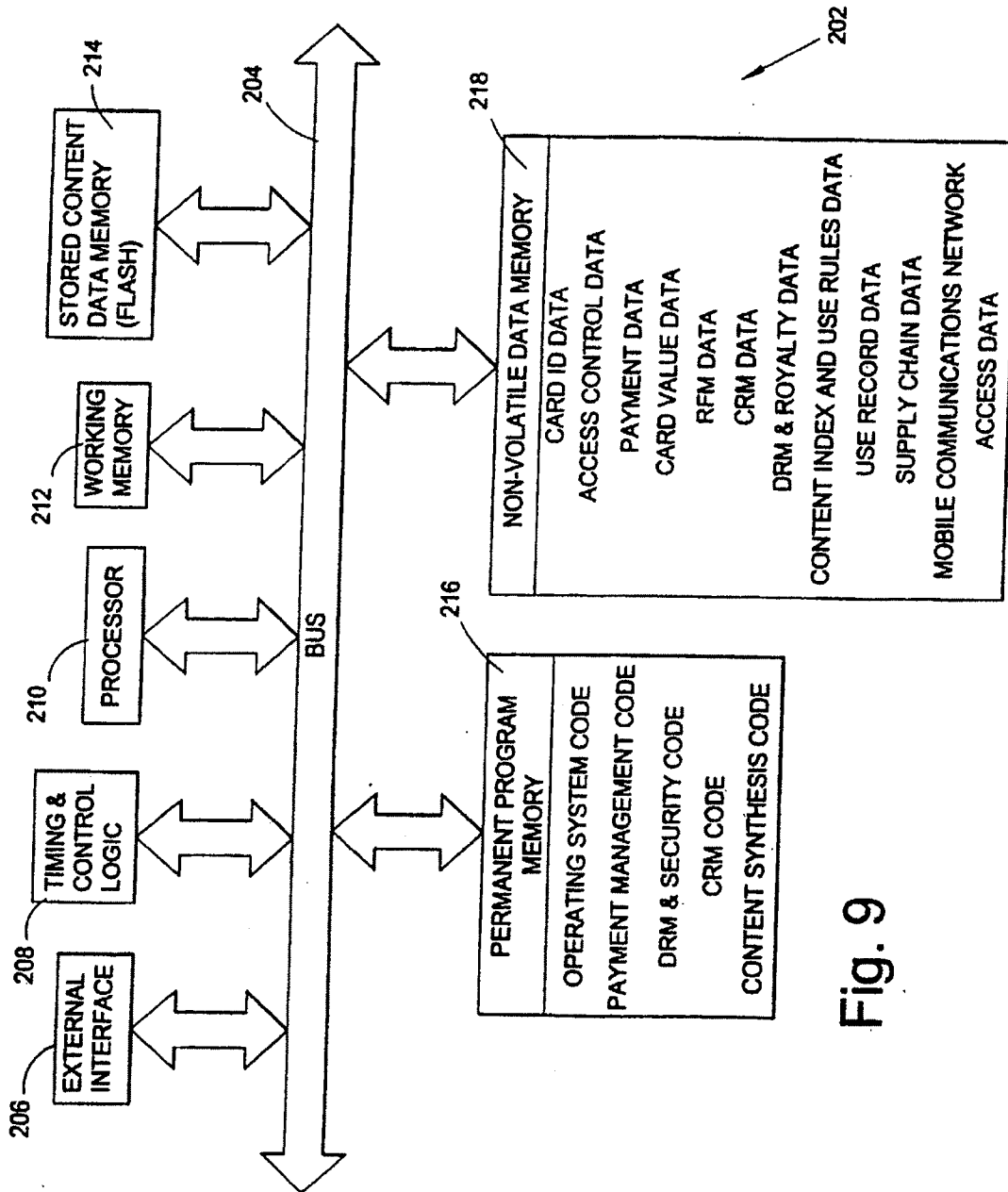

Fig. 9

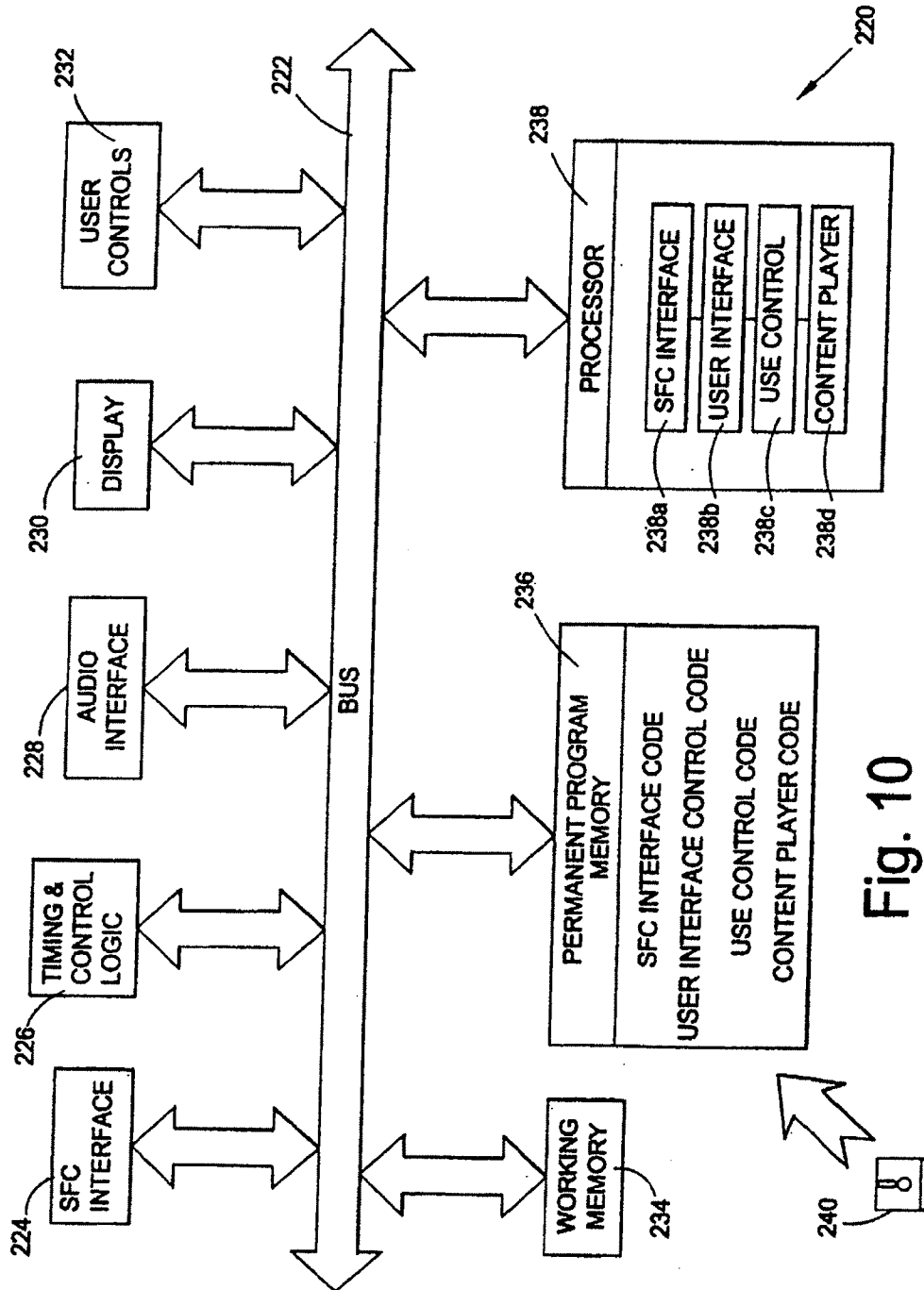

Fig. 10

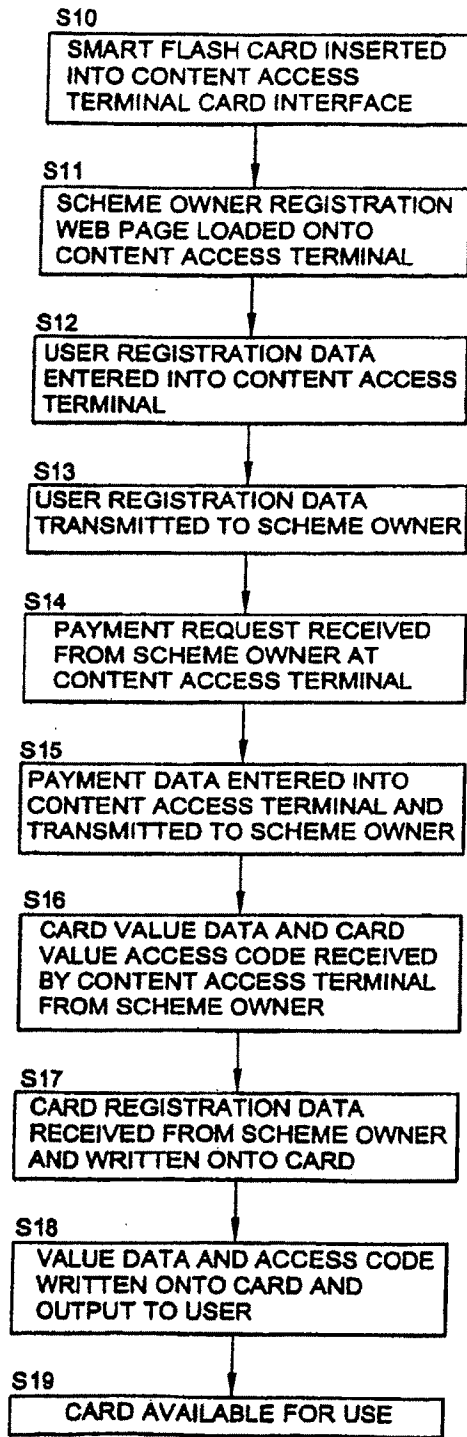

Fig 11a

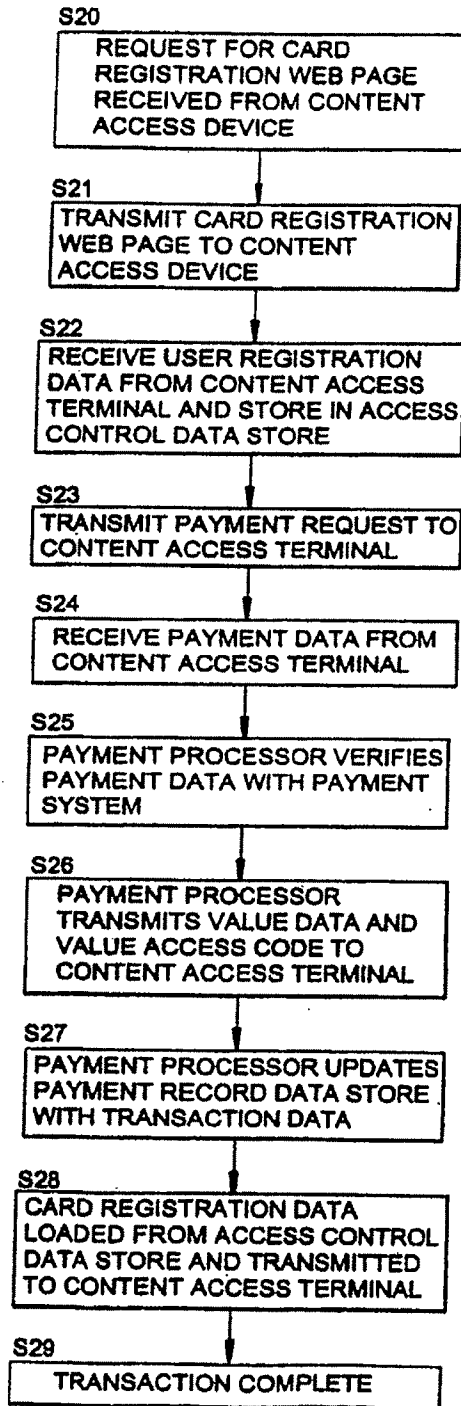

Fig.11b

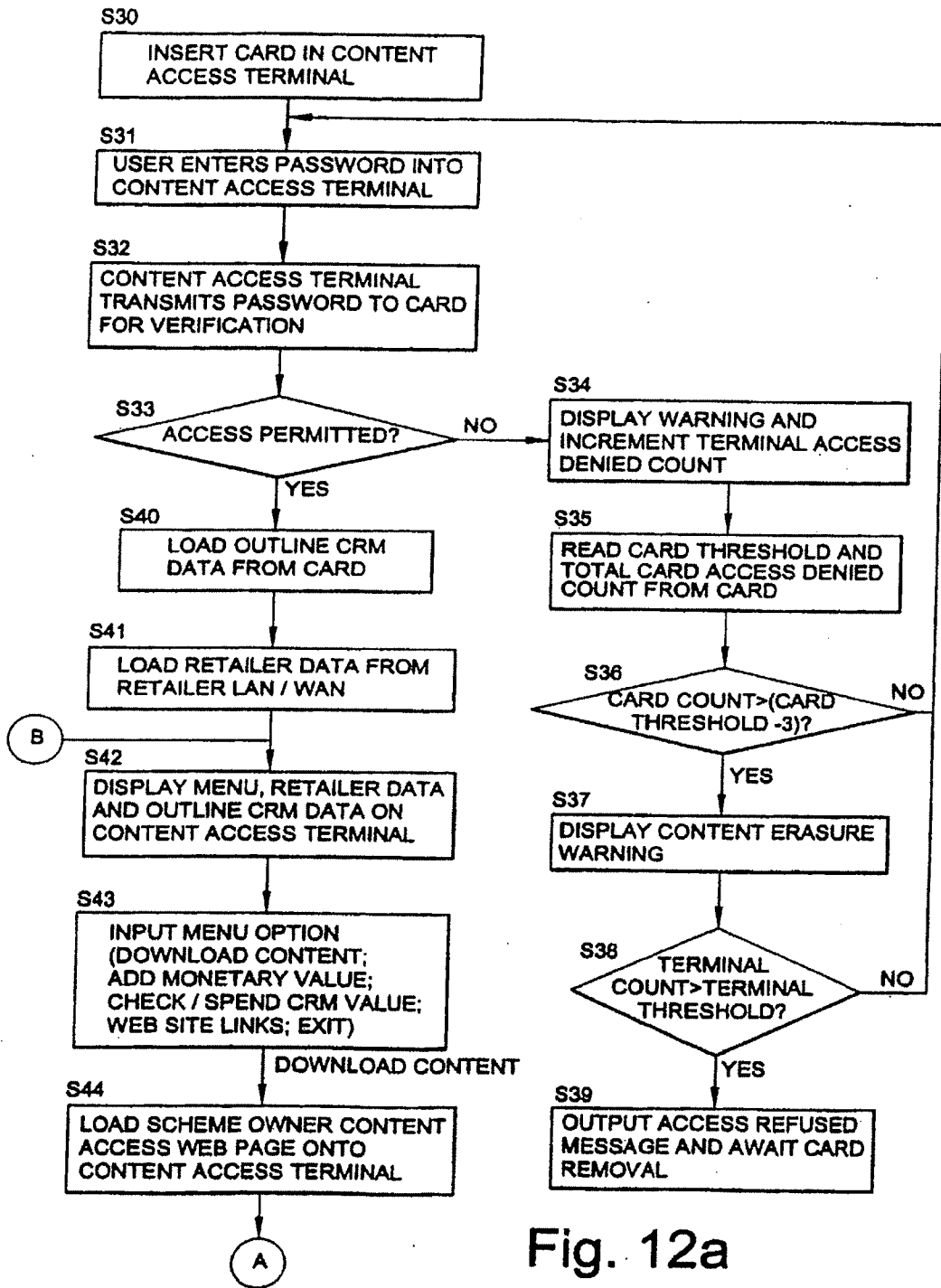
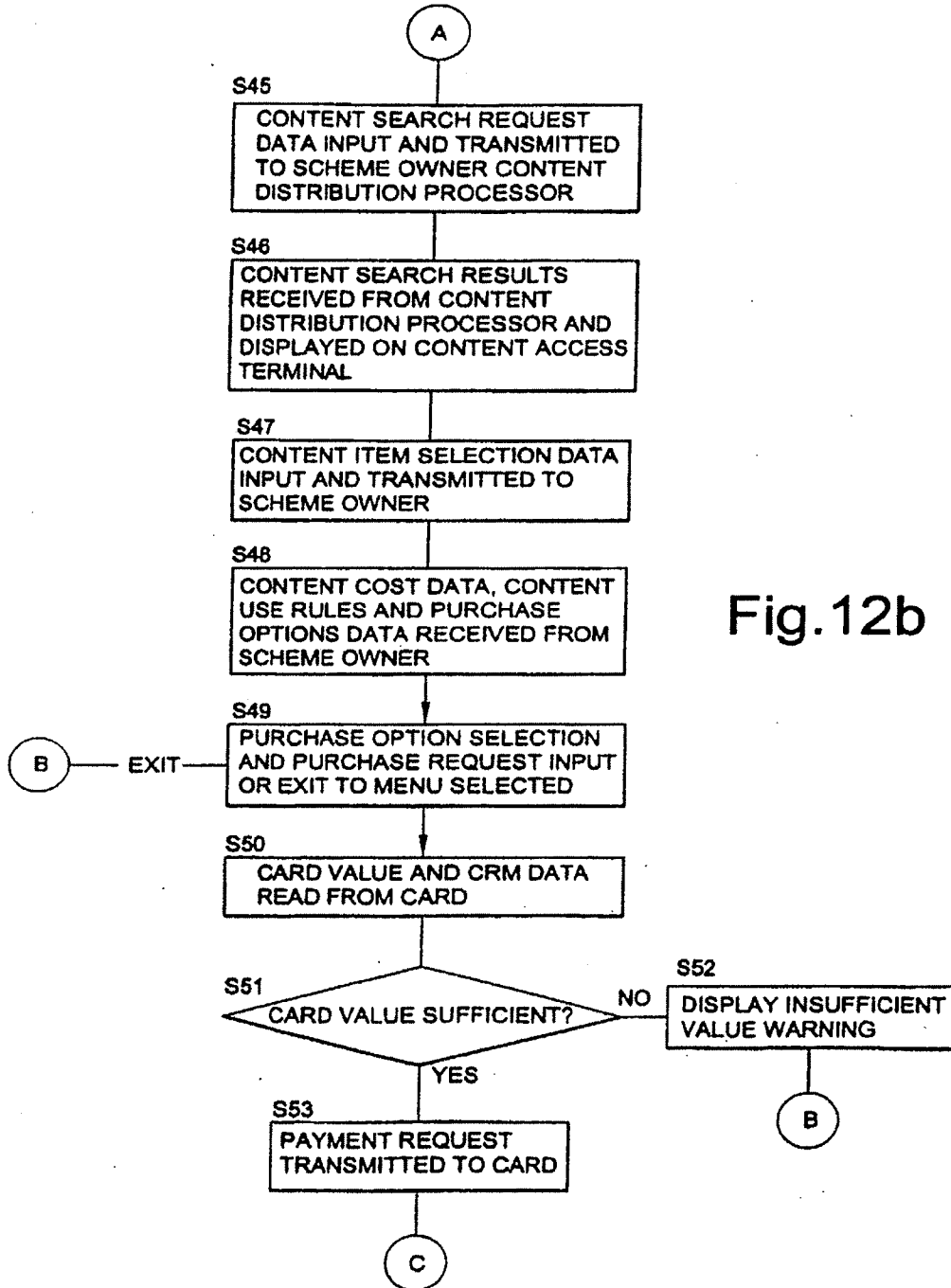

Fig. 12a



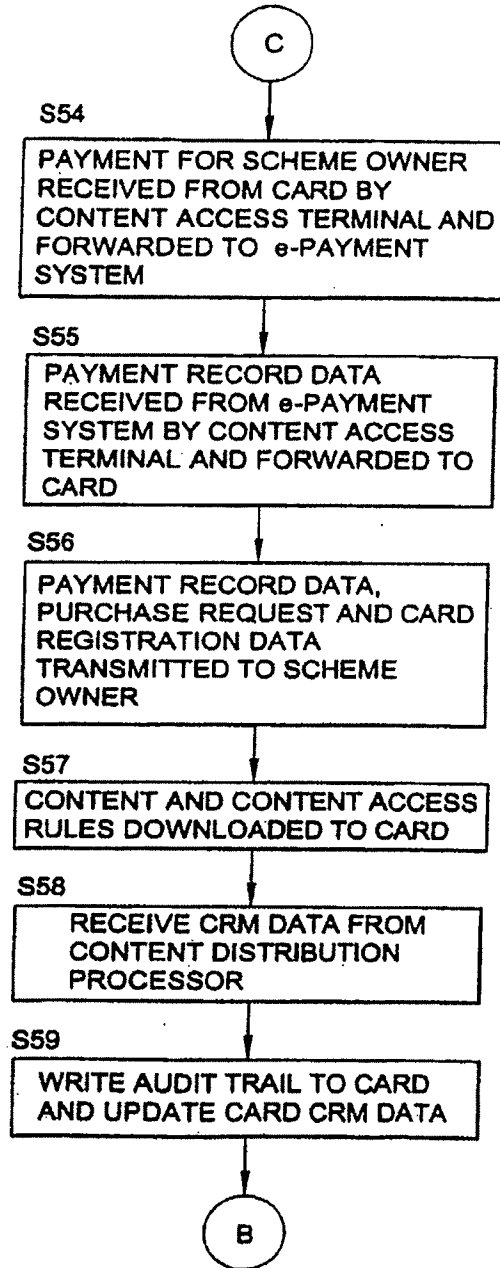

Fig.12c

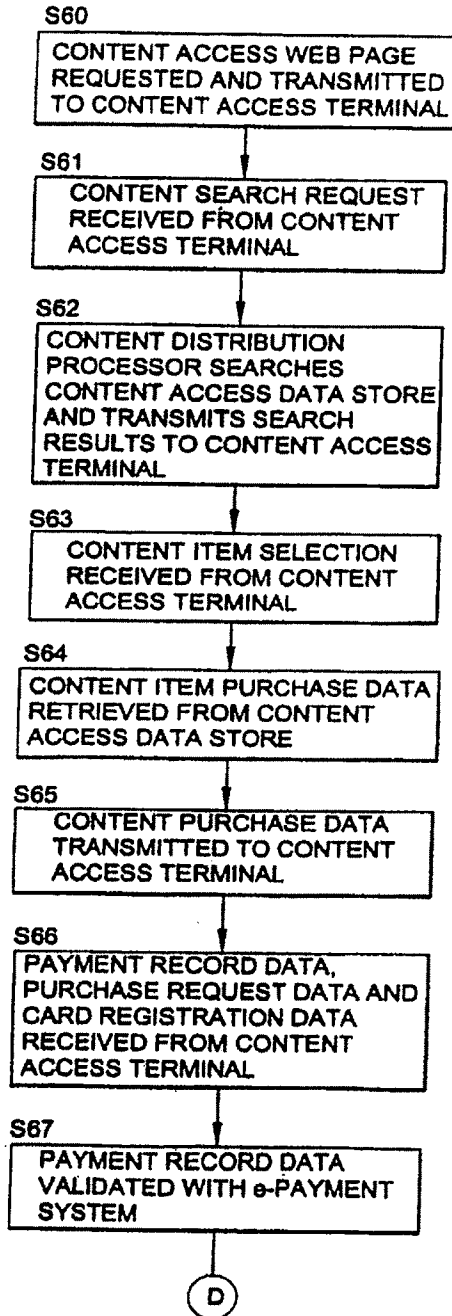

Fig. 12d

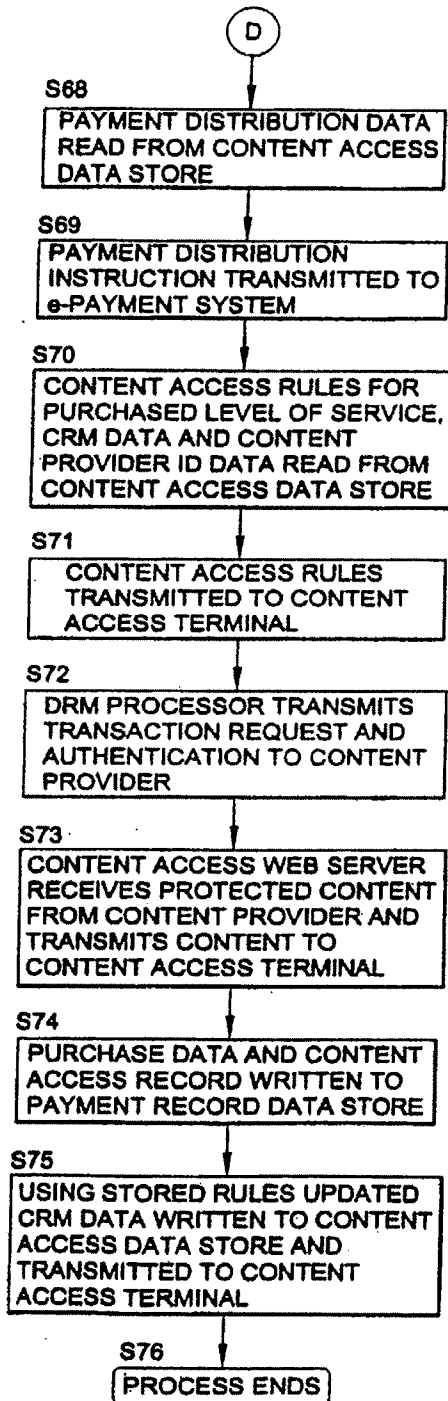

Fig. 12e

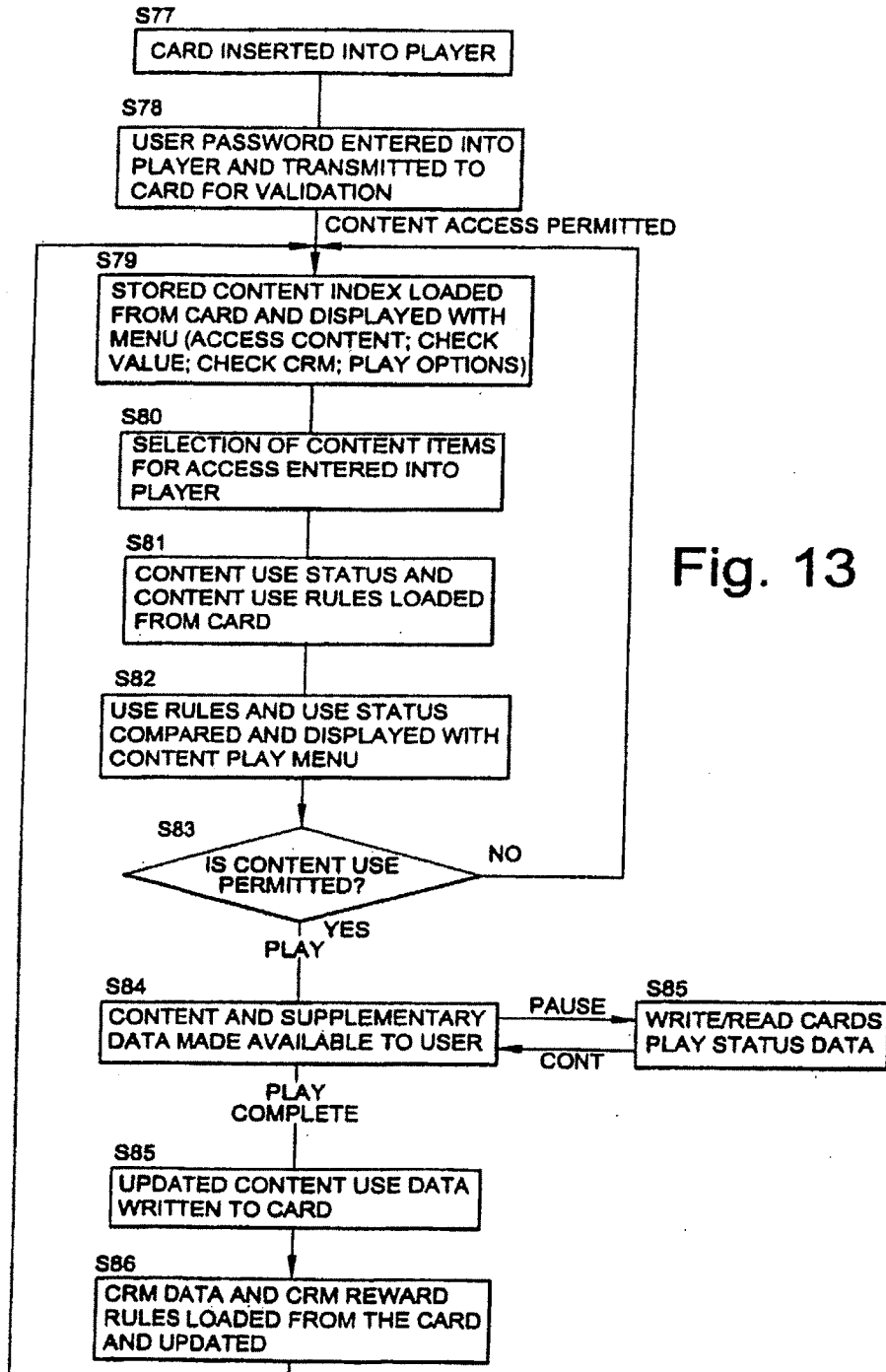

Fig. 13

Under the Paperwork Reduction Act of 1995, no persons are required to respond to a collection of information unless it contains a valid OMB control number.

DECLARATION FOR UTILITY OR DESIGN PATENT APPLICATION (37 CFR 1.63)	Attorney Docket Number	080379-000000US
	First Named Inventor	HULST, Hermen-ard
	COMPLETE IF KNOWN	
	Application Number	10/111,716
	Filing Date	October 25, 2000
	Art Unit	
<input type="checkbox"/> Declaration Submitted With Initial Filing		<input checked="" type="checkbox"/> Declaration Submitted after Initial Filing (surcharge (37 CFR 1.16(e)) required)
OR		
Examiner Name		

As the below named inventor, I hereby declare that:

My residence, mailing address, and citizenship are as stated below next to my name.

I believe I am the original and first inventor of the subject matter which is claimed and for which a patent is sought on the invention entitled:

DATA STORAGE AND ACCESS SYSTEMS

(Title of the Invention)

the specification of which

is attached hereto

OR

was filed on (MM/DD/YYYY) 10/25/00 as United States Application Number or PCT International

Application Number 10/111,716 and was amended on (MM/DD/YYYY) (if applicable).

I hereby state that I have reviewed and understand the contents of the above identified specification, including the claims, as amended by any amendment specifically referred to above.

I acknowledge the duty to disclose information which is material to patentability as defined in 37 CFR 1.56, including for continuation-in-part applications, material information which became available between the filing date of the prior application and the national or PCT international filing date of the continuation-in-part application.

I hereby claim foreign priority benefits under 35 U.S.C. 119(a)-(d) or (f), or 365(b) of any foreign application(s) for patent, inventor's or plant breeder's rights certificate(s), or 365(a) of any PCT international application which designated at least one country other than the United States of America, listed below and have also identified below, by checking the box, any foreign application for patent, inventor's or plant breeder's rights certificate(s), or of any PCT international application having a filing date before that of the application on which priority is claimed.

Prior Foreign Application Number(s)	Country	Foreign Filing Date (MM/DD/YYYY)	Priority Not Claimed	Certified Copy Attached?	
				YES	NO
9925227.2	Great Britain	10/25/1999	<input type="checkbox"/>	<input type="checkbox"/>	<input checked="" type="checkbox"/>
			<input type="checkbox"/>	<input type="checkbox"/>	<input type="checkbox"/>
			<input type="checkbox"/>	<input type="checkbox"/>	<input type="checkbox"/>
			<input type="checkbox"/>	<input type="checkbox"/>	<input type="checkbox"/>

Additional foreign application numbers are listed on a supplemental priority data sheet PTO/SB/02B attached hereto:

[Page 1 of 2]

Burden Hour Statement: This form is estimated to take 21 minutes to complete. Time will vary depending upon the needs of the individual case. Any comments on the amount of time you are required to complete this form should be sent to the Chief Information Officer, U.S. Patent and Trademark Office, Washington, DC 20231. DO NOT SEND FEES OR COMPLETED FORMS TO THIS ADDRESS. SEND TO: Assistant Commissioner for Patents, Washington, DC 20231.

Under the Paperwork Reduction Act of 1995, no persons are required to respond to a collection of information unless it contains a valid OMB control number.

DECLARATION — Utility or Design Patent Application

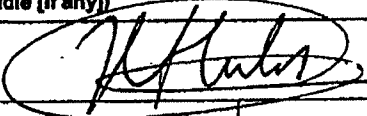
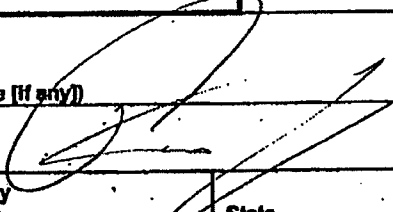
Direct all correspondence to: <input checked="" type="checkbox"/> Customer Number or Bar Code Label		20350	OR	<input type="checkbox"/> Correspondence address below
Name				
Address				
City		State		ZIP
Country		Telephone		Fax
I hereby declare that all statements made herein of my own knowledge are true and that all statements made on information and belief are believed to be true; and further that these statements were made with the knowledge that willful false statements and the like so made are punishable by fine or imprisonment, or both, under 18 U.S.C. 1001 and that such willful false statements may jeopardize the validity of the application or any patent issued thereon.				
NAME OF SOLE OR FIRST INVENTOR:		<input type="checkbox"/> A petition has been filed for this unsigned inventor		
Hermen-ard Given Name (first and middle [if any])		HULST Family Name or Surname		
 Inventor's Signature				Date June 12 th 2002
Amsterdam Residence: City	State	Netherlands Country	Dutch Citizenship	
Van Tuyll van Serooskerkenweg 75h ^s Mailing Address				
Amsterdam City	State	1076 JG ZIP	Netherlands Country	
NAME OF SECOND INVENTOR:		<input type="checkbox"/> A petition has been filed for this unsigned inventor		
Patrick Sandor Given Name (first and middle [if any])		RACZ Family Name or Surname		
 Inventor's Signature				Date 12/5/02
St. Heller, Jersey Residence: City	State	Great Britain Country	GB Citizenship	
19 Royal Square Mailing Address				
St. Heller, Jersey City	State	JE1 4WA ZIP	Great Britain Country	
<input type="checkbox"/> Additional inventors are being named on the _____ supplemental Additional Inventor(s) sheet(s) PTO/SB/02A attached hereto.				

[Page 2 of 2]

SF 1340208 v1

Application Data Sheet

Application Information

Application number::	Unassigned
Filing Date::	Herewith
Application Type::	Regular
Title::	DATA STORAGE AND ACCESS SYSTEMS
Attorney Docket Number::	87790-818158 (000150US)
Request for Early Publication::	No
Request for Non-Publication::	No
Suggested Drawing Figure::	
Total Drawing Sheets::	17
Small Entity?::	Yes
Petition included?::	No
Secrecy Order in Parent Appl.::	No

Applicant Information

Applicant Authority Type::	Inventor
Primary Citizenship Country::	United Kingdom
Status::	Full Capacity
Given Name::	Patrick
Middle Name::	
Family Name::	RACZ
Name Suffix::	
City of Residence::	Saint Heller
State or Province of Residence::	
Country of Residence::	Jersey
Street of Mailing Address::	19 Royal Street
City of Mailing Address::	Saint Heller
State or Province of mailing address::	

Country of mailing address:: Jersey
Postal or Zip Code of mailing address:: JE1 4WA

Applicant Authority Type:: Inventor
Primary Citizenship Country:: Netherlands
Status:: Full Capacity
Given Name:: Hermen-ard
Middle Name::
Family Name:: HULST
Name Suffix::

City of Residence:: Amsterdam
State or Province of Residence::
Country of Residence:: Netherlands
Street of Mailing Address:: Van Tuyll van Serooskerweg 75hs
City of Mailing Address:: Amsterdam
State or Province of mailing address::
Country of mailing address:: Netherlands
Postal or Zip Code of mailing address:: 1076 JG

Correspondence Information

Correspondence Customer Number:: 20350

Representative Information

Representative Customer Number:: 20350

Domestic Priority Information

Application::	Continuity Type::	Parent Application::	Parent Filing Date::
This Application	Continuation of	12/943,872	11/10/10
12/943,872	Continuation of	12/014,558	01/15/08
12/014,558	Continuation of	11/336,758	01/19/06
11/336,758	Continuation of	10/111,716	09/17/02

Foreign Priority Information

Country::	Application number::	Filing Date::
PCT	GB00104110	10/25/00
United Kingdom	9925227.2	10/25/99

Assignee Information

Assignee Name:: Smartflash Technologies Limited
Street of mailing address:: 1070908 Palm Grove House, P.O. Box 438
City of mailing address:: Wickhams' Cay, Road Town
State or Province of mailing address:: Tortola
Country of mailing address:: British Virgin Islands
Postal or Zip Code of mailing address::

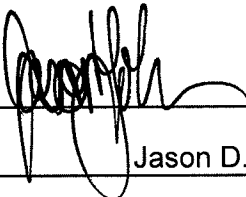
Submitted by: 
Signature _____ Date 08/17/2011
Printed Name Jason D. Lohr Registration Number 48,163

POWER OF ATTORNEY TO PROSECUTE APPLICATIONS BEFORE THE USPTO

I hereby revoke all previous powers of attorney given in the application identified in the attached statement under 37 CFR 3.73(b).

I hereby appoint:

Practitioners associated with the Customer Number: 20350

OR

Practitioner(s) named below (if more than ten patent practitioners are to be named, then a customer number must be used):

Name	Registration Number	Name	Registration Number

as attorney(s) or agent(s) to represent the undersigned before the United States Patent and Trademark Office (USPTO) in connection with any and all patent applications assigned only to the undersigned according to the USPTO assignment records or assignment documents attached to this form in accordance with 37 CFR 3.73(b). I further authorize any of the above-identified practitioners to execute a Statement Under 37 CFR 3.73(b) on the undersigned's behalf to certify the chain of title and establish the undersigned's ownership in any and all patent applications in which rights have been assigned to the undersigned.

Please change the correspondence address for the application identified in the attached statement under 37 CFR 3.73(b) to:

The address associated with Customer Number: 20350

OR

<input type="checkbox"/> Firm or Individual Name			
Address			
City	State	Zip	
Country			
Telephone	Email		

Assignee Name and Address:

Smartflash Technologies Limited
1070908 Palm Grove House, P.O. Box 438
Wickhams' Cay, Road Town
Tortola
British Virgin Islands

A copy of this form, together with a statement under 37 CFR 3.73(b) (Form PTO/SB/96 or equivalent) is required to be filed in each application in which this form is used. The statement under 37 CFR 3.73(b) may be completed by one of the practitioners appointed in this form if the appointed practitioner is authorized to act on behalf of the assignee, and must identify the application in which this Power of Attorney is to be filed.

SIGNATURE of Assignee of Record

The individual whose signature and title is supplied below is authorized to act on behalf of the assignee

Signature		Date	19.01.2011
Name	MAURICE EMERY JEAN MAURICE EMERY	Telephone	+41 32 723 2500
Title	a director a director		

63097047 v1

For and on behalf of Kestrel S.A.,
acting in its capacity as corporate director
of Smartflash Technologies Ltd

Under the Paperwork Reduction Act of 1995, no persons are required to respond to a collection of information unless it displays a valid OMB control number.

STATEMENT UNDER 37 CFR 3.73(b)

Applicant/Patent Owner: Smartflash Technologies Limited

Application No./Patent No.: _____ Filed/Issue Date: Herewith

Titled: DATA STORAGE AND ACCESS SYSTEMS

Smartflash Technologies Limited, a corporation

(Name of Assignee) (Type of Assignee, e.g., corporation, partnership, university, government agency, etc.)

states that it is:

- 1. the assignee of the entire right, title, and interest in;
- 2. an assignee of less than the entire right, title, and interest in (The extent (by percentage) of its ownership interest is _____ %); or
- 3. the assignee of an undivided interest in the entirety of (a complete assignment from one of the joint inventors was made)

the patent application/patent identified above, by virtue of either:

A. An assignment from the inventor(s) of the patent application/patent identified above. The assignment was recorded in the United States Patent and Trademark Office at Reel 013583, Frame 0554, or for which a copy therefore is attached.

OR

B. A chain of title from the inventor(s), of the patent application/patent identified above, to the current assignee as follows:

1. From: _____ To: _____

The document was recorded in the United States Patent and Trademark Office at Reel _____, Frame _____, or for which a copy thereof is attached.

2. From: _____ To: _____

The document was recorded in the United States Patent and Trademark Office at Reel _____, Frame _____, or for which a copy thereof is attached.

3. From: _____ To: _____

The document was recorded in the United States Patent and Trademark Office at Reel _____, Frame _____, or for which a copy thereof is attached.

Additional documents in the chain of title are listed on a supplemental sheet(s).

As required by 37 CFR 3.73(b)(1)(i), the documentary evidence of the chain of title from the original owner to the assignee was, or concurrently is being, submitted for recordation pursuant to 37 CFR 3.11.

[NOTE: A separate copy (i.e., a true copy of the original assignment document(s)) must be submitted to Assignment Division in accordance with 37 CFR Part 3, to record the assignment in the records of the USPTO. See MPEP 302.08]

The undersigned (whose title is supplied below) is authorized to act on behalf of the assignee.

Signature

Jason D. Lohr, Reg. No. 48,163

Printed or Typed Name

08/17/2011

Date

Attorney Representing Client

Title

This collection of information is required by 37 CFR 3.73(b). The information is required to obtain or retain a benefit by the public which is to file (and by the USPTO to process) an application. Confidentiality is governed by 35 U.S.C. 122 and 37 CFR 1.11 and 1.14. This collection is estimated to take 12 minutes to complete, including gathering, preparing, and submitting the completed application form to the USPTO. Time will vary depending upon the individual case. Any comments on the amount of time you require to complete this form and/or suggestions for reducing this burden, should be sent to the Chief Information Officer, U.S. Patent and Trademark Office, U.S. Department of Commerce, P.O. Box 1450, Alexandria, VA 22313-1450. DO NOT SEND FEES OR COMPLETED FORMS TO THIS ADDRESS. SEND TO: Commissioner for Patents, P.O. Box 1450, Alexandria, VA 22313-1450.

I hereby certify that this correspondence is being filed via
EFS-Web with the United States Patent and Trademark Office
on August 17, 2011

KILPATRICK TOWNSEND & STOCKTON LLP

By: 

PATENT
Attorney Docket No.: 87790-818158
(000150US)
Client Reference No.: PN759544USF

IN THE UNITED STATES PATENT AND TRADEMARK OFFICE

In re application of:

Patrick RACZ, et al.

Application No.: Unassigned

Filed: Herewith

For: DATA STORAGE AND ACCESS
SYSTEMS

Customer No.: 20350

Confirmation No.: Unassigned

Examiner: Unassigned

Art Unit: Unassigned

INFORMATION DISCLOSURE
STATEMENT UNDER 37 CFR §1.97 and
§1.98

Mail Stop Amendment
Commissioner for Patents
P.O. Box 1450
Alexandria, VA 22313-1450

Commissioner:

The references cited on attached form PTO/SB/08A and PTO/SB/08B are being called to the attention of the Examiner. In accordance with 37 CFR §1.98(d), copies of the references can be found in Application No. 12/943,872, filed November 10, 2010 (Attorney Docket No. 87790-794402 (000120US)); Application No. 12/014,558, filed January 15, 2008 (Attorney Docket No. 87790-743055 (000110US)); and Application No. 11/336,758, filed January 19, 2006 (Attorney Docket No. 87790-707431 (000100US)). It is respectfully requested that the cited references be expressly considered during the prosecution of this application, and the references be made of record therein and appear among the "references cited" on any patent to issue therefrom.

As provided for by 37 CFR §1.97(g) and (h), no inference should be made that the information and references cited are prior art merely because they are in this statement and no

representation is being made that a search has been conducted or that this statement encompasses all the possible relevant information.

Applicant believes that no fee is required for submission of this statement. However, if a fee is required, the Commissioner is authorized to deduct such fee from the undersigned's Deposit Account No. 20-1430. Please deduct any additional fees from, or credit any overpayment to, the above-noted Deposit Account.

Respectfully submitted,

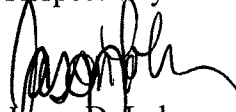

Jason D. Lohr
Reg. No. 48,163

KILPATRICK TOWNSEND & STOCKTON LLP
Two Embarcadero Center, Eighth Floor
San Francisco, California 94111-3834
Tel: 925-472-5000
Fax: 925-472-8895
JDL:sep
63668221 v1

Substitute for form 1449/PTO INFORMATION DISCLOSURE STATEMENT BY APPLICANT <i>(Use as many sheets as necessary)</i>		Complete if Known			
		Application Number	Unassigned		
		Filing Date	Unassigned		
		First Named Inventor	RACZ, Patrick		
		Art Unit	Unassigned		
		Examiner Name	Unassigned		
Sheet	1	of	4	Attorney Docket Number	87790-818158

U.S. PATENT DOCUMENTS					
Examiner Initials*	Cite No. ¹	Document Number	Publication Date MM-DD-YYYY	Name of Patentee or Applicant of Cited Document	Pages, Columns, Lines, Where Relevant Passages or Relevant Figures Appear
		Number Kind Code ² (<i>if known</i>)			
	AA	US 2003/0163594	8/28/2003	Aasheim et al.	
	AB	US 2003/0168515 A1	9/11/2003	Gray	
	AC	US 2006/0179211	8/10/2006	Aasheim et al.	
	AD	US 2006/0249570	11/9/2006	Seifert et al.	
	AE	US 2007/0162300	7/12/2007	Roever et al.	
	AF	US 2008/0041938	2/21/2008	Wise	
	AG	US 2008/0314974	12/25/2008	Hulst et al.	
	AH	US 4,341,951	Jul-82	Benton	
	AI	US 4,341,951	7/27/1982	Benton	
	AJ	US 4,697,073	9/29/1987	Hara	
	AK	US 5,148,432	9/15/1992	Gordon et al.	
	AL	US 5,226,145	7/6/1993	Moronaga et al.	
	AM	US 5,226,145	7/6/1993	Moronaga et al.	
	AN	US 5,367,150	11/22/1994	Kitta et al.	
	AO	US 5,406,619	4/11/1995	Akhteruzzaman et al.	
	AP	US 5,457,746	10/10/1995	Dolphin	
	AQ	US 5,532,466	7/2/1996	Konno et al.	
	AR	US 5,588,146	12/24/1996	Leroux	
	AS	US 5,677,953	10/14/1997	Dolphin	
	AT	US 5,703,951	12/30/1997	Dolphin	
	AU	US 5,740,369	4/14/1998	Yokozawa et al.	
	AV	US 5,744,787	4/28/1998	Teicher	
	AW	US 5,754,654	5/19/1998	Hiroya et al.	
	AX	US 5,794,202	8/11/1998	Kim	
	AY	US 5,809,241	9/15/1998	Hanel et al.	
	AZ	US 5,845,201	12/1/1998	Funke et al.	
	BA	US 5,845,281 A	12/1/1998	Benson et al.	
	BB	US 5,847,372	12/8/1998	Kreft	
	BC	US 5,874,760	2/23/1999	Burns et al.	
	BD	US 5,889,860	3/30/1999	Eller et al.	
	BE	US 5,901,330	5/4/1999	Sun et al.	
	BF	US 5,918,213	6/29/1999	Bernard et al.	
	BG	US 5,923,884	7/13/1999	Peyret et al.	
	BH	US 5,933,498 A	8/3/1999	Schneck et al.	
	BI	US 5,936,220	8/10/1999	Hoshino et al.	

Examiner Signature		Date Considered	
-----------------------	--	--------------------	--

*EXAMINER: Initial if reference considered, whether or not citation is in conformance with MPEP 609. Draw line through citation if not in conformance and not considered. Include copy of this form with next communication to applicant. ¹ Applicant's unique citation designation number (optional). ² See Kind Codes of U.S. Patent Documents at www.uspto.gov or MPEP 901.04. ³ Enter Office that issued the document, by the two-letter code (WIPO Standard ST.3). ⁴ For Japanese patent documents, the indication of the year of the reign of the Emperor must precede the serial number of the patent document. ⁵ Kind of document by the appropriate symbols as indicated on the document under WIPO Standard ST. 16 if possible. ⁶ Applicant is to place a check mark here if English language Translation is attached.

Substitute for form 1449/PTO INFORMATION DISCLOSURE STATEMENT BY APPLICANT <i>(Use as many sheets as necessary)</i>				Complete if Known	
				Application Number	Unassigned
				Filing Date	Unassigned
				First Named Inventor	RACZ, Patrick
				Art Unit	Unassigned
				Examiner Name	Unassigned
Sheet	2	of	4	Attorney Docket Number	87790-818158

U.S. PATENT DOCUMENTS						
Examiner Initials*	Cite No. ¹	Document Number		Publication Date MM-DD-YYYY	Name of Patentee or Applicant of Cited Document	Pages, Columns, Lines, Where Relevant Passages or Relevant Figures Appear
		Country Code ³	Number ⁴			
	BJ	US	6,012,634	1/11/2000	Brogan et al.	
	BK	US	6,018,720 A	1/25/2000	Fujimoto	Corresponds to JP 11-53184
	BL	US	6,078,917	6/20/2000	Paulsen et al.	
	BM	US	6,119,945	9/19/2000	Muller et al.	
	BN	US	6,142,369	Nov-00	Jonstromer	
	BO	US	6,202,056	3/13/2001	Nuttall	
	BP	US	6,385,731	5/7/2002	Ananda	
	BQ	US	6,415,156 B1	7/2/2002	Stadelmann	
	BR	US	6,424,975	7/23/2002	Walter et al.	
	BS	US	6,442,570	8/27/2002	Wu	
	BT	US	6,473,829	10/29/2002	Dahman et al.	
	BU	US	6,510,236	1/21/2003	Crane et al.	
	BV	US	6,553,413	4/22/2003	Leighton et al.	
	BW	US	6,554,192	4/29/2003	Tingl	
	BX	US	6,574,643	6/3/2003	Walter et al.	
	BY	US	6,658,568 B1	12/2/2003	Ginter et al.	
	BZ	US	6,721,749	4/13/2004	Najm et al.	
	BAA	US	6,747,930 B1	6/8/2004	Weldon et al.	
	CA	US	6,993,507	1/31/2006	Meyer et al.	
	CB	US	6,999,936	2/14/2006	Sehr	
	CC	US	7,000,836 B2	2/21/2006	Saeki	
	CD	US	7,044,362	5/16/2006	Yu	
	CE	US	7,083,081	8/1/2006	McGee et al.	
	CF	US	7,334,720	2/26/2008	Hulst et al.	
	CG	US	7,677,446	3/16/2010	Wise	
	CH	US	7,942,317	5/17/2011	Racz et al.	

FOREIGN PATENT DOCUMENTS								
Examiner Initials*	Cite No. ¹	Foreign Patent Document			Publication Date MM-DD-YYYY	Name of Patentee or Applicant of Cited Document	Pages, Columns, Lines, Where Relevant Passages or Relevant Figures Appear	T ⁶
		Country Code ³	Number ⁴	Kind Code ⁵ (if known)				
	CI	EP	0 195 098		10-03-1990	FPDC, Inc.		
	CJ	EP	0 542 298		04-22-1998	Hitachi, Ltd.		
	CK	EP	0 713 198	A2	05-22-1996	Nederland PTT		
	CL	EP	0 823 694	A1	02-11-1998	Citibank NA		

Examiner Signature		Date Considered	
--------------------	--	-----------------	--

*EXAMINER: Initial if reference considered, whether or not citation is in conformance with MPEP 609. Draw line through citation if not in conformance and not considered. Include copy of this form with next communication to applicant. ¹ Applicant's unique citation designation number (optional). ² See Kind Codes of U.S. Patent Documents at www.uspto.gov or MPEP 901.04. ³ Enter Office that issued the document, by the two-letter code (WIPO Standard ST.3). ⁴ For Japanese patent documents, the indication of the year of the reign of the Emperor must precede the serial number of the patent document. ⁵ Kind of document by the appropriate symbols as indicated on the document under WIPO Standard ST. 16 if possible. ⁶ Applicant is to place a check mark here if English language Translation is attached.

Substitute for form 1449/PTO INFORMATION DISCLOSURE STATEMENT BY APPLICANT <i>(Use as many sheets as necessary)</i>				Complete if Known	
				Application Number	Unassigned
				Filing Date	Unassigned
				First Named Inventor	RACZ, Patrick
				Art Unit	Unassigned
				Examiner Name	Unassigned
Sheet	3	of	4	Attorney Docket Number	87790-818158

FOREIGN PATENT DOCUMENTS								
Examiner Initials*	Cite No. ¹	Foreign Patent Document			Publication Date MM-DD-YYYY	Name of Patentee or Applicant of Cited Document	Pages, Columns, Lines, Where Relevant Passages or Relevant Figures Appear	T ⁶
		Country Code ³	Number ⁴	Kind Code ⁵ (if known)				
	CM	EP	0 843 449	A2	05-07-1998	Sunhawk Corp. Inc.		
	CN	EP	0 914 001	A1	05-06-1999	Canal Plus SA		
	CO	JP	10-269291	A	10-09-1998	Sony Corp.		
	CR	JP	11-212785	A	08-06-1999	Casio Comput. Co. Ltd.		
	CQ	JP	11-213010	A	08-06-1999	Planet Computer:KK		
	CR	JP	11-272762	A	10-08-1999	Hitachi Ltd.		
	CS	JP	11-53184	A	02-26-1999	Seta:KK	Corresponds to US 6,018,720	
	CT	WO	98/19237	A1	05-07-1998	Schulumberger Technologies, Inc.		
	CU	WO	98/33343		07-30-1998	Sonera OY et al.		
	CV	WO	98/37526		08-27-1998	Mondex Int. Ltd.		

Examiner Signature		Date Considered	
--------------------	--	-----------------	--

*EXAMINER: Initial if reference considered, whether or not citation is in conformance with MPEP 609. Draw line through citation if not in conformance and not considered. Include copy of this form with next communication to applicant. ¹ Applicant's unique citation designation number (optional). ² See Kind Codes of U.S. Patent Documents at www.uspto.gov or MPEP 901.04. ³ Enter Office that issued the document, by the two-letter code (WIPO Standard ST.3). ⁴ For Japanese patent documents, the indication of the year of the reign of the Emperor must precede the serial number of the patent document. ⁵ Kind of document by the appropriate symbols as indicated on the document under WIPO Standard ST. 16 if possible. ⁶ Applicant is to place a check mark here if English language Translation is attached.

Substitute for form 1449/PTO INFORMATION DISCLOSURE STATEMENT BY APPLICANT <i>(Use as many sheets as necessary)</i>				Complete if Known	
				Application Number	Unassigned
				Filing Date	Unassigned
				First Named Inventor	RACZ, Patrick
				Art Unit	Unassigned
				Examiner Name	Unassigned
Sheet	4	of	4	Attorney Docket Number	87790-818158

NON PATENT LITERATURE DOCUMENTS			
Examiner Initials *	Cite No. ¹	Include name of the author (in CAPITAL LETTERS), title of the article (when appropriate), title of the item (book, magazine, journal, serial, symposium, catalog, etc.), date, page(s), volume-issue number(s), publisher, city and/or country where published.	T ²

Examiner Signature		Date Considered	
-----------------------	--	--------------------	--

*EXAMINER: Initial if reference considered, whether or not citation is in conformance with MPEP 609. Draw line through citation if not in conformance and not considered. Include copy of this form with next communication to applicant.

¹ Applicant's unique citation designation number (optional). ² Applicant is to place a check mark here if English language Translation is attached.

I hereby certify that this correspondence is being filed via
EFS-Web with the United States Patent and Trademark Office
on August 17, 2011

PATENT
Docket No.: 87790-818158 (000150US)
Client Ref. No.: PN759544USF

KILPATRICK TOWNSEND & STOCKTON LLP

By: 

IN THE UNITED STATES PATENT AND TRADEMARK OFFICE

In re application of:

Patrick RACZ, et al.

Application No.: Unassigned

Filed: Herewith

For: DATA STORAGE AND ACCESS
SYSTEMS

Customer No.: 20350

Confirmation No.: Unassigned

Examiner: Unassigned

Art Unit: Unassigned

COMMUNICATION

Commissioner for Patents
P.O. Box 1450
Alexandria, VA 22313-1450

Commissioner:

In accordance with the accompanying continuation application, please
enter the following remarks:

Remarks/Arguments begin on page 2 of this paper.

REMARKS/ARGUMENTS

This continuation application presents claims that are similar in scope to claims originally presented in other cases in the family. While in many cases these claims were canceled or not elected in these related cases, Applicants respectfully submit that the Examiner should be aware that claims presented herein may be similar to at least some of the claims prosecuted in the related cases, and the Examiner might want to consider art cited in these cases for relevance. The art cited in these related cases will be cited in an Information Disclosure Statement, but in order to comply with the duty of disclosure Applicants submit that the Examiner might also want to look to the Office Actions in the related cases.

CONCLUSION

If the Examiner believes a telephone conference would expedite prosecution of this application, please telephone the undersigned at 925-472-5000.

Respectfully submitted,

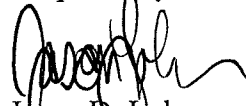

Jason D. Lohr
Reg. No. 48,163

KILPATRICK TOWNSEND & STOCKTON LLP
Two Embarcadero Center, Eighth Floor
San Francisco, California 94111-3834
Tel: (415) 576-0200
Fax: (415) 576-0300
JDL:sep

63668178 v1

Electronic Patent Application Fee Transmittal

Application Number:	
Filing Date:	
Title of Invention:	DATA STORAGE AND ACCESS SYSTEMS
First Named Inventor/Applicant Name:	Patrick RACZ
Filer:	Jason Donald Lohr/Heather Armstrong
Attorney Docket Number:	87790-818158 (000150US)

Filed as Small Entity

Utility under 35 USC 111(a) Filing Fees

Description	Fee Code	Quantity	Amount	Sub-Total in USD(\$)
Basic Filing:				
Utility filing Fee (Electronic filing)	4011	1	82	82
Utility Search Fee	2111	1	270	270
Utility Examination Fee	2311	1	110	110

Pages:

Claims:

Claims in excess of 20	2202	19	26	494
Independent claims in excess of 3	2201	8	110	880

Miscellaneous-Filing:

Description	Fee Code	Quantity	Amount	Sub-Total in USD(\$)
Petition:				
Patent-Appeals-and-Interference:				
Post-Allowance-and-Post-Issuance:				
Extension-of-Time:				
Miscellaneous:				
			Total in USD (\$)	1836

Electronic Acknowledgement Receipt

EFS ID:	10760547
Application Number:	13212047
International Application Number:	
Confirmation Number:	5477
Title of Invention:	DATA STORAGE AND ACCESS SYSTEMS
First Named Inventor/Applicant Name:	Patrick RACZ
Customer Number:	20350
Filer:	Jason Donald Lohr/Heather Armstrong
Filer Authorized By:	Jason Donald Lohr
Attorney Docket Number:	87790-818158 (000150US)
Receipt Date:	17-AUG-2011
Filing Date:	
Time Stamp:	18:49:55
Application Type:	Utility under 35 USC 111(a)

Payment information:

Submitted with Payment	yes
Payment Type	Credit Card
Payment was successfully received in RAM	\$1836
RAM confirmation Number	5066
Deposit Account	
Authorized User	

File Listing:

Document Number	Document Description	File Name	File Size(Bytes)/ Message Digest	Multi Page / Zip	Pages (if appl.)
-----------------	----------------------	-----------	-------------------------------------	---------------------	---------------------

1		2011-08-17- Application-87790-818158.pdf	4437150 40823f309836eecedf601ca5bd4ee7cfc0ea547d4	yes	85
Multipart Description/PDF files in .zip description					
Document Description		Start		End	
Transmittal of New Application		1		2	
Specification		3		39	
Claims		40		52	
Abstract		53		53	
Drawings-only black and white line drawings		54		70	
Oath or Declaration filed		71		72	
Application Data Sheet		73		75	
Power of Attorney		76		76	
Assignee showing of ownership per 37 CFR 3.73(b).		77		77	
Transmittal Letter		78		79	
Information Disclosure Statement (IDS) Form (SB08)		80		83	
Miscellaneous Incoming Letter		84		85	
Warnings:					
Information:					
2	Fee Worksheet (SB06)	fee-info.pdf	38152 18a8f2af5592b5e9e093197d4e9380da46e486b7	no	2
Warnings:					
Information:					
Total Files Size (in bytes):			4475302		

This Acknowledgement Receipt evidences receipt on the noted date by the USPTO of the indicated documents, characterized by the applicant, and including page counts, where applicable. It serves as evidence of receipt similar to a Post Card, as described in MPEP 503.

New Applications Under 35 U.S.C. 111

If a new application is being filed and the application includes the necessary components for a filing date (see 37 CFR 1.53(b)-(d) and MPEP 506), a Filing Receipt (37 CFR 1.54) will be issued in due course and the date shown on this Acknowledgement Receipt will establish the filing date of the application.

National Stage of an International Application under 35 U.S.C. 371

If a timely submission to enter the national stage of an international application is compliant with the conditions of 35 U.S.C. 371 and other applicable requirements a Form PCT/DO/EO/903 indicating acceptance of the application as a national stage submission under 35 U.S.C. 371 will be issued in addition to the Filing Receipt, in due course.

New International Application Filed with the USPTO as a Receiving Office

If a new international application is being filed and the international application includes the necessary components for an international filing date (see PCT Article 11 and MPEP 1810), a Notification of the International Application Number and of the International Filing Date (Form PCT/RO/105) will be issued in due course, subject to prescriptions concerning national security, and the date shown on this Acknowledgement Receipt will establish the international filing date of the application.



UNITED STATES PATENT AND TRADEMARK OFFICE

UNITED STATES DEPARTMENT OF COMMERCE
United States Patent and Trademark Office
Address: COMMISSIONER FOR PATENTS
P.O. Box 1450
Alexandria, Virginia 22313-1450
www.uspto.gov

Table with 7 columns: APPLICATION NUMBER, FILING or 371(c) DATE, GRP ART UNIT, FIL FEE REC'D, ATTY. DOCKET NO, TOT CLAIMS, IND CLAIMS. Row 1: 13/212,047, 08/17/2011, 2827, 1836, 87790-818158 (000150US), 39, 11

CONFIRMATION NO. 5477

20350
KILPATRICK TOWNSEND & STOCKTON LLP
TWO EMBARCADERO CENTER
EIGHTH FLOOR
SAN FRANCISCO, CA 94111-3834

FILING RECEIPT



Date Mailed: 09/02/2011

Receipt is acknowledged of this non-provisional patent application. The application will be taken up for examination in due course. Applicant will be notified as to the results of the examination. Any correspondence concerning the application must include the following identification information: the U.S. APPLICATION NUMBER, FILING DATE, NAME OF APPLICANT, and TITLE OF INVENTION. Fees transmitted by check or draft are subject to collection. Please verify the accuracy of the data presented on this receipt. If an error is noted on this Filing Receipt, please submit a written request for a Filing Receipt Correction. Please provide a copy of this Filing Receipt with the changes noted thereon. If you received a "Notice to File Missing Parts" for this application, please submit any corrections to this Filing Receipt with your reply to the Notice. When the USPTO processes the reply to the Notice, the USPTO will generate another Filing Receipt incorporating the requested corrections

Applicant(s)

Hermen-ard Hulst, Amsterdam, NETHERLANDS;
Patrick Sandor RACZ, Saint Heller, UNITED KINGDOM;

Assignment For Published Patent Application

Smartflash Technologies Limited, Road Town, VIRGIN ISLANDS, BRITISH

Power of Attorney: The patent practitioners associated with Customer Number 20350

Domestic Priority data as claimed by applicant

This application is a CON of 12/943,872 11/10/2010
which is a CON of 12/014,558 01/15/2008 PAT 7,942,317
which is a CON of 11/336,758 01/19/2006 PAT 7,334,720
which is a CON of 10/111,716 09/17/2002 ABN
which is a 371 of PCT/GB2000/104110 10/25/2000

Foreign Applications (You may be eligible to benefit from the Patent Prosecution Highway program at the USPTO. Please see http://www.uspto.gov for more information.)
UNITED KINGDOM 9925227.2 10/25/1999

Request to Retrieve - This application either claims priority to one or more applications filed in an intellectual property Office that participates in the Priority Document Exchange (PDX) program or contains a proper Request to Retrieve Electronic Priority Application(s) (PTO/SB/38 or its equivalent). Consequently, the USPTO will attempt to electronically retrieve these priority documents.

If Required, Foreign Filing License Granted: 08/26/2011

The country code and number of your priority application, to be used for filing abroad under the Paris Convention, is **US 13/212,047**

Projected Publication Date: 12/08/2011

Non-Publication Request: No

Early Publication Request: No

**** SMALL ENTITY ****

Title

DATA STORAGE AND ACCESS SYSTEMS

Preliminary Class

365

PROTECTING YOUR INVENTION OUTSIDE THE UNITED STATES

Since the rights granted by a U.S. patent extend only throughout the territory of the United States and have no effect in a foreign country, an inventor who wishes patent protection in another country must apply for a patent in a specific country or in regional patent offices. Applicants may wish to consider the filing of an international application under the Patent Cooperation Treaty (PCT). An international (PCT) application generally has the same effect as a regular national patent application in each PCT-member country. The PCT process **simplifies** the filing of patent applications on the same invention in member countries, but **does not result** in a grant of "an international patent" and does not eliminate the need of applicants to file additional documents and fees in countries where patent protection is desired.

Almost every country has its own patent law, and a person desiring a patent in a particular country must make an application for patent in that country in accordance with its particular laws. Since the laws of many countries differ in various respects from the patent law of the United States, applicants are advised to seek guidance from specific foreign countries to ensure that patent rights are not lost prematurely.

Applicants also are advised that in the case of inventions made in the United States, the Director of the USPTO must issue a license before applicants can apply for a patent in a foreign country. The filing of a U.S. patent application serves as a request for a foreign filing license. The application's filing receipt contains further information and guidance as to the status of applicant's license for foreign filing.

Applicants may wish to consult the USPTO booklet, "General Information Concerning Patents" (specifically, the section entitled "Treaties and Foreign Patents") for more information on timeframes and deadlines for filing foreign patent applications. The guide is available either by contacting the USPTO Contact Center at 800-786-9199, or it can be viewed on the USPTO website at <http://www.uspto.gov/web/offices/pac/doc/general/index.html>.

For information on preventing theft of your intellectual property (patents, trademarks and copyrights), you may wish to consult the U.S. Government website, <http://www.stopfakes.gov>. Part of a Department of Commerce initiative, this website includes self-help "toolkits" giving innovators guidance on how to protect intellectual property in specific countries such as China, Korea and Mexico. For questions regarding patent enforcement issues, applicants may call the U.S. Government hotline at 1-866-999-HALT (1-866-999-4158).

LICENSE FOR FOREIGN FILING UNDER
Title 35, United States Code, Section 184
Title 37, Code of Federal Regulations, 5.11 & 5.15

GRANTED

The applicant has been granted a license under 35 U.S.C. 184, if the phrase "IF REQUIRED, FOREIGN FILING LICENSE GRANTED" followed by a date appears on this form. Such licenses are issued in all applications where the conditions for issuance of a license have been met, regardless of whether or not a license may be required as set forth in 37 CFR 5.15. The scope and limitations of this license are set forth in 37 CFR 5.15(a) unless an earlier license has been issued under 37 CFR 5.15(b). The license is subject to revocation upon written notification. The date indicated is the effective date of the license, unless an earlier license of similar scope has been granted under 37 CFR 5.13 or 5.14.

This license is to be retained by the licensee and may be used at any time on or after the effective date thereof unless it is revoked. This license is automatically transferred to any related applications(s) filed under 37 CFR 1.53(d). This license is not retroactive.

The grant of a license does not in any way lessen the responsibility of a licensee for the security of the subject matter as imposed by any Government contract or the provisions of existing laws relating to espionage and the national security or the export of technical data. Licensees should apprise themselves of current regulations especially with respect to certain countries, of other agencies, particularly the Office of Defense Trade Controls, Department of State (with respect to Arms, Munitions and Implements of War (22 CFR 121-128)); the Bureau of Industry and Security, Department of Commerce (15 CFR parts 730-774); the Office of Foreign Assets Control, Department of Treasury (31 CFR Parts 500+) and the Department of Energy.

NOT GRANTED

No license under 35 U.S.C. 184 has been granted at this time, if the phrase "IF REQUIRED, FOREIGN FILING LICENSE GRANTED" DOES NOT appear on this form. Applicant may still petition for a license under 37 CFR 5.12, if a license is desired before the expiration of 6 months from the filing date of the application. If 6 months has lapsed from the filing date of this application and the licensee has not received any indication of a secrecy order under 35 U.S.C. 181, the licensee may foreign file the application pursuant to 37 CFR 5.15(b).

PATENT APPLICATION FEE DETERMINATION RECORD

Substitute for Form PTO-875

Application or Docket Number
13/212,047

APPLICATION AS FILED - PART I

(Column 1) (Column 2)

FOR	NUMBER FILED	NUMBER EXTRA
BASIC FEE (37 CFR 1.16(a), (b), or (c))	N/A	N/A
SEARCH FEE (37 CFR 1.16(k), (l), or (m))	N/A	N/A
EXAMINATION FEE (37 CFR 1.16(o), (p), or (q))	N/A	N/A
TOTAL CLAIMS (37 CFR 1.16(j))	39 minus 20 = *	19
INDEPENDENT CLAIMS (37 CFR 1.16(h))	11 minus 3 = *	8
APPLICATION SIZE FEE (37 CFR 1.16(s))	If the specification and drawings exceed 100 sheets of paper, the application size fee due is \$270 (\$135 for small entity) for each additional 50 sheets or fraction thereof. See 35 U.S.C. 41(a)(1)(G) and 37 CFR 1.16(s).	
MULTIPLE DEPENDENT CLAIM PRESENT (37 CFR 1.16(j))		

* If the difference in column 1 is less than zero, enter "0" in column 2.

SMALL ENTITY

RATE(\$)	FEE(\$)
N/A	82
N/A	270
N/A	110
x 26 =	494
x 110 =	880
	0.00
	0.00
TOTAL	1836

OR OTHER THAN SMALL ENTITY

RATE(\$)	FEE(\$)
N/A	
N/A	
N/A	
TOTAL	

APPLICATION AS AMENDED - PART II

(Column 1) (Column 2) (Column 3)

AMENDMENT A		CLAIMS REMAINING AFTER AMENDMENT		HIGHEST NUMBER PREVIOUSLY PAID FOR	PRESENT EXTRA
	Total (37 CFR 1.16(i))	*	Minus	**	=
	Independent (37 CFR 1.16(h))	*	Minus	***	=
	Application Size Fee (37 CFR 1.16(s))				
FIRST PRESENTATION OF MULTIPLE DEPENDENT CLAIM (37 CFR 1.16(j))					

SMALL ENTITY

RATE(\$)	ADDITIONAL FEE(\$)
x =	
x =	
TOTAL ADD'L FEE	

OR OTHER THAN SMALL ENTITY

RATE(\$)	ADDITIONAL FEE(\$)
x =	
x =	
TOTAL ADD'L FEE	

(Column 1) (Column 2) (Column 3)

AMENDMENT B		CLAIMS REMAINING AFTER AMENDMENT		HIGHEST NUMBER PREVIOUSLY PAID FOR	PRESENT EXTRA
	Total (37 CFR 1.16(i))	*	Minus	**	=
	Independent (37 CFR 1.16(h))	*	Minus	***	=
	Application Size Fee (37 CFR 1.16(s))				
FIRST PRESENTATION OF MULTIPLE DEPENDENT CLAIM (37 CFR 1.16(j))					

RATE(\$)	ADDITIONAL FEE(\$)
x =	
x =	
TOTAL ADD'L FEE	

OR OTHER THAN SMALL ENTITY

RATE(\$)	ADDITIONAL FEE(\$)
x =	
x =	
TOTAL ADD'L FEE	

* If the entry in column 1 is less than the entry in column 2, write "0" in column 3.

** If the "Highest Number Previously Paid For" IN THIS SPACE is less than 20, enter "20".

*** If the "Highest Number Previously Paid For" IN THIS SPACE is less than 3, enter "3".

The "Highest Number Previously Paid For" (Total or Independent) is the highest found in the appropriate box in column 1.



UNITED STATES PATENT AND TRADEMARK OFFICE

UNITED STATES DEPARTMENT OF COMMERCE
United States Patent and Trademark Office
Address: COMMISSIONER FOR PATENTS
P.O. Box 1450
Alexandria, Virginia 22313-1450
www.uspto.gov

APPLICATION NUMBER	FILING OR 371(C) DATE	FIRST NAMED APPLICANT	ATTY. DOCKET NO./TITLE
13/212,047	08/17/2011	Hermen-ard Hulst	87790-818158 (000150US)

CONFIRMATION NO. 5477

POA ACCEPTANCE LETTER

20350
KILPATRICK TOWNSEND & STOCKTON LLP
TWO EMBARCADERO CENTER
EIGHTH FLOOR
SAN FRANCISCO, CA 94111-3834



Date Mailed: 09/02/2011

NOTICE OF ACCEPTANCE OF POWER OF ATTORNEY

This is in response to the Power of Attorney filed 08/17/2011.

The Power of Attorney in this application is accepted. Correspondence in this application will be mailed to the above address as provided by 37 CFR 1.33.

/spkannathip/

Office of Data Management, Application Assistance Unit (571) 272-4000, or (571) 272-4200, or 1-888-786-0101



UNITED STATES PATENT AND TRADEMARK OFFICE

UNITED STATES DEPARTMENT OF COMMERCE
United States Patent and Trademark Office
Address: COMMISSIONER FOR PATENTS
P.O. Box 1450
Alexandria, Virginia 22313-1450
www.uspto.gov

Table with 4 columns: APPLICATION NUMBER (13/212,047), FILING OR 371(C) DATE (08/17/2011), FIRST NAMED APPLICANT (Hermen-ard Hulst), ATTY. DOCKET NO./TITLE (87790-818158 (000150US))

CONFIRMATION NO. 5477

PUBLICATION NOTICE



20350
KILPATRICK TOWNSEND & STOCKTON LLP
TWO EMBARCADERO CENTER
EIGHTH FLOOR
SAN FRANCISCO, CA 94111-3834

Title:DATA STORAGE AND ACCESS SYSTEMS

Publication No.US-2011-0302054-A1
Publication Date:12/08/2011

NOTICE OF PUBLICATION OF APPLICATION

The above-identified application will be electronically published as a patent application publication pursuant to 37 CFR 1.211, et seq. The patent application publication number and publication date are set forth above.

The publication may be accessed through the USPTO's publically available Searchable Databases via the Internet at www.uspto.gov. The direct link to access the publication is currently http://www.uspto.gov/patft/.

The publication process established by the Office does not provide for mailing a copy of the publication to applicant. A copy of the publication may be obtained from the Office upon payment of the appropriate fee set forth in 37 CFR 1.19(a)(1). Orders for copies of patent application publications are handled by the USPTO's Office of Public Records. The Office of Public Records can be reached by telephone at (703) 308-9726 or (800) 972-6382, by facsimile at (703) 305-8759, by mail addressed to the United States Patent and Trademark Office, Office of Public Records, Alexandria, VA 22313-1450 or via the Internet.

In addition, information on the status of the application, including the mailing date of Office actions and the dates of receipt of correspondence filed in the Office, may also be accessed via the Internet through the Patent Electronic Business Center at www.uspto.gov using the public side of the Patent Application Information and Retrieval (PAIR) system. The direct link to access this status information is currently http://pair.uspto.gov/. Prior to publication, such status information is confidential and may only be obtained by applicant using the private side of PAIR.

Further assistance in electronically accessing the publication, or about PAIR, is available by calling the Patent Electronic Business Center at 1-866-217-9197.

Office of Data Management, Application Assistance Unit (571) 272-4000, or (571) 272-4200, or 1-888-786-0101

I hereby certify that this correspondence is being filed via
EFS-Web with the United States Patent and Trademark Office
on March 16, 2012.

PATENT
Attorney Docket No. 87790-818158 (000150US)
Client Ref. No. PN759544USF

KILPATRICK TOWNSEND & STOCKTON LLP

By: Willce
William Chinn

IN THE UNITED STATES PATENT AND TRADEMARK OFFICE

In re continuation application of:

PATRICK RACZ, ET AL.

Application No. 13/212,047

Filed: August 17, 2011

For: DATA STORAGE AND ACCESS
SYSTEMS

Customer No. 20350

Confirmation No. 5477

Examiner: Thien Minh Le

Art Unit: 2887

PETITION TO CHANGE ORDER OF
NAMES OF JOINT INVENTORS IN
THE HEADING OF THE PATENT
APPLICATION UNDER 37 CFR 1.182

Commissioner for Patents
P.O. Box 1450
Alexandria, VA 22313-1450

Commissioner:

Applicants respectfully request that the order of the inventor names be changed to reflect inventor Patrick Racz as first-named inventor. Both inventors are listed on the most recent filing receipt incorrectly and based on the pending claims should be listed as inventors on the present application. Only the order of the inventors should be changed. The corrected order of inventor names is listed below:

Patrick S. Racz, a citizen of the United Kingdom, residing at
19 Royal Square
St. Heller, JE1 4WA Jersey

Hermen-ard Hulst, a citizen of Netherlands, residing at

It is respectfully requested that this change be reflected on all subsequent correspondence from the United States Patent and Trademark Office directed to this application and that any patent issuing from this application, or a continuation thereof, names the inventors in the order listed above.

A copy of the Application Data Sheet (ADS) denoting the correct order of inventor names for inventors Patrick Racz and Hermen-ard Hulst as filed of August 17, 2011 is also attached.

The Commissioner is hereby authorized to deduct the required fee of \$400 pursuant to 37 CFR 1.17(f) from the undersigned's American Express credit card ending in -1008. Pleased deduct any additional fees from, or credit any overpayment to our deposit account No. 20-1430.

If it is believed a telephone conference would be helpful, please telephone the undersigned at (415) 576-0200.

Respectfully submitted,

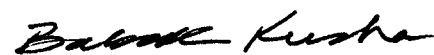

Babak Kusha
Reg. No. 51,095

KILPATRICK TOWNSEND & STOCKTON, LLP
Two Embarcadero Center, Eighth Floor
San Francisco, California 94111-3834
Tel: (415) 576-0200
Fax: (415) 576-0300
BK:wlc
63932221 v1

PETITION FEE
Under 37 CFR 1.17(f), (g) & (h)
TRANSMITTAL

(Fees are subject to annual revision)

Send completed form to: Commissioner for Patents
P.O. Box 1450, Alexandria, VA 22313-1450

Application Number	13/212,047
Filing Date	August 17, 2011
First Named Inventor	Racz, Patrick
Art Unit	2887
Examiner Name	Thien Minh Le
Attorney Docket Number	87790-818158 (000150US)

Enclosed is a petition filed under 37 CFR §1.182 that requires a processing fee (37 CFR 1.17(f), (g), or (h)). Payment of \$ 400 is enclosed.

This form should be included with the above-mentioned petition and faxed or mailed to the Office using the appropriate Mail Stop (e.g., Mail Stop Petition), if applicable. *For transmittal of processing fees under 37 CFR 1.17(i), see form PTO/SB/17i.*

Payment of Fees (small entity amounts are NOT available for the petition fees)

- The Commissioner is hereby authorized to charge the following fees to Deposit Account No. 20-1430 :
 petition fee under 37 CFR 1.17(f), (g) or (h) any deficiency of fees and credit of any overpayments

Check in the amount of \$ _____ is enclosed.

Payment by credit card (Form PTO-2038 or equivalent enclosed). Do not provide credit card information on this form.

Petition Fees under 37 CFR 1.17(f): Fee \$400 Fee Code 1462

For petitions filed under:

- § 1.36(a) - for revocation of a power of attorney by fewer than all applicants.
§ 1.53(e) - to accord a filing date.
§ 1.57(a) - to accord a filing date.
 § 1.182 - for decision on a question not specifically provided for.
§ 1.183 - to suspend the rules.
§ 1.378(e) - for reconsideration of decision on petition refusing to accept delayed payment of maintenance fee in an expired patent.
§ 1.741(b) - to accord a filing date to an application under § 1.740 for extension of a patent term.

Petition Fees under 37 CFR 1.17(g): Fee \$200 Fee Code 1463

For petitions filed under:

- § 1.12 - for access to an assignment record.
§ 1.14 - for access to an application.
§ 1.47 - for filing by other than all the inventors or a person not the inventor.
§ 1.59 - for expungement of information.
§ 1.103(a) - to suspend action in an application.
§ 1.136(b) - for review of a request for extension of time when the provisions of section 1.136(a) are not available.
§ 1.295 - for review of refusal to publish a statutory invention registration.
§ 1.296 - to withdraw a request for publication of a statutory invention registration filed on or after the date the notice of intent to publish issued.
§ 1.377 - for review of decision refusing to accept and record payment of a maintenance fee filed prior to expiration of a patent.
§ 1.550(c) - for patent owner requests for extension of time in ex parte reexamination proceedings.
§ 1.956 - for patent owner requests for extension of time in inter partes reexamination proceedings.
§ 5.12 - for expedited handling of a foreign filing license.
§ 5.15 - for changing the scope of a license.
§ 5.25 - for retroactive license.

Petition Fees under 37 CFR 1.17(h): Fee \$130 Fee Code 1464

For petitions filed under:

- § 1.19(g) - to request documents in a form other than that provided in this part.
§ 1.84 - for accepting color drawings or photographs.
§ 1.91 - for entry of a model or exhibit.
§ 1.102(d) - to make an application special.
§ 1.138(c) - to expressly abandon an application to avoid publication.
§ 1.313 - to withdraw an application from issue.
§ 1.314 - to defer issuance of a patent.

Babak Kusha

Signature

Babak Kusha

Typed or printed name

March 16, 2012

Date

51,095

Registration No., if applicable

Application Data Sheet

Application Information

Application number:: Unassigned
Filing Date:: Herewith
Application Type:: Regular
Title:: DATA STORAGE AND ACCESS SYSTEMS
Attorney Docket Number:: 87790-818158 (000150US)
Request for Early Publication:: No
Request for Non-Publication:: No
Suggested Drawing Figure::
Total Drawing Sheets:: 17
Small Entity?:: Yes
Petition included?:: No
Secrecy Order in Parent Appl.:: No

Applicant Information

Applicant Authority Type:: Inventor
Primary Citizenship Country:: United Kingdom
Status:: Full Capacity
Given Name:: Patrick
Middle Name::
Family Name:: RACZ
Name Suffix::
City of Residence:: Saint Heller
State or Province of Residence::
Country of Residence:: Jersey
Street of Mailing Address:: 19 Royal Street
City of Mailing Address:: Saint Heller
State or Province of mailing address::

Country of mailing address:: Jersey
Postal or Zip Code of mailing address:: JE1 4WA

Applicant Authority Type:: Inventor
Primary Citizenship Country:: Netherlands
Status:: Full Capacity
Given Name:: Hermen-ard
Middle Name::
Family Name:: HULST
Name Suffix::
City of Residence:: Amsterdam
State or Province of Residence::
Country of Residence:: Netherlands
Street of Mailing Address:: Van Tuyll van Serooskerweg 75hs
City of Mailing Address:: Amsterdam
State or Province of mailing address::
Country of mailing address:: Netherlands
Postal or Zip Code of mailing address:: 1076 JG

Correspondence Information

Correspondence Customer Number:: 20350

Representative Information

Representative Customer Number:: 20350

Domestic Priority Information

Application::	Continuity Type::	Parent Application::	Parent Filing Date::
This Application	Continuation of	12/943,872	11/10/10
12/943,872	Continuation of	12/014,558	01/15/08
12/014,558	Continuation of	11/336,758	01/19/06
11/336,758	Continuation of	10/111,716	09/17/02

Foreign Priority Information

Country::	Application number::	Filing Date::
PCT	GB00104110	10/25/00
United Kingdom	9925227.2	10/25/99

Assignee Information

Assignee Name::	Smartflash Technologies Limited
Street of mailing address::	1070908 Palm Grove House, P.O. Box 438
City of mailing address::	Wickhams' Cay, Road Town
State or Province of mailing address::	Tortola
Country of mailing address::	British Virgin Islands
Postal or Zip Code of mailing address::	

Submitted by:

Signature

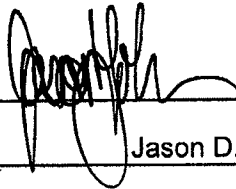

Date

08/17/2011

Printed Name

Jason D. Lohr

Registration Number

48,163

Electronic Patent Application Fee Transmittal

Application Number:	13212047
Filing Date:	17-Aug-2011
Title of Invention:	DATA STORAGE AND ACCESS SYSTEMS
First Named Inventor/Applicant Name:	Hermen-ard Hulst
Filer:	Babak Kusha/William Chinn
Attorney Docket Number:	87790-818158 (000150US)

Filed as Small Entity

Utility under 35 USC 111(a) Filing Fees

Description	Fee Code	Quantity	Amount	Sub-Total in USD(\$)
Basic Filing:				
Pages:				
Claims:				
Miscellaneous-Filing:				
Petition:				
Petition fee- 37 CFR 1.17(f) (Group I)	1462	1	400	400

Patent-Appeals-and-Interference:

Post-Allowance-and-Post-Issuance:

Extension-of-Time:

Description	Fee Code	Quantity	Amount	Sub-Total in USD(\$)
Miscellaneous:				
Total in USD (\$)				400

Electronic Acknowledgement Receipt

EFS ID:	12328814
Application Number:	13212047
International Application Number:	
Confirmation Number:	5477
Title of Invention:	DATA STORAGE AND ACCESS SYSTEMS
First Named Inventor/Applicant Name:	Hermen-ard Hulst
Customer Number:	20350
Filer:	Babak Kusha/William Chinn
Filer Authorized By:	Babak Kusha
Attorney Docket Number:	87790-818158 (000150US)
Receipt Date:	16-MAR-2012
Filing Date:	17-AUG-2011
Time Stamp:	18:50:18
Application Type:	Utility under 35 USC 111(a)

Payment information:

Submitted with Payment	yes
Payment Type	Credit Card
Payment was successfully received in RAM	\$400
RAM confirmation Number	5850
Deposit Account	201430
Authorized User	KILPATRICK TOWNSEND & STOCKTON, LLP

The Director of the USPTO is hereby authorized to charge indicated fees and credit any overpayment as follows:

Charge any Additional Fees required under 37 C.F.R. Section 1.17 (Patent application and reexamination processing fees)

Charge any Additional Fees required under 37 C.F.R. Section 1.21 (Miscellaneous fees and charges)

Page 00107

File Listing:					
Document Number	Document Description	File Name	File Size(Bytes)/ Message Digest	Multi Part /.zip	Pages (if appl.)
1		Marks_Clerks_87790-818158_Petition_to_Change_Order_Names_Joint_Inventors.PDF	231532 ad79c61cc761e52e6c6ee2885093ae2cc8bd a876	yes	6
	Multipart Description/PDF files in .zip description				
	Document Description		Start	End	
	Petition for review by the Office of Petitions.		1	2	
	Miscellaneous Incoming Letter		3	3	
Application Data Sheet		4	6		
Warnings:					
Information:					
2	Fee Worksheet (SB06)	fee-info.pdf	30703 0fd8a3b0ed5dee46c10f8c072cad74ce8384 8308	no	2
Warnings:					
Information:					
Total Files Size (in bytes):			262235		
<p>This Acknowledgement Receipt evidences receipt on the noted date by the USPTO of the indicated documents, characterized by the applicant, and including page counts, where applicable. It serves as evidence of receipt similar to a Post Card, as described in MPEP 503.</p> <p><u>New Applications Under 35 U.S.C. 111</u> If a new application is being filed and the application includes the necessary components for a filing date (see 37 CFR 1.53(b)-(d) and MPEP 506), a Filing Receipt (37 CFR 1.54) will be issued in due course and the date shown on this Acknowledgement Receipt will establish the filing date of the application.</p> <p><u>National Stage of an International Application under 35 U.S.C. 371</u> If a timely submission to enter the national stage of an international application is compliant with the conditions of 35 U.S.C. 371 and other applicable requirements a Form PCT/DO/EO/903 indicating acceptance of the application as a national stage submission under 35 U.S.C. 371 will be issued in addition to the Filing Receipt, in due course.</p> <p><u>New International Application Filed with the USPTO as a Receiving Office</u> If a new international application is being filed and the international application includes the necessary components for an international filing date (see PCT Article 11 and MPEP 1810), a Notification of the International Application Number and of the International Filing Date (Form PCT/RO/105) will be issued in due course, subject to prescriptions concerning national security, and the date shown on this Acknowledgement Receipt will establish the international filing date of the application.</p>					



UNITED STATES PATENT AND TRADEMARK OFFICE

UNITED STATES DEPARTMENT OF COMMERCE
United States Patent and Trademark Office
Address: COMMISSIONER FOR PATENTS
P.O. Box 1450
Alexandria, Virginia 22313-1450
www.uspto.gov

Table with 7 columns: APPLICATION NUMBER, FILING or 371(c) DATE, GRP ART UNIT, FIL FEE REC'D, ATTY. DOCKET NO, TOT CLAIMS, IND CLAIMS. Row 1: 13/212,047, 08/17/2011, 2887, 1836, 87790-818158 (000150US), 39, 11

CONFIRMATION NO. 5477

CORRECTED FILING RECEIPT



20350
KILPATRICK TOWNSEND & STOCKTON LLP
TWO EMBARCADERO CENTER
EIGHTH FLOOR
SAN FRANCISCO, CA 94111-3834

Date Mailed: 05/22/2012

Receipt is acknowledged of this non-provisional patent application. The application will be taken up for examination in due course. Applicant will be notified as to the results of the examination. Any correspondence concerning the application must include the following identification information: the U.S. APPLICATION NUMBER, FILING DATE, NAME OF APPLICANT, and TITLE OF INVENTION. Fees transmitted by check or draft are subject to collection. Please verify the accuracy of the data presented on this receipt. If an error is noted on this Filing Receipt, please submit a written request for a Filing Receipt Correction. Please provide a copy of this Filing Receipt with the changes noted thereon. If you received a "Notice to File Missing Parts" for this application, please submit any corrections to this Filing Receipt with your reply to the Notice. When the USPTO processes the reply to the Notice, the USPTO will generate another Filing Receipt incorporating the requested corrections

Applicant(s)

Patrick Sandor RACZ, Saint Heller, UNITED KINGDOM;
Hermen-ard Hulst, Amsterdam, NETHERLANDS;

Assignment For Published Patent Application

Smartflash Technologies Limited, Road Town, VIRGIN ISLANDS, BRITISH

Power of Attorney: The patent practitioners associated with Customer Number 20350

Domestic Priority data as claimed by applicant

This application is a CON of 12/943,872 11/10/2010 PAT 8118221
which is a CON of 12/014,558 01/15/2008 PAT 7942317
which is a CON of 11/336,758 01/19/2006 PAT 7334720
which is a CON of 10/111,716 09/17/2002 ABN
which is a 371 of PCT/GB2000/104110 10/25/2000

Foreign Applications (You may be eligible to benefit from the Patent Prosecution Highway program at the USPTO. Please see http://www.uspto.gov for more information.)

UNITED KINGDOM 9925227.2 10/25/1999

Request to Retrieve - This application either claims priority to one or more applications filed in an intellectual property Office that participates in the Priority Document Exchange (PDX) program or contains a proper Request to Retrieve Electronic Priority Application(s) (PTO/SB/38 or its equivalent). Consequently, the USPTO will attempt to electronically retrieve these priority documents.

If Required, Foreign Filing License Granted: 08/26/2011

The country code and number of your priority application, to be used for filing abroad under the Paris Convention, is **US 13/212,047**

Projected Publication Date: Not Applicable

Non-Publication Request: No

Early Publication Request: No

**** SMALL ENTITY ****

Title

DATA STORAGE AND ACCESS SYSTEMS

Preliminary Class

235

PROTECTING YOUR INVENTION OUTSIDE THE UNITED STATES

Since the rights granted by a U.S. patent extend only throughout the territory of the United States and have no effect in a foreign country, an inventor who wishes patent protection in another country must apply for a patent in a specific country or in regional patent offices. Applicants may wish to consider the filing of an international application under the Patent Cooperation Treaty (PCT). An international (PCT) application generally has the same effect as a regular national patent application in each PCT-member country. The PCT process **simplifies** the filing of patent applications on the same invention in member countries, but **does not result** in a grant of "an international patent" and does not eliminate the need of applicants to file additional documents and fees in countries where patent protection is desired.

Almost every country has its own patent law, and a person desiring a patent in a particular country must make an application for patent in that country in accordance with its particular laws. Since the laws of many countries differ in various respects from the patent law of the United States, applicants are advised to seek guidance from specific foreign countries to ensure that patent rights are not lost prematurely.

Applicants also are advised that in the case of inventions made in the United States, the Director of the USPTO must issue a license before applicants can apply for a patent in a foreign country. The filing of a U.S. patent application serves as a request for a foreign filing license. The application's filing receipt contains further information and guidance as to the status of applicant's license for foreign filing.

Applicants may wish to consult the USPTO booklet, "General Information Concerning Patents" (specifically, the section entitled "Treaties and Foreign Patents") for more information on timeframes and deadlines for filing foreign patent applications. The guide is available either by contacting the USPTO Contact Center at 800-786-9199, or it can be viewed on the USPTO website at <http://www.uspto.gov/web/offices/pac/doc/general/index.html>.

For information on preventing theft of your intellectual property (patents, trademarks and copyrights), you may wish to consult the U.S. Government website, <http://www.stopfakes.gov>. Part of a Department of Commerce initiative, this website includes self-help "toolkits" giving innovators guidance on how to protect intellectual property in specific countries such as China, Korea and Mexico. For questions regarding patent enforcement issues, applicants may call the U.S. Government hotline at 1-866-999-HALT (1-866-999-4158).

LICENSE FOR FOREIGN FILING UNDER
Title 35, United States Code, Section 184
Title 37, Code of Federal Regulations, 5.11 & 5.15

GRANTED

The applicant has been granted a license under 35 U.S.C. 184, if the phrase "IF REQUIRED, FOREIGN FILING LICENSE GRANTED" followed by a date appears on this form. Such licenses are issued in all applications where the conditions for issuance of a license have been met, regardless of whether or not a license may be required as set forth in 37 CFR 5.15. The scope and limitations of this license are set forth in 37 CFR 5.15(a) unless an earlier license has been issued under 37 CFR 5.15(b). The license is subject to revocation upon written notification. The date indicated is the effective date of the license, unless an earlier license of similar scope has been granted under 37 CFR 5.13 or 5.14.

This license is to be retained by the licensee and may be used at any time on or after the effective date thereof unless it is revoked. This license is automatically transferred to any related applications(s) filed under 37 CFR 1.53(d). This license is not retroactive.

The grant of a license does not in any way lessen the responsibility of a licensee for the security of the subject matter as imposed by any Government contract or the provisions of existing laws relating to espionage and the national security or the export of technical data. Licensees should apprise themselves of current regulations especially with respect to certain countries, of other agencies, particularly the Office of Defense Trade Controls, Department of State (with respect to Arms, Munitions and Implements of War (22 CFR 121-128)); the Bureau of Industry and Security, Department of Commerce (15 CFR parts 730-774); the Office of Foreign Assets Control, Department of Treasury (31 CFR Parts 500+) and the Department of Energy.

NOT GRANTED

No license under 35 U.S.C. 184 has been granted at this time, if the phrase "IF REQUIRED, FOREIGN FILING LICENSE GRANTED" DOES NOT appear on this form. Applicant may still petition for a license under 37 CFR 5.12, if a license is desired before the expiration of 6 months from the filing date of the application. If 6 months has lapsed from the filing date of this application and the licensee has not received any indication of a secrecy order under 35 U.S.C. 181, the licensee may foreign file the application pursuant to 37 CFR 5.15(b).

SelectUSA

The United States represents the largest, most dynamic marketplace in the world and is an unparalleled location for business investment, innovation and commercialization of new technologies. The USA offers tremendous resources and advantages for those who invest and manufacture goods here. Through SelectUSA, our nation works to encourage, facilitate, and accelerate business investment. To learn more about why the USA is the best country in the world to develop technology, manufacture products, and grow your business, visit SelectUSA.gov.



KILPATRICK TOWNSEND & STOCKTON LLP
TWO EMBARCADERO CENTER
EIGHTH FLOOR
SAN FRANCISCO, CA 94111-3834

MAILED
MAY 23 2012
OFFICE OF PETITIONS

In re Application of Racz et al. :
Application No. 13/212,047 : Decision on Petition
Filing Date: August 17, 2011 :
Atty. Docket No. 87790-81858(000150US) :

This is a decision on the petition under 37 CFR 1.182, filed March 16, 2012, to change the order of the names of the inventors.

The petition is **granted**.

The order of the names of the inventors has been changed as follows:

1. Patrick S. Racz
2. Herman-ard Huist

Telephone inquiries regarding this communication should be directed to Petitions Attorney Steven Brantley at (571) 272-3203.

Charles Steven Brantley
Senior Petitions Attorney
Office of Petitions

Attached: Corrected Filing Receipt



UNITED STATES PATENT AND TRADEMARK OFFICE

UNITED STATES DEPARTMENT OF COMMERCE
United States Patent and Trademark Office
Address: COMMISSIONER FOR PATENTS
P.O. Box 1450
Alexandria, Virginia 22313-1450
www.uspto.gov

Table with 6 columns: APPLICATION NUMBER, FILING or 371(c) DATE, GRP ART UNIT, FIL FEE REC'D, ATTY. DOCKET NO, TOT CLAIMS, IND CLAIMS. Values: 13/212,047, 08/17/2011, 2887, 1836, 87790-818158 (000150US), 39, 11

CONFIRMATION NO. 5477

CORRECTED FILING RECEIPT



20350
KILPATRICK TOWNSEND & STOCKTON LLP
TWO EMBARCADERO CENTER
EIGHTH FLOOR
SAN FRANCISCO, CA 94111-3834

Date Mailed: 05/22/2012

Receipt is acknowledged of this non-provisional patent application. The application will be taken up for examination in due course. Applicant will be notified as to the results of the examination. Any correspondence concerning the application must include the following identification information: the U.S. APPLICATION NUMBER, FILING DATE, NAME OF APPLICANT, and TITLE OF INVENTION. Fees transmitted by check or draft are subject to collection. Please verify the accuracy of the data presented on this receipt. If an error is noted on this Filing Receipt, please submit a written request for a Filing Receipt Correction. Please provide a copy of this Filing Receipt with the changes noted thereon. If you received a "Notice to File Missing Parts" for this application, please submit any corrections to this Filing Receipt with your reply to the Notice. When the USPTO processes the reply to the Notice, the USPTO will generate another Filing Receipt incorporating the requested corrections

Applicant(s)

Patrick Sandor RACZ, Saint Heller, UNITED KINGDOM;
Hermen-ard Hulst, Amsterdam, NETHERLANDS;

Assignment For Published Patent Application

Smartflash Technologies Limited, Road Town, VIRGIN ISLANDS, BRITISH

Power of Attorney: The patent practitioners associated with Customer Number 20350

Domestic Priority data as claimed by applicant

This application is a CON of 12/943,872 11/10/2010 PAT 8118221
which is a CON of 12/014,558 01/15/2008 PAT 7942317
which is a CON of 11/336,758 01/19/2006 PAT 7334720
which is a CON of 10/111,716 09/17/2002 ABN
which is a 371 of PCT/GB2000/104110 10/25/2000

Foreign Applications (You may be eligible to benefit from the Patent Prosecution Highway program at the USPTO. Please see http://www.uspto.gov for more information.)
UNITED KINGDOM 9925227.2 10/25/1999

Request to Retrieve - This application either claims priority to one or more applications filed in an intellectual property Office that participates in the Priority Document Exchange (PDX) program or contains a proper Request to Retrieve Electronic Priority Application(s) (PTO/SB/38 or its equivalent). Consequently, the USPTO will attempt to electronically retrieve these priority documents.

If Required, Foreign Filing License Granted: 08/26/2011

The country code and number of your priority application, to be used for filing abroad under the Paris Convention, is **US 13/212,047**

Projected Publication Date: Not Applicable

Non-Publication Request: No

Early Publication Request: No

**** SMALL ENTITY ****

Title

DATA STORAGE AND ACCESS SYSTEMS

Preliminary Class

235

PROTECTING YOUR INVENTION OUTSIDE THE UNITED STATES

Since the rights granted by a U.S. patent extend only throughout the territory of the United States and have no effect in a foreign country, an inventor who wishes patent protection in another country must apply for a patent in a specific country or in regional patent offices. Applicants may wish to consider the filing of an international application under the Patent Cooperation Treaty (PCT). An international (PCT) application generally has the same effect as a regular national patent application in each PCT-member country. The PCT process **simplifies** the filing of patent applications on the same invention in member countries, but **does not result** in a grant of "an international patent" and does not eliminate the need of applicants to file additional documents and fees in countries where patent protection is desired.

Almost every country has its own patent law, and a person desiring a patent in a particular country must make an application for patent in that country in accordance with its particular laws. Since the laws of many countries differ in various respects from the patent law of the United States, applicants are advised to seek guidance from specific foreign countries to ensure that patent rights are not lost prematurely.

Applicants also are advised that in the case of inventions made in the United States, the Director of the USPTO must issue a license before applicants can apply for a patent in a foreign country. The filing of a U.S. patent application serves as a request for a foreign filing license. The application's filing receipt contains further information and guidance as to the status of applicant's license for foreign filing.

Applicants may wish to consult the USPTO booklet, "General Information Concerning Patents" (specifically, the section entitled "Treaties and Foreign Patents") for more information on timeframes and deadlines for filing foreign patent applications. The guide is available either by contacting the USPTO Contact Center at 800-786-9199, or it can be viewed on the USPTO website at <http://www.uspto.gov/web/offices/pac/doc/general/index.html>.

For information on preventing theft of your intellectual property (patents, trademarks and copyrights), you may wish to consult the U.S. Government website, <http://www.stopfakes.gov>. Part of a Department of Commerce initiative, this website includes self-help "toolkits" giving innovators guidance on how to protect intellectual property in specific countries such as China, Korea and Mexico. For questions regarding patent enforcement issues, applicants may call the U.S. Government hotline at 1-866-999-HALT (1-866-999-4158).

LICENSE FOR FOREIGN FILING UNDER
Title 35, United States Code, Section 184
Title 37, Code of Federal Regulations, 5.11 & 5.15

GRANTED

The applicant has been granted a license under 35 U.S.C. 184, if the phrase "IF REQUIRED, FOREIGN FILING LICENSE GRANTED" followed by a date appears on this form. Such licenses are issued in all applications where the conditions for issuance of a license have been met, regardless of whether or not a license may be required as set forth in 37 CFR 5.15. The scope and limitations of this license are set forth in 37 CFR 5.15(a) unless an earlier license has been issued under 37 CFR 5.15(b). The license is subject to revocation upon written notification. The date indicated is the effective date of the license, unless an earlier license of similar scope has been granted under 37 CFR 5.13 or 5.14.

This license is to be retained by the licensee and may be used at any time on or after the effective date thereof unless it is revoked. This license is automatically transferred to any related applications(s) filed under 37 CFR 1.53(d). This license is not retroactive.

The grant of a license does not in any way lessen the responsibility of a licensee for the security of the subject matter as imposed by any Government contract or the provisions of existing laws relating to espionage and the national security or the export of technical data. Licensees should apprise themselves of current regulations especially with respect to certain countries, of other agencies, particularly the Office of Defense Trade Controls, Department of State (with respect to Arms, Munitions and Implements of War (22 CFR 121-128)); the Bureau of Industry and Security, Department of Commerce (15 CFR parts 730-774); the Office of Foreign Assets Control, Department of Treasury (31 CFR Parts 500+) and the Department of Energy.

NOT GRANTED

No license under 35 U.S.C. 184 has been granted at this time, if the phrase "IF REQUIRED, FOREIGN FILING LICENSE GRANTED" DOES NOT appear on this form. Applicant may still petition for a license under 37 CFR 5.12, if a license is desired before the expiration of 6 months from the filing date of the application. If 6 months has lapsed from the filing date of this application and the licensee has not received any indication of a secrecy order under 35 U.S.C. 181, the licensee may foreign file the application pursuant to 37 CFR 5.15(b).

SelectUSA

The United States represents the largest, most dynamic marketplace in the world and is an unparalleled location for business investment, innovation and commercialization of new technologies. The USA offers tremendous resources and advantages for those who invest and manufacture goods here. Through SelectUSA, our nation works to encourage, facilitate, and accelerate business investment. To learn more about why the USA is the best country in the world to develop technology, manufacture products, and grow your business, visit SelectUSA.gov.



UNITED STATES PATENT AND TRADEMARK OFFICE

UNITED STATES DEPARTMENT OF COMMERCE
United States Patent and Trademark Office
Address: COMMISSIONER FOR PATENTS
P.O. Box 1450
Alexandria, Virginia 22313-1450
www.uspto.gov

APPLICATION NO.	FILING DATE	FIRST NAMED INVENTOR	ATTORNEY DOCKET NO.	CONFIRMATION NO.
13/212,047	08/17/2011	Patrick Sandor RACZ	87790-818158 (000150US)	5477
20350	7590	07/12/2012	EXAMINER	
KILPATRICK TOWNSEND & STOCKTON LLP TWO EMBARCADERO CENTER EIGHTH FLOOR SAN FRANCISCO, CA 94111-3834			LE, THIEN MINH	
			ART UNIT	PAPER NUMBER
			2887	
			NOTIFICATION DATE	DELIVERY MODE
			07/12/2012	ELECTRONIC

Please find below and/or attached an Office communication concerning this application or proceeding.

The time period for reply, if any, is set in the attached communication.

Notice of the Office communication was sent electronically on above-indicated "Notification Date" to the following e-mail address(es):

Docket@kilpatricktownsend.com
ipefiling@kilpatricktownsend.com
jlhice@kilpatrick.foundationip.com

Office Action Summary**Application No.**

13/212,047

Applicant(s)

RACZ ET AL.

Examiner

Thien M. Le

Art Unit

2887

-- The MAILING DATE of this communication appears on the cover sheet with the correspondence address --**Period for Reply**

A SHORTENED STATUTORY PERIOD FOR REPLY IS SET TO EXPIRE 3 MONTH(S) OR THIRTY (30) DAYS, WHICHEVER IS LONGER, FROM THE MAILING DATE OF THIS COMMUNICATION.

- Extensions of time may be available under the provisions of 37 CFR 1.136(a). In no event, however, may a reply be timely filed after SIX (6) MONTHS from the mailing date of this communication.
- If NO period for reply is specified above, the maximum statutory period will apply and will expire SIX (6) MONTHS from the mailing date of this communication.
- Failure to reply within the set or extended period for reply will, by statute, cause the application to become ABANDONED (35 U.S.C. § 133). Any reply received by the Office later than three months after the mailing date of this communication, even if timely filed, may reduce any earned patent term adjustment. See 37 CFR 1.704(b).

Status

- 1) Responsive to communication(s) filed on _____.
- 2a) This action is **FINAL**. 2b) This action is non-final.
- 3) An election was made by the applicant in response to a restriction requirement set forth during the interview on _____; the restriction requirement and election have been incorporated into this action.
- 4) Since this application is in condition for allowance except for formal matters, prosecution as to the merits is closed in accordance with the practice under *Ex parte Quayle*, 1935 C.D. 11, 453 O.G. 213.

Disposition of Claims

- 5) Claim(s) 1-39 is/are pending in the application.
 5a) Of the above claim(s) _____ is/are withdrawn from consideration.
- 6) Claim(s) _____ is/are allowed.
- 7) Claim(s) 1-39 is/are rejected.
- 8) Claim(s) _____ is/are objected to.
- 9) Claim(s) _____ are subject to restriction and/or election requirement.

Application Papers

- 10) The specification is objected to by the Examiner.
- 11) The drawing(s) filed on 17 August 2011 is/are: a) accepted or b) objected to by the Examiner.
 Applicant may not request that any objection to the drawing(s) be held in abeyance. See 37 CFR 1.85(a).
 Replacement drawing sheet(s) including the correction is required if the drawing(s) is objected to. See 37 CFR 1.121(d).
- 12) The oath or declaration is objected to by the Examiner. Note the attached Office Action or form PTO-152.

Priority under 35 U.S.C. § 119

- 13) Acknowledgment is made of a claim for foreign priority under 35 U.S.C. § 119(a)-(d) or (f).
 a) All b) Some * c) None of:
1. Certified copies of the priority documents have been received.
 2. Certified copies of the priority documents have been received in Application No. _____.
 3. Copies of the certified copies of the priority documents have been received in this National Stage application from the International Bureau (PCT Rule 17.2(a)).

* See the attached detailed Office action for a list of the certified copies not received.

Attachment(s)

- | | |
|--|---|
| 1) <input checked="" type="checkbox"/> Notice of References Cited (PTO-892) | 4) <input type="checkbox"/> Interview Summary (PTO-413)
Paper No(s)/Mail Date. _____ |
| 2) <input type="checkbox"/> Notice of Draftperson's Patent Drawing Review (PTO-948) | 5) <input type="checkbox"/> Notice of Informal Patent Application |
| 3) <input checked="" type="checkbox"/> Information Disclosure Statement(s) (PTO/SB/08)
Paper No(s)/Mail Date <u>8/17/2011</u> . | 6) <input type="checkbox"/> Other: _____ |

DETAILED ACTION

The information disclosure statement filed on 8/17/2011 has been entered.

Claims 1-39 are presented for examination.

Double Patenting

The nonstatutory double patenting rejection is based on a judicially created doctrine grounded in public policy (a policy reflected in the statute) so as to prevent the unjustified or improper timewise extension of the “right to exclude” granted by a patent and to prevent possible harassment by multiple assignees. A nonstatutory obviousness-type double patenting rejection is appropriate where the conflicting claims are not identical, but at least one examined application claim is not patentably distinct from the reference claim(s) because the examined application claim is either anticipated by, or would have been obvious over, the reference claim(s). See, e.g., *In re Berg*, 140 F.3d 1428, 46 USPQ2d 1226 (Fed. Cir. 1998); *In re Goodman*, 11 F.3d 1046, 29 USPQ2d 2010 (Fed. Cir. 1993); *In re Longi*, 759 F.2d 887, 225 USPQ 645 (Fed. Cir. 1985); *In re Van Ornum*, 686 F.2d 937, 214 USPQ 761 (CCPA 1982); *In re Vogel*, 422 F.2d 438, 164 USPQ 619 (CCPA 1970); and *In re Thorington*, 418 F.2d 528, 163 USPQ 644 (CCPA 1969).

A timely filed terminal disclaimer in compliance with 37 CFR 1.321(c) or 1.321(d) may be used to overcome an actual or provisional rejection based on a nonstatutory double patenting ground provided the conflicting application or patent either is shown to

Art Unit: 2887

be commonly owned with this application, or claims an invention made as a result of activities undertaken within the scope of a joint research agreement.

Effective January 1, 1994, a registered attorney or agent of record may sign a terminal disclaimer. A terminal disclaimer signed by the assignee must fully comply with 37 CFR 3.73(b).

Claims 1-36 are rejected on the ground of nonstatutory obviousness-type double patenting as being unpatentable over claims of U.S. Patent No. 7,334,720. Although the conflicting claims are not identical, they are not patentably distinct from each other because they essentially reciting the same limitations.

Claims 1-36 (specifically claims 1, 8, 14, 19, 25, 30, 35 and 36) are rejected in view of the claims of the '720 patent in that they recite the following features:

- a mobile data access terminal (claims 3, 12, 13);
- a non-volatile data memory (claim 1);
- a program store (claim 3);
- a processor (claim 3);
- a user interface (claims 1, 3);
- a display (displaying to the user – claim 1);
- code to request identifier data (claims 1, 5, 7);
- code to receive identifier data (claims 1, 5, 7, 18);
- code to display one or more item (claims 1, 5, 7, 11, 17);
- code to receive user selection (user's request for access to content data; user's inputs; claims 1, 8, 11, 17);

Art Unit: 2887

- code to receive payment validation (claims 3, 4, 14, 15);
- code to control access data (claims 1, 8).

As can be seen, claims 1-35 of this instant application are the combination of various features that have been recited in the claims of the '720 patent and would have been obvious to an ordinary skilled in the art. Thus, the patent protections have been provided to the earlier filed patent application.

The entire claim set of the '720 patent is herein presented for further reviews:

1. A method of controlling access to content data on a data carrier, the data carrier comprising non-volatile data memory storing content memory and non-volatile parameter memory storing use status data and use rules, the method comprising: receiving a data access request from a user for at least one content item of the content data stored in the non-volatile data memory; reading the use status data and use rules from the parameter memory that pertain to use of the at least one requested content item; evaluating the use status data using the use rules to determine whether access to the at least one requested content item stored in the content memory is permitted; and displaying to the user whether access is permitted for each of the at least one requested content item stored in the non-volatile data memory.

2. A method as claimed in claim 1 wherein said parameter memory further stores payment data and further comprising selecting one of said use rules dependent upon said payment data.

3. A data access terminal for retrieving data from a data supplier and providing the retrieved data to a data carrier, the terminal comprising: a first interface for communicating with the data supplier; a data carrier interface for interfacing with the data carrier; a program store storing code; and a processor coupled to the first interface, the data carrier interface, and the program store for implementing the stored code, the code comprising: code to read payment data from the data carrier and to forward the payment data to a payment validation system; code to receive payment validation data from the payment validation system; code responsive to the payment validation data to retrieve data from the data supplier and to write the retrieved data into the data carrier; and code responsive to the payment validation data to receive at least one access rule from the data supplier and to write the at least one access rule into the data carrier, the at least one access rule specifying at least one condition for accessing the retrieved data written into the data carrier, the at least one condition being dependent upon the amount of payment

Art Unit: 2887

associated with the payment data forwarded to the payment validation system.

4. A data access terminal as claimed in claim 3 further comprising code to transmit at least a portion of the payment validation data to the data supplier or to a destination received from the data supplier.

5. A data access terminal as claimed in claim 3 further comprising code to retrieve from the data supplier and output to a user stored data identifier data and associated value data and use rule data for a data item available from the data supplier.

6. A data access terminal as claimed in claim 5 further comprising code to write use rule data for a data item into the data carrier with the associated data item.

7. A data access terminal as claimed in claim 5 further comprising code to read a stored value from the data carrier, code to compare said stored value with said value data, and code to provide a modified output to a user of one or more of said stored data identifier data, said value data and said use rule data, in response to a result of the comparison.

8. A data access terminal according to claim 3 further comprising code for user input of access control data, code to output the access control data to the data carrier, and code to receive access permission data and output data to the user in response to the received access permission data.

9. A data access terminal as claimed in claim 8 further comprising code to output a data erasure warning in response to the received access permission data.

10. A data access terminal according to claim 3 further comprising code to read reward data from the data carrier and to write modified reward data to the data carrier in response to said retrieval of data from the data supplier.

11. A data access terminal according to claim 3 further comprising: code to read identity data from the data carrier; code to transmit the identity data to the data supplier; code to receive user characterizing data from the data supplier; code to retrieve supplementary data in response to said characterizing data; and code to output the supplementary data.

12. A data access terminal according to claim 3 further comprising a cash input device coupled to the processor, to provide cash input value data; and code to update payment data in the data carrier, in accordance with the cash input value data.

13. A data access terminal according to claim 3 integrated with a mobile communication device, a personal computer, an audio/video player, and/or a cable or satellite television interface device.

14. A method of providing data from a data supplier to a data carrier, the method comprising: reading payment data from the data carrier; forwarding the payment data to a payment validation system; retrieving data from the data supplier; writing the retrieved data into the data carrier; receiving at

Art Unit: 2887

least one access rule from the data supplier; and writing the at least one access rule into the data carrier, the at least one access rule specifying at least one condition for accessing the retrieved data written into the data carrier, the at least one condition being dependent upon the amount of payment associated with the payment data forwarded to the payment validation system.

15. A method of providing data from a data supplier according to claim 14 further comprising: receiving payment validation data from the payment validation system; and transmitting at least a portion of the payment validation data to the data supplier.

16. A method of providing data as claimed in claim 15, wherein the payment validation system comprises a payment processor at the data supplier.

17. A method of providing data as claimed in claim 16, further comprising: reading a stored value from the data carrier; comparing the stored value with said value data; and outputting to a user information indicating the result of said comparing.

18. A method of providing data as claimed in claim 14, further comprising: retrieving from the data supplier a stored data item identifier and associated value data; and writing the stored second data item identifier and associated value data for the data item into the data carrier.

Claim Rejections - 35 USC § 102

The following is a quotation of the appropriate paragraphs of 35 U.S.C. 102 that form the basis for the rejections under this section made in this Office action:

A person shall be entitled to a patent unless –

(b) the invention was patented or described in a printed publication in this or a foreign country or in public use or on sale in this country, more than one year prior to the date of application for patent in the United States.

Claims 37-39 are rejected under 35 U.S.C. 102(b) as being anticipated by Bertina et al. (Bertina et al. – 5,682,027; herein after referred to as Bertina).

Regarding claim 37, Bertina discloses IC card (IC card 13, figure 1) having a non-volatile memory (EEPROM 19) for containing transaction data and non-volatile memory (ROM 17 – figure 1) for storing instructions for conducting transactions with an external transaction device (figure 2).

Regarding claim 38, see the discussions regarding claim 37. The EEPROM is considered to include memory partitions as recited in this claim (also noted that applicant's data memory is also an EEPROM – par. 20, page 6 of the specification).

Regarding claim 39, see the discussions regarding claims 37-38. Further, the specific storage capacity value for the EEPROM is considered inherent since Bertina also discloses the use of an EEPROM and thus is not limited to a particular type of EEPROM.

Conclusion

Any inquiry concerning this communication or earlier communications from the examiner should be directed to Thien M. Le whose telephone number is (571)272-2396. The examiner can normally be reached on Monday - Friday from 7:30am - 4:00pm.

If attempts to reach the examiner by telephone are unsuccessful, the examiner's supervisor, Steve S. Paik can be reached on (571) 272-2404. The fax phone number for the organization where this application or proceeding is assigned is 571-273-8300.

Art Unit: 2887

Information regarding the status of an application may be obtained from the Patent Application Information Retrieval (PAIR) system. Status information for published applications may be obtained from either Private PAIR or Public PAIR. Status information for unpublished applications is available through Private PAIR only. For more information about the PAIR system, see <http://pair-direct.uspto.gov>. Should you have questions on access to the Private PAIR system, contact the Electronic Business Center (EBC) at 866-217-9197 (toll-free). If you would like assistance from a USPTO Customer Service Representative or access to the automated information system, call 800-786-9199 (IN USA OR CANADA) or 571-272-1000.

/Thien M. Le/
Primary Examiner, Art Unit 2887

Notice of References Cited	Application/Control No. 13/212,047	Applicant(s)/Patent Under Reexamination RACZ ET AL.	
	Examiner Thien M. Le	Art Unit 2887	Page 1 of 1

U.S. PATENT DOCUMENTS

*	Document Number Country Code-Number-Kind Code	Date MM-YYYY	Name	Classification
*	A US-5,682,027	10-1997	Bertina et al.	235/380
*	B US-4,590,365	05-1986	Okada, Toshihiko	235/379
*	C US-6,981,179	12-2005	Shigemasa et al.	714/36
*	D US-6,025,973	02-2000	Mizoshita et al.	360/98.08
	E US-			
	F US-			
	G US-			
	H US-			
	I US-			
	J US-			
	K US-			
	L US-			
	M US-			

FOREIGN PATENT DOCUMENTS

*	Document Number Country Code-Number-Kind Code	Date MM-YYYY	Country	Name	Classification
	N				
	O				
	P				
	Q				
	R				
	S				
	T				

NON-PATENT DOCUMENTS

*	Document Number Country Code-Number-Kind Code	Date MM-YYYY	Country	Name	Classification
	Include as applicable: Author, Title Date, Publisher, Edition or Volume, Pertinent Pages)				
	U				
	V				
	W				
	X				

*A copy of this reference is not being furnished with this Office action. (See MPEP § 707.05(a).)
Dates in MM-YYYY format are publication dates. Classifications may be US or foreign.

EAST Search History

EAST Search History (Prior Art)

Ref #	Hits	Search Query	DBs	Default Operator	Plurals	Time Stamp
S1	3	((("8118221") or ("7942317") or ("7334720")).PN.	US-PGPUB; USPAT	OR	OFF	2012/07/08 14:51
S2	1	S1 and identifier.clm. and processor.clm. and interface.clm. and memory.clm. and payment.clm. and validation.clm.	US-PGPUB; USPAT; EPO; JPO; DERWENT	OR	OFF	2012/07/08 15:12
S3	0	S1 and identifier.clm. and processor.clm. and interface.clm. and memory.clm. and payment.clm. and validation.clm. and display.clm.	US-PGPUB; USPAT; EPO; JPO; DERWENT	OR	OFF	2012/07/08 15:12
S4	1	S1 and identifier.clm. and processor.clm. and interface.clm. and memory.clm. and payment.clm. and validation.clm. and program.clm.	US-PGPUB; USPAT; EPO; JPO; DERWENT	OR	OFF	2012/07/08 15:13
S5	0	S1 and identifier.clm. and processor.clm. and interface.clm. and memory.clm. and payment.clm. and validation.clm. and program.clm. same request.clm.	US-PGPUB; USPAT; EPO; JPO; DERWENT	OR	OFF	2012/07/08 15:25
S6	2	S1 and request.clm.	US-PGPUB; USPAT; EPO; JPO; DERWENT	OR	OFF	2012/07/08 15:25
S7	0	S1 and request.clm. and receive.clm. and present.clm.	US-PGPUB; USPAT; EPO; JPO; DERWENT	OR	OFF	2012/07/08 15:33
S8	27343	code.clm. same request.clm.	US-PGPUB; USPAT; EPO; JPO; DERWENT	OR	OFF	2012/07/08 15:37
S9	1	S8 and S1	US-PGPUB; USPAT; EPO; JPO; DERWENT	OR	OFF	2012/07/08 15:37
S10	35059	code.clm. same receive.clm.	US-PGPUB; USPAT; EPO; JPO; DERWENT	OR	OFF	2012/07/08 15:38
S11	3	S10 and S1	US-PGPUB; USPAT; EPO; JPO; DERWENT	OR	OFF	2012/07/08 15:38
S12	1	S9 and S11	US-PGPUB; USPAT; EPO; JPO; DERWENT	OR	OFF	2012/07/08 15:38
S13	0	code.clm. same present.clm.	US-PGPUB;	OR	OFF	2012/07/08

			USPAT; EPO; JPO; DERWENT			15:39
S14	3000	code.clm. same payment.clm.	US-PGPUB; USPAT; EPO; JPO; DERWENT	OR	OFF	2012/07/08 15:39
S15	3	S14 and S1	US-PGPUB; USPAT; EPO; JPO; DERWENT	OR	OFF	2012/07/08 15:39
S16	1	S12 and S15	US-PGPUB; USPAT; EPO; JPO; DERWENT	OR	OFF	2012/07/08 15:39
S17	36126	code.clm. same access.clm.	US-PGPUB; USPAT; EPO; JPO; DERWENT	OR	OFF	2012/07/08 15:41
S18	1	S16 and S17	US-PGPUB; USPAT; EPO; JPO; DERWENT	OR	OFF	2012/07/08 15:42
S19	13678	code.clm. same selection\$1.clm.	US-PGPUB; USPAT; EPO; JPO; DERWENT	OR	OFF	2012/07/08 15:42
S20	0	S19 and S1	US-PGPUB; USPAT; EPO; JPO; DERWENT	OR	OFF	2012/07/08 15:42
S21	3	((("8118221") or ("7942317") or ("7334720")).PN.	US-PGPUB; USPAT	OR	OFF	2012/07/09 05:52
S22	3	S21 and user.clm.	US-PGPUB; USPAT; EPO; JPO; DERWENT	OR	OFF	2012/07/09 05:52
S23	3	((("8118221") or ("7942317") or ("7334720")).PN.	US-PGPUB; USPAT	OR	OFF	2012/07/09 07:46
S24	2	S23 and status.clm.	US-PGPUB; USPAT; EPO; JPO; DERWENT	OR	OFF	2012/07/09 07:47
S25	2	S23 and status.clm. and mobile.clm.	US-PGPUB; USPAT; EPO; JPO; DERWENT	OR	OFF	2012/07/09 07:47
S26	3	((("8118221") or ("7942317") or ("7334720")).PN.	US-PGPUB; USPAT	OR	OFF	2012/07/09 09:13
S27	1	S26 and portable.clm. and carrier.clm.	US-PGPUB; USPAT; EPO; JPO; DERWENT	OR	OFF	2012/07/09 09:13
S28	0	S27 and byte\$1.clm.	US-PGPUB; USPAT; EPO; JPO; DERWENT	OR	OFF	2012/07/09 09:13
S29	0	S27 and Mbyte.clm.	US-PGPUB;	OR	OFF	2012/07/09

			USPAT; EPO; JPO; DERWENT			09:13
S30	0	S26 and Mbyte.dlm.	US-PGPUB; USPAT; EPO; JPO; DERWENT	OR	OFF	2012/07/09 09:13
S31	2178	memory same network same parameter\$1 same card	US-PGPUB; USPAT; EPO; JPO; DERWENT	OR	OFF	2012/07/09 09:16
S32	39	memory same network same parameter\$1 same card same ((payment or transaction) near10 data)	US-PGPUB; USPAT; EPO; JPO; DERWENT	OR	OFF	2012/07/09 09:16
S33	61	memory same storing same card same ((payment or transaction) near10 data) same instructions	US-PGPUB; USPAT; EPO; JPO; DERWENT	OR	OFF	2012/07/09 09:35
S34	26	(IC adj2 card) same (mbyte\$1 or gbyte\$1) same capacity	US-PGPUB; USPAT; EPO; JPO; DERWENT	OR	OFF	2012/07/09 09:52

EAST Search History (Interference)

< This search history is empty >

7/9/2012 11:56:11 AM**C:\Users\tle4\Documents\EAST\Workspaces\13212047.wsp**

Substitute for form 1449/PTO INFORMATION DISCLOSURE STATEMENT BY APPLICANT (Use as many sheets as necessary)		Complete if Known	
		Application Number	Unassigned
		Filing Date	Unassigned
		First Named Inventor	RACZ, Patrick
		Art Unit	Unassigned 2887
		Examiner Name	Unassigned T. Le
Sheet	1	of	4
		Attorney Docket Number	87790-818158

U.S. PATENT DOCUMENTS					
Examiner Initials*	Cite No. ¹	Document Number	Publication Date MM-DD-YYYY	Name of Patentee or Applicant of Cited Document	Pages, Columns, Lines, Where Relevant Passages or Relevant Figures Appear
		Number Kind Code ² (if known)			
	AA	US 2003/0163594	8/28/2003	Aasheim et al.	
	AB	US 2003/0168515 A1	9/11/2003	Gray	
	AC	US 2006/0179211	8/10/2006	Aasheim et al.	
	AD	US 2006/0249570	11/9/2006	Seifert et al.	
	AE	US 2007/0162300	7/12/2007	Roever et al.	
	AF	US 2008/0041938	2/21/2008	Wise	
	AG	US 2008/0314974	12/25/2008	Hulst et al.	
	AH	US 4,341,951	Jul-82	Benton	
	AI	US 4,341,951	7/27/1982	Benton	
	AJ	US 4,697,073	9/29/1987	Hara	
	AK	US 5,148,432	9/15/1992	Gordon et al.	
	AL	US 5,226,145	7/6/1993	Moronaga et al.	
	AM	US 5,226,145	7/6/1993	Moronaga et al.	
	AN	US 5,367,150	11/22/1994	Kitta et al.	
	AO	US 5,406,619	4/11/1995	Akhteruzzaman et al.	
	AP	US 5,457,746	10/10/1995	Dolphin	
	AQ	US 5,532,466	7/2/1996	Konno et al.	
	AR	US 5,588,146	12/24/1996	Leroux	
	AS	US 5,677,953	10/14/1997	Dolphin	
	AT	US 5,703,951	12/30/1997	Dolphin	
	AU	US 5,740,369	4/14/1998	Yokozawa et al.	
	AV	US 5,744,787	4/28/1998	Teicher	
	AW	US 5,754,654	5/19/1998	Hiroya et al.	
	AX	US 5,794,202	8/11/1998	Kim	
	AY	US 5,809,241	9/15/1998	Hanel et al.	
	AZ	US 5,845,201	12/1/1998	Funke et al.	
	BA	US 5,845,281 A	12/1/1998	Benson et al.	
	BB	US 5,847,372	12/8/1998	Kreft	
	BC	US 5,874,760	2/23/1999	Burns et al.	
	BD	US 5,889,860	3/30/1999	Eller et al.	
	BE	US 5,901,330	5/4/1999	Sun et al.	
	BF	US 5,918,213	6/29/1999	Bernard et al.	
	BG	US 5,923,884	7/13/1999	Peyret et al.	
	BH	US 5,933,498 A	8/3/1999	Schneck et al.	
	BI	US 5,936,220	8/10/1999	Hoshino et al.	

Examiner Signature	/Thien Le/	Date Considered	07/09/2012
--------------------	------------	-----------------	------------

*EXAMINER: Initial if reference considered, whether or not citation is in conformance with MPEP 609. Draw line through citation if not in conformance and not considered. Include copy of this form with next communication to applicant. ¹ Applicant's unique citation designation number (optional). ² See Kind Codes of U.S. Patent Documents at www.uspto.gov or MPEP 901.04. ³ Enter Office that issued the document, by the two-letter code (WIPO Standard ST.3). ⁴ For Japanese patent documents, the indication of the year of the reign of the Emperor must precede the serial number of the patent document. ⁵ Kind of document by the appropriate symbols as indicated on the document under WIPO Standard ST. 16 if possible. ⁶ Applicant is to place a check mark here if English language Translation is attached.

Substitute for form 1449/PTO INFORMATION DISCLOSURE STATEMENT BY APPLICANT (Use as many sheets as necessary)				Complete if Known	
				Application Number	Unassigned
				Filing Date	Unassigned
				First Named Inventor	RACZ, Patrick
				Art Unit	Unassigned
				Examiner Name	Unassigned
Sheet	2	of	4	Attorney Docket Number	87790-818158

U.S. PATENT DOCUMENTS						
Examiner Initials*	Cite No. ¹	Document Number		Publication Date MM-DD-YYYY	Name of Patentee or Applicant of Cited Document	Pages, Columns, Lines, Where Relevant Passages or Relevant Figures Appear
		Number	Kind Code ² (if known)			
	BJ	US 6,012,634		1/11/2000	Brogan et al.	
	BK	US 6,018,720 A		1/25/2000	Fujimoto	Corresponds to JP 11-53184
	BL	US 6,078,917		6/20/2000	Paulsen et al.	
	BM	US 6,119,945		9/19/2000	Muller et al.	
	BN	US 6,142,369		Nov-00	Jonstromer	
	BO	US 6,202,056		3/13/2001	Nuttall	
	BP	US 6,385,731		5/7/2002	Ananda	
	BQ	US 6,415,156 B1		7/2/2002	Stadelmann	
	BR	US 6,424,975		7/23/2002	Walter et al.	
	BS	US 6,442,570		8/27/2002	Wu	
	BT	US 6,473,829		10/29/2002	Dahman et al.	
	BU	US 6,510,236		1/21/2003	Crane et al.	
	BV	US 6,553,413		4/22/2003	Leighton et al.	
	BW	US 6,554,192		4/29/2003	Tingl	
	BX	US 6,574,643		6/3/2003	Walter et al.	
	BY	US 6,658,568 B1		12/2/2003	Ginter et al.	
	BZ	US 6,721,749		4/13/2004	Najm et al.	
	BAA	US 6,747,930 B1		6/8/2004	Weldon et al.	
	CA	US 6,993,507		1/31/2006	Meyer et al.	
	CB	US 6,999,936		2/14/2006	Sehr	
	CC	US 7,000,836 B2		2/21/2006	Saeki	
	CD	US 7,044,362		5/16/2006	Yu	
	CE	US 7,083,081		8/1/2006	McGee et al.	
	CF	US 7,334,720		2/26/2008	Hulst et al.	
	CG	US 7,677,446		3/16/2010	Wise	
	CH	US 7,942,317		5/17/2011	Racz et al.	

FOREIGN PATENT DOCUMENTS								
Examiner Initials*	Cite No. ¹	Foreign Patent Document			Publication Date MM-DD-YYYY	Name of Patentee or Applicant of Cited Document	Pages, Columns, Lines, Where Relevant Passages or Relevant Figures Appear	T ⁶
		Country Code ³	Number ⁴	Kind Code ⁵ (if known)				
	CI	EP	0 195 098		10-03-1990	FPDC, Inc.		
	CJ	EP	0 542 298		04-22-1998	Hitachi, Ltd.		
	CK	EP	0 713 198	A2	05-22-1996	Nederland PTT		
	CL	EP	0 823 694	A1	02-11-1998	Citibank NA		

Examiner Signature	/Thien Le/	Date Considered	07/09/2012
--------------------	------------	-----------------	------------

*EXAMINER: Initial if reference considered, whether or not citation is in conformance with MPEP 609. Draw line through citation if not in conformance and not considered. Include copy of this form with next communication to applicant. ¹ Applicant's unique citation designation number (optional). ² See Kind Codes of U.S. Patent Documents at www.uspto.gov or MPEP 901.04. ³ Enter Office that issued the document, by the two-letter code (WIPO Standard ST.3). ⁴ For Japanese patent documents, the indication of the year of the reign of the Emperor must precede the serial number of the patent document. ⁵ Kind of document by the appropriate symbols as indicated on the document under WIPO Standard ST. 16 if possible. ⁶ Applicant is to place a check mark here if English language Translation is attached.

Substitute for form 1449/PTO INFORMATION DISCLOSURE STATEMENT BY APPLICANT (Use as many sheets as necessary)				Complete if Known	
				Application Number	Unassigned
				Filing Date	Unassigned
				First Named Inventor	RACZ, Patrick
				Art Unit	Unassigned
				Examiner Name	Unassigned
Sheet	3	of	4	Attorney Docket Number	87790-818158

FOREIGN PATENT DOCUMENTS								
Examiner Initials*	Cite No. ¹	Foreign Patent Document			Publication Date MM-DD-YYYY	Name of Patentee or Applicant of Cited Document	Pages, Columns, Lines, Where Relevant Passages or Relevant Figures Appear	T ⁶
		Country Code ³	Number ⁴	Kind Code ⁵ (if known)				
	CM	EP	0 843 449	A2	05-07-1998	Sunhawk Corp. Inc.		
	CN	EP	0 914 001	A1	05-06-1999	Canal Plus SA		
	CO	JP	10-269291	A	10-09-1998	Sony Corp.		
	CR	JP	11-212785	A	08-06-1999	Casio Comput. Co. Ltd.		
	CQ	JP	11-213010	A	08-06-1999	Planet Computer:KK		
	CR	JP	11-272762	A	10-08-1999	Hitachi Ltd.		
	CS	JP	11-53184	A	02-26-1999	Seta:KK	Corresponds to US 6,018,720	
	CT	WO	98/19237	A1	05-07-1998	Schulumberger Technologies, Inc.		
	CU	WO	98/33343		07-30-1998	Sonera OY et al.		
	CV	WO	98/37526		08-27-1998	Mondex Int. Ltd.		

Examiner Signature	/Thien Le/	Date Considered	07/09/2012
--------------------	------------	-----------------	------------

*EXAMINER: Initial if reference considered, whether or not citation is in conformance with MPEP 609. Draw line through citation if not in conformance and not considered. Include copy of this form with next communication to applicant. ¹ Applicant's unique citation designation number (optional). ² See Kind Codes of U.S. Patent Documents at www.uspto.gov or MPEP 901.04. ³ Enter Office that issued the document, by the two-letter code (WIPO Standard ST.3). ⁴ For Japanese patent documents, the indication of the year of the reign of the Emperor must precede the serial number of the patent document. ⁵ Kind of document by the appropriate symbols as indicated on the document under WIPO Standard ST. 16 if possible. ⁶ Applicant is to place a check mark here if English language Translation is attached.

Substitute for form 1449/PTO INFORMATION DISCLOSURE STATEMENT BY APPLICANT (Use as many sheets as necessary)				<i>Complete if Known</i>	
				Application Number	Unassigned
				Filing Date	Unassigned
				First Named Inventor	RACZ, Patrick
				Art Unit	Unassigned
				Examiner Name	Unassigned
Sheet	4	of	4	Attorney Docket Number	87790-818158

NON PATENT LITERATURE DOCUMENTS			
Examiner Initials *	Cite No. ¹	Include name of the author (in CAPITAL LETTERS), title of the article (when appropriate), title of the item (book, magazine, journal, serial, symposium, catalog, etc.), date, page(s), volume-issue number(s), publisher, city and/or country where published.	T ²

Examiner Signature	/Thien Le/	Date Considered	07/09/2012
--------------------	------------	-----------------	------------

*EXAMINER: Initial if reference considered, whether or not citation is in conformance with MPEP 609. Draw line through citation if not in conformance and not considered. Include copy of this form with next communication to applicant.
¹ Applicant's unique citation designation number (optional). ² Applicant is to place a check mark here if English language Translation is attached.

Search Notes 	Application/Control No. 13212047	Applicant(s)/Patent Under Reexamination RACZ ET AL.
	Examiner THIEN M LE	Art Unit 2887

SEARCHED			
Class	Subclass	Date	Examiner
235	380,382, 492, 451, 486, 487	7/9/2012	LTM

SEARCH NOTES		
Search Notes	Date	Examiner
EAST, review parent applications for double patenting	7/9/2012	LTM

INTERFERENCE SEARCH			
Class	Subclass	Date	Examiner

--	--

Index of Claims 	Application/Control No. 13212047	Applicant(s)/Patent Under Reexamination RACZ ET AL.
	Examiner THIEN M LE	Art Unit 2887

✓	Rejected
=	Allowed

-	Cancelled
÷	Restricted

N	Non-Elected
I	Interference

A	Appeal
O	Objected

Claims renumbered in the same order as presented by applicant
 CPA
 T.D.
 R.1.47

CLAIM		DATE							
Final	Original	07/09/2012							
	1	✓							
	2	✓							
	3	✓							
	4	✓							
	5	✓							
	6	✓							
	7	✓							
	8	✓							
	9	✓							
	10	✓							
	11	✓							
	12	✓							
	13	✓							
	14	✓							
	15	✓							
	16	✓							
	17	✓							
	18	✓							
	19	✓							
	20	✓							
	21	✓							
	22	✓							
	23	✓							
	24	✓							
	25	✓							
	26	✓							
	27	✓							
	28	✓							
	29	✓							
	30	✓							
	31	✓							
	32	✓							
	33	✓							
	34	✓							
	35	✓							
	36	✓							

<i>Index of Claims</i> 	Application/Control No. 13212047	Applicant(s)/Patent Under Reexamination RACZ ET AL.
	Examiner THIEN M LE	Art Unit 2887

✓	Rejected
=	Allowed

-	Cancelled
÷	Restricted

N	Non-Elected
I	Interference

A	Appeal
O	Objected

Claims renumbered in the same order as presented by applicant
 CPA
 T.D.
 R.1.47

CLAIM		DATE							
Final	Original	07/09/2012							
	37	✓							
	38	✓							
	39	✓							

UNITED STATES PATENT AND TRADEMARK OFFICE

UNITED STATES DEPARTMENT OF COMMERCE
United States Patent and Trademark Office
 Address: COMMISSIONER FOR PATENTS
 P.O. Box 1450
 Alexandria, Virginia 22313-1450
 www.uspto.gov

BIB DATA SHEET
CONFIRMATION NO. 5477

SERIAL NUMBER	FILING or 371(c) DATE	CLASS	GROUP ART UNIT	ATTORNEY DOCKET NO.	
13/212,047	08/17/2011	235	2887	87790-818158 (000150US)	
APPLICANTS Patrick Sandor RACZ, Saint Heller, UNITED KINGDOM; Hermen-ard Hulst, Amsterdam, NETHERLANDS;					
** CONTINUING DATA ***** This application is a CON of 12/943,872 11/10/2010 PAT 8,118,221 which is a CON of 12/014,558 01/15/2008 PAT 7,942,317 which is a CON of 11/336,758 01/19/2006 PAT 7,334,720 which is a CON of 10/111,716 09/17/2002 ABN which is a 371 of PCT/GB2000/104110 10/25/2000					
** FOREIGN APPLICATIONS ***** UNITED KINGDOM 9925227.2 10/25/1999					
** IF REQUIRED, FOREIGN FILING LICENSE GRANTED ** ** SMALL ENTITY ** 08/26/2011					
Foreign Priority claimed <input type="checkbox"/> Yes <input checked="" type="checkbox"/> No 35 USC 119(a-d) conditions met <input type="checkbox"/> Yes <input checked="" type="checkbox"/> No Verified and Acknowledged <u>/THIEN MINH LE/</u> Examiner's Signature	<input type="checkbox"/> Met after Allowance Initials _____	STATE OR COUNTRY UNITED KINGDOM	SHEETS DRAWINGS 17	TOTAL CLAIMS 39	INDEPENDENT CLAIMS 11
ADDRESS KILPATRICK TOWNSEND & STOCKTON LLP TWO EMBARCADERO CENTER EIGHTH FLOOR SAN FRANCISCO, CA 94111-3834 UNITED STATES					
TITLE DATA STORAGE AND ACCESS SYSTEMS					
FILING FEE RECEIVED 1836	FEES: Authority has been given in Paper No. _____ to charge/credit DEPOSIT ACCOUNT No. _____ for following:		<input type="checkbox"/> All Fees <input type="checkbox"/> 1.16 Fees (Filing) <input type="checkbox"/> 1.17 Fees (Processing Ext. of time) <input type="checkbox"/> 1.18 Fees (Issue) <input type="checkbox"/> Other _____ <input type="checkbox"/> Credit		

I hereby certify that this correspondence is being filed via
EFS-Web with the United States Patent and Trademark Office
on October 11, 2012.

PATENT
Attorney Docket No.: 87790-818158 (000150US)
Client Ref. No.: PN759544USF

KILPATRICK TOWNSEND & STOCKTON LLP

By: /Sylvia E. Arnold/

IN THE UNITED STATES PATENT AND TRADEMARK OFFICE

In re Application of:

Patrick Sandor Racz et al.

Application No.: 13/212,047

Filed: August 17, 2011

For: DATA STORAGE AND ACCESS
SYSTEMS

Customer No.: 20350

Confirmation No.: 5477

Examiner: Thien Minh Le

Technology Center/Art Unit: 2887

AMENDMENT

Mail Stop Amendment
Commissioner for Patents
P.O. Box 1450
Alexandria, VA 22313-1450

Commissioner:

In response to the Office Action mailed July 12, 2012, please enter the following
amendments and remarks:

Amendments to the Claims are reflected in the listing of claims which begins on
page 2 of this paper.

Remarks/Arguments begin on page 14 of this paper.

Amendments to the Claims:

This listing of claims will replace all prior versions, and listings of claims in the application:

Listing of Claims:

- 1 1. (Original) A handheld multimedia terminal, comprising:
 - 2 a wireless interface configured to interface with a wireless network for accessing
 - 3 a remote computer system;
 - 4 non-volatile memory configured to store multimedia content, wherein said
 - 5 multimedia content comprises one or more of music data, video data and computer game data;
 - 6 a program store storing processor control code;
 - 7 a processor coupled to said non-volatile memory, said program store, said
 - 8 wireless interface and
 - 9 a user interface to allow a user to select and play said multimedia content;
 - 10 a display for displaying one or both of said played multimedia content and data
 - 11 relating to said played multimedia content;
 - 12 wherein the processor control code comprises:
 - 13 code to request identifier data identifying one or more items of multimedia
 - 14 content stored in the non-volatile memory;
 - 15 code to receive said identifier data;
 - 16 code to present to a user on said display said identified one or more items
 - 17 of multimedia content available from the non-volatile memory;
 - 18 code to receive a user selection to select at least one of said one or more of
 - 19 said stored items of multimedia content;
 - 20 code responsive to said user selection of said at least one selected item of
 - 21 multimedia content to transmit payment data relating to payment for said at least one
 - 22 selected item of multimedia content via said wireless interface for validation by a
 - 23 payment validation system;
 - 24 code to receive payment validation data via said wireless interface
 - 25 defining if said payment validation system has validated payment for said at least one
 - 26 selected item of multimedia content; and

27 code to control access to said at least one selected item of multimedia
28 content on said terminal responsive to said payment validation data,
29 wherein said user interface is operable to enable a user to select said at least one
30 item of multimedia content available from said non-volatile memory; and
31 wherein said user interface is operable to enable a user to access said at least one
32 selected item of multimedia content responsive to said code to control access permitting access
33 to said at least one selected item of multimedia content.

1 2. (Original) A handheld multimedia terminal as claimed in claim 1, wherein
2 the code to control access to said at least one selected item of multimedia content on said
3 terminal responsive to said payment validation data comprises code to modify use control data
4 stored in said non-volatile memory to enable access to said at least one selected item of
5 multimedia content.

1 3. (Original) A handheld multimedia terminal as claimed in claim 1, further
2 comprising code to request content cost data via said wireless interface for said identified one or
3 more items of multimedia content, and further comprising code to receive said requested content
4 cost data via said wireless interface for said identified one or more items of multimedia content.

1 4. (Original) A handheld multimedia terminal as claimed in claim 1, wherein
2 said code responsive to said user selection of said at least one selected item of multimedia
3 content to transmit payment data relating to payment for said at least one selected item of
4 multimedia content via said wireless interface for validation by a payment validation system
5 comprises transmitting said payment data to a data access service provider.

1 5. (Original) A handheld multimedia terminal as claimed in claim 1, further
2 comprising code to retrieve supplementary data via said wireless interface and output said
3 supplementary data to said user using said display.

1 6. (Original) A handheld multimedia terminal as claimed in claim 1, further
2 comprising:
3 code to read use status data and use rules from said non-volatile memory
4 pertaining to said at least one selected item of multimedia content; and

5 wherein said code to control access to said selected item of multimedia content
6 further comprises code to evaluate said use status data and said use rules to determine whether
7 access is permitted to said at least one selected item of multimedia content.

1 7. (Original) A handheld multimedia terminal as claimed in claim 1, wherein
2 said at least one selected items of multimedia content comprises additional multimedia content
3 for another stored item of multimedia content.

1 8. (Original) A data access terminal for controlling access to one or more
2 content data items stored on a data carrier, the data access terminal comprising:

3 a user interface;

4 a data carrier interface;

5 a program store storing code implementable by a processor; and

6 a processor coupled to the user interface, to the data carrier interface and to the
7 program store for implementing the stored code, the code comprising:

8 code to request identifier data identifying one or more content data items stored
9 on the data carrier;

10 code to receive said identifier data;

11 code to present to a user via said user interface said identified one or more content
12 data items available from the data carrier;

13 code to receive a user selection selecting at least one of said one or more of said
14 stored content data items;

15 code responsive to said user selection of said selected content data item to
16 transmit payment data relating to payment for said selected content item for validation by a
17 payment validation system;

18 code to receive payment validation data defining if said payment validation
19 system has validated payment for said content data item; and

20 code to control access to said selected content data item responsive to the
21 payment validation data.

1 9. (Original) A data access terminal as claimed in claim 8, wherein said data
2 carrier is integrated into the data access terminal, and wherein said data carrier comprises flash
3 memory.

1 10. (Original) A data access terminal as claimed in claim 8, wherein said data
2 access terminal is integrated with a mobile communications device and audio/video player.

1 11. (Original) A data access terminal as claimed in claim 8, wherein said data
2 access terminal is integrated with a set top box.

1 12. (Original) A data access terminal as claimed in claim 8, wherein the
2 content data item comprises additional content data for another stored content data item.

1 13. (Original) A data access terminal as claimed in claim 12, wherein the
2 additional content data comprises a level on a game.

1 14. (Original) A handheld multimedia terminal, comprising:
2 a wireless interface configured to interface with a wireless network for
3 communicating with a data supplier;
4 non-volatile memory configured to store multimedia content, wherein said
5 multimedia content comprises one or more of music data, video data and computer game data;
6 a program store storing processor control code;
7 a processor coupled to said non-volatile memory, said program store, said
8 wireless interface and a user interface to allow a user to select and play said multimedia content;
9 a display for displaying one or both of said played multimedia content and data
10 relating to said played multimedia content;
11 wherein the processor control code comprises:
12 code to request identifier data identifying one or more items of multimedia
13 content available for retrieving via said wireless interface;
14 code to receive said identifier data via said wireless interface, said
15 identifier data identifying said one or more items of multimedia content available for
16 retrieving via said wireless interface;
17 code to request content information via said wireless interface, wherein
18 said content information comprises one or more of description data and cost data
19 pertaining to at least one of said one or more items of multimedia content identified by
20 said identifier data;
21 code to receive said content information via said wireless interface;

22 code to present said content information pertaining to said identified one
23 or more items of multimedia content available for retrieving to a user on said display;
24 code to receive a user selection selecting at least one of said one or more
25 items of multimedia content available for retrieving;
26 code responsive to said user selection of said selected at least one item of
27 multimedia content to transmit payment data relating to payment for said selected at least
28 one item of multimedia content via said wireless interface for validation by a payment
29 validation system;
30 code to receive payment validation data via said wireless interface
31 defining if said payment validation system has validated payment for said selected at
32 least one item of multimedia content; and
33 code responsive to said payment validation data to retrieve said selected at
34 least one item of multimedia content via said wireless interface from a data supplier and
35 to write said retrieved at least one item of multimedia content into said non-volatile
36 memory,
37 wherein said user interface is operable to enable a user to select said selected at
38 least one item of multimedia content available for retrieving.

1 15. (Original) A handheld multimedia terminal as claimed in claim 14,
2 wherein said code to request content information comprises code to request said content
3 information from a content access web server.

1 16. (Original) A handheld multimedia terminal as claimed in claim 14,
2 wherein said code to receive said content data item comprises code to retrieve said content data
3 item from a content provider.

1 17. (Original) A handheld multimedia terminal as claimed in claim 14,
2 wherein said identifier data is retrieved from a data supplier.

1 18. (Original) A handheld multimedia terminal as claimed in claim 14, further
2 comprising code to transmit at least a portion of said payment validation data to a data supplier
3 or to a destination received from said data supplier.

1 19. (Original) A data access terminal for retrieving a content data item from a
2 data supplier and providing the retrieved data item to a data carrier, the data access terminal
3 comprising:

4 a first interface for communicating with the data supplier;

5 a user interface;

6 a data carrier interface;

7 a program store storing code implementable by a processor; and

8 a processor coupled to the user interface, to the data carrier interface and to the
9 program store for implementing the stored code, the code comprising:

10 code to request identifier data identifying one or more content data items
11 available for retrieving;

12 code to receive said identifier data identifying said one or more content
13 data items available for retrieving;

14 code to request content information pertaining to at least one of said one
15 or more content data items identified by said identified data;

16 code to receive said content information;

17 code to present said content information to a user via said user interface
18 pertaining to said identified one or more content data items available for retrieving;

19 code to receive a user selection selecting at least one of said one or more
20 of said content data items available for retrieving;

21 code responsive to said user selection of said selected at least one content
22 data item to transmit payment data relating to payment for said selected at least one
23 content item for validation by a payment validation system;

24 code to receive payment validation data defining if said payment
25 validation system has validated payment for said selected at least one content data item;
26 and

27 code responsive to the payment validation data to retrieve said selected at
28 least one content data item from a data supplier and to write said retrieved at least one
29 content data item into said data carrier.

1 20. (Original) A data access terminal as claimed in claim 19, wherein said
2 content information comprises at least one of a content data item description and content cost
3 data.

1 21. (Original) A data access terminal as claimed in claim 19, wherein said
2 data carrier is integrated into said data access terminal, and wherein said data carrier comprises
3 flash memory.

1 22. (Original) A data access terminal as claimed in claim 19, wherein said
2 data access terminal is integrated with a mobile communications device and audio/video player.

1 23. (Original) A data access terminal as claimed in claim 19, wherein said
2 data access terminal is integrated with a set top box.

1 24. (Original) A data access terminal as claimed in claim 19, wherein the
2 content data item comprises one or more of music, films, TV programs, text, software, or games
3 software.

1 25. (Original) A handheld multimedia terminal for retrieving and accessing
2 protected multimedia content, comprising:

3 a wireless interface configured to interface with a wireless network for
4 communicating with a data supplier;

5 non-volatile memory configured to store multimedia content, wherein said
6 multimedia content comprises one or more of music data, video data and computer game data;

7 a program store storing processor control code;

8 a processor coupled to said non-volatile memory, said program store, said
9 wireless interface and

10 a user interface to allow a user to select and play said multimedia content;

11 a display for displaying one or both of said played multimedia content and data
12 relating to said played multimedia content;

13 wherein the processor control code comprises:

14 code to request identifier data identifying one or more items of multimedia
15 content available for retrieving via said wireless interface;

16 code to receive said identifier data via said wireless interface, said
17 identifier data identifying said one or more items of multimedia content available for
18 retrieving via said wireless interface;

19 code to request content information via said wireless interface, wherein
20 said content information comprises one or more of description data and cost data
21 pertaining to at least one of said one or more items of multimedia content identified by
22 said identifier data;

23 code to receive said content information via said wireless interface;

24 code to present said content information pertaining to said identified one
25 or more items of multimedia content available for retrieving to a user on said display;

26 code to receive a first user selection selecting at least one of said one or
27 more items of multimedia content available for retrieving;

28 code responsive to said first user selection of said selected at least one
29 item of multimedia content to transmit payment data relating to payment for said selected
30 at least one item of multimedia content via said wireless interface for validation by a
31 payment validation system;

32 code to receive payment validation data via said wireless interface
33 defining if said payment validation system has validated payment for said selected at
34 least one item of multimedia content; and

35 code responsive to said payment validation data to retrieve said selected at
36 least one item of multimedia content via said wireless interface from a data supplier and
37 to write said retrieved at least one item of multimedia content into said non-volatile
38 memory,

39 code to receive a second user selection selecting one or more of said items
40 of retrieved multimedia content to access;

41 code to read use status data and use rules from said non-volatile memory
42 pertaining to said second selected one or more items of retrieved multimedia content; and

43 code to evaluate said use status data and use rules to determine whether
44 access is permitted to said second selected one or more items of retrieved multimedia
45 content,

46 wherein said user interface is operable to enable a user to make said first user
47 selection of said selected at least one item of multimedia content available for retrieving,

48 wherein said user interface is operable to enable a user to make said second user
49 selection of said one or more items of retrieved multimedia content available for accessing, and
50 wherein said user interface is operable to enable a user to access said second user
51 selection of said one or more item of retrieved multimedia content responsive to said code to
52 control access permitting access to said second selected one or more items of retrieved
53 multimedia content.

1 26. (Original) A handheld multimedia terminal as claimed in claim 25,
2 further comprising code to present said second selected one or more items of retrieved
3 multimedia content to a user via said display if access is permitted.

1 27. (Original) A handheld multimedia terminal as claimed in claim 25,
2 wherein the rules comprise one or more of purchase rules, rental rules and subscription rules for
3 said second selected one or more items of retrieved multimedia content.

1 28. (Original) A handheld multimedia terminal as claimed in claim 25,
2 further comprising code to write updated use status data to said non volatile memory after user
3 access to the second selected one or more items of retrieved multimedia content.

1 29. (Original) A handheld multimedia as claimed in claim 28, further
2 comprising code to write partial use status data to said non volatile memory when only part of
3 one of said second selected one or more items of retrieved multimedia content has been accessed.

1 30. (Original) A data access terminal for controlling access to one or more
2 content data items stored on a data carrier, the data access terminal comprising:
3 a user interface;
4 a data carrier interface;
5 a program store storing code implementable by a processor; and
6 a processor coupled to the user interface, to the data carrier interface and to the
7 program store for implementing the stored code, the code comprising:
8 code to request identifier data identifying one or more content data
9 items available for retrieving;
10 code to receive said identifier data identifying said one or more
11 content data items available for retrieving;

12 code to request content information pertaining to at least one of
13 said one or more content data items identified by said identified data;
14 code to receive said content information;
15 code to present said content information to a user via said user
16 interface pertaining to said identified one or more content data items available for
17 retrieving;
18 code to receive a first user selection selecting at least one of said
19 one or more of said content data items available for retrieving;
20 code responsive to said first user selection of said selected at least
21 one content data item to transmit payment data relating to payment for said
22 selected at least one content item for validation by a payment validation system;
23 code to receive payment validation data defining if said payment
24 validation system has validated payment for said selected at least one content data
25 item;
26 code responsive to the payment validation data to retrieve said
27 selected at least one content data item from a data supplier and to write said
28 retrieved at least one content data item into said data carrier;
29 code to receive a second user selection selecting one of said one or
30 more of said retrieved content data items to access;
31 code to read use status data and use rules from said data carrier
32 pertaining to said second selected one or more retrieved content data items; and
33 code to evaluate said use status data and use rules to determine
34 whether access is permitted to said second selected one or more retrieved content
35 data items.

1 31. (Original) A data access terminal as claimed in claim 30, wherein said
2 data carrier is integrated into said data access terminal, and wherein said data carrier comprises
3 flash memory.

1 32. (Original) A data access terminal as claimed in claim 30, wherein said
2 data access terminal is integrated with a mobile communications device and audio/video player.

1 33. (Original) A data access terminal as claimed in claim 30, wherein said
2 data access terminal is integrated with a set top box.

1 34. (Original) A data access terminal as claimed in claim 30, wherein the
2 content data item comprises one or more of music, films, TV programs, text, software, or games
3 software.

1 35. (Original) A data access terminal for retrieving data from a data supplier
2 and providing the retrieved data to a data carrier, the terminal comprising:

3 a first interface for communicating with the data supplier;

4 a data carrier interface for interfacing with the data carrier;

5 a program store storing code; and

6 a processor coupled to the first interface, the data carrier interface, and the
7 program store for implementing the stored code,

8 the code comprising:

9 code to read payment data from the data carrier and to forward the
10 payment data to a payment validation system;

11 code to receive payment validation data from the payment validation
12 system;

13 code responsive to the payment validation data to retrieve data from the
14 data supplier and to write the retrieved data into the data carrier;

15 code responsive to the payment validation data to receive at least one
16 access rule from the data supplier and to write the at least one access rule into the data
17 carrier, the at least one access rule specifying at least one condition for accessing the
18 retrieved data written into the data carrier, the at least one condition being dependent
19 upon the amount of payment associated with the payment data forwarded to the payment
20 validation system;

21 code to retrieve from the data supplier and output to a user stored data
22 identifier data and associated value data and use rule data for a data item available from
23 the data supplier; and

24 code to write use rule data for a data item into the data carrier with the
25 associated data item,

26 wherein the data access terminal is integrated with a mobile
27 communication device, a personal computer, an audio/video player, and/or a set top box.

1 36. (Original) A data access device for retrieving stored data from a data
2 carrier, the device comprising:

3 a user interface;
4 a data carrier interface;
5 a program store storing code implementable by a processor; and
6 a processor coupled to the user interface, to the data carrier interface and to the
7 program store for implementing the stored code,

8 the code comprising:

9 code to retrieve use status data indicating a use status of data stored on the
10 carrier, and use rules data indicating permissible use of data stored on the carrier;

11 code to evaluate the use status data using the use rules data to determine
12 whether access is permitted to the stored data;

13 code to access the stored data when access is permitted; and

14 code to write partial use status data to the data carrier when only part of a
15 stored data item has been accessed,

16 wherein the data access terminal is integrated with a mobile communication
17 device, a personal computer, an audio/video player, and/or a set top box.

1 37-39. (Cancelled)

REMARKS/ARGUMENTS

This Amendment is in response to the Office Action mailed July 12, 2012. Before this Amendment, claims 1-39 were pending. Claims 1-39 are rejected. Specifically, claims 1-36 stand rejected under nonstatutory obviousness-type double patenting. Claims 37-39 were rejected under 35 U.S.C. § 102(b) as being anticipated by Bertina et al. (US 5,682,027) (hereinafter "Bertina"). In this Amendment, claims 37-39 have been cancelled. After entry of this Amendment, which is respectfully requested, claims 1-36 will be pending. Reconsideration of the remaining rejected claims is hereby requested.

I. Examiner Interview

A telephone interview was conducted with Examiner Le on October 10, 2012, at 1:00 PM Eastern Time. The undersigned attorney represented Applicant in the interview. In the interview, it was agreed that claims 1-36 would be allowable if a terminal disclaimer was filed. It was also agreed that cancelling claims 37-39 would then put the application in condition for allowance. Applicant appreciates Examiner Le's suggestions and presents this response accordingly.

II. Double Patenting Rejection

The Office Action rejects claims 1-36 on the ground of nonstatutory obviousness-type double patenting as being unpatentable over the claims of U.S. Patent No. 7,334,720. A terminal disclaimer will be filed separately. It is Applicant's understanding that this will place claims 1-36 in condition for allowance.

III. Rejections Under 35 U.S.C. § 102

The Office Action rejected claims 37-39 under 35 U.S.C. 102(b) as being anticipated by Lin (US 5,682,027) (hereinafter "Bertina"). Without conceding the rejection, Applicant has incorporated the Examiner's suggestion for the purpose of efficiently advancing prosecution. Claims 37-39 have been cancelled in accordance with an agreement with the Examiner. Rejection of claims 37-39 are now moot in light of their cancelled status.

IV. Discussion of the Claims

By focusing on specific claims and claim elements in the discussion above, Applicant does not imply that other claim elements are disclosed or suggested by the references. In addition, any characterizations of claims and/or cited art are being made to facilitate expeditious prosecution of this application. Applicant reserves the right to pursue at a later date any other broader or narrower claims that capture any subject matter supported by the present disclosure, including subject matter found to be specifically disclaimed herein or by another prosecution. Accordingly, reviewers of this or any child or related prosecution history shall not reasonably infer that Applicant has made any disclaimers or disavowals of any subject matter supported by the present disclosure.

CONCLUSION

In view of the foregoing, Applicant believes all claims now pending in this Application are in condition for allowance. The issuance of a formal Notice of Allowance at an early date is respectfully requested.

Further, the Commissioner is hereby authorized to charge any additional fees or credit any overpayment in connection with this paper to Deposit Account No. 20-1430.

If the Examiner believes a telephone conference would expedite prosecution of this application, please telephone the undersigned at 925-472-4741.

Respectfully submitted,

/Ben Holt/

Benjamin J. Holt
Registration No. 67,536

KILPATRICK TOWNSEND & STOCKTON LLP
Two Embarcadero Center, Eighth Floor
San Francisco, California 94111-3834
Tel: 415-576-0200
Fax: 415-576-0300
BJH/sea
64535164v.1

Electronic Acknowledgement Receipt

EFS ID:	13960157
Application Number:	13212047
International Application Number:	
Confirmation Number:	5477
Title of Invention:	DATA STORAGE AND ACCESS SYSTEMS
First Named Inventor/Applicant Name:	Patrick Sandor RACZ
Customer Number:	20350
Filer:	Benjamin J. Holt/Sylvia Arnold
Filer Authorized By:	Benjamin J. Holt
Attorney Docket Number:	87790-818158 (000150US)
Receipt Date:	11-OCT-2012
Filing Date:	17-AUG-2011
Time Stamp:	12:41:06
Application Type:	Utility under 35 USC 111(a)

Payment information:

Submitted with Payment	no
------------------------	----

File Listing:

Document Number	Document Description	File Name	File Size(Bytes)/ Message Digest	Multi Part /.zip	Pages (if appl.)
1	Amendment/Req. Reconsideration-After Non-Final Reject	2012_10_11_AMEND_87790-818158-000150US.pdf	121393 <small>fc6099b9ded6a865391b6a6e35b5bc7902a7d7cd</small>	no	15

Warnings:

Information:

This Acknowledgement Receipt evidences receipt on the noted date by the USPTO of the indicated documents, characterized by the applicant, and including page counts, where applicable. It serves as evidence of receipt similar to a Post Card, as described in MPEP 503.

New Applications Under 35 U.S.C. 111

If a new application is being filed and the application includes the necessary components for a filing date (see 37 CFR 1.53(b)-(d) and MPEP 506), a Filing Receipt (37 CFR 1.54) will be issued in due course and the date shown on this Acknowledgement Receipt will establish the filing date of the application.

National Stage of an International Application under 35 U.S.C. 371

If a timely submission to enter the national stage of an international application is compliant with the conditions of 35 U.S.C. 371 and other applicable requirements a Form PCT/DO/EO/903 indicating acceptance of the application as a national stage submission under 35 U.S.C. 371 will be issued in addition to the Filing Receipt, in due course.

New International Application Filed with the USPTO as a Receiving Office

If a new international application is being filed and the international application includes the necessary components for an international filing date (see PCT Article 11 and MPEP 1810), a Notification of the International Application Number and of the International Filing Date (Form PCT/RO/105) will be issued in due course, subject to prescriptions concerning national security, and the date shown on this Acknowledgement Receipt will establish the international filing date of the application.

Under the Paperwork Reduction Act of 1995, no persons are required to respond to a collection of information unless it displays a valid OMB control number.

**TERMINAL DISCLAIMER TO OBTAIN A DOUBLE PATENTING
REJECTION OVER A "PRIOR" PATENT**Docket Number (Optional)
87790-818158(000150US)

In re Application of: Patrick Sandor Racz

Application No. 13/212,047 Conf.: 5477

Filed: August 17, 2011

For: DATA STORAGE AND ACCESS SYSTEMS

The owner*, Smartflash Technologies Limited, of 100% percent interest in the instant application hereby disclaims, except as provided below, the terminal part of the statutory term of any patent granted on the instant application which would extend beyond the expiration date of the full statutory term **prior patent** No. 7,334,720 as the term of said prior patent is defined in 35 U.S.C. 154 and 173, and as the term of said **prior patent** is presently shortened by any terminal disclaimer. The owner hereby agrees that any patent so granted on the instant application shall be enforceable only for and during such period that it and the **prior patent** are commonly owned. This agreement runs with any patent granted on the instant application and is binding upon the grantee, its successors or assigns.

In making the above disclaimer, the owner does not disclaim the terminal part of the term of any patent granted on the instant application that would extend to the expiration date of the full statutory term as defined in 35 U.S.C. 154 and 173 of the **prior patent**, "as the term of said **prior patent** is presently shortened by any terminal disclaimer," in the event that said **prior patent** later:

- expires for failure to pay a maintenance fee;
- is held unenforceable;
- is found invalid by a court of competent jurisdiction;
- is statutorily disclaimed in whole or terminally disclaimed under 37 CFR 1.321;
- has all claims canceled by a reexamination certificate;
- is reissued; or
- is in any manner terminated prior to the expiration of its full statutory term as presently shortened by any terminal disclaimer.

Check either box 1 or 2 below, if appropriate.

1. For submissions on behalf of a business/organization (e.g., corporation, partnership, university, government agency, etc.), the undersigned is empowered to act on behalf of the business/organization.

I hereby declare that all statements made herein of my own knowledge are true and that all statements made on information and belief are believed to be true; and further that these statements were made with the knowledge that willful false statements and the like so made are punishable by fine or imprisonment, or both, under Section 1001 of Title 18 of the United States Code and that such willful false statements may jeopardize the validity of the application or any patent issued thereon.

2. The undersigned is an attorney of record. Reg. No. 67,536

/Ben Holt/

10/10/2012

Signature

Date

Benjamin J. Holt

Typed or printed name

925-472-4741

Telephone Number

- Terminal disclaimer fee under 37 CFR 1.20(d) is included.

WARNING: Information on this form may become public. Credit card information should not be included on this form. Provide credit card information and authorization on PTO-2038.

*Statement under 37 CFR 3.73(b) is required if terminal disclaimer is signed by the assignee (owner).

Form PTO/SB/96 may be used for making this certification. See MPEP § 324.

This collection of information is required by 37 CFR 1.321. The information is required to obtain or retain a benefit by the public which is to file (and by the USPTO to process) an application. Confidentiality is governed by 35 U.S.C. 122 and 37 CFR 1.11 and 1.14. This collection is estimated to take 12 minutes to complete, including gathering, preparing, and submitting the completed application form to the USPTO. Time will vary depending upon the individual case. Any comments on the amount of time you require to complete this form and/or suggestions for reducing this burden, should be sent to the Chief Information Officer, U.S. Patent and Trademark Office, U.S. Department of Commerce, P.O. Box 1450, Alexandria, VA 22313-1450. DO NOT SEND FEES OR COMPLETED FORMS TO THIS ADDRESS. **SEND TO: Commissioner for Patents, P.O. Box 1450, Alexandria, VA22313-1450.**

If you need assistance in completing the form, call 1-800-PTO-9199 and select option 2.

Electronic Patent Application Fee Transmittal

Application Number:	13212047			
Filing Date:	17-Aug-2011			
Title of Invention:	DATA STORAGE AND ACCESS SYSTEMS			
First Named Inventor/Applicant Name:	Patrick Sandor RACZ			
Filer:	Benjamin J. Holt/Sylvia Arnold			
Attorney Docket Number:	87790-818158 (000150US)			
Filed as Large Entity				
Utility under 35 USC 111(a) Filing Fees				
Description	Fee Code	Quantity	Amount	Sub-Total in USD(\$)
Basic Filing:				
Pages:				
Claims:				
Miscellaneous-Filing:				
Petition:				
Patent-Appeals-and-Interference:				
Post-Allowance-and-Post-Issuance:				
Extension-of-Time:				

Description	Fee Code	Quantity	Amount	Sub-Total in USD(\$)
Miscellaneous:				
Statutory or terminal disclaimer	1814	1	160	160
Total in USD (\$)				160

Electronic Acknowledgement Receipt

EFS ID:	13960898
Application Number:	13212047
International Application Number:	
Confirmation Number:	5477
Title of Invention:	DATA STORAGE AND ACCESS SYSTEMS
First Named Inventor/Applicant Name:	Patrick Sandor RACZ
Customer Number:	20350
Filer:	Benjamin J. Holt/Sylvia Arnold
Filer Authorized By:	Benjamin J. Holt
Attorney Docket Number:	87790-818158 (000150US)
Receipt Date:	11-OCT-2012
Filing Date:	17-AUG-2011
Time Stamp:	13:35:34
Application Type:	Utility under 35 USC 111(a)

Payment information:

Submitted with Payment	yes
Payment Type	Credit Card
Payment was successfully received in RAM	\$160
RAM confirmation Number	10760
Deposit Account	201430
Authorized User	KILPATRICK TOWNSEND & STOCKTON, LLP

The Director of the USPTO is hereby authorized to charge indicated fees and credit any overpayment as follows:

Charge any Additional Fees required under 37 C.F.R. Section 1.16 (National application filing, search, and examination fees)

Charge any Additional Fees required under 37 C.F.R. Section 1.17 (Patent application and reexamination proceeding fees)

File Listing:

Document Number	Document Description	File Name	File Size(Bytes)/ Message Digest	Multi Part /.zip	Pages (if appl.)
1	Statutory disclaimers per MPEP 1490.	2012_10_11_TD_87790-81815 8-000150US.pdf	82428 75fb8c6c94d44298f60932922805a6f51231f6554	no	1

Warnings:**Information:**

2	Fee Worksheet (SB06)	fee-info.pdf	30534 23ec42dcf2a9358b545260428fd6b54be6b93718	no	2
---	----------------------	--------------	---	----	---

Warnings:**Information:**

Total Files Size (in bytes):			112962		
-------------------------------------	--	--	--------	--	--

This Acknowledgement Receipt evidences receipt on the noted date by the USPTO of the indicated documents, characterized by the applicant, and including page counts, where applicable. It serves as evidence of receipt similar to a Post Card, as described in MPEP 503.

New Applications Under 35 U.S.C. 111

If a new application is being filed and the application includes the necessary components for a filing date (see 37 CFR 1.53(b)-(d) and MPEP 506), a Filing Receipt (37 CFR 1.54) will be issued in due course and the date shown on this Acknowledgement Receipt will establish the filing date of the application.

National Stage of an International Application under 35 U.S.C. 371

If a timely submission to enter the national stage of an international application is compliant with the conditions of 35 U.S.C. 371 and other applicable requirements a Form PCT/DO/EO/903 indicating acceptance of the application as a national stage submission under 35 U.S.C. 371 will be issued in addition to the Filing Receipt, in due course.

New International Application Filed with the USPTO as a Receiving Office

If a new international application is being filed and the international application includes the necessary components for an international filing date (see PCT Article 11 and MPEP 1810), a Notification of the International Application Number and of the International Filing Date (Form PCT/RO/105) will be issued in due course, subject to prescriptions concerning national security, and the date shown on this Acknowledgement Receipt will establish the international filing date of the application.

Under the Paperwork Reduction Act of 1995, no persons are required to respond to a collection of information unless it displays a valid OMB control number.

PATENT APPLICATION FEE DETERMINATION RECORD Substitute for Form PTO-875	Application or Docket Number 13/212,047	Filing Date 08/17/2011	<input checked="" type="checkbox"/> To be Mailed
---	---	----------------------------------	--

APPLICATION AS FILED – PART I			OTHER THAN SMALL ENTITY			
	(Column 1)	(Column 2)	SMALL ENTITY <input checked="" type="checkbox"/>	OR		
FOR	NUMBER FILED	NUMBER EXTRA	RATE (\$)	FEE (\$)	RATE (\$)	FEE (\$)
<input type="checkbox"/> BASIC FEE <small>(37 CFR 1.16(a), (b), or (c))</small>	N/A	N/A	N/A		N/A	
<input type="checkbox"/> SEARCH FEE <small>(37 CFR 1.16(k), (j), or (m))</small>	N/A	N/A	N/A		N/A	
<input type="checkbox"/> EXAMINATION FEE <small>(37 CFR 1.16(o), (p), or (q))</small>	N/A	N/A	N/A		N/A	
TOTAL CLAIMS <small>(37 CFR 1.16(j))</small>	minus 20 =	*	X \$ =	OR	X \$ =	
INDEPENDENT CLAIMS <small>(37 CFR 1.16(h))</small>	minus 3 =	*	X \$ =		X \$ =	
<input type="checkbox"/> APPLICATION SIZE FEE <small>(37 CFR 1.16(s))</small>	If the specification and drawings exceed 100 sheets of paper, the application size fee due is \$250 (\$125 for small entity) for each additional 50 sheets or fraction thereof. See 35 U.S.C. 41(a)(1)(G) and 37 CFR 1.16(s).					
<input type="checkbox"/> MULTIPLE DEPENDENT CLAIM PRESENT <small>(37 CFR 1.16(j))</small>						
* If the difference in column 1 is less than zero, enter "0" in column 2.			TOTAL		TOTAL	

APPLICATION AS AMENDED – PART II					OTHER THAN SMALL ENTITY			
	(Column 1)	(Column 2)	(Column 3)					
AMENDMENT	10/11/2012	CLAIMS REMAINING AFTER AMENDMENT	HIGHEST NUMBER PREVIOUSLY PAID FOR	PRESENT EXTRA	RATE (\$)	ADDITIONAL FEE (\$)	RATE (\$)	ADDITIONAL FEE (\$)
	Total (37 CFR 1.16(i))	* 36	Minus ** 39	= 0	X \$31 =	0	OR	X \$ =
	Independent (37 CFR 1.16(h))	* 8	Minus ***11	= 0	X \$125 =	0	OR	X \$ =
	<input type="checkbox"/> Application Size Fee (37 CFR 1.16(s))						OR	
	<input type="checkbox"/> FIRST PRESENTATION OF MULTIPLE DEPENDENT CLAIM (37 CFR 1.16(j))						OR	
					TOTAL ADD'L FEE	0	OR	TOTAL ADD'L FEE

	(Column 1)	(Column 2)	(Column 3)					
AMENDMENT		CLAIMS REMAINING AFTER AMENDMENT	HIGHEST NUMBER PREVIOUSLY PAID FOR	PRESENT EXTRA	RATE (\$)	ADDITIONAL FEE (\$)	RATE (\$)	ADDITIONAL FEE (\$)
	Total (37 CFR 1.16(i))	*	Minus **	=	X \$ =		OR	X \$ =
	Independent (37 CFR 1.16(h))	*	Minus ***	=	X \$ =		OR	X \$ =
	<input type="checkbox"/> Application Size Fee (37 CFR 1.16(s))						OR	
	<input type="checkbox"/> FIRST PRESENTATION OF MULTIPLE DEPENDENT CLAIM (37 CFR 1.16(j))						OR	
					TOTAL ADD'L FEE		OR	TOTAL ADD'L FEE

* If the entry in column 1 is less than the entry in column 2, write "0" in column 3.
 ** If the "Highest Number Previously Paid For" IN THIS SPACE is less than 20, enter "20".
 *** If the "Highest Number Previously Paid For" IN THIS SPACE is less than 3, enter "3".
 The "Highest Number Previously Paid For" (Total or Independent) is the highest number found in the appropriate box in column 1.

Legal Instrument Examiner:
 /ANGELA JOHNSON/

This collection of information is required by 37 CFR 1.16. The information is required to obtain or retain a benefit by the public which is to file (and by the USPTO to process) an application. Confidentiality is governed by 35 U.S.C. 122 and 37 CFR 1.14. This collection is estimated to take 12 minutes to complete, including gathering, preparing, and submitting the completed application form to the USPTO. Time will vary depending upon the individual case. Any comments on the amount of time you require to complete this form and/or suggestions for reducing this burden, should be sent to the Chief Information Officer, U.S. Patent and Trademark Office, U.S. Department of Commerce, P.O. Box 1450, Alexandria, VA 22313-1450. DO NOT SEND FEES OR COMPLETED FORMS TO THIS ADDRESS. **SEND TO: Commissioner for Patents, P.O. Box 1450, Alexandria, VA 22313-1450.**

If you need assistance in completing the form, call 1-800-PTO-9199 and select option 2.

Application Number 	Application/Control No. 13/212,047	Applicant(s)/Patent under Reexamination RACZ ET AL.	

Document Code - DISQ	Internal Document – DO NOT MAIL
-----------------------------	--

TERMINAL DISCLAIMER	<input checked="" type="checkbox"/> APPROVED	<input type="checkbox"/> DISAPPROVED
Date Filed : 10/11/12	This patent is subject to a Terminal Disclaimer	

Approved/Disapproved by:

Felicia D. Roberts
 7,334,720



NOTICE OF ALLOWANCE AND FEE(S) DUE

20350 7590 10/30/2012
KILPATRICK TOWNSEND & STOCKTON LLP
TWO EMBARCADERO CENTER
EIGHTH FLOOR
SAN FRANCISCO, CA 94111-3834

EXAMINER
LE, THIEN MINH
ART UNIT PAPER NUMBER

2887

DATE MAILED: 10/30/2012

Table with 5 columns: APPLICATION NO., FILING DATE, FIRST NAMED INVENTOR, ATTORNEY DOCKET NO., CONFIRMATION NO.

13/212,047 08/17/2011 Patrick Sandor RACZ 87790-818158 (000150US) 5477

TITLE OF INVENTION: DATA STORAGE AND ACCESS SYSTEMS

Table with 7 columns: APPLN. TYPE, SMALL ENTITY, ISSUE FEE DUE, PUBLICATION FEE DUE, PREV. PAID ISSUE FEE, TOTAL FEE(S) DUE, DATE DUE

nonprovisional YES \$885 \$300 \$0 \$1185 01/30/2013

THE APPLICATION IDENTIFIED ABOVE HAS BEEN EXAMINED AND IS ALLOWED FOR ISSUANCE AS A PATENT. PROSECUTION ON THE MERITS IS CLOSED. THIS NOTICE OF ALLOWANCE IS NOT A GRANT OF PATENT RIGHTS. THIS APPLICATION IS SUBJECT TO WITHDRAWAL FROM ISSUE AT THE INITIATIVE OF THE OFFICE OR UPON PETITION BY THE APPLICANT. SEE 37 CFR 1.313 AND MPEP 1308.

THE ISSUE FEE AND PUBLICATION FEE (IF REQUIRED) MUST BE PAID WITHIN THREE MONTHS FROM THE MAILING DATE OF THIS NOTICE OR THIS APPLICATION SHALL BE REGARDED AS ABANDONED. THIS STATUTORY PERIOD CANNOT BE EXTENDED. SEE 35 U.S.C. 151. THE ISSUE FEE DUE INDICATED ABOVE DOES NOT REFLECT A CREDIT FOR ANY PREVIOUSLY PAID ISSUE FEE IN THIS APPLICATION. IF AN ISSUE FEE HAS PREVIOUSLY BEEN PAID IN THIS APPLICATION (AS SHOWN ABOVE), THE RETURN OF PART B OF THIS FORM WILL BE CONSIDERED A REQUEST TO REAPPLY THE PREVIOUSLY PAID ISSUE FEE TOWARD THE ISSUE FEE NOW DUE.

HOW TO REPLY TO THIS NOTICE:

I. Review the SMALL ENTITY status shown above.

If the SMALL ENTITY is shown as YES, verify your current SMALL ENTITY status:

A. If the status is the same, pay the TOTAL FEE(S) DUE shown above.

B. If the status above is to be removed, check box 5b on Part B - Fee(s) Transmittal and pay the PUBLICATION FEE (if required) and twice the amount of the ISSUE FEE shown above, or

If the SMALL ENTITY is shown as NO:

A. Pay TOTAL FEE(S) DUE shown above, or

B. If applicant claimed SMALL ENTITY status before, or is now claiming SMALL ENTITY status, check box 5a on Part B - Fee(s) Transmittal and pay the PUBLICATION FEE (if required) and 1/2 the ISSUE FEE shown above.

II. PART B - FEE(S) TRANSMITTAL, or its equivalent, must be completed and returned to the United States Patent and Trademark Office (USPTO) with your ISSUE FEE and PUBLICATION FEE (if required). If you are charging the fee(s) to your deposit account, section "4b" of Part B - Fee(s) Transmittal should be completed and an extra copy of the form should be submitted. If an equivalent of Part B is filed, a request to reapply a previously paid issue fee must be clearly made, and delays in processing may occur due to the difficulty in recognizing the paper as an equivalent of Part B.

III. All communications regarding this application must give the application number. Please direct all communications prior to issuance to Mail Stop ISSUE FEE unless advised to the contrary.

IMPORTANT REMINDER: Utility patents issuing on applications filed on or after Dec. 12, 1980 may require payment of maintenance fees. It is patentee's responsibility to ensure timely payment of maintenance fees when due.

PART B - FEE(S) TRANSMITTAL

**Complete and send this form, together with applicable fee(s), to: Mail Mail Stop ISSUE FEE
 Commissioner for Patents
 P.O. Box 1450
 Alexandria, Virginia 22313-1450
 or Fax (571)-273-2885**

INSTRUCTIONS: This form should be used for transmitting the ISSUE FEE and PUBLICATION FEE (if required). Blocks 1 through 5 should be completed where appropriate. All further correspondence including the Patent, advance orders and notification of maintenance fees will be mailed to the current correspondence address as indicated unless corrected below or directed otherwise in Block 1, by (a) specifying a new correspondence address; and/or (b) indicating a separate "FEE ADDRESS" for maintenance fee notifications.

CURRENT CORRESPONDENCE ADDRESS (Note: Use Block 1 for any change of address)

Note: A certificate of mailing can only be used for domestic mailings of the Fee(s) Transmittal. This certificate cannot be used for any other accompanying papers. Each additional paper, such as an assignment or formal drawing, must have its own certificate of mailing or transmission.

20350 7590 10/30/2012
KILPATRICK TOWNSEND & STOCKTON LLP
 TWO EMBARCADERO CENTER
 EIGHTH FLOOR
 SAN FRANCISCO, CA 94111-3834

Certificate of Mailing or Transmission

I hereby certify that this Fee(s) Transmittal is being deposited with the United States Postal Service with sufficient postage for first class mail in an envelope addressed to the Mail Stop ISSUE FEE address above, or being facsimile transmitted to the USPTO (571) 273-2885, on the date indicated below.

(Depositor's name)
(Signature)
(Date)

APPLICATION NO.	FILING DATE	FIRST NAMED INVENTOR	ATTORNEY DOCKET NO.	CONFIRMATION NO.
13/212,047	08/17/2011	Patrick Sandor RACZ	87790-818158 (000150US)	5477

TITLE OF INVENTION: DATA STORAGE AND ACCESS SYSTEMS

APPLN. TYPE	SMALL ENTITY	ISSUE FEE DUE	PUBLICATION FEE DUE	PREV. PAID ISSUE FEE	TOTAL FEE(S) DUE	DATE DUE
nonprovisional	YES	\$885	\$300	\$0	\$1185	01/30/2013

EXAMINER	ART UNIT	CLASS-SUBCLASS
LE, THIEN MINH	2887	235-380000

<p>1. Change of correspondence address or indication of "Fee Address" (37 CFR 1.363).</p> <p><input type="checkbox"/> Change of correspondence address (or Change of Correspondence Address form PTO/SB/122) attached.</p> <p><input type="checkbox"/> "Fee Address" indication (or "Fee Address" Indication form PTO/SB/47; Rev 03-02 or more recent) attached. Use of a Customer Number is required.</p>	<p>2. For printing on the patent front page, list</p> <p>(1) the names of up to 3 registered patent attorneys or agents OR, alternatively, 1 _____</p> <p>(2) the name of a single firm (having as a member a registered attorney or agent) and the names of up to 2 registered patent attorneys or agents. If no name is listed, no name will be printed. 2 _____</p> <p>3 _____</p>
---	---

3. ASSIGNEE NAME AND RESIDENCE DATA TO BE PRINTED ON THE PATENT (print or type)

PLEASE NOTE: Unless an assignee is identified below, no assignee data will appear on the patent. If an assignee is identified below, the document has been filed for recordation as set forth in 37 CFR 3.11. Completion of this form is NOT a substitute for filing an assignment.

(A) NAME OF ASSIGNEE _____ (B) RESIDENCE: (CITY and STATE OR COUNTRY) _____

Please check the appropriate assignee category or categories (will not be printed on the patent) : Individual Corporation or other private group entity Government

<p>4a. The following fee(s) are submitted:</p> <p><input type="checkbox"/> Issue Fee</p> <p><input type="checkbox"/> Publication Fee (No small entity discount permitted)</p> <p><input type="checkbox"/> Advance Order - # of Copies _____</p>	<p>4b. Payment of Fee(s); (Please first reapply any previously paid issue fee shown above)</p> <p><input type="checkbox"/> A check is enclosed.</p> <p><input type="checkbox"/> Payment by credit card. Form PTO-2038 is attached.</p> <p><input type="checkbox"/> The Director is hereby authorized to charge the required fee(s), any deficiency, or credit any overpayment, to Deposit Account Number _____ (enclose an extra copy of this form).</p>
---	--

5. Change in Entity Status (from status indicated above)

a. Applicant claims SMALL ENTITY status. See 37 CFR 1.27. b. Applicant is no longer claiming SMALL ENTITY status. See 37 CFR 1.27(g)(2).

NOTE: The Issue Fee and Publication Fee (if required) will not be accepted from anyone other than the applicant; a registered attorney or agent; or the assignee or other party in interest as shown by the records of the United States Patent and Trademark Office.

Authorized Signature _____ Date _____

Typed or printed name _____ Registration No. _____

This collection of information is required by 37 CFR 1.311. The information is required to obtain or retain a benefit by the public which is to file (and by the USPTO to process) an application. Confidentiality is governed by 35 U.S.C. 122 and 37 CFR 1.14. This collection is estimated to take 12 minutes to complete, including gathering, preparing, and submitting the completed application form to the USPTO. Time will vary depending upon the individual case. Any comments on the amount of time you require to complete this form and/or suggestions for reducing this burden, should be sent to the Chief Information Officer, U.S. Patent and Trademark Office, U.S. Department of Commerce, P.O. Box 1450, Alexandria, Virginia 22313-1450. DO NOT SEND FEES OR COMPLETED FORMS TO THIS ADDRESS. SEND TO: Commissioner for Patents, P.O. Box 1450, Alexandria, Virginia 22313-1450.

Under the Paperwork Reduction Act of 1995, no persons are required to respond to a collection of information unless it displays a valid OMB control number.



UNITED STATES PATENT AND TRADEMARK OFFICE

UNITED STATES DEPARTMENT OF COMMERCE
United States Patent and Trademark Office
Address: COMMISSIONER FOR PATENTS
P.O. Box 1450
Alexandria, Virginia 22313-1450
www.uspto.gov

Table with 5 columns: APPLICATION NO., FILING DATE, FIRST NAMED INVENTOR, ATTORNEY DOCKET NO., CONFIRMATION NO.
13/212,047 08/17/2011 Patrick Sandor RACZ 87790-818158 (000150US) 5477

20350 7590 10/30/2012
KILPATRICK TOWNSEND & STOCKTON LLP
TWO EMBARCADERO CENTER
EIGHTH FLOOR
SAN FRANCISCO, CA 94111-3834

Table with 2 columns: EXAMINER, ART UNIT, PAPER NUMBER
EXAMINER: LE, THIEN MINH
ART UNIT: 2887
PAPER NUMBER: (blank)

DATE MAILED: 10/30/2012

Determination of Patent Term Adjustment under 35 U.S.C. 154 (b)

(application filed on or after May 29, 2000)

The Patent Term Adjustment to date is 0 day(s). If the issue fee is paid on the date that is three months after the mailing date of this notice and the patent issues on the Tuesday before the date that is 28 weeks (six and a half months) after the mailing date of this notice, the Patent Term Adjustment will be 0 day(s).

If a Continued Prosecution Application (CPA) was filed in the above-identified application, the filing date that determines Patent Term Adjustment is the filing date of the most recent CPA.

Applicant will be able to obtain more detailed information by accessing the Patent Application Information Retrieval (PAIR) WEB site (http://pair.uspto.gov).

Any questions regarding the Patent Term Extension or Adjustment determination should be directed to the Office of Patent Legal Administration at (571)-272-7702. Questions relating to issue and publication fee payments should be directed to the Customer Service Center of the Office of Patent Publication at 1-(888)-786-0101 or (571)-272-4200.

Privacy Act Statement

The Privacy Act of 1974 (P.L. 93-579) requires that you be given certain information in connection with your submission of the attached form related to a patent application or patent. Accordingly, pursuant to the requirements of the Act, please be advised that: (1) the general authority for the collection of this information is 35 U.S.C. 2(b)(2); (2) furnishing of the information solicited is voluntary; and (3) the principal purpose for which the information is used by the U.S. Patent and Trademark Office is to process and/or examine your submission related to a patent application or patent. If you do not furnish the requested information, the U.S. Patent and Trademark Office may not be able to process and/or examine your submission, which may result in termination of proceedings or abandonment of the application or expiration of the patent.

The information provided by you in this form will be subject to the following routine uses:

1. The information on this form will be treated confidentially to the extent allowed under the Freedom of Information Act (5 U.S.C. 552) and the Privacy Act (5 U.S.C. 552a). Records from this system of records may be disclosed to the Department of Justice to determine whether disclosure of these records is required by the Freedom of Information Act.
2. A record from this system of records may be disclosed, as a routine use, in the course of presenting evidence to a court, magistrate, or administrative tribunal, including disclosures to opposing counsel in the course of settlement negotiations.
3. A record in this system of records may be disclosed, as a routine use, to a Member of Congress submitting a request involving an individual, to whom the record pertains, when the individual has requested assistance from the Member with respect to the subject matter of the record.
4. A record in this system of records may be disclosed, as a routine use, to a contractor of the Agency having need for the information in order to perform a contract. Recipients of information shall be required to comply with the requirements of the Privacy Act of 1974, as amended, pursuant to 5 U.S.C. 552a(m).
5. A record related to an International Application filed under the Patent Cooperation Treaty in this system of records may be disclosed, as a routine use, to the International Bureau of the World Intellectual Property Organization, pursuant to the Patent Cooperation Treaty.
6. A record in this system of records may be disclosed, as a routine use, to another federal agency for purposes of National Security review (35 U.S.C. 181) and for review pursuant to the Atomic Energy Act (42 U.S.C. 218(c)).
7. A record from this system of records may be disclosed, as a routine use, to the Administrator, General Services, or his/her designee, during an inspection of records conducted by GSA as part of that agency's responsibility to recommend improvements in records management practices and programs, under authority of 44 U.S.C. 2904 and 2906. Such disclosure shall be made in accordance with the GSA regulations governing inspection of records for this purpose, and any other relevant (i.e., GSA or Commerce) directive. Such disclosure shall not be used to make determinations about individuals.
8. A record from this system of records may be disclosed, as a routine use, to the public after either publication of the application pursuant to 35 U.S.C. 122(b) or issuance of a patent pursuant to 35 U.S.C. 151. Further, a record may be disclosed, subject to the limitations of 37 CFR 1.14, as a routine use, to the public if the record was filed in an application which became abandoned or in which the proceedings were terminated and which application is referenced by either a published application, an application open to public inspection or an issued patent.
9. A record from this system of records may be disclosed, as a routine use, to a Federal, State, or local law enforcement agency, if the USPTO becomes aware of a violation or potential violation of law or regulation.

Notice of Allowability

Application No.

13/212,047

Examiner

Thien M. Le

Applicant(s)

RACZ ET AL.

Art Unit

2887

-- The MAILING DATE of this communication appears on the cover sheet with the correspondence address--

All claims being allowable, PROSECUTION ON THE MERITS IS (OR REMAINS) CLOSED in this application. If not included herewith (or previously mailed), a Notice of Allowance (PTOL-85) or other appropriate communication will be mailed in due course. **THIS NOTICE OF ALLOWABILITY IS NOT A GRANT OF PATENT RIGHTS.** This application is subject to withdrawal from issue at the initiative of the Office or upon petition by the applicant. See 37 CFR 1.313 and MPEP 1308.

- 1. This communication is responsive to an amendment filed on 10/11/2012.
- 2. An election was made by the applicant in response to a restriction requirement set forth during the interview on _____; the restriction requirement and election have been incorporated into this action.
- 3. The allowed claim(s) is/are 1-36.
- 4. Acknowledgment is made of a claim for foreign priority under 35 U.S.C. § 119(a)-(d) or (f).
 - a) All b) Some* c) None of the:
 - 1. Certified copies of the priority documents have been received.
 - 2. Certified copies of the priority documents have been received in Application No. _____ .
 - 3. Copies of the certified copies of the priority documents have been received in this national stage application from the International Bureau (PCT Rule 17.2(a)).

* Certified copies not received: _____.

Applicant has **THREE MONTHS FROM THE "MAILING DATE"** of this communication to file a reply complying with the requirements noted below. Failure to timely comply will result in **ABANDONMENT** of this application.

THIS THREE-MONTH PERIOD IS NOT EXTENDABLE.

- 5. A SUBSTITUTE OATH OR DECLARATION must be submitted. Note the attached EXAMINER'S AMENDMENT or NOTICE OF INFORMAL PATENT APPLICATION (PTO-152) which gives reason(s) why the oath or declaration is deficient.
 - 6. CORRECTED DRAWINGS (as "replacement sheets") must be submitted.
 - (a) including changes required by the Notice of Draftsperson's Patent Drawing Review (PTO-948) attached
 - 1) hereto or 2) to Paper No./Mail Date _____.
 - (b) including changes required by the attached Examiner's Amendment / Comment or in the Office action of Paper No./Mail Date _____.
- Identifying indicia such as the application number (see 37 CFR 1.84(c)) should be written on the drawings in the front (not the back) of each sheet. Replacement sheet(s) should be labeled as such in the header according to 37 CFR 1.121(d).**
- 7. DEPOSIT OF and/or INFORMATION about the deposit of BIOLOGICAL MATERIAL must be submitted. Note the attached Examiner's comment regarding REQUIREMENT FOR THE DEPOSIT OF BIOLOGICAL MATERIAL.

Attachment(s)

- 1. Notice of References Cited (PTO-892)
- 2. Notice of Draftsperson's Patent Drawing Review (PTO-948)
- 3. Information Disclosure Statements (PTO/SB/08), Paper No./Mail Date _____
- 4. Examiner's Comment Regarding Requirement for Deposit of Biological Material
- 5. Notice of Informal Patent Application
- 6. Interview Summary (PTO-413), Paper No./Mail Date _____ .
- 7. Examiner's Amendment/Comment
- 8. Examiner's Statement of Reasons for Allowance
- 9. Other _____.

Applicant-Initiated Interview Summary	Application No. 13/212,047	Applicant(s) RACZ ET AL.	
	Examiner Thien M. Le	Art Unit 2887	

All participants (applicant, applicant's representative, PTO personnel):

(1) Thien M. Le. (3)_____.

(2) Ben Holt. (4)_____.

Date of Interview: 10 October 2012.

Type: Telephonic Video Conference
 Personal [copy given to: applicant applicant's representative]

Exhibit shown or demonstration conducted: Yes No.
If Yes, brief description: _____.

Issues Discussed 101 112 102 103 Others
(For each of the checked box(es) above, please describe below the issue and detailed description of the discussion)

Claim(s) discussed: 1-39.

Identification of prior art discussed: Applicant's representative agrees to cancel claims 37-39. The examiner indicates that the obvious double patenting is considered moot when a terminal disclaimer is filed and approved.

Substance of Interview

(For each issue discussed, provide a detailed description and indicate if agreement was reached. Some topics may include: identification or clarification of a reference or a portion thereof, claim interpretation, proposed amendments, arguments of any applied references etc...)

_____.

Applicant recordation instructions: The formal written reply to the last Office action must include the substance of the interview. (See MPEP section 713.04). If a reply to the last Office action has already been filed, applicant is given a non-extendable period of the longer of one month or thirty days from this interview date, or the mailing date of this interview summary form, whichever is later, to file a statement of the substance of the interview

Examiner recordation instructions: Examiners must summarize the substance of any interview of record. A complete and proper recordation of the substance of an interview should include the items listed in MPEP 713.04 for complete and proper recordation including the identification of the general thrust of each argument or issue discussed, a general indication of any other pertinent matters discussed regarding patentability and the general results or outcome of the interview, to include an indication as to whether or not agreement was reached on the issues raised.

Attachment

/Thien M. Le/
Primary Examiner, Art Unit 2887

Summary of Record of Interview Requirements

Manual of Patent Examining Procedure (MPEP), Section 713.04, Substance of Interview Must be Made of Record

A complete written statement as to the substance of any face-to-face, video conference, or telephone interview with regard to an application must be made of record in the application whether or not an agreement with the examiner was reached at the interview.

Title 37 Code of Federal Regulations (CFR) § 1.133 Interviews

Paragraph (b)

In every instance where reconsideration is requested in view of an interview with an examiner, a complete written statement of the reasons presented at the interview as warranting favorable action must be filed by the applicant. An interview does not remove the necessity for reply to Office action as specified in §§ 1.111, 1.135. (35 U.S.C. 132)

37 CFR §1.2 Business to be transacted in writing.

All business with the Patent or Trademark Office should be transacted in writing. The personal attendance of applicants or their attorneys or agents at the Patent and Trademark Office is unnecessary. The action of the Patent and Trademark Office will be based exclusively on the written record in the Office. No attention will be paid to any alleged oral promise, stipulation, or understanding in relation to which there is disagreement or doubt.

The action of the Patent and Trademark Office cannot be based exclusively on the written record in the Office if that record is itself incomplete through the failure to record the substance of interviews.

It is the responsibility of the applicant or the attorney or agent to make the substance of an interview of record in the application file, unless the examiner indicates he or she will do so. It is the examiner's responsibility to see that such a record is made and to correct material inaccuracies which bear directly on the question of patentability.

Examiners must complete an Interview Summary Form for each interview held where a matter of substance has been discussed during the interview by checking the appropriate boxes and filling in the blanks. Discussions regarding only procedural matters, directed solely to restriction requirements for which interview recordation is otherwise provided for in Section 812.01 of the Manual of Patent Examining Procedure, or pointing out typographical errors or unreadable script in Office actions or the like, are excluded from the interview recordation procedures below. Where the substance of an interview is completely recorded in an Examiners Amendment, no separate Interview Summary Record is required.

The Interview Summary Form shall be given an appropriate Paper No., placed in the right hand portion of the file, and listed on the "Contents" section of the file wrapper. In a personal interview, a duplicate of the Form is given to the applicant (or attorney or agent) at the conclusion of the interview. In the case of a telephone or video-conference interview, the copy is mailed to the applicant's correspondence address either with or prior to the next official communication. If additional correspondence from the examiner is not likely before an allowance or if other circumstances dictate, the Form should be mailed promptly after the interview rather than with the next official communication.

The Form provides for recordation of the following information:

- Application Number (Series Code and Serial Number)
- Name of applicant
- Name of examiner
- Date of interview
- Type of interview (telephonic, video-conference, or personal)
- Name of participant(s) (applicant, attorney or agent, examiner, other PTO personnel, etc.)
- An indication whether or not an exhibit was shown or a demonstration conducted
- An identification of the specific prior art discussed
- An indication whether an agreement was reached and if so, a description of the general nature of the agreement (may be by attachment of a copy of amendments or claims agreed as being allowable). Note: Agreement as to allowability is tentative and does not restrict further action by the examiner to the contrary.
- The signature of the examiner who conducted the interview (if Form is not an attachment to a signed Office action)

It is desirable that the examiner orally remind the applicant of his or her obligation to record the substance of the interview of each case. It should be noted, however, that the Interview Summary Form will not normally be considered a complete and proper recordation of the interview unless it includes, or is supplemented by the applicant or the examiner to include, all of the applicable items required below concerning the substance of the interview.

A complete and proper recordation of the substance of any interview should include at least the following applicable items:

- 1) A brief description of the nature of any exhibit shown or any demonstration conducted,
- 2) an identification of the claims discussed,
- 3) an identification of the specific prior art discussed,
- 4) an identification of the principal proposed amendments of a substantive nature discussed, unless these are already described on the Interview Summary Form completed by the Examiner,
- 5) a brief identification of the general thrust of the principal arguments presented to the examiner,
(The identification of arguments need not be lengthy or elaborate. A verbatim or highly detailed description of the arguments is not required. The identification of the arguments is sufficient if the general nature or thrust of the principal arguments made to the examiner can be understood in the context of the application file. Of course, the applicant may desire to emphasize and fully describe those arguments which he or she feels were or might be persuasive to the examiner.)
- 6) a general indication of any other pertinent matters discussed, and
- 7) if appropriate, the general results or outcome of the interview unless already described in the Interview Summary Form completed by the examiner.

Examiners are expected to carefully review the applicant's record of the substance of an interview. If the record is not complete and accurate, the examiner will give the applicant an extendable one month time period to correct the record.

Examiner to Check for Accuracy

If the claims are allowable for other reasons of record, the examiner should send a letter setting forth the examiner's version of the statement attributed to him or her. If the record is complete and accurate, the examiner should place the indication, "Interview Record OK" on the paper recording the substance of the interview along with the date and the examiner's initials.

DETAILED ACTION

The amendment filed on 10/11/2012 has been entered. The TD filed on 10/11/2012 has been approved. Claims 37-39 have been canceled. Claims 1-36 remain for examination.

Allowable Subject Matter

Claims 1-36 are allowed.

The following is a statement of reasons for the indication of allowable subject matter: The TD filed on 10/11/2012 has been approved and thus vacates all double patent grounds of rejection on claims 1-36. Accordingly, the prior art fails to disclose a handheld device having a memory, a program store, a processor, a user interface, a display and wherein processor control code comprises the codes having the functions and characteristics as recited in claim 1. The prior art also fails to disclose the limitations of claims 8, 14, 19, 25, 30, 35 and 36.

Conclusion

Any inquiry concerning this communication or earlier communications from the examiner should be directed to Thien M. Le whose telephone number is (571)272-2396. The examiner can normally be reached on Monday - Friday from 7:30am - 4:00pm.

Art Unit: 2887

If attempts to reach the examiner by telephone are unsuccessful, the examiner's supervisor, Steve S. Paik can be reached on (571) 272-2404. The fax phone number for the organization where this application or proceeding is assigned is 571-273-8300.

Information regarding the status of an application may be obtained from the Patent Application Information Retrieval (PAIR) system. Status information for published applications may be obtained from either Private PAIR or Public PAIR. Status information for unpublished applications is available through Private PAIR only. For more information about the PAIR system, see <http://pair-direct.uspto.gov>. Should you have questions on access to the Private PAIR system, contact the Electronic Business Center (EBC) at 866-217-9197 (toll-free). If you would like assistance from a USPTO Customer Service Representative or access to the automated information system, call 800-786-9199 (IN USA OR CANADA) or 571-272-1000.

/Thien M. Le/
Primary Examiner, Art Unit 2887

Search Notes 	Application/Control No. 13212047	Applicant(s)/Patent Under Reexamination RACZ ET AL.
	Examiner THIEN M LE	Art Unit 2887

SEARCHED			
Class	Subclass	Date	Examiner
235	380,382, 492, 451, 486, 487	7/9/2012	LTM
updated	same as above	10/22/2012	LTM

SEARCH NOTES		
Search Notes	Date	Examiner
EAST, review parent applications for double patenting	7/9/2012	LTM
EAST	10/22/2012	LTM

INTERFERENCE SEARCH			
Class	Subclass	Date	Examiner
235	380, 492	10/22/2012	LTM

--	--

Index of Claims 	Application/Control No. 13212047	Applicant(s)/Patent Under Reexamination RACZ ET AL.
	Examiner THIEN M LE	Art Unit 2887

✓	Rejected
=	Allowed

-	Cancelled
÷	Restricted

N	Non-Elected
I	Interference

A	Appeal
O	Objected

Claims renumbered in the same order as presented by applicant
 CPA
 T.D.
 R.1.47

CLAIM		DATE							
Final	Original	07/09/2012	10/22/2012						
1	1	✓	=						
2	2	✓	=						
3	3	✓	=						
4	4	✓	=						
5	5	✓	=						
6	6	✓	=						
7	7	✓	=						
8	8	✓	=						
9	9	✓	=						
10	10	✓	=						
11	11	✓	=						
12	12	✓	=						
13	13	✓	=						
14	14	✓	=						
15	15	✓	=						
16	16	✓	=						
17	17	✓	=						
18	18	✓	=						
19	19	✓	=						
20	20	✓	=						
21	21	✓	=						
22	22	✓	=						
23	23	✓	=						
24	24	✓	=						
25	25	✓	=						
26	26	✓	=						
27	27	✓	=						
28	28	✓	=						
29	29	✓	=						
30	30	✓	=						
31	31	✓	=						
32	32	✓	=						
33	33	✓	=						
34	34	✓	=						
35	35	✓	=						
36	36	✓	=						

<i>Index of Claims</i> 	Application/Control No. 13212047	Applicant(s)/Patent Under Reexamination RACZ ET AL.
	Examiner THIEN M LE	Art Unit 2887

✓	Rejected
=	Allowed

-	Cancelled
÷	Restricted

N	Non-Elected
I	Interference

A	Appeal
O	Objected

Claims renumbered in the same order as presented by applicant
 CPA
 T.D.
 R.1.47

CLAIM		DATE							
Final	Original	07/09/2012	10/22/2012						
	37	✓	-						
	38	✓	-						
	39	✓	-						

Issue Classification 	Application/Control No. 13212047	Applicant(s)/Patent Under Reexamination RAGZ ET AL.
	Examiner THIEN M LE	Art Unit 2887

ORIGINAL					INTERNATIONAL CLASSIFICATION											
CLASS		SUBCLASS			CLAIMED					NON-CLAIMED						
235		380			G	O	6	K	5 / 00 (2006.01.01)							
CROSS REFERENCE(S)																
CLASS	SUBCLASS (ONE SUBCLASS PER BLOCK)															
235	492															

<input type="checkbox"/> Claims renumbered in the same order as presented by applicant																<input type="checkbox"/> CPA																<input checked="" type="checkbox"/> T.D.																<input type="checkbox"/> R.1.47															
Final	Original	Final	Original	Final	Original	Final	Original	Final	Original	Final	Original	Final	Original	Final	Original	Final	Original	Final	Original	Final	Original	Final	Original	Final	Original	Final	Original																																				
1	1	17	17	33	33																																																										
2	2	18	18	34	34																																																										
3	3	19	19	35	35																																																										
4	4	20	20	36	36																																																										
5	5	21	21																																																												
6	6	22	22																																																												
7	7	23	23																																																												
8	8	24	24																																																												
9	9	25	25																																																												
10	10	26	26																																																												
11	11	27	27																																																												
12	12	28	28																																																												
13	13	29	29																																																												
14	14	30	30																																																												
15	15	31	31																																																												
16	16	32	32																																																												

NONE		Total Claims Allowed: 36	
(Assistant Examiner) _____ (Date) _____			
/THIEN M LE/ Primary Examiner. Art Unit 2887		10/22/2012	
(Primary Examiner) _____ (Date) _____		O.G. Print Claim(s) 1	O.G. Print Figure 1



UNITED STATES PATENT AND TRADEMARK OFFICE

UNITED STATES DEPARTMENT OF COMMERCE
 United States Patent and Trademark Office
 Address: COMMISSIONER FOR PATENTS
 P.O. Box 1450
 Alexandria, Virginia 22313-1450
 www.uspto.gov

BIB DATA SHEET

CONFIRMATION NO. 5477

SERIAL NUMBER	FILING or 371(c) DATE	CLASS	GROUP ART UNIT	ATTORNEY DOCKET NO.		
13/212,047	08/17/2011	235	2887	87790-818158 (000150US)		
APPLICANTS Patrick Sandor RACZ, Saint Heller, UNITED KINGDOM; Hermen-ard Hulst, Amsterdam, NETHERLANDS;						
** CONTINUING DATA ***** This application is a CON of 12/943,872 11/10/2010 PAT 8,118,221 which is a CON of 12/014,558 01/15/2008 PAT 7,942,317 which is a CON of 11/336,758 01/19/2006 PAT 7,334,720 which is a CON of 10/111,716 09/17/2002 ABN which is a 371 of PCT/GB2000/104110 10/25/2000						
** FOREIGN APPLICATIONS ***** UNITED KINGDOM 9925227.2 10/25/1999						
** IF REQUIRED, FOREIGN FILING LICENSE GRANTED ** ** SMALL ENTITY ** 08/26/2011						
Foreign Priority claimed <input type="checkbox"/> Yes <input checked="" type="checkbox"/> No 35 USC 119(a-d) conditions met <input type="checkbox"/> Yes <input checked="" type="checkbox"/> No Verified and Acknowledged <u>/THIEN MINH LE/</u> Examiner's Signature		<input type="checkbox"/> Met after Allowance Initials	STATE OR COUNTRY UNITED KINGDOM	SHEETS DRAWINGS 17	TOTAL CLAIMS 39	INDEPENDENT CLAIMS 11
ADDRESS KILPATRICK TOWNSEND & STOCKTON LLP TWO EMBARCADERO CENTER EIGHTH FLOOR SAN FRANCISCO, CA 94111-3834 UNITED STATES						
TITLE DATA STORAGE AND ACCESS SYSTEMS						
FILING FEE RECEIVED 1836	FEES: Authority has been given in Paper No. _____ to charge/credit DEPOSIT ACCOUNT No. _____ for following:		<input type="checkbox"/> All Fees <input type="checkbox"/> 1.16 Fees (Filing) <input type="checkbox"/> 1.17 Fees (Processing Ext. of time) <input type="checkbox"/> 1.18 Fees (Issue) <input type="checkbox"/> Other _____ <input type="checkbox"/> Credit			

EAST Search History

EAST Search History (Prior Art)

Ref #	Hits	Search Query	DBs	Default Operator	Plurals	Time Stamp
L1	3	((("8118221") or ("7942317") or ("7334720")).PN.	US-PGPUB; USPAT	OR	OFF	2012/10/22 14:25
L2	1	L1 and identifier.clm. and processor.clm. and interface.clm. and memory.clm. and payment.clm. and validation.clm.	US-PGPUB; USPAT; EPO; JPO; DERWENT	OR	OFF	2012/10/22 14:25
L3	0	L1 and identifier.clm. and processor.clm. and interface.clm. and memory.clm. and payment.clm. and validation.clm. and display.clm.	US-PGPUB; USPAT; EPO; JPO; DERWENT	OR	OFF	2012/10/22 14:25
L4	1	L1 and identifier.clm. and processor.clm. and interface.clm. and memory.clm. and payment.clm. and validation.clm. and program.clm.	US-PGPUB; USPAT; EPO; JPO; DERWENT	OR	OFF	2012/10/22 14:25
L5	0	L1 and identifier.clm. and processor.clm. and interface.clm. and memory.clm. and payment.clm. and validation.clm. and program.clm. same request.clm.	US-PGPUB; USPAT; EPO; JPO; DERWENT	OR	OFF	2012/10/22 14:25
L6	2	L1 and request.clm.	US-PGPUB; USPAT; EPO; JPO; DERWENT	OR	OFF	2012/10/22 14:25
L7	0	L1 and request.clm. and receive.clm. and present.clm.	US-PGPUB; USPAT; EPO; JPO; DERWENT	OR	OFF	2012/10/22 14:25
L8	28666	code.clm. same request.clm.	US-PGPUB; USPAT; EPO; JPO; DERWENT	OR	OFF	2012/10/22 14:25
L9	1	L8 and L1	US-PGPUB; USPAT; EPO; JPO; DERWENT	OR	OFF	2012/10/22 14:25
L10	37012	code.clm. same receive.clm.	US-PGPUB; USPAT; EPO; JPO; DERWENT	OR	OFF	2012/10/22 14:25
L11	3	L10 and L1	US-PGPUB; USPAT; EPO; JPO; DERWENT	OR	OFF	2012/10/22 14:25
L12	1	L9 and L11	US-PGPUB; USPAT; EPO; JPO; DERWENT	OR	OFF	2012/10/22 14:25
L13	0	code.clm. same present.clm.	US-PGPUB;	OR	OFF	2012/10/22

			USPAT; EPO; JPO; DERWENT			14:25
L14	3161	code.clm. same payment.clm.	US-PGPUB; USPAT; EPO; JPO; DERWENT	OR	OFF	2012/10/22 14:25
L15	3	L14 and L1	US-PGPUB; USPAT; EPO; JPO; DERWENT	OR	OFF	2012/10/22 14:25
L16	1	L12 and L15	US-PGPUB; USPAT; EPO; JPO; DERWENT	OR	OFF	2012/10/22 14:25
L17	37531	code.clm. same access.clm.	US-PGPUB; USPAT; EPO; JPO; DERWENT	OR	OFF	2012/10/22 14:25
L18	1	L16 and L17	US-PGPUB; USPAT; EPO; JPO; DERWENT	OR	OFF	2012/10/22 14:25
L19	14209	code.clm. same selection\$1.clm.	US-PGPUB; USPAT; EPO; JPO; DERWENT	OR	OFF	2012/10/22 14:25
L20	0	L19 and L1	US-PGPUB; USPAT; EPO; JPO; DERWENT	OR	OFF	2012/10/22 14:25
L21	3	((("8118221") or ("7942317") or ("7334720")).PN.	US-PGPUB; USPAT	OR	OFF	2012/10/22 14:25
L22	3	L21 and user.clm.	US-PGPUB; USPAT; EPO; JPO; DERWENT	OR	OFF	2012/10/22 14:25
L23	3	((("8118221") or ("7942317") or ("7334720")).PN.	US-PGPUB; USPAT	OR	OFF	2012/10/22 14:25
L24	2	L23 and status.clm.	US-PGPUB; USPAT; EPO; JPO; DERWENT	OR	OFF	2012/10/22 14:25
L25	2	L23 and status.clm. and mobile.clm.	US-PGPUB; USPAT; EPO; JPO; DERWENT	OR	OFF	2012/10/22 14:25
L26	3	((("8118221") or ("7942317") or ("7334720")).PN.	US-PGPUB; USPAT	OR	OFF	2012/10/22 14:25
L27	1	L26 and portable.clm. and carrier.clm.	US-PGPUB; USPAT; EPO; JPO; DERWENT	OR	OFF	2012/10/22 14:25
L28	0	L27 and byte\$1.clm.	US-PGPUB; USPAT; EPO; JPO; DERWENT	OR	OFF	2012/10/22 14:25
L29	0	L27 and Mbyte.clm.	US-PGPUB;	OR	OFF	2012/10/22

			USPAT; EPO; JPO; DERWENT			14:25
L30	0	L26 and Mbyte.clm.	US-PGPUB; USPAT; EPO; JPO; DERWENT	OR	OFF	2012/10/22 14:25
L31	2322	memory same network same parameter\$1 same card	US-PGPUB; USPAT; EPO; JPO; DERWENT	OR	OFF	2012/10/22 14:25
L32	40	memory same network same parameter\$1 same card same ((payment or transaction) near10 data)	US-PGPUB; USPAT; EPO; JPO; DERWENT	OR	OFF	2012/10/22 14:25
L33	69	memory same storing same card same ((payment or transaction) near10 data) same instructions	US-PGPUB; USPAT; EPO; JPO; DERWENT	OR	OFF	2012/10/22 14:25
L34	26	(IC adj2 card) same (mbyte\$1 or gbyte\$1) same capacity	US-PGPUB; USPAT; EPO; JPO; DERWENT	OR	OFF	2012/10/22 14:25
L43	542	"I37" and "I42"	US-PGPUB; USPAT; EPO; JPO; DERWENT	OR	OFF	2012/10/22 14:39
S1	3	((("8118221") or ("7942317") or ("7334720")).PN.	US-PGPUB; USPAT	OR	OFF	2012/07/08 14:51
S2	1	S1 and identifier.clm. and processor.clm. and interface.clm. and memory.clm. and payment.clm. and validation.clm.	US-PGPUB; USPAT; EPO; JPO; DERWENT	OR	OFF	2012/07/08 15:12
S3	0	S1 and identifier.clm. and processor.clm. and interface.clm. and memory.clm. and payment.clm. and validation.clm. and display.clm.	US-PGPUB; USPAT; EPO; JPO; DERWENT	OR	OFF	2012/07/08 15:12
S4	1	S1 and identifier.clm. and processor.clm. and interface.clm. and memory.clm. and payment.clm. and validation.clm. and program.clm.	US-PGPUB; USPAT; EPO; JPO; DERWENT	OR	OFF	2012/07/08 15:13
S5	0	S1 and identifier.clm. and processor.clm. and interface.clm. and memory.clm. and payment.clm. and validation.clm. and program.clm. same request.clm.	US-PGPUB; USPAT; EPO; JPO; DERWENT	OR	OFF	2012/07/08 15:25
S6	2	S1 and request.clm.	US-PGPUB; USPAT; EPO; JPO; DERWENT	OR	OFF	2012/07/08 15:25
S7	0	S1 and request.clm. and receive.clm. and present.clm.	US-PGPUB; USPAT; EPO; JPO; DERWENT	OR	OFF	2012/07/08 15:33
S8	27343	code.clm. same request.clm.	US-PGPUB; USPAT; EPO; JPO; DERWENT	OR	OFF	2012/07/08 15:37

S9	1	S8 and S1	US-PGPUB; USPAT; EPO; JPO; DERWENT	OR	OFF	2012/07/08 15:37
S10	35059	code.clm. same receive.clm.	US-PGPUB; USPAT; EPO; JPO; DERWENT	OR	OFF	2012/07/08 15:38
S11	3	S10 and S1	US-PGPUB; USPAT; EPO; JPO; DERWENT	OR	OFF	2012/07/08 15:38
S12	1	S9 and S11	US-PGPUB; USPAT; EPO; JPO; DERWENT	OR	OFF	2012/07/08 15:38
S13	0	code.clm. same present.clm.	US-PGPUB; USPAT; EPO; JPO; DERWENT	OR	OFF	2012/07/08 15:39
S14	3000	code.clm. same payment.clm.	US-PGPUB; USPAT; EPO; JPO; DERWENT	OR	OFF	2012/07/08 15:39
S15	3	S14 and S1	US-PGPUB; USPAT; EPO; JPO; DERWENT	OR	OFF	2012/07/08 15:39
S16	1	S12 and S15	US-PGPUB; USPAT; EPO; JPO; DERWENT	OR	OFF	2012/07/08 15:39
S17	36126	code.clm. same access.clm.	US-PGPUB; USPAT; EPO; JPO; DERWENT	OR	OFF	2012/07/08 15:41
S18	1	S16 and S17	US-PGPUB; USPAT; EPO; JPO; DERWENT	OR	OFF	2012/07/08 15:42
S19	13678	code.clm. same selection\$1.clm.	US-PGPUB; USPAT; EPO; JPO; DERWENT	OR	OFF	2012/07/08 15:42
S20	0	S19 and S1	US-PGPUB; USPAT; EPO; JPO; DERWENT	OR	OFF	2012/07/08 15:42
S21	3	((("8118221") or ("7942317") or ("7334720")).PN.	US-PGPUB; USPAT	OR	OFF	2012/07/09 05:52
S22	3	S21 and user.clm.	US-PGPUB; USPAT; EPO; JPO; DERWENT	OR	OFF	2012/07/09 05:52
S23	3	((("8118221") or ("7942317") or ("7334720")).PN.	US-PGPUB; USPAT	OR	OFF	2012/07/09 07:46
S24	2	S23 and status.clm.	US-PGPUB; USPAT; EPO;	OR	OFF	2012/07/09 07:47

			JPO; DERWENT			
S25	2	S23 and status.clm. and mobile.clm.	US-PGPUB; USPAT; EPO; JPO; DERWENT	OR	OFF	2012/07/09 07:47
S26	3	((("8118221") or ("7942317") or ("7334720")).PN.	US-PGPUB; USPAT	OR	OFF	2012/07/09 09:13
S27	1	S26 and portable.clm. and carrier.clm.	US-PGPUB; USPAT; EPO; JPO; DERWENT	OR	OFF	2012/07/09 09:13
S28	0	S27 and byte\$1.clm.	US-PGPUB; USPAT; EPO; JPO; DERWENT	OR	OFF	2012/07/09 09:13
S29	0	S27 and Mbyte.clm.	US-PGPUB; USPAT; EPO; JPO; DERWENT	OR	OFF	2012/07/09 09:13
S30	0	S26 and Mbyte.clm.	US-PGPUB; USPAT; EPO; JPO; DERWENT	OR	OFF	2012/07/09 09:13
S31	2178	memory same network same parameter\$1 same card	US-PGPUB; USPAT; EPO; JPO; DERWENT	OR	OFF	2012/07/09 09:16
S32	39	memory same network same parameter\$1 same card same ((payment or transaction) near10 data)	US-PGPUB; USPAT; EPO; JPO; DERWENT	OR	OFF	2012/07/09 09:16
S33	61	memory same storing same card same ((payment or transaction) near10 data) same instructions	US-PGPUB; USPAT; EPO; JPO; DERWENT	OR	OFF	2012/07/09 09:35
S34	26	(IC adj2 card) same (mbyte\$1 or gbyte\$1) same capacity	US-PGPUB; USPAT; EPO; JPO; DERWENT	OR	OFF	2012/07/09 09:52

EAST Search History (Interference)

Ref #	Hits	Search Query	DBs	Default Operator	Plurals	Time Stamp
L35	29199	code.clm. same request.clm.	US-PGPUB; USPAT; UPAD	OR	OFF	2012/10/22 14:34
L36	3300	code.clm. same payment.clm.	US-PGPUB; USPAT; UPAD	OR	OFF	2012/10/22 14:34
L37	14468	code.clm. same selection\$1.clm.	US-PGPUB; USPAT; UPAD	OR	OFF	2012/10/22 14:35
L38	2284	memory same network same parameter\$1	US-	OR	OFF	2012/10/22

		same card	PGPUB; USPAT; UPAD			14:38
L39	73	memory same storing same card same ((payment or transaction) near10 data) same instructions	US- PGPUB; USPAT; UPAD	OR	OFF	2012/10/22 14:38
L40	25	(IC adj2 card) same (mbyte\$1 or gbyte\$1) same capacity	US- PGPUB; USPAT; UPAD	OR	OFF	2012/10/22 14:38
L42	21580	(235/375,380,382,492,383,486,487).OCLS.	US- PGPUB; USPAT; UPAD	OR	OFF	2012/10/22 14:39
L44	212	I37 and I42	US- PGPUB; USPAT; UPAD	OR	OFF	2012/10/22 14:40
L45	469	I35 and I42	US- PGPUB; USPAT; UPAD	OR	OFF	2012/10/22 14:40
L46	404	I36 and I42	US- PGPUB; USPAT; UPAD	OR	OFF	2012/10/22 14:40
L47	19	I39 and I42	US- PGPUB; USPAT; UPAD	OR	OFF	2012/10/22 14:40

10/22/2012 2:43:30 PM

C:\Users\tle4\Documents\EAST\Workspaces\13212047.wsp

PART B - FEE(S) TRANSMITTAL

Complete and send this form, together with applicable fee(s), to: **Mail** **Mail Stop ISSUE FEE**
Commissioner for Patents
P.O. Box 1450
Alexandria, Virginia 22313-1450
or Fax **(571)-273-2885**

INSTRUCTIONS: This form should be used for transmitting the ISSUE FEE and PUBLICATION FEE (if required). Blocks 1 through 5 should be completed where appropriate. All further correspondence including the Patent, advance orders and notification of maintenance fees will be mailed to the current correspondence address as indicated unless corrected below or directed otherwise in Block 1, by (a) specifying a new correspondence address; and/or (b) indicating a separate "FEE ADDRESS" for maintenance fee notifications.

CURRENT CORRESPONDENCE ADDRESS (Note: Use Block 1 for any change of address)

Note: A certificate of mailing can only be used for domestic mailings of the Fee(s) Transmittal. This certificate cannot be used for any other accompanying papers. Each additional paper, such as an assignment or formal drawing, must have its own certificate of mailing or transmission.

20350 7590 10/30/2012
KILPATRICK TOWNSEND & STOCKTON LLP
TWO EMBARCADERO CENTER
EIGHTH FLOOR
SAN FRANCISCO, CA 94111-3834

Certificate of Mailing or Transmission

I hereby certify that this Fee(s) Transmittal is being deposited with the United States Postal Service with sufficient postage for first class mail in an envelope addressed to the Mail Stop ISSUE FEE address above, or being facsimile transmitted to the USPTO (571) 273-2885, on the date indicated below.

Sylvia E. Arnold	(Depositor's name)
/Sylvia E. Arnold/	(Signature)
November 15, 2012	(Date)

APPLICATION NO.	FILING DATE	FIRST NAMED INVENTOR	ATTORNEY DOCKET NO.	CONFIRMATION NO.
13/212,047	08/17/2011	Patrick Sandor RACZ	87790-818158 (000150US)	5477

TITLE OF INVENTION: DATA STORAGE AND ACCESS SYSTEMS

APPLN. TYPE	SMALL ENTITY	ISSUE FEE DUE	PUBLICATION FEE DUE	PREV. PAID ISSUE FEE	TOTAL FEE(S) DUE	DATE DUE
nonprovisional	YES	\$885	\$300	\$0	\$1185	01/30/2013

EXAMINER	ART UNIT	CLASS-SUBCLASS
LE. THEN MINH	2887	235-380000

1. Change of correspondence address or indication of "Fee Address" (37 CFR 1.363).
 Change of correspondence address (or Change of Correspondence Address form PTO/SB/122) attached.
 "Fee Address" indication (or "Fee Address" Indication form PTO/SB/47; Rev 03-02 or more recent) attached. Use of a **Customer Number is required.**

2. For printing on the patent front page, list
 (1) the names of up to 3 registered patent attorneys or agents OR, alternatively,
 (2) the name of a single firm (having as a member a registered attorney or agent) and the names of up to 2 registered patent attorneys or agents. If no name is listed, no name will be printed.

1 KILPATRICK TOWNSEND & STOCKTON LLP
 2 _____
 3 _____

3. ASSIGNEE NAME AND RESIDENCE DATA TO BE PRINTED ON THE PATENT (print or type)

PLEASE NOTE: Unless an assignee is identified below, no assignee data will appear on the patent. If an assignee is identified below, the document has been filed for recordation as set forth in 37 CFR 3.11. Completion of this form is NOT a substitute for filing an assignment.

(A) NAME OF ASSIGNEE **SMARTFLASH TECHNOLOGIES LIMITED** (B) RESIDENCE: (CITY and STATE OR COUNTRY) **ROAD TOWN, TORTOLA, BRITISH VIRGIN ISLANDS**

Please check the appropriate assignee category or categories (will not be printed on the patent): Individual Corporation or other private group entity Government

4a. The following fee(s) are submitted:
 Issue Fee
 Publication Fee (No small entity discount permitted)
 Advance Order - # of Copies _____

4b. Payment of Fee(s): (Please first reapply any previously paid issue fee shown above)
 A check is enclosed.
 Payment by credit card. Form PTO-2038 is attached.
 The Director is hereby authorized to charge ~~XXXXXXXXXX~~ any deficiency, or credit any overpayment, to Deposit Account Number 20-1430 (enclose an extra copy of this form).

5. Change in Entity Status (from status indicated above)
 a. Applicant claims SMALL ENTITY status. See 37 CFR 1.27. b. Applicant is no longer claiming SMALL ENTITY status. See 37 CFR 1.27(g)(2).

NOTE: The Issue Fee and Publication Fee (if required) will not be accepted from anyone other than the applicant; a registered attorney or agent; or the assignee or other party in interest as shown by the records of the United States Patent and Trademark Office.

Authorized Signature /Ben Holt/ Date November 15, 2012
 Typed or printed name Benjamin J. Holt Registration No. 67,536

This collection of information is required by 37 CFR 1.311. The information is required to obtain or retain a benefit by the public which is to file (and by the USPTO to process) an application. Confidentiality is governed by 35 U.S.C. 122 and 37 CFR 1.14. This collection is estimated to take 12 minutes to complete, including gathering, preparing, and submitting the completed application form to the USPTO. Time will vary depending upon the individual case. Any comments on the amount of time you require to complete this form and/or suggestions for reducing this burden, should be sent to the Chief Information Officer, U.S. Patent and Trademark Office, U.S. Department of Commerce, P.O. Box 1450, Alexandria, Virginia 22313-1450. DO NOT SEND FEES OR COMPLETED FORMS TO THIS ADDRESS. SEND TO: Commissioner for Patents, P.O. Box 1450, Alexandria, Virginia 22313-1450.

Under the Paperwork Reduction Act of 1995, no persons are required to respond to a collection of information unless it displays a valid OMB control number.

Electronic Patent Application Fee Transmittal

Application Number:	13212047
Filing Date:	17-Aug-2011
Title of Invention:	DATA STORAGE AND ACCESS SYSTEMS
First Named Inventor/Applicant Name:	Patrick Sandor RACZ
Filer:	Benjamin J. Holt/Sylvia Arnold
Attorney Docket Number:	87790-818158 (000150US)

Filed as Small Entity

Utility under 35 USC 111(a) Filing Fees

Description	Fee Code	Quantity	Amount	Sub-Total in USD(\$)
Basic Filing:				
Pages:				
Claims:				
Miscellaneous-Filing:				
Petition:				
Patent-Appeals-and-Interference:				
Post-Allowance-and-Post-Issuance:				
Utility Appl issue fee	2501	1	885	885
Publ. Fee- early, voluntary, or normal	1504	1	300	300

Description	Fee Code	Quantity	Amount	Sub-Total in USD(\$)
Extension-of-Time:				
Miscellaneous:				
Total in USD (\$)				1185

Electronic Acknowledgement Receipt

EFS ID:	14242248
Application Number:	13212047
International Application Number:	
Confirmation Number:	5477
Title of Invention:	DATA STORAGE AND ACCESS SYSTEMS
First Named Inventor/Applicant Name:	Patrick Sandor RACZ
Customer Number:	20350
Filer:	Benjamin J. Holt/Sylvia Arnold
Filer Authorized By:	Benjamin J. Holt
Attorney Docket Number:	87790-818158 (000150US)
Receipt Date:	15-NOV-2012
Filing Date:	17-AUG-2011
Time Stamp:	17:54:37
Application Type:	Utility under 35 USC 111(a)

Payment information:

Submitted with Payment	yes
Payment Type	Credit Card
Payment was successfully received in RAM	\$1185
RAM confirmation Number	5554
Deposit Account	201430
Authorized User	KILPATRICK TOWNSEND & STOCKTON, LLP

The Director of the USPTO is hereby authorized to charge indicated fees and credit any overpayment as follows:

Charge any Additional Fees required under 37 C.F.R. Section 1.16 (National application filing, search, and examination fees)

Charge any Additional Fees required under 37 C.F.R. Section 1.17 (Patent application and reexamination proceeding fees)

File Listing:

Document Number	Document Description	File Name	File Size(Bytes)/ Message Digest	Multi Part /.zip	Pages (if appl.)
1	Issue Fee Payment (PTO-85B)	2012_11_15_ISSUEFEE_87790-818158-000150US.pdf	1789967 06877f0fcea8f65fb8211a9dd1576b3aa7c1c411	no	1

Warnings:**Information:**

2	Fee Worksheet (SB06)	fee-info.pdf	32130 2e417c9c56ff804d02547bb887c558586f9c32	no	2
---	----------------------	--------------	---	----	---

Warnings:**Information:**

Total Files Size (in bytes):	1822097
-------------------------------------	---------

This Acknowledgement Receipt evidences receipt on the noted date by the USPTO of the indicated documents, characterized by the applicant, and including page counts, where applicable. It serves as evidence of receipt similar to a Post Card, as described in MPEP 503.

New Applications Under 35 U.S.C. 111

If a new application is being filed and the application includes the necessary components for a filing date (see 37 CFR 1.53(b)-(d) and MPEP 506), a Filing Receipt (37 CFR 1.54) will be issued in due course and the date shown on this Acknowledgement Receipt will establish the filing date of the application.

National Stage of an International Application under 35 U.S.C. 371

If a timely submission to enter the national stage of an international application is compliant with the conditions of 35 U.S.C. 371 and other applicable requirements a Form PCT/DO/EO/903 indicating acceptance of the application as a national stage submission under 35 U.S.C. 371 will be issued in addition to the Filing Receipt, in due course.

New International Application Filed with the USPTO as a Receiving Office

If a new international application is being filed and the international application includes the necessary components for an international filing date (see PCT Article 11 and MPEP 1810), a Notification of the International Application Number and of the International Filing Date (Form PCT/RO/105) will be issued in due course, subject to prescriptions concerning national security, and the date shown on this Acknowledgement Receipt will establish the international filing date of the application.



UNITED STATES PATENT AND TRADEMARK OFFICE

UNITED STATES DEPARTMENT OF COMMERCE
United States Patent and Trademark Office
Address: COMMISSIONER FOR PATENTS
P.O. Box 1450
Alexandria, Virginia 22313-1450
www.uspto.gov

Table with 7 columns: APPLICATION NUMBER, FILING or 371(c) DATE, GRP ART UNIT, FIL FEE REC'D, ATTY.DOCKET.NO, TOT CLAIMS, IND CLAIMS. Row 1: 13/212,047, 08/17/2011, 2887, 2136, 87790-818158 (000150US), 39, 11

CONFIRMATION NO. 5477

CORRECTED FILING RECEIPT



20350
KILPATRICK TOWNSEND & STOCKTON LLP
TWO EMBARCADERO CENTER
EIGHTH FLOOR
SAN FRANCISCO, CA 94111-3834

Date Mailed: 11/21/2012

Receipt is acknowledged of this non-provisional patent application. The application will be taken up for examination in due course. Applicant will be notified as to the results of the examination. Any correspondence concerning the application must include the following identification information: the U.S. APPLICATION NUMBER, FILING DATE, NAME OF APPLICANT, and TITLE OF INVENTION. Fees transmitted by check or draft are subject to collection. Please verify the accuracy of the data presented on this receipt. If an error is noted on this Filing Receipt, please submit a written request for a Filing Receipt Correction. Please provide a copy of this Filing Receipt with the changes noted thereon. If you received a "Notice to File Missing Parts" for this application, please submit any corrections to this Filing Receipt with your reply to the Notice. When the USPTO processes the reply to the Notice, the USPTO will generate another Filing Receipt incorporating the requested corrections

Inventor(s)

Patrick Sandor RACZ, Saint Heller, JERSEY;
Hermen-ard Hulst, Amsterdam, NETHERLANDS;

Applicant(s)

Patrick Sandor RACZ, Saint Heller, JERSEY;
Hermen-ard Hulst, Amsterdam, NETHERLANDS;

Assignment For Published Patent Application

Smartflash Technologies Limited, Road Town, VIRGIN ISLANDS, BRITISH

Power of Attorney: The patent practitioners associated with Customer Number 20350

Domestic Priority data as claimed by applicant

This application is a CON of 12/943,872 11/10/2010 PAT 8118221
which is a CON of 12/014,558 01/15/2008 PAT 7942317
which is a CON of 11/336,758 01/19/2006 PAT 7334720
which is a CON of 10/111,716 09/17/2002 ABN
which is a 371 of PCT/GB2000/104110 10/25/2000

Foreign Applications (You may be eligible to benefit from the Patent Prosecution Highway program at the USPTO. Please see http://www.uspto.gov for more information.)

UNITED KINGDOM 9925227.2 10/25/1999

Request to Retrieve - This application either claims priority to one or more applications filed in an intellectual property Office that participates in the Priority Document Exchange (PDX) program or contains a proper Request to

Retrieve Electronic Priority Application(s) (PTO/SB/38 or its equivalent). Consequently, the USPTO will attempt to electronically retrieve these priority documents.

If Required, Foreign Filing License Granted: 08/26/2011

The country code and number of your priority application, to be used for filing abroad under the Paris Convention, is **US 13/212,047**

Projected Publication Date: Not Applicable

Non-Publication Request: No

Early Publication Request: No

**** SMALL ENTITY ****

Title

DATA STORAGE AND ACCESS SYSTEMS

Preliminary Class

235

PROTECTING YOUR INVENTION OUTSIDE THE UNITED STATES

Since the rights granted by a U.S. patent extend only throughout the territory of the United States and have no effect in a foreign country, an inventor who wishes patent protection in another country must apply for a patent in a specific country or in regional patent offices. Applicants may wish to consider the filing of an international application under the Patent Cooperation Treaty (PCT). An international (PCT) application generally has the same effect as a regular national patent application in each PCT-member country. The PCT process **simplifies** the filing of patent applications on the same invention in member countries, but **does not result** in a grant of "an international patent" and does not eliminate the need of applicants to file additional documents and fees in countries where patent protection is desired.

Almost every country has its own patent law, and a person desiring a patent in a particular country must make an application for patent in that country in accordance with its particular laws. Since the laws of many countries differ in various respects from the patent law of the United States, applicants are advised to seek guidance from specific foreign countries to ensure that patent rights are not lost prematurely.

Applicants also are advised that in the case of inventions made in the United States, the Director of the USPTO must issue a license before applicants can apply for a patent in a foreign country. The filing of a U.S. patent application serves as a request for a foreign filing license. The application's filing receipt contains further information and guidance as to the status of applicant's license for foreign filing.

Applicants may wish to consult the USPTO booklet, "General Information Concerning Patents" (specifically, the section entitled "Treaties and Foreign Patents") for more information on timeframes and deadlines for filing foreign patent applications. The guide is available either by contacting the USPTO Contact Center at 800-786-9199, or it can be viewed on the USPTO website at <http://www.uspto.gov/web/offices/pac/doc/general/index.html>.

For information on preventing theft of your intellectual property (patents, trademarks and copyrights), you may wish to consult the U.S. Government website, <http://www.stopfakes.gov>. Part of a Department of Commerce initiative, this website includes self-help "toolkits" giving innovators guidance on how to protect intellectual property in specific countries such as China, Korea and Mexico. For questions regarding patent enforcement issues, applicants may call the U.S. Government hotline at 1-866-999-HALT (1-866-999-4158).

LICENSE FOR FOREIGN FILING UNDER
Title 35, United States Code, Section 184
Title 37, Code of Federal Regulations, 5.11 & 5.15

GRANTED

The applicant has been granted a license under 35 U.S.C. 184, if the phrase "IF REQUIRED, FOREIGN FILING LICENSE GRANTED" followed by a date appears on this form. Such licenses are issued in all applications where the conditions for issuance of a license have been met, regardless of whether or not a license may be required as set forth in 37 CFR 5.15. The scope and limitations of this license are set forth in 37 CFR 5.15(a) unless an earlier license has been issued under 37 CFR 5.15(b). The license is subject to revocation upon written notification. The date indicated is the effective date of the license, unless an earlier license of similar scope has been granted under 37 CFR 5.13 or 5.14.

This license is to be retained by the licensee and may be used at any time on or after the effective date thereof unless it is revoked. This license is automatically transferred to any related applications(s) filed under 37 CFR 1.53(d). This license is not retroactive.

The grant of a license does not in any way lessen the responsibility of a licensee for the security of the subject matter as imposed by any Government contract or the provisions of existing laws relating to espionage and the national security or the export of technical data. Licensees should apprise themselves of current regulations especially with respect to certain countries, of other agencies, particularly the Office of Defense Trade Controls, Department of State (with respect to Arms, Munitions and Implements of War (22 CFR 121-128)); the Bureau of Industry and Security, Department of Commerce (15 CFR parts 730-774); the Office of Foreign Assets Control, Department of Treasury (31 CFR Parts 500+) and the Department of Energy.

NOT GRANTED

No license under 35 U.S.C. 184 has been granted at this time, if the phrase "IF REQUIRED, FOREIGN FILING LICENSE GRANTED" DOES NOT appear on this form. Applicant may still petition for a license under 37 CFR 5.12, if a license is desired before the expiration of 6 months from the filing date of the application. If 6 months has lapsed from the filing date of this application and the licensee has not received any indication of a secrecy order under 35 U.S.C. 181, the licensee may foreign file the application pursuant to 37 CFR 5.15(b).

SelectUSA

The United States represents the largest, most dynamic marketplace in the world and is an unparalleled location for business investment, innovation and commercialization of new technologies. The USA offers tremendous resources and advantages for those who invest and manufacture goods here. Through SelectUSA, our nation works to encourage, facilitate, and accelerate business investment. To learn more about why the USA is the best country in the world to develop technology, manufacture products, and grow your business, visit SelectUSA.gov.



APPLICATION NO.	ISSUE DATE	PATENT NO.	ATTORNEY DOCKET NO.	CONFIRMATION NO.
13/212,047	12/25/2012	8336772	87790-818158 (000150US)	5477

20350 7590 12/05/2012
KILPATRICK TOWNSEND & STOCKTON LLP
TWO EMBARCADERO CENTER
EIGHTH FLOOR
SAN FRANCISCO, CA 94111-3834

ISSUE NOTIFICATION

The projected patent number and issue date are specified above.

Determination of Patent Term Adjustment under 35 U.S.C. 154 (b) (application filed on or after May 29, 2000)

The Patent Term Adjustment is 0 day(s). Any patent to issue from the above-identified application will include an indication of the adjustment on the front page.

If a Continued Prosecution Application (CPA) was filed in the above-identified application, the filing date that determines Patent Term Adjustment is the filing date of the most recent CPA.

Applicant will be able to obtain more detailed information by accessing the Patent Application Information Retrieval (PAIR) WEB site (<http://pair.uspto.gov>).

Any questions regarding the Patent Term Extension or Adjustment determination should be directed to the Office of Patent Legal Administration at (571)-272-7702. Questions relating to issue and publication fee payments should be directed to the Application Assistance Unit (AAU) of the Office of Data Management (ODM) at (571)-272-4200.

APPLICANT(s) (Please see PAIR WEB site <http://pair.uspto.gov> for additional applicants):

Patrick Sandor RACZ, Saint Heller, JERSEY;
Hermen-ard Hulst, Amsterdam, NETHERLANDS;

The United States represents the largest, most dynamic marketplace in the world and is an unparalleled location for business investment, innovation, and commercialization of new technologies. The USA offers tremendous resources and advantages for those who invest and manufacture goods here. Through SelectUSA, our nation works to encourage and facilitate business investment. To learn more about why the USA is the best country in the world to develop technology, manufacture products, and grow your business, visit SelectUSA.gov.

AO 120 (Rev. 08/10)

TO: Mail Stop 8 Director of the U.S. Patent and Trademark Office P.O. Box 1450 Alexandria, VA 22313-1450	REPORT ON THE FILING OR DETERMINATION OF AN ACTION REGARDING A PATENT OR TRADEMARK
---	---

In Compliance with 35 U.S.C. § 290 and/or 15 U.S.C. § 1116 you are hereby advised that a court action has been filed in the U.S. District Court Eastern District of Texas Tyler Division on the following

Trademarks or Patents. (the patent action involves 35 U.S.C. § 292.):

DOCKET NO. 6:13-cv-448	DATE FILED 5/29/2013	U.S. DISTRICT COURT Eastern District of Texas Tyler Division
PLAINTIFF Smartflash LLC and Smartflash Technologies Limited		DEFENDANT Samsung Electronics Co., Ltd., Samsung Electronics America, Inc., Samsung Telecommunications America, LLC, HTC Corporation, HTC America, Inc., Exedeia, Inc. and Game Circus LLC
PATENT OR TRADEMARK NO.	DATE OF PATENT OR TRADEMARK	HOLDER OF PATENT OR TRADEMARK
1 7,334,720	2/26/2008	Smartflash LLC
2 7,942,317	5/17/2011	Smartflash LLC
3 8,033,458	10/11/2011	Smartflash LLC
4 8,061,598	11/22/2011	Smartflash LLC
5 8,118,221	2/21/2012	Smartflash LLC

In the above—entitled case, the following patent(s)/ trademark(s) have been included:

DATE INCLUDED	INCLUDED BY <input type="checkbox"/> Amendment <input type="checkbox"/> Answer <input type="checkbox"/> Cross Bill <input type="checkbox"/> Other Pleading	
PATENT OR TRADEMARK NO.	DATE OF PATENT OR TRADEMARK	HOLDER OF PATENT OR TRADEMARK
1 8,336,772		
2		
3		
4		
5		

In the above—entitled case, the following decision has been rendered or judgement issued:

DECISION/JUDGEMENT

CLERK	(BY) DEPUTY CLERK	DATE
-------	-------------------	------

AO 120 (Rev. 08/10)

TO: Mail Stop 8 Director of the U.S. Patent and Trademark Office P.O. Box 1450 Alexandria, VA 22313-1450	REPORT ON THE FILING OR DETERMINATION OF AN ACTION REGARDING A PATENT OR TRADEMARK
---	---

In Compliance with 35 U.S.C. § 290 and/or 15 U.S.C. § 1116 you are hereby advised that a court action has been filed in the U.S. District Court Eastern District of Texas Tyler Division on the following

Trademarks or Patents. (the patent action involves 35 U.S.C. § 292.):

DOCKET NO. 6:13-cv-447	DATE FILED 5/29/2013	U.S. DISTRICT COURT Eastern District of Texas Tyler Division
PLAINTIFF Smartflash LLC and Smartflash Technologies Limited		DEFENDANT Apple Inc., Robot Entertainment, Inc., Kingsisle Entertainment, Inc. and Game Circus LLC
PATENT OR TRADEMARK NO.	DATE OF PATENT OR TRADEMARK	HOLDER OF PATENT OR TRADEMARK
1 7,334,720	2/26/2008	Smartflash LLC
2 7,942,317	5/17/2011	Smartflash LLC
3 8,033,458	10/11/2011	Smartflash LLC
4 8,061,598	11/22/2011	Smartflash LLC
5 8,118,221	2/21/2012	Smartflash LLC

In the above—entitled case, the following patent(s)/ trademark(s) have been included:

DATE INCLUDED	INCLUDED BY	
	<input type="checkbox"/> Amendment <input type="checkbox"/> Answer <input type="checkbox"/> Cross Bill <input type="checkbox"/> Other Pleading	
PATENT OR TRADEMARK NO.	DATE OF PATENT OR TRADEMARK	HOLDER OF PATENT OR TRADEMARK
1 8,336,772		
2		
3		
4		
5		

In the above—entitled case, the following decision has been rendered or judgement issued:

DECISION/JUDGEMENT

CLERK	(BY) DEPUTY CLERK	DATE
-------	-------------------	------