

SERIAL NUMBER (Series of 1987) 206497		PATENT DATE		PATENT NUMBER	
ORIGINAL NUMBER 07/206,497	FILING DATE 06/13/88	CLASS 360	SUBCLASS 13	GROUP ART UNIT 235 239	EXAMINER Doo Nguyen
ARTHUR R. HAIR, PITTSBURGH, PA.					
CONTINUING DATA*** VERIFIED <i>AK</i>					
FOREIGN/PCT APPLICATIONS*** VERIFIED <i>AK</i>					
FOREIGN FILING LICENSE GRANTED 03/09/88			***** SMALL ENTITY *****		
Foreign priority claimed 35 USC 119 conditions met		<input type="checkbox"/> yes <input checked="" type="checkbox"/> no	AS FILED	STATE OR COUNTRY PA	SHEETS DRWGS. 2
Verified and Acknowledged		Examiner's Initials <i>AK</i>		TOTAL CLAIMS 17	INDEP. CLAIMS 9
				FILING FEE RECEIVED \$ 327.50	ATTORNEY'S DOCKET NO.
ARTHUR R. HAIR 301 OAKLAWN DRIVE PITTSBURGH, PA 15241		Ansel M. Schwartz, Esq. Rood Smith Shaw & McClay P.O. Box 2009 Pittsburgh PA 15230			
TITLE METHODOLOGY/SYSTEM FOR THE ELECTRONIC SALES, DISTRIBUTION, STORAGE, MAINPULATION, RETRIEVAL, PLAYBACK, AND COPYRIGHT PROTECTION OF DIGITAL AUDIO MUSIC.					
U.S. DEPT. of COMM.-Pat. & TM Office - PTO-436L (rev. 10-78)					
PARTS OF APPLICATION FILED SEPARATELY 4 shts. of drwgs. filed 8/24/90					
NOTICE OF ALLOWANCE MAILED		PREPARED FOR ISSUE		CLAIMS ALLOWED	
		Assistant Examiner		Total Claims	Print Claim
		Docket Clerk			
ISSUE FEE				DRAWING	
Amount Due	Date Paid			Sheets Drwg.	Figs. Drwg.
		Primary Examiner		Print Fig.	
		ISSUE CLASSIFICATION		ISSUE BATCH NUMBER	
		Class	Subclass		
Label Area					
WARNING: The information disclosed herein may be restricted. Unauthorized disclosure may be					

BEST AVAILABLE COPY

SEARCHED			
Class	Sub.	Date	Exmr.
369	33,34 13,15 84,85	11/89	Ⓟ
235	380 381 375		
364	479 410		
updated		5/20	RCU

SEARCH NOTES	
Date	Exmr.

INTERFERENCE SEARCHED			
Class	Sub.	Date	Exmr.

BEST AVAILABLE COPY

ATTORNEY'S DOCKET NO.

PATENT APPLICATION TRANSMITTAL LETTER

206497

TO THE COMMISSIONER OF PATENTS AND TRADEMARKS:

Transmitted herewith for filing is the patent application of Arthur Robert Hair

for A methodology/system for the electronic sales, distribution, storage, manipulation, retrieval, playback, and copyright protection of Digital Audio Music.
 Enclosed are:

- Two (2) sheets of drawing.
- an assignment of the invention to _____
- a certified copy of a _____ application.
- associate power of attorney.
- verified statement to establish small entity status under 37 CFR 1.9 and 1.27. _____

CLAIMS AS FILED

SMALL ENTITY

OTHER THAN A SMALL ENTITY

FOR:	NO. FILED	NO. EXTRA
BASIC FEE		
TOTAL CLAIMS	- 20 -	- 0 -
INDEP. CLAIMS	- 3 -	- 6 -
MULTIPLE DEPENDENT CLAIM PRESENT		

RATE	FEE
	\$ 170
x \$ 8 =	\$ 102
x \$ 17 =	\$ 55
+	\$ 55 =
TOTAL	\$ 327

RATE	FEE
	\$ 340
x \$ 12 =	\$
x \$ 34 =	\$
+	\$ 110 =
TOTAL	\$

* If the difference in col. 1 is less than zero, enter "0" in col. 2

- Please charge my Deposit Account No. _____ in the amount of \$ _____.
- A duplicate copy of this sheet is enclosed.
- A check in the amount of \$ 327 to cover the filing fee is enclosed.
- The Commissioner is hereby authorized to charge payment of the following fees associated with this communication or credit any overpayment to Deposit Account No. _____. A Duplicate copy of this sheet is enclosed.
 - Any additional filing fees required under 37 CFR 1.16.
 - Any patent application processing fees under 37 CFR 1.17.
- The Commissioner is hereby authorized to charge payment of the following fees during the pendency of this application or credit any overpayment to Deposit Account No. _____. A duplicate copy of this sheet is enclosed.
 - Any filing fees under 37 CFR 1.16 for presentation of extra claims.
 - Any patent application processing fees under 37 CFR 1.17.
 - The issue fee set in 37 CFR 1.18 at or before mailing of the Notice of Allowance, pursuant to 37 CFR 1.311(a).

June 9, 1988
date

Arthur Robert Hair
signature

Patent and Trademark Office - U.S. DEPARTMENT OF COMMERCE

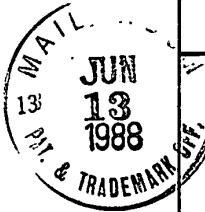

Under the Paperwork Reduction Act of 1995, no persons are required to respond to a collection of information unless it displays a valid OMB control number.

REQUEST FOR ACCESS OF ABANDONED APPLICATION UNDER 37 CFR 1.14(a)

In re Application of

Arthur B. Hair

Application Number

07/206497

Filed

6-13-88

Group Art Unit

Examiner

Paper No. _____

Assistant Commissioner for Patents
Washington, DC 20231

I hereby request access under 37 CFR 1.14(a)(3)(iv) to the application file record of the above-identified ABANDONED application, which is: (CHECK ONE)

(A) referred to in United States Patent Number 5191573, column Front page

(B) referred to in an application that is open to public inspection as set forth in 37 CFR 1.11, i.e., Application No. _____, filed _____, on page _____ of paper number _____.

(C) an application that claims the benefit of the filing date of an application that is open to public inspection, i.e., Application No. _____, filed _____, or

(D) an application in which the applicant has filed an authorization to lay open the complete application to the public.

Please direct any correspondence concerning this request to the following address:

Michael P. Hair

2-2-99

Signature

Date

Michael P. Hair

Typed or printed name

FOR PTO USE ONLY

Approved by: _____

(initials)

Unit: _____

Burden Hour Statement: This form is estimated to take 0.2 hours to complete. Time will vary depending upon the needs of the individual case. Any comments on the amount of time you are required to complete this form should be sent to the Chief Information Officer, Patent and Trademark Office, Washington, DC 20231. DO NOT MAIL THESE UNCOMPLETED FORMS TO THIS ADDRESS. Send to: Assistant Commissioner for Patents, Washington, DC 20231.

2. Benefit of Prior U.S. Application(s) (35 USC 120)

NOTE: If the new application being transmitted is a divisional, continuation or a continuation-in-part of a parent case, or where the parent case is an International Application which designated the U.S., then check the following item and complete and attach ADDED PAGES FOR NEW APPLICATION TRANSMITTAL WHERE BENEFIT OF PRIOR U.S. APPLICATION(S) CLAIMED.

- The new application being transmitted claims the benefit of prior U.S. application(s) and enclosed are ADDED PAGES FOR NEW APPLICATION TRANSMITTAL WHERE BENEFIT OF PRIOR U.S. APPLICATION(S) CLAIMED.

3. Papers Enclosed Which Are Required For Filing Date Under 37 CFR 1.53(b) (Regular) or 37 CFR 1.153 (Design) Application

- 11 Pages of specification
 11 Pages of claims
 1 Pages of Abstract
 2 Sheets of drawing
 formal
 informal

WARNING: *DO NOT submit original drawings. A high quality copy of the drawings should be supplied when filing a patent application. The drawings that are submitted to the Office must be on strong, white, smooth, and non-shiny paper and meet the standards according to § 1.84. If corrections to the drawings are necessary, they should be made to the original drawing and a high-quality copy of the corrected original drawing then submitted to the Office. Only one copy is required or desired. Comments on proposed new 37 CFR 1.84. Notice of March 9, 1988 (1990 O.G. 57-62).*

NOTE: *"Identifying indicia such as the serial number, group and unit, title of the invention, attorney's docket number, inventor's name, number of sheets, etc., not to exceed 2 3/4 inches (7.0 cm.) in width may be placed in a centered location between the side edges within three fourths inch (19.1 mm.) of the top edge. Either this marking technique on the front of the drawing or the placement, although not preferred, of this information and the title of the invention on the back of the drawings is acceptable." Proposed 37 CFR 1.84(1). Notice of March 9, 1988 (1090 O.G. 57-62).*

4. Additional papers enclosed

- Preliminary Amendment
 Information Disclosure Statement (37 CFR 1.98)
 Form PTO-1449
 Citations
 Declaration of Biological Deposit
 Submission of "Sequence Listing," computer readable copy and/or amendment pertaining thereto for biotechnology invention containing nucleotide and/or amino acid sequence.
 Authorization of Attorney(s) to Accept and Follow Instructions from Representative
 Special Comments
 Other

5. Declaration or oath

- Enclosed
executed by (check all applicable boxes)
 - inventor(s).
 - legal representative of inventor(s). 37 CFR 1.42 or 1.43
 - joint inventor or person showing a proprietary interest on behalf of inventor who refused to sign or cannot be reached.
 - this is the petition required by 37 CFR 1.47 and the statement required by 37 CFR 1.47 is also attached. See item 13 below for fee.
- Not Enclosed.

WARNING: Where the filing is a completion in the U.S. of an international Application but where a declaration is not available or where the completion of the U.S. application contains subject matter in addition to the international Application the application may be treated as a continuation or continuation-in-part, as the case may be, utilizing ADDED PAGE FOR NEW APPLICATION TRANSMITTAL WHERE BENEFIT OF PRIOR U.S. APPLICATION CLAIMED.

- Application is made by a person authorized under 37 CFR 1.41(c) on behalf of all the above named inventor(s). (The declaration or oath, along with the surcharge required by 37 CFR 1.16(e) can be filed subsequently).

NOTE: It is important that all the correct inventor(s) are named for filing under 37 CFR 1.41(c) and 1.53(b).

- Showing that the filing is authorized. (Not required unless called into question. 37 CFR 1.41(d).

6. Inventorship Statement

WARNING: If the named inventors are each not the inventors of all the claims an explanation, including the ownership of the various claims at the time the last claimed invention was made, should be submitted.

The inventorship for all the claims in this application are:

- The same
- or
- Are not the same. An explanation, including the ownership of the various claims at the time the last claimed invention was made,
 - is submitted.
 - will be submitted.

7. Language

NOTE: An application including a signed oath or declaration may be filed in a language other than English. A verified English translation of the non-English language application and the processing fee of \$130.00 required by 37 CFR 1.17(k) is required to be filed with the application or within such time as may be set by the Office. 37 CFR 1.52(d).

NOTE: A non-English oath or declaration in the form provided or approved by the PTO need not be translated. 37 CFR 1.69(b).

- English
- non-English
 - the attached translation is a verified translation. 37 CFR 1.52(d).

8. Assignment

- An assignment of the invention to _____
- is attached. A separate "COVER SHEET FOR ASSIGNMENT (DOCUMENT) ACCOMPANYING NEW PATENT APPLICATION" or FORM PTO 1906 is also attached.
- will follow.

NOTE: "If an assignment is submitted with a new application, send two separate letters—one for the application and one for the assignment." Notice of May 4, 1990 (1114 O.G. 77-78).

9. Certified Copy

Certified copy(ies) of application(s)

(country)	(appln. no.)	(filed)
(country)	(appln. no.)	(filed)
(country)	(appln. no.)	(filed)

from which priority is claimed

- is(are) attached.
- will follow.

NOTE: The foreign application forming the basis for the claim for priority must be referred to in the oath or declaration. 37 CFR 1.55(a) and 1.63.

NOTE: This item is for any foreign priority for which the application being filed directly relates. If any parent U.S. application or International Application from which this application claims benefit under 35 U.S.C. 120 is itself entitled to priority from a prior foreign application then complete item 18 on the ADDED PAGES FOR NEW APPLICATION TRANSMITTAL WHERE BENEFIT OF PRIOR U.S. APPLICATION(S) CLAIMED.

10. Fee Calculation (37 CFR 1.16)

- A. Regular application

CLAIMS AS FILED						
Number filed	Number Extra	Rate	Basic Fee 37 CFR 1.16(a) \$710.00			
Total						
Claims (37 CFR 1.16(c)) 31 -20=	11	X	\$ 22.00			242.00
Independent						
Claims (37 CFR 1.16(b)) 8 -3=	5	X	\$ 74.00			370.00
Multiple dependent claim(s), if any (37 CFR 1.16(d))			\$230.00			

- Amendment cancelling extra claims enclosed.
- Amendment deleting multiple-dependencies enclosed.
- Fee for extra claims is not being paid at this time.

NOTE: If the fees for extra claims are not paid on filing they must be paid or the claims cancelled by amendment, prior to the expiration of the time period set for response by the Patent and Trademark Office in any notice of fee deficiency. 37 CFR 1.16(d).

Filing Fee Calculation

\$ 1,322.00

B. Design application
(\$280.00—37 CFR 1.16(f))

Filing Fee Calculation \$ _____

C. Plant application
(\$460.00—37 CFR 1.16(g))

Filing fee calculation \$ _____

11. Small Entity Statement(s)

Verified Statement(s) that this is a filing by a small entity under 37 CFR 1.9 and 1.27 is(are) attached.

Filing Fee Calculation (50% of A, B or C above) \$ 661.00

NOTE: Any excess of the full fee paid will be refunded if a verified statement and a refund request are filed within 2 months of the date of timely payment of a full fee. 37 CFR 1.28(a).

12. Request for International-Type Search (37 CFR 1.104(d)) (complete, if applicable)

Please prepare an international-type search report for this application at the time when national examination on the merits takes place.

13. Fee Payment Being Made At This Time

Not Enclosed

No filing fee is to be paid at this time. (This and the surcharge required by 37 CFR 1.16(e) can be paid subsequently.)

Enclosed

basic filing fee \$ 661.00

recording assignment (\$40.00; 37 CFR 1.21(h)) \$ _____

petition fee for filing by other than all the inventors or person on behalf of the inventor where inventor refused to sign or cannot be reached. (\$130.00; 37 CFR 1.47 and 1.17(h)) \$ _____

for processing an application with a specification in a non-English language. (\$130.00; 37 CFR 1.52(d) and 1.17(k)) \$ _____

processing and retention fee (\$130.00; 37 CFR 1.53(d) and 1.21(l)) \$ _____

fee for international-type search report (\$35.00; 37 CFR 1.21(e)). \$ _____

NOTE: 37 CFR 1.21(l) establishes a fee for processing and retaining any application which is abandoned for failing to complete the application pursuant to 37 CFR 1.53(d) and this, as well as the changes to 37 CFR 1.53 and 1.78, indicate that in order to obtain the benefit of a prior U.S. application, either the basic filing fee must be paid or the processing and retention fee of § 1.21(l) must be paid within 1 year from notification under § 53(d).

Total fees enclosed \$ 661.00

Incorporation by reference of added pages

Check the following item if the application in this transmittal claims the benefit of prior U.S. application(s) (including an international application entering the U.S. stage as a continuation, divisional or C-I-P application) and complete and attach the ADDED PAGES FOR NEW APPLICATION TRANSMITTAL WHERE BENEFIT OF PRIOR U.S. APPLICATION(S) CLAIMED

Plus Added Pages For New Application Transmittal Where Benefit Of Prior U.S. Application(s) Claimed

Number of pages added 5

Plus Added Pages For Papers Referred To In Item 4 Above

Number of pages added _____

Plus "Assignment Cover Letter Accompanying New Application"

Number of pages added _____

Statement Where No Further Pages Added

(If no further pages form a part of this Transmittal then end this Transmittal with this page and check the following item)

This transmittal ends with this page.

2019
586391

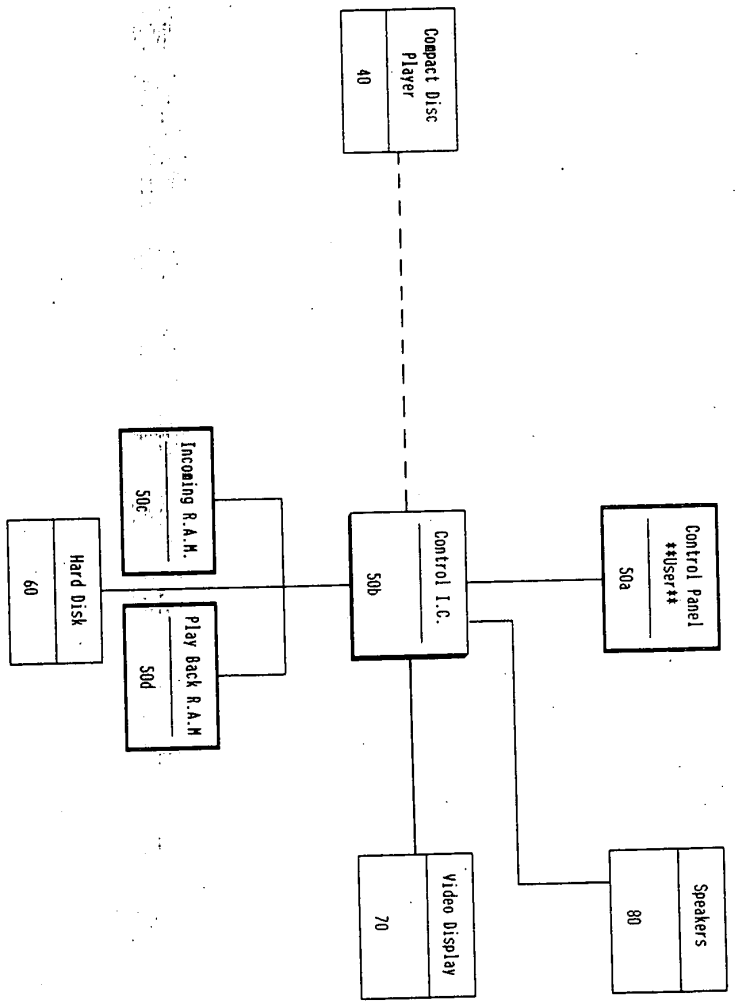

FIGURE 2
A methodology/system for
the electronic transfer
Digital Audio Music
A. R. HAIR

She

206497
586391

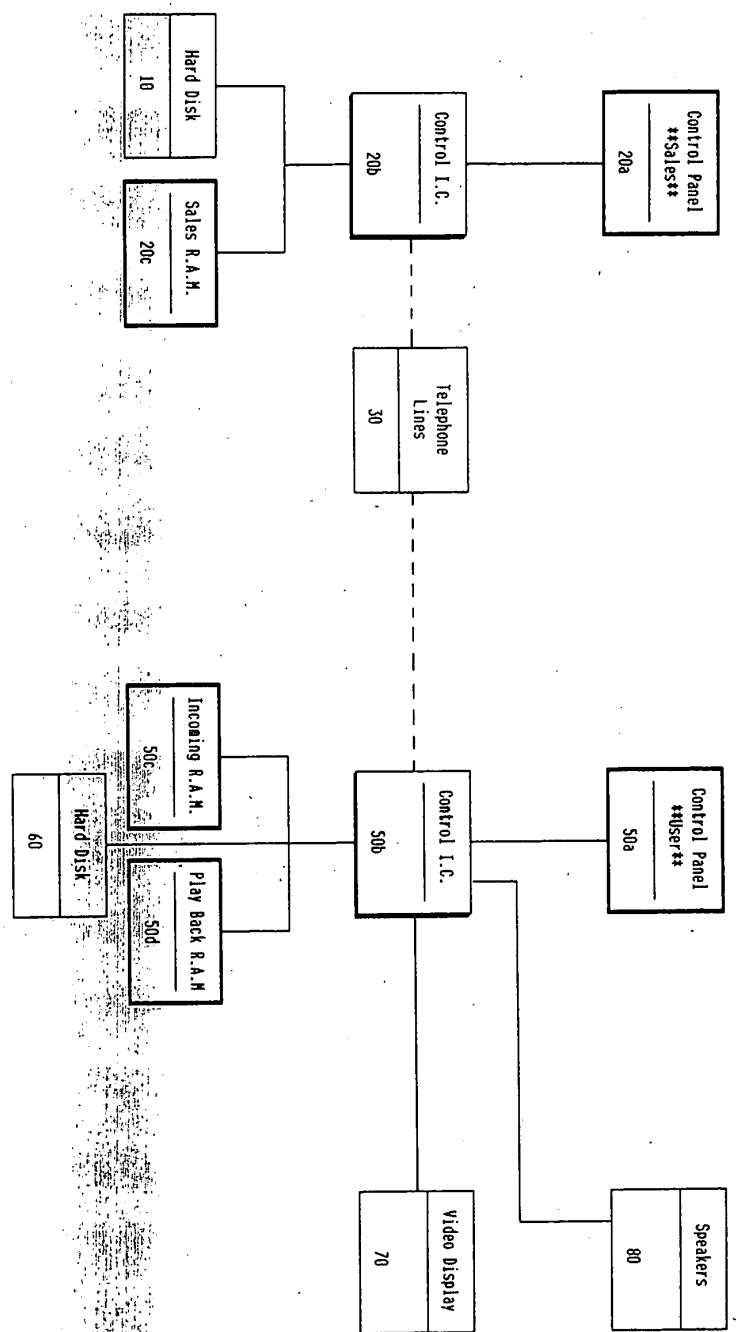

FIGURE 1
A methodology/system for
the electronic transfer
of Digital Audio Music
A.R. HAIR

272-201 A
55-205 A
Page 1 of 6
586391

2007

2
13
JUL 13 1988
FBI

~~TRANSMISSIONAL SYSTEM~~

~~Title of the Invention~~

~~A methodology/system for the electronic sales, distribution, storage, manipulation, retrieval, playback, and copyright protection of Digital Audio Music.~~

~~[B] Cross-References to related applications~~

~~None~~

~~[C] Brief summary of the Invention~~

Sub New Spec #9

~~This invention relates in general to a new and improved methodology/system for the electronic sales, distribution, storage, manipulation, retrieval, playback, and copyright protection of Digital Audio Music.~~

The three basic mediums (hardware units) of music: records, tapes, and compact discs, greatly restricts the transferability of music and results in a variety of inefficiencies.

CAPACITY: The individual hardware units as cited above are limited as to the amount of music that can be stored on each.

MATERIALS: The materials used to manufacture the hardware units are subject to damage and deterioration during normal operations, handling, and exposure to the elements.

SIZE: The physical size of the hardware units imposes constraints on the quantity of hardware units which can be housed for playback in confined areas such as in automobiles, boats, planes, etc.

RETRIEVAL: Hardware units limit the ability to play, in a sequence selected by the user, songs from different albums. For example, if the user wants to play one song from ten different albums, the user would spend an inordinant amount of time handling, sorting, and cueing the ten different hardware units.

SALES and DISTRIBUTION: Prior to final purchase, hardware units need to be physically transfered from the manufacturing facility to the wholesale warehouse to the retail warehouse to the retail outlet, resulting in lengthly lag time between music creation and music marketing, as well as incurring unnessary and inefficient transfer and handling costs. Additionally, tooling costs required for mass production of the hardware units and the material cost of the hardware units themselves, further drives up the cost of music to the end user.

QUALITY: Until the recent invention of Digital Audio Music, as used on Compact Discs, distortion free transfer from the hardware units to the stereo system was virtually impossible. Digital Audio Music is simply music converted into a very basic computer language known as binary. A series of commands known as zeros or ones encode the music for future playback. Use of laser retrieval of the binary commands results in distortion free transfer of the music from the compact disc to the stereo system. Quality Digital Audio Music is defined as the binary structure of the Digital Audio Music. Conventional analog tape recording of Digital Audio Music is not to be considered quality inasmuch as the binary structure itself is not recorded. While Digital Audio Music on compact discs is a technological breakthrough in audio quality, the method by which the music is sold, distributed, stored, manipulated, retrieved, played, and protected from copyright infringements remains as inefficient as with records and tapes.

COPYRIGHT PROTECTION: Since the invention of tape recording devices, strict control and enforcement of copyright laws have proved difficult and impossible with home recorders. Additionally, the recent invention of Digital Audio Tape Recorders now jeopardizes the electronic copyright protection of quality Digital Audio Music on Compact Discs or Digital Audio Tapes. If music exists on hardware units, it can be copied.

Accordingly, it is an objective of this invention is to provide a new and improved ^{method} ~~methodology~~/system to electronically sell and distribute Digital Audio Music.

A further objective of this invention to provide a new and improved ^{method} ~~methodology~~/system to electronically store and retrieve Digital Audio Music.

Another objective of this invention is to provide a new and improved ^{method} ~~methodology~~/system to electronically manipulate, i.e., sort, cue, and select, Digital Audio Music for playback.

Still another objective of this invention is to offer a new and improved ^{method} ~~methodology~~/system which can prevent unauthorized electronic copying of quality Digital Audio Music.

Briefly, this invention ⁶³ accomplishes the above cited objectives by providing a new and improved ^{method} ~~methodology~~/system of electronic sales, distribution, storage, manipulation, retrieval, playback, and copyright protection of Digital Audio Music. The high speed transfer of Digital Audio Music as prescribed by this invention is stored onto one piece of hardware, a hard disk, thus eliminating the need to unnecessarily handle records, tapes, or compact discs on a regular basis. This invention recalls stored music for playback as selected/programmed by the user. This invention can easily and electronically sort stored music based on many different criteria such as, but not limited to, music category, artist, album, user's favorite songs, etc. An additional feature of this invention is the random playback of songs, also based on the user's selection. For example, the user could have this invention randomly play all jazz songs stored on the user's hard disk, or randomly play all songs by a certain artist, or randomly play all of the user's favorite songs which the user previously electronically "tagged" as favorites. Further, being more specific, the user can electronically select a series of individual songs from different albums for sequential playback.

This invention can be configured to either accept direct input of Digital Audio Music from the digital output of a Compact Disc, such transfer would be performed by the private user, or this invention can be configured to accept Digital Audio Music from a source authorized by the copyright holder to sell and distribute the copyrighted materials, thus guaranteeing the protection of such copyrighted materials. Either method of electronically transferring Digital Audio Music by means of this invention is intended to comply with all copyright laws and restrictions and any such transfer is subject to the appropriate authorization by the copyright holder. Inasmuch as Digital Audio Music is software and this invention electronically transfers and stores such music, electronic sales and distribution of the music can take place via telephone lines onto a hard disk. This new ^{method} ~~methodology~~/system of music sales and distribution will greatly reduce the cost of goods sold and will reduce the lag time between music creation and music marketing from weeks down to hours.

63
64

Further objectives and advantages of this invention will become apparent as the following description proceeds and the particular features of novelty which characterize this invention will be pointed out in the claims annexed to and forming a part of this declaration.

[B] Brief description of the several views of the drawings

For a better understanding of this invention, reference should be made to the following detailed description, taken in conjunction with the accompanying drawings, in which:

Fig. 1 is a pictorial flow chart which may be used in carrying out the teachings of this invention for the purposes of electronic sales, distribution, storage, manipulation, retrieval, playback, and copyright protection of Digital Audio Music; and

Fig. 2 is a pictorial flow chart which may be used in carrying out the teachings of this invention for the purposes of electronic storage, manipulation, retrieval, and playback of Digital Audio Music.

Referring now to Fig. 1, this invention is comprised of the following:

- 10 Hard Disk of the copyright holder
- 20 Control Unit of the copyright holder
 - 20a Control Panel
 - 20b Control Integrated Circuit
 - 20c Sales Random Access Memory Chip
- 30 Telephone Lines/Input Transfer
- 50 Control Unit of the user
 - 50a Control Panel
 - 50b Control Integrated Circuit
 - 50c Incoming Random Access Memory Chip
 - 50d Play Back Random Access Memory Chip
- 60 Hard Disk of the user
- 70 Video Display Unit
- 80 Stereo Speakers

The Hard Disk 10 of the agent authorized to electronically sell and distribute the copyrighted Digital Audio Music is the originating source of music in the configuration as outlined in Fig. 1. The Control Unit 20 of the authorized agent is the means by which the electronic transfer of the Digital Audio Music from the agent's Hard Disk 10 via the Telephone Lines 30 to the user's Control Unit 50 is possible. The user's Control Unit would be comprised of a Control Panel 50a, a Control Integrated Circuit 50b, an Incoming Random Access Memory Chip 50c, and a Play Back Random Access Memory Chip 50d. Similarly, the authorized agent's Control Unit 20 would have a control panel and control integrated circuit similar to that of the user's Control Unit 50. The authorized agent's Control Unit 20, however, would only require the Sales Random Access Memory Chip 20c. The other components in Fig. 1 include a Hard Disk 60, a Video Display Unit 70, and a set of Stereo Speakers 80.

Referring now to Fig. 2, with the exception of a substitution of a Compact Disc Player 40 (as the initial source of Digital Audio Music) for the agent's Hard Disk 10, the agent's Control Unit 20, and the Telephone Lines 30 in Fig. 1, Fig. 2 is the same as Fig. 1.

In Fig. 1 and Fig. 2 the following components are already commercially available: the agent's Hard Disk 10, the Telephone Lines 30, the Compact Disc Player 40, the user's Hard Disk 60, the Video Display Unit 70, and the Stereo Speakers 80. The Control Units 20 and 50, however, would be designed specifically to meet the teachings of this invention. The design of the control units would incorporate the following functional features:

1) the Control Panels 20a and 50a would be designed to permit the agent and user to program the respective Control Integrated Circuits 20b and 50b,

2) the Control Integrated Circuits 20b and 50b would be designed to control and execute the respective commands of the agent and user and regulate the electronic transfer of Digital Audio Music throughout the system, additionally, the sales Control Integrated Circuit 20b could electronically code the Digital Audio Music in a configuration which would prevent unauthorized reproductions of the copyrighted material,

3) the Sales Random Access Memory Chip 20c would be designed to temporarily store user purchased Digital Audio Music for subsequent electronic transfer via telephone lines to the user's Control Unit 50,

4) the Incoming Random Access Memory Chip 50c would be designed to temporarily store Digital Audio Music for subsequent electronic storage to the user's Hard Disk 60,

5) the Play Back Random Access Memory Chip 50d would be designed to temporarily store Digital Audio Music for sequential playback.

The foregoing description of the Control Units 20 and 50 is intended as an example only and thereby is not restrictive with respect to the exact number of components and/or its actual design.

~~[E] Detailed description~~

Once the Digital Audio Music has been electronically stored onto the user's Hard Disk 60, having the potential to store literally thousands of songs, the user is free to perform the many functions of this invention. To play a stored song, the user types in the appropriate commands on the Control Panel 50a, and those commands are relayed to the Control Integrated Circuit 50b which retrieves the selected song from the Hard Disk 60. When a song is retrieved from the Hard Disk 60 only a replica of the permanently stored song is retrieved. The permanently stored song remains intact on the Hard Disk 60, thus allowing repeated playback. The Control Integrated Circuit 50b stores the replica onto the Play Back Random Access Memory Chip 50d at a high transfer rate. The Control Integrated Circuit 50b then sends the electronic output to the Stereo Speakers 80 at a controlled rate using the Play Back Random Access Memory Chip 50d as a temporary staging point for the Digital Audio Music.

Unique to this invention is that the Control Unit 50 also serves as the user's personal disk jockey. The user may request specific songs to be electronically cued for playback, or may request the Control Unit 50 to randomly select songs based on the user's criteria. All of these commands are electronically stored in random access memory enabling the control unit to remember prior commands while simultaneously performing other tasks requested by the user and, at the same time, continuing to play songs previously cued.

Offering a convenient visual display of the user's library of songs is but one more new and improved aspect of this invention. As the Control Unit 50 is executing the user's commands to electronically sort, select, randomly play, etc., the Video Display Screen 70 is continually providing feedback to the user. The Video Display Screen 70 can list/scroll all songs stored on the Hard Disk 60, list/scroll all cued songs, display the current command function selected by the user, etc. Further expanding upon the improvements this invention has to offer, the Video Display Screen 70 can display the lyrics of the song being played, as well as the name of the song, album, artist, recording company, date of recording, duration of song, etc. This is possible if the lyrics and other incidental information are electronically stored to the Hard Disk 60 with the Digital Audio Music.

In summary, there has been disclosed a new and improved ^{method} ~~methodology~~/system by which Digital Audio Music can be electronically sold, distributed, transferred and stored. Further, there has been disclosed a new and improved ^{method} ~~methodology~~/system by which Digital Audio Music can be electronically manipulated, i.e., sorted, cued, and selected for playback. Further still, there has been disclosed a new and improved ^{method} ~~methodology~~/system by which the electronic manipulation of Digital Audio Music can be visually displayed for the convenience of the user. Additionally, there has been disclosed a new and improved ^{method} ~~methodology~~/system by which electronic copyright protection of quality Digital Audio Music is possible through use of this invention.

~~[F] Claims~~

Since numerous changes may be made in the above described process and apparatus and different embodiments of the invention may be made without departing from the spirit thereof, it is intended that all matter contained in the foregoing description or shown in the accompanying drawings shall be interpreted as illustrative, and not in a limiting sense. Further, it is intended that this invention is not to be limited to Digital Audio Music and can include Digital Video, Digital Commercials, and other applications of digital information.

Claims

I claim:

1. A methodology/system by which the binary structure of Digital Audio Music can be electronically transferred via telephone lines from a hard disk of the seller to the hard disk of the user in a software configuration which will allow repeated future playback by the user.

2. A methodology/system by which the binary structure of Digital Audio Music stored on a Compact Disc can be electronically stored in a software configuration onto a hard disk which will allow repeated future playback by the user.

3. A methodology/system of electronic retrieval from a hard disk and temporary storage of the binary structure of Digital Audio Music on random access memory for sequential playback.

4. A methodology/system of electronically regulating the playback rate of Digital Audio Music from random access memory to the stereo speakers.

5. A methodology/system of specific electronic selection of Digital Audio Music stored on a hard disk for cued playback.

6. A methodology/system of multiple electronic sorting capabilities of Digital Audio Music stored on a hard disk for cued playback.

7. A methodology/system of automatic and multiple random electronic selection of Digital Audio Music stored on a hard disk for cued playback.

8. A methodology/system to simultaneously and electronically encode lyrics and incidental information with Digital Audio Music in the same binary structure which can be displayed on a video display screen.

9. A methodology/system to electronically display on a video display screen the activities mentioned in claims 1 through 8.

10. A methodology/system which can prevent electronic copyright infringement of the binary structure of quality Digital Audio Music when using this invention.

[G] Abstract of the Disclosure

A methodology/system to electronically store the binary structure of Digital Audio Music onto a conventional hard disk in a configuration which enables electronic sales, distribution, storage, manipulation, retrieval, playback, and copyright protection of such Digital Audio Music. This invention expands upon and integrates prior inventions relating to stereo systems and microcomputers to form an advanced stereo system.

Submitted by:

Arthur Robert Hair

June 9, 1988

DECLARATION FOR PATENT APPLICATION

Docket No. _____

As a below named inventor, I hereby declare that:

My residence, post office address and citizenship are as stated below next to my name.

I believe I am the original, first and sole inventor (if only one name is listed below) or an original, first and joint inventor (if plural names are listed below) of the subject matter which is claimed and for which a patent is sought on the invention entitled A methodology/system for the electronic sales, distribution, storage, the specification of which manipulation, retrieval, playback, and copyright protection of Digital Audio Music, (check one) is attached hereto.

was filed on _____ as Application Serial No. _____ and was amended on _____ (if applicable).

I hereby state that I have reviewed and understand the contents of the above identified specification, including the claims, as amended by any amendment referred to above.

I acknowledge the duty to disclose information which is material to the examination of this application in accordance with Title 37, Code of Federal Regulations, §1.56(a).

I hereby claim foreign priority benefits under Title 35, United States Code, §119 of any foreign application(s) for patent or inventor's certificate listed below and have also identified below any foreign application for patent or inventor's certificate having a filing date before that of the application on which priority is claimed:

Prior Foreign Application(s)			Priority Claimed	
(Number)	(Country)	(Day/Month/Year Filed)	Yes	No
_____	_____	_____	Yes	No
_____	_____	_____	Yes	No
_____	_____	_____	Yes	No

I hereby claim the benefit under Title 35, United States Code, §120 of any United States application(s) listed below and, insofar as the subject matter of each of the claims of this application is not disclosed in the prior United States application in the manner provided by the first paragraph of Title 35, United States Code, §112, I acknowledge the duty to disclose material information as defined in Title 37, Code of Federal Regulations, §1.56(a) which occurred between the filing date of the prior application and the national or PCT international filing date of this application:

_____ (Application Serial No.)	_____ (Filing Date)	_____ (Status—patented, pending, abandoned)
_____ (Application Serial No.)	_____ (Filing Date)	_____ (Status—patented, pending, abandoned)

I hereby appoint the following attorney(s) and/or agent(s) to prosecute this application and to transact all business in the Patent and Trademark Office connected therewith:

Address all telephone calls to _____ at telephone no. _____
Address all correspondence to _____

I hereby declare that all statements made herein of my own knowledge are true and that all statements made on information and belief are believed to be true; and further that these statements were made with the knowledge that willful false statements and the like so made are punishable by fine or imprisonment, or both, under Section 1001 of Title 18 of the United States Code and that such willful false statements may jeopardize the validity of the application or any patent issued thereon.

Full name of sole or first inventor Arthur Robert Hair
Inventor's signature Arthur Robert Hair Date June 9, 1988
Residence 301 Oaklawn Drive Citizenship USA
Post Office Address Pittsburgh, PA 15241

Full name of second joint inventor, if any -none-
Second Inventor's signature _____ Date _____
Residence _____ Citizenship _____
Post Office Address _____

(Supply similar information and signature for third and subsequent joint inventors.)

206497

OMB No. 0651-0011 (12/31/86)

Applicant or Patentee: Arthur Robert Hair Attorney's
 Serial or Patent No.: _____ Docket No.: _____
 Filed or Issued: _____
 For: _____
 1988
 TRADEMARK OFF.

VERIFIED STATEMENT (DECLARATION) CLAIMING SMALL ENTITY STATUS (37 CFR 1.9 (f) and 1.27 (b)) — INDEPENDENT INVENTOR

As a below named inventor, I hereby declare that I qualify as an independent inventor as defined in 37 CFR 1.9 (c) for purposes of paying reduced fees under section 41 (a) and (b) of Title 35, United States Code, to the Patent and Trademark Office with regard to the invention entitled A methodology/system for the electronic sales, described in

the specification filed herewith
 application serial no. _____, filed _____
 patent no. _____, issued _____

I have not assigned, granted, conveyed or licensed and am under no obligation under contract or law to assign, grant, convey or license, any rights in the invention to any person who could not be classified as an independent inventor under 37 CFR 1.9 (c) if that person had made the invention, or to any concern which would not qualify as a small business concern under 37 CFR 1.9 (d) or a nonprofit organization under 37 CFR 1.9 (e).

Each person, concern or organization to which I have assigned, granted, conveyed, or licensed or am under an obligation under contract or law to assign, grant, convey, or license any rights in the invention is listed below:

no such person, concern, or organization
 persons, concerns or organizations listed below*

*NOTE: Separate verified statements are required from each named person, concern or organization having rights to the invention averring to their status as small entities. (37 CFR 1.27)

FULL NAME _____
 ADDRESS _____
 INDIVIDUAL SMALL BUSINESS CONCERN NONPROFIT ORGANIZATION

FULL NAME _____
 ADDRESS _____
 INDIVIDUAL SMALL BUSINESS CONCERN NONPROFIT ORGANIZATION

FULL NAME _____
 ADDRESS _____
 INDIVIDUAL SMALL BUSINESS CONCERN NONPROFIT ORGANIZATION

I acknowledge the duty to file, in this application or patent, notification of any change in status resulting in loss of entitlement to small entity status prior to paying, or at the time of paying, the earliest of the issue fee or any maintenance fee due after the date on which status as a small entity is no longer appropriate. (37 CFR 1.28 (b))

I hereby declare that all statements made herein of my own knowledge are true and that all statements made on information and belief are believed to be true; and further that these statements were made with the knowledge that willful false statements and the like so made are punishable by fine or imprisonment, or both, under section 1001 of Title 18 of the United States Code, and that such willful false statements may jeopardize the validity of the application, any patent issuing thereon, or any patent to which this verified statement is directed.

Arthur Robert Hair ////////////////
 NAME OF INVENTOR NAME OF INVENTOR NAME OF INVENTOR

Arthur Robert Hair
 Signature of Inventor Signature of Inventor Signature of Inventor

June 9, 1988
 Date Date Date

206497

PATENT APPLICATION SERIAL NO.

U.S. DEPARTMENT OF COMMERCE
PATENT AND TRADEMARK OFFICE
FEE RECORD SHEET

~~090 06/24/88 206497~~
~~090 06/24/88 206497~~

~~1 201 272.00 CK~~
~~1-205 55.00 CK~~

~~050 08/01/88 206497~~
050 08/01/88 206497

~~1 205 55.00 CK~~
1 201 55.00 CK

PATENT APPLICATION FEE DETERMINATION RECORD

APPLICANT (PRINT NAME)
A. Hair

CLAIMS AS FILED - PART I

FOR	NO. FILED	NO. EXTRA
BASIC FEE		
TOTAL CLAIMS	17	0
INDEP. CLAIMS	9	6
<input checked="" type="checkbox"/> MULTIPLE DEPENDENT CLAIMS PRESENT		

* The difference in col. 1 is less than zero enter 0 in col. 2

SMALL ENTITY		OR	OTHER THAN A SMALL ENTITY	
RATE	FEE		RATE	FEE
	\$170	OR		\$340
x6	\$	OR	x2	\$
x17	\$102	OR	x36	\$
x55	\$35	OR	x100	\$
TOTAL	\$277	OR	TOTAL	\$

CLAIMS AS AMENDED - PART II

AMENDMENT A	CLAIMS REMAINING AFTER AMENDMENT	MINUS	HIGHEST NO. PREVIOUSLY PAID FOR	PRESENT EXTRA
			1)	3)
TOTAL				
INDEP.				
FIRST PRESENTATION OF MULTIPLE DEP. CLAIMS				

SMALL ENTITY		OR	OTHER THAN A SMALL ENTITY	
RATE	ADDITIONAL FEE		RATE	ADDITIONAL FEE
\$	\$	OR	\$10	\$
15	\$	OR	30	\$
50	\$	OR	100	\$
TOTAL ADDITIONAL FEE	\$	OR	TOTAL	\$

AMENDMENT B	CLAIMS REMAINING AFTER AMENDMENT	MINUS	HIGHEST NO. PREVIOUSLY PAID FOR	PRESENT EXTRA
			1)	3)
TOTAL				
INDEP.				
FIRST PRESENTATION OF MULTIPLE DEP. CLAIMS				

SMALL ENTITY		OR	OTHER THAN A SMALL ENTITY	
RATE	ADDITIONAL FEE		RATE	ADDITIONAL FEE
\$	\$	OR	\$	\$
5	\$	OR	20	\$
10	\$	OR	50	\$
TOTAL ADDITIONAL FEE	\$	OR	TOTAL	\$

AMENDMENT C	CLAIMS REMAINING AFTER AMENDMENT	MINUS	HIGHEST NO. PREVIOUSLY PAID FOR	PRESENT EXTRA
			1)	3)
TOTAL				
INDEP.				
FIRST PRESENTATION OF MULTIPLE DEP. CLAIMS				

SMALL ENTITY		OR	OTHER THAN A SMALL ENTITY	
RATE	ADDITIONAL FEE		RATE	ADDITIONAL FEE
\$	\$	OR	\$	\$
10	\$	OR	30	\$
50	\$	OR	100	\$
TOTAL ADDITIONAL FEE	\$	OR	TOTAL	\$

* If the entry in Col. 1 is less than the entry in Col. 2, enter 0 in Col. 3.
 ** If the highest no. previously paid for is in this space it is less than 25, enter "25".
 *** If the highest no. previously paid for is in this space it is less than 100, enter "100".

BEST AVAILABLE COPY

FEE CALCULATION SHEET
(FOR USE WITH FORM PTO-875)

APPLICANT(S)

A. Hair

CLAIMS

	AS FILED		AFTER 1st AMENDMENT		AFTER 2nd AMENDMENT			*		*		*	
	IND.	DEP.	IND.	DEP.	IND.	DEP.		IND.	DEP.	IND.	DEP.	IND.	DEP.
1	/												
2	/												
3	/												
4	/												
5	/												
6	/												
7	/												
8	/												
9	/	8											
10	/												
11													
12													
13													
14													
15													
16													
17													
18													
19													
20													
21													
22													
23													
24													
25													
26													
27													
28													
29													
30													
31													
32													
33													
34													
35													
36													
37													
38													
39													
40													
41													
42													
43													
44													
45													
46													
47													
48													
49													
50													
TOTAL IND.	9												
TOTAL DEP.	8												
TOTAL													
51													
52													
53													
54													
55													
56													
57													
58													
59													
60													
61													
62													
63													
64													
65													
66													
67													
68													
69													
70													
71													
72													
73													
74													
75													
76													
77													
78													
79													
80													
81													
82													
83													
84													
85													
86													
87													
88													
89													
90													
91													
92													
93													
94													
95													
96													
97													
98													
99													
100													
TOTAL IND.													
TOTAL DEP.													
TOTAL													

230

GPE

IN THE UNITED STATES PATENT AND TRADEMARK OFFICE

RECEIVED

RECEIVED

Williams
3-21-89

In re Application of)
ARTHUR ROBERT HAIR)
Serial No. 07/206,497)
Filed: June 13, 1988)
Art Unit 235)

JAN 05 1989

JAN 04 1989

GROUP 230

GROUP 210

METHODOLOGY/SYSTEM FOR THE
ELECTRONIC SALES, DISTRIBUTION,
STORAGE, MANIPULATION, RETRIEVAL,
PLAYBACK, AND COPYRIGHT PROTECTION
OF DIGITAL AUDIO MUSIC

Pittsburgh, Pennsylvania 15230

December 19, 1988

CERTIFICATE OF MAILING

Hon. Commissioner of Patents and Trademarks
Washington, D.C. 20231
Sir:

I hereby certify that the correspondence is
being deposited with the United States Postal
Service as first class mail in an envelope
addressed to: Commissioner of Patents and
Trademarks, Washington, DC 20231,
on 12/19/88

PRELIMINARY AMENDMENT

Ansel Schwartz

Ansel M. Schwartz
Registration No. 30,587

IN THE CLAIMS

12/19/88
Date

Cancel Claims 1-10.

Please add the following claims:

*Sub E2
#23*

11. A method for transmitting a desired digital audio
music signal stored on a first memory to a second memory
comprising the steps of:

*B
ins B1
a1*

transferring money to a party controlling use of the
first memory from a ^{first} party controlling use of the second memory;

connecting electronically the first memory with the
second memory such that the digital signal can pass therebetween;

transmitting the digital signal from the first memory to
the second memory; and

RECEIVED

DEC 30 1988

APPLICATION BRANCH

storing the digital signal in the second memory.

²12. A method as described in Claim ~~11~~ including after the transferring step, the steps of searching the first memory for the desired digital audio ~~music~~ signal; and selecting the desired digital audio ~~music~~ signal from the first memory.

at
Aut Co
P
n
H
~~13. A method as described in Claim 12 wherein the transferring step includes the steps of telephoning the party controlling use of the first memory by the party controlling the second memory; providing a credit card number of the party controlling the second memory to the party controlling the first memory so the party controlling the second memory is charged money.~~

- 2 |

CL3

REMARKS

Claims 1-10 have been canceled.

Claims 11-13 have been added. Antecedent support for these new claims is found in the figures.

In view of the foregoing amendments and remarks, it is respectfully requested that this application be reconsidered and withdrawn, in Claims 11-13, now in this application, be allowed.

Respectfully submitted,

ARTHUR ROBERT HAIR

By Ansel Schwartz
Ansel M. Schwartz, Esq.
Reg. No. 30,587
Reed Smith Shaw & McClay
435 Sixth Avenue
P.O. Box 2009
Pittsburgh, Pennsylvania 15230
(412) 288-4184

Attorney for Applicant

CERTIFICATE OF MAILING

I hereby certify that the correspondence is being deposited with the United States Postal Service as first class mail in an envelope addressed to: Commissioner of Patents and Trademarks, Washington, DC 20231, on 12/19/88

Ansel Schwartz
Ansel M. Schwartz
Registration No. 30,587
12/19/88
Date



RECEIVED

JAN 04 1989

GROUP 210

me J 1/9/89

PATENT RECEIVED

IN THE UNITED STATES PATENT AND TRADEMARK OFFICE

JAN 05 1989

GROUP 230

In re application of*: Arthur R. Hair

Serial No.: 07/206,497 Group No.

Filed: June 13, 1988 Examiner:

For*: METHODOLOGY/SYSTEM FOR THE ELECTRONIC SALES, DISTRIBUTION, STORAGE, MANIPULATION, RETRIEVAL, PLAYBACK AND COPYRIGHT PROTECTION OF DIGITAL

Patent No.: Issued: AUDIO MUSIC

*NOTE: Insert name(s) of all inventor(s) and title also for patent.

Commissioner of Patents and Trademarks

Washington, D.C. 20231

RECEIVED

POWER OF ATTORNEY BY INVENTOR(S) (REVOCAION OF PRIOR POWERS)

DEC 27 1988

GROUP 290

As a named inventor for the above identified

application

patent

REVOCAION OF PRIOR POWERS OF ATTORNEY

I hereby revoke all powers of attorney previously given and

NEW POWER OF ATTORNEY

I hereby appoint the following attorney(s) and/or agent(s) to prosecute and transact all business in the Patent and Trademark Office connected therewith.

(List name and registration number)

Thomas C. Wettach, Reg. No. 24,455; Arland T. Stein, Reg. No. 25,062; Frederick H. Colon, Reg. No. 28,061; James G. Uber, Reg. No. 30,600; W. Scott Raiton, Reg. No. 23,039; William K. Wells, Reg. No. 27,042; Michael J. Kline, Reg. No. 31,632; and Ansel M. Schwartz, Reg. No. 30,587; Louis M. Heidelberger, Reg. No. 27,899 and Steven R. Petersen, Reg. No. 31,287

SEND CORRESPONDENCE TO

DIRECT TELEPHONE CALLS TO:

Ansel M. Schwartz, Esquire
Reed Smith Shaw & McClay
P.O. Box 2009
Pittsburgh, PA 15230

Ansel M. Schwartz, Esq.
412/288-4184

(Power of Attorney by Inventors [12-1]—page 1 of 2)

Date: <u>12/15/1988</u>	Type or print inventor's name
	<u>Arthur R. Hair</u>
	Inventor's signature <u>Arthur R. Hair</u>
	Post Office Address <u>337 Quail Run Road</u> <u>Venetia, Pennsylvania 15367</u>

Date: _____	Type or print inventor's name

	Inventor's signature
	Post Office Address

Date: _____	Type or print inventor's name

	Inventor's signature
	Post Office Address

NOTE: A power of attorney may be revoked at any stage in the prosecution of a case.

(Supply similar information and signature for fourth and subsequent inventors.)

00/15/88 200,427
Arthur R. Hair

Ansel M. Schwartz, Esq.
Reed Smith Shaw & McClay
P. O. Box 2009
Pittsburgh, PA 15230

MAILED

19,1989

GROUP 230

This is in response to the communication re the Power of Attorney filed DECEMBER 22, 1988

1. The power of attorney to you in this application has been revoked by the applicant ^{assignee.}
2. In view of the notice in this application of the death of _____ his power of attorney is terminated.
3. The power of attorney to you in this application has been accepted by the Commissioner of Patents, & Trademarks.

K. A. Nelson
For Director, Operation

4. The assignee in this application has intervened and appointed an attorney of his own selection. Further correspondence will be held with said attorney. (Rule 36, Rules of Practice.)
5. The revocation of the power of attorney to _____ has been entered and said attorney has been notified. Further correspondence will be addressed to you.
6. On _____, the applicant appointed _____ ^{assignee} as additional attorney in this application. Further correspondence will continue to be addressed to you as specified in the new power of attorney.
7. On _____, the applicant appointed _____ ^{assignee} as additional attorney in this application. Further correspondence will be addressed to said attorney. MPEP 403.02
8. The associate power of attorney to you in this application has been revoked by the attorney of record.

For Director, Operation



60 235 #5

IN THE UNITED STATES PATENT AND TRADEMARK OFFICE

RECEIVED

re Application of
ARTHUR R. HAIR
Serial No. 07/206,497
Filed: June 13, 1988
Art Unit: 235
Patent Examiner:

) MAR 17 1989
)
) GROUP 230
)
) TRANSMISSION SYSTEM
)
)
)
)
)
)

Pittsburgh, Pennsylvania 15230
March 13, 1989

Hon. Commissioner of Patents and Trademarks
Washington, D.C. 20231
Sir:

CHANGE OF ADDRESS

Please be informed that applicants' attorney's address has changed to Alder, Cohen, and Grigsby, P.C., 2900 CNG Tower, 625 Liberty Avenue, Pittsburgh, Pennsylvania 15222. Please direct all correspondence to this address. Thank you.

Respectfully submitted,
ARTHUR R. HAIR

CERTIFICATE OF MAILING

I hereby certify that the correspondence is being deposited with the United States Postal Service as first class mail in an envelope addressed to: Commissioner of Patents and Trademarks, Washington, DC 20231.

3/13/89

Ansel M. Schwartz
Registration No. 30,587

3/13/89

Date

By
Ansel M. Schwartz, Esquire
Reg. No. 30,587
Alder, Cohen & Grigsby, P.C.
2900 CNG Tower
625 Liberty Avenue
Pittsburgh, PA 15222
(412) 394-4987

Attorney for Applicant



UNITED STATES DEPARTMENT OF COMMERCE
Patent and Trademark Office

Address: COMMISSIONER OF PATENTS AND TRADEMARKS
Washington, D.C. 20231

07/208,497 08/13/88 RDLR

ALDER, COHEN, AND CRIDSBY, P.C.
2900 ONE TOWER
625 LIBERTY AVE.
PITTSBURGH, PA 15222

NGUYEN, H

235

11/30/89

This application has been examined Responsive to communication filed on 12/22/88 This action is made final.

A shortened statutory period for response to this action is set to expire 3 month(s), _____ days from the date of this letter.
Failure to respond within the period for response will cause the application to become abandoned. 35 U.S.C. 133

Part I THE FOLLOWING ATTACHMENT(S) ARE PART OF THIS ACTION:

- | | |
|---|--|
| 1. <input checked="" type="checkbox"/> Notice of References Cited by Examiner, PTO-892. | 2. <input type="checkbox"/> Notice re Patent Drawing, PTO-948. |
| 3. <input type="checkbox"/> Notice of Art Cited by Applicant, PTO-1449. | 4. <input type="checkbox"/> Notice of Informal Patent Application, Form PTO-152. |
| 5. <input type="checkbox"/> Information on How to Effect Drawing Changes, PTO-1474. | 6. <input type="checkbox"/> _____ |

Part II SUMMARY OF ACTION

1. Claims 11-13 are pending in the application.
Of the above, claims _____ are withdrawn from consideration.
2. Claims 1-10 have been cancelled.
3. Claims _____ are allowed.
4. Claims 11-13 are rejected.
5. Claims _____ are objected to.
6. Claims _____ are subject to restriction or election requirement.
7. This application has been filed with informal drawings under 37 C.F.R. 1.85 which are acceptable for examination purposes.
8. Formal drawings are required in response to this Office action.
9. The corrected or substitute drawings have been received on _____. Under 37 C.F.R. 1.84 these drawings are acceptable. not acceptable (see explanation or Notice re Patent Drawing, PTO-948).
10. The proposed additional or substitute sheet(s) of drawings, filed on _____, has (have) been approved by the examiner. disapproved by the examiner (see explanation).
11. The proposed drawing correction, filed on _____, has been approved. disapproved (see explanation).
12. Acknowledgment is made of the claim for priority under U.S.C. 119. The certified copy has been received not been received been filed in parent application, serial no. _____; filed on _____.

Application appears to be in condition for allowance except for formal matters, prosecution as to the merits is closed in accordance with the practice under Ex parte Quayle, 1935 C.D. 11; 453 O.G. 213.

NOTION

Serial No. 07/206497

-2-

Art Unit 235

1. The title of the invention is not descriptive. A new title is required that is clearly indicative of the invention to which the claims are directed.

2. The Abstract of the Disclosure is objected to because it is not provided on a separate sheet. Correction is required. See M.P.E.P. § 608.01(b).

3. The disclosure is objected to because of the following informalities: The use of the term "methodology" through out the disclosure is not familiar. Perhaps applicant means --method--. On page 5, line 33, "Claims" should be deleted. Appropriate correction is required.

4. The following is a quotation of the appropriate paragraphs of 35 U.S.C. § 102 that form the basis for the rejections under this section made in this Office action:

A person shall be entitled to a patent unless --

(b) the invention was patented or described in a printed publication in this or a foreign country or in public use or on sale in this country, more than one year prior to the date of application for patent in the United States.

5. Claims 11-13 are rejected under 35 U.S.C. § 102(b) as being clearly anticipated by Lightener'US/3718906.

See the abstract, figs. 1-2 and 9, col. 2 lines 15-36, col. 8 lines 15-67, col. 13 line 61 to col. 14 line 6, and col. 15

Serial No. 07/206497

-3-

Art Unit 235

lines 19-30 of Lightener.

6. The prior art made of record and not relied upon is considered pertinent to applicant's disclosure.

Hughes'US/3990710 and Ogaki et al.'US/4654799 teach the duplication of information onto another medium at a vending site. Lockwood'US/4567359 teaches dispensing information from a remotely located processor. Geddes'US/4647989 teaches indicating and supplying money for a designated selection.

7. Any inquiry concerning this communication or earlier communications from the examiner should be directed to Hoa Nguyen whose telephone number is (703) 557-4930.

Any inquiry of a general nature or relating to the status of this application should be directed to the Group receptionist whose telephone number is (703) 557-2878.



Hoa T. Nguyen
Examiner, Art Unit 235
November 15, 1989



STEVEN L. STEPHAN
PRIMARY EXAMINER
ART UNIT 235

FORM PTO 892 (REV. 3-78)	U.S. DEPARTMENT OF COMMERCE PATENT AND TRADEMARK OFFICE	SERIAL NO. 586391 206497	GROUP/UNIT 235	ATTACHMENT TO PAPER NUMBER 6
NOTICE OF REFERENCES CITED		APPLICANT(S) HARR		

U.S. PATENT DOCUMENTS										
*	DOCUMENT NO.					DATE	NAME	CLASS	SUB-CLASS	FILING DATE IF APPROPRIATE
A	4	5	6	7	359	1/28/86	Lockwood	235	381	
B	4	6	5	4	799	3/31/87	Ogaki et al	364	479	
C	4	6	4	7	989	3/31/87	Geddes	235	381	3/18/83
D	3	9	9	0	710	11/9/76	Hughes	369	34	
E	3	7	1	8	906	2/27/73	Lightner	235	381	
F										
G										
H										
I										
J										
K										

FOREIGN PATENT DOCUMENTS												
*	DOCUMENT NO.					DATE	COUNTRY	NAME	CLASS	SUB-CLASS	PERTINENT SHTS. DWG.	PP. SPEC.
L												
M												
N												
O												
P												
Q												

OTHER REFERENCES (Including Author, Title, Date, Pertinent Pages, Etc.)									
R									
S									
T									
U									

NGUYEN	DATE 11/15/89
--------	------------------

* A copy of this reference is not being furnished with this office action.
(See Manual of Patent Examining Procedure, section 707.05 (a).)



IN THE UNITED STATES PATENT AND TRADEMARK OFFICE

RECEIVED

MAR 05 1990

GROUP 230

In re Application of:)

ARTHUR HAIR)

Serial No. 07/206,497)

Filed: June 13, 1988)

Art Unit 235)

Patent Examiner:)

H. T. Nguyen)

METHODOLOGY/SYSTEM FOR THE ELECTRONIC
SALES, DISTRIBUTION, STORAGE,
MANIPULATION, RETRIEVAL, PLAYBACK,
AND COPYRIGHT PROTECTION OF DIGITAL
AUDIO MUSIC

mj
3/10/90

Pittsburgh, Pennsylvania 15222

February 26, 1990

CERTIFICATE OF MAILING

I hereby certify that the correspondence is
being deposited with the United States Postal
Service as first class mail in an envelope
addressed to: Commissioner of Patents and
Trademarks, Washington, DC 20231,
on 2/26/90

Hon. Commissioner of Patents and Trademarks

Washington, D.C. 20231

Sir:

Ansel Schwartz

Ansel M. Schwartz
Registration No. 30,587

2/26/90

Date

AMENDMENT

In response to the Office Action dated November 30,

1989, please amend the above-identified application as follows:

IN THE TITLE:

Please delete the paragraph entitled "TITLE OF THE
INVENTION" and insert -- TRANSMISSION SYSTEM -- .

IN THE CLAIMS:

Please add the following claims.

Claim 11, line 4, before "party" insert -- first -- ;

3/12/90
gou

Claim 11, line 5, change "party" to - second party

B1 financially distinct from the first party, said second party

14. A method as described in Claim 11 wherein the transmitting step includes the step of transmitting the digital signal from the first memory to the second memory at a location determined by the second party controlling use of the second memory.

Sub E3
G9 F4 15. A method for transmitting a desired digital, a video or audio music signal stored on a first memory to a second memory comprising the steps of:

charging a fee to a first party controlling use of the second memory;

B2 connecting the first memory with the second memory such that the digital signal can pass therebetween;

transmitting the digital signal from the first memory to the second memory; and

storing the digital signal in the second memory.

16. A method as described in Claim 15 wherein the transmitting step includes the step of transmitting the digital signal from the first memory to the second memory at a location determined by the second party controlling use of the second memory.

17. A method as described in Claim 14 wherein the step of transferring money includes the step of transferring money to the party controlling use of the first memory from the second party controlling the use and the location of the second memory.

18. A method as described in Claim 16 wherein the step of charging a fee includes the step of charging a fee to a party controlling the use and the location of the second memory.

B2
19. A method as described in Claim 17 including before the connecting step the step of placing by the second party the second memory into a position that the second memory can be connected with the first memory.

20. A method as described in Claim 18 including before the connecting step the step of placing by the second party the second memory into a position that the second memory can be connected with the first memory.

IN THE ABSTRACT OF THE DISCLOSURE:

Please delete the paragraph entitled (G) Abstract of the Disclosure on page 6 and add on a new page 7 add the following abstract of the disclosure. - A method and system to electronically store the binary structure of Digital Audio Music or Video onto a conventional hard disk in a configuration which enables electronic sales, distribution, storage, manipulation, retrieval, playback, and copyright protection of such Digital

BB Audio Music. This invention expands upon and integrates prior inventions relating to stereo systems and microcomputers to form an advanced stereo system. ~~AAVVV~~

IN THE SPECIFICATION:

- Page 1, line 8, change "methodology" to -- method -- .
- Page 2, line 8, change "methodology" to -- method -- ;
- Page 2, line 11, change "methodology" to -- method -- ;
- Page 2, line 14, change "methodology" to -- method -- ;
- Page 2, line 17, change "methodology" to -- method -- ;
- Page 2, line 20, change "methodology" to -- method -- ;
- Page 2, line 49, change "methodology" to -- method -- .
- Page 5, line 22, change "methodology" to -- method -- ;
- Page 5, line 25, change "methodology" to -- method -- ;
- Page 5, line 28, change "methodology" to -- method -- ;
- Page 5, line 31, change "methodology" to -- method -- ;
- Page 5, line 33, delete "[F] CLAIMS".

REMARKS

Claims 11-20 are currently active.

Applicant's invention is a method for transmitting a desired digital audio music signal or video signal stored on a first memory to a second memory. The method comprises the steps of either transferring money to or charging a fee by a party controlling use of the first memory from a party controlling use of the second memory; connecting the first memory with the second memory such that the digital signal can pass therebetween; transmitting the digital signal from the first memory to the second memory; and storing the digital signal in the second memory. The party controlling use of the second memory can then utilize the signal on the second memory as desired.

The Examiner has rejected Claims 11-13 under 35 U.S.C. §102(b) as being clearly anticipated by Lightner. Applicant respectfully traverses this rejection.

Referring to Lightner, there is disclosed a vending system for remotely accessible stored information. The vending system includes a central station in which various information stored on master recordings can be selectively accessed by purchasers from any of multiple remote vending machines. The accessed information is reproduced on cartridge type storage media at that vending machine. Once currency or a credit card is received by the vending machine, the selected information is transferred to the cartridge. After transmission is complete,

the cartridge is then ejected from the vending machine and received by the purchaser to be then controlled by the purchaser.

In contradiction, applicant's claimed invention has money transferred, or credit charged "from a party controlling use of the second memory" to a party controlling use of the first memory. In Lightner, the party controlling the master recording is "controlling use of the second memory" up until transmission of the "digital signal from the first memory to the second memory" occurs. "The vending machine includes a high speed duplicator and a quantity of acquirable media, such as blank tape cassettes. The data selected by the consumer is transmitted from the master tape center to the vending machine where it is copied by the duplicator onto the cassette which is then ejected from the machine". See column 2, lines 27-34. It is only after the ejection from the machine that the consumer has control of the "second memory". This is an important distinction since applicant defines his invention as the ability for the "second party" to have transmitted a desired digital signal to the "second memory" that the second party is "controlling". This could be, for instance, some type of recording machine at the home of the "party controlling the second memory" or even at a commercial vending machine but which allows the "party controlling use of the second memory" to supply it to the commercial vending machine and compile a collection of desired signal over time. Lightner teaches the second memory is in the possession of the vending machine and provides no ability to

receive a "second memory" which is controlled by the party providing the "second memory".

Claims 12-14 and 17 are dependent to parent Claim 11 and has all the limitations thereof. Since parent Claim 11 is patentable, so are Claims 12-14 and 17. Accordingly, Lightner does not teach or suggest "transmitting the digital signal from the first memory to the second memory" with the "second party controlling use of the second memory" and does not anticipate applicant's claimed invention.

Moreover, Claims 14, 17 and 19 have the limitation that the "step of transmitting the digital signal from the first memory to the second memory" occurs "at a location determined by the second party controlling use of the second memory". Lightner teaches and suggests that the vending machine is at a location determined by the "first party" (or its agent or representative which is the same thing) and requires the second party to go to the location of the vending machine which is determined by the first party. Claims 14, 17 and 19 are patentable for this additional reason.

Claim 15 is patentable for the reason Claim 11 is patentable. Claim 16, 18 and 20 are dependent to parent Claim 15 and have all the limitations thereof. Since Claim 15 is patentable so are Claims 16, 18 and 20. Moreover, Claims 16, 18 and 20 are additionally patentable for the reasons Claims 14, 17 and 19 are patentable.

Claims 14-20 have been added. Antecedent support for these claims is found in Figure 1.

The figures have been amended to delete superfluous information as shown in red.

The title of the invention has been amended.

The Commissioner is hereby authorized to charge all fees to Deposit Account No. 01-0693. A duplicate copy of this Amendment is enclosed.

In view of the foregoing amendments and remarks, it is respectfully requested that the outstanding rejections and objections to this application be reconsidered and withdrawn, and Claims 11 through 20, now in this application, be allowed.

Respectfully submitted,

ARTHUR HAIR

By Ansel Schwartz
Ansel M. Schwartz, Esquire
Reg. No. 30,587
Alder, Cohen & Grigsby, P.C.
2900 CNG Tower
625 Liberty Avenue
Pittsburgh, PA 15222
(412) 394-4900

Attorney for Applicant

CERTIFICATE OF MAILING

I hereby certify that the correspondence is being deposited with the United States Postal Service as first class mail in an envelope addressed to: Commissioner of Patents and Trademarks, Washington, DC 20231,
on 2/26/90

Ansel Schwartz

Ansel M. Schwartz
Registration No. 30,587

2/26/90

Date



UNITED STATES DEPARTMENT OF COMMERCE
Patent and Trademark Office

Address: COMMISSIONER OF PATENTS AND TRADEMARKS
Washington, D.C. 20231

SERIAL NUMBER: 07/206,497-06/13/88
CLASS: HAIR
FIRST NAMED INVENTOR: A
ATTORNEY DOCKET NO:

ALDER, COHEN, AND GRIGSBY, P.C.
2900 CNG TOWER
625 LIBERTY AVE.
PITTSBURGH, PA 15222

EXAMINER: NGUYEN, H

239

8

05/14/90

- This application has been examined
- Responsive to communication filed on 2/28/90
- This action is made final.

A shortened statutory period for response to this action is set to expire 3 month(s), _____ days from the date of this letter. Failure to respond within the period for response will cause the application to become abandoned. 35 U.S.C. 133

Part I THE FOLLOWING ATTACHMENT(S) ARE PART OF THIS ACTION:

- 1. Notice of References Cited by Examiner, PTO-892.
- 2. Notice re Patent Drawing, PTO-948.
- 3. Notice of Art Cited by Applicant, PTO-1449.
- 4. Notice of Informal Patent Application, Form PTO-152.
- 5. Information on How to Effect Drawing Changes, PTO-1474.
- 6.

Part II SUMMARY OF ACTION

- 1. Claims 11-20 are pending in the application.
Of the above, claims _____ are withdrawn from consideration.
- 2. Claims 1-10 have been cancelled.
- 3. Claims _____ are allowed.
- 4. Claims 11-20 are rejected.
- 5. Claims _____ are objected to.
- 6. Claims _____ are subject to restriction or election requirement.
- 7. This application has been filed with informal drawings under 37 C.F.R. 1.85 which are acceptable for examination purposes.
- 8. Formal drawings are required in response to this Office action.
- 9. The corrected or substitute drawings have been received on _____ Under 37 C.F.R. 1.84 these drawings are acceptable. not acceptable (see explanation or Notice re Patent Drawing, PTO-948).
- 10. The proposed additional or substitute sheet(s) of drawings, filed on _____ has (have) been approved by the examiner. disapproved by the examiner (see explanation).
- 11. The proposed drawing correction, filed on _____, has been approved. disapproved (see explanation).
- 12. Acknowledgment is made of the claim for priority under U.S.C. 119. The certified copy has been received not been received been filed in parent application, serial no. _____; filed on _____.
- 13. Since this application appears to be in condition for allowance except for formal matters, prosecution as to the merits is closed in accordance with the practice under Ex parte Quayle, 1935 C.D. 11; 453 O.G. 213.
- 14. Other

Art Unit 239

1. The title of the invention is not descriptive. A new title is required that is clearly indicative of the invention to which the claims are directed.

This objection is repeated.

2. The spacing of the lines of the specification is such as to make reading and entry of amendments difficult. New application papers with lines double spaced on good quality paper are required. The substitute specification should also include an abstract of the disclosure provided on a separate page.

3. The following is a quotation of the appropriate paragraphs of 35 U.S.C. § 102 that form the basis for the rejections under this section made in this Office action:

A person shall be entitled to a patent unless --
(b) the invention was patented or described in a printed publication in this or a foreign country or in public use or on sale in this country, more than one year prior to the date of application for patent in the United States.

4. Claims 11-18 are rejected under 35 U.S.C. § 102(b) as being anticipated by Lightner'US/3718906 .

See figs. 1 and 10 and their description.

Applicant argues that Lightner does not teach or suggest "transmitting the digital signal from the first memory to the second memory" with the "second party controlling use of the second memory" and does not anticipate applicant's claimed

Serial No. 07/206497

-3-

Art Unit 239

invention. This argument is not found to be persuasive because in the system of Lightner, since the second party makes selections of type and format of information to be duplicated to the second memory from the first memory and since the selections of the kind and format of information made by the second party would initiate the first memory to reproduce the requested kind and format of information, the second party is thus seen to control the second memory. Applicant should note that the term "control" is interpreted to mean "authority to guide or manage". Applicant further argues that applicant's claimed limitation that the step of transmitting the digital signal from the first memory to the second memory occurs "at a location determined by the second party controlling use of the second memory" while Lightner teaches and suggests that the vending machine is at location determined by the "first party" (or its agent or representative) and requires the second party to go to the location of the vending machine which is determined by the first party. This argument is not found to be persuasive because with Lightner's system even though the vending machines are "determined" by the first party as stated by applicant, the second party still has to pick which vending machine of the vending machines to use, thus the second party "determines" the location of the second memory where the digital signal is transmitted to. See col.3 line 25 through col.4 line 25.

Art Unit 239

5. Claims 11, 14, 17, 19 and 20 are rejected under 35 U.S.C. § 102(b) as being anticipated by Huges'US/3990710.

See figs.1, 6, 8 and 9. and their descriptions.

6. Applicant's amendment necessitated the new grounds of rejection. Accordingly, THIS ACTION IS MADE FINAL. See M.P.E.P. § 706.07(a). Applicant is reminded of the extension of time policy as set forth in 37 C.F.R. § 1.136(a). The practice of automatically extending the shortened statutory period an additional month upon the filing of a timely first response to a final rejection has been discontinued by the Office. See 1021 TMOG 35.

A SHORTENED STATUTORY PERIOD FOR RESPONSE TO THIS FINAL ACTION IS SET TO EXPIRE THREE MONTHS FROM THE DATE OF THIS ACTION. IN THE EVENT A FIRST RESPONSE IS FILED WITHIN TWO MONTHS OF THE MAILING DATE OF THIS FINAL ACTION AND THE ADVISORY ACTION IS NOT MAILED UNTIL AFTER THE END OF THE THREE-MONTH SHORTENED STATUTORY PERIOD, THEN THE SHORTENED STATUTORY PERIOD WILL EXPIRE ON THE DATE THE ADVISORY ACTION IS MAILED, AND ANY EXTENSION FEE PURSUANT TO 37 C.F.R. § 1.136(a) WILL BE CALCULATED FROM THE MAILING DATE OF THE ADVISORY ACTION. IN NO EVENT WILL THE STATUTORY PERIOD FOR RESPONSE EXPIRE LATER THAN SIX MONTHS FROM THE DATE OF THIS FINAL ACTION.

7. Any inquiry concerning this communication or earlier communications from the examiner should be directed to HOA NGUYEN whose telephone number is (703) 557-4930.

Any inquiry of a general nature or relating to the status of

Serial No. 07/206497

-5-

Art Unit 239

this application should be directed to the Group receptionist
whose telephone number is (703) 557-2878.

ALA

HOA T. NGUYEN
Examiner, A.U. 239
May 10, 1990

Stuart S. Levy
STUART S. LEVY
SUPERV. STUART S. LEVY
SUPERVISORY PATENT EXAMINER
ART UNIT 245
239

ATTACHMENT TO PAPER NUMBER	8
S.N.	206497

GROUP	239
-------	-----

NOTICE OF PATENT DRAWINGS OBJECTION

Drawing Corrections and/or new drawings may only be submitted in the manner set forth in the attached letter, "Information on How to Effect Drawing Changes" PTO-1474.

A. The drawings, filed on 6/13/88, are objected to as informal for reason(s) checked below:

- | | |
|--|--|
| 1. <input type="checkbox"/> Lines Pale. | 11. <input type="checkbox"/> Parts in Section Must Be Hatched. |
| 2. <input type="checkbox"/> Paper Poor. | 12. <input type="checkbox"/> Solid Black Objectionable. |
| 3. <input checked="" type="checkbox"/> Numerals Poor. | 13. <input type="checkbox"/> Figure Legends Placed Incorrectly. |
| 4. <input checked="" type="checkbox"/> Lines Rough and Blurred. | 14. <input type="checkbox"/> Mounted Photographs. |
| 5. <input type="checkbox"/> Shade Lines Required. | 15. <input type="checkbox"/> Extraneous Matter Objectionable.
[37 CFR 1.84 (1)] |
| 6. <input type="checkbox"/> Figures Must be Numbered. | 16. <input type="checkbox"/> Paper Undersized; either 8 1/2" x 14",
or 21.0 cm. x 29.7 cm. required. |
| 7. <input checked="" type="checkbox"/> Heading Space Required. <i>2" TOP</i> | 17. <input type="checkbox"/> Proper A4 Margins Required:
<input type="checkbox"/> TOP 2.5 cm. <input type="checkbox"/> RIGHT 1.5 cm.
<input type="checkbox"/> LEFT 2.5 cm. <input type="checkbox"/> BOTTOM 1.0 cm. |
| 8. <input type="checkbox"/> Figures Must Not be Connected. <i>Fig 1</i> | |
| 9. <input type="checkbox"/> Criss-Cross Hatching Objectionable. | |
| 10. <input type="checkbox"/> Double-Line Hatching Objectionable. | 18. <input checked="" type="checkbox"/> Other: |

- Descriptive matter by (Fig 1, 2)
- characters poor; must be solid, smooth; at least 1/8" taller

B. The drawings, submitted on 6/13/88, are so informal they cannot be corrected. New drawings are required. Submission of the new drawings MUST be made in accordance with the attached letter.



#9
206,497

[A] Title of the Invention

A methodology/system for the electronic sales, distribution, storage, manipulation, retrieval, playback, and copyright protection of Digital Audio Music.

[B] Cross-References to related applications

-None-

[C] Brief summary of the Invention

This invention relates in general to a new and improved methodology/system for the electronic sales, distribution, storage, manipulation, retrieval, playback, and copyright protection of Digital Audio Music.

The three basic mediums (hardware units) of music: records, tapes, and compact discs, greatly restricts the transferability of music and results in a variety of inefficiencies.

CAPACITY: The individual hardware units as cited above are limited as to the amount of music that can be stored on each.

MATERIALS: The materials used to manufacture the hardware units are subject to damage and deterioration during normal operations, handling, and exposure to the elements.

SIZE: The physical size of the hardware units imposes constraints on the quantity of hardware units which can be housed

for playback in confined areas such as in automobiles, boats, planes, etc.

RETRIEVAL: Hardware units limit the ability to play, in a sequence selected by the user, songs from different albums. For example, if the user wants to play one song from ten different albums, the user would spend an inordinate amount of time handling, sorting, and cueing the ten different hardware units.

SALES AND DISTRIBUTION: Prior to final purchase, hardware units need to be physically transferred from the manufacturing facility to the wholesale warehouse to the retail warehouse to the retail outlet, resulting in lengthy lag time between music creation and music marketing, as well as incurring unnecessary and inefficient transfer and handling costs. Additionally, tooling costs required for mass production of the hardware units and the material cost of the hardware units themselves, further drives up the cost of music to the end user.

QUALITY: Until the recent invention of Digital Audio Music, as used on Compact Discs, distortion free transfer from the hardware units to the stereo system was virtually impossible. Digital Audio Music is simply music converted into a very basic computer language known as binary. A series of commands known as zeros or ones encode the music for future playback. Use of laser retrieval of the binary commands results in distortion free transfer of the music from the compact disc to the stereo system.

Quality Digital Audio Music is defined as the binary structure of the Digital Audio Music. Conventional analog tape recording of Digital Audio Music is not to be considered quality inasmuch as the binary structure itself is not recorded. While Digital Audio Music on compact discs is a technological breakthrough in audio quality, the method by which the music is sold, distributed, stored, manipulated, retrieved, played and protected from copyright infringements remains as inefficient as with records and tapes.

COPYRIGHT PROTECTION: Since the invention of tape recording devices, strict control and enforcement of copyright laws have proved difficult and impossible with home recorders. Additionally, the recent invention of Digital Audio Tape Recorders now jeopardizes the electronic copyright protection of quality Digital Audio Music on Compact Discs or Digital Audio Tapes. If music exists on hardware units, it can be copied.

Accordingly, it is an objective of this invention is to provide a new and improved methodology/system to electronically sell and distribute Digital Audio Music.

A further objective of this invention to provide a new and improved methodology/system to electronically store and retrieve Digital Audio Music.

Another objective of this invention is to provide a new and improved methodology/system to electronically manipulate, i.e., sort, cue, and select, Digital Audio Music for playback.

Still another objective of this invention is to offer a new and improved methodology/system which can prevent unauthorized electronic copying of quality Digital Audio Music.

Briefly, this invention accomplishes the above cited objectives by providing a new and improved methodology/system of electronic sales, distribution, storage, manipulation, retrieval, playback, and copyright protection of Digital Audio Music. The high speed transfer of Digital Audio Music as prescribed by this invention is stored onto one piece of hardware, a hard disk, thus eliminating the need to unnecessarily handle records, tapes, or compact discs on a regular basis. This invention recalls stored music for playback as selected/programmed by the user. This invention can easily and electronically sort stored music based on many different criteria such as, but not limited to, music category, artist, album, user's favorite songs, etc. An additional feature of this invention is the random playback of songs, also based on the user's selection. For example, the user could have this invention randomly play all jazz songs stored on the user's hard disk, or randomly play all songs by a certain artist, or randomly play all of the user's favorite songs which the user previously electronically "tagged" as favorites. Further, being more specific, the user can electronically select

a series of individual songs from different albums for sequential playback.

This invention can be configured to either accept direct input of Digital Audio Music from the digital output of a Compact Disc, such transfer would be performed by the private user, or this invention can be configured to accept Digital Audio Music from a source authorized by the copyright holder to sell and distribute the copyrighted materials, thus guaranteeing the protection of such copyrighted materials. Either method of electronically transferring Digital Audio Music by means of this invention is intended to comply with all copyright laws and restrictions and any such transfer is subject to the appropriate authorization by the copyright holder. Inasmuch as Digital Audio Music is software and this invention electronically transfers and stores such music, electronic sales and distribution of the music can take place via telephone lines onto a hard disk. This new methodology/system of music sales and distribution will greatly reduce the cost of goods sold and will reduce the lag time between music creation and music marketing from weeks down to hours.

Referring now to Fig. 2, with the exception of a substitution of a compact Disc Player 40 (as the initial source of Digital Audio Music) for the agent's Hard Disk 10, the agent's Control Unit 20, and the Telephone Lines 30 in Fig. 1, Fig. 2 is the same as Fig. 1.

In Fig. 1 and Fig. 2 the following components are already commercially available: the agent's Hard Disk 10, the Telephone Lines 30, the Compact Disc Player 40, the user's Hard Disk 60, the Video Display Unit 70, and the Stereo Speakers 80. The Control Units 20 and 50, however, would be designed specifically to meet the teachings of this invention. The design of the control units would incorporate the following functional features:

- 1) the Control Panels 20a and 50a would be designed to permit the agent and user to program the respective Control Integrated Circuits 20b and 50b,

- 2) the Control Integrated Circuits 20b and 50b would be designed to control and execute the respective commands of the agent and user and regulate the electronic transfer of Digital Audio Music throughout the system, additionally, the sales Control Integrated Circuit 20b could electronically code the Digital Audio Music in a configuration which would prevent unauthorized reproductions of the copyrighted material,

- 3) the Sales Random Access Memory Chip 20c would be designed to temporarily store user purchased Digital Audio Music for subsequent electronic transfer via telephone lines to the user's Control Unit 50,

4) the Incoming Random Access Memory Chip 50c would be designed to temporarily store Digital Audio Music for subsequent electronic storage to the user's Hard Disk 60,

5) the Play Back Random Access Memory Chip 50d would be designed to temporarily store Digital Audio Music for sequential playback.

The foregoing description of the Control Units 20 and 50 is intended as an example only and thereby is not restrictive with respect to the exact number of components and/or its actual design.

[E] Detailed description

Once the Digital Audio Music has been electronically stored onto the user's Hard Disk 60, having the potential to store literally thousands of songs, the user is free to perform the many functions of this invention. To play a stored song, the user types in the appropriate commands on the Control Panel 50a, and those commands are relayed to the Control Integrated Circuit 50b which retrieves the selected song from the Hard Disk 60. When a song is retrieved from the Hard Disk 60 only a replica of the permanently stored song is retrieved. The permanently stored song remains intact on the Hard Disk 60, thus allowing repeated playback. The Control Integrated Circuit 50b stores the replica onto the Play Back Random Access Memory Chip 50d at a high transfer rate. The Control Integrated Circuit 50b then sends the

electronic output to the Stereo Speakers 80 at a controlled rate using the Play Back Random Access Memory Chip 50d as a temporary staging point for the Digital Audio Music.

Unique to this invention is that the Control Unit 50 also serves as the user's personal disk jockey. The user may request specific songs to be electronically cued for playback, or may request the Control Unit 50 to randomly select songs based on the user's criteria. All of these commands are electronically stored in random access memory enabling the control unit to remember prior commands while simultaneously performing other tasks requested by the user and, at the same time, continuing to play songs previously cued.

Offering a convenient visual display of the user's library of songs is but one more new and improved aspect of this invention. As the Control Unit 50 is executing the user's commands to electronically sort, select, randomly play, etc., the Video Display Screen 70 is continually providing feedback to the user. The Video Display Screen 70 can list/scroll all songs stored on the Hard Disk 60, list/scroll all cued songs, display the current command function selected by the user, etc. Further expanding upon the improvements this invention has to offer, the Video Display Screen 70 can display the lyrics of the song being played, as well as the name of the song, album, artist, recording company, date of recording, duration of song, etc. This is possible if the lyrics and other incidental information are

electronically stored to the Hard Disk 60 with the Digital Audio Music.

In summary, there has been disclosed a new and improved methodology/system by which Digital Audio Music can be electronically sold, distributed, transferred, and stored. Further, there has been disclosed a new and improved methodology/system by which Digital Audio Music can be electronically manipulated, i.e., sorted, cued, and selected for playback. Further still, there has been disclosed a new and improved methodology/system by which the electronic manipulation of Digital Audio Music can be visually displayed for the convenience of the user. Additionally, there has been disclosed a new and improved methodology/system by which electronic copyright protection of quality Digital Audio Music is possible through use of this invention.

[F] Claims

Since numerous changes may be made in the above described process and apparatus and different embodiments of the invention may be made without departing from the spirit thereof, it is intended that all matter contained in the foregoing description or shown in the accompanying drawings shall be interpreted as illustrative, and not in a limiting sense. Further, it is intended that this invention is not to be limited to Digital

Audio Music and can include Digital Video, Digital Commercials,
and other applications of digital information.

I claim:

1. A methodology/system by which the binary structure of Digital Audio Music can be electronically transferred via telephone lines from a hard disk of the seller to the hard disk of the user in a software configuration which will allow repeated future playback by the user.

2. A methodology/system by which the binary structure of Digital Audio Music stored on a Compact Disc can be electronically stored in a software configuration onto a hard disk which will allow repeated future playback by the user.

3. A methodology/system of electronic retrieval from a hard disk and temporary storage of the binary structure of Digital Audio Music on random access memory for sequential playback.

4. A methodology/system of electronically regulating the playback rate of Digital Audio Music from random access memory to the stereo speakers.

5. A methodology/system of specific electronic selection of Digital Audio Music stored on a hard disk for cued playback.

6. A methodology/system of multiple electronic sorting capabilities of Digital Audio Music stored on a hard disk for cued playback.

7. A methodology/system of automatic and multiple random electronic selection of Digital Audio Music stored on a hard disk for cued playback.

8. A methodology/system to simultaneously and electronically encode lyrics and incidental information with Digital Audio Music in the same binary structure which can be displayed on a video display screen.

9. A methodology/system to electronically display on a video display screen the activities mentioned in Claims 1 through 8.

10. A methodology/system which can prevent electronic copyright infringement of the binary structure of quality Digital Audio Music when using this invention.

[G] Abstract of the Disclosure

A methodology/system to electronically store the binary structure of Digital Audio Music onto a conventional hard disk in a configuration which enables electronic sales, distribution, storage, manipulation, retrieval, playback, and copyright protection of such Digital Audio Music. This invention expands upon and integrates prior inventions relating to stereo systems and microcomputers to form an advanced stereo system.

Submitted by:

Arthur Robert Hair

August 8, 1990

Op 239



IN THE UNITED STATES PATENT AND TRADEMARK OFFICE

RECEIVED

AUG 29 1990

GROUP 230

11/C

J.E.

NE

Application of:)
)
 ARTHUR HAIR)
)
 Serial No. 07/206,497)
)
 Filed: June 13, 1988)
)
 Art Unit 239)
)
 Patent Examiner:)
)
 H. Nguyen)

TRANSMISSION SYSTEM

Pittsburgh, Pennsylvania 15222

August 20, 1990

CERTIFICATE OF MAILING

I heroby certify that the correspondence is
 being deposited with the United States Postal
 Service as first class mail in an envelope
 addressed to: Commissioner of Patents and
 Trademarks, Washington, DC 20231,
 on 8/21/90

Hon. Commissioner of Patents and Trademarks

Washington, D.C. 20231

Sir:

Ansel Schwartz

Ansel M. Schwartz
Registration No. 30,587

8/21/90

Date

AMENDMENT UNDER RULE 116

In response to the Office Action dated May 14, 1990,
 please enter the following amendments to the above-identified
 application as follows:

IN THE TITLE:

Please change the "Transmission System" to -- Method
 for Transmitting a Desired Digital Video or Audio Signal -- .

IN THE CLAIMS:

11. (Twice Amended) A method for transmitting a desired digital audio music signal stored on a first memory to a second memory comprising the steps of:

transferring money to a first party controlling use of the first memory from a second party financially distinct from the first party, said second party controlling use and in possession of the second memory;

connecting electronically the first memory with the second memory such that the digital signal can pass therebetween;

transmitting the digital signal from the first memory with a transmitter in control and possession of the first party to a receiver having the second memory at a location determined by the second party, said receiver in possession and control of the second party; and

storing the digital signal in the second memory.

Claim 12, line 3, delete "music";

Claim 12, line 4, delete "music".

15. (Amended) A method for transmitting a desired digital, [a] video or audio [music] signal stored on a first memory to a second memory comprising the steps of:

charging a fee [to] by a first party controlling use of the [second] first memory to a second party financially distinct from the first party, said second party in control and in possession of the second memory;

connecting the first memory with the second memory such that the digital signal can pass therebetween;

transmitting the digital signal from the first memory with a transmitter in control and possession of the first party to a receiver having the second memory at a location determined by the second party, said receiver in possession and control of the second party; and

storing the digital signal in the second memory.

Please add the following claim.

21. A method as described in Claim 15 including after the charging step, the step of searching the first memory for the desired digital signal; and selecting the desired digital signal from the first memory.

REMARKS

Claims 11-13, 15 and 21 are currently active.

Claims 14 and 16-20 have been cancelled.

Applicant requests this Amendment Under Rule 116 be entered in view of the comments of the Examiner concerning the fact that with respect to the claims as they appeared before this amendment, applicant could control the transmission of the signal and choose the location at which transmission occurs regardless of possession.

The title of the invention has been amended to be clearly indicative of the invention to which the claims are directed.

A new copy of the original application is provided herewith that is double spaced and includes an abstract of the disclosure on a separate page.

Another copy of the drawings is provided herewith. These new drawings are believed to be in conformance with the Official Draftsman's request based on the notice of patent drawings objection.

Applicant's invention is a method for transmitting a desired digital, video or audio signal stored on a first memory to a second memory. The method comprises the steps of charging a

fee by a first party controlling use of the first memory to a second party financially distinct from the first party. The second party is in control and in possession of the second memory. Additionally, the method comprises the step of then connecting the first memory with the second memory such that the digital signal can pass therebetween. Next, there is the step of transmitting the digital signal from the first memory with a transmitter in control and in possession of the first party to a receiver having the second memory at a location determined by the second party. The receiver is in possession and in control of the second party. There is also the step of then storing the digital signal in the second memory.

The Examiner has rejected Claims 11-18 under 35 U.S.C. §102(b) as being anticipated by Lightner. Applicant respectfully traverses this rejection.

Referring to Lightner, there is disclosed a vending system for remotely accessible stored information. The vending system includes a central station in which various information stored on master recordings can be selectively accessed by purchasers from any of multiple remote vending machines. The accessed information is reproduced on cartridge type storage media at that vending machine. Once currency or a credit card is received by the vending machine, the selected information is transferred to the cartridge. After transmission is complete,

the cartridge is then ejected from the vending machine and received by the purchaser to be then controlled by the purchaser.

There is no teaching or suggestion in Lightner of the "second memory" to which the digital signal is transmitted to be "in control and in possession" by the "second party".

Furthermore, there is no teaching or suggestion in Lightner for the "receiver" having the second memory being "in possession and in control of the second party" and "at a location determined by the second party" as found in applicant's Claim 15.

Lightner actually teaches away from applicant's claimed invention. Lightner teaches vending machines which have in them blank tape cassettes which receive the transmitted signal from the master tape. When payment is complete, the cassette is then ejected from the vending machine to the consumer. See lines 25-37 of column 2. Thus, these blank tape cassettes are not "in possession of the second party". The vending machines themselves are "in the possession of the "first party controlling use of the first memory" and not "in the possession of the second party". This is a substantive distinction between applicant's claimed invention and the prior art. Applicant's claimed method allows "a second party" to have a desired signal transmitted to a "receiver . . . in possession of the second party . . . at a location determined by the second party". This means, for instance, in the pleasure of the second party's home, the second party can simply telephone the "first party" and obtain desired

signals immediately and conveniently. The "second party" does not have to leave his house and go to a vending machine location is chosen by the first party who is in possession of the vending machine. Accordingly, Lightner does not anticipate Claim 15 and is patentable. Claim 21 is dependent to parent Claim 15 and has all the limitations thereof. Since Claim 15 is patentable, so is Claim 21.

Claim 11 is patentable for the reasons Claim 15 is patentable. Claims 12 and 13 are dependent to parent Claim 11 and have the limitations thereof. Since Claim 11 is patentable, so are Claims 12 and 13.

The Examiner has rejected Claims 11, 14, 17, 19 and 20 under 35 U.S.C. §102(b) as being anticipated by Hughes. Applicant respectfully traverses this rejection.

Referring to Hughes, there is disclosed a coin operated recording machine. The coin operated recording machine allows a consumer to record on his audio or video magnetic tape cartridge at a selected audio video recording stored in the machine upon insertion of the appropriate coins in much the same manner as a conventional juke box. There is no teaching or suggestion in Hughes of the "receiver" being "in possession of the second party . . . at a location determined by the second party". Hughes actually teaches away from applicant's claimed invention since the recording apparatus is taught to be in possession of the

"first party controlling use of the first memory" not the "second party in possession of the second memory". Essentially for the reasons set forth as to why applicant's claimed invention is patentable over Lightner, applicant's claimed invention is also patentable over Hughes. Accordingly, Hughes does not anticipate or make obvious applicant's Claim 11. Claims 12 and 13 are dependent to parent Claim 11 and have all the limitations thereof. Since Claim 11 is patentable, so are Claims 12 and 13.

The Commissioner is hereby authorized to charge any fees or credit any overpayment to Deposit Account No. 03-2411. A duplicate copy of this Amendment is enclosed.

In view of the foregoing amendments and remarks, it is respectfully requested that the outstanding rejections and objections to this application be reconsidered and withdrawn, and Claims 11-13, 15 and 21, now in this application, be allowed.

CERTIFICATE OF MAILING

I hereby certify that the correspondence is being deposited with the United States Postal Service as first class mail in an envelope addressed to: Commissioner of Patents and Trademarks, Washington, DC 20231, on 8-21-90

Ansel Schwartz

Ansel M. Schwartz
Registration No. 30,587

8-21-90

Date

Respectfully submitted,

ARTHUR HAIR

By Ansel Schwartz
Ansel M. Schwartz, Esquire

Reg. No. 30,587
Cohen & Grigsby
2900 CNG Tower
625 Liberty Avenue
Pittsburgh, PA 15222
(412) 394-4900

Attorney for Applicant

31-215

10



RECEIVED IN THE UNITED STATES PATENT AND TRADEMARK OFFICE

In re Application of
ARTHUR HAIR GROUP 230
Serial No. 07/206,497
Filed: June 13, 1988
Art Unit 239
Patent Examiner:
H. Nguyen

TRANSMISSION SYSTEM

Pittsburgh, Pennsylvania 15222

CERTIFICATE OF MAILING

August 21, 1990

Hon. Commissioner of Patents and Trademarks

Washington, D.C. 20231

Sir:

I hereby certify that the correspondence is being deposited with the United States Postal Service as first class mail in an envelope addressed to: Commissioner of Patents and Trademarks, Washington, DC 20231, on 8-21-90

Ansel Schwartz

Ansel M. Schwartz
Registration No. 30,587

PETITION FOR ONE-MONTH
EXTENSION OF TIME

8/21/90
Date

The first Official Action dated May 14, 1990, which issued in the above-referenced patent application, has been received. Applicant, by the subject Petition, now requests that he be granted a one-month extension of time to permit him to file an amendment to the outstanding Official Action. By this Petition, the period of response is extended to and including September 14, 1990. Applicant's response in the form of an amendment is being filed with this Petition. Enclosed is a check in the amount of \$31.00 to cover the extension fee.

100 LH 08/27/90 07206497

1 215

31.00 CK

The Commissioner is hereby authorized to charge any fees, or credit any overpayment, to Deposit Account No. 03-2411. A duplicate copy of this Petition is enclosed.

Respectfully submitted,

ARTHUR HAIR

By Ansel Schwartz
Ansel M. Schwartz, Esquire
Cohen & Grigsby
Reg. No. 30,587
2900 CNG Tower
625 Liberty Avenue
Pittsburgh, PA 15222
(412) 394-4900

Attorney for Applicant

CERTIFICATE OF MAILING

I hereby certify that the correspondence is being deposited with the United States Postal Service as first class mail in an envelope addressed to: Commissioner of Patents and Trademarks, Washington, DC 20231, on 8/21/90

Ansel Schwartz

Ansel M. Schwartz
Registration No. 30,587

8/21/90

Date



UNITED STATES DEPARTMENT OF COMMERCE
Patent and Trademark Office

Address: COMMISSIONER OF PATENTS AND TRADEMARKS
Washington, D.C. 20231

SERIAL NUMBER	FILING DATE	FIRST NAMED APPLICANT	ATTORNEY DOCKET NO.
077206,497	06/13/88	HAIR	A

ALDER, COHEN, AND GRIGSBY, P.C.
2900 CNG TOWER
625 LIBERTY AVE.
PITTSBURGH, PA 15222

EXAMINER	
NGUYEN, H	
ART UNIT	PAPER NUMBER
239	12

DATE MAILED: 09/05/90

Below is a communication from the EXAMINER in charge of this application
COMMISSIONER OF PATENTS AND TRADEMARKS

ADVISORY ACTION

THE PERIOD FOR RESPONSE:

- is extended to run 4 months from the date of the Final Rejection
- continues to run _____ from the date of the Final Rejection
- expires three months from the date of the final rejection or as of the mailing date of this Advisory Action, whichever is later. In no event however, will the statutory period for response expire later than six months from the date of the final rejection.

Any extension of time must be obtained by filing a petition under 37 CFR 1.136(a), the proposed response and the appropriate fee. The date on which the response, the petition, and the fee have been filed is the date of the response and also the date for the purposes of determining the period of extension and the corresponding amount of the fee. Any extension fee pursuant to 37 CFR 1.17 will be calculated from the date that the shortened statutory period for response expires as set forth above.

- Appellant's Brief is due in accordance with 37 CFR 1.192(a).
- Applicant's response to the final rejection, filed 8/24/90, has been considered with the following affect, but it is not deemed to place the application in condition for allowance:

1. The proposed amendments to the claim and/or specification will not be entered and the final rejection stands because:
 - a. There is no convincing showing under 37 CFR 1.116(b) why the proposed amendment is necessary and was not earlier presented.
 - b. They raise new issues that would require further consideration and/or search. (See Note).
 - c. They raise the issue of new matter. (See Note).
 - d. They are not deemed to place the application in better form for appeal by materially reducing or simplifying the issues for appeal.
 - e. They present additional claims without cancelling a corresponding number of finally rejected claims.

NOTE: The recitation of "said receiver in possession and control of the second party" recited in claims 11 and 15 is new issue.

2. Newly proposed or amended claims _____ would be allowed if submitted in a separately filed amendment cancelling the non-allowable claims.
3. Upon the filing of an appeal, the proposed amendment will be will not be, entered and the status of the claims in this application would be as follows:

Allowed claims: _____
Claims objected to: _____
Claims rejected: _____

However:

- a. The rejection of claims _____ on references is deemed to be overcome by applicant's response.
 - b. The rejection of claims _____ on non-reference grounds only is deemed to be overcome by applicant's response.
4. The affidavit, exhibit or request for reconsideration has been considered but does not overcome the rejection.
 5. The affidavit or exhibit will not be considered because applicant has not shown good and sufficient reasons why it was not earlier presented.
- The proposed drawing correction has has not been approved by the examiner.
- Other _____

Stuart S. Levy
STUART S. LEVY
SUPERVISORY PATENT EXAMINER
ART UNIT 239

SERIAL NUMBER (Series of 1987) **07586391** PATENT NUMBER **MAR 2 1993** PATENT NUMBER **5191573**

SERIAL NUMBER **07586391** FILING DATE **09/12/90** CLASS **369** SUBCLASS **H084** GROUP ART UNIT **237** EXAMINER **Hoa Nguyen**

APPLICANTS **ARTHUR R. HAIR, VENETIA, PA.**

****CONTINUING DATA*******
 VERIFIED THIS APPLN IS A CON OF 07/20/6,497 06/13/88 ABN

****FOREIGN/PCT APPLICATIONS*******
 VERIFIED

FOREIGN FILING LICENSE GRANTED 10/10/90 ***** SMALL ENTITY *****

Foreign priority claimed 35 USC 119 conditions met	<input type="checkbox"/> yes <input type="checkbox"/> no	AS FILED	STATE OR COUNTRY	SHEETS DRWGS	TOTAL CLAIMS	INDEP CLAIMS	FILING FEE RECEIVED	ATTORNEY'S DOCKET NO.
Verified and Acknowledged	Examiners Initials	→	PA	2	5	2	\$ 185.00	2102301-CON

ADDRESS ~~ANSEL M. SCHWARTZ
COHEN & GRISWOLD
2950 ENG TOWER
625 LIBERTY AVE
PITTSBURGH, PA 15222~~ **Ansel M. Schwartz
425 N. Craig Street
Suite 301
Pittsburgh, PA 15213**

TITLE ~~TRANSMISSION SYSTEM METHOD FOR TRANSMITTING A DESIRED DIGITAL VIDEO OR AUDIO SIGNAL~~

U.S. DEPT. OF COMM. - Pat. & TM Office - PTO-436L (rev. 10-78)



7402
CERTIFICATE
 DEC 21 1993
OF CORRECTION

Scanned
 11-4-04

PARTS OF APPLICATION FILED SEPARATELY

NOTICE OF ALLOWANCE MAILED 10-19-92	PREPARED FOR ISSUE 10/20/92	CLAIMS ALLOWED Total Claims 6 Print Claim 1
ISSUE FEE Amount Due 5585.00 Date Paid 12-7-92	Assistant Examiner (RW) Docket Clerk D. Rote	DRAWING Sheets Drwg. 2 Figs. Drwg. 2 Print Fig. 2
Label Area	ISSUE CLASSIFICATION Class 369 Subclass 084	ISSUE BATCH NUMBER H24

WARNING: The information disclosed herein may be restricted. Unauthorized disclosure may be prohibited by the United States Code Title 35, Sections 122, 181 and 368.

BEST AVAILABLE COPY

SEARCHED			
Class	Sub.	Date	Exmr.
369	33, 34, 13, 15, 84, 85	9/91	KLW
235	380, 381, 375		
364	479 410		
Updated		10/92	KLW

SEARCH NOTES		
	Date	Exmr.
consulted	9/91	KLW
Robert Weinhardt for class 235 and 364	9/91	KLW

INTERFERENCE SEARCHED			
Class	Sub.	Date	Exmr.
369	084 085 033 034 015	6/92	KLW
235	381 380		

BEST AVAILABLE COPY

POSITION	INIT.	DATE
CLASSIFIER		
EXAMINER	Jrcje	10-4-78
VERIFYER	AKO	10-10-78
TYPIST		
CORR. CORR.		
SPEC. HAND.		
FILE MAINT.		

INDEX OF CLAIMS

Claim	Final	Original	Date
1			
2			
3			
4			
5			
6			
7			
8			
9			
10			
11			
12			
13			
14			
15			
16			
17			
18			
19			
20			
21			
22			
23			
24			
25			
26			
27			
28			
29			
30			
31			
32			
33			
34			
35			
36			
37			
38			
39			
40			
41			

Claim	Final	Original	Date
51			
52			
53			
54			
55			
56			
57			
58			
59			
60			
61			
62			
63			
64			
65			
66			
67			
68			
69			
70			
71			
72			
73			
74			
75			
76			
77			
78			
79			
80			
81			
82			
83			
84			
85			
86			
87			
88			
89			
90			
91			
92			
93			

SYMBOLS

- Project
- Allow
- Case
- (Through numerals) Ret.
- Non-
- Inert
- Appr.
- Object

BEST AVAILABLE COPY

185.00 - 201 77A 586391

#18/
J.E.
8/2/91



PATENT

IN THE UNITED STATES PATENT AND TRADEMARK OFFICE

Docket No. 2102.001 CONT
Anticipated Classification of this application:
Class _____ Subclass _____
Prior application:
Examiner: H. Nguyen
Art Unit: 239

Box FWC
Commissioner of Patents and Trademarks
Washington, D.C. 20231

FILE WRAPPER CONTINUING APPLICATION (FWC) (37 CFR 1.62)

- WARNING:** This form cannot be used where the parent case may not be abandoned since the filing of a request under the FWC procedure "will be considered to be a request to expressly abandon the prior application as of the filing date granted to the continuing application." 37 CFR 1.62(g).
- WARNING:** This procedure can only be used for a pending application prior to payment of the issue fee. 37 CFR 1.62(a).
- WARNING:** The filing of an application as the United States stage of an international application requires an oath or declaration. 37 CFR 1.61(a)(4).
- WARNING:** The claims of this new application may be finally rejected in the first Office action where all claims of the new application are drawn to the same invention claimed in the earlier application and would have been properly finally rejected on the grounds or art of record in the next Office action if they had been entered in the earlier application. MPEP § 706.07(b).
- WARNING:** An application under 37 CFR 1.62 is filed by making changes by amendment to the prior application, 37 CFR 1.62(a), and not by filing a new application.
- WARNING:** Filing under 37 CFR 1.62 is permitted only if filed by the same or less than all the inventors named in the prior application.

I. This is a request for a filing under the file wrapper continuing application procedure, 37 CFR 1.62, for a

- continuation
- divisional
- continuation-in-part (for oath or declaration see III below)
- attached is an amendment for added subject matter

CERTIFICATION UNDER 37 CFR 1.10

I hereby certify that this FWC transmittal and the documents referred to, as attached therein are being deposited with the United States Postal Service on this date September 14, 1990 in an envelope as "Express Mail Post Office to Addressee" mailing Label Number MB137703489 addressed to the: Commissioner of Patents and Trademarks Washington, D.C. 20231.

Tracey L. Milka
(Type or print name of person mailing paper)
Tracey L. Milka
(Signature of person mailing paper)

NOTE: Each paper or fee filed by "Express Mail" has the number of the "Express Mail" mailing label placed thereon prior to mailing. 37 CFR 1.62(g).

WARNING: The filing date under 37 CFR 1.62(a) is "... the date on which a request is filed for an application ... including identification of the Serial Number, filing date and applicant's name of the prior application". The prior application under 37 CFR 1.62(a) must be "... a prior complete application." According to 37 CFR 1.51(a) a prior complete application comprises: (1) a specification, including a claim or claims, (2) a declaration, (3) drawings, when necessary and (4) the prescribed filing fee. Accordingly, as presently worded, 37 CFR 1.62 does not permit the FWC procedure to be used where the prior application is pending but only the processing and retention fee required by 37 CFR 1.21(l) is paid.

PARTICULARS OF PRIOR APPLICATION

- A. Application Serial No. O 7/206,497 filed 6/13/88
(date)
- B. Title (as originally filed TRANSMISSION SYSTEM
and as last amended) TRANSMISSION SYSTEM
- C. Name of applicant(s) (as originally filed and as last amended) and current correspondence address of applicant(s)

1. FULL NAME OF INVENTOR	<i>John</i> FAMILY NAME Hair	FIRST GIVEN NAME Arthur	SECOND GIVEN NAME R.
RESIDENCE & CITIZENSHIP	CITY Venetia	STATE OR FOREIGN COUNTRY Pennsylvania	COUNTRY OF CITIZENSHIP United States
POST OFFICE ADDRESS	POST OFFICE ADDRESS 337 Quail Run Road	CITY Venetia	STATE & ZIP CODE/ COUNTRY USA Pennsylvania 15367
2. FULL NAME OF INVENTOR	FAMILY NAME	FIRST GIVEN NAME	SECOND GIVEN NAME
RESIDENCE & CITIZENSHIP	CITY	STATE OR FOREIGN COUNTRY	COUNTRY OF CITIZENSHIP
POST OFFICE ADDRESS	POST OFFICE ADDRESS	CITY	STATE & ZIP CODE/ COUNTRY
3. FULL NAME OF INVENTOR	FAMILY NAME	FIRST GIVEN NAME	SECOND GIVEN NAME
RESIDENCE & CITIZENSHIP	CITY	STATE OR FOREIGN	COUNTRY OF CITIZENSHIP
POST OFFICE ADDRESS	POST OFFICE ADDRESS	CITY	STATE & ZIP CODE/ COUNTRY

Continued on added page for Inventor's Data

The above identified application, in which no payment of issue fee, abandonment of, or termination of proceedings has occurred, is hereby expressly abandoned as of the filing date of this new application. Please use all the contents of the prior application file wrapper, including the drawings, as the basic papers for the new application.

It is understood that secrecy under 35 U.S.C. 122 is hereby waived to the extent that if information or access is available to any one of the applications in the file wrapper of a 37 CFR 1.62 application, be it either this application or a prior application in the same file wrapper, the PTO may provide similar information or access to all the other applications in the same file wrapper.

(FWC [4-2]—page 2 of 9)

II. Inventorship statement

NOTE: "If the continuation, continuation-in-part, or divisional application is filed by less than all the inventors named in the prior application a statement must accompany the application when filed requesting deletion of the names of the person or persons who are not inventors of the invention being claimed in the continuation, continuation-in-part, or divisional application." 37 CFR 1.62(a) [emphasis added].

NOTE: "In the case of a continuation-in-part application which adds and claims additional disclosure by amendment, an oath or declaration as required by § 1.63 must be filed. In those situations where a new oath or declaration is required due to additional subject matter being claimed, additional inventors may be named in the continuing application. In a continuation or divisional application which discloses and claims only subject matter disclosed in a prior application, no additional oath or declaration is required and the application must name as inventors the same or less than all the inventors in the prior application." 37 CFR 1.60(c).

(complete applicable item (a), (b) and/or (c) below)

- (a) This application discloses and claims only subject matter disclosed in the prior application whose particulars are set out above and the inventor(s) in this application are

the same

- less than those named in the prior application and it is requested that the following inventor(s) identified above for the prior application be deleted:

(Type name(s) of inventor(s) to be deleted)

- (b) This application discloses and claims additional disclosure by amendment and a new declaration or oath is being filed. With respect to the prior application whose particulars are set out above the inventor(s) in this application are

the same

- add the following additional inventor(s)

(Type name of inventor(s) to be added)

- (c) The inventorship for all the claims in this application are

the same

- not the same, and an explanation, including the ownership of the various claims at the time the last claimed invention was made, is submitted.

III. Declaration or oath

A. Continuation or divisional

- none required

B. Continuation-in-part

- attached

executed by (check all applicable items)

inventor(s).

legal representative of inventor(s) 37 CFR 1.42 or 1.43.

joint inventor or person showing a proprietary interest for inventor who refused to sign or cannot be reached. 37 CFR 1.47;

This is the petition required by 37 CFR 1.47 and the statement required by 37 CFR 1.47 is also attached. (See item VIII below for fee.)

- not attached

(FWC [4-2]—page 3 of 9)

- Application is made by a person authorized under 37 CFR 1.41(c) on behalf of all of the above named applicant(s). (The declaration or oath, along with the surcharge required by 37 CFR 1.16(e) can be filed subsequently.)
- showing that the filing is authorized. (Not required unless called into question. 37 CFR 1.41(d).)

IV. Identification of Claims for Further Prosecution

WARNING: "The claims of a new application may be finally rejected in the first Office action in those situations where (1) the new application is a continuing application of, or a substitute for, an earlier application, and (2) all the claims of the new application (a) are drawn to the same invention claimed in the earlier application, and (b) would have been properly finally rejected on the grounds of art of record in the next Office action if they had been entered in the earlier application." MPEP, § 706.07(b).

- The fees to be charged are to be based on the number of claims remaining as a result of the
 - attached preliminary amendment.
 - the unentered amendment filed under 37 CFR 1.116 in the prior application, which is now repeated.
 - the claims as on file in the prior application.

V. Fee Calculation (37 CFR 1.16)

NOTE: The filing fee for a continuation, continuation-in-part, or divisional application is based on the number of claims remaining in the application after entry of any preliminary amendment and entry of any amendments under 37 CFR 1.116 unentered in the prior application which is requested to be entered in this FWC application. 37 CFR 1.62.

CLAIMS FOR FEE CALCULATION						
	Number Filed		Number Extra		Rate	Basic Fee \$370.00
Total						
Claims	5	-20=	0	X	\$ 12.00	0.00
Independent						
Claims						
(37 CFR 1.16(b))	2	-3=	0	X	\$ 36.00	0.00
Multiple dependent claim(s), if any						
(37 CFR 1.16(d))					\$120.00	

- The fee for extra claims is not being paid at this time.
- Filing fee calculation \$ 370.00

NOTE: If the fees for extra claims are not paid on filing they must be paid or the claims cancelled by amendment, prior to the expiration of the time period set for response by the Patent and Trademark Office in any notice of fee deficiency. 37 CFR 1.16(d).

VI. Petition for Suspension of Prosecution for the Time Necessary to File an Amendment

NOTE: Where it is possible that the claims on file will give rise to a first action final for this continuation application and for some reason an amendment cannot be filed promptly (e.g., experimental data is being gathered) it may be desirable to file a petition for suspension of prosecution for the time necessary.

(check the next item, if applicable)

- There is provided herewith a Petition to Suspend Prosecution For The Time Necessary to File An Amendment (New Application Filed Concurrently).

VII. Small Entity Statement

- A verified statement that this is a filing by a small entity is attached.
- The small entity statement was filed in the parent application Serial No. 07/206,497 which parent application was filed on 6/13/88 and this status is still proper and its benefit under 37 CFR 1.28(a) is hereby claimed.

Filing fee calculation (50% of above) \$ 185.00

NOTE: 37 CFR 1.28(a) states "Status as a small entity must be specifically established by a verified statement filed in each application or patent in which the status is available and desired, except those applications filed under § 1.60 or § 1.62 of this part where the status as a small entity has been established in a parent application and is still proper."

The last sentence of 37 CFR 1.28(a) states: "Applications filed under § 1.60 or § 1.62 of this part must include a reference to a verified statement in a parent application if status as a small entity is still proper and desired."

Any excess of the full fee paid will be refunded if a verified statement and a refund request are filed within 2 months of the date of timely payment of a full fee then the excess fee paid will be refunded on request. 37 CFR 1.28(a).

VIII. Fee Payment Being Made at This Time

Not attached

- No filing fee is submitted. (This and the surcharge required by 37 CFR 1.16(e) can be paid subsequently.)

Attached

- filing fee \$ 185.00
- recording assignment (\$8.00; 37 CFR 1.21(h)).
See item XIV below. \$ _____
- petition fee for filing by other than all the inventors or person not the inventor where inventor refused to sign or cannot be reached (\$120.00; 37 CFR 1.47 and 1.17(h)) \$ _____
- processing and retention fee (\$120.00; 37 CFR 1.53(d) and 1.21(l)) \$ _____

NOTE: 37 CFR 1.21(l) establishes a fee for processing and retaining any application which is abandoned for failing to complete the application pursuant to 37 CFR 1.53(d) and this, as well as, the changes to 37 CFR 1.53 and 1.78 indicate that in order to obtain the benefit of a prior U.S. application, either the basic filing fee must be timely paid or the processing and retention fee in § 1.21(l) must be paid within 1 year from the notification under § 1.53(d).

Total fees enclosed \$ 185.00

(FWC [4-2]—page 5 of 9)

IX. Method of Payment of Fees

- attached is check in the amount of \$ 185.00
- charge Account No. _____ in the amount of \$ _____
- A duplicate of this request is attached.

NOTE: Fees should be itemized in such a manner that it is clear for which purpose the fees are paid. 37 CFR 1.22(b).

X. Authorization to Charge Additional Fees

WARNING: If no fee payment is made at this time this item should not be completed.

WARNING: Accurately count claims, especially multiple dependent claims, to avoid unexpected high charges if extra claim charges are authorized.

- The Commissioner is hereby authorized to charge the following additional fees which may be required by this paper and during the entire pendency of this application to Account No. 03-2411:

- 37 CFR 1.16(a), (f) or (g) (filing fees)
- 37 CFR 1.16(b), (c) and (d) (presentation of extra claims)

NOTE: Because additional fees for excess or multiple dependent claims not paid on filing or on later presentation must only be paid or these claims cancelled by amendment prior to the expiration of the time period set for response by the PTO in any notice of fee deficiency (37 CFR 1.16(d)) it might be best not to authorize the PTO to charge additional claim fees, except possibly when dealing with amendments after final action.

- 37 CFR 1.16(e) (surcharge for filing the basic filing fee and/or declaration on a date later than the filing date of the application)
- 37 CFR 1.17 (application processing fees)

WARNING: While 37 CFR 1.17(a), (b), (c) and (d) deal with extensions of time under § 1.136(a) this authorization should be made only with the knowledge that: "Submission of the appropriate extension fee under 37 CFR 1.136(a) is to no avail unless a request or petition for extension is filed" (Emphasis added). Notice of November 5, 1985 (1060 O.G. 27).

- 37 CFR 1.18 (issue fee at or before mailing of Notice of Allowance, pursuant to 37 CFR 1.311(b))

NOTE: Where an authorization to charge the issue fee to a deposit account has been filed before the mailing of a Notice of Allowance, the issue fee will be automatically charged to the deposit account at the time of mailing the notice of allowance, 37 CFR 1.311(b).

From the wording of 37 CFR 1.28(b): (a) notification of change of status must be made even if the fee is paid as "other than a small entity" and (b) no notification is required if the change is to another small entity. Notification of any change of status resulting in loss of entitlement to small entity status must be filed in the application prior to, or at the time of, paying the issue fee. 37 CFR 1.28(b).

XI. Instructions as to Overpayment

- credit Account No. 03-2411
- refund

XII. Priority—35 U.S.C. 119

- Priority of application Serial No. 0 / _____ filed on

(FWC [4-2]—page 6 of 9)

T
N
P
N
K

_____ in _____ is claimed under
35 U.S.C. 119. (country)

- The certified copy has been filed on _____ in prior U.S. applica-
tion Serial No. 0 / _____, which prior application was filed on

- certified copy will follow

XIII. Relate Back—35 U.S.C. 120

Amend the specification by inserting before the first line the sentence:

SPP "This is a

- continuation
- divisional
- continuation-in-part

of copending application(s) _____

serial number 0 7 / 206,497 filed on 6/13/88, now abandoned

International Application _____ filed on _____
and which designated the U.S."

D

W

P

NOTE: The proper reference to a prior filed PCT application which entered the U.S. national phase is the U.S. serial number and the filing date of the PCT application which designated the U.S.

XIV. Assignment

- the prior application is assigned of record to _____
 - an assignment of the invention to _____
- is attached.

W

XV. Power of Attorney

The power of attorney in the prior application is to

Ansel M. Schwartz, Esquire 30,587
Attorney ~~Reg. No.~~

K

62 3

- a. The power appears in the original papers in the prior application.
- b. The power does not appear in the original papers, but was filed on _____.
- c. A new power has been executed and is attached.
- d. Address all future communications to:

601 Ansel M. Schwartz, Esquire 30,587
 Name Reg. No.
 Cohen & Grigsby
 Address 2900 CNG Tower (412) 394-4987
 625 Liberty Avenue
 Pittsburgh, PA 15222 Tel. No.

(Item d may only be completed by applicant, or attorney or agent of record).

XVI. Maintenance of Copendency of Prior Application

(This item must be completed and the necessary papers filed in the prior application if the period set in the prior application has run)

- A petition, fee and response has been filed to extend the term in the pending prior application until September 14, 1990.

NOTE: The PTO finds it useful if a copy of the petition filed in the prior application extending the term for response is filed with the papers constituting the filing of the continuation application. Notice of November 5, 1985 (1060 O.G. 27).

- A copy of the petition for extension of time in the prior application is attached.

XVII. Conditional Petitions for Extension of Time in Prior Application

(complete this item and file conditional petition in prior application if previous item not applicable)

- A conditional petition for extension of time is being filed in the pending prior application

NOTE: The PTO finds it useful if a copy of the petition filed in the prior application extending the term for response is filed with the papers constituting the filing of the continuation application. Notice of November 5, 1985 (1060 O.G. 27).

- A copy of the conditional petition for extension of time in the prior application is attached.

XVIII. Abandonment of Prior Application

- Please abandon the prior application at a time while the prior application is pending or when the petition for extension of time or to revive in that application is granted and when this application is granted a filing date so as to make this application copending with said prior application. At the same time please add the words "now abandoned" to the amendment to the specification set forth in XIII above.

NOTE: According to the Notice of May 13, 1983 (103, TMOG 6-7) the filing of a continuation or continuation-in-part application is a proper response with respect to a petition for extension of time or a petition to revive and should include the express abandonment of the prior application conditioned upon the granting of the petition and the granting of a filing date to the continuing application.

NOTE: "A registered attorney or agent acting under the provisions of § 1.34(a), or of record, may also expressly abandon a prior application as of the filing date granted to a continuing application when filing such a continuing application." 37 CFR 1.138.

(FWC [4-2]—page 8 of 9)

9/14/90

Ansel M. Schwartz, Esquire

Type or print name of person signing

Ansel Schwartz

Signature

Date

Cohen & Grigsby

P.O. Address of Signatory

2900 CNG Tower

625 Liberty Avenue

Pittsburgh, PA 15222

Tel. No.: (412) 394-4987

Inventor

Assignee of complete interest

Person authorized to sign on behalf of assignee

Attorney or agent of record

Filed under Rule 34(a)

Reg. No. 30,587

(if applicable)

(Complete the following if applicable)

Type name of assignee

Address of assignee

Title of person authorized to sign on behalf of assignee

Assignment recorded in PTO on _____

Reel _____ Frame _____

Plus ADDED PAGE FOR INVENTOR'S DATA FOR FWC FILING

**ADDED PAGES FOR APPLICATION TRANSMITTAL WHERE BENEFIT OF
PRIOR U.S. APPLICATION(S) CLAIMED**

NOTE: "In order for an application to claim the benefit of a prior filed copending national application, the prior application must name as an inventor at least one inventor named in the later filed application and disclose the named inventor's invention claimed in at least one claim of the later filed application in the manner provided by the first paragraph of 35 U.S.C. 112." 37 CFR 1.78(a).

NOTE: "In addition the prior application must be (1) complete as set forth in § 1.51, or (2) entitled to a filing date as set forth in § 1.53(b) and include the basic filing fee set forth in § 1.16; or (3) entitled to a filing date as set forth in § 1.53(b) and have paid therein the processing and retention fee set forth in § 1.21(1) within the time period set forth in § 1.53(d)." 37 CFR 1.78(a).

17. Relate Back—35 U.S.C. 120

NOTE: "Any application claiming the benefit of a prior filed copending national or international application must contain or be amended to contain in the first sentence of the specification following the title a reference to such prior application identifying it by serial number and filing date or international application number and international filing date and indicating the relationship of the applications." 37 CFR 1.78(a). See also the Notice of April 28, 1987 (1079 O.G. 32 to 46).

Amend the Specification by inserting before the first line the sentence:

"This is a

- continuation
 continuation-in-part
 divisional

of copending application(s)

- serial number 0 7 / 586,391 filed on September 18, 1990 "
 International Application _____ filed on _____
_____ and which designated the U.S."

NOTE: The proper reference to a prior filed PCT application which entered the U.S. national phase is the U.S. serial number and the filing date of the PCT application which designated the U.S.

NOTE: (1) Where the application being transmitted adds subject matter to the International Application then the filing can be as a continuation-in-part or (2) it is desired to do so for other reasons, e.g. where no declaration is available, no English translation is available or no fee is to be paid on filing then the filing can be as a continuation. In these cases the International Application designating the U.S. is treated as the parent case in the U.S. and is an alternative to the completion of the International Application under 35 U.S.C. 371(c)(4) which must meet the requirements of 37 CFR 1.61(a). This alternative permits the completion of the filing requirements within any term set by the PTO under 37 CFR 1.53(d) to which the extension provisions of 37 CFR 1.136(a) apply. (Whereas, if the filing is as an international application entering the U.S. stage then the fee, declaration and/or English translation (where necessary) is due within 20 months of the priority date but can be paid within 22 months of the priority date (or is due within 30 months of the priority date but can be submitted within 32 months of the priority date) with the surcharges set forth in 37 CFR 1.492(e), (f) and 37 CFR 1.495(c); however, the provisions of 37 CFR 1.136 do not apply to this 22 or (32 month) period. 37 CFR 1.61(b).)

NOTE: The deadline for entering the national phase in the U.S. for an international application was clarified in the Notice of April 28, 1987 (1079 O.G. 32 to 46) as follows:

"The Patent and Trademark Office considers the International application to be pending until the 22nd month from the priority date if the United States has been designated and no Demand for International Preliminary Examination has been filed prior to the expiration of the 19th month from the priority date and until the 32nd month from the priority date if a Demand for International Preliminary Examination which elected the United States of America has been filed prior to the expiration of the 19th month from the priority date, provided that a copy of the international application has been communicated to the Patent and Trademark Office within the 20 or 30 month period respectively. If a copy of the international application has not been communicated to the Patent and Trademark Office within the 20 or 30 month period respectively, the international application becomes abandoned or to the United States 2

(Added Pages for Application Transmittal Where Benefit of Prior U.S. Application(s)
Claimed [4-1.1]—page 1 of 4)

or 30 months from the priority date respectively. These periods have been placed in the rules as paragraph (h) of § 1.494 and paragraph (2) of § 1.495. A continuing application under 35 U.S.C. 365(c) and 120 may be filed anytime during the pendency of the international application."

18. Relate Back—35 U.S.C. 119 Priority Claim for Prior Application

The prior U.S. application(s), including any prior International Application designating the U.S., identified above in item 16, in turn itself claim(s) foreign priority (ies) as follows:

country	appl. no.	filed on
---------	-----------	----------

The certified copy (ies) has (have)

- been filed on _____ in prior application 0 / _____ which was filed on _____
- is (are) attached

WARNING: The certified copy of the priority application which may have been communicated to the PTO by the International Bureau may **not** be relied on without any need to file a certified copy of the priority application in the continuing application. This is so because the certified copy of the priority application communicated by the International Bureau is placed in a folder and is not assigned a U.S. serial number unless the national stage is entered. Such folders are disposed of if the national stage is not entered. Therefore such certified copies may not be available if needed later in the prosecution of a continuing application. An alternative would be to physically remove the priority documents from the folders and transfer them to the continuing application. The resources required to request transfer, retrieve the folders, make suitable record notations, transfer the certified copies, enter and make a record of such copies in the Continuing Application are substantial. Accordingly, the priority documents in folders of international applications which have not entered the national stage may not be relied on. Notice of April 28, 1987 (1079 O.G. 32 to 46).

19. Maintenance of Copendency of Prior Application

NOTE: The PTO finds it useful if a copy of the petition filed in the prior application extending the term for response is filed with the papers constituting the filing of the continuation application. Notice of November 5, 1985 (1060 O.G. 27).

- A. Extension of time in prior application

(This item **must** be completed and the papers filed in the prior application if the period set in the prior application has run)

- A petition, fee and response extends the term in the pending prior application until _____
- A copy of the petition filed in prior application is attached

- B. Conditional Petition for Extension of Time in Prior Application

(complete this item if previous item not applicable)

- A conditional petition for extension of time is being filed in the pending prior application.
- A copy of the conditional petition filed in the prior application is attached

20. Further Inventorship Statement Where Benefit of Prior Application(s) Claimed

NOTE: "If the continuation, continuation-in-part, or divisional application is filed by less than all the inventors named in the prior application a statement **must** accompany the application when filed requesting deletion of the names of the person or persons who are not inventors of the invention being claimed in the continuation, continuation-in-part, or divisional application." 37 CFR 1.62(a) [emphasis added]. (dealing with the file wrapper continuation situation).

NOTE: "In the case of a continuation-in-part application which adds and claims additional disclosure by amendment, an oath or declaration as required by § 1.63 must be filed. In those situations where a new oath or declaration is required due to additional subject matter being claimed, additional inventors may be named in the continuing application. In a continuation or divisional application which discloses (Added Pages for Application Transmittal Where Benefit of Prior U.S. Application(s)

Claimed [4-1.1]—page 2 of 4)

and claims only subject matter disclosed in a prior application, no additional oath or declaration is required and the application must name as inventors the same or less than all the inventors in the prior application." 37 CFR 1.60(c). (dealing with the continuation situation).

(complete applicable item (a), (b) and/or (c) below)

- (a) This application discloses and claims only subject matter disclosed in the prior application whose particulars are set out above and the inventor(s) in this application are
- the same
 - less than those named in the prior application and it is requested that the following inventor(s) identified for the prior application be deleted:

(Type name(s) of inventor(s) to be deleted)

- (b) This application discloses and claims additional disclosure by amendment and a new declaration or oath is being filed. With respect to the prior application the inventor(s) in this application are
- the same
 - the following additional inventor(s) have been added

(Type name(s) of inventor(s) to be added)

- (c) The inventorship for all the claims in this application are
- the same
 - not the same, and an explanation, including the ownership of the various claims at the time the last claimed invention was made
 - is submitted
 - will be submitted

21. Abandonment of Prior Application (if applicable)

- Please abandon the prior application at a time while the prior application is pending or when the petition for extension of time or to revive in that application is granted and when this application is granted a filing date so as to make this application copending with said prior application.

NOTE: According to the Notice of May 13, 1983 (103, TMOG 6-7) the filing of a continuation or continuation-in-part application is a proper response with respect to a petition for extension of time or a petition to revive and should include the express abandonment of the prior application conditioned upon the granting of the petition and the granting of a filing date to the continuing application.

22. Petition for Suspension of Prosecution for the Time Necessary to File an Amendment

WARNING: "The claims of a new application may be finally rejected in the first Office action in those situations where (1) the new application is a continuing application of, or a substitute for, an earlier application, and (2) all the claims of the new application (a) are drawn to the same invention claimed in the earlier application, and (b) would have been properly finally rejected on the grounds of art of record in the next Office action if they had been entered in the earlier application." MPEP, § 706.07(b).

NOTE: Where it is possible that the claims on file will give rise to a first action final for this continuation application and for some reason an amendment cannot be filed promptly (e.g., experimental data is being gathered) it may be desirable to file a petition for suspension of prosecution for the time necessary.

(Added Pages for Application Transmittal Where Benefit of Prior U.S. Application(s)
Claimed [4-1.1]—page 3 of 4)

(check the next item, if applicable)

- There is provided herewith a Petition To Suspend Prosecution for the Time Necessary to File An Amendment (New Application Filed Concurrently)

23. NOTIFICATION IN PARENT APPLICATION OF THIS FILING

- A notification of the filing of this
(check one of the following)
- continuation
 - continuation-in-part
 - divisional

is being filed in the parent application from which this application claims priority under 35 USC § 120.

(Added Pages for Application Transmittal Where Benefit of Prior U.S. Application(s)
Claimed [4-1.1]—page 4 of 4)

**ADDED PAGE(S) FOR APPLICATION TRANSMITTAL WHERE BENEFIT OF
A PRIOR U.S. APPLICATION CLAIMED**

This is a continuation application of U.S. patent application serial number 07/586,391 filed September 18, 1990, now U.S. Patent No. 5,191,573, issued March 2, 1993, which is a continuation application of U.S. patent application serial number 07/206,497, filed June 13, 1988, abandoned.

Added page 1

(Added Page for Special Comments for Application Transmittal Where Benefit of a Prior
U.S. Application Claimed [4-1.1])



UNITED STATES DEPARTMENT OF COMMERCE
 Patent and Trademark Office
 ASSISTANT SECRETARY AND COMMISSIONER
 OF PATENTS AND TRADEMARKS
 Washington, D.C. 20231 586391

FROM : Sallye M. Rayford, Manager
 Correspondence & Mail Division

SUBJECT: Receipt of Papers and Fees File Under 37 CFR 1.10 By Express Mail

The filing date of Sept 18th 1990 is the correct date. The date on the Express Mail label under 37 CFR 1.10 is _____. On that date the PTO was closed all day due to _____ adverse weather conditions (authorized by Office of Personnel Management) or a _____ normally scheduled Federal holiday within the District of Columbia. In accordance with 37 CFR 1.6 the papers have been stamped with the next succeeding day which is not a Saturday, Sunday or Federal holiday within the District of Columbia. The provision of 35 U.S.C. 21 (b) apply.

The papers were not stamped with the date on the certificate of mailing by Express Mail because the date on the certificate does not coincide with the date of deposit on the Express Mail label which the PTO takes as evidence of when the package was mailed.

Date on certificate of mailing by Express Mail is Sept 14th 1990

Date on Express Mail label is Sept 18th 1990

Date of receipt in PTO is Sept 19th 1990

Therefore, the filing date is Sept 18th 1990

The papers are not entitled to the benefits of 37 CFR 1.10 because:

SIGNED: Brima Wiggall

DATE : Sept 20th 1990



IN THE UNITED STATES PATENT AND TRADEMARK OFFICE

In re Application of:

ARTHUR HAIR

Serial No. 07/206,497

Filed: June 13, 1988

Art Unit 239

Patent Examiner:

H. Nguyen

)
)
)
)
)
)
)
)
)
)
)
)
)

TRANSMISSION SYSTEM

Pittsburgh, Pennsylvania 15222

CERTIFICATE OF MAILING

August 21, 1990

Hon. Commissioner of Patents and Trademarks

Washington, D.C. 20231

Sir:

I hereby certify that the correspondence is being deposited with the United States Postal Service as first class mail in an envelope addressed to: Commissioner of Patents and Trademarks, Washington, DC 20231, on 8-21-90

Ansel M. Schwartz
Registration No. 30,587

PETITION FOR ONE-MONTH
EXTENSION OF TIME

8/21/90

Date

The first Official Action dated May 14, 1990, which issued in the above-referenced patent application, has been received. Applicant, by the subject Petition, now requests that he be granted a one-month extension of time to permit him to file an amendment to the outstanding Official Action. By this Petition, the period of response is extended to and including September 14, 1990. Applicant's response in the form of an amendment is being filed with this Petition. Enclosed is a check in the amount of \$31.00 to cover the extension fee.

The Commissioner is hereby authorized to charge any fees, or credit any overpayment, to Deposit Account No. 03-2411. A duplicate copy of this Petition is enclosed.

Respectfully submitted,

ARTHUR HAIR

By Ansel Schwartz
Ansel M. Schwartz, Esquire
Cohen & Grigsby
Reg. No. 30,587
2900 CNG Tower
625 Liberty Avenue
Pittsburgh, PA 15222
(412) 394-4900

Attorney for Applicant

CERTIFICATE OF MAILING

I hereby certify that the correspondence is being deposited with the United States Postal Service as first class mail in an envelope addressed to: Commissioner of Patents and Trademarks, Washington, DC 20231.

Ansel Schwartz

Ansel M. Schwartz
Registration No. 30,587

5/21/90

Date

07 586391

PATENT APPLICATION SERIAL NO. _____

U.S. DEPARTMENT OF COMMERCE
PATENT AND TRADEMARK OFFICE
FEE RECORD SHEET

040 TP 09/28/90 07586391

1 101

185.00 CK 2102.001-CON

PTO-1556
(5/87)

FORM PTO-875
REV. 11-88

U.S. DEPARTMENT OF COMMERCE
PATENT AND TRADEMARK OFFICE

SERIAL NO
586391

FILING DATE
7-18-90

PATENT APPLICATION FEE DETERMINATION RECORD

APPLICANT (FIRST NAMED):
Hair

CLAIMS AS FILED - PART I

FOR	NO FILED	NO EXTRA
BASIC FEE		
TOTAL CLAIMS	5	20
INDEP CLAIMS	2	3
MULTIPLE DEPENDENT CLAIMS PRESENT		

SMALL ENTITY		OR	OTHER THAN A SMALL ENTITY	
RATE	FEE		RATE	FEE
	\$ 185	OR		\$ 370
x 6	\$	OR	x 12	\$
x 18	\$	OR	x 36	\$
60	\$	OR	120	\$
TOTAL	\$ 185	OR	TOTAL	\$

* If the difference in col. 1 is more than 20% enter 0 in col. 2

CLAIMS AS AMENDED - PART II

AMENDMENT A	CLAIMS REMAINING AFTER AMENDMENT		MINUS	HIGHEST NO PREVIOUSLY PAID FOR	PRESENT EXTRA
	(1)	(2)		(3)	
TOTAL	6			20	
INDEP	2			3	
FIRST PRESENTATION OF MULTIPLE DEP CLAIM					

SMALL ENTITY		OR	OTHER THAN A SMALL ENTITY	
RATE	ADDIT. FEE		RATE	ADDIT. FEE
x 6	\$	OR	x 12	\$
x 18	\$	OR	x 36	\$
60	\$	OR	120	\$
TOTAL ADDIT. FEE	\$	OR	TOTAL	\$

AMENDMENT B	CLAIMS REMAINING AFTER AMENDMENT		MINUS	HIGHEST NO PREVIOUSLY PAID FOR	PRESENT EXTRA
	(1)	(2)		(3)	
TOTAL	7				
INDEP	3				
FIRST PRESENTATION OF MULTIPLE DEP CLAIM					

SMALL ENTITY		OR	OTHER THAN A SMALL ENTITY	
RATE	ADDIT. FEE		RATE	ADDIT. FEE
x 6	\$	OR	x 12	\$
x 18	\$	OR	x 36	\$
60	\$	OR	120	\$
TOTAL ADDIT. FEE	\$	OR	TOTAL	\$

AMENDMENT C	CLAIMS REMAINING AFTER AMENDMENT		MINUS	HIGHEST NO PREVIOUSLY PAID FOR	PRESENT EXTRA
	(1)	(2)		(3)	
TOTAL	6				
INDEP	2				
FIRST PRESENTATION OF MULTIPLE DEP CLAIM					

SMALL ENTITY		OR	OTHER THAN A SMALL ENTITY	
RATE	ADDIT. FEE		RATE	ADDIT. FEE
x 6	\$	OR	x 12	\$
x 18	\$	OR	x 36	\$
60	\$	OR	120	\$
TOTAL ADDIT. FEE	\$	OR	TOTAL	\$

BEST AVAILABLE COPY



07 586391

#19 / E
J.E.
8/2/91

IN THE UNITED STATES PATENT AND TRADEMARK OFFICE

In re Application of:)

ARTHUR HAIR)

Serial No. 07/)

Filed:)

TRANSMISSION SYSTEM

Art Unit 239)

Patent Examiner:)

H. Nguyen)

Pittsburgh, Pennsylvania 15222

September 14, 1990

Hon. Commissioner of Patents and Trademarks

Washington, D.C. 20231

Sir:

PRELIMINARY AMENDMENT

In response to the Office Action of parent application 07/206,497 dated May 14, 1990, please enter the following amendments to the above-identified application as follows:

IN THE TITLE:

Please change the "Transmission System" to Method

E for Transmitting a Desired Digital Video or Audio Signal m

IN THE CLAIMS:

11. (Twice Amended) A method for transmitting a desired digital audio music signal stored on a first memory to a second memory comprising the steps of:

E² transferring money to a first party controlling use of the first memory from a second party financially distinct from the first party, said second party controlling use and in possession of the second memory;

F connecting electronically the first memory with the second memory such that the digital signal can pass therebetween;

transmitting the digital signal from the first memory with a transmitter in control and possession of the first party to a receiver having the second memory at a location determined by the second party, said receiver in possession and control of the second party; and

storing the digital signal in the second memory.

Claim 12, line 3, delete "music";

Claim 12, line 4, delete "music".

E³ 15. (Amended) A method for transmitting a desired digital, [a] video or audio [music] signal stored on a first memory to a second memory comprising the steps of:

charging a fee [to] by a first party controlling use of
the [second] first memory to a second party financially distinct
from the first party, said second party in control and in
possession of the second memory;

connecting the first memory with the second memory such
that the digital signal can pass therebetween;

transmitting the digital signal from the first memory
with a transmitter in control and possession of the first party
to a receiver having the second memory at a location determined
by the second party, said receiver in possession and control of
the second party; and

storing the digital signal in the second memory.

Please add the following claim.

³ 21. A method as described in ⁴ claim 15 including after
^{transferring money} the ^{charging} step, the step of searching the first memory for the
desired digital signal; and selecting the desired digital signal
from the first memory.

arg 25 -3-

REMARKS

Claims 11-13, 15 and 21 are currently active.

((/
Claims 14 and 16-20 have been cancelled.

The above-identified patent application is a file wrapper continuation of U.S. Patent Application Serial No. 07/206,497.

The title of the invention has been amended to be clearly indicative of the invention to which the claims are directed.

Applicant's invention is a method for transmitting a desired digital, video or audio signal stored on a first memory to a second memory. The method comprises the steps of charging a fee by a first party controlling use of the first memory to a second party financially distinct from the first party. The second party is in control and in possession of the second memory. Additionally, the method comprises the step of then connecting the first memory with the second memory such that the digital signal can pass therebetween. Next, there is the step of transmitting the digital signal from the first memory with a transmitter in control and in possession of the first party to a receiver having the second memory at a location determined by the second party. The receiver is in possession and in control of

the second party. There is also the step of then storing the digital signal in the second memory.

The Examiner has rejected Claims 11-18 under 35 U.S.C. §102(b) as being anticipated by Lightner. Applicant respectfully traverses this rejection.

Referring to Lightner, there is disclosed a vending system for remotely accessible stored information. The vending system includes a central station in which various information stored on master recordings can be selectively accessed by purchasers from any of multiple remote vending machines. The accessed information is reproduced on cartridge type storage media at that vending machine. Once currency or a credit card is received by the vending machine, the selected information is transferred to the cartridge. After transmission is complete, the cartridge is then ejected from the vending machine and received by the purchaser to be then controlled by the purchaser.

There is no teaching or suggestion in Lightner of the "second memory" to which the digital signal is transmitted to be "in control and in possession" by the "second party". Furthermore, there is no teaching or suggestion in Lightner for the "receiver" having the second memory being "in possession and in control of the second party" and "at a location determined by the second party" as found in applicant's Claim 15.

Lightner actually teaches away from applicant's claimed invention. Lightner teaches vending machines which have in them blank tape cassettes which receive the transmitted signal from the master tape. When payment is complete, the cassette is then ejected from the vending machine to the consumer. See lines 25-37 of column 2. Thus, these blank tape cassettes are not "in possession of the second party". The vending machines themselves are "in the possession of the "first party controlling use of the first memory" and not "in the possession of the second party". This is a substantive distinction between applicant's claimed invention and the prior art. Applicant's claimed method allows "a second party" to have a desired signal transmitted to a "receiver . . . in possession of the second party . . . at a location determined by the second party". This means, for instance, in the pleasure of the second party's home, the second party can simply telephone the "first party" and obtain desired signals immediately and conveniently. The "second party" does not have to leave his house and go to a vending machine location is chosen by the first party who is in possession of the vending machine. Accordingly, Lightner does not anticipate Claim 15 and is patentable. Claim 21 is dependent to parent Claim 15 and has all the limitations thereof. Since Claim 15 is patentable, so is Claim 21.

Claim 11 is patentable for the reasons Claim 15 is patentable. Claims 12 and 13 are dependent to parent Claim 11

and have the limitations thereof. Since Claim 11 is patentable, so are Claims 12 and 13.

The Examiner has rejected Claims 11, 14, 17, 19 and 20 under 35 U.S.C. §102(b) as being anticipated by Hughes. Applicant respectfully traverses this rejection.

Referring to Hughes, there is disclosed a coin operated recording machine. The coin operated recording machine allows a consumer to record on his audio or video magnetic tape cartridge at a selected audio video recording stored in the machine upon insertion of the appropriate coins in much the same manner as a conventional juke box. There is no teaching or suggestion in Hughes of the "receiver" being "in possession of the second party . . . at a location determined by the second party". Hughes actually teaches away from applicant's claimed invention since the recording apparatus is taught to be in possession of the "first party controlling use of the first memory" not the "second party in possession of the second memory". Essentially for the reasons set forth as to why applicant's claimed invention is patentable over Lightner, applicant's claimed invention is also patentable over Hughes. Accordingly, Hughes does not anticipate or make obvious applicant's Claim 11. Claims 12 and 13 are dependent to parent Claim 11 and have all the limitations thereof. Since Claim 11 is patentable, so are Claims 12 and 13.

The Commissioner is hereby authorized to charge any fees or credit any overpayment to Deposit Account No. 03-2411. A duplicate copy of this Amendment is enclosed.

In view of the foregoing amendments and remarks, it is respectfully requested that Claims 11-13, 15 and 21, now in this application, be allowed.

Respectfully submitted,

ARTHUR HAIR

By 

Ansel M. Schwartz, Esquire
Reg. No. 30,587
Cohen & Grigsby
2900 CNG Tower
625 Liberty Avenue
Pittsburgh, PA 15222
(412) 394-4900

Attorney for Applicant



**UNITED STATES DEPARTMENT OF COMMERCE
Patent and Trademark Office**

Address: COMMISSIONER OF PATENTS AND TRADEMARKS
Washington, D.C. 20231

SERIAL NUMBER	RECEIPT DATE	FIRST NAMED APPLICANT	ATTORNEY DOCKET NO.
07/586,391	09/18/90	HAIR	A 2102.001-CON

ANSEL M. SCHWARTZ
 COHEN & GRIGSBY
 2900 CNG TOWER
 625 LIBERTY AVE.
 PITTSBURGH, PA 15222

239 15
 DATE MAILED: 10/31/90

Dear Sir:

Upon further review it has been determined that the official filing receipt for the above identified application was mailed in error and the filing date has been cancelled.

The application was received in the Patent and Trademark Office on 9/18/90 requesting a continuation under 37 CFR 1.62 of serial number 07/206497 filed on 06.13.88.

It has been determined that no copendency was established between the prior application and the file wrapper since the prior application was abandoned before the file wrapper was filed. The application is being held as Improper File Wrapper Continuation under 37 CFR 1.62 with "No Filing Date Granted" in the Application Processing Division awaiting response.

Any review of this matter must be made by way of petition directed to the office of the Assistant Commissioner for Patents Crystal Park 2 Suite 923. Any such petition must be filed within TWO MONTHS from the date of this letter and accompanied by the \$120.00 petition fee. If the petition alleges that no defects exists or that an office error was made, a request for refund of the petition fee may be included in the petition.

Sincerely,

 Special Processing Branch
 ONLAR, Application Processing Division
 (703) 557-3831



15 1/2

PATENT

IN THE UNITED STATES PATENT AND TRADEMARK OFFICE

10/30/90
03B

In re application of: Arthur R. Hair
Serial No.: 07 / 586,391
Filed: September 14, 1990
For: TRANSMISSION SYSTEM

Group No.: 239
Examiner: RECEIVED

Commissioner of Patents and Trademarks
Washington, D.C. 20231

11 7 1990

GROUP 230

239

REQUEST FOR CORRECTED FILING RECEIPT

- 1. Attached is a copy of the official filing receipt received from the PTO in the above application for which issuance of a corrected filing receipt is respectfully requested.
- 2. There is an error in that the following data is:

- incorrectly entered
and/or
- omitted
 - Applicant's name
 - Applicant's address
 - Title
 - Filing Date
 - Serial Number
 - Foreign/PCT Application Reference
 - Other

RECEIVED
FEB 22 1991
OFFICE OF THE ASSISTANT
COMMISSIONER FOR PATENTS

RECEIVED
JAN 17 1991
APPLICATION DIVISION-402

in that the filing receipt should read as follows: 9/14/90

CERTIFICATE OF MAILING (37 CFR 1.8a)

I hereby certify that this paper (along with any paper referred to as being attached or enclosed) is being deposited with the United States Postal Service on the date shown below with sufficient postage as first class mail in an envelope addressed to the: Commissioner of Patents and Trademarks, Washington, D.C. 20231.

Tracey L. Milka
(Type or print name of person mailing paper)

Date: 10/30/90

Tracey L. Milka
(Signature of person mailing paper)

3. (complete the following applicable item A or B)

A. The correction is not due to any error by applicant and no fee is due

OR

B. The correction is due to applicant's error and the fee therefor under 37 CFR 1.19(h) of \$15.00 is paid as follows:

enclosed is check for \$15.00

charge Account _____ \$15.00

Reg. No.: 30,587

Tel. No.: (412) 394-4987

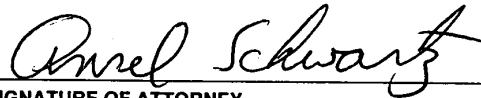

SIGNATURE OF ATTORNEY

Ansel M. Schwartz, Esquire

Type or print name of attorney

Cohen & Grigsby

P.O. Address 2900 CNG Tower

625 Liberty Avenue

Pittsburgh, PA 15222

(Request for Corrected Filing Receipt [5-8]—page 2 of 2)

124-8120
#16

IN THE UNITED STATES PATENT AND TRADEMARK OFFICE

In re Application of:)	
ARTHUR R. HAIR)	
Serial No. 07/586,391)	
Filed: September 14, 1990)	TRANSMISSION SYSTEM
Art Unit 239)	
Patent Examiner:)	

Pittsburgh, Pennsylvania 15222
December 13, 1990 CERTIFICATE OF MAILING

Assistant Commissioner of Patents
Crystal Park 2
Suite 923
Washington, D.C. 20231

RECEIVED

DEC 17 1990

ASSISTANT
COMMISSIONER'S OFFICE
PETITION

I hereby certify that the correspondence is being deposited with the United States Postal Service as first class mail in an envelope addressed to: Commissioner of Patents and Trademarks, Washington, DC 20231, on 12/14/90

Ansel Schwartz

Ansel M. Schwartz
Registration No. 30,587

12/14/90

Date

Sir:

This Petition is for removal of designation of improper file wrapper continuation under 37 C.F.R. 1.62 with no filing date granted.

Applicant's file wrapper continuation for the above-identified patent application was filed by Express Mail on September 14, 1990. A Declaration in support of this fact is included. This Declaration is by Tracey L. Milka, the secretary who physically placed the subject application into Express Mail on September 14, 1990. Accordingly, the above-identified application should have received a filing date of September 14, 1990 in the mail room as per 37 C.F.R. §1.10 (copy attached), but instead incorrectly received a date of September 18, 1990, making it an

080 DF 12/21/90 07586391

1 124

120.00 CK

improper file wrapper continuation under C.F.R. 1.62 and received no filing date.

Furthermore, on October 30, 1990, essentially as soon as Applicant received the incorrect filing date and before receipt of your October 31, 1990, letter, Applicant filed a form requesting a corrected filing receipt (see Enclosure D).

Enclosed you will find a \$120.00 petition fee, but since this was a Patent Office error, please return the fee. The Commissioner is hereby authorized to charge any fees or credit any overpayment to Deposit Account No. 03-2411. A duplicate copy of this Petition is enclosed.

Applicant therefore requests that the subject patent application be afforded a proper filing date of September 14, 1990, instead of the incorrect filing date of September 18, 1990 and the subject application be permitted to continue to be prosecuted to allowance.

Respectfully submitted,

ARTHUR R. HAIR

By Ansel Schwartz

Ansel M. Schwartz, Esquire
Reg. No. 30,587
Cohen & Grigsby
2900 CNG Tower
625 Liberty Avenue
Pittsburgh, PA 15222
(412) 394-4900

Attorney for Applicant

CERTIFICATE OF MAILING

I hereby certify that the correspondence is being deposited with the United States Postal Service as first class mail in an envelope addressed to: Commissioner of Patents and Trademarks, Washington, DC 20231,

on 12/14/90

Ansel Schwartz

Ansel M. Schwartz
Registration No. 30,587

12/14/90

Date

INVOICE #/DETAIL

CLIENT # MATTER #

DESCRIPTION

AMOUNT

091290

09/12/90

2102/001

185.00

\$****185.00*

ENCLOSURE A

ENCLOSURE B

PATENT

IN THE UNITED STATES PATENT AND TRADEMARK OFFICE

Docket No. 2102.001 CONT
Anticipated Classification of this application:
Class Subclass
Prior application:
Examiner: H. Nguyen
Art Unit: 239

Box FWC
Commissioner of Patents and Trademarks
Washington, D.C. 20231

FILE WRAPPER CONTINUING APPLICATION (FWC) (37 CFR 1.62)

- WARNING: This form cannot be used where the parent case may not be abandoned since the filing of a request under the FWC procedure "will be considered to be a request to expressly abandon the prior application as of the filing date granted to the continuing application." 37 CFR 1.62(g).
WARNING: This procedure can only be used for a pending application prior to payment of the Issue fee. 37 CFR 1.62(a).
WARNING: The filing of an application as the United States stage of an international application requires an oath or declaration. 37 CFR 1.61(a)(4).
WARNING: The claims of this new application may be finally rejected in the first Office action where all claims of the new application are drawn to the same invention claimed in the earlier application and would have been properly finally rejected on the grounds or art of record in the next Office action if they had been entered in the earlier application. MPEP § 706.07(b).
WARNING: An application under 37 CFR 1.62 is filed by making changes by amendment to the prior application, 37 CFR 1.62(a), and not by filing a new application.
WARNING: Filing under 37 CFR 1.62 is permitted only if filed by the same or less than all the inventors named in the prior application.

I. This is a request for a filing under the file wrapper continuing application procedure, 37 CFR 1.62, for a

- [X] continuation
[] divisional
[] continuation-in-part (for oath or declaration see III below)
[] attached is an amendment for added subject matter

CERTIFICATION UNDER 37 CFR 1.10

I hereby certify that this FWC transmittal and the documents referred to as attached therein are being deposited with the United States Postal Service on this date September 14, 1990 in an envelope as "Express Mail Post Office to Addressee" mailing Label Number MB137703489 addressed to the: Commissioner of Patents and Trademarks Washington, D.C. 20231.

Tracey L. Milka
(Type or print name of person mailing paper)
Tracey L. Milka
(Signature of person mailing paper)

NOTE: Each paper or fee filed by "Express Mail" has the number of the "Express Mail" mailing label placed thereon prior to mailing. 37 CFR 1.10(b).

POST OFFICE TO ADRESSEE **EXPRESS MAIL** **NEXT DAY SERVICE**

MB 137703469

Post Office ZIP Code: 15203 Date in: 9/14/90 Time in: 11:00 AM P.M.
 Initials of Receiving Clerk: AG Weight: 0.5 lbs. oz.
 Next Day Delivery or Second Day Delivery
 By 12 Noon or By 3:00 P.M.
 Express Mail International Express Mail
 Military Service Country Code

Service Guarantee: If the recipient is unable to accept the mail, the carrier will attempt to deliver the mail to the addressee. If delivery is not possible, the carrier will return the mail to the sender. The sender will be notified by the carrier. The sender will be responsible for the return postage. The sender will be responsible for the return postage. The sender will be responsible for the return postage.

Waiver of Signature and Indemnity (Domestic Only)
 I, the undersigned, hereby waive my right to a signature receipt and I authorize the delivery employee to deliver the enclosed contents to the addressee without my signature. The enclosed contents must be properly sealed in a container that meets the requirements of the Domestic Mail Manual.

CUSTOMER RECEIPT
TO: Telephone Number: _____
 Commissioner of Patents and Trademarks
 Washington, D.C. 20231
 Box EWC

FROM:
 Ansel M. Schwartz, Esquire
 Cohen & Grigsby
 2900 CNG Tower
 625 Liberty Avenue
 Pittsburgh, PA 15222
 Our Ref: 2102.001 CONT

Total Postage & Fees: \$ _____
 Return Receipt: \$ _____
 COD: \$ _____
 Federal Agency Account No.: _____

AMS:tlm

The dating stamp of FILE WRAPPER CONTINUING APPLICATION (FWC) (37 CFR 1.62) PRELIMINARY AMENDMENT + one duplicate copy COPY OF PETITION FOR ONE-MONTH EXTENSION OF TIME ~~SH~~ Ser. No. _____ C&G CK. #0009031 for \$185.00 Paper Mailed 9/14/90 Atty's File No. 2102.001 CONT Art Hair



07 586391

ENCLOSURE C

Thank You For Using Express Mail Service

ENCLOSURE D

PATENT

IN THE UNITED STATES PATENT AND TRADEMARK OFFICE

In re application of: Arthur R. Hair

Serial No.: 07 / 586,391

Group No.: 239

Filed: September 14, 1990

Examiner:

For: TRANSMISSION SYSTEM

RECEIVED

DEC 17 1990

Commissioner of Patents and Trademarks
Washington, D.C. 20231

ASSISTANT
COMMISSIONER'S OFFICE

REQUEST FOR CORRECTED FILING RECEIPT

1. Attached is a copy of the official filing receipt received from the PTO in the above application for which issuance of a corrected filing receipt is respectfully requested.

2. There is an error in that the following data is:

- incorrectly entered
and/or
- omitted
 - Applicant's name
 - Applicant's address
 - Title
 - Filing Date
 - Serial Number
 - Foreign/PCT Application Reference
 - Other

in that the filing receipt should read as follows: 9/14/90

CERTIFICATE OF MAILING (37 CFR 1.8a)

I hereby certify that this paper (along with any paper referred to as being attached or enclosed) is being deposited with the United States Postal Service on the date shown below with sufficient postage as first class mail in an envelope addressed to the: Commissioner of Patents and Trademarks, Washington, D.C. 20231.

Tracey L. Milka

(Type or print name of person mailing paper)

Date:

10/30/90

Tracey L. Milka

(Signature of person mailing paper)

(Request for Corrected Filing Receipt [5-8]—page 1 of 2)

IN THE UNITED STATES PATENT AND TRADEMARK OFFICE

In re Application of:)
ARTHUR R. HAIR)
Serial No. 07/586,391)
Filed: September 14, 1990)
Art Unit 239)
Patent Examiner:)

TRANSMISSION SYSTEM

RECEIVED

DEC 17 1990

ASSISTANT
COMMISSIONER'S OFFICE

Pittsburgh, Pennsylvania 15222

November 29, 1990

Assistant Commissioner of Patents
Crystal Park 2
Suite 923
Washington, D.C. 20231

Sir:

DECLARATION

I, Tracey L. Milka, am employed as a patent secretary for the law firm of Cohen & Grigsby.

I obtained a check for \$185.00 on September 12, 1990 (see Enclosure A) and mailed the above-identified patent application with this check by Express Mail on September 14, 1990, as evidenced by the certification under 37 C.F.R. §1.10 (see Enclosure B).

As a substantial part of my job, I file many patent applications, and I always do this by Express Mail. So far, all the applications I have ever mailed (at least more than 100) by

followed the same procedure in mailing and filing the above-identified patent application as I always do and am unaware of any reason why the above-identified patent application should not receive a filing date of September 14, 1990, the date that I placed the above-identified patent application in Express Mail.

Also enclosed is a copy of the return receipt card (see Enclosure C) showing that the above-identified patent application, Preliminary Amendment and copy of Petition for One-Month Extension of Time was mailed on September 14, 1990, but received a mail room stamp of September 18, 1990.

I further declare that all statements made herein of my own knowledge are true and that all statements made on information and belief are believed to be true; and further, that these statements are made with the knowledge that willful false statements in the like so made are punishable by fine or imprisonment, or both, under Section 1001 of Title 18 of the United States Code, and that such willful false statements may jeopardize the validity of the application or any patent issuing thereon.

12/14/90
Date

Tracey L. Milka
Tracey L. Milka



UNITED STATES DEPARTMENT OF COMMERCE
Patent and Trademark Office
 ASSISTANT SECRETARY AND COMMISSIONER
 OF PATENTS AND TRADEMARKS
 Washington, D.C. 20231

17

MAR 11 1991

Ansel M. Schwartz
 Cohen & Grigsby
 2900 CNG Tower
 625 Liberty Ave.,
 Pittsburgh, PA 15222

In re Application of :
 Arthur R. Hair :
 Serial No. 07/586,391 : DECISION ON PETITION
 Deposited: September 18, 1990 :
 For: TRANSMISSION SYSTEM :

The above-identified application has been referred to the Office of the Assistant Commissioner for Patents for consideration of the petition filed on December 17, 1990, requesting that the application be accorded a filing date of September 14, 1990, instead of September 18, 1990.

On October 31, 1990, Application Branch mailed a Notice of Improper FWC filing under 37 CFR 1.62 stating that the original filing receipt was mailed in error and that this was an improper filing under 37 CFR 1.62 since the request for a FWC application was deposited after the parent application became abandoned.

In response, the present petition was filed wherein petitioner alleges that the request for a FWC application of the prior application was mailed to the Patent and Trademark Office (PTO) via "Express Mail" on September 14, 1990, and, therefore, the proper procedures under 37 CFR 1.62 were followed. The petition is accompanied by a photocopy of Express Mail customer receipt No. MB137703489, a verified statement of Tracey L. Milka, an employee of the law firm of Cohen & Grigsby and a postcard receipt for the above application having a Mail Room date stamp of September 18, 1990.

A review of this application file reveals that the papers allegedly deposited on September 14, 1990, have a certificate of mailing by Express Mail, including an Express Mail label number and deposit date. The certificate of mailing by Express Mail indicates the date of deposit to be September 14, 1990.

The copy of the Express Mail customer receipt submitted with the petition and the copy of the Express Mail label retained by the PTO, bear a "Date-in" of September 18, 1990, literally "9 18 90." The copy of the Express Mail customer receipt, the Express Mail label retained by the PTO and the certificate of mailing by Express Mail all bear the same label number.

Paragraph (c) of 37 CFR 1.10 states that:

"the...Office will accept the certificate of mailing by 'Express Mail' and accord the paper or fee the certificate date under 35 U.S.C. 21(a)...without further proof of the date on which the mailing by 'Express Mail' occurred unless a question is present regarding the date of mailing."

Clearly, when the certificate of mailing by Express Mail contains one date and the Express Mail label contains another date there is a question "regarding the date of mailing." The certificate of mailing by Express Mail is not sufficient evidence by itself to establish the date of mailing.

37 CFR 1.10(a) indicates that papers or fees filed under the practice set forth in 37 CFR 1.10 will "be considered as having been filed in the Office on the date the paper or fee is shown to have been deposited as 'Express Mail' with the United States Postal Service." Therefore, in those cases where there is a discrepancy, the question is resolved by using the "Date-In" on the Express Mail receipt, which verifies when it was mailed via Express Mail." The date inserted on the Express Mail label by the Postal Service employee indicates that the application was filed after the abandonment of the prior application.

Petitioner has failed to provide any statement from the Postal Service indicating that the particular Express Mail package in question was incorrectly dated by the Postal Service.

Further, while the petition is accompanied by a verified statement of Tracey L. Milka averring to the fact that the mailing occurred on the date certified, the statement does not indicate whether the allegations contained therein are based upon personal remembrance of the circumstances surrounding the filing of the application because of some unusual circumstances, or whether the allegations are based upon some records, e.g., docket or log book, maintained by the law firm. If the statement is based upon law firm records, a copy of those records and explanation thereof in the form of a declaration is required. If the statement is based upon personal remembrance of the facts, a supplemental declaration is required which clearly indicates that fact and explains why facts regarding this particular application are remembered. Presumably many applications are handled in the

law firm such that specific dates and facts regarding a particular application would not be remembered unless there was something exceptional about the application or its processing.

The petition is denied.

If petitioner desires to prosecute this application, then appropriate steps must be taken pursuant to 37 CFR 1.137 to revive application Serial No. 07/206,497 to establish copendency between Serial No. 07/206,497 and the present application. Inquiries regarding petitions to revive should be directed to Petitions Information, Office of the Assistant Commissioner for Patents at (703) 557-4282.

The petition fee will not be refunded since it has not been shown to have been necessitated by Office error.

Any request for reconsideration of the above decision (no further petition fee is required) and any petition to revive directed to application Serial No. 07/206,497 should be filed within TWO MONTHS of the date of this decision to be considered timely filed and directed to the undersigned, Crystal Park Building 2, Room 919, Washington, D.C. 20231. Any petition to revive will be forwarded to the Office of the Deputy Assistant Commissioner for Patents for consideration.

Failure to timely file a petition will result in the return of this application to Application Branch for processing as an improperly filed application under 37 CFR 1.62-No Filing Date Granted.

C. E. Van Horn

Charles E. Van Horn
Patent Policy and Programs Administrator
Office of the A/C for Patents

msm/rkg



525.00-241

DAC

PATENT

IN THE UNITED STATES PATENT AND TRADEMARK OFFICE

In re application of: Arthur R. Hair
Serial No.: 07 / 206,487
Filed: June 13, 1988
For: TRANSMISSION SYSTEM

Group No.: 239
Examiner: H. Nguyen

#13
R137(b)

RECEIVED

APR 22 1991

kw

Commissioner of Patents and Trademarks
Washington, D.C. 20231

DEPUTY ASST. COMM. 137(b)

PETITION FOR REVIVAL OF AN APPLICATION FOR PATENT
ABANDONED UNINTENTIONALLY UNDER 37 CFR 1.137(b)

NOTE: A terminal disclaimer should not accompany a petition based on unintentional abandonment. Notice of July 9, 1985 (1056 O.G. 60-61).

NOTE: An application abandoned under 37 CFR 1.53(d) for failure to timely provide the appropriate filing fee, oath or declaration and/or surcharge may not be revived under the procedure of 37 CFR 1.137(b).

1. This application became abandoned on September 14, 1990

NOTE: Extensions under 37 CFR 1.136 are available only if asked for "prior to or with the response." Accordingly, if the question of abandonment arises when the provisions of § 1.136 can no longer be used then the application is abandoned when the unextended time for response expired. Therefore, no extension fees are due on a petition for revival.

2. This petition is filed:

within one year of the date of abandonment.

NOTE: Under very limited conditions a petition to revive for unintentional abandonment may exceed the one year limit when abandonment is due to action or inaction by the applicant and the PTO performs a positive documented official act which could lead a reasonable individual to conclude that the action or inaction was appropriate. Notice of August 26, 1985 (1059 O.G. 4).

within three months of the date of the first decision on a petition to revive under 37 CFR 1.137(a) which was filed within one year of the date of abandonment.

(check next box if applicable)

the three month period has been extended up to _____

NOTE: The non-statutory three month period may be extended up to four months if a petition for an extension of time and the fee set in 37 CFR 1.17(a) to (d) are filed with or prior to this petition.

CERTIFICATE OF MAILING (37 CFR 1.8a)

I hereby certify that this paper (along with any referred to as being attached or enclosed) is being deposited with the United States Postal Service on the date shown below with sufficient postage as first class mail in an envelope addressed to the: Commissioner of Patents and Trademarks, Washington, D.C. 20231.

Tracey L. Milka

(Type or print name of person mailing paper)

Date: 4/11/91

Tracey L. Milka
(Signature of person mailing paper)

(Petition for Revival of Unintentionally Abandoned Application [11-3]—page 1 of 3)

2a. This application is being revived only for purposes of creating continuity with a File Wrapper Continuation.

3. This application became abandoned unintentionally.

4. Proposed response

- has been filed.
 is attached.

(complete the following if applicable)

NOTE: The PTO accepts the filing of a continuing application as a response under 37 CFR 1.137. To facilitate processing in such a case the petition to revive should specifically refer to the filing of a continuing application and also include an express abandonment of the prior application conditioned upon the granting of the petition and the granting of a filing date to the continuing application. Notice of May 13, 1983, 1031 O.G. 11-12.

- the response is the filing of a continuation application having an express abandonment conditioned on the granting of a filing date to the continuing application copending with this application.

5. Fee (37 CFR 1.17(m))

Application status is:

- small business entity—fee ~~\$310.00~~ \$525.00
 verified statement attached
 verified statement filed
 other than small entity—fee \$620.00

6. Payment of fee:

- Enclosed please find check for \$ 525.00
 Charge Account 03-2411 for any additional fee required.
 Charge Account _____ the sum of \$ _____ A duplicate of this petition is attached.

7. Verification:

NOTE: The statement that the abandonment was unintentional must be a verified statement if made by a person not registered to practice before the PTO. 37 CFR 1.137. Check the next box if this is the case.

I hereby declare that all statements made herein of my own knowledge are true and that all statements made on information and belief are believed to be true; and further that these statements were made with the knowledge that willful false statements and the like so made are punishable by fine or imprisonment, or both, under Section 1001 of Title 18 of the United States Code, and that such willful false statements may jeopardize the validity of the application, any patent issuing thereon, or any patent to which this verified statement is directed.

Date: 4/11/91

Ansel Schwartz
(Signature of person making statement
that abandonment was unintentional)

Ansel M. Schwartz
(Type or print name of person making
statement)
5514 Claybourne Street
Pittsburgh, PA 15213
(Residence of person making statement)

Reg. No.: 30,587

Tel. No.: (412) 394-4900



SIGNATURE OF ATTORNEY

Ansel M. Schwartz, Esquire

Type or print name of attorney

Cohen & Grigsby

P.O. Address 2900 CNG Tower
625 Liberty Avenue
Pittsburgh, PA 15222



235
7-19-
020

410-1-1988
41

239#20

PATENT

IN THE UNITED STATES PATENT AND TRADEMARK OFFICE

In re application of: A. HAIR

Serial No.: 0715861391

Group No.: 239

Filed: 9/18/90

Examiner: H. NGUYEN

For: TRANSMISSION SYSTEM

Commissioner of Patents and Trademarks
Washington, D.C. 20231

CHANGE OF ATTORNEY'S ADDRESS IN APPLICATION

Please send all correspondence for this application as follows:

Ansel M. Schwartz
Attorney at Law
425 N. Craig Street
Suite 301
Pittsburgh, PA 15213

RECEIVED

JUN 05 1991

GROUP 230

RECEIVED
JUN - 6 1991
OFFICE OF THE ASSISTANT
COMMISSIONER FOR PATENTS

Please direct telephone calls to:

Ansel M. Schwartz, Esquire
(412) 621-9222

Ansel Schwartz

SIGNATURE OF ATTORNEY
Ansel M. Schwartz

Reg.: 30,587

Type or print name of attorney
Attorney at Law

Tel. No. (412) 621-9222

P.O. Address 425 N. Craig Street, Suite 301
Pittsburgh, PA 15213

CERTIFICATE OF MAILING (37 CFR 1.8a)

I hereby certify that this paper (along with any paper referred to as being attached or enclosed) is being deposited with the United States Postal Service on the date shown below with sufficient postage as first class mail in an envelope addressed to the: Commissioner of Patent and Trademarks, Washington, D.C. 20231.

Tracey L. Milka

(Type or print name of person mailing paper)

Date: _____

(Signature of person mailing paper)

(Change of Attorney's Address in Application [12-3])



UNITED STATES DEPARTMENT OF COMMERCE
Patent and Trademark Office
 ASSISTANT SECRETARY AND COMMISSIONER
 OF PATENTS AND TRADEMARKS
 Washington, D.C. 20231

SFH/FMH/sh.6

Paper No. 14

Alder, Cohen and Grigsby, P.C.
 2900 CNG Tower, 625 Liberty Avenue
 Pittsburgh, Pennsylvania 15222

COPY MAILED

JUN 20 1991

DEPUTY ASST. COMM.

In re Application of
 Arthur R. Hair
 Serial No. 206,497
 Filed: June 13, 1988

:
 :
 : ON PETITION
 :

This is a decision on the petition under 37 CFR 1.137(b), filed April 15, 1991, to revive an unintentionally abandoned application.

The petition is granted.

Since this application is being revived for purposes of continuity only and since continuity has been established by this decision reviving the application, the application is again abandoned in favor of filewrapper continuing application, Serial No. 586,391, filed September 18, 1990.

The application is being forwarded to Group 230.

Frances M. Hicks

Frances M. Hicks
 Office of the Assistant Commissioner
 for Patents



UNITED STATES DEPARTMENT OF COMMERCE
Patent and Trademark Office

Address: COMMISSIONER OF PATENTS AND TRADEMARKS
Washington, D.C. 20231

SERIAL NUMBER	FILING DATE	FIRST NAMED INVENTOR	ATTORNEY DOCKET NO.
077586-391	09/18/90	HAIR	A 2102.001-CON

EXAMINER
NGUYEN, H

ANSEL M. SCHWARTZ
425 N. CRAIG STREET
SUITE 301
PITTSBURGH, PA 15213

ART UNIT 239 PAPER NUMBER 21

DATE MAILED: 09/09/91

This is a communication in the prosecution of your application.

This application has been examined Responsive to communication filed on 9/18/90 This action is made final.

A shortened statutory period for response to this action is set to expire 3 month(s), _____ days from the date of this letter.
Failure to respond within the period for response will cause the application to become abandoned. 35 U.S.C. 133

Part I THE FOLLOWING ATTACHMENT(S) ARE PART OF THIS ACTION:

- Notice of References Cited by Examiner, PTO-892.
- Notice re Patent Drawing, PTO-948.
- Notice of Art Cited by Applicant, PTO-1449.
- Notice of Informal Patent Application, Form PTO-152
- Information on How to Effect Drawing Changes, PTO-1474.
- _____

Part II SUMMARY OF ACTION

1. Claims 11-13, 15 and 21 are pending in the application.

Of the above, claims _____ are withdrawn from consideration.

2. Claims 1-10, 14, 16-20 have been cancelled.

3. Claims _____ are allowed.

4. Claims 11-13, 15 and 21 are rejected.

5. Claims _____ are objected to.

6. Claims _____ are subject to restriction or election requirement.

7. This application has been filed with informal drawings under 37 C.F.R. 1.85 which are acceptable for examination purposes.

8. Formal drawings are required in response to this Office action.

9. The corrected or substitute drawings have been received on _____. Under 37 C.F.R. 1.84 these drawings are acceptable; not acceptable (see explanation or Notice re Patent Drawing, PTO-948).

10. The proposed additional or substitute sheet(s) of drawings, filed on _____, has (have) been approved by the examiner; disapproved by the examiner (see explanation).

11. The proposed drawing correction, filed _____, has been approved; disapproved (see explanation).

12. Acknowledgement is made of the claim for priority under U.S.C. 119. The certified copy has been received not been received been filed in parent application, serial no. _____; filed on _____.

13. Since this application appears to be in condition for allowance except for formal matters, prosecution as to the merits is closed in accordance with the practice under Ex parte Quayle, 1935 C.D. 11; 453 O.G. 213.

14. Other

Art Unit 239

1. The preliminary amendment filed on 9/18/90 has been entered.

2. The following is a quotation of 35 U.S.C. § 103 which forms the basis for all obviousness rejections set forth in this Office action:

A patent may not be obtained though the invention is not identically disclosed or described as set forth in section 102 of this title, if the differences between the subject matter sought to be patented and the prior art are such that the subject matter as a whole would have been obvious at the time the invention was made to a person having ordinary skill in the art to which said subject matter pertains. Patentability shall not be negated by the manner in which the invention was made.

Subject matter developed by another person, which qualifies as prior art only under subsection (f) or (g) of section 102 of this title, shall not preclude patentability under this section where the subject matter and the claimed invention were, at the time the invention was made, owned by the same person or subject to an obligation of assignment to the same person.

3. Claims 11-13, 15 and 21 are rejected under 35 U.S.C. § 103 as being unpatentable over Hughes'US/3990710.

Hughes shows a system for dubbing information from a first memory of a first party (20) to a second memory of a second party (35) who controls the use and in possession of the second memory. Hughes shows a slot (28) for receiving money transferred to the first party from the second party. Hughes further shows that the first and the second memory are connected electronically (18-24) such that information can pass therethrough. Hughes further

Serial No. 07/586391

-3-

Art Unit 239

shows that signal is transmitted from the first memory to the second memory with a transmitter in control and possession of the first party to a receiver having the second memory at a location determined by the second party wherein the receiver is in possession and control of the second party (col. 2 lines 27-65, col. 1 lines 55-68, col. 5 lines 7-21, col.6 lines 32-55). Hughes fails to specifically teach the claimed method and steps. However, the claimed method and steps are seen to obviously correspond to the apparatus and its features shows by Hughes.

4. Any inquiry concerning this communication or earlier communications from the examiner should be directed to Hoa Nguyen whose telephone number is (703) 308-1292.

Any inquiry of a general nature or relating to the status of this application should be directed to the Group receptionist whose telephone number is (703) 308-0754.

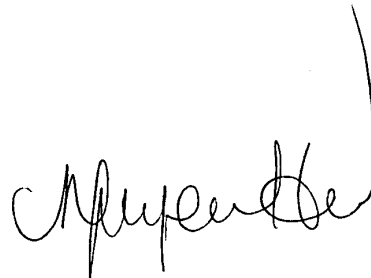

Hoa Nguyen
Examiner, A.U. 239
September 06, 1991



UNITED STATES DEPARTMENT OF COMMERCE
 Patent and Trademark Office
 Address: COMMISSIONER OF PATENTS AND TRADEMARKS
 Washington, D. C. 20231

SERIAL NUMBER	FILING DATE	FIRST NAMED APPLICANT	ATTORNEY DOCKET NO.
---------------	-------------	-----------------------	---------------------

07/586391

EXAMINER

ART UNIT	PAPER NUMBER
----------	--------------

23

DATE MAILED: 10-21-91

EXAMINER INTERVIEW SUMMARY RECORD

All participants (applicant, applicant's representative, PTO personnel):

- (1) Mr. Arthur Hair
- (2) HOA T. Nguyen (PTO)
- (3) _____
- (4) _____

Date of interview 10/24/91

Type: Telephonic Personal (copy is given to applicant applicant's representative).

Exhibit shown or demonstration conducted: Yes No. If yes, brief description: _____

Agreement was reached with respect to some or all of the claims in question. was not reached.

Claims discussed: _____

Identification of prior art discussed: Huges and lightner

Description of the general nature of what was agreed to if an agreement was reached, or any other comments: Mr. Hair explains to the Examiner how the invention works. The examiner explains to Mr. Hair how the references were applied against claim 11 in details. The examiner also explains in details the procedure of examination of a patent application to Mr. Hair.

(A fuller description, if necessary, and a copy of the amendments, if available, which the examiner agreed would render the claims allowable must be attached. Also, where no copy of the amendments which would render the claims allowable is available, a summary thereof must be attached.)

Unless the paragraphs below have been checked to indicate to the contrary, A FORMAL WRITTEN RESPONSE TO THE LAST OFFICE ACTION IS NOT WAIVED AND MUST INCLUDE THE SUBSTANCE OF THE INTERVIEW (e.g., items 1-7 on the reverse side of this form). If a response to the last Office action has already been filed, then applicant is given one month from this interview date to provide a statement of the substance of the interview.

It is not necessary for applicant to provide a separate record of the substance of the interview.

Since the examiner's interview summary above (including any attachments) reflects a complete response to each of the objections, rejections and requirements that may be present in the last Office action, and since the claims are now allowable, this completed form is considered to fulfill the response requirements of the last Office action.

[Handwritten Signature]
 Examiner's Signature



UNITED STATES DEPARTMENT OF COMMERCE
Patent and Trademark Office

Address: COMMISSIONER OF PATENTS AND TRADEMARKS
Washington, D.C. 20231

SERIAL NUMBER	FILING DATE	FIRST NAMED APPLICANT	ATTORNEY DOCKET NO.
---------------	-------------	-----------------------	---------------------

07/586 391

EXAMINER

ART UNIT	PAPER NUMBER
----------	--------------

22

DATE MAILED:

10-22-91

EXAMINER INTERVIEW SUMMARY RECORD

All participants (applicant, applicant's representative, PTO personnel):

- (1) MR. SCHWARTZ (3) _____
- (2) HOA T. NGUYEN (PTO) (4) _____

Date of interview 10-22-91

Type: Telephonic Personal (copy is given to applicant applicant's representative).

Exhibit shown or demonstration conducted: Yes No. If yes, brief description: _____

Agreement was reached with respect to some or all of the claims in question. was not reached.

Claims discussed: _____

Identification of prior art discussed: _____

Description of the general nature of what was agreed to if an agreement was reached, or any other comments: Mr. Schwartz called and scheduled an appointment for an interview between the inventor (Mr. Hair) and the examiner. The time and date of the personal interview will be at 11.00 A.M., on October 24, 1991, respectively. S/N 07/586391

(A fuller description, if necessary, and a copy of the amendments, if available, which the examiner agreed would render the claims allowable must be attached. Also, where no copy of the amendments which would render the claims allowable is available, a summary thereof must be attached.)

Unless the paragraphs below have been checked to indicate to the contrary, A FORMAL WRITTEN RESPONSE TO THE LAST OFFICE ACTION IS NOT WAIVED AND MUST INCLUDE THE SUBSTANCE OF THE INTERVIEW (e.g., items 1-7 on the reverse side of this form). If a response to the last Office action has already been filed, then applicant is given one month from this interview date to provide a statement of the substance of the interview.

It is not necessary for applicant to provide a separate record of the substance of the interview.

Since the examiner's interview summary above (including any attachments) reflects a complete response to each of the objections, rejections and requirements that may be present in the last Office action, and since the claims are now allowable, this completed form is considered to fulfill the response requirements of the last Office action.

[Signature]
Examiner's Signature



24 /
F
J.E.
12/18/91

IN THE UNITED STATES PATENT AND TRADEMARK OFFICE

In re Application of:)
ARTHUR R. HAIR)
Serial No. 07/586,391)
Filed: September 18, 1990)
Art Unit: 239)
Patent Examiner:)
H. Nguyen)

RECEIVED

DEC 16 1991

GROUP 230

TRANSMISSION SYSTEM

Pittsburgh, Pennsylvania 15213

December 9, 1991

CERTIFICATE OF MAILING

Hon. Commissioner of Patents and Trademarks

Washington, D.C. 20231

Sir:

I hereby certify that the correspondence is being deposited with the United States Postal Service as first class mail in an envelope addressed to: Commissioner of Patents and Trademarks, Washington, DC 20231, on 12/9/91

Ansel Schwartz

Ansel M. Schwartz
Registration No. 30,587

12/9/91

Date

AMENDMENT

In response to the Office Action dated September 9, 1991, please enter the following amendments to the above-identified application as follows:

IN THE SPECIFICATION:

Page 3, before the paragraph starting with "Referring" insert the following:

The invention is a method for transmitting a desired digital audio music signal stored on a first memory to a second

F



BC

PATENT

IN THE UNITED STATES PATENT AND TRADEMARK OFFICE

In re application of: Arthur R. Hair

Serial No.: 0 7/ 586,391

Group No.: 239

Filed: September 18, 1990

Examiner: H. Nguyen

For: TRANSMISSION SYSTEM

RECEIVED

DEC 16 1991

GROUP 230

Commissioner of Patents and Trademarks
Washington, D.C. 20231

AMENDMENT TRANSMITTAL

- 1. Transmitted herewith is an amendment for this application.

STATUS

- 2. Applicant is
 a small entity — verified statement
 attached.
 already filed.
 other than a small entity.

CERTIFICATE OF MAILING (37 CFR 1.8a)

I hereby certify that this paper (along with any referred to as being attached or enclosed) is being deposited with the United State Postal Service on the date shown below with sufficient postage as first class mail in an envelope addressed to the: Commissioner of Patents and Trademarks, Washington, D.C. 20231.

Tracey L. Milka

(Type or print name of person mailing paper)

Date: 12/9/91

Tracey L. Milka
(Signature of person mailing paper)

(Amendment Transmittal [9-19]—page 1 of 4)

EXTENSION OF TERM

NOTE: "Extension of Time in Patent Cases (Supplement Amendments) — If a timely and complete response has been filed after a Non-Final Office Action, an extension of time is not required to permit filing and/or entry of an additional amendment after expiration of the shortened statutory period.

If a timely response has been filed after a Final Office Action, an extension of time is required to permit filing and/or entry of a Notice of Appeal or filing and/or entry of an additional amendment after expiration of the shortened statutory period unless the timely-filed response placed the application in condition for allowance. Of course, if a Notice of Appeal has been filed within the shortened statutory period, the period has ceased to run." Notice of December 10, 1985 (1061 O.G. 34-35).

NOTE: See 37 CFR 1.645 for extensions of time in interference proceedings and 37 CFR 1.550(c) for extensions of time in reexamination proceedings.

3. The proceedings herein are for a patent application and the provisions of 37 CFR 1.136 apply

(complete (a) or (b) as applicable)

(a) Applicant petitions for an extension of time under 37 CFR 1.136 (fees: 37 CFR 1.17(a)-(d) for the total number of months checked below:

Extension (months)	Fee for other than small entity	Fee for small entity
<input type="checkbox"/> one month	\$100.00	\$50.00
<input type="checkbox"/> two months	\$300.00	\$150.00
<input type="checkbox"/> three months	\$730.00	\$365.00
<input type="checkbox"/> four months	\$1,150.00	\$575.00
		Fee \$ _____

If an additional extension of time is required please consider this a petition therefor.

(check and complete the next item, if applicable)

An extension for _____ months has already been secured and the fee paid therefor of \$ _____ is deducted from the total fee due for the total months of extension now requested.

Extension fee due with this request \$ _____

OR

(b) Applicant believes that no extension of term is required. However, this conditional petition is being made to provide for the possibility that applicant has inadvertently overlooked the need for a petition for extension of time.

FEE FOR CLAIMS

4. The fee for claims (37 CFR 1.16(b)-(d)) has been calculated as shown below:

	(Col. 1)	(Col. 2)	(Col. 3)	SMALL ENTITY	OTHER THAN A SMALL ENTITY			
	CLAIMS REMAINING AFTER AMENDMENT	HIGHEST NO PREVIOUSLY PAID FOR	PRESENT EXTRA	RATE	ADDIT. FEE	OR	RATE	ADDIT. FEE
TOTAL	•	MINUS	**	=	x10= \$		x20= \$	
INDEP.	•	MINUS	***	=	x30= \$		x60= \$	
<input type="checkbox"/> FIRST PRESENTATION OF MULTIPLE DEP. CLAIM					+100=			
					\$		+200= \$	
				TOTAL		OR		TOTAL
				ADDIT. FEE	\$			ADDIT. FEE \$

- * If the entry in Col. 1 is less than entry in Col. 2, write "0" in Col. 3.
 - ** If the "Highest No. Previously Paid for" IN THIS SPACE is less than 20, enter "20".
 - *** If the "Highest No. Previously Paid For" IN THIS SPACE is less than 3, enter "3".
- The "Highest No. Previously Paid For" (Total or indep.) is the highest number found in the appropriate box in Col. 1 of a prior amendment or the number of claims originally filed.

(complete (c) or (d) as applicable)

(c) No additional fee for claims is required.

OR

(d) Total additional fee for claims required \$_____

FEE PAYMENT

5. Attached is a check in the sum of \$_____

Charge Account No. _____ the sum of \$_____

A duplicate of this transmittal is attached.

FEE DEFICIENCY

NOTE: *If there is a fee deficiency and there is no authorization to charge an account, additional fees are necessary to cover the additional time consumed in making up the original deficiency. If the maximum, six-month period has expired before the deficiency is noted and corrected, the application is held abandoned. In those instances where authorization to charge is included, processing delays are encountered in returning the papers to the PTO Finance Branch in order to apply these charges prior to action on the cases. Authorization to charge the deposit account for any fee deficiency should be checked. See the Notice of April-7, 1986, 1065 O.G. 31-33.*

6. If any additional extension and/or fee is required, charge Account No. 19-0737

(Amendment Transmittal [9-19]—page 3 of 4)

AND/OR

If any additional fee for claims is required, charge Account No.
19-0737

Reg. No.: 30,587

Tel. No.: (412) 621-9222

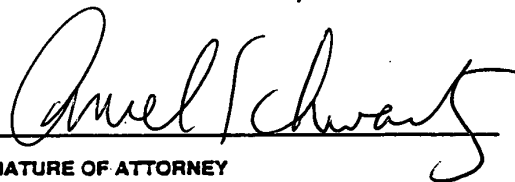

SIGNATURE OF ATTORNEY

Ansel M. Schwartz

Type or print name of attorney

Attorney at Law

P.O. Address

425 N. Craig Street
Suite 301

Pittsburgh, PA 15213

(Amendment Transmittal [9-19]—page 4 of 4)

memory. The method includes the first step of transferring money to a first party at a location remote from the second memory and controlling use of the first memory from a second party financially distinct from the first party, said second party controlling use and in possession of the second memory. Then there is the step of connecting electronically via a telecommunications line the first memory with the second memory such that the digital signal can pass therebetween. Next, there is the step of transmitting the digital signal from the first memory with a transmitter in control and possession of the first party to a receiver having the second memory at a location determined by the second party, said receiver in possession and control of the second party. Then, there is the step of storing the digital signal in the second memory. The invention is also a method for transmitting a desired digital, video or audio signal stored on a first memory to a second memory. The method comprises the first step of transferring a fee to a first party at a location remote from the second memory and controlling use of the first memory from a second party financially distinct from the first party, said second party in control and in possession of the second memory. Then, there is the step of connecting the first memory with the second memory via a telecommunication link such that the digital signal can pass therebetween. Next, there is the step of transmitting the digital signal from the first memory with a transmitter in control and possession of the first

F¹ party to a receiver having the second memory at a location determined by the second party, said receiver in possession and control of the second party. Then, there is the step of storing the digital signal in the second memory. ~

Page 5, before the paragraph starting with "In summary" insert the following:

F² ~ The invention is a method for transmitting a desired digital audio music signal stored on a first memory to a second memory. The method includes the first step of transferring money to a first party at a location remote from the second memory and controlling use of the first memory from a second party financially distinct from the first party, said second party controlling use and in possession of the second memory. Then there is the step of connecting electronically via a telecommunications line the first memory with the second memory such that the digital signal can pass therebetween. Next, there is the step of transmitting the digital signal from the first memory with a transmitter in control and possession of the first party to a receiver having the second memory at a location determined by the second party, said receiver in possession and control of the second party. Then, there is the step of storing the digital signal in the second memory. The invention is also a method for transmitting a desired digital, video or audio signal

F²

stored on a first memory to a second memory. The method comprises the first step of transferring a fee to a first party at a location remote from the second memory and controlling use of the first memory from a second party financially distinct from the first party, said second party in control and in possession of the second memory. Then, there is the step of connecting the first memory with the second memory via a telecommunication link such that the digital signal can pass therebetween. Next, there is the step of transmitting the digital signal from the first memory with a transmitter in control and possession of the first party to a receiver having the second memory at a location determined by the second party, said receiver in possession and control of the second party. Then, there is the step of storing the digital signal in the second memory. ~~AA~~

IN THE CLAIMS:

Please amend the following claims.

F³

11. (Thrice Amended). A method for transmitting a desired digital audio music signal stored on a first memory to a second memory comprising the steps of:

transferring money to a first party at a location remote from the second memory and controlling use of the first

memory from a second party financially distinct from the first party, said second party controlling use and in possession of the second memory;

F³ connecting electronically via a telecommunications link the first memory with the second memory such that the digital signal can pass therebetween;

transmitting the digital signal from the first memory with a transmitter in control and possession of the first party to a receiver having the second memory at a location determined by the second party, said receiver in possession and control of the second party; and

storing the digital signal in the second memory.

15. (Twice Amended) A method for transmitting a desired digital, video [or audio] signal stored on a first memory to a second memory comprising the steps of:

F⁴ [charging] transferring a fee [by] to a first party at a location remote from the second memory and controlling use of the first memory from [to] a second party financially distinct from the first party, said second party in control and in possession of the second memory;

connecting the first memory with the second memory via a telecommunication link such that the digital signal can pass therebetween;

F⁴ transmitting the digital signal from the first memory with a transmitter in control and possession of the first party to a receiver having the second memory at a location determined by the second party, said receiver in possession and control of the second party; and

storing the digital signal in the second memory.

Please add the following claim.

F⁵ 22. A method as described in Claim 21 wherein the transferring step includes the steps of telephoning the party controlling use of the first memory by the party controlling the second memory; providing a credit card number of the party controlling the second memory to the party controlling the first memory so the party controlling the second memory is charged money.

REMARKS

Claims 11-13, 15 and 22 are currently active.

Claims 11 and 15 have been amended.

Claim 22 has been added.

Applicant's invention is a method for transmitting a desired digital, video or audio signal stored on a first memory to a second memory. The method comprises the steps of transferring a fee to a first party at a location remote from the second memory and controlling use of the first memory from a second party financially distinct from the first party. The second party is in control and in possession of the second memory. The second party transfers the fee to a location remote from the second memory. Additionally, the method comprises the step of then connecting the first memory with the second memory via a telecommunications link such that the digital signal can pass therebetween. Next, there is the step of transmitting the digital signal from the first memory with a transmitter in control and in possession of the first party to a receiver having the second memory at a location determined by the second party. The receiver is in possession and in control of the second party.

There is also the step of then storing the digital signal in the second memory.

The Examiner has rejected Claims 11-13, 15 and 21 under 35 U.S.C. §103 as being anticipated by Hughes. Applicant respectfully traverses this rejection.

Referring to Hughes, there is disclosed a coin operated recording machine (200). The machine (200) has a transmitting station (202) where the audio/video records are stored. There are also remote recording stations (204) where the customer can record the station's audio/video signal onto a magnetic tape. The transmitting station (202) may be situated at any convenient central location, and the recording stations (204) may be located in private houses. The transmitting station (202) and recording stations (204) are linked by telephone lines or other signal transmission means.

In all the teachings of Hughes, the recording stations (204) are owned or "in possession" of the owner of the transmitter station (202). This is clearly supported by the fact that the user "records new programs at any time they wish . . . by inserting the appropriate coins into the apparatus" (column 9, lines 54-56). Accordingly, the recording machine (200) of Hughes requires its owner or representative thereof to travel to the

remote recording stations (204) to collect the coins: much in the same manner as an arcade game owner. This extra and tedious step necessitates the need for a strictly controlled collection system which must determine when the users are home so that the coins can be collected.

There is simply no teaching or suggestion within Hughes of "transferring money (or fee) to a first party at a location remote from the second memory and controlling use of the first memory from a second party financially distinct from the first party", as disclosed in applicant's newly amended Claims 11 and 15. Further, there is no teaching or suggestion within Hughes wherein "said receiver in possession and control of second party" as disclosed in applicant's newly amended Claims 11 and 15. Hughes' receiver, although located in the user's home is taught to be owned by the owner of the transmitter and is thus "in possession" of the owner. Further, the owner clearly "controls" the receiver since he must collect the coins therefrom.

"Transferring money (or fee) to a first party at a location remote from the second memory and controlling use of the first memory from a second party financially distinct from the first party" is critical to the operation of the applicant's invention. The step of transferring the money to a remote location eliminates the need for the collection step of the first

party or its representative from having to go to the second memory and collect the money deposited therein, which is required by Hughes. With the applicant's method, the money or fee is transferred to a remote location which is suitable for the first party in control of the transmitter, such as his bank or his place of business. Further, in this manner, the user can use other forms of monies, besides coins, such as credit cards, charge accounts or the like. The user is not burdened with the task of saving the appropriate coins, and waiting for the owner of the transmitter to come collect the coins. It should be noted that the first party is defined as a licensee, franchiser, distributor, or whoever stands in for the first party with respect to receiving the money and accessing the transmitter in way so authorization is forthcoming to transmit the digital signal to the second party receiver and his memory.

A second clear distinction between the applicant's method and Hughes' teachings is that the applicant's method in no manner necessitates the need for a receiver which is controlled by the controller of the transmitter. Any suitable recording apparatus controlled and in possession of the second party can be used to record the incoming digital signals. Accordingly, the second party's own stereo system can be coupled to the incoming signals for recording. In this manner, the second party is not limited to a predesigned receiver of the first party controlling

the transmitter, but instead can alter the recording components, change recording media, equalize the signal and many other parameters of the system.

Accordingly, since Hughes does not teach or suggest the step of "transferring money (or fee) to a first party at a location remote from the second memory and controlling use of the first memory from a second party financially distinct from the first party" or "said receiver in possession and control of second party", Claims 11 and 15 are patentable over Hughes. Claims 12, 13 and 21 are dependent to Claims 11 and 15 and have all of their limitations. Therefore, Claims 12, 13 and 21 are also patentable.

The Commissioner is hereby authorized to charge any fees or credit any overpayment to Deposit Account No. 19-0737. A duplicate copy of this Amendment is enclosed.

In view of the foregoing amendments and remarks, it is respectfully requested that the outstanding rejections and



objections to this application be reconsidered and withdrawn, and
Claims 11-13, 15 and 22, now in this application be allowed.

CERTIFICATE OF MAILING

I hereby certify that the correspondence is
being deposited with the United States Postal
Service as first class mail in an envelope
addressed to: Commissioner of Patents and
Trademarks, Washington, DC, 20231.

on 12/9/91
Ansel Schwartz

Ansel M. Schwartz
Registration No. 30,587

12/9/91
Date

Respectfully submitted,

ARTHUR R. HAIR

By Ansel Schwartz

Ansel M. Schwartz, Esquire
Reg. No. 30,587
425 N. Craig Street
Suite 301
Pittsburgh, PA 15213
(412) 621-9222

Attorney for Applicant



UNITED STATES DEPARTMENT OF COMMERCE
Patent and Trademark Office

Address: COMMISSIONER OF PATENTS AND TRADEMARKS
Washington, D.C. 20231

SERIAL NUMBER	FILING DATE	FIRST NAMED INVENTOR	ATTORNEY DOCKET NO.
07/588,391	08/18/90	HAIR	A 2102.081-CON

ANSEL M. SCHWARTZ
425 N. CRAIG STREET
SUITE 301
PITTSBURGH, PA 15219

EXAMINER	
NGUYEN, H	
ART UNIT	PAPER NUMBER
2309	25

DATE MAILED: 02/24/92

This is a communication from the examiner in charge of your application.
COMMISSIONER OF PATENTS AND TRADEMARKS

This application has been examined Responsive to communication filed on 12/11/91 This action is made final.

A shortened statutory period for response to this action is set to expire 3 month(s), _____ days from the date of this letter.
Failure to respond within the period for response will cause the application to become abandoned. 35 U.S.C. 133

Part I THE FOLLOWING ATTACHMENT(S) ARE PART OF THIS ACTION:

- Notice of References Cited by Examiner, PTO-892.
- Notice re Patent Drawing, PTO-948.
- Notice of Art Cited by Applicant, PTO-1449.
- Notice of Informal Patent Application, Form PTO-152.
- Information on How to Effect Drawing Changes, PTO-1474.
- _____

Part II SUMMARY OF ACTION

- Claims 11-13, 15, 21-22 are pending in the application.
Of the above, claims _____ are withdrawn from consideration.
- Claims _____ have been cancelled.
- Claims _____ are allowed.
- Claims 11-13, 15, 21-22 are rejected.
- Claims _____ are objected to.
- Claims _____ are subject to restriction or election requirement.
- This application has been filed with informal drawings under 37 C.F.R. 1.85 which are acceptable for examination purposes.
- Formal drawings are required in response to this Office action.
- The corrected or substitute drawings have been received on _____ Under 37 C.F.R. 1.84 these drawings are acceptable. not acceptable (see explanation or Notice re Patent Drawing, PTO-948).
- The proposed additional or substitute sheet(s) of drawings, filed on _____ has (have) been approved by the examiner. disapproved by the examiner (see explanation).
- The proposed drawing correction, filed on _____ has been approved. disapproved (see explanation).
- Acknowledgment is made of the claim for priority under U.S.C. 119. The certified copy has been received not been received been filed in parent application, serial no. _____; filed on _____
- Since this application appears to be in condition for allowance except for formal matters, prosecution as to the merits is closed in accordance with the practice under Ex parte Quayle, 1935 C.D. 11; 453 O.G. 213.
- Other

EXAMINER'S ACTION

0-89)

The amendment filed on 12/11/91 has been entered.

1. The following guidelines illustrate the preferred layout and content for patent applications. These guidelines are suggested for the applicant's use.

Arrangement of the Specification

The following order or arrangement is preferred in framing the specification and, except for the title of the invention, each of the lettered items should be preceded by the headings indicated below.

- (a) Title of the Invention.
- (b) Cross-References to Related Applications (if any).
- (c) Statement as to rights to inventions made under Federally-sponsored research and development (if any).
- (d) Background of the invention.
 1. Field of the Invention.
 2. Description of the Related Art including information disclosed under 37 C.F.R. §§ 1.97-1.99.
- (e) Summary of the Invention.
- (f) Brief Description of the Drawing.
- (g) Description of the Preferred Embodiment(s).
- (h) Claim(s).
- (i) Abstract of the Disclosure.

2.

Content of Specification

- (a) Title of the Invention. (See 37 C.F.R. § 1.72(a)). The title of the invention should be placed at the top of the first page of the specification. It should be brief but technically accurate and descriptive, preferably from two to seven words.
- (b) Cross-References to Related Applications: See 37 C.F.R. § 1.78 and section 201.11 of the M.P.E.P.
- (c) Statement as to rights to inventions made under Federally sponsored research and development (if any): See section 310 of the M.P.E.P.
- (d) Background of the Invention: The specification should set forth the Background of the Invention in two parts:
 - (1) Field of the Invention: A statement of the field of art to which the invention pertains. This statement may include a paraphrasing of the

- applicable U.S. patent classification definitions of the subject matter of the claimed invention. This item may also be titled "Technical Field".
- (2) Description of the Related Art: A description of the related art known to the applicant and including, if applicable, references to specific related art and problems involved in the prior art which are solved by the applicant's invention. This item may also be titled "Background Art".
- (e) Summary: A brief summary or general statement of the invention as set forth in 37 C.F.R. § 1.73. The summary is separate and distinct from the abstract and is directed toward the invention rather than the disclosure as a whole. The summary may point out the advantages of the invention or how it solves problems previously existent in the prior art (and preferably indicated in the Background of the Invention). In chemical cases it should point out in general terms the utility of the invention. If possible, the nature and gist of the invention or the inventive concept should be set forth. Objects of the invention should be treated briefly and only to the extent that they contribute to an understanding of the invention.
- (f) Brief Description of the Drawing(s): A reference to and brief description of the drawing(s) as set forth in 37 C.F.R. § 1.74.
- (g) Description of the Preferred Embodiment(s): A description of the preferred embodiment(s) of the invention as required in 37 C.F.R. § 1.71. The description should be as short and specific as is necessary to describe the invention adequately and accurately. This item may also be titled "Best Mode for Carrying Out the Invention". Where elements or groups of elements, compounds, and processes, which are conventional and generally widely known in the field of the invention described and their exact nature or type is not necessary for an understanding and use of the invention by a person skilled in the art, they should not be described in detail. However, where particularly complicated subject matter is involved or where the elements, compounds, or processes may not be commonly or widely known in the field, the specification should refer to another patent or readily available publication which adequately describes the subject matter.
- (h) Claim(s) (See 37 C.F.R. § 1.75): A claim may be typed with the various elements subdivided in paragraph form. There may be plural indentations to further segregate

subcombinations or related steps.

- (i) Abstract: A brief narrative of the disclosure as a whole in a single paragraph of 250 words or less.

3. Applicant is reminded of the proper content of an Abstract of the Disclosure.

A patent abstract is a concise statement of the technical disclosure of the patent and should include that which is new in the art to which the invention pertains.

If the patent is of a basic nature, the entire technical disclosure may be new in the art, and the abstract should be directed to the entire disclosure.

If the patent is in the nature of an improvement in an old apparatus, process, product, or composition, the abstract should include the technical disclosure of the improvement.

In certain patents, particularly those for compounds and compositions, wherein the process for making and/or the use thereof are not obvious, the abstract should set forth a process for making and/or use thereof.

If the new technical disclosure involves modifications or alternatives, the abstract should mention by way of example the preferred modification or alternative.

The abstract should not refer to purported merits or speculative applications of the invention and should not compare the invention with the prior art.

Where applicable, the abstract should include the following:

- (1) if a machine or apparatus, its organization and operation;
- (2) if an article, its method of making; (3) if a chemical compound, its identity and use; (4) if a mixture, its ingredients; (5) if a process, the steps. Extensive mechanical and design details of apparatus should not be given.

The abstract should be in narrative form and generally limited to a single paragraph on a separate sheet within the range of 50 to 250 words. It is important that the abstract not exceed 250 words in length since the space provided for the abstract on the computer tape used by the printer is limited. The form and legal phraseology often used in patent claims, such as "means" and "said", should be avoided. The abstract should describe the disclosure sufficiently to assist readers in deciding whether there is a need for consulting the full patent text for details.

The language should be clear and concise and should not repeat information given in the title. It should avoid using

Serial No. 07/586391

-5-

Art Unit 2309

phrases which can be implied, such as, "The disclosure concerns," "The disclosure defined by this invention," "The disclosure describes," *etc.*

4. The spacing of the lines of the specification is such as to make reading and entry of amendments difficult. New application papers with lines double spaced on good quality paper are required.

The following is a quotation of the first paragraph of 35 U.S.C. § 112:

The specification shall contain a written description of the invention, and of the manner and process of making and using it, in such full, clear, concise, and exact terms as to enable any person skilled in the art to which it pertains, or with which it is most nearly connected, to make and use the same and shall set forth the best mode contemplated by the inventor of carrying out his invention.

The specification is objected to under 35 U.S.C. § 112, first paragraph, as failing to provide support for the now claimed invention.

The step of "transferring money", the phrase "second party financially distinct from the first party" in the controlling step, the phrase "said receiver in possession...of the second party" recited in claims 11 and 15 and the step of telephoning and providing credit card recited in claim 22 do not have basis in the original specification.

Claims 11-13, 15, 21-22 are rejected under 35 U.S.C. § 112,

Serial No. 07/586391

-6-

Art Unit 2309

first paragraph, for the reasons set forth in the objection to the specification.

The following is a quotation of the first paragraph of 35 U.S.C. § 112:

The specification shall contain a written description of the invention, and of the manner and process of making and using it, in such full, clear, concise, and exact terms as to enable any person skilled in the art to which it pertains, or with which it is most nearly connected, to make and use the same and shall set forth the best mode contemplated by the inventor of carrying out his invention.

The specification is objected to under 35 U.S.C. § 112, first paragraph, as originally filed, failing to provide clear support for the amendments to pages 3 and 5.

Claims are rejected under 35 U.S.C. § 112, second paragraph, as being indefinite for failing to particularly point out and distinctly claim the subject matter which applicant regards as the invention:

In claims 11:

"at a location remote from the second memory" is unclear and confusing as to what is meant at a remote location. Further, the "telecommunication link" is not well connected in the system.

Claim 15 has similar problems.

The following is a quotation of 35 U.S.C. § 103 which forms the basis for all obviousness rejections set forth in this Office action:

A patent may not be obtained though the invention is not identically disclosed or described as set forth in section 102 of this title, if the differences between the subject matter sought to be patented and the prior art are such that

Serial No. 07/586391

-7-

Art Unit 2309

the subject matter as a whole would have been obvious at the time the invention was made to a person having ordinary skill in the art to which said subject matter pertains. Patentability shall not be negated by the manner in which the invention was made.

Subject matter developed by another person, which qualifies as prior art only under subsection (f) or (g) of section 102 of this title, shall not preclude patentability under this section where the subject matter and the claimed invention were, at the time the invention was made, owned by the same person or subject to an obligation of assignment to the same person.

Claims 11-13, 15 and 21 are rejected under 35 U.S.C. § 103 as being unpatentable over Hughes'US/3990710 .

This rejection is repeated. See explanation and citation set forth in the last office action.

Remarks:

Applicant appears to argue that in all teaching of Hughes, the recording stations 204 are owned or in "possession" of the owner of the transmitter station 202 while in applicant claims, it is own by the second party. This argument is not found to be persuasive because the claimed "possession" of the receiver does not have basis in the original specification therefore it can not be given with patentable weight. Applicant also appears to argues that the step of "transferring money (or fee) to a first party at a location remote from the second memory" is critical because with this step it eliminate the need for the collection step which is required in Hughes. This argument is not found to be persuasive because the location where the money is

Serial No. 07/586391

-8-

Art Unit 2309

transferred, i.e. 28, is seen to be remote from the second memory 35 in Hughes.

Any inquiry concerning this communication or earlier communications from the examiner should be directed to Hoa Nguyen whose telephone number is (703) 308-1292.

Any inquiry of a general nature or relating to the status of this application should be directed to the Group receptionist whose telephone number is (703) 308-0754.

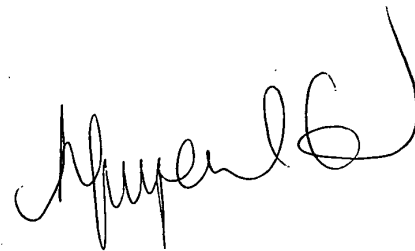
A handwritten signature in cursive script, appearing to read 'Hoa Nguyen', with a large flourish at the end.

Hoa Nguyen
Primary Examiner, A.U. 2309
February 11, 1992



IN THE UNITED STATES PATENT AND TRADEMARK OFFICE

28/C
MS
7/15/92

In re Application of:)
ARTHUR R. HAIR)
Serial No. 07/586,391)
Filed: September 18, 1990)
Art Unit: 2309)
Patent Examiner:)
H. Nguyen)

TRANSMISSION SYSTEM

RECEIVED

JUN 30 1992

Pittsburgh, Pennsylvania 15213

June 22, 1992

CERTIFICATE OF MAILING

GROUP 230

Hon. Commissioner of Patents and Trademarks

I hereby certify that the correspondence is being deposited with the United States Postal Service as first class mail in an envelope addressed to: Commissioner of Patents and Trademarks, Washington, DC 20231, on 6/23/92

Washington, D.C. 20231

Sir:

Ansel Schwartz

AMENDMENT

Ansel M. Schwartz
Registration No. 30,587

6/23/92

Date

In response to the Office Action dated February 24, 1992, please enter the following amendments to the above-identified application as follows:

IN THE ABSTRACT:

Please replace the abstract with the following.

-- The present invention is a method for transmitting a desired digital video or audio signal stored on a first memory of a first party to a second memory of a second party. The method

Q

comprises the steps of transferring money via a
telecommunications line to the first party from the second party.
Additionally, the method comprises the step of then connecting
electronically via a telecommunications line the first memory
with the second memory such that the desired digital signal can
pass therebetween. Next, there is the step of transmitting the
desired digital signal from the first memory with a transmitter
in control and in possession of the first party to a receiver
having the second memory at a location determined by the second
party. The receiver is in possession and in control of the
second party. There is also the step of then storing the digital
signal in the second memory. --

IN THE SPECIFICATION:

✓ Page 3 of the originally filed single spaced
application before the paragraph starting with "Referring",
delete the preceding paragraph which was added in the amendment
filed December 9, 1991.

✓ Page 5 of the originally filed single spaced
application before the paragraph starting with "In summary",
delete the preceding paragraph which was added in the amendment
filed December 9, 1991.

The remainder of the changes concern the included double spaced copy of the applicant's original application.

Page 1, delete lines 1-11 and insert the following.

-- A Method for Transmitting a Desired Digital Video or Audio Signal.

Field of the Invention

G2

The present invention is related to a method for the electronic sales and distribution of digital audio or video signals, and more particularly, to a method which a user may purchase and receive digital audio or video signal from any location which the user has access to a telecommunications line.

Background of the Invention

G3

Page 4, after line 12, insert -- Summary of the Invention

Page 6, after line 6, insert the following.

CH

-- The present invention is a method for transmitting a desired digital video or audio signal stored on a first memory of

C4
a first party to a second memory of a second party. The method comprises the steps of transferring money via a telecommunications line to the first party from the second party. Additionally, the method comprises the step of then connecting electronically via a telecommunications line the first memory with the second memory such that the desired digital signal can pass therebetween. Next, there is the step of transmitting the desired digital signal from the first memory with a transmitter in control and in possession of the first party to a receiver having the second memory at a location determined by the second party. The receiver is in possession and in control of the second party. There is also the step of then storing the digital signal in the second memory.

Page 6, line 12, delete "[D]".

Page 7, after line 4, insert -- Description of the

C5
Preferred Embodiment

Page 10, line 8, delete "[E] Detailed description".

Page 12, after line 3, insert the following.

— The present invention is a method for transmitting a
C6 desired digital video or audio signal stored on a first memory of

7

N

Ge

P

a first party to a second memory of a second party. The method comprises the steps of transferring money via a telecommunications line to the first party from the second party. Additionally, the method comprises the step of then connecting electronically via a telecommunications line the first memory with the second memory such that the desired digital signal can pass therebetween. Next, there is the step of transmitting the desired digital signal from the first memory with a transmitter in control and in possession of the first party to a receiver having the second memory at a location determined by the second party. The receiver is in possession and in control of the second party. There is also the step of then storing the digital signal in the second memory.

N

Page 12, delete line 17.

Page 13, after line 4, insert -- Claims -- .

K

IN THE CLAIMS:

Please amend the following claims.

CX

CM 11. (Amended) A method for transmitting a desired digital audio [music] signal stored on a first memory of a first

party to a second memory of a second party comprising the steps of:

P1 transferring money electronically via a telecommunication line to [a] the first party at a location remote from the second memory and controlling use of the first memory from [a] the second party financially distinct from the first party, said second party controlling use and in possession of the second memory;

GX P1 connecting electronically via a telecommunications [link] line the first memory with the second memory such that the desired digital audio signal can pass therebetween;

P1 transmitting the desired digital audio signal from the first memory with a transmitter in control and possession of the first party to a receiver having the second memory at a location determined by the second party, said receiver in possession and control of the second party; and

P1 storing the digital signal in the second memory.

ND
GS
WK
3. (Amended) A method as described in Claim 2 wherein the transferring step includes the steps of telephoning the first party controlling use of the first memory by the second

20

CS party [controlling the second memory]; providing a credit card number of the second party controlling the second memory to the first party controlling the first memory so the second party [controlling the second memory] is charged money.

15. ~~(Amended)~~ A method for transmitting a desired digital[,] video [or audio] signal stored on a first memory of a first party to a second memory of a second party comprising the steps of:

PI transferring [a fee] money electronically via a telecommunications line to [a] the first party at a location remote from the second memory and controlling use of the first memory, from a second party financially distinct from the first party, said second party in control and in possession of the second memory;

PI connecting electronically via a telecommunications line the first memory with the second memory [via a telecommunication link] such that the desired digital video signal can pass therebetween;

PI transmitting the desired digital video signal from the first memory with a transmitter in control and possession of the first party to a receiver having the second memory at a location

27-
23

G⁹

determined by the second party, said receiver in possession and control of the second party; and

P1

storing the digital signal in the second memory.

Claim 21, line 2, replace "charging" with

N -- transferring money -- .

~~622~~. (Amended) A method as described in Claim ~~21~~⁵

wherein the transferring step includes the steps of telephoning the first party controlling use of the first memory by the second party controlling the second memory; providing a credit card number of the second party controlling the second memory to the first party controlling the first memory so the second party controlling the second memory is charged money.

P
G10

[Please add the following claim.]

~~23~~. A method for transmitting a desired digital signal stored in a first memory of a first party to a second memory of a second party comprising the steps of:

K

selling electronically via telecommunication lines a digital signal possessed by the first party to the second party,

24

said first party and said second party in communication via said telecommunication lines;

connecting electronically via telecommunication lines the first memory with the second memory such that the desired digital signal can pass therebetween;

610 transferring electronically via telecommunication lines the digital signal from a first location with the first memory to a second location with the second memory, said second location remote from said first location, said first memory in communication with said second location via the telecommunication lines; and

storing the digital signal in the second memory.

REMARKS

Claims 11-13, 15, and 21-23 are currently active.

Claims 11, 13, 15, 21 and 22 have been amended. Antecedent support for the amendments to the claims is found in the figures and page 6, line 1.

Claim 23 has been added. Antecedent support for this claim is found in the figures and page 6, line 1.

The Examiner has suggested that the specification be amended in accordance with the disclosed proper format.

Accordingly, applicant has amended the specification in accordance with the disclosed proper format. The paragraphs added to pages 3 and 5 of the originally filed single spaced specification requested in applicant's amendment dated December 9, 1991 have been removed. Updated paragraphs in accordance with the newly amended claims have been added to pages 6 and 12 of the included double spaced copy of the original specification.

The specification is objected to under 35 U.S.C. §112, first paragraph, as failing to provide support for the claimed

invention. Claims 11-13, 15, 21-22 are also rejected for the same reasons.

The step of "transferring money", the phrase "second party financially distinct from the first party" and the phrase "said receiver in possession of the second party" recited in Claims 11 and 15 has been objected to by the Examiner, along with the steps of "telephoning" and "providing a credit card number" in Claim 22. Applicant respectfully disagrees with the Examiner. There is basis in the original specification for such language, which only defines "electronic sales" in terms that are well accepted to one skilled in the art.

In response to the Examiner's objection, applicant has respectfully submitted a Declaration Under 37 C.F.R. 1.132 essentially stating that the objectionable language is inherently provided by the originally filed disclosure. The term "electronically transferring of money" though not literally cited, is nonetheless equivalent in scope and function to the description of the invention as originally filed with respect to electronic sales.

The terms "electronically sell", "electronic sales" and "electronically sold" are used throughout the originally filed specification.

The originally filed (single spaced) "summary" section of the above-identified patent application states on page 2, line 8 that it "is an objective of the invention to provide a new and improved methodology/system to electronically sell and distribute" digital audio music. Further, page 2, last paragraph states that "electronic sales and distribution of music can take place via telephone lines onto a hard disc".

The originally filed "brief description of the drawings" section of applicant's originally filed specification states on page 3, last paragraph that the "hard disc 10 of the agent authorized to electronically sell and distribute the copyrighted digital audio music is the originating source as outlined in figure 1". Further, figure 1 clearly shows that the hard disc 10 communicates with the second parties system via telephone line 30.

Consequently, one skilled in the art, upon knowing that an object of the invention is "to electronically sell digital audio music" and that the hard disc 10, which communicates with the receiver through telephone lines 30, is authorized to electronically sell and distribute, would reasonably understand that a "transferring of money step" is naturally implied.

Electronic sales via telephone lines inherently assumes a transferring of money. Any "sale" by definition assumes a transference of money for a desired commodity, in this instance, digital audio or video signals.

In a similar argument, "electronic sales" over "telephone lines 30" are terms which encompass the well known process of "providing a credit card number" over a telephone line and "telephoning" to make the connection.

Thus, in summary, the present language of the claims to which the Examiner is objecting, has been added to more suitably describe the intended purpose of the applicant's invention. In no manner does it suggest or imply steps which are beyond the scope of the structure and methods described in the originally filed disclosure.

Applicant also brings to the Examiner's attention that for about 4 years, applicant has utilized the now questioned language in the claims and the Examiner has never questioned it. Only now, after 4 years does the Examiner raise a rejection based on the same. It was understood by applicant after the preliminary amendment filed on the parent application was responded to with an Office Action which did not raise an objection or rejection under 35 U.S.C. §112 concerning the

language, that the Examiner agreed with applicant the now questioned language just more specifically defines electronic sales. Applicant does not understand how after 4 years of Office Actions that this new issue suddenly is raised and that the Examiner has suddenly changed her position.

Accordingly, Claims 11-13, 15, 21 and 22 are patentable with respect to 35 U.S.C. §112.

The Examiner has requested a double spaced copy of the specification. Applicant has included a double spaced copy of the specification with this amendment. It should be noted that applicant had included a double spaced copy of the original specification with the amendment under Rule 116 dated August 21, 1990 in the parent case.

The specification is also objected to under 35 U.S.C. §112, first paragraph. The Examiner states that, as originally filed, it fails to provide clear support for the amendments to pages 3 and 5.

The amendments to pages 3 and 5 of the single spaced copy of the original application have been removed and similar but updated paragraphs have been added to the included double spaced copy of the original application. The paragraphs added to



PATENT

55-215-239
#26

IN THE UNITED STATES PATENT AND TRADEMARK OFFICE

In re application of: Arthur R. Hair
Serial No.: 0 7/ 586,391 Group No.: 2309
Filed: September 18, 1990 Examiner: H. Nguyen
For: TRANSMISSION SYSTEM

RECEIVED

Commissioner of Patents and Trademarks
Washington, D.C. 20231

JUN 30 1992

GROUP 230

AMENDMENT TRANSMITTAL

- 1. Transmitted herewith is an amendment for this application.

STATUS

- 2. Applicant is
 a small entity — verified statement:
 attached.
 already filed.
 other than a small entity.

CERTIFICATE OF MAILING (37 CFR 1.8a)

I hereby certify that this paper (along with any referred to as being attached or enclosed) is being deposited with the United State Postal Service on the date shown below with sufficient postage as first class mail in an envelope addressed to the: Commissioner of Patents and Trademarks, Washington, D.C. 20231.

Tracey L. Milka

(Type or print name of person mailing paper)

Date: 6/23/92

Tracey L. Milka

(Signature of person mailing paper)

(Amendment Transmittal [9-19]—page 1 of 4)

100 SC 06/29/92 07586391

1 215 55.00 CK

EXTENSION OF TERM

NOTE: "Extension of Time in Patent Cases (Supplement Amendments) — If a timely and complete response has been filed after a Non-Final Office Action, an extension of time is not required to permit filing and/or entry of an additional amendment after expiration of the shortened statutory period.

If a timely response has been filed after a Final Office Action, an extension of time is required to permit filing and/or entry of a Notice of Appeal or filing and/or entry of an additional amendment after expiration of the shortened statutory period unless the timely-filed response placed the application in condition for allowance. Of course, if a Notice of Appeal has been filed within the shortened statutory period, the period has ceased to run." Notice of December 10, 1985 (1061 O.G. 34-35).

NOTE: See 37 CFR 1.645 for extensions of time in interference proceedings and 37 CFR 1.550(c) for extensions of time in reexamination proceedings.

3. The proceedings herein are for a patent application and the provisions of 37 CFR 1.136 apply

(complete (a) or (b) as applicable)

(a) Applicant petitions for an extension of time under 37 CFR 1.136 (fees: 37 CFR 1.17(a)-(d) for the total number of months checked below:

Extension (months)	Fee for other than small entity	Fee for small entity
<input checked="" type="checkbox"/> one month	\$ 110.00	\$ 55.00
<input type="checkbox"/> two months	\$ 350.00	\$175.00
<input type="checkbox"/> three months	\$ 810.00	\$405.00
<input type="checkbox"/> four months	\$1,280.00	\$640.00
	Fee \$ <u>55.00</u>	

If an additional extension of time is required please consider this a petition therefor.

(check and complete the next item, if applicable)

An extension for _____ months has already been secured and the fee paid therefor of \$_____ is deducted from the total fee due for the total months of extension now requested.

Extension fee due with this request \$ _____

OR

(b) Applicant believes that no extension of term is required. However, this conditional petition is being made to provide for the possibility that applicant has inadvertently overlooked the need for a petition for extension of time.

FEE FOR CLAIMS

4. The fee for claims (37 CFR 1.16(b)-(d)) has been calculated as shown below:

	(Col. 1)	(Col. 2)	(Col. 3)	SMALL ENTITY	OTHER THAN A SMALL ENTITY
	CLAIMS REMAINING AFTER AMENDMENT	HIGHEST NO PREVIOUSLY PAID FOR	PRESENT EXTRA	RATE	ADDIT. FEE
TOTAL	* MINUS **	=	x10=	\$	x20= \$
INDEP.	* MINUS ***	=	x36=	\$	x72= \$
<input type="checkbox"/>	FIRST PRESENTATION OF MULTIPLE DEP. CLAIM			+110=	\$ +220= \$
			TOTAL ADDIT. FEE	\$	OR TOTAL ADDIT. FEE \$

- * If the entry in Col. 1 is less than entry in Col. 2, write "0" in Col. 3.
 - ** If the "Highest No. Previously Paid for" IN THIS SPACE is less than 20, enter "20".
 - *** If the "Highest No. Previously Paid For" IN THIS SPACE is less than 3, enter "3".
- The "Highest No. Previously Paid For" (Total or indep.) is the highest number found in the appropriate box in Col. 1 of a prior amendment or the number of claims originally filed.

(complete (c) or (d) as applicable)

(c) No additional fee for claims is required.

OR

(d) Total additional fee for claims required \$ _____

FEE PAYMENT

5. Attached is a check in the sum of \$ 55.00

Charge Account No. _____ the sum of \$ _____

A duplicate of this transmittal is attached.

FEE DEFICIENCY

NOTE: *If there is a fee deficiency and there is no authorization to charge an account, additional fees are necessary to cover the additional time consumed in making up the original deficiency. If the maximum, six-month period has expired before the deficiency is noted and corrected, the application is held abandoned. In those instances where authorization to charge is included, processing delays are encountered in returning the papers to the PTO Finance Branch in order to apply these charges prior to action on the cases. Authorization to charge the deposit account for any fee deficiency should be checked. See the Notice of April 7, 1986, 1065 O.G. 31-33.*

6. If any additional extension and/or fee is required, charge Account No. 19-0737

AND/OR

If any additional fee for claims is required, charge Account No. 19-0737

Reg. No.: 30,587

Tel. No.: (412) 621-9222

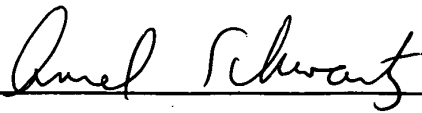

SIGNATURE OF ATTORNEY

Ansel M. Schwartz

Type or print name of attorney

Attorney at Law

P.O. Address

425 N. Craig Street, Suite 301

Pittsburgh, PA 15213

(Amendment Transmittal [9-19]—page 4 of 4)

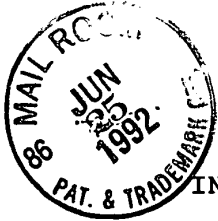

#27

IN THE UNITED STATES PATENT AND TRADEMARK OFFICE

In re Application of:)	
ARTHUR R. HAIR)	
Serial No. 07/586,391)	
Filed: September 18, 1990)	TRANSMISSION SYSTEM
Art Unit: 2309)	
Patent Examiner:)	
H. Nguyen)	

Pittsburgh, Pennsylvania 15213

May 5, 1992

Hon. Commissioner of Patents and Trademarks

Washington, D.C. 20231

DECLARATION UNDER 37 C.F.R. §1.132

I, Arthur R. Hair, hereby declare that:

I currently reside at 330 Murrays Lane, Pittsburgh, Pennsylvania 15234.

I am the sole inventor of the above-identified patent application.

I have reviewed the contents of the specification, and the claims of the above-identified patent application.

The originally filed "Summary" section of the above-identified patent application states on page 2, line 8, that "it is an objective of the invention to provide a new and improved methodology/system to electronically sell and distribute digital audio music".

The terms "electronically sell", "electronic sales" and "electronically sold" are used throughout the originally filed specification of the above-identified patent application.

One skilled in the art would know that an electronic sale inherently assumes a transferring of money by providing a credit or debit card number (since that is the only way for electronic sales to occur) coupled with a transferring of a service or product.

The use of transferring money across telecommunication connections, such as by telephoning the agent who has the hard disc over the phone lines, for obtaining data on the hard disc is well known to one skilled in the art to be part of electronic sales.

The originally filed "brief description of the drawings" section of the above-identified patent application states on page 3, last paragraph that the "Hard Disc 10 of the

agent authorized to electronically sell and distribute the copyrighted Digital Audio Music is the originating source of music in the configuration as outlined in figure 1".

One skilled in the art would know that, as found in Claim 1, the "first party" includes the agent who is authorized to electronically sell and distribute music; and the "second party" is to whom the music is distributed. One skilled in the art would also know since the music is distributed through electronic sale, "the second party must be financially distinct from the first party" or there could be no sale. Furthermore, the "second party" must have a "receiver" (the control IC of the user in figure 1) in his "possession" in order to receive the music electronically from the hard disc of the agent over the telephone lines.

One skilled in the art knowing that an object of the invention relates to "electronic sales" and that the agent, "a first party", who has control of the hard disc 10 is authorized "to electronically sell and distribute", and that the hard disc 10 communicates with the user's ("second party's") control unit 50, the "receiver" in the "possession of the second party", through "telephone lines 30" (electrical lines) would also know that the "electronic sales" as disclosed refers to the well known

practice of "transferring" and verifying monies across telephone lines such as by a "credit card".

I further declare that all statements made herein of my own knowledge are true and that all statements made on information and belief are believed to be true; and further, that these statements are made with the knowledge that willful false statements in the like so made are punishable by fine or imprisonment, or both, under Section 1001 of Title 18 of the United States Code, and that such willful false statements may jeopardize the validity of the application or any patent issuing thereon.

May 12, 1992
Date

Arthur R. Hair
Arthur R. Hair



586,391 #28

~~[A] Title of the Invention~~

Sub
B2

A methodology/system for the electronic sales, distribution, storage, manipulation, retrieval, playback, and copyright protection of Digital Audio Music.

5
P

[B] Cross-References to related applications

-None-

N

[C] Brief summary of the Invention

10
R

This invention relates in general to a new and improved methodology/system for the electronic sales, distribution, storage, manipulation, retrieval, playback, and copyright ~~protection of Digital Audio Music.~~

P

The three basic mediums (hardware units) of music: records, tapes, and compact discs, greatly restricts the transferability of music and results in a variety of inefficiencies.

15

CAPACITY: The individual hardware units as cited above are limited as to the amount of music that can be stored on each.

5

MATERIALS: The materials used to manufacture the hardware units are subject to damage and deterioration during normal operations, handling, and exposure to the elements.

5 SIZE: The physical size of the hardware units imposes constraints on the quantity of hardware units which can be housed for playback in confined areas such as in automobiles, boats, planes, etc.

10 RETRIEVAL: Hardware units limit the ability to play, in a sequence selected by the user, songs from different albums. For example, if the user wants to play one song from ten different albums, the user would spend an inordinant amount of time handling, sorting, and cueing the ten different hardware units. ✓

15 SALES AND DISTRIBUTION: Prior to final purchase, hardware units need to be physically transferred from the manufacturing facility to the wholesale warehouse to the retail warehouse to the retail outlet, resulting in lengthly lag time between music creation and music marketing, as well as incurring unnessary and inefficient transfer and handling costs. Additionally, tooling costs required for mass production of the hardware units and the material cost of the hardware units themselves, further drives up
20 the cost of music to the end user. ✓

QUALITY: Until the recent invention of Digital Audio Music, as used on Compact Discs, distortion free transfer from the hardware units to the stereo system was virtually impossible. Digital Audio Music is simply music converted into a very basic computer language known as binary. A series of commands known as
5 zeros or ones encode the music for future playback. Use of laser retrieval of the binary commands results in distortion free transfer of the music from the compact disc to the stereo system. Quality Digital Audio Music is defined as the binary structure of the Digital Audio Music. Conventional analog tape recording of
10 Digital Audio Music is not to be considered quality inasmuch as the binary structure itself is not recorded. While Digital Audio Music on compact discs is a technological breakthrough in audio quality, the method by which the music is sold, distributed, stored, manipulated, retrieved, played and protected from
15 copyright infringements remains as inefficient as with records and tapes.

COPYRIGHT PROTECTION: Since the invention of tape recording devices, strict control and enforcement of copyright laws have
20 proved difficult and impossible with home recorders. Additionally, the recent invention of Digital Audio Tape Recorders now jeopardizes the electronic copyright protection of quality Digital Audio Music on Compact Discs or Digital Audio Tapes. If music exists on hardware units, it can be copied.

Accordingly, it is an objective of this invention is to provide a new and improved methodology/system to electronically sell and distribute Digital Audio Music.

A further objective of this invention to provide a new and improved methodology/system to electronically store and retrieve Digital Audio Music.

Another objective of this invention is to provide a new and improved methodology/system to electronically manipulate, i.e., sort, cue, and select, Digital Audio Music for playback.

Still another objective of this invention is to offer a new and improved methodology/system which can prevent unauthorized electronic copying of quality Digital Audio Music.

Briefly, this invention accomplishes the above cited objectives by providing a new and improved methodology/system of electronic sales, distribution, storage, manipulation, retrieval, playback, and copyright protection of Digital Audio Music. The high speed transfer of Digital Audio Music as prescribed by this invention is stored onto one piece of hardware, a hard disk, thus eliminating the need to unnecessarily handle records, tapes, or compact discs on a regular basis. This invention recalls stored music for playback as selected/programmed by the user. This

invention can easily and electronically sort stored music based on many different criteria such as, but not limited to, music category, artist, album, user's favorite songs, etc. An additional feature of this invention is the random playback of songs, also based on the user's selection. For example, the user could have this invention randomly play all jazz songs stored on the user's hard disk, or randomly play all songs by a certain artist, or randomly play all of the user's favorite songs which the user previously electronically "tagged" as favorites. Further, being more specific, the user can electronically select a series of individual songs from different albums for sequential playback.

This invention can be configured to either accept direct input of Digital Audio Music from the digital output of a Compact Disc, such transfer would be performed by the private user, or this invention can be configured to accept Digital Audio Music from a source authorized by the copyright holder to sell and distribute the copyrighted materials, thus guaranteeing the protection of such copyrighted materials. Either method of electronically transferring Digital Audio Music by means of this invention is intended to comply with all copyright laws and restrictions and any such transfer is subject to the appropriate authorization by the copyright holder. Inasmuch as Digital Audio Music is software and this invention electronically transfers and

9

stores such music, electronic sales and distribution of the music
can take place via telephone lines onto a hard disk. This new
methodology/system of music sales and distribution will greatly
reduce the cost of goods sold and will reduce the lag time
5 between music creation and music marketing from weeks down to
hours.

das H4 → Further objectives and advantages of this invention will
become apparent as the following description proceeds and the
particular features of novelty which characterize this invention
10 will be pointed out in the claims annexed to and forming a part
of this declaration.

Drawn [D] Brief Description of the Several Views of Drawings

P For a better understanding of this invention, reference
should be made to the following detailed description, taken in
15 conjunction with the accompanying drawings, in which:

Fig. 1 is a pictorial flow chart which may be used in
carrying out the teachings of this invention for the purposes of
electronic sales, distribution, storage, manipulation, retrieval,
playback, and copyright protection of Digital Audio Music; and ✓

Fig. 2 is a pictorial flow chart which may be used in carrying out the teachings of this invention for the purposes of electronic storage, manipulation, retrieval, and playback of Digital Audio Music.

Imag 5

Referring now to the Fig. 1, this invention is comprised of the following:

- | | | |
|-----------------|-----|--------------------------------------|
| <p>PO
L</p> | 10 | Hard Disk of the copyright holder |
| <p>PI I</p> | 20 | Control Unit of the copyright holder |
| <p>10</p> | 20a | Control Panel |
| <p>PO</p> | 20b | Control Integrated Circuit |
| <p>PI I</p> | 20c | Sales Random Access Memory Chip |
| <p>15</p> | 30 | Telephone Lines/Input Transfer |
| <p>PO</p> | 50 | Control Unit of the user |
| <p>PI I</p> | 50a | Control Panel |
| <p>20</p> | 50b | Control Integrated Circuit |
| <p>PO</p> | 50c | Incoming Random Access Memory Chip |
| <p>PO</p> | 50d | Play Back Random Access Memory Chip |
| <p>20</p> | 60 | Hard Disk of the user |
| <p>PO</p> | 70 | Video Display Unit |
| <p>PO</p> | 80 | Stereo Speakers |

The Hard Disk 10 of the agent authorized to electronically sell and distribute the copyrighted Digital Audio Music is the

-7-

originating source of music in the configuration as outlined in Fig. 1. The Control Unit 20 of the authorized agent is the means by which the electronic transfer of the Digital Audio Music from the agent's Hard Disk 10 via the Telephone Lines 30 to the user's Control Unit 50 is possible. The user's Control Unit would be comprised of a Control Panel 50a, a Control Integrated Circuit 50b, an Incoming Random Access Memory Chip 50c, and a Play Back Random Access Memory Chip 50d. Similarly, the authorized agent's Control Unit 20 would have a control panel and control integrated circuit similar to that of the user's Control Unit 50. The authorized agent's Control Unit 20, however, would only require the Sales Random Access Memory Chip 20c. The other components in Fig. 1 include a Hard Disk 60, a Video Display Unit 70, and a set of Stereo Speakers 80.

15 Referring now to Fig. 2, with the exception of a substitution of a Compact Disc Player 40 (as the initial source of Digital Audio Music) for the agent's Hard Disk 10, the agent's Control Unit 20, and the Telephone Lines 30 in Fig. 1, Fig. 2 is the same as Fig. 1.

20 In Fig. 1 and Fig. 2, the following components are already commercially available: the agent's Hard Disk 10, the Telephone Lines 30, the Compact Disc Player 40, the user's Hard Disk 60, the Video Display Unit 70, and the Stereo Speakers 80. The

12

Control Units 20 and 50, however, would be designed specifically to meet the teachings of this invention. The design of the control units would incorporate the following functional features:

- B 5 | 1) the Control Panels 20a and 50a would be designed to permit the agent and user to program the respective Control Integrated Circuits 20b and 50b,
- B | 2) the Control Integrated Circuits 20b and 50b would be designed to control and execute the respective commands of the agent and user and regulate the electronic transfer of Digital Audio Music throughout the system, additionally, the sales Control Integrated Circuit 20b could electronically code the Digital Audio Music in a configuration which would prevent unauthorized reproductions of the copyrighted material,
- A 15 | 3) the Sales Random Access Memory Chip 20c would be designed to temporarily store user purchased Digital Audio Music for subsequent electronic transfer via telephone lines to the user's Control Unit 50,
- B 1 | 4) the Incoming Random Access Memory Chip 50c would be designed to temporarily store Digital Audio Music for subsequent electronic storage to the user's Hard Disk 60,

5) the Play Back Random Access Memory Chip 50d would be designed to temporarily store Digital Audio Music for sequential playback.

The foregoing description of the Control Units 20 and 50 is intended as an example only and thereby is not restrictive with respect to the exact number of components and/or its actual design.

~~[E] Detailed description~~

Once the Digital Audio Music has been electronically stored onto the user's Hard Disk 60, having the potential to store literally thousands of songs, the user is free to perform the many functions of this invention. To play a stored song, the user types in the appropriate commands on the Control Panel 50a, and those commands are relayed to the Control Integrated Circuit 50b which retrieves the selected song from the Hard Disk 60. When a song is retrieved from the Hard Disk 60 only a replica of the permanently stored song is retrieved. The permanently stored song remains intact on the Hard Disk 60, thus allowing repeated playback. The Control Integrated Circuit 50b stores the replica onto the Play Back Random Access Memory Chip 50d at a high transfer rate. The Control Integrated Circuit 50b then sends the electronic output to the Stereo Speakers 80 at a controlled rate

using the Play Back Random Access Memory Chip 50d as a temporary staging point for the Digital Audio Music.

3 Unique to this invention is that the Control Unit 50 also
3 serves as the user's personal disk jockey. The user may request
5 specific songs to be electronically cued for playback, or may
request the Control Unit 50 to randomly select songs based on the
3 user's criteria. All of these commands are electronically stored
in random access memory enabling the control unit to remember
prior commands while simultaneously performing other tasks
10 requested by the user and, at the same time, continuing to play
songs previously cued.

3 Offering a convenient visual display of the user's library
of songs is but one more new and improved aspect of this
3 invention. As the Control Unit 50 is executing the user's
15 commands to electronically sort, select, randomly play, etc., the
Video Display Screen 70 is continually providing feedback to the
user. The Video Display Screen 70 can list/scroll all songs
stored on the Hard Disk 60, list/scroll all cued songs, display
the current command function selected by the user, etc. Further
20 expanding upon the improvements this invention has to offer, the
Video Display Screen 70 can display the lyrics of the song being
played, as well as the name of the song, album, artist, recording
company, date of recording, duration of song, etc. This is

15

possible if the lyrics and other incidental information are electronically stored to the Hard Disk 60 with the Digital Audio Music.

Copy 16

In summary, there has been disclosed a new and improved methodology/system by which Digital Audio Music can be electronically sold, distributed, transferred, and stored. Further, there has been disclosed a new and improved methodology/system by which Digital Audio Music can be electronically manipulated, i.e., sorted, cued, and selected for playback. Further still, there has been disclosed a new and improved methodology/system by which the electronic manipulation of Digital Audio Music can be visually displayed for the convenience of the user. Additionally, there has been disclosed a new and improved methodology/system by which electronic copyright protection of quality Digital Audio Music is possible through use of this invention.

A ~~[F] Claims~~

Since numerous changes may be made in the above described process and apparatus and different embodiments of the invention may be made without departing from the spirit thereof, it is intended that all matter contained in the foregoing description or shown in the accompanying drawings shall be interpreted as

illustrative, and not in a limiting sense. Further, it is intended that this invention is not to be limited to Digital Audio Music and can include Digital Video, Digital Commercials, and other applications of digital information.

B

7 Claims

pages 6 and 12 are based on the language of the claims. These added paragraphs are allowable for the previously argued reasons why the claim language is allowable. That is, essentially, no new matter has been added. Rather, the claim language clarifies the intended function of the applicant's invention, as explained in the originally filed specification.

Claims 11 and 15 are rejected under 35 U.S.C. §112, second paragraph, for failing to particularly point out and distinctly claim the subject matter which the applicant regards as the invention. The objectionable phrase "at a location remote from the second memory" is acceptable since by definition, the memories are at different locations and by being connected by telecommunication lines have to be remote. The Examiner has also stated that the "telecommunication link" is not well connected in the system. Accordingly, "link" has been amended to the more familiar term "line" and "via a telephone line" has been added to the connecting step in Claims 11 and 15.

Applicant's invention is a method for transmitting a desired digital, video or audio signal stored on a first memory of a first party to a second memory of a second party. The method comprises the steps of transferring money electronically via a telecommunications line to the first party from the second party. Additionally, the method comprises the step of then

connecting electronically via a telecommunications line the first memory with the second memory such that the desired digital signal can pass therebetween. Next, there is the step of transmitting the desired digital signal from the first memory with a transmitter in control and in possession of the first party to a receiver having the second memory at a location determined by the second party. The receiver is in possession and in control of the second party. There is also the step of then storing the digital signal in the second memory.

The Examiner has rejected Claims 11-13, 15 and 21 under 35 U.S.C. §103 as being anticipated by Hughes. Applicant respectfully traverses this rejection.

Referring to Hughes, there is disclosed a coin operated recording machine (200). The machine (200) has a transmitting station (202) where the audio/video records are stored. There are also remote recording stations (204) where the customer can record the station's audio/video signal onto a magnetic tape. The transmitting station (202) may be situated at any convenient central location, and the recording stations (204) may be located in private houses. The transmitting station (202) and recording stations (204) are linked by telephone lines or other signal transmission means.

In all the teachings of Hughes, the user inserts coins into the remote recording stations (204) in order to activate transferral of the desired digital signal over the telephone lines. This is clearly supported by the fact that the user "records new programs at any time they wish . . . by inserting the appropriate coins into the apparatus" (column 9, lines 54-56). Accordingly, the recording machine (200) of Hughes requires its owner or representative thereof to travel to the remote recording stations (204) to collect the coins: much in the same manner as an arcade game owner travels to collect coins in his or her machines.

There is simply no teaching or suggestion within Hughes of "transferring money electronically via a telecommunications line to the first party from the second party", as disclosed in applicant's newly amended Claims 11 and 15.

"Transferring money electronically via a telecommunications line to the first party from the second party" is critical to the operation of the applicant's invention. The step of transferring the money over telecommunication lines eliminates the need for the collection step of the first party or its representative from having to go to the second memory and collect the money deposited therein, which is required by Hughes. With the applicant's method, the money or fee is transferred to

the first party over telecommunications lines. In this manner, the user can use other forms of monies, besides coins, such as credit cards, charge accounts, debit cards or the like. The user is not burdened with the task of saving the appropriate coins and the owner is not burdened by having to come and collect the coins.

Most importantly, the user is free to choose the location where he desires to have the digital signal transferred to him, essentially only requiring a telephone access be present which in this day and age is essentially everywhere.

A second clear distinction between the applicant's method and Hughes' teachings is that the applicant's method in no manner necessitates the need for a receiver which is controlled by the controller of the transmitter. Any suitable memory device controlled and in possession of the second party can be used to record the incoming digital signals. Accordingly, the second party's own stereo system can be coupled to the incoming signals for recording. In this manner, the second party is not limited to a predesigned receiver of the first party controlling the transmitter, but instead can alter the recording components, change recording media, equalize the signal and many other parameters of the system.

Accordingly, since Hughes does not teach or suggest the step of "transferring money via a telecommunications line to the first party from the second party", Claims 11 and 15 are patentable over Hughes. Claims 12, 13, 21 and 22 are dependent to Claims 11 and 15 and have all of their limitations. Therefore, Claims 12, 13, 21 and 22 are also patentable.

With respect to newly added Claim 23, it has the limitation of "electronically selling via a telecommunication line a digital signal possessed by the first party to the second party . . . For the reasons identified above with respect to Claims 11 and 15, Hughes does not teach or suggest to electrically sell via telecommunication lines digital signals.

Lastly, even though Lightner, U.S. Patent 3,718,906 is currently not a basis of rejection of the claim, it has been in the past. With respect to new Claim 23, Lightner on column 8, lines 15-65 teaches that currency or a credit card is inserted into the vending machine. Once the proper amount of currency is received at receiver 91, then switch relay 96 is energized and connects the telephone dial lines for the vending machine to conventional touch tone dialing device 15. Thus, there is no electronic sales via telecommunication lines for the digital signal. The sale is taught in Lightner to be strictly either credit card or currency sale at the vending machine. There is no

teaching or suggestion of using telephone or telecommunication lines with respect to the sales aspect in Lightner.

Only after the proper currency is received by the vending machine do the telephone dial lines connect as indicated in lines 48-53 of column 8 of Lightner. When this happens, the customer can then push an appropriate combination of buttons of a touch tone device 15 to select whatever master tape the customer wishes to duplicate at the vending machine. See lines 60-65 of column 8 of Lightner. Lightner teaches to use telephone lines to transfer digital signals but does not teach or suggest the use of telephone or telecommunication lines with respect to the transfer of money. As a matter of fact, Lightner teaches against the same since it calls for the sales to occur at the physical location of the vending machine. Moreover, the vending machine, is not in the possession of the second party who is receiving the digital signal. Thus, the second party does not have a second memory to which the digital signal is transferred. Only after transference is complete does the tape eject from the machine and become that of the customer. Also, Claim 23 has the term "setting electronically" rather than "transferring electronically money" which is directly supported by the original specification. Accordingly, Claim 23 is patentable over Lightner.

In view of the foregoing amendments and remarks, it is respectfully requested that the outstanding rejections and objections to this application be reconsidered and withdrawn, and Claims 11-13, 15, and 21-23, now in this application be allowed.

Respectfully submitted,

ARTHUR R. HAIR

By Ansel Schwartz
Ansel M. Schwartz, Esquire
Reg. No. 30,587
425 N. Craig Street
Suite 301
Pittsburgh, PA 15213
(412) 621-9222

Attorney for Applicant

CERTIFICATE OF MAILING

I hereby certify that the correspondence is being deposited with the United States Postal Service as first class mail in an envelope addressed to: Commissioner of Patents and Trademarks, Washington, DC 20231.
on 6/23/92

Ansel Schwartz

Ansel M. Schwartz
Registration No. 30,587

6/23/92
Date



Address: COMMISSIONER OF PATENTS AND TRADEMARKS
Washington, D.C. 20231

SERIAL NUMBER: 07/586,391 FILING DATE: 09/18/90 FIRST NAMED INVENTOR: HAIK ATTORNEY DOCKET NO.:

A 2102.001-CON EXAMINER

ANSEL M. SCHWARTZ
425 N. CRAIG STREET
SUITE 301
PITTSBURGH, PA 15213

NGUYEN, H
ART UNIT: PAPER NUMBER: 29

2313
DATE MAILED: 09/21/92

This is a communication from the examiner in charge of your application.
COMMISSIONER OF PATENTS AND TRADEMARKS

- This application has been examined
- Responsive to communication filed on 6/25/92
- This action is made final.

A shortened statutory period for response to this action is set to expire _____ month(s), _____ days from the date of this letter.
Failure to respond within the period for response will cause the application to become abandoned. 35 U.S.C. 133

Part I THE FOLLOWING ATTACHMENT(S) ARE PART OF THIS ACTION:

- 1. Notice of References Cited by Examiner, PTO-892.
- 2. Notice re Patent Drawing, PTO-948.
- 3. Notice of Art Cited by Applicant, PTO-1449.
- 4. Notice of Informal Patent Application, Form PTO-152.
- 5. Information on How to Effect Drawing Changes, PTO-1474.
- 6.

Part II SUMMARY OF ACTION

- 1. Claims 11-13, 15, 21-23 are pending in the application.
- Of the above, claims _____ are withdrawn from consideration.
- 2. Claims 1-10, 14, 16-20 have been cancelled.
- 3. Claims 11-13, 15, 21, 22 are allowed.
- 4. Claims 23 are rejected.
- 5. Claims _____ are objected to.
- 6. Claims _____ are subject to restriction or election requirement.
- 7. This application has been filed with informal drawings under 37 C.F.R. 1.85 which are acceptable for examination purposes.
- 8. Formal drawings are required in response to this Office action.
- 9. The corrected or substitute drawings have been received on _____ Under 37 C.F.R. 1.84 these drawings are acceptable. not acceptable (see explanation or Notice re Patent Drawing, PTO-948).
- 10. The proposed additional or substitute sheet(s) of drawings, filed on _____ has (have) been approved by the examiner. disapproved by the examiner (see explanation).
- 11. The proposed drawing correction, filed on _____ has been approved. disapproved (see explanation).
- 12. Acknowledgment is made of the claim for priority under U.S.C. 119. The certified copy has been received not been received been filed in parent application, serial no. _____; filed on _____
- 13. Since this application appears to be in condition for allowance except for formal matters, prosecution as to the merits is closed in accordance with the practice under Ex parte Quayle, 1935 C.D. 11; 453 O.G. 213.
- 14. Other

Serial No. 07/586391

-2-

Art Unit 2313

1. The amendment filed on 6/25/92 has been entered. The substitute specification with double spaces between lines has been entered.

2. Claims 11-13 and 15, 21-22 are allowable over the prior art of record.

The prior art of record considered as a whole fails to teach or suggest a method for transmitting a desired digital audio signal stored on a first memory of a first party to a second memory of a second party as recited in claims 11 and 15 (the claims, each is considered as a whole) which includes the step of transmitting the desired digital audio signal from the first memory with a transmitter in control and possession of the first party to a receiver having the second memory at a location determined by the second party, the receiver in possession and control of the second party.

3. The following is a quotation of the appropriate paragraphs of 35 U.S.C. § 102 that form the basis for the rejections under this section made in this Office action:

A person shall be entitled to a patent unless --
(b) the invention was patented or described in a printed publication in this or a foreign country or in public use or on sale in this country, more than one year prior to the date of application for patent in the United States.

4. Claim 23 is rejected under 35 U.S.C. § 102(b) as being anticipated by Lightner.

See the entire document.

5. Claim 23 is rejected under 35 U.S.C. § 112, second

Serial No. 07/586391

-3-

Art Unit 2313

paragraph, as being indefinite for failing to particularly point out and distinctly claim the subject matter which applicant regards as the invention.

Line 9, "the second memory" lacks clear antecedent basis.

6. Applicant's amendment necessitated the new grounds of rejection. I.e., newly added claim 23. Accordingly, THIS ACTION IS MADE FINAL. See M.P.E.P. § 706.07(a). Applicant is reminded of the extension of time policy as set forth in 37 C.F.R. § 1.136(a).

A SHORTENED STATUTORY PERIOD FOR RESPONSE TO THIS FINAL ACTION IS SET TO EXPIRE THREE MONTHS FROM THE DATE OF THIS ACTION. IN THE EVENT A FIRST RESPONSE IS FILED WITHIN TWO MONTHS OF THE MAILING DATE OF THIS FINAL ACTION AND THE ADVISORY ACTION IS NOT MAILED UNTIL AFTER THE END OF THE THREE-MONTH SHORTENED STATUTORY PERIOD, THEN THE SHORTENED STATUTORY PERIOD WILL EXPIRE ON THE DATE THE ADVISORY ACTION IS MAILED, AND ANY EXTENSION FEE PURSUANT TO 37 C.F.R. § 1.136(a) WILL BE CALCULATED FROM THE MAILING DATE OF THE ADVISORY ACTION. IN NO EVENT WILL THE STATUTORY PERIOD FOR RESPONSE EXPIRE LATER THAN SIX MONTHS FROM THE DATE OF THIS FINAL ACTION.

7. Any inquiry concerning this communication or earlier communications from the examiner should be directed to Hoa Nguyen whose telephone number is (703) 308-1292.

Any inquiry of a general nature or relating to the status of this application should be directed to the Group receptionist whose telephone number is (703) 308-0754.

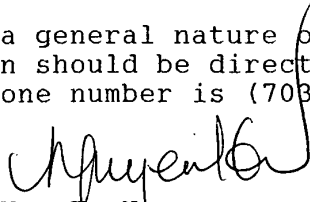
Hoa T. Nguyen
Primary Examiner, A.U. 2313
September 16, 1992

MAIL ROOM
OCT 05 1992
PAT. & TRADEMARKS

IN THE UNITED STATES PATENT AND TRADEMARK OFFICE

In re Application of:

ARTHUR R. HAIR

Serial No. 07/586,391

Filed: September 18, 1990

Art Unit: 2309

Patent Examiner:

H. Nguyen

TRANSMISSION SYSTEM

RECEIVED

OCT 04

GROUP 2300

#30/H
P.E.

Pittsburgh, Pennsylvania 15213

September 30, 1992 CERTIFICATE OF MAILING

Hon. Commissioner of Patents and Trademarks

Washington, D.C. 20231

Sir:

I hereby certify that the correspondence is being deposited with the United States Postal Service as first class mail in an envelope addressed to: Commissioner of Patents and Trademarks, Washington, DC 20231, on 9/30/92



Ansel M. Schwartz
Registration No. 30,587

9/30/92

Date

AMENDMENT UNDER RULE 116

Please enter the following amendments to the above-identified application as follows:

IN THE CLAIMS:

Please cancel Claim 23.

OK
10/15/92

OK
to enter
CWS
10/19/92



PATENT

AF

IN THE UNITED STATES PATENT AND TRADEMARK OFFICE

In re application of: Arthur R. Hair

Serial No.: 07 / 586,391

Group No.: 2309

Filed: September 18, 1990

Examiner: H. Nguyen

For: TRANSMISSION SYSTEM

RECEIVED

OCT 09 1992

GROUP 2300

Commissioner of Patents and Trademarks
Washington, D.C. 20231

AMENDMENT TRANSMITTAL

- 1. Transmitted herewith is an amendment for this application.

STATUS

- 2. Applicant is

- a small entity — verified statement:
 - attached.
 - already filed.
- other than a small entity.

CERTIFICATE OF MAILING (37 CFR 1.8a)

I hereby certify that this paper (along with any referred to as being attached or enclosed) is being deposited with the United State Postal Service on the date shown below with sufficient postage as first class mail in an envelope addressed to the: Commissioner of Patents and Trademarks, Washington, D.C. 20231.

Tracey L. Milka

(Type or print name of person mailing paper)

Date: 9/30/92

Tracey L. Milka

(Signature of person mailing paper)

EXTENSION OF TERM

NOTE: "Extension of Time in Patent Cases (Supplement Amendments) — If a timely and complete response has been filed after a Non-Final Office Action, an extension of time is not required to permit filing and/or entry of an additional amendment after expiration of the shortened statutory period.

If a timely response has been filed after a Final Office Action, an extension of time is required to permit filing and/or entry of a Notice of Appeal or filing and/or entry of an additional amendment after expiration of the shortened statutory period unless the timely-filed response placed the application in condition for allowance. Of course, if a Notice of Appeal has been filed within the shortened statutory period, the period has ceased to run." Notice of December 10, 1985 (1061 O.G. 34-35).

NOTE: See 37 CFR 1.645 for extensions of time in interference proceedings and 37 CFR 1.550(c) for extensions of time in reexamination proceedings.

3. The proceedings herein are for a patent application and the provisions of 37 CFR 1.136 apply

(complete (a) or (b) as applicable)

(a) Applicant petitions for an extension of time under 37 CFR 1.136 (fees: 37 CFR 1.17(a)-(d) for the total number of months checked below:

Extension (months)	Fee for other than small entity	Fee for small entity
<input type="checkbox"/> one month	\$ 110.00	\$ 55.00
<input type="checkbox"/> two months	\$ 350.00	\$175.00
<input type="checkbox"/> three months	\$ 810.00	\$405.00
<input type="checkbox"/> four months	\$1,280.00	\$640.00

Fee \$ _____

If an additional extension of time is required please consider this a petition therefor.

(check and complete the next item, if applicable)

An extension for _____ months has already been secured and the fee paid therefor of \$_____ is deducted from the total fee due for the total months of extension now requested.

Extension fee due with this request \$ _____

OR

(b) Applicant believes that no extension of term is required. However, this conditional petition is being made to provide for the possibility that applicant has inadvertently overlooked the need for a petition for extension of time.

FEE FOR CLAIMS

4. The fee for claims (37 CFR 1.16(b)-(d)) has been calculated as shown below:

	(Col. 1)	(Col. 2)	(Col. 3)	SMALL ENTITY	OTHER THAN A SMALL ENTITY
	CLAIMS REMAINING AFTER AMENDMENT	HIGHEST NO PREVIOUSLY PAID FOR	PRESENT EXTRA	ADDIT. RATE FEE	ADDIT. RATE FEE
TOTAL	MINUS	**	=	x10= \$	x20= \$
INDEP.	MINUS	***	=	x36= \$	x72= \$
<input type="checkbox"/>	FIRST PRESENTATION OF MULTIPLE DEP. CLAIM			+110= \$	+220= \$
				TOTAL ADDIT. FEE \$	OR TOTAL ADDIT. FEE \$

- * If the entry in Col. 1 is less than entry in Col. 2, write "0" in Col. 3.
- ** If the "Highest No. Previously Paid for" IN THIS SPACE is less than 20, enter "20".
- *** If the "Highest No. Previously Paid For" IN THIS SPACE is less than 3, enter "3".
The "Highest No. Previously Paid For" (Total or indep.) is the highest number found in the appropriate box in Col. 1 of a prior amendment or the number of claims originally filed.

(complete (c) or (d) as applicable)

(c) No additional fee for claims is required.

OR

(d) Total additional fee for claims required \$_____

FEE PAYMENT

5. Attached is a check in the sum of \$_____
- Charge Account No. _____ the sum of \$_____

A duplicate of this transmittal is attached.

FEE DEFICIENCY

NOTE: *If there is a fee deficiency and there is no authorization to charge an account, additional fees are necessary to cover the additional time consumed in making up the original deficiency. If the maximum, six-month period has expired before the deficiency is noted and corrected, the application is held abandoned. In those instances where authorization to charge is included, processing delays are encountered in returning the papers to the PTO Finance Branch in order to apply these charges prior to action on the cases. Authorization to charge the deposit account for any fee deficiency should be checked. See the Notice of April 7, 1986, 1065 O.G. 31-33.*

6. If any additional extension and/or fee is required, charge Account No. 19-0737

AND/OR

If any additional fee for claims is required, charge Account No. 19-0737

Reg. No.: 30,587

Tel. No.: (412) 621-9222



SIGNATURE OF ATTORNEY

Ansel M. Schwartz

Type or print name of attorney

Attorney at Law

P.O. Address

425 N. Craig Street, Suite 301

Pittsburgh, PA 15213

(Amendment Transmittal [9-19]—page 4 of 4)

REMARKS

Claims 11-13, 15, 21 and 22 are currently active.

Claim 23 has been cancelled.

In the Office Action dated September 21, Claims 11-13, 15, 21 and 22 were allowed.

Claim 23 is rejected under 35 U.S.C. §102(b) as being anticipated by Lightner and under 35 U.S.C. §112, second paragraph, as being indefinite for failing to particularly point out and distinctly claim the subject matter which applicant regards as the invention.

Claim 23 has been cancelled.

Accordingly, the rejections to Claim 23 are obviated.

Claims 11-13, 15, 21 and 22 have already been allowed.

In view of the foregoing amendments and remarks, it is respectfully requested that the outstanding rejections and

objections to this application be reconsidered and withdrawn, and that a Notice of Allowance be forthcoming for Claims 11-13, 15, 21 and 22.

CERTIFICATE OF MAILING

I hereby certify that the correspondence is being deposited with the United States Postal Service as first class mail in an envelope addressed to: Commissioner of Patents and Trademarks, Washington, DC 20231, on 9/30/92

Ansel M. Schwartz

Ansel M. Schwartz
Registration No. 30,587

9/30/92

Date

Respectfully submitted,

ARTHUR R. HAIR

By Ansel M. Schwartz

Ansel M. Schwartz, Esquire
Reg. No. 30,587
425 N. Craig Street
Suite 301
Pittsburgh, PA 15213
(412) 621-9222

Attorney for Applicant



UNITED STATES DEPARTMENT OF COMMERCE
 Patent and Trademark Office
 Address: COMMISSIONER OF PATENTS AND TRADEMARKS
 Washington, D.C. 20231

SERIAL NUMBER	FILING DATE	FIRST NAMED APPLICANT	ATTORNEY DOCKET NO.
---------------	-------------	-----------------------	---------------------

07/586,391 09/18/90 HAIR

A EXAM 102.001-CON

ANSEL M. SCHWARTZ
 425 N. CRAIG STREET
 SUITE 301
 PITTSBURGH, PA 15213

NGUYEN, H
 ART UHN PAPER NUMBER

31

DATE MAILED

10/19/92

NOTICE OF ALLOWABILITY

PART I.

1. This communication is responsive to APPLICANT'S AMENDMENT FILED ON 10/5/92
2. All the claims being allowable, PROSECUTION ON THE MERITS IS (OR REMAINS) CLOSED in this application. If not included herewith (or previously mailed), a Notice Of Allowance And Issue Fee Due or other appropriate communication will be sent in due course.
3. The allowed claims are 11-13, 15, 21-22, renumbered as 1-6, respectively
4. The drawings filed on _____ are acceptable.
5. Acknowledgment is made of the claim for priority under 35 U.S.C. 119. The certified copy has been received. not been received. been filed in parent application Serial No. _____ filed on _____
6. Note the attached Examiner's Amendment.
7. Note the attached Examiner Interview Summary Record, PTOL-413.
8. Note the attached Examiner's Statement of Reasons for Allowance.
9. Note the attached NOTICE OF REFERENCES CITED, PTO-892.
10. Note the attached INFORMATIONAL DISCLOSURE CITATION, PTO-1449.

PART II.

A SHORTENED STATUTORY PERIOD FOR RESPONSE to comply with the requirements noted below is set to EXPIRE THREE MONTHS FROM THE "DATE MAILED" indicated on this form. Failure to timely comply will result in the ABANDONMENT of this application. Extensions of time may be obtained under the provisions of 37 CFR 1.136(a).

1. Note the attached EXAMINER'S AMENDMENT or NOTICE OF INFORMAL APPLICATION, PTO-152, which discloses that the oath or declaration is deficient. A SUBSTITUTE OATH OR DECLARATION IS REQUIRED.
2. APPLICANT MUST MAKE THE DRAWING CHANGES INDICATED BELOW IN THE MANNER SET FORTH ON THE REVERSE SIDE OF THIS PAPER.
 - a. Drawing informalities are indicated on the NOTICE RE PATENT DRAWINGS, PTO-948, attached hereto or to Paper No. 8. CORRECTION IS REQUIRED.
 - b. The proposed drawing correction filed on _____ has been approved by the examiner. CORRECTION IS REQUIRED.
 - c. Approved drawing corrections are described by the examiner in the attached EXAMINER'S AMENDMENT. CORRECTION IS REQUIRED.
 - d. Formal drawings are now REQUIRED.

Any response to this letter should include in the upper right hand corner, the following information from the NOTICE OF ALLOWANCE AND ISSUE FEE DUE: ISSUE BATCH NUMBER, DATE OF THE NOTICE OF ALLOWANCE, AND SERIAL NUMBER.

Attachments:

- Examiner's Amendment
- Examiner Interview Summary Record, PTOL-413
- Reasons for Allowance
- Notice of References Cited, PTO-892
- Information Disclosure Citation, PTO-1449

- Notice of Informal Application, PTO-152
- Notice re Patent Drawings, PTO-948
- Listing of Bonded Draftsmen *See O.G. of 8/15/85*
- Other

Nguyen H
 HOA NGUYEN
 Primary Examiner
 A.U. 2813

BC



**UNITED STATES DEPARTMENT OF COMMERCE
Patent and Trademark Office**

Address: Box ISSUE FEE
COMMISSIONER OF PATENTS AND TRADEMARKS
Washington, D.C. 20231

**ANSEL M. SCHWARTZ
425 N. CRAIG STREET
SUITE 301
PITTSBURGH, PA 15213**

**NOTICE OF ALLOWANCE
AND ISSUE FEE DUE**

- Note attached communication from the Examiner
- This notice is issued in view of applicant's communication filed _____

SERIES CODE/SERIAL NO.	FILING DATE	TOTAL CLAIMS	EXAMINER AND GROUP ART UNIT	DATE MAILED
07/586,391	09/18/90	006	NGUYEN, H 2313	10/19/92
First Named Applicant				
HAIR,		ARTHUR R.		

TITLE OF INVENTION **METHOD FOR TRANSMITTING A DESIRED DIGITAL VIDEO OR AUDIO SIGNAL
(AS AMENDED)**

ATTY'S DOCKET NO.	CLASS-SUBCLASS	BATCH NO.	APPLN. TYPE	SMALL ENTITY	FEE DUE	DATE DUE
2	2102.001-CON	369-084.000	H24 UTILITY	YES	\$585.00	01/19/93

THE APPLICATION IDENTIFIED ABOVE HAS BEEN EXAMINED AND IS ALLOWED FOR ISSUANCE AS A PATENT. PROSECUTION ON THE MERITS IS CLOSED.

THE ISSUE FEE MUST BE PAID WITHIN THREE MONTHS FROM THE MAILING DATE OF THIS NOTICE OR THIS APPLICATION SHALL BE REGARDED AS ABANDONED. THIS STATUTORY PERIOD CANNOT BE EXTENDED.

HOW TO RESPOND TO THIS NOTICE:

I. Review the SMALL ENTITY Status shown above.

If the SMALL ENTITY is shown as YES, verify your current SMALL ENTITY status:

- A. If the Status is changed, pay twice the amount of the FEE DUE shown above and notify the Patent and Trademark Office of the change in status, or
- B. If the Status is the same, pay the FEE DUE shown above.

If the SMALL ENTITY is shown as NO:

- A. Pay FEE DUE shown above, or
- B. File verified statement of Small Entity Status before, or with, payment of 1/2 the FEE DUE shown above.

II. Part B of this notice should be completed and returned to the Patent and Trademark Office (PTO) with your ISSUE FEE. Even if the ISSUE FEE has already been paid by a charge to deposit account, Part B should be completed and returned. If you are charging the ISSUE FEE to your deposit account, Part C of this notice should also be completed and returned.

III. All communications regarding this application must give series code (or filing date), serial number and batch number. Please direct all communications prior to issuance to Box ISSUE FEE unless advised to the contrary.

IMPORTANT REMINDER: Patents issuing on applications filed on or after Dec. 12, 1980 may require payment of maintenance fees.

32



PATENT

IN THE UNITED STATES PATENT AND TRADEMARK OFFICE

In re application of: Arthur R. Hair

Serial No.: 0 7/586,391

Group No.: 2313

Filed: September 18, 1990

Examiner: H. Nguyen

For: METHOD FOR TRANSMITTING A DESIRED (complete if applicable)
DIGITAL VIDEO OR AUDIO
SIGNAL

Date of mailing of "Notice of Allowance and

Base Issue Fee Due" 10/19/92

Issue Batch No. H24

32
12.4.92

Commissioner of Patents and Trademarks
Washington, D. C. 20231

TRANSMITTAL OF FORMAL DRAWINGS

Attached please find the formal drawings for this application.

Reg. No. 30,587

Tel. No. (412) 621-9222

Ansel Schwartz

SIGNATURE OF ATTORNEY

Ansel M. Schwartz

Type or print name of attorney

Attorney at Law

P.O. Address
425 N. Craig Street, Suite 301
Pittsburgh, PA 15213

NOTE: The art unit, serial number and number of drawing sheets should be written on the reverse side of the drawings. However, for identification of the serial number, the PTO prefers that it be placed on the front. Notice of September 5, 1986 (1070 O.G. 46 to 59, 54).

RECEIVED
PATENT DIVISION
NOV 18 1992

CERTIFICATE OF MAILING (37 CFR 1.8a)

I hereby certify that this paper (along with any paper referred to as being attached or enclosed) is being deposited with the United States Postal Service on the date shown below with sufficient postage as first class mail in an envelope addressed to the: Commissioner of Patents and Trademarks, Washington, D.C. 20231.

Tracey L. Milka

(Type or print name of person mailing paper)

Date: 11/16/92

Tracey L. Milka

(Signature of person mailing paper)

(Transmittal of Formal Drawings [5-2])

369 084 2

5191573

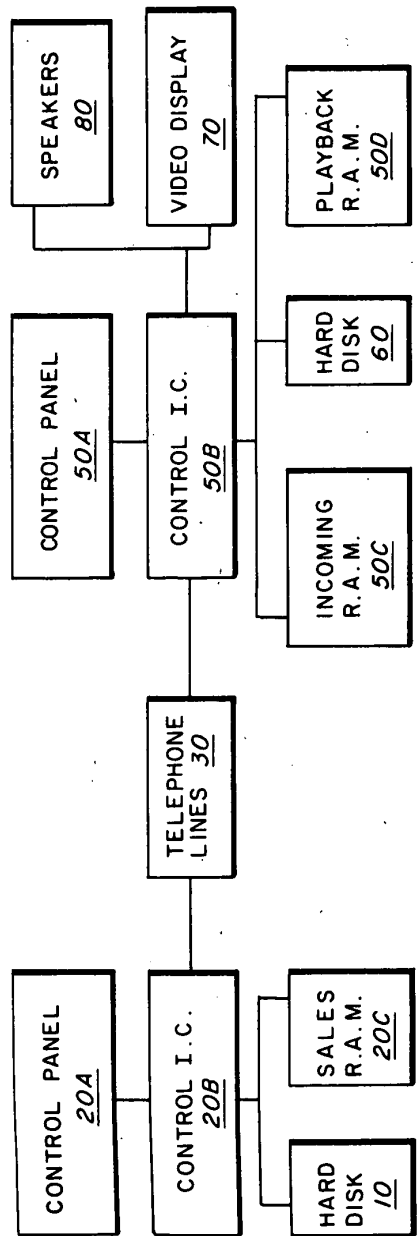

FIG. 1

369 084 2

011586591

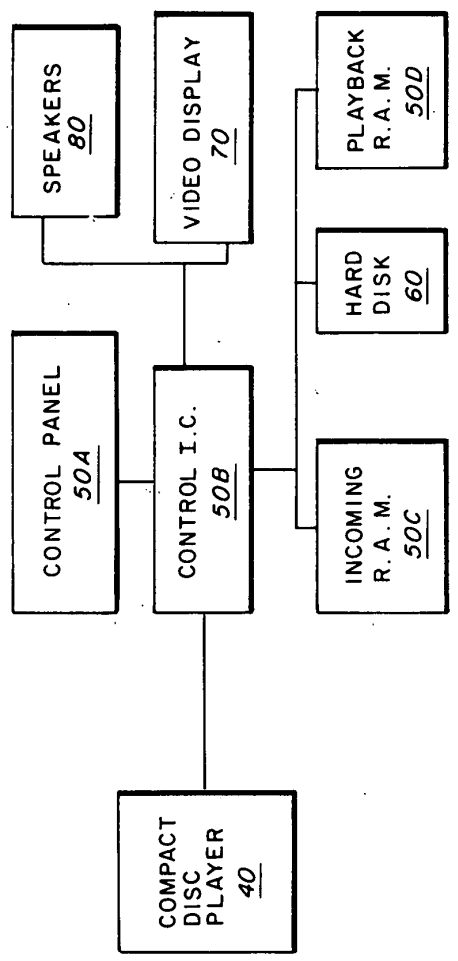

FIG. 2

PART B - ISSUE FEE TRANSMITTAL

\$ 585.00-242
\$ 15.10-501 B

MAILING INSTRUCTIONS: This form should be used for transmitting the ISSUE FEE. Blocks 2 through 6 should be completed where appropriate. All further correspondence including the Issue Fee Receipt, the Patent, advanced orders and notification of maintenance fees will be mailed to addressee entered in Block 1 unless you direct otherwise, by: (a) specifying a new correspondence address in Block 3 below; or (b) providing the PTO with a separate "FEE ADDRESS" for maintenance fee notifications with the payment of Issue Fee or thereafter. See reverse for Certificate of Mailing.



ANSEL M. SCHWARTZ
425 N. CRAIG STREET
SUITE 301
PITTSBURGH, PA 15213

1. CORRESPONDENCE ADDRESS	2. INVENTOR(S) ADDRESS CHANGE (Complete only if there is a change)
	INVENTOR'S NAME
	Street Address
	City, State and ZIP Code
	CO-INVENTOR'S NAME
	Street Address
	City, State and ZIP Code
	<input type="checkbox"/> Check if additional changes are on reverse side

SERIES CODE/SERIAL NO.	FILING DATE	TOTAL CLAIMS	EXAMINER AND GROUP ART UNIT	DATE MAILED
07/586,391	09/18/90	006	NGUYEN, H	2313 10/19/92
First Named Applicant	HAIR, ARTHUR R.			

TITLE OF INVENTION: METHOD FOR TRANSMITTING A DESIRED DIGITAL VIDEO OR AUDIO SIGNAL. (AS AMENDED)

ATTY'S DOCKET NO.	CLASS-SUBCLASS	BATCH NO.	APPLN. TYPE	SMALL ENTITY	FEE DUE	DATE DUE
2	2102.001-CON	369-084.000	H24	UTILITY	YRS \$585.00	01/19/93

3. Further correspondence to be mailed to the following: Ansel M. Schwartz Attorney at Law 425 N. Craig Street Suite 301 Pittsburgh, PA. 15213	4. For printing on the patent front page, list the names of not more than 3 registered patent attorneys or agents OR alternatively, the name of a firm having as a member a registered attorney or agent. If no name is listed, no name will be printed.
	1 Ansel M. Schwartz
	2 _____
	3 _____

090 BA 12/10/92 07586391 DO NOT USE THIS SPACE
1 242 585.00 CK
1 585 00.00 CK

5. ASSIGNMENT DATA TO BE PRINTED ON THE PATENT (print or type) (1) NAME OF ASSIGNEE: (2) ADDRESS: (City & State or Country) (3) STATE OF INCORPORATION, IF ASSIGNEE IS A CORPORATION	6a. The following fees are enclosed: CK. # 0869 <input checked="" type="checkbox"/> Issue Fee <input checked="" type="checkbox"/> Advanced Order - # of Copies 5 (Minimum of 10)
	6b. The following fees should be charged to: DEPOSIT ACCOUNT NUMBER 19-0737 (Enclose Part C) <input type="checkbox"/> Issue Fee <input type="checkbox"/> Advanced Order - # of Copies _____ <input checked="" type="checkbox"/> Any Deficiencies in Enclosed Fees (Minimum of 10)
	The COMMISSIONER OF PATENTS AND TRADEMARKS is requested to apply the Issue Fee to the application identified above. (Signature of party in interest or record) Ansel Schwartz (Date) 12/14/92 NOTE: The Issue Fee will not be accepted from anyone other than the applicant; a registered attorney or agent; or the assignee or other party in interest as shown by the records of the Patent and Trademark Office.

A. This application is NOT assigned.
 Assignment previously submitted to the Patent and Trademark Office.
 Assignment is being submitted under separate cover. Assignments should be directed to Box ASSIGNMENTS.
PLEASE NOTE: Unless an assignee is identified in Block 5, no assignee data will appear on the patent. Inclusion of assignee data is only appropriate when an assignment has been previously submitted to the PTO or is being submitted under separate cover. Completion of this form is NOT a substitute for filing an assignment.

TRANSMIT THIS FORM WITH FEE-CERTIFICATE OF MAILING ON REVERSE

Certificate of Mailing

I hereby certify that this correspondence is being deposited with the United States Postal Service with sufficient postage as first class mail in an envelope addressed to:

Box ISSUE FEE
Commissioner of Patents and Trademarks
Washington, D.C. 20231

on December 4, 1992
(Date)

Tracey L. Milka
(Name of person making deposit)

Tracey L. Milka
(Signature)

12/4/92
(Date)

Note: If this certificate of mailing is used, it can only be used to transmit the Issue Fee. This certificate cannot be used for any other accompanying papers. Each additional paper, such as an assignment or formal drawings, must have its own certificate of mailing.

This form is estimated to take 20 minutes to complete. Time will vary depending upon the needs of the individual applicant. Any comments on the amount of time you require to complete this form should be sent to the Office of Management and Organization, Patent and Trademark Office, Washington, D.C. 20231 and to the Office of Information and Regulatory Affairs, Office of Management and Budget, Washington, D.C. 20503.



PART C - CHARGE TO DEPOSIT ACCOUNT

1. CORRESPONDENCE ADDRESS

ANSEL W. SCHWARTZ
425 N. CRAIG STREET
SUITE 301
PITTSBURGH, PA 15213

SERIES CODE/SERIAL NO.	FILING DATE	TOTAL CLAIMS	EXAMINER AND GROUP ART UNIT	DATE MAILED
07/586,391	09/18/90	006	NGUYEN, H	2313 10/19/92
First Named Applicant	HAIR,		ARTHUR R.	

TITLE OF INVENTION: METHOD FOR TRANSMITTING A DESIRED DIGITAL VIDEO OR AUDIO SIGNAL (AS AMENDED)

ATTY'S DOCKET NO.	CLASS-SUBCLASS	BATCH NO.	APPLN. TYPE	SMALL ENTITY	FEE DUE	DATE DUE
2	2102.001-CON	369-084.000	H24 UTILITY	YES	\$585.00	01/19/93

DO NOT USE THIS SPACE

2a. The following fees are enclosed: CK. # 0869
 Issue Fee Advanced Order - # of Copies 5 (Minimum of 10)
 2b. The following fees should be charged to: DEPOSIT ACCOUNT NUMBER 19-0737
 Issue Fee Advanced Order - # of Copies _____
 Any Deficiencies in Enclosed Fees (Minimum of 10)

The COMMISSIONER OF PATENTS AND TRADEMARKS is requested to apply the Issue Fee to the application identified above.

(Signature of party in interest of record) *Arnel Schwart* (Date) 12/4/92

NOTE: The Issue Fee will not be accepted from anyone other than the applicant; a registered attorney or agent; or the assignee or other party in interest as shown by the records of the Patent and Trademark Office.

TRANSMIT THIS FORM WITH PART B WHEN AUTHORIZING USE OF A DEPOSIT ACCOUNT.

PTO UTILITY GRANT
Paper Number 33

The
United
States
of
America

The Commissioner of Patents
and Trademarks

Has received an application for a patent
for a new and useful invention. The title
and description of the invention are en-
closed. The requirements of law have
been complied with, and it has been de-
termined that a patent on the invention
shall be granted under the law.

Therefore, this

United States Patent

Grants to the person or persons having
title to this patent the right to exclude
others from making, using or selling the
invention throughout the United States
of America for the term of seventeen
years from the date of this patent, sub-
ject to the payment of maintenance fees
as provided by law.



Stephen S. Fein

Acting Commissioner of Patents and Trademarks

Matthew A. Thompson
Attest

PTO-1584

BEST AVAILABLE COPY



#100. 0-145
C/C

PATENT

IN THE UNITED STATES PATENT AND TRADEMARK OFFICE

Patent Number: 5,191,573

Issued: March 2, 1993

Name of Patentee: Hair

Title of Invention: METHOD FOR TRANSMITTING A DESIRED DIGITAL VIDEO AUDIO SIGNAL

Commissioner of Patents and Trademarks
Washington, D.C. 20231

ATTENTION: Decision and Certificate of Correction
Branch of the Patent Issue Division

APPROVED
NOV 21 1993
FOR THE COMMISSIONER OF PAT. & T.M.
CERTIFICATE OF CORRECTION
OF PATENT & TRADEMARK OFF.
CORRECTION BRANCH O.F.C.

RECEIVED
MAY 7 93

REQUEST FOR CERTIFICATE OF CORRECTION OF PATENT FOR APPLICANT'S MISTAKE (37 CFR 1.323)

1. It is noted that an error appears in this patent of a

- clerical
- typographical
- minor

[Signature]

nature or character as more fully described below and occurred in good faith and correction thereof does not involve such changes in the patent as would constitute new matter or would require re-examination and a certificate of correction is requested.

2. Attached hereto in duplicate is Form PTO-1050 with at least one copy being suitable for printing.

NOTE: Form PTO-1050, using the column and line number in the printed patent, should be used exclusively regardless of the length or complexity of the subject matter. MPEP § 1485.

NOTE: The patent grant should be retained by the patentee. The PTO does not attach the certificate of correction to the patentee's copy of the patent. The patent grant will be returned to the patentee if submitted. MPEP § 1485.

(Request for Certificate of Correction of Patent for Applicant's Mistake (37 CFR 1.323)

[14-2]—page 1 of 3

5

3. The exact page and line number where the error occurs in the application file are:

NOTE: This information should be identified in this request, however, on Form PTO-1050, only the column and line number in the printed patent should be used. MPEP § 1485.

In the double-spaced copy of the application filed with the amendment dated June 22, 1992, page 3, line 10, replace "signal" with -- signals -- .

In the double-spaced copy of the application filed with the amendment dated June 22, 1992, page 1, line 12, replace ":" with -- , i.e., -- .

In the double-spaced copy of the application filed with the amendment dated June 22, 1992, page 2, line 13, replace "cueing" with -- queuing -- .

In the double-spaced copy of the application filed with the amendment dated June 22, 1992, page 2, line 14, replace "transfered" with -- transferred -- .

In the double-spaced copy of the application filed with the amendment dated June 22, 1992, page 2, line 15.

In the double-spaced copy of the application filed with the amendment dated June 22, 1992, page 2, line 16, replace "lengthly" with -- lengthy -- .

In the double-spaced copy of the application filed with the amendment dated June 22, 1992, page 2, line 17, replace "unessary" with -- unnecessary --

In the double-spaced copy of the application filed with the amendment dated June 22, 1992, page 2, line 19, after "units" insert -- , -- .

In the double-spaced copy of the application filed with the amendment dated June 22, 1992, page 4, line 1, delete "is", second occurrence.

In the double-spaced copy of the application filed with the amendment dated June 22, 1992, page 4, line 4, after "invention" insert -- is -- .

In the double-spaced copy of the application filed with the amendment dated June 22, 1992, page 4, line 9, replace "cue" with -- queue -- .

In the double-spaced copy of the application filed with the amendment dated June 22, 1992, page 4, line 21.

In the double-spaced copy of the application filed with the amendment dated June 22, 1992, page 5, line 20.

In the double-spaced copy of the application filed with the amendment dated June 22, 1992, page 5, line 20, replace "transferring" with -- transferring -- .

In the double-spaced copy of the application filed with the amendment filed June 22, 1992, page 5, line 24.

(Request for Certificate of Correction of Patent for Applicant's Mistake (37 CFR 1.323))

[14-2]—page 2 of 3)

5

3. The exact page and line number where the error occurs in the application file are:

NOTE: This information should be identified in this request, however, on Form PTO-1050, only the column and line number in the printed patent should be used. MPEP § 1485.

In the double-spaced copy of the application filed with the amendment dated June 22, 1992, page 6, line 19, replace "; and" with -- . -- .

In the double-spaced copy of the application filed with the amendment dated June 22, 1992, page 8, line 5, after "unit", second occurrence, insert -- 50 -- .

In the double-spaced copy of the application filed with the amendment dated June 22, 1992, page 8, line 9, after "panel" insert -- 20a -- .

In the double-spaced copy of the application filed with the amendment dated June 22, 1992, page 8, line 10, after "circuit" insert -- 20b -- .

In the double-spaced copy of the application filed with the amendment dated June 22, 1992, page 8, line 13.

In the double-spaced copy of the application filed with the amendment dated June 22, 1992, page 9, line 11, replace "system, additionally" with -- system. Additionally, -- .

In the double-spaced copy of the application filed with the amendment dated June 22, 1992, page 11, line 4, replace "jocky" with -- jockey -- .

In the double-spaced copy of the application filed with the amendment dated June 22, 1992, page 11, line 5, replace "cued" with -- queued -- .

In the double-spaced copy of the application filed with the amendment dated June 22, 1992, page 11, line 10.

In the double-spaced copy of the application filed with the amendment dated June 22, 1992, page 11, line 11, replace "cued" with -- queued -- .

In the double-spaced copy of the application filed with the amendment dated June 22, 1992, page 11, line 18, replace "cued" with -- queued -- .

In the double-spaced copy of the application filed with the amendment dated June 22, 1992, page 12, line 2, replace "to" with -- on -- .

In the amendment dated June 22, 1992, page 5, line 2, replace "steps" with -- step -- .

In the double-spaced copy of the application filed with the amendment dated June 22, 1992, page 12, line 10, replace "to" with -- on -- .

In the amendment dated June 22, 1992, page 2, line 1, replace "steps" with -- step -- .

(Request for Certificate of Correction of Patent for Applicant's Mistake (37 CFR 1.323)

[14-2]—page 2 of 3
3 5

3. The exact page and line number where the error occurs in the application file are:

NOTE: This information should be identified in this request, however, on Form PTO-1050, only the column and line number in the printed patent should be used. MPEP § 1485.

In the double-spaced copy of the application filed with the amendment dated June 22, 1992, page 12, line 9, replace "cued" with -- queued -- .

In the amendment dated June 22, 1992, page 2, line 5.

In the amendment dated June 22, 1992, page 6, line 4.

In the amendment dated June 22, 1992, page 6, line 4, after "party" insert -- , -- .

In the amendment dated June 22, 1992, page 6, line 6, after "memory" insert -- , -- .

In the amendment dated June 22, 1992, page 7, line 9, after "party" insert -- , -- .

In the abstract, line 4, replace "steps" with -- step -- .

In the abstract, line 9, after "desired" insert -- digital -- .

(Request for Certificate of Correction of Patent for Applicant's Mistake (37 CFR 1.323)

[14-2]—page 2 of 2

4 of 5

4. Please send the Certificate to

Name: Ansël M. Schwartz

Address: 425 N. Craig Street, Suite 301

Pittsburgh, PA 15213

5. Please pay the fee of \$100.00 as required by 37 CFR 1.20(a), as follows:

enclosed is a check for \$100.00

charge Deposit Account _____ the sum of \$100.00. A duplicate of this request is attached.

Reg. No. 30,587

Tel. No. (412) 621-9222



SIGNATURE OF ATTORNEY

Ansel M. Schwartz

Type or print name of attorney

425 N. Craig Street
Suite 301

P.O. Address

Pittsburgh, PA 15213

NOTE: The certificate of correction for applicant's mistake may be signed by the attorney of record unlike that for PTO mistake where the patentee or an owner of an interest in the invention must make the request.

(Request for Certificate of Correction of Patent for Applicant's Mistake (37 CFR 1.323) [14-2]—page 3 of 3)

5 of 5

UNITED STATES DISTRICT COURT
OFFICE OF THE CLERK
WESTERN DISTRICT OF PENNSYLVANIA
P. O. BOX 1805
PITTSBURGH, PA 15230

SOLICITOR

JAN 23 1998

U.S. PATENT & TRADEMARK OFFICE

JAMES A. DRACH
CLERK
412-644-3528

IN REPLYING, GIVE NUMBER
OF CASE AND NAMES OF PARTIES

January 20, 1998

Commissioner of Patents
and Trademarks
Washington, DC 20231

Re: Parsec Sight/Sound, Inc. V. N2K, Inc.
Civil Action No. 98-118

Dear Commissioner:

In compliance with 35 § 290 and/or 15 U.S.C. §1116 enclosed is a copy of the docket entries and complaint which was filed in the United States District Court for the Western District of Pennsylvania.

Sincerely,

James A. Drach
CLERK OF COURT

By Eileen M. Chettle
Eileen M. Chettle
Deputy Clerk

5,191,573
5,675,734

Enclosures

U.S. District Court
Western District of Pennsylvania (Pittsburgh)

CIVIL DOCKET FOR CASE #: 98-CV-118

PARSEC SIGHT/SOUND v. N2K, INC.
Assigned to: Judge Donald J. Lee
Demand: \$0,000
Lead Docket: None
Dkt# in other court: None

Filed: 01/16/98
Jury demand: Plaintiff
Nature of Suit: 830
Jurisdiction: Federal Question

Cause: 28:1338 Patent Infringement

PARSEC SIGHT/SOUND, INC., a
Pennsylvania corporation
plaintiff

Richard F. Rinaldo
456-2876
[COR LD NTC]
Hugh E. McGough
[COR LD NTC]
Meyer, Unkovic & Scott
1300 Oliver Building
Pittsburgh, PA 15222
(412) 456-2800

v.

N2K, INC., a Delaware
corporation
defendant

Proceedings include all events.
2:98cv118 PARSEC SIGHT/SOUND v. N2K, INC.

1/16/98 1 COMPLAINT with summons issued; jury demand Filing Fee \$
150.00 Receipt # 3058 (emc) [Entry date 01/20/98]

COPY

IN THE UNITED STATES DISTRICT COURT
FOR THE WESTERN DISTRICT OF PENNSYLVANIA

PARSEC SIGHT/SOUND, INC., a)
Pennsylvania corporation,)
)
Plaintiff,)
)
v.)
)
N2K, INC., a Delaware corpora-)
tion,)
)
Defendant.)

Civil Action No.

JURY TRIAL DEMAND

U.S. DISTRICT COURT
CLERK

1998 JAN 16 3:55

FILED

COMPLAINT

Plaintiff, Parsec Sight/Sound, Inc., by its attorneys, Meyer, Unkovic & Scott LLP, brings this civil action for patent infringement and complains against Defendant, N2K, Inc., on grounds of which the following is a statement:

Parties

1. Plaintiff, Parsec Sight/Sound, Inc. (hereinafter "Parsec"), is a corporation organized and existing under the laws of the Commonwealth of Pennsylvania, with its principal place of business at 733 Washington Road, Pittsburgh, Pennsylvania 15241.

2. Defendant, N2K, Inc. ("N2K"), is a corporation organized and existing under the laws of the State of Delaware, with its principal place of business at 55 Broad Street, 10th

Floor, New York, NY 10004, and at all times material hereto has been registered to do business and has conducted business in the Commonwealth of Pennsylvania.

Jurisdiction

3. This Court has jurisdiction over the subject matter of this action under 28 U.S.C. §§ 1331 and 1338(a).

Venue

4. Venue is proper in this Court under the provisions of 28 U.S.C. § 1391(c) and 28 U.S.C. § 1400(b).

General Facts

5. Arthur R. Hair ("Hair") is the inventor to whom the United States Patent Office issued United States Patent No. 5,191,573 on March 2, 1993 (hereinafter the "'573 Patent"). A true and correct copy of the '573 Patent is attached hereto as Exhibit "A".

6. Parsec is the assignee of the rights, title and interest in the '573 Patent issued to Hair.

7. Hair is the inventor and Parsec is the assignee to whom the United States Patent Office issued United States Patent No. 5,675,734 on October 7, 1997 (hereinafter the "'734 Patent").

A true and correct copy of the '734 Patent is attached hereto as Exhibit "B".

8. The '734 Patent is a continuation of the '573 Patent.

COUNT I

Patent Infringement

9. Paragraphs 1-8, inclusive, above, are hereby incorporated herein by reference.

10. N2K has been making and continues to make and/or has sold and continues to sell and/or offer for sale and/or use and/or has induced and/or continues to induce others to sell and/or use and/or contribute to the making, using or selling of one or more digital audio signals for or with processes within the scope of the claims of the '573 Patent and of the '734 Patent in this judicial district and elsewhere in the United States.

11. N2K has notice of the '573 Patent and of the '734 Patent, pursuant to 35 U.S.C. § 287, prior to the commencement of this civil action.

12. The unauthorized making, use, or sale of such a digital audio signal by N2K infringes one or more claims of the '573 patent and of the '734 patent.

13. N2K is a direct and/or contributory infringer of the '573 Patent and of the '734 Patent and/or has induced infringement of the '573 Patent and the '734 Patent by others in violation of 35 U.S.C. § 271.

14. Unless enjoined by this Court, N2K will continue to infringe the '573 Patent and the '734 Patent in the future.

COUNT TWO

Willful Patent Infringement

15. Paragraphs 1-14, inclusive, above, are hereby incorporated herein by reference.

16. N2K has infringed and is infringing the '573 Patent and the '734 Patent with full knowledge of the '573 Patent and the '734 Patent, and the infringement has been willful and deliberate and continues to be willful and deliberate. This case is exceptional under 35 U.S.C. § 285.

PRAYER FOR RELIEF

WHEREFORE, Plaintiff, Parsec Sight/Sound, Inc., demands judgment in its favor and against Defendant, N2K, Inc., as follows:

A. That this Court adjudge and decree that United States Patent No. 5,191,573 and United States Patent No. 5,675,734 are valid and enforceable against Defendant, N2K, Inc.;

B. That this Court adjudge and decree that N2K, Inc. has infringed the '573 Patent and the '734 Patent;

C. That this Court preliminarily and permanently enjoin N2K, Inc., its officers, directors, agents, employees, servants, attorneys, successors, assigns and all others controlling, controlled by, affiliated with or in privity with N2K, Inc. from committing further acts of infringement of the '573 and '734 patents, pursuant to 35 U.S.C. § 283;

D. That this Court direct N2K, Inc. to file with this Court and serve on counsel for Parsec, within thirty (30) days of the entry of said injunction, a report in writing under oath setting forth in detail the manner and form in which N2K has complied with the injunction.

E. That this Court order an accounting for damages sufficient to compensate Parsec for the past infringement of the '573 Patent and the '734 Patent by N2K, Inc., pursuant to 35 U.S.C. § 284, together with costs and prejudgment interest for the amount of damages determined;

F. That this Court increase such damages up to three (3) times the amount found or assessed in view of the willful and

deliberate character of such infringement of said patents by N2K, Inc., pursuant to 35 U.S.C. § 284;

G. That this Court find this case "exceptional," thus entitling Parsec to an award of reasonable attorneys' fees, pursuant to 35 U.S.C. § 285; and

H. That this Court award Parsec such other and further relief as the Court may deem just and proper.

PLAINTIFF DEMANDS A JURY TRIAL

MEYER, UNKOVIC & SCOTT LLP

By: 

Richard F. Rinaldo, Esquire
Pa. I.D. No. 33222
Hugh F. McGough, Esquire
Pa. I.D. No. 66025
1300 Oliver Building
Pittsburgh, PA 15222
(412) 456-2800
ATTORNEYS FOR PLAINTIFF PARSEC
SIGHT/SOUND, INC.

ORDER FORM

Date: 3-10-99

RUSH / REGULAR

Need by: _____

Fed. X Priority	Fed. X. Afternoon	Fed. X. 2nd Day	Telefax	Courier	Regular Mail
<input checked="" type="checkbox"/>					

Patent Copy	Patent File Wrapper & Refs	<input checked="" type="checkbox"/>
Foreign Document/Publication	Patent File Wrapper NO Refs	
Trademark File Wrapper	TAB FILE	
Trademark Registration	Assignment Search (need copies?)	
Trademark Search	copy of Assignment (reel/frame)	
	Certification Needed?	

FW + Refs 5 191 573

6066 file 2-299

Christine La dran Patent

*Pub related
3/10*

If order was incomplete for any reason when mailed and notes are on paper work.

Patent No. 5191573

Paper No. 35

NOTICE OF *EX PARTE* REEXAMINATION

Notice is hereby given that a request for *ex parte* reexamination of U.S. Patent No. 5191573 was filed on 1-31-05 pursuant to 35 U.S.C. 302 and 37 CFR 1.510(a).

The reexamination proceeding has been assigned Control No. 90/007402.

This Notice incorporates by reference into the patent file, all papers entered into the reexamination file.

Note: This Notice should be entered into the patent file and given a paper number.

Revised July 2004

**IN THE UNITED STATES DISTRICT COURT
FOR THE WESTERN DISTRICT OF PENNSYLVANIA**

_____)	
SIGHTSOUND TECHNOLOGIES, LLC and)		
SIGHTSOUND TECHNOLOGIES, INC.,)		
)		
Plaintiff,)	CIVIL ACTION NO. 04-1549	
)		
v.)	JUDGE DONETTA W. AMBROSE	
)		
ROXIO, INC., and NAPSTER, LLC,)	JURY TRIAL DEMANDED	
)		
Defendants.)		Pat ^W 5,191,573
)		5,675,734
_____)		5,986,440

FIRST AMENDED COMPLAINT

Plaintiffs SightSound Technologies, LLC and SightSound Technologies, Inc., (collectively, "SightSound"), by their attorneys, Meyer, Unkovic & Scott LLP, brings this civil action for patent infringement against Defendants Roxio, Inc. and Napster, LLC, and their successors in interest, and in support thereof alleges as follows:

Parties

1. SightSound Technologies, Inc., through its successor by merger, SightSound Technologies Holdings, LLC, is a corporation that is organized and existing under the laws of the State of Delaware, with its principal place of business at 311 South Craig Street, Pittsburgh, Pennsylvania, 15213.
2. SightSound Technologies LLC is a corporation that is organized and existing under the laws of the State of Delaware , with its principal place of business at 311 South Craig Street, Pittsburgh, Pennsylvania, 15213.

3. Defendant, Roxio, Inc. (“Roxio”), has at the relevant times been a corporation organized and existing under the laws of the State of Delaware with a principal place of business located at 455 El Camino Real, Santa Clara, CA, 95050.

4. Defendant, Napster, LLC has at the relevant times been a limited liability company organized and existing under the laws of the State of Delaware, with its principal place of business at 9044 Melrose Ave., Los Angeles, California 90069.

5. On information and belief, Roxio acquired certain assets from Napster, Inc., Napster Music Company, Inc., Napster Mobile Company, Inc. and Pressplay, Inc., including the business of selling digital music electronically.

6. On information and belief, Roxio and Napster, LLC (collectively referred to herein as “Napster”), and their successors in interest, working individually and/or together in conjunction, are involved in the electronic sale, and transmission of digital music throughout the United States, including in the Commonwealth of Pennsylvania.

Jurisdiction

7. This Court has jurisdiction over the subject matter of this action under 28 U.S.C. § 1331 and 1338(a).

Venue

8. Venue is proper in this Court under the provisions of 28 U.S.C. § 1391(c) and 28 U.S.C. § 1400(b).

General Facts

9. Arthur R. Hair (“Hair”) is the inventor to whom the United States Patent Office issued United States Patent No. 5,191,573 on March 2, 1993 (hereinafter the “‘573 Patent”). A true and correct copy of the ‘573 Patent is attached hereto as Exhibit “A”.

10. SightSound is the assignee of the rights, title and interest in the '573 Patent issued to Hair.

11. Hair is the inventor to whom the United States Patent Office issued United States Patent No. 5,675,734 on October 7, 1997 (hereinafter the "'734 Patent"). A true and correct copy of the '734 Patent is attached hereto as Exhibit "B".

12. SightSound is the assignee of the rights, title and interest in the '734 Patent issued to Hair.

13. The '734 Patent is a continuation of the application that led to the '573 Patent.

14. Hair is the inventor to whom the United States Patent Office issued United States Patent No. 5,966,440 on October 12, 1999 (hereinafter the "'440 Patent"). A true and correct copy of the '440 Patent is attached hereto as Exhibit "C."

15. SightSound is the assignee of the rights, title and interest in the '440 Patent issued to Hair.

16. The '440 Patent is a continuation of the application that led to the '573 Patent.

17. On January 1, 1998, a SightSound predecessor in interest, SightSound.com, Inc. filed a patent infringement action against N2K, Inc. ("N2K"), for infringement of the '573 Patent, and the '734 Patent in the United States District Court for the Western District of Pennsylvania, Civil Action No. 98-0118. In March, 2000 CDnow, Inc., and CDnow Online Inc. (collectively "CDnow") were joined as defendants in that lawsuit and a claim of infringement of the '440 Patent was added against all defendants.

18. In the lawsuit against CDnow and N2K, this Court held a Markman hearing and issued an order on construction of relevant terms of the claims of the patents in suit. Subsequently, a motion for summary judgment filed by N2K and CDnow alleging invalidity of

the '573 Patent, the '734 Patent, and the '440 Patent, was denied. Plaintiff's motion for summary judgment was granted, dismissing allegations by N2K and CDnow that the plaintiff had committed inequitable conduct.

19. Pursuant to a settlement agreement among the parties, CDnow and N2K agreed to a Final Judgment and Order on Consent, entered by this Court on February 20, 2004, that the '573 Patent, the '734 Patent, and the '440 Patent are valid and enforceable.

COUNT 1

Patent Infringement

20. Paragraphs 1-19, inclusive, above, are hereby incorporated herein by reference.

21. Napster and/or its successors in interest has been making and continues to make and/or has sold and continues to sell and/or continues to induce others to sell and/or use and/or contribute to the making, using or selling of one or more digital audio signals for or with systems and/or processes within the scope of the claims of the '573 Patent in this judicial district and elsewhere in the United States.

22. Napster and/or its successors in interest had notice of the '573 Patent, pursuant to 35 U.S.C. § 287, prior to the commencement of this civil action.

23. The unauthorized making, use, or sale of such digital audio signals by Napster and/or its successors in interest infringes the '573 Patent.

24. Napster and/or its successors in interest is a direct and/or contributory infringer of the '573 Patent, and/or has induced infringement of the '573 Patent by others in violation of 35 U.S.C. § 271.

25. Unless enjoined by this Court, Napster and/or its successors in interest will continue to infringe the '573 Patent in the future.

26. On information and belief, Napster and/or its successors in interest has infringed and is infringing the '573 Patent, with full knowledge of the '573 Patent, and the infringement has been willful and deliberate and continues to be willful and deliberate. This case is exceptional under 35 U.S.C. § 285.

COUNT II

27. Paragraphs 1-26, inclusive, above, are hereby incorporated herein by reference.

28. Napster and/or its successors in interest has been making and continues to make and/or has sold and continues to sell and/or continues to induce others to sell and/or use and/or contribute to the making, using or selling of one or more digital audio signals for or with processes within the scope of the claims of the '734 Patent in this judicial district and elsewhere in the United States.

29. Napster and/or its successors in interest received notice of the '734 Patent pursuant to 35 U.S.C. § 287, prior to the commencement of this civil action.

30. The unauthorized making, use, or sale of such a digital audio signal by Napster and/or its successors in interest infringes the '734 Patent.

31. Napster and/or its successors in interest is a direct and/or contributory infringer of the '734 Patent and/or has induced infringement of the '734 Patent by others in violation of 35 U.S.C. § 271.

32. Unless enjoined by this Court, Napster and/or its successors in interest will continue to infringe the '734 Patent in the future.

33. On information and belief, Napster and/or its successors in interest has infringed and is infringing the '734 Patent with full knowledge of the '734 Patent, and the infringement

has been willful and deliberate and continues to be willful and deliberate. This case is exceptional under 35 U.S.C. § 285.

COUNT III

34. Paragraphs 1-33, inclusive, above, are hereby incorporated herein by reference.

35. Napster and/or its successors in interest has been making and continues to make and/or has sold and continues to sell and/or continues to induce others to sell and/or use and/or contribute to the making, using or selling of one or more digital audio signals for or with processes within the scope of the claims of the '440 Patent in this judicial district and elsewhere in the United States.

36. Napster and/or its successors in interest received notice of the '440 Patent pursuant to 35 U.S.C. § 287, prior to the commencement of this civil action.

37. The unauthorized making, use, or sale of such a digital audio signal by Napster or its successors in interest infringes the '440 Patent.

38. Napster and/or its successors in interest is a direct and/or contributory infringer of the '440 Patent and/or has induced infringement of the '440 Patent by others in violation of 35 U.S.C. § 271.

39. Unless enjoined by this Court, Napster and/ or its successors in interest will continue to infringe the '440 Patent in the future.

40. On information and belief, Napster and/or its successors in interest has infringed and is infringing the '440 Patent, with full knowledge of the '440 Patent, and the infringement has been willful and deliberate and continues to be willful and deliberate. This case is exceptional under 35 U.S.C. § 285.

PRAYER FOR RELIEF

WHEREFORE, Plaintiff SightSound Technologies, LLC demands judgment in its favor and against Napster and/or its successors in interest, as follows:

- A. That this Court adjudge and decree that United States Patent No. 5, 191,573, United States patent No. 5, 675,734, and United States Patent No. 5,966,440 are valid and enforceable against Napster and/or its successors in interest;
- B. That this Court adjudge and decree that Napster and/or its successors in interest has infringed the '573 Patent, the '734 Patent, and the '440 Patent;
- C. That this Court preliminarily and permanently enjoin Napster, its officers, directors, agents, employees, servants, attorneys, successors, assigns and all others controlling, controlled by, affiliated with or in privity with Napster, from committing further acts of infringement of the '573 Patent, the '734 Patent, and the '440 Patent, pursuant to 35 U.S.C. § 283;
- D. That this Court direct Napster and/or its successors in interest to file with this Court and serve on counsel for SightSound, within thirty (30) days of the entry of said injunction, a report in writing under oath setting forth in detail the manner and form in which Napster and/or its successors in interest has complied with the injunction;
- E. That this Court award damages sufficient to compensate SightSound for the infringement of the '573 Patent, the '734 Patent, and the '440 Patent by Napster and/or its successors in interest, pursuant to 35 U.S.C. § 284, together with costs and prejudgment interest for the amount of damages determined;

F. That this Court increase such damages up to three (3) times the amount found or assessed in view of the willful and deliberate character of such infringement of said patents by Napster and or its successors in interest, pursuant to 35 U.S.C. § 284;

G. That this Court find this case “exceptional” and award SightSound its reasonable attorneys’ fees, pursuant to 35 U.S.C. § 285; and

H. That this Court award SightSound such other and further relief as the Court may deem just and proper.

PLAINTIFF DEMANDS A JURY TRIAL

Dated: January 4, 2012

/s/ Russell J. Ober

Russell J. Ober
E-Mail: rjo@muslaw.com
MEYER, UNKOVIC & SCOTT LLP
Suite 1300, Oliver Building
535 Smithfield Street
Pittsburgh, PA 15222-2315
Telephone: (412) 456-2806
Facsimile: (412) 456-3255

Attorneys for SightSound Technologies, Inc. and
SightSound Technologies, LLC