

Class Subclass
ISSUE CLASSIFICATION

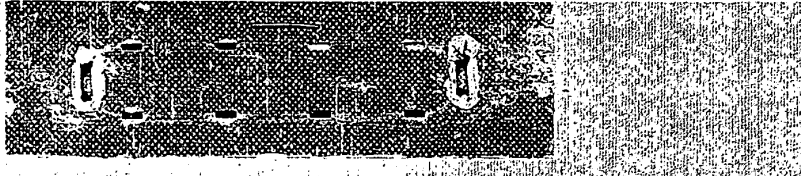

1/023398

PATENT DATE PATENT NUMBER

VERIFIER			
CORPS CORR.			
SPEC. HAND			
FILE MAINT.			
DRAFTING			

INDEX OF CLAIMS

Claim	Date
Final	
Original	
1	
2	
3	
4	
5	
6	
7	
8	
9	
10	
11	
12	
13	
14	
15	
16	
17	
18	
19	
20	
21	
22	
23	
24	
25	
26	
27	
28	
29	
30	
31	
32	
33	
34	
35	
36	
37	
38	
39	
40	
41	
42	
43	
44	
45	
46	
47	
48	
49	
50	

Claim	Date
Final	
Original	
51	
52	
53	
54	
55	
56	
57	
58	
59	
60	
61	
62	
63	
64	
65	
66	
67	
68	
69	
70	
71	
72	
73	
74	
75	
76	
77	
78	
79	
80	
81	
82	
83	
84	
85	
86	
87	
88	
89	
90	
91	
92	
93	
94	
95	
96	
97	
98	
99	
100	

SYMBOLS
 ✓ Rejected
 = Allowed
 (Through numeral) Cancelled
 + Restricted
 N Non-elected
 I Interference
 A Appeal
 O Objected

BEST AVAILABLE COPY

(LEFT INSIDE)

08/023398

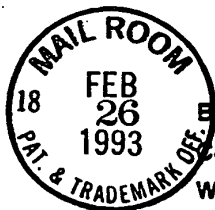

PATENT

Docket No. HAIR-1 CONT II

Express Patent Application
Commissioner of Patents and Trademarks
Washington, D.C. 20231

NEW APPLICATION TRANSMITTAL

Transmitted herewith for filing is the patent application of
Inventor(s): Arthur R. Hair

WARNING: Patent must be applied for in the name(s) of all of the actual inventor(s). 37 CFR 1.41(a) and 1.53(b).

For (title): A SYSTEM FOR TRANSMITTING DIGITAL VIDEO OR
AUDIO SIGNALS

1. Type of Application

This new application is for a(n) (check one applicable item below):

- Original
- Design
- Plant

WARNING: Do not use this transmittal for a completion in the U.S. of an International Application under 35 U.S.C. 371(c)(4) unless the International Application is being filed as a divisional, continuation or continuation-in-part application.

NOTE: If one of the following 3 items apply then complete and attach ADDED PAGES FOR NEW APPLICATION TRANSMITTAL WHERE BENEFIT OF A PRIOR U.S. APPLICATION CLAIMED and a NOTIFICATION IN PARENT APPLICATION OF THE FILING OF THIS CONTINUATION APPLICATION.

- Divisional
- Continuation
- Continuation-in-part (CIP)

CERTIFICATION UNDER 37 CFR 1.10

I hereby certify that this New Application Transmittal and the documents referred to as enclosed therein are being deposited with the United States Postal Service on this date February 26, 1993 in an envelope as "Express Mail Post Office to Addressee" Mailing Label Number TB252287398 US addressed to the: Commissioner of Patents and Trademarks, Washington, D.C. 20231.

Tracey L. Milka

(Type or print name of person mailing paper)

Tracey L. Milka

(Signature of person mailing paper)

NOTE: Each paper or fee referred to as enclosed herein has the number of the "Express Mail" mailing label placed thereon prior to mailing. 37 CFR 1.10(b).

(Application Transmittal [4-1]—page 1 of 7)

RETAIN THIS NUMBER-CUSTOMER RECEIPT WILL BE MAILED TO YOU.

TB252287398US

2. Benefit of Prior U.S. Application(s) (35 USC 120)

NOTE: If the new application being transmitted is a divisional, continuation or a continuation-in-part of a parent case, or where the parent case is an International Application which designated the U.S., then check the following item and complete and attach ADDED PAGES FOR NEW APPLICATION TRANSMITTAL WHERE BENEFIT OF PRIOR U.S. APPLICATION(S) CLAIMED.

- The new application being transmitted claims the benefit of prior U.S. application(s) and enclosed are ADDED PAGES FOR NEW APPLICATION TRANSMITTAL WHERE BENEFIT OF PRIOR U.S. APPLICATION(S) CLAIMED.

3. Papers Enclosed Which Are Required For Filing Date Under 37 CFR 1.53(b) (Regular) or 37 CFR 1.153 (Design) Application

- 11 Pages of specification
 11 Pages of claims
 1 Pages of Abstract
 2 Sheets of drawing

- formal
 informal

WARNING: *DO NOT submit original drawings. A high quality copy of the drawings should be supplied when filing a patent application. The drawings that are submitted to the Office must be on strong, white, smooth, and non-shiny paper and meet the standards according to § 1.84. If corrections to the drawings are necessary, they should be made to the original drawing and a high-quality copy of the corrected original drawing then submitted to the Office. Only one copy is required or desired. Comments on proposed new 37 CFR 1.84. Notice of March 9, 1988 (1990 O.G. 57-62).*

NOTE: *"Identifying indicia such as the serial number, group and unit, title of the invention, attorney's docket number, inventor's name, number of sheets, etc., not to exceed 2 3/4 inches (7.0 cm.) in width may be placed in a centered location between the side edges within three fourths inch (19.1 mm.) of the top edge. Either this marking technique on the front of the drawing or the placement, although not preferred, of this information and the title of the invention on the back of the drawings is acceptable." Proposed 37 CFR 1.84(1). Notice of March 9, 1988 (1090 O.G. 57-62).*

4. Additional papers enclosed

- Preliminary Amendment
 Information Disclosure Statement (37 CFR 1.98)
 Form PTO-1449
 Citations
 Declaration of Biological Deposit
 Submission of "Sequence Listing," computer readable copy and/or amendment pertaining thereto for biotechnology invention containing nucleotide and/or amino acid sequence.
 Authorization of Attorney(s) to Accept and Follow Instructions from Representative
 Special Comments
 Other

(Application Transmittal [4-1]—page 2 of 7)

5. Declaration: Oath

Enclosed

executed by (check all applicable boxes)

inventor(s).

legal representative of inventor(s). 37 CFR 1.42 or 1.43

joint inventor or person showing a proprietary interest on behalf of inventor who refused to sign or cannot be reached.

this is the petition required by 37 CFR 1.47 and the statement required by 37 CFR 1.47 is also attached. See item 13 below for fee.

Not Enclosed.

WARNING: Where the filing is a completion in the U.S. of an International Application but where a declaration is not available or where the completion of the U.S. application contains subject matter in addition to the International Application the application may be treated as a continuation or continuation-in-part, as the case may be, utilizing ADDED PAGE FOR NEW APPLICATION TRANSMITTAL WHERE BENEFIT OF PRIOR U.S. APPLICATION CLAIMED.

Application is made by a person authorized under 37 CFR 1.41(c) on behalf of all the above named inventor(s). (The declaration or oath, along with the surcharge required by 37 CFR 1.16(e) can be filed subsequently).

NOTE: It is important that all the correct inventor(s) are named for filing under 37 CFR 1.41(c) and 1.53(b).

Showing that the filing is authorized. (Not required unless called into question. 37 CFR 1.41(d).

6. Inventorship Statement

WARNING: If the named inventors are each not the inventors of all the claims an explanation, including the ownership of the various claims at the time the last claimed invention was made, should be submitted.

The inventorship for all the claims in this application are:

The same

or

Are not the same. An explanation, including the ownership of the various claims at the time the last claimed invention was made,

is submitted.

will be submitted.

7. Language

NOTE: An application including a signed oath or declaration may be filed in a language other than English. A verified English translation of the non-English language application and the processing fee of \$130.00 required by 37 CFR 1.17(k) is required to be filed with the application or within such time as may be set by the Office. 37 CFR 1.52(d).

NOTE: A non-English oath or declaration in the form provided or approved by the PTO need not be translated. 37 CFR 1.69(b).

English

non-English

the attached translation is a verified translation. 37 CFR 1.52(d).

(Application Transmittal [4-1]—page 3 of 7)

8. Assignment

- An assignment of the invention to _____
- is attached. A separate "COVER SHEET FOR ASSIGNMENT (DOCUMENT) ACCOMPANYING NEW PATENT APPLICATION" or FORM PTO 1906 is also attached.
- will follow.

NOTE: "If an assignment is submitted with a new application, send two separate letters-one for the application and one for the assignment." Notice of May 4, 1990 (1114 O.G. 77-78).

9. Certified Copy

Certified copy(ies) of application(s)

(country)	(appln. no.)	(filed)
(country)	(appln. no.)	(filed)
(country)	(appln. no.)	(filed)

from which priority is claimed

- is(are) attached.
- will follow.

NOTE: The foreign application forming the basis for the claim for priority must be referred to in the oath or declaration. 37 CFR 1.55(a) and 1.63.

NOTE: This item is for any foreign priority for which the application being filed directly relates. If any parent U.S. application or International Application from which this application claims benefit under 35 U.S.C. 120 is itself entitled to priority from a prior foreign application then complete item 18 on the ADDED PAGES FOR NEW APPLICATION TRANSMITTAL WHERE BENEFIT OF PRIOR U.S. APPLICATION(S) CLAIMED.

10. Fee Calculation (37 CFR 1.16)

- A. Regular application

CLAIMS AS FILED						
Number filed		Number Extra		Rate		Basic Fee 37 CFR 1.16(a) \$710.00
Total						
Claims (37 CFR 1.16(c))	31	-20=	11	X	\$ 22.00	242.00
Independent						
Claims (37 CFR 1.16(b))	8	-3=	5	X	\$ 74.00	370.00
Multiple dependent claim(s), if any (37 CFR 1.16(d))					\$230.00	

- Amendment cancelling extra claims enclosed.
- Amendment deleting multiple-dependencies enclosed.
- Fee for extra claims is not being paid at this time.

NOTE: If the fees for extra claims are not paid on filing they must be paid or the claims cancelled by amendment, prior to the expiration of the time period set for response by the Patent and Trademark Office in any notice of fee deficiency. 37 CFR 1.16(d).

Filing Fee Calculation

\$ 1,322.00

B. Design application
(\$280.00—37 CFR 1.16(f))

Filing Fee Calculation \$ _____

C. Plant application
(\$460.00—37 CFR 1.16(g))

Filing fee calculation \$ _____

11. Small Entity Statement(s)

Verified Statement(s) that this is a filing by a small entity under 37 CFR 1.9 and 1.27 is(are) attached.

Filing Fee Calculation (50% of A, B or C above) \$ 661.00

NOTE: Any excess of the full fee paid will be refunded if a verified statement and a refund request are filed within 2 months of the date of timely payment of a full fee. 37 CFR 1.28(a).

12. Request for International-Type Search (37 CFR 1.104(d)) (complete, if applicable)

Please prepare an international-type search report for this application at the time when national examination on the merits takes place.

13. Fee Payment Being Made At This Time

Not Enclosed

No filing fee is to be paid at this time. (This and the surcharge required by 37 CFR 1.16(e) can be paid subsequently.)

Enclosed

basic filing fee \$ 661.00

recording assignment (\$40.00; 37 CFR 1.21(h)) \$ _____

petition fee for filing by other than all the inventors or person on behalf of the inventor where inventor refused to sign or cannot be reached. (\$130.00; 37 CFR 1.47 and 1.17(h)) \$ _____

for processing an application with a specification in a non-English language. (\$130.00; 37 CFR 1.52(d) and 1.17(k)) \$ _____

processing and retention fee (\$130.00; 37 CFR 1.53(d) and 1.21(l))

fee for international-type search report (\$35.00; 37 CFR 1.21(e)). \$ _____

NOTE: 37 CFR 1.21(l) establishes a fee for processing and retaining any application which is abandoned for failing to complete the application pursuant to 37 CFR 1.53(d) and this, as well as the changes to 37 CFR 1.53 and 1.78, indicate that in order to obtain the benefit of a prior U.S. application, either the basic filing fee must be paid or the processing and retention fee of § 1.21(l) must be paid within 1 year from notification under § 53(d).

Total fees enclosed \$ 661.00

(Application Transmittal [4-1]—page 5 of 7)

14. Method of Payment of Fees

- Check in the amount of \$ 661.00
- Charge Account No. _____ in the amount of \$ _____ A duplicate of this transmittal is attached.

NOTE: Fees should be itemized in such a manner that it is clear for which purpose the fees are paid. 37 CFR 1.22(b).

15. Authorization to Charge Additional Fees

WARNING: *If no fees are to be paid on filing the following items should not be completed.*

WARNING: *Accurately count claims, especially multiple dependent claims, to avoid unexpected high charges, if extra claim charges are authorized.*

- The Commissioner is hereby authorized to charge the following additional fees by this paper and during the entire pendency of this application to Account No. 19-0737.

- 37 CFR 1.16(a), (f) or (g) (filing fees)

- 37 CFR 1.16(b), (c) and (d) (presentation of extra claims)

NOTE: Because additional fees for excess or multiple dependent claims not paid on filing or on later presentation must only be paid or these claims cancelled by amendment prior to the expiration of the time period set for response by the PTO in any notice of fee deficiency (37 CFR 1.16(d)), it might be best not to authorize the PTO to charge additional claim fees, except possibly when dealing with amendments after final action.

- 37 CFR 1.16(e) (surcharge for filing the basic filing fee and/or declaration on a date later than the filing date of the application)

- 37 CFR 1.17 (application processing fees)

WARNING: *While 37 CFR 1.17(a), (b), (c) and (d) deal with extensions of time under § 1.136(a) this authorization should be made only with the knowledge that: "Submission of the appropriate extension fee under 37 C.F.R. 1.136(a) is to no avail unless a request or petition for extension is filed." (Emphasis added). Notice of November 5, 1985 (1060 O.G. 27).*

- 37 CFR 1.18 (issue fee at or before mailing of Notice of Allowance, pursuant to 37 CFR 1.311(b))

NOTE: Where an authorization to charge the issue fee to a deposit account has been filed before the mailing of a Notice of Allowance, the issue fee will be automatically charged to the deposit account at the time of mailing the notice of allowance. 37 CFR 1.311(b).

NOTE: 37 CFR 1.28(b) requires "Notification of any change in loss of entitlement to small entity status must be filed in the application . . . prior to paying, or at the time of paying, . . . issue fee". From the wording of 37 CFR 1.28(b): (a) notification of change of status must be made even if the fee is paid as "other than a small entity" and (b) no notification is required if the change is to another small entity.

16. Instructions As To Overpayment

- credit Account No. 19-0737
- refund

Reg. No. 30,587

Tel. No. (412) 621-9222

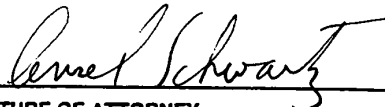

SIGNATURE OF ATTORNEY

Ansel M. Schwartz

Type or print name of attorney

Attorney at Law

P.O. Address

425 N. Craig Street, Suite 301

Pittsburgh, PA 15213

(Application Transmittal [4-1]—page 6 of 7)

Incorporation by reference of added pages

Check the following item if the application in this transmittal claims the benefit of prior U.S. application(s) (including an international application entering the U.S. stage as a continuation, divisional or C-I-P application) and complete and attach the ADDED PAGES FOR NEW APPLICATION TRANSMITTAL WHERE BENEFIT OF PRIOR U.S. APPLICATION(S) CLAIMED

Plus Added Pages For New Application Transmittal Where Benefit Of Prior U.S. Application(s) Claimed

Number of pages added 5

Plus Added Pages For Papers Referred To In Item 4 Above

Number of pages added _____

Plus "Assignment Cover Letter Accompanying New Application"

Number of pages added _____

Statement Where No Further Pages Added

(If no further pages form a part of this Transmittal then end this Transmittal with this page and check the following item)

This transmittal ends with this page.

**ADDED PAGES FOR APPLICATION TRANSMITTAL WHERE BENEFIT OF
PRIOR U.S. APPLICATION(S) CLAIMED**

NOTE: "In order for an application to claim the benefit of a prior filed copending national application, the prior application must name as an inventor at least one inventor named in the later filed application and disclose the named inventor's invention claimed in at least one claim of the later filed application in the manner provided by the first paragraph of 35 U.S.C. 112." 37 CFR 1.78(a).

NOTE: "In addition the prior application must be (1) complete as set forth in § 1.51, or (2) entitled to a filing date as set forth in § 1.53(b) and include the basic filing fee set forth in § 1.16; or (3) entitled to a filing date as set forth in § 1.53(b) and have paid therein the processing and retention fee set forth in § 1.21(1) within the time period set forth in § 1.53(d)." 37 CFR 1.78(a).

17. Relate Back—35 U.S.C. 120

NOTE: "Any application claiming the benefit of a prior filed copending national or international application must contain or be amended to contain in the first sentence of the specification following the title a reference to such prior application identifying it by serial number and filing date or international application number and international filing date and indicating the relationship of the applications." 37 CFR 1.78(a). See also the Notice of April 28, 1987 (1079 O.G. 32 to 46).

Amend the Specification by inserting before the first line the sentence:

"This is a

- continuation
 continuation-in-part
 divisional

of copending application(s)

- serial number 0 7 / 586,391 filed on September 18, 1990 "
 International Application _____ filed on _____
_____ and which designated the U.S."

NOTE: The proper reference to a prior filed PCT application which entered the U.S. national phase is the U.S. serial number and the filing date of the PCT application which designated the U.S.

NOTE: (1) Where the application being transmitted adds subject matter to the International Application then the filing can be as a continuation-in-part or (2) it is desired to do so for other reasons, e.g. where no declaration is available, no English translation is available or no fee is to be paid on filing then the filing can be as a continuation. In these cases the International Application designating the U.S. is treated as the parent case in the U.S. and is an alternative to the completion of the International Application under 35 U.S.C. 371(c)(4) which must meet the requirements of 37 CFR 1.61(a). This alternative permits the completion of the filing requirements within any term set by the PTO under 37 CFR 1.53(d) to which the extension provisions of 37 CFR 1.136(a) apply. (Whereas, if the filing is as an international application entering the U.S. stage then the fee, declaration and/or English translation (where necessary) is due within 20 months of the priority date but can be paid within 22 months of the priority date (or is due within 30 months of the priority date but can be submitted within 32 months of the priority date) with the surcharges set forth in 37 CFR 1.492(e), (f) and 37 CFR 1.495(c); however, the provisions of 37 CFR 1.136 do not apply to this 22 or (32 month) period. 37 CFR 1.61(b).)

NOTE: The deadline for entering the national phase in the U.S. for an international application was clarified in the Notice of April 28, 1987 (1079 O.G. 32 to 46) as follows:

"The Patent and Trademark Office considers the international application to be pending until the 22nd month from the priority date if the United States has been designated and no Demand for International Preliminary Examination has been filed prior to the expiration of the 19th month from the priority date and until the 32nd month from the priority date if a Demand for International Preliminary Examination which elected the United States of America has been filed prior to the expiration of the 19th month from the priority date, provided that a copy of the international application has been communicated to the Patent and Trademark Office within the 20 or 30 month period respectively. If a copy of the international application has not been communicated to the Patent and Trademark Office within the 20 or 30 month period respectively, the international application becomes abandoned or to the United States 2

(Added Pages for Application Transmittal Where Benefit of Prior U.S. Application(s)
Claimed [4-1.1]—page 1 of 4)

or 30 months from the priority date respectively. These periods have been placed in the rules as paragraph (h) of § 1.494 and paragraph (2) of § 1.495. A continuing application under 35 U.S.C. 365(c) and 120 may be filed anytime during the pendency of the international application."

18. Relate Back—35 U.S.C. 119 Priority Claim for Prior Application

The prior U.S. application(s), including any prior International Application designating the U.S., identified above in item 16, in turn itself claim(s) foreign priority (ies) as follows:

country	appl. no.	filed on
---------	-----------	----------

The certified copy (ies) has (have)

- been filed on _____ in prior application 0 / _____ which was filed on _____
- is (are) attached

WARNING: The certified copy of the priority application which may have been communicated to the PTO by the International Bureau may not be relied on without any need to file a certified copy of the priority application in the continuing application. This is so because the certified copy of the priority application communicated by the International Bureau is placed in a folder and is not assigned a U.S. serial number unless the national stage is entered. Such folders are disposed of if the national stage is not entered. Therefore such certified copies may not be available if needed later in the prosecution of a continuing application. An alternative would be to physically remove the priority documents from the folders and transfer them to the continuing application. The resources required to request transfer, retrieve the folders, make suitable record notations, transfer the certified copies, enter and make a record of such copies in the Continuing Application are substantial. Accordingly, the priority documents in folders of international applications which have not entered the national stage may not be relied on. Notice of April 28, 1987 (1079 O.G. 32 to 46).

19. Maintenance of Copendency of Prior Application

NOTE: The PTO finds it useful if a copy of the petition filed in the prior application extending the term for response is filed with the papers constituting the filing of the continuation application. Notice of November 5, 1985 (1060 O.G. 27).

- A. Extension of time in prior application

(This item must be completed and the papers filed in the prior application if the period set in the prior application has run)

- A petition, fee and response extends the term in the pending prior application until _____
- A copy of the petition filed in prior application is attached

- B. Conditional Petition for Extension of Time in Prior Application

(complete this item if previous item not applicable)

- A conditional petition for extension of time is being filed in the pending prior application.
- A copy of the conditional petition filed in the prior application is attached

20. Further Inventorship Statement Where Benefit of Prior Application(s) Claimed

NOTE: "If the continuation, continuation-in-part, or divisional application is filed by less than all the inventors named in the prior application a statement must accompany the application when filed requesting deletion of the names of the person or persons who are not inventors of the invention being claimed in the continuation, continuation-in-part, or divisional application." 37 CFR 1.62(a) [emphasis added]. (dealing with the file wrapper continuation situation).

NOTE: "In the case of a continuation-in-part application which adds and claims additional disclosure by amendment, an oath or declaration as required by § 1.63 must be filed. In those situations where a new oath or declaration is required due to additional subject matter being claimed, additional inventors may be named in the continuing application. In a continuation or divisional application which discloses

(Added Pages for Application Transmittal Where Benefit of Prior U.S. Application(s) Claimed [4-1.1]—page 2 of 4)

and claims only subject matter disclosed in a prior application, no additional oath or declaration is required and the application must name as inventors the same or less than all the inventors in the prior application." 37 CFR 1.60(c). (dealing with the continuation situation).

(complete applicable item (a), (b) and/or (c) below)

- (a) This application discloses and claims only subject matter disclosed in the prior application whose particulars are set out above and the inventor(s) in this application are
- the same
 - less than those named in the prior application and it is requested that the following inventor(s) identified for the prior application be deleted:

(Type name(s) of inventor(s) to be deleted)

- (b) This application discloses and claims additional disclosure by amendment and a new declaration or oath is being filed. With respect to the prior application the inventor(s) in this application are
- the same
 - the following additional inventor(s) have been added

(Type name(s) of inventor(s) to be added)

- (c) The inventorship for all the claims in this application are
- the same
 - not the same, and an explanation, including the ownership of the various claims at the time the last claimed invention was made
 - is submitted
 - will be submitted

21. Abandonment of Prior Application (if applicable)

- Please abandon the prior application at a time while the prior application is pending or when the petition for extension of time or to revive in that application is granted and when this application is granted a filing date so as to make this application copending with said prior application.

NOTE: According to the Notice of May 13, 1983 (103, TMOG 6-7) the filing of a continuation or continuation-in-part application is a proper response with respect to a petition for extension of time or a petition to revive and should include the express abandonment of the prior application conditioned upon the granting of the petition and the granting of a filing date to the continuing application.

22. Petition for Suspension of Prosecution for the Time Necessary to File an Amendment

WARNING: "The claims of a new application may be finally rejected in the first Office action in those situations where (1) the new application is a continuing application of, or a substitute for, an earlier application, and (2) all the claims of the new application (a) are drawn to the same invention claimed in the earlier application, and (b) would have been properly finally rejected on the grounds of art of record in the next Office action if they had been entered in the earlier application." MPEP, § 706.07(b).

NOTE: Where it is possible that the claims on file will give rise to a first action final for this continuation application and for some reason an amendment cannot be filed promptly (e.g., experimental data is being gathered) it may be desirable to file a petition for suspension of prosecution for the time necessary.

(Added Pages for Application Transmittal Where Benefit of Prior U.S. Application(s)
Claimed [4-1.1]—page 3 of 4)

(check the next item, if applicable)

- There is provided herewith a Petition To Suspend Prosecution for the Time Necessary to File An Amendment (New Application Filed Concurrently)

23. NOTIFICATION IN PARENT APPLICATION OF THIS FILING

- A notification of the filing of this
(check one of the following)

- continuation
 continuation-in-part
 divisional

is being filed in the parent application from which this application claims priority under 35 USC § 120.

(Added Pages for Application Transmittal Where Benefit of Prior U.S. Application(s)
Claimed [4-1.1]—page 4 of 4)

**ADDED PAGE(S) FOR APPLICATION TRANSMITTAL WHERE BENEFIT OF
A PRIOR U.S. APPLICATION CLAIMED**

This is a continuation application of U.S. patent application serial number 07/586,391 filed September 18, 1990, now U.S. Patent No. 5,191,573, issued March 2, 1993, which is a continuation application of U.S. patent application serial number 07/206,497, filed June 13, 1988, abandoned.

Added page 1

(Added Page for Special Comments for Application Transmittal Where Benefit of a Prior
U.S. Application Claimed [4-1.1])

607,648

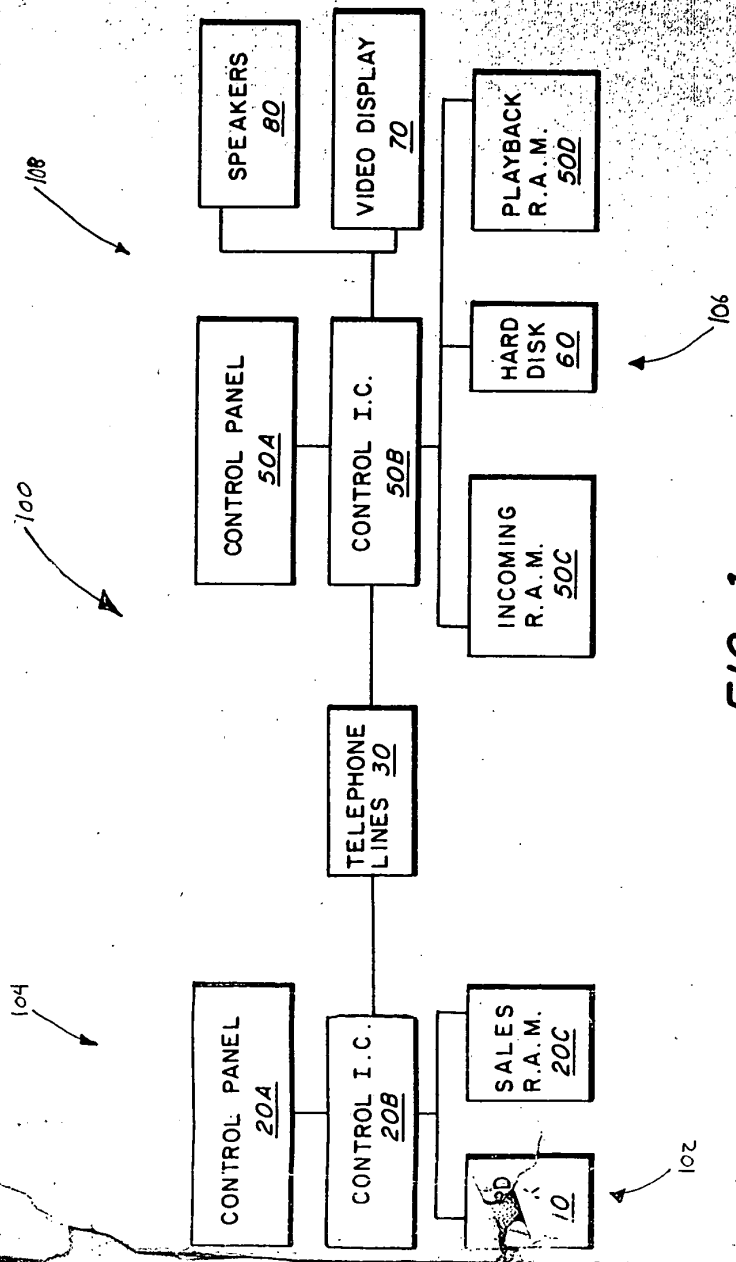

FIG. 1

BEST AVAILABLE COPY

607,648

108 ↗

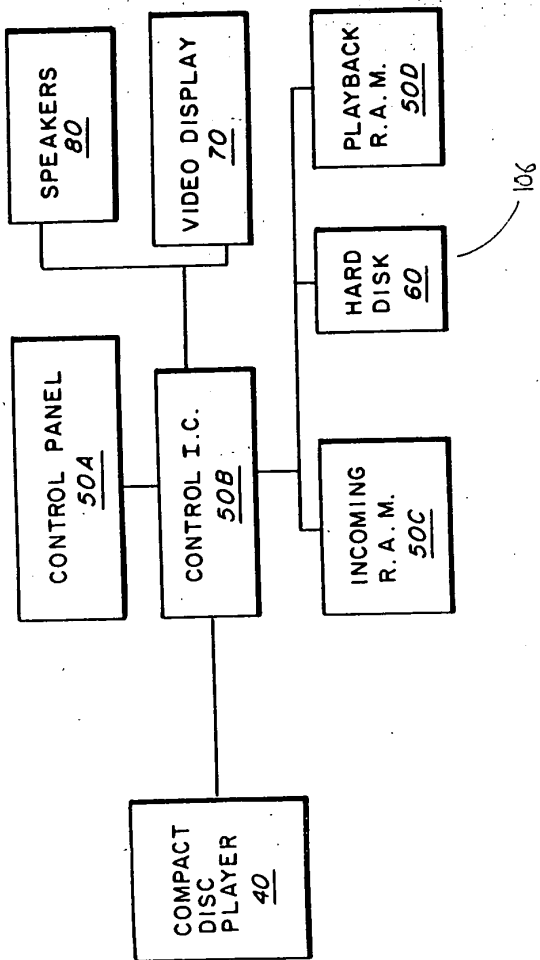

FIG. 2

BEST AVAILABLE COPY

8661 1201

A

08/023398
607,648

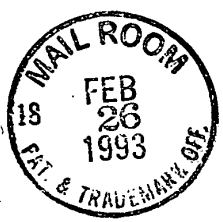

Handwritten notes:
A
C
E

~~A SYSTEM FOR TRANSMITTING DESIRED
DIGITAL VIDEO OR AUDIO SIGNALS~~

CROSS REFERENCE TO OTHER PATENTS

(E) which ~~this~~ is a continuation application of U.S. patent
5 application serial number 07/586,391 filed September 18, 1990, now
U.S. Patent No. 5,191,573, issued March 2, 1993, which is a
continuation application of U.S. patent application serial number
07/206,497, filed June 13, 1988, abandoned.

FIELD OF THE INVENTION

10 The present invention is related to a system and
associated method for the electronic sales and distribution of
digital audio or ^{digital} video signals, and more particularly, to a system
and method which a user may purchase and receive digital audio or
^{digital} video ~~signal~~ ^{signals} from any location which the user has access to
15 telecommunications lines.

BACKGROUND OF THE INVENTION

The three basic mediums (hardware units) of music:
records, tapes, and compact discs, greatly restricts the
transferability of music and results in a variety of
20 inefficiencies.

CAPACITY: The individual hardware units as cited above
are limited as to the amount of music that can be stored on each.

MATERIALS: The materials used to manufacture the
hardware units are subject to damage and deterioration during
25 normal operations, handling, and exposure to the elements.

SIZE: The physical size of the hardware units imposes constraints on the quantity of hardware units which can be housed for playback in confined areas such as in automobiles, boats, planes, etc.

5 RETRIEVAL: Hardware units limit the ability to play, in a sequence selected by the user, songs from different albums. For example, if the user wants to play one song from ten different albums, the user would spend an inordinate amount of time handling, sorting, and cueing the ten different hardware units.

10 SALES AND DISTRIBUTION: Prior to final purchase, hardware units need to be physically transferred from the manufacturing facility to the wholesale warehouse to the retail warehouse to the retail outlet, resulting in lengthy lag time between music creation and music marketing, as well as incurring
15 unnecessary and inefficient transfer and handling costs. Additionally, tooling costs required for mass production of the hardware units and the material cost of the hardware units themselves, further drives up the cost of music to the end user.

QUALITY: Until the recent invention of Digital Audio
20 Music, as used on Compact Discs, distortion free transfer from the hardware units to the stereo system was virtually impossible. Digital Audio Music is simply music converted into a very basic computer language known as binary. A series of commands known as zeros or ones encode the music for future playback. Use of laser
25 retrieval of the binary commands results in distortion free transfer of the music from the compact disc to the stereo system. Quality Digital Audio Music is defined as the binary structure of the Digital Audio Music. Conventional analog tape recording of Digital Audio Music is not to be considered quality inasmuch as the
30 binary structure itself is not recorded. While Digital Audio Music

on compact discs is a technological breakthrough in audio quality, the method by which the music is sold, distributed, stored, manipulated, retrieved, played and protected from copyright infringements remains as inefficient as with records and tapes.

5 COPYRIGHT PROTECTION: Since the invention of tape recording devices, strict control and enforcement of copyright laws have proved difficult and impossible with home recorders. Additionally, the recent invention of Digital Audio Tape Recorders now jeopardizes the electronic copyright protection of quality Digital Audio Music on Compact Discs or Digital Audio Tapes. If music exists on hardware units, it can be copied. *g2*

*class 10
g2*

Accordingly, it is an objective of this invention is to provide a new and improved methodology/system to electronically sell and distribute Digital Audio Music *or digital video*

a

15 A further objective of this invention to provide a new and improved methodology/system to electronically store and retrieve Digital Audio Music *or digital video*

a

Another objective of this invention is to provide a new and improved methodology/system to electronically manipulate, i.e., sort, cue, and select, Digital Audio Music *or digital video* for playback.

a

20 Still another objective of this invention is to offer a new and improved methodology/system which can prevent unauthorized electronic copying of quality Digital Audio Music *or digital video*.

a

SUMMARY OF THE INVENTION

25 Briefly, this invention accomplishes the above cited objectives by providing a new and improved methodology/system of

4

electronic sales, distribution, storage, manipulation, retrieval, playback, and copyright protection of Digital Audio Music. The high speed transfer of Digital Audio Music as prescribed by this invention is stored onto one piece of hardware, a hard disk, thus
5 eliminating the need to unnecessarily handle records, tapes, or compact discs on a regular basis. This invention recalls stored music for playback as selected/programmed by the user. This invention can easily and electronically sort stored music based on many different criteria such as, but not limited to, music
10 category, artist, album, user's favorite songs, etc. An additional feature of this invention is the random playback of songs, also based on the user's selection. For example, the user could have this invention randomly play all jazz songs stored on the user's hard disk, or randomly play all songs by a certain artist, or
15 randomly play all of the user's favorite songs which the user previously electronically "tagged" as favorites. Further, being more specific, the user can electronically select a series of individual songs from different albums for sequential playback.

This invention can be configured to either accept direct
20 input of Digital Audio Music from the digital output of a Compact Disc, such transfer would be performed by the private user, or this invention can be configured to accept Digital Audio Music from a source authorized by the copyright holder to sell and distribute the copyrighted materials, thus guaranteeing the protection of such
25 copyrighted materials. Either method of electronically transferring Digital Audio Music by means of this invention is intended to comply with all copyright laws and restrictions and any such transfer is subject to the appropriate authorization by the copyright holder. Inasmuch as Digital Audio Music is software and
30 this invention electronically transfers and stores such music, electronic sales and distribution of the music can take place via telephone lines onto a hard disk. This new methodology/system of

music sales and distribution will greatly reduce the cost of goods sold and will reduce the lag time between music creation and music marketing from weeks down to hours.

The present invention is a system for transmitting
 5 desired ^{digital} digital video or ^{preferably} audio signals stored on a first memory of
 a first party to a second memory of a second party. The system
 comprises ^{or mechanism} means for electronically selling the desired digital
 video or ^{digital} audio signals, ^{preferably} via telecommunications lines to the first
 party from the second party. Moreover, the system preferably
 10 comprises ^{or mechanism} means for connecting electronically via
 telecommunications lines the first ^{preferably} memory with the second memory
 such that the desired digital video or ^{digital} audio signals can pass
 therebetween. Additionally, the system comprises ^{or mechanism} means for
 transmitting the desired digital video or ^{digital} audio signals from the
 15 first memory with a transmitter in control and in possession of the
 first party to a receiver, ^{preferably} having the second memory ~~at a location~~
~~determined by the second party,~~ ^{while the} the receiver is in possession and
 in control of the second party. ^{Preferably, there} ~~is~~ ^{or mechanism} means for storing
 the ^{video or digital audio} digital signal in the second memory.

20 Further objectives and advantages of this invention will become apparent as the following description proceeds and the particular features of novelty which characterize this invention will be pointed out in the claims annexed to and forming a part of this declaration.

25 BRIEF DESCRIPTION OF THE DRAWINGS

For a better understanding of this invention, reference should be made to the following detailed description, taken in conjunction with the accompanying drawings, in which:

6

Fig. 1 is a pictorial flow chart which may be used in carrying out the teachings of this invention for the purposes of electronic sales, distribution, storage, manipulation, retrieval, playback, and copyright protection of Digital Audio Music; and

5 Fig. 2 is a pictorial flow chart which may be used in carrying out the teachings of this invention for the purposes of electronic storage, manipulation, retrieval, and playback of Digital Audio Music.

DESCRIPTION OF THE PREFERRED EMBODIMENT

10 Referring now to the drawings wherein like reference numerals refer to similar or identical parts throughout the several views, and more specifically to figure thereof, there is shown

a Referring now to the Fig. 1, this invention ^{preferably} is comprised of the following:

- 15 10 Hard Disk of the copyright holder
- 20 20 Control Unit of the copyright holder
 - 20a Control Panel
 - 20b Control Integrated Circuit
 - 20c Sales Random Access Memory Chip
- 20 30 Telephone Lines/Input Transfer
- 50 50 Control Unit of the user
 - 50a Control Panel
 - 50b Control Integrated Circuit
 - 50c Incoming Random Access Memory Chip
 - 25 50d Play Back Random Access Memory Chip
- 60 60 Hard Disk of the user
- 70 70 Video Display Unit
- 80 80 Stereo Speakers

The Hard Disk 10 of the first party or agent authorized to electronically sell and distribute the copyrighted Digital Audio Music is the originating source of music in the configuration as outlined in Fig. 1. The Control Unit 20 of the authorized agent is
5 the means by which the electronic transfer of the Digital Audio Music from the agent's Hard Disk 10 via the Telephone Lines 30 to the user's or second party's Control Unit 50 is possible. The user's Control Unit is comprised of a Control Panel 50a, a Control Integrated Circuit 50b, an Incoming Random Access Memory Chip 50c,
10 and a Play Back Random Access Memory Chip 50d. Similarly, the authorized agent's Control Unit 20 has a control panel and control integrated circuit similar to that of the user's Control Unit 50. The authorized agent's Control Unit 20, however, only requires the Sales Random Access Memory Chip 20c. The other components in Fig.
15 1 include a Hard Disk 60, a Video Display Unit 70, and a set of Stereo Speakers 80.

Referring now to Fig. 2, with the exception of a substitution of a Compact Disc Player 40 (as the initial source of Digital Audio Music) for the agent's Hard Disk 10, the agent's
20 Control Unit 20, and the Telephone Lines 30 in Fig. 1, Fig. 2 is the same as Fig. 1.

In Fig. 1 and Fig. 2, the following components are already commercially available: the agent's Hard Disk 10, the Telephone Lines 30, the Compact Disc Player 40, the user's Hard
25 Disk 60, the Video Display Unit 70, and the Stereo Speakers 80. The Control Units 20 and 50, however, would be designed specifically to meet the teachings of this invention. The design of the control units would incorporate the following functional features:



1) the Control Panels 20a and 50a would be designed to permit the agent and user to program the respective Control Integrated Circuits 20b and 50b,

2) the Control Integrated Circuits 20b and 50b would be
5 designed to control and execute the respective commands of the agent and user and regulate the electronic transfer of Digital Audio Music throughout the system, additionally, the sales Control Integrated Circuit 20b could electronically code the Digital Audio Music in a configuration which would prevent unauthorized
10 reproductions of the copyrighted material,

3) the Sales Random Access Memory Chip 20c would be designed to temporarily store user purchased Digital Audio Music for subsequent electronic transfer via telephone lines to the user's Control Unit 50,

15 4) the Incoming Random Access Memory Chip 50c would be designed to temporarily store Digital Audio Music for subsequent electronic storage to the user's Hard Disk 60,

5) the Play Back Random Access Memory Chip 50d would be designed to temporarily store Digital Audio Music for sequential
20 playback.

The foregoing description of the Control Units 20 and 50 is intended as an example only and thereby is not restrictive with respect to the exact number of components and/or its actual design.

25 Once the Digital Audio Music has been electronically stored onto the user's Hard Disk 60, having the potential to store literally thousands of songs, the user is free to perform the many functions of this invention. To play a stored song, the user types

19

in the appropriate commands on the Control Panel 50a, and those commands are relayed to the Control Integrated Circuit 50b which retrieves the selected song from the Hard Disk 60. When a song is retrieved from the Hard Disk 60 only a replica of the permanently
5 stored song is retrieved. The permanently stored song remains intact on the Hard Disk 60, thus allowing repeated playback. The Control Integrated Circuit 50b stores the replica onto the Play Back Random Access Memory Chip 50d at a high transfer rate. The Control Integrated Circuit 50b then sends the electronic output to
10 the Stereo Speakers 80 at a controlled rate using the Play Back Random Access Memory Chip 50d as a temporary staging point for the Digital Audio Music.

Unique to this invention is that the Control Unit 50 also serves as the user's personal disk jockey. The user may request
15 specific songs to be electronically cued for playback, or may request the Control Unit 50 to randomly select songs based on the user's criteria. All of these commands are electronically stored in random access memory enabling the control unit to remember prior commands while simultaneously performing other tasks requested by
20 the user and, at the same time, continuing to play songs previously cued.

Offering a convenient visual display of the user's library of songs is but one more new and improved aspect of this invention. As the Control Unit 50 is executing the user's commands
25 to electronically sort, select, randomly play, etc., the Video Display Screen 70 is continually providing feedback to the user. The Video Display Screen 70 can list/scroll all songs stored on the Hard Disk 60, list/scroll all cued songs, display the current command function selected by the user, etc. Further expanding upon
30 the improvements this invention has to offer, the Video Display Screen 70 can display the lyrics of the song being played, as well

as the name of the song, album, artist, recording company, date of recording, duration of song, etc. This is possible if the lyrics and other incidental information are electronically stored to the Hard Disk 60 with the Digital Audio Music.

5 The present invention is a method for transmitting
 a desired digital video ^{digital} or audio signals stored on a first memory of
 a a first party, ^{preferably} to a second memory of a second party. The method
 comprises the steps of transferring money via telecommunications
 lines to the first party from the second party or electronically
 10 selling to the second party by the first party. Additionally, the
 method comprises the step of then connecting electronically via
 a telecommunications lines the first ^{preferably} memory with the second memory
 a such that the desired digital video ^{digital} or audio signals can pass
 therebetween. Next, there is the step of transmitting the desired
 a 15 digital video ^{digital} or audio signals from the first memory with a
 transmitter in control and in possession of the first party to a
 receiver ^{preferably} having the second memory ~~at a location determined by the~~
~~second party.~~ ^{While the} The receiver is in possession and in control of the
 a second party. ^{preferably} There is also the step of then storing the desired
 a 20 digital video ^{digital} or audio signals in the second memory.

a In summary, there has been disclosed a new and improved
 methodology/system by which Digital Audio Music ^{or digital video} can be
 electronically sold, distributed, transferred, and stored.
 Further, there has been disclosed a new and improved
 a 25 methodology/system by which Digital Audio ^{or digital video} Music can be
 electronically manipulated, i.e., sorted, cued, and selected for
 playback. Further still, there has been disclosed a new and
 improved methodology/system by which the electronic manipulation of
 30 Digital Audio Music can be visually displayed for the convenience
 of the user. Additionally, there has been disclosed a new and
 improved methodology/system by which electronic copyright

||

protection of quality Digital Audio Music is possible through use of this invention.

Since numerous changes may be made in the above described process and apparatus and different embodiments of the invention
5 may be made without departing from the spirit thereof, it is intended that all matter contained in the foregoing description or shown in the accompanying drawings shall be interpreted as illustrative, and not in a limiting sense. Further, it is intended that this invention is not to be limited to Digital Audio Music and
10 can include Digital Video, Digital Commercials, and other applications of digital information. ↙

clerk AS

Although the invention has been described in detail in the foregoing embodiments for the purpose of illustration, it is to be understood that such detail is solely for that purpose and that
15 variations can be made therein by those skilled in the art without departing from the spirit and scope of the invention except as it may be described by the following claims.

12

WHAT IS CLAIMED IS:

*Sub
a⁴* 1. A method for transferring desired digital video or audio signals comprising the steps of:

forming a connection through telecommunications lines between a first memory of a first party and a second memory of a second party, said first memory having said desired digital video or audio signals;

selling electronically by the first party to the second party through telecommunications lines, the desired digital video or audio signals in the first memory; and

transferring the desired digital video or audio signals from the first memory of the first party to the second memory of the second party through telecommunications lines.

2. A method as described in Claim 1 including after the transferring step, the step of storing the desired digital video or audio signals in the second memory.

3. A method as described in Claim 2 including before the transferring step, the step of electronically coding the desired digital video or audio signals into a configuration which would prevent unauthorized reproduction of the desired digital video or audio signals.

4. A method as described in Claim 3 wherein the first memory includes a first party hard disk having a plurality of digital video or audio signals, and a sales random access memory chip which temporarily stores a replica of the desired digital video or audio signals purchased by the second party for subsequent

13

transfer via telecommunications lines to the second memory of the second party; and including before the transferring step, there is the step of storing a replica of the desired digital video or audio signals from the hard disk into the sales random access memory chip.

5. A method as described in Claim 4 wherein there is a second party integrated circuit which controls and executes commands of the second party, and a second party control panel connected to the second party integrated circuit, and before the forming step, there is the step of commanding the second party integrated circuit with the second party control panel to initiate the purchase of the desired digital video or audio signals from the first party.

6. A method as described in Claim 5 wherein the second memory includes an incoming random access memory chip which temporarily stores the desired digital video or audio signals received from the sales random access memory chip, a second party hard disk for storing the desired digital video or audio signals, and a playback random access memory chip for temporarily storing the desired digital video or audio signals for sequential playback; and the storing step includes the steps of storing the desired digital video or audio signals in the incoming random access memory chip, transferring the desired digital video or audio signals from the incoming random access memory chip to the second party hard disk, storing the desired digital video or audio signals in the second party hard disk, commanding the second party integrated circuit with the second party control panel to play the desired digital video or audio signals and transferring a replica of the desired digital video or audio signals from the second party hard disk to the playback random access memory chip for playback.

7. A method as described in Claim 6 including after the transferring step, there is the step of repeating the commanding, playing, and transferring steps.

~~8.~~ A method for transferring digital video or audio signals comprising the steps of:

entering into a second party control panel of a second party control unit of a second party commands by the second party to purchase desired digital video or audio signals from a first party;

forming a connection through telecommunications lines between a first memory of the first party and a second memory of the second party control unit, said first memory having desired digital video or audio signals;

selling electronically by the first party to the second party through telecommunications lines, the desired digital video or audio signals in the first memory;

transferring the desired digital video or audio signals from the first memory of the first party to the second memory of the second party through telecommunications lines;

entering into the second party control panel commands to play the desired digital video or audio signals; and

playing the desired digital video or audio signals with the second party control unit.

~~9.~~ A system for transferring digital video or audio signals comprising:

a first party control unit having a first memory having desired digital video or audio signals, and means for electronically selling the desired digital video or audio signals;

a second party control unit having a second party control panel, a second memory connected to the second party control panel, and means for playing the desired digital video or audio signals connected to the second memory and the second party control panel, said playing means operatively controlled by the second party control panel, said second party control unit remote from the first party control unit; and

telecommunications lines connected to the first party control unit and the second party control unit through which the electronic sales of the desired digital video or audio signals occur and through which the desired digital video or audio signals are electronically transferred from the first memory to the second memory after the desired digital video or audio signals are sold to the second party by the first party.

10. A system as described in Claim 9 wherein the first party control unit includes a first party hard disk having a plurality of digital video or audio signals which include the desired digital video or audio signals, and a sales random access memory chip electronically connected to the first party hard disk for storing a replica of the desired digital video or audio signals of the first party's hard disk.

11. A system as described in Claim 10 wherein the second party control unit includes a second party hard disk which stores a plurality of digital video or audio signals, and a playback random access memory chip electronically connected to the second

party hard disk for storing a replica of the desired digital video or audio signals as a temporary staging area for playback.

12. A system as described in Claim 11 wherein the first party control unit includes a first party control integrated circuit which controls and executes commands of the first party and is connected to the first party hard disk, the first party sales random access memory, and the second party control integrated circuit through the telecommunications lines, said first party control integrated circuit and said second party control integrated circuit regulate the transfer of the desired digital video or audio signals; and a first party control panel through which the first party control integrated circuit is programmed and is sent commands and which is connected to the first party control integrated circuit.

13. A system as described in Claim 12 wherein the second party control unit includes a second party control integrated circuit which controls and executes commands of the second party and is connected to the second party hard disk, the playback random access memory, and the first party control integrated circuit through the telecommunications lines, said second party control integrated circuit and said first party control integrated circuit regulate the transfer of the desired digital video or audio signals; and a second party control panel through which the second party control integrated circuit is programmed and is sent commands and which is connected to the second party integrated circuit.

14. A system as described in Claim 13 wherein the second party control unit includes an incoming random access memory chip connected to the second party hard drive and the second party control integrated circuit, and the first party control unit through the telecommunications lines for temporarily storing the

desired digital video or audio signals received from the first party's control unit for subsequent storage to the second party hard disk.

15. A system as described in Claim 14 wherein the second party control unit includes a video display unit connected to the playback random access memory chip and to the second party integrated circuit for displaying the desired digital video or audio signals.

~~16.~~ A method for transmitting desired digital video or audio signals stored on a first memory of a first party to a second memory of a second party comprising the steps of:

selling electronically via telecommunications lines to the second party at a location remote from the first memory by the first party controlling use of the first memory, said second party financially distinct from the first party, said second party in control and in possession of the second memory;

connecting electronically via telecommunications lines the first memory with the second memory such that the desired digital video or audio signals can pass therebetween;

transmitting the desired digital video or audio signals from the first memory with a transmitter in control and possession of the first party to a receiver having the second memory at a location determined by the second party, said receiver in possession and control of the second party; and

storing the digital video or audio signals in the second memory.

17. A system for transmitting desired digital video or audio signals stored on a first memory of a first party to a second memory of a second party comprising:

means for transferring money electronically via telecommunications lines from the second party to the first party controlling use of the first memory, at a location remote from the second memory, said second party controlling use and in possession of the second memory;

means for connecting electronically via telecommunications lines the first memory with the second memory such that the desired digital video or audio signals can pass therebetween, said connecting means in electrical communication with the transferring means;

means for transmitting the desired digital video or audio signals from the first memory with a transmitter in control and possession of the first party to a receiver having the second memory at a location determined by the second party, said receiver in possession and control of the second party, said transmitting means in electrical communication with said connecting means; and

means for storing the digital video or audio signals in the second memory, said storing means in electrical communication with said transmitting means.

18. A system as described in Claim 17 wherein the connecting means comprises a first control unit in possession and control of the first party and a second control unit in possession and control of the second party.

19. A system as described in Claim 18 wherein the first control unit comprises a first control panel, first control integrated circuit and a sales random access memory, said sales random access memory and said first control panel in electrical communication with said first control integrated circuit, said second control unit comprising a second control panel, a second control integrated circuit, an incoming random access memory and a playback random access memory, said second control panel, said incoming random access memory and said playback random access memory in electrical communication with said second control integrated circuit.

C

¹² 20. A system as described in Claim ¹¹ ~~19~~ wherein the telecommunications lines include telephone lines.

¹³ 21. A system as described in Claim ¹² ~~20~~ wherein the first memory comprises a first hard disk and the second memory comprises a second hard disk.

¹⁴ 22. A system as described in Claim ¹³ ~~21~~ including a video display and speakers in possession and control of the second party, said video display and speakers in electrical communication with said second control integrated circuit.

Sub 27

~~23. A system for transmitting desired digital video or audio signals stored on a first memory of a first party to a second memory of a second party comprising:~~

means for transferring money electronically via telecommunications lines to the first party at a location remote from the second memory and controlling use of the first memory from the second party, said second party controlling use and in possession of the second memory;

14

means for connecting electronically via telecommunications lines the first memory with the second memory such that the desired digital video or audio signals can pass therebetween, said connecting means in electrical communication with the transferring means;

means for transmitting the desired digital video or audio signals from the first memory with a transmitter in control and possession of the first party to a receiver having the second memory at a location determined by the second party, said receiver in possession and control of the second party, said transmitting means in electrical communication with said connecting means; and

means for storing the digital video or audio signals in the second memory, said storing means in electrical communication with said transmitting means.

24. A system as described in Claim 23 wherein the connecting means comprises a first control unit in possession and control of the first party and a second control unit in possession and control of the second party.

25. A system as described in Claim 24 wherein the first control unit comprises a first control panel, first control integrated circuit and a sales random access memory, said sales random access memory and said first control panel in electrical communication with said first control integrated circuit, said second control unit comprising a second control panel, a second control integrated circuit, an incoming random access memory and a playback random access memory, said second control panel, said incoming random access memory and said playback random access memory in electrical communication with said second control integrated circuit.

B
C

¹⁷₂₆. A system as described in Claim ¹⁶₂₅ wherein the telecommunications lines include telephone lines.

~~27. A system as described in Claim 26 wherein the first memory comprises a first hard disk and the second memory comprises a second hard disk.~~

c *Sub 145*
28. A system as described in Claim 27 including a video display and ^{said second party} speakers in possession and control of the second party, said video display and speakers in electrical communication with said second control integrated circuit.

Sub 148
~~29. A method for transmitting desired digital video or audio signals stored in a first memory of a first party to a second memory of a second party comprising the steps of:~~

~~selling electronically via telecommunications lines digital video or audio signals possessed by the first party to the second party, said first party and said second party in communication via said telecommunications lines;~~

~~connecting electronically via telecommunications lines the first memory with the second memory such that the desired digital video or audio signals can pass therebetween;~~

~~transferring electronically via telecommunications lines the digital video or audio signals from a first location with the first memory to a second location with the second memory, said second location remote from said first location, said first memory in communication with said second memory via the telecommunications lines; and~~

15

storing the digital video or audio signals in the second memory.

30. A method as described in Claim 29 including after the transferring step, there is the step of repeating the selling, connecting, and transferring steps.

~~31.~~ A method for transmitting desired digital video or audio signals stored on a first memory of a first party to a second memory of a second party comprising the steps of:

selling electronically via telecommunications lines to the second party at a location remote from the first memory by the first party controlling use of the first memory, said second party financially distinct from the first party, said second party in control and in possession of the second memory;

connecting electronically via telecommunications lines the first memory with the second memory such that the desired digital video or audio signals can pass therebetween;

transmitting the desired digital video or audio signals from the first memory with a transmitter in control and possession of the first party to a receiver having the second memory at a location determined by the second party, said receiver in possession and control of the second party; and

storing the digital video or audio signals in the second memory.

Add B7

Add G10

08/023398

607,648

ABSTRACT OF THE DISCLOSURE

A SYSTEM FOR TRANSMITTING DESIRED
DIGITAL VIDEO OR AUDIO SIGNALS

B

B

B
B

class
P. 1
B

A method for transferring desired digital video or ^{digital} audio signals. The method comprises the steps of forming a connection through telecommunications lines between a first memory of a first party and a second memory of a second party. The first memory has the desired digital video or ^{digital} audio signals. Then, there is the step of selling electronically by the first party to the second party through telecommunications lines, the desired digital video or ^{digital} audio signals in the first memory. Then, there is the step of transferring the desired digital video or ^{digital} audio signals from the first memory of the first party to the second memory of the second party through the telecommunications lines. ^{digital} Additionally, there is a system for transferring digital video or ^{digital} audio signals. ~~The system comprises a first party control unit having a first memory having desired digital video or audio signals, and a device for electronically selling the desired digital video or audio signals. The system is also comprised of a second party control unit having a second party control panel, a second memory connected to the second party control panel, and a mechanism for playing the desired digital video or audio signals connected to the second memory and the second party control panel. The playing means is operatively controlled by the second party control panel. The second party control unit is remote from the first party control unit. Additionally, the system is comprised of telecommunications lines connected to the first party control unit and the second party control unit through which electronic sales of the desired digital video or audio signals occur and to which the desired digital video or audio signals are electronically transferred from the first memory to the second memory after the desired digital video or audio signals are sold to the second party by the first party.~~

Declaration and Power of Attorney For Patent Application English Language Declaration

As a below named inventor, I hereby declare that:

My residence, post office address and citizenship are as stated below next to my name.

I believe I am the original, first and sole inventor (if only one name is listed below) or an original, first and joint inventor (if plural names are listed below) of the subject matter which is claimed and for which a patent is sought on the invention entitled

A SYSTEM FOR TRANSMITTING DESIRED DIGITAL VIDEO OR AUDIO SIGNALS
the specification of which

(check one)

is attached hereto.

was filed on _____ as

Application Serial No. 0 / _____

and was amended on _____
(if applicable)

I hereby state that I have reviewed and understand the contents of the above identified specification, including the claims, as amended by any amendment referred to above.

I acknowledge the duty to disclose information which is material to the examination of this application in accordance with Title 37, Code of Federal Regulations, §1.56(a).

I hereby claim foreign priority benefits under Title 35, United States Code, §119 of any foreign application(s) for patent or inventor's certificate listed below and have also identified below any foreign application for patent or inventor's certificate having a filing date before that of the application on which priority is claimed:

Prior Foreign Application(s)

Priority Claimed

_____ (Number)	_____ (Country)	_____ (Day/Month/Year Filed)	<input type="checkbox"/> Yes	<input type="checkbox"/> No
_____ (Number)	_____ (Country)	_____ (Day/Month/Year Filed)	<input type="checkbox"/> Yes	<input type="checkbox"/> No
_____ (Number)	_____ (Country)	_____ (Day/Month/Year Filed)	<input type="checkbox"/> Yes	<input type="checkbox"/> No

I hereby claim the benefit under Title 35, United States Code, §120 of any United States application(s) listed below and, insofar as the subject matter of each of the claims of this application is not disclosed in the prior United States application in the manner provided by the first paragraph of Title 35, United States Code, §112, I acknowledge the duty to disclose material information as defined in Title 37, Code of Federal Regulations, §1.56(a) which occurred between the filing date of the prior application and the national or PCT international filing date of this application:

0 / _____
 (Application Serial No.) (Filing Date) (Status)
 (patented, pending, abandoned)

0 / _____
 (Application Serial No.) (Filing Date) (Status)
 (patented, pending, abandoned)

I hereby declare that all statements made herein of my own knowledge are true and that all statements made on information and belief are believed to be true; and further that these statements were made with the knowledge that willful false statements and the like so made are punishable by fine or imprisonment, or both, under Section 1001 of Title 18 of the United States Code and that such willful false statements may jeopardize the validity of the application or any patent issued thereon.

POWER OF ATTORNEY: As a named inventor, I hereby appoint the following attorney(s) and/or agent(s) to prosecute this application and transact all business in the Patent and Trademark Office connected therewith. *(list name and registration number)*

Ansel M. Schwartz, Reg. No. 30,587

Send Correspondence to:

✓ Ansel M. Schwartz 412/621-9222

Direct Telephone Calls to: *(name and telephone number)*

Full name of sole or first inventor	
Arthur R. Hair	
Inventor's signature	Date
<i>Arthur R. Hair</i>	2/22/1993
Residence	
330 Murrays Lane, Pittsburgh, PA 15234 PA	
Citizenship	
United States	
Post Office Address	
330 Murrays Lane, Pittsburgh, PA 15234	
Full name of second joint inventor, if any	
Second inventor's signature	
Date	
Residence	
Citizenship	
Post Office Address	

(Supply similar information and signature for third and subsequent joint inventors.)

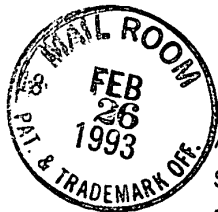

PATENT

Attorney's Docket No. HAIR-1 CONT II

Applicant or Patentee: Arthur R. Hair

Serial or Patent No.: 0 /

Filed or Issued:

For: A SYSTEM FOR TRANSMITTING DESIRED DIGITAL VIDEO OR AUDIO SIGNALS

VERIFIED STATEMENT (DECLARATION) CLAIMING SMALL ENTITY STATUS (37 CFR 1.9(f) and 1.27(b))—INDEPENDENT INVENTOR

As a below named inventor, I hereby declare that I qualify as an independent inventor as defined in 37 CFR 1.9(c) for purposes of paying reduced fees under Section 41(a) and (b) of Title 35, United States Code, to the Patent and Trademark Office with regard to the invention entitled A SYSTEM FOR TRANSMITTING DESIRED DIGITAL VIDEO OR AUDIO SIGNALS described in

- [X] the specification filed herewith.
[] application serial no. 0 / , filed
[] patent no. , issued

I have not assigned, granted, conveyed or licensed and am under no obligation under contract or law to assign, grant, convey or license, any rights in the invention to any person who could not be classified as an independent inventor under 37 CFR 1.9(c) if that person had made the invention, or to any concern which would not qualify as a small business concern under 37 CFR 1.9(d) or a nonprofit organization under 37 CFR 1.9(e).

Each person, concern or organization to which I have assigned, granted, conveyed, or licensed or am under an obligation under contract or law to assign, grant, convey, or license any rights in the invention is listed below:

- [X] no such person, concern, or organization
[] persons, concerns or organizations listed below*

*NOTE: Separate verified statements are required from each named person, concern or organization having rights to the invention averring to their status as small entities. (37 CFR 1.27).

FULL NAME

ADDRESS

- [] INDIVIDUAL [] SMALL BUSINESS CONCERN [] NONPROFIT ORGANIZATION

FULL NAME

ADDRESS

- [] INDIVIDUAL [] SMALL BUSINESS CONCERN [] NONPROFIT ORGANIZATION

FULL NAME

ADDRESS

- [] INDIVIDUAL [] SMALL BUSINESS CONCERN [] NONPROFIT ORGANIZATION

I acknowledge the duty to file, in this application or patent, notification of any change in status resulting in loss of entitlement to small entity status prior to paying, or at the time of pay-

ing, the earliest of the issue fee or any maintenance fee due after the date on which status as a small entity is no longer appropriate. (37 CFR 1.28(b)).

I hereby declare that all statements made herein of my own knowledge are true and that all statements made on information and belief are believed to be true; and further that these statements were made with the knowledge that willful false statements and the like so made are punishable by fine or imprisonment, or both, under Section 1001 of Title 18 of the United States Code, and that such willful false statements may jeopardize the validity of the application, any patent issuing thereon, or any patent to which this verified statement is directed.

Arthur R. Hair

Name of inventor

Arthur R. Hair

Signature of Inventor

Date 2/22/1993

Name of inventor

Signature of Inventor

Date _____

Name of inventor

Signature of Inventor

Date _____

08/023398

PATENT APPLICATION SERIAL NO.

U. S. DEPARTMENT OF COMMERCE
PATENT AND TRADEMARK OFFICE
FEE RECORD SHEET

100 MG 03/22/93 08023398

1 201 661.00 CK HAIR-1-CONT

~~DF11159 04/08/93 07023394~~

~~19-0737 110 201 74.00CR~~

DF11161 04/08/93 08023398

19-0737 110 201 74.00CR

GB14172 04/29/93 08023398

19-0737 140 201 74.00CH

PTO-1556
(5/87)

BEST AVAILABLE COPY

BEST AVAILABLE COPY

PATENT APPLICATION FEE DETERMINATION RECORD					Application or Docket Number. 023398		
Effective October 1, 1992							
CLAIMS AS FILED - PART I					SMALL ENTITY OR OTHER THAN SMALL ENTITY		
		(Column 1)	(Column 2)				
FOR	NUMBER FILED	NUMBER EXTRA	RATE	FEE	RATE	FEE	
BASIC FEE				\$355.00		\$710.00	
TOTAL CLAIMS	31	minus 20 = * 11	x\$11=	121	x\$22=		
INDEPENDENT CLAIMS	8	minus 3 = * 5	x 37=	185	x 74=		
MULTIPLE DEPENDENT CLAIM PRESENT			+115=		+230=		
			TOTAL	661	TOTAL		
* If the difference in column 1 is less than zero, enter "0" in column 2							
CLAIMS AS AMENDED - PART II					SMALL ENTITY OR OTHER THAN SMALL ENTITY		
		(Column 1)	(Column 2)	(Column 3)			
AMENDMENT A	CLAIMS REMAINING AFTER AMENDMENT	HIGHEST NUMBER PREVIOUSLY PAID FOR	PRESENT EXTRA	RATE	ADDITIONAL FEE	RATE	ADDITIONAL FEE
Total	* 63	Minus ** 31	= 32	x\$11=	352	x\$22=	
Independent	* 14	Minus *** 8	= 6	x 37=	202	x 74=	
FIRST PRESENTATION OF MULTIPLE DEPENDENT CLAIM			+ 115=		+230=		
			TOTAL ADDIT. FEE	574	TOTAL ADDIT. FEE		
* If the difference in column 1 is less than zero, enter "0" in column 2							
AMENDMENT B					SMALL ENTITY OR OTHER THAN SMALL ENTITY		
		(Column 1)	(Column 2)	(Column 3)			
AMENDMENT B	CLAIMS REMAINING AFTER AMENDMENT	HIGHEST NUMBER PREVIOUSLY PAID FOR	PRESENT EXTRA	RATE	ADDITIONAL FEE	RATE	ADDITIONAL FEE
Total	* 37	Minus ** 63	= 0	x\$11=		x\$22=	
Independent	* 7	Minus *** 14	= 0	x 37=		x 74=	
FIRST PRESENTATION OF MULTIPLE DEPENDENT CLAIM			+ 115=		+ 230=		
			TOTAL ADDIT. FEE		TOTAL ADDIT. FEE		
* If the difference in column 1 is less than zero, enter "0" in column 2							
AMENDMENT C					SMALL ENTITY OR OTHER THAN SMALL ENTITY		
		(Column 1)	(Column 2)	(Column 3)			
AMENDMENT C	CLAIMS REMAINING AFTER AMENDMENT	HIGHEST NUMBER PREVIOUSLY PAID FOR	PRESENT EXTRA	RATE	ADDITIONAL FEE	RATE	ADDITIONAL FEE
Total	* 36	Minus **	=	x\$11=		x\$22=	
Independent	* 7	Minus ***	=	x 37=		x 74=	
FIRST PRESENTATION OF MULTIPLE DEPENDENT CLAIM			+115=		+230=		
			TOTAL ADDIT. FEE		TOTAL ADDIT. FEE		
* If the entry in column 1 is less than the entry in column 2, write "0" in column 3.							
** If the "Highest Number Previously Paid For" IN THIS SPACE is less than 20, enter "20".							
*** If the "Highest Number Previously Paid For" IN THIS SPACE is less than 3, enter "3".							
The "Highest Number Previously Paid For" (Total or Independent) is the highest number found in the appropriate box in column 1.							

APPLICATION TRANSFER REQUEST

Section I. APPLICATION TRANSFER REQUEST Date 5/6/93 SN 08/023398

TO: Receiving A.U. 2515 Class/sub _____ Examiner _____

FROM: Originating A.U. 2513 Class/sub 36.9 Examiner P. 23

REASON: Request for Reconsideration (Return to Classification)

*Cont. of 586,391 re Nguyen
Do you want?*

Section II. DISPOSITION BY RECEIVING A.U. Date 5/10/93 Exr Baker

Accepted (keep in receiving A.U.)

Not Accepted Forward to Chem/Elect Classification Group _____

Return to Originating A.U. Nonclassification issue only:

REASON: Restriction
 Other

Section III. DISPOSITION BY _____ Classification Group. Date _____

Transfer Approved-Forward to A.U. _____ Class/sub _____ Classifier _____

Transfer Disapproved-Forward to Originating A.U. _____ Concurring _____

REASON: _____ Classifier _____

Nonclassification issue raised: Restriction
 Other

BEST AVAILABLE COPY



UNITED STATES DEPARTMENT OF COMMERCE
Patent and Trademark Office

Address: COMMISSIONER OF PATENTS AND TRADEMARKS
Washington, D.C. 20231

SERIAL NUMBER	FILING DATE	FIRST NAMED INVENTOR	ATTORNEY DOCKET NO.
---------------	-------------	----------------------	---------------------

08/023,398 02/26/93 HAIR

A	HAIR-1CONT11
EXAMINER	

NGUYEN, H

B3M1/0701

ANSEL M. SCHWARTZ
425 N. CRAIG STREET, SUITE 301
PITTSBURGH, PA 15213

ART UNIT	PAPER NUMBER
----------	--------------

2

2313

DATE MAILED:

07/01/93

This is a communication from the examiner in charge of your application.
COMMISSIONER OF PATENTS AND TRADEMARKS

- This application has been examined Responsive to communication filed on _____ This action is made final.

A shortened statutory period for response to this action is set to expire _____ month(s), _____ days from the date of this letter.
Failure to respond within the period for response will cause the application to become abandoned. 35 U.S.C. 133

Part I THE FOLLOWING ATTACHMENT(S) ARE PART OF THIS ACTION:

- | | |
|---|--|
| 1. <input checked="" type="checkbox"/> Notice of References Cited by Examiner, PTO-892. | 2. <input type="checkbox"/> Notice re Patent Drawing, PTO-948. |
| 3. <input type="checkbox"/> Notice of Art Cited by Applicant, PTO-1449. | 4. <input type="checkbox"/> Notice of Informal Patent Application, Form PTO-152. |
| 5. <input type="checkbox"/> Information on How to Effect Drawing Changes, PTO-1474. | 6. <input type="checkbox"/> _____ |

Part II SUMMARY OF ACTION

- Claims 1-31 are pending in the application.
Of the above, claims _____ are withdrawn from consideration.
- Claims _____ have been cancelled.
- Claims _____ are allowed.
- Claims 1-31 are rejected.
- Claims _____ are objected to.
- Claims _____ are subject to restriction or election requirement.
- This application has been filed with informal drawings under 37 C.F.R. 1.85 which are acceptable for examination purposes.
- Formal drawings are required in response to this Office action.
- The corrected or substitute drawings have been received on _____. Under 37 C.F.R. 1.84 these drawings are acceptable. not acceptable (see explanation or Notice re Patent Drawing, PTO-948).
- The proposed additional or substitute sheet(s) of drawings, filed on _____ has (have) been approved by the examiner. disapproved by the examiner (see explanation).
- The proposed drawing correction, filed on _____, has been approved. disapproved (see explanation).
- Acknowledgment is made of the claim for priority under U.S.C. 119. The certified copy has been received not been received been filed in parent application, serial no. _____; filed on _____.
- Since this application appears to be in condition for allowance except for formal matters, prosecution as to the merits is closed in accordance with the practice under Ex parte Quayle, 1935 C.D. 11; 453 O.G. 213.
- Other _____

EXAMINER'S ACTION

Serial No. 07/023398
Art Unit 2313

The drawings are objected to because of the reasons set forth in the PTOL-948. Correction is required.

The title of the invention is not descriptive. A new title is required that is clearly indicative of the invention to which the claims are directed.

The Abstract of the Disclosure is objected to because the content of the abstract exceeds 250 words and because the title of the invention should not be included in the abstract. Correction is required. See M.P.E.P. § 608.01(b).

The following is a quotation of the first paragraph of 35 U.S.C. § 112:

The specification shall contain a written description of the invention, and of the manner and process of making and using it, in such full, clear, concise, and exact terms as to enable any person skilled in the art to which it pertains, or with which it is most nearly connected, to make and use the same and shall set forth the best mode contemplated by the inventor of carrying out his invention.

The specification is objected to under 35 U.S.C. § 112, first paragraph, as failing to provide an adequate written description of the invention.

The specification fails to make clear what the problems in the prior art that the present invention intends to overcome.

Claims 1-31 are rejected under 35 U.S.C. § 112, first paragraph, for the reasons set forth in the objection to the specification.

Serial No. 07/023398
Art Unit 2313

The following is a quotation of the appropriate paragraphs of 35 U.S.C. § 102 that form the basis for the rejections under this section made in this Office action:

A person shall be entitled to a patent unless --
(b) the invention was patented or described in a printed publication in this or a foreign country or in public use or on sale in this country, more than one year prior to the date of application for patent in the United States.

Claims 1-2, 8-12, 16 are rejected under 35 U.S.C. § 102(b) as being anticipated by Lightner'US/3718906.

Lightner disclose a method for transferring audio signal over telecommunication links by forming connection between the seller and purchaser, selling electronically by the seller to the purchaser, desired audio signal and transferring the audio signal over the telecommunication links. See figs. 1, 10 and their description.

The following is a quotation of 35 U.S.C. § 103 which forms the basis for all obviousness rejections set forth in this Office action:

A patent may not be obtained though the invention is not identically disclosed or described as set forth in section 102 of this title, if the differences between the subject matter sought to be patented and the prior art are such that the subject matter as a whole would have been obvious at the time the invention was made to a person having ordinary skill in the art to which said subject matter pertains. Patentability shall not be negated by the manner in which the invention was made.

Subject matter developed by another person, which qualifies as prior art only under subsection (f) or (g) of section 102 of this title, shall not preclude patentability under this section where the subject matter and the claimed invention were, at the time the invention was made, owned by the same person or subject to an obligation of assignment to the same person.

Claims 3-7, 15, 17-31 are rejected under 35 U.S.C. § 103 as

Serial No. 07/023398
Art Unit 2313

being unpatentable over Ogaki et al in view of Lightner.

Ogaki et al discloses all that is claimed except that he does not disclose transferring audio or video signals. However, he does disclose transferring the software programs through telecommunication lines for distributing or selling these programs to consumers. Lightner discloses transferring audio/video signals through telecommunications lines for distributing or selling to purchasers. It would have been obvious to one of ordinary skill in the art to transfer or seller distribute audio/video signals in the system and method taught by Ogaki et al. It would have been obvious because one of ordinary skill in the art, based on common knowledge and common sense, would be able to recognize a substitution of the contents of the software program signals with the audio/video signals.

Any inquiry concerning this communication or earlier communications from the examiner should be directed to Hoa Nguyen whose telephone number is (703) 305-9687.

Any inquiry of a general nature or relating to the status of this application should be directed to the Group receptionist whose telephone number is (703) 305-9600.

HOA T. NGUYEN
PRIMARY EXAMINER
GROUP 2300

TO SEPARATE TOP AND BOTTOM EDGES, SNAP APART AND CARD CARBON

80

FORM PTO-892 (REV. 2-92)	U.S. DEPARTMENT OF COMMERCE PATENT AND TRADEMARK OFFICE	SERIAL NO. ^{07/648} 07/023,398	GROUP ART UNIT 2313	ATTACHMENT TO PAPER NUMBER 2
NOTICE OF REFERENCES CITED		APPLICANT(S) HAIR		

U.S. PATENT DOCUMENTS							
*	DOCUMENT NO.	DATE	NAME	CLASS	SUB-CLASS	FILING DATE IF APPROPRIATE	
A	4647989	3/87	Geddes	360	55		
B	4567359	01/86	Lockwood	235	381		
C	3990710	11/76	Hughes	235	381		
D	5191573	3/93	Hair	364	84	6/13/88	
E	4654799	3/87	Ogaki et al	364	479		
F	3718906	2/73	Lightner	235	381		
G							
H							
I							
J							
K							

FOREIGN PATENT DOCUMENTS							
*	DOCUMENT NO.	DATE	COUNTRY	NAME	CLASS	SUB-CLASS	PERTINENT PAGES, DWG. SPEC.
L							
M							
N							
O							
P							
Q							

OTHER REFERENCES (Including Author, Title, Date, Pertinent Pages, Etc.)	
R	
S	
T	
U	

EXAMINER Hoa Nguyen	DATE 6/93
------------------------	--------------

A copy of this reference is not being furnished with this office action.
(See Manual of Patent Examining Procedure, section 707.05 (a).)

Line 13, after "lines" insert -- while the second memory is in possession and

A' control of the second party -- .

Line 14, after "signals." delete the remainder of the abstract.

IN THE SPECIFICATION:

Page 3, line 11, after "copied." add the following.

A² Thus, as is apparent from the above discussion, the inflexible form in which the songs are purchased by an end user, and the distribution channels of the songs, requires the end user to go to a location to purchase the songs, and not necessarily be able to purchase only the songs desired to be heard, in a sequence the end user would like to hear them. This is not limited to just songs, but also includes, for example, videos. ✓

Page 3, line 14, after "music" insert -- or digital video -- .

Page 3, line 17, after "music" insert -- or digital video -- .

Page 3, line 20, after "music" insert -- or digital video -- .

Page 3, line 23, after "music" insert -- or digital video -- .

Page 5, line 6, after "to" insert -- preferably -- .

Page 5, line 7, after "means" insert -- or mechanism -- .

Page 5, line 8, after "or" insert -- digital -- .

Page 5, line 8, after "signals" insert -- preferably -- .

Page 5, line 10, after "means" insert -- or mechanism -- .

Page 5, line 11, after "first memory" insert -- preferably -- .

Page 5, line 12, after "or" insert -- digital -- .

Page 5, line 13, after "means" insert -- or mechanism -- .

Page 5, line 16, after "receiver" insert -- preferably -- .

Page 5, line 16, delete "at a location".

Page 5, line 17, delete "determined by the second party".

Page 5, line 17, change ^T"the receiver" to -- ^Wwhile the receiver -- .

Page 5, line 18, after "party." insert -- The receiver is placed at a second

^{A3} party location determined by the second party -- .

Page 5, line 18, change "There" to -- Preferably, there -- .

Page 5, line 18, after "means" insert -- or mechanism -- .

Page 5, line 19, after "digital" insert -- video or digital audio -- .

Page 6, line 13, after "invention" insert -- preferably -- .

Page 10, line 6, before "audio" insert -- digital -- .

Page 10, line 7, after "first party" insert -- preferably -- .

Page 10, line 12, after "first memory" insert -- preferably -- .

Page 10, line 13, after "or" insert -- digital -- .

Page 10, line 15, after "or" insert -- digital -- .

Page 10, line 17, after "receiver" insert -- preferably -- .

Page 10, line 17, delete "at a location determined by the".

Page 10, line 18, delete "second party".

Page 10, line 18, change "The" to -- while the -- .

Page 10, line 19, after "party." insert -- The receiver is placed by the second

A4 party at a second party location determined by the second party. -- .

Page 10, line 19, after "There" insert -- preferably -- .

Page 10, line 20, after "or" insert -- digital -- .

Page 10, line 22, after "music" insert -- or digital video -- .

Page 10, line 25, after "music" insert -- or digital video -- .

Page 11, line 11, after "information." insert the following.

AS

-- For instance, the present invention is a system 100 for transferring digital video signals from a first party to a second party. The system 100 comprises a first party control unit 20 having a first memory having a plurality of desired individual video selections as desired digital video signals. The first party control unit 20 also has means or a mechanism for the first party to charge a fee to the second party for access to the desired digital video signals. The system 100 also comprises a second party control unit 50 having a second party control panel 50a, a receiver and a video display for playing the desired digital video or digital audio signals received by the receiver. The second party control panel 50a is connected to the video display and the receiver. The receiver and the video display is operatively controlled by the second party control panel 50a. The second party control unit 50 is remote from the first party control unit 20. The second party control unit 50 is placed by the second party at a second party location determined by the second party which is remote from the first party control unit 20. The second party chooses the desired digital video signals from the first memory with the second party control panel 20a. The system 100 is also comprised of telecommunications lines connected to the first party control unit 20 and the second party control unit 50 through which the desired digital video signals are electronically transferred from the first memory to the receiver while the second party control unit 50 is in possession and control of the second party after the desired digital video signals are sold to the second party by the first party.

Preferably, the second party control unit 50 includes a second memory which is connected to the receiver and the video display. The second memory stores the digital

video signals that are received by the receiver for providing them to the video display. The second party control unit 50 preferably includes a second party hard disk 60 which stores a plurality of digital video signals, and a playback random access memory chip 50d electronically connected to the second party hard disk 60 for storing a replica of the desired digital video signals as a temporary staging area for playback. The second party control unit 50 includes a second party control integrated circuit 50b which controls and executes commands of the second party and is connected to the second party hard disk 60, the playback random access memory 50d, and the first party control integrated circuit 20b through the telecommunications lines. The second party control integrated circuit 50b preferably includes the receiver. Additionally, the second party control unit 50 includes a second party control panel 20a through which the second party control integrated circuit 20b is programmed and is sent commands and which is connected to the second party integrated circuit 50b. Preferably, the second party control unit 50 includes an incoming random access memory chip 50c connected to the second party hard ^{disk} drive 60 and the second party control integrated circuit 50b, and the first party control unit 20 through the telecommunications lines for temporarily storing the desired digital video signals received from the first party's control unit 20 for subsequent storage to the second party hard disk 60. Preferably, the video display includes a video display unit connected to the playback random access memory chip 50c and to the second party integrated circuit 50b for displaying the desired digital video signals.

A3

C

20

The first party control unit 20 preferably includes a first party hard disk 10 having a plurality of digital video signals which include the desired digital video signals, and a sales random access memory chip 20c electronically connected to the first party hard disk 10 for storing a replica of the desired digital video signals of the first party's hard disk 10. The first party control unit 20 preferably includes a first party control integrated circuit 20b which controls and executes commands of the first party and is connected to the first party hard disk 10, the first party sales random access memory 20c, and the second party control integrated circuit 20b through the telecommunications lines. The first party control integrated circuit 20b and the second party control integrated circuit 50b regulate the transfer of the desired digital video signals. The first party control unit 20 preferably also includes a first party control panel 20a through which the first party control integrated circuit 20b is programmed and is sent commands and which is connected to the first party control integrated circuit 20b.

A 3

The means or mechanism for charging a fee includes means or a mechanism for charging a fee via telecommunications lines by the first party to the second party at a location remote from the second party location. Preferably, the second party has an account and the means or mechanism for charging a fee includes means or a mechanism for charging the account of the second party. Preferably, the means or mechanism for charging the account includes means or a mechanism for charging a credit card number of the second party. Preferably, the means or mechanism for electronically selling includes means or a mechanism for electronically selling includes means or a mechanism for charging a fee via

21

telecommunications lines by the first party to the second party at a first party location remote from the second party location. Preferably, the second party has an account and the means or mechanism for charging a fee includes means or a mechanism for charging the account of the second party. Preferably, the means or mechanism for charging the account includes means or a mechanism for receiving a credit card number of the second party. The means or mechanism for receiving a credit card number preferably is part of the control integrated circuit 20b. The telecommunications lines are preferably telephone lines 30.

A⁵
The present invention also pertains to a method for transmitting desired digital video signals stored in a first memory having a plurality of individual video selections as digital video signals of a first party at a first party location to a second party at a second party location so the second party can view the desired digital video signals. The method comprises the steps of placing by the second party a receiver, and a video display connected to the receiver at the second party location determined by the second party which is remote from the first party location. Next, there is the step of charging a fee by the first party to the second party at a location remote from the second party location so the second party can obtain access to the desired digital video signals. Then, there is the step of connecting electronically via telecommunications lines the first memory with a receiver of the second party while the receiver is in possession and control of the second party. Next, there is the step of choosing the desired digital video signals by the second party from the first memory of the first party so desired digital video selections are selected. Next, there is the step of transmitting the desired digital video signals from the first memory with a transmitter in

control and possession of the first party to the receiver of the second party while the receiver is in possession and control of the second party at the second party location determined by the second party. Next, there is the step of displaying the desired video signals received by the receiver on a video display in possession and control of the second party. The video display is connected with the receiver.

A }
Preferably, the step of charging a fee includes the step of charging a fee via telecommunications lines by the first party to the second party so the second party can obtain access to the desired digital video signals stored on the first memory. Preferably, the second party has an account and the step of charging a fee includes the step of charging the account of the second party. Preferably, the step of charging the account of the second party includes the steps of telephoning the first party controlling use of the first memory by the second party. Then, there is the step of providing a credit card number of the second party controlling the second memory to the first party controlling the first memory so the second party is charged money. Preferably, the means or mechanism for the first party to charge a fee includes means or a mechanism for transferring money electronically via telecommunications lines to the first party at a location remote from the second memory at the second ^{party} location. w

c
[IN THE CLAIMS:

Sub
Bp
H1

1. (Amended) A method for transferring desired digital video or digital audio signals comprising the steps of:

forming a connection through telecommunications lines between a first memory of a first party and a second memory of a second party, said first memory having said desired digital video or digital audio signals;

Ab

selling electronically by the first party to the second party through telecommunications lines, the desired digital video or digital audio signals in the first memory; and

transferring the desired digital video or digital audio signals from the first memory of the first party to the second memory of the second party through telecommunications lines while the second memory is in possession and control of the second party.

2. (Amended) A method as described in Claim [1] 34 including after the transferring step, the step of storing the desired digital video or digital audio signals in the second memory.

B

3. (Amended) A method as described in Claim 2 including before the transferring step, the step of electronically coding the desired digital video or digital audio

signals into a configuration which would prevent unauthorized reproduction of the desired digital video or digital audio signals.

4. (Amended) A method as described in Claim 3 wherein the first memory includes a first party hard disk having a plurality of digital video or digital audio signals, and a sales random access memory chip which temporarily stores a replica of the desired digital video or digital audio signals purchased by the second party for subsequent transfer via telecommunications lines to the second memory of the second party; and including before the transferring step, there is the step of storing a replica of the desired digital video or digital audio signals from the hard disk into the sales random access memory chip.

5. (Amended) A method as described in Claim 4 wherein there is a second party integrated circuit which controls and executes commands of the second party, and a second party control panel connected to the second party integrated circuit, and before the forming step, there is the step of commanding the second party integrated circuit with the second party control panel to initiate the purchase of the desired digital video or digital audio signals from the ^{hard disk} first party.

6. (Amended) A method as described in Claim 5, wherein the second memory includes an incoming random access memory chip which temporarily stores the desired digital video or digital audio signals ~~received from the sales random access memory chip, a~~ second party hard disk for storing the desired digital video or digital audio signals, and a ^{from the first party hard disk}

© playback random access memory chip for temporarily storing the desired digital video or *from the first party hard disk* *the transferred replica* digital audio signals for sequential playback; and the storing step includes the steps of storing the desired digital video or digital audio signals in the incoming random access memory chip, transferring the desired digital video or digital audio signals from the incoming random access memory chip to the second party hard disk, storing the desired digital video or digital audio signals in the second party hard disk, commanding the second party integrated circuit with the second party control panel to play the desired digital video or *from the first party hard disk* digital audio signals, and transferring a replica of the desired digital video or digital audio signals from the second party hard disk to the playback random access memory chip for playback.

C
A⁶
© 7. (Amended) A method as described in Claim 6 including after the *the stored replica* transferring step, there is the step of repeating the *the second party integrated circuit to play* commanding, playing, and transferring a replica steps.

8. (Amended) A method for transferring digital video or digital audio signals from a first party to a second party comprising the steps of:

placing a second party control unit in possession and control of the second party by the second party at a desired location determined by the second party;

entering into a second party control panel of [a] the second party control unit of [a] the second party commands by the second party to purchase desired digital video or digital audio signals from a first party;

forming a connection through telecommunications lines between a first memory of the first party and a second memory of the second party control unit, said first memory having desired digital video or digital audio signals;

Ab selling electronically by the first party to the second party through telecommunications lines, the desired digital video or digital audio signals in the first memory;

transferring the desired digital video or digital audio signals from the first memory of the first party to the second memory of the second party through telecommunications lines while the second memory is in possession and control of the second party;

entering into the second party control panel commands to play the desired digital video or digital audio signals; and

playing the desired digital video or digital audio signals with the second party control unit.

Sub
75
C3

9. (Amended) A system for transferring digital video or digital audio signals

comprising:

a first party control unit having a first memory having desired digital video or digital audio signals, and means or a mechanism for electronically selling the desired digital video or digital audio signals;

A6

a second party control unit having a second party control panel, a second memory connected to the second party control panel, and means or a mechanism for playing the desired digital video or digital audio signals connected to the second memory and the second party control panel, said playing means or mechanism operatively controlled by the second party control panel, said second party control unit remote from the first party control unit, said second party control unit placed by the second party at a location determined by the second party; and

telecommunications lines connected to the first party control unit and the second party control unit through which the electronic sales of the desired digital video or digital audio signals occur and through which the desired digital video or digital audio signals are electronically transferred from the first memory to the second memory while the second memory is in possession and control of the second party after the desired digital video or digital audio signals are sold to the second party by the first party.

10. (Amended) A system as described in Claim 9 wherein the first party control unit includes a first party hard disk having a plurality of digital video or digital audio signals which include the desired digital video or digital audio signals, and a sales random access memory chip electronically connected to the first party hard disk for storing a replica of the desired digital video or digital audio signals of the first party's hard disk.

11. (Amended) A system as described in Claim ⁶³10 wherein the second party control unit includes a second party hard disk which stores a plurality of digital video or digital audio signals, and a playback random access memory chip electronically connected to the second party hard disk for storing a replica of the desired digital video or digital audio signals as a temporary staging area for playback.

12. (Amended) A system as described in Claim 11 wherein the first party control unit includes a first party control integrated circuit which controls and executes commands of the first party and is connected to the first party hard disk, the first party sales random access memory, and the second party control integrated circuit through the telecommunications lines, said first party control integrated circuit and said second party control integrated circuit regulate the transfer of the desired digital video or digital audio signals; and a first party control panel through which the first party control integrated circuit is programmed and is sent commands and which is connected to the first party control integrated circuit.

13. (Amended) A system as described in Claim 12 wherein the second party control unit includes a second party control integrated circuit which controls and executes commands of the second party and is connected to the second party hard disk, the playback random access memory, and the first party control integrated circuit through the telecommunications lines, said second party control integrated circuit and said first party control integrated circuit regulate the transfer of the desired digital video or digital audio signals; and a second party control panel through which the second party control integrated circuit is programmed and is sent commands and which is connected to the second party integrated circuit.

Al
14. (Amended) A system as described in Claim 13 wherein the second party control unit includes an incoming random access memory chip connected to the second party hard drive, and the second party control integrated circuit, and the first party control unit through the telecommunications lines for temporarily storing the desired digital video or digital audio signals received from the first party's control unit for subsequent storage to the second party hard disk.

15. (Amended) A system as described in Claim 14 wherein the second party control unit includes a video display unit connected to the playback random access memory chip and to the second party integrated circuit for displaying the desired digital video or digital audio signals.

16. (Amended) A method for transmitting desired digital video or digital audio signals stored on a first memory of a first party to a second memory of a second party comprising the steps of:

placing a receiver by the second party at a desired location determined by the second party;

Ab
selling electronically via telecommunications lines to the second party at a location remote from the first memory by the first party controlling use of the first memory, said second party financially distinct from the first party, said second party in control and in possession of the second memory;

connecting electronically via telecommunications lines the first memory with the second memory such that the desired digital video or digital audio signals can pass therebetween;

transmitting the desired digital video or digital audio signals from the first memory with a transmitter in control and possession of the first party to a receiver having the second memory at [a] the location determined by the second party[,] while said receiver is in possession and control of the second party; and

storing the digital video or digital audio signals in the second memory.

Sub
183
04

17. (Amended) A system for transmitting desired digital video or digital audio signals stored on a first memory of a first party to a second memory of a second party comprising:

means or a mechanism for transferring money electronically via telecommunications lines from the second party to the first party controlling use of the first memory, at a location remote from the second memory, said second party controlling use and in possession of the second memory;

A6

means or a mechanism for connecting electronically via telecommunications lines the first memory with the second memory such that the desired digital video or digital audio signals can pass therebetween, said connecting means or mechanism in electrical communication with the transferring means or mechanism;

means or a mechanism for transmitting the desired digital video or digital audio signals from the first memory with a transmitter in control and possession of the first party to a receiver having the second memory [at a location determined by the second party,] while said receiver is in possession and control of the second party, said receiver placed at a location determined by the second party, said transmitting means or mechanism in electrical communication with said connecting means or mechanism; and

means or a mechanism for storing the digital video or digital audio signals in the second memory, said storing means or mechanism in electrical communication with said transmitting means or mechanism.

A6

18. (Amended) A system as described in Claim 17 wherein the connecting means or mechanism [comprises] comprise a first control unit in possession and control of the first party and a second control unit in possession and control of the second party.

23. (Amended) A system for transmitting desired digital video or digital audio signals stored on a first memory of a first party at a first location to a second memory of a second party at a second party location comprising:

Sub A
B
C

means or a mechanism for [transferring money electronically via telecommunications lines to the first party] the first party to charge a fee to the second party for access to the desired digital video or digital audio signals at a location remote from the second [memory and] location, said first party controlling use of the first memory [from the second party], said second party controlling use and in possession of the second memory;

A7

means or a mechanism for connecting electronically via telecommunications lines the first memory with the second memory such that the desired digital video or digital audio signals can pass therebetween, said connecting means or mechanism in electrical communication with the transferring means or mechanism;

means or a mechanism for transmitting the desired digital video or digital audio signals from the first memory with a transmitter in control and possession of the first party to a receiver having the second memory [at a location determined by the second party,] while said receiver is in possession and control of the second party, said receiver placed by the second party at the second party location determined by the second party, said transmitting means or mechanism in electrical communication with said connecting means or mechanism; and

A7

means or a mechanism for storing the digital video or digital audio signals in the second memory, said storing means or mechanism in electrical communication with said ~~transmitting means or mechanism.~~

24. (Amended) A system as described in Claim [23] 61 wherein the connecting means or mechanism [comprises] comprise a first control unit in possession and control of the first party and a second control unit in possession and control of the second party.

B

29. (Amended) A method for transmitting desired digital video or digital audio signals stored in a first memory of a first party at a first party location to a second memory of a second party comprising the steps of:

A8

placing a receiver by the second party at a desired second party location determined by the second party, said second party location remote from the first party location;

[selling electronically via telecommunications lines] charging a fee by the first party to the second party at a location remote from the second party location so the second party can obtain access to the digital video or digital audio signals possessed by the first party [to the second party], said first party and said second party in communication via said telecommunications lines;

A⁸
connecting electronically via telecommunications lines the first memory with the second memory such that the desired digital video or digital audio signals can pass therebetween;

transferring electronically via telecommunications lines the digital video or digital audio signals from a first location with the first memory to a second party location with the second memory while the second memory is in possession and control of the second party, said second party location remote from said first location, said first memory in communication with said second memory via the telecommunications lines; and

storing the digital video or digital audio signals in the second memory.

30. (Amended) A method as described in Claim [29] 37 including after the transferring step, there is the step of repeating the [selling] charging a fee, connecting, and transferring steps.

31. (Amended) A method for transmitting desired digital video or digital audio signals stored on a first memory of a first party to a second memory of a second party comprising the steps of:

A8 selling electronically via telecommunications lines to the second party at a location remote from the first memory by the first party controlling use of the first memory, said second party financially distinct from the first party, said second party in control and in possession of the second memory;

connecting electronically via telecommunications lines the first memory with the second memory such that the desired digital video or digital audio signals can pass therebetween;

transmitting the desired digital video or digital audio signals from the first memory with a transmitter in control and possession of the first party to a receiver having the second memory at [a] the location determined by the second party[,], while said receiver is in possession and control of the second party; and

storing the digital video or digital audio signals in the second memory.

(Please add the following claims.)

32. A method as described in Claim 1 wherein the second party is at a second party location and the step of selling electronically includes the step of charging a fee via telecommunications lines by the first party to the second party at a first party location remote from the second party location.

A⁸
33. A method as described in Claim 32 wherein the second party has an account and the step of charging a fee includes the step of charging the account of the second party.

34. A method as described in Claim 33 wherein the step of charging the account of the second party includes the steps of telephoning the first party controlling use of the first memory by the second party; providing a credit card number of the second party controlling the second memory to the first party controlling the first memory so the second party is charged money.

35. A method as described in Claim 29 wherein the step of charging a fee includes the step of charging a fee via telecommunications lines by the first party to the second party at a location remote from the second party location.

36. A method as described in Claim 35 wherein the second party has an account and the step of charging a fee includes the step of charging the account of the second party.

37. A method as described in Claim 36 wherein the step of charging the account of the second party includes the steps of telephoning the first party controlling use of the first memory by the second party; providing a credit card number of the second party controlling the second memory to the first party controlling the first memory so the second party is charged money.

38. A method for transferring desired digital video or digital audio signals from a first party to a second party comprising the steps of:

placing a receiver by the second party at a desired location determined by the second party;

forming a connection through telecommunications lines between a first memory of a first party and a second memory of a second party, said first memory having said desired digital video or digital audio signals;

selling electronically by the first party to the second party through telecommunications lines, the desired digital video or digital audio signals in the first memory; and

transferring the desired digital video or digital audio signals from the first memory of the first party to the second memory of the second party through telecommunications lines.

A⁸
39. A method as described in Claim 38 wherein the second party is at a second party location and the step of selling electronically includes the step of charging a fee via telecommunications lines by the first party to the second party at a first party location remote from the second party location.

40. A method as described in Claim 39 wherein the second party has an account and the step of charging a fee includes the step of charging the account of the second party.

41. A method as described in Claim 40 wherein the step of charging the account of the second party includes the steps of telephoning the first party controlling use of the first memory by the second party; providing a credit card number of the second party controlling the second memory to the first party controlling the first memory so the second party is charged money.

42. A method for transferring desired digital video or digital audio signals comprising the steps of:

placing a receiver by the second party at a desired second party location determined by the second party;

forming a connection through telecommunications lines between a first memory of a first party and a second memory of a second party, said first memory having said desired digital video or digital audio signals;

AB
incurring a fee by the second party to the first party for the use of telecommunications lines, the desired digital video or digital audio signals in the first memory; and

transferring the desired digital video or digital audio signals from the first memory of the first party to the second memory of the second party through telecommunications lines while the second memory is in possession and control of the second party

Sub B5 C6
43. A system for transferring digital video signals from a first party to a second party at a second party location comprising:

a first party control unit having a first memory having a plurality of desired individual video selections as desired digital video signals, and means or a mechanism for the first party to charge a fee to the second party for access to the desired digital video signals at a location remote from the second party location;

A⁸
a second party control unit having a second party control panel, a receiver and a video display for playing the desired digital video signals received by the receiver, said second party control panel connected to the video display and the receiver, said receiver and video display operatively controlled by the second party control panel, said second party control unit remote from the first party control unit, said second party control unit placed by the second party at a second party location determined by the second party which is remote from said first party control unit, said second party choosing the desired digital video signals from the first memory with said second party control panel; and

telecommunications lines connected to the first party control unit and the second party control unit through which the desired digital video signals are electronically transferred from the first memory to the receiver while the second party control unit is in possession and control of the second party after the desired digital video signals are sold to ~~the second party by the first party.~~

44. A system as described in Claim 43 wherein the second party control unit includes a second memory which is connected to the receiver and the video display, said

second memory storing the digital video signals that are received by the receiver to provide the video display with the digital video signals.

45. A system as described in Claim 44 wherein the first party control unit includes a first party hard disk having a plurality of digital video signals which include the desired digital video signals, and a sales random access memory chip electronically connected to the first party hard disk for storing a replica of the desired digital video signals of the first party's hard disk.

BAG ²¹/₁₆ ²⁰/₁₇ ¹⁶/₆
46. A system as described in Claim 45 wherein the second party control unit includes a second party hard disk which stores a plurality of digital video signals, and a playback random access memory chip electronically connected to the second party hard disk for storing a replica of the desired digital video signals as a temporary staging area for playback.

c 47. A system as described in Claim 46 wherein the first party control unit includes ^{said} a first party control integrated circuit which controls and executes commands of the first party and is connected to the first party hard disk, the first party sales random access memory, and the second party control integrated circuit through the telecommunications lines, said first party control integrated circuit and said second party control integrated circuit regulate the transfer of the desired digital video signals; and a first party control panel

through which the first party control integrated circuit is programmed and is sent commands and which is connected to the first party control integrated circuit.

c
said
48. A system as described in Claim 47 wherein the second party control unit includes a second party control integrated circuit which controls and executes commands of the second party and is connected to the second party hard disk, the playback random access memory, and the first party control integrated circuit through the telecommunications lines, said second party control integrated circuit and said first party control integrated circuit regulate the transfer of the desired digital video signals; and a second party control panel through which the second party control integrated circuit is programmed and is sent commands and which is connected to the second party integrated circuit.

*A*⁸

e
49. A system as described in Claim 48 wherein the second party control unit includes an incoming random access memory chip connected to the second party hard *disk* drive and the second party control integrated circuit, and the first party control unit through the telecommunications lines for temporarily storing the desired digital video signals received from the first party's control unit for subsequent storage to the second party hard disk.

50. A system as described in Claim 49 wherein the second party control unit includes a video display unit connected to the playback random access memory chip and to the second party integrated circuit for displaying the desired digital video signals.

51. A system as described in Claim 43 wherein the means or mechanism for charging a fee includes means or a mechanism for charging a fee via telecommunications lines by the first party to the second party at a location remote from the second party location.

52. A system as described in Claim 51 wherein the second party has an account and the means or mechanism for charging a fee includes means or a mechanism for charging the account of the second party.

A⁸
53. A system as described in Claim 52 wherein the means or mechanism for charging the account includes means or a mechanism for charging a credit card number of the second party.

54. A system as described in Claim 9 wherein the means or mechanism for electronically selling includes means or a mechanism for electronically selling includes means or a mechanism for charging a fee via telecommunications lines by the first party to the second party at a first party location remote from the second party location.

55. A system as described in Claim 54 wherein the second party has an account and the means or mechanism for charging a fee includes means or a mechanism for charging the account of the second party.

56. A system as described in Claim 55 wherein the means or mechanism for charging the account includes means or a mechanism for receiving a credit card number of the second party.

57. A method for transmitting desired digital video signals stored in a first memory having a plurality of individual video selections as digital video signals of a first party at a first party location to a second party at a second party location so the second party can view the desired digital video signals comprising the steps of:

AS
placing by the second party a receiver, and a video display connected to the receiver at the second party location determined by the second party which is remote from the first party location;

charging a fee by the first party to the second party at a location remote from the second party location so the second party can obtain access to the desired digital video signals;

connecting electronically via telecommunications lines the first memory with a receiver of the second party while the receiver is in possession and control of the second party;

choosing the desired digital video signals by the second party from the first memory of the first party so desired video selections are selected;

transmitting the desired digital video signals from the first memory with a transmitter in control and possession of the first party to the receiver of the second party while the receiver is in possession and control of the second party at the second party location determined by the second party; and

displaying the desired video signals received by the receiver on the video display in possession and control of the second party.

A⁸
58. A method as described in Claim 57 wherein the step of charging a fee includes the step of charging a fee via telecommunications lines by the first party to the second party so the second party can obtain access to the desired digital video signals stored on the first memory.

59. A method as described in Claim 58 wherein the second party has an account and the step of charging a fee includes the step of charging the account of the second party.

60. A method as described in Claim 59 wherein the step of charging the account of the second party includes the steps of telephoning the first party controlling use of

the first memory by the second party; providing a credit card number of the second party controlling the second memory to the first party controlling the first memory so the second party is charged money.

61. A system as described in Claim 23 wherein the means or mechanism for the first party to charge a fee includes means or a mechanism for transferring money electronically via telecommunications lines to the first party at a location remote from the second memory at the second location.

A⁸ sub
C7
62. A system for transferring digital audio signals from a first party to a second party at a second party location comprising:

a first party control unit having a first memory having a plurality of desired individual songs as desired digital audio signals, and means or a mechanism for the first party to charge a fee to the second party for access to the desired digital audio signals at a location remote from the second party location;

a second party control unit having a second party control panel, a receiver and speakers for playing the desired digital audio signals received by the receiver, said second party control panel connected to the speakers and the receiver, said receiver and speakers operatively controlled by the second party control panel, said second party control unit remote from the first party control unit, said second party control unit placed by the second

party at a second party location determined by the second party which is remote from said first party control unit, said second party choosing the desired digital audio signals from the first memory with said second party control panel; and

telecommunications lines connected to the first party control unit and the second party control unit through which the desired digital audio signals are electronically transferred from the first memory to the receiver while the second party control unit is in possession and control of the second party after the desired digital audio signals are sold to the ~~second party by the first party.~~

A⁸

63. A method for transmitting desired digital audio signals stored in a first memory having a plurality of individual songs as digital audio signals of a first party at a first party location to a second party at a second party location so the second party can view the desired digital audio signals comprising the steps of:

placing by the second party a receiver, and speakers connected to the receiver at the second party location determined by the second party which is remote from the first party location;

charging a fee by the first party to the second party at a location remote from the second party location so the second party can obtain access to the desired digital audio signals;

connecting electronically via telecommunications lines the first memory with a receiver of the second party while the receiver is in possession and control of the second party;

choosing the desired digital audio signals by the second party from the first memory of the first party so desired songs are selected;

A8
transmitting the desired digital audio signals from the first memory with a transmitter in control and possession of the first party to the receiver of the second party while the receiver is in possession and control of the second party at the second party location determined by the second party; and

playing the desired audio signals received by the receiver on the speakers in possession and control of the second party.

REMARKS

Claims 1-63 are currently active.

Claims 32-63 have been added.

Claims 1, 2, 8, 9, 16, 17, 18, 23, 24, 29, 30 and 31 have been amended.

The amendment to Claims 1, 8, 9, 16, 17, 23, 29 and 31 in regard to the limitation "while said receiver or second memory is in possession and control of the second party" has antecedent support at page 8, lines 15-17 and figure 1 of the above-identified patent application.

Antecedent support for the amendment to Claims 8, 9, 16, 17, 23 and 29 in regard to the placement of the receiver or the second memory, or the second control unit by the second party is found in Claim 16, lines 12-16. The amended language more specifically defines the language of Claim 16, lines 12-16.

Similarly, the same antecedent support is found for newly added Claims 32-63. In addition, in regard to Claim 43 and Claim 57, and the "individual video selections", antecedent support for the same is found on page 11, lines 8-11 and page 4, lines 17 and 18. Furthermore, a Declaration by inventor Art Hair, one skilled in the art, is enclosed. This

Declaration supports the introduction of, for instance, "charging a fee" or "using an 'account' or a 'credit card' into the above-identified patent application and is inherent in the definition of electronic sales. Also, just by the nature of description of the invention in the above-identified patent application, the receiver or the second memory must be in possession of the second party. Thus, no new matter is being added. Clarification of the existing subject matter is all that is occurring with this amendment.

The specification has been amended to be consistent with the changes and additions to the claims. For instance, the addition to page 11 is essentially new Claims 43 and 51 written out in more customary grammatical form with reference to the figures.

The abstract has been amended to conform to the Examiner's request.

The Examiner has requested the problem solved by the present invention be identified in the specification. On page 3, line 11, an explanation of this problem has been added. Respectfully, a review of the background of the invention already reveals the problems of the prior art.

The Examiner has rejected Claims 1, 2, 8-12 and 16 under 35 U.S.C. §102(b) as being anticipated by Lightner. Applicant respectfully traverses this rejection. Lightner does not teach or suggest "transferring the desired digital video or audio signals . . . while the second memory is the possession and control of the second party". Lightner does not

teach or suggest "placing the receiver by the second party at a location determined by the second party".

Lightner discloses a vending system for remotely accessible stored information. As the title states, Lightner teaches a vending system where the first memory is of the first party and the second memory is of the first party while transferring of the desired video or audio signals from the first memory to the second memory occurs. As is further stated, for instance, in column 2, lines 27-33,

"The vending machine includes a high speed duplicator and a quantity of recordable media, such as blank tape cassettes, the data selected by the consumer is transmitted from the master tape center to the vending machine where it is copied by the duplicator onto the cassette which is then ejected from the machine." (emphasis added)

Thus, the limitation of Claim 1 of the step of "transferring the desired digital video or audio signals from the first memory of the first party to the second memory of the second party through telecommunications lines while the second memory is in possession and control of the second party" (emphasis added) is not taught or suggested by Lightner. The blank tape cassettes taught by Lightner do not come into the "possession and control of the second party" (until after the transfer of the desired video or audio signals from the first memory of the first party to the second memory has been completed whereupon it is ejected from the vending machine.

This operation of transfer is further elaborated upon in Lightner beginning in column 6, lines 2-5, where Lightner teaches that,

"extending upwardly from each rectangular hole 52 is a cassette storage magazine 63 arranged to support a stack of tape cassettes".

As is more easily seen in figure 6, this cassette storage magazine 63 is disposed inside a cassette changer 40 which is disposed in each of the remote vending machines. See column 5, lines 24 and 25. Not until after the duplication is completed does the consumer take possession of the second memory. As is stated in column 6, lines 60-65,

"when the duplication of information on the cassette and the duplicator is completed, a signal, generated in the manner described hereinbelow in relation to FIG. 10, actuates the eject mechanism to cause the full cassette to be ejected via port 68 and be taken by the consumer". (emphasis added)

The consumer only gains access to the tape with a desired video or audio signal at the vending machine subsequent to transfer from the first memory and subsequent to the deposit of currency or insertion of a credit card into the vending machine by a consumer. See column 8, lines 19 and 20.

More specifically, after the proper amount of currency has been received by receiver 91 or a valid credit card has been inserted in credit card terminal 92, start and enable signals are generated to begin the transfer of the desired video or audio signal from

the first memory of the first party to the second memory of the first party. During transfer of the audio or video signal, the selected master tape of the first party is thereby duplicated on the cassette currently in duplicator 49. See column 9, lines 47-49, and as shown in figure 6. There is no teaching or suggestion of the second party ever having possession or control of the second memory at any time before the transfer of the desired audio or video signals from the first memory to the second memory. Before the second party ever comes to the vending machine to purchase the desired audio or video signal and the storage cassette which holds the transferred audio or video signal, the second memories are already present and have been loaded into the vending machine by the first party before the second party ever comes before the vending machine.

On the contrary, from the teachings that the transfer of the desired audio or video signal from the first memory to the second memory occurs only after the insertion of currency or a valid credit card into the vending machine occurs, the second memory is not in possession or control of the second party but is in possession and control of the first party. The insertion of currency or a valid credit card allows the second party to buy not only the video or audio signal, but also the blank cassette which has the desired video or audio signal. The requirement of purchase of the blank cassette evidences a transfer of title of the cassette which occurs only after the cassette is ejected from the vending machine.

Furthermore, the fact that coins are taught to be used with the vending machine indicates that the vending machine is not in the possession or control of the second

party. No one in possession or control of their own machine would ever put in coins into their own machine. Since they already own the machine, putting their own coins into their own machine would be an illogical and nonsensical act. Obviously, the insertion of coins is not a redundant act, it must have some substance to it. The only way substance can be given to such an act is if someone other than the second party owns the vending machine. The coins are taught to be equivalent of a credit card in Lightner and thus the coins are an implied additional representation or statement by Lightner that the vending machine is not in the possession or control of the second party. Applicant only teaches the use of electronic sales or charging a fee at a location remote from the second party location, not any use of coins to be put physically into the machine. This is because the second memory is in the possession and control of the second party, and is always accessible to the second party at any stage of the transfer of the first video or audio signal to the second video or audio signal, by definition.

This use of coins to purchase a cassette on which to store the video or audio signal, and the use of blank cassettes loaded by the first party into the vending machine, as taught by Lightner, actually teaches away from applicant's claimed invention. It teaches the second party does not need to be concerned with ownership of the vending machine and thus the maintenance, upkeep, risk of damage, connection of transmission lines between the master tape and the vending machine, etc. associated therewith. Lightner teaches a second party can just show up, drop coins or a credit card into the vending machine, make his or her selection, and leave with a cassette having his or her selection. Applicant's claimed

invention requires that the second party be in possession and control of the receiver with the attached risks and responsibilities but which, for instance, allows the second party to bring the video or audio signal to him or her at a second party location determined by the second party, since the second party possesses and controls the receiver and thus can place it where he or she wants, and not have to go to where the video or audio signal can be obtained from a vending machine positioned at a location chosen by the first party.

Thus, besides the obvious understanding to one skilled in the art that a vending machine, by definition, is not owned by or in control or possession of the second party, as taught by Lightner, and for the specific reasons set out above, the second party is not in possession or control over the vending machine in Lightner and thus is not in possession and control of the receiver, or the second memory until after transfer of the video or audio signal is complete and it has been ejected from the vending machine. Accordingly, Claim 1 is not anticipated by Lightner.

Claims 2 is dependent to parent Claim 1 and has all the limitations of parent Claim 1. For the reasons Claim 1 is patentable, so is Claim 2.

In regard to independent Claim 8, it has the limitation of "transferring the desired digital video or audio signals from the first memory . . . to the second memory . . . while the second memory is in possession and control of the second party". For the reasons explained above in regard to Claim 1 and this limitation, Claim 8 is also patentable.

Moreover, Claim 8 has the additional limitation of "placing a second party control unit in possession and control of the second party by the second party at a desired location determined by the second party. There is no teaching or suggestion in Lightner of the same. It is clear from the teachings of Lightner as explained above, that it is the first party, not the second party which is in possession and control of the vending machine 10. Furthermore, the vending machine 10 is placed by the first party, not by the second party at a desired location determined by the first party, not by the second party. The second party can determine which vending machine location to go to, to purchase a second memory with a desired signal, but it is a choice from the locations where the vending machine has been placed by the first party. Accordingly, Claim 8 is also patentable because of this additional limitation and associated reasons.

Independent Claim 9 has the limitation that the "desired digital video or audio signals are electronically transferred from the first memory to the second memory while the second memory is in possession and control of the second party". As explained above in regard to Claim 1, Lightner does not teach or suggest this limitation. Accordingly, for the reasons explained above, as to why Claim 1 is patentable, so is Claim 9 over Lightner.

Claims 10-12 are dependent to parent Claim 9 and have all the limitations of Claim 9. Since parent Claim 9 is patentable, so are Claims 10-12.

Independent Claim 16 has the limitation of "placing the receiver by the second party at a desired location determined by the second party. Independent Claim 16 also has the limitation of "transmitting the desired digital video or audio signals from the first memory while said receiver is in possession and control of the second party". For the reasons explained above in regard to Claim 8, and Claim 1, respectively, Claim 16 is patentable over Lightner

It should be noted that the step of placing the receiver by the second party can mean that the second party physically and personally places the receiver at a desired location. It could also mean that the second party directs someone, such as a friend, who is under the direction of the second party and is thus essentially also the second party to place the receiver. The same also holds true for placing a second party control unit as is found in the limitation of Claim 8. The first party can be the owner, dealer, distributor, or retailer who receives payment from the second party for the sale of the digital video or audio signals.

The Examiner has rejected Claims 3-7, 15, 17-31 under 35 U.S.C. §103 as being unpatentable over Ogaki et al. in view of Lightner. Applicant respectfully traverses this rejection. Neither Lightner nor Ogaki et al. teach or suggest "transferring the desired digital video or audio signals . . . while the second memory is in the possession and control of the second party". Neither Lightner nor Ogaki et al. teach or suggest "placing the receiver by the second party at a location determined by the second party".

Referring to Ogaki et al., there is disclosed a software vending system. The software vending system of Ogaki et al. allows a purchaser to obtain a desired software program at a local vending instrument which duplicates the program on a blank tape cassette or other suitable recording medium supplied by the vending machine that allows software maniacs or amateur fans to provide their software programs to the vending machine company through the vending instrument. See column 1, lines 23-26 and column 2, lines 15-21 and 27-31.

The software vending system of Ogaki et al. only accepts bills or coins in a 1,000 yen bill inlet 19, a 100 yen coin slot 20 and a 10 yen coin slot 21. See column 4, lines 20-30. There is no teaching or suggestion of charging a fee at a location remote from the second location where the vending machine is situated. When the proper money is paid, the desired program is duplicated onto a tape cassette 25. The blank or nonrecorded tape cassette 25 is stored in the vending machine 1 in large quantities, without a label stuck to its front face. Blank sheets for the labels 27 are stored in the instrument 1 and each blank sheet is printed by the label printer 48. When a desired program is chosen, the label printer 48 prints the label 27 which is attached to the tape cassette 25 that receives the duplicated desired program. See column 4, lines 59-69. There are also floppy disk drives 28, 29 which are used by the software maniacs who transfer their programs onto the hard disk memory 33 of the instrument 10. See column 5, lines 10-13. The hard disk memory 33 serves as a secondary memory means and is accommodated within the housing of the instrument 1 which comprises a front door 34 equipped with a lock. The door 34 can be

opened only by an authorized person or persons having a key for the lock. See column 5, lines 23-28. Also within the housing are disposed a sales record switch to reveal the desired amounts of sales of individual programs to purchasers. See column 5, lines 49-54.

Each peripheral vending instrument 1 is located at a local dealer through a modem interface 42 of the host system 2 and a private or exclusive data communication line connecting the modem interfaces 42 and 43. See column 6, lines 12-18. There is a cassette detector 52 provided to check if the blank tape cassette to be supplied to the duplicating device 51 is in stock or not. The cassette detector 52 generates a signal when the blank tape cassette 25 has become out of stock and the signal is sent to the first CPU 44. See column 7, lines 26-31. In reference to figures 5-7, step S1 identifies the first CPU 44 checking to see if the blank tape cassette 25 is in stock or not. See column 8, lines 1-3. When there is no blank tape cassette 25 stored in the instrument 1, the first CPU 44 causes an alarm signal to be sounded so the instrument 1 is charged with a new stock of the blank tape cassette 25. See column 8, lines 14-19.

After the purchaser has chosen the desired program, the first CPU 44 provides price data to the CRT 8 so the purchaser can decide whether to buy the desired program. See column 8, lines 55 and 60-63. Only after completion of the program duplication is the recorded tape cassette 25 ejected to the tray 30. When the instrument 1 is used by software maniacs to provide the program to the distributor or supplier for evaluation, see column 10, lines 22 and 23, a tape cassette of floppy disk storing a user developed software program is

inserted into the floppy disk drive 28 or 29 and the program on the floppy disk drive transferred to the hard disk 33. When it is desired to send the user developed software programs to the host system for evaluation by the supplier or distributor, the vending instrument 1 is opened by the owner of the instrument commonly at suitable intervals, for example, once a day. See column 10, lines 46-53. The owner is different from the purchasers or software maniacs.

Furthermore, Ogaki et al. does not teach or suggest the transmission of any type of signals in "digital" form as is found in applicant's claimed invention. Ogaki et al. only teaches to transfer software programs, not digital video or digital audio signals.

As it is clear from the above, the vending instrument 1 and the cassettes 25 are all in possession and control of the first party, the first party being either the owner, supplier, dealer, or distributor of the program. The second party does not obtain possession of the program until after it is ejected from the vending instrument 1. The fact that coins or bills must be deposited directly into the machine before any duplication of the program occurs, the fact that there is sales data that is accumulated for the owner to keep track of the programs that are sold to the second parties (plural), the fact that the blank cassettes 25 are stored in large quantities inside the instrument which are never provided to the purchaser until after duplication of the program has occurred and an individual cassette 25 is ejected from the machine, the fact that the hard disk memory 33 is held in a locked housing from which only the owner has a key and the fact that the vending instrument 1 is located at a

local dealer and is connected to the host system through a private or exclusive data communication line teaches that the vending instrument 1 is in the possession of the first party and is made to sell to the masses without any second party possessing and controlling the second memory while the audio or video signal is transferred to the second. Also, for the reasons elaborated upon above in regard to Lightner and the vending machine only accepting coins or bills for payment and what that represents, Ogaki et al. does not teach or suggest applicant's claimed invention.

The Examiner contends that Ogaki et al., taken together with Lightner, arrives at applicant's claimed invention. As more fully explained above, Ogaki et al., taken together with Lightner, fails to teach various limitations found in the claims. Since there is no teaching or suggestion for several limitations of applicant's claimed invention, Ogaki et al. in view of Lightner cannot arrive at applicant's claimed invention.

More specifically, in regard to Claims 3-7, they are dependent to parent Claim 1. As explained above, neither Lightner nor Ogaki et al. teach or suggest "transferring the desired digital video or audio signals from the first memory . . . to the second memory . . . while the second memory is in possession and control of the second party". Lightner teaches there to be a quantity of recordable media, such as blank tape cassettes located in the vending machine. The consumer purchases a blank tape cassette upon which the desired signal is duplicated and only obtains possession and control of the cassette after it has been ejected from the vending machine. This has been more fully described above in regard to Lightner

and Claim 1. Similarly, Ogaki et al. teaches that blank or nonrecorded tape cassettes 25 are stored in the vending machine 1 in large quantities. Only after completion of the program duplication is recorded tape cassette 25 ejected to the tray 30. It is then and only then that the purchaser is in possession and control of the cassette 25. Thus, Ogaki et al., for the reasons more fully elaborated upon above, does not teach or suggest the limitations of Claim 1. Since neither Lightner nor Ogaki et al. teach or suggest Claim 1 and Claims 3-7 are dependent to parent Claim 1 and have all of its limitations, Claims 3-7 are also patentable over Ogaki et al. in view of Lightner.

Similarly, Claim 15 is dependent to parent Claim 9. For the reasons explained above, Lightner does not teach or suggest Claim 9. In regard to Ogaki et al., Ogaki et al. does not teach or suggest the "desired digital video or audio signals" being "electronically transferred from the first memory to the second memory while the second memory is in possession and control of the second party", as explained above. Moreover, Ogaki et al. does not teach "said second party control unit placed by the second party at a location determined by the second party". Ogaki et al. teaches that the vending machine 1 is placed by the first party and not by the second party. This is because the first party owns the vending machine 1, and even has a private line connecting the host system 2 with the vending instrument 1. Furthermore, the instrument's 1 front door 34 is locked and only an authorized person having a key can open it. See the above discussion of Ogaki et al. for a more elaborate explanation of the same. Accordingly, Ogaki et al. does not teach or suggest "said second party control unit placed by the second party at a location determined by the

second party". Since neither Ogaki et al. nor Lightner, as explained above, teach these limitations, Claim 9 is patentable over Ogaki et al. in view of Lightner. Since Claim 15 has all the limitations of Claim 9, Claim 15 is also patentable.

In regard to Claim 17, it also has the limitation of "means or a mechanism for transmitting the desired digital video or audio signals from the first memory . . . to a receiver having the second memory while said receiver is in possession and control of the second party . . .". As explained above, neither Lightner nor Ogaki et al. teach or suggest this limitation. Accordingly, Claim 17 is patentable over Ogaki et al. in view of Lightner. Claims 18-22 are dependent to parent Claim 17 and have all the limitations of parent Claim 17. Since parent Claim 17 is patentable over Ogaki in view of Lightner, so are Claims 18-22.

Claim 23 is patentable for the reasons Claim 17 is patentable. Moreover, Claim 23 has the additional limitation of "said receiver placed by the second party at a location determined by the second party". As explained above, neither Ogaki et al. nor Lightner teach or suggest this limitation. Also, because of this additional limitation, Claim 23 is patentable over Ogaki et al. in view of Lightner.

Claims 24-28 are dependent to parent Claim 23 and have all the limitations of Claim 23. Since Claim 23 is patentable over Ogaki et al. in view of Lightner, so are Claims 24-28.

Claim 29 is patentable over Ogaki et al. in view of Lightner for the reasons that Claim 23 is patentable over Ogaki et al. in view of Lightner.

Claim 30 is dependent to Claim 29 and has all the limitations of Claim 29. Since Claim 29 is patentable over Ogaki et al. in view of Lightner, Claim 30 is patentable over Ogaki et al. in view of Lightner.

Claim 31 is patentable over Ogaki et al. in view of Lightner for the reasons that Claim 1 is patentable over Ogaki et al. in view of Lightner.

Newly added Claims 32-34 are dependent to parent Claim 1 and have all the limitations of parent Claim 1. Since parent Claim 1 is patentable over Ogaki et al. in view of Lightner, then Claims 32-34 are patentable over Ogaki et al. in view of Lightner.

Similarly, Claims 35-37 are dependent to parent Claim 29. Since parent Claim 29 is patentable over Ogaki et al. in view of Lightner, so are Claims 35-37.

Claim 38 is patentable over Ogaki et al. in view of Lightner for the reasons that Claim 29 is patentable over Ogaki et al. in view of Lightner. Claims 39-41 are dependent to parent Claim 38. Since parent Claim 38 is patentable over Ogaki et al. in view of Lightner, so are Claims 39-41.

Claim 43 is patentable for the reasons that Claim 23 is patentable. Since Claims 44-53 are dependent to parent Claim 43, they have all the limitations of parent Claim 43 and are patentable for the reasons Claim 43 is patentable over Ogaki et al. in view Lightner.

Claims 54-56 are dependent to parent Claim 9 and have all the limitations of parent Claim 9. Since parent Claim 9 is patentable over Lightner, Claims 54-56 are patentable over Lightner.

Claim 57 is patentable over Ogaki et al. in view of Lightner for the same reasons Claim 29 is patentable over Ogaki et al. in view of Lightner. Furthermore, Claims 58-60 are dependent to parent Claim 57 and have all the limitations of parent Claim 57. Since Claim 57 is patentable over Ogaki et al. in view of Lightner, so are Claims 58-60.

Claim 61 is dependent to parent Claim 23 and has all of its limitations. Since parent Claim 23 is patentable over Ogaki et al. in view of Lightner, so is Claim 61.

In view of the foregoing amendments and remarks, it is respectfully requested that the outstanding rejections and objections to this application be reconsidered and withdrawn, and Claims 1-63, now in this application be allowed.

CERTIFICATE OF MAILING

I hereby certify that the correspondence is being deposited with the United States Postal Service as first class mail in an envelope addressed to: Commissioner of Patents and Trademarks, Washington, DC 20231.
on 12/30/93

Ansel Schwartz

Ansel M. Schwartz
Registration No. 30,587

12/30/93

Date

Respectfully submitted,

ARTHUR R. HAIR

By Ansel Schwartz

Ansel M. Schwartz, Esquire

Reg. No. 30,587

425 N. Craig Street

Suite 301

Pittsburgh, PA 15213

(412) 621-9222

Attorney for Applicant



IN THE UNITED STATES PATENT AND TRADEMARK OFFICE

#4

In re Application of:

ARTHUR R. HAIR

Serial No. 08/023,398

Filed: February 26, 1993

Art Unit: 2313

Patent Examiner:

H. Nguyen

)
)
)
)
) A SYSTEM FOR TRANSMITTING
) DESIRED DIGITAL VIDEO OR
) AUDIO SIGNALS
)
)
)
)
)

Pittsburgh, Pennsylvania 15213

December 30, 1993

Hon. Commissioner of Patents and Trademarks

Washington, D.C. 20231

Sir:

INFORMATION DISCLOSURE STATEMENT

It is respectfully requested that the documents listed below be considered in the above-identified patent application and made of record. Full text copies of the pertinent papers are enclosed and this submission is believed to be in compliance with the appropriate rules concerning information disclosure statements.

This patent came to the attention of applicant within the last two months of the date of this statement.

No representation is made or intended that better art than that submitted hereunder is available.

JM20132 01/28/94 08023398

19-0737 020 126

200.00CH



IN THE UNITED STATES PATENT AND TRADEMARK OFFICE

#3

In re Application of:)

ARTHUR R. HAIR)

Serial No. 08/023,398)

Filed: February 26, 1993)

Art Unit: 2313)

Patent Examiner:)

H. Nguyen)

) A SYSTEM FOR TRANSMITTING
) DESIRED DIGITAL VIDEO OR
) AUDIO SIGNALS

Pittsburgh, Pennsylvania 15213

December 30, 1993

Hon. Commissioner of Patents and Trademarks

Washington, D.C. 20231

DECLARATION UNDER 37 C.F.R. §1.132

I, Arthur R. Hair, hereby declare that:

I currently reside at 330 Murrays Lane, Pittsburgh,
Pennsylvania 15234.

I am the sole inventor of the above-identified patent
application.

I have reviewed the contents of the specification, and
the claims of the above-identified patent application, as
amended.

On page 3, line 12 of the above-identified patent application, it states "it is an objective of the invention to provide a new and improved methodology/system to electronically sell and distribute digital audio music".

The terms "electronically sell", "electronic sales" and "electronically sold" are used throughout the specification of the above-identified patent application.

One skilled in the art would know that an electronic sale inherently assumes a transferring of money by providing an account number or a credit or debit card number which then allows for access to or a transferring of a service or product through telecommunications lines.

One skilled in the art would know that an electronic sale inherently assumes a charging of a fee to an account which then allows for access to or a transferring of a product or service through telecommunications lines.

The use of transferring money across telecommunication connections, such as by telephoning over the phone lines the agent who has a first party's hard disk, or charging a fee to a purchaser or "second party" preferably at a location remote from a purchaser or "second party", for obtaining data on the first

party's hard disk through telecommunications lines is well known to one skilled in the art to be part of electronic sales.

The above-identified patent application states on page 7, first paragraph that the "Hard Disk 10 of the agent authorized to electronically sell and distribute the copyrighted Digital Audio Music is the originating source of music in the configuration as outlined in figure 1".

One skilled in the art would know that, as found in Claim 1, the "first party" includes the agent who is authorized to electronically sell and distribute music; and the "second party" is to whom the music is distributed. One skilled in the art would also know since the music is distributed through electronic sale, "the second party must be financially distinct from the first party" or there could be no sale. Furthermore, the "second party" must have a "receiver" (the control IC of the user in figure 1) in his "possession" in order to receive the music electronically from the hard disk of the agent over the telecommunications lines, such as telephone lines. This "possession" can further be seen since the telephone lines connect to the receiver which is in turn connected to the hard disk 60, playback ram 50d, video display 70, speakers 80 and control panel 50a, as shown in figure 1; and as stated beginning on page 8, line 24 that after "literally thousands of songs" are

stored on the "user's hard disk 60 . . . the user types in the appropriate commands on the control panel 50a" to ultimately play the desired song. "The user may request specific songs to be electronically cued for playback . . . or randomly" selected songs. "[T]he video display screen 70 can display the lyrics of the songs being played . . .". The playing of multiple songs takes time, and since they are "permanently stored" (page 9, line 4) for the user to listen to them over and over, it is clear to one skilled in the art that the "receiver" and the "second memory" are in the possession of the second party. This is because it only makes sense for all of this to occur -- the listening over and over, the cueing, the playing of multiple songs, the displaying of the lyrics of the song being played -- if the second party can possess and control the receiver or the second memory over long periods of time, such as days, weeks, months or years. This is opposed to the time to purchase a tape or cassette with a desired song or a video from a vending machine in possession and control of the distributor or retailer, which occurs in minutes, both so the purchaser can obtain the product quickly and move on, and so the next purchaser can gain access to the first party's vending machine and purchase his or her selection. The quicker the transaction, the more money the distributor or retailer can make in regard to vending machines.

One skilled in the art knowing that an object of the invention relates to "electronic sales" and that the agent, "a first party", who has control of the hard disk 10 is authorized "to electronically sell and distribute", and that the hard disk 10 communicates with the user's ("second party's") control unit 50, the "receiver" in the "possession of the second party", through "telephone lines 30" (electrical lines) would also know that the "electronic sales" as disclosed refers to the well known practices of "transferring" and verifying monies across telephone lines such as by a "credit card"; or by "charging a fee" to the second party, so the second party can gain access to the first party's memory through telecommunications lines to select the desired digital video or digital audio signals.

Electronic sales encompasses all of the above. Essentially, electronic sales covers any type of fee charges or money transfers, except an actual physical transfer of coins or bills at the second party location of the second party, with a connection via telecommunication lines between the first memory of the first party, and the receiver in possession and control of the second party.

I further declare that all statements made herein of my own knowledge are true and that all statements made on information and belief are believed to be true; and further, that

these statements are made with the knowledge that willful false statements in the like so made are punishable by fine or imprisonment, or both, under Section 1001 of Title 18 of the United States Code, and that such willful false statements may jeopardize the validity of the application or any patent issuing thereon.

12/30/1993
Date

Arthur R. Hair
Arthur R. Hair

IN THE UNITED STATES PATENT AND TRADEMARK OFFICE

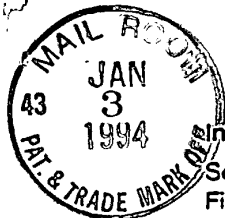

In re application of: Arthur R. Hair
Serial No.: 0 8 / 023,398 Group No.: 2313
Filed: February 26, 1993 Examiner: H. Nguyen
For: A SYSTEM FOR TRANSMITTING DESIRED DIGITAL VIDEO OR AUDIO SIGNALS

Commissioner of Patents and Trademarks
Washington, D.C. 20231

AMENDMENT TRANSMITTAL

- 1. Transmitted herewith is an amendment for this application.

STATUS

- 2. Applicant is
 a small entity — verified statement:
 attached.
 already filed.
 other than a small entity.

CERTIFICATE OF MAILING (37 CFR 1.8(a))

I hereby certify that this paper (along with any referred to as being attached or enclosed) is being deposited with the United State Postal Sevice on the date shown below with sufficient postage as first class mail in an envelope addressed to the: Commissioner of Patents and Trademarks, Washington, D.C. 20231.

Tracey L. Milka

(Type or print name of person mailing paper)

Date: 12/30/93

Tracey L. Milka

(Signature of person mailing paper)

EXTENSION OF TERM

NOTE: "Extension of Time in Patent Cases (Supplement Amendments) — If a timely and complete response has been filed after a Non-Final Office Action, an extension of time is not required to permit filing and/or entry of an additional amendment after expiration of the shortened statutory period.

If a timely response has been filed after a Final Office Action, an extension of time is required to permit filing and/or entry of a Notice of Appeal or filing and/or entry of an additional amendment after expiration of the shortened statutory period unless the timely-filed response placed the application in condition for allowance. Of course, if a Notice of Appeal has been filed within the shortened statutory period, the period has ceased to run." Notice of December 10, 1985 (1061 O.G. 34-35).

NOTE: See 37 CFR 1.645 for extensions of time in interference proceedings and 37 CFR 1.550(c) for extensions of time in reexamination proceedings.

3. The proceedings herein are for a patent application and the provisions of 37 CFR 1.136 apply

(complete (a) or (b) as applicable)

(a) Applicant petitions for an extension of time under 37 CFR 1.136 (fees: 37 CFR 1.17(a)-(d) for the total number of months checked below:

Extension (months)	Fee for other than <u>small entity</u>	Fee for <u>small entity</u>
<input type="checkbox"/> one month	\$ 110.00	\$ 55.00
<input type="checkbox"/> two months	\$ 360.00	\$180.00
<input checked="" type="checkbox"/> three months	\$ 840.00	\$420.00
<input type="checkbox"/> four months	\$1,320.00	\$660.00

Fee \$ 420.00

If an additional extension of time is required please consider this a petition therefor.

(check and complete the next item, if applicable)

An extension for _____ months has already been secured and the fee paid therefor of \$_____ is deducted from the total fee due for the total months of extension now requested.

Extension fee due with this request \$_____

OR

(b) Applicant believes that no extension of term is required. However, this conditional petition is being made to provide for the possibility that applicant has inadvertently overlooked the need for a petition for extension of time.

FEE FOR CLAIMS

4. The fee for claims (37 CFR 1.16(b)-(d)) has been calculated as shown below:

	(Col. 1)		(Col. 2)		(Col. 3)	SMALL ENTITY	OTHER THAN A SMALL ENTITY		
	CLAIMS REMAINING AFTER AMENDMENT		HIGHEST NO PREVIOUSLY PAID FOR		PRESENT EXTRA	RATE	ADDIT. FEE	OR RATE	ADDIT. FEE
TOTAL	63	MINUS	31	=	32	x11= \$	352.00	x22= \$	
INDEP.	14	MINUS	8	=	6	x37= \$	222.00	x74= \$	
<input type="checkbox"/> FIRST PRESENTATION OF MULTIPLE DEP. CLAIM						+115= \$		+230= \$	
						TOTAL	OR	TOTAL	
						ADDIT. FEE \$	574.00	ADDIT. FEE \$	

- * If the entry in Col. 1 is less than entry in Col. 2, write "0" in Col. 3.
 - ** If the "Highest No. Previously Paid for" IN THIS SPACE is less than 20, enter "20".
 - *** If the "Highest No. Previously Paid For" IN THIS SPACE is less than 3, enter "3".
 - The "Highest No. Previously Paid For" (Total or indep.) is the highest number found in the appropriate box in Col. 1 of a prior amendment or the number of claims originally filed.
- WARNING:** "After final rejection or action (§ 1.113) amendments may be made cancelling claims or complying with any requirement of form which has been made." 37 CFR § 1.116(a) (emphasis added).

(complete (c) or (d) as applicable)

(c) No additional fee for claims is required.

OR

(d) Total additional fee for claims required \$ 574.00

FEE PAYMENT

5. Attached is a check in the sum of \$ 994.00
- Charge Account No. _____ the sum of \$ _____

A duplicate of this transmittal is attached.

FEE DEFICIENCY

NOTE: If there is a fee deficiency and there is no authorization to charge an account, additional fees are necessary to cover the additional time consumed in making up the original deficiency. If the maximum, six-month period has expired before the deficiency is noted and corrected, the application is held abandoned. In those instances where authorization to charge is included, processing delays are encountered in returning the papers to the PTO Finance Branch in order to apply these charges prior to action on the cases. Authorization to charge the deposit account for any fee deficiency should be checked. See the Notice of April 7, 1986, (1065 O.G. 31-33).

6. If any additional extension and/or fee is required, charge Account No. 19-0737

(Amendment Transmittal [9-19]—page 3 of 4)

AND/OR

If any additional fee for claims is required, charge Account No. 19-0737

Reg. No.: 30,587

Tel. No.: (412) 621-9222



SIGNATURE OF ATTORNEY

Ansel M. Schwartz
Attorney at Law

Type or print name of attorney
425 N. Craig Street
Suite 301

P.O. Address

Pittsburgh, PA 15213

(Amendment Transmittal [9-19]—page 4 of 4)

23D2

1-21-94

041

#7

IN THE UNITED STATES PATENT AND TRADEMARK OFFICE

In re Application of:

ARTHUR R. HAIR

Serial No. 08/023,398

Filed: February 26, 1993

Art Unit: 2313

Patent Examiner:

H. Nguyen



RECEIVED
JAN 28 1994
GROUP 2300

) A SYSTEM FOR TRANSMITTING
) DESIRED DIGITAL VIDEO OR
) AUDIO SIGNALS

Pittsburgh, Pennsylvania 15213

January 20, 1994

CERTIFICATE OF MAILING

I hereby certify that the correspondence is being deposited with the United States Postal Service as first class mail in an envelope addressed to: Commissioner of Patents and Trademarks, Washington, DC 20231, on 1/20/94

Hon. Commissioner of Patents and Trademarks

Washington, D.C. 20231

Sir:

Ansel M. Schwartz

Ansel M. Schwartz
Registration No. 30,587

1/20/94
Date

INFORMATION DISCLOSURE STATEMENT

It is respectfully requested that the document listed below be considered in the above-identified patent application and made of record. A full text copy of the pertinent paper is enclosed and this submission is believed to be in compliance with the appropriate rules concerning information disclosure statements.

This patent came to the attention of applicant within the last month of the date of this statement.

No representation is made or intended that better art than that submitted hereunder is available.

U.S. Patent No. 4,521,806

This patent discloses a recorded program communication system for the transfer of video/audio program material.

CERTIFICATE OF MAILING

I hereby certify that the correspondence is being deposited with the United States Postal Service as first class mail in an envelope addressed to: Commissioner of Patents and Trademarks, Washington, DC 20231, on 1/20/94

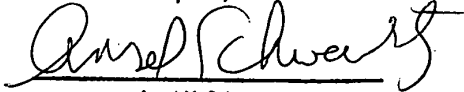

Ansel M. Schwartz
Registration No. 30,587

1/20/94
Date

Respectfully submitted,

ARTHUR R. HAIR

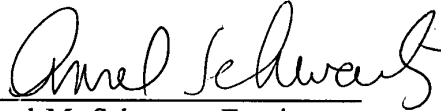
By 

Ansel M. Schwartz, Esquire
Reg. No. 30,587
425 N. Craig Street
Suite 301
Pittsburgh, PA 15213
(412) 621-9222

Attorney for Applicant



2313 1/21/94

2313

233

#6

IN THE UNITED STATES PATENT AND TRADEMARK OFFICE

In re Application of:)
ARTHUR R. HAIR)
Serial No. 08/023,398)
Filed: February 26, 1993)
Art Unit: 2313)
Patent Examiner:)
H. Nguyen)

) A SYSTEM FOR TRANSMITTING
) DESIRED DIGITAL VIDEO OR
) AUDIO SIGNALS
RECEIVED
JAN 31 1994
GROUP 2300

Pittsburgh, Pennsylvania 15213
January 18, 1994

Hon. Commissioner of Patents and Trademarks
Washington, D.C. 20231

Sir:

LETTER

Enclosed is a listing on Form PTO-1449 of the prior art reference not considered in the previous Form PTO-1449. This form was not included with the Information Disclosure Statement that was filed on December 30, 1993. Also please find a copy of the cited patent thereon.

Respectfully submitted,

ARTHUR R. HAIR

By Ansel Schwartz
Ansel M. Schwartz, Esquire

Reg. No. 30,587
425 N. Craig Street
Suite 301
Pittsburgh, PA 15213
(412) 621-9222

Attorney for Applicant

CERTIFICATE OF MAILING

I hereby certify that the correspondence is being deposited with the United States Postal Service as first class mail in an envelope addressed to: Commissioner of Patents and Trademarks, Washington, DC 20231,
on 1/18/94

Ansel Schwartz
Ansel M. Schwartz
Registration No. 30,587

1/18/94
Date

U.S. Patent No. 4,538,176

This patent discloses a buffer memory dispersion type vide/audio transmission system.

Respectfully submitted,

ARTHUR R. HAIR

By



Ansel M. Schwartz, Esquire
Reg. No. 30,587
425 N. Craig Street
Suite 301
Pittsburgh, PA 15213
(412) 621-9222

Attorney for Applicant



2301

2313

IN THE UNITED STATES PATENT AND TRADEMARK OFFICE

In re Application of:

ARTHUR R. HAIR

Serial No. 08/023,398

Filed: February 26, 1993

Art Unit: 2313

Patent Examiner:

H. Nguyen

RECEIVED

MAY 05 1994

GROUP 2300

A SYSTEM FOR TRANSMITTING
DESIRED DIGITAL VIDEO OR
AUDIO SIGNALS

Pittsburgh, Pennsylvania 15213

April 26, 1994

CERTIFICATE OF MAILING

I hereby certify that the correspondence is being deposited with the United States Postal Service as first class mail in an envelope addressed to: Commissioner of Patents and Trademarks, Washington, DC 20231, on 4/26/94

Ansel Schwartz
Ansel M. Schwartz
Registration No. 30,587

Hon. Commissioner of Patents and Trademarks

Washington, D.C. 20231

Sir:

INFORMATION DISCLOSURE STATEMENT

4/26/94
Date

It is respectfully requested that the document listed below be considered in the above-identified patent application and made of record. A full text copy of the pertinent paper is enclosed and this submission is believed to be in compliance with the appropriate rules concerning information disclosure statements.

This patent came to the attention of applicant within the last two months of the date of this statement.

No representation is made or intended that better art than that submitted hereunder is available.

U.S. Patent No. 4,789,863

This patent discloses a pay per view entertainment system.

Respectfully submitted,

ARTHUR R. HAIR

By Ansel Schwartz

Ansel M. Schwartz, Esquire

Reg. No. 30,587

425 N. Craig Street

Suite 301

Pittsburgh, PA 15213

(412) 621-9222

Attorney for Applicant

CERTIFICATE OF MAILING

I hereby certify that the correspondence is being deposited with the United States Postal Service as first class mail in an envelope addressed to: Commissioner of Patents and Trademarks, Washington, DC 20231.
on 4/26/94

Ansel Schwartz

Ansel M. Schwartz
Registration No. 30,587

4/26/94

Date



UNITED STATES DEPARTMENT OF COMMERCE
Patent and Trademark Office

Address: COMMISSIONER OF PATENTS AND TRADEMARKS
Washington, D.C. 20231

SERIAL NUMBER	FILING DATE	FIRST NAMED INVENTOR	ATTORNEY DOCKET NO.
---------------	-------------	----------------------	---------------------

08/023,398 02/26/93 HAIR

A HAIR-1CONT II
EXAMINER

NGUYEN, H

B3M1/0504

ART UNIT PAPER NUMBER

ANSEL M. SCHWARTZ
425 N. CRAIG STREET, SUITE 301
PITTSBURGH, PA 15213

2313
DATE MAILED:

05/04/94

This is a communication from the examiner in charge of your application.
COMMISSIONER OF PATENTS AND TRADEMARKS

This application has been examined Responsive to communication filed on 01/3/94 This action is made final.

A shortened statutory period for response to this action is set to expire 3 month(s), _____ days from the date of this letter.
Failure to respond within the period for response will cause the application to become abandoned. 35 U.S.C. 133

Part I THE FOLLOWING ATTACHMENT(S) ARE PART OF THIS ACTION:

- 1. Notice of References Cited by Examiner, PTO-892.
- 2. Notice re Patent Drawing, PTO-948.
- 3. Notice of Art Cited by Applicant, PTO-1449.
- 4. Notice of Informal Patent Application, Form PTO-152.
- 5. Information on How to Effect Drawing Changes, PTO-1474.
- 6. _____

Part II SUMMARY OF ACTION

1. Claims 1-63 are pending in the application.

Of the above, claims _____ are withdrawn from consideration.

2. Claims _____ have been cancelled.

3. Claims _____ are allowed.

4. Claims 1-3, 8-9, 16-18, 23-24, 29, 44, 51-63 are rejected.

5. Claims 4-7, 10-15, 19-22, 25-28, 45-50 are objected to.

6. Claims _____ are subject to restriction or election requirement.

7. This application has been filed with informal drawings under 37 C.F.R. 1.85 which are acceptable for examination purposes.

8. Formal drawings are required in response to this Office action.

9. The corrected or substitute drawings have been received on _____ Under 37 C.F.R. 1.84 these drawings are acceptable not acceptable (see explanation or Notice re Patent Drawing, PTO-948).

10. The proposed additional or substitute sheet(s) of drawings, filed on _____ has (have) been approved by the examiner disapproved by the examiner (see explanation).

11. The proposed drawing correction, filed on _____ has been approved disapproved (see explanation).

12. Acknowledgment is made of the claim for priority under U.S.C. 119. The certified copy has been received not been received been filed in parent application, serial no. _____ filed on _____

13. Since this application appears to be in condition for allowance except for formal matters, prosecution as to the merits is closed in accordance with the practice under Ex parte Quayle, 1935 C.D. 11; 453 O.G. 213

1. The amendment filed on 01/03/94 has been entered.
2. The following is a quotation of the appropriate paragraphs of 35 U.S.C. § 102 that form the basis for the rejections under this section made in this Office action:

A person shall be entitled to a patent unless --
(b) the invention was patented or described in a printed publication in this or a foreign country or in public use or on sale in this country, more than one year prior to the date of application for patent in the United States.

3. Claims 1-3, 8-9, 16-18, 23-24, 29-44, 51-63 are rejected under 35 U.S.C. § 102(b) as being anticipated by Freeny, Jr.'US/4528643.

Freeny, Jr. a method for transferring digital information which includes forming a connection through telecommunications lines between a first memory of a first party and a second memory of a second party, the first part having the digital signals, selling electronically by the first party to the second party through the telecommunication lines the desired digital signals, transferring the desired digital signals from the first party to the second party through said lines while the second memory is in possession and control of the second party and the step of storing the digital signals in the second memory. See figure 1 and its fully description.

4. Claims 4-7, 10-15, 19-22, 25-28, 45-50 would be allowable if rewritten to include all of the limitations of the base claim and any intervening claims.

Serial No. 08/023398
Art Unit 2313

-3-

3

5. Any inquiry concerning this communication or earlier communications from the examiner should be directed to Hoa Nguyen whose telephone number is (703) 305-9687.

Any inquiry of a general nature or relating to the status of this application should be directed to the Group receptionist whose telephone number is (703) 305-9600.

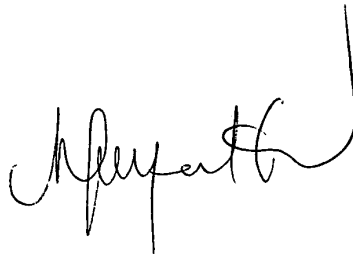

HOA T. NGUYEN
PRIMARY EXAMINER
GROUP 2300

TO SEPARATE

RD CARBON

FORM PTO-892 (REV. 2-92)	U.S. DEPARTMENT OF COMMERCE PATENT AND TRADEMARK OFFICE	SERIAL NO. 08/023798 607648	GROUP ART UNIT 233	ATTACHMENT TO PAPER NUMBER 8
NOTICE OF REFERENCES CITED		APPLICANT(S) Hair		

U.S. PATENT DOCUMENTS

*	DOCUMENT NO.	DATE	NAME	CLASS	SUB-CLASS	FILING DATE IF APPROPRIATE
A	4528643	7/85	Freemy Jr.	280 364	4 900	
B						
C						
D						
E						
F						
G						
H						
I						
J						
K						

FOREIGN PATENT DOCUMENTS

*	DOCUMENT NO.	DATE	COUNTRY	NAME	CLASS	SUB-CLASS	PERTINENT SHTS. DWG.	PP. SPEC.
L								
M								
N								
O								
P								
Q								

OTHER REFERENCES (Including Author, Title, Date, Pertinent Pages, Etc.)

R	
S	
T	
U	

EXAMINER HOA NGUYEN	DATE 4/94
------------------------	--------------

* A copy of this reference is not being furnished with this office action. (See Manual of Patent Examining Procedure, section 707.05 (a).)

ATTACHMENT TO PAPER NUMBER 8
APPLICATION NUMBER 023398

GROUP 2317

NOTICE OF DRAFTSPERSON'S PATENT DRAWING REVIEW

THE PTO DRAFTSMEN REVIEW ALL ORIGINALLY FILED DRAWINGS REGARDLESS OF WHETHER THEY WERE DESIGNATED AS INFORMAL OR FORMAL. ADDITIONALLY, THE PATENT EXAMINER WILL ALSO REVIEW THE DRAWINGS FOR COMPLIANCE WITH THE REGULATIONS.

The drawings filed 2/26/93

- A. are approved by the draftsman.
- B. are objected to by the draftsman under 37 CFR 1.84 for the reason(s) checked below. The examiner will require submission of new, corrected drawings at the appropriate time. Corrected drawings must be submitted according to the instructions listed on the back of this Notice.

1. Paper and ink. 37 CFR 1.84(a)

Sheet(s) _____ Poor.

2. Size of Sheet and Margins. 37 CFR 1.84(b)

Acceptable Paper Sizes and Margins

Margin	Paper Size		
	8 1/2 by 14 inches	8 1/2 by 13 inches	DIN size A4 21 by 29.7 cm.
Top	2 inches	1 inch	2.5 cm.
Left	1/4 inch	1/4 inch	2.5 cm.
Right	1/4 inch	1/4 inch	1.5 cm.
Bottom	1/4 inch	1/4 inch	1.0 cm.

Proper Size Paper Required. All Sheets Must be Same Size. Sheet(s) _____

Proper Margins Required. Sheet(s) _____

- TOP RIGHT
 LEFT BOTTOM

3. Character of Lines. 37 CFR 1.84(c)

Lines Pale or Rough and Blurred. Fig(s) 1

Solid Black Shading Not Allowed. Fig(s) _____

4. Photographs Not Approved.

Comments;

5. Hatching and Shading. 37 CFR 1.84(d)

Shade Lines are Required. Fig(s) _____

Criss-Cross Hatching Not Allowed. Fig(s) _____

Double Line Hatching Not Allowed. Fig(s) _____

Parts in Section Must be Hatched. Fig(s) _____

6. Reference Characters. 37 CFR 1.84(f)

Reference Characters Poor or Incorrectly Sized. Fig(s) 42

Reference Characters Placed Incorrectly. Fig(s) _____

7. Views. 37 CFR 1.84(i) & (j)

Figures Must be Numbered Properly.

Figures Must Not be Connected. Fig(s) _____

8. Identification of Drawings. 37 CFR 1.84(1) Extraneous Matter or Copy Machine Marks Not Allowed. Fig(s) _____

9. Changes Not Completed from Prior PTO-948 dated _____

Telephone Inquires concerning this review should be directed to the Chief Draftsman at telephone number (703) 305-8404.

70
Reviewing Draftsman

5/7/93
Date

Line 10, before "audio" insert -- digital -- ;

Line 11, before "audio" insert -- digital -- ;

Line 14, before "audio" insert -- digital -- ;

N.E. Line 16, before "audio" insert -- digital -- ;

N.E. Line 17, before "audio" insert -- digital -- ;

N.E. Line 21, before "audio" insert -- digital -- ;

N.E. Line 28, before "audio" insert -- digital -- ;

N.E. Line 29, before "audio" insert -- digital -- ;

N.E. Line 31, before "audio" insert -- digital -- ;

IN THE CLAIMS:

1. (Twice Amended) A method for transferring desired digital video or digital audio signals comprising the steps of:

forming a connection through telecommunications lines between a first memory of a first party at a first party location and a second memory of a second party at a second party location remote from the first party location, said first memory having [said desired digital video or digital audio signals] a first party hard disk having a plurality of digital video or digital audio signals including the desired digital video or digital audio signals, and a sales random access memory chip which temporarily stores a replica of the desired digital video or digital audio signals purchased by the second party for subsequent transfer via telecommunications lines to the second memory of the second party;

B
[selling electronically by the first party to the second party through telecommunications lines, the desired digital video or digital audio signals in the first memory; and]

telephoning the first party controlling use of the first memory by the second party;

providing a credit card number of the second party controlling the second memory to the first party controlling the first memory so the second party is charged money;

electronically coding the desired digital video or digital audio signals into a configuration which would prevent unauthorized reproduction of the desired digital video or digital audio signals;

B¹
storing a replica of the desired digital video or digital audio signals from the hard disk into the sales random access memory chip;

transferring the desired digital video or digital audio signals from the first memory of the first party to the second memory of the second party through telecommunications lines while the second memory is in possession and control of the second party[.]; and

storing the desired digital video or digital audio signals in the second memory.

Cancel Claims 2-4 and 8.

Claim 5, line 1, change "4" to -- 1 -- .

9. (Twice Amended) A system for transferring digital video or digital audio signals comprising:

B²
a first party control unit having [a first memory having desired digital video or digital audio signals] a first party hard disk having a plurality of digital video or digital audio signals which include desired digital video or digital audio signals, a sales random access memory chip electronically connected to the first party hard disk for storing a replica of the

desired digital video or digital audio signals of the first party's hard disk, and means [or a mechanism] for electronically selling the desired digital video or digital audio signals;

B
a second party control unit having a second party control panel, a second memory connected to the second party control panel, and means [or a mechanism] for playing the desired digital video or digital audio signals connected to the second memory and the second party control panel, said playing means [or mechanism] operatively controlled by the second party control panel, said second party control unit remote from the first party control unit, said second party control unit placed by the second party at a location determined by the second party; and

telecommunications lines connected to the first party control unit and the second party control unit through which the electronic sales of the desired digital video or digital audio signals occur and through which the desired digital video or digital audio signals are electronically transferred from the first memory to the second memory while the second memory is in possession and control of the second party after the desired digital video or digital audio signals are sold to the second party by the first party.

Cancel Claim 10.

Claim 11, line 1, change "10" to -- 63 -- .

Cancel Claim 16.

17. (Twice Amended) A system for transmitting desired digital video or digital audio signals stored on a first memory of a first party to a second memory of a second party comprising:

means or a mechanism for transferring money electronically via telecommunications lines from the second party to the first party controlling use of the first memory, at a location remote from the second memory, said second party controlling use and in possession of the second memory;

B3
means or a mechanism for connecting electronically via telecommunications lines the first memory with the second memory such that the desired digital video or digital audio signals can pass therebetween; said connecting means or mechanism in electrical communication with the transferring means or mechanism, said connecting means or mechanism comprises a first control unit in possession and control of the first party and a second control unit in possession and control of the second party, said first control unit - comprises a first control panel, first control integrated circuit and a sales random access memory, said sales random access memory and said first control panel in electrical communication with said first control integrated circuit, said second control unit comprising a second control panel, a second control integrated circuit, an incoming random access memory and a playback random access memory, said second control panel, said incoming

random access memory and said playback random access memory in electrical communication with said second control integrated circuit;

B³
means or a mechanism for transmitting the desired digital video or digital audio signals from the first memory with a transmitter in control and possession of the first party to a receiver having the second memory, while said receiver is in possession and control of the second party, said receiver placed at a location determined by the second party, said transmitting means or mechanism in electrical communication with said connecting means or mechanism; and

means or a mechanism for storing the digital video or digital audio signals in the second memory, said storing means or mechanism in electrical communication with said transmitting means or mechanism.

Cancel Claims 18 and 19.

Claim 20, line 1, change "19" to -- 64 -- .

B⁴
23. (Twice Amended) A system for transmitting desired digital video or digital audio signals stored on a first memory of a first party at a first location to a second memory of a second party at a second party location comprising:

means or a mechanism for the first party to charge a fee to the second party for access to the desired digital video or digital audio signals at a location remote from the second location, said first party controlling use of the first memory, said second party controlling use and in possession of the second memory, said means or mechanism for the first party to charge a fee includes means or a mechanism for transferring money electronically via telecommunications lines to the first party at a location remote from the second memory at the second location;

B^M
means or a mechanism for connecting electronically via telecommunications lines the first memory with the second memory such that the desired digital video or digital audio signals can pass therebetween, said connecting means or mechanism in electrical communication with the transferring means or mechanism, said connecting means or mechanism comprises a first control unit in possession and control of the first party and a second control unit in possession and control of the second party, said first control unit comprises a first control panel, first control integrated circuit and a sales random access memory, said sales random access memory and said first control panel in electrical communication with said first control integrated circuit, said second control unit comprising a second control panel, a second control integrated circuit, an incoming random access memory and a playback random access memory, said second control panel, said incoming random access memory and said playback random access memory in electrical communication with said second control integrated circuit;

means or a mechanism for transmitting the desired digital video or digital audio signals from the first memory with a transmitter in control and possession of the first party to a receiver having the second memory while said receiver is in possession and control of the second party, said receiver placed by the second party at the second party location determined by the second party, said transmitting means or mechanism in electrical communication with said connecting means or mechanism; and

B4

means or a mechanism for storing the digital video or digital audio signals in the second memory, said storing means or mechanism in electrical communication with said transmitting means or mechanism.

Cancel Claims 24, 25, 29-42 and 61.

Claim 26, line 1, change "25" to -- 65 -- .

43. (Amended) A system for transferring digital video signals from a first party to a second party at a second party location comprising:

B5

a first party control unit having a first memory having a plurality of desired individual video selections as desired digital video signals, a first party control unit which includes a first party hard disk having the plurality of digital video signals which include desired digital video signals, and a sales random access memory chip electronically

connected to the first party hard disk for storing a replica of the desired digital video signals of the first party's hard disk, and means or a mechanism for the first party to charge a fee to the second party for access to the desired digital video signals at a location remote from the second party location;

35
a second party control unit having a second party control panel, a receiver and a video display for playing the desired digital video signals received by the receiver, said second party control panel connected to the video display and the receiver, said receiver and video display operatively controlled by the second party control panel, said second party control unit remote from the first party control unit, said second party control unit placed by the second party at a second party location determined by the second party which is remote from said first party control unit, said second party choosing the desired digital video signals from the first memory with said second party control panel, said second party control unit includes a second memory which is connected to the receiver and the video display, said second memory storing the digital video signals that are received by the receiver to provide the video display with the digital video signals; and

telecommunications lines connected to the first party control unit and the second party control unit through which the desired digital video signals are electronically transferred from the first memory to the receiver while the second party control unit is in possession and control of the second party after the desired digital video signals are sold to the second party by the first party.

Cancel Claims 44, 45 and 51-61.

Claim 46, line 1, change "45" to -- 66 -- .

62. (Amended) A system for transferring digital audio signals from a first party to a second party at a second party location comprising:

B⁶
a first party control unit having a first memory having a plurality of desired individual songs as desired digital audio signals, a first party control unit which includes a first party hard disk having a plurality of digital audio signals which include the desired digital audio signals, and a sales random access memory chip electronically connected to the first party hard disk for storing a replica of the desired digital audio signals of the first party's hard disk, and means or a mechanism for the first party to charge a fee to the second party for access to the desired digital audio signals at a location remote from the second party location;

a second party control unit having a second party control panel, a receiver and speakers for playing the desired digital audio signals received by the receiver, said second party control panel connected to the audio display and the receiver, said receiver and speakers operatively controlled by the second party control panel, said second party control unit remote from the first party control unit, said second party control unit placed by the second party at a second party location determined by the second party which is remote from

said first party control unit, said second party choosing the desired digital audio signals from the first memory with said second party control panel, said second party control unit includes a second memory which is connected to the receiver and the speakers, said second memory storing the digital audio signals that are received by the receiver to provide the speakers with the digital audio signals; and

B6

telecommunications lines connected to the first party control unit and the second party control unit through which the desired digital audio signals are electronically transferred from the first memory to the receiver while the second party control unit is in possession and control of the second party after the desired digital audio signals are sold to the second party by the first party.

Cancel Claim 63.

Please add the following claims.

¹⁰~~64~~. A system as described in Claim ⁴~~9~~ wherein the telecommunications lines include telephone lines.

B7

¹⁵~~65~~. A system as described in Claim ¹¹~~17~~ wherein the telecommunications lines include telephone lines.

26

66. A system as described in Claim 23 wherein the telecommunications lines include telephone lines.

²⁰67. A system as described in Claim ¹⁹43 wherein the telecommunications lines include telephone lines.

²⁷68. A system as described in Claim ²⁶62 wherein the telecommunications lines include telephone lines.

B7
Sub C8
69. A system for transferring digital video or digital audio signals comprising:
a first party control unit having a first party hard disk having a plurality of digital video or digital audio signals which include desired digital video or digital audio signals, a sales random access memory chip electronically connected to the first party hard disk for storing a replica of the desired digital video or digital audio signals of the first party's hard disk, and a mechanism for electronically selling the desired digital video or digital audio signals;

a second party control unit having a second party control panel, a second memory connected to the second party control panel, and a mechanism for playing the desired digital video or digital audio signals connected to the second memory and the second party control panel, said playing mechanism operatively controlled by the second party

control panel, said second party control unit remote from the first party control unit, said second party control unit placed by the second party at a location determined by the second party; and

telecommunications lines connected to the first party control unit and the second party control unit through which the electronic sales of the desired digital video or digital audio signals occur and through which the desired digital video or digital audio signals are electronically transferred from the first memory to the second memory while the second memory is in possession and control of the second party after the desired digital video or digital audio signals are sold to the second party by the first party.

B7

70. A system as described in Claim 69 wherein the telecommunications lines include telephone lines.

Sub
C9

71. A system as described in Claim 70 wherein the second party control unit includes a second party hard disk which stores a plurality of digital video or audio signals, and a playback random access memory chip electronically connected to the second party hard disk for storing a replica of the desired digital video or audio signals as a temporary staging area for playback.

72. A system as described in Claim 71 wherein the first party control unit includes a first party control integrated circuit which controls and executes commands of the

first party and is connected to the first party hard disk, the first party sales random access memory, and the second party control integrated circuit through the telecommunications lines, said first party control integrated circuit and said second party control integrated circuit regulate the transfer of the desired digital video or audio signals; and a first party control panel through which the first party control integrated circuit is programmed and is sent commands and which is connected to the first party control integrated circuit.

B7
73. A system as described in Claim 72 wherein the second party control unit includes a second party control integrated circuit which controls and executes commands of the second party and is connected to the second party hard disk, the playback random access memory, and the first party control integrated circuit through the telecommunications lines, said second party control integrated circuit and said first party control integrated circuit regulate the transfer of the desired digital video or audio signals; and a second party control panel through which the second party control integrated circuit is programmed, and is sent commands and which is connected to the second party integrated circuit.

C
74. A system as described in Claim 73 wherein the second party control unit includes an incoming random access memory chip connected to the second party hard ^{disk} drive and the second party control integrated circuit, and the first party control unit through the telecommunications lines for temporarily storing the desired digital video or audio signals received from the first party's control unit for subsequent storage to the second party hard disk.

sub 10 75. A system as described in Claim 74 wherein the second party control unit includes a video display unit connected to the playback random access memory chip and to the second party integrated circuit for displaying the desired digital video or audio signals.

B7

REMARKS

Claims 1, 5-7, 9, 11-15, 17, 20-23, 26-28, 43, 46-50, 62 and 64-75 are currently active.

Claims 2-4, 8, 10, 16, 18 and 19, 24, 25, 29-42, 44, 45, 51-61 and 63 have been cancelled.

Claims 64-75 have been added.

The Examiner in the last Office Action stated that Claims 4-7, 10-15, 19-22, 25-28 and 45-50 would be patentable if rewritten in independent form. Applicant has done this, canceling or eliminating the claims identified as not patentable at this time.

Amended Claim 1 is Claim 4 written in independent form with the limitations of any intervening claims. Amended Claim 9 is dependent Claim 10 written in independent form with the limitations of any intervening claims. Amended Claim 17 is dependent Claim 19 written in independent form with the limitations of any intervening claims. Amended Claim 23 is dependent Claim 25 written in independent form with the limitations of any intervening claims. Amended Claim 43 is dependent Claim 45 written in independent form with the limitations of any intervening claims. Amended Claim 62 is Claim 45 written in independent form with the limitations of any intervening claims except that instead of digital

video signals, it refers to digital audio signals. Claims 64-68 have antecedent basis from figure 1.

Claim 69 has antecedent basis in Claim 9. Claim 70 has antecedent basis from figure 1. Claims 71-75 have antecedent basis from Claims 11-15, respectively.

The difference between independent Claim 9 and dependent claims thereto, and independent Claim 69 and dependent claims thereto is that the former set of claims utilizes means plus function language in regard to 35 U.S.C. §112, while the latter set of claims do not have means plus function language and thus are not controlled by 35 U.S.C. §112, paragraph 6.

Applicant requests the Examiner to review any double patenting possibility of the above-identified patent application in regard to U.S. Patent 5, 191,573. If the Examiner determines there is no need for any double patenting concern, then applicant requests that the Examiner deem this request to consider double patenting as moot.

Applicant also brings to the attention of the Examiner two separate information disclosure statements concerning the reference Abraham filed on January 20, 1994 and the reference Bush filed on April 26, 1994, in the Patent and Trademark Office. In the last Office Action, no mention is made of these two information disclosure statements. Applicant requests they be made of record. If the Examiner does not have these in her possession,

then it is requested that the Examiner call applicant's attorney who will be glad to provide her with new copies of the same.

In view of the foregoing amendments and remarks, it is respectfully requested that the outstanding rejections and objections to this application be reconsidered and withdrawn, and Claims 1, 5-7, 9, 11-15, 17, 20-23, 26-28, 43, 46-50, 62 and 64-75, now in this application be allowed.

CERTIFICATE OF MAILING

I hereby certify that the correspondence is being deposited with the United States Postal Service as first class mail in an envelope addressed to: Commissioner of Patents and Trademarks, Washington, DC 20231, on 7/13/94

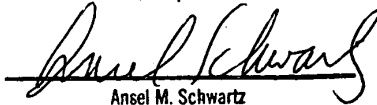
Ansel M. Schwartz
Registration No. 30,587
7/13/94
Date

Respectfully submitted,

ARTHUR R. HAIR

By 
Ansel M. Schwartz, Esquire
Reg. No. 30,587
425 N. Craig Street
Suite 301
Pittsburgh, PA 15213
(412) 621-9222

Attorney for Applicant

234

PATENT

IN THE UNITED STATES PATENT AND TRADEMARK OFFICE



In re application of: Arthur R. Hair
Serial No.: 0 8 / 023,398 Group No.: 2313
Filed: February 26, 1993 Examiner: H. Nguyen
For: A SYSTEM FOR TRANSMITTING DESIRED DIGITAL VIDEO OR AUDIO SIGNALS

Commissioner of Patents and Trademarks
Washington, D.C. 20231

RECEIVED

JUL 25 1994

GROUP 2300

AMENDMENT TRANSMITTAL

- 1. Transmitted herewith is an amendment for this application.

STATUS

- 2. Applicant is
 a small entity — verified statement:
 attached.
 already filed.
 other than a small entity.

CERTIFICATE OF MAILING (37 CFR 1.8(a))

I hereby certify that this paper (along with any referred to as being attached or enclosed) is being deposited with the United State Postal Sevice on the date shown below with sufficient postage as first class mail in an envelope addressed to the: Commissioner of Patents and Trademarks, Washington, D.C. 20231.

Tracey L. Milka

(Type or print name of person mailing paper)

Date: 7/13/94

Tracey L. Milka

(Signature of person mailing paper)

EXTENSION OF TERM

NOTE: "Extension of Time in Patent Cases (Supplement Amendments) — If a timely and complete response has been filed after a Non-Final Office Action, an extension of time is not required to permit filing and/or entry of an additional amendment after expiration of the shortened statutory period.

If a timely response has been filed after a Final Office Action, an extension of time is required to permit filing and/or entry of a Notice of Appeal or filing and/or entry of an additional amendment after expiration of the shortened statutory period unless the timely-filed response placed the application in condition for allowance. Of course, if a Notice of Appeal has been filed within the shortened statutory period, the period has ceased to run." Notice of December 10, 1985 (1061 O.G. 34-35).

NOTE: See 37 CFR 1.645 for extensions of time in interference proceedings and 37 CFR 1.550(c) for extensions of time in reexamination proceedings.

3. The proceedings herein are for a patent application and the provisions of 37 CFR 1.136 apply

(complete (a) or (b) as applicable)

(a) Applicant petitions for an extension of time under 37 CFR 1.136 (fees: 37 CFR 1.17(a)-(d) for the total number of months checked below:

Extension (months)	Fee for other than <u>small entity</u>	Fee for <u>small entity</u>
<input type="checkbox"/> one month	\$ 110.00	\$ 55.00
<input type="checkbox"/> two months	\$ 360.00	\$180.00
<input type="checkbox"/> three months	\$ 840.00	\$420.00
<input type="checkbox"/> four months	\$1,320.00	\$660.00

Fee \$ _____

If an additional extension of time is required please consider this a petition therefor.

(check and complete the next item, if applicable)

An extension for _____ months has already been secured and the fee paid therefor of \$_____ is deducted from the total fee due for the total months of extension now requested.

Extension fee due with this request \$ _____

OR

(b) Applicant believes that no extension of term is required. However, this conditional petition is being made to provide for the possibility that applicant has inadvertently overlooked the need for a petition for extension of time.

(Amendment Transmittal [9-19]—page 2 of 4)

FEE FOR CLAIMS

4. The fee for claims (37 CFR 1.16(b)-(d)) has been calculated as shown below:

	(Col. 1)	(Col. 2)	(Col. 3)	SMALL ENTITY	OTHER THAN A SMALL ENTITY
	CLAIMS REMAINING AFTER AMENDMENT	HIGHEST NO PREVIOUSLY PAID FOR	PRESENT EXTRA	ADDIT. RATE	ADDIT. RATE
TOTAL	MINUS	"	=	x11= \$	x22= \$
INDEP.	MINUS	***	=	x37= \$	x74= \$
<input type="checkbox"/> FIRST PRESENTATION OF MULTIPLE DEP. CLAIM				+115= \$	+230= \$
				TOTAL ADDIT. FEE \$	OR TOTAL ADDIT. FEE \$

- * If the entry in Col. 1 is less than entry in Col. 2, write "0" in Col. 3.
 - ** If the "Highest No. Previously Paid for" IN THIS SPACE is less than 20, enter "20".
 - *** If the "Highest No. Previously Paid For" IN THIS SPACE is less than 3, enter "3".
- The "Highest No. Previously Paid For" (Total or indep.) is the highest number found in the appropriate box in Col. 1 of a prior amendment or the number of claims originally filed.
- WARNING:** "After final rejection or action (§ 1.113) amendments may be made cancelling claims or complying with any requirement of form which has been made." 37 CFR § 1.116(a) (emphasis added).

(complete (c) or (d) as applicable)

(c) No additional fee for claims is required.

OR

(d) Total additional fee for claims required \$_____.

FEE PAYMENT

5. Attached is a check in the sum of \$_____.
- Charge Account No. _____ the sum of \$_____.

A duplicate of this transmittal is attached.

FEE DEFICIENCY

NOTE: If there is a fee deficiency and there is no authorization to charge an account, additional fees are necessary to cover the additional time consumed in making up the original deficiency. If the maximum, six-month period has expired before the deficiency is noted and corrected, the application is held abandoned. In those instances where authorization to charge is included, processing delays are encountered in returning the papers to the PTO Finance Branch in order to apply these charges prior to action on the cases. Authorization to charge the deposit account for any fee deficiency should be checked. See the Notice of April 7, 1986, (1065 O.G. 31-33).

6. If any additional extension and/or fee is required, charge Account No. 19-0737

(Amendment Transmittal [9-19]—page 3 of 4)

AND/OR

If any additional fee for claims is required, charge Account No. 19-0737

Reg. No.: 30,587

Tel. No.: (412) 621-9222



SIGNATURE OF ATTORNEY

Ansel M. Schwartz
Attorney at Law

Type or print name of attorney
425 N. Craig Street
Suite 301

P.O. Address

Pittsburgh, PA 15213

(Amendment Transmittal [9-19]—page 4 of 4)



UNITED STATES DEPARTMENT OF COMMERCE
Patent and Trademark Office

Address: COMMISSIONER OF PATENTS AND TRADEMARKS
Washington, D.C. 20231

SERIAL NUMBER: 08/023,398 FILING DATE: 02/26/93 FIRST NAMED INVENTOR: HAIR ATTORNEY DOCKET NO.:

08/023,398 02/26/93 HAIR

HAIR-1CONT-11

EXAMINER

NGUYEN H

B3M1/1028

ART UNIT

PAPER NUMBER

ANSEL M. SCHWARTZ
425 N. CRAIG STREET, SUITE 301
PITTSBURGH, PA 15213

2313

DATE MAILED: 10/28/94

This is a communication from the examiner in charge of your application.
COMMISSIONER OF PATENTS AND TRADEMARKS

This application has been examined. Responsive to communication filed on 7/20/94. This action is made final.

A shortened statutory period for response to this action is set to expire 3 month(s), _____ days from the date of this letter.
Failure to respond within the period for response will cause the application to become abandoned. 35 U.S.C. 133

Part I THE FOLLOWING ATTACHMENT(S) ARE PART OF THIS ACTION:

- 1. Notice of References Cited by Examiner, PTO-892.
- 2. Notice of Draftsman's Patent Drawing Review, PTO-948.
- 3. Notice of Art Cited by Applicant, PTO-1449. (3 sheets)
- 4. Notice of Informal Patent Application, PTO-152.
- 5. Information on How to Effect Drawing Charges, PTO-1474.
- 6. _____

Part II SUMMARY OF ACTION

1. Claims 1, 5-7, 9, 11-15, 17, 20-23, 26-28, 43, 46-50, 64-75 are pending in the application.

Of the above, claims _____ are withdrawn from consideration.

2. Claims 2, 4, 8, 10, 16, 18-19, 24-25, 29-42, 44-45, 51-61, 63 have been cancelled.

3. Claims _____ are allowed.

4. Claims 1, 5-7, 9, 11-15, 17, 20-23, 26-28, 43, 46-50, 64-75 are rejected.

5. Claims _____ are objected to.

6. Claims _____ are subject to restriction or election requirement.

7. This application has been filed with informal drawings under 37 C.F.R. 1.85 which are acceptable for examination purposes.

8. Formal drawings are required in response to this Office action.

9. The corrected or substitute drawings have been received on _____ Under 37 C.F.R. 1.84 these drawings are acceptable; not acceptable (see explanation or Notice of Draftsman's Patent Drawing Review, PTO-948).

10. The proposed additional or substitute sheet(s) of drawings, filed on _____ has (have) been approved by the examiner; disapproved by the examiner (see explanation).

11. The proposed drawing correction, filed _____, has been approved; disapproved (see explanation).

12. Acknowledgement is made of the claim for priority under 35 U.S.C. 119. The certified copy has been received not been received been filed in parent application, serial no. _____; filed on _____.

13. Since this application appears to be in condition for allowance except for formal matters, prosecution as to the merits is closed in accordance with the practice under Ex parte Quayle, 1935 C.D. 11; 453 O.G. 213.

14. Other

1. The amendment filed on 07/20/94 has been entered. Claims 2-4, 8, 10, 16, 18-19, 24-25, 29-42, 44-45, 51-61, 63 have been canceled. Claims 1, 5-7, 9, 11-15, 17, 20-23, 26-28, 43, 46-50, 62 and 64-75 are pending for examination.

2. The title of the invention is not descriptive. A new title is required that is clearly indicative of the invention to which the claims are directed. The title should be included with a novelty of the invention to help for use as a key for searching later on when the application matures into a patent.

3. Prior art submitted on PTOL-1449s (01/24/94, 01/24/94 and 04/29/94) which are Nakajima'US/4538176, Abraham'US/4521806 and Bush'US/4789863 have been considered and are hereby made of record.

4. Claims 11-15, 20-22 are rejected under 35 U.S.C. § 112, fourth paragraph, as being of improper dependent form for failing to further limit the subject matter of a previous claim.

Claims 11-15 are dependent on canceled claim 63. Claim 20 is a duplicate of claim 64.

5. Claims 1, 5-7, 9, 17, 20-23, 26-28, 43, 46-50, 62, 64-75 are rejected under 35 U.S.C. § 112, second paragraph, as being indefinite for failing to particularly point out and distinctly claim the subject matter which applicant regards as the invention.

Claim 1, lines 8-9, "the desired digital video orsecond

party" does not have antecedent basis. Lines 18-20, the step of "electronically coding..." does not have connection or relation to other steps in the claim. Perhaps, applicant means (in lines 21+) to store a replica of the coded desired digital signals, transfer the stored replica of the coded signals and store the transferred replica of the coded signals.

Claim 5, in the last three lines, it is not clear if applicant means to initiate "from the first party" or if applicant means that the video or audio signals are "from the first party".

Claim 6, lines 2-3, "the desired digital video or digital audio signals received from the sales random access memory chip" (emphasis is added) does not have antecedent basis. Also, this limitation is an indirect limitation which renders the claim language indefinite. Lines 3-4, "a ...hard disk for storing.. audio signals" is not clear which "desired...signals" are meant. Lines 5-6, "...temporarily storing...signals" is not clear which desired signals are meant. Line 6, "the storing step" is not clear which storing step is meant because claim 1 includes more than one storing step. Line 11, it is not clear what is meant by "to play the desired...signals".

Claim 7, lines 1-2, "the transferring step..." is unclear and confusing as to which transferring step is meant.

Claim 9, lines 10-13, "means operatively controlled....control panel" should be provided with functions. Line 19, "the first memory" does not have antecedent basis.

Claim 17, lines 4-5, "via telecommunications lines" is an indirect limitation which is vague and indefinite. Lines 5-7, "the first party controlling use of the first memory, at a location remote from the second memory, said second party controlling use and in possession of the second memory" (emphasis is added) is indirect limitation which is vague and indefinite. If applicant means to claim the limitation as a part of the system, positive recitation should be placed in the body of the claim after "comprising:", e.g.:--

first party controlling use of a first memory;

second party controlling use of a second memory wherein said first memory is at a location remote from said second memory.--

Lines 8-9, "via telecommunications lines" is not clear if these lines are the same or different from those recited in lines 4-5 above. Line 12, "said connectingcontrol of the first party" does not make sense as to how the "first control unit" (which is a part of the claimed system" is "in possession and control of the first party" (which is not claimed as a part of the system). Similarly, line 13, "a second control unit....of the second party" is found with similar problems. Lines 22-23, "with a transmitter in control and possession of the first party", "a receiver having the second memory", "said receiver placed at a location determined by the second part" are indirect limitations which are vague and indefinite. In the last paragraph, the "means or mechanism for storing....." is not clear as to how it relates to the receiver.

Applicant first seems to recite that the transmitting means transmits desired signals from the first memory to the receiver and wherein the second memory is a part of the receiver, then recites that storing means or mechanism is for storing the desired signals into the second memory. This is confusing because it can not be determined how the storing means associates with the other elements in the claimed system. Further, it is confusing as to which "the digital video or digital audio signals" are meant.

Claim 23, line 5, "for access to the desired ...signals at location....second location" is functional language without support of a source. Lines 6-7, "said first party...possession of the second memory" is indirect limitation. Line 9, "the first party at a location remote from the second memory...." lacks clear antecedent basis. Lines 15-16, "a first control unit...control ...party" does not make sense. Lines 29-32, contains similar problems to those of lines 21+ mentioned with respect to claim 17.

Claim 28, "...display...control of the second party" does not make sense.

Claim 47, "includes a" should be --includes said--. Claim 48 contains similar problems.

Claim 62, applicant claims "a first party control unit" with a first memory having songs as desired signals, then claims " a first party control unit" including a hard disk with audio signals that includes "the desired...signals". This is confusing because it does not make sense. These two first party control units need

to be provided with functions. Lines 9-10, "for access to the desired digital audio signals at location remote ...location" is not clear which "the desired...signals....remote..." is meant. Line 12, "the desired digital audio signals received by the receiver" does not have antecedent basis. This is an indirect limitation. Line 13, "the audio display" does not have antecedent basis. Line 15, "the first party control unit" is not clear which unit is meant. Lines 20-21, " to provide the speakers with ...signals" is confusing because, here, the speakers seem to be separate from the receiver while, above, (lines 11-12) seems to mean the receiver and speakers are one unit for playing signals. Line 24, "are transferred" is functional language which is vague and indefinite as to where the source of it. Lines 24-26, "while...after...first party" does not make sense. Also, in the preamble of the claim, applicant recites a system for transmitting signals from a first party to a second party. This does not make sense because signals can be transferred between devices not between parties. The body of the claim recites two first control units and a second control unit, connected to each other by telecommunications lines. However, the body of the claim does not make it clear as to what is functioning to transfer signals. The claim also does not make it clear how the elements in the claim associates to each other as a whole.

Claim 69, lines 17-18, "through...transferred" does not make sense because other means such as first or second control unit must

activates a transfer of signals so that the signals will be sent through the communications lines. Lines 18-20, "while...first party" does not make sense.

Claim 71, functions of the second hard disk, playback RAM chip with respect to the system as a whole are not clear. The memory recited as a part of the second control unit is for storing digital signals, and the hard disk (a part of the second control unit) recited for storing digital signals, as well. This is confusing. Relations between the hard disk, playback RAM chip, control panel, second memory, and playing mechanism is not clear.

Claim 72, line 4, "the second...circuit" does not have antecedent basis. Further, lines 4-5, "through...lines" is not clear what is meant to be connected therethrough. Lines 5-6, "said first....signals" is not clear what applicant is trying to claim since a structural relationship between the first and second control integrated circuit are not clear. Line 7, "is programmed" and "is sent" is not clear is meant to function to program and send. Perhaps, "is sent commands" should be --is sent with commands--.

Claim 73, lines 6-8, "second part control panel" is confusing with respect to the "a second party control panel" recited in claim 71. Further, "is programmed, "is sent" is vague.

Claim 75, "a video display unit" is confusing with respect to the displaying mechanism in claim 71.

Claims which have not been mentioned are rejected because they

are dependent on the rejected base claims.

6. Claims 1, 4-7, 9, 17, 20-23, 26-28, 43, 46-50, 62 and 64-75 would be allowable if rewritten or amended to overcome the rejection under 35 U.S.C. § 112.

7. Any inquiry concerning this communication or earlier communications from the examiner should be directed to Hoa Nguyen whose telephone number is (703) 305-9687.

Any inquiry of a general nature or relating to the status of this application should be directed to the Group receptionist whose telephone number is (703) 305-9600.

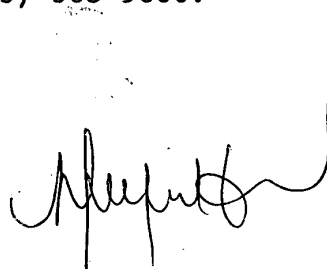

HOA T. NGUYEN
PRIMARY EXAMINER
GROUP 2300

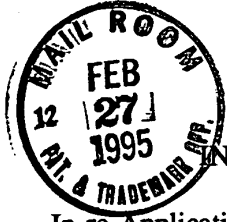

RECEIVED
MAR 15 1995

IN THE UNITED STATES PATENT AND TRADEMARK OFFICE

GROUP 2300

#13/
@

In re Application of:)

ARTHUR R. HAIR)

Serial No. 08/023,398)

Filed: February 26, 1993)

Art Unit: 2313)

Patent Examiner:)

H. Nguyen)

) A SYSTEM FOR TRANSMITTING
) DESIRED DIGITAL VIDEO OR
) AUDIO SIGNALS

DA
3/12/95

Pittsburgh, Pennsylvania 15213

February 24, 1995

CERTIFICATE OF MAILING

Hon. Commissioner of Patents and Trademarks

Washington, D.C. 20231

Sir:

I hereby certify that the correspondence is being deposited with the United States Postal Service as first class mail in an envelope addressed to: Commissioner of Patents and Trademarks, Washington, DC 20231, on 2/24/95

Ansel M. Schwarz

Ansel M. Schwarz
Registration No. 30,587

2/24/95
Date

AMENDMENT

In response to the Office Action dated October 28, 1994, please enter the following amendments to the above-identified application as follows:

IN THE TITLE:

Please change the title to read: A System and Method for Transmitting

Desired Digital Video or Digital Audio Signals of a First Party to a Second Party

Independent of the First Party".

cl

IN THE SPECIFICATION:

Page 1, line 12, after "audio or" insert -- digital -- ;

Page 1, line 14, before "video" insert -- digital -- ;

Page 1, line 14, change "signal" to -- signals -- .

Page 5, line 5, after "video or" insert -- digital -- ;

Page 5, line 14, after "video or" insert -- digital -- ;

Page 5, line 17, delete ".".

Page 10, line 17, delete ".".

In the amendment to the specification dated December 30, 1993:

On page 7, line 14, change "drive" to -- disk -- .

On page 10, line 17, after "second" insert -- party -- .

IN THE CLAIMS:

Sub
GT

1. (Thrice Amended) A method for transferring desired digital video or digital audio signals comprising the steps of:

CR

forming a connection through telecommunications lines between a first memory of a first party at a first party location and a second memory of a second party at a second party location remote from the first party location, said first memory having a first party hard disk having a plurality of digital video or digital audio signals including [the] desired digital video or digital audio signals, and a sales random access memory chip which temporarily stores a replica of the desired digital video or digital audio signals purchased by the second party for subsequent transfer via telecommunications lines to the second memory of the second party;

telephoning the first party controlling use of the first memory by the second party;

providing a credit card number of the second party controlling the second memory to the first party controlling the first memory so the second party is charged money;

electronically coding the desired digital video or digital audio signals into a configuration which would prevent unauthorized reproduction of the desired digital video or digital audio signals;

storing a replica of the coded desired digital video or digital audio signals from the hard disk into the sales random access memory chip;

transferring the stored replica of the coded desired digital video or digital audio signals from the first memory of the first party to the second memory of the second party through telecommunications lines while the second memory is in possession and control of the second party; and

storing the transferred replica of the coded desired digital video or digital audio signals in the second memory.

Claim 5, line 8, after "first party" insert -- hard disk -- .

Claim 6, line 3, delete "received from the sales random access memory chip".

Claim 6, line 4, after "signals" insert -- from the first party hard disk -- .

Claim 6, line 6, after "signals" insert -- from the first party hard disk -- .

Claim 6, line 6, change "the storing step" to -- the storing the transferred replica step -- .

Claim 6, line 7, after "signals" insert -- from the first party hard disk -- .

N.E. Claim 6, line ~~11~~³, after "signals" insert -- for the second party hard disk -- .

N.E. Claim 6, line 12, change "and" to -- , -- .

N.E. Claim 6, line 13, after "for playback" insert -- and, playing the desired digital video or digital audio signals from the second party hard disk -- .

Claim 7, line 2, after "transferring" insert -- the stored replica -- .

Claim 7, line 2, after "commanding" insert -- the second party integrated circuit to play -- .

Sub
GA
PS 9. (Thrice Amended) A system for transferring digital video or digital audio signals comprising:

a first party control unit having a first party hard disk having a plurality of digital video or digital audio signals which include desired digital video or digital audio signals, a sales random access memory chip electronically connected to the first party hard disk for storing a replica of the desired digital video or digital audio signals of the first party's hard disk, and means for electronically selling the desired digital video or digital audio signals;

3
C
a second party control unit having a second party control panel, a second memory connected to the second party control panel, and means for playing the desired digital video or digital audio signals connected to the second memory and the second party control panel, said [playing] means for playing operatively controlled by the second party control panel, said second party control unit remote from the first party control unit, said second party control unit placed by the second party at a location determined by the second party; and

telecommunications lines connected to the first party control unit and the second party control unit through which the electronic sales of the desired digital video or digital audio signals occur and through which the desired digital video or digital audio signals are electronically transferred from the first [memory] party hard disk to the second memory while the second memory is in possession and control of the second party and after the desired digital video or digital audio signals are sold to the second party by the first party.

Claim 11, line 1, change "63" to -- 9 -- .

Claim 14, line 3, change "drive" to -- disk -- .

Sub
G5

17. (Thrice Amended) A system for transmitting desired digital video or digital audio signals stored on a first memory of a first party to a second memory of a second party comprising:

first party controlling use and in possession of a first memory;

second party controlling use and in possession of a second memory, where in said second memory is at a location remote from said first memory;

telecommunications lines;

means or a mechanism for transferring money electronically via the telecommunications lines from the second party controlling use and in possession of the second memory to the first party controlling use and in possession of the first memory[, at a location remote from the second memory, said second party controlling use and in possession of the second memory];

CH

means or a mechanism for connecting electronically via the telecommunications lines the first memory with the second memory such that the desired digital video or digital audio signals can pass therebetween, said connecting means or mechanism in electrical communication with the transferring means or mechanism, said connecting means or mechanism comprises a first control unit, the first party in possession and control of the first [party] control unit, and a second control unit, said second party in possession and control of the second [party] control unit, said first control unit comprises a first control panel, first control integrated circuit and a sales random access memory, said sales random access memory and said first control panel in electrical communication with said first control integrated circuit, said second control unit comprising a second control panel, a second control integrated circuit, an incoming random access memory and a playback random access memory, said second control panel, said incoming random access memory and said playback random access memory in electrical communication with said second control integrated circuit;

means or a mechanism for transmitting the desired digital video or digital audio signals from the first memory [with a transmitter] to the second memory, said means or mechanism for transmitting comprising a transmitter connected to the first memory and the telecommunications lines and a receiver connected to the second memory, the transmitter and the telecommunications lines, said first party in control and possession of the transmitter, said second party in control and possession of the receiver [first party to a receiver having

the second memory, while said receiver is in possession and control of the second party],
said receiver remote from said transmitter and said receiver [placed] at a location determined
by the second party, said transmitting means or mechanism in electrical communication with
said connecting means or mechanism; and

means or a mechanism for storing the desired digital video or digital audio
signals from the first memory in the second memory, said storing means or mechanism in
electrical communication with said receiver of said transmitting means or mechanism and
with said second memory.

Claim 20, line 1, change "64" to -- 17 -- .

23. (Thrice Amended) A system for transmitting desired digital video or
digital audio signals stored on a first memory of a first party at a first party location to a
second memory of a second party at a second party location comprising:

first party controlling use and in possession of a first memory;

second party controlling use and in possession of a second memory, wherein
said second memory is at a location remote from said first memory;

telecommunications lines:

means or a mechanism for the first party to charge a fee to the second party and provide [for] access to the desired digital video or digital audio signals at a location remote from the second party location, said first party controlling use of the first memory, said second party controlling use and in possession of the second memory, said means or mechanism for the first party to charge a fee includes means or a mechanism for transferring money electronically via telecommunications lines to the first party at a location remote from the second memory at the second party location;

CS
means or a mechanism for connecting electronically via telecommunications lines the first memory with the second memory such that the desired digital video or digital audio signals can pass therebetween, said connecting means or mechanism in electrical communication with the transferring means or mechanism, said connecting means or mechanism comprises a first control unit [in possession and control of the first party] and a second control unit remote from said first control unit [in possession and control of the second party], said first party in possession and control of the first control unit, said second party in possession and control of the second control unit, said first control unit comprises a first control panel, first control integrated circuit and a sales random access memory, said sales random access memory and said first control panel in electrical communication with said first control integrated circuit, said second control unit comprising a second control

panel, a second control integrated circuit, an incoming random access memory and a playback random access memory, said second control panel, said incoming random access memory and said playback random access memory in electrical communication with said second control integrated circuit;

CS
means or a mechanism for transmitting the desired digital video or digital audio signals from the first memory [with a transmitter] to the second memory, said means or mechanism for transmitting comprising a transmitter connected to the first memory and the telecommunications lines and a receiver connected to the second memory, the transmitter and the telecommunications lines, said first party in control and possession of the transmitter, said second party in control and possession of the receiver [first party to a receiver having the second memory while said receiver is in possession and control of the second party], said receiver remote from said transmitter and said receiver [placed by the second party] at the second party location determined by the second party, said transmitting means or mechanism in electrical communication with said connecting means or mechanism; and

means or a mechanism for storing the digital video or digital audio signals from the first memory in the second memory, said storing means or mechanism in electrical communication with said receiver of said transmitting means or mechanism and with said second memory.

Claim 26, line 1, change "65" to -- 23 -- .

Claim 28, line 2, after "speakers" insert -- , said second party -- .

Claim 28, line 2, change "second party" to -- video display and speakers -- .

Sub
G7
43. (Twice Amended) A system for transferring digital video signals [from a first party to a second party at a second party location] comprising:

a first party controlling use and in possession of a first party control unit;

a second party controlling use and in possession of a second party control unit,
wherein said second party control unit is at a location remote from said first party control
unit;

16
a first party control unit having a first memory having a plurality of desired individual video selections as desired digital video signals, a first party control unit which includes a first party hard disk having the plurality of digital video signals which include desired digital video signals, and a sales random access memory chip electronically connected to the first party hard disk for storing a replica of the desired digital video signals of the first party's hard disk, and means or a mechanism for the first party to charge a fee to

the second party for access to the desired digital video signals of the first party's hard disk at a location remote from the second party location;

26
a second party control unit having a second party control panel, a receiver and a video display for playing the desired digital video signals received by the receiver, said second party control panel connected to the video display and the receiver, said receiver and video display operatively controlled by the second party control panel, said second party control unit remote from the first party control unit, said second party control unit placed by the second party at a second party location determined by the second party which is remote from said first party control unit, said second party choosing the desired digital video signals from the first [memory] party's hard disk with said second party control panel, said second party control unit includes a second memory which is connected to the receiver and the video display, said second memory storing the desired digital video signals that are received by the receiver to provide the video display with the desired digital video signals of the first party's hard disk; and

telecommunications lines connected to the first party control unit and the second party control unit through which the desired digital video signals are electronically transferred from the first memory to the receiver while the second party control unit is in possession and control of the second party after the desired digital video signals are sold to the second party by the first party.

Claim 47, line 2, change "includes a" to -- includes said -- .

Claim 48, line 2, change "includes a" to -- includes said -- .

Claim 49, line ²~~3~~, change "drive" to -- disk -- .

Sub
G8
62. (Twice Amended) A system for transferring digital audio signals [from a first party to a second party at a second party location] comprising:

07
a first party controlling use and in possession of a first party control unit, and a second party controlling use and in possession of a second party control unit, wherein said second party control unit is at a second party location remote from the first party control unit, [a first party control unit having a first memory having a plurality of desired individual songs as desired digital audio signals, a] said first party control unit for controlling and transferring digital signals, said first party control unit [which includes] having a first party hard disk having a plurality of digital audio signals which include [the] a plurality of desired individual songs as desired digital audio signals, [and] said first party control unit having a sales random access memory chip electronically connected to the first party hard disk for storing a replica of the desired digital audio signals of the first party's hard disk, means or mechanism for transmitting the desired digital audio signals of the first party's hard disk to the second party control unit, said means or mechanism for transferring connected to the

sales random access memory chip, and said first party control unit having means or a mechanism for the first party to charge a fee to the second party [for] to provide the second party access to the desired digital audio signals of the first party's hard disk, said means or mechanism for the first party to charge a fee [at a location] remote from the second party location;

07
[a] said second party control unit having a second party control panel, a receiver connected to the second party control panel and speakers connected to the receiver for playing the desired digital audio signals of the first party's hard disk [received by the receiver], said second party control panel connected to [the audio display and] the receiver, said receiver and speakers operatively controlled by the second party control panel, [said second party control unit remote from the first party control unit,] said second party control unit placed by the second party at a second party location determined by the second party which is remote from said first party control unit, said second party choosing the desired digital audio signals from the first party's hard disk [memory] with said second party control panel, said second party control unit includes a second memory which is connected to the receiver and the speakers, said second memory storing the digital audio signals of the first party's hard disk that are received by the receiver [to provide the speakers with the digital audio signals]; and

C7
telecommunications lines connected to the first party control unit and the second party control unit through which the desired digital audio signals of the first party's hard disk are electronically transferred by the means or mechanism for transferring [from the first memory] to the receiver while the second party [control unit] is in possession and control of the second party control unit and after the desired digital audio signals of the first party's hard disk are sold to the second party by the first party with the means or mechanism for the first party to charge a fee.

Cancel Claim 66.

Sub 69
69. (Amended) A system for transferring digital video or digital audio signals comprising:

C8
a first party control unit having a first party hard disk having a plurality of digital video or digital audio signals which include desired digital video or digital audio signals, a sales random access memory chip electronically connected to the first party hard disk for storing a replica of the desired digital video or digital audio signals of the first party's hard disk, and a mechanism for electronically selling the desired digital video or digital audio signals of the first party's hard disk;

a second party control unit having a second party control panel, a second memory connected to the second party control panel, and a mechanism for playing the desired digital video or digital audio signals connected to the second memory and the second party control panel, said playing mechanism operatively controlled by the second party control panel, said second party control unit remote from the first party control unit, said second party control unit placed by the second party at a location determined by the second party; and

telecommunications lines connected to the first party control unit and the second party control unit through which the electronic sales of the desired digital video or digital audio signals occur of the first party's hard disk, and [through] over which the desired digital video or digital audio signals of the first party's hard disk are electronically transferred from the first [memory] party's hard disk to the second memory while the second [memory] party is in possession and control of the second [party] memory and after the desired digital video or digital audio signals are sold to the second party by the first party.

71. A system as described in Claim 70 wherein the second memory of the second party control unit includes a second party hard disk which stores a plurality of digital video or digital audio signals, said second party hard disk connected to the second party control panel; and said second memory also including a playback random access memory chip electronically connected to the second party hard disk, the second party control panel

and the playing mechanism, said playback random access memory chip for storing a replica of the desired digital video or digital audio signals of the first party's hard disk as a temporary staging area for playback.

72. (Amended) A system as described in Claim 71 wherein the first party control unit includes a first party control integrated circuit which controls and executes commands of the first party and is connected to the first party hard disk, the first party sales random access memory, and the first party control integrated circuit connected to the second party control unit [integrated circuit] through the telecommunications lines[, said first party control integrated circuit and said second party control integrated circuit regulate the transfer of the desired digital video or audio signals]; and a first party control panel through which the first party control integrated circuit is programmed and through which the first party control integrated circuit is sent with commands, said first party control party [and which] is connected to the first party control integrated circuit.

73. (Amended) A system as described in Claim 72 wherein the second party control unit includes a second party control integrated circuit which controls and executes commands of the second party and is connected to the second party hard disk, the playback random access memory, and the first party control integrated circuit through the telecommunications lines, said second party control integrated circuit and said first party control integrated circuit regulate the transfer of the desired digital video or digital audio

09
signals[; and a], said second party control integrated circuit also connected to the second party control panel through which the second party control integrated circuit is programmed and through which the second party control integrated circuit is sent with commands [and which is connected to the second party integrated circuit].

2
Claim 74, line 3, change "drive" to -- disk -- ;

N.E.
Claim 74, line 6, after "video or" insert -- digital -- .

010
75. (Amended) A system as described in Claim 74 wherein the playing mechanism of the second party control unit includes a video display unit connected to the playback random access memory chip and to the second party integrated circuit for displaying the desired digital video or digital audio signals of the first party's hard disk.

REMARKS

Claims 1, 5-7, 9, 11-15, 17, 20-23, 26-28, 43, 46-50, 62, 64, 65 and 67-75 are currently active.

Claim 66 has been cancelled. The specification has been amended to remove typos, etc.

The Examiner has indicated the title of the invention is not descriptive. Applicant has amended the title of the invention to be "A System and Method for Transmitting Desired Digital Video or Audio Signals of a First Party to a Second Party Independent of the First Party".

The Examiner has rejected Claims 11-15 and 20-22 under 35 U.S.C. §112, fourth paragraph, as being of improper dependent form for failing to further limit the subject matter of a previous claim. Claims 11-15 are dependent on canceled Claim 63. Claim 20 is a duplicate of Claim 64. Claim 20 has been amended to be dependent to Claim 17.

The Examiner has rejected Claims 1, 5-7, 9, 17, 20-23, 26-28, 43, 46-50, 62, 64-75 under 35 U.S.C. §112, second paragraph.

The Examiner indicates that in Claim 1, lines 8-9, "the desired digital video or . . . second party" does not have antecedent basis. Claim 1 has been amended so that desired digital video or . . . second party" has antecedent basis. Furthermore, the Examiner has identified in lines 18-20, the step of "electronically coding . . ." does not have connection or relation to other steps in the claim. Applicant has amended Claim 1 to include the limitation of "storing a replica of the coded desired digital video . . . transferring the stored replica of the coded desired digital video . . . and storing the transferred replica of the coded desired digital video . . .".

The Examiner questions in Claim 5 if applicant means to initiate "from the first party" or if applicant means that the video or audio signals are "from the first party". Applicant has amended Claim 5 to indicate the initiation is from the first party's hard disk to make it clear that the desired digital video or digital audio signals are from the first party's hard disk.

In regard to Claim 6, lines 2 and 3, the limitation "received from the sales random access memory chip" has been deleted to eliminate any antecedent basis problem. In Claim 6, line 4, the claim has been amended to identify the desired signals to be "from the first party's hard disk".

In regard to Claim 6, lines 6 and 7, the desired signals are to be in regard to the first party hard disk. The limitation "the storing step" has been amended to be "the storing the transferred replica step" to make it clear which step in regard to Claim 1 is meant. The limitation "to play the desired . . . signals" has been amended to refer to the fact that the desired signals are from the second party hard disk, and in regard to Claim 6, the step of playing the desired digital video or audio signals from the second party hard disk has been added to make it clear what is meant by "to play the desired . . . signals".

In regard to Claim 7, it has been amended to refer to the step of transferring the stored replica so it is clear to which transferring step is meant. Furthermore, after the "commanding" limitation, there has been inserted the different limitation of -- the second party integrated circuit to play --.

In regard to Claim 9, lines 10-13, they have been amended so there is limitation of "means for playing . . .". Thus, function has been provided to this language. In regard to line 19, the "first memory" has been amended to be -- first party hard disk -- which does have antecedent basis.

In regard to Claim 17, applicant has affirmatively claimed the first party, the second party and the telecommunications lines, etc. consistent with the comments of the Examiner. Furthermore, the Examiner asks whether the "via the telecommunications lines"

of lines 8 and 9 are the same or different from those recited in lines 4 and 5. Applicant has amended the claim to refer to "the telecommunications lines" to make it clear that it is the same telecommunications lines as recited earlier in the claim. However, when it is said the same telecommunications lines are used, it is meant the same type of lines - telecommunication lines - are used, but not necessarily at the same time, although they could be used at the same time. The Examiner also questions how a control unit can be in position control of the first party. Applicant has amended the claim so the first party or second party are in position in control of the respective control unit, etc. Additionally, applicant has amended the claim so that the receiver is defined how it relates to the remainder of the claim. As to which digital video or digital audio signals are meant, it is the same digital video or digital audio signals that were identified earlier in the claim that were in the first memory.

In regard to Claim 23, the Examiner identifies functional language without support of a source, antecedent basis concerns and confusing language. Applicant has amended Claim 23 to overcome these objections pursuant to the Examiner's comments.

In regard to Claim 28, applicant has amended Claim 28 so that it is clear that the second party is in possession and control of the video display and speakers.

Claim 47 and Claim 48 have been amended pursuant to the Examiner's suggestion.

In regard to Claim 62, it has been amended to obviate the Examiner's objections to it. Claim 62 now has the limitation of a first party controlling use and in possession of a first party control unit, and a second party controlling use and possession of a second party control unit. The control units have been provided with functions. Also, the desired signals stored are the desired digital audio signals of the first party's hard disk. All indirect limitations or lack of antecedent basis have been corrected. Confusion regarding the receiver and speakers being one unit for playing signals has been eliminated. A "means or mechanism for transferring" provides a source for the limitation "are transferred". In regard to lines 24-26, the language while . . . first party" has been made clear. Furthermore, means or mechanism for transferring the desired digital audio signals of the first party's hard disk has been introduced to make clear there is a function to transfer signals. Furthermore, the claim has been amended so that signals are transferred between devices and not between parties.

In regard to Claim 69, the Examiner states that on lines 17-18, "through . . . transferred" does not make sense because other means such as first or second control units must activate a transfer of signals so that the signals will be sent through the communications lines. Applicant has amended the claims so that the signals are transferred over rather than

through the telecommunications lines. Also, the Examiner, on lines 18-20, states that "while . . . the first party" does not make sense. Applicant has amended the claim so that the second party is in possession and control of the second memory. Applicant has further amended Claim 69 to more clearly define the elements and their relationships.

In regard to Claim 71, the Examiner questions the functions of the second hard disk and playback RAM chip with respect to the system as a whole. Applicant has amended Claim 71 to define that the second memory of the second party control unit includes a second party hard disk which stores a plurality of digital video or audio signals; also that the second party hard disk is connected to the second party control panel. Furthermore, the second memory also includes a playback random access memory chip which is electrically connected to the second party hard disk, the second party control panel and the playing mechanism and that the playback random access memory chip is for storing a replica of the desired digital video or audio signals of the first party hard disk as a temporary staging area for playback.

In regard to Claim 72, on line 4, the Examiner states that the "second circuit" does not have antecedent basis. Claim 72 has been amended so that it refers to the second party control unit and not the second party control integrated circuit. Thus, there is antecedent basis for the second party control unit. The Examiner states in lines 4-5 it is not clear to what "through . . . lines" is meant to be connected. Applicant has amended Claim 72 so that the first party control integrated circuit is connected to the second party control

unit. In lines 5-6, the Examiner states, "said first . . . signals" are not clear in regard to what applicant is trying to claim since a structural relationship between the first and second control integrated circuit is not clear. With the amendments to the claim, the relationships have been defined, and the language "said first . . . signals" have been deleted since they are now redundant. The Examiner also states that on line 7, "is programmed" and "is sent" is not clear as to what is meant to function to program and send. Applicant has amended Claim 72 pursuant to the Examiner's suggestion that the first party integrated circuit is sent with commands.

In regard to Claim 73, the Examiner states that lines 6-8, "second party control panel" is confusing with respect to the "a second party control panel" recited in Claim 71. Further, "is programmed", "is sent" is vague. Applicant has amended Claim 73 to overcome these objections. A second party control panel now is "said party control integrated circuit". Also, pursuant to the Examiner's suggestions in regard to Claim 72, "the second party control integrated circuit is sent with commands".

In regard to Claim 75, "a video display unit" is determined by the Examiner to be confusing with respect to the displaying mechanism in Claim 71. Applicant has amended Claim 75 to be consistent with Claim 71. Applicant now states that "the playing mechanism of the second party control unit includes a video display unit" to clarify the relationship of the video display unit with respect to the playing mechanism.

The Examiner has stated that Claims 1, 4-7, 9, 17, 20-23, 26-28, 43, 46-50, 62 and 64-75 would be allowable if rewritten or amended to overcome the rejection under 35 U.S.C. §112. Applicant has amended the claims to overcome the rejections under 35 U.S.C. §112. These claims are now clear and definite and are allowable.

Applicant has also amended Claim 43 pursuant to the Examiner's overall comments concerning the other claims. Applicant believes the Examiner meant to reject Claim 43.

In view of the foregoing amendments and remarks, it is respectfully requested that the outstanding rejections and objections to this application be reconsidered and withdrawn, and Claims 1, 5-7, 9, 11-15, 17, 20-23, 26-28, 43, 46-50, 62, 64, 65 and 67-75, now in this application be allowed.

Respectfully submitted,

ARTHUR R. HAIR

By Ansel Schwartz

Ansel M. Schwartz, Esquire
Reg. No. 30,587
425 N. Craig Street
Suite 301
Pittsburgh, PA 15213
(412) 621-9222

Attorney for Applicant

CERTIFICATE OF MAILING

I hereby certify that the correspondence is being deposited with the United States Postal Service as first class mail in an envelope addressed to: Commissioner of Patents and Trademarks, Washington, DC 20231.
on 2/24/95

Ansel Schwartz

Ansel M. Schwartz
Registration No. 30,587

2/24/95
Date



55.00 215

Attorney's Docket No. HAIR-1 CONT II

PATENT RECEIVED #12

IN THE UNITED STATES PATENT AND TRADEMARK OFFICE

MAR 15 1995

GROUP 2300

In re application of: Arthur R. Hair

Serial No.: 0 8 / 023,398 Group No.: 2313
Filed: February 26, 1993 Examiner: H. Nguyen

For: A SYSTEM FOR TRANSMITTING DESIRED DIGITAL VIDEO OR AUDIO SIGNALS

Commissioner of Patents and Trademarks
Washington, D.C. 20231

AMENDMENT TRANSMITTAL

1. Transmitted herewith is an amendment for this application.

STATUS

- 2. Applicant is
 - a small entity. A verified statement:
 - is attached.
 - was already filed.
 - other than a small entity.

CERTIFICATE OF MAILING/TRANSMISSION (37 CFR 1.8a)

I hereby certify that this correspondence is, on the date shown below, being:

MAILING

FACSIMILE

deposited with the United States Postal Service with sufficient postage as first class mail in an envelope addressed to the Commissioner of Patents and Trademarks, Washington, D.C. 20231

transmitted by facsimile to the Patent and Trademark Office

Date: 2/24/95

Tracey L. Milka

Signature

Tracey L. Milka

(type or print name of person certifying)

120 KM 03/14/95 08023398

1 215

55.00 CK

(Amendment Transmittal [9-19]—page 1 of 4)

EXTENSION OF TERM

NOTE: "Extension of Time in Patent Cases (Supplement Amendments) — If a timely and complete response has been filed after a Non-Final Office Action, an extension of time is not required to permit filing and/or entry of an additional amendment after expiration of the shortened statutory period.

If a timely response has been filed after a Final Office Action, an extension of time is required to permit filing and/or entry of a Notice of Appeal or filing and/or entry of an additional amendment after expiration of the shortened statutory period unless the timely-filed response placed the application in condition for allowance. Of course, if a Notice of Appeal has been filed within the shortened statutory period, the period has ceased to run." Notice of December 10, 1985 (1061 O.G. 34-35).

NOTE: See 37 CFR 1.645 for extensions of time in interference proceedings and 37 CFR 1.550(c) for extensions of time in reexamination proceedings.

3. The proceedings herein are for a patent application and the provisions of 37 CFR 1.136 apply

(complete (a) or (b) as applicable)

(a) Applicant petitions for an extension of time under 37 CFR 1.136 (fees: 37 CFR 1.17(a)-(d) for the total number of months checked below:

Extension (months)	Fee for other than <u>small entity</u>	Fee for <u>small entity</u>
<input checked="" type="checkbox"/> one month	\$ 110.00	\$ 55.00
<input type="checkbox"/> two months	\$ 360.00	\$180.00
<input type="checkbox"/> three months	\$ 840.00	\$420.00
<input type="checkbox"/> four months	\$1,320.00	\$660.00

Fee \$ 55.00

If an additional extension of time is required please consider this a petition therefor.

(check and complete the next item, if applicable)

An extension for _____ months has already been secured and the fee paid therefor of \$_____ is deducted from the total fee due for the total months of extension now requested.

Extension fee due with this request \$ _____

OR

(b) Applicant believes that no extension of term is required. However, this conditional petition is being made to provide for the possibility that applicant has inadvertently overlooked the need for a petition for extension of time.

FEE FOR CLAIMS

4. The fee for claims (37 CFR 1.16(b)-(d)) has been calculated as shown below:

	(Col. 1)	(Col. 2)	(Col. 3)	SMALL ENTITY	OTHER THAN A SMALL ENTITY
	CLAIMS REMAINING AFTER AMENDMENT	HIGHEST NO PREVIOUSLY PAID FOR	PRESENT EXTRA	ADDIT. RATE	ADDIT. RATE
				FEE	FEE
TOTAL *	MINUS **	=	x11 =	\$	x22 = \$
INDEP. *	MINUS ***	=	x37 =	\$	x74 = \$
<input type="checkbox"/>	FIRST PRESENTATION OF MULTIPLE DEP. CLAIM			+115 =	\$ +230 = \$
			TOTAL ADDIT. FEE	\$	OR TOTAL ADDIT. FEE \$

* If the entry in Col. 1 is less than entry in Col. 2, write "0" in Col. 3.

** If the "Highest No. Previously Paid for" IN THIS SPACE is less than 20, enter "20".

*** If the "Highest No. Previously Paid For" IN THIS SPACE is less than 3, enter "3".

The "Highest No. Previously Paid For" (Total or indep.) is the highest number found in the appropriate box in Col. 1 of a prior amendment or the number of claims originally filed.

WARNING: "After final rejection or action (§ 1.113) amendments may be made cancelling claims or complying with any requirement of form which has been made." 37 CFR § 1.116(a) (emphasis added).

(complete (c) or (d) as applicable)

(c) No additional fee for claims is required.

OR

(d) Total additional fee for claims required \$ _____

FEE PAYMENT

5. Attached is a check in the sum of \$ 55.00

Charge Account No. _____ the sum of \$ _____

A duplicate of this transmittal is attached.

FEE DEFICIENCY

NOTE: If there is a fee deficiency and there is no authorization to charge an account, additional fees are necessary to cover the additional time consumed in making up the original deficiency. If the maximum, six-month period has expired before the deficiency is noted and corrected, the application is held abandoned. In those instances where authorization to charge is included, processing delays are encountered in returning the papers to the PTO Finance Branch in order to apply these charges prior to action on the cases. Authorization to charge the deposit account for any fee deficiency should be checked. See the Notice of April 7, 1986, (1065 O.G. 31-33).

6. If any additional extension and/or fee is required, charge Account No. 19-0737

(Amendment Transmittal [9-19]—page 3 of 4)

AND/OR

If any additional fee for claims is required, charge Account No. 19-0737

Reg. No.: 30,587

Tel. No.: (412) 621-9222

Ansel Schwartz

SIGNATURE OF ATTORNEY

Ansel M. Schwartz

type or print name of attorney

425 N. Craig Street
Suite 301

P.O. Address

Pittsburgh, PA 15213



IN THE UNITED STATES PATENT AND TRADEMARK OFFICE

#14/72

RECEIVED

MAR 15 1995

GROUP 2300

PA 3/16/95

In Application of:

ARTHUR R. HAIR

Serial No. 08/023,398

Filed: February 26, 1993

Art Unit: 2313

Patent Examiner:

H. Nguyen

)
)
)
)
)
) A SYSTEM FOR TRANSMITTING
) DESIRED DIGITAL VIDEO OR
) AUDIO SIGNALS
)
)
)
)

Pittsburgh, Pennsylvania 15213

March 7, 1995

CERTIFICATE OF MAILING

I hereby certify that the correspondence is being deposited with the United States Postal Service as first class mail in an envelope addressed to: Commissioner of Patents and Trademarks, Washington, DC 20231, on 3/7/95

Ansel Schwartz

Ansel M. Schwartz
Registration No. 30,587

3/7/95
Date

AS
2/16/95

Hon. Commissioner of Patents and Trademarks
Washington, D.C. 20231

Sir:

SUPPLEMENTAL AMENDMENT

Please enter the following Supplemental Amendment to the Amendment filed

February 24, 1995 in response to the Office Action dated October 28, 1994.

IN THE CLAIMS:

Claim 46, line 1, change "66" to -- 67 -- .

REMARKS

In the Office Action dated February 24, 1995, applicant canceled Claim 66. But Claim 46 depended to Claim 66. Since Claim 66 has been canceled, and so Claim 46 would properly depend on Claim 67, the above amendment is made.

In view of the foregoing amendments and remarks, it is respectfully requested that the outstanding rejections and objections to this application be reconsidered and withdrawn, and the outstanding claims now in this application be allowed.

CERTIFICATE OF MAILING

I hereby certify that the correspondence is being deposited with the United States Postal Service as first class mail in an envelope addressed to: Commissioner of Patents and Trademarks, Washington, DC 20231.

on 3/7/95

Ansel Schwartz

Ansel M. Schwartz
Registration No. 30,587

3/7/95
Date

Respectfully submitted,

ARTHUR R. HAIR

By Ansel Schwartz

Ansel M. Schwartz, Esquire

Reg. No. 30,587

425 N. Craig Street

Suite 301

Pittsburgh, PA 15213

(412) 621-9222

Attorney for Applicant



Attorney's Docket No. HAIR-1 CONT II

RECEIVED
PATENT
MAR 1 1995
GROUP 2300

IN THE UNITED STATES PATENT AND TRADEMARK OFFICE

In re application of: Arthur R. Hair

Serial No.: 0 8 /023,398

Group No.: 2313

Filed: February 26, 1993

Examiner: H. Nguyen

For: A SYSTEM FOR TRANSMITTING DESIRED DIGITAL VIDEO OR AUDIO SIGNALS

Commissioner of Patents and Trademarks

Washington, D.C. 20231

AMENDMENT TRANSMITTAL

1. Transmitted herewith is an amendment for this application.

STATUS

2. Applicant is

a small entity. A verified statement:

is attached.

was already filed.

other than a small entity.

CERTIFICATE OF MAILING/TRANSMISSION (37 CFR 1.8a)

I hereby certify that this correspondence is, on the date shown below, being:

MAILING

deposited with the United States Postal Service with sufficient postage as first class mail in an envelope addressed to the Commissioner of Patents and Trademarks, Washington, D.C. 20231

Date: 3/7/95

FACSIMILE

transmitted by facsimile to the Patent and Trademark Office

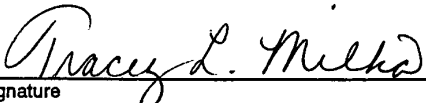

Signature

Tracey L. Milka

(type or print name of person certifying)

EXTENSION OF TERM

NOTE: "Extension of Time in Patent Cases (Supplement Amendments) — If a timely and complete response has been filed after a Non-Final Office Action, an extension of time is not required to permit filing and/or entry of an additional amendment after expiration of the shortened statutory period.

If a timely response has been filed after a Final Office Action, an extension of time is required to permit filing and/or entry of a Notice of Appeal or filing and/or entry of an additional amendment after expiration of the shortened statutory period unless the timely-filed response placed the application in condition for allowance. Of course, if a Notice of Appeal has been filed within the shortened statutory period, the period has ceased to run." Notice of December 10, 1985 (1061 O.G. 34-35).

NOTE: See 37 CFR 1.645 for extensions of time in interference proceedings and 37 CFR 1.550(c) for extensions of time in reexamination proceedings.

3. The proceedings herein are for a patent application and the provisions of 37 CFR 1.136 apply

(complete (a) or (b) as applicable)

(a) Applicant petitions for an extension of time under 37 CFR 1.136 (fees: 37 CFR 1.17(a)-(d) for the total number of months checked below:

Extension (months)	Fee for other than <u>small entity</u>	Fee for <u>small entity</u>
<input type="checkbox"/> one month	\$ 110.00	\$ 55.00
<input type="checkbox"/> two months	\$ 360.00	\$180.00
<input type="checkbox"/> three months	\$ 840.00	\$420.00
<input type="checkbox"/> four months	\$1,320.00	\$660.00

Fee \$ _____

If an additional extension of time is required please consider this a petition therefor.

(check and complete the next item, if applicable)

An extension for _____ months has already been secured and the fee paid therefor of \$_____ is deducted from the total fee due for the total months of extension now requested.

Extension fee due with this request \$ _____

OR

(b) Applicant believes that no extension of term is required. However, this conditional petition is being made to provide for the possibility that applicant has inadvertently overlooked the need for a petition for extension of time.

FEE FOR CLAIMS

4. The fee for claims (37 CFR 1.16(b)-(d)) has been calculated as shown below:

	(Col. 1)	(Col. 2)	(Col. 3)	SMALL ENTITY	OTHER THAN A SMALL ENTITY
	CLAIMS REMAINING AFTER AMENDMENT	HIGHEST NO PREVIOUSLY PAID FOR	PRESENT EXTRA	ADDIT. RATE FEE	ADDIT. RATE FEE
TOTAL *	MINUS **	=	x11 =	\$	x22 = \$
INDEP. *	MINUS ***	=	x37 =	\$	x74 = \$
<input type="checkbox"/> FIRST PRESENTATION OF MULTIPLE DEP. CLAIM				+115 =	\$ +230 = \$
				TOTAL ADDIT. FEE \$	OR TOTAL ADDIT. FEE \$

- * If the entry in Col. 1 is less than entry in Col. 2, write "0" in Col. 3.
 - ** If the "Highest No. Previously Paid for" IN THIS SPACE is less than 20, enter "20".
 - *** If the "Highest No. Previously Paid For" IN THIS SPACE is less than 3, enter "3".
- The "Highest No. Previously Paid For" (Total or indep.) is the highest number found in the appropriate box in Col. 1 of a prior amendment or the number of claims originally filed.
- WARNING:** "After final rejection or action (§ 1.113) amendments may be made cancelling claims or complying with any requirement of form which has been made." 37 CFR § 1.116(a) (emphasis added).

(complete (c) or (d) as applicable)

(c) No additional fee for claims is required.

OR

(d) Total additional fee for claims required \$ _____

FEE PAYMENT

5. Attached is a check in the sum of \$ _____
- Charge Account No. _____ the sum of \$ _____

A duplicate of this transmittal is attached.

FEE DEFICIENCY

NOTE: If there is a fee deficiency and there is no authorization to charge an account, additional fees are necessary to cover the additional time consumed in making up the original deficiency. If the maximum, six-month period has expired before the deficiency is noted and corrected, the application is held abandoned. In those instances where authorization to charge is included, processing delays are encountered in returning the papers to the PTO Finance Branch in order to apply these charges prior to action on the cases. Authorization to charge the deposit account for any fee deficiency should be checked. See the Notice of April 7, 1986, (1065 O.G. 31-33).

6. If any additional extension and/or fee is required, charge Account No. 19-0737

(Amendment Transmittal [9-19]—page 3 of 4)

AND/OR

If any additional fee for claims is required, charge Account No. 19-0737

Reg. No.: 30,587

Tel. No.: (412) 621-9222

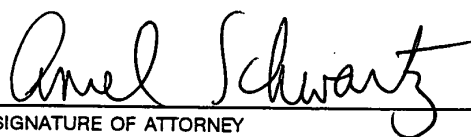

SIGNATURE OF ATTORNEY

Ansel M. Schwartz

type or print name of attorney

425 N. Craig Street
Suite 301

P.O. Address

Pittsburgh, PA 15213



**UNITED STATES DEPARTMENT OF COMMERCE
Patent and Trademark Office**

Address: COMMISSIONER OF PATENTS AND TRADEMARKS
Washington, D.C. 20231

DS

SERIAL NUMBER FILING DATE FIRST NAMED INVENTOR ATTORNEY DOCKET NO.

08/023,398 02/26/93 HAIR

A HAIR-1CONT-11
EXAMINER

NGUYEN, H

ART UNIT PAPER NUMBER

15

24M1/0628

ANSEL M. SCHWARTZ
425 N. CRAIG STREET, SUITE 301
PITTSBURGH, PA 15213

2413

DATE MAILED:

06/28/95

This is a communication from the examiner in charge of your application.
COMMISSIONER OF PATENTS AND TRADEMARKS

This application has been examined Responsive to communication filed on 2/27/95, 3/13/95 This action is made final.

A shortened statutory period for response to this action is set to expire 3 month(s), _____ days from the date of this letter.
Failure to respond within the period for response will cause the application to become abandoned. 35 U.S.C. 133

Part I THE FOLLOWING ATTACHMENT(S) ARE PART OF THIS ACTION:

- 1. Notice of References Cited by Examiner, PTO-892.
- 2. Notice of Draftsman's Patent Drawing Review, PTO-948.
- 3. Notice of Art Cited by Applicant, PTO-1449.
- 4. Notice of Informal Patent Application, PTO-152.
- 5. Information on How to Effect Drawing Changes, PTO-1474.
- 6. _____

Part II SUMMARY OF ACTION

1. Claims 1, 5-7, 11-15, 20-23, 26-28, 43, 46-50 are pending in the application. 62, 64-65, 67-75

Of the above, claims _____ are withdrawn from consideration.

- 2. Claims _____ have been cancelled.
- 3. Claims _____ are allowed.
- 4. Claims same as above are rejected.
- 5. Claims _____ are objected to.
- 6. Claims _____ are subject to restriction or election requirement.
- 7. This application has been filed with informal drawings under 37 C.F.R. 1.85 which are acceptable for examination purposes.
- 8. Formal drawings are required in response to this Office action.
- 9. The corrected or substitute drawings have been received on _____. Under 37 C.F.R. 1.84 these drawings are acceptable; not acceptable (see explanation or Notice of Draftsman's Patent Drawing Review, PTO-948).
- 10. The proposed additional or substitute sheet(s) of drawings, filed on _____, has (have) been approved by the examiner; disapproved by the examiner (see explanation).
- 11. The proposed drawing correction, filed _____, has been approved; disapproved (see explanation).
- 12. Acknowledgement is made of the claim for priority under 35 U.S.C. 119. The certified copy has been received not been received been filed in parent application, serial no. _____; filed on _____.
- 13. Since this application appears to be in condition for allowance except for formal matters, prosecution as to the merits is closed in accordance with the practice under Ex parte Quayle, 1935 C.D. 11; 453 O.G. 213.
- 14. Other _____

The amendment filed on 2/27/95 and the supplemental amendment filed on 3/13/95 have been entered into the record.

Claims 1, 5-7, 9, 11-15, 20-23, 26-28, 43, 46-50, 64-65, 67-75 are rejected under 35 U.S.C. § 112, second paragraph, as being indefinite for failing to particularly point out and distinctly claim the subject matter which applicant regards as the invention.

Claim 1:

Lines 8-9, "the descired digital video or audio signals purchased by the second party" does not have antecedent basis.

Lines 8-9 recited that the sales RAM chip is for storing "the descired digital video or audio signals purchased by the second party" while lines 18-19 recited that the sales RAM chip stores "the coded descired digital video or digital audio signals from the hard disk". The two recitations are not correlated.

Line 15, "the desired digital video or digital audio signals" is not clear if it is meant to refer back to the the signals recited on line 7 or lines 8-9.

Claim 6:

Lines 2-3, it is not clear which "the desciredsignals are meant here.

Lines 3-4 recites that the second hard disk stores the desired digital video or digital audio signals from the first party hard disk. Lines 8-9 appears to recite that the second hard disk receives the desired ...signals tranferred from the incomming RAM chip, not from the first part hard disk. This is confusing.

Line 9, "storing the desired....signals in the second part hard disk" is not clear which "desired....signals" are meant here.

Lines 10-13, the step of "commanding from the second party hard disk" does not make sense as to what is meant to claim.

Claim 7:

Lines 2-3, "the step of repeating commanding the second party integrated circuit to play, playing, and transferring a replica steps." does not make sense.

Claim 9:

Lines 5-7, a function of the replica of the desired ...signals to be stored in the sales random access memory is not clear. The stored replica desired ...signals is not functionally associated and participated within the claimed system.

Claim 11:

Lines 2-3, it is not clear which "a plurality of ...signals" are meant. I.e., it is not clear where the source of these signals is.

Lines 4-5, "a replica of the desired ...signals" is not clear in light of the "replica....signals" recited in claim 9. The sturtural relationship between the second party hard disk and the playback random access memory as recited does not support the functional language "for storing a replica....signals".

Claim 12:

Line 4, "the second party control integrated circuit" does not have clear antecedent basis. It therefore is not clear whaere the

source of the second party control integrated circuit is.

Lines 6-7, the structural relationship as recited in the claim does not support the functional language "said first party control integrated circuit and said second party control integrated regulate the transfer of the desired.....signals".

Claim 14:

Lines 2-3, "the second party hard drive" does not have antecedent basis.

The structural relationship between the claimed elements and the function relative therefor do not support each other.

Claim 17:

Lines 4-5, the first party and the second party claimed as parts of the transmitting system does not seem to make sense because it is not clear how a person or a group of people as a party can be read as a part of a transmitting system.

Lines 17-18, "the first party in possession and control of the first control unit, andunit" does not make sense.

Claims 23, 43, 62, 69 contain substantial similar problems that have mentioned earlier.

Claims which have not been mentioned are rejected because they are dependent on the rejected base claims.

Claims 1, 5-7, 11-15, 17-20-23, 26-28, 43, 46-50, 62, 64-65, 67-75 would be allowable if rewritten or amended to overcome the rejection under 35 U.S.C. § 112.

THIS ACTION IS MADE FINAL. Applicant is reminded of the

extension of time policy as set forth in 37 C.F.R. § 1.136(a).

A SHORTENED STATUTORY PERIOD FOR RESPONSE TO THIS FINAL ACTION IS SET TO EXPIRE THREE MONTHS FROM THE DATE OF THIS ACTION. IN THE EVENT A FIRST RESPONSE IS FILED WITHIN TWO MONTHS OF THE MAILING DATE OF THIS FINAL ACTION AND THE ADVISORY ACTION IS NOT MAILED UNTIL AFTER THE END OF THE THREE-MONTH SHORTENED STATUTORY PERIOD, THEN THE SHORTENED STATUTORY PERIOD WILL EXPIRE ON THE DATE THE ADVISORY ACTION IS MAILED, AND ANY EXTENSION FEE PURSUANT TO 37 C.F.R. § 1.136(a) WILL BE CALCULATED FROM THE MAILING DATE OF THE ADVISORY ACTION. IN NO EVENT WILL THE STATUTORY PERIOD FOR RESPONSE EXPIRE LATER THAN SIX MONTHS FROM THE DATE OF THIS FINAL ACTION.

Any inquiry concerning this communication or earlier communications from the examiner should be directed to Hoa Nguyen, whose telephone number is (703) 305-9687. The examiner can normally be reached on Monday through Friday, from 9.30 A.M to 6.00 P.M.

If attempts to reach the examiner by telephone are unsuccessful, the examiner's supervisor, Robert Beausoliel, can be reached on (703) 305-9713. The fax phone number for this Group is (703) 305-9564.

Any inquiry of a general nature or relating to the status of this application should be directed to the Group receptionist whose telephone number is (703) 305-9600.

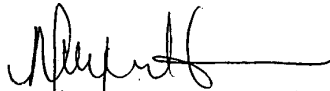

HOA T. NGUYEN
PRIMARY EXAMINER
GROUP 2400



2413

\$145.00 - 219
75.00 - 215
GP
2413

Attorney's Docket No. HAIR-1 CONT II

PATENT

IN THE UNITED STATES PATENT AND TRADEMARK OFFICE

In re application of: Arthur R. Hair
Serial No.: 0 8 / 023,398 Group No.: 2413
Filed: February 26, 1993 Examiner: H. Nguyen
For: A SYSTEM FOR TRANSMITTING DESIRED DIGITAL VIDEO
OR AUDIO SIGNALS

#16
RECEIVED
1995 NOV 21 AM 11:17
GROUP 240

Commissioner of Patents and Trademarks
Washington, D.C. 20231

NOTICE OF APPEAL FROM THE PRIMARY EXAMINER TO THE BOARD OF PATENT APPEALS AND INTERFERENCES

Applicant hereby appeals to the Board from the decision of the Primary Examiner mailed June 28, 1995 finally rejecting claims 1, 5-7, 11-15, 20-23, 26-28, 43, 46-50, 62, 64-65, 67-75

The item(s) checked below are appropriate:

1. STATUS OF APPLICANT

This application is on behalf of
 other than a small entity.
 a small entity.
A verified statement
 is attached
 was already filed on 2/26/93

2. FEE FOR FILING NOTICE OF APPEAL

Pursuant to 37 CFR 1.17(e) the fee for filing the Notice of Appeal is:
 small entity ~~\$140.00~~ 145.00
 other than a small entity \$280.00
Notice of Appeal fee due \$ 145.00

CERTIFICATE OF MAILING/TRANSMISSION (37 CFR 1.8a)

I hereby certify that this correspondence is, on the date shown below, being:

MAILING
 deposited with the United States Postal Service with sufficient postage as first class mail in an envelope addressed to the Commissioner of Patents and Trademarks, Washington, D.C. 20231

FACSIMILE
 transmitted by facsimile to the Patent and Trademark Office

Date: 10/27/95

Tracey L. Melka
Signature 310 CS 11/16/95 08023398
Tracey L. Melka 145.00 CK
(type or print name of person certifying)

(Notice of Appeal from the Primary Examiner to Board [9-6]—page 1 of 3)

3. EXTENSION OF TERM

NOTE: The time periods set forth in 37 CFR 1.191 are subject to the provision of § 1.136 for patent applications 37 CFR 1.191(d). (But see 37 CFR 1.645 for extension of time in interference proceedings and 37 CFR 1.550(c) for extension of time in reexamination proceedings).

(complete (a) or (b) as applicable)

The proceedings herein are for a patent application and the provisions of 37 CFR 1.136 apply.

(a) Applicant petitions for an extension of time under 37 CFR 1.136 (fees: 37 CFR 1.17(a)-(d)) for the total number of months checked below:

Extension (months)	Fee for other than small entity	Fee for small entity
<input checked="" type="checkbox"/> one month	\$110.00	\$55.00
<input type="checkbox"/> two months	\$370.00	\$185.00
<input type="checkbox"/> three months	\$870.00	\$435.00
<input type="checkbox"/> four months	\$1,360.00	\$680.00
		Fee \$ <u>55.00</u>

If an additional extension of time is required please consider this a petition therefor.

(check and complete the next item, if applicable)

An extension for _____ months has already been secured and the fee paid therefor of \$_____ is deducted from the total fee due for the total months of extension now requested.
Extension fee due with this request \$_____

or

(b) Applicant believes that no extension of term is required. However, this conditional petition is being made to provide for the possibility that applicant has inadvertently overlooked the need for a petition and fee for extension of time.

4. TOTAL FEE DUE

The total fee due is:

Notice of Appeal fee \$145.00

Extension fee (if any) \$ 55.00

TOTAL FEE DUE \$ 200.00

5. FEE PAYMENT

Attached is a check in the sum of \$ 200.00

Charge Account No. _____ the sum of \$_____

A duplicate of this transmittal is attached.

(Notice of Appeal from the Primary Examiner to Board [9-6]—page 2 of 3)

6. FEE DEFICIENCY

NOTE: If there is a fee deficiency and there is no authorization to charge an account, additional fees are necessary to cover the additional time consumed in making up the original deficiency. If the maximum, six-month period has expired before the deficiency is noted and corrected, the application is held abandoned. In those instances where authorization to charge is included, processing delays are encountered in returning the papers to the PTO Finance Branch in order to apply these charges prior to action on the cases. Authorization to charge the deposit account for any fee deficiency should be checked. See the Notice of April 7, 1986, 1065 O.G. 31-33.

If any additional extension and/or fee is required charge Account No. 19-0737

AND/OR

If any additional fee for claims is required, charge Account No. 19-0737



SIGNATURE OF ATTORNEY

Reg. No.: 30,587

Ansel M. Schwartz

(type or print name of attorney)

Tel. No.: (412) 621-9222

425 N. Craig Street
Suite 301

P.O. Address

Pittsburgh, PA 15213

5675734



UTILITY SERIAL NUMBER 08/607648 PATENT DATE OCT 07 1997

PATENT NUMBER

SERIAL NUMBER 08/607,648 FILING DATE 02/27/96 CLASS 395 SUBCLASS 200.01 GROUP ART UNIT 2413 EXAMINER Aguirre

APPLICANT: ARTHUR R. HAIR, UPPER ST. CLAIR, PA

CONTINUING DATA VERIFIED THIS APPLN IS A CON OF 08/023,898 02/26/93 7403 WHICH IS A CON OF 07/584,391 09/18/90 PAT 5,191,573 WHICH IS A CON OF 07/206,497 06/13/88 abandoned

FOREIGN/PCT APPLICATIONS VERIFIED

FOREIGN FILING LICENSE GRANTED 03/17/96 SMALL ENTITY

Foreign priority claimed 35 USC 119 conditions met. AS FILED STATE OR COUNTRY PA SHEETS DRWGS. 2 TOTAL CLAIMS 20 INDEP CLAIMS 5 FILING FEE RECEIVED \$453.00 ATTORNEY'S DOCKET NO HAIR-1CONTIT

ANSER, M. SCHWARTZ SUITE 301 425 N CRAIG STREET PITTSBURGH PA 15213

TITLE: SYSTEM FOR TRANSMITTING DESIRED DIGITAL VIDEO OR AUDIO SIGNALS

U.S. DEPT. OF COMM./PAT. & TM PTO-436L (Rev. 12-94)

Form with sections: PARTS OF APPLICATION FILED SEPARATELY, NOTICE OF ALLOWANCE MAILED (5/18/97), ISSUE FEE (645.00), DATE PAID (5/6/97), CLAIMS ALLOWED (Total 34, Print 1), DRAWING (Sheets 2, Figs 2, Print 2), ISSUE BATCH NUMBER (J30), PREPARED FOR ISSUE, WARNING: The information disclosed herein may be restricted.

Form PTO-436A (Rev. 8/92)

BEST AVAILABLE COPY

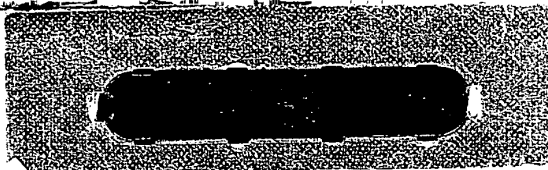

08/607,648

BEST AVAILABLE COPY

SEARCHED			
Class	Sub.	Date	Exmr.
395	200.1	6/96	HN
235	381		
364	479.04		
364	410		
235	380		
235	375		
395	200.01		
369	33		
369	34		
369	84		
369	85		
380	4		
380	43		
379	77		
360	55		

SEARCH NOTES		
	Date	Exmr.

INTERFERENCE SEARCHED			
Class	Sub.	Date	Exmr.
395	200.1	01/97	HN
380	4		
	43		

Staple Issue Slip Here

08/607,648

BEST AVAILABLE COPY

POSITION	ID NO.	DATE
CLASSIFIER		
EXAMINER	414	8-25-96
TYPIST	357	03/27/94
VERIFIER		
CORPS CORR.		
SPEC. HAND		
FILE MAINT.		
DRAFTING		

INDEX OF CLAIMS

Claim	Date
1	
2	
3	
4	
5	
6	
7	
8	
9	
10	
11	
12	
13	
14	
15	
16	
17	
18	
19	
20	
21	
22	
23	
24	
25	
26	
27	
28	
29	
30	
31	
32	
33	
34	
35	
36	
37	
38	
39	
40	
41	
42	
43	
44	
45	
46	
47	
48	
49	
50	

Claim	Date
51	
52	
53	
54	
55	
56	
57	
58	
59	
60	
61	
62	
63	
64	
65	
66	
67	
68	
69	
70	
71	
72	
73	
74	
75	
76	
77	
78	
79	
80	
81	
82	
83	
84	
85	
86	
87	
88	
89	
90	
91	
92	
93	
94	
95	
96	
97	
98	
99	
100	

SYMBOLS
 (Through numbers) Correct
 Deleted
 Non-essential
 Added
 Deleted

453 - 201

08/30/96 48



Attorney's Docket No. HAIR-1 CONT IIA

PATENT

IN THE UNITED STATES PATENT AND TRADEMARK OFFICE

#19/E

276
4/18/96

Anticipated Classification of this application:

Class _____ Subclass _____

Application No.: / _____

PRIOR APPLICATION Examiner: H. Nguyen

Art Unit: 2313

Box FWC
Commissioner of Patents and Trademarks
Washington, D.C. 20231

FILE WRAPPER CONTINUING APPLICATION (FWC) TRANSMITTAL
(37 C.F.R. 1.62)

- WARNING:** This form cannot be used where the parent case may not be abandoned because the filing of a request under the FWC procedure "will be considered to be a request to expressly abandon the prior application as of the filing date granted to the continuing application." 37 CFR 1.62(g).
- WARNING:** This procedure can only be used for a pending application prior to payment of the issue fee (37 CFR 1.62(a)), except if the parent application was withdrawn under 37 CFR 1.313(b)(5) "to permit consideration of an information disclosure statement under 1.97 in a continuing application." 37 C.F.R. 1.62(a).
- WARNING:** The filing of an application at the United States stage of an international application requires an oath or declaration. 37 CFR 1.61(a)(4).
- WARNING:** The claims of this new application may be finally rejected in the first Office action where all claims of the new application are drawn to the same invention claimed in the earlier application and would have been properly finally rejected on the grounds or art of record in the next Office action if they had been entered in the earlier application. MPEP § 706.07(b).
- WARNING:** An application under 37 CFR 1.62 is filed by making changes by amendment to the prior application, (37 CFR 1.62(a)), and not by filing a new application. 37 CFR 1.62(e).
- WARNING:** Filing under 37 CFR 1.62 is permitted only if filed by the same or less than all the inventors named in the prior application. 37 CFR 1.62(a).

Amendment to GP

CERTIFICATION UNDER 37 CFR 1.10

I hereby certify that this FWC Transmittal and the documents referred to as attached therein are being deposited with the United States Postal Service on this date February 27, 1996, in an envelope as "Express Mail Post Office to Addressee," mailing Label Number EM345114451US, addressed to the: Commissioner of Patents and Trademarks, Washington, D.C. 20231.

Tracey L. Milka

(type or print name of person mailing paper)

Tracey L. Milka

Signature of person mailing paper

NOTE: Each paper or fee filed by "Express Mail" must have the number of the "Express Mail" mailing label placed thereon prior to mailing. (37 CFR 1.10(b)).

WARNING: Certificate of mailing (first class) or facsimile transmission procedures of 37 CFR 1.8 cannot be used to obtain a date of mailing or transmission for this correspondence.

(FWC [4-2]-page 1 of 13)

E

WARNING: File wrapper continuing procedure filings can only be based on a prior complete application as defined by § 1.51(a)(1), and not a prior complete provisional application as defined by § 1.51(a)(2).

This is a request for a filing under the file wrapper continuing application procedure (37 CFR 1.62), for a

- continuation
- divisional
- continuation-in-part (for oath or declaration, see III below)

Attached is an amendment for added subject matter

- continuing application to permit consideration of an information disclosure statement under 37 CFR 1.97.

NOTE: The filing date under 37 CFR 1.62(a) is "... the date on which a request is filed for an application ... including identification of the application number and applicant's name of the prior application." The prior application under 37 CFR 1.62(a) must be "... a prior complete application," as defined in 37 CFR 1.51(a)(1).

PARTICULARS OF PRIOR APPLICATION

WARNING: File wrapper continuing procedure filings can only be based on a prior complete application as defined by § 1.51(a)(1), and not a prior complete provisional application as defined by § 1.51(a)(2). 37 CFR 1.62(a).

- A. Application No. 0 8 / 023,398 filed 2/26/93 (date).
- B. Title (as originally filed A SYSTEM FOR TRANSMITTING DESIRED DIGITAL and as last amended) VIDEO OR AUDIO SIGNALS
- C. Name of applicant(s) (as originally filed and as last amended) and current correspondence address of applicant(s)

1. FULL NAME OF INVENTOR	FAMILY NAME <u>Hair</u>	FIRST GIVEN NAME 1-00 <u>Arthur</u>	SECOND GIVEN NAME <u>R.</u>
RESIDENCE & CITIZENSHIP	CITY <u>Upper St. Clair</u>	STATE OR FOREIGN COUNTRY Pennsylvania ^{PA}	COUNTRY OF CITIZENSHIP United States
POST OFFICE ADDRESS	POST OFFICE ADDRESS 1518 Allison Drive	CITY Upper St. Clair	STATE & ZIP CODE/COUNTRY Pennsylvania 15241 USA
2. FULL NAME OF INVENTOR	FAMILY NAME	FIRST GIVEN NAME	SECOND GIVEN NAME
RESIDENCE & CITIZENSHIP	CITY	STATE OR FOREIGN COUNTRY	COUNTRY OF CITIZENSHIP
POST OFFICE ADDRESS	POST OFFICE ADDRESS	CITY	STATE & ZIP CODE/COUNTRY
3. FULL NAME OF INVENTOR	FAMILY NAME	FIRST GIVEN NAME	SECOND GIVEN NAME
RESIDENCE & CITIZENSHIP	CITY	STATE OR FOREIGN COUNTRY	COUNTRY OF CITIZENSHIP
POST OFFICE ADDRESS	POST OFFICE ADDRESS	CITY	STATE & ZIP CODE/COUNTRY

Continued on Added Page for Inventor's Data

(FWC [4-2]—page 3 of 13)

The above identified application, in which no payment of issue fee, abandonment of (other than where the above identified application was abandoned under 37 CFR 1.313(b)(5) to permit consideration of an information disclosure statement under 37 CFR 1.97), or termination of proceedings has occurred, is hereby expressly abandoned as of the filing date of this new application. Please use all the contents of the prior application file wrapper, including the drawings, as the basic papers for the new application.

It is understood that secrecy under 35 U.S.C 122 is hereby waived to the extent that if information or access is available to any one of the applications in the file wrapper of a 37 CFR 1.62 application, be it either this application or a prior application in the same file wrapper, the PTO may provide similar information or access to all the other applications in the same file wrapper.

II. Inventorship statement

NOTE: "If the continuation, continuation-in-part, or divisional application is filed by less than all the inventors named in the prior application a statement must accompany the application when filed requesting deletion of the names of the person or persons who are not inventors of the invention being claimed in the continuation, continuation-in-part, or divisional application." 37 CFR 1.62(a).

NOTE: "In the case of a continuation-in-part application which adds and claims additional disclosure by amendment, an oath or declaration as required by § 1.63 must be filed. In those situations where a new oath or declaration is required due to additional subject matter being claimed, additional inventors may be named in the continuing application. In a continuation or divisional application which discloses and claims only subject matter disclosed in a prior application, no additional oath or declaration is required and the application must name as inventors the same or less than all the inventors in the prior application." 37 CFR 1.60(c).

(complete applicable item (a), (b) and/or (c) below)

- (a) This application discloses and claims only subject matter disclosed in the prior application whose particulars are set out above and the inventor(s) in this application are
- the same
 - less than those named in the prior application and it is requested that the following inventor(s) identified above for the prior application be deleted:

(type name(s) of inventor(s) to be deleted)

- (b) This application discloses and claims additional disclosure by amendment and a new declaration or oath is being filed. With respect to the prior application whose particulars are set out above, the inventor(s) in this application are
- the same
 - add the following additional inventor(s)

(type name of inventor(s) to be added)

- (c) The inventorship for all the claims in this application is
- the same
 - not the same, An explanation, including the ownership of the various claims at the time the last claimed invention was made, is submitted.

III. Declaration or oath

A. Continuation or divisional

None required.

B. Continuation-in-part

Attached.

Executed by (check all applicable items)

inventor(s).

legal representative of inventor(s). 37 CFR 1.42 or 1.43.

joint inventor or person showing a proprietary interest for inventor who refused to sign or cannot be reached. 37 CFR 1.47;

This is the petition required by 37 CFR 1.47 and the statement required by 37 CFR 1.47 is also attached. (See item VIII below for fee.)

Not attached.

Application is made by a person authorized under 37 CFR 1.41(c) on behalf of all of the above named applicant(s). (The declaration or oath, along with the surcharge required by 37 CFR 1.16(e) can be filed subsequently.)

Attached is a showing that the filing is authorized. (Not required unless called into question. 37 CFR 1.41(d).)

IV. Identification of Claims for Further Prosecution

WARNING: "The claims of a new application may be finally rejected in the first Office action in those situations where (1) the new application is a continuing application of, or a substitute for, an earlier application, and (2) all the claims of the new application (a) are drawn to the same invention claimed in the earlier application, and (b) would have been properly finally rejected on the grounds of art of record in the next Office action if they had been entered in the earlier application." MPEP § 706.07(b).

The fees to be charged are to be based on the number of claims remaining as a result of the:

attached preliminary amendment.

the unentered amendment filed under 37 CFR 1.116 in the prior application, which is now repeated.

the claims as on file in the prior application.

(FWC [4-2]—page 5 of 13)

V. Fee Calculation (37 C.F.R. 1.16)

NOTE: The filing fee for a continuation, continuation-in-part, or divisional application is based on the number of claims remaining in the application after entry of any preliminary amendment and entry of any amendments under 37 C.F.R. 1.116 unentered in the prior application which is requested to be entered in this FWC application. 37 C.F.R. 1.62.

CLAIMS FOR FEE CALCULATION								
Number Filed			Number Extra		Rate	Basic Fee 37 C.F.R. 1.16(a) \$750.00		
Total Claims								
(37 C.F.R. 1.16(c))	20	-	20	=	0	×	\$ 22.00	0.00
Independent Claims								
(37 C.F.R. 1.16(b))	5	-	3	=	2	×	\$ 78.00	156.00
Multiple dependent claim(s), if any								
(37 C.F.R. 1.16(d))						+	\$250.00	

The fee for extra claims is not being paid at this time.

Filing fee calculation \$ 906.00

NOTE: If the fees for extra claims are not paid on filing they must be paid or the claims cancelled by amendment, prior to the expiration of the time period set for response by the Patent and Trademark Office in any notice of fee deficiency. 37 C.F.R. 1.16(d).

VI. Petition for Suspension of Prosecution for the Time Necessary to File an Amendment

NOTE: Where it is possible that the claims on file will give rise to a first action final for this continuation application and for some reason an amendment cannot be filed promptly (e.g., experimental data is being gathered), it may be desirable to file a petition for suspension of prosecution for the time necessary.

(check the next item, if applicable)

There is provided herewith a Petition to Suspend Prosecution for the time Necessary to File an Amendment (New Application Filed Concurrently).

VII. Small Entity Statement

A verified statement that this is a filing by a small entity is attached.

WARNING: "Status as a small entity in one application or patent does not affect any other application or patent, including applications or patents which are directly or indirectly dependent upon the application or patent in which the status has been established. A nonprovisional application claiming benefit under 35 U.S.C. 119(e), 120, 121 or 365(c) of a prior application may rely on a verified statement filed in the prior application if the nonprovisional application includes a reference to a verified statement in the prior application or includes a copy of the verified statement filed in the prior application if status as a small entity is still proper and desired." 37 C.F.R. § 1.28(a).

(complete the following, if applicable)

- Status as a small entity was claimed in prior application 08 / 023,398, filed on 2/26/93, from which benefit is being claimed for this application under:

35 U.S.C. 120,
 121,
 365(c),

and which status as a small entity is still proper and desired.

- A copy of the verified statement in the prior application is included.

Reduced filing fee calculation (50% of above) \$ 453.00

NOTE: 37 CFR 1.28(a) states "Status as a small entity must be specifically established by a verified statement filed in each application or patent in which the status is available and desired, except those applications filed under § 1.60 or § 1.62 of this part where the status as a small entity has been established in a parent application and is still proper."

The last sentence of 37 CFR 1.28(a) states: "Applications filed under § 1.60 or § 1.62 of this part must include a reference to a verified statement in a parent application if status as a small entity is still proper and desired."

Any excess of the full fee paid will be refunded if a verified statement and a refund request are filed within 2 months of the date of timely payment of a full fee then the excess fee paid will be refunded on request. 37 CFR 1.28(a).

VIII. Fee Payment Being Made at This Time

Not attached

- No filing fee is submitted. (This and the surcharge required by 37 CFR 1.16(e) can be paid subsequently.)

Attached

- | | |
|--|------------------|
| <input checked="" type="checkbox"/> filing fee | \$ <u>453.00</u> |
| <input type="checkbox"/> recording assignment
(\$40.00; 37 CFR 1.21(h)).
For payment of fee see item XIV below. | \$ _____ |
| <input type="checkbox"/> petition fee for filing by other than all the
inventors or person not the inventor where
inventor refused to sign or cannot be reached
(\$130.00; 37 CFR 1.47 and 1.17(h)) | \$ _____ |
| <input type="checkbox"/> processing and retention fee
(\$130.00; 37 CFR 1.53(d) and 1.21(l)) | \$ _____ |

NOTE: 37 CFR 1.21(l) establishes a fee for processing and retaining any application that is abandoned for failing to complete the application pursuant to 37 CFR 1.53(d) and this, as well as the changes to 37 CFR 1.53 and 1.78, indicate that in order to obtain the benefit of a prior U.S. application, either the basic filing fee must be timely paid or the processing and retention fee in § 1.21(l) must be paid within 1 year from the notification under § 1.53(d).

Total fees enclosed \$ 453.00

(FWC [4-2]—page 7 of 13)

IX. Method of Payment of Fees

- Attached is check in the amount of \$ 453.00
- Charge Account No. _____ in the amount of \$ _____
- A duplicate of this request is attached.

NOTE: Fees should be itemized in such a manner that it is clear for which purpose the fees are paid. 37 CFR 1.22(b).

X. Authorization to Charge Additional Fees

WARNING: If no fee payment is made at this time, this item should not be completed.

WARNING: Accurately count claims, especially multiple dependent claims, to avoid unexpected high charges if extra claim charges are authorized.

- The Commissioner is hereby authorized to charge the following additional fees that may be required by this paper and during the entire pendency of this application to Account No. 19-0737:
- 37 CFR 1.16(a), (f) or (g) (filing fees)
- 37 CFR 1.16(b), (c) and (d) (presentation of extra claims)

NOTE: Because additional fees for excess or multiple dependent claims not paid on filing or on later presentation must only be paid or these claims cancelled by amendment prior to the expiration of the time period set for response by the PTO in any notice of fee deficiency (37 CFR 1.16(d)), it might be best not to authorize the PTO to charge additional claim fees, except possibly when dealing with amendments after final action.

- 37 CFR 1.16(e) (surcharge for filing the basic filing fee and/or declaration on a date later than the filing date of the application)
- 37 CFR 1.17 (application processing fees)

WARNING: While 37 CFR 1.17(a), (b), (c) and (d) deal with extensions of time under § 1.136(a), this authorization should be made only with the knowledge that: "Submission of the appropriate extension fee under 37 CFR 1.136(a) is to no avail unless a request or petition for extension is filed" (Emphasis added). Notice of November 5, 1985 (1060 O.G. 27).

- 37 CFR 1.18 (issue fee at or before mailing of Notice of Allowance, pursuant to 37 CFR 1.311(b))

NOTE: Where an authorization to charge the issue fee to a deposit account has been filed before the mailing of a Notice of Allowance, the issue fee will be automatically charged to the deposit account at the time of mailing the Notice of Allowance. 37 CFR 1.311(b).

37 CFR 1.28(b) states: (a) notification of change of status must be made even if the fee is paid as "other than a small entity" and (b) no notification is required if the change is to another small entity. Notification of any change of status resulting in loss of entitlement to small entity status must be filed in the application prior to, or at the time of, paying the issue fee. 37 CFR 1.28(b).

XI. Instructions as to Overpayment

- Credit Account No. 19-0737
- Refund

XII. Priority—35 U.S.C. 119(a)-(d)

- Priority of Application No. _____ / _____ filed on _____ in _____ (country) is claimed under 35 U.S.C. 119.
- The certified copy has been filed on _____ in prior U.S. application Serial No. 0 / _____, which prior application was filed on _____
- Certified copy will follow.

XIII. Relate Back

WARNING: If an application claims the benefit of the filing date of an earlier filed application under 35 U.S.C. 120, 121 or 365(c), the 20-year term of that application will be based upon the filing date of the earliest U.S. application that the application makes reference to under 35 U.S.C. 120, 121 or 365(c). (35 U.S.C. 154(a)(2) does not take into account, for the determination of the patent term, any application on which priority is claimed under 35 U.S.C. 119, 365(a) or 365(b).) For a c-i-p application, applicant should review whether any claim in the patent that will issue is supported by an earlier application and, if not, the applicant should consider canceling the reference to the earlier filed application. The term of a patent is not based on a claim-by-claim approach. See Notice of April 14, 1995, 60 Fed. Reg. 20,194, at 20,205.

NOTE: "Any nonprovisional application claiming the benefit of one or more prior filed copending nonprovisional applications or international applications designating the United States of America must contain or be amended to contain in the first sentence of the specification following the title a reference to each such prior application, identifying it by application number (consisting of the series code and serial number) or international application number and international filing date and indicating the relationship of the applications. Cross-references to other related applications may be made when appropriate. (See § 1.14(b))." 37 C.F.R. § 1.78(2).

(complete the following, if applicable)

- Amend the specification by inserting, before the first line, the sentence:
"This application claims the benefit of the following:

A. 35 U.S.C. 119(e)

NOTE: "Any nonprovisional application claiming the benefit of one or more prior filed copending provisional applications must contain or be amended to contain in the first sentence of the specification following the title a reference to each such prior provisional application, identifying it as a provisional application, and including the provisional application number (consisting of series code and serial number)." 37 C.F.R. § 1.78(a)(4).

WARNING: While this application under 37 C.F.R. § 1.62 cannot be a file wrapper continuation application of a provisional application, the nonprovisional application giving rise to this FWC filing could claim the benefit of a provisional application.

- U.S. Provisional Application(s) No(s):

APPLICATION NO(S):

FILING DATE

B. 35 U.S.C. 120, 121 and 365(c)

NOTE: "Any nonprovisional application claiming the benefit of one or more prior filed copending nonprovisional applications or international applications designating the United States of America must contain or be amended to contain in the first sentence of the specification following the title a reference to each such prior application, identifying it by application number (consisting of the series code and serial number) or international application number and international filing date and indicating the relationship of the applications. Cross-references to other related applications may be made when appropriate. (See § 1.14(b))." 37 C.F.R. § 1.78(2).

- "This application is a
 - continuation
 - divisional
 - continuation-in-part

of copending application(s)

Serial Number 0 8/ 023,398 filed on February 26, 1993 ^{now abandoned.}"

International Application _____ filed on _____ and which designated the U.S."

NOTE: The proper reference to a prior filed PCT application that entered the U.S. national phase is the U.S. serial number and the filing date of the PCT application that designated the U.S.

XIV. Assignment

- The prior application is assigned of record to Parsec Sight/Sound, Inc.
- An assignment of the invention to _____

is attached. A separate "COVER SHEET FOR ASSIGNMENT (DOCUMENT) ACCOMPANYING NEW PATENT APPLICATION" or FORM PTO 1595 is also attached.

NOTE: "If an assignment is submitted with a new application, send two separate letters—one for the application and one for the assignment." Notice of May 4, 1990 (1114 O.G. 77-78).

XV. Power of Attorney

The power of attorney in the prior application is to

Ansel M. Schwartz	30,587
Attorney	Reg. No.

- a. The power appears in the original papers in the prior application.
- b. The power does not appear in the original papers, but was filed on _____.
- c. A new power has been executed and is attached.
- d. Address all future communications to:

(item d may only be completed by applicant, or attorney or agent of record.)

Ansel M. Schwartz	30,587
Name	Reg. No.
425 N. Craig Street, Suite 301	
Address	
Pittsburgh, PA 15213	412/621-9222
	Tel. No.

28

XVI. Maintenance of Copendency of Prior Application

(this item must be completed and the necessary papers filed in the prior application, if the period set in the prior application has run.)

- A petition, fee and response has been filed to extend the term in the pending prior application until February 27, 1996.

NOTE: The PTO finds it useful if a copy of the petition filed in the prior application extending the term for response is filed with the papers constituting the filing of the continuation application. Notice of November 5, 1985 (1060 O.G. 27).

- A copy of the petition for extension of time in the prior application is attached.

XVII. Conditional Petitions for Extension of Time in Prior Application

(complete this item and file conditional petition in prior application, if previous item is not applicable)

- A conditional petition for extension of time is being filed in the pending prior application

NOTE: The PTO finds it useful if a copy of the petition filed in the prior application extending the term for response is filed with the papers constituting the filing of the continuation application. Notice of November 5, 1985 (1060 O.G. 27).

- A copy of the conditional petition for extension of time in the prior application is attached.

XVIII. Abandonment of Prior Application

- Please abandon the prior application at a time while the prior application is pending or when the petition for extension of time or to revive in that application is granted and when this application is granted a filing date so as to make this application copending with said prior application. At the same time, please add the words "now abandoned" to the amendment to the specification set forth in XIII above.

NOTE: According to the Notice of May 13, 1983 (103 TMOG 6-7), the filing of a continuation or continuation-in-part application is a proper response with respect to a petition for extension of time or a petition to revive and should include the express abandonment of the prior application conditioned upon the granting of the petition and the granting of a filing date to the continuing application.

NOTE: "A registered attorney or agent acting under the provisions of § 1.34(a), or of record, may also expressly abandon a prior application as of the filing date granted to a continuing application when filing such a continuing application." 37 CFR 1.138.

XIX. Information Disclosure Statement

- Submitted herewith is an Information Disclosure Statement.

(FWC [4-2]—page 11 of 13)

XX. Assignee Certification

WARNING: When an assignee files a continuation or divisional application (under 37 C.F.R. 1.53, 1.60 or 1.62), reference may be made to a statement filed under 37 C.F.R. 3.73(b) in the parent application or a copy of that statement may be filed. A newly executed statement under 37 C.F.R. 3.73(b) must be filed when a continuation-in-part application is filed by an assignee. Notice of April 30, 1993, 1150 O.G. 62-64.

(complete the following, if the assignee is signing below)

- This is a continuation divisional application and the statement under 37 C.F.R. 3.73(b)
 - has been filed in the parent application.
 - A copy of the previously filed statement in the parent application is attached.
- This is a continuation-in-part application and a "CERTIFICATE UNDER 37 C.F.R. 3.73(b)" is attached.

Ansel M. Schwartz

(type or print name of person signing declaration)

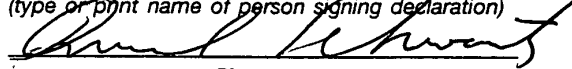

Signature

2/27/96

Date

425 N. Craig Street

P.O. Address of Signatory
Suite 301

Pittsburgh, PA 15213

(if applicable)

Tel. No.: (412) 621-9222

Reg. No.: 30,587

- Inventor
- Assignee of complete interest
- Person authorized to sign on behalf of assignee
- Attorney or agent of record
- Filed under Rule 34(a)

(complete the following, if applicable)

(type name of assignee)

Address of assignee

Title of person authorized to sign on behalf of Assignee

Assignment recorded in PTO on _____

Reel _____ Frame _____

- Plus ADDED PAGE FOR INVENTOR'S DATA FOR FWC FILING
- Plus ASSIGNMENT (DOCUMENT) COVER LETTER ACCOMPANYING NEW PATENT APPLICATION

Reg. No. 30,587

SIGNATURE OF ATTORNEY

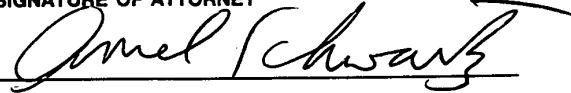

Ansel M. Schwartz

(type or print name of attorney)

425 N. Craig Street
Suite 301

P.O. Address

Pittsburgh, PA 15213

Tel. No.: (412) 621-9222

(FWC [4-2]—page 13 of 13)

Certificate Under 37 CFR 3.73(b)

RECEIVED
FEB 29 1996
RECEIPT ACCEPTING DAY

Applicant: Arthur R. Hair

Application No.: 08/023,398 Filed: February 26, 1993

For: A SYSTEM FOR TRANSMITTING DESIRED DIGITAL VIDEO OR AUDIO SIGNALS

Parsec Sight/Sound, Inc., a corporation
(Name of Assignee) (Type of Assignee, e.g., corporation, partnership, university, government agency, etc.)

certifies that it is the assignee of the entire right, title and interest in the patent application identified above by virtue of either:

A. An assignment from the inventor(s) of the patent application identified above. The assignment was recorded in the Patent and Trademark Office at Reel 7656, Frame 0701, or for which a copy thereof is attached.

OR

B. A chain of title from the inventor(s), of the patent application identified above, to the current assignee as shown below:

- 1. From: _____ To: _____
The document was recorded in the Patent and Trademark Office at Reel _____, Frame _____, or for which a copy thereof is attached.
- 2. From: _____ To: _____
The document was recorded in the Patent and Trademark Office at Reel _____, Frame _____, or for which a copy thereof is attached.
- 3. From: _____ To: _____
The document was recorded in the Patent and Trademark Office at Reel _____, Frame _____, or for which a copy thereof is attached.

Additional documents in the chain of title are listed on a supplemental sheet.

Copies of assignments or other documents in the chain of title are attached.

The undersigned has reviewed all the documents in the chain of title of the patent application identified above and, to the best of undersigned's knowledge and belief, title is in the assignee identified above.

The undersigned (whose title is supplied below) is empowered to sign this certificate on behalf of the assignee.

I hereby declare that all statements made herein of my own knowledge are true, and that all statements made on information and belief are believed to be true; and further, that these statements are made with the knowledge that willful false statements, and the like so made, are punishable by fine or imprisonment, or both, under Section 1001, Title 18 of the United States Code, and that such willful false statements may jeopardize the validity of the application or any patent issuing thereon.

Date: 2/27/96

Name: Ansel M. Schwartz

Title: Attorney of Record

Signature: Ansel Schwartz

96 APR 11 AM 7:15

96 APR 11 AM 11:31
OFFICE OF PUBLIC SERVICES
DIRECTOR'S OFFICE

RECEIVED

(Certificate Under 37 CFR 3.73(b)—PTO FORM [16-16.1])

REMARKS

This is a file wrapper continuation of U.S. patent application 08/023,398 filed February 26, 1993, which is a continuation of U.S. patent application 07/586,391 filed September 18, 1990, now U.S. Patent 5,191,573 issued March 2, 1993, which is a continuation of U.S. patent application 07/206,497 filed June 13, 1988, abandoned.

Claims 1, 5-7, 11, 20-23, 26-28, 43, 46, 62, 64, 65 and 67-69 are currently active.

In view of the foregoing amendments, it is respectfully requested that the outstanding rejections and objections to this application be reconsidered and withdrawn, and Claims 1, 5-7, 11, 20-23, 26-28, 43, 46, 62, 64, 65 and 67-69, now in this application be allowed.

Respectfully submitted,

ARTHUR R. HAIR

By Ansel Schwartz

Ansel M. Schwartz, Esquire

Reg. No. 30,587

425 N. Craig Street

Suite 301

Pittsburgh, PA 15213

(412) 621-9222

Attorney for Applicant

BAR CODE LABEL



U.S. PATENT APPLICATION

SERIAL NUMBER

08/607,648

FILING DATE

02/27/96

CLASS

395

GROUP ART UNIT

2413

APPLICANT

ARTHUR R. HAIR, UPPER ST. CLAIR, PA.

****CONTINUING DATA*******

VERIFIED	THIS APPLN IS A CON OF	08/023,398	02/26/93	
	WHICH IS A CON OF	07/586,391	09/18/90	PAT 5,191,573
	WHICH IS A CON OF	07/206,497	06/13/88	

****FOREIGN/PCT APPLICATIONS*******

VERIFIED

FOREIGN FILING LICENSE GRANTED 03/27/96

***** SMALL ENTITY *****

STATE OR COUNTRY

PA

SHEETS DRAWING

2

TOTAL CLAIMS

20

INDEPENDENT CLAIMS

5

FILING FEE RECEIVED

\$453.00

ATTORNEY DOCKET NO.

HAIR-1CONTII

ADDRESS

ANSEL M SCHWARTZ
SUITE 301
425 N CRAIG STREET
PITTSBURGH PA 15213

TITLE

SYSTEM FOR TRANSMITTING DESIRED DIGITAL VIDEO OR AUDIO SIGNALS

This is to certify that annexed hereto is a true copy from the records of the United States Patent and Trademark Office of the application which is identified above.

By authority of the
COMMISSIONER OF PATENTS AND TRADEMARKS

Date

Certifying Officer

PATENT APPLICATION SERIAL NO. **08/607648**

U.S. DEPARTMENT OF COMMERCE
PATENT AND TRADEMARK OFFICE
FEE RECORD SHEET

200 JH 03/13/96 08607648
1 201 453.00 CK

PTO-1556
(5/87)

BEST AVAILABLE COPY

BEST AVAILABLE COPY

PATENT APPLICATION FEE DETERMINATION RECORD Effective October 1, 1995	Application or Docket Number 607648
---	---

CLAIMS AS FILED - PART I		
	(Column 1)	(Column 2)
FOR	NUMBER FILED	NUMBER EXTRA
BASIC FEE		
TOTAL CLAIMS	20	minus 20 = *
INDEPENDENT CLAIMS	5	minus 3 = * 2
MULTIPLE DEPENDENT CLAIM PRESENT		

* If the difference in column 1 is less than zero, enter "0" in column 2

SMALL ENTITY		OR	OTHER THAN SMALL ENTITY	
RATE	FEE		RATE	FEE
	375.00	OR		750.00
x\$11=		OR	x\$22=	
x39=	78	OR	x78=	
+125=		OR	+250=	
TOTAL	453	OR	TOTAL	

CLAIMS AS AMENDED - PART II				
	(Column 1)	(Column 2)	(Column 3)	
AMENDMENT A	CLAIMS REMAINING AFTER AMENDMENT	MINUS	HIGHEST NUMBER PREVIOUSLY PAID FOR	PRESENT EXTRA
Total	23	Minus	** 20	= 3
Independent	* 7	Minus	*** 5	= 2
FIRST PRESENTATION OF MULTIPLE DEPENDENT CLAIM				

SMALL ENTITY		OR	OTHER THAN SMALL ENTITY	
RATE	ADDITIONAL FEE		RATE	ADDITIONAL FEE
x\$11=		OR	x\$22=	
x39=		OR	x78=	
+125=		OR	+250=	
TOTAL ADDIT. FEE		OR	TOTAL ADDIT. FEE	

	(Column 1)	(Column 2)	(Column 3)	
AMENDMENT B	CLAIMS REMAINING AFTER AMENDMENT	MINUS	HIGHEST NUMBER PREVIOUSLY PAID FOR	PRESENT EXTRA
Total	* 37	Minus	**	=
Independent	*	Minus	***	=
FIRST PRESENTATION OF MULTIPLE DEPENDENT CLAIM				

RATE	ADDITIONAL FEE	OR	RATE	ADDITIONAL FEE
x\$11=		OR	x\$22=	
x39=		OR	x78=	50
+125=		OR	+250=	
TOTAL ADDIT. FEE		OR	TOTAL ADDIT. FEE	

	(Column 1)	(Column 2)	(Column 3)	
AMENDMENT C	CLAIMS REMAINING AFTER AMENDMENT	MINUS	HIGHEST NUMBER PREVIOUSLY PAID FOR	PRESENT EXTRA
Total	*	Minus	**	=
Independent	*	Minus	***	=
FIRST PRESENTATION OF MULTIPLE DEPENDENT CLAIM				

RATE	ADDITIONAL FEE	OR	RATE	ADDITIONAL FEE
x\$11=		OR	x\$22=	
x39=		OR	x78=	
+125=		OR	+250=	
TOTAL ADDIT. FEE		OR	TOTAL ADDIT. FEE	

* If the entry in column 1 is less than the entry in column 2, write "0" in column 3.
 ** If the "Highest Number Previously Paid For" IN THIS SPACE is less than 20, enter "20."
 *** If the "Highest Number Previously Paid For" IN THIS SPACE is less than 3, enter "3."
 The "Highest Number Previously Paid For" (Total or Independent) is the highest number found in the appropriate box in column 1.

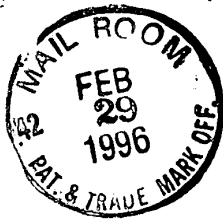

190 216

Attorney's Docket No. HAIR-1 CONT II

PATENT

IN THE UNITED STATES PATENT AND TRADEMARK OFFICE

In re application of: Arthur R. Hair

Application No.: 08 / 023,398 Group No.: 2313
Filed: February 26, 1993 Examiner: H. Nguyen

For: A SYSTEM FOR TRANSMITTING DESIRED DIGITAL VIDEO OR AUDIO SIGNALS

#17

Commissioner of Patents and Trademarks
Washington, D.C. 20231

PETITION AND FEE FOR EXTENSION OF TIME (37 CFR 1.136(a))

1. This is a petition for an extension of the time for a total period of TWO months to respond to Office Action

(indicate matter being extended)

NOTE: "Extensions of Time in Patent Cases (Supplement Amendments)—If a timely and complete response has been filed after a Non-Final Office Action, an extension of time is not required to permit filing and/or entry of an additional amendment after expiration of the shortened statutory period.

"If a timely response has been filed after a Final Office Action, an extension of time is required to permit filing and/or entry of a Notice of Appeal or filing and/or entry of an additional amendment after expiration of the shortened statutory period unless the timely-filed response placed the application in condition for allowance. Of course, if a Notice of Appeal has been filed within the shortened statutory period, the period has ceased to run." Notice of December 10, 1985 (1061 O.G. 34-35).

NOTE: See 37 CFR 1.645 for extensions of time in interference proceedings and 37 CFR 1.550(c) for extensions of time in reexamination proceedings.

2. A response in connection with the matter for which this extension is requested:

- is filed herewith.
- has been filed.

RECEIVED
96 MAR 14 AM 6:11
GROUP: 240

CERTIFICATE OF MAILING/TRANSMISSION (37 CFR 1.8(a))

I hereby certify that this correspondence is, on the date shown below, being:

MAILING

FACSIMILE

deposited with the United States Postal Service with sufficient postage as first class mail, in an envelope addressed to the Commissioner of Patents and Trademarks, Washington, D.C. 20231.

transmitted by facsimile to the Patent and Trademark Office.

Date: 2/27/96

Tracey L. Milka
Signature
Tracey L. Milka
(type or print name of person certifying)

300 SC 03/11/96 08023398

(Petition and Fee for Extension of Time (37 CFR 1.136(a)) [11-2]—page 1 of 3)

(complete the following, if applicable)

NOTE: The PTO accepts the filing of a continuing application as a response under 37 CFR 1.136 and 1.137. To facilitate processing in such a case, the petition for extension of time should specifically refer to the filing of a continuing application and also include an express abandonment of the prior application conditioned upon the granting of the petition and the granting of a filing date to the continuing application. Notice of May 13, 1983, 1031 O.G. 11-12.

- The response is the filing of a continuation application having an express abandonment conditioned on the granting of a filing date to the continuing application.

3. Applicant is

- a small entity. A verified statement:
 is attached.
 was already filed.
 other than a small entity.

4. Calculation of extension fee (37 CFR 1.17(a)-(d)):

<u>Extension</u> <u>(months)</u>	<u>Fee for other than</u> <u>small entity</u>	<u>Fee for</u> <u>small entity</u>
<input type="checkbox"/> one month	\$ 110.00	\$ 55.00
<input checked="" type="checkbox"/> two months	\$ 370.00	\$185.00
<input type="checkbox"/> three months	\$ 870.00	\$435.00
<input type="checkbox"/> four months	\$ 1,360.00	\$680.00

Fee \$ 190.00

If an additional extension of time is required, please consider this a petition therefor.

(check and complete the next item, if applicable)

- An extension for _____ months has already been secured and the fee paid therefor of \$_____ is deducted from the total fee due for the total months of extension now requested.

Extension fee due with this request \$ 190.00

5. Extended period for response

Based on the extension requested in this petition (and that for which a previous petition has been filed, if any), the extended period for response will expire on 2/27/96
(date)

6. Fee Payment

NOTE: *If there is a fee deficiency and there is no authorization to charge an account, additional fees are necessary to cover the additional time consumed in making up the original deficiency. If the maximum, six-month period has expired before the deficiency is noted and corrected, the application is held abandoned. In those instances where authorization to charge is included, processing delays are encountered in returning the papers to the PTO Finance Branch in order to apply these charges prior to action on the cases. Authorization to charge the deposit account for any fee deficiency should be checked. See the Notice of April 7, 1986; 1065 O.G. 31-33.*

- Attached is a check in the sum of \$ 190.00.
- Charge Account 19-0737 for any additional extension and/or fee required or credit for any excess fee paid.
- Charge fee to Account No. _____ This is a request to charge for any additional extension and/or fee required or credit for any excess fee paid.

A duplicate copy of this petition is attached.



SIGNATURE OF ATTORNEY

Reg. No.: 30,587

Ansel M. Schwartz

(type or print name of attorney)

Tel. No.: (412) 621-9222

425 N. Craig Street

P.O. Address
Suite 301
Pittsburgh, PA 15213

DS



**UNITED STATES DEPARTMENT OF COMMERCE
Patent and Trademark Office**

Address : COMMISSIONER OF PATENTS AND TRADEMARKS
Washington, D.C. 20231

SERIAL NUMBER	FILING DATE	FIRST NAMED APPLICANT	ATTORNEY DOCKET NO.
08/023,398	02/26/93	HAIR	A HAIR-1CONT II

24M1/0416

ANSEL M. SCHWARTZ
425 N. CRAIG STREET, SUITE 301
PITTSBURGH, PA 15213

NGUYEN, EXAMINER	
ART UNIT	PAPER NUMBER
2413	18

DATE MAILED: 04/16/96

NOTICE OF ABANDONMENT

This application is abandoned in view of:

- Applicant's failure to respond to the Office letter, mailed 6/28/95.
- Applicant's letter of express abandonment which is in compliance with 37 C.F.R. 1.138.
- Applicant's failure to timely file the response received _____ within the period set in the Office letter.
- Applicant's failure to pay the required issue fee within the statutory period of 3 months from the mailing date of _____ of the Notice of Allowance.
 - The issue fee was received on _____.
 - The issue fee has not been received in Allowed Files Branch as of _____.

In accordance with 35 U.S.C. 151, and under the provisions of 37 C.F.R. 1.316(b), applicant(s) may petition the Commissioner to accept the delayed payment of the issue fee if the delay in payment was unavoidable. The petition must be accompanied by the issue fee, unless it has been previously submitted, in the amount specified by 37 C.F.R. 1.17 (l), and a verified showing as to the causes of the delay.

If applicant(s) never received the Notice of Allowance, a petition for a new Notice of Allowance and withdrawal of the holding of abandonment may be appropriate in view of Delgar Inc. v. Schuyler, 172 U.S.P.Q. 513.

- Applicant's failure to timely correct the drawings and/or submit new or substitute formal drawings by _____ as required in the last Office action.
 - The corrected and/or substitute drawings were received on _____.

6. The reason(s) below.

abandoned in light of filing FWC 08/607, 648

HOA T. NGUYEN
PRIMARY EXAMINER
GROUP 2400



UNITED STATES DEPARTMENT OF COMMERCE
Patent and Trademark Office

Address: COMMISSIONER OF PATENTS AND TRADEMARKS
Washington, D.C. 20231

SERIAL NUMBER	FILING DATE	FIRST NAMED APPLICANT	ATTORNEY DOCKET NO.
08/607648	2/27/95	Hair	Hair-CONTIi

EXAMINER	
ART UNIT	PAPER NUMBER
2413	21

DATE MAILED:

EXAMINER INTERVIEW SUMMARY RECORD

All participants (applicant, applicant's representative, PTO personnel):

- (1) Mr. Ansel Schwartz (3) Hoa Nguyen (PTO)
 (2) Mr. Arthur Hair (4) _____

Date of interview 5/7/95

Type: Telephonic Personal (copy is given to applicant applicant's representative).

Exhibit shown or demonstration conducted: Yes No. If yes, brief description: _____

Agreement was reached with respect to some or all of the claims in question. was not reached.

Claims discussed: _____

Identification of prior art discussed: _____

Description of the general nature of what was agreed to if an agreement was reached, or any other comments: Clarifications were made regarding 12 issues raised in the final office action including how to overcome these issues - Applicant will submit a preliminary amendment in approximately two weeks.

(A fuller description, if necessary, and a copy of the amendments, if available, which the examiner agreed would render the claims allowable must be attached. Also, where no copy of the amendments which would render the claims allowable is available, a summary thereof must be attached.)

Unless the paragraphs below have been checked to indicate to the contrary, A FORMAL WRITTEN RESPONSE TO THE LAST OFFICE ACTION IS NOT WAIVED AND MUST INCLUDE THE SUBSTANCE OF THE INTERVIEW (e.g., items 1-7 on the reverse side of this form). If a response to the last Office action has already been filed, then applicant is given one month from this interview date to provide a statement of the substance of the interview.

- It is not necessary for applicant to provide a separate record of the substance of the interview.
- Since the examiner's interview summary above (including any attachments) reflects a complete response to each of the objections, rejections and requirements that may be present in the last Office action, and since the claims are now allowable, this completed form is considered to fulfill the response requirements of the last Office action.

[Signature]
Examiner's Signature

forming a connection through telecommunications lines between a first memory of a first party at a first party location and a second memory of a second party at a second party location remote from the first party location, said first memory having a first party hard disk having a plurality of digital video or digital audio signals including coded desired digital video or digital audio signals, and a sales random access memory chip which temporarily stores a replica of the coded desired digital video or digital audio signals purchased by the second party for subsequent transfer via telecommunications lines to the second memory of the second party;

HL

telephoning the first party controlling use of the first memory by the second party;

GI cont.

providing a credit card number of the second party controlling the second memory to the first party controlling the first memory so the second party is charged money;

electronically coding the coded desired digital video or digital audio signals into a configuration which would prevent unauthorized reproduction of the desired digital video or digital audio signals;

storing a replica of the coded desired digital video or digital audio signals from the hard disk into the sales random access memory chip;

Page 3 is
missing
file.

party hard disk to the playback random access memory chip for playback and, playing the desired digital video or digital audio signals from the second party hard disk.

Cancel Claim 7.

4/8. (Fourth Amended) A system for transferring digital video or digital audio signals comprising:

a first party control unit having a first party hard disk having a plurality of digital video or digital audio signals which include desired digital video or digital audio signals, a sales random access memory chip electronically connected to the first party hard disk for storing a replica of the desired digital video or digital audio signals of the first party's hard disk to be transferred from the first party control unit, and means for electronically selling the desired digital video or digital audio signals;

a second party control unit having a second party control panel, a second memory connected to the second party control panel, and means for playing the desired digital video or digital audio signals connected to the second memory and the second party control panel, said means for playing operatively controlled by the second party control panel, said second party control unit remote from the first party control unit, said second party control unit placed by the second party at a location determined by the second party; and

telecommunications lines connected to the first party control unit and the second party control unit through which the electronic sales of the desired digital video or digital audio signals occur and through which the desired digital video or digital audio signals are electronically transferred from the [first party hard disk] sales random access memory chip to the second memory while the second memory is in possession and control of the second party and after the desired digital video or digital audio signals are sold to the second party by the first party.

G3
concl.

11. A system as described in Claim 9 wherein the second party control unit includes a second party hard disk which stores the desired [a plurality of] digital video or digital audio signals, and a playback random access memory chip electronically connected to the second party hard disk for storing a replica of the desired digital video or digital audio signals of the second party hard disk as a temporary staging area for playback.

11 ~~17~~. (Fourth Amended) A system for transmitting desired digital video or digital audio signals stored on a first memory of a first party to a second memory of a second party comprising:

G5

[first party controlling use and in possession of] a first memory in possession and control of the first party;

130

[second party controlling use and in possession of] a second memory in possession and control of the second party, [where in] said second memory is at a location remote from said first memory;

telecommunications lines;

means or a mechanism for transferring money electronically via the telecommunications lines from the second party controlling use and in possession of the second memory to the first party controlling use and in possession of the first memory;

means or a mechanism for connecting electronically via the telecommunications lines the first memory with the second memory such that the desired digital video or digital audio signals can pass therebetween, said connecting means or mechanism in electrical communication with the transferring means or mechanism, said connecting means or mechanism comprises a first control unit[, the first party] in possession and control of the first party [control unit], and a second control unit[, said second party] in possession and control of the second party [control unit], said first control unit comprises a first control panel, first control integrated circuit and a sales random access memory, said sales random access memory and said first control panel in electrical communication with said first control integrated circuit, said second control unit comprising a second control panel, a second control integrated circuit, an incoming random access memory and a playback random access memory, said second control panel, said incoming random access

Q5
cont.

31

memory and said playback random access memory in electrical communication with said second control integrated circuit;

means or a mechanism for transmitting the desired digital video or digital audio signals from the first memory to the second memory, said means or mechanism for transmitting comprising a transmitter connected to the first memory and the telecommunications lines and a receiver connected to the second memory, the transmitter and the telecommunications lines, said first party in control and possession of the transmitter, said second party in control and possession of the receiver, said receiver remote from said transmitter and said receiver at a location determined by the second party, said transmitting means or mechanism in electrical communication with said connecting means or mechanism;

Q5
concl.

and
means or a mechanism for storing the desired digital video or digital audio signals from the first memory in the second memory, said storing means or mechanism in electrical communication with said receiver of said transmitting means or mechanism and with said second memory.

23. (Fourth Amended) A system for transmitting desired digital video or digital audio signals stored on a first memory of a first party at a first party location to a second memory of a second party at a second party location comprising:

34
32

[first party controlling use and in possession of] a first memory in possession and control of the first party;

HA
[second party controlling use and in possession of] a second memory in possession and control of the second party, wherein said second memory is at a location remote from said first memory;

telecommunications lines;

GLB cont.
means or a mechanism for the first party to charge a fee to the second party and provide access to the desired digital video or digital audio signals at a location remote from the second party location, said first party controlling use of the first memory, said second party controlling use and in possession of the second memory, said means or mechanism for the first party to charge a fee includes means or a mechanism for transferring money electronically from the second party via telecommunications lines to the first party at a location remote from the second memory at the second party location;

means or a mechanism for connecting electronically via telecommunications lines the first memory with the second memory such that the desired digital video or digital audio signals can pass therebetween, said connecting means or mechanism in electrical communication with the transferring means or mechanism, said connecting means or mechanism comprises a first control unit and a second control unit remote from said first

control unit, said first party in possession and control of the first control unit, said second party in possession and control of the second control unit, said first control unit comprises a first control panel, first control integrated circuit, a first hard disk in which the desired digital video and digital audio signals are stored, and a sales random access memory connected to the first memory for storing a replica of the desired digital video or digital audio signals to be transmitted from the first control unit, said sales random access memory, said first hard disk and said first control panel in electrical communication with said first control integrated circuit, said first hard disk and said sales random access memory comprising the first memory, said second control unit comprising a second control panel, a second control integrated circuit, an incoming random access memory which stores the desired digital video or digital audio signals transmitted from the sales random access memory, and a playback random access memory connected to the incoming random access memory for storing a replica of the desired digital video signals or digital audio signals to be played, said second control panel, said incoming random access memory and said playback random access memory in electrical communication with said second control integrated circuit, said incoming random access memory and said playback random access memory together comprising said second memory;

means or a mechanism for transmitting the desired digital video or digital audio signals from the sales random access memory [first memory] to the incoming random access memory [second memory], said means or mechanism for transmitting comprising a transmitter connected to the [first memory] sales random access memory and the

telecommunications lines and a receiver connected to the incoming random access memory [second memory], the transmitter and the telecommunications lines, said first party in control and possession of the transmitter, said second party in control and possession of the receiver, said receiver remote from said transmitter, and said receiver at the second party location determined by the second party, said transmitting means or mechanism in electrical communication with said connecting means or mechanism; and

Handwritten: *concl.*

means or a mechanism for storing the desired digital video or digital audio signals from the [first memory] sales random access memory in the incoming random access memory [second memory], said storing means or mechanism in electrical communication with said receiver of said transmitting means or mechanism and with said sales random access memory [second memory].

1943. (Thrice Amended) A system for transferring digital video signals

comprising:

[a first party controlling use and in possession of] a first party control unit in possession and control of a first party;

Handwritten: *GM*

[a second party controlling use and in possession of] a second party control unit in possession and control of the second party, wherein said second party control unit is at a location remote from said first party control unit;

Handwritten: *33*

H
[a] said first party control unit having a first memory having a plurality of desired individual video selections as desired digital video signals, ^{said} a first party control unit which includes a first party hard disk having the plurality of digital video signals which include desired digital video signals, and a sales random access memory chip electronically connected to the first party hard disk for storing a replica of the desired digital video signals of the first party's hard disk to be transferred from the first party control unit, and means or a mechanism for the first party to charge a fee to the second party for access to the desired digital video signals of the first party's hard disk at a location remote from the second party location;

Q7 cont.
a second party control unit having a second party control panel, a receiver and a video display for playing the desired digital video signals received by the receiver, said second party control panel connected to the video display and the receiver, said receiver and video display operatively controlled by the second party control panel, said second party control unit remote from the first party control unit, said second party control unit placed by the second party at a second party location determined by the second party which is remote from said first party control unit, said second party choosing the desired digital video signals from the first party's hard disk with said second party control panel, said second party control unit includes a second memory which is connected to the receiver and the video display, said second memory storing the desired digital video signals that are received by the receiver to provide the video display with the desired digital video signals from the sales random access memory chip [of the first party's hard disk]; and

34

GM
cancel.

telecommunications lines connected to the first party control unit and the second party control unit through which the desired digital video signals are electronically transferred from the [first memory] sales random access memory chip to the receiver while the second party control unit is in possession and control of the second party after the desired digital video signals are sold to the second party by the first party.

2462. (Thrice Amended) A system for transferring digital audio signals

comprising:

GS

[a first party controlling use and in possession of] a first party control unit in possession and control of a first party, and [a second party controlling use and in possession of] a second party control unit in possession and control of a second party, wherein said second party control unit is at a second party location remote from the first party control unit, said first party control unit for controlling and transferring digital audio signals, said first party control unit having a first party hard disk having a plurality of digital audio signals which include a plurality of desired individual songs as desired digital audio signals, said first party control unit having a sales random access memory chip electronically connected to the first party hard disk for storing a replica of the desired digital audio signals of the first party's hard disk to be transferred from the first party control unit, means or mechanism for transmitting the desired digital audio signals [of the first party's hard disk to the second party control unit] from the sales random access memory chip, said means or mechanism for transferring connected to the sales random access memory chip, and said first party control

35

unit having means or a mechanism for the first party to charge a fee to the second party to provide the second party access to the desired digital audio signals of the first party's hard disk, said means or mechanism for the first party to charge a fee to the second party remote from the second party location;

said second party control unit having a second party control panel, a second memory for storing the desired digital audio signals from the sales random access memory chip, a receiver connected to the second party control panel and speakers connected to the receiver for playing the desired digital audio signals in the second memory [of the first party's hard disk], said second party control panel connected to the receiver, said receiver and speakers operatively controlled by the second party control panel, said second party control unit placed by the second party at a second party location determined by the second party which is remote from said first party control unit, said second party choosing the desired digital audio signals from the first party's hard disk with said second party control panel, said [second party control unit includes a] second memory [which is] connected to the receiver and the speakers, said second memory storing the desired digital audio signals [of the first party's hard disk] that are received by the receiver; and

38
cont.

telecommunications lines connected to the first party control unit and the second party control unit through which the desired digital audio signals in the sales random access memory [of the first party's hard disk] are electronically transferred by the means or mechanism for transferring to the receiver while the second party is in possession and control

36

G8
concl.

of the second party control unit and after the desired digital audio signals of the first party's hard disk are sold to the second party by the first party with the means or mechanism for the first party to charge a fee.

~~2869~~. (Twice Amended) A system for transferring digital video or digital audio signals comprising:

G9

a first party control unit having a first party hard disk having a plurality of digital video or digital audio signals which include desired digital video or digital audio signals, a sales random access memory chip electronically connected to the first party hard disk for storing a replica of the desired digital video or digital audio signals of the first party's hard disk to be transferred from the first party control unit, and a mechanism for electronically selling the desired digital video or digital audio signals of the first party's hard disk;

a second party control unit having a second party control panel, a second memory connected to the second party control panel, and a mechanism for playing the desired digital video or digital audio signals connected to the second memory and the second party control panel, said playing mechanism operatively controlled by the second party control panel, said second party control unit remote from the first party control unit, said second party control unit placed by the second party at a location determined by the second party; and

37

telecommunications lines connected to the first party control unit and the second party control unit through which the electronic sales of the desired digital video or digital audio signals occur of the first party's hard disk, and over which the desired digital video or digital audio signals of the first party's hard disk are electronically transferred from the [first party's hard disk] sales random access memory chip to the second memory while the second party is in possession and control of the second memory and after the desired digital video or digital audio signals are sold to the second party by the first party.

G9
concl.

Please add the following claims.

676. A system as described in Claim ~~11~~⁵ wherein the first party control unit includes a first party control integrated circuit which controls and executes commands of the first party and is connected to the first party hard disk, the first party sales random access memory, and the second party control panel through the telecommunications lines; and a first party control panel through which the first party control integrated circuit is programmed and is sent commands and which is connected to the first party control integrated circuit.

H

G10

777. A system as described in Claim ~~76~~⁶ wherein the second party control unit includes a second party control integrated circuit which controls and executes commands of the second party and is connected to the second party hard disk, the playback random access memory, and the first party control integrated circuit through the telecommunications lines,

38

said second party control integrated circuit and said first party control integrated circuit regulate the transfer of the desired digital video or audio signals; and a second party control panel through which the second party control integrated circuit is programmed and is sent commands and which is connected to the second party integrated circuit.

Sub H6
78. A system as described in Claim 77 wherein the second party control unit includes an incoming random access memory chip connected to the second party hard disk and the second party control integrated circuit, and the first party control unit through the telecommunications lines for temporarily storing the desired digital video or audio signals received from the first party's control unit for subsequent storage to the second party hard disk.

G10 cont.
79. A system as described in Claim 78 wherein the second party control unit includes a video display unit connected to the playback random access memory chip and to the second party integrated circuit for displaying the desired digital video or audio signals.

22
~~80~~. A system as described in Claim ~~40~~ *21* wherein the first party control unit includes a first party control integrated circuit which controls and executes commands of the first party and is connected to the first party hard disk, the first party sales random access memory, and the second party control integrated circuit through the telecommunications lines, said first party control integrated circuit and said second party control integrated circuit regulate the transfer of the desired digital video signals; and a first party control panel

39

through which the first party control integrated circuit is programmed and is sent commands and which is connected to the first party control integrated circuit.

²³
~~81~~. A system as described in Claim ~~80~~²⁰ wherein the second party control unit includes a second party control integrated circuit which controls and executes commands of the second party and is connected to the second party hard disk, the playback random access memory, and the first party control integrated circuit through the telecommunications lines, said second party control integrated circuit and said first party control integrated circuit regulate the transfer of the desired digital video signals; and a second party control panel through which the second party control integrated circuit is programmed and is sent commands and which is connected to the second party integrated circuit.

210
cont

²⁴
~~82~~. A system as described in Claim ~~81~~²³ wherein the second party control unit includes an incoming random access memory chip connected to the second party hard drive and the second party control integrated circuit, and the first party control unit through the telecommunications lines for temporarily storing the desired digital video signals received from the first party's control unit for subsequent storage to the second party hard disk.

²⁵
~~83~~. A system as described in Claim ~~82~~²⁴ wherein the second party control unit includes a video display unit connected to the playback random access memory chip and to the second party integrated circuit for displaying the desired digital video signals.

40

²⁹~~84~~. A system as described in Claim ²⁸~~89~~ wherein the telecommunications lines include telephone lines.

³⁰~~85~~. A system as described in Claim ²⁹~~84~~ wherein the second party control unit includes a second party hard disk which stores a plurality of digital video or audio signals, and a playback random access memory chip electronically connected to the second party hard disk for storing a replica of the desired digital video or audio signals as a temporary staging area for playback.

GI Cont. ³¹~~86~~. A system as described in Claim ³⁰~~85~~ wherein the first party control unit includes a first party control integrated circuit which controls and executes commands of the first party and is connected to the first party hard disk, the first party sales random access memory, and the second party control integrated circuit through the telecommunications lines, said first party control integrated circuit and said second party control integrated circuit regulate the transfer of the desired digital video or audio signals; and a first party control panel through which the first party control integrated circuit is programmed and is sent commands and which is connected to the first party control integrated circuit.

³²~~87~~. A system as described in Claim ³¹~~86~~ wherein the second party control unit includes a second party control integrated circuit which controls and executes commands of the second party and is connected to the second party hard disk, the playback random access memory, and the first party control integrated circuit through the telecommunications lines,

41

said second party control integrated circuit and said first party control integrated circuit regulate the transfer of the desired digital video or audio signals; and a second party control panel through which the second party control integrated circuit is programmed and is sent commands and which is connected to the second party integrated circuit.

Q10
answer

³³
~~88~~. A system as described in Claim ³²~~87~~ wherein the second party control unit includes an incoming random access memory chip connected to the second party hard drive and the second party control integrated circuit, and the first party control unit through the telecommunications lines for temporarily storing the desired digital video or audio signals received from the first party's control unit for subsequent storage to the second party hard disk.

³⁴
~~88~~. A system as described in Claim ³³~~88~~ wherein the second party control unit includes a video display unit connected to the playback random access memory chip and to the second party integrated circuit for displaying the desired digital video or audio signals.

42

REMARKS

Claims 1, 5, 6, 9, 11, 20-23, 26-28, 43, 46, 64, 65, 67-69 and 76-89 are currently active.

Claims 76-89 have been added.

The applicant wishes to thank the Examiner for meeting with the applicant and discussing the rejections under 35 U.S.C. §112 to assist applicant in overcoming this rejection.

The Examiner has rejected Claims 1, 5-7, 9, 11-15, 20-23, 26-28, 43, 46-50, 64-65, 67-75 under 35 U.S.C. §112, second paragraph. Applicant has amended the claims in accordance with the Examiner's comments to obviate this rejection. Claims 12-15 are newly added Claims 76-79; Claims 47-50 are now Claims 80-83; and Claims 70-75 are now Claims 84-89. Claims 12-15, 47-50 and 70-75 were cancelled in the earlier preliminary amendment.

In regard to Claim 1, the Examiner has determined that "the desired digital video or audio signals purchased by the second party" does not have antecedent basis. Applicant has amended Claim 1 to identify the "desired digital video or digital audio signals" as the -- coded desired digital video or digital audio signals -- . The Examiner has also

identified in regard to lines 8-9 that the sales RAM chip is for storing "the desired digital video or audio signals" while lines 18-19 recite that the sales RAM chip stores "the coded desired digital video or digital audio signals". Consequently, these two recitations are not correlated. With the amendments to Claim 1, the sales RAM chip stores "the coded desired digital video or audio signals" in a consistent manner. Additionally, the Examiner questions line 15 where the recitation "the desired digital video or digital audio signals" are identified but are not clear if they refer back to the signals recited on line 7 or lines 8-9. With the amendment of Claim 1, it is clear that "the coded desired digital video or digital audio signals" are now meant to refer back to the "coded desired digital video or digital audio signals".

In regard to Claim 6, the Examiner questions "the desired . . . signals" of lines 2-3. Claim 6 has been amended to refer to "the coded desired . . . signals". Also, the Examiner questions in lines 3-4 that the second hard disk stores the desired signals from the first party hard disk but in lines 8-9 the second hard disk receives the desired . . . signals transferred from the incoming RAM chip. Claim 6 has been amended to be consistent and recite that the second hard disk receives or stores the desired digital video or digital audio signals from the incoming RAM chip. On line 9, the Examiner questions which "desired . . . signals" are meant. Line 9 has been amended to refer to the -- coded -- desired . . . signals. On lines 10-13, the Examiner questions what is meant by the "commanding the second party . . .". Applicant has amended the step of "commanding . . ." to refer instead to -- causing -- to more clearly define applicant's claimed invention.

The Examiner questions what lines 2-3 of Claim 7 mean. Claim 7 has been cancelled.

The Examiner questions in regard to Claim 9, at lines 5-7, that the function of the replica of the desired . . . signals to be stored in the sales RAM is not clear and is not functionality associated and participated within the claimed system. Applicant has amended Claim 9 to identify that the sales random access memory chip is electronically connected to the first party hard disk and is for the purpose of storing a replica of the desired digital video or digital audio signals of the first party's hard disk to be transferred from the first party control unit. Furthermore, at line 19, the "first party hard disk" has been replaced by -- sales random access memory chip -- to more clearly define applicant's claimed invention and the function of the sales random access memory chip in the claimed invention. In this way, it is now clear that the plurality of digital audio or video signals are stored in the first party hard disk, but those desired video or audio signals which are to be transferred from the first party control unit are replicated from the first party hard disk and then stored in the sales random access memory chip so they can be electronically transferred from the sales random access memory chip.

In regard to Claim 11, the Examiner questions what is meant by the "plurality of . . . signals" on lines 2-3. Applicant has amended Claim 11 to refer instead to "the desired . . . signals" instead of "a plurality of . . . signals ". The Examiner also questions

on line 4 -- what the "replica of the desired . . . signals " means. Furthermore, the structural relationship between the second party hard disk and the playback random access memory does not support the functional language" for storing a replica . . . signals". Applicant has amended Claim 11 to refer to the "replica . . . signals" to be of the second party hard disk and not the replica of desired signals from the sales random access memory chip. Thus, it is clear that the desired . . . signals are replicated first from the first party hard disk in the sales random access memory chip in preparation for transfer. Upon transfer, they are received by the second party control unit and stored in the second party hard disk where they can be accumulated with other desired digital . . . signals to, for instance, create a library. When it is desired that the desired . . . signals are to be played, the desired . . . signals of the second party hard disk are replicated in the playback random access memory chip so they are ready for playback.

In regard to Claim 12 which is now Claim 76, the Examiner identifies that "the second party control integrated circuit" does not have clear antecedent basis. Applicant has amended Claim 12 as Claim 76 to have the limitation of a -- second party control panel -- instead of a "second party control integrated circuit". The second party control panel finds antecedent basis in Claim 9 from which Claim 76 depends. Additionally, the Examiner questions on lines 6-7 that the structural relationship as recited does not support the functional language "said first party control integrated circuit and said second party control integrated circuit regulating the transfer of the desired . . . signals". Applicant has amended Claim 12 as Claim 76 and has deleted this limitation.

The Examiner has identified in Claim 14, line 2 -- rate that "the second party hard drive" does not have antecedent basis. Applicant has amended Claim 14 as Claim 78 to refer to "the second party hard disk" which does have antecedent basis.

In regard to Claim 17, the Examiner questions in lines 4-5 how the first party and the second party can be claimed since they are not part of a transmitting system. Applicant has amended Claim 14 to affirmatively claim a first memory -- in possession and control of the first party -- and to affirmatively claim a second memory -- in position in control of the second party -- . The first party and the second party are not claimed as part of the transmitting system in Claim 17, as amended. The Examiner also questions in lines 17-18 what the "first party in possession and control of the first control unit, and . . . unit " means. Applicant has amended Claim 17 at lines 17-18 to be clear that it is the first control unit which is in possession and control of the first party, and a second control unit which is in position and control of the second party.

The Examiner also questions Claims 23, 43, 62, 69 because of substantially similar problems that have been mentioned by the examiner already. In regard to Claim 23, it has been amended similarly to Claim 17. In regard to Claim 43, it has been amended similarly to Claim 17. In regard to Claim 62, it has been amended similarly to Claim 17. In regard to Claim 69, it has been amended similarly to Claim 9.

Accordingly, applicant has attempted to amend the claims consistent with applicant's understanding of the Examiner's comments in the Office Action and from the Examiner's interview with the applicant. If applicant has misunderstood the Examiner's comments in some way, applicant is most receptive to the Examiner pointing out or calling applicant's attorney and informing applicant where applicant has erred, and applicant will be glad to correct applicant's mistake.

In view of the foregoing amendments and remarks, it is respectfully requested that the outstanding rejections and objections to this application be reconsidered and withdrawn, and Claims 1, 5, 6, 9, 11, 20-23, 26-28, 43, 46, 64, 65, 67-69 and 76-89, now in this application be allowed.

Respectfully submitted,

ARTHUR R. HAIR

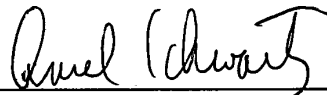
By 

Ansel M. Schwartz, Esquire
Reg. No. 30,587
425 N. Craig Street
Suite 301
Pittsburgh, PA 15213
(412) 621-9222

Attorney for Applicant

102-132

Attorney's Docket No. HAIR-1 CONT IIA

PATENT

IN THE UNITED STATES PATENT AND TRADEMARK OFFICE

In re application of: Arthur R. Hair

Serial No.: 0 8 / 607,648 Group No.: 2413
Filed: February 27, 1996 Examiner: H. Nguyen
For: A SYSTEM FOR TRANSMITTING DESIRED DIGITAL
 VIDEO OR AUDIO SIGNALS

Assistant Commissioner for Patents
Washington, D.C. 20231

1996 MAY 21 AM 10:33
GROUP 240

AMENDMENT TRANSMITTAL

- 1. Transmitted herewith is an amendment for this application.

STATUS

- 2. Applicant is
 a small entity. A verified statement:
 is attached.
 was already filed.
 other than a small entity.

CERTIFICATE OF MAILING/TRANSMISSION (37 CFR 1.8a)

I hereby certify that this correspondence is, on the date shown below, being:

MAILING

deposited with the United States Postal Service with sufficient postage as first class mail in an envelope addressed to the Assistant Commissioner for Patents, Washington, D.C. 20231.

FACSIMILE

transmitted by facsimile to the Patent and Trademark Office.

Date: _____

Signature

230 EK 05/24/96 0860744R

(type or print name of person certifying)

(Amendment Transmittal [9-19]-page 1 of 4)

EXTENSION OF TERM

NOTE: "Extension of Time in Patent Cases (Supplement Amendments) — If a timely and complete response has been filed after a Non-Final Office Action, an extension of time is not required to permit filing and/or entry of an additional amendment after expiration of the shortened statutory period.

If a timely response has been filed after a Final Office Action, an extension of time is required to permit filing and/or entry of a Notice of Appeal or filing and/or entry of an additional amendment after expiration of the shortened statutory period unless the timely-filed response placed the application in condition for allowance. Of course, if a Notice of Appeal has been filed within the shortened statutory period, the period has ceased to run." Notice of December 10, 1985 (1061 O.G. 34-35).

NOTE: See 37 CFR 1.645 for extensions of time in interference proceedings, and 37 CFR 1.550(c) for extensions of time in reexamination proceedings.

3. The proceedings herein are for a patent application and the provisions of 37 CFR 1.136 apply.

(complete (a) or (b), as applicable)

- (a) Applicant petitions for an extension of time under 37 CFR 1.136 (fees: 37 CFR 1.17(a)-(d) for the total number of months checked below:

Extension (months)	Fee for other than <u>small entity</u>	Fee for <u>small entity</u>
<input type="checkbox"/> one month	\$ 110.00	\$ 55.00
<input type="checkbox"/> two months	\$ 380.00	\$190.00
<input type="checkbox"/> three months	\$ 900.00	\$450.00
<input type="checkbox"/> four months	\$1,400.00	\$700.00

Fee \$ _____

If an additional extension of time is required, please consider this a petition therefor.

(check and complete the next item, if applicable)

- An extension for _____ months has already been secured and the fee paid therefor of \$_____ is deducted from the total fee due for the total months of extension now requested.

Extension fee due with this request \$ _____

OR

- (b) Applicant believes that no extension of term is required. However, this conditional petition is being made to provide for the possibility that applicant has inadvertently overlooked the need for a petition for extension of time.

FEE FOR CLAIMS

4. The fee for claims (37 CFR 1.16(b)-(d)) has been calculated as shown below:

	(Col. 1)		(Col. 2)		(Col. 3)	SMALL ENTITY	OTHER THAN A SMALL ENTITY	
	CLAIMS REMAINING AFTER AMENDMENT		HIGHEST NO PREVIOUSLY PAID FOR		PRESENT EXTRA	RATE	ADDIT. FEE	
							OR RATE	
							ADDIT. FEE	
TOTAL	32	MINUS	20	=	12	x11= \$	132.00	x22= \$
INDEP.	7	MINUS	7	=	0	x39= \$	0.00	x78= \$
<input type="checkbox"/> FIRST PRESENTATION OF MULTIPLE DEP. CLAIM						+125= \$		+250= \$
						TOTAL	OR	TOTAL
						ADDIT. FEE \$	132.00	ADDIT. FEE \$

- * If the entry in Col. 1 is less than entry in Col. 2, write "0" in Col. 3.
 - ** If the "Highest No. Previously Paid for" IN THIS SPACE is less than 20, enter "20".
 - *** If the "Highest No. Previously Paid For" IN THIS SPACE is less than 3, enter "3".
- The "Highest No. Previously Paid For" (Total or indep.) is the highest number found in the appropriate box in Col. 1 of a prior amendment or the number of claims originally filed.

WARNING: "After final rejection or action (§ 1.113) amendments may be made cancelling claims or complying with any requirement of form which has been made." 37 CFR § 1.116(a) (emphasis added).

(complete (c) or (d), as applicable)

(c) No additional fee for claims is required.

OR

(d) Total additional fee for claims required \$ 132.00.

FEE PAYMENT

5. Attached is a check in the sum of \$ 132.00.
- Charge Account No. _____ the sum of \$ _____.
- A duplicate of this transmittal is attached.

FEE DEFICIENCY

NOTE: If there is a fee deficiency and there is no authorization to charge an account, additional fees are necessary to cover the additional time consumed in making up the original deficiency. If the maximum, six-month period has expired before the deficiency is noted and corrected, the application is held abandoned. In those instances where authorization to charge is included, processing delays are encountered in returning the papers to the PTO Finance Branch in order to apply these charges prior to action on the cases. Authorization to charge the deposit account for any fee deficiency should be checked. See the Notice of April 7, 1986, (1065 O.G. 31-33).

6. If any additional extension and/or fee is required, charge Account No. 19-0737.

AND/OR

- If any additional fee for claims is required, charge Account No. 19-0737.



SIGNATURE OF ATTORNEY

Reg. No.: 30,587

Tel. No.: (412) 621-9222

Ansel M. Schwartz

(type or print name of attorney)

425 N. Craig Street

Suite 301

P.O. Address

Pittsburgh, PA 15213



UNITED STATES DEPARTMENT OF COMMERCE
Patent and Trademark Office
 Address: COMMISSIONER OF PATENTS AND TRADEMARKS
 Washington, D.C. 20531

DS

SERIAL NUMBER FILING DATE FIRST NAMED INVENTOR ATTORNEY DOCKET NO.

08/607,648 02/27/96 HAIR

A HAIR-1CONTII

EXAMINER

NGUYEN, H

24M1/0610

ART UNIT PAPER NUMBER

23

ANSEL M SCHWARTZ
 SUITE 301
 425 N CRAIG STREET
 PITTSBURGH PA 15213

2413

DATE MAILED: 06/10/96

This is a communication from the examiner in charge of your application.
 COMMISSIONER OF PATENTS AND TRADEMARKS

This application has been examined Responsive to communication filed on 5/21/96 This action is made final.

A shortened statutory period for response to this action is set to expire 3 month(s), _____ days from the date of this letter.
 Failure to respond within the period for response will cause the application to become abandoned. 35 U.S.C. 133

Part I THE FOLLOWING ATTACHMENT(S) ARE PART OF THIS ACTION:

- 1. Notice of References Cited by Examiner, PTO-892.
- 2. Notice of Draftsman's Patent Drawing Review, PTO-948.
- 3. Notice of Art Cited by Applicant, PTO-1449.
- 4. Notice of Informal Patent Application, PTO-152.
- 5. Information on How to Effect Drawing Changes, PTO-1474.
- 6. _____

Part II SUMMARY OF ACTION

1. Claims 1, 5-6, 9, 11, 17, 20-23, 26-28, 43, 46, 62, 64-65, 67-69, 76-89 are pending in the application.

Of the above, claims _____ are withdrawn from consideration.

2. Claims 2-4, 7-8, 10, 12-16, 18-19, 24-25, 27-42, 44-45, 47-60, 63, 66, 70-75 have been cancelled.

3. Claims 17, 20-22, 55, 9, 64, 62, 68, 69, 84-89 are allowed.

4. Claims 1, 5, 6, 11, 76-79, 23, 26-28, 43, 67, 46, 80-83 are rejected.

5. Claims _____ are objected to.

6. Claims _____ are subject to restriction or election requirement.

7. This application has been filed with informal drawings under 37 C.F.R. 1.85 which are acceptable for examination purposes.

8. Formal drawings are required in response to this Office action.

9. The corrected or substitute drawings have been received on _____. Under 37 C.F.R. 1.84 these drawings are acceptable; not acceptable (see explanation or Notice of Draftsman's Patent Drawing Review, PTO-948).

10. The proposed additional or substitute sheet(s) of drawings, filed on _____, has (have) been approved by the examiner; disapproved by the examiner (see explanation).

11. The proposed drawing correction, filed _____, has been approved; disapproved (see explanation).

12. Acknowledgement is made of the claim for priority under 35 U.S.C. 119. The certified copy has been received not been received been filed in parent application, serial no. _____; filed on _____.

13. Since this application appears to be in condition for allowance except for formal matters, prosecution as to the merits is closed in accordance with the practice under Ex parte Quayle, 1935 C.D. 11; 453 O.G. 213.

14. Other

The preliminary amendment filed on 5/21/96 has been entered into the record. In this amendment it is noticed that claim 11 is made to be dependent on claim 9, however, claim 11 as shown of record was made dependent on claim 63. It is confusing as to if applicant has made a mistake or has meant to amend claim 11 so that the claim is dependent on claim 9. If applicant means to make claim 11 no longer dependent on claim 63 but dependent on claim 9, proper use of underlines and brackets for insertions and deletions must be used. A clarification of this matter is required.

Claims 17, 20-22, 65; 9, 64; 62, 68; 69, 84-89; are allowable over the prior art of record.

Claims 1, 5-6, 11, 76-79, 23, 26-28, 43, 67, 46, 80-83 are rejected under 35 U.S.C. § 112, second paragraph, as being indefinite for failing to particularly point out and distinctly claim the subject matter which applicant regards as the invention.

Claim 1:

In the paragraph starting with "electronically coding the coded", it appears that "coding the coded desired digital video..." is misdescriptive. It seems that the coding is performed on the "desired digital video..." not on the "coded desired...". Therefore, it is suggested that "coded" should be deleted out of the phrase, and after "audio signals", --, to form said coded desired digital video or digital audio signals-- should be

inserted.

In the paragraph starting with "transferring the stored replica...", "the first memory" should be --sales random access memory-- to conform with what was relatively set forth in the step of forming... recited previously in the claim.

Claim 6 is dependent on claim 5 which is in turn dependent on claim 1, however, claim 6 when read together with claim 1 is not conformable relatively to the limitation of claim 1.

Claim 11 is confusing in its dependency as mentioned above. If it is meant to be dependent on claim 9, line 1, "party control unit" appears to be --memory--. Line 3, after "audio signals", --transferred from the sales random access memory--. Line 5, after "signals", "of" should be changed to --from--.

Claim 23, in the paragraph starting with "means or a mechanism for connecting electronically via....", lines 6-7, the phrase "said first party in possession and control of the first control unit" and "said second party in possession and control of the second unit" do not make sense. Lines 13-14, "said first hard disk and said sales random access memory comprising the first memory" does not make sense since the memory is an integral part of the RAM and the hard disk not that the hard disk and the RAM are integral parts of the memory. Lines 21-22 contain similar issue to that of lines 13-14. Note claim 27 for references on which elements are considered to the integral parts.

Claim 28, "said second party in possession and control of the

second party" makes no sense.

Claim 43, line 9, "a first party control unit which includes" should be --said first part control unit which includes--.

Claim 76, line 4, ",;" is incorrectly used together.

Claim 78, "the an incoming random access memory chip" should be made clear as to if it is part of or separate from the memory in claim 9.

Claim 79, line 2, it should be made clear as to if the video display unit is part of or separate from the means for displaying recited previously.

Claims which have not been mentioned are rejected because they are dependent on the rejected base claims.

Applicant should review carefully each claim of record for any non-conformation matters between related claims to avoid 112 second paragraph problems. Also, when referring to the video/audio signals it should be formulated in clear language to define the source of origination so that one would be able to clearly understand from which elements of the system the signals are from to avoid misunderstanding.

Claims 1, 5-6, 11, 76-79, 23, 26-28, 43, 67, 46, 80-89 would be allowable if rewritten or amended to overcome the rejection under 35 U.S.C. § 112.

Any inquiry concerning this communication or earlier communications from the examiner should be directed to Hoà Nguyen, whose telephone number is (703) 305-9687. The examiner can normally be reached on Monday through Friday, from 9.30 A.M to 6.00 P.M.

If attempts to reach the examiner by telephone are

Serial No. 08/607648
Art Unit 2413

5

unsuccessful, the examiner's supervisor, Robert Beausoliel, can be reached on (703) 305-9713. The fax phone number for this Group is (703) 305-9724.

Any inquiry of a general nature or relating to the status of this application should be directed to the Group receptionist whose telephone number is (703) 305-3800.

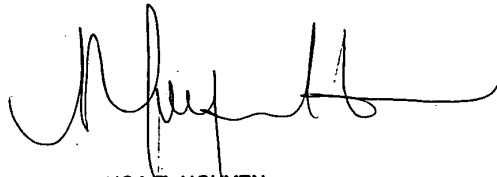

HOA T. NGUYEN
PRIMARY EXAMINER
GROUP 2400



\$ 45 217 P2413

IN THE UNITED STATES PATENT AND TRADEMARK OFFICE

Application of:)
)
 ARTHUR R. HAIR)
)
 Serial No. 08/607,648)
)
 Filed: February 27, 1996)
)
 Art Unit: 2413)
)
 Patent Examiner:)
)
 H. Nguyen)

05/H
APC
12/30

A SYSTEM FOR TRANSMITTING
DESIRED DIGITAL VIDEO OR
AUDIO SIGNALS

330 GL 12/27/96 08607648
1 217 35.00 CK

Pittsburgh, Pennsylvania 15213

December 6, 1996

CERTIFICATE OF MAILING

Assistant Commissioner for Patents
Washington, D.C. 20231

I hereby certify that the correspondence is
being deposited with the United States Postal
Service as first class mail in an envelope
addressed to: Commissioner of Patents and
Trademarks, Washington, DC 20231,
on 12/6/96

Sir:

AMENDMENT

Ansel Schwartz
Ansel M. Schwartz
Registration No. 30,587
12/6/96
Date

In response to the Office Action dated June 10, 1996, please enter the following
amendments to the above-identified application as follows:

IN THE CLAIMS:

1. (Fifth Amended) A method for transferring desired digital video or digital
audio signals comprising the steps of:

411

43

forming a connection through telecommunications lines between a first memory of a first party at a first party location and a second memory of a second party at a second party location remote from the first party location, said first memory having a first party hard disk having a plurality of digital video or digital audio signals including coded desired digital video or digital audio signals, and a sales random access memory chip which temporarily stores a replica of the coded desired digital video or digital audio signals purchased by the second party for subsequent transfer via telecommunications lines to the second memory of the second party;

1
H
telephoning the first party controlling use of the first memory by the second party;

providing a credit card number of the second party controlling the second memory to the first party controlling the first memory so the second party is charged money;

electronically coding the [coded] desired digital video or digital audio signals to form said coded desired digital video or digital audio signals into a configuration which would prevent unauthorized reproduction of the desired digital video or digital audio signals;

storing a replica of the coded desired digital video or digital audio signals from the hard disk into the sales random access memory chip;

transferring the stored replica of the coded desired digital video or digital audio signals from the [first] sales random access memory chip of the first party to the second memory of the second party through telecommunications lines while the second memory is in possession and control of the second party; and

storing the transferred replica of the coded desired digital video or digital audio signals in the second memory.

³/_β. (Thrice Amended) A method as described in Claim ²/_γ wherein the second memory includes an incoming random access memory chip which temporarily stores the coded desired digital video or digital audio signals from the sales random access memory chip, a second party hard disk for storing the coded desired digital video or audio digital signals from the incoming random access memory chip, and a playback random access memory chip for temporarily storing the coded desired digital video or digital audio signals from the first party hard disk for sequential playback; and the storing the transferred replica step includes the steps of storing the coded desired digital video or digital audio signals from the [first party hard disk] sales random access memory chip in the incoming random access memory chip, transferring the desired digital video or digital audio signals from the incoming random access memory chip to the second party hard disk, storing the desired digital video or digital audio signals in the second party hard disk, causing the second party integrated circuit with the second party control panel to play the desired digital video or digital audio signals [for] from

H2
the second party hard disk, transferring a replica of the desired digital video or digital audio signals from the second party hard disk to the playback random access memory chip for playback and, playing the desired digital video or digital audio signals from the second party hard disk.

H3
34. (Second Amended) A system as described in Claim [63] ^{4/} wherein the second [party control unit] memory includes a second party hard disk which stores the desired digital video or digital audio signals transferred from the sales random access memory chip, and a playback random access memory chip electronically connected to the second party hard disk for storing a replica of the desired digital video or digital audio signals [of] from the second party hard disk as a temporary staging area for playback.

H4
¹⁶ 25. (Fifth Amended) A system for transmitting desired digital video or digital audio signals stored on a first memory of a first party at a first party location to a second memory of a second party at a second party location comprising:

a first memory at a first party location, said first memory in possession and control of the first party, said first memory comprising a first party hard disk in which the desired digital video or digital audio signals are stored;

46

a second memory in possession and control of the second party, wherein said second memory is at a second party location remote from said first memory, said second memory comprising a second party hard disk in which the desired digital video or digital audio signals are stored that are received from the first memory and a playback random access memory connected to the second party hard disk;

telecommunications lines;

means or a mechanism for the first party to charge a fee to the second party and provide access to the desired digital video or digital audio signals at [a] the first party location remote from the second party location, said first party controlling use of the first memory, said second party controlling use and in possession of the second memory, said means or mechanism for the first party to charge a fee includes means or a mechanism for transferring money electronically from the second party via telecommunications lines to the first party at [a] the first party location remote from the second memory at the second party location;

means or a mechanism for connecting electronically via telecommunications lines the first memory with the second memory such that the desired digital video or digital audio signals can pass therebetween, said connecting means or mechanism in electrical communication with the transferring means or mechanism, said connecting means or mechanism comprises a first control unit disposed at the first party location and a second

control unit disposed at the second party location remote from said first control unit, [said first party in possession and control of the first control unit, said second party in possession and control of the second control unit,] said first control unit comprises a first control panel, first control integrated circuit[, a first hard disk in which the desired digital video and digital audio signals are stored], and a sales random access memory connected to the first [memory] hard disk for temporarily storing a replica of the desired digital video or digital audio signals to be transmitted from the first control unit, said sales random access memory, said first hard disk and said first control panel in electrical communication with said first control integrated circuit[, said first hard disk and said sales random access memory comprising the first memory], said second control unit comprising a second control panel, a second control integrated circuit, and an incoming random access memory which temporarily stores the desired digital video or digital audio signals transmitted from the sales random access memory, [and a] said playback random access memory connected to the incoming random access memory for temporarily storing a replica of the desired digital video signals or digital audio signals to be played, said incoming random access memory connected to said second party hard disk, said second control panel, said incoming random access memory, said second party hard disk and said playback random access memory in electrical communication with said second control integrated circuit[, said incoming random access memory and said playback random access memory together comprising said second memory];

4/4

48

means or a mechanism for transmitting the desired digital video or digital audio signals from the sales random access memory to the incoming random access memory, said means or mechanism for transmitting comprising a transmitter connected to the sales random access memory and the telecommunications lines and a receiver connected to the incoming random access memory, the transmitter and the telecommunications lines, said first party in control and possession of the transmitter, said second party in control and possession of the receiver, said receiver remote from said transmitter, and said receiver at the second party location determined by the second party, said transmitting means or mechanism in electrical communication with said connecting means or mechanism; and

1/4

means or a mechanism for storing the desired digital video or digital audio signals from the sales random access memory in the incoming random access memory, said storing means or mechanism in electrical communication with said receiver of said transmitting means or mechanism and with said sales random access memory.

Cancel Claim 27.

[

¹⁸28. (Amended) A system as described in Claim [27] ¹⁷~~26~~ including a video display and speakers [in possession and control of the second party, said video display and speakers] in electrical communication with said second control integrated circuit.

1/5

49

Claim 43, line 9, change "a" to -- said -- .

Claim 76, line 4, delete ", " (second occurrence).

h/b
878. (Amended) A system as described in Claim ~~77~~⁷⁸ wherein the second [party control unit] memory includes an incoming random access memory chip connected to the second party hard disk and the second party control integrated circuit, and the first party control unit through the telecommunications lines for temporarily storing the desired digital video or audio signals received from the first party's control unit for subsequent storage to the second party hard disk.

979. (Amended) A system as described in Claim ~~78~~⁸ wherein the [second party control unit] playing means includes a video display unit connected to the playback random access memory chip and to the second party integrated circuit for displaying the desired digital video or audio signals.

REMARKS

Claims 1, 5, 6, 9, 11, 17, 20-23, 26, 28, 43, 46, 62, 64, 65, 67-69 and 76-89 are currently active.

Claim 27 has been cancelled.

Claims 1, 6, 11, 23, 28, 43, 76, 78 and 79 have been amended to overcome rejections under 35 U.S.C. §112. No new matter has been added.

The Examiner has questioned the dependency of Claim 11. Claim 11 depends on Claim 9.

The Examiner has found Claims 17, 20-22, 65; 9, 64; 62, 68; 69, 84-89 allowable.

The Examiner has rejected Claims 1, 5-6, 11, 76-79, 23, 26-28, 43, 67, 26, 18-83 under 35 U.S.C. §112, second paragraph.

In regard to Claim 1, the Examiner has questioned the "coding the coded desired digital video . . ." as misdescriptive. Pursuant to the Examiner's suggestions,

applicant has amended Claim 1 so that "coded" is deleted out of such phrase, and after "audio signals", the limitation -- , to form said coded desired digital video or digital audio signals -- has been inserted in the paragraph beginning with "electronically coding".

In the paragraph starting with "transferring the stored replica . . .", the limitation "the first memory" has been changed to -- sales random access memory -- to conform with what was relatively set forth in the step of forming . . . recited previously in the claim.

The Examiner states Claim 6 is dependant on Claim 5 which is in turn dependant on Claim 1, however, Claim 6 when read together with Claim 1, is not conformable relative to the limitation of Claim 1. Applicant has amended Claim 6 to be conformable with Claim 1 by making it clear that "the incoming random access memory chip temporarily stores the coded desired digital video or digital audio signals from the sales random access memory chip", and the language "first party hard disk" has been replaced with -- sales random access memory chip -- .

The Examiner has found Claim 11 confusing in regard to its dependency. Claim 11, which is dependent on Claim 9, in line 1, the language "party control unit " has been changed to -- memory -- . In line 3, after "audio signals", the limitation -- transferred

from the sales random access memory -- has been added. In line 5, after "signals", "of" has been changed to -- from -- .

The Examiner has determined that in Claim 23, in the paragraph starting with "means or a mechanism for connecting electronically via . . .", lines 6-7, the phrase "said first party in possession and control of the first control unit" and "said second party in possession and control of the second unit" do not make sense. Applicant has deleted this language. The Examiner has also found on lines 13-14, "said first hard disk and said sales random access memory comprising the first memory" does not make sense since the memory is an integral part of the RAM and the hard disk, not that the hard disk and the RAM are integral parts of the memory. Lines 21-22 contain similar issues to that of lines 13-14. Applicant has amended the claims to make it more clear that the first disk is of the first memory, and the second disk and the playback random access memory is of the second memory. These changes to Claim 23 have been carried throughout the claim to make the entire claim consistent. Also, the second control unit has been modified to correctly portray this relationship in regard to the second memory.

Additionally, the Examiner suggests that Claim 27 be referenced in regard to the elements which are considered to be integral parts. Applicant has noted this suggestion. Claim 27 has been cancelled and its limitations brought into Claim 23.

In regard to Claim 28, the Examiner finds that "said second party in possession and control of the second party" makes no sense. Applicant has amended Claim 28 to obviate this concern of the Examiner.

In regard to Claim 43, line 9, it has been amended to now read " -- said first party control unit which includes -- .

Claim 76, line 4 has been amended to correct the grammar as the Examiner points out.

Claim 78 has been amended to make it clear that "an incoming random access memory chip" is part of the second memory of Claim 9.

Claim 79, line 2, has been amended to make it clear that the video display unit is part of the playing means.

Applicant has attempted to review all the claims to make them consistent and correct.

Applicant submits that Claims 1, 5, 6, 11, 76-79, 23, 26, 27, 43, 67,46, 80-89 are now allowable because they have been rewritten or amended to overcome the rejection under 35 U.S.C. §112.

In view of the foregoing amendments and remarks, it is respectfully requested that the outstanding rejections and objections to this application be reconsidered and withdrawn, and Claims 1, 5, 6, 9, 11, 17, 20-23, 26, 28, 43, 46, 62, 64, 65, 67-69 and 76-89, now in this application be allowed.

Respectfully submitted,

ARTHUR R. HAIR

By Ansel Schwartz
Ansel M. Schwartz, Esquire
Reg. No. 30,587
425 N. Craig Street
Suite 301
Pittsburgh, PA 15213
(412) 621-9222

Attorney for Applicant

CERTIFICATE OF MAILING
I hereby certify that the correspondence is being deposited with the United States Postal Service as first class mail in an envelope addressed to: Commissioner of Patents and Trademarks, Washington, DC 20231, on 12/6/96
Ansel Schwartz
Ansel M. Schwartz
Registration No. 30,587
12/6/96
Date



Attorney's Docket No. HAIR-1 CONT IIA

PATENT

24
ALP
12/30

IN THE UNITED STATES PATENT AND TRADEMARK OFFICE

are application of: Arthur R. Hair

Serial No.: 08 /607,648 Group No.: 2413
Filed: February 27, 1996 Examiner: H. Hguyen
For: A SYSTEM FOR TRANSMITTING DESIRED DIGITAL VIDEO OR AUDIO SIGNALS

Assistant Commissioner for Patents
Washington, D.C. 20231

AMENDMENT TRANSMITTAL

- 1. Transmitted herewith is an amendment for this application.

STATUS

- 2. Applicant is
 a small entity. A verified statement:
 is attached.
 was already filed.
 other than a small entity.

SEARCHED
SERIALIZED
INDEXED
DEC 10 1996

CERTIFICATE OF MAILING/TRANSMISSION (37 CFR 1.8a)

I hereby certify that this correspondence is, on the date shown below, being:

MAILING

FACSIMILE

deposited with the United States Postal Service with sufficient postage as first class mail in an envelope addressed to the Assistant Commissioner for Patents, Washington, D.C. 20231.

transmitted by facsimile to the Patent and Trademark Office.

Date: 12/6/96

Tracey L. Milka
Signature
Tracey L. Milka
(type or print name of person certifying)

(Amendment Transmittal [9-19]—page 1 of 4)

EXTENSION OF TERM

NOTE: "Extension of Time in Patent Cases (Supplement Amendments) — If a timely and complete response has been filed after a Non-Final Office Action, an extension of time is not required to permit filing and/or entry of an additional amendment after expiration of the shortened statutory period.

If a timely response has been filed after a Final Office Action, an extension of time is required to permit filing and/or entry of a Notice of Appeal or filing and/or entry of an additional amendment after expiration of the shortened statutory period unless the timely-filed response placed the application in condition for allowance. Of course, if a Notice of Appeal has been filed within the shortened statutory period, the period has ceased to run." Notice of December 10, 1985 (1061 O.G. 34-35).

NOTE: See 37 CFR 1.645 for extensions of time in interference proceedings, and 37 CFR 1.550(c) for extensions of time in reexamination proceedings.

3. The proceedings herein are for a patent application and the provisions of 37 CFR 1.136 apply.

(complete (a) or (b), as applicable)

(a) Applicant petitions for an extension of time under 37 CFR 1.136 (fees: 37 CFR 1.17(a)-(d) for the total number of months checked below:

Extension (months)	Fee for other than <u>small entity</u>	Fee for <u>small entity</u>
<input type="checkbox"/> one month	\$ 110.00	\$ 55.00
<input type="checkbox"/> two months	\$ 380.00	\$190.00
<input checked="" type="checkbox"/> three months	\$ 900.00	\$450.00
<input type="checkbox"/> four months	\$1,400.00	\$700.00

Fee \$ 465.00

If an additional extension of time is required, please consider this a petition therefor.

(check and complete the next item, if applicable)

An extension for _____ months has already been secured and the fee paid therefor of \$_____ is deducted from the total fee due for the total months of extension now requested.

Extension fee due with this request \$ _____

OR

(b) Applicant believes that no extension of term is required. However, this conditional petition is being made to provide for the possibility that applicant has inadvertently overlooked the need for a petition for extension of time.

FEE FOR CLAIMS

4. The fee for claims (37 CFR 1.16(b)-(d)) has been calculated as shown below:

(Col. 1)	(Col. 2)	(Col. 3)	SMALL ENTITY	OTHER THAN A SMALL ENTITY
CLAIMS REMAINING AFTER AMENDMENT	HIGHEST NO PREVIOUSLY PAID FOR	PRESENT EXTRA	ADDIT. RATE	ADDIT. RATE
TOTAL	MINUS	=	x11 = \$	x22 = \$
INDEP.	MINUS	=	x39 = \$	x78 = \$
<input type="checkbox"/> FIRST PRESENTATION OF MULTIPLE DEP. CLAIM			+125 = \$	+250 = \$
			TOTAL ADDIT. FEE \$	OR TOTAL ADDIT. FEE \$

* If the entry in Col. 1 is less than entry in Col. 2, write "0" in Col. 3.
 ** If the "Highest No. Previously Paid for" IN THIS SPACE is less than 20, enter "20".
 *** If the "Highest No. Previously Paid For" IN THIS SPACE is less than 3, enter "3".
 The "Highest No. Previously Paid For" (Total or indep.) is the highest number found in the appropriate box in Col. 1 of a prior amendment or the number of claims originally filed.
WARNING: "After final rejection or action (§ 1.113) amendments may be made cancelling claims or complying with any requirement of form which has been made." 37 CFR § 1.116(a) (emphasis added).

(complete (c) or (d), as applicable)

(c) No additional fee for claims is required.

OR

(d) Total additional fee for claims required \$_____.

FEE PAYMENT

5. Attached is a check in the sum of \$ 465.00.
 Charge Account No. _____ the sum of \$ _____.
 A duplicate of this transmittal is attached.

FEE DEFICIENCY

NOTE: If there is a fee deficiency and there is no authorization to charge an account, additional fees are necessary to cover the additional time consumed in making up the original deficiency. If the maximum, six-month period has expired before the deficiency is noted and corrected, the application is held abandoned. In those instances where authorization to charge is included, processing delays are encountered in returning the papers to the PTO Finance Branch in order to apply these charges prior to action on the cases. Authorization to charge the deposit account for any fee deficiency should be checked. See the Notice of April 7, 1986, (1065 O.G. 31-33).

6. If any additional extension and/or fee is required, charge Account No. 19-0737

AND/OR

- If any additional fee for claims is required, charge Account No. 19-0737

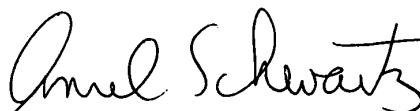

SIGNATURE OF ATTORNEY

Ansel M. Schwartz

(type or print name of attorney)

425 N. Craig Street

Suite 301

P.O. Address

Pittsburgh, PA 15213

Reg. No.: 30,587

Tel. No.: (412) 621-9222



UNITED STATES DEPARTMENT OF COMMERCE
 Patent and Trademark Office
 Address: COMMISSIONER OF PATENTS AND TRADEMARKS
 Washington, D.C. 20231

SERIAL NUMBER	FILING DATE	FIRST NAMED APPLICANT	ATTORNEY DOCKET NO.
08/607,648	02/27/96	HAIR	HAIR-100111

24M1/0205

ANSEL M SCHWARTZ
 SUITE 301
 425 N CRAIG STREET
 PITTSBURGH PA 15213

EXAMINER

NGUYEN, H

ART UNIT PAPER NUMBER

2413

26

02/05/97

DATE MAILED:

NOTICE OF ALLOWABILITY

PART I

- This communication is responsive to Amendment of 12/9/96
- All the claims being allowable, PROSECUTION ON THE MERITS IS (OR REMAINS) CLOSED in this application. If not included herewith (or previously mailed), a Notice Of Allowance And Issue Fee Due or other appropriate communication will be sent in due course.
- The allowed claims are 1-5, 6, 9, 11, 17, 20, 23, 26, 28, 43, 46, 62, 64, 65, 67-68, 69, 76-89, and
- The drawings filed on now as 1-5, 11-14, 16-18, 19, 21, 26, 28, 15, 20, 27-28, 6-9, 22-25, 29-34, respectively. are acceptable.
- Acknowledgment is made of the claim for priority under 35 U.S.C. 119. The certified copy has been received. not been received. been filed in parent application Serial No. _____ filed on _____
- Note the attached Examiner's Amendment.
- Note the attached Examiner Interview Summary Record, PTOL-413.
- Note the attached Examiner's Statement of Reasons for Allowance.
- Note the attached NOTICE OF REFERENCES CITED, PTO-892.
- Note the attached INFORMATION DISCLOSURE CITATION, PTO-1449.

PART II

A SHORTENED STATUTORY PERIOD FOR RESPONSE to comply with the requirements noted below is set to EXPIRE THREE MONTHS FROM THE "DATE MAILED" indicated on this form. Failure to timely comply will result in the ABANDONMENT of this application. Extensions of time may be obtained under the provisions of 37 CFR 1.136(a).

- Note the attached EXAMINER'S AMENDMENT or NOTICE OF INFORMAL APPLICATION, PTO-152, which discloses that the oath or declaration is deficient. A SUBSTITUTE OATH OR DECLARATION IS REQUIRED.
- APPLICANT MUST MAKE THE DRAWING CHANGES INDICATED BELOW IN THE MANNER SET FORTH ON THE REVERSE SIDE OF THIS PAPER.
 - Drawing informalities are indicated on the NOTICE RE PATENT DRAWINGS, PTO-948, attached hereto or to Paper No. 8. CORRECTION IS REQUIRED.
 - The proposed drawing correction filed on _____ has been approved by the examiner. CORRECTION IS REQUIRED.
 - Approved drawing corrections are described by the examiner in the attached EXAMINER'S AMENDMENT. CORRECTION IS REQUIRED.
 - Formal drawings are now REQUIRED.

Any response to this letter should include in the upper right hand corner, the following information from the NOTICE OF ALLOWANCE AND ISSUE FEE DUE: ISSUE BATCH NUMBER, DATE OF THE NOTICE OF ALLOWANCE, AND SERIAL NUMBER.

Attachments:

- Examiner's Amendment
- Examiner Interview Summary Record, PTOL-413
- Reasons for Allowance
- Notice of References Cited, PTO-892
- Information Disclosure Citation, PTO-1449
- Notice of Informal Application, PTO-152
- Notice re Patent Drawings, PTO-948
- Listing of Bonded Draftsmen
- Other

[Handwritten Signature]

HOAT T. NGUYEN
 PRIMARY EXAMINER
 GROUP 2400

USCOM



UNITED STATES DEPARTMENT OF COMMERCE
Patent and Trademark Office

Address: Box ISSUE FEE
ASSISTANT COMMISSIONER FOR PATENTS
WASHINGTON, D.C. 20231

NOTICE OF ALLOWANCE AND ISSUE FEE DUE

24M1/0205

ANSEL M SCHWARTZ
SUITE 301
425 N CRAIG STREET
PITTSBURGH PA 15213

APPLICATION NO.	FILING DATE	TOTAL CLAIMS	EXAMINER AND GROUP ART. UNIT	DATE MAILED
08/607,648	02/27/96	034	NGUYEN, H 2413	02/05/97

First Named Applicant	HAIR,	ARTHUR R.
-----------------------	-------	-----------

TITLE OF INVENTION: SYSTEM FOR TRANSMITTING DESIRED DIGITAL VIDEO OR AUDIO SIGNALS

ATTY'S DOCKET NO.	CLASS-SUBCLASS	BATCH NO.	APPLN. TYPE	SMALL ENTITY	FEE DUE	DATE DUE
2	HAIR-1CONTII	395-200.010	J30 UTILITY	YES	\$645.00	05/05/97

THE APPLICATION IDENTIFIED ABOVE HAS BEEN EXAMINED AND IS ALLOWED FOR ISSUANCE AS A PATENT. PROSECUTION ON THE MERITS IS CLOSED.

THE ISSUE FEE MUST BE PAID WITHIN THREE MONTHS FROM THE MAILING DATE OF THIS NOTICE OR THIS APPLICATION SHALL BE REGARDED AS ABANDONED. THIS STATUTORY PERIOD CANNOT BE EXTENDED.

HOW TO RESPOND TO THIS NOTICE:

- I. Review the SMALL ENTITY status shown above. If the SMALL ENTITY is shown as yes, verify your current SMALL ENTITY status:

<ul style="list-style-type: none"> A. If the status is changed, pay twice the amount of the FEE DUE shown and notify the Patent and Trademark Office of the change in status, or B. If the status is the same, pay the FEE DUE shown above. 	<p>If the SMALL ENTITY is shown as NO:</p> <ul style="list-style-type: none"> A. Pay FEE DUE shown above, or B. File verified statement of Small Entity Status before, or with, payment of 1/2 the FEE DUE shown above.
---	---
- II. Part B of this notice should be completed and returned to the Patent and Trademark Office (PTO) with your ISSUE-FEE. Even if the ISSUE FEE has already been paid by charge to deposit account, Part B should be completed and returned. If you are charging the ISSUE FEE to your deposit account, section "6b" of Part B should be completed.
- III. All communications regarding this application must give application number and batch number. Please direct all communication prior to issuance to Box ISSUE FEE unless advised to the contrary.

IMPORTANT REMINDER: Patents Issuing on applications filed on or after Dec. 12, 1980 may require payment of maintenance fees. It is patentee's responsibility to ensure timely payment of maintenance fees when due.

Attorney's Docket No. HAIR-1 CONT'IA

PATENT #27 AM

IN THE UNITED STATES PATENT AND TRADEMARK OFFICE

In re application of: Arthur R. Hair
Serial No.: 08/607,648 Group No.: 24130
Filed: February 27, 1996 Examiner: H. Nguyen
For: A SYSTEM FOR TRANSMITTING DESIRED DIGITAL VIDEO OR AUDIO SIGNALS

Date of mailing of PTOL 85 entitled "Notice of Allowance and Base Issue Fee Due" 2/5/97
Issue Batch No. J30

BOX ISSUE FEE
Assistant Commissioner for Patents
Washington, D.C. 20231

RECEIVED
Publishing Division
APR 28 1997

TRANSMITTAL OF NEW DRAWING(S) TO CORRECT INFORMALITIES 03
WITHIN THREE MONTH PERIOD OF RESPONSE SET
IN NOTICE OF ALLOWABILITY (PTOL 37)

- NOTE: Applicant may correct any informalities in the drawings made by the Draftsman's objections on PTO-948 by filing new drawings with the changes incorporated therein.
NOTE: Corrected drawings, as well as the issue fee, should be addressed to: Box Issue Fee. Notice of November 30, 1990 (1122 O.G. 571 to 591).
NOTE: Applicant is required to submit ACCEPTABLE corrected drawings within the three month shortened statutory period set in the "Notice of Allowability" (PTOL-37).

CERTIFICATE OF MAILING (37 C.F.R. 1.8)

I hereby certify that this paper (along with any paper referred to as being attached or enclosed) is being deposited with the United States Postal Service on the date shown below with sufficient postage as first class mail in an envelope addressed to the: Assistant Commissioner for Patents, Washington, D.C. 20231.

Date: 4/21/97
Tracey L. Milka
(type or print name of person mailing paper)
Tracey L. Milka
Signature of person mailing paper

WARNING: "Facsimile transmissions are not permitted and if submitted will not be accorded a date of receipt" for "(4) Drawings submitted under §§ 1.81, 1.83 through 1.85, 1.152, 1.165, 1.174, 1.437" 37 C.F.R. 1.6(d)(4).

(Transmittal of New Drawing(s) to Correct Informalities Within Three Month Period of Response Set in Notice of Allowability (PTOL 37) [5-2.1]-page 1 of 2)

SUBMISSION OF DRAWING(S)

1. To correct the informalities in the drawings as noted in the Draftsman's objection(s) on PTO-948, applicant submits herewith new drawing(s) for this application. Number of sheets of drawings submitted 2

NOTE: "Identifying indicia, if provided, should include the application number or the title of the invention, inventor's name, docket number (if any), and the name and telephone number of a person to call if the Office is unable to match the drawings to the proper application. This information should be placed on the back of each sheet of drawing a minimum distance of 1.5 cm. (5/8 inch) down from the top of the page. In addition, a reference to the application number, or, if an application number has not been assigned, the inventor's name, may be included in the left-hand corner, provided that the reference appears within 1.5 cm (9/16 inch) from the top of the sheet." 37 C.F.R. 1.84(c).

2. The three month period of response set in the Notice of Allowability (PTOL 37) expires on May 5, 1997. This submission is on or before this expiry date.

CONDITIONAL EXTENTION OF TERM

3. If an extension of term is deemed to be required, please consider this a request therefor, and an authorization to charge this deposit account 19-0737 for the extension fee.

Reg. No. 30,587

Tel. No.: (412) 621-9222



SIGNATURE OF ATTORNEY

Ansel M. Schwartz

(type or print name of attorney)

425 N. Craig Street, Suite 301

P.O. Address

Pittsburgh, PA 15213

(Transmittal of New Drawing(s) to Correct Informalities Within Three Month Period of Response Set in Notice of Allowability (PTOL 37) [5-2.1]—page 2 of 2)

APPROVED	O.G FIG. 2	
BY	CLASS	SUBCLASS
RAFTSMAN	395	200.0

5675734

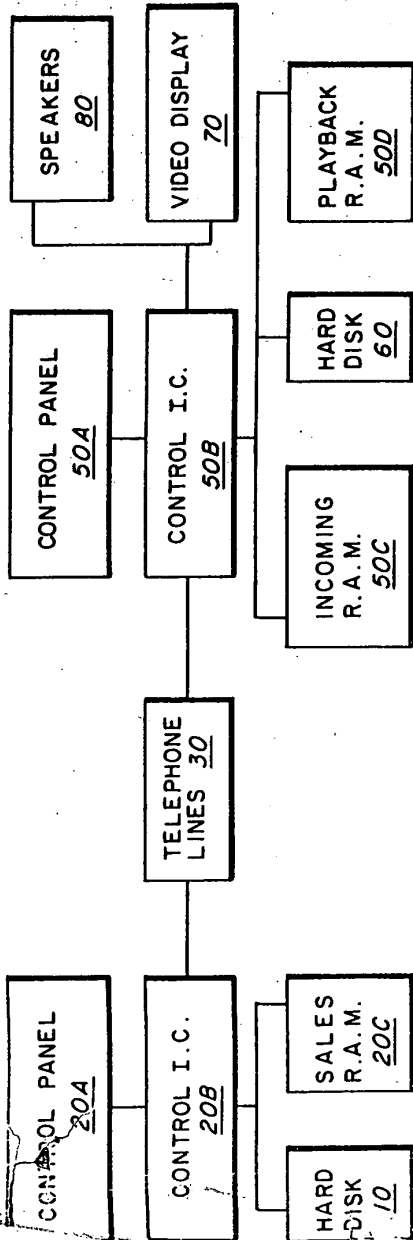

FIG. 1

BEST AVAILABLE COPY

APPROVED	O.G. FIG. 2	
BY	CLASS	SUBCLASS
DRAFTSMAN	395	200.01

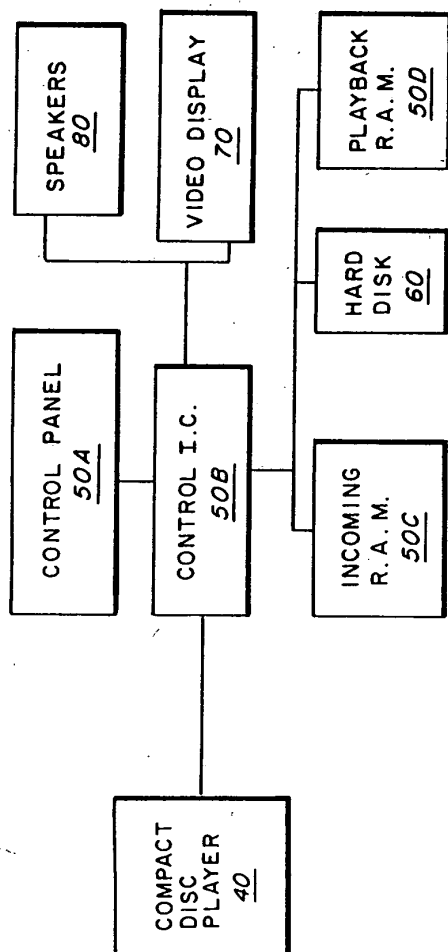

FIG. 2



410 (Drafting)
5/8/97
094

GP2413

IN THE UNITED STATES PATENT AND TRADEMARK OFFICE

In re Application of:)
)
ARTHUR R. HAIR)
)
Serial No. 08/607,648)
)
Filed: February 27, 1996)
)
Art Unit: 2413)
)
Patent Examiner:)
)
H. Nguyen)

A SYSTEM FOR TRANSMITTING
DESIRED DIGITAL VIDEO OR
AUDIO SIGNALS

129/2/97
RECEIVED
MAY 23 97
GROUP 2600

Pittsburgh, Pennsylvania 15213

May 2, 1997

CERTIFICATE OF MAILING

I hereby certify that the correspondence is being deposited with the United States Postal Service as first class mail in an envelope addressed to: Commissioner of Patents and Trademarks, Washington, DC 20231, on 5/2/97

Ansel M. Schwartz
Ansel M. Schwartz
Registration No. 30,537

5/2/97
Date

AMENDMENT UNDER RULE 312

Please enter the following amendments to the above-identified application as

follows:

IN THE SPECIFICATION:

Page 5, line 19, after "memory" please add the following paragraphs.

RECEIVED
MAY 11 1997
PT. & TRADEMARK OFF.

5675734
10/67/97

Assistant Commissioner for Patents
Washington, D.C. 20231

Sir:

possession and control of the second party. Next there is the step of storing be transferred replica of the coded desired digital video or digital audio signals in the second memory.

Preferably, the second memory includes an incoming random access memory chip which temporarily stores the coded desired digital video or digital audio signals from the sales random access memory chip, a second party hard disk for storing the coded desired digital video or audio digital signals from the incoming random access memory chip, and a playback random access memory chip for temporarily storing the coded desired digital video or digital audio signals from the first party hard disk for sequential playback. The storing the transferred replica step preferably includes the steps of storing the coded desired digital video or digital audio signals from the sales random access memory chip in the incoming random access memory chip, transferring the desired digital video or digital audio signals from the incoming random access memory chip to the second party hard disk, storing the desired digital video or digital audio signals in the second party hard disk, causing the second party integrated circuit with the second party control panel to play the desired digital video or digital audio signals from the second party hard disk, transferring a replica of the desired digital video or digital audio signals from the second party hard disk to the playback random access memory chip for playback and, playing the desired digital video or digital audio signals from the second party hard disk.

-- The present invention pertains to a method for transferring desired digital video or digital audio signals. The method comprises the steps of forming a connection through telecommunications lines between a first memory of a first party at a first party location and a second memory of a second party at a second party location remote from the first party location. The first memory has a first party hard disk having a plurality of digital video or digital audio signals including coded desired digital video or digital audio signals. The first memory has a sales random access memory chip which temporarily stores a replica of the coded desired digital video or digital audio signals purchased by the second party for subsequent transfer via telecommunications lines to the second memory of the second party. Next there is the step of telephoning the first party controlling use of the first memory by the second party. Then there is the step of providing a credit card number of the second party controlling a second memory to the first party controlling the first memory so the second party is charged money. Then there is the step of electronically coding the desired digital video or digital audio signals to form the coded desired digital video or digital audio signals into a configuration which would prevent unauthorized reproduction of the desired digital video or digital audio signals. Next there is the step of storing a replica of the coded desired digital video or digital audio signals from the hard disk into the sales random access memory chip. Then there is the step of transferring the stored replica of the coded desired digital video or digital audio signals from the sales random access memory chip of the first party to the second memory of the second party through telecommunications lines while the second memory is in

The present invention pertains to a system for transferring digital video or digital audio signals. The system comprises a first party control unit having a first party hard disk having a plurality of digital video or digital audio signals which include desired digital video or digital audio signals, a sales random access memory chip electronically connected to the first party hard disk for storing a replica of the desired digital video or digital audio signals of the first party's hard disk to be transferred from the first party control unit, and means for electronically selling the desired digital video or digital audio signals. The system comprises a second party control unit having a second party control panel, a second memory connected to the second party control panel, and means for playing the desired digital video or digital audio signals connected to the second memory and the second party control panel. The means for playing is operatively controlled by the second party control panel. The system comprises second party control unit is remote from the first party control unit. The second party control unit is placed by the second party at a location determined by the second party. The system comprises telecommunications lines connected to the first party control unit and the second party control unit through which the electronic sales of the desired digital video or digital audio signals occur and through which the desired digital video or digital audio signals are electronically transferred from the sales random access memory chip to the second memory while the second memory is in possession and control of the second party and after the desired digital video or digital audio signals are sold to the second party by the first party. The second memory preferably includes a second party hard disk which stores the desired digital video or digital audio signals transferred from the sales random access memory chip, and a

playback random access memory chip electronically connected to the second party hard disk for storing a replica of the desired digital video or digital audio signals from the second party hard disk as a temporary staging area for playback. The first party control unit preferably includes a first party control integrated circuit which controls and executes commands of the first party and is connected to the first party hard disk, the first party sales random access memory, and the second party control panel through the telecommunications lines. The first party control unit preferably comprises a first party control panel through which the first party control integrated circuit is programmed and is sent commands and which is connected to the first party control integrated circuit. The second party control unit preferably includes a second party control integrated circuit which controls and executes commands of the second party and is connected to the second party hard disk, the playback random access memory, and the first party control integrated circuit through the telecommunications lines. The second party control integrated circuit and the first party control integrated circuit regulate the transfer of the desired digital video or audio signals. The second party control unit preferably includes a second party control panel through which the second party control integrated circuit is programmed and is sent commands and which is connected to the second party integrated circuit. The second memory preferably includes an incoming random access memory chip connected to the second party hard disk and the second party control integrated circuit, and the first party control unit through the telecommunications lines for temporarily storing the desired digital video or audio signals received from the first party's control unit for subsequent storage to the second party hard disk. The playing means preferably includes a video display unit

connected to the playback random access memory chip and to the second party integrated circuit for displaying the desired digital video or audio signals.

The present invention pertains to a system for transmitting desired digital video or digital audio signals stored on a first memory of a first party to a second memory of a second party. The system comprises a first memory in possession and control of the first party. The system comprises a second memory in possession and control of the second party. The second memory is at a location remote from said first memory. The system comprises telecommunications lines. The system comprises means or a mechanism for transferring money electronically via the telecommunications lines from the second party controlling use and in possession of the second memory to the first party controlling use and in possession of the first memory. The system comprises means or a mechanism for connecting electronically via the telecommunications lines the first memory with the second memory such that the desired digital video or digital audio signals can pass therebetween. The connecting means or mechanism is in electrical communication with the transferring means or mechanism. The connecting means or mechanism comprises a first control unit in possession and control of the first party, and a second control unit in possession and control of the second party. The first control unit comprises a first control panel, first control integrated circuit and a sales random access memory. The sales random access memory and the first control panel in electrical communication with the first control integrated circuit. The second control unit comprises a second control panel, a second control integrated circuit, an incoming random access memory

and a playback random access memory. The second control panel, the incoming random access memory and the playback random access memory is in electrical communication with the second control integrated circuit. The system comprises means or a mechanism for transmitting the desired digital video or digital audio signals from the first memory to the second memory. The means or mechanism for transmitting comprising a transmitter connected to the first memory and the telecommunications lines and a receiver connected to the second memory, the transmitter and the telecommunications lines. The first party is in control and possession of the transmitter. The second party is in control and possession of the receiver. The receiver is remote from the transmitter and the receiver at a location determined by the second party. The transmitting means or mechanism is in electrical communication with the connecting means or mechanism. The system also comprises means or a mechanism for storing the desired digital video or digital audio signals from the first memory in the second memory. The storing means or mechanism is in electrical communication with the receiver of the transmitting means or mechanism and with the second memory.

The present invention pertains to a system for transmitting desired digital video or digital audio signals stored on a first memory of a first party at a first party location to a second memory of a second party at a second party location. The system comprises a first memory at a first party location. The first memory is in possession and control of the first party. The first memory comprises a first party hard disk in which the desired digital video or digital audio signals are stored. The system comprises a second memory in possession and

control of the second party. The second memory is at a second party location remote from said first memory. The second memory comprises a second party hard disk in which the desired digital video or digital audio signals are stored that are received from the first memory and a playback random access memory connected to the second party hard disk. The system comprises telecommunications lines. The system comprises means or a mechanism for the first party to charge a fee to the second party and provide access to the desired digital video or digital audio signals at the first party location remote from the second party location. The first party controls use of the first memory. The second party controls use and in possession of the second memory. The means or mechanism for the first party to charge a fee includes means or a mechanism for transferring money electronically from the second party via telecommunications lines to the first party at the first party location remote from the second memory at the second party location. The system comprises means or a mechanism for connecting electronically via telecommunications lines the first memory with the second memory such that the desired digital video or digital audio signals can pass therebetween. The connecting means or mechanism is in electrical communication with the transferring means or mechanism. The connecting means or mechanism comprises a first control unit disposed at the first party location and a second control unit disposed at the second party location remote from said first control unit. The first control unit comprises a first control panel, first control integrated circuit, and a sales random access memory connected to the first hard disk for temporarily storing a replica of the desired digital video or digital audio signals to be transmitted from the first control unit. The sales random access memory, the first hard disk

and the first control panel is in electrical communication with the first control integrated circuit. The second control unit comprises a second control panel, a second control integrated circuit, and an incoming random access memory which temporarily stores the desired digital video or digital audio signals transmitted from the sales random access memory. The playback random access memory is connected to the incoming random access memory for temporarily storing a replica of the desired digital video signals or digital audio signals to be played. The incoming random access memory is connected to the second party hard disk. The second control panel, the incoming random access memory, the second party hard disk and the playback random access memory are in electrical communication with the second control integrated circuit. The system comprises means or a mechanism for transmitting the desired digital video or digital audio signals from the sales random access memory to the incoming random access memory. The means or mechanism for transmitting comprises a transmitter connected to the sales random access memory and the telecommunications lines, and a receiver connected to the incoming random access memory, the transmitter and the telecommunications lines. The first party is in control and possession of the transmitter. The second party is in control and possession of the receiver. The receiver is remote from the transmitter, and the receiver at the second party location determined by the second party. The transmitting means or mechanism is in electrical communication with the connecting means or mechanism. The system comprises means or a mechanism for storing the desired digital video or digital audio signals from the sales random access memory in the incoming random access memory. The storing means or mechanism is in electrical communication with the receiver of the

transmitting means or mechanism and with the sales random access memory. The system preferably includes a video display and speakers in electrical communication with said second control integrated circuit.

The present invention pertains to a system for transferring digital video signals. The system comprises a first party control unit in possession and control of a first party. The system comprises a second party control unit in possession and control of the second party. The second party control unit is at a location remote from the first party control unit. The first party control unit has a first memory having a plurality of desired individual video selections as desired digital video signals, a first party control unit which includes a first party hard disk having the plurality of digital video signals which include desired digital video signals, and a sales random access memory chip electronically connected to the first party hard disk for storing a replica of the desired digital video signals of the first party's hard disk to be transferred from the first party control unit, and means or a mechanism for the first party to charge a fee to the second party for access to the desired digital video signals of the first party's hard disk at a location remote from the second party location. The system comprises a second party control unit having a second party control panel, a receiver and a video display for playing the desired digital video signals received by the receiver. The second party control panel is connected to the video display and the receiver. The receiver and video display is operatively controlled by the second party control panel. The second party control unit is remote from the first party control unit. The second party control unit is placed by the second

party at a second party location determined by the second party which is remote from the first party control unit. The second party chooses the desired digital video signals from the first party's hard disk with the second party control panel. The second party control unit includes a second memory which is connected to the receiver and the video display. The second memory stores the desired digital video signals that are received by the receiver to provide the video display with the desired digital video signals from the sales random access memory chip. The system also comprises telecommunications lines connected to the first party control unit and the second party control unit through which the desired digital video signals are electronically transferred from the sales random access memory chip to the receiver while the second party control unit is in possession and control of the second party after the desired digital video signals are sold to the second party by the first party. The first party control unit preferably includes a first party control integrated circuit which controls and executes commands of the first party and is connected to the first party hard disk, the first party sales random access memory, and the second party control integrated circuit through the telecommunications lines. The first party control integrated circuit and the second party control integrated circuit regulate the transfer of the desired digital video signals. The first party control unit preferably includes a first party control panel through which the first party control integrated circuit is programmed and is sent commands and which is connected to the first party control integrated circuit. The second party control unit preferably includes a second party control integrated circuit which controls and executes commands of the second party and is connected to the second party hard disk, the playback random access memory, and the first party control

integrated circuit through the telecommunications lines. The second party control integrated circuit and the first party control integrated circuit regulate the transfer of the desired digital video signal. The second party control unit preferably includes a second party control panel through which the second party control integrated circuit is programmed and is sent commands and which is connected to the second party integrated circuit. The second party control unit preferably includes an incoming random access memory chip connected to the second party hard drive and the second party control integrated circuit, and the first party control unit through the telecommunications lines for temporarily storing the desired digital video signals received from the first party's control unit for subsequent storage to the second party hard disk. The second party control unit preferably includes a video display unit connected to the playback random access memory chip and to the second party integrated circuit for displaying the desired digital video signals.

The present invention pertains to a system for transferring digital audio signals. The system comprises a first party control unit in possession and control of a first party, and a second party control unit in possession and control of a second party. The second party control unit is at a second party location remote from the first party control unit. The first party control unit is for controlling and transferring digital audio signals. The first party control unit has a first party hard disk having a plurality of digital audio signals which include a plurality of desired individual songs as desired digital audio signals. The first party control unit has a sales random access memory chip electronically connected to the first party hard

disk for storing a replica of the desired digital audio signals of the first party's hard disk to be transferred from the first party control unit. The system comprises means or mechanism for transmitting the desired digital audio signals from the sales random access memory chip. The means or mechanism for transferring is connected to the sales random access memory chip, and the first party control unit has means or a mechanism for the first party to charge a fee to the second party to provide the second party access to the desired digital audio signals of the first party's hard disk. The means or mechanism for the first party to charge a fee to the second party is remote from the second party location. The second party control unit has a second party control panel, a second memory for storing the desired digital audio signals from the sales random access memory chip, a receiver connected to the second party control panel and speakers connected to the receiver for playing the desired digital audio signals in the second memory. The second party control panel is connected to the receiver. The receiver and speakers are operatively controlled by the second party control panel. The second party control unit is placed by the second party at a second party location determined by the second party which is remote from the first party control unit. The second party chooses the desired digital audio signals from the first party's hard disk with the second party control panel. The second memory is connected to the receiver and the speakers. The second memory stores the desired digital audio signals that are received by the receiver. The system also comprises telecommunications lines connected to the first party control unit and the second party control unit through which the desired digital audio signals in the sales random access memory are electronically transferred by the means or mechanism for transferring to the receiver while the

second party is in possession and control of the second party control unit and after the desired digital audio signals of the first party's hard disk are sold to the second party by the first party with the means or mechanism for the first party to charge a fee.

The present invention pertains to a system for transferring digital video or digital audio signals. The system comprises a first party control unit having a first party hard disk having a plurality of digital video or digital audio signals which include desired digital video or digital audio signals, a sales random access memory chip electronically connected to the first party hard disk for storing a replica of the desired digital video or digital audio signals of the first party's hard disk to be transferred from the first party control unit, and a mechanism for electronically selling the desired digital video or digital audio signals of the first party's hard disk. The system comprises a second party control unit having a second party control panel, a second memory connected to the second party control panel, and a mechanism for playing the desired digital video or digital audio signals connected to the second memory and the second party control panel. The playing mechanism is operatively controlled by the second party control panel. The second party control unit is remote from the first party control unit. The second party control unit is placed by the second party at a location determined by the second party. The system is also comprised of telecommunications lines connected to the first party control unit and the second party control unit through which the electronic sales of the desired digital video or digital audio signals occur of the first party's hard disk, and over which the desired digital video or digital audio signals of the first party's

hard disk are electronically transferred from the sales random access memory chip to the second memory while the second party is in possession and control of the second memory and after the desired digital video or digital audio signals are sold to the second party by the first party. The telecommunications lines preferably include telephone lines. The second party control unit preferably includes a second party hard disk which stores a plurality of digital video or audio signals, and a playback random access memory chip electronically connected to the second party hard disk for storing a replica of the desired digital video or audio signals as a temporary staging area for playback. The first party control unit preferably includes a first party control integrated circuit which controls and executes commands of the first party and is connected to the first party hard disk, the first party sales random access memory, and the second party control integrated circuit through the telecommunications lines. The first party control integrated circuit and the second party control integrated circuit regulate the transfer of the desired digital video or audio signals. The first party control unit preferably comprises a first party control panel through which the first party control integrated circuit is programmed and is sent commands and which is connected to the first party control integrated circuit. The second party control unit preferably includes a second party control integrated circuit which controls and executes commands of the second party and is connected to the second party hard disk, the playback random access memory, and the first party control integrated circuit through the telecommunications lines. The second party control integrated circuit and the first party control integrated circuit regulate the transfer of the desired digital video or audio signals. The second party control unit preferably comprises a second party control panel

through which the second party control integrated circuit is programmed and is sent commands and which is connected to the second party integrated circuit. The second party control unit preferably includes an incoming random access memory chip connected to the second party hard drive and the second party control integrated circuit, and the first party control unit through the telecommunications lines for temporarily storing the desired digital video or audio signals received from the first party's control unit for subsequent storage to the second party hard disk. The second party control unit preferably includes a video display unit connected to the playback random access memory chip and to the second party integrated circuit for displaying the desired digital video or audio signals. --

REMARKS

Please enter the aforesaid amendments into the above-identified patent application. These amendments are the independent claims and many of the dependant claims that are now allowed written in more traditional English style. They are being placed in the Summary of the above-identified patent application to more clearly have the Summary reflect the allowed independent claims and many of the dependent claims. The added paragraphs are the independent claims in the order that they were originally filed with dependant claims to the independent claims following the respective independent claims. The newly added paragraphs are essentially word for word identical to the allowed corresponding claims except for grammatical changes or sentence structure changes to make the claims read as traditional English. No new matter has been added.

Please also find enclosed U.S. Patent No. 5,191,193 to Le Roux that had been identified by the Examiner. Applicant does not believe it is relevant at all to this application but wishes to disclose it and have it placed in this file.

Accordingly, it is respectfully requested that the amendments to the above-identified patent application be entered.

Respectfully submitted,

ARTHUR R. HAIR

By Ansel Schwartz

Ansel M. Schwartz, Esquire

Reg. No. 30,587

425 N. Craig Street

Suite 301

Pittsburgh, PA 15213

(412) 621-9222

Attorney for Applicant

CERTIFICATE OF MAILING

I hereby certify that the correspondence is being deposited with the United States Postal Service as first class mail in an envelope addressed to: Commissioner of Patents and Trademarks, Washington, DC 20231, on 5/2/97

Ansel Schwartz

Ansel M. Schwartz
Registration No. 30,587

5/2/97

Date

PART B - ISSUE FEE TRANSMITTAL

242-04500
561-30-0

INSTRUCTIONS: This form should be used for transmitting the ISSUE FEE. Blocks 2 through 6 should be completed where appropriate. All further correspondence including the Issue Fee Receipt, the Patent, advance orders and notification of maintenance fees will be mailed to addresses entered in Block 1 unless you direct otherwise by (a) specifying a new correspondence address in Block 3 below or (b) providing the PTO with a separate "FEE ADDRESS" for maintenance fee notifications with the payment of Issue Fee or hereafter. See reverse for Certificate of Mailing, below.

Under the Paperwork Reduction Act of 1995, no persons are required to respond to a collection of information unless it displays a valid OMB control number.

Burden Hour Statement: This form is estimated to take 0.2 hours to complete. Time will vary depending on the needs of the individual case. Any comments on the amount of time required to complete this form should be sent to the Chief Information Officer, Patent and Trademark Office, Washington, D.C. 20231.

DO NOT SEND FEES OR COMPLETED FORMS TO THIS ADDRESS: SEND TO: Box Issue Fee, Assistant Commissioner for Patents, Washington D.C. 20231

2. INVENTOR(S) ADDRESS CHANGE (Complete only if there is a change)

INVENTOR'S NAME _____

Street Address _____

City, State and Zip Code _____

CO-INVENTOR'S NAME _____

Street Address _____

City, State and Zip Code _____

Check if additional changes are enclosed

1. CORRESPONDENCE ADDRESS 24M1/0205

ANSEL M SCHWARTZ
SUITE 301
425 N CRAIG STREET
PITTSBURGH PA 15213

APPLICATION NO.	FLING DATE	TOTAL CLAIMS	EXAMINER AND GROUP ART UNIT	DATE MAILED
08/607,648	02/27/96	034	NGUYEN, H 2413	02/05/97

First Named Applicant: **HAIR, ARTHUR R.**

TITLE OF INVENTION: **SYSTEM FOR TRANSMITTING DESIRED DIGITAL VIDEO OR AUDIO SIGNALS**

ATTY'S DOCKET NO.	CLASS-SUBCLASS	BATCH NO.	APPLN. TYPE	SMALL ENTITY	FEE DUE	DATE DUE
2	HAIR-1CONT11	395-200.010	J30 UTILITY	YES	\$645.00	05/05/97

3. Correspondence address change (Complete only if there is a change)

4. For printing on the patent front page, list the names of not more than 3 registered patent attorneys or agents OR, alternatively, the name of a firm having as a member a registered attorney or agent. If no name is listed, no name will be printed.

1 Ansel M. Schwartz

2 _____

3 _____

5. ASSIGNMENT DATA TO BE PRINTED ON THE PATENT (print or type)

(1) NAME OF ASSIGNEE: Parsec Sight/Sound, Inc.

(2) ADDRESS: (CITY & STATE OR COUNTRY) Upper St. Clair, Pennsylvania

A. This application is NOT assigned.
 Assignment previously submitted to the Patent and Trademark Office.
 Assignment is being submitted under separate cover. Assignment should be directed to Box ASSIGNMENTS.

PLEASE NOTE: Unless an assignee is identified in Block 5, no assignee data will appear on the patent. Inclusion of assignee data is only appropriate when an assignment has been previously submitted to the PTO or is being submitted under separate cover. Completion of this form is NOT a substitute for filing an assignment.

6a. The following fees are enclosed:
 Issue Fee Advance Order - # of Copies 10

6b. The following fees should be charged to:
 DEPOSIT ACCOUNT NUMBER 19-0737
 (ENCLOSE A COPY OF THIS FORM)
 Issue Fee Advance Order - # of Copies _____
 Any Deficiencies in Enclosed Fees

The COMMISSIONER OF PATENTS AND TRADEMARKS is requested to apply the Issue Fee to the application identified above.

(Authorized Signature) Ansel M. Schwartz (Date) 5/5/97

NOTE: The Issue Fee will not be accepted from anyone other than the applicant, a registered attorney or agent, or the assignee or other party in interest as shown by the records of the Patent and Trademark Office.

Certificate of Mailing

Note: If this certificate of mailing is used, it can be used to transmit the Issue Fee. This certificate cannot be used for any other accompanying papers. Each additional paper, such as an assignment or formal drawing, must have its own certificate of mailing.

I hereby certify that this correspondence is being deposited with the United States Postal Service with sufficient postage as first class mail in an envelope addressed to:

Box ISSUE FEE
Assistant Commissioner for Patents
Washington, D.C. 20231

810 BL 05/13/97 08607648
 1 242 645.00 CK
 1 561 30.00 CK

on: May 5, 1997 (Date)
Tracey L. Milka (Name of person making deposit)
Tracey L. Milka (Signature)
5/5/97 (Date)

1. TRANSMIT THIS FORM WITH FEE



UNITED STATES DEPARTMENT OF COMMERCE
Patent and Trademark Office

Address: COMMISSIONER OF PATENTS AND TRADEMARKS
Washington, D.C. 20231

SERIAL NUMBER	FILING DATE	HAIR	FIRST NAMED APPLICANT	ATTORNEY DOCKET NO.
---------------	-------------	------	-----------------------	---------------------

ANSEL M SCHWARTZ
SUITE 301
425 N CRAIG STREET
PITTSBURGH PA 15213

24M1/0912

NEGATIVE EXAMINER

ART UNIT	PAPER NUMBER
----------	--------------

DATE MAILED: 09/12/97

A. The petition filed _____ under 37 CFR 1.312(b) is granted.
The paper has been forwarded to the examiner for consideration on the merits.

B. The amendment filed May 6, 1997 under 37 CFR 1.312 has been considered, and has been:

- 1. entered
- 2. entered as directed to matters of form not affecting the scope of the invention (0.3311).
- 3. disapproved. A report appears below.
- 4. entered in part. A report appears below.

Report:

The amendments filed on 5/6/97 contains excessive amendments to the specification which require a "substantial amount of additional work" on the part of the Examiner (i.e. which place a burden to the Examiner) to consider these amendments.
MPEP 1302.021.

HOA T. NGUYEN
PRIMARY EXAMINER
GROUP 2400

PLEASE FURNISH YOUR ZIP CODE IN ALL CORRESPONDENCE

PTO UTILITY GRANT

Paper Number 22

**The Commissioner of Patents
and Trademarks**

Has received an application for a patent for a new and useful invention. The title and description of the invention are enclosed. The requirements of law have been complied with, and it has been determined that a patent on the invention shall be granted under the law.

Therefore, this

United States Patent

Grants to the person(s) having title to this patent the right to exclude others from making, using, offering for sale, or selling the invention throughout the United States of America or importing the invention into the United States of America for the term set forth below, subject to the payment of maintenance fees as provided by law.

If this application was filed prior to June 8, 1995, the term of this patent is the longer of seventeen years from the date of grant of this patent or twenty years from the earliest effective U.S. filing date of the application, subject to any statutory extension.

If this application was filed on or after June 8, 1995, the term of this patent is twenty years from the U.S. filing date, subject to a statutory extension. If the application contains a specific reference to an earlier filed application or applications under 35 U.S.C. 120, 121 or 365(c), the term of the patent is twenty years from the date on which the earliest application was filed, subject to any statutory extension.

Bence Lehman
Commissioner of Patents and Trademarks
Andrea Morton
Attest

The
United
States
of
America



UNITED STATES DISTRICT COURT
OFFICE OF THE CLERK
WESTERN DISTRICT OF PENNSYLVANIA
P. O. BOX 1805
PITTSBURGH, PA 15230

SOLICITOR

JAN 23 1998

U.S. PATENT & TRADEMARK OFFICE

JAMES A. DRACH
CLERK
412-644-3528

IN REPLYING, GIVE NUMBER
OF CASE AND NAMES OF PARTIES

January 20, 1998

Commissioner of Patents
and Trademarks
Washington, DC 20231

Re: Parsec Sight/Sound, Inc. V. N2K, Inc.
Civil Action No. 98-118

Dear Commissioner:

In compliance with 35 § 290 and/or 15 U.S.C. §1116 enclosed is a copy of the docket entries and complaint which was filed in the United States District Court for the Western District of Pennsylvania.

Sincerely,

James A. Drach
CLERK OF COURT

By Eileen M. Chettle
Eileen M. Chettle
Deputy Clerk

Enclosures

5,191,573
5,675,734

Patent No. 5675734

Paper No. 31

NOTICE OF *EX PARTE* REEXAMINATION

Notice is hereby given that a request for *ex parte* reexamination of U.S. Patent No. 5675734 was filed on 1-31-05 pursuant to 35 U.S.C. 302 and 37 CFR 1.510(a).

The reexamination proceeding has been assigned Control No. 90/007403.

This Notice incorporates by reference into the patent file, all papers entered into the reexamination file.

Note: This Notice should be entered into the patent file and given a paper number.

Revised July 2004



UNITED STATES PATENT AND TRADEMARK OFFICE

UNITED STATES DEPARTMENT OF COMMERCE
United States Patent and Trademark Office
Address: COMMISSIONER FOR PATENTS
P.O. Box 1450
Alexandria, Virginia 22313-1450
www.uspto.gov

APPLICATION NUMBER	FILING OR 371(C) DATE	FIRST NAMED APPLICANT	ATTY. DOCKET NO./TITLE
08/607,648	02/27/1996	ARTHUR R. HAIR	HAIR-1CONTII

ANSEL M SCHWARTZ
SUITE 304
201 N. CRAIG STREET
PITTSBURGH, PA 15213

CONFIRMATION NO. 1613
POWER OF ATTORNEY NOTICE



OC00000042347977

Date Mailed: 06/29/2010

NOTICE REGARDING CHANGE OF POWER OF ATTORNEY

This is in response to the Power of Attorney filed 06/28/2010.

- The Power of Attorney to you in this application has been revoked by the assignee who has intervned as provided by 37 CFR 3.71. Future correspondence will be mailed to the new address of record(37 CFR 1.33).

/jawhitfield/

Office of Data Management, Application Assistance Unit (571) 272-4000, or (571) 272-4200, or 1-888-786-0101



UNITED STATES PATENT AND TRADEMARK OFFICE

UNITED STATES DEPARTMENT OF COMMERCE
United States Patent and Trademark Office
Address: COMMISSIONER FOR PATENTS
P.O. Box 1450
Alexandria, Virginia 22313-1450
www.uspto.gov

APPLICATION NUMBER	FILING OR 371(C) DATE	FIRST NAMED APPLICANT	ATTY. DOCKET NO./TITLE
08/607,648	02/27/1996	ARTHUR R. HAIR	HAIR-1CONTII

CONFIRMATION NO. 1613

POA ACCEPTANCE LETTER

42624
DAVIDSON BERQUIST JACKSON & GOWDEY LLP
4300 WILSON BLVD., 7TH FLOOR
ARLINGTON, VA 22203



Date Mailed: 06/29/2010

NOTICE OF ACCEPTANCE OF POWER OF ATTORNEY

This is in response to the Power of Attorney filed 06/28/2010.

The Power of Attorney in this application is accepted. Correspondence in this application will be mailed to the above address as provided by 37 CFR 1.33.

/jawhitfield/

Office of Data Management, Application Assistance Unit (571) 272-4000, or (571) 272-4200, or 1-888-786-0101

3. Defendant, Roxio, Inc. (“Roxio”), has at the relevant times been a corporation organized and existing under the laws of the State of Delaware with a principal place of business located at 455 El Camino Real, Santa Clara, CA, 95050.

4. Defendant, Napster, LLC has at the relevant times been a limited liability company organized and existing under the laws of the State of Delaware, with its principal place of business at 9044 Melrose Ave., Los Angeles, California 90069.

5. On information and belief, Roxio acquired certain assets from Napster, Inc., Napster Music Company, Inc., Napster Mobile Company, Inc. and Pressplay, Inc., including the business of selling digital music electronically.

6. On information and belief, Roxio and Napster, LLC (collectively referred to herein as “Napster”), and their successors in interest, working individually and/or together in conjunction, are involved in the electronic sale, and transmission of digital music throughout the United States, including in the Commonwealth of Pennsylvania.

Jurisdiction

7. This Court has jurisdiction over the subject matter of this action under 28 U.S.C. § 1331 and 1338(a).

Venue

8. Venue is proper in this Court under the provisions of 28 U.S.C. § 1391(c) and 28 U.S.C. § 1400(b).

General Facts

9. Arthur R. Hair (“Hair”) is the inventor to whom the United States Patent Office issued United States Patent No. 5,191,573 on March 2, 1993 (hereinafter the “’573 Patent”). A true and correct copy of the ‘573 Patent is attached hereto as Exhibit “A”.

10. SightSound is the assignee of the rights, title and interest in the '573 Patent issued to Hair.

11. Hair is the inventor to whom the United States Patent Office issued United States Patent No. 5,675,734 on October 7, 1997 (hereinafter the "'734 Patent"). A true and correct copy of the '734 Patent is attached hereto as Exhibit "B".

12. SightSound is the assignee of the rights, title and interest in the '734 Patent issued to Hair.

13. The '734 Patent is a continuation of the application that led to the '573 Patent.

14. Hair is the inventor to whom the United States Patent Office issued United States Patent No. 5,966,440 on October 12, 1999 (hereinafter the "'440 Patent"). A true and correct copy of the '440 Patent is attached hereto as Exhibit "C."

15. SightSound is the assignee of the rights, title and interest in the '440 Patent issued to Hair.

16. The '440 Patent is a continuation of the application that led to the '573 Patent.

17. On January 1, 1998, a SightSound predecessor in interest, SightSound.com, Inc. filed a patent infringement action against N2K, Inc. ("N2K"), for infringement of the '573 Patent, and the '734 Patent in the United States District Court for the Western District of Pennsylvania, Civil Action No. 98-0118. In March, 2000 CDnow, Inc., and CDnow Online Inc. (collectively "CDnow") were joined as defendants in that lawsuit and a claim of infringement of the '440 Patent was added against all defendants.

18. In the lawsuit against CDnow and N2K, this Court held a Markman hearing and issued an order on construction of relevant terms of the claims of the patents in suit. Subsequently, a motion for summary judgment filed by N2K and CDnow alleging invalidity of

the '573 Patent, the '734 Patent, and the '440 Patent, was denied. Plaintiff's motion for summary judgment was granted, dismissing allegations by N2K and CDnow that the plaintiff had committed inequitable conduct.

19. Pursuant to a settlement agreement among the parties, CDnow and N2K agreed to a Final Judgment and Order on Consent, entered by this Court on February 20, 2004, that the '573 Patent, the '734 Patent, and the '440 Patent are valid and enforceable.

COUNT 1

Patent Infringement

20. Paragraphs 1-19, inclusive, above, are hereby incorporated herein by reference.

21. Napster and/or its successors in interest has been making and continues to make and/or has sold and continues to sell and/or continues to induce others to sell and/or use and/or contribute to the making, using or selling of one or more digital audio signals for or with systems and/or processes within the scope of the claims of the '573 Patent in this judicial district and elsewhere in the United States.

22. Napster and/or its successors in interest had notice of the '573 Patent, pursuant to 35 U.S.C. § 287, prior to the commencement of this civil action.

23. The unauthorized making, use, or sale of such digital audio signals by Napster and/or its successors in interest infringes the '573 Patent.

24. Napster and/or its successors in interest is a direct and/or contributory infringer of the '573 Patent, and/or has induced infringement of the '573 Patent by others in violation of 35 U.S.C. § 271.

25. Unless enjoined by this Court, Napster and/or its successors in interest will continue to infringe the '573 Patent in the future.

26. On information and belief, Napster and/or its successors in interest has infringed and is infringing the '573 Patent, with full knowledge of the '573 Patent, and the infringement has been willful and deliberate and continues to be willful and deliberate. This case is exceptional under 35 U.S.C. § 285.

COUNT II

27. Paragraphs 1-26, inclusive, above, are hereby incorporated herein by reference.

28. Napster and/or its successors in interest has been making and continues to make and/or has sold and continues to sell and/or continues to induce others to sell and/or use and/or contribute to the making, using or selling of one or more digital audio signals for or with processes within the scope of the claims of the '734 Patent in this judicial district and elsewhere in the United States.

29. Napster and/or its successors in interest received notice of the '734 Patent pursuant to 35 U.S.C. § 287, prior to the commencement of this civil action.

30. The unauthorized making, use, or sale of such a digital audio signal by Napster and/or its successors in interest infringes the '734 Patent.

31. Napster and/or its successors in interest is a direct and/or contributory infringer of the '734 Patent and/or has induced infringement of the '734 Patent by others in violation of 35 U.S.C. § 271.

32. Unless enjoined by this Court, Napster and/or its successors in interest will continue to infringe the '734 Patent in the future.

33. On information and belief, Napster and/or its successors in interest has infringed and is infringing the '734 Patent with full knowledge of the '734 Patent, and the infringement

has been willful and deliberate and continues to be willful and deliberate. This case is exceptional under 35 U.S.C. § 285.

COUNT III

34. Paragraphs 1-33, inclusive, above, are hereby incorporated herein by reference.

35. Napster and/or its successors in interest has been making and continues to make and/or has sold and continues to sell and/or continues to induce others to sell and/or use and/or contribute to the making, using or selling of one or more digital audio signals for or with processes within the scope of the claims of the '440 Patent in this judicial district and elsewhere in the United States.

36. Napster and/or its successors in interest received notice of the '440 Patent pursuant to 35 U.S.C. § 287, prior to the commencement of this civil action.

37. The unauthorized making, use, or sale of such a digital audio signal by Napster or its successors in interest infringes the '440 Patent.

38. Napster and/or its successors in interest is a direct and/or contributory infringer of the '440 Patent and/or has induced infringement of the '440 Patent by others in violation of 35 U.S.C. § 271.

39. Unless enjoined by this Court, Napster and/ or its successors in interest will continue to infringe the '440 Patent in the future.

40. On information and belief, Napster and/or its successors in interest has infringed and is infringing the '440 Patent, with full knowledge of the '440 Patent, and the infringement has been willful and deliberate and continues to be willful and deliberate. This case is exceptional under 35 U.S.C. § 285.

PRAYER FOR RELIEF

WHEREFORE, Plaintiff SightSound Technologies, LLC demands judgment in its favor and against Napster and/or its successors in interest, as follows:

- A. That this Court adjudge and decree that United States Patent No. 5, 191,573, United States patent No. 5, 675,734, and United States Patent No. 5,966,440 are valid and enforceable against Napster and/or its successors in interest;
- B. That this Court adjudge and decree that Napster and/or its successors in interest has infringed the '573 Patent, the '734 Patent, and the '440 Patent;
- C. That this Court preliminarily and permanently enjoin Napster, its officers, directors, agents, employees, servants, attorneys, successors, assigns and all others controlling, controlled by, affiliated with or in privity with Napster, from committing further acts of infringement of the '573 Patent, the '734 Patent, and the '440 Patent, pursuant to 35 U.S.C. § 283;
- D. That this Court direct Napster and/or its successors in interest to file with this Court and serve on counsel for SightSound, within thirty (30) days of the entry of said injunction, a report in writing under oath setting forth in detail the manner and form in which Napster and/or its successors in interest has complied with the injunction;
- E. That this Court award damages sufficient to compensate SightSound for the infringement of the '573 Patent, the '734 Patent, and the '440 Patent by Napster and/or its successors in interest, pursuant to 35 U.S.C. § 284, together with costs and prejudgment interest for the amount of damages determined;

F. That this Court increase such damages up to three (3) times the amount found or assessed in view of the willful and deliberate character of such infringement of said patents by Napster and or its successors in interest, pursuant to 35 U.S.C. § 284;

G. That this Court find this case “exceptional” and award SightSound its reasonable attorneys’ fees, pursuant to 35 U.S.C. § 285; and

H. That this Court award SightSound such other and further relief as the Court may deem just and proper.

PLAINTIFF DEMANDS A JURY TRIAL

Dated: January 4, 2012

/s/ Russell J. Ober

Russell J. Ober
E-Mail: rjo@muslaw.com
MEYER, UNKOVIC & SCOTT LLP
Suite 1300, Oliver Building
535 Smithfield Street
Pittsburgh, PA 15222-2315
Telephone: (412) 456-2806
Facsimile: (412) 456-3255

Attorneys for SightSound Technologies, Inc. and
SightSound Technologies, LLC